

Editor:

BERNARD E. JONES

Technical Editor:

J. H. REYNER,  
B.Sc. (Hons.), A.M.I.E.E.

# Wireless Magazine

Assistant Editor:

D. SISSON RELPH

Research Consultant:

W. JAMES

The Best Shillingsworth in Radio

Vol. XVI :: SEPTEMBER, 1932 :: No. 92

Published by BERNARD JONES PUBLICATIONS, LTD., publishers of "Wireless Magazine" and "Amateur Wireless." Editorial and Advertisement Offices: 58-61 Fetter Lane, London, E.C.4. Telephone: City 3733, 3744. Telegrams: "Beejapee, Fleet, London." Subscription: Great Britain and abroad, 15s. 6d. a year post free (Canada only, 13s. 6d.). Contributions are invited and will be promptly considered. Next issue published on Wednesday, Sept. 21

## A Taste of Our Quality

THE radio season starts one month earlier this year, the Radio Manufacturers' Association having brought forward their Olympia Exhibition into August. The season being earlier, we have consequently been obliged to formulate our autumn plans much earlier and, in this present issue, we give some taste of our autumn quality.

Undoubtedly we make a departure this month with our "Prosperity" sets. The whole nation is making an effort to recapture prosperity and there is no question that if the effort be sustained the result will be achieved. We have tried to catch a reflection of this spirit, and our Technical Staff has made a tremendous effort to produce a set—or, rather, a series of sets—that would be in advance of other receivers and that would meet with the approval of the most ambitious constructors.

The Prosperity Three is really the "Prosperity Three's," for in this present issue we give full constructional details of the Prosperity Three in three distinct forms: (1) a battery-operated set, (2) an A.C. mains set, and (3) a D.C. mains set, and we believe that every reader will find in one of these models something that will meet his needs.

The reader who builds one of the Prosperity Threes can rest assured that he will be providing for himself an absolutely first-class radio outfit. Very briefly, the Prosperity Three in any one of its forms includes an all-wave tuner which covers short, medium and long waves, and can be used as a radio gramophone. For the circuit and a host of other interesting details, will you please turn to the pages dealing with the sets?

A member of our Technical Staff describes the construction of a very simple experimental receiver that opens up an entirely new field. In view of the B.B.C. short-wave broadcasts, his Two for 7 Metres will attract much attention.

P. K. Turner is dealing with the question of "A" quality from the point of view of the man whose house is supplied with D.C.; while J. H. Reyner in his article "Are We Getting the Best from the Long Waves?" produces some figures proving that a little extra care in design would improve long-wave reception.

Percy Harris, whose knowledge of the radio trade is intimate and far-reaching, reveals some of his hopes and expectations with regard to the exhibits on view at Olympia, and in addition continues his "Components As I Know Them" series with a discussion of the low-frequency transformer.

Alan Hunter offers readers this month a very timely article in his "How to Choose a New Set." The range of manufactured sets to choose from is constantly increasing and Alan Hunter serves the reader by pointing out the merits of each type of set. In addition we give in our feature—"We Test Before You Buy"—independent reviews of five sets on the market.

I fear I can find room for only one more of our features, but that is one which I think most readers will read with peculiar interest. The chief criticism of the B.B.C. has long centred in the Sunday programme. For years the B.B.C. has been asked to give consideration to the broadening of the base of that programme, but the response has been wellnigh negligible.

Whitaker-Wilson in an article this month—one of the best articles he has written for me for quite a long time—makes a most eloquent and sensible appeal to the B.B.C. It is not overdone; it is reasonable, but presents a case which we feel the B.B.C. should answer.

His article concludes by asking Sir John Reith whether he will permit an alternative programme on Sunday evenings, if only as an act of grace towards those whose opinions do not coincide with his own.  
B. E. J.

### EXHIBITION "SPECIALS"

WHAT I EXPECT TO SEE AT THE RADIO EXHIBITION. By Percy W. Harris, M.Inst.Rad.E.	177
RADIO AT OLYMPIA: WHAT'S NEW THIS SEASON	203
EXHIBITS AT OLYMPIA	236

### FOR THE CONSTRUCTOR

THE PROSPERITY THREE: INTRODUCTION BY THE "W.M." TECHNICAL STAFF	145
THE PROSPERITY THREE FOR BATTERIES	146
THE PROSPERITY THREE FOR A.C. MAINS	151
THE PROSPERITY THREE FOR D.C. MAINS	154
A TWO FOR 7 METRES. By K. Jowers	166
MORE ABOUT THE PERCY HARRIS RADIOGRAM. By Percy W. Harris, M.Inst.Rad.E.	220

### GENERAL ARTICLES

GUIDE TO THE WORLD'S BROADCASTERS. By Jay Coote	116
WORLD'S BROADCAST WAVELENGTHS IN TUNE WITH THE TRADE. By Fetter Lane	124
NEWS OF THE SHORT WAVES	132
THE ABC OF STATION IDENTIFICATION. By J. Golchaux Abrahams	136
SOME RADIO GAMES	141
	163

## Contents

STORIES OF THE OPERAS: THE IMMORTAL HOUR	164
1932 SUPER 60 REPORTS	164
BROADCASTERS YOU MUST HAVE HEARD	165
CAN RADIO PLAYS BE IMPROVED? By Watson Lyle	169
HOW TO CHOOSE A NEW SET. By Alan Hunter	174
THE B.B.C. WEATHER FORECASTS	196
BROADCAST RELIGION. By Whitaker-Wilson	201
THE WIRELESS ZOO: THE PING. Verse	202
MUSICAL NEWS AND VIEWS. By T. F. Henn	209
TRYING TO "BUY BRITISH"	228
EGYPTIAN BROADCASTING	228
THE REAL TONIC. Verse	330
ON THE CREST OF THE WAVES. By Jay Coote	232
RADIO MEDLEY. By BM/PRESS	254
ORDEAL BY MICROPHONE. Verse	254
BLUEPRINT AND INFORMATION COUPONS	264
INDEX TO ADVERTISERS	264

### TECHNICAL FEATURES

VALUES TO USE IN YOUR SET	108
WE TEST BEFORE YOU BUY	179
FERRANTI SUPER-HET CONSOLLETTE	180
LOTUS BUD TWO-VALVER	181
EKCO MODEL M23 CONSOLETTTE	182

R.I. SHORT-WAVE ADAPTOR-AMPLIFIER	183
LISSEN SKYSCRAPER THREE (Kit Set)	184
RADIO IN REVIEW. By Morton Barr	185
THE CRYSTAL LOUD-SPEAKER	186
A UNIQUE LEAD-IN	186
"A" QUALITY FROM D.C. MAINS. By P. K. Turner, M.I.E.E.	187
ARE WE GETTING THE BEST FROM THE LONG WAVES? By J. H. REYNER, B.Sc., A.M.I.E.E.	191
SOMETHING ABOUT NOISE! By W. H. O. Sweeney	193
RECTIFIER METERS FOR A.C. By J. H. Keyner, B.Sc., A.M.I.E.E.	197
THE LOW-FREQUENCY TRANSFORMER. By Percy W. Harris, M.Inst. Rad.E.	198
HOW RADIO HAS HELPED HOME TALKIES. By Kenneth Ullyett	212
WHAT IS PARASITIC OSCILLATION? By J. H. Reyner, B.Sc., A.M.I.E.E.	230
NEW THREE-GAN CONDENSER	252

### GRAMO-RADIO SECTION

GRAMO-RADIO NOTES AND NEWS	157
THE NEEDLE AND THE RECORD—2. By P. Wilson, M.A.	158
CHOOSING YOUR RECORDS. By Whitaker-Wilson and Chopstick	161
ONE RECORD—122 ARTISTS OF SEVEN NATIONS!	162

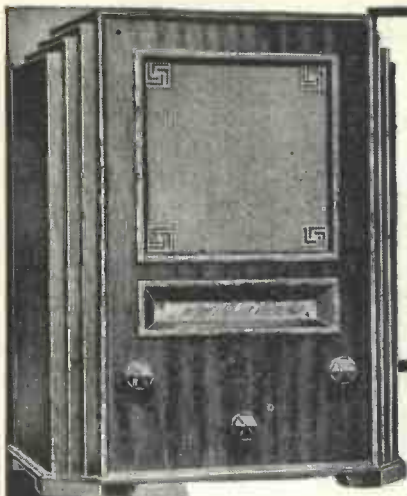

**GECOPHONE  
ALL-ELECTRIC  
RADIO  
RECEIVER  
(For A.C. Mains)  
"GALA" Model**

Cat. No. BC3335  
**PRICE 18**  
including OSRAM  
VALVES and Royalty, GNS.  
**HIRE PURCHASE:**  
Deposit £2 os. od. and  
12 monthly payments of  
£1 10s. od.

# G.E.C. ENTIRELY RECEIVERS AND

## BETTER RADIO for the discriminating listener

G.E.C. Radio offers discriminating listeners better radio at competitive prices—*immaculate cabinet work: superlative performance: prices to suit the times.* The models as will be seen from the illustrations are elegantly designed and finished. From the 18-guinea "GALA" model to the 30-guinea "CARNIVAL" model Radio-Gramophone there is a full selection from which to choose the set you want at the price you wish to pay.

**HIRE PURCHASE** terms are stated for each model to the value of £5 or over given in this advertisement. Equally attractive terms for other models are also stated in Folder B.C. 6312 which gives full particulars of the complete G.E.C. Radio Range. A copy will be sent you **POST FREE** for coupon at bottom right-hand corner. **WRITE FOR A COPY TO-DAY.**



**GECOPHONE  
ALL-ELECTRIC  
RADIO  
RECEIVER  
(For A.C. Mains)  
"VIKING" Model**

Cat. No. BC3340  
**PRICE 23**  
including OSRAM  
VALVES and Royalty, GNS.  
**HIRE PURCHASE:**  
Deposit £2 os. od. and  
12 monthly payments of  
£2 os. od.

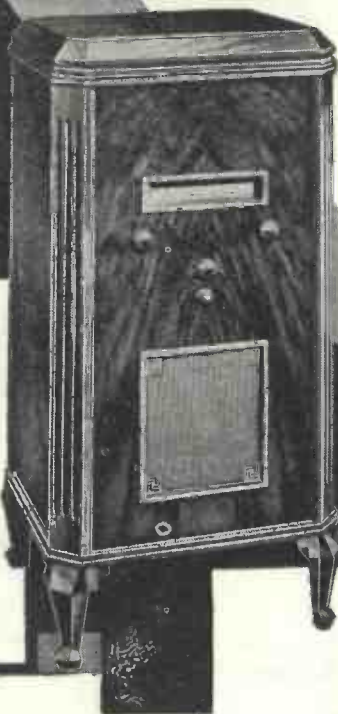

**GECOPHONE  
ALL-ELECTRIC  
RADIO-  
GRAMOPHONE  
(For A.C. Mains)**

**"CARNIVAL" Model**

Cat. No. BC3338

**PRICE 30**  
including OSRAM  
VALVES and Royalty, GNS.  
**HIRE PURCHASE:** Deposit  
£2 12s. 6d. and 12 monthly pay-  
ments of £2 12s. 6d.

**GECOPHONE MAGNETIC  
LOUD SPEAKER  
in Bakelite Cabinet  
Cat. No. BC1845**

**PRICE £2.5**

Chassis only, Cat. No. BC1840

**PRICE 21/-**

**MADE  
IN  
ENGLAND**

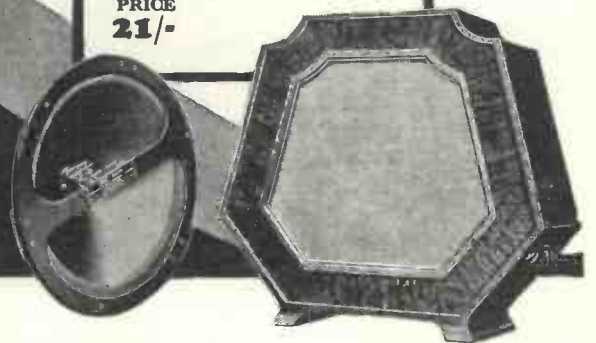

## Supremacy in Radio

Advt. of The General Electric Co. Ltd. Magnet House, Kingsway, London, W.C.2

There is news in the "Wireless Magazine" advertisements

# Radio

## NEW RANGE OF LOUD SPEAKERS

**SUPERB QUALITY yet competitive in price**

By choosing a GECophone you assure to yourself the utmost enjoyment from modern broadcasting. Qualities which have made GECophone famous—reliability, real engineering construction and simplicity of operation—are brought up-to-date to meet present-day conditions. G.E.C. offers the best investment in efficient, trouble-free and economical home entertainment—all the best broadcasting programmes delightfully rendered and gramophone reproduction as you never heard it before.

**NATIONAL RADIO EXHIBITION**

See the complete range of G.E.C. Radio Products on the G.E.C. Stands.

**GECophone ALL-ELECTRIC RADIO RECEIVER for A.C. Mains.**

**"SUPER-HETERODYNE" Model.**

Cat. No. BC3358.

**PRICE 26**  
including OSRAM VALVES and Royalty. **GNS.**  
**HIRE PURCHASE:** Deposit £2 5s. od. and 12 monthly payments of £2 5s. od.



**GECophone ALL-ELECTRIC RADIO RECEIVER for D.C. Mains.**

**"NOMAD" Model.**

Cat. No. BC3345

**PRICE 23**  
including OSRAM Valves and Royalty. **GNS.**

**HIRE PURCHASE:** Deposit £2 0s. od. and 12 monthly payments of £2 0s. od.

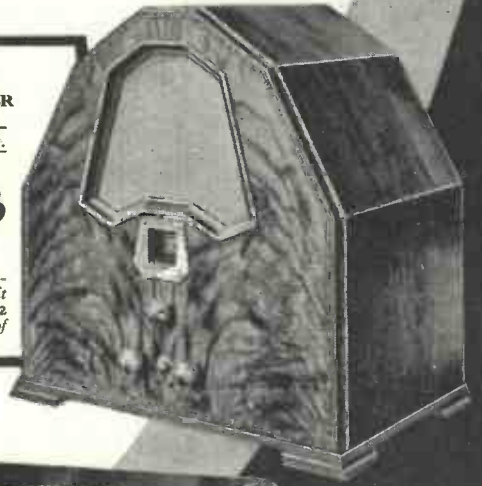

**GECophone ALL-ELECTRIC RADIO RECEIVER for A.C. Mains**

**"CONSOLE" Model.**

Cat. No. BC3244

**REDUCED PRICE**

**24**  
including OSRAM VALVES and Royalty. **GNS.**

**HIRE PURCHASE** Deposit £2 2s. od. and 12 monthly payments of £2 2s. od.

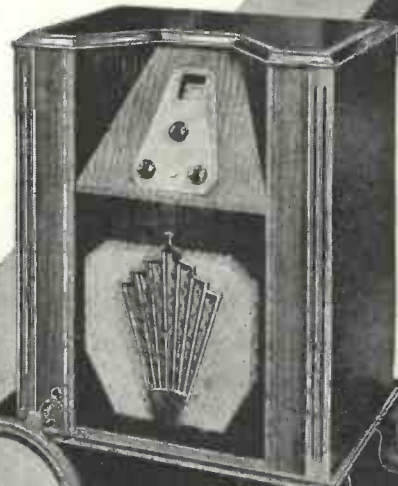

**GECophone PERMANENT MAGNET MOVING COIL LOUD SPEAKER**

Cat. No. BC1825.

**PRICE £3. 15**

Chassis only, Cat. No. BC1820.

**PRICE 45/-**

Sold by all Wireless Dealers

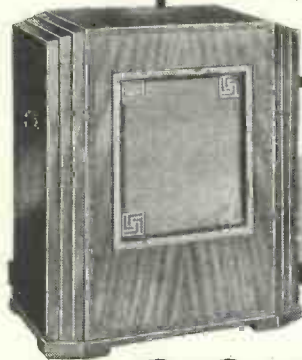

**GECophone INDUCTOR DYNAMIC LOUD SPEAKER CHASSIS**

(Ferrand Inductor Patent) Cat. No. BC1850.

**PRICE £3. 10**

**COUPON**

Please send me Folder No. B.C. 6312 giving particulars of GECophone Radio Receivers and Loud Speakers

Name \_\_\_\_\_ Address \_\_\_\_\_

The General Electric Co. Ltd.  
Magnet House,  
Kingsway London  
W.C.2  
W.M.

**G.E.C. Radio**

Branches and Public Showrooms throughout Great Britain

Cut out and paste on a postcard, or enclose in unsealed envelope, *hd.* postage.

Speedy replies result from mentioning "Wireless Magazine"

# VALVES TO USE IN YOUR SET

## Characteristics of All the Most Important British Types

Make	Type	Impedance	Amplification Factor	Filament Current	Mutual Conductance	Anode Current at 120 volts	Grid Bias at 100 volts	Grid Bias at 150 volts
<b>2-volt Three-electrode Valves</b>								
Mazda ..	H210	59,000	47	.1	.8	5	.5	1.0
Lissen ..	H210	50,000	35	.1	.7	1.1	1.1	1.5
Lissen ..	H2	50,000	45	.1	.9	2.0	1.0	1.5
Cossor ..	210RC	50,000	40	.1	.8	5	.9	1.5
Osram ..	H210	50,000	35	.1	0.7	1.0	—	—
Six-Sixty	210RC	45,400	50	.1	1.1	1.0	1.0	1.5
Mullard..	PM1A	41,600	50	.1	1.2	.75	1.5	—
Marconi ..	H2	35,000	35	.1	1.0	1.0	1.0	1.5
Osram ..	H2	35,000	35	.1	1.0	1.0	—	1.5
Six-Sixty	210HF	25,000	19	.1	.75	1.0	—	1.5
Osram ..	HL210	23,000	20	.1	.87	1.5	—	1.5
Marconi ..	HL210	23,000	20	.1	.87	1.5	—	1.5
Mullard..	PM1HF	22,500	18	.1	.8	1.0	1.5	3.0
Cossor ..	210HL	22,000	24	.1	1.1	1.75	1.5	3.0
Lissen ..	HL2	22,000	35	.1	1.6	3.0	1.0	1.5
Mazda ..	HL2	21,000	31	.1	1.5	—	—	—
Lissen ..	HL210	20,000	20	.1	1.0	2.2	1.5	4.5
Mullard..	PM1HL	20,000	28	.1	1.4	1.2	1.5	3.0
Mazda ..	HL210	18,500	26	.1	1.4	3.0	1.5	3.0
Marconi ..	HL2	18,000	27	.1	1.5	1.0	1.5	3.0
Osram ..	HL2	18,000	27	.1	1.5	1.0	1.5	3.0
Six-Sixty	210HL	17,200	26	.1	1.5	1.0	1.5	3.0
Cossor ..	210HF	15,800	24	.1	1.5	2.25	1.5	3.0
Cossor ..	210Dat	13,000	15	.1	1.15	2.5	1.5	3.0
Six-Sixty	210LF	12,500	10.6	.1	.85	2.5	4.5	7.5
Mullard..	PM1LF	12,000	11	.1	.9	2.6	4.5	7.5
Osram ..	L210	12,000	11	.1	.92	2.0	3.0	6.0
Marconi ..	L210	12,000	11	.1	.92	2.0	3.0	6.0
Six-Sixty	210D	10,600	17	.1	1.6	2.0	3.0	7.5
Cossor ..	210LF	10,000	14	.1	1.4	3.0	3.0	4.5
Lissen ..	L210	10,000	12	.1	1.2	3.0	3.0	7.5
Lissen ..	L2	10,000	20	.1	2.0	3.0	1.5	3.0
Mullard..	PM2DX	10,000	17	.1	1.7	2.0	3.0	6.0
Mazda ..	L210	10,000	17	.1	1.7	5.0	2.5	4.5
Mazda ..	L2	10,000	19	.1	1.9	3.0	—	3.0
Osram ..	P215	5,000	7	.15	1.4	6.0	7.5	12.0
Six-Sixty	220P	4,800	7.2	.2	1.5	5.0	7.5	12.0
Mullard..	PM2	4,400	7.5	.2	1.7	5.0	7.5	12.0
Lissen ..	P220	4,000	7	.2	1.75	5.0	7.5	15.0
Cossor ..	220P	4,600	9	.2	2.25	6.0	4.5	9.0
Cossor ..	215P	4,000	9	.15	2.2	5.0	4.5	7.5
Cossor ..	220Pa	4,000	16	.2	4.0	5.5	3.0	4.5
Marconi ..	LP2	3,900	15	.2	3.85	6.0	3.0	4.5
Osram ..	LP2	3,900	15	.2	3.85	6.0	3.0	4.5
Mazda ..	P220	3,700	12.5	.2	3.4	11.0	3.0	6.0
Six-Sixty	220PA	3,700	13	.2	3.5	6.0	3.0	6.0
Mullard..	PM2A	3,600	12.5	.2	3.5	6.5	3.0	6.0
Lissen ..	LP2	3,500	12.0	.2	3.4	8.0	6.0	7.0
Marconi ..	P240	2,500	4	.4	1.6	12.0	15.0	24.0
Marconi ..	P2	2,150	7.5	.2	3.5	12.0	6.0	11.5
Osram ..	P2	2,150	7.5	.2	3.5	10.0	7.5	10.5
Six-Sixty	220SP	2,060	7	.2	3.4	13.5	7.5	15.0
Mullard..	PM202	2,000	7	.2	3.5	14.0	7.5	15.0
Mazda ..	P240	1,900	7	.4	3.7	18.0	6.0	13.5
Mullard..	PM252	1,900	7	.4	3.7	14.0	6.0	12.0
Six-Sixty	240SP	1,900	6.6	.4	3.5	14.0	6.0	13.5
Mazda ..	P220A	1,850	6.5	.2	3.5	13.0	9.0	15.0
Lissen ..	P220A	1,700	6	.2	3.5	12.0	9.0	15.0
Lissen ..	PX240	1,500	4.5	.4	3.0	14.0	12.5	22.5
Cossor ..	230XP	1,500	4.5	.3	3.0	15.0	10.5	18.0
Lissen ..	P240A	1,000	5.0	.4	5.0	20.0	15.0	20.0

2-volt Double-grid Valves							
Marconi ..	DG2	3,750	4.5	.2	1.2	—	—
Osram ..	DG2	3,750	4.5	.2	1.2	—	—
Cossor ..	210DG	3,400	2.7	.1	.8	—	—
Mullard..	PM1DG	—	—	.1	.8	—	—
Six-Sixty	210DG	—	—	.1	.8	—	—

2-volt Screen-grid Valves							
Lissen ..	SG215	900,000	1,000	.15	1.1	—	1.5
Mazda ..	215SG	400,000	450	.15	1.1	—	—
Cossor ..	215SG	300,000	330	.15	1.1	1.25	.9
Cossor ..	220SG	200,000	320	.2	1.6	1.5	.9
Osram ..	S22	200,000	350	.2	1.75	3.0	—
Marconi ..	S22	200,000	350	.2	1.75	2.5	.9
Marconi ..	S21	200,000	220	.1	1.1	3.0	.9
Osram ..	S21	200,000	220	.1	1.1	3.0	—
Six-Sixty	215SG	190,000	200	.15	1.05	2.0	—
Mullard..	PM12	180,000	200	.15	1.1	—	—
Mazda ..	S215A	—	800	.15	1.1	—	—

Make	Type	Impedance	Amplification Factor	Filament Current	Mutual Conductance	Anode Current at 120 volts	Grid Bias at 100 volts	Grid Bias at 150 volts
<b>2-volt Variable-mu Screen-grid Valves</b>								
Lissen ..	SG2V	750,000	—	.15	1.6	—	—	—
Cossor ..	220VSG	110,000	—	.2	1.6	—	—	—

2-volt Pentode Valves								
Lissen ..	PT225	71,000	100	.25	1.4	7.0	3.0	6.0
Six-Sixty	230PP	64,000	80	.3	1.25	10.0	6.0	12.0
Marconi ..	PT240	55,000	90	.4	1.65	9.0	6.0	9.0
Lissen ..	PT240	28,000	64	.4	2.3	12.5	7.5	10.5
Lissen ..	PT220A	22,500	45	.2	2.5	15.0	7.5	9.0
Cossor ..	230PT	—	—	.3	2.0	13.0	15.0	15.0
Cossor ..	230HPT	—	—	.3	1.8	6.5	7.5	7.5
Marconi ..	PT2	—	—	.3	2.5	5.0	3.0	4.5
Mazda ..	220Pen.	—	—	.2	2.5	—	—	—
Mazda ..	220A Pen.	—	—	.2	2.5	—	—	—
Mazda ..	Pen.230	—	—	.3	1.5	—	—	—
Mullard..	PM22	—	—	.3	1.3	12.0	6.0	10.0
Osram ..	PT2	—	—	.2	2.5	5.0	3.0	4.5

4-volt Three-electrode Valves								
Marconi ..	H410	60,000	40	.1	.66	5	—	1.5
Osram ..	H410	60,000	40	.1	.66	.35	—	1.5
Six-Sixty	4075RC	58,000	37	.075	.64	.55	1.0	1.5
Mullard..	PM3A	55,000	33	.075	.66	.3	1.5	1.5
Cossor ..	410RC	50,000	40	.1	.8	.6	.5	1.5
Lissen ..	H410	40,000	36	.1	.9	1.6	1.0	1.5
Lissen ..	HLD410	21,000	25	.1	1.2	2.5	1.5	3.0
Marconi ..	HL410	20,800	25	.1	1.2	1.25	1.5	3.0
Osram ..	HL410	20,800	25	.1	1.2	1.25	1.5	3.0
Cossor ..	410HF	20,000	22	.1	1.1	1.0	1.5	3.0
Mullard..	PM3	13,000	14	.075	1.05	2.0	3.0	6.0
Six-Sixty	4075Hr	12,500	13.5	.075	1.1	3.0	3.0	4.5
Cossor ..	410LF	10,000	17	.1	1.7	2.5	1.5	4.5
Lissen ..	L410	8,500	15	.1	1.8	3.5	1.5	4.5
Marconi ..	L410	8,500	15	.1	1.77	3.0	2.0	4.5
Osram ..	L410	8,500	15	.1	1.77	3.0	3.0	4.5
Mullard..	PM4DX	7,500	15	.1	2.0	2.0	3.0	6.0
Six-Sixty	410D	7,250	14.5	.1	2.0	4.0	3.0	6.0
Marconi ..	P410	5,000	7.5	.1	1.5	6.0	6.0	10.5
Osram ..	P410	5,000	7.5	.1	1.5	6.0	6.0	10.5
Six-Sixty	410P	4,100	7.8	.1	1.9	7.5	7.5	12.0
Cossor ..	410P	4,000	8	.1	2.0	8.0	4.5	9.0
Mullard..	PM4	4,000	8	.1	2.0	7.5	5.0	8.0
Lissen ..	P410	4,000	8	.1	2.0	7.0	6.0	9.0
Marconi ..	P425	2,300	4.5	.25	1.95	14.0	9.0	16.5
Mullard..	PM254	2,150	6.5	.2	3.0	9.0	9.0	15.0
Six-Sixty	420SP	2,150	6.5	.2	3.0	10.0	8.0	15.0
Osram ..	P415	2,080	5.0	.15	2.4	14.0	9.0	16.5
Osram ..	P415	2,080	5	.15	2.4	14.0	9.0	16.5
Cossor ..	425XP	2,000	7	.25	3.5	13.0	6.0	12.0
Mazda ..	P425	1,950	3.5	.25	1.8	26.0	14.0	26.0
Lissen ..	P425	1,500	4.5	.25	3.0	28.0	12.0	20.0
Cossor ..	415XP	1,500	4.5	.15	3.0	15.0	9.0	18.0
Cossor ..	4Xr	1,200	4.8	.6	4.0	18.0	12	24.0
(at 200 v.)								
Marconi ..	PX4	830	5	1.0	6.0	35.0	12.0	16.0
Osram ..	PX4	830	5	1.0	6.0	35.0	12.0	16.0

4-volt Screen-grid Valves								
Lissen ..	SG410	635,000	700	.1	1.1	—	—	—
Mullard..	PM14	230,000	200	.075	.87	—	—	—
Six-Sixty	4075SG	220,000	190	.075	.87	3.0	—	—
Cossor ..	410SG	200,000	200	.1	1.0	—	1.5	1.5
Marconi ..	S410	200,000	180	.1	.9	3.		



## A Mullard All-Mains Combination.

When set designers need valves that are efficient, reliable and up-to-the-minute, they choose Mullard.

The new series of A.C. mains valves is designed to set a higher and better standard of radio reception. Perfect reliability and outstanding performance is the result of Mullard experience and Mullard workmanship while the new **Rigid Unit Construction** renders them free from microphony.

The valves specified for the A.C. Prosperity Three are :

- 1 MM4V
- 1 904V
- 1 PEN4V

MADE IN ENGLAND

**Mullard**  
**THE MASTER VALVE**

WE ARE EXHIBITING AT



Advt. The Mullard Wireless Service Co., Ltd., Mullard House, Charing Cross Road, London, W.C. 2.

ARKS

# THE OLYMPIC STANDARD OF "FITNESS"

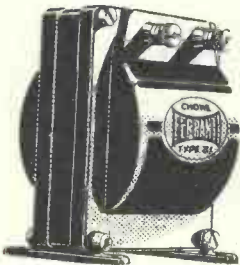
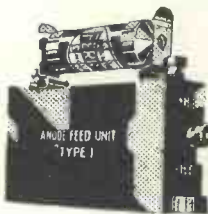
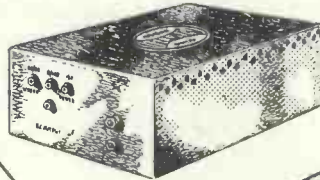

**AF TRANSFORMERS**  
(Metal cases)

AF3. Ratio 1/3.5	<b>25/6</b>
AF4. " "	<b>17/6</b>
AF5. " "	<b>30/6</b>
AF6. " 1/7	<b>30/6</b>
AF7. " 1/1.75	<b>30/6</b>

**ELIMINATORS**  
Prices from  
**£3. 10. 6** to  
**£11. 11. 0.**

**RADIO METERS**  
Prices from **£1. 5.**  
For A.C. and D.C.  
Portable and Flush  
Patterns.

**ANODE FEED UNITS**  
Without Resistance  
**4/3**  
With Resistance  
**7/3**  
Resistances in  
holders **4/6**  
Resistances without  
holders **3/6**

**CHOKES**  
Prices from **7/6** to  
**£1. 7. 6**

Ferranti Radio Components have marked each year's progress at Olympia, and have become the very structure of Radio—the standard by which others are judged.

Radio Components have come and gone: names well known in the early years are forgotten, either the products could not progress, or else they could not stand the test of time.

But through ten years of Radio development, the name Ferranti has been pre-eminent for quality, reliability, and soundness of design.

FERRANTI LTD., Head Office & Works: HOLLINWOOD, LANCASHIRE

# FERRANTI COMPONENTS

Better service results from mentioning "Wireless Magazine" when writing to advertisers

# THE VERY STRUCTURE OF RADIO AT OLYMPIA

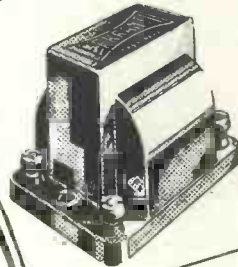
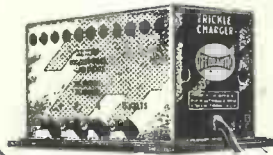
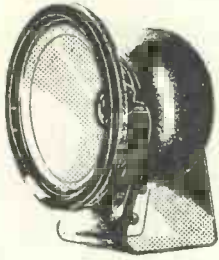

## M. C. SPEAKERS

Chassis

- D3. £2. 7. 6
- M3. £2. 15. 0
- M2. £5. 0. 0
- M1. £7. 10. 0

1932 Inductor  
Speaker £1.10.0  
Cabinets £2 extra.

## CONDENSERS

Prices from 2/4 to  
9/6. Packs 22/6  
to 28/=

## TRICKLE CHARGERS

Prices £2. 15. 0  
and £3. 15. 0

Soundness which is typified from the AF3—still in the identical form in which it was first put on the market 8 years ago—to the M1 speaker, altered and improved with every new discovery of moving coil construction, yet gaining the honour of the first choice in the "Wireless World" Olympia Ballot for the last three consecutive years.

Only the Very Best could have built up the FERRANTI Reputation.

**STAND NO. 78**

LONDON: BUSH HOUSE, ALDWYCH, W.C.2

# FERRANTI COMPONENTS



When you send your order don't forget to say you "saw it in the 'W.M.'"

# VALVES TO USE IN YOUR SET — Continued from p. 108

Make	Type	Impedance	Amplification Factor	Filament Current	Mutual Conductance	Anode Current at 120 volts	Grid Bias at 100 volts	Grid Bias at 150 volts
<b>4-volt Pentode Valves—Continued</b>								
Mullard..	PM24A	25,000	50	.275	2.0	15.0	6.0	21.0
Cossor ..	415PT	—	—	.15	2.0	13.0	15.0	15.0
Mazda ..	425Pen.	—	—	.25	2.0	14.0	14.0	—
Mullard..	PM24C	—	—	1.0	3.0	—	—	—
Mullard..	PM24	—	—	.15	1.75	16.0	6.0	12.0
Six-Sixty	SS/Pen.SP	—	—	.275	2.0	—	—	—

Make	Type	Impedance	Amplification Factor	Filament Current	Mutual Conductance	Anode Current at 120 volts	Grid Bias at 100 volts	Grid Bias at 150 volts
<b>6-volt Three-electrode Valves</b>								
Mazda ..	H607	90,000	40	.07	.45	1.0	.8	1.5
Mazda ..	H610	66,000	40	.1	.6	1.0	—	—
Marconi ..	H610	60,000	40	.1	.66	.35	1.5	1.5
Osram ..	H610	60,000	40	.1	.66	.35	1.5	1.5
Six-Sixty	6075RC	58,000	42	.075	.7	.5	1.0	1.5
Cossor ..	610RC	50,000	40	.1	.8	.75	1.5	1.5
Mullard..	PM15B	49,000	40	.075	.85	.5	1.5	1.5
Lissen ..	H610	40,000	36	.1	.9	1.0	1.0	1.5
Marconi ..	HL610	30,000	30	.1	1.0	1.0	1.5	1.5
Osram ..	HL610	30,000	30	.1	1.0	1.0	1.5	1.5
Lissen ..	HLD610	21,000	25	.1	1.2	2.5	1.5	3.0
Cossor ..	610HF	20,000	20	.1	1.0	1.75	1.5	3.0
Mazda ..	HL610	20,000	22	.1	1.1	1.8	1.5	3.0
Mullard..	PM15D	20,000	26	.075	1.3	1.0	1.5	3.0
Six-Sixty	607HF	15,200	17	.075	1.1	2.0	2.0	4.0
Mullard..	PM15X	14,700	17.5	.075	1.2	1.6	3.0	4.5
Six-Sixty	610D	9,250	18.5	.1	2.0	2.0	3.0	4.0
Mullard..	PM6D	9,000	18	.1	2.0	2.0	3.0	4.5
Lissen ..	L610	8,000	16	.1	2.0	2.0	3.0	4.5
Cossor ..	610LF	7,500	15	.1	2.0	3.4	1.5	4.5
Marconi ..	L610	7,500	15	.1	2.0	3.0	2.0	4.0
Osram ..	L610	7,500	15	.1	2.0	3.0	1.5	4.5
Mullard..	PM6	3,550	8	.1	2.25	7.0	6.0	9.0
Cossor ..	610P	3,500	8	.1	2.28	8.0	3.0	7.5
Marconi ..	P610	3,500	8	.1	2.28	6.0	6.0	9.0
Osram ..	P610	3,500	8	.1	2.28	6.0	6.0	9.0
Six-Sixty	610P	3,400	7.8	.1	2.3	8.0	6.0	9.0
Lissen ..	P610	3,200	8	.1	2.5	6.0	6.0	9.0
Cossor ..	625P	2,500	7	.25	2.8	13.0	6.0	12.0
Lissen ..	P625	2,500	7.5	.25	3.0	8.0	7.5	12.0
Marconi ..	P625	2,400	6	.25	2.5	11.0	7.0	24.0
Osram ..	P625	2,400	6	.25	2.5	11.0	7.0	26.0
Cossor ..	610XP	2,000	5	.1	2.5	15.0	9.0	18.0
Mullard..	PM256	1,850	6	.25	3.25	8.0	9.0	27.0
Six-Sixty	625SP	1,780	5.8	.25	3.25	8.0	10.0	15.0
Marconi ..	P625A	1,600	3.7	.25	2.3	20.0	13.5	36.0
Osram ..	P625A	1,600	3.7	.25	2.3	16.0	13.5	24.0
Lissen ..	P625A	1,500	4.5	.25	3.0	12.0	13.5	24.0
Six-Sixty	625SPA	1,500	3.9	.25	2.6	20.0	12.0	22.5
Cossor ..	620T	1,400	3.2	2.0	2.3	—	—	—
Mullard..	PM1256A	1,400	3.6	.25	2.6	20.0	12.0	33.0
Marconi ..	LS6A	1,300	3	2.0	2.3	—	—	30.0
Mazda ..	P650	1,300	3.5	.5	2.7	30.0	12.0	25.0
Osram ..	LS6A	1,300	3	2.0	2.3	—	—	30.0
Marconi ..	DA60	835	2.5	4.0	3.0	—	—	—
Osram ..	DA60	835	2.5	4.0	3.0	—	—	—

Make	Type	Impedance	Amplification Factor	Filament Current	Mutual Conductance	Anode Current at 120 volts	Grid Bias at 100 volts	Grid Bias at 150 volts
<b>6-volt Screen-grid Valves</b>								
Six-Sixty	SS6075SG	210,000	190	.075	.9	—	—	—
Cossor ..	610SG	200,000	200	.1	1.0	—	1.5	1.5
Mullard..	PM16	200,000	200	.075	1.0	—	—	—
Osram ..	S610	200,000	210	.1	1.05	4.0	1.5	—
Marconi ..	S610	200,000	210	.1	1.05	4.0	1.5	—

Make	Type	Impedance	Amplification Factor	Filament Current	Mutual Conductance	Anode Current at 120 volts	Grid Bias at 100 volts	Grid Bias at 150 volts
<b>6-volt Pentode Valves</b>								
Marconi ..	PT625	43,000	80	.25	1.85	10.0	6.0	15.0
Osram ..	PT625	43,000	80	.25	1.85	10.0	6.0	15.0
Six-Sixty	SS617PP	28,500	54	.17	1.9	15.0	8.0	14.0
Lissen ..	PT625	24,000	60	.25	2.5	14.0	7.5	10.0
Cossor ..	615PT	—	—	.15	2.0	17.0	6.9	7.5
Mullard..	PM26	—	—	.17	2.0	15.0	9.0	15.0

Make	Type	Impedance	Amplification Factor	Filament Current	Mutual Conductance	Anode Current at 120 volts	Grid Bias at 100 volts	Grid Bias at 150 volts
<b>A.C. Three-electrode Valves</b>								
Mullard..	904V	34,000	75	1.0	2.2	2.0	1.0	1.25
Cossor ..	41MRC	19,500	50	1.0	2.6	2.0	—	1.5
Cossor ..	41MIH	18,000	72	1.0	4.0	2.0	—	1.5
Six-Sixty	4DX.AC	17,700	85	1.0	4.8	3.0	1.0	1.5
Cossor ..	41MHF	14,500	41	1.0	2.8	2.5	—	2.0

Make	Type	Impedance	Amplification Factor	Filament Current	Mutual Conductance	Anode Current at 120 volts	Grid Bias at 100 volts	Grid Bias at 150 volts
<b>A.C. Three-electrode Valves—Continued</b>								
Six-Sixty	4GP.AC	12,000	36	1.0	3.0	2.0	2.0	3.0
Lissen ..	AC/HL	11,700	35	1.0	3.0	5.0	1.5	3.0
Mazda ..	AC/HL	11,700	35	1.0	3.0	4.5	1.5	3.0
Cossor ..	41MHL	11,500	52	1.0	4.5	4.0	1.2	2.0
Mazda ..	AC2HL	11,500	75	1.0	6.5	3.0	—	1.5
Marconi ..	MH4	11,100	40	1.0	3.6	4.0	1.5	3.0
Osram ..	MH4	11,100	40	1.0	3.6	4.0	1.5	3.0
Mullard..	354V	10,000	35	1.0	3.5	2.0	2.0	3.0
Marconi ..	MHL4	8,000	20	1.0	2.5	5.0	3.0	6.0
Osram ..	MHL4	8,000	20	1.0	2.5	5.0	3.0	6.0
Cossor ..	41MLF	7,900	15	1.0	1.9	4.5	4.5	6.0
Six-Sixty	4L.AC	7,500	15	1.0	2.0	6.0	3.0	4.5
Mullard..	164V	4,850	16	1.0	3.3	5.0	4.5	6.5
Mullard..	104V	3,000	12	1.0	4.0	9.0	6.0	7.0
Six-Sixty	SS4PAC	3,000	10	1.0	3.3	10.0	5.9	8.0
Mazda ..	PP3/425	2,900	2.9	1.25	1.0	—	—	100
Osram ..	ML4	2,860	12	1.0	4.2	12.0	5.0	7.0
Marconi ..	ML4	2,800	12	1.0	2.5	13.0	4.0	6.0
Mazda ..	AC/P	2,650	10	1.0	3.75	14.0	6.0	12.0
Cossor ..	41MP	2,500	18.7	1.0	7.5	10.0	3.0	6.0
Mullard..	AC064	2,000	6	1.0	3.0	15.0	9.0	14.0
Cossor ..	41MXP	1,500	11.2	1.0	7.5	23.0	6.0	9.0
Mazda ..	PP5/400	1,500	9	2.0	6.0	—	—	32.0
Mazda ..	AC/P1	1,450	5.4	1.0	3.7	—	—	—
Six-Sixty	HV4/1	1,450	6.3	1.0	3.0	15.0	9.0	14.0
Mullard..	AC044	1,150	4	.7	3.5	17.0	14.0	23.0

Make	Type	Impedance	Amplification Factor	Filament Current	Mutual Conductance	Anode Current at 120 volts	Grid Bias at 100 volts	Grid Bias at 150 volts
<b>A.C. Double-grid Value</b>								
Cossor ..	41MDG	40,000	10	1.0	.25	—	—	—

Make	Type	Impedance	Amplification Factor	Filament Current	Mutual Conductance	Anode Current at 120 volts	Grid Bias at 100 volts	Grid Bias at 150 volts
<b>A.C. Screen-grid Valves</b>								
Six-Sixty	4SGAC	1,000,000	1,000	1.0	1.0	1.5	—	—
Mullard..	S4V	909,000	1,000	1.0	1.1	—	—	—
Mazda ..	AC/SG	800,000	1,200	1.0	3.0	5.0	.5	.5
Mazda ..	ACS2	600,000	3,000	1.0	5.0	—	—	—
Cossor ..	MSG/HA	500,000	1,000	1.0	2.0	2.0	1.5	1.5
Marconi ..	MS4	500,000	550	1.0	1.1	2.2	1.5	1.5
Osram ..	MS4	500,000	550	1.0	1.1	2.2	—	—
Osram ..	VMS4	500,000	550	1.0	—	—	—	—
Six-Sixty	4XSGAC	485,000	1,600	1.0	3.3	—	—	—
Marconi ..	VMS4	450,000	500	1.0	1.1	—	—	—
Mullard..	S4VA	430,000	1,500	1.0	3.5	1.7	—	—
Cossor ..	41MSG	400,000	1,000	1.0	2.5	2.0	—	1.5
Marconi ..	MS4B	350,000	1,120	1.0	3.2	3.2	1.0	1.0
Osram ..	MS4B	350,000	1,120	1.0	3.2	3.2	1.0	1.0
Lissen ..	AC/SG	340,000	1,100	1.0	3.25	—	—	—
Lissen ..	AC/SGV	300,000	975	1.0	3.25	—	—	—
Six-Sixty	SS4MMAC	300,000	900	—	3.0	—	4.0	—
Mullard..	S4VB	257,000	900	1.0	3.5	4.0	1.5	1.5
Cossor ..	MSG/LA	200,000	200	1.0	3.75	4.5	—	1.5
Cossor ..	MSGLA	200,000	750	1.0	2.5	1.5	—	—
Six-Sixty	4YSGAC	—	900	1.0	3.5	—	—	—

Make	Type	Impedance	Amplification Factor	Filament Current	Mutual Conductance	Anode Current at 120 volts	Grid Bias at 100 volts	Grid Bias at 150 volts
<b>A.C. Pentode Valves</b>								
Marconi ..	MPT4	33,000	100	1.0	3.0	—	—	—
Osram ..	MPT4	33,000	100	1.0	3.0	—	—	—
Cossor ..	MS.Pen.A	—	—	1.0	4.0	9.0	2.5	2.5
Cossor ..	MP.Pen.	—	—	1.0</				





—WRITE FOR LEAFLET GIVING FULL DETAILS—

**THE FINEST THAT MODERN  
SCIENCE CAN PRODUCE  
A COMPLETE RANGE FOR EVERY  
REQUIREMENT**

*PRICES FROM 5/6 TO 17/-*

Tungram Electric Lamp Works (Gt. Britain) Ltd. Radio Dept: 72 Oxford St.,  
London, W.1. Factories in Austria, Czecho-Slovakia, Hungary, Italy and Poland

*Advertisers take more interest when you mention "Wireless Magazine"*

1932 1933  
**NEW SEASON'S SETS**  
**ON THE**  
**BEST TERMS**

A large number of Manufacturers have now released their New Season's sets, which represent a considerable advance on previous models. We are demonstrating these new receivers during broadcasting hours and our advice is at your disposal.

**NEW MURPHY A3A PEDESTAL RECEIVER.** An outstanding receiver in the 3-valve A.C. class. **39/-**  
 Cash Price 19 Gns.  
 And 12 monthly payments of 33/- order

**NEW FERRANTI 7-VALVE SUPER-HET-CONSOLETTA.** **38/6**  
 Cash Price 22 Gns.  
 And 12 monthly payments of 38/6 order

**NEW EKCO M.23 3-VALVE RECEIVER (A.C.).** **30/-**  
 Cash Price 17 Gns.  
 And 11 monthly payments of 30/- order

**NEW LOTUS BUDD 2-VALVE A.C. RECEIVER.** **15/-**  
 Cash Price 10 Gns.  
 And 11 monthly payments of 19/9 order

**SAME RECEIVER AS ABOVE, BUT FOR D.C. MAINS.** **17/6**  
 Cash Price 11 Gns.  
 And 11 monthly payments of 21/9 order

**NEW PYE "K" 2-VALVE A.C. RECEIVER.** **22/6**  
 Cash Price 12 Gns.  
 And 11 monthly payments of 22/6 order

**NEW BLUE SPOT 4-VALVE BATTERY RECEIVER.** Complete with 100U loud-speaker and variable-Mu valves. **24/6**  
 Cash Price 12 Gns.  
 And 11 monthly payments of 24/6 order

**MANUFACTURERS' KITS**  
**NEW COSSOR MELODY MAKER,** With complete with cabinet, loud-speaker, and valves. **10/-**  
 Cash Price £7 17 6.  
 And 12 monthly payments of 21/- order

Descriptive leaflets of any of the above receivers will be sent on request. At present we can give prompt delivery.

**The LONDON RADIO SUPPLY COMPANY** ESTD 1925  
 11, Oat Lane, Noble St., LONDON, E.C.2  
 Phone NATIONAL 1977

**It's Easy!**  
 to

**tune stations on the ultra short-wave bands if you fit an Ealex Short-Wave Converter**

Over 70 extra stations can be received with your present S.G. set if you fit an Ealex Short-wave Converter—no alterations necessary, just connect to the aerial and earth terminals. You will be amazed at the increased range of programmes possible.

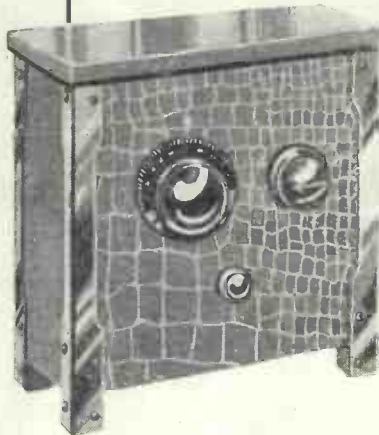

With this wonderful instrument stations on the 16-60-metre band can be received, or with additional coils 16/120 and 140/190-metre bands are available at 5s. extra.

Price one-valve model, 60s. (including valve).  
 All-mains model, 65s. (without valve).  
 Two-valve model, 85s. (without valves).

Write for list K.12.

National Radio Exhibition  
 OLYMPIA, STAND 239



**J. J. EASTICK & SONS**  
 Ealex House, 118 Bunhill Row, E.C.1  
 Phone: METROPOLITAN 0314/5/6.

**At last!**  
**PERMANENT**  
**EFFICIENT**  
**EVER-DAMP**  
**EARTHING**

*A Sensational Radio Invention!*

Get the utmost out of your set by fitting **FILT**—the newest and most efficient earth ever invented—based on a completely new principle. Its operation is unique. You simply bury the copper receptacle containing the wonderful **FILT** chemical, which at once begins to spread through the earth, attracting moisture and making a **PERMANENT** highly conductive area to the depth of several feet.

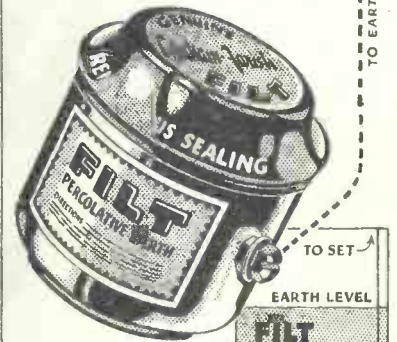

**Never dries up.**  
 In all weathers, in every soil, **FILT** keeps moist and highly conductive. It spreads like a tentacle, earthing your set perfectly and giving you every ounce of power, range and purity no matter what set you use.

**GET A FILT TO-DAY**  
 It is inexpensive, permanent and the most efficient obtainable.

**GRAHAM FARISH**  
**FILT**  
**PERCOLATIVE EARTH**

Ask your dealer to obtain, or write direct to:

**GRAHAM FARISH Ltd.**  
 197, MASON'S HILL  
 BROMLEY - KENT

PRICE  
**2/6**  
 COMPLETE

# " PROSPERITY THREE "

— the first of its kind

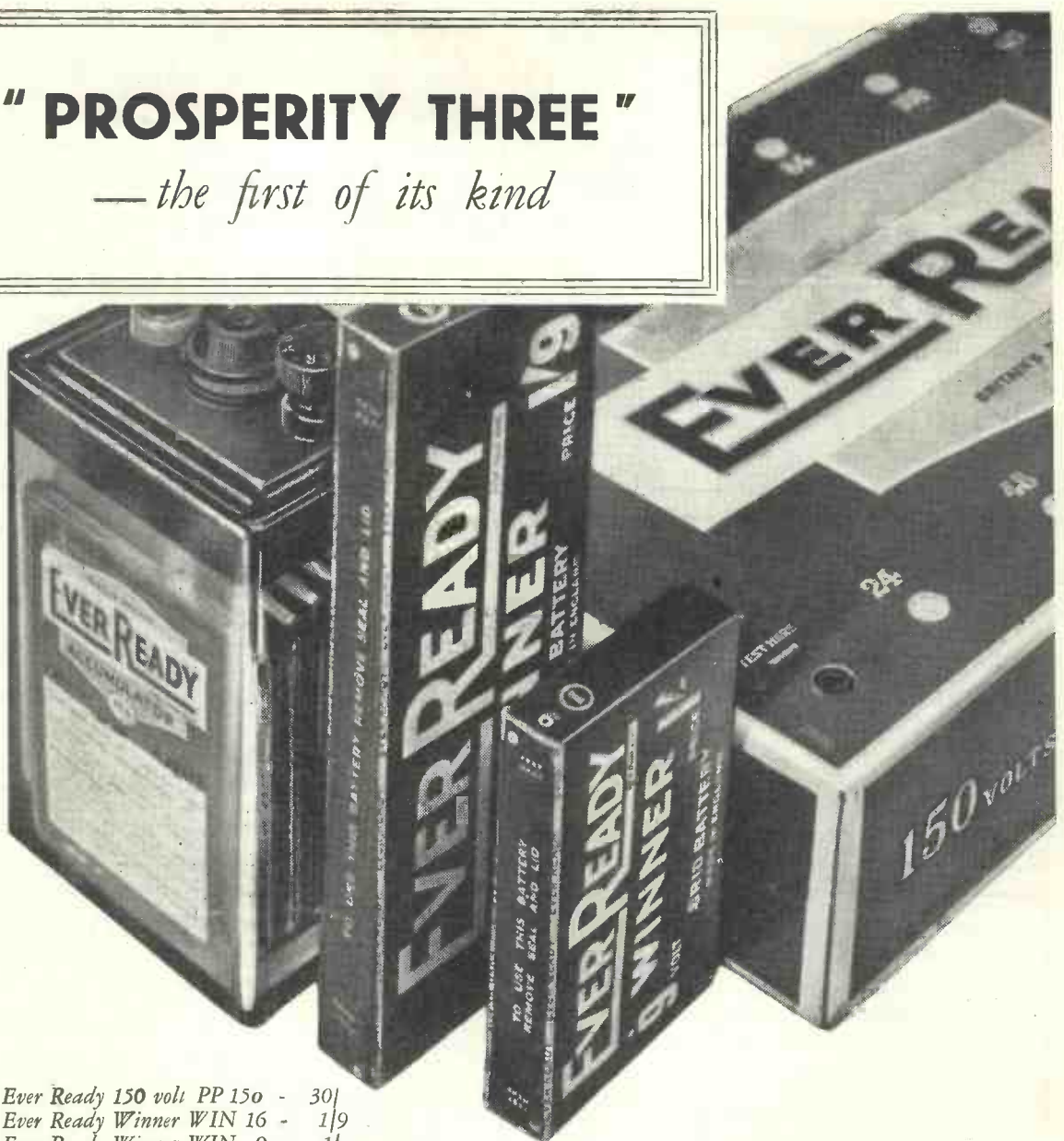

- Ever Ready 150 volt PP 150 - 30/-
- Ever Ready Winner WIN 16 - 1/9
- Ever Ready Winner WIN 9 - 1/-
- Ever Ready Accumulator  
GZ 2/36 - 11/6

The new "Prosperity Three," described and illustrated in this issue, is the latest successful attempt to provide a set which meets all requirements. It is highly selective, allowing for ultra short, medium or long wave lengths. And in order that the reception over this wide range may be as perfect as possible, the Ever Ready units listed here, are recommended for use with the set. It is over thirty years since the first Ever Ready Batteries were made; they can now be obtained in a size to fit every set on the market with exactly the right amount of unwavering power; and they are guaranteed satisfactory for the whole of their long life.



The Ever Ready Co.  
(Great Britain) Ltd.,  
Hercules Place,  
Holloway, London,  
N.7.

## BATTERIES & ACCUMULATORS

When replying to advertisements, please mention "Wireless Magazine"

# GUIDE TO THE WORLD'S BROADCASTERS

Specially Compiled for "Wireless Magazine" by JAY COOTE

**Metres : 31.25 LISBON (CTIAA) Kilocycles : 9,598**  
**Power : 2 kw. Portugal**

**Distance from London:** Approximately 975 miles.  
**Standard Time:** Greenwich Mean Time.  
**Announcer:** Man. All announcements are made in Portuguese, Spanish, English, French, and (sometimes) in German.  
**Call:** "Estação Radio Lisboa." In English: "This is the Portuguese amateur radio station, CTIAA, Lisbon."  
**Interval Signal:** Cuckoo (*ad. lib.*)  
**Times of Transmission:** B.S.T. 23.00—01.00 (Thursdays and Fridays). On 282.25 metres from B.S.T. 22.30—01.00 (Mondays, Wednesdays, and Saturdays).  
 Closes down with the playing of the Portuguese National Anthem.

**Metres : 48 CASABLANCA (CN8MC) Kilocycles : 6,250**  
**Power : 4 kw. North Africa**

**Distance from London:** Approximately 1,335 miles.  
**Standard Time:** Greenwich Mean Time.  
**Announcer:** Man. All items are given out in the French language.  
**Call:** "Ici le poste CN8MC à ondes courtes (short waves) de Casablanca" (Maroc). When relaying Rabat: "Ici Radio Maroc."  
**Times of Transmission:** B.S.T. 21.00-22.00 (Monday); 13.00-14.00 and 21.00-22.00 (Tuesday).  
 Closes down with usual French greetings followed by "La Marseillaise."

**Metres : 48.35 BOGOTA (HKC) Kilocycles : 6,205**  
**Power : 3 kw. Colombia, S. America**

**Distance from London:** Approximately 4,500 miles.  
**Standard Time:** Greenwich Mean Time LESS 5 hours.  
**Announcers:** Man and woman.  
**Interval Signal:** Bugle call.  
**Call:** In Spanish and English: "This is station HKC, Bogota, Republic of Colombia."  
**Times of Transmission:** B.S.T. 16.00 daily.

**Metres : 49.96 DRUMMONDVILLE (VE9DR) Kilocycles : 6,005**  
**Power : 4 kw. Quebec, Canada**

**Distance from London:** Approximately 2,600 miles.  
**Standard Time:** Greenwich Mean Time LESS 5 hours.  
**Announcer:** Man.  
**Call:** "This is CFCF, Montreal calling" (*Also see below.*)  
**Times of Transmission:** G.M.T. 23.00-05.00 daily.  
 Relays programmes from CFCF, Montreal, through which it links up with the National Broadcasting Company's network (United States). In such cases the call heard is that of New York, Chicago, or from whichever studio the broadcast is carried out.

**Metres : 269.2 BARI Kilocycles : 1,115**  
**Power : 20 kw. Italy**

**Distance from London:** Approximately 1,020 miles.  
**Standard Time:** Central European (coincides with B.S.T.).  
**Opening Signal:** Carillon (gramophone record).  
**Call (phon.):** "Eh-yah rah-dee-owe Bah-ree."  
**Announcer:** Woman.  
**Main Daily Transmissions:** Broadcasts from own studio, but towards October will link up with Rome and Naples, with which stations programmes will be exchanged. B.S.T. 20.00, gramophone records, time signal, news bulletin; 20.45, main evening entertainment; 22.55, final news bulletin.  
 Closes down as other Italian stations (q.v.) with the words "Signori, Buona Notte," followed by Fascist Hymn and Royal Anthem.

**Metres : 293 LIMOGES (PTT) Kilocycles : 1,022**  
**Power : .7 kw. France**

**Distance from London:** Approximately 402 miles.  
**Standard Time:** Greenwich Mean Time (France adopts B.S.T.).  
**Announcer:** Man. All items are given out in the French language.  
**Call:** "Allô! Allô! Ici Limoges PTT" (phon.: "Pay-ta:-tay.")  
**Main Daily Programme:** B.S.T. 12.30, concert or gramophone records; 20.30, main evening entertainment.  
 Frequently relays Ecole Supérieure, PTT (q.v.) and occasionally Marseilles and Lyons (PTT).  
 Closes down with usual French formula followed by "La Marseillaise."





**Metres : 312.8 GENOA (IGE) Kilocycles : 959**  
**Power : 10 kw. Italy**

**Distance from London:** Approximately 640 miles.  
**Standard Time:** Central European (coincides with B.S.T.).  
**Opening Signal:** Carillon (gramophone record).  
**Call:** (phon.): "Eh-yah Radio Alt-ee-tal-ee-ya" (Alt'Italia).  
**Interval Signal:** Song of the nightingale.  
**Announcer:** Woman.  
**Main Daily Programme:** Exchanges broadcasts with Milan, Turin, Florence, and Trieste. B.S.T. 08.15, news, gramophone records; 12.00, light music; 13.00, time signal, news, concert; 16.45, gramophone records, talks; 19.00, light music, news, time signal, weather forecast; 20.30, main evening entertainment, dance music (not daily); 22.55, final news bulletin.  
 Closes down with the words "Signori, Buona Notte," followed by Fascist Hymn and Royal Anthem.  
**Associated Transmitters:** Trieste, 247.7 metres (1,211 kilocycles); Turin, 273.7 metres (1,096 kilocycles); Milan, 331.5 metres (905 kilocycles); Florence, 500.8 metres (599 kilocycles).

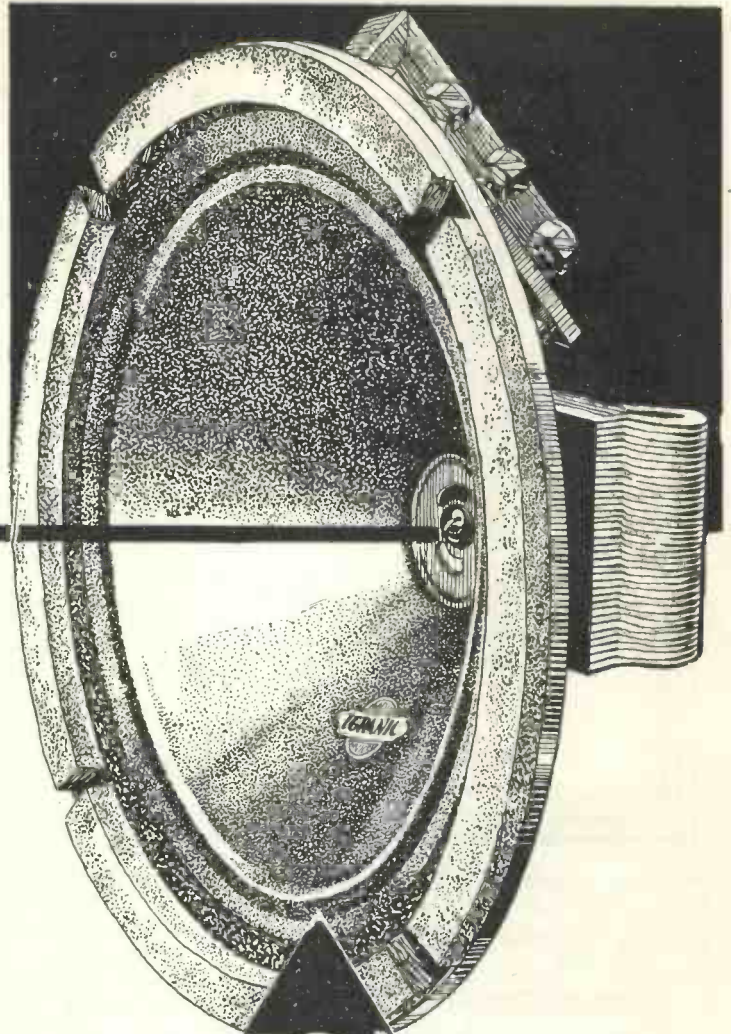
**Metres : 345.2 STRASBOURG (PTT) Kilocycles : 869**  
**Power : 11.5 kw. France**

**Distance from London:** Approximately 415 miles.  
**Standard Time:** Greenwich Mean Time (France adopts B.S.T.).  
**Announcers:** Man and woman. All items are given out in both the French and German languages.  
**Opening and Interval Signal:** Deep buzzing boom for 5 seconds with 5-second interval.  
**Call:** "Allô! Allô! Ici Radio Strasbourg PTT," followed by German translation.  
**Main Daily Programmes:** B.S.T. 10.45, sacred service in German (Sunday); 11.30, Roman Catholic service (Sunday), concert (week-days); 12.45, news, concert; 18.15, talks, etc.; 19.30, time signal, concert or dance music; 20.15, main evening entertainment. Frequently relays Paris PTT.  
 Closes down with usual good-night greetings in French and German followed by "La Marseillaise."

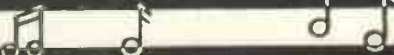

  
**EVERY NOTE**  
  
**IN THE REGISTER**  
  
**COMES THROUGH**  
  
**FAITHFULLY**  
  
**VIVIDLY**  
  
**AND TRUE**

**32/6**

OLYMPIA  
STAND 36

# IGRANIK

D.9.

From the top register down to the deep bass of the drum the Igranik D.9 delivers every note with its true tonal value. Stations which were once mere murmurings come in at full volume—Igranik D.9 widens the scope of your set. Let your dealer demonstrate that the Igranik D.9 permanent magnet moving-coil loud-speaker at 32/6 is the best value that money can buy.

*Advt. of The Igranik Electric Co., Ltd., 149 Queen Victoria Street, E.C.4. Works at Bedford.*

## NEW TYPE PERMANENT MAGNET MOVING COIL LOUD SPEAKER

CVS-11

*Mention of the "Wireless Magazine" will ensure prompt attention*

# YOU SAW THE NEW

# PARMEKO PRODUCTS!

IF NOT ask your dealer about them, or write for our new Catalogue. This Catalogue is beautifully produced, and forms a complete guide to up-to-date Transformer and Choke construction. It gives full details of the new products, which are some of the most interesting ever produced. Write to either of our addresses for the Catalogue.

**PARTRIDGE & MEE LTD.**

LEICESTER and 74 New Oxford St., LONDON

Aylestone 487

Museum 5070

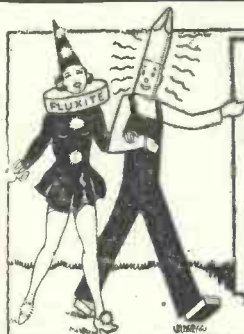

**FLUXITE**  
INDISPENSABLE  
TO EVERY  
RADIO  
ENTHUSIAST  
IT SIMPLIFIES  
ALL SOLDERING

"We're Fluxite and Solder. The reliable pair. Famous for Soldering. Known everywhere!"

Now here is a statement—Bound to come true, If you'll invite US To come and help You!"

See that Fluxite and Solder are always by you—in the house, garage, workshop—anywhere where simple, speedy, soldering is needed. They cost so little, but will make scores of everyday articles last years longer! For Pots, Pans, Silver, and Brassware; RADIO; odd jobs in the garage—there's always something useful for Fluxite and Solder to do.

All Hardware and Ironmongery Stores sell Fluxite in tins, 8d., 1/4 and 2/8.

NEW "JUNIOR" SIZE, 4d. per tin  
FLUXITE SOLDERING SET

Simple to use and lasts for years in constant use. Contains special "small-space" soldering iron with non-heating metal handle; pocket blow-lamp, Fluxite, Solder, etc. and full instructions.

COMPLETE, 7/6 or LAMP only 2/6

FLUXITE LTD.,  
(Dept. 332),  
ROTHERHITHE, S.E.16.

ANOTHER USE FOR FLUXITE  
Hardening Tools and Case Hardening.  
Ask for Leaflet on improved method.

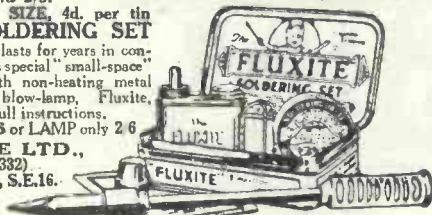

ALL MECHANICS WILL HAVE

# FLUXITE

IT SIMPLIFIES ALL SOLDERING

## PAREX

METAL CABINETS, SCREENS & COILS  
FOR PUBLISHED CIRCUITS

**THE GOLD COASTER**  
Special Aluminium Cabinet as Specified £ -15-0  
**PROSPERITY THREE**  
Foil as Specified 1/6

VISIT STAND No. 238  
and see latest "PAREX" A.C. Receiver.

**E. PAROUSSI,**  
10, FEATHERSTONE BUILDINGS, W.C. 1.  
PHONE: CHANCERY 7010

## YOU WANT THIS

Scientifically designed, "Low-pass" Filter in your detector anode to eliminate—

- (1) Heterodyne Whistle.
- (2) Mingling of the Upper Frequencies of Adjacent Stations.
- (3) High Pitched Mush.
- (4) Needle Scratch. (R. Grams). Tone Quality Unaffected.

Available in Three Types, Prices from 7/-. (See free descriptive matter).

POSTLETHWAITE BROS.,  
Kinver, Stourbridge.

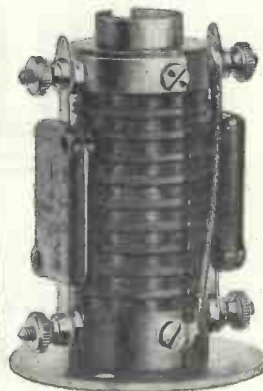

It helps us if you mention "Wireless Magazine"

# NEW J.B. 'UNITUNE' CONDENSER *- a triumph of precision*

**NEW J.B. PRODUCTS** include the J.B. "NUGANG" Condensers in semi- or fully-screened types. **New Gang Condensers for Super Hets.** **New Illuminated Disc Drive** for use with above gangs.

**New Short-wave Condensers** with many novel features. **New capacities in Air-spaced Differential Condensers.** **J.B. "Illuminator"** for use with J.B. Chassimount and "R" Type gangs. Practically all existing J.B. models are being retained.

**STAND NO. 204,  
NATIONAL RADIO  
EXHIBITION**

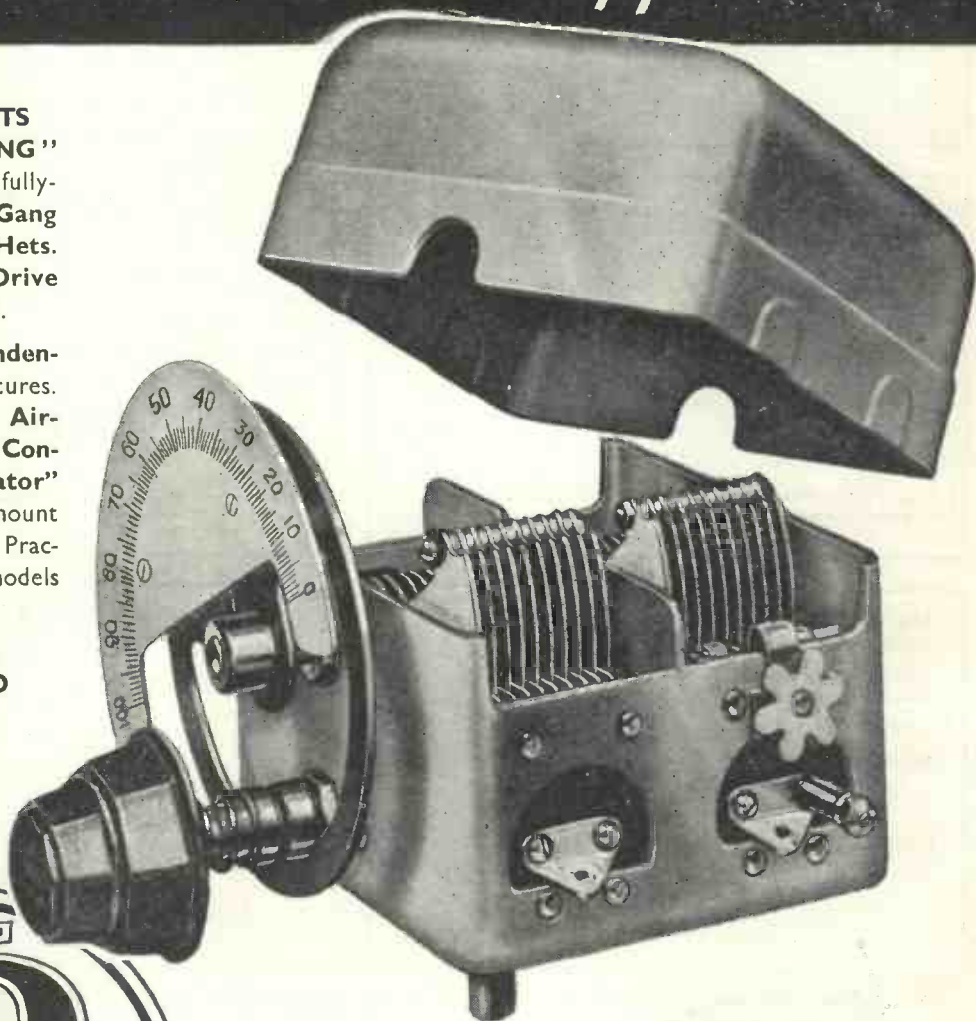

### J.B. "UNITUNE" Gang Condenser

Rigid one-piece chassis. Very robust construction. A pre-set trimmer is fitted to one half, while the other half has a trimmer which is operated from the front of the panel. The panel-trimmer control is concentric with the main tuning knob. Capacity, .0005. Complete with disc drive and bakelite escutcheon plate.

2 gang .. 18/6      3 gang .. 27/-

# PRECISION INSTRUMENTS

Advertisement of Jackson Bros., 72, St. Thomas' Street, London S.E.1.

Telephone: Hop 1837.

You will get prompt replies by mentioning "Wireless Magazine"

# GUIDE TO WORLD'S BROADCASTERS

 Cont.  
from p. 116

**Metres: 441**      **ROME (1RO)**      **Kilocycles: 680**  
**Power: 50 kw.**      *Italy*

Distance from London: Approximately 895 miles.  
 Standard Time: Central European (coincides with B.S.T.).  
 Announcer: Woman. All items are given out in the Italian language only.  
 Call: "EIAR (phon.: Eh-yah) Ente Italiano Audizioni Radiofoniche, Stazione di Roma." Between items, abbreviated call (phon.): "Eh-yah Radio Roma" ("e Napoli," if Naples is taking part in the broadcast).  
 Opening Signal: Carillon (gramophone record).  
 Interval Signal: Short melody played in three different keys.  
 Main Daily Programme: B.S.T. 08.35, news; 10.00, sacred service (Sunday); 12.00, gramophone records and concert; 17.30, concert; 19.00, news; 20.00, time signal; 20.45, main evening entertainment; 22.55, last news bulletin.  
 When closing down the announcer repeats the full call followed by "Signori, Buona Notte," after which the Fascist Hymn and Royal Anthem are played.  
 Note.—Programmes are frequently re-broadcast through Rome (2RO) on 25.4 metres (11,810 kilocycles).

**Metres: 447.1**      **PARIS (FPTT)**      **Kilocycles: 671**  
**Power: 6 kw.**      *France*  
*École Supérieure des PTT, France*

Distance from London: Approximately 214 miles.  
 Standard Time: Greenwich Mean Time (France adopts B.S.T.).  
 Call: "Allô! Allô! Ici le poste de radiodiffusion de l'École Supérieure des Postes et T. l'graphes à Paris"; or, if S.B. with other provincial PTT transmitters: "Ici l'ensemble des stations de radiodiffusion du réseau de l'Etat Français."  
 Announcer: Man. All items are given out in the French language only.  
 Main Daily Programme: B.S.T. 08.00, news; 12.25 and 13.30, gramophone records; 18.00, talks; 19.45, gramophone records; 20.30, main evening entertainment followed by final news bulletin.  
 Relays: Eiffel Tower (Paris), Lyons (PTT), Grenoble, Marseilles, Bordeaux-Lafayette, Limoges, Montpellier, Rennes, Lille, Strasbourg, and Toulouse (PTT).  
 Programmes are occasionally re-broadcast through Poste Colonial (Paris).

**Metres: 454.6**      **SAN SEBASTIAN (EAJ6)**      **Kilocycles: 660**  
**Power: 6 kw.**      *Spain*

Distance from London: Approximately 570 miles.  
 Standard Time: Greenwich Mean Time (Spain does not adopt B.S.T.).  
 Languages: Spanish and Catalan.  
 Call: (phon.): "Ay ah rhotia ocho oon-ee-own radio San Say-bar-tee-yahn, instalada en el Mont-ay Ee-gel-doe."  
 Main Daily Programme: B.S.T. 19.30-21.00 (Monday, Wednesday, Friday); 22.00-24.00 or 01.00 (Sunday, Tuesday, Thursday Saturday). Also relays Madrid (EAJ7).  
 Closes down with peal of bells, followed by gramophone record ("Song of Riego") and the words "Buenas Noches, Señores; hasta mañana" (until to-morrow).

**Metres: 472.4**      **LANGENBERG**      **Kilocycles: 635**  
**Power: 60 kw.**      *Germany*

Distance from London: Approximately 314 miles.  
 Standard Time: Central European (coincides with B.S.T.).  
 Announcer: Man.  
 Opening and Interval Signal: Chimes (five notes).  
 Call: "Achtung! Westdeutscher Rundfunk."  
 Main Daily Programme: B.S.T. 08.45, physical exercises, weather forecast, concert; 12.00 (midday), concert or gramophone records, news, weather forecast; 15.50, children's hour, talks, concert; 20.00, main evening entertainment; dance music (relayed) or late concert.  
 Closes down with the words: "Gute Nacht, meine Damen und Herren. Vergessen Sie nicht die Antenne zu erden" (Don't forget to earth the aerial), followed by German National Anthem, "Deutschland ueber Alles."

**Metres: 563**      **WILNO**      **Kilocycles: 533**  
**Power: 16 kw.**      *Poland*

Distance from London: Approximately 1,070 miles.  
 Standard Time: Central European (coincides with B.S.T.).  
 Announcer: Woman.  
 Call: "Uwaga! Uwaga! (phon. Oo-var-gha) Polskie Radio Wilno."  
 Opening Signal: Trumpet (three blasts).  
 Interval Signal: Cuckoo.  
 Main Daily Programmes: Mostly relays Warsaw and other Polish studios; if own evening entertainment usually at 20.30 B.S.T.  
 Closes down with the Polish National Anthem (Dombrowski mazurka).

**Metres: 1,083**      **OSLO**      **Kilocycles: 277**  
**Power: 60 kw.**      *Norway*

Distance from London: Approximately 712 miles.  
 Standard Time: Central European (coincides with B.S.T.).  
 Announcer: Man.  
 Call: "Hallo Oslo (phon. Ou-zlo) her."  
 Opening Signal: Musical box playing first four bars of National Anthem ("Ja vi elsker").  
 Interval Signal: Condensed theme from Grieg's "Sigurd Jorsalfar."  
 Main Daily Programmes: B.S.T. 11.05, weather forecast, stock exchange prices, sacred service; 12.55, time signal, gramophone records; 17.30, concert, talks and weather forecast, news bulletin.  
 Good Night: "God Nat" (twice), followed by opening signal.  
 Relays: Hamar, 560 metres (536 kilocycles); Trondheim, 493.4 metres (608 kilocycles); Bodo, Porsgrund, Tromso, 453.2 metres (662 kilocycles); Aalesund, Notodden, Rjukan, 447.1 metre (671 kilocycles); Fredrikstad, 367.6 metres (816 kilocycles); Bergen, 384 metres (824 kilocycles); Stavanger, 240.6 metres (1,247 kilocycles); Christiansand, 235.5 metres (1,274 kilocycles).

**Metres: 1,350**      **TUNIS-KASBAH**      **Kilocycles: 222.2**  
**Power: .6 kw.**      *Tunis, N. Africa*

Distance from London: Approximately 1,360 miles.  
 Standard Time: Greenwich Mean Time PLUS 1 hour (coincides with B.S.T.).  
 Announcer: Man.  
 Call: "Allô! Allô! Ici le poste radiotéléphonique de Tunis-Kasbah" or "Ici station du Radio Club de Tunisie et de la Chambre des Agriculteurs de Tunis." All announcements are made in the French language.  
 Main Daily Programmes: B.S.T. 20.10, commercial and news bulletin; weather forecast, gramophone records; occasionally a studio concert of French and native artists is given.  
 Closes down with usual French formula, followed by "La Marseillaise."

**Metres: 1,935**      **KAUNAS**      **Kilocycles: 155**  
**Power: 7 kw.**      *Lithuania*

Distance from London: Approximately 1,015 miles.  
 Standard Time: Central European (coincides with B.S.T.).  
 Announcer: Man.  
 Call: "Allo! Allo! Lietuvos Radio Kaunas."  
 Opening Signal: A few chords struck on piano, followed by the ticking of a metronome and a time signal.  
 Interval Signal: Gong.  
 Main Daily Programme: B.S.T. 12.00 and 20.00, weather forecast and news; 20.30, talks; main evening entertainment.  
 Closes down with the words "Radio Kaunas sako la banaki" (Radio Kaunas says good night), followed by the Lithuanian National Anthem (gramophone record).

Look out in next month's issue of "Wireless Magazine" for a free gift that is of the greatest value to all who want to pick up foreign programmes. The October issue will be a special Autumn Double Number and will be published on Wednesday, September 21



# POWER

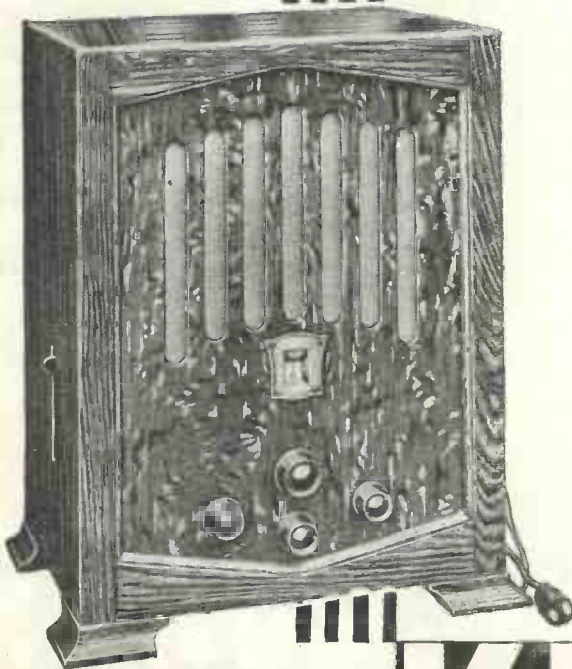
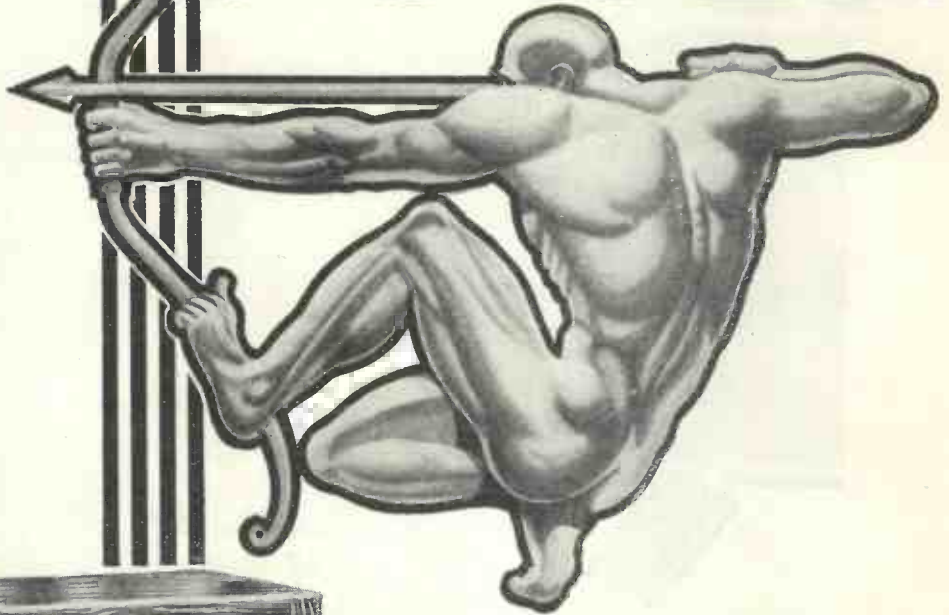

**K-B. ELECTRIC 'KOBRA'**  
 Complete with  
 Moving-Coil Speaker  
**£11 - 18 - 6**

The power that makes foreign stations as clear as your own local and gives "home" reception the realism that makes radio so enjoyable, is only one of the features of the new K-B. All-Electric "KoBra" receiver. Add to this simplicity of operation, attractive appearance, completely trouble-free working and you can appreciate the reasons for the immediate success of this new K-B. receiver.

Fully guaranteed one year the K-B. 3-valve All-Electric "KoBra" for A.C. mains is complete with moving-coil speaker, valves, and royalties for £11-18-6 or 35/- down. Ask your nearest K-B. dealer for a demonstration or send the form below.



# K-B

**ALL BRITISH  
 INEXPENSIVE**

# RADIO

To Kolster-Brandes, Ltd., Sidcup, Kent.  
 Please send me illustrated Catalogue with name of nearest K-B. dealer.  
 NAME.....  
 ADDRESS..... W.M.S.

Causton

*Speedy replies result from mentioning "Wireless Magazine"*

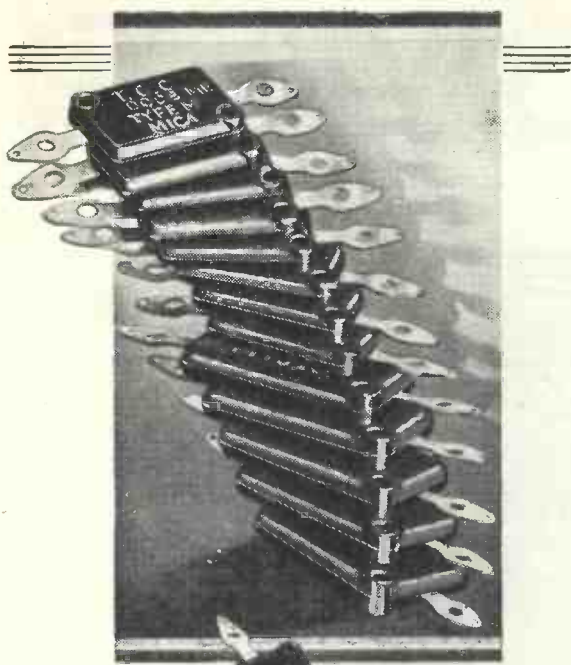

Here are shown the T.C.C. Type "M" Mica Condensers. Made in capacities from .00005 mfd. to .01 mfd. inclusive. Prices: 1s. 0d. to 2s. 3d.

# T.C.C. RESEARCH in tangible form

THESE mica condensers are the smallest item in the vast T.C.C. range. At the other end of the scale are to be found condensers of huge capacity for working at thousands of volts pressure.

Here is tangible proof of T.C.C.'s research. With a laboratory equipped with apparatus for every possible test and experiment, with manufacturing facilities second-to-none the world over, T.C.C. have built a reputation of over 25 years' standing for condensers of unquestioned reliability and merit. For whatever purpose—use a T.C.C. and be sure.

# T.C.C.

ALL-BRITISH  
CONDENSERS

The Telegraph Condenser Co., Ltd., Wales Farm Road, N. Acton, W.3

813

# 1933's GREATEST RADIO ADVANCE

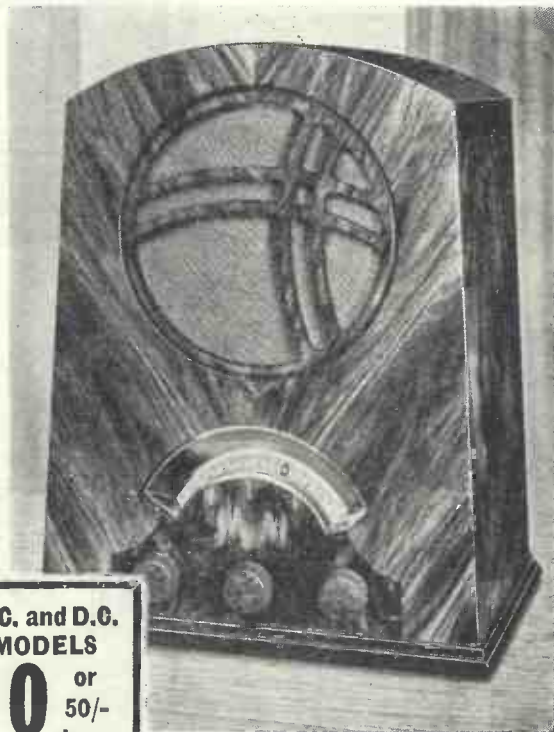

A.C. and D.C. MODELS  
**10** or 50/-  
GNS. down  
BATTERY MODEL  
£6 - 10 - 0  
or 40/- down  
(less batteries)

## The "ATLAS TWO" starts new era of Tone-True Radio

• • • The "ATLAS TWO" now brings a completely new thrill to every music-lover; catching the very personality of the artist: every subtlety of tone reproduced with a brilliance and sparkle that seems to put you in the front row at every entertainment. You're actually *there* with the "ATLAS TWO."

The specification includes "ATLAS" Moving Coil Speaker, One-Knob Tuning, provision for Pick-Up and Extra Speaker, Westinghouse Rectifier in A.C. Model, Mains Aerial in both A.C. and D.C. Models.

See, hear and test it for yourself. Ask your dealer for a demonstration and insist on the "ATLAS TWO." Post the coupon to-day for full details.

# "CLARKE'S ATLAS TWO"

H. CLARKE & CO. (M/CR), LTD. PATRICROFT, MANCHESTER.

Southern Offices: Bush House, W.C.2

**POST THIS COUPON NOW**

Messrs. H. CLARKE & CO. (M/CR) LTD.  
GEORGE STREET, PATRICROFT, MANCHESTER.

Please send me full details of the new "ATLAS TWO" Receivers.

Name (in capitals).....

Address .....

W.M.9

When replying to advertisements, please mention "Wireless Magazine"

VISIT  
STAND 23



# BRING IN THE WORLD

At Full Loud-speaker Volume!

The Kilodyne 4 is the voice of the world ; it receives stations from every continent and operates at loud-speaker volume. It opens up a vast new field of interest to the wireless fan.

Tunes down to 12 metres and is adaptable up to 2,000 metres, incorporates S.G. H.F. amplification, absolutely no hand capacity, perfectly smooth reaction, one-dial tuning, has been designed by short-wave specialists and praised by leading short-wave critics. It is supplied complete ready for any home constructor to assemble easily, or the individual components are obtainable separately.

Total cost of all parts, with blueprints, leads, grid battery, coils for 12.5/85 metres, not including valves, £6 17s. 8d.

Set of blueprints, constructional details, and list of parts, 1s. 6d., post free.

Send for the new list of Short-wave Components.

Sole Manufacturers:

STRATTON & Co., Ltd.  
BROMSGROVE ST.,  
BIRMINGHAM

London Service Depot:  
WEBB'S Radio Stores  
164, Charing Cross Road.  
Telephone: W.C.2  
Temple Bar 2944

THE  
**KILODYNE**  
4

EDDYSTONE Short-wave Manual, 1/6, post free

**EDDYSTONE**

# THE "PROSPERITY THREE"

The Most  
Outstanding  
Set of  
the Show is

For the star set of the Season, the "Prosperity Three," the designer specifies the following Utility components—

W 314/2	.0005 2 gang complete with	
	coupler	18/-
W 320	.0003 reaction condenser	4/-
W 187	.0002 short-wave condenser	6/6
W 317	The new straight line dial	7/6

If you cannot get these from your dealer write direct and we will supply post free.

**Utility  
TUNED**

**WILKINS & WRIGHT LTD.**  
UTILITY WORKS, Holyhead Road, Birmingham

AGENTS—London: E. R. Morton, Ltd., 22 Bartlett's Buildings, Holborn Circus, E.C.4. Scottish: E. B. Hammond, 113 Vincent Street, Glasgow. Lancashire and Cheshire: J. R. Lister, 93 Old Road, Blackley, Manchester. Westmorland, Cumberland, Durham, Northumberland, Yorkshire and Derbyshire: H. C. Rawson, Ltd., 100 London Road, Sheffield. South Western: Lawrence Fraser, Chelsea House, Lansdown Road, Bath.

Speedy replies result from mentioning "Wireless Magazine"

Belmont

# WORLD'S BROADCAST WAVELENGTHS



Wave-length	Name of Station	Dial Readings	Country	Wave-length	Name of Station	Dial Readings	Country
7.4	La Turbie ..		France	38.476	Prangins (Radio Nations) ..		Switzerland
9.8	Coltano IAG ..		Italy	39.74	Calgary (Alb.) CKS ..		Canada
13.04	Malabar PLZ ..		Java	39.98	Tscheng-Ju XGD ..		China
14.28	Ste Assise ..		France	40.4	Warsaw SPIAX ..		Poland
14.47	Buenos Aires LSY ..		Argentina	40.54	New York WEM ..		United States
14.60	Malabar PMB ..		Java	41	Bangkok HSP2 ..		Siam
14.83	Nauen DGW ..		Germany	41.6	Las Palmas EAR58 ..		Canary Isles
15.5	Ste Assise FTM ..		France	41.7	Singapore VSIAB ..		Singapore
15.5	Kootwijk PCP ..		Holland	42.3	Stuttgart D4XAA ..		Germany
15.53	Sydney VK2ME ..		Australia	40.3	Prangins (Radio Nations) ..		Switzerland
15.625	Ruyselede (Bruges) ORG		Belgium	43.75	Paris (Vitus) F8LH ..		France
15.93	Bandoeng PLE ..		Java	43.83	Stuhlweissenburg ..		Hungary
16.19	Coltano IAC ..		Italy	44.5	Rocky Point (N.Y.) WEJ ..		United States
16.3	Kootwijk PCK ..		Holland	44.9	Nauen DGK ..		Germany
16.8	Malabar PLF ..		Java	45	Constantine FM8KR ..		Tunis
16.56	Bandoeng PMC ..		Java	45.38	Moscow REN ..		U.S.S.R.
16.66	Rocky Point (N.Y.) WAJ ..		United States	45.5	Bucharest ..		Roumania
16.85	Kootwijk PCV ..		Holland	45.31	Riobamba PRADO ..		Ecuador
18.9	Rocky Point (N.J.) WIY ..		United States	46.67	London (Ont) VE9BY ..		Canada
18.9	Rocky Point (N.Y.) WIY ..		United States	46.69	Boundbrook W3XL ..		United States
18.41	Kootwijk PCL ..		Holland	46.72	Minsk RW62 ..		U.S.S.R.
19	Barcelona ..		Spain	47	Coltano IAC ..		Italy
19.557	Prangins (Radio Nations) ..		Switzerland	48	Casablanca CN8MC ..		Morocco
19.57	Schenectady W2XAD ..		United States	48.5	Brussels ON4FB ..		Belgium
19.68	Pontoise FYA ..		France	48.05	Barranquilla HKD ..		Colombia
19.72	East Pittsburgh W8XK ..		United States	48.35	Bogota HKC ..		Colombia
19.737	Zeezen DJB ..		Germany	48.95	Maracaibo YV11BMO ..		Venezuela
19.94	Rome (Vatican) HVJ ..		Italy	48.86	East Pittsburgh W8XK ..		United States
20.0	Prangins (Radio Nations) ..		Switzerland	49.0	Bombay VUB ..		Br. India
20.27	Rocky Point (N.Y.) WQV ..		United States	49.2	Johannesburg JB ..		Sth Africa
20.5	Chapultepec ..		Mexico	49.02	Richmond Hill W2XE ..		United States
21.5	Bucharest CV1 ..		Roumania	49.18	Boundbrook W3XAL ..		United States
21.53	Rocky Point (N.J.) WIY ..		United States	49.22	Bowmanville VE9GW ..		Canada
21.73	Rocky Point (N.Y.) WAJ ..		United States	49.34	Chicago W9XAA ..		United States
22.25	Rocky Point (N.Y.) WAJ ..		United States	49.43	Vancouver VE9CS ..		British Columbia
22.3	Rocky Point (N.J.) WMA ..		United States	49.43	Nairobi VQ7LO ..		Kenya Colony
23.5	Coltano IAC ..		Italy	49.5	Philadelphia W3XAU ..		United States
23.28	Radio Maroc (Rabat) ..		Morocco	49.59	Mason (Ohio) W8XAL ..		United States
25.20	Pontoise FYA ..		France	49.83	Halifax VE9HX ..		Nova Scotia
25.24	East Pittsburgh W8XK ..		United States	49.96	Chicago W9XF ..		United States
25.25	East Pittsburgh (Pa) W8XK ..		United States	49.96	Drummondville VE9DR ..		Canada
25.4	Bowmanville VE9GW ..		Canada	50	Tegucigalpa HRB ..		Honduras
25.53	Rome 2RO ..		Italy	50	Bucharest ..		Roumania
25.53	Chelmsford 5SW ..		Great Britain	50.1	Moscow RV59 ..		U.S.S.R.
25.6	Pontoise FYA ..		France	50.26	Eindhoven ..		Holland
25.63	Winnipeg VE9JR ..		Canada	51.22	Rome (Vatican) HVJ ..		Italy
25.63	Pontoise FYA ..		France	52.7	Chapultepec XDA ..		Mexico
25.7	Rio de Janeiro PPO ..		Brazil	52.7	Tananarive FIUI ..		Madagascar
25.7	Rio de Janeiro PPO ..		Brazil	54.4	Moscow RV38 ..		U.S.S.R.
25.7	S. Y. Electra IBDX ..		—	54.52	New York W2XBH ..		United States
29.16	Königswusterhausen DIQ ..		Germany	58.3	Prague Ok1MPT ..		Czechoslovakia
29.83	Abu Zabal (Cairo) ..		Egypt	60.26	Bandoeng PMY ..		Java
30	Belgrade ..		Yugoslavia	61	Rugby GBC G6RX ..		Great Britain
30.2	Leopoldville ..		Belgian Congo	61	Radio LL (Paris) ..		France
30.3	Prangins (Radio Nations) ..		Switzerland	62.5	Long Island (N.J.) W2XV ..		United States
30.4	Madrid EAQ ..		Spain	62.5	Deal Beach WOO ..		United States
30.57	Buenos Aires LQE ..		Argentina	62.56	London (Ont.) VE9BY ..		Canada
30.64	Rugby GBW ..		Great Britain	65	Budapest ..		Hungary
30.77	Rocky Point WEL ..		United States	67.65	Doerberitz DFK ..		Germany
30.94	Buenos Aires LQA ..		Argentina	70.2	Khabarovsk RV15 ..		U.S.S.R.
31.7	Rio de Janeiro PPU ..		Brazil	74.0	Prangins (Radio Nations) ..		Switzerland
31.25	Lisbon CT1AA ..		Portugal	76.0	Maracaibo YV11AM ..		Venezuela
31.28	Philadelphia ..		United States	80.0	Rome ..		Italy
31.28	Sydney VK2ME ..		New South Wales	88.3	Rugby G6RX ..		Great Britain
31.315	Melbourne VK3ME ..		Victoria	92.31	Doerberitz ..		Germany
31.315	Prangins (Radio Nations) ..		Switzerland	198.5	Riga ..		Latvia
31.35	Springfield W1XAZ ..		United States	207.3	Franchimont ..		Belgium
31.35	Poznan SRI ..		Poland	208.3	Antwerp ..		Belgium
31.38	Zeezen DJA ..		Germany	210	Magyazovar ..		Hungary
31.48	Schenectady W2XAF ..		United States	210.1	Liege ..		Belgium
31.51	Skarnlebaek OXY ..		Denmark	211.3	Newcastle ..		Great Britain
31.55	Melbourne VK3ME ..		Victoria	211.7	Budapest ..		Hungary
31.58	Rio de Janeiro ..		Brazil	214.2	Warsaw (No. 2) ..		Poland
31.75	Rocky Point (N.Y.) WEJ ..		United States	214.3	Aberdeen ..		Great Britain
31.86	Bandoeng PLV ..		Java	215.3	Chatelineau ..		Belgium
32.26	Rabat ..		Morocco	217	Brussels (Conference) ..		Belgium
32.85	Zurich HB9OC ..		Switzerland	217	Königsberg ..		Germany
33.0	Radio L. L. (Paris) ..		France	218.5	Flensburg ..		Germany
33.61	Elisabethville OQH ..		Congo	218	Salzburg ..		Austria
34.4	Aranjuez (Madrid) ..		Spain	219.9	Beziere ..		France
34.66	Drummondville VE9AP ..		Canada	222.1	Fécamp ..		France
34.68	Long Island W2XV ..		United States	224.4	Cork ..		Irish Free State
35	Prangins (Radio Nations) ..		Switzerland	230.3	Radio Wallonia ..		Belgium
35.25	Deal Beach (N.Y.) WOO ..		United States	232	Malmo ..		Sweden
36	Norddeich ..		Germany	232.2	Kiel ..		Germany
36.92	Bandoeng PLW ..		Java	235	Lodz ..		Poland
38.07	Kemikawoa-Cho-Chiba-Ken ..		Japan	235.5	Kristianssand ..		Norway
38.17	Abul Zabal (Cairo) SU Y ..		Egypt	237.2	Bordeaux-Sud-Ouest ..		France
37.50	Tokio JKBB ..		Japan	238.9	Nurnberg ..		Germany
38.65	Kootwijk PDM ..		Holland	239	Binche ..		Belgium
38.65	Kootwijk PDM ..		Holland	230.2	Liege Experimental ..		Belgium

(Continued on page 128)

# THE NEW

# Varley

PROPRIETORS :- OLIVER PELL CONTROL LTD.

## "RECTATONE" L.F. TRANSFORMER

Radio reproduction with full and natural treble response. Gramophone reproduction with the bass in proper balance, without over-emphasis of treble. You can get both, from the same receiver with the Varley **RECTATONE**.

This new transformer compensates for high-note losses in the tuning circuits by frequency compensation in the L.F. amplifier. **The RECTATONE frequency response curve is straight up to 1,000 cycles per second and then rises reaching a maximum at approximately 4,500 cycles—the ideal arrangement.**

The degree of compensation is controlled by a variable resistance connected externally between two of the transformer terminals. If this resistance is omitted the **RECTATONE** functions as a normal transformer, giving high and even amplification.

**RECTATONE** is thus the ideal L.F. coupling for sets using a pick-up or for radio-gramophones, since the tone-control, so valuable on radio, can be switched out on gramophone where it is unnecessary.



**STAND 160  
NATIONAL RADIO  
EXHIBITION  
OLYMPIA**

True tone-balance from  
Radio or Record — with  
**ONE** transformer  
**PRICE 15/-**

Advertisement of Oliver Pell Control Ltd., Kingsway House, 103, Kingsway, London, W.C.2.

Tel : Holborn 5303

It helps us if you mention "Wireless Magazine"

THE *famous*  
**BRITISH GENERAL  
TUNING UNIT**

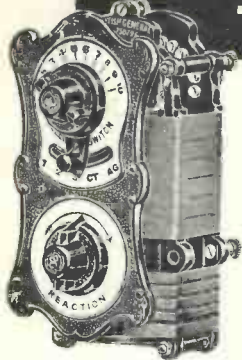

*now reduced  
to 10'6*

By reason of increased demand and enlarged production, we are able this season to offer our well-known Tuning Unit at 10s. 6d. instead of 14s. 6d. as before. This Unit effectively replaces plug-in coils and covers the entire wave-band from 200-2,000 metres. Easy fixing; simple tuning.

Full instructions supplied with every model.

From all dealers or direct from the manufacturers:—

See our display at the RADIO EXHIBITION, Aug. 19-27. **STAND 29**

**BRITISH GENERAL MANUFACTURING CO., Ltd.,**  
Brockley Works, London, S.E.4

**Used and Recommended  
for the 7 Metre Set**



Constructors of this marvellous receiver to get the very best out of it will need the same telephones used in the preliminary experiments. Ericsson Supersensitive Telephones are uncanny in their sensitivity.

Beautifully made and sturdily built for hard wear. In three resistances—120, 2,000 and 4,000 ohms.

One price  
**12/6**

and worth every penny of it.

At all good dealers or direct from: **ERICSSON TELEPHONES LTD.,** 67/73, Kingsway, London, W.C.2

**Ericsson**  
**BRITISH  
SUPERSENSITIVE  
TELEPHONES**

# A FREE COPY OF THE WIRELESS MAGAZINE

*THE interest and pleasure which you derive from the "Wireless Magazine" will be greatly enhanced if you can discuss its monthly articles with a friend who is also familiar with its contents.*

*In order that anyone you know who is interested in wireless but is not yet a reader of "Wireless Magazine" may become acquainted with it, a complimentary copy will be sent to him gratis*

*and post free, if you will kindly complete the attached coupon, or if you do not wish to mutilate your copy, send your request on a postcard.*

**THE "WIRELESS MAGAZINE" IS "THE BEST SHILLINGSWORTH IN RADIO."** Tells you every month all you want to know about recent progress in Radio Design. Look out for the Oct. issue on Wed., Sept. 21.

## POST THIS COUPON NOW

**FREE COUPON**

To the Publisher,  
"Wireless Magazine,"  
58/61 Fetter Lane, E.C.4

Please send a specimen copy of the  
"Wireless Magazine," free and post  
free, to my friend:

My own name and address are:

Put this coupon in an unsealed envelope bearing 1d.  
S1-1111

There is news in the "Wireless Magazine" advertisements

**All ORMOND'S**

**VAST RESOURCES  
HAVE GONE TO PRODUCE  
THESE - The Perfect  
Loudspeakers**



**ORMOND Permanent Magnet  
M.C. LOUDSPEAKER**

In quality and efficiency this model is not inferior to Loud-speakers of the most expensive types. An excellent response throughout the frequency range without over-emphasis at the upper end is immediately apparent, a full bass with a brilliance which is highly commendable. Of robust construction, it is fitted with a large Cobalt Permanent Magnet, to ensure long life and reliability. Complete with input transformer.

size: Diameter 8 inches, Depth **38/6**  
Overall size: R/ 475.  
Price

**ORMOND Electro Magnet  
M.C. LOUDSPEAKER**

This model is designed for use on D.C. supplies. With 2,500 ohms field coil, an ideal high inductance smoothing choke is available. The construction shows a thoroughly sound engineering job. The cone, speech coil and suspension are arranged to handle heavy inputs with every success. Quality of reproduction is all that can be desired, a full bass response being obtainable with no over-emphasis at the higher end of the frequency scale. Complete with input transformer.

**30/-**

Over-all size: Diameter 8 inches; Depth 5 1/2 inches. Catalogue No. R/476. Price

**THE ORMOND ENGINEERING COMPANY, LTD.**  
ORMOND HOUSE, ROSEBURY AVENUE, LONDON, E.C.1  
Telephone: Clerkenwell 5334-5-6 & 9344-5-6. Telegrams: "Ormondengi, Isling."



Visit us at  
**STAND 87**  
Grand Hall,  
National  
Radio  
Exhibition,  
Olympia



**for PUNCH POWER & PURITY!**

Advertisers like to know whence the business comes—please mention "W.M."





THE  
MASTER TOUCH  
OF THE  
"AUTHENTIC"  
PRODUCT



**UNIQUE**  
in their story  
in their superiority

From Fleming and De Forest to the present day, unceasing research has lifted the valve from one triumph to another, and in the van of every real development the name of Marconi can invariably be found. The first dull-emitter valve—the first power valve—the first special H.F. valve—the first British screen grid valve—the first A.C. mains valve—the first satisfactory D.C. mains valve—the first British variable-Mu valve—every one MARCONI! This is indeed a record to be proud of, but in the factory and research laboratory the work of progress even now continues unabated.

That is why MARCONI valves are the invariable choice of all who demand consistent high efficiency.

Come and see the latest MARCONI developments, and discuss your valve problems with us. at

**RADIOLYMPIA STAND No. 74**

THE MARCONIPHONE COMPANY LIMITED  
RADIO HOUSE 210-212 TOTTENHAM COURT ROAD LONDON W 1

MARCONI VALVES

# ELEGANCE WAS THE KEYNOTE — The CAMCO "GRESHAM" was the choice for the "Prosperity 3"



This is the Camco "Gresham" Radiogram Cabinet Price

**£6:0:0**



CARRINGTON Mfg. Co., Ltd.  
Showrooms: 24 Hatton Garden, London, E.C.1.  
Phone: HOL 8202.  
Works: S. Croydon.

Where elegance of appearance and all-round efficiency are first essentials, Camco Cabinets are the inevitable choice. That is why the designers of the "Prosperity 3" chose the Camco "Gresham!" This cabinet is typical of all Camco products. It is designed for beauty allied to utility and is executed in the finest materials by some of the most skilled craftsmen in the trade. Follow the lead of the experts and put your "Prosperity 3" in this splendid cabinet.

Make certain of your FREE copy—send the coupon NOW.

**OLYMPIA STAND 123**

Name .....

Address .....

# GREATER EFFICIENCY at less cost with the FORMO Nigen Transformer



provide a large combination of connections. It can be arranged as a resistance-fed transformer with three ratios, while the two feed resistances can be connected to give various values. A very useful component at a useful price.

**The MULTI-COUPLER**

is combined with two feed resistances and a condenser. Its eight terminals

**10/6**

Set construction is simplified—hum due to low-frequency induction is abolished by the new, exclusive features incorporated in these two new Formo Transformers—the Nigen and the Multicoupler. They are screened, both electrostatically and electromagnetically, by a double screen, and may be placed adjacent to an unscreened mains transformer or in the vicinity of H.F. fields, without fear of high-frequency interference. See them at



The Formo Nigen Transformer has a special nickel alloy core, so designed that the primary inductance is not diminished by its economical arrangement.

It is the most efficient Transformer yet produced at such an attractive price.

**8/6**

**Olympia Stand 100**

Or send for the new Formo Catalogue of Improved, Up-to-date Components.

If unable to obtain locally, write to **FORMO CO.,**

Crown Works, Regents Park, SOUTHAMPTON  
London Offices, 23, Golden Sq., Piccadilly Circus, W.1. Phone Ger. 2088

Advertisers take more interest when you mention "Wireless Magazine"

**A**  
**PERTRIX**  
TRADE MARK  
**BATTERY FOR**  
**EVERY PURPOSE**  
**AND PRICE**

High Tension or Low Tension—inexpensive or Super Capacity Batteries—every need for wireless power can be met from the Pertrix range. The extraordinary long life qualities of Pertrix Batteries are the result of over forty years of battery manufacture. Plug into Pertrix and forget all your battery troubles!

**PERTRIX**  
TRADE MARK  
**DRY BATTERIES**  
**AND**  
**ACCUMULATORS**

H.T.  
BATTERIES  
from  
**5/6**

L.T.  
ACCUMULATORS  
from  
**4/6**

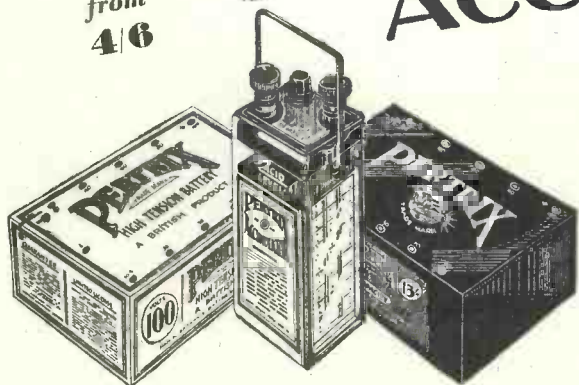

SEE THEM  
AT  
RADIOLYMPIA  
AUG. 19-27  
STAND No  
**126**  
GRAND HALL

Advt. of Britannia Batteries Ltd., 233 Shaftesbury Avenue, London, W.C.2. Telephone: Temple-Bar 7971 (5 lines). Works: Redditch (Worcs.)

Mention of the "Wireless Magazine" will ensure prompt attention

# In Tune with the Trade

FETTER LANE'S Review of Catalogues

## SEND TO US FOR THESE CATALOGUES!

Here we review the newest booklets and folders issued by six manufacturers. If you want copies of any or all of them just cut out this coupon and send it to us. We will see that you get all the literature you desire.

Just indicate the numbers (seen at the end of each paragraph) of the catalogues you want below.

My name and address are :—

Send this coupon in an unsealed envelope, bearing ½ d. stamp, to "Catalogue Service," WIRELESS MAGAZINE, 58/61 Fetter Lane, E.C.4. Valid till Sept. 30

## FOR BIG POWER

NOT all of us want quite such a big power output as 25 watts, which is far in excess of that needed comfortably to fill the average living-room. But the snag is that on those rare occasions when a club pal asks you to fill a concert or dance hall at full volume, it is not at all an easy job.

A folder I have just had from the Parmeko people will help you when this problem presents itself. It describes a 25-watt kit for power amplification. Parmeko smoothing chokes and mains transformers are used, of course. It is quite a useful amplifier, as it can be used with radio, gramophone, or microphone input. **276**

## ATLAS AND COMPLETE SETS

I EXTEND a welcome to the Atlas people in entering the field of complete sets. This is the first time that the enterprising firm of H. Clarke & Co. (Manchester), Ltd., has supplied complete receivers; they having previously specialised in individual components. The new sets appear to be winners.

Two-valvers are the order of the day and these can be obtained either for mains or battery drive. The mains-driven models have energised moving-coil loud-speakers and work from outdoor, indoor, or mains aerials. The battery models have

permanent-magnet moving-coil loud-speakers and incorporate a pentode output stage.

All the sets are housed in attractive two-colour figured-walnut cabinets and all general details you need to know can be obtained from the latest Atlas literature. **277**

## THE BUREAU-GRAM IDEA

WHAT is a Bureau-Gram? It is a new piece of furniture introduced by Lawson & Raphael, of Regent Street, which converts any standard set into a radio gramophone. The Bureau-Gram itself is a console containing electric gramophone drive with automatic stop (a Garrard motor is used) and a B.T.H. pick-up.

The set stands on top of the Bureau-Gram and a convenient connection is made by means of a plug. You do not have to pull the wiring of your set to pieces in order to fit the Bureau-Gram. I like the idea because it saves all the trouble of building a set specially for radio-gram reproduction, and it has the merit of keeping the gramophone apparatus enclosed when not required.

There are three models—table, standard, and cabriole—so you needn't be afraid that the Bureau-Gram will clash with your furnishing style. An idea of the neat appearance can be gained from the new Lawson-Raphael illustrated catalogue. **278**

## THE "MAIN" IDEA

I F you make your own mains apparatus you will want to have a copy of a very useful booklet which G. Scott Sessions & Co. have just issued. This is not only a catalogue of mains transformers and constant-inductance chokes of all types, but it is quite a useful treatise on the correct use of chokes and transformers.

The booklet is called "The 'Main' Idea," but many of the constant-inductance low-capacity

chokes detailed are suitable for other purposes in a set apart from the mains supply side. There is a good power-grid choke, some pentode chokes and three useful output chokes of 20-, 30-, and 50-henry inductance. The new Scott Sessions booklet will interest home constructors and all set tinkerers.

I should perhaps add that any special choke or transformer can be made up, so that amateur set designers can try out their own ideas. **279**

## PARTS THAT PULL TOGETHER

AT this time of year there is more than the usual necessity for keeping up-to-date on the details of new parts, and so I welcome a large broadsheet which arrived in the post this morning from Lissen.

No words are wasted in this; it is not a publication full of sales talk, but one giving just the vital facts you need to know about each component—what its job is, price, size, working tests and so on. All kinds of things are dealt with from complete mains units down to grid leaks.

No matter whether you go to the show or not, you should get this Lissen publication as it will keep you up to date with the new prices and gadgets available. **280**

## LITTLE THINGS THAT COUNT

I WAS very pleased to receive from two old friends of mine the particulars of the new lines in the Belling & Lee range for 1932-33. Mr. Belling and Mr. Lee, if I may refer to them in that personal way, have for many years past specialised in really high-class radio details, terminals, wander plugs, fuses, and the like.

I hate parts of this kind when they are cheaply constructed and Belling-Lee has always stood for the better class material. I strongly advise you to get a copy of the new literature because the new lines are particularly helpful. **281**

Build your  
NEW SET with a

# PILOT AUTHORS' KIT

*The No Substitute Kit*

EXACT TO SPECIFICATION

## PROSPERITY 3

BATTERY MODEL

KIT "A"

£7:19:0

Or 12 monthly payments of 14/7

ANY PARTS SUPPLIED SEPARATELY  
If value over 10/- sent C.O.D. All post charges paid.

	£	s.	d.
1 Peto-Scott foil-covered baseboard assembly	3	6	
1 Wearite standard type HFO H.F. choke	6	6	
1 Wearite screened type HFP H.F. choke	3	6	
1 Igranite type C40 L.F. choke	12	6	
1 Set Magnum type WM 3 coils	1	10	0
2 Dubilier type 870 fixed condensers, .0002 mfd.	2	0	
1 Dubilier type 870 fixed condenser, .006 mfd.	1	6	
1 Dubilier type 9200 fixed condenser, 1 mfd.	2	9	
3 Dubilier type 9200 fixed condensers, 2 mfd.	11	3	
1 Utility variable condenser, type W314/2, two-gang, with coupler, .0005 mfd.	18	0	
1 Utility .0003-mfd. reaction condenser, type W/92	4	0	
1 Utility .0002-mfd. short-wave condenser, type W/187	6	6	
1 Peto-Scott neutralising condenser	3	6	
1 Sovereign pre-set condenser, .0003-mfd. maximum, type J	1	3	
1 Utility SL full-aperture type W317 slow-motion dial	7	6	
1 2.5-volt flash-lamp bulb	6		
2 W.B. four-pin miniature-type valve holders	1	4	
1 W.B. five-pin miniature-type valve holder	8		
8 Belling-Lee marked wander plugs	1	4	
2 Belling-Lee spade terminals (marked)	4		
3 Lissen marked terminal blocks	3	0	
1 Claude Lyons 5,000-ohm, 1-watt fixed resistance	10	1	
1 Claude Lyons 20,000-ohm, 1-watt fixed resistance	10	1	
1 Lissen 3-megohm grid leak, with wire ends	1	0	
1 Lissen 400-ohm baseboard-mounting potentiometer, type LN140	1	6	
1 Wearite 50,000-ohm potentiometer, type QVC, combined with mains switch, type G 40	6	6	
1 Wearite 100,000-ohm potentiometer, type QVC, combined with mains switch, type G40	7	6	
1 packet Göttsche shielded wire	9		
Tinned copper wire, lengths of oiled cotton sleeving, length of rubber-covered wire, wood screws, etc.	1	0	
1 Bulgin 4-in. extension spindle, type EB2	1	9	
2 Pairs Bulgin grid-bias battery clips, type No. 5	4		
5 Wearite brackets	1	3	
1 Becker on-off switch, type 460	1	10	
1 Lissen Hypernik L.F. transformer	12	6	

KIT "A" £7 19 0

## CASH, C.O.D., or H.P.

Immediate Delivery

## P. W. HARRIS RADIO-GRAMPHONE KIT "A" £11:16:0

Or 12 monthly payments of 21/8  
Set of specified Valves £2:2:0

## KEYSTONE

BASEBOARD

## NEUTRALISING CONDENSER

As specified in the "Prosperity 3" and 7-Metre Receiver **3/6**

## 7-METRE RECEIVER

KIT "A" £2:6:0

Or 6 monthly payments of 8/4

Set of specified Valves 14/-

## PROSPERITY 3

A.C. MAINS MODEL

KIT "A"

£10:15:0

Or 12 monthly payments of 19/8

ANY PARTS SUPPLIED SEPARATELY  
If value over 10/- sent C.O.D. All post charges paid.

	£	s.	d.
1 Wearite standard H.F. choke, type HFO	6	6	
1 Wearite screened H.F. choke, type HFP	3	6	
1 Igranite L.F. choke, type C40	12	6	
1 Set Magnum type WM 3 coils	1	10	0
1 Dubilier .0001-mfd. fixed condenser, type 870	1	0	
2 Dubilier .0002-mfd. fixed condensers, type 870	2	0	
2 Dubilier 1-mfd. fixed condensers, type 9200	2	9	
3 Dubilier 2-mfd. fixed condensers, type 9200	11	3	
1 Peak 2-mfd., 1,500-volt test, fixed condenser	3	9	
3 Peak 4-mfd., 1,500-volt test, fixed condensers	1	0	3
1 Dubilier 8-mfd. dry electrolytic, 450-volt D.C., peak working, fixed condenser	5	6	
1 Utility .0003-mfd. variable condenser, type W314/2, two-gang, with coupler	18	0	
1 Utility .0003-mfd. reaction condenser, type W/920	4	0	
1 Utility .0002-mfd. short-wave condenser, type W/187	6	6	
1 Peto-Scott neutralising condenser	3	6	
1 Sovereign pre-set condenser, .0003 mfd., type J	1	3	
1 Utility SL full-aperture slow-motion dial, type W317	7	6	
3 W.B. 5-pin miniature-type valve holders	2	0	
1 Claude Lyons 200-ohm, 1 watt fixed resistance	10	1	
1 Claude Lyons 400-ohm, 1 watt fixed resistance	10	1	
2 Claude Lyons 20,000-ohm, 1 watt fixed resistances	1	9	
1 Claude Lyons 50,000-ohm, 1 watt fixed resistance	10	1	
1 Claude Lyons 8,000-ohm, 1 watt fixed resistance	10	1	
1 Lissen 2-meg. grid leak, with wire ends	1	0	
1 Lissen 400-ohm, baseboard-mounting potentiometer, type LN140	1	6	
1 Wearite 15,000-ohm potentiometer, type QVC, combined with mains switch, type G40	6	6	
1 Wearite 100,000-ohm potentiometer, type QVC, combined with mains switch, type G40	7	6	
1 Peto-Scott foil-covered baseboard assembly	3	6	
Tinned copper wire for connecting, lengths of oiled-covered sleeving, length of rubber-covered wire, wood screws, etc.	1	0	
1 Bulgin 4-in. extension spindle, type E.H.2	1	9	
5 Wearite brackets	1	3	
3 Lissen marked terminal blocks	3	0	
1 Becker on-off switch, type 460	1	10	
1 Lissen Hypernik L.F. transformer	12	6	
1 Sound Sales mains transformer, type HS, shielded super	1	5	0

KIT "A" £10 15 0

## KIT BITS SELECTED C.O.D. LINES

1 Set valves, as specified	22	1	0
1 Cameo Gresham radio-gram cabinet	6	6	0
1 Rothermel Sonochoad, type P.M.P. speaker	1	12	6
1 Garrard clockwork motor, type No. 30, with 12-in. turntable	1	10	0
1 Marconiophone pick-up	2	2	0
Pertrix batteries and accumulator as specified	2	6	0

## PILOT AUTHOR KITS ENSURE 100% SUCCESS

AND REMOVE ALL DOUBT

## KIT BITS SELECTED C.O.D. LINES

1 Set specified valves	22	12	6
1 Cameo Gresham radio-gram cabinet	6	6	0
1 Rothermel moving-coil D.C. model, 2,500-ohm winding	1	5	0
1 Garrard induction motor, No. 201, with automatic stop	4	17	6
1 Marconiophone pick-up	2	2	0
1 Westinghouse metal rectifier, type H.T.8	18	6	

PETO-SCOTT CO., LTD., 77, CITY ROAD, LONDON, E.C.1

Please send me KIT "A", Cash/C.O.D./H.P., Prosperity 3 (Battery Model) P. W. Harris Radio-gramophone.  
Prosperity 3 (A.C. Mains Model). 7-Metre Receiver.

NAME.....

ADDRESS.....

W.M.9/32

West End Showroom: 62, High Holborn, London, W.C.1.

Advertisers like to know you "saw it in the 'Wireless Magazine'"

# The NEW Full O'Power CADET RADIO BATTERIES

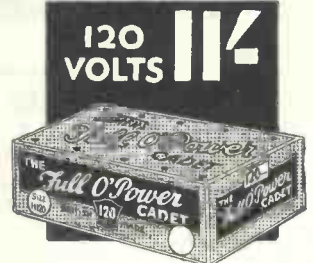

GRID BIAS  
9 Volts, 1/- 16 1/2 Volts, 1/9

THESE PRICES DO NOT APPLY IN THE IRISH FREE STATE

Be sure and visit our  
**STAND NO. 88, at the  
Radio Exhibition, Olympia**

MANUFACTURED BY SIEMENS BROTHERS & CO. LTD. WOOLWICH  
ONE OF THE OLDEST COMPANIES IN THE ELECTRICAL INDUSTRY  
WHO HAVE BEEN MAKING BATTERIES FOR OVER 60 YEARS

Buy  
**Full O'Power**  
by **SIEMENS**

Advt. of SIEMENS ELECTRIC LAMPS AND SUPPLIES LIMITED. 38/9, Upper Thames Street, London, E.C.4.

## SIMPLICON SOLELY SPECIFIED

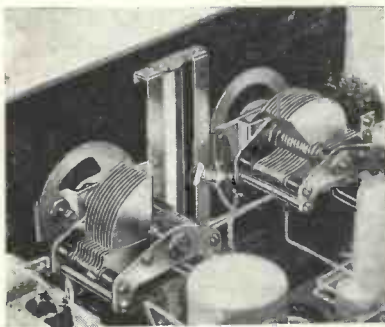

There is no substitute for the best, therefore follow Percy Harris's example and fit **SIMPLICON CONDENSERS**.

Type .0005 STAR U.R. L. and R. Price 5/- each

Full vision vertical control Drive type F.V.V. Price 13/6

### PERCY HARRIS RADIOGRAM

The form of control adopted by SIMPLICON is entirely new—advanced—and has the effect of "ganged tuning with individual control." Both pointers work on a common scale, giving ideal control.

#### COUPON

If you have any difficulty in obtaining "SIMPLICON" CONDENSERS, write direct to the sole manufacturers: **WILLIAMS AND MOFFAT, LTD.**, Ladypool Road, Sparkbrook, Birmingham. Literature FREE on request.

Name .....

Address .....

## THE BECKER SWITCH FOR THE "PROSPERITY 3"

The Becker type 460 is a most efficient quick make-and-break sunk switch in Bakelite, rated at 4 amps.

The design and movement are a definite advance in switches for Radio, and the Becker switch is a first-class electrical job.

Rated at 4 amps., tested at Faraday House to 29 amps!

Specified for the "Prosperity 3."

Look for Becker Switches at the Exhibition

If you find any difficulty in buying Becker Switches please write to us.



TYPE  
460  
1/10<sup>D</sup>

**GEO. BECKER LTD.**  
**AMPERE WORKS, WEMBLEY, MIDDLESEX**

Better service results from mentioning "Wireless Magazine" when writing to advertisers

# SONOCHORDE

## a Product of Outstanding Merit

### Specially Selected by the "Wireless Magazine"



Note the new Sonochorde concentric disc suspension, which ensures permanent alignment of speech coil.



After exhaustive tests of all types of moving-coil speakers, the acoustical engineers and designers of the "Wireless Magazine" Star Exhibition receivers came to the conclusion that the SONOCHORDE SPEAKER was the best unit suitable to their instrument.

SONOCHORDE Moving-coil Speakers have been developed as the result of intensive research and years of practical experience. The new concentric disc method of suspension ensures a better overall frequency response, added sensitivity, and permanent alignment of the speech coil.

We congratulate the engineers of the "Wireless Magazine" in designing such perfect sets, which give SONOCHORDE Moving-coil Speakers an opportunity to operate to full advantage. We strongly recommend these sets to constructors who are anxious to build a receiver which will give them faithful reproduction accompanied with extreme selectivity and sensitivity.

SONOCHORDE SPEAKERS ARE AVAILABLE IN BOTH FIELD EXCITED AND PERMANENT MAGNET TYPES OR IN DUAL MATCHED UNITS, ALL EQUIPPED WITH UNIVERSAL TRANSFORMERS AND 7-IN. CONES.

D.C. Mains Models, 2,500, 4,700, and 6,500 ohms, complete .. .. .	25/-
Permanent Magnet Model, complete .. .. .	32/6
D.C. Dual Matched Units, all resistance values, with universal transformer, per pair	50/-
Permanent Magnet Dual Matched Units, with universal transformer per pair ..	65/-

**OBTAINABLE FROM ALL HIGH-CLASS RADIO DEALERS**

THE  
**ROTHERMEL CORPORATION LTD.**

Works and Offices: **Rothermel House, 1 WILLESDEN LANE, LONDON, N.W.6**  
'PHONE: MAIDA VALE 6066 (5 lines).

*Advertisers like to know you "saw it in the 'Wireless Magazine'"*

# NEWS of the SHORT WAVES

**A**MONG the various types of portable receivers to which we have become accustomed, the idea of a portable short-wave receiver does not appear to have found very much favour. For those who like experimenting with different types of short-wave receivers, however, the portable offers rather attractive possibilities.

## Small and Compact

The outfit can be made exceedingly small and compact, owing to the small number of parts necessary and, as you know, nothing very ambitious in the nature of an aerial pick-up system is necessary to produce quite respectable signals on phones.

A two-valve portable can be very easily made up and will only require the use of three or four 9-volt grid-bias batteries to supply the necessary high tension, while if the valve filaments are wired in series a single flashlamp battery will last for quite a time as the low-tension supply.

Various pick-up systems can be used. If plug-in coils of large diameter are utilised, it is possible to pick up quite a number of signals without external aerial or earth. If one of the more compact dual-range short-wave coil units is employed, then a short length of wire attached to the aerial terminal will provide sufficient pick-up.

Anyway, to those who do not mind the extra trouble involved in building a receiver of this description the result is a further happy hunting ground, for the bored radio fan!

## Horrible Effects!

All kinds of horrible effects will probably be met with and hand-capacity effects, threshold howling, and similar troubles of the short-wave receiver of many months ago will turn up in full force unless extra care is taken in the design.

Not having thrilling broadcasts, such as police messages, fire alarms, etc., to listen to, as they do over the pond, you will still have to rely on the normal broadcasting and telephone stations.

Soon we shall be talking about ultra short-wave portables, when every man will carry his 7- or

3-metre receiver for the local station in an attaché case, or maybe in his hat; but I leave the fun to you and do not propose describing such a system here!

Talking of carrying a receiver in your hat reminds me of those smart-looking short-wave transmitters which some American announcers are in the habit of carrying on their backs when broadcasting a running commentary, the idea being that the announcer can run with the performers and say what he thinks of them all the way, the remarks being picked up by a nearby receiver and thence relayed to the medium-wave broadcaster.

What these transmitters weigh I have no idea, but they seem very effective. I wonder if any use of them has or will be made over here?

Again using our imagination a little, we can see what the portable television transmitter of the future will be like. Here, no doubt, the ultra-short waves will demonstrate their extreme usefulness, and we can picture the time when portable ultra short-wave television transmitters will be rushed to the scenes of national events in much the same way in which the talking news-reel outfit is made use of to-day.

Well, here we are once again with a further exhibition upon us, together with all the new season's products and whatnots. At the time of writing, nothing particularly startling in the way of new short-wave apparatus has appeared.

Enthusiasm for short-wave reception has increased considerably during the last twelve months, but this field still remains largely in the hands of the home constructor. So, of course, we find that considerable advances have been made in the field of short-wave components.

Although not strictly a short-wave matter, it is distinctly cheering to note that considerable improvements have been made in the design of slow-motion dials. This particular piece of apparatus was always a cause of much woe and gnashing of teeth in the days gone by.

Dials either slipped or they were too stiff. They suffered from backlash or else went in jerks and then only when they felt like it. The constructor who goes in for short-wave work to-day does not know his luck, because, after all, a slow-motion dial is an absolute essential with *any* short-wave receiver, and we are now able to obtain a number of examples of really excellent efforts in dials at a fraction of the cost of the older product.

## Value for Money

Mass production has had its good effects here, and we can now obtain something like value for money. As an experimenter of the raw and rough days, I am tempted to remark that a few years ago you would not get any change from a pound note for a very poor example of a condenser which did not even attempt to boast a vernier movement.

The recent relay of the speeches at the opening of the Ottawa Conference demonstrates once again the usefulness of the short waves. The signals were sent over by the commercial station CGA at Drummondville, Quebec, and, of course, were relayed over here by the B.B.C.

The broadcast was recorded, and I, for one, heard the Peace Tower clock chime out eleven o'clock three times in one day, for, besides the re-broadcast over the normal stations in the evening, it was apparently also re-broadcast over G5SW at a later hour.

## More Relays Wanted

This brings to mind the fact that this was the first time that a broadcast from Canada has been relayed over here. Now that we have an efficient beam service operating between this country and Canada, could we not have more relays of programmes from the Dominion in the future on the basis of a programme exchange, similar to those which we "sent and took" with the Americans some short time ago?

Surely it would be possible for both sides concerned to arrange such a series of broadcasts.

Mander Barnett



**On Stand  
69  
GRAND HALL · OLYMPIA  
a new  
development  
in  
Moving Coil  
Reproducers  
will be exhibited**



The **R & A**  
"VICTOR"  
PERMANENT MAGNET MOVING COIL  
REPRODUCER DE-LUXE

**BRIEF SPECIFICATION**

The "VICTOR" P.M.C. Reproducer-de-Luxe has a cobalt steel magnet, giving a flux density of 8,000 lines per square centimetre. Average speech coil impedance, 5.5 ohms. The magnet and 6-ratio transformer are totally enclosed and the cadmium plated grille and armoured construction eliminate all possibility of damage to diaphragm and magnet. Dimensions, 10 $\frac{3}{4}$  in. by 5 $\frac{3}{4}$  in. deep.

Write for fully descriptive literature of the complete range of R&A Reproducers including the VICTOR.  
Sent Post Free on request.

**70%**  
including  
6 RATIO TRANSFORMER

The R. & A. "VICTOR" is a de-luxe reproducer in every sense of the word. Quite apart from its unique design, its massive construction, and its flawless finish, the reproduction of speech and music from the lowest to the highest frequency is a revelation. Moreover its transformer, with six ratios, permits accurate matching of the speech coil with every type of power valve, including pentodes.

If you are interested in quality reproduction, we invite you to a demonstration on our Stand No. 69, Olympia. We should like your candid opinion of the "VICTOR," and to this end we invite you to state briefly on a sheet of notepaper your impressions after having inspected it and heard its performance.

We will present a "VICTOR," in de-luxe cabinet or cheque for 5 guineas, at entrant's option, to the writer who sends what, in our opinion, is the most apt, comprehensive, and *impartial* criticism, limited to 100 words, provided the entry form at the foot of this page is attached thereto.

Criticisms must reach us not later than September 5, and the result will be published in the *Wireless World*, September 16 issue.

The staff and employees of R. & A., Ltd., and the company's advertising agents are excluded from this invitation.

**REPRODUCERS & AMPLIFIERS LTD.**  
**FREDERICK STREET, WOLVERHAMPTON.**  
*This portion to be attached to your criticism of the VICTOR.*  
**Post to reach us not later than Sept. 5**  
*(Wireless Magazine)*

Better service results from mentioning "Wireless Magazine" when writing to advertisers

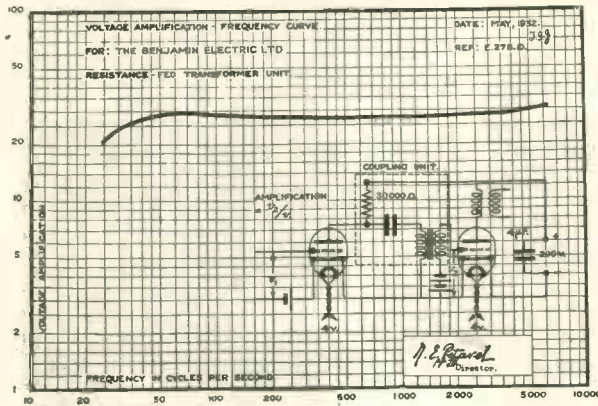

This N.P.L. curve shows why  
 the  
**BENJAMIN** (REGD)  
**"TRANSFEEDA"**

is the  
**CHOICE**  
 of  
**CHIEF**  
**DESIGNERS**



PRICE **11/6**

Little wonder that the chief designers of some of the most famous British-made receivers gave their preference to the BENJAMIN "TRANSFEEDA" and incorporated it as standard in their sets.

The "TRANSFEEDA" is a neat job—looks well in your set. Its case is of METAL, so that stray oscillations are effectively screened. The components within the case are made from high-class material and individually matched (e.g., the anode resistance is wire-wound, not spaghetti or composition, the condenser has its own metal case, the transformer core is of special nickel iron, etc., etc.).

Naturally a standard specimen of so well-designed and made an instrument, when submitted to the N.P.L. for their test, showed a response curve that gave designers and constructors "something to think about."

Wherever a L.F. Transformer is used or specified in your set, put in a BENJAMIN "TRANSFEEDA" and get a volume and purity that will delight you.

Ask for Leaflet No. 1292, which fully describes the "TRANSFEEDA" and gives circuits and connections.

THE BENJAMIN ELECTRIC, LTD., TARIFF ROAD, TOTTENHAM, N.17.

# MAKE YOUR CHOICE!

Six special guaranteed lines that will modernise your RADIO.

- 1 A heavily constructed Radiogram Cabinet, made in oak. Price, polished, £3 18s. 6d. Unpolished, £3 7s. 6d.
- 2 A complete kit of parts of a very distinctive Radiogram Cabinet. Simple to assemble—you cannot fail. Price in oak, £2 7s. 6d. In birch, £2.
- 3 An essentially modern Radiogram Cabinet. Constructed of birch and beautifully finished in oak, mahogany and walnut. Price in any finish £2 5s. Also fitted with Collaro double-spring motor, £3 12s. 6d.
- 4 A specially constructed Radiogram Cabinet for the Osram Music Magnet. (1931-1932 kit models.) Price, £3 19s. 6d. Price with motor, £7 10s.
- 5 The most famous and efficient baffleboard. Constructed entirely from a single board, size 24 by 24 by 3/8 in. Beautifully polished—in oak, mahogany, etc.
- 6 The scientifically constructed box baffle cabinet. A very popular speaker cabinet. Perfect in appearance and performance. Price, polished in oak, 22/6. In mahogany, 22/6.

To VIBRANTI PRODUCTS Co. 303 Euston Rd., N.W.1

Please send me complete lists of your special offers.

POST  
 Coupon  
 in 1/4  
 envelope

Name.....  
 Address.....

## No Chatter - - -

No Scratching - No  
 Case Resonance  
 with the All-British



# Clarion Pick-up



PRICE  
**21/-**

Handsome finished in Walnut Bakelite

Ask your dealer to let you see and hear the wonderful range of Clarion 100-per-cent. British-made Radio instruments.

Table Model, Console Model, Radiogramophone, Radio-gramophone with Automatic Record Changer.

The all-British Clarion Pick-up is amazing in its realism. The entire absence of extraneous noises ensures smoothness of tone which provides an added joy from your records. This model is fitted to the famous Clarion Radiogram. Can be fitted to any gramophone in five minutes.

**BRITISH CLARION Co., Ltd.**  
 Clarion Works, Miller Street, N.W.1

Telephone: Museum 3624/3625  
 Telegrams: Crosradcla, Norwest, London

Please mention "Wireless Magazine" when corresponding with advertisers

# GREAT DEVELOPMENTS

*by*



## NEW

**PERMANENT  
MAGNET**

## NEW

**ENERGISED**

# MOVING-COIL SPEAKERS

### NEW VALVEHOLDERS AND NEW SWITCHES

This season a complete range of ENERGISED Moving-coil Speakers has been added to the famous series. They have all the qualities of extreme sensitivity and supreme British workmanship that have built up so tremendous a sale for the PERMANENT MAGNET Moving-coil Speakers. Have you heard yet the new "Mansfield" Permanent Magnet Moving-coil Speaker? Hear it at your dealers. You will marvel that so fine an instrument can be possible at so low a price.

**Stand No. 108  
OLYMPIA**

**PIONEERS AND LEADERS ALWAYS**  
*Write for the New Catalogue (FREE).*

WHITELEY ELECTRICAL RADIO CO., LTD., NOTTINGHAM ROAD, MANSFIELD, NOTTS.

*Irish Free State Distributors Kelly & Shiel, Ltd., 47, Fleet Street, Dublin*

*Advertisers like to know you "saw it in the 'Wireless Magazine'"*

# Inherent Stability

- due to abnormally low inter-electrode capacity

A remarkable degree of stability is ensured with Cossor Screened Grid Valves due to the reduction of their inter-electrode capacity to the order of .001 micro-micro - farads This negligible residual

capacity results in the virtual elimination of coupling within the valve. In practice, this ensures that the full capabilities of the valve—its exceptionally high amplification — may be fully realised without fear of instability.



# COSSOR

ALL - BRITISH  
SCREENED GRID VALVES



A copy of the 40 page Cossor Wireless Book B.17 will be sent you free on application to A. C. Cossor Ltd., Melody Dept., Highbury Grove, London, N.5.

Get one of the new Cossor Station Charts price 2d. Ask your dealer for a copy of this useful novelty or write to us enclosing 2d stamp.

A. C. Cossor Ltd., Highbury Grove, London, N.5. Depots at Birmingham, Bristol, Glasgow, Leeds, Liverpool, Manchester, Newcastle, Sheffield and Dublin 93 ♡ 804

Please mention "Wireless Magazine" when corresponding with advertisers

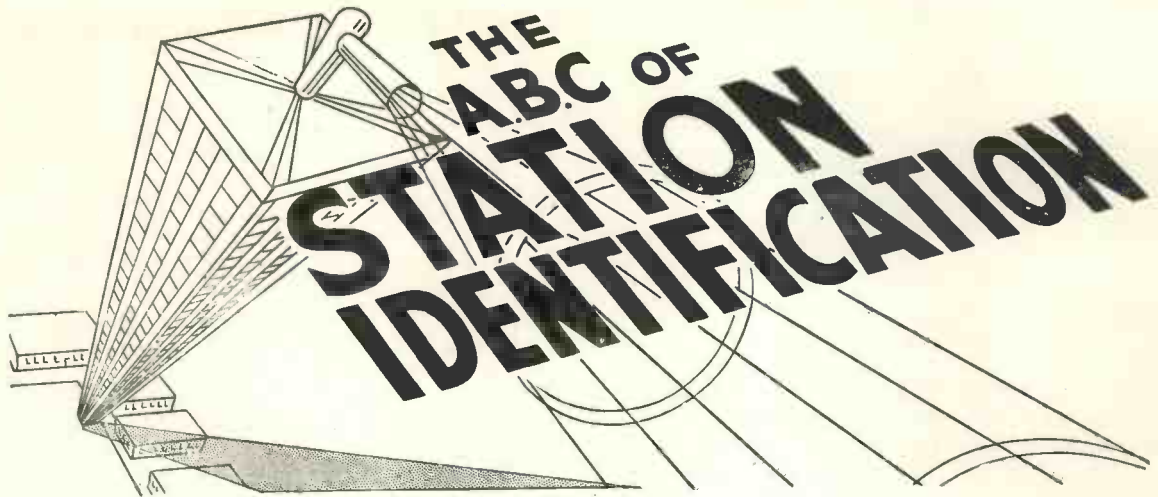

By J. GODCHAUX ABRAHAM

**L**ISTENING to the transmissions of such stations as Paris, Berlin, Rome, Vienna, Oslo, Warsaw and so on, has a peculiar charm; it is a worth-while pastime, a useful stand-by in the event of the home programmes lacking on that particular night the kind of entertainment that pleases you; it extends your horizon, frequently offers surprise items, and generally adds to radio listening that extra spice of interest so greatly appreciated by all fans.

#### Knowledge of Languages

The fact that your knowledge of languages is confined solely to English or, alternatively, that you only possess a scanty smattering of foreign tongues, should not deter you from tuning in Continental broadcasts; the identification of any individual transmitter, in practice, is much easier than it appears in theory. Interest is enhanced if you know definitely the origin of the broadcasts, but you need not be a foreign linguist to secure that information.

It is essential, at the outset, that you should know roughly on what wavelength you are receiving the transmission. First, was it on a channel above, say, 1,000 metres or below that figure? If below 1,000 metres, you

must ascertain to which portion of the medium waveband your set is tuned.

After all, this is not a difficult matter, in view of the fact that most receivers can pick up with ease transmissions from such stations as London and North National, Midland, North, and Scottish Regional; consequently these stations, fairly well spaced over the medium waveband, furnish excellent landmarks for the estimation of wavelength.

Secondly, by noting whether the "mystery" broadcast comes between two such stations or immediately above or below so-and-so, you narrow down your search to a great extent, and from the data so obtained you are able to state that the transmitter you are seeking to identify is on roughly so many metres.

Thirdly, the plotting of a graph—a method which has been frequently advocated and described in these columns—is an easy matter and a little care in making it and in keeping the record up to date, as each fresh station has been found and recognised, will amply repay the slight work involved in jotting down a few notes at every sitting.

#### Relayed Programmes

One little point, however, you *must* bear in mind. On the Continent, similarly to the practice adopted in the British Isles, a programme broadcast from a station may be relayed by a number of others in the same country. On certain nights, when international transmissions are carried out, many countries may put out the same concert.

It is on such occasions that you may hear an identical entertainment from stations in, say, Austria, Germany, Poland, Hungary, Czecho-slovakia, or from France, Belgium, and Switzerland. Then again, Sweden, Norway, and Denmark may effect an interchange of entertainments; Switzerland may occasionally link up with Italy, or Yugoslavia with one of its neighbours.

Now although at times these excep-



AN UNUSUAL BROADCASTING STATION

This novel and imposing building houses the Bucharest station. Bucharest is pronounced "Book-oo-recht" by the station announcers

# ABC OF IDENTIFICATION—Continued

tional combinations may prove puzzling, on others the fact that the same programme can be picked up on different dial readings will furnish a valuable clue regarding the identity of the original transmitter or "feeder."

## Groups of Stations

For instance, you know—or should know—that Munich connects up with Nürnberg, Kaiserslautern with Augsburg; that Stuttgart (Mühlacker) and Frankfurt-am-Main work hand in hand; and that Milan, Turin, Genoa, Trieste, and Florence form another group.

lar studio the transmission emanates, for most relays remain switched on to the mother station between items and thus the original call will be picked up.

I say "not without exceptions," as the Italian studios linked up in one and the same group invariably give out in the announcement the names of all their associates taking the broadcast. The call "Radio Roma-Napoli" might lead you to believe that the concert or operatic performance is provided by Rome, but an identical call might also be given by Naples.

Fortunately, most of the studios

quite a number of transmitters still possess one, if a note be made of the number of beats, it will be found possible to trace the gadget to its respective station.

The following data should prove useful: Radio Maroc (Rabat) and Belgrade, 60 beats per minute; Kosice, 80; Katowice, 120; Frankfurt-am-Main, 190; Riga, Breslau, and Gleiwitz, 200; Königswusterhausen and Berlin relays, Leipzig, and Dresden, 240; Vienna and Austrian relays, a fast-beating metro-nome averaging 270.

## Difference in Pitch

Notice that the ear soon detects differences, not only in the number of beats, but in their actual pitch; you will soon differentiate between the harsh metallic "ping" of the Rabat note and the rapid Viennese "tock-tock-tock."

Further, a number of stations use gongs to identify themselves to their listeners. Of these, we have the Swedish studios with 80 strokes to the minute; Tallinn, 60; Radio Strasbourg, a series of deep booms—about 16 per minute; Radio Toulouse, 60; Istanbul, 77; and so on. Here again we can detect differences in the respective tones, although in the case of the stations enumerated the signal consists of one single note.

In order to secure individuality and to prevent confusion, the studios have developed these interval signals into combinations of two, three, and more notes, and also into short melodies with peculiar and distinctive characteristics.

## B-A-C-H

Thus, from Heilsberg (Königsberg and Danzig) you will hear in the intervals of programmes two notes (D flat, A flat) repeated three times in four and a half seconds, with an equivalent silent period; from Leipzig, the sound of the metronome interrupted every half-minute by four notes (B flat, A, C, B)—spelling in German musical terms the name of the composer B-A-C-H—and from Mühlacker three notes (C, D, G), produced by hammers striking steel bars.

If you have once heard these signals it does not require a retentive memory to recall them when they are again picked up at a later date.

Chimes and peals of bells have also

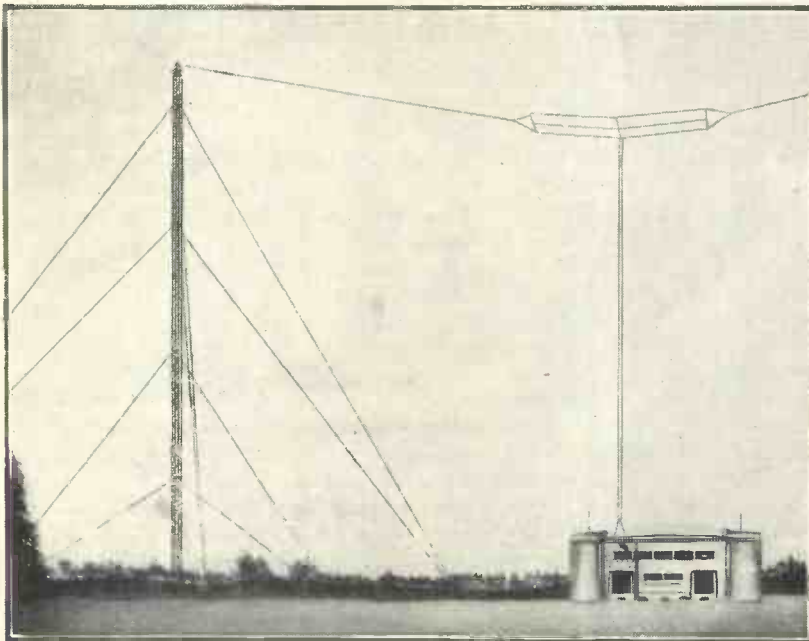

OSLO'S HIGH-POWER TRANSMITTER

*This comparatively new high-power station is well received in the British Isles. It transmits a distinctive melody as an identification signal*

Taking these facts into consideration, therefore, if a given musical composition is heard on about 530 metres, repeated on a higher wavelength and again continued at the bottom part of the condenser scale, you will be right in stating without much fear of contradiction that you are listening to one of the Bavarian relays.

## Wavelength List

Consultation of the list of broadcasting stations published every month in "Wireless Magazine" will supply the necessary information.

In most cases, but not without exceptions, as actual confirmation, the call will tell you from which particu-

lar studio their transmissions can be recognised by listeners even if the official call has not been heard or understood. In the majority of cases you will find that some form of interval signal—be it gong, metronome, trumpet, bird-song, musical-box melody, or chimes—has been adopted.

Such a signal, coupled with the knowledge even of only the approximate wavelength on which the station operates, should give you the clue to the studio responsible.

Until recently, the metronome was the instrument mostly used; gradually many stations have replaced it by a less monotonous and more musical signal. But, although to-day

# HOW TO RECOGNISE THE FOREIGNERS

acquired popularity; for example, tune in to Langenberg relaying the Cologne programme. If you listen to Beromuenster, according to the melody heard you will be able to tell, with a little practice, whether the broadcast is taken from Berne, Basle, or Zurich.

Where short phrases of melodies are adopted to fill intervals, the toy musical box, specially adapted for the purpose, has been brought into action. No doubt by now you will have logged the signal put out by Munich (or Nürnberg), Budapest, Oslo, and, comparatively recently, by Kalundborg (Copenhagen).

## Five-note Signal

From Radio Paris on Sundays you may have noticed the five-note signal which spells out the name of the company sponsoring the gramophone broadcast or possibly the carillon-like call of the Poznan (Poland) studio as it comes on the air.

It is only natural that stations offering good programmes should be anxious to identify themselves to listeners in other lands. Of these, four have chosen short melodies which are directly associated with their cities or countries—namely, Copenhagen, a Danish traditional dating back to the fourteenth century; Leipzig, notes to recall its composer, Bach; Warsaw, the first few bars of the "Polonaise in F major," by its beloved genius, Chopin; and

Oslo, which as an opening signal uses a theme from the Norwegian National Anthem ("Ja Vi Elsker") and, during intervals, a condensed motif from Grieg's "Sigurd Jorsalfar."

Prague, I understand, is seeking a similar inspiration and there is no doubt that other countries will follow suit in the immediate future.

It is sometimes possible to identify a studio by the fact that a woman is acting as announcer, but this is only circumstantial evidence; it does not constitute conclusive proof, as at some stations these female officials do not introduce all the programmes, but share the duties with their male colleagues. As examples I may mention Radio Strasbourg, Stockholm, Copenhagen, Berlin, Oslo, Algiers, Söttens, Warsaw, and Katowice. On the other hand, in Italy the chief announcers are *always* women.

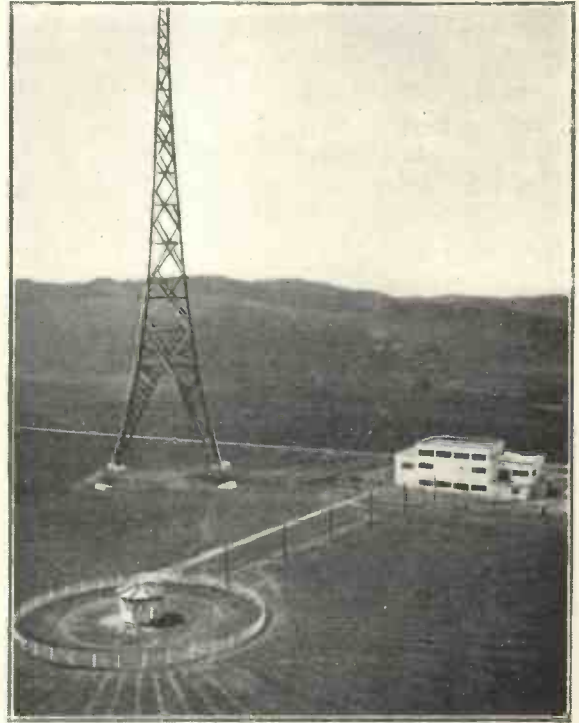

A VIEW OF THE BEROMUENSTER STATION  
On the left is seen the hut from which the aerial feeder is taken. This is connected, of course, to the main transmitting building on the right

Considering the number of stations at present operating in Europe—you are nearing the 250 mark—you will agree that it is difficult to invent or discover a new "noise" and great ingenuity has been shown by newcomers in thinking out fresh devices to attract the attention of their unseen audiences.

With this end in view, apart from the official or more conventional call which may or may not be picked up by the foreign listener, many studios have adopted specially distinctive signals; some of them have selected the songs of birds.

## Trilling of Nightingale

The trilling of the nightingale which you hear when switched on to Milan, Turin, or to any of the stations of the Northern Italian group, is a typical example. Ljubljana, in the same manner, treats you to a cuckoo call, which is also imitated by Wilno and—but not always—by Leningrad.

Radio Vitus (Paris), in view of its association with the Pathé film company, brings their well-known "rooster" on the ether, a signal which Prague has copied to open up its early



A PICTURESQUE BROADCASTING STATION

This is the transmitter at Salsburg, which relays the programmes put out from Vienna. It works on a wavelength of 218.7 metres

## ABC OF IDENTIFICATION—Continued

With next month's issue of "Wireless Magazine" will be given a free gift of the greatest value to those listeners who want to extend their log of foreign stations. Make a note that the October issue—a special Autumn Double Number—will be published on Wednesday, September 21. There is certain to be a great demand, so ask your newsagent to reserve a copy now!

morning transmission. Béziers (France) also gives us the call of a lusty cockerel.

The song of the canary may be heard from Lille PTT—an anaemic bird to judge from its performance—and even the call of the laughing jackass (kookaburra) has been made familiar to listeners on short waves by the Sydney (N.S.W.) station.

Morse signals are also still used by some broadcasting stations; Hamburg transmits the initial letters "HA," whilst Kiel and Hanover respectively sign "K" and "HR" between programme items. Vienna when coming on the air emits a series of "V's" (—.—) and Graz, as an alternative to the metronome, sometimes uses a morse "K" (—.—).

### Recognising Calls

It is evident that the average listener cannot be expected to wait until the end of a concert or play to ascertain the identity of a transmitter and it seldom happens that he actually tunes in at the moment the announcer introduces the forthcoming programme.

For this reason alone, good-night greetings, although useful at times, in most instances are too remote to assist in the recognition of a station, but there is every chance that in the course of a sitting some call will be picked up.

Bear in mind, therefore, that with all the German stations (without exception) the name of the city is preceded by the word "Achtung"; the French, on the other hand, favour the double-barrelled "Allo! Allo!" and the Italians (always women announcers) the specially coined "Eh-yah" (E.I.A.R.), representing the initial letters of the broadcasting association.

One point of importance, however, when listening to foreign-station calls must be borne in mind; it is that the native names of cities do not necessarily correspond to those which have been given to them in other languages.

For some unaccountable reason such names have been translated, with the result that when we hear them announced by their own citizens they cause confusion in our mind. As an example, let me cite Munich, which in Germany is "Muenchen" and becomes "Monaco" with the Italian announcer.

From Italy you may expect "Firenze" (Florence), "Genova" (Genoa), "Torino" (Turin), "Napoli" (Naples), and so on; in the same way, Huizen (Holland) is pronounced "Hoy-zen" and not "wheezing," as an acquaintance of mine termed it. Warsaw is "Warschavva," Moscow "Moskva," Prague "Praha," Kovno "Kaunas."

Almost everybody recognises "Par-ee" as Paris, but perhaps Brussels announced by the Belgians phonetically as "Brew-sell" may not prove so familiar.

Similarly, "Al-jay" must be written down as Algiers, "Bar-zel" as Basle, "Bay-o-grad" (Belgrade), "Bair-gen" (Bergen), "Bair-leen" (Berlin), "Bairn" (Berne), "Bairomewnster" (Beromuenster), "Bay-zee-aye" (Béziers), "Brew-no" (Brno), "Book-oo-recht" (Bucharest), "Curl-n" (Cologne), "Key-ob-en-harvn" (Copenhagen); "Krar-koof" (Cracow), "Jen-nayve" (Geneva), "Low-zarn" (Lausanne), "Tsew-risch" (Zurich), "Kat-owe-vee-tsay" (Katowice), "Kosh-eet-say" (Kosice), "Loub-lee-ah-nah" (Ljubljana), "Woodsh" (Lodz), "Two-er-ay-fell" (Eiffel Tower), "Ray-key-ar-veek" (Reykjavik), "Tree-ess-tay" (Trieste), etc., etc.

Doubtless, failing a knowledge of the particular language, there are many Continental broadcasts to which you will not care to listen; political speeches, scientific talks, and educational courses will only make an appeal to the linguist.

### International Interest

But, in view of the number of foreign broadcasts within the grasp of the average wireless receiver, you will, without doubt, pick up concerts of every description, relays of operatic performances, dance music, and the like, all of which are of international interest.

These alone are capable of providing good entertainment, but in addition I feel convinced that if their origin can be traced and that when hearing such transmissions you are capable of stating with full assurance that they emanate from some particular city, the pleasure in listening to the broadcast is increased.

I hope that the data I have given may assist you to identify your captures. Touring Europe *via* ether is a worth-while pastime!



THE STATION IN A CORNFIELD

An unusual view of the Sottens station in Switzerland, another Continental station well received in Britain. Its wavelength is 403 metres



# The Prosperity Three

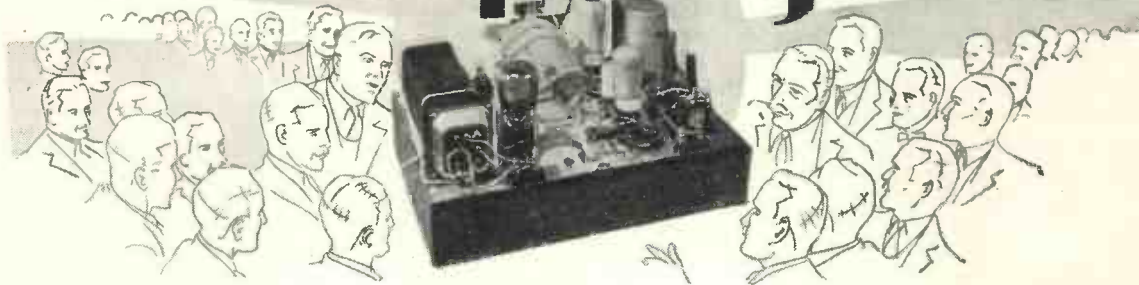

**EVERYBODY** is looking forward to better times during the next few months, and the whole nation is making an effort to recapture its former prosperity. With these facts in mind the "Wireless Magazine" Technical Staff decided to attempt something out of the ordinary in the way of a set for the Radio Exhibition—something that would be in advance of other receivers and that would meet with the approval of the most ambitious constructors.

## For Batteries, A.C. and D.C. Mains

We believe that these requirements have been achieved with the production of the Prosperity Three or, rather, of the Prosperity Three's, for here we give full constructional details of (1) a battery set, (2) an A.C. mains set, and (3) a D.C. mains set. One of these three models will meet the needs of every constructor.

All three versions of the Prosperity Three have certain features in common. For instance, in each case the valve sequence is a variable-mu high-frequency amplifier

## for D.C. Mains

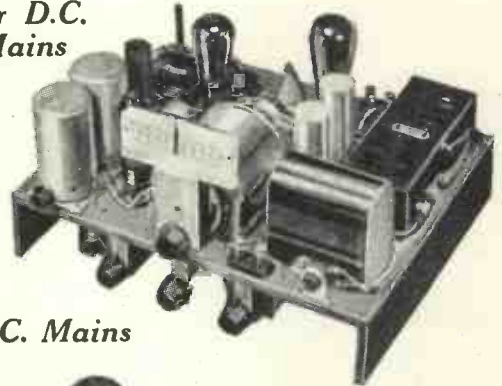

## for A.C. Mains

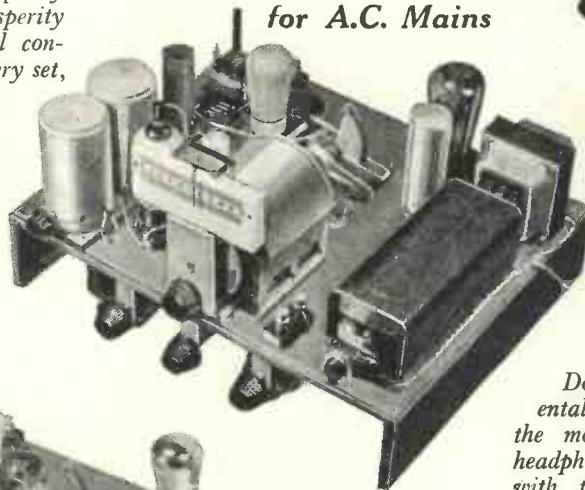

followed by a detector and a pentode output valve.

Each set also covers the short waves from 15 to 80 metres as well as the medium and long broadcast wavelengths. It will thus be seen that the Prosperity sets are intended to get the very best from modern broadcasting.

Dozens of high-power Continental stations can be picked up on the moving-coil loud-speaker, while headphones will put you in touch with the whole world through the medium of the short-wave transmitters scattered all over the globe.

## Gramophone-record Reproduction

And when radio reception palls the turn of a switch enables you to reproduce gramophone records with a purity and volume unobtainable from an acoustic instrument. In fact with any one of the three versions of the Prosperity Three you have some kind of entertainment on tap throughout the day.

Constructors who build up any one of these three versions can rest assured that they will possess a first-class radio outfit that will give them many months of enjoyable musical reproduction!

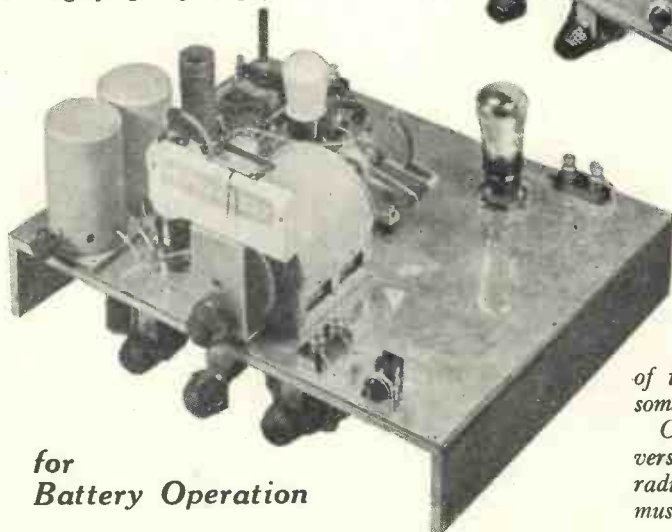

## for Battery Operation

All Three Sets Cover Short, Medium, and Long Waves : : Each Has a Radio and Gramophone Volume Control : : Switching for Using a Pick-up : : Variable-mu Valves for High-frequency Amplification Baseboard-chassis Construction : : Designed by the "Wireless Magazine" Technical Staff

# The Prosperity Three for Batteries

Here the "Wireless Magazine" Technical Staff presents full constructional and operating details of a three-valve radiogram that will receive on short, medium and long waves

FOR a long time listeners have been waiting for a set that will give them good results on short, medium and long waves with a minimum of complication. Such designs have been attempted in the past, but in nearly every case the short-wave portion has been a poor compromise.

Here is a three-valve screen-grid set that covers wave ranges of (1) 15 to 35 metres, (2) 35 to 80 metres, (3) 230 to 550 metres and (4) 1,000 to 2,000 metres by the operation of a single wave-change switch. By this means the listener takes advantage of the numerous short-wave broadcasts without having to alter his set in any way or connect up any additional unit.

Provision is also made for the electrical reproduction of gramophone records, so with the Prosperity Three there is always a good supply of music on tap, as it were, in the home.

As far as possible the number of controls has been minimised, but nothing essential for the best results has been omitted. The "Wireless Magazine"

used with different aerials and enables the operator to obtain the best compromise between strength and selectivity under his particular conditions.

## Neutralising Condenser for Short Waves

This condenser is too large for the best results on the short waves, so arrangements are made for switching into circuit a condenser of the neutralising type when the set is adjusted for short-wave reception.

The medium- and long-wave coils are tuned in the ordinary way by a .0005-microfarad variable condenser, while a .0002-microfarad condenser is used for short-wave tuning.

For the moment we will only consider the circuit arrangement for medium- and long-wave working. The tuning coil in the aerial circuit is connected to the screen-grid high-frequency amplifier in the usual way. This valve, it should be noted, is of the variable-mu type and therefore needs a special form of volume control.

## Volume Control without Distortion

In the grid-filament circuit of the first valve is a 15-volt grid-bias battery, across which is placed a 50,000-ohm potentiometer. In order to present a low impedance to high-frequency currents this potentiometer is shunted by a 1-microfarad fixed condenser. As the setting of the potentiometer is varied so is the bias on the grid adjusted and volume is controlled within fine limits without any trace of distortion. When the set is not in use the knob of the potentiometer should be turned to the left, so preventing the grid-bias battery from being run down.



COMPLETE RADIOGRAM

This is the Camco Gresham radio-gramophone cabinet for all three versions of the Prosperity Three. See it on Stand 7 at Olympia

Technical Staff presents the Prosperity Three sets with every confidence that they will meet the needs of nearly all listeners.

The circuit of the battery version appears on this page, so it will be as well to run through the main features of the design at this stage.

For medium- and long-wave reception the aerial is led to the tuning coil through a .0003-microfarad (maximum) series condenser in the usual way. This arrangement gives a simple method of controlling the selectivity of the receiver when

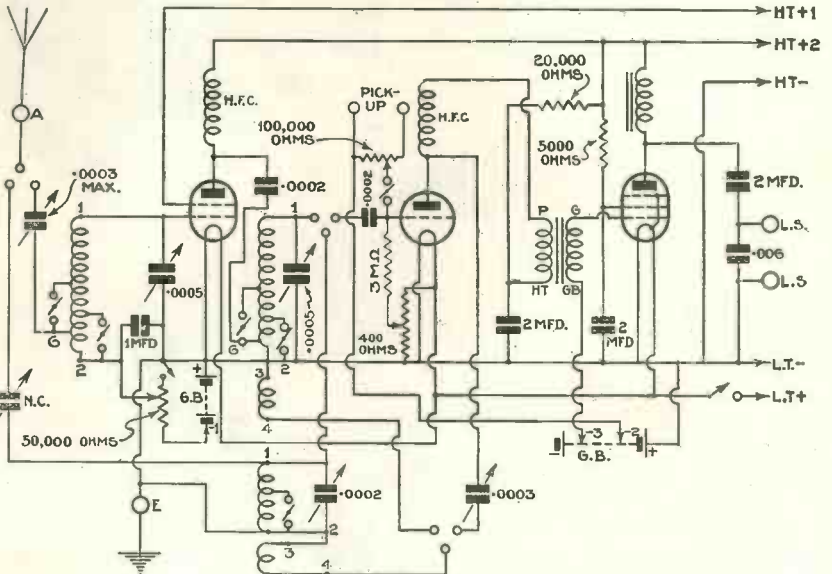

CIRCUIT OF THE BATTERY-OPERATED SET

The valve combination consists of a variable-mu high-frequency amplifier, detector and pentode. Long, medium and short waves can be received and there is provision for using a gramophone pick-up

The variable- $\mu$  valve is coupled to the detector by the tuned-grid method. This means that a high-frequency choke is placed in the anode circuit of the first valve and that a second tuning coil and .0005-microfarad variable condenser is arranged in the detector-grid circuit. The tuning condensers for the aerial and tuned-grid circuits are ganged together.

Coupled to this tuned-grid coil is a reaction winding, the amount of feedback being controlled as usual by a condenser of .0003-microfarad capacity.

### Leaky-grid Detector

The detector is arranged on the leaky-grid principle, the leak having a value of 3 megohms and the condenser being of .0002 microfarad.

In the grid circuit of this valve is also arranged the grammo-radio switching. When the switch is placed in the gramophone position the detector valve is supplied with grid bias so that it works as an amplifier instead of as a detector. There is a 100,000-ohm potentiometer across the pick-up to control the volume of record reproduction.

It will be noted that in the filament circuit of the detector valve there is a 400-ohm potentiometer to which one end of the grid leak is connected. The purpose of this potentiometer is to give a little extra bias to the valve so that the best reaction control is obtained for short-wave working.

### Adequate Decoupling Arrangements

There is nothing unusual about the connections of the low-frequency transformer used for coupling the detector to the power valve, which for the sake of extra output for a given high-tension consumption is a pentode. The usual decoupling arrangements are made at the detector stage, the resistance having a value of 20,000 ohms and the condenser a capacity of 2 microfarads.

In order to provide complete stability of operation the pentode screening grid is provided with a 5,000-ohm resistance and a 2-microfarad by-pass condenser.

There are two objects in providing a choke-capacity output system in this receiver. In the first place it helps towards stability and, in the second place, it enables the operator to use a pair of headphones for the reception of weak short-wave transmissions.

### Short-wave Reception

When the wave-change switch is put into either of the short-wave positions the tuning coil is connected directly to the detector valve. From this it is apparent that only the last two valves are used for short-wave reception; nevertheless, excellent results are obtained and a number of transmissions can be picked up at loud-speaker strength.

Those who want a really good bag of short-wave programmes are recommended to use a pair of headphones, when literally scores of transmissions will be heard.

To summarise, then, it will be seen that the Prosperity Three incorporates the following novel features:—

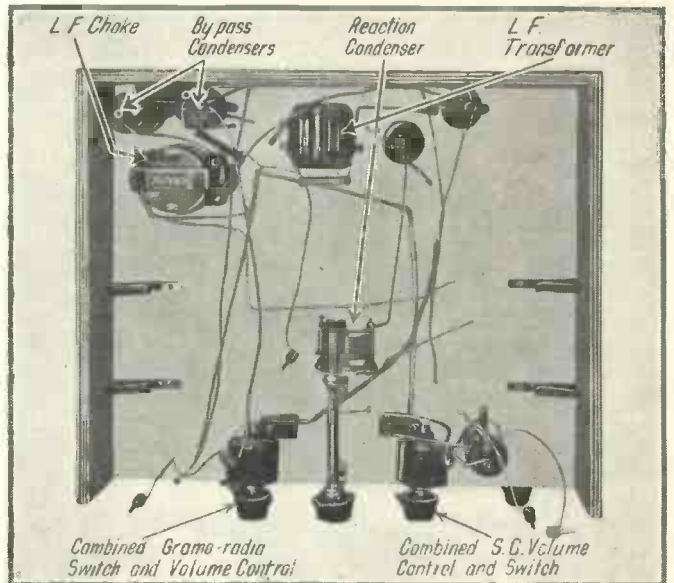
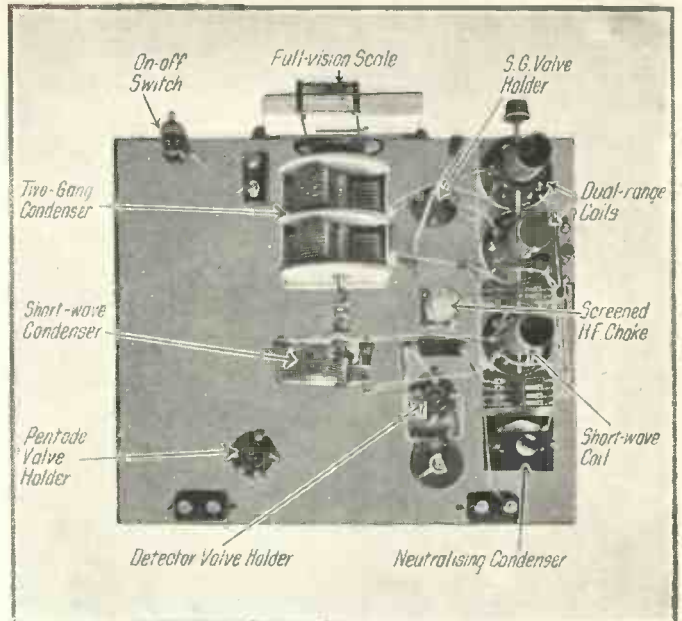

SPECIAL PLAN VIEWS OF THE BATTERY SET

At the top is a view of the top of the baseboard, while underneath the sub-chassis assembly is seen. The top of the baseboard is covered with aluminium foil

- (1) A screen-grid, detector and pentode combination for medium- and long-wave reception.
- (2) Detector and pentode combination for short-wave reception.
- (3) Variable- $\mu$  valve for distortionless high-frequency amplification and easy control of volume.
- (4) Switching for reception on four wave ranges by means of a single knob, and
- (5) Provision for record reproduction, with control of volume.

When housed in its cabinet the Prosperity Three represents the latest type of radio receiver—an all-wave radio gramophone with moving-coil loud-speaker.

In order to keep the set within reasonable dimensions, use has been made of the special baseboard-chassis

# PROSPERITY THREE FOR BATTERIES—Cont.

## PARTS COMMON TO ALL THREE VERSIONS OF THE PROSPERITY THREE

### CHOKES, HIGH-FREQUENCY

- 1—Wearite standard, type HFO, 6s. 6d.
- 1—Wearite screened, type HFP, 3s. 6d.

### CHOKE, LOW-FREQUENCY

- 1—Igranic, type C40, 12s. 6d.

### COILS

- 1—Magnum three-coil assembly, type WM3, £1 10s.

### CONDENSERS, FIXED

- 2—Dubilier .0002-microfarad, type 670, 2s. (or Telsen, T.C.C.).
- 1—Dubilier .006-microfarad, type 670, 1s. 6d. (or Telsen, T.C.C.).
- 1—Dubilier 1-microfarad, type 9200, 2s. 9d. (or Telsen, T.C.C.).
- 3—Dubilier 2-microfarad, type 9200, 11s. 3d. (or Telsen, T.C.C.).

### CONDENSERS, VARIABLE

- 1—Utility .0005-microfarad two-gang, type W314/2, 17s.
- 1—Utility .0003-microfarad reaction, type W/320, 4s.
- 1—Utility .0002-microfarad short-wave, type W/187, 6s. 6d.
- 1—Peto-Scott neutralising, 3s. 6d.
- 1—Sovereign preset, .0003-microfarad max., type J, 1s. 3d. (or Porino, Igranic).
- 1—Utility non-insulated coupler, 1s.
- 1—Bulgin 4-in. condenser extension spindle, type BH2, 1s. 9d.

### DIAL, SLOW-MOTION

- 1—Utility SL full-aperture, type W/317, 7s. 6d.

## EXTRA PARTS NEEDED FOR THE BATTERY VERSION

### HOLDERS, VALVE

- 2—W.B. four-pin, miniature type, 1s. 4d. (or Benjamin, Lotus).

### PLUGS AND TERMINALS

- 8—Belling-Lee wander plugs, marked: H.T.+2, H.T.+1, H.T.—, G.B.+ (2), G.B.—1, G.B.—2, G.B.—3, 1s. 4d. (or Clix, Ealex).
- 2—Belling-Lee spade terminals, marked: L.T.—, L.T.—, 4d. (or Clix, Ealex).

### RESISTANCES, FIXED

- 1—Claude Lyons 5,000-ohm, 1-watt type, 10½d.
- 1—Lissen 3-megohm grid leak with wire ends, 1s. (or Dubilier).

### RESISTANCE, VARIABLE

- 1—Wearite 50,000-ohm potentiometer (type QVC) combined with switch (type G40), 6s. 6d.

### SUNDRIES

- 2—Pairs Bulgin grid-battery clips, type No. 5, 4d.
- 1—2.5-volt flashlamp bulb for dial.

### HOLDER, VALVE

- 1—W.B. five-pin, miniature type, 8d. (Benjamin, Lotus).

### RESISTANCE, FIXED

- 1—Claude Lyons 20,000-ohm, 1-watt type, 10½d.

### RESISTANCES, VARIABLE

- 1—Lissen 400-ohm baseboard potentiometer, type LN140, 1s. 6d. (or Igranic).
- 1—Wearite 100,000-ohm potentiometer (type QVC) combined with switch (type G40), 7s. 6d.

### SUNDRIES

- Tinned copper wire for connecting (Lewcos).
- Lengths of oiled-cotton sleeving (Lewcos).
- Lengths of rubber-covered flex (Lewcos).
- 1—Packet of Goltone shielded wire, 9d.
- 1—Baseboard-chassis assembly.
- 1—Parex sheet of aluminium foil, 17 in. by 14 in., 1s. 6d.
- 5—Wearite aluminium brackets, 1s. 3d.
- 3—Lissen terminal blocks, marked: A and E, L.S., P.U., 3s. (or Belling-Lee).
- 1—Pair Ericsson headphones, 12s. 6d.
- 1—Belling-Lee insulated anode connector, 4d.

### TRANSFORMER, LOW-FREQUENCY

- 1—Lissen Hypernik, 12s. 6d.

## ACCESSORIES

### CABINET

- 1—Camco Gresham radiogram, £6.

### PICK-UP

- 1—Marconiphone, type K17, £2 2s.

### SWITCH

- 1—Becker on-off, type 460, 1s. 10d.

## ACCESSORIES

### BATTERIES

- 1—\*Pertrix 150-volt super-power high-tension, type 301, £1 11s. (or Ever Ready).
- 1—Pertrix 15-volt grid-bias, type 262, 2s. 3d. (or Ever Ready).
- 1—Pertrix 9-volt grid-bias, type 260, 1s. 3d. (or Ever Ready).
- 1—Pertrix 2-volt accumulator, type PLB2, 12s. 6d. (or Ever Ready).
- (\* Or Atlas AC 188 unit for A.C. mains, £6.)

### GRAMOPHONE MOTOR

- 1—Garrard No. 30 clockwork, with 12-in. turntable, £1 10s.

### LOUD-SPEAKER

- 1—Rothermel Sonochorde, type PMP, £1 12s. 6d.

### VALVES

- 1—Cossor 220VSG, 16s. 6d.
- 1—Cossor HL2 metallised, 7s.
- 1—Cossor 220PT, 17s. 6d.

type of construction that proved so popular in the case of the Quadradyne a few months ago. This system has most of the advantages of the chassis form of assembly, without any of its disadvantages.

## Simple Assembly

For instance, the necessary wiring holes can easily be made in the aluminium foil with which the baseboard is covered and good screening is obtained. Unlike the thick metal chassis, the baseboard chassis can easily be adapted to accommodate any size or shape of component. A bradawl will make all the necessary fixing and wiring holes in a few moments.

Although all the essential details for the construction of the set are included in these pages, it is realised that many readers will prefer to work from a full-size blueprint. This can be obtained for half price, that is 6d., post free, if the coupon to be found on the last page of this issue is used by September 30.

## Where to Send

Address your application to "Wireless Magazine," Blueprint Dept., 58-61 Fetter Lane, London, E.C.4, and ask for No. WM296.

A quarter-scale reproduction of the blueprint will be seen on the opposite page.

Before discussing the actual construction, however, it is necessary to say something about the components

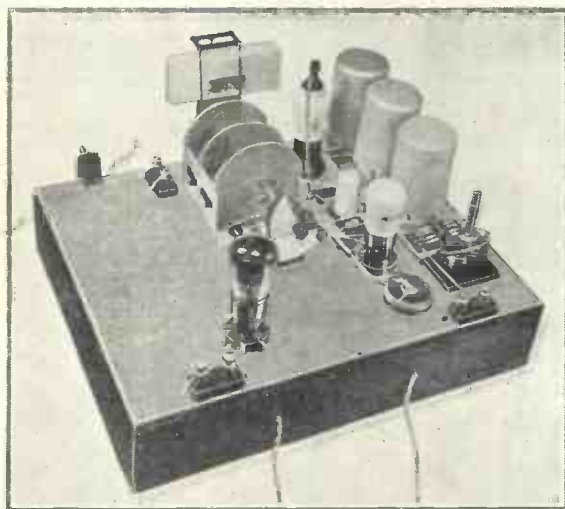

**FIRST EXPERIMENTAL ASSEMBLY**  
Exhaustive tests were made on this original model. The short-wave coil is now supplied without a can

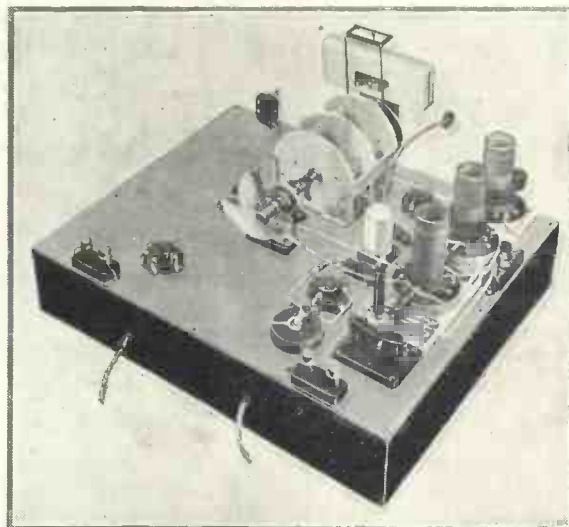

**SIMPLE AND ACCESSIBLE LAYOUT**  
The final model of the battery-operated Prosperity Three, one of the most outstanding "W.M." designs yet



## PROSPERITY THREE FOR BATTERIES—Cont.

## The Battery Version on Test

ONLY two and a half hours were spent for the test of the battery model of the Prosperity Three. Every station included in the log—and there are well over thirty of them—was definitely identified in that time. When we take into consideration that the test was made in July, the results must be considered very fine.

## South London Test

The test was made in South London, using a 70-ft. outdoor aerial and the specified valves and loud-speaker.

In addition to the splendid performance on the medium and long wavebands, short-wave transmissions were picked up; gramophone reproduction was also most satisfactory.

There are four distinct fields of amusement which the listener has at his disposal—a point which few sets offer. I will discuss the test results of each in turn.

The medium-wave log, for so short a test time, is remarkable for the time of year. For listeners who enjoy listening to foreign stations, the upper part of this waveband is the ideal thing. Every station from Midland Regional upwards was received at full loud-speaker strength and free from all interference.

The big high-power trio—Prague, North Regional and Langenberg—were heard entirely clear

of one another. Beromuenster was a splendid signal—quite as good as Midland or North Regional. From Midland Regional downwards there was slight interference between some of the stations, but with careful adjustment of the controls the interference would hardly spoil the individual programmes.

On the long waves there was no interference between Hilversum, Radio Paris and Daventry. Each of these stations gave clear-cut signals with 100-per-cent. entertainment value.

The short waveband is a feature that will please the enthusiastic amateur and, once he gets the distance craze, he will be knob-twiddling far into the early hours of the morning trying to get America. During the half hour which I spent on this band I heard Moscow and Rome, besides several other signals which were not identified. All of these were heard on the loud-speaker.

## America on Phones

America was heard very clearly on headphones. Atmospheric conditions were bad or probably the New World would have come in on the loud-speaker. Quality and strength on the gramophone side was certainly very pleasing.

This is certainly an attractive set which is thoroughly up to date for modern conditions. T. F. Henn.

## Log of Prosperity Three

## MEDIUM WAVEBAND

London National  
Heilsberg  
Huizen  
North National  
Bordeaux  
Poste Parisien  
Brussels (No. 2)  
London Regional  
Scottish Regional  
Toulouse  
Midland Regional  
Söttens  
Madrid

Stockholm  
Rome  
Paris (Ecole Sup.)  
Beromuenster  
Lyons  
Langenberg  
North Regional  
Prague  
Florence  
Brussels (No. 1)  
Vienna  
Palermo  
Budapest

## LONG WAVEBAND

Oslo  
Kalundborg  
Motala  
Warsaw

Eiffel Tower  
Daventry National  
Radio Paris  
Hilversum

for the fixing screws in the metal foil; a bradawl can be used for this purpose.

The wiring of the set should be carried out carefully. Although this may appear to be complicated, it will be found very simple and straightforward if the blueprint is followed. Each connecting wire is numbered in the proper order of assembly, so the wiring should be carried out in the numerical order indicated.

## Checking Blueprint Numbers

Start with lead No. 1 and, when this has been completed, cross through the number on the blueprint. If the wires are put in position in the proper order and the corresponding numbers on the blueprint are crossed through as the connections are made, there will be no possibility of making a mistake.

It will be clear from the photographs and layout diagram that there are six controls on the set. On the extreme left is the wave-change switch; this has four positions, each being marked with the particular wavelength range.

## Radio Volume Control

Next to this is the radio volume control, with which is incorporated a switch to cut the variable-mu valve out of circuit when records are being reproduced and when short-wave reception is being undertaken.

In the centre are two controls, one being placed above the other. The top control is the main tuning knob; it actuates the two-gang .0005-microfarad condenser that adjusts the aerial and tuned-grid circuits for medium and long waves, and it also actuates the short-wave .0002-microfarad tuning condenser, which is coupled to the spindle of the two-gang instrument.

## Single Tuning Control

It will thus be evident that this single tuning knob is the only one to be operated on whatever wave range reception is being carried out.

Underneath the main tuning knob is the reaction control, which is, of course, operated in the ordinary way.

The next knob on the right is the gramophone volume control, with

(Continued on page 234)

# The Prosperity Three for A.C. Mains

Using the same basic circuit as the battery model described in preceding pages, this version gives even better results on account of the efficiency of mains valves

**T**HIS set is exactly the same as the battery receiver described in the preceding pages except for the addition of a number of extra components to enable it to be operated from A.C. electric mains.

### Same Basic Circuit

Otherwise, the basic circuit and layout remain the same and the controls are identical with those for the battery-operated version.

Although this set employs no

stands it is completely stable in operation and almost entirely free from hum.

There is no need to go into a detailed analysis of the circuit arrangement; it is a variable-mu, detector and pentode combination

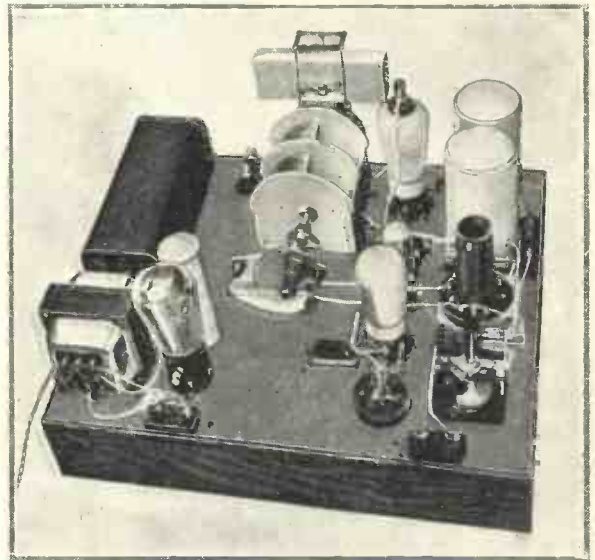

**COMPLETELY ASSEMBLED AND READY FOR USE**  
Note the top-of-baseboard layout of the A.C. version of the Prosperity Three, an all-wave variable-mu, detector, and pentode combination

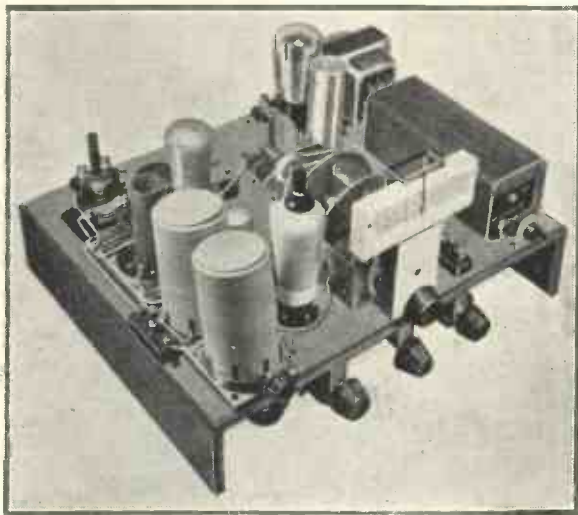

### SIX STRAIGHTFORWARD CONTROLS

The controls on all three editions of the Prosperity Three are arranged in the same way. For details see article on the battery version

more valves than the battery edition it will, of course, in practice give better results. That is because mains valves are more efficient than corresponding battery types; the output stage is also larger and can handle much more power without distortion.

It will be seen from the circuit diagram that this A.C. version has more complete decoupling than was necessary in the battery receiver. As it

rectifier. This gives a rectified output of approximately 60 milliamperes

at 200 volts, so that there is plenty of power to operate the output valve.

### Comparative Cost

There is an idea among constructors that a metal rectifier is much more expensive than a valve rectifier, but this is not the case. The particular model of rectifier used in the Prosperity Three costs less than £1, and can be regarded, for all practical purposes, as being everlasting.

An interesting point about the circuit is that a

condenser of the dry electrolytic type is used for smoothing. This condenser has a capacity of 8 microfarads, yet it is not so large as a valve and costs only a fraction over five shillings — surely something revolutionary in condensers!

The switching arrangements for gramophone reproduction and short-wave reception are the same

## SEE THE "PROSPERITY" SETS ON STAND 7 AT OLYMPIA

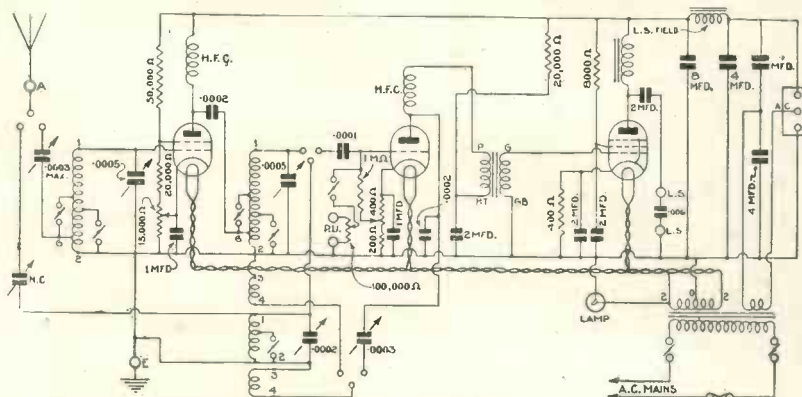

### CIRCUIT FOR GOOD PERFORMANCE WITH STABILITY

The circuit of the A.C. edition of the Prosperity Three has been designed to give the maximum efficiency with absolute stability in operation

# THE PROSPERITY THREE FOR A.C. — Cont.

## COMPONENTS NEEDED FOR THE A.C. VERSION OF THE PROSPERITY THREE

All "common" parts listed on page 148 will be required.

### EXTRA PARTS NEEDED FOR A.C. VERSION

#### CONDENSERS, FIXED

- 1—Dubilier .0001-microfarad, type 670, 1s. (or Telsen, T.C.C.).
- 1—Dubilier 1-microfarad, type 9200, 2s. 9d. (or Telsen, T.C.C.).
- 1—Peak 2-microfarad, 1,500-volt test, 3s. 9d.
- 3—Peak 4-microfarad, 1,500-volt test, £1 0s. 3d.
- 1—Dubilier 8-microfarad dry electrolytic, 450-volt D.C. working, 5s. 6d. (or T.C.C.).

#### HOLDERS, VALVE

- 2—W.B. five-pin, miniature type, 1s. 4d. (or Benjamin, Lotus).

#### METAL RECTIFIER

- 1—Westinghouse type HT8, 18s. 6d.

#### RESISTANCES, FIXED

- 1—Claude Lyons 200-ohm, 1-watt type, 10½d.
- 1—Claude Lyons 400-ohm, 1-watt type, 10½d.
- 1—Claude Lyons 8,000-ohm, 1-watt type, 10½d.
- 1—Claude Lyons 20,000-ohm, 1-watt type, 10½d.

- 1—Claude Lyons 50,000-ohm, 1-watt type, 10½d.

- 1—Lissen 1-megohm grid leak with wire ends, 1s. (or Dubilier).

#### RESISTANCE, VARIABLE

- 1—Wearite 15,000-ohm potentiometer (type QVC), 4s. 6d.

#### SWITCH

- 1—Becker double-pole, type 461, 2s. 0½d.

#### TRANSFORMER, MAINS

- 1—Sound Sales, type H8 shielded super, £1 5s.

#### ACCESSORIES

##### GRAMOPHONE MOTOR

- 1—Garrard No. 201 induction with automatic stop, £4 17s. 6d.

##### LOUD-SPEAKER

- 1—Rothermel Sonochorde, D.C. type with 2,500-ohm winding, £1 5s.

##### VALVES

- 1—Mullard MM4V metallised, 19s.
- 1—Mullard 904V metallised, 13s. 6d.
- 1—Mullard Pen4V, £1.

as employed in the battery version; the constructor should read the remarks made about the battery set on pages 146 to 150, for many of the features are common to all three versions of the Prosperity Three.

### Radio Volume Control

One point of difference is the arrangement for controlling volume during radio reception. The grid bias is so applied that the cathode is made positive with respect to the grid, instead of the grid being made negative with respect to the cathode. This arrangement has the merit of keeping the voltage on the screen of the valve more or less constant

whatever the setting of the grid-bias potentiometer.

It will be seen that there is a 50,000-ohm resistance in the anode supply lead, with a tapping taken off to the screen of the variable-mu valve. Between the cathode and the screen are connected a 15,000-ohm potentiometer and a 20,000-ohm fixed resistance. The part of the potentiometer that is unused is shunted by a 1-microfarad condenser that acts as a high-

loud-speaker is therefore essential unless an extra low-frequency choke is put in the circuit at this point. The advantage of using the loud-speaker as a choke is that the energising current is obtained without any complication and the cost of a choke is saved.

The smoothing condensers across this choke are a 4-microfarad and the 8-microfarad electrolytic already referred to. This arrangement gives ample smoothing for all ordinary purposes.

### Standard Components

Again we would emphasise the fact that all the parts used in the construction of this receiver are standard and should be obtained from radio dealers without difficulty.

The list of parts is arranged in the way referred to in the article on the battery version of the Prosperity Three. All the parts common to the three versions will be needed (they are listed on page 148); in addition the extra components indi-

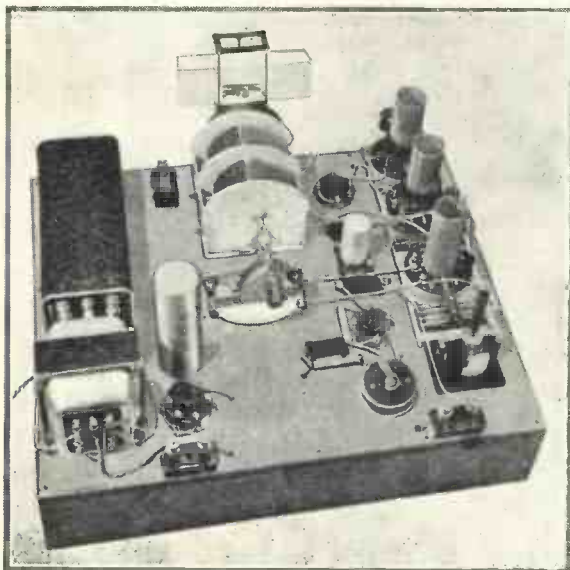

**BEFORE THE VALVES ARE PUT IN POSITION**  
Another view of the A.C. version of the Prosperity Three, showing the metal foil on the baseboard. The condenser and coil covers have been removed

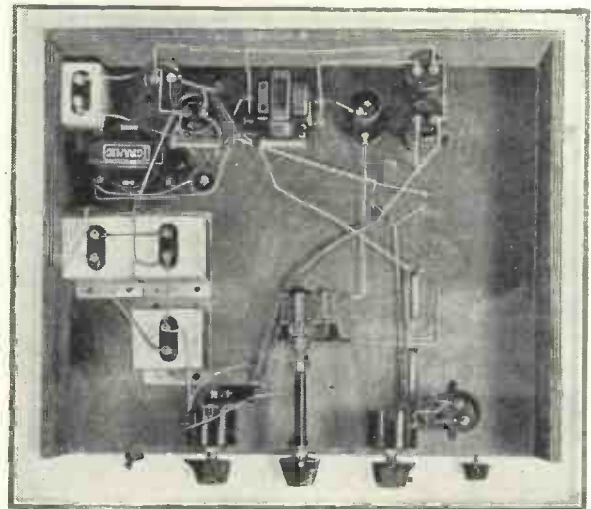

**UNDER SIDE OF THE BASEBOARD-CHASSIS**  
Many of the components in the A.C. edition of the Prosperity Three are mounted under the baseboard-chassis; this results in short and direct wiring

frequency by-passed on this page will be required.

The assembly is made on the same type of baseboard-chassis used for the battery set. As before explained, the top part of the blueprint should be placed over the baseboard and the centres of the holes for the sub-baseboard leads type, is used as a smoothing choke. This type of



# COMPLETE ALL-WAVE RADIOGRAM

On this page is reproduced a quarter-scale layout and wiring diagram of the set; those who desire one can obtain a full-size blueprint for half price, that is 6d., post free, if the coupon to be found on the last page is used by September 30. Ask for No. WM297 and address your application to "Wireless Magazine" Blueprint Dept., 58/61 Fetter Lane, London, E.C.4. A copy will be sent by return of post.

The set has been thoroughly tested and can be relied on to give excellent results wherever it may be used. Quality is better than with the battery version, of course, because of the larger power valve that is utilised. In fact the volume will be too great in most homes unless the volume control is brought into play.

## Radiogram Cabinet

This set has been designed to fit into the radio gramophone cabinet illustrated on page 146, but, of course, any other suitable model can be used. The terminals for the pick-up are deliberately placed near the front edge of the set so that the necessary leads from the motor-board will be as short and direct as possible. The pick-up leads in all three sets should be made with metal-braided cable, as indicated on the blueprints.

## Operating Details

The method of operating the set is similar to the method of working the battery model, which has already been explained in detail. We will not waste space by going through the details again; constructors are referred in particular to the remarks made on page 234.

As the detector valve is automatically biased for gramophone reproduction, and as the power valve is also supplied with bias in the same way, no alternative valves have been indicated. If other types were used it might be necessary to change the values of the bias resistances and this would necessitate a little calculation. The method of working out the proper value of biasing resistance has been explained many times in these pages.

## Detector Potentiometer

Particular note should be made of the setting of the 400-ohm baseboard potentiometer when short-wave reception is being undertaken. This resistance varies the bias on the valve, and when set correctly will enable a very smooth control of reaction to be obtained. A little care taken with the preliminary setting will be amply repaid in the way of better short-wave reception.

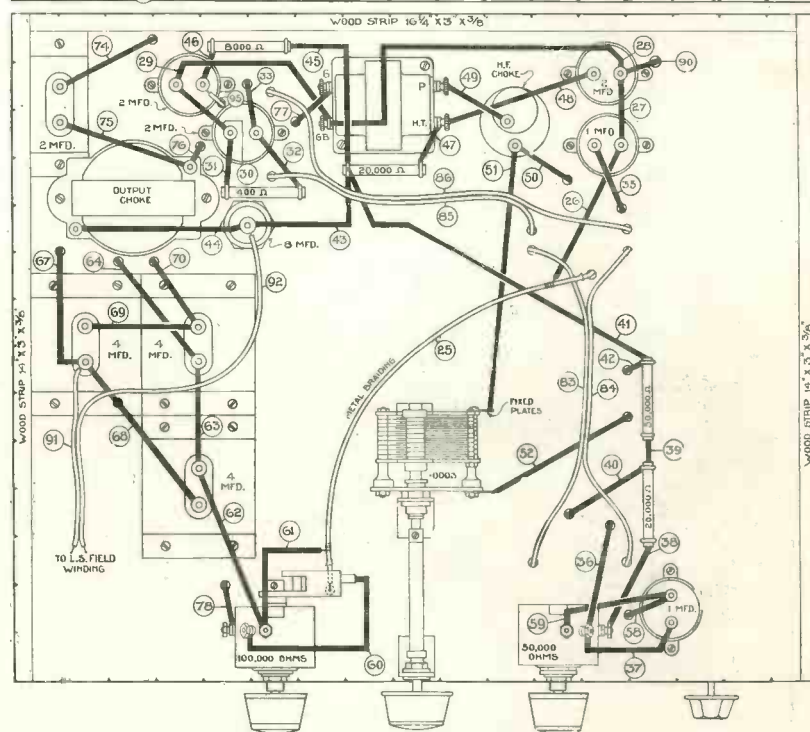
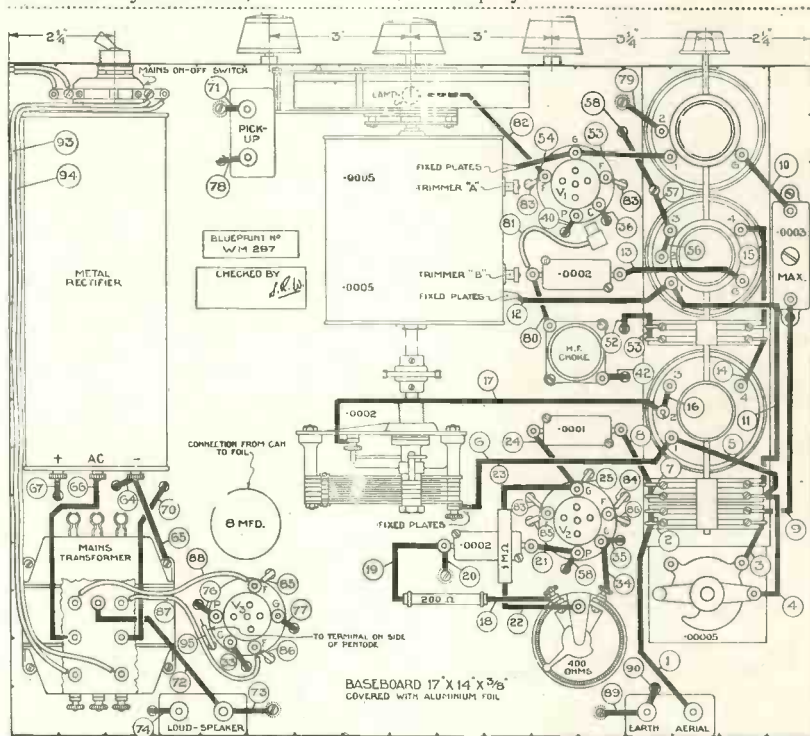

QUARTER-SCALE LAYOUT AND WIRING DIAGRAM

If desired a full-size blueprint can be obtained for half price (that is, 6d., post free) if the coupon on the last page is used by September 30. Ask for No. WM297 when ordering. Make the connections in the numerical sequence indicated—each wire is numbered separately.

# The Prosperity Three for D.C. Mains

Here is a design that will be welcomed by all who have only D.C. mains available for running their sets—an absolutely up-to-date receiver

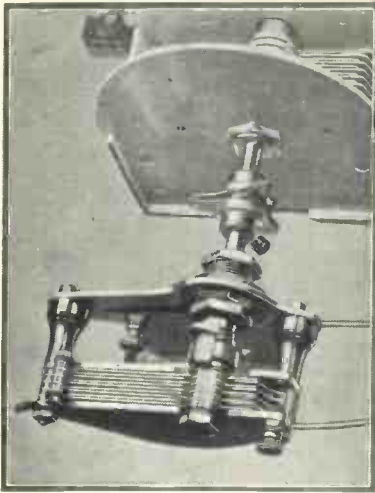

**CONDENSER COUPLER**

*This photograph shows clearly the coupling between the two-gang condenser and the .0002-microfarad short-wave condenser; this fitting is common to all three versions of the Prosperity Three*

THE D.C. version of the Prosperity Three is unique in that it is the first set with D.C. mains valves to be described in the pages of "Wireless Magazine." In the past we have not had very much faith in D.C. valves, but tests made during the past few months have convinced us that they are now as satisfactory in service as the standard A.C. types.

Not only is this the first "Wireless Magazine" set to use D.C. mains valves; it is probably also the first published set to make use of a variable-mu D.C. valve, for this

type has only become available during the past few weeks.

This set needs no batteries at all. All the current for high tension, filament supply and grid bias is obtained from the mains. The filament consumption is .25 ampere, which means that the power consumed (assuming a mains voltage of 200) is about 50 watts. *From this it will be appreciated that the cost of running the set is no more than the cost of running an electric-light bulb of quite ordinary power.*

### Reasonable Consumption

We wish to emphasise the fact that the consumption of this set is quite reasonable, for the beginner who reads P. K. Turner's article on getting "A" quality from D.C. mains (which appears on page 187 of this issue) might assume that all D.C. sets are prohibitive in running cost.

The circuit employed is basically the same as those of the battery and A.C. versions, which have been dealt with in the preceding pages. Of course, there are slight modifications.

Unlike an A.C. set, there is no need for a mains rectifier in a D.C. receiver, and the supply can be taken direct to the valve anodes

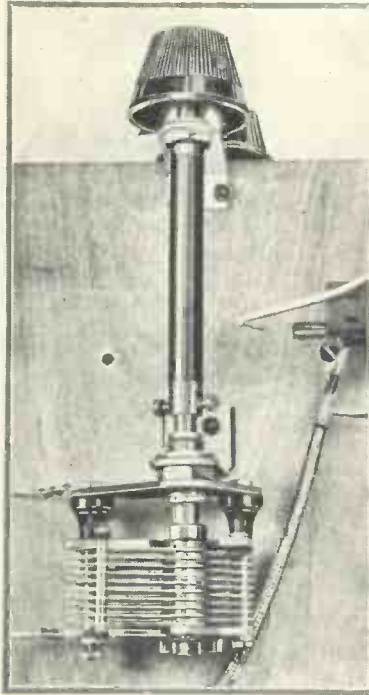

**REACTION EXTENSION SPINDLE**

*In all three of the Prosperity sets the knob of the reaction condenser is fixed to the main component by means of an extension spindle*



**COMPLETED ASSEMBLY**

*This is how the D.C. version of the Prosperity Three appears when it is completely wired up. The breakdown resistance is seen on the left*

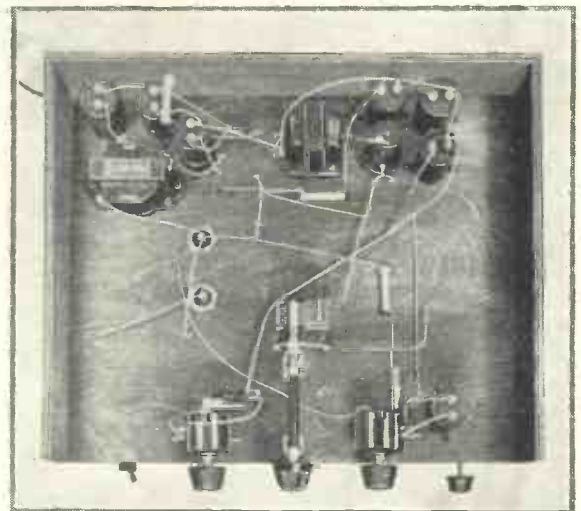

**UNDER SIDE OF CHASSIS**

*Several components are mounted on the under side of the baseboard-chassis. This method of assembly gives short and direct wiring*

after smoothing has been carried out. In this set the pot winding of the loud-speaker, although of the same energised type as used in the A.C. version, is not used as a smoothing choke as there is not sufficient voltage to spare.

**Smoothing Choke**

Actually use has been made of what is really a pentode output choke. This has a comparatively high resistance and limits the anode voltage to the right value. The smoothing condensers are two 8-microfarad models of the dry electrolytic type, which have the merits of occupying but small space and of being inexpensive. On most D.C. mains the set will be found to be as free from hum as a good set should be.

The mains voltage has to be reduced, of course, for application to the valve heaters, each of which takes 16 volts. In practice the problem is not so difficult to solve as might be imagined; the valves are wired in series and the breakdown resistance has only to carry the current required by one valve, that is .25 ampere.

**Total Voltage**

In a D.C. set it is possible to run all the valves in series, provided the total filament voltage thus required does not exceed the voltage of the mains.

The breakdown resistance used is of a type that has been on the market for a few months, and there is no difficulty about supplies. Terminals are provided so that the resistance can be adapted for use on any mains above 200 volts. The set will not work from 100- or 110-volts mains, of course, because this voltage is not sufficient for running the valves efficiently.

**Precautions**

Care has to be taken in the handling of a D.C. mains set because a direct connection to earth may result in the main house fuses being blown. Some D.C. mains are so arranged that the positive wire is earthed; this means that should the negative lead of the set be also accidentally earthed the mains will be short-circuited.

In practice this possibility is guarded against by making the earth connection proper through a fixed condenser. Great care should

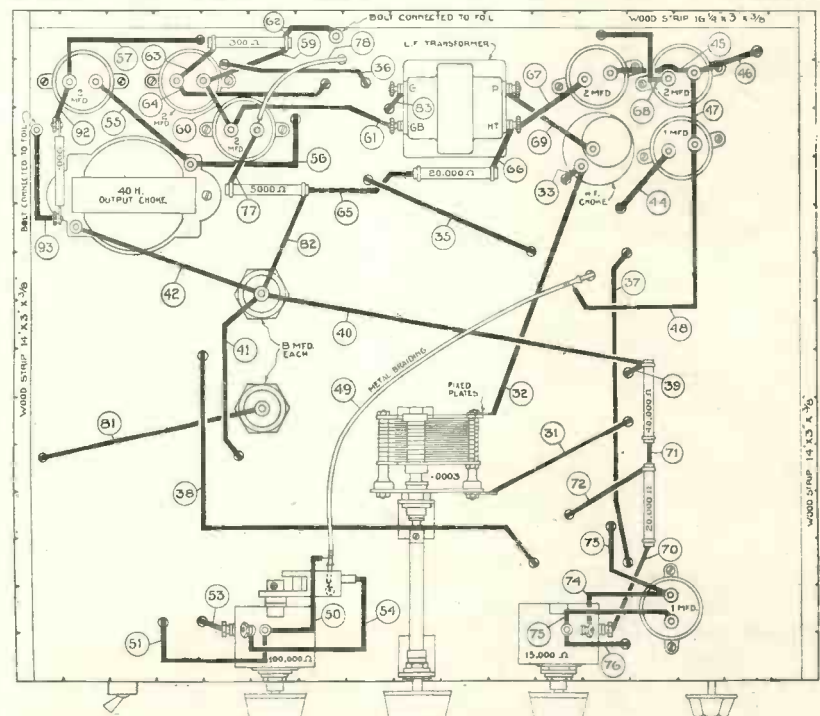
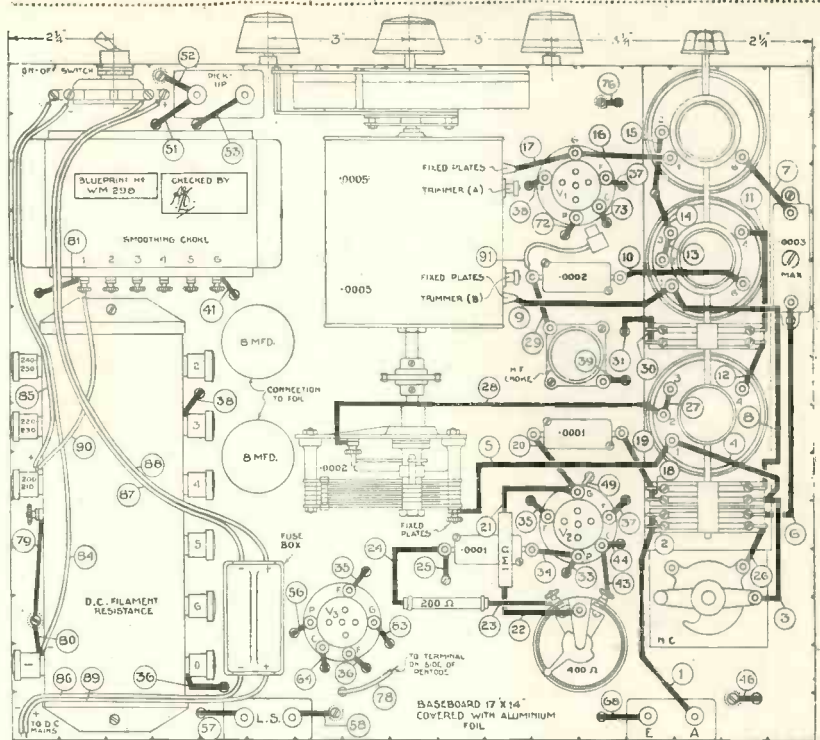

**QUARTER-SCALE LAYOUT AND WIRING DIAGRAM**  
 A full-size blueprint can be obtained for half-price (that is 6d., post free) if the coupon on the last page is used by September 30. Ask for No. WM298. Wire up the lead in the numerical sequence indicated

be taken, therefore, never to earth the set except by means of the earth terminal. Constructors should not attempt to economise by omitting the 1-microfarad condenser in series with the earth terminal.

It is also as well to take precau-

tions to see that the aerial or the lead-in cannot be accidentally earthed or the main fuses may be blown in this way. A good plan is to use insulated wire for the aerial, so that if it falls down there will be no circuit to earth.

# THE PROSPERITY THREE FOR D.C.—Cont.

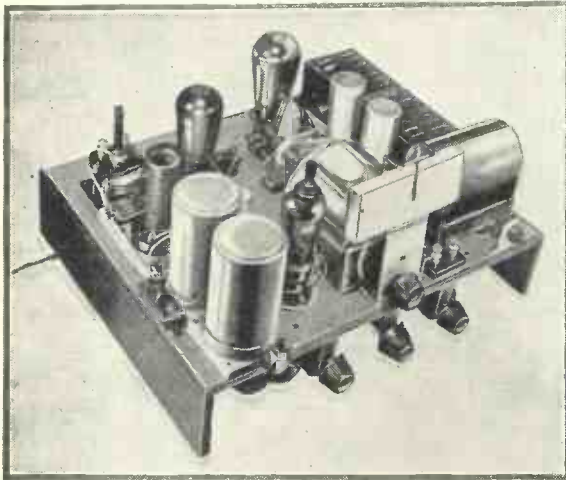

**CONTROLS AS ON THE BATTERY AND A.C. SETS**  
The controls on all three versions of the Prosperity Three are identical. On the right can be seen the pentode output choke that is used with the D.C. set for smoothing

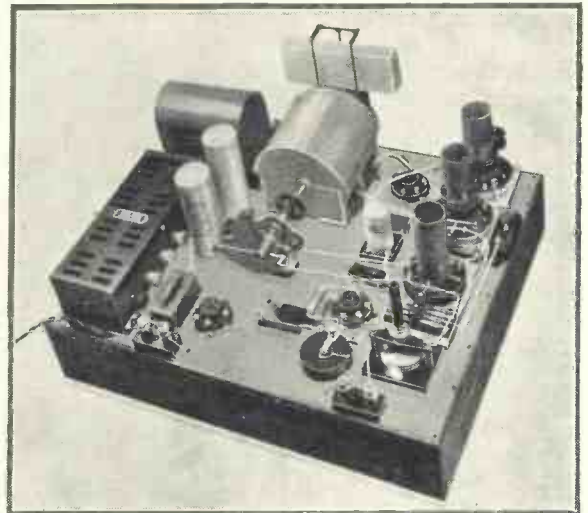

**COMPACT BUT STRAIGHTFORWARD ASSEMBLY**  
This photograph of the D.C. Prosperity Three shows how compactly the parts are arranged

If these precautions are carefully observed there is no likelihood of your application to "Wireless Magazine," Blueprint Dept., 58/61

have not been mentioned in detail in either of the two preceding articles are illustrated in these pages.

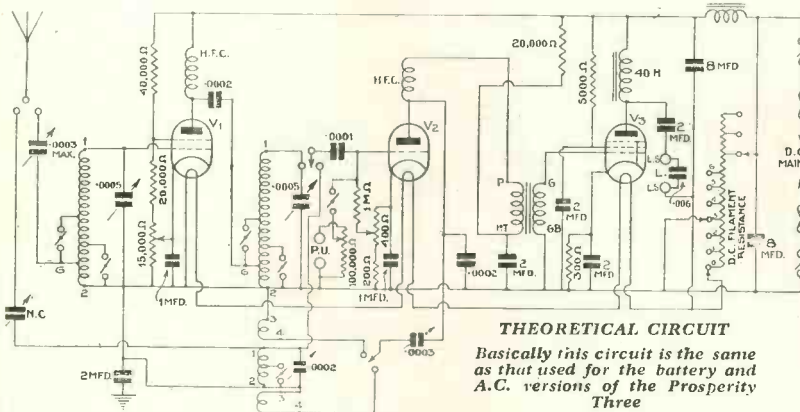

In the first place it should be noted that the .0002-microfarad short-wave tuning condenser is coupled to the spindle of the two-gang condenser by means of a non-insulated coupler obtainable from the condenser manufacturers. It should be noted that the coupler is of the non-insulated type because the metal connection forms one of the leads to the short-wave condenser, which would be effectively disconnected were an insulated coupler to be used.

The second point is that the knob of the reaction condenser is attached to the main component by means of an extension spindle. This is

any damage being done, and the set can be used with perfect safety.

Fetter Lane, London, E.C.4.  
Two points of construction that

As in the case of the A.C. version, the list of components needed is arranged in two parts. All the "common" parts listed on page 148 will be required in addition to the extra components indicated on this page.

The main lines of construction are as for the battery and A.C. editions of the Prosperity Three, the descriptions of which should be read even if it is not intended to build either of them.

A full-size blueprint of the D.C. set can be obtained for half price, that is 6d., post free, if the coupon to be found on the last page of this issue is used by September 30. Ask for No. WM298, and address

(Continued on page 252)

## COMPONENTS NEEDED FOR THE D.C. VERSION OF THE PROSPERITY THREE

All the parts listed as "Common" on page 148 will be required

### EXTRA PARTS NEEDED FOR THE D.C. VERSION

#### CHOKE, LOW-FREQUENCY

1—Atlas type CPT for smoothing, £1 1s.

#### CONDENSERS, FIXED

1—Dubilier .0001-microfarad, type 670, 1s. (or Telsen, T.C.C.).

1—Dubilier 1-microfarad, type 9200, 2s. 9d. (or Telsen, T.C.C.).

1—Dubilier 2-microfarad, type 9,200, 3s. 9d. (or Telsen, T.C.C.).

2—Dubilier 8-microfarad dry electrolytic, 450-volt D.C. working, 11s. (or T.C.C.).

#### FUSE

1—Belling-Lee double fuse and holder, 2s. 6d.

#### HOLDERS, VALVE

2—W.B. five-pin, miniature type, 1s. 4d. (or Benjamin, Lotus).

#### RESISTANCES, FIXED

1—Bulgin universal D.C. mains resistance, type B, 18s. 6d.

1—Claude Lyons 300-ohm, 1-watt type, 10½d.

1—Claude Lyons 5,000-ohms, 1-watt type, 10½d.

1—Claude Lyons 40,000-ohms, 1-watt type, 10 d.

1—Claude Lyons 20,000-ohm, 1-watt type, 10½d.

#### RESISTANCE, VARIABLE

1—Wearite 15,000-ohm potentiometer (type QVC), 4s. 6d.

#### SWITCH

1—Becker double-pole type 461, 2s. 0½d.

### ACCESSORIES

#### GRAMOPHONE MOTOR

1—Garrard standard universal with automatic switch, £5 15s.

#### LOUD-SPEAKER

1—Rothermel Sonochorde D.C. model with 2,500-ohm winding, £1 5s.

#### VALVES

1—Osram VDS, 19s.

1—Osram DH, 18s. 6d.

1—Osram DPT, £1

# GRAMOPHONE SECTION RADIO

A Special Section for Those Interested in Electrical Record Reproduction

## Gramo-Radio Notes and News

**H**AVE you thought of fitting a tone control to your radio-gramophone? Tone controls will undoubtedly become popular during the next few months. They enable the particular set and loud-speaker being used to be adjusted for the most pleasing tone. For instance, with speech reproduction a little more top usually sounds better, while for organ-record reproduction the bass can be emphasised at will. The cost of adding a tone control to an existing set is only about 5s. or so, and is very easily done.

Nowadays if you 'phone up the Gramophone Company's Oxford Street branch and the person to whom you wish to speak is temporarily engaged you are entertained for a few minutes by music reproduced from records.

Many gramo-radio enthusiasts will be interested in a book published recently under the title "Gramophones: Acoustic and Radio." It has been compiled by G. Wilson, brother of the P. Wilson who contributes to "Wireless Magazine."

The book contains 124 pages and its scope can best be indicated by running through the chapter headings, which are as follows: Buying an Acoustic Gramophone; How a Gramophone Works; Using a Gramophone; Needles; Points in

Gramophone Design; Overhauling a Gramophone; Records; Buying a Radio Gramophone; Points in Radio-gramophone Design; Pick-ups; and Miscellaneous Hints. There are also three appendices: (1) Defects in Gramophone Records, (2) Ohm's Law Simply Explained, and (3) Pick-up Connections and Some Gramophone Queries Simply Answered.

The book is published by Gramophone (Publications), Ltd., of 10a Soho Square, London, W.1, at 1s. and is good value for money.



**SEVEN-VALVE RADIOGRAM**  
Variable- $\mu$  valves and a tone control are features of this H.M.V. Super-het Radiogram Seven, which is priced at 50 guineas

For the Leicester Pageant, which had an audience of 30,000, Partridge and Mee, Ltd., installed a special 1-kilowatt amplifier, which made use of two M7B valves in parallel, fed by four VL3 rectifiers, a 250-watt amplifier, and a 50-watt amplifier. Twenty-five projective type Parmeko loud-speakers were also used.

As the organ has been removed because of extensive repair work at St. Asaph Cathedral, the music for a wedding was recently obtained from records reproduced by a system installed by the British Manufacturing Co., of Liverpool. An output of 25 watts was provided.

If you want to build yourself a new radio-gramophone do not overlook the description of the "Prosperity" models in this issue. There is also a further article on the Percy Harris Radiogram, the construction of which was fully dealt with in the August issue.

Among the new sets announced by the Gramophone Co., Ltd., are two entirely new radio gramophones. One is the Super-het Ten Autoradiogram, which sells at 80 guineas, and the other is the Super-het Radiogram Seven, priced at 50 guineas. Both of these instruments have variable- $\mu$  valves and provision for tone control.

# The Needle and the Record

By P. WILSON, M.A.

This is the second of a series of articles by one of the best-known authorities in the gramophone world. The first article appeared on page 66 of "Wireless Magazine" for August. Gramo-radio fans will find these contributions of the greatest value

THE models, or perhaps one should call them enlargements, of needle points and record grooves which I have already described in a general sort of way can be used to study quite a number of interesting problems.

P. K. Turner has already explained in these pages\* in some detail the principles of needle-track alignment, so I do not propose to spend much time on that particular problem. But doubting Thomases like myself are much more satisfied with a theoretical proof of a proposition if it can be translated into a practical demonstration which one can see or handle.

## Special Models

Well, one cannot exactly do that for thousands of readers in all parts of the country, so I have done the next best thing, and that is to set up the models to be photographed at the "Wireless Magazine" offices. Here are six photographs in three pairs.

The first pair (Figs. 1 and 2) represent an unworn loud steel needle set up in the model of a modern record groove at a needle angle of about 60 degrees. In the first illustration (Fig. 1) the needle is symmetrical and has a very small alignment error.

It will be noticed that there is a tolerably good fit; the only place where light can be seen between the two is just at the surface of the record. The fit, in fact, is so good

that very few revolutions of the record would be needed to make it a good surface contact.

In the second illustration (Fig. 2) the needle has been twisted round so as to correspond to an alignment error of about 15 degrees, as near as I could judge at the time.

Here the fit is obviously very bad, and a great deal of grinding would be necessary to make anything like a reasonably good surface contact. What happens to the record whilst this grinding process is going on may well be imagined.

The second pair of pictures (Figs. 3 and 4) show a badly-worn loud-tone needle in similar fashion. I chose this badly-worn needle for the purpose in order to accentuate the horror.

It is, in fact, a model of a needle which had been used for six sides of a 12-in. record on an instrument in which the alignment was never more than two degrees in error; so that it represents the minimum wear for six playings. It shows pronounced shoulders with rather sharp edges.

With ordinary steel needles these shoulders begin to form during the third playing as a rule, though I have known them form towards the end of the first record.

One's ear usually gives the first warning of the formation of a shoulder of this kind: the tone of the reproduction becomes muzzy,

as though the sound were coming through a bag of cotton wool; in addition, more or less faint squeaks are often to be heard.

It should be unnecessary to mention, though unfortunately experience shows that this is not the case, that a needle with a shoulder on it is a very efficient tool for "chewing up" records.

You only need look at the second photograph of the pair (Fig. 4) to realise how dangerous such a weapon is. This picture, as before, may be taken to illustrate bad alignment.

## Record Curvature

But if you think about the matter, you will soon see that it also represents, in an exaggerated form, what happens in any case at those parts of the record where the groove is curving away from the mean position; for however good the alignment the needle cannot twist and turn so as to be tangential to the groove throughout its undulations.

The sharper the curvature of the groove the less able the needle is to keep a close fit with the groove. This has bad effects on reproduction, particularly of high notes and transients, as I hope to explain in a little more detail later on; and it is obviously very unfortunate in the matter of record wear.

It is easy to demonstrate by

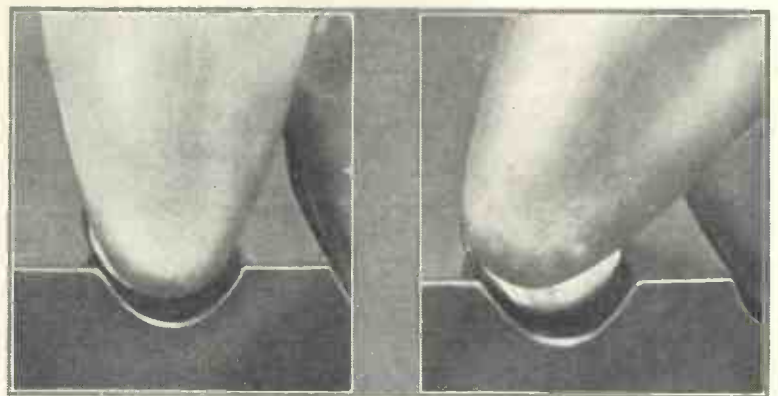

Fig. 1.—Loud steel needle with small alignment error

Fig. 2.—Loud steel needle at an alignment error of about 15 degrees

\*"Setting Your Pick-up," by P. K. Turner, M.I.E.E., page 427 of "Wireless Magazine" for May, 1932.

means of these models that the fatter the point the more pronounced this effect is. It follows that a loud-tone steel needle will tend, other things being equal, to wear records more than those medium- or soft-tone needles which have a finer tapering point.

### Fine Steel Needles

The next pair of pictures (Figs. 5 and 6) illustrate this to some extent. They represent an Edison Bell Sympathetic Chromic needle in the record groove after playing one side of a 12-in. record.

It is also seen, however, that the area of contact of the needle with the groove is smaller and therefore the pressure per square inch between the two is greater. This is one of the reasons, though not the only one, why such needles are prone to give a somewhat pronounced hiss.

The same disadvantage applies, though perhaps not to the same degree, to a Tungstyle needle.

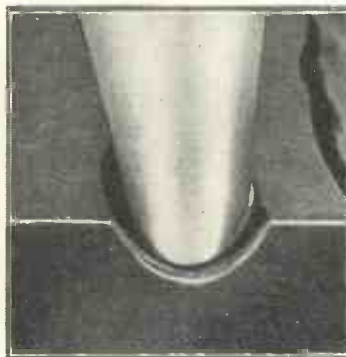

Fig. 5.—Sympathetic Chromic needle after playing one side of a 12-in. record



Fig. 3.—Loud needle after playing six 12-in. sides



Fig. 4.—As in Fig. 3, but with needle skewed across the groove

is used which is none too good in the matter of alignment.

This fact is perhaps better illustrated in the photograph Fig. 7 of a new needle. Indeed, a record which has been badly worn with ordinary steel needles used in such conditions may often be given a new lease of life by the use of fine-pointed needles.

These virtues of fine-pointed

these difficulties, apart altogether from the fact that each one adds unnecessary mass to the armature.

### Chatter

Tungstyles are not open to the same objection, as a rule, though I have known cases where the tungsten wire has not been firmly gripped at the end of the sheath, with the result that there has been a certain amount of chatter between the two.

But here again I must confess that I have a rooted objection to Tungstyles in that the tungsten point can do irreparable damage to a record if it happens to buckle, which it not infrequently does, particularly if the pick-up is handled carelessly in a moment of forgetfulness.

Apart from carelessness on the part of the user, however, I have known buckling to occur in the middle of playing a record, and have occasionally come across buckled needles as bought in the shop.

### Prior Examination

Whenever I use Tungstyles now I always make a point of examining them first to ensure that the tungsten wire is not bent or buckled.

Another interesting point that the models can be used to demonstrate is the effect of needle angle. Unfortunately, it is not possible to illustrate some of the conclusions by means of photographs.

As a result of experiments first carried out on these models and later verified with proper records and needles I have long made it a practice to use a needle angle as steep as possible. If I could use a needle with its point at right

needles must be admitted by all who have studied the matter in any great detail. And yet I have to admit that I personally do not like them, and in these days very rarely use them.

I have experimented with them in all sorts of ways in the past, but have never been able to overcome the "whip" in them to my satisfaction.

The difficulties which I shall refer to later on of obtaining such a firm grip on a gramophone needle that it becomes in effect an integral part of a pick-up armature are accentuated ten-fold in these fine needles; and no special needle-grip that has yet been placed on the market has successfully overcome

With both types, however, the actual dimensions of the business ends are such that with modern records there is no danger of shoulders being formed, provided in the case of the fine-pointed needle that not more than about half a dozen sides of 12-in. records are played.

This proviso is important because the fine-pointed needle wears down much more quickly than the ordinary steel needle owing to the increased pressure of contact referred to above.

Another point in favour of the fine-pointed needle can readily be appreciated from the illustrations: the needle penetrates deeper into the groove even when an instrument

# THE NEEDLE AND THE RECORD—Cont.



**NEEDLE DRAG**

*If you hold a pencil vertically on a piece of paper you will notice how the point jerks as it is pulled backwards and forwards*

angles to the record surface I should certainly do so.

### Vertical Point

Indeed, I actually do that very thing when I use fibre needles: the shank of the fibre is sloping at an angle to the record, but the actual point, or what passes under the name of a point in a fibre needle, is vertical.

That, in my estimation, is one of the special virtues of a fibre needle and no other type of needle possesses it.

But one cannot use an ordinary steel needle with its axis at right angles to the record. You will easily appreciate why if you lay this book flat on a table and try to draw across it a lead pencil held vertically at its blunt end.

### Moving in Jerks

You will notice that the pencil moves or tries to move in a series of little jerks. Slant the pencil ever so little in the direction in which the point is being moved and the jerks begin to diminish.

If the pencil were being constrained to follow undulations corresponding to those of a record groove the effect would be even worse.

Some slant is quite essential with an ordinary gramophone needle. How much depends to a very large degree on the design of the pick-up and the shape of the cross-section

of the record groove. In modern conditions an angle of less than 65 degrees to 70 degrees should not be necessary, except with the flexible "acetate" records where a trailing needle is recommended.

The practice of using a small needle angle, of 45 degrees or so, with ordinary shellac records has nothing whatever to commend it. Indeed, it is positively dangerous with any but very fine-pointed needles used on an instrument with exceptionally good alignment, and even in those conditions it has no advantages over a steeper angle.

There is, it is claimed, a certain reduction of surface noise with the smaller angle, but it can be demonstrated, positively and definitely, that any such reduction is only due to the fact that in such conditions the response to high notes is severely curtailed.

The disadvantages of the small needle angle arise from the fact that as the needle point is ground down by the record to fit the groove the length of needle in contact longitudinally increases as the needle angle is made smaller. No models are necessary to realise this; all one need do is to draw a silhouette of a needle as in the diagram Fig. 8, and cut off the tip at various angles to the axis.

The line *x y* represents the length which eventually comes into contact when a steep needle angle is used, while the line *AB* represents that for a small angle.

I am not merely putting this figure forward as a theoretical explanation which I have invented out of my own head; it actually corresponds to what one sees when

one projects the outline of worn needles on to a screen by means of a screw-thread projector.

Now the greater the length of the longitudinal contact line the more difficult it is for the needle to find a fit in the groove throughout the various twists and turns. What happens to it is not very easy to see unless one has first carried out the experiment by means of the enlarged models. Then the matter

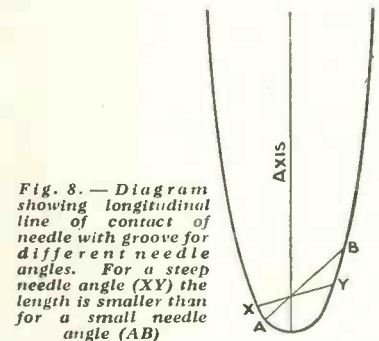

*Fig. 8. — Diagram showing longitudinal line of contact of needle with groove for different needle angles. For a steep needle angle (*XY*) the length is smaller than for a small needle angle (*AB*)*

becomes as plain as a pikestaff.

It was this feature that gave me the surprise to which I referred in my first article. The needle simply lifts up and down in the groove.

The amount of motion is not sufficient, of course, to be seen by the naked eye in ordinary playing conditions; but the models show that sometimes it may be more than half the depth of the groove.

### Causing Record Wear

This up-and-down motion causes both record wear and loss of high notes, for the needle tends to ride over the walls of the groove, if it doesn't cut through them, instead of going round the corner.

The awkward features are that a worn needle has its greatest cutting effect at places of sharp curvature where it is skewing across the groove, and also that, if the up-and-down motion is pronounced, a greater pressure between needle and record is needed to keep the two in contact; this assists the cutting away of the groove.

Is there any way of avoiding the dilemma? Yes, I think there is. And the fibre needle gives the clue; it has a vertical point and in those circumstances there is no up-and-down motion.



*Fig. 7.—New Sympathetic Chromic needle*



# Choosing Your Records

## PIANO SOLOS

- ★(a) Tarantelle, Op. 43 (Chopin), (b) Valse in A Flat, Op. 69, No. 1 (Chopin), Alfred Cortot, 4s.  
H.M.V. DA1213

The waltz is the small one in A flat—amongst the posthumous works. Beautifully played. The tone is ringing, but not hard. If you regulate your volume control carefully, you will get a perfect result.

## LIGHT ORCHESTRAL MUSIC

At the Tchaikovsky Fountain (d.s.), Marek Weber and His Orchestra, 4s.

H.M.V. C2440

A fantasia on Tchaikovsky's melodies. Very good, too. Such an improvement on the usual medley. Tchaikovsky lends himself to this sort of thing. I enjoyed the record immensely.

- (a) Bird Songs at Eventide, (b) Ginsy Moon (Zigeunerweisen), Albert Sandler and His Orchestra, 2s. 6d.  
COL DB853

This, of course, might be a Sunday evening broadcast in progress. Need I say any more? If you buy it you will see I am right.

## INSTRUMENTAL SOLO

- ★(a) Le Cygne (The Swan) (Saint-Saens), (b) Melodie, Op. 42, No. 3 (Tchaikovsky), Mischa Elman, 4s.  
H.M.V. DA1143

This should be in every collector's library. He plays *Le Cygne* perfectly. A thoroughly popular record. Buy it.

## LIGHT SONGS AND BALLADS

- ★(a) Elly Mavourneen, (b) I Know of Two Bright Eyes, Heddie Nash ten., 2s. 6d.  
COL DB863

Heddie Nash can always be relied on for a good record. His voice has the real microphone quality. I recommend this as being outstanding as a vocal record.

- ★(a) Everything But You, (b) I Don't Want You To, Frances Day with Max Kirby, 2s. 6d.  
H.M.V. B4223

A splendid voice for comedy singing—surprisingly "tuneful." I recommend this record strongly for that reason. The songs will appeal also.

- ★(a) Fly's Day Out, (b) Waltzing Time in Old Vienna, Gracie Fields, 2s. 6d.  
H.M.V. B4214

She is well up to form. This is quite charming in parts. Gracie's faculty for singing well—and then atrociously—all comes. I imagine this record will sell.

Here are reviews of the latest releases by WHITAKER-WILSON, the "W.M." Music Critic. Outstanding records are indicated by an asterisk (\*) against the title

- ★(a) Just One of My Dreams, (b) Roses at Dawning, Birrell O'Malley, 2s. ZONO 6150

The recording here is so good that the record must be starred. The singer's voice is virile and expressive. There is also a little resonance that makes the effect very pleasant. A very good record, with plenty of bass.

- ★(a) Napulitanata (Costa), (b) Chi Se Nno Scorda Occhii! (Barthelemy), Tito Schipa, ten., 4s.  
H.M.V. DA1054

There is some fine singing in this record. Please understand that the songs are *light*, not classical nor operatic. A red label rather suggests the operatic style, that is why I make the observation.

## MILITARY BAND MUSIC

- Aldershot Command Searchlight Tattoo, 1932 (d.s.), Massed Bands of the Aldershot Command, 2s. 6d.  
H.M.V. B4218

Of its kind, this is very good. Personally, I cannot rake up the slightest enthusiasm for tattoos, either recorded or by wireless, but I must say I think the playing here excellent. It is certainly a record to hear.

## HUMOROUS

- Channel Swimmer (d.s.), Descriptive Sketch by Horace Kenney, 2s. 6d.  
COL DB865

Very characteristic of him. Some of the dialogue is very amusing. Quite worth having.

- (a) Happy Hikers, (b) Laughing Stuttering Sam, Charles Penrose and Company, 2s. 6d.  
COL DB856

The stuttering is very well done. Quite original and well done. The only objection I have to it is that it is decidedly near the mark. Has Columbia failed to amuse cleanly that it descends to this sort of thing? A pity!

- ★Horse Sense (d.s.), Descriptive Sketch by Haver and Lee, 2s. 6d.  
COL DB858

This is just as they do it on the wireless. Very clear and distinct, not a word misses. Very characteristic.

- Nonchalant Nonsense (d.s.), Humorous Monologue by Naunton Wayne, 2s. 6d.  
COL DB864

These humorous records are improving. Not before they need to! I suggest you ask to hear this. Its humour is not too apparent, but there is a chuckle here and there in it.

## Additional Records Reviewed by CHOPSTICK

### LIGHT SONGS

- (a) Lullaby of the Leaves, (b) When Work is Through, Sam Browne, 2s.  
ZONO 6154

Sam Browne, who is the vocalist in Ambrose's Mayfair Hotel band, sings two croony ballads in his usual faultless style. (a) is with orchestral accompaniment and (b) is with piano accompaniment, delightfully played, together with an orchestral interlude. I have congratulated Zonophone before on the excellence of their orchestral accompaniments. An ideal disc for a dance programme interlude.

### NOVELTY RECORDS

- (a) Hoch, Caroline, (b) Sing Brothers, International Accordion Band, 2s.  
ZONO 6156

Played as well as accordion bands can play light dance tunes. There is some fine harmony singing on both sides, which is very attractive. Ask to hear one side of this before you buy it.

### HUMOROUS

- ★Back Poreh (d.s.), Carson Robison and His Pioneers, 2s.  
ZONO 6160

Carson Robison, a newcomer to the Zonophone lists, believes in variety. The disc starts with a noise somewhat like a dozen people falling downstairs. One by one the band arrive and introduce themselves by playing on their instruments. A banjoist and a whistler are the artists on the first side who give first-rate exhibitions of their art, while a waltz played on three guitars on the second side is alone worth the cost of the disc.

### DANCE MUSIC

- ★(a) Flies Crawled Up the Window (f.), (b) I Want to Cling to Ivy (f.), Blue Lyres, 2s.  
ZONO 6158

These are two very invigorating tunes from the film *Jack's the Boy*, which stars Cicely Courtneidge and Jack Hulbert. Both numbers are ideal quick-steps and contain some good examples of snappy syncopation. It is not possible to define the syncopators, but I should imagine that every member of the band takes part in the rollicking fun. Recommended, of course.

- (a) Humming to Myself (f.), (b) Soft Lights and Sweet Music (f.), Ambrose and His Orchestra, 2s. 6d.  
H.M.V. B6205

These are two of Ambrose's most popular tunes at the moment. He broadcasts them every Saturday night in the late dance-music period. Time is good and the arrangement is fresh and makes full use of the many tonal effects of the modern dance orchestra. The name of (b) gives an unmistakable clue to its type.

- ★(a) I'm Carefree (f.), (b) My Mum (f.), Savoy Hotel Orpheans, 2s. 6d.  
COL CB468

These two straight foxtrots are played without any blaring frills or fancies in the quiet musical style which has made the New Orpheans so popular. That remark and the fact that both numbers are played in good time and are well recorded should be enough to recommend it.

- ★(a) 'Leven Pounds of Heaven (f.), (b) Please Don't Mention It (f.), Blue Lyres, 2s.  
ZONO 6152

This is the best record yet issued featuring the Dorchester Hotel Band. It is tuneful, the time is just right for dancing and the lady vocalist who sings the choruses has a delightfully refreshing voice. (b) is the better tune, the refrain of which is sung as a duet. A disc like this which has new ideas is a treat to listen to. All dance lovers should get it.

- ★(a) Reginello (w.), (b) Rosita (tango), Geraldo's Gaucho Tango Orchestra, 2s. 6d.  
COL CB470

(a) is a Neapolitan song with a vocal chorus sung in Neapolitan. Although this is played in waltz time it is too fast for dancing. Dancers will find in (b) a tango played at "just the time" for a perfect tango. There is an atmosphere created by this record which makes it really delightful. I recommend it to all classes of listeners.

- ★(a) There I Go Dreaming Again (f.), (b) You Can Make My Life a Bed of Roses (f.), George Olsen and His Music, 2s. 6d.  
H.M.V. B6202

One of the best "sweet" music records I have heard for a long time. (a) is a quiet foxtrot with splendid examples of good saxophone and trumpet playing. The vocalist is a lady who possesses one of those deep haunting voices. An unusual melody makes (b) very attractive. I unhesitatingly recommend this record.

- ★(a) Way I Feel To-day (f.), McKinney's Cotton Pickers, (f) At the Prom. (f.), Irving Mills and His Modernists, 2s. 6d.  
H.M.V. B6204

I can assure you that (b) has no connection with the Queen's Hall concerts. I can find no logical reason for its title. The violin playing on this side is ideal for young budding violinists, who have ambitions of joining a dance orchestra, to study. As a matter of fact, those already in the profession should get this. They will then learn how to play "modern." This, the only real "hot" record of the month, is well worth getting.

# ONE RECORD-122 ARTISTS of SEVEN NATIONS!

**T**HAT ought to be a record, surely. The figures are official, so, of course, they are true.

I went to see this record-beating record in the making at the H.M.V. studios in Abbey Road, St. John's Wood. Three studios were used

By **WHITAKER-WILSON**

eager to do their bit in this super-record. Various noises were supplied from twenty-two special records. I was very interested in one which gave the effect of water

tainer—through London, Paris, Berlin, Venice, Cairo, and back to New York.

As each country is reached the various effects are faded in and out. In London you hear the crowd at a restaurant; in Berlin a beer-garden in the Unter den Linden; in Venice the water and a Venetian tenor singing; and so on.

I peeped at Miss Couper, alone in a studio solemnly reading from a typescript, a copy of which I held in my hand. From that I was taken to the transfer room where five gravity-driven turntables were in use for various effects. In another room I saw the record actually being made.

## Making History

I did not hear the finished product because they had not finished it when I left, but I heard enough to assure my readers that record history was made in St. John's Wood that afternoon. There is no end to the possibilities of such a method of recording.

I did not hear when the disc is to be released, but I suggest you look out for it. Jot down its title—"Oh, Mamie!" by Barbara Couper and others.



IN THE H.M.V. RECORDING STUDIO

Some of the artists taking part in the production of the record "Oh, Mamie!" Whitaker-Wilson is seen sitting in the centre of the group

simultaneously, much in the same way as they are at Broadcasting House when a play is being performed. These studios were linked up to a central control room by over four miles of wire. Again, official figures. I did not measure it myself.

Out of the hundred and twenty-two performers, one hundred and two were there in spirit only. In other words, they had given their performances in various parts of the world and their records were requisitioned. Still, we had the benefit of them.

## Twenty in Person

The remaining twenty were there in person. For some reason I was photographed with some of them as soon as I arrived. I expected to have my fingerprints taken before I left.

These good people included French and German students, Italians and Spaniards. The Central Tower of Babel was not in it. They were very cheerful and

lapping against the side of a gondola. The track was wavy, not unlike watered silk.

The record itself (apart from other records, actors, and effects) was in reality a smartly written monologue by Kester Dodgson, one of the H.M.V. staff. You will remember his letter grumbling at me about that article on recorded humour. We met for the first time and, despite our squabble in these pages, parted the best of friends.

It was a little disturbing to meet former victims, so to speak. One of the staff said: "I want you to be introduced to Ray Noble, whose records you have been so rude to." I found him charming also. Nice people at H.M.V.

The monologue forming the basis of the record is a satire purporting to be an American woman's tour of Europe in six days. The dialogue is extremely funny. That, however, is not the real point about it. This supposed tour takes the American—Miss Barbara Couper, the well-known wireless enter-

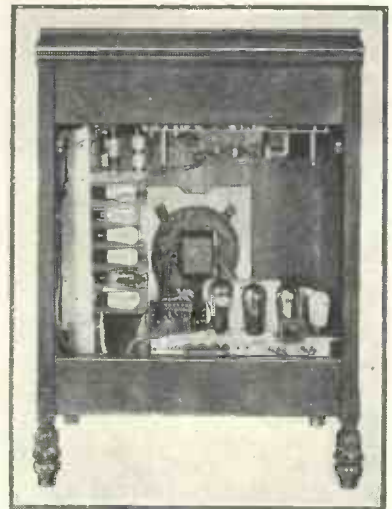

TEN-VALVE SUPER-HET

This photograph shows the accessible internal arrangement of the new H.M.V. Super-het Ten Autoradiogram. It has single-knob tuning and a tone control. The price is 80 guineas

# SOME RADIO GAMES

Catching the High Note :: Who's That? :: Word Trapping  
and Verse Making :: Spotting the Bloomer

IN the restless family to which I belong we not only love to call a spade a shovel, but we take delight in using it as a hammer or bird shoo-er or life preserver. When we find that the broken handle, inverted, will serve as a putter for clock golf, our joy knows no bounds.

I mention this tendency to prepare you for our biggest desecration—we make parlour games out of broadcasting!

## Time—the Enemy

Not that we ever poke fun at the programmes of the British Broadcasting Corporation. We take them as we find them and for the purpose of any particular game we regard them with as unbiassed an eye as a baboon choosing a coconut to slay an enemy. The enemy in our case may be "time on hand," wet weather or an attack of the *blasés*.

Have you ever tried "Catching the

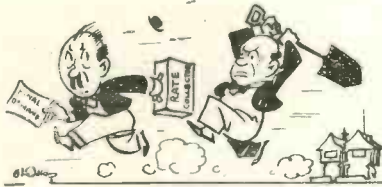

Using it as a hammer

High Note"? The players gather round the radio set (it is summer and the rain is beating on the window panes) and wait until a soprano is announced. A full-blooded coloratura yields the best results, but a mezzo will serve. We turn off the set.

## Flicking the Switch

It is Uncle Harry's turn first. Tremulously he fingers the switch, for he knows that it must be "on" and "off" in a second, or he will be disqualified. Flick! "Shut it off!" Flick!

We reel backwards a trifle, for Uncle has done well. Mary feels for the note on the piano. G sharp! Not bad for an old gentleman of seventy-two summers!

Now Wilfred, with the condescension of youth, approaches the switch.

He, it seems, is not so badly handicapped, for he knows the tune and has been humming it in his mind's ear from the point at which Uncle Harry intruded. Flick! Flick! But what now? Was it "Good-night, Vienna"?

We think you were wrong, Wilfred. We heard the word "Brixton." In any case your note was mighty near the piano lock. D natural, or even baser.

Mary next . . . and so it goes on until it becomes clear that Uncle Harry has won the banana.

Poor man, he is welcome to it for, being an infrequent listener and no student of the works of our enlightened broadcast critics, he will do badly at the next game. He knows little of personal idiosyncrasies at the microphone. We are going to play "Who's That?", commonly known as "That's Thingummy, That Was!"

With the programmes hidden behind the coal bucket we once more crowd round the loud-speaker. The switch remains on until the announcer speaks. With his first intake of breath the set becomes mute, staying so long enough to allow the artist or artists to begin their turn.

Again the night is filled with music, or talk, and the rigour of the game is upon us. "Henry Hall!" roars Wilfred, and forthwith is minus five points for being facetious as well as wrong. "Sir Walford Davies!" grunts Uncle Harry from behind his banana skin, stupendously winning the trick.

But this is a slow game, with unfair outlets for the super-intelligent. Let us try something more uproarious though more dangerous. We shall indulge in "Word Trapping and Verse Making."



Uncle has done well

The raw material—broadcast speech—we have in abundance, for nightly it droppeth much more prolifically than the gentle dew from Heaven. Uncle Harry, being unfitted by the infirmities of approaching age to cross swords with the younger



You, good slug?

generation in this palpitating battle of wits (or, as he says, "nit-wits"), acts as comptroller.

His duty is to switch on the set for brief and hectic moments while we intellectuals hurriedly jot down whatever word, or words, the gods may send us. Twelve words, or word groups (half words don't count) are allowed; with the sacred literary economy of sonneteers we must make these suffice for compositions in free verse. The best verse, in Uncle's estimation, wins.

## Richness of Vocabulary

For richness of vocabulary gardening talks are probably unrivalled. It was from one of these that our comptroller a few weeks ago trapped these words: "only the evening"—"slug"—"you the summer will" (slow with the switch)—"what"—"sulphate"—"good"—"burn and blister" (slow again)—"don't"—"cannot kill"—"bother"—"good-night." (The talk concluded before the twelfth shot.)

Wilfred would have won the other banana, if there had been one, with this:—

You, good slug?  
The evening sulphate cannot kill  
What the summer will only burn  
and blister.  
Don't bother.  
Good-night.

Wilfred plays a game of his own which is excessively irritating to the musical members of the family, but which we occasionally tolerate for a

Stories of the Operas

THE IMMORTAL HOUR  
(Rutland Boughton)

CHARACTERS

DALUA .....	Baritone
ETAIN .....	Soprano
ECHOAIDH .....	Baritone
SPIRIT VOICE .....	Mezzo
MANUS .....	Bass
MAIVE .....	Contralto
OLD BARD .....	Bass
MIDIR .....	Tenor

ACT I

Scene 1.—Dalua, the Lord of Shadow, passes through the forest. Tree-spirits dance round him in the darkness; ghostly voices mock him. He orders them to cease because another wanderer comes. Dalua hides and Etain enters. She comes from the land of the young immortals and wishes to return.

Dalua salutes her; she has forgotten the fairy land to which she belongs and does not know him. She does not even know why she is in the wood. Dalua knows. King Eochaidh, an earth-soul, has called upon the gods to send him someone fairer than mortal maid. The gods have sent Etain.

The King now seeks her. Dalua salutes the King, who recognises him as one whom he has seen in dreams. Dalua explains that he himself is here to drink at the Fountain of Dreams. The King follows Dalua in spite of a warning voice telling him to return.

Scene 2.—The Hut of Manus and Maive. Manus sitting before a log fire with his wife, Maive. Etain is also there. Manus and Maive discuss the visit of a stranger. Etain laments the beauty of her lost world. The King enters and sees Etain. Manus finds the King's cloak is dry even though it is raining outside. The King and Etain sing of their love. (This is where the beautiful song, "How beautiful they are, the lordly ones," is sung.)

ACT II

A year has passed. The Druids are celebrating the anniversary of the meeting of the King and Etain. Much as Etain would like to speak to those present she is filled with strange forebodings. She bids them retire and the King begs her not to leave him alone. There is strange, ghostly music, which they both hear. The King sends the company away. Midir comes in. He is himself a King's son and makes a small request of Eochaidh.

This is granted and the King asks to be left alone with Midir. He turns to Midir who, he realises, is more than mortal. Midir asks to kiss the Queen's hand. He does so and sings the famous song again. Its effect is that of a spell. Etain is drawn towards Midir. The King dare not interfere. Immortal has met immortal. This is the King's dark hour; he falls insensible at the touch of Dalua.

Whitaker-Wilson.

SOME RADIO GAMES—Cont.

few minutes as it enables him, in his own words, "to express his personality"; we agree that it might easily choose even less pleasant manifestations.

Swinging the Reaction

He selects an orchestral symphony, or perhaps an organ recital, and gives it his own "interpretation" by swinging the reaction condenser or volume control in sympathy with his musical [sic] instincts. The net result is that loud passages become seething pianissimos while the softer portions come belching forth rather like the breath of a whale.

The effect is very unsettling and we soon feel the need of a sedative. This we find in "Spotting the Bloomer."

I ought, perhaps, to explain that "Spotting the Bloomer" was not always in the nature of a bromide; in the early days of broadcasting it was quite exciting because mistakes in

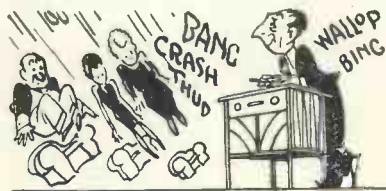

His own "interpretation"

the programmes, and even minor disasters, were nearly as common as oscillations from neighbours, and much more entertaining.

Nowadays the affair is a long languorous vigil in which we hope against hope that the tenor will

succumb to hiccups or an announcer split an infinitive. Alas, these things rarely happen (I write as a sportsman, not as a listener) and anyone who can score even twenty-five points in the hour has done creditably

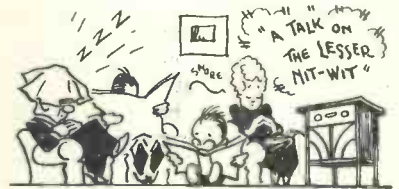

Common or garden listening

and should be watched; he is a promising player and would, with training, make a good broadcast critic.

The method of scoring is quite simple. The first player to spot a bloomer holds up his hand, and Mary marks the score.

Among the scores are the following: Broken Fiddle String, 3; the Cough Direct, 5; "Drink to me only," 10; Collapse of Piano Stool, 30; or, with mutterings, 50; Conductor's Expletive, 75; Announcer's Curse, grand slam.

Too Difficult Games

If space permitted I could describe "Splitting the Time Pips" and also that highly invidious game, "Human Fat Stock Prices." The former, however, is appallingly difficult and the latter usually ends in blows. Sooner or later we revert to common or garden listening, which, all things considered, is the best game of the lot! B. E. B.

1932 Super 60 Reports

Redcar (Yorks).—I must congratulate you on your excellent set, the 1932 Super 60. The first night I logged sixty stations on the medium waves, and every one identified. This is going some, eh? The volume is more than enough. Selectivity is simply amazing. I have used a metal rectifier, type HT8, instead of a valve, and there is not the least bit of hum. The pick-up is grand.

Passing by a wireless shop in this town I saw the following notice:—

FOR SALE. A six-valve super-het—Gets 120 stations, and gets them separate.

On looking through the window I saw the old Super 60 with frame aerial. The Super 60 is some set.

Warrington (Lancs).—Thanks to "Wireless Magazine" and W. James for such a fine set: really the best I have ever built. I have logged all the stations mentioned in the "W.M." log on the 1932 Super 60. I have also built the super-het short-wave adaptor on which I can receive a number of stations at full loud-speaker strength. With the quality excellent indeed, I am proud of both the Super 60 and the short-wave adaptor.

# Broadcasters You Must Have Heard!



**MOSCHETTI**  
is conductor of the Dorchester  
Hotel Orchestra. He broadcasts  
once a week during the afternoons

These caricatures  
have been specially  
drawn for "Wireless  
Magazine" by  
**LISSENDEN**



**GERALDO**  
and his band of piano-accordions  
are quite frequently heard in the  
broadcast programmes



**HENRY HALL**  
needs no introduction as conductor of  
the B.B.C. Dance Orchestra, although  
this impression of him is new



**"BILL" GERHARDI**  
is conductor of Jack Harris'  
Grosvenor House Band. This  
band broadcasts regularly



**ALEC MCGILL and GWEN  
VAUGHAN**  
are very frequent broadcasters  
well known to all listeners



**ROY FOX**  
is conductor of the Monseigneur  
Restaurant Dance Band. He re-  
cently returned after a long illness

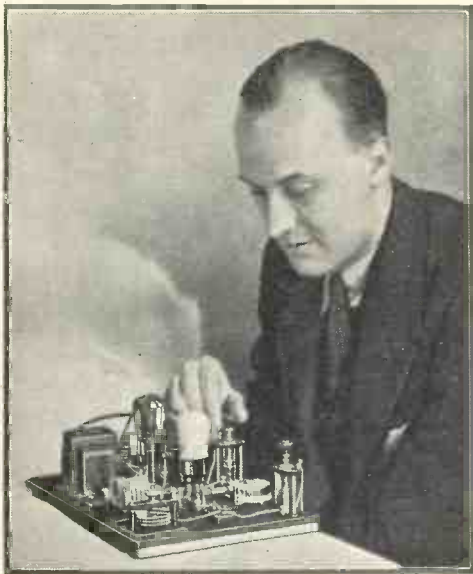

**ALL READY FOR 7-METRE RECEPTION**  
This simple experimental set can be built at small expense by any listener—but remember that the range of 7-metre transmissions is normally very restricted

THE experiments that the B.B.C. are now carrying out on wavelengths of about 7 metres have aroused considerable interest. The reason is because, contrary to expectations, the service area of stations on these wavelengths, although having only a power of 200 to 300 watts, instead of being only suitable for ranges up to 15 miles have proved to be satisfactory up to 50 miles.

The National Broadcasting Company of America is taking a very active interest in experimental work on 7 to 8 metres and has been successful in setting up a daily service between two stations, situated on very high points, 200 miles apart. They have also managed to transmit from a normal building to a receiving station 50 miles away.

It therefore follows that we may anticipate these overwavelengths to be a solution to the overcrowding of the ether and a medium for putting out successful and interference-free television transmissions.

**Wide Frequency Band**

An instance of their advantages over the normal band of wavelengths now in use may be derived from the following: Between 7 and 8 metres, or approximately 42,000 and 37,500 kilocycles, we have a frequency

channel of approximately 4,500 kilocycles. As it is only necessary (to avoid interference) to have a separation between stations of 10 kilocycles, we should be able to accommodate practically the whole of the 300 or 400 European stations now broadcasting on the medium-wave band between 200 and 500 metres on the 7-8 metre band, provided that their wavelengths were allotted with due regard to their geographical position. The bulk of our present hetero-

# A TWO *for* 7 METRES

Transmissions on 7 metres open up an entirely new field for the experimenter. Here is a simple receiver for such wavelengths that has been designed and thoroughly tested by K. JOWERS, of the "Wireless Magazine" Technical Staff

channel of approximately 4,500 kilocycles. As it is only necessary (to avoid interference) to have a separation between stations of 10 kilocycles, we should be able to accommodate practically the whole of the 300 or 400 European stations now broadcasting on the medium-wave band

between 200 and 500 metres only gives a frequency channel of approximately 1,000 kilocycles.

Not only do telephony stations interfere with each other on these wavelengths, but spark telegraphy stations are also a trouble.

**Ground and Upward Waves**

Most readers are familiar with the way in which ultra-short waves travel. We know that there is both a ground and an upward wave. The upward wave is reflected by the Heaviside layer, and for wavelengths above 10 metres or so it is on this reflected wave that we depend for our reception. As the height of the Heaviside layer from the earth is a variable factor, we are consistently troubled with fading, for which there is no known cure.

On wavelengths below 10 metres, however, the upward wave has a greater power of penetration; so much so, in fact, that it is not reflected by the Heaviside layer. Below about 10 metres, we depend solely on the ground wave for reception.

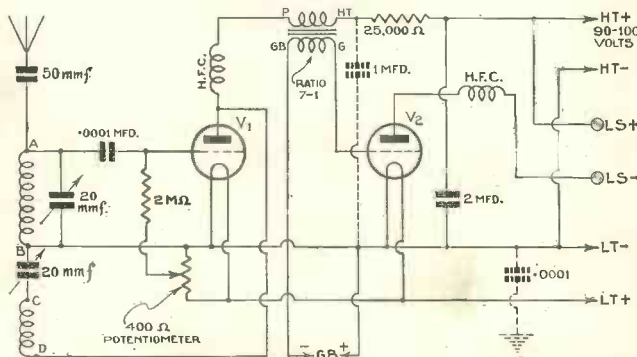

**SIMPLE TWO-VALVE CIRCUIT**  
There is nothing elaborate about the circuit of this set for 7-metre reception. It consists of a leaky-grid detector and a transformer-coupled power valve

dying, etc., would then be avoided and the design of receivers would be greatly simplified in comparison with the multi-valve receivers that are now necessary.

In contrast to the 4,500-kilocycle channel between 7 and 8 metres, we find that the normal broadcast band



**A NEW FIELD FOR THE KEEN FAN**  
The new 7-metre transmissions open up a new field for the keen experimenter. This simple set can be built at very low cost

This eliminates fading, because the ground wave does not come into contact with the Heaviside layer.

Furthermore, interference, such as atmospherics, etc., does not spoil reception, as is the case on the higher wavelengths; these short waves are called "quasi-optical," because they do not travel through space in the same way as the longer waves. Wavelengths under 10 metres have characteristics similar to those of a light ray in that they do not bend or follow the curvature of the earth, as do ordinary wireless waves.

**Easy to Handle**

A receiver for use on the "quasi-optical" waves is quite easy to handle.

A glance at the component list for this receiver will prove how inexpensive the construction of a suitable two-valve receiver will be. Readers may possibly wonder why we have chosen a conventional "detector and low-frequency" receiver. Consider-

entailed would not be worth while, considering the restricted nature of the transmissions at present available.

A screen-grid three would have been quite satisfactory except that no appreciable amplification would have been obtained from the screen-grid valve on such high frequencies and, beyond giving selectivity, the valve would

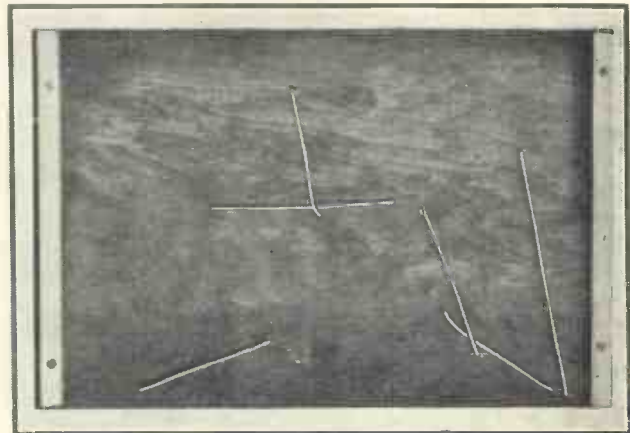
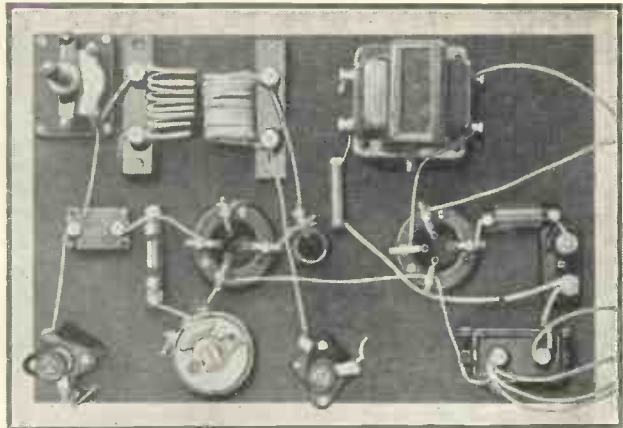

**HOW THE PARTS ARE ASSEMBLED AND WIRED**  
At the top is a plan view of the baseboard, while underneath is shown the sub-baseboard wiring

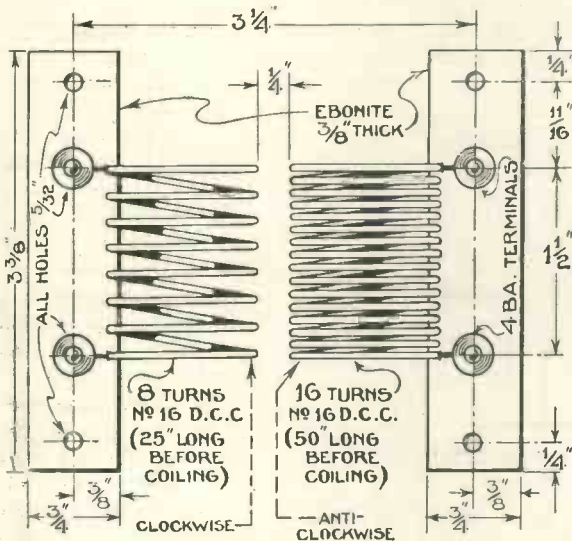

**DETAILS FOR MAKING THE COILS**

Here are details for making the coils for 7-metre reception. The cost is negligible, as will be evident from these particulars

ing the various possibilities we find there are three workable alternatives :

1. A super-het.
2. A standard screen-grid three receiver.
3. A simple detector and low-frequency arrangement.

A super-het is inclined to be unstable and somewhat difficult to handle on wavelengths below 10 metres. Furthermore, the average amateur will agree that the cost

a very expensive item in the construction of a receiver, can in this case be made for a few pence.

Those who desire one can obtain a full-size blueprint for half price (that is, 6d., post free), by using the coupon on the last page of this issue by September 30. Address your inquiry to "Wireless Magazine," Blueprint Department, 58-61 Fetter Lane, London, E.C.4, and ask for No. WM295.

Constructors who already have in

have been a passenger.

The receiver arrangement finally selected has proved itself to be very satisfactory and has the advantage that it can be assembled for a very small sum.

In a number of cases the constructor will probably have many of the components on hand. The coils, which are usually

their possession a spare 1-microfarad fixed condenser can use it in the anode circuit of the detector valve, but if desired this condenser can be omitted. In this case the condenser at the side of the low-frequency transformer will not appear in the set and the wires Nos. 3 and 12 are omitted. All the other wires should be put in the numerical order indicated. This optional condenser is indicated by dotted lines in the circuit and layout diagrams.

**Wavelength Range of Coils**

Variations in valve capacity will vary the wavelength range of the coils, so in some cases it may be advisable for the reader to experiment a little with the number of turns employed. The coils used in this receiver were constructed in the following manner :

Grid coil, eight turns of No. 16 d.c.c. wire (approximately 25 in.) wound tightly round a 1-in. former. The reaction coil is wound in a similar manner, except that it has sixteen turns of No. 16 d.c.c. wire, approximately 50 in. in length. The sixteen turns are unspaced.

## A TWO FOR 7 METRES—Continued

## COMPONENTS NEEDED FOR THE 7-METRE RECEIVER

## CHOKES, HIGH-FREQUENCY

- 1—Igranic short-wave, 2s.
- 1—Eddystone short-wave 5-10 metre type, 1s. 6d.

## CONDENSERS, FIXED

- 1—T.C.C. .0001-microfarad, type flat S, 1s. 3d. (or Telsen, Dubilier).
- 1—T.C.C. 1-microfarad, type 50, 2s. 10d. (or Telsen, Dubilier). (OPTIONAL)
- 1—T.C.C. 2-microfarad, type 50, 8s. 10d. (or Telsen, Dubilier).

## CONDENSERS, VARIABLE

- 2—J.B. neutralising, 7s.
- 1—Peto Scott neutralising, 3s. 6d.

## HOLDER, GRID-LEAK

- 1—Readi-Rad, 6d.

## HOLDERS, VALVE

- 2—Eddystone low-loss, 3s.

## RESISTANCES, FIXED

- 1—Claude Lyons 25,000-ohm 1-watt type, 10s. 10d.
- 1—Dubilier 2-megohm grid leak, 1s.

## RESISTANCES, VARIABLE

- 1—Igranic 400-ohm baseboard-mounting potentiometer, 1s. 8d. (or Lissen)

## SUNDRIES

- 3 yd. No. 16-gauge d.c.c. wire for coils (Lewcos).

Length of rubber-covered wire.

Tinned-copper wire for connecting.

Lengths of oiled-cotton sleeving.

Wooden baseboard, 14 in. by 9 in.

2—Ebonite strips, 3½ in. by ½ in. by ¼ in., for coil mounts.

2—Small pieces of wood for runners.

1—Lissen terminal block, 1s.

## PLUGS

6—Belling-Lee wander plugs, marked: H.T.+, H.T.—, L.T.+, L.T.—, G.B.+, G.B.—, 1s. (or Clix, Ealex).

## TRANSFORMER, LOW-FREQUENCY

1—Telsen Radiogrand, ratio 1 to 7, 12s. 6d. (or Ferranti AFG, R.I.)

## ACCESSORIES

## BATTERIES

1—Siemens 90-volt high-tension, Cadet type, 9s. (or Ever Ready, Lissen).

1—Siemens 0-volt grid-bias, 1s. (or Ever Ready, Lissen).

1—Oldham 2-volt accumulator, type 025, 5s. 6d. (or Ever Ready, Lissen).

## HEADPHONES

1—Pair Ericsson 4,000-ohm, 12s. 6d.

## VALVES

1—Mazda L210 (metallised), 7s.

1—Mazda L210, 7s.

The prices mentioned are those for the parts used in the original set; the prices of alternatives as indicated in the brackets may be either higher or lower

in normal circumstances a coil consisting of 60 in. of No. 16-gauge d.c.c. wire wound on a 1½-in. former will prove satisfactory.

As regards valves, the detector should have an impedance of about 10,000 to 14,000 ohms. It should preferably be metallised. The output valve should be a low-frequency or power type, with an impedance of 4,000 to 10,000 ohms.

## Aerial Length

It must be clearly understood that this receiver is very sensitive to aerial damping and an aerial having a total length of 15 to 20 ft. will be ample. Any increase over this length will not make any improvement in the results obtained and may cause the receiver to stop oscillating.

If any difficulty is experienced in obtaining satisfactory oscillation, this can easily be overcome by adjusting the series aerial condenser towards its minimum position.

If an earth is used, it should preferably be a counterpoise of about 15 ft. of wire. As no earth or aerial terminals are provided, the connections should be made as follows:

The aerial to the top of the terminal on the top of the series condenser and the earth to the negative terminal of the high-tension battery. If a direct earth is used, a .0001-microfarad fixed condenser should be joined in series with it.

The high-tension voltage is not critical, between 80 and 90 volts will be ample for head-phone work. If a power valve is used, such as a PM2A, it may be necessary to increase the voltage to 100 volts.

The 25,000-ohm resistance in the anode of the detector valve is sufficient to balance the effects of different battery voltages.

It is important to arrange a 2-microfarad condenser across the positive and negative terminals of the high-tension; it serves as a terminal point for the batteries.

A 400-ohm potentiometer is used to vary the potential applied to the grid of the leaky-grid detector valve.

When the coils are removed from the winding former, they will spring out to about 1¼ in. in diameter.

It is best to measure the exact length of wire for each coil to avoid making a mistake in the inductance.

Before starting to wind the coils, clamp one end of the wire in a vice and stretch it until it is quite straight. Then cut off 25 in. and wind this tightly round the 1-in. former, evenly spacing the turns. The coil should be arranged for length between the terminals on the coil block.

These coil blocks consist of a strip of ebonite 3½ in. by ¾ in. by ¼ in., the terminals being spaced approximately 1½ in. apart.

The grid coil, when tuned with the specified "neutralising" condenser, will tune between 5.5 and 8.8 metres. Both the tuning and the reaction condensers have a minimum capacity of 1.5 micromicrofarads and a maximum capacity of 20 micromicrofarads.

The condenser in series with the aerial is of a different type from the tuning condenser and has a maximum capacity of 50 micromicrofarads.

By the way, a new Italian station—1AG—is now testing on 9.8 metres

and has been received in this country. These transmissions usually take the form of gramophone records, followed by the call "Pronto-Roma." Readers who wish to construct a coil to include this wavelength may be interested in the following details:

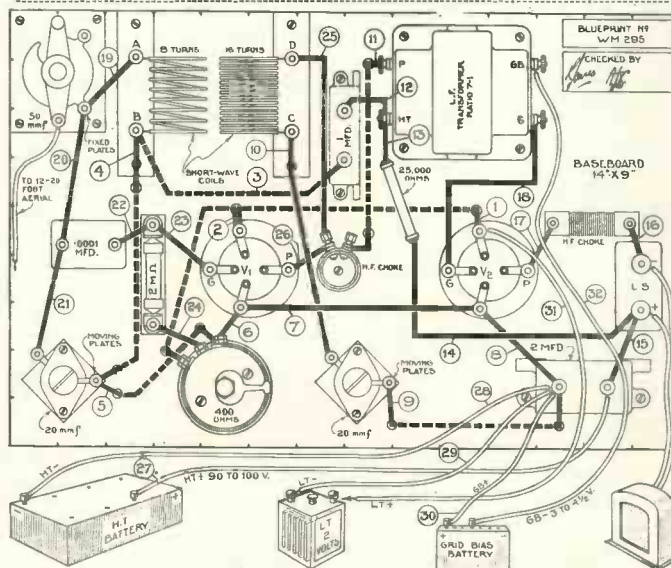

## LAYOUT AND WIRING DIAGRAM

A full-size blueprint can be obtained for half price (that is, 6d., post free), if the coupon on the last page is used by September 30. Ask for No. WM295

A coil consisting of 37 in. of No. 16-gauge double cotton-covered wire wound on a 1½-in. former will tune between 6.7 and 10.8 metres approximately. This coil should be spaced so that the total length is 1½ in. It will be necessary to experiment with the reaction winding, but



# CAN RADIO PLAYS BE IMPROVED?



By WATSON LYLE

In this exclusive article the pros and cons of radio plays, expressed to Watson Lyle in conversations and correspondence with prominent playwrights, actors, and actresses, may be regarded as representative of the views of the legitimate stage towards its youngest off-shoot, the radio play. The following have been kind enough to give their opinions in the interests of the public and the radio drama: Clemence Dane, Clifford Bax, Cedric Hardwicke, Nancy Price, Emlyn Williams, Nora Swinburne, and Edward Chapman



**REALISM IN THE DRAMATIC STUDIO**  
*Hamburg likes realism, as is evident from this photograph taken during the performance of a radio drama*

**W**HEN the Editor discussed with me, several months ago, the idea of this article, we realised that the big public importance of the question raised demanded a consensus of opinion from representative members of the theatrical profession; from actresses, actors, and playwrights who know, from practical experience in the world of the theatre, just the particular technical details of their art upon which depends the success of its appeal, apart from physical movement of any kind.

## Sightless Audience

There is no need to more than mention the fact that until television in a perfected form becomes universal the radio play must be planned

for an audience which is sightless, figuratively speaking; and an audience, too, composed of far more varied mentalities and tastes than any theatre audience.

To be regarded as a success, the radio play must create a complete illusion of actuality, in so far as the players and play are concerned.

The difficulties inherent in this new medium for the expression of dramatic art must be got over. Sightlessness is the universal handicap to be faced, and if the radio play does not make its audience forget this limitation in its expressive power, it fails as art, and remains definitely in the experimental stage common to all inventions, whether connected with art or purely mechanical.

It is a mistake to suppose that the

radio play is an art form of spontaneous generation. Like all new things animate and inanimate, factual and aesthetic, it has a parentage. This parentage is the stage and, possibly, the novel. But most certainly the stage, the fundamental requirements of which the radio play can no more afford to disregard as affecting itself than can its elder sisters, the silent and sound films.

## CLEMENCE DANE

Soon after this article was decided upon, Clemence Dane, in response to an appeal of mine, most considerately suggested a nice, comfortable, teatime talk upon the subject early in the New Year, when she got back to town; but most unhappily she was

# CAN RADIO PLAYS BE IMPROVED?—Cont.



CLEMENCE DANE

*This well-known authoress has written many successful novels and plays; she is well qualified to express an opinion on radio drama*

overtaken by an illness demanding a long convalescence.

Thus it was that when she wrote me in February, pluckily offering her help by letter, to keep her promise as far as possible, I felt I simply had no right to bother her just then with more than one most vital question, a question she was peculiarly fitted to answer by her brilliance as novelist as well as playwright. Here is her reply:—

Dear Mr. Lyle,—Many thanks for your letter. You are quite right about rest. That is what I am trying to do.

As regards your question—"In what way can a playwright best ensure the preservation of separate individuality in the characters of a radio play?"—this is what I feel.

### Tricks of the Voice

Apart from the character drawing, which is the essential in any sort of play, the author must come to the rescue of the actor who cannot indicate character by tricks of the body, but only by tricks of voice—by emphasising the rhythm of individual speech.

Every character should have his particular manner of speaking, not only in his choice of words and phrases, but in the rhythm in which his sentiments, and his choice of words, is expressed. This, of course, is a truism, and it applies to all characterisation.

But I think, nevertheless, that a particular insistence on the rhythm of individual speech, even by deliberately exaggerating and stylising it, is the best way out of the difficulty—for the author in writing for the radio and for the actor in presenting a radio play.

... If there is anything else I can help you in, please tell me.

Yours very sincerely,

CLEMENCE DANE.

### CEDRIC HARDWICKE

Something of this marvellously succinct statement of the fundamental needs of a good radio-play broadcast was, I feel, at the back of Cedric Hardwicke's frequent insistence, in the course of the talk he gave me for this article, upon the too-static effect induced by listening to a broadcast play, although, like all prominent members of his profession, Mr. Hardwicke's opportunities to tune-in in the evening are rare.

"Putting the matter briefly, and to use an expressive vulgarism," he went on, in his direct fashion, "the comparatively few radio plays my work at the theatre has permitted me to hear have seemed to me to lack 'guts.'"

"They lack life and movement. They are static. To convince his audience, the actor must be able to let himself go,"—he momentarily raised his voice, and made an expressive movement with his arms—"and that, of course, he cannot do close to the microphone which, like the sound film, quickly amplifies."

"But don't you think that radio plays may be rather a blessing to folks in remote country hamlets?"

"Well, maybe; as regards that aspect of broadcast plays, my feeling is that people who have never been inside a decent theatre may get the impression from those static radio plays that the theatre is a very dull institution and will never want to



CEDRIC HARDWICKE

*Intended to become a doctor, but failed to pass his qualifying exam and became a successful actor instead. He has played many outstanding parts*

come to it. I do not for one moment suppose that radio plays keep away from the theatre those who know what a good play, well acted and produced, can be in reality."

This original and logical viewpoint clearly shows the widely spread danger of the ineffectual radio play, not only to the actors and playwrights who are exerting themselves to make a success of this new art form, but also to the legitimate theatre.

### The Unwilling B.B.C.?

Only the best of anything—music, drama, talks—is fit to be broadcast, because of the widespread responsibility of the appeal. Apparently the B.B.C. is unable, or unwilling, to pay the best actors, musicians, *littérateurs*, etc., retaining fees making it worth their while to place themselves at the disposal of the Corporation instead of attending, in the first place, to outside engagements.

Under existing conditions the finest actors are rarely available on week-day evenings; but as many of them are induced to do far more exacting work than broadcasting during the daytime by the film companies, it is feasible that a suitable fee would secure their art for occasional broadcast *matinée* performances; or Sunday evenings.

As regards Sundays, there would be an aesthetic, as well as a truly devotional, gain if the services broadcast from certain churches, and rendered unbearably dreary by the handicap of the conventional clerical intonation, were expressively spoken.

### NANCY PRICE

This was an aspect of broadcasting emphasised by Nancy Price in a long talk I had with her recently one unforgettable morning at her flat in town and, although there was much else of great general interest in her conversation, it must here be condensed to the salient points bearing upon the subject of this article.

Vivid, witty, intellectual; cast for the rôle of tragedienne, and saved by Nature from heaviness by a dash of the comedienne—such is the personality of this great actress.

"Come along," said she, energetically poking the fire, "you set the ball rolling."

# OPINIONS OF PEOPLE WHO MATTER

"As a beginning, what kind of play do you think best suited to broadcasting?"

She settled herself comfortably in a chair opposite me and drew a woollen wrap across the back of her shoulders before replying.

"Well, I suppose," she said slowly, "—but, mind you, on the wireless I prefer a good orchestra before anything else—however, as regards plays, I suppose the kinds best suited to radio are those with good, natural dialogue, rather poetic in conception. Galsworthy's *Windows*, for example.

"I don't mention it because we of the National Theatre are doing it at the Duchess Theatre (as a matter of fact, we finish it to-night to put on Clifford Bax's new play on February



**NANCY PRICE**  
Honorary director of the People's National Theatre, at the Duchess. She is here seen with her peke, "Buddy"

10), but simply because it occurs to me as the sort of play I have in mind. *The Silver Box* is another."

"What of Shakespeare?"

"Wireless has a unique opportunity to take good art to thousands who would never hear it otherwise. In that way, Shakespeare should be suitable."

"You mean to those living in remote country places?"

"No; not only. I believe I had in mind more those who are ill; too ill to read, but needing something to take their thoughts away from their sufferings. And I think, too, the Bible should be broadcast, read by a beautiful voice, giving full dramatic or lyrical value to the words read; giving the stories in the Old and

New Testaments their proper value as literature.

"Not the way it is monotonously intoned in most churches, or in the morning broadcast services"—here she gave an amusing imitation of the "curate voice"—"and mumbled and jumbled in the most appalling way."

"An insult instead of an offering to the Almighty!" I laughed.

"Precisely; and this mumbling business seems to afflict most of those who broadcast plays. This may explain the failure of the general appeal of Shakespeare when broadcast. All plays broadcast should be memorised and enacted, too. That was the plan we adopted when we broadcast from Manchester, and I had three hundred letters myself from listeners complimenting us upon the natural effect of the broadcast."

"What of morbid plays? The medium of radio certainly suits an eerie atmosphere."

"That may be; but I think them thoroughly objectionable. They are rarely good art; and, when they are, I think we must remember their possible effect upon those who are ill."

"But they can switch off!"

"Possibly; but in prolonged illness the mind has an unhealthy hankering after such subjects and nurses are not always judiciously censorious."

When one reflects that Miss Price saw three years war service as a hospital nurse, it will be realised that here, as in her views upon plays and players suited to radio, what she said was the outcome of first-hand, practical knowledge.

## EMLYN WILLIAMS

Like hundreds more of the public, I expect, I found Emlyn Williams's delineation of the complex character of Lord Lebanon in *The Case of the Frightened Lady* a remarkably convincing performance, and because of that, and his authorship of two radio plays (the second, *Vigil*, was broadcast from Cardiff in December last), I felt that his views would be of value to the subject of this article.

They were, most decidedly, although, owing to his engagement at the theatre, he had been unable to



**EMLYN WILLIAMS**

Educated at Oxford and already, at the age of twenty-seven, has written a number of excellent plays

hear the broadcast even of his own play mentioned.

"In listening to broadcast plays," I said, "I get the impression, as a rule, that the actors are simply reading their lines. Save in a few cases, there is a lack of expression, a lack of conviction, in the words. I don't know what you think about this as an actor, but it seems to me that in radio the actor must depend almost completely upon the inflexion of his words to get through to the audience."

## Inflecting the Voice

"They may, or may not, be reading. After all, nobody sees them. Inflecting the voice is, naturally, most important. Even in the theatre it is surprising to find how few actors make proper use of this detail of technique. I think, too, there are a great many people who are tone deaf, and who do not notice inflexions in the speech of those on the stage, or at the microphone.

"Many, too, have probably become so used to their eyes helping their ears in the theatre that their ears are badly out of practice when they have to listen as blind folks, so to say, to a broadcast performance. Not many people, if they could choose, would prefer blindness to deafness. Sight is the most precious of the senses."

"I cannot understand why the B.B.C. seems to be so fond of mor-

# CAN RADIO PLAYS BE IMPROVED?—Cont.

bid subjects for their plays," I remarked.

"That is just what seems rather important—to surprise, to startle; to play strongly upon the emotions of the unseen audience surely is the best way open to the dramatist to make effective use of his new medium."

Undeniably true; and yet, I felt, there must be pathways less bizarre along which the radio play can travel to its real sphere of service to the drama.

## CLIFFORD BAX

I was therefore distinctly heartened to receive just about the time of this conversation (at the beginning of this year) the following very kind and illuminative letter from Clifford Bax. He says:—

I would have answered your letter sooner if I had not fallen a victim to the influenza epidemic. For the same



CLIFFORD BAX

Began his career as a painter, but later concentrated on literary and dramatic work. Has written many plays and poems

reason I fear it may be some days before I can get out and that is why I offer you a few notes which I have put together upon the subject of your inquiry.

A few years ago an official of the B.B.C. did me the honour of asking me "to devise a dramatic technique for the wireless," but, having considered the problem, I decided to leave its solution to someone else. I am not in a position to say much about wireless drama, because I have heard very few specimens.

When I have listened-in to a play of my own, I have always felt that to anyone who knew nothing about it the play must have seemed entirely unintelligible. However, I understand that Captain Berkeley and Mr. Richard Hughes did ingeniously devise plays

that took advantage of the new medium. To me it seems obvious that to appropriate a stage play is futile. If it is well written for the stage, it is written with a view to the action being seen and, in consequence, a great deal of its meaning will be left to the actors to convey by action.

For a short time we witnessed a very strange situation. There were silent films which presented plays, as it were, to an audience of stone-deaf people; and wireless plays which presented theirs to an audience, as it were, of the blind. Then came the talkies, combining the effects of both.

Silent films ought obviously to have concentrated upon "strength." They ought to have given plays of strong action and physical movement, and have used to the full their power to move instantaneously from place to place: a facility which the legitimate-drama has not enjoyed since the days of the Elizabethans. They ought to have encouraged all incipient Sardous.

An argument, however fascinating in itself, would manifestly be uninteresting if conducted between two photographs. The wireless, on the other hand, ought to have concentrated upon an intellectual appeal. It should have encouraged any incipient Tchekov or Bernard Shaw whom it could discover. The arrival of the talkies, combining the effects of both mediums, has left little for either.

The only hope for the wireless drama, as I see the matter, is to go out altogether for an intellectual appeal. Its noise effects, though ingenious, can hardly be more effective than the somewhat childish onomatopoeic effects that poets of an older day contrived. A battle of wits, not a battle of fists—that should be its aim.

Moreover, it should concentrate upon beauty of language. Here it has an advantage over the talkies, and over the stage, for when our eyes are in use it is more difficult to use our ears; but unfortunately our ears are becoming atrophied, and an audience of acute listeners is likely to be small and to become smaller.

With good wishes,  
Yours very truly,  
CLIFFORD BAX

## EDWARD CHAPMAN

Edward Chapman, the theatre public's well-beloved "Jess Oakroyd" of *The Good Companions*, prefers to tune-in to music on the rare occasions when his busy professional life permits him to use the radio.

"As regards the broadcasting of plays," he remarked to me during one of the delightful talks we had in his dressing-room at the Lyric (Piccadilly), "one has the feeling that listeners, as a whole, take the announcement of a serious play as a signal to

switch off until some nice music is due."

"I do not think the public feel quite like that about plays. I should think they are much more likely to switch off at the announcement of a broadcast of Stravinsky or Schönberg. Personally, as regards serious drama, I have never heard a satisfactory broadcast of Shakespeare. Have you?"

Before answering, he looked at me



EDWARD CHAPMAN

Recently scored a signal success as Jess Oakroyd in J. B. Priestley's "The Good Companions"

attentively, rather quizzically, for a moment.

Then he said: "I don't know if you heard a broadcast of *Hamlet*, specially arranged by Howard Rose? No doubt it seemed rather a liberty to take with the piece, but it was effective on the wireless."

"Perhaps the actors helped towards that end. My main impressions in listening to Shakespeare (though I did not hear this particular *Hamlet* arrangement) have been of hopelessly mumbled and jumbled speech, as if the lines were being merely read, and badly read at that. There seems to be no sense of personality, either of the actor or the character."

Edward Chapman smiled slowly. "If they read their lines, they would have to be pretty careful not to broadcast the sounds of turning over the pages, and I should think that avoidance of these noises would be apt to interfere with a full comprehension of what is read and expression in the voice.

"Naturalness of speech is indis-

# SYMPOSIUM OF OUTSTANDING INTEREST

pensible. The personality comes out in the merest inflexions of the voice. For this reason I think the plays most likely to succeed as broadcasts would be those having fragmentary, conversational dialogue."

## Listener's Artificiality

"An excellent point, I think. The mere length, the continuity, of anything in the nature of a speech at once introduces a note of formality and reminds the unseeing listener of the artificiality of his position."

"I remember once," he replied meditatively, "when I was filming at Golders Green, and we were doing a big shoot, the producer said: 'I wish some of you people would get more life into your words. Say that line, for instance, like this'—and he emphasised the star's line. 'My dear —,' answered the star, 'that is just reading it intelligently, as anyone might be taught to do. You don't pay me for that, surely, but for my personality. How about this?' And he said the line with the little more, that almost imperceptible difference, the sheer naturalness, that meant everything. Getting the personality through is the great point in acting."

## B.B.C.'s Resource

"Exactly; and you cannot broadcast that if it is not there to broadcast to begin with. Everyone—even Shakespeare and Beethoven—was at one time unknown. I am not, therefore, saying anything against the galaxy of new talent the B.B.C. so

resourcefully keeps on discovering merely because it is unknown; or comparatively so.

"The fact remains, however, that actors having well-established stage reputations are likely—indeed, certain—to make every effort to retain them, and increase them, if their services can be secured for radio. Don't you think, too, some of the radio plays are nauseatingly, or laughably, morbid; such as *Rope*, which seems to fall into either category according to one's nerves and point of view?"

"It may have lost in effect because, of course, the audience would not see the box; otherwise, I think it a good play for broadcasting. Ernest Milton's voice, in itself, would be most compelling. Thrills and shocks seem to me necessary to secure dramatic effect in broadcast plays."

## NORA SWINBURNE

Frankly disclaiming any right to express an authoritative opinion on radio plays because of her few opportunities to listen in to them, but willing to be of any possible service to the theatre and its newest offshoot, the broadcast play, charming Nora Swinburne gave me a most helpful viewpoint and unique blend of the angle of the actress and the ordinary listener to radio-play performances.

"What quality in an actor's equipment do you think most important to reach the radio audience?" I asked.



NORA SWINBURNE

Renowned for her great beauty, Nora Swinburne is at present playing in "The Gay Adventure," at the Whitehall Theatre

"The voice; the expressive use made of it, naturally, I suppose; and individuality. I think that comedy should broadcast better than drama. On the rare occasions I am able to listen, drama seems to demand so much conscious effort in listening that its chance of making the right, unconscious appeal to the audience is lost. With comedy or light items, as with Payne's Band, one just turns on the radio without feeling obliged to sit to attention; and so the whole effect is natural and easy."

"But comedy so often depends for its appeal on gesture; maybe on the mere flicker of an eyelid, to 'get over.'"

"Yes; but I mean the genuine comedian. Cicely Courtneidge, now, comes over perfectly. I think she's marvellous."

## One Among Many

"Agreed; a thousand times, if need be! But she is only one among very many," I answered.

Still, walking across St. James's Park in the bright sunshine of that February afternoon, after leaving Miss Swinburne to go on to the stage of the Whitehall for her part in *The Gay Adventure*, I was conscious of the deep truth, the importance, for the success of all radio plays, underlying her remark about being able to "turn on the radio without feeling obliged to sit to attention; and so the whole effect is easy and natural."



HOW THEY DO IT AT BUDAPEST

A group of actors, actresses, and dramatic producers in the Budapest broadcasting studio. They certainly all look very keen!

# How to Choose a New Set

By ALAN HUNTER

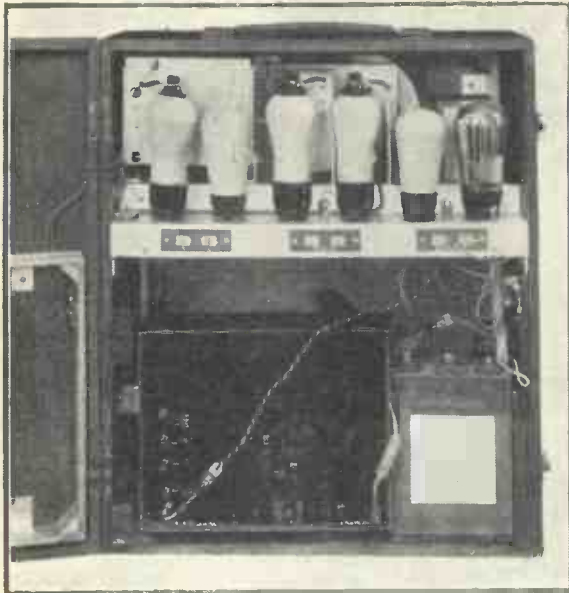

**THE ONLY BRITISH SUPER-HET PORTABLE**  
Note the compact layout of the H.M.V. Super-net Portable Six, which costs £17 17s. Tuning is effected by a single dial calibrated in wavelengths

**N**OW is the time to buy a new set. There are literally dozens of new models available. Perhaps there are too many to choose from, especially if the intending set buyer is fairly new to radio.

Dealers are not always very helpful to such purchasers, who often get the impression that they are being sold something that is either too expensive for their requirements or that is deficient in some aspect of performance.

### Value of Test Reports

Even the reports published every month in "Wireless Magazine" are not necessarily of use to the man who does not know what set to buy. Test reports usually appeal to those who have already made up their minds as to the general type of set that is needed and who are merely waiting for a suitable model at a reasonable price.

I am thinking now, though, of the many thousands of new recruits to the

listening brigade—those to whom such phrases as "quality of reproduction" and "ease of control" have no absolute meaning.

Some indication of what the modern set can be expected to do may be of great assistance to these newcomers. Certainly, a knowledge of the differences between the various types will enable the field of choice to be narrowed down.

Instead of classifying sets according to price or type of cabinet, as is so frequently done, I propose to deal with this question by considering the main points of performance and indicating how far the different types

available will satisfy various listeners' needs.

Shall we make a start with the vexed question of quality of reproduction? Every listener finally comes to the conclusion that clear speech and well-balanced music are the main essentials in reception.

### Quality Costs Money

The first point to understand is that good quality costs money. The second point is that the term "good quality" is extremely elastic. We say a certain make of portable gives good quality, but we never intend to suggest that this particular brand of good quality is the same thing as good quality from a powerful A.C.-mains set.

Yet to the uninitiated set-buyer



**TWO-VALVE MAINS SET**  
A permanent-magnet moving-coil reproducer is incorporated in the Atlas two-valver. The price for either A.C. or D.C. models is £10 10s.

there is nothing to indicate the degree of praise that is being bestowed on a portable said to have good quality.

You see my point? Perhaps not, just yet, but you will!

Good quality in a portable can never mean first-class quality, because the power supply available, usually a small high-tension battery, limits the choice of power valve to one of the smallest on the market.



**AN A.C. THREE**  
While retaining last season's cabinet, the Lotus three-valve A.C. has a considerably improved chassis. It has a moving-coil reproducer and sells at £16 16s.

And in turn the small power valve limits the output.

The limited output in turn necessitates the inclusion of a very sensitive loud-speaker—usually a



**ALL-ELECTRIC RADIOGRAM**

*This handsome Halford radio gramophone has an automatic record-changer and is priced at £65 2s. The set itself is a seven-valve super-het*

balanced-armature cone type having definite frequency-response limitations.

Even if a moving-coil reproducer of the widest frequency response were fitted to such a set it would be wasted because, for reasons I cannot discuss here, a wide frequency response needs large power.

### Resonance

What, then, has good quality to do with the portable type of set we have taken as an example? Frankly, in absolute terms, practically nothing. Good quality applied to such a set implies an absence of objectionable resonances rather than the presence of all the desirable frequencies.

Natural reproduction of either speech or music in-

volves a much wider range of frequencies than it is possible for any battery-operated portable to handle. For those prepared to put up with a certain artificiality in the reproduction, portables of to-day can be said to give good quality. Speech can be clearly heard and music makes a pleasant sound.

As already mentioned, the power available largely determines the standard of reproduction. That is why mains sets, with their much greater reserve of power drawn from the mains, can render so much more life-like speech and music than can battery sets.

Sets of approximately equal power may exhibit different timbres of tone due to the use of different types of loud-speaker. Some sound low-pitched, others high-pitched; some seem better on speech than music, while others can reproduce only music with anything like realism.

Much depends on the individual listener. Always it is best to choose for quality on a comparison between several machines. Only in that way can personal tastes be satisfied.

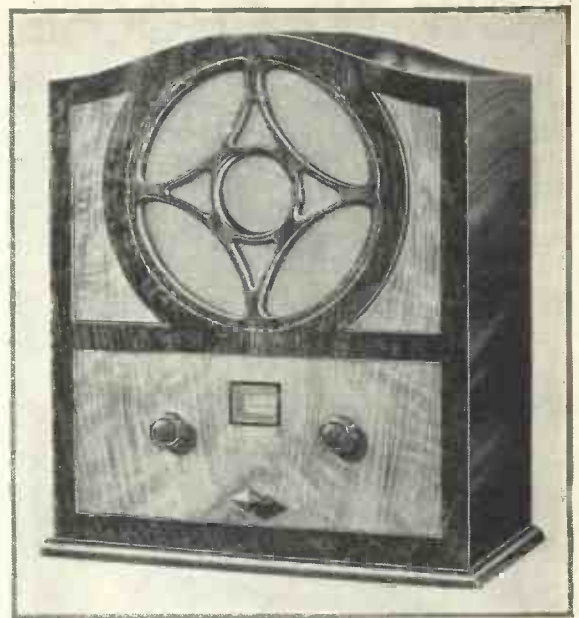

**FOUR-VALVER WITH INDUCTOR LOUD-SPEAKER**

*This Blue Spot K252 four-valve set for battery operation incorporates the well-known type 100U inductor loud-speaker. The price is £12 12s*

As practically all the new sets in the mains-operated class now incorporate some form of moving-coil loud-speaker, the bass-note response is nearly always well pronounced. In addition to good bass you need plenty of top notes for clear defini-



**BATTERY FOUR-VALVER**

*The Philips type 530B receiver is a four-valver for battery working; a fifth valve is used for regulating anode-current consumption. Price £11 11s*



**KOLSTER BRANDES ALL-WAVE A.C. THREE-VALVER**

*This set tunes from 25 to 75 metres as well as on the medium and long waves. It has a moving-coil reproducer*

tion of speech and for that brilliant effect in music.

This is where the poorly designed moving coil fails. Only a properly arranged moving coil can give equally good high- and low-note response, though it is very easy to emphasise the bass for the benefit of what I might term uneducated listeners—uneducated, that is, as to what is natural quality and what is faked.

# HOW TO CHOOSE A NEW SET—Continued

Let us now take another criterion of set selection—range of reception. Here we are on easier ground, for there are definite limitations in range imposed by the arrangement and number of valve stages in a set. The two-valver, whether battery- or mains-operated, is essentially a local-station set, capable of giving full

will do rather than for the way in which the result is achieved.

By ease of control is meant the absence of any control that requires technical knowledge to get the maximum effect from it. A two-valver with reaction is really more difficult to control than a four-valver without reaction, because the ability to get foreigners on the two-valver depends almost entirely on the operator's *finesse* in handling the reaction knob.

The intermediate set—the three-valver with one stage of high-frequency and, presumably, reaction—also needs some adeptness in handling the reaction if the maximum range and the best degree of selectivity is to be obtained. I mention this because the

expert and the novice meet on level terms so far as control is concerned. All you do is turn the tuning knob and adjust the volume control—and take what stations the ether feels disposed to offer.

## Art of Using Reaction

In contrast with this I might cite dozens of examples where three-valvers, perfectly capable of bring in a dozen or more foreigners at good strength, never reproduce anything outside the local, because the owner of the set, being non-technical, has never mastered the art of using reaction in its critical nearly oscillating condition.

From which it follows, I suggest, that if you want both long range and ease of control you must go in for a biggish set, either a straight four or a super-het.

Still keeping intentionally off the question of price, let us consider the effect of the aerial and earth system on the choice of the set. Some people have a rooted objection to erecting an outside aerial wire.

## Aerial Efficiency

To-day it would be very nearly true to say that the efficiency of the aerial is of secondary importance. Even the smallest two-valvers will, with expert control and under suitable conditions of the ether, bring in several foreigners on the loud-speaker with the most meagre of indoor aerials.

The really large sets—straight fours and fives and the super-hets—definitely do better on a short piece of wire erected indoors, unless there is local electrical interference, in which case an outdoor wire is sometimes essential to overcome the interference.

So we come at last to the question of price. Consider all the other points first, make up your mind which type of set is really necessary to satisfy quality, range, control and installation needs and then see whether there is a set conforming with these needs available at your price limit. The range is wider to-day than it has ever been. I hope you are satisfied!

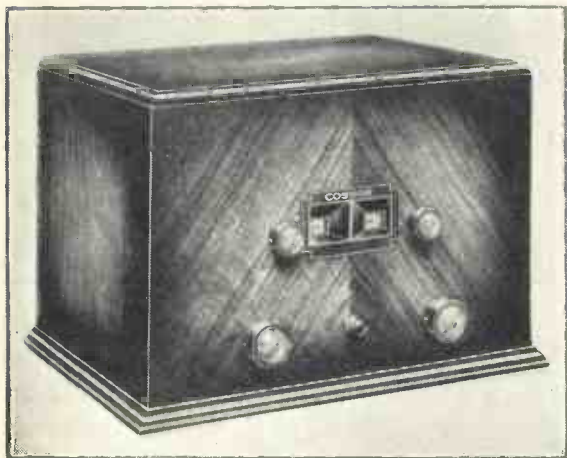

FAMOUS KIT SET IN NEW FORM

Here is the new Cossor Melody Maker (model 334). This year it makes use of a variable- $\mu$  valve; the price complete is £6 7s. 6d.

loud-speaker reproduction from any broadcasting station within "service" range—say up to fifty miles from a regional.

Sets with a stage of high-frequency amplification before the detector—three-valvers—have loud-speaker range up to the limit of a regional, say eighty miles, and after dark will bring in twenty or thirty foreigners at good strength.

Additional valves are not so much for additional stations as for simplification of control and possibly for the elimination of a large outside aerial wire. This point is seldom understood by the non-technical set-buyer. The "stations-per-valve" fallacy dies hard.

## Ether Conditions

It cannot be too greatly emphasised that conditions in the ether have a greater bearing on one's ability to hear foreign stations than does the number of valves or the order in which they are arranged.

It will be as well to mention at this point the question of ease of control, since this is intimately connected with the number of valves, and will, of course, greatly influence listeners who buy the set for what it

idea is growing up that a four-valver, with two high-frequency stages and no reaction, is really unnecessary with such lively three-valvers on the market.

The fact is that the modern four-valver is about the easiest type of set to get good results with, because the



TABLE A.C. THREE

This neat Murphy console is for use on A.C. mains only. It incorporates an energised moving-coil loud-speaker and sells at £17 17s



# What I expect to See at the Radio Exhibition

By PERCY W. HARRIS, M.Inst.Rad.E.

WELL, here we are again on the eve of the annual Radio Exhibition—at least, I am as I write this article. By the time it appears in print the exhibition will have opened. I am looking forward to it, as I always do, knowing that probably it will be better than the last one (it generally is!) and that I shall not be able to spend anything like enough time there (a dead certainty!).

As usual, there will be thrills and disappointments—thrills at finding just that kind of component you have been wanting for years—and disappointments in finding the same old blunders repeated again.

As usual we shall see certain manufacturers producing sets just in time for the exhibition and then finding that the public quite unreasonably wants delivery before Christmas! We shall see the manufacturer who is still more up-to-date and does not get his set ready in time for the exhibition, so is forced to exhibit a box with knobs on (and nothing inside).

## Another Bad Case!

And we shall most certainly see the manufacturer who has not only designed a first-class receiver, but has made adequate arrangements for production. The set will be bristling with improvements, delivery can be guaranteed within reasonable time, and nobody on the stand will be able to tell you the first thing about it.

You know what happens! Something like this:

ME: "Good afternoon. Is this your new set?"

ASSISTANT (complete with patent-leather hair and long cigarette holder): "Yes, sir, that is our latest 1933 model. It's the finest set in the show, sir."

ME: "How many valves has it?"

ASSISTANT (looking slightly worried): "Valves, sir? Oh, yes, it uses valves. They go inside, sir—at least, I believe so. I haven't had the back off yet."

ME: "Yes, I know; but is it a four- or a five-valve set?"

ASSISTANT (properly hot and bothered by now): "Do you mind waiting a few minutes, sir? The gentleman who looks after the technical side has gone to have a dr—er— has gone to the telephone for a few minutes. I only look after the business side."

On the other side of the picture we shall have, I am glad to say, a number of firms who not only "have the goods," but take particular pains to see that somebody competent is there to explain them.

## Answering Queries

I have intense admiration for some of these companies—it would be invidious to mention any by name—who go to no end of trouble to answer queries from visitors. Sometimes it happens that the component in question costs only a shilling or two, yet the makers do not grudge the time in giving a complete circuit diagram to some keen enthusiast who wants to make the best of his set.

And I can assure these manufacturers from a voluminous correspondence that the goodwill created in this way is of immense value to them. Each exhibition they make friends for life.

And, of course, we shall also have a few people who, having missed the boat themselves through lack of ideas or failure to keep up-to-date, will be anxious to tell everybody that "the component business is dead, old man, we're going in for sets!"

I know one or two manufacturers who said this confidently two or three years ago—now they make neither components nor sets. The only thing they make is an income-tax return and that does not take them long. They simply write the word "Nil," and sign it.

But viewing the exhibition seriously, I am looking forward with more than ordinary interest to this particular exhibition, as I do feel that

at last the British radio industry is getting on to sound lines.

In the past the manufacturers' sets have required far too much servicing—this has been largely due to faults in mechanical design rather than in electrical and radio engineering. There is, and should be, a distinct difference between the methods adopted by the home constructor and those used by the manufacturer.

The home constructor is out to make a single up-to-date model with certain definite components by a constructional method which is designed to be simplicity itself and to require the minimum number of tools. His set will not have to be packed and unpacked, jolted about in delivery vans, sealed in a packing case, and dropped on a railway siding, rolled over and over across the pavement, and slid down a chute into a cellar; whereas this and a good deal more must be expected of a commercial set.

The home constructor's set is not built to a rigid price specification and to use certain particular valves and none others, nor must it necessarily be designed to fit one particular cabinet.

## Hand-made Advantages

It is a hand-made set, with all the advantages which go with this method of construction.

It also has the great advantage that with the arrival of a new and improved component, this latter can be incorporated with a minimum of structural change—a condition almost impossible of fulfilment in the average commercial receiver.

The more enlightened set manufacturers, realising the immense difference between the two types of set, have, I am glad to say, got out of the rut. By utilising the latest machinery and production methods, specially designed components, and so forth, they have produced sets which not

## WHAT I SHALL EXPECT TO SEE—Cont.

only give first-class results, but which stand up to the rough handling inevitable in commercial transport and distribution.

At the same time, the leading component manufacturers are at last coming to realise the special requirements of the home constructor and are catering well for him.

### Saving Money

Some years ago, when commercially produced sets began to get cheaper, too many people jumped to the conclusion that the only reason people had for building their own receivers was the saving of money so effected.

I wrote at the time, and have repeated on many occasions since, that the intelligent home constructor will always be with us even when, as sometimes happens, it costs more to build a receiver than to buy one ready made. Not only is there a fascination in building your own set, but also the home constructor realises the advantage in being up-to-the-minute in his design and in being able to incorporate certain refinements and improvements which experience dictates.

It must be remembered that the low prices and excellent value of modern commercial receivers are only achieved by planning ahead and arranging jigs and tools for large quantity production. Once this production has started, it cannot be altered without completely upsetting the year's programme. A home constructor is under no such disadvantage.

### A Thing of Joy

I shall be very interested to see the latest variable condensers and tuning arrangements, for in England great progress has been made in this regard during the last year or two. A variable condenser which is well made both electrically and mechanically is always a thing of joy to me.

I also welcome the considerable improvement in tuning coils. The old faults of break-through of the medium waves on the long-wave side, inefficient switching, and general flatness of tuning, seem to have disappeared—there is certainly no excuse for these faults nowadays.

In transformers, I want to see more real tone-control devices or means by which the overall characteristics of a

receiver can be adjusted so as to give a proper straight-line output. Some progress has already been made in this direction, and I am hoping to see considerably more. Tone control is one of the most vital points in receiver design and proper tone correction will become universal before long.

Two or three years ago, when I assisted Dr. James Robinson in developing the Stenode invention, our statements that by making a receiver extremely sharp in tuning—far sharper than had ever been done before—and then subsequently correcting the tone in the audio end gave

Come along and see the new "Prosperity" sets on the "Wireless Magazine" stand at Olympia. The stand number is "7" and a hearty welcome awaits all readers

a big improvement in selectivity, was greeted with derision by the scientific world as a whole.

It was pointed out to us in a very patronising way that the reduction of interference caused by our excessive sharpness in tuning was all brought back again in the tone correction. They could prove it theoretically, so it was no use listening to the receiver on which we were demonstrating the truth of our statement. It was theoretically impossible, we were deceiving ourselves, and so forth.

Now the same gentlemen are falling over themselves to prove that the result we obtained is fully in accordance with theory. Future progress, then, will undoubtedly be along the lines of very sharp radio-frequency tuning with audio compensation for the attenuated higher frequencies which come about from the very sharp tuning. I want to see plenty of devices to achieve this and I hope I shall.

And I don't mind telling you that I shall wander on to certain manufacturers' stands and tell them exactly what I think about the way they manufacture some of their parts.

There are very few electrical faults these days, but there are still a number of mechanical ones which cause me intense irritation. For example, take the moulded knobs so often supplied with panel-mounting potentiometers and the like. They

are supposed to be secured to a round spindle by means of a grub screw running in a thread which is cut out of the moulded material itself without any suggestion of a metal bushing.

Give this screw anything more than a gentle twist and the thread will strip at once, rendering the knob useless. Often, too, the grub screw is so small that nothing but a watchmaker's screwdriver will fit into the hole in which it is placed. Few amateurs have these.

### Panel Bushes

And then I would like to see the abolition of the  $\frac{1}{2}$ -in. bush which is necessary for mounting some panel parts. The average home constructor has no drill bigger than  $\frac{3}{8}$  in., and it should be possible to make every panel-mounted component satisfactorily without needing a bigger hole than this.

I want to see, too, the abolition of those niggling little screw-down terminals which are so small that they will scarcely grip a piece of fairly heavy wire, and I want to see more common sense in the size of fixing holes in the mounting seat of components.

We all use  $\frac{3}{8}$ -in. baseboards, yet some components are made with such large holes in the feet that it is practically impossible to find a  $\frac{3}{8}$ -in. screw with a large enough head to hold them.

I would like to see the universal adoption of the idea already adopted by several firms of supplying with a component suitable fixing screws for baseboard mounting. It costs very little more to provide these screws and they are a great help.

### Soldering Lugs

Finally, may I ask all manufacturers who supply soldering lugs to see that they are of the type which will tin easily? Some parts are still supplied with soldering lugs on which nothing less than a highly corrosive soldering fluid is any good as a flux. Please remember that it is not everybody who can solder expertly and that if the home constructor has a "dry joint" in his set due to one of your lugs being faulty, it is the component which will get the blame!

Good luck to the Radio Exhibition, anyhow. With all its faults, I love it still!

# We Test Before You Buy

By the "W.M." Set Selection Bureau

## Tone Filters

FROM a preliminary examination of the new season's sets we find a tendency to adopt some form of tone control or high-note suppressor. Such a device will be very useful during the coming season, for there is no doubt that the rapidly increasing number of high-power foreign stations will make the ether extremely congested.

Ordinary selectivity will not cope with heterodynes such as are set up by interference between adjacent high-power stations. But a heterodyne filter, as incorporated in one

## FREE ADVICE TO PROSPECTIVE SET BUYERS

To take advantage of this service it is necessary only to mention (1) the maximum price and whether this is for a complete installation or the bare set; (2) where the set will be used; (3) what particular stations are desired; (4) whether a self-contained set with or without aerial, or an ordinary set with external accessories, is preferred; and (5), in the case of mains-driven sets, whether the mains are A.C. or D.C.

A stamped-addressed envelope for reply is the only expense. Address your inquiry to Set Selection Bureau, "Wireless Magazine," 58-61 Fetter Lane, E.C.4. There is no need to send any coupon, but it is essential to give the information detailed above on one side of the paper only. Tell your friends about this useful service.

make of set, or a tone control, as featured in another of the advance models, will go a long way towards diminishing the nuisance.

These new tone filters also have a useful function in cutting down the background noises usually heard when a powerful set is tuned to a foreign station. As much of the background interference is of fairly high frequency it is possible, with a high-note filter or tone control, to reduce its intensity.

The loss of quality, usually denoted by a certain lack of brilliance in music, is often more endurable than the presence of the background. In a perfectly regulated ether we should not need to apply these methods of quality suppression. But the European ether is a long way from being well regulated and listeners must make the most of set developments that help to overcome the present chaos.



AT HOME WITH KOLSTER BRANDES  
A corner of the Kolster Brandes works at Sidcup where many thousands of radio receivers are produced. One of the latest K.B. sets was reported on last month

Although the average set-buyer may not know much about the characteristics of the variable-mu valve, its effect on the new season's sets will certainly be of interest. The variable-mu, as has been many times explained, provides a distortionless control of volume.

Most of the bigger sets now include one or more stages of screen-grid valves, and these are almost invariably of the variable-mu type. With such sets it will be found that volume can be cut down to very low outputs without appreciably affecting the tone.

In general, a wider range of audibility is also being obtained, which means that volume controls will cope with the problem of cutting down the locals to moderate output and of bringing up the strength of distant stations to the same level as the locals.

In some sets there is a tendency to reduce the number of controls too much, with the result that the best performance is not obtainable.

Sets with ganged tuning circuits can only be tuned with a single knob

if the gang condenser is manufactured to very fine limits. It is better to go to the trouble of adding a trimmer than to sacrifice efficiency through inaccurate tuning.

The radio gramophone is no longer the prerogative of the plutocratic set-buyer. Excellent instruments are now available for the modest price of 30 guineas, and one or two reliable machines can be obtained for even less.

Such instruments have a powerful three-valve chassis, with the usual gramophone accessories, such as electric motor, pick-up and separate volume controls.

## Moving-coil Loud-speakers

They give full-bodied reproduction of records, and enough foreign stations on the loud-speaker to satisfy most listeners. Nearly all the latest radiograms have moving coils, either of the permanent-magnet or mains-energised type.

It is as well when considering the purchase of a new set to remember that an equivalent radio gramophone can be purchased for a very few pounds extra.



# Ferranti Super-het Consolette



### A TRIUMPH OF GOOD DESIGN

Nothing has been overlooked in the design of the latest Ferranti receiver—a seven-valve super-het complete with moving-coil loud-speaker

IT is seldom that we can find absolutely nothing to criticise in a set; but such is the story we have to tell of this Ferranti super-het, which is, at the moment, in a class by itself. Yet the price is within the reach of a large number of discriminating set buyers.

We must condense our praise of the set and recount the imposing specification. This is a consolette. A good earth and almost any sort of aerial completes the installation.

The cabinet containing this paragon of super-hets is attractively made in walnut. The seven valves are on a metal chassis at the bottom and the moving-coil loud-speaker is at the top. There is no back to the cabinet, in order to allow unrestricted operation of the loud-speaker.

Dimensions: 19 in. high, 17 in. wide, and 11½ in. from back to front. The weight is 36 pounds.

As the makers rightly claim, this set is ultra-

modern. Initial high-frequency amplification prevents interference with other receivers and avoids "mush." Variable-mu valves provide good volume control. Band-pass coupling provides selectivity without loss of quality.

These are outstanding circuit features. The controls are equally modern. One-knob tuning—of course; achieved by the new Ferranti gang condenser. There is no trimming externally.

Volume control is excellent, giving a really wide range of audibility without loss of quality.

As in all Ferranti sets, the wave-length scales are interconnected with the wave-change switch, so that only one scale at a time is visible behind the escutcheon.

At the centre of the loud-speaker grill is a neat little knob to control the tone. This it does by switching

in or out of circuit a high-note filter across the loud-speaker.

We were highly impressed with this control when tuning in foreigners. The way it cut out background noises—with, of course, some loss of quality—was a revelation.

With the full-range tone the quality is exceptionally "clean" and free from box resonance. The quality is well maintained up to the limit of

### NUTSHELL SPECIFICATION

**MAKER:** Ferranti, Ltd.  
**PRICE:** 22 guineas.  
**VALVE COMBINATION:** High-frequency amplifier (Osram VMS4), oscillator (Ferranti D4), first detector (Osram VMS4), intermediate high-frequency amplifier (Osram VMS4), second detector (Ferranti D4), power output (Ferranti P4), and valve rectifier (Ferranti R5).  
**POWER SUPPLY:** A.C. mains only, 200 to 250 volts, and special models for other voltages.  
**POWER CONSUMPTION:** 55 watts.  
**TYPE:** Self-contained table set needing only an external aerial and earth to complete installation.  
**REMARKS:** Best value in super-hets at present on the market. De-luxe radio at moderate cost.



### SELF-CONTAINED "ALL-STATIONS" SET

Practically every station worth hearing can be picked up on the Ferranti super-het. It is well made and is remarkable value for the money

the power valve, which hands on to the loud-speaker about 1,000 milliwatts. An important design point is that the power valve overloads before the detector, so that distortion due to detector overloading is prevented.

As the volume control varies the grid bias on the variable-mu valves it is possible to get excellent quality, even on the locals, by suitable adjustment of the volume control.

### All Stations !

This is an "all-stations" set so far as range is concerned. At night we have logged everything having any sort of downward ray! Selectivity is marvellous. Mühlacker clear of London Regional—Zeesen, to all intents, clear of Daventry. Such is the order of the selectivity.

Tests were made with a 50-ft. aerial, but on withdrawing the aerial plug the mains aerial automatically comes into action. Very effective, though, of course, some additional noise was noticed.

We could detect none of the more pernicious faults of super-hets in the Ferranti model. It gives clear, undistorted signals free from all but the faintest trace of background.



# Lotus Bud Two-valver

IT is always a surprise to find how much can be got out of a simple two-valver. This Lotus Bud set is no exception, giving as it does first-rate local reception and offering plenty of scope for the enthusiastic knob-twiddler who seeks foreign-station alternatives.

## Pleasant Surprise

Our first pleasant surprise on testing the set had to do with the quality. The output from the Cossor 41MP power valve, when applied to the Magnovox moving-coil loud-speaker incorporated in this set, has to be heard to be fully appreciated.

No more volume could normally be desired from the local stations. Quality has a pleasing roundness. There is plenty of top-note response, though this is not carried too far.

Feeding the pentode power valve is a sensitive detector, the Mazda

supply between 200 and 250 volts. Fuses are fitted in the mains leads to guard against the possibility of breakdown.

Above the chassis is the loud-speaker baffle board, backing on to the front of the cabinet. On this board are mounted most of the power unit parts, thus economising space. The whole job is very robust and should stand a fair amount of rough treatment.

Other points of interest at the back are the mains-aerial plug connection and the series aerial condenser to control the selectivity of the tuning circuit associated with the detector valve.

Two aerial terminals are fitted, one giving a direct coil connection and the other being used with the series aerial condenser. No provision is made for a gramophone pick-up.

Tested on 200-volt A.C. supply the set was connected to the standard 60-ft. aerial and a series of tuning readings taken. It was at once obvious that for normal use the aerial terminal with the series condenser was essential.

The ability to separate the two locals—after all, the main function of the tuning in a two-valver—depends a great deal on the setting of this aerial condenser. We found that complete separation was obtained with the condenser set about half way towards its minimum.

With reaction suitably advanced to give good volume we then got London National at 28 degrees and London Regional at 58 degrees. It is difficult to give "spread limits" in dial degrees on this type of set, because a single selective circuit will almost cut out a station within a few degrees but will retain a faint trace for a considerable space.

Suffice it to say that complete separation was readily obtained and that under this condition the volume was more than adequate. Quality did not in any way suffer at this setting of the selectivity control.

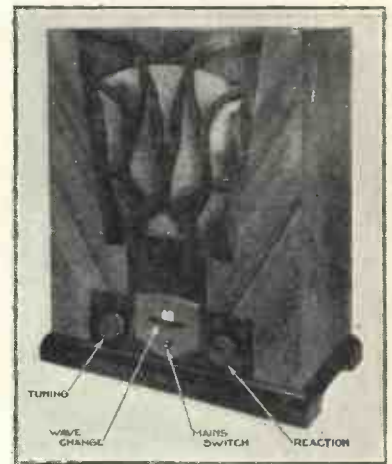

## ATTRACTIVE APPEARANCE

Like all other Lotus sets, the new Bud two-valver is housed in an attractive cabinet. This receiver will attract those who want something good at low cost.

On the long waves we found Daventry a strong signal at 78 degrees. Strength was about equal on both the aerial terminals, with the series condenser set at its maximum.

No trace of the medium-wave stations could be detected on any part of the dial when set to long waves—a good point.

The tuning range is wide on both wavebands, going down to 200 metres on the medium and down to the Heston Airport transmissions (830 metres) on the long waves.

## THE SET IN BRIEF

MAKER: Lotus Radio, Ltd.  
 PRICE: 10 guineas.  
 VALVE COMBINATION: Detector (Mazda AC2/HL metalised) and power output (Cossor 41MP).  
 POWER SUPPLY: A.C. mains, from 200 to 250 volts.  
 POWER CONSUMPTION: 30 watts.  
 TYPE: Table set with self-contained loud-speaker, two-valve chassis and A.C. power supply.  
 REMARKS: A local-station mains set that can be recommended to give very satisfying quality of reproduction.

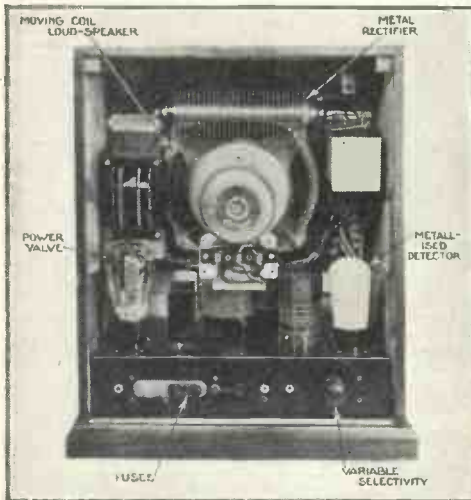

## NEAT AND COMPACT ASSEMBLY

The "innards" of the Lotus Bud receiver are well arranged, as will be evident from this photograph of the back. Note the moving-coil reproducer

AC2/HL. Both these valves are fed from the A.C. mains, the filament supply being a 4-volt winding on the mains transformer and the high-tension supply coming through a Westinghouse metal rectifier, which also energises the moving coil.

On removing the back of the cabinet we find a neat metal chassis for the set, with a conveniently placed mains transformer with three tappings to cover all voltages of

At night we should say half a dozen of the more powerful foreigners would come in at fair strength. During our daylight test Radio Paris on the long waves was fair, and on the medium waves Midland Regional, Fécamp and Brussels could be identified without difficulty.

The level of mains hum is very low.



# Ekco Model M23 Consolette

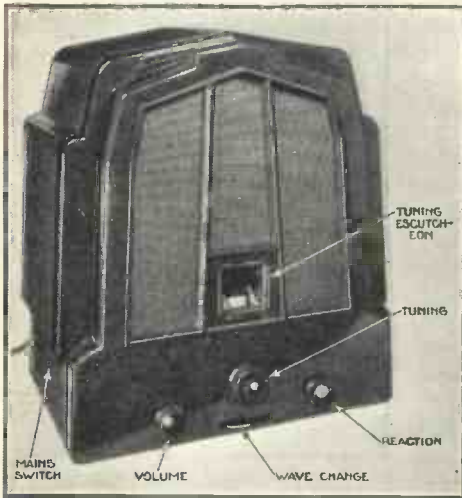

### HANDSOME BAKELITE CABINET

The clean lines of the bakelite cabinet that houses the Ekco model M23 three-valver will attract many set buyers

**I**N this new Ekco consolette we find all the desirable features of a modern three-valver for mains operation. Contained within the good-looking bakelite case is the set chassis and the moving-coil loud-speaker. In addition, there is the apparatus for A.C. mains working, including a metal rectifier.

Although the design is perfectly straightforward, the overall performance is above the average for the type of set.

Our first impression was gained

#### THE SET IN BRIEF

MAKER: E. K. Cole, Ltd.

PRICE: 17 guineas.

VALVE COMBINATION: Screen-grid (Cosor MSG/HA), detector (Mazda AC/HL), and pentode output (Mullard PM24M). Metal rectifier.

POWER SUPPLY: A.C. or D.C. mains.

POWER CONSUMPTION: 40 watts.

TYPE: Table console, with self-contained aerial, but intended to be used with normal aerial and earth.

REMARKS: A well-designed three-valver, giving good quality, clean-cut tuning, and long range.

by a test on the usual 60-ft. aerial in south-west London. We found the sensitivity remarkably good, stations such as Poste Parisien and Brussels coming through at full loud-speaker strength in broad daylight.

On the mains aerial we got these and other stations almost equally well, which proves that the screen-grid valve is working at unusually

high efficiency. With the internal aerial, which is simply a piece of flex tacked inside the back of the case, local stations came in at full strength, though the foreigners were, naturally, rather weak.

With a good earth the mains hum is negligible. There is an internal cathode-potentiometer adjustment should any hum manifest itself.

Some idea of the sensitivity of the set may be gained from the reception of Radio Paris, which came in at full strength on the external aerial with reaction set at its zero position.

For such a lively set the selectivity is exceptional.

We were able to limit the local stations to a 15-metre spread—excellent going for two tuned circuits. There is no appreciable high-note cutting. Indeed, the quality is notable for its incisiveness—enough bass to please most listeners and enough top to give definition to speech. This good quality is maintained for all settings of the volume control.

Control, as noted during tests, is not critical. The veriest novice should be able to bring in plenty of programmes straightaway. Tuning has a compensator knob superimposed on the main knob, which works the wavelength scale and the gang condenser.

We are glad to see that the makers have separated the volume and reaction controls, because in this type of set the selectivity largely depends on working volume against reaction. We were able to separate most of the adjacent foreigners quite

easily by reducing the setting of the volume control and increasing the amount of reaction.

This facility, added to the inherently good selectivity of the two tuned circuits, makes the Ekco M23 very manageable, as will be appreciated more as the season develops.

The set can be used with an external loud-speaker and provision is made to connect a pick-up. This needs a volume control added externally.

### Wavelength Ranges

The wavelength ranges cover all the stations likely to be wanted. Medium waves are calibrated from 200 to 550 in steps of 50 metres, and long waves in steps of 100 metres from 1,000 to 2,000 metres.

When the back of the set is on the valves and the mains-voltage

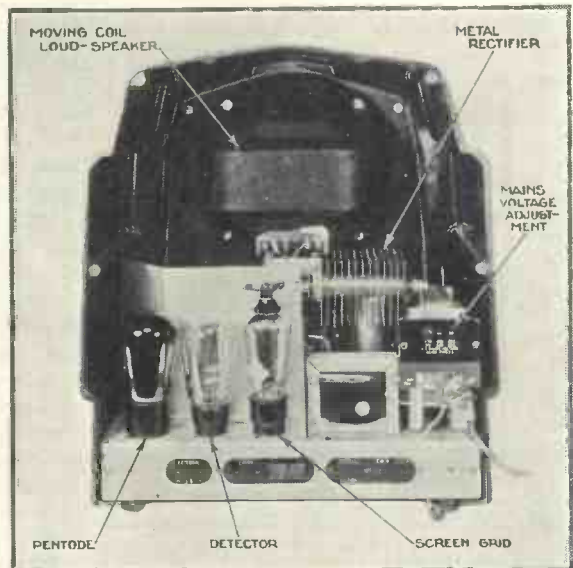

### A NOTABLE MAINS DESIGN

Tests have proved that the new Ekco set gives a performance above the average. It represents a great advance in the "A.C. three" type of set

panel are exposed to view, and can be got at without undoing the fixing screws.

We consider this is a really notable design that represents a great advance in the A.C. three-valver type of set. The M23 is also available for D.C. mains at the same price. Sets are guaranteed for a year.



# R.I. Short-wave Adaptor-amplifier

AS we have many times stated, the simplest way the ordinary broadcast listener can try his luck on the short waves below 100 metres—and, incidentally, the cheapest—is to invest in some form of short-wave adaptor.

To the two distinct types of short-

### NUTSHELL SPECIFICATION

**MAKER:** Radio Instruments, Ltd.  
**PRICE:** £4 10s. (including valve).  
**VALVE COMBINATION:** Short-wave detector, arranged so that existing detector of set becomes low-frequency amplifier.  
**POWER SUPPLY:** Batteries of the set are used.  
**POWER CONSUMPTION:** The only additional drain on the batteries is for the detector valve of the unit.  
**TYPE:** Short-wave adaptor, provided with amplifier circuit to render existing detector of set useful as a low-frequency amplifier.  
**REMARKS:** A thoroughly well-designed short-wave unit, having the advantage over the normal unit that the existing detector is not wasted. Very easy control and a wide range of the short-wave stations.

wave adaptor on the market must now be added the R.I. Antinodal unit, which is not merely an adaptor but an amplifying stage into the bargain.

This new type of unit can be used with any type of broadcast set. It is particularly suitable for sets having detector and low-frequency amplifier circuits, but as there is a stage of amplification in the unit it can well be used with the popular screen-grid, detector and low-frequency sequence.

### Self-contained Amplifier

The high-frequency stage or stages must be cut out of circuit with this type of short-wave adaptor, though in the so-called super-het type of unit the existing high-frequency stages are utilised. To offset the loss of the high-frequency stages there is the self-contained amplifier, so perhaps this point is not important.

The unit under review consists of a short-wave detector circuit, with the new Antinodal coil—a short-wave assembly designed especially to overcome "blind spots" in the tuning range. This is achieved by switching in an aerial loading coil—quite a simple procedure, but remarkably effective, as tests have shown.

The usual detector-adaptor type of unit plugs into the detector-valve

holder of the broadcast set, the normal detector valve being used in the unit and any valves after the set's detector used to amplify the short-wave detector's output.

This normally means that a two-valve broadcast set becomes a two-valve short-waver, but a three-valver, with a stage of high-frequency, is still only a two-valver on short waves, as the first valve is cut out.

Quite a different procedure applies to this R.I. unit. A two-valve broadcast set becomes a three-valve short-waver, while a three-valver with a stage of high-frequency is a three-valve short-waver. It will be appreciated that in connecting up the unit to the set the existing detector becomes a low-frequency amplifier, and an extra valve is needed for the short-wave unit.

By means of a combined valve holder and three-way plug it is the work of a moment to hook on the R.I. unit to an existing set. The set's



SHORT WAVES ON ANY SET

With the addition of this R.I. short-wave adaptor any standard broadcast set will pick up the short-wave stations at good strength

can be adjusted sufficiently finely to bring in steady signals even from the lowest wavelengths. The slow-motion reaction is exemplary, being very smooth on all wavelengths, and entirely free from backlash and blind spots.

For the rest there are the two coil switches, one for the aerial-loading device and the other for changing the wave range from the 12-30 metre band to the 25-80 metre band. No battery switch is needed as the set's switch does this job.

We tested the unit with a well-known make of battery two-valver—thereby converted into a short-wave three with two low-frequency stages—and we were amazed at the power of the many short-wave signals received.

Later on a three-valve set there was equally great power, especially around 30 metres.

We were especially impressed with the smoothness of the reaction, which is maintained throughout the tuning range. This smoothness is achieved by a grid-leak potentiometer, which can be adjusted from the back.

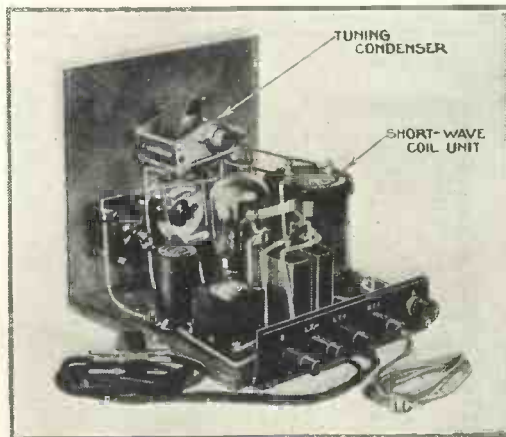

### ALSO AVAILABLE AS KIT

Besides being supplied in its complete form, the R.I. short-wave adaptor can also be obtained as a kit of parts for home construction

tuning is cut out by the plug and the short-wave detector tuning brought into action.

Operation of the unit proved to be extremely simple. On the panel is the slow-motion tuning dial, which



# Lissen Skyscraper Three (Kit Set)



### HANDSOME KIT ASSEMBLY

The Lissen Skyscraper is of handsome proportions, as this photograph shows. Tests prove that it is also good value for money

WE have been trying out a completely assembled model of the new Lissen kit set, which is designed to make the most of three valves arranged in the popular screen-grid, detector and pentode sequence.

As this is a set for constructors, a few details of the circuit will be appropriate. There are no frills, but everything essential to good working is included.

The screen-grid stage has a straight-forward aerial tuning circuit, with a Lissen screened dual-range coil and the usual .0005-microfarad variable condenser. The larger portion of the winding is shorted for medium-wave tuning and the aerial is connected to the grid end through a series condenser, either .0001 microfarad or, for extra selective tuning, .00006 microfarad.

A similar screened

coil is used to couple the screen-grid valve to the detector, the coil being arranged as a tuned-grid coupling. This parallel-tuned circuit is fed with the high-frequency signal through a .0003-microfarad fixed condenser.

Normal values for the grid leak and condenser have been chosen. The detector has an anode bypass condenser of .0002 microfarad, but amp. reaction is ensured by the use of a .0005-microfarad reaction condenser, which is connected in series with a separate reaction winding on the intervalve coil. The usual high-frequency choke is inserted in the detector anode circuit, in which is the low-frequency intervalve transformer.

To ensure against high-frequency current getting into the pentode circuit, and to act as a tone-correcting device, there is a grid-stopper resistance of .25 megohm in the pentode grid lead.

A common shorting switch is

used for the two coils, and there is a switch common to the high- and low-tension circuits for switching the set on and off.

### Simple and Efficient Layout

In the layout of this circuit the makers have made a very simple and efficient job, with the two screened coils mounted on a metal chassis. The two tuning condensers and

### NUTSHELL SPECIFICATION

**MAKER:** Lissen, Ltd.  
**PRICE:** £6 5s. (with valves and batteries)  
**VALVE COMBINATION:** Screen-grid (Lissen SG215), detector (Lissen HL210) and pentode output (Lissen PT225).  
**POWER SUPPLY:** Batteries, self-contained in the model tested.  
**POWER CONSUMPTION:** Total anode current was found to be 11 milliamperes.  
**TYPE:** Kit set for home assembly.  
**REMARKS:** The metal-chassis construction is easy to follow and produces a powerful set that is quite easy to control.

subsidiary controls are mounted on a metal panel at the front.

This chassis is fitted below the cone loud-speaker in the console cabinet. There is space for the usual batteries.

On test we obtained very powerful reception of the locals and of such stations as Midland Regional and Brussels. On long waves Radio Paris came in with quite exceptional volume. Average selectivity was obtained—quite up to the standard expected of two tuned circuits.

Quality has a certain crispness, which gives speech admirable clarity and music a brilliance that is preferable to boominess.

Although there are two tuning knobs to be controlled, the location of the stations within range at this time of the year (July) was easy enough. Reaction is smooth and builds up the foreigners well.

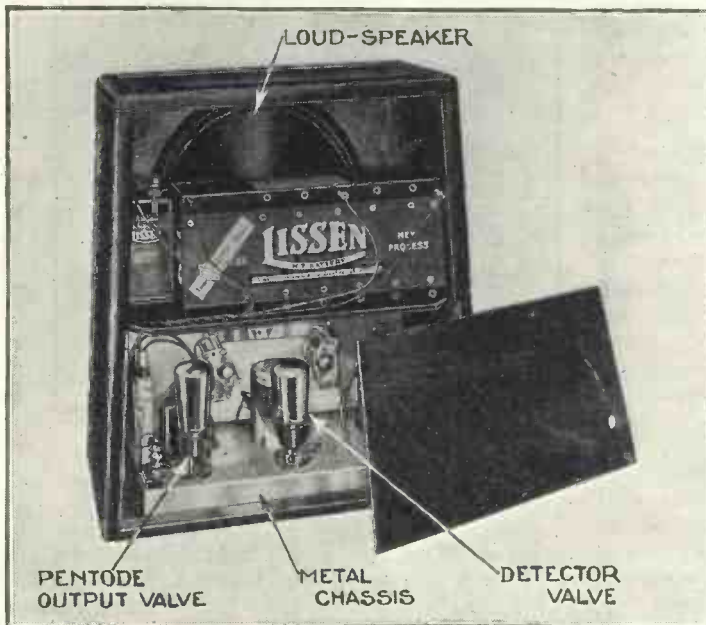

### SIMPLE YET EFFECTIVE LAYOUT

This back view of the Lissen Skyscraper shows the simple nature of the layout. Metal-chassis construction is used and the coils are screened





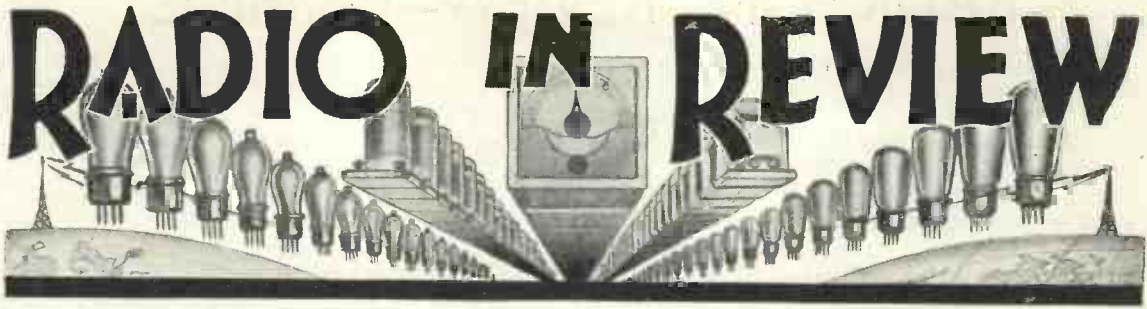

The New Season's Sets :: Some Features of Interest :: Studying the Heaviside Layer

BY the time this issue of "Wireless Magazine" is published we shall know exactly what the manufacturers have kept "up their sleeves" in preparation for the annual show at Olympia. It is always difficult to forecast the way the cat will jump, but there are one or two "pointers" of general interest.

#### Low-priced Super-hets.

The super-het, for instance, is pretty certain to make its appearance at a price more suited than before to the man of moderate means. It has always been one of the most selective circuits available, and just now things are worse than ever in the ether for those who like to bring in the distant stations. This means that there will be a big demand for a really selective set at the right price.

The problem of ganging the tuning condenser of the local oscillator to the input circuits, so as to give uni-control, has been tackled in various ways, some of which will be featured at the show.

The modern super-het is designed to get rid of "double" tuning, that is, bringing in a desired station at two settings on the dial, one as far above the real frequency as the other is below. Now the station only comes in at one setting, the "image" frequency being thrown outside the tuning range of the set. Interference is also reduced in the same way.

#### Constant Coupling

Great strides have also been made in the direction of securing constant coupling—and therefore uniform amplification—over the whole tuning range, so that there is no longer a relatively strong response on the shorter waves, and a falling-off as one tunes in to the longer-wave stations. This improvement has been brought about by a development of the "mixed" type of coupling circuit.

#### By MORTON BARR

By adjusting the relative ratio of magnetic and capacity coupling, as the tuning is altered, the effective impedance of the tuned circuits is kept constant throughout, and the operation of the set is correspondingly improved.

The use of more thorough screening to prevent "stray" coupling, and the absence of interelectrode capacity in the new screen-grid valves, have also helped to make "constant amplification" possible, as both these defects are more prominent on the medium waves than on the long.

The variable-mu valve is certain to be used in most of the new sets, particularly now that they are available with a maximum mutual conductance of 2.5; which is comparable with the ordinary screen-grid valve.

The variable-mu valve prevents cross-modulation, a particularly useful point in these days of ether congestion because unlike ordinary interference, once cross-modulation has been introduced it cannot be removed by subsequent tuning. The obvious solution for long-range receivers is, therefore, to shut out cross-modulation by using the right type of input valve.

The variable-mu valve also goes a long way to ensure automatic volume control, because it naturally amplifies strong signals less than the weaker ones, and it does this without in anyway affecting the tuning of the circuits. This is naturally a big point in its favour from the point of view of the set designer.

Band-pass tuning is likely to be a favourite with the discriminating listener, who may perhaps be defined as one who will not be bothered with

distant stations unless the quality is right.

Band-pass circuits bring in the sidebands as well as the carrier, and this makes for good quality. On the other hand they have a sharp cut-off for outside interference.

#### Metal Rectifiers

Amongst minor features of interest there is likely to be a big increase in the use of the dry-contact type of rectifier for all-mains sets, as well as in eliminator units. Its chief advantage over the valve rectifier lies in the mains transformer, which is simpler in design and therefore costs less to make.

One hears, too, of various interesting and ingenious "gadgets" to simplify tuning and to help in locating distant stations. The pentode is also likely to be widely used in certain types of set, particularly as it gives an undistorted output two or three times that of a triode for a given input voltage and peak voltage. Its tendency to accentuate the higher frequencies is also an advantage in certain cases, as it helps automatically to compensate for any "cutting" of the sidebands in the high-frequency circuits.

#### Appleton's Expedition

Many people will envy the happy lot of the members of the radio expedition now in Tromso helping Professor Appleton to investigate the nature and behaviour of the Heaviside Layer. Apart altogether from merely scientific interest there is something very attractive just now in the idea of being able to carry out one's daily "spot of work" in Arctic regions instead of in town.

A few years ago Professor Appleton discovered a second layer of ionised

## RADIO IN REVIEW—Continued

air, which plays an important part in the transmission of short-wave signals.

The first or Heaviside layer lies at an average height of 60 miles above the ground and serves to reflect back the short and medium waves. The second, or "Appleton" layer, is twice as high as the first, and acts as a "ceiling" for those ultra-short waves which usually manage to pass through the first layer and would be entirely lost were it not for the second layer.

The chief object of the expedition

is to measure the ionisation density of both the layers, in order to judge of the advisability of using the North Pole route as the shortest link between certain long-range commercial beam stations.

Another point of interest is to discover what exactly occurs when wireless waves are reflected by the layer, and why it is that in some cases the plane of the wave is merely twisted through a certain angle, whilst in other cases the reflected wave is circularly or elliptically polarised.

many as ten "crystal" loud-speakers may be operated from a source which can only deliver sufficient speech energy to operate one reproducer of any other type.

Sensitivity hitherto unheard of is claimed for this new device, and polarising potential is not a necessity for its operation. Light weight, small physical dimensions, and cheapness all contribute to the favourable impression it has so far created.

The power-handling capacity of the Rochelle salt loud-speaker appears to be adequate, because several New York talkie theatres are using them in conjunction with moving-coil reproducers. Such a combination extends the acoustic range, and helps materially to keep the load impedance constant at all frequencies.

Further experimentation may reveal unsuspected potentialities, which may result in a cheapening of amplifier design and enable the small set owner to obtain greater realism from the most modest output stage.

J.L.M.

## The Crystal Loud-speaker

IT can truthfully be said that the loud-speaker of to-day is a component whose development has taken the form of a gradual emergence from its original crudity as a glorified telephone earpiece. No overnight phenomenal change has marked its progress, and the old electromagnetic principle still forms the basis of its *modus operandi*.

### Breakaway from Tradition

The electrostatic loud-speaker is gaining more attention than formerly and represents the first breakaway from the electromagnetic tradition and, as might be expected, shows characteristics the reverse of those obtaining in its more orthodox predecessors.

Whereas the electromagnetically operated reproducer of the moving-coil type favours the lower end of the audio spectrum, the converse is true of the electrostatic type.

The Americans have been the first to realise that frequency discrimination is bound to result from the electromagnetic or electrostatic basis of operation, and have turned their attention to the development of a driving unit which offers a more constant impedance over the frequency gamut.

### Piezo-electric Crystal

This driving unit takes the form of a piezo-electric crystal, which is capable of producing mechanical movement on the application of electrical potential.

Loud-speakers using this new

"motor" have been found to possess many excellent qualities, notably a more constant working impedance than orthodox types, which results in more linear response.

Since the Rochelle salt loud-speaker is a potentially operated device, no power is consumed by its use, and this fact explains why a

## A Unique Lead-in

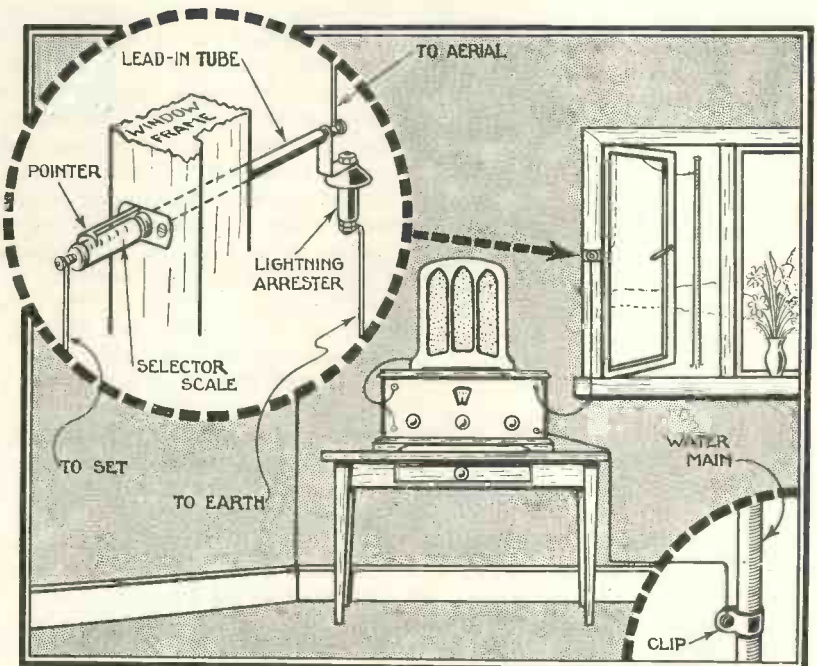

Known as the Selectoguard, this device constitutes a lead-in, pre-set condenser and spark gap. It is made by Contal Radio, Ltd., of 38b New Inn Yard, London, E.C.2 and the price is 3s. The illustrations show how it is fixed

# 'A' Quality from D.C. Mains

By P. K. TURNER, M.I.E.E.

**A**MONG the many letters that I have received since the publication of the A-P-A and its first radio unit there are some impassioned appeals for a similar outfit designed to work on D.C. mains.

## Not an Easy Problem

Naturally, I have devoted a good deal of thought to this problem, but it is not an easy one. True, it is not too difficult to get "A" quality with the high-tension supply derived from D.C. mains, if they are at 200 volts or more; but as one extends the use of the mains to supply the grid bias and heaters or filaments, so the difficulties increase, unless one is prepared to consume an altogether excessive amount of power.

difficulty that, when such valves are found, they take quite a large filament current.

If this is to be got from the mains it can only be done by using a resistor in series: and for every watt taken at 4 volts for the filaments, 50 to 60 watts will be wasted in the resistor, which may make the whole set prohibitively expensive to run.

There is one point about D.C. mains sets which is so important that I will deal with it now, right at the beginning of things. In a set working on D.C. mains, the whole receiver must be actually connected to the mains, and this means that *any* part of the set, including what are usually regarded as "earthed" parts, may be dangerous to touch, and also that actually earthing it

Very great interest was aroused by the publication of P. K. Turner's design for an A-quality power amplifier in the March issue of "Wireless Magazine." The original A-P-A, as it was called, operated from A.C. mains. Here Mr. Turner discusses the problem of "A" quality from the point of view of the man with a D.C. supply

will stand up to the full mains voltage: also, since there is always the chance that the aerial may break and fall, or that someone may touch it, the same applies to the aerial.

Further, pick-up and loud-speaker leads must also be connected through condensers, unless, of course, their connection to the set is *via* transformers. But this is not all.

## Insulation

Screening boxes, which are connected to the cathode or filament circuit, may also be alive, and so may control spindles, metal panels, and baseboards. A D.C. mains set should therefore have a bakelite panel and a wooden cabinet, and it *must* be switched off, by a double-pole switch, before it is opened.

Lastly, since control spindles may be alive and grub-screws are connected to them, the control knobs themselves may be dangerous unless the grub-screws are sunk well below the surface of the knob. In fact it is best to use insulating couplings for all control spindles.

## Possible Alternatives

Now, returning to the case of a man who wants "A" quality, and has only D.C. mains. What are the possible alternatives for him?

(1) ARRANGEMENTS WHICH DO NOT ACTUALLY USE THE MAINS ON THE SET ITSELF.

The first of these is to use a battery set, the high-tension being supplied from accumulators, which are in turn charged from the mains. This has the fatal disadvantage that

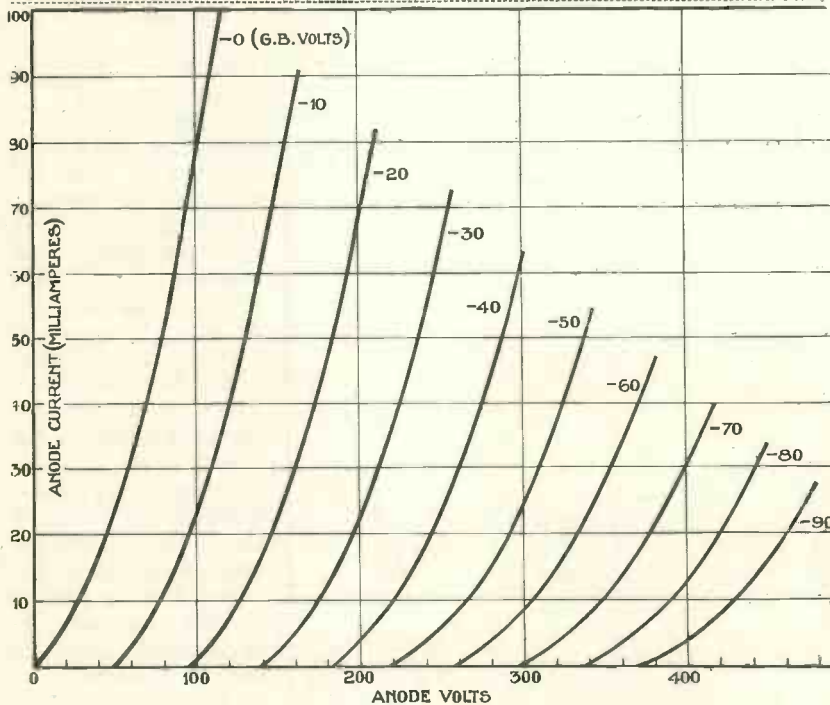

Fig. 1.—Anode current/anode volts curves of a PX4 valve for various grid-bias voltages from 0 to 90 volts. See also Fig. 2

The trouble, of course, lies almost entirely in the last stage. There is first the difficulty of finding power valves which give enough output with only 200 volts or so of anode supply. Then follows the further

may blow all the house fuses.

To avoid the latter event, the first and most obvious precaution is that the earth terminal of the set must only be connected to the rest of the wiring through a condenser which

# "A" QUALITY FROM D.C. MAINS—Continued

high-tension accumulators need skilled attention. Anyone who is capable of looking after them is probably also capable of designing a high-power battery set to use them, so I shall not deal further with this system.

Another system of this class consists of a rotary converter, driven from the mains and giving A.C., and then an A.C. mains set such as the A-P-A. This is in my opinion by far the best outfit; and it is practically the only possible one for 100-volt mains.

## Question of Cost

It is, however, expensive: in addition to the usual cost of the set with full A.C. mains equipment, there is a further £10 to £15 for the converter. Also, the outfit will use a good deal of power.

For example, the A-P-A needs 25 watts into the anode of the last valve. This in turn means about 50 watts of A.C. supply to the rectifier; and the supplies to the earlier valves, and for heaters, etc., bring the total A.C. up to nearly 100 watts. To get this from the rotary converter probably means putting in nearly 200 watts from the mains, giving 5 hours' working for the price of one unit.

Lastly in this class is the use of a rotary converter which uses D.C. from the mains, and gives not A.C. but D.C. at the various voltages required for the set. The set itself is built like a high-power battery set. This is an excellent solution. The power is used with reasonable efficiency, and the set is fairly easy and cheap to design.

The great trouble is a lack of flexibility. The D.C.-A.C. converter can be used for any A.C. set, provided it is big enough; but the various D.C. outputs of the other type are practically fixed, so that developments in valve and set design might make it obsolete.

I believe myself that

this trouble is not so great as it appears; but it has been effective in discouraging the building of such converters, so that I know of none on the market; and until there are some it is useless to design sets for them. So that from the set design point of view the whole of this class of outfit calls for no further remark.

(2) USING THE D.C. MAINS FOR HIGH-TENSION SUPPLY ONLY, AND BATTERIES FOR GRID BIAS AND FILA-MENTS.

This is undoubtedly the cheapest and most satisfactory arrangement as regards first cost and efficiency. The greatest difficulty is the filament battery. Charging low-voltage batteries off D.C. mains is hopelessly wasteful unless done in quantity with proper apparatus; so that this system means having the filament battery charged by a dealer or electrician. Whether to adopt it or not depends mostly on whether there is a cheap and reliable battery service in the listener's neighbourhood.

(3) ALL-MAINS, OR ALL-MAINS EXCEPT FOR A GRID-BIAS BATTERY.

This is the most troublesome as regards the design and building of the set, but of course the simplest

in use. I myself should avoid it whenever any of the other systems is possible, but of course that is a personal view, mostly due to the fact that I am used to handling batteries and such things.

Before we go further into the two last systems, we must have some general idea of the sort of set to be designed; for although the greatest difficulty is going to be the last stage, we must arrange for the whole set to be a consistent design.

## Similar to the A-P-A

I am going to adopt the following "general idea" to correspond as closely as possible in performance with the A-P-A outfit—a last stage giving about 5,000 milliwatts maximum output, or somewhere near it; a detector working under linear conditions to avoid distortion; and one screen-grid high-frequency stage.

We will first consider system (2), the use of the mains for high-tension supply only. The first thing is to decide on the power valve or valves. In practice it must be "valves," for there is at present no valve which will give our required output at the low voltage of 200 or so. There are valves rated to dissipate 12 watts, and two of these will do what we require. There are two such valves available; the Marconi or Osram PX4 and the Mullard AC044.

Both these valves suffer from a defect which is almost universal in valves of this general type. When one draws the valve curve-sheet, which is the basis of design, one finds that the curves don't lie parallel to one another. As an example, Fig. 1 is the curve-sheet of a PX4. In Fig. 2 I show just the two curves for 0 and 50 volts bias from Fig. 1 and, also, dotted, how the 50-volt curve *should* go if the valve were perfect. The reasons for this trouble are well known to the valve makers, but

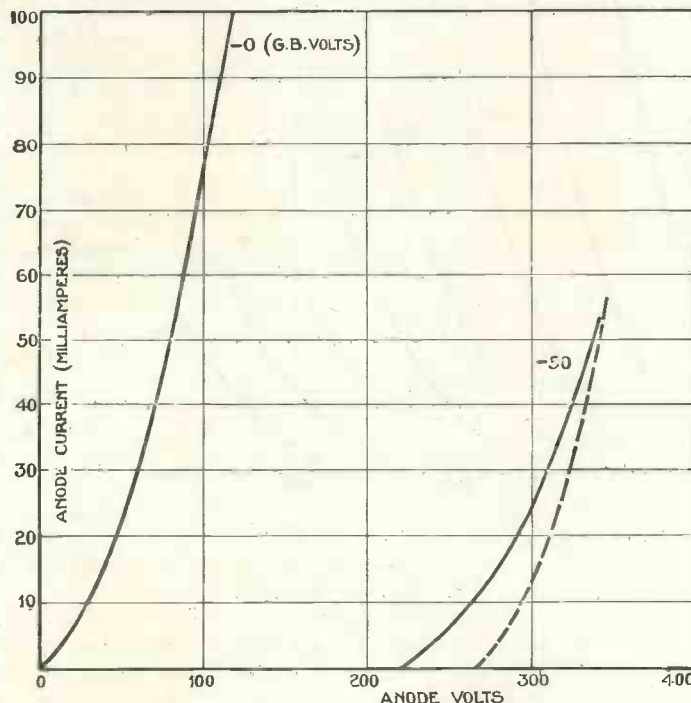

Fig. 2.—The dotted line shows how the 50-volt curve should go if the valve were perfect

# A SPECIAL ARTICLE BY P. K. TURNER

unfortunately it is unavoidable at present when it is essential that the valve should have a high performance with low anode volts.

It will be seen from Fig. 2 that every time the grid is made extra negative by the audio-frequency input voltage, the current is not decreased as far as it ought to be; and the result is the introduction of rather large "second-harmonic distortion" if we try to get anything like the rated power out of the valve.

Since the most notable effect of "push-pull" working is to abolish even harmonics, this is obviously the occasion to use it. Readers may remember that I recently described what I called "economy push-pull": a system in which the valves are biased so heavily that there is only a very small anode current when no signals are coming in.

I should like to make it clear that that system is not suitable for mains working. The push-pull arrangement now being discussed is the more usual one, in which the valves are biased to their normal working current.

A detailed investigation of the PX4 curve-sheet leads to the following specification for an "A" quality last stage: two valves in push-pull; anode volts, 235\*; bias, 30 volts; current, 50 milliamperes per valve, or 100 milliamperes when idle, rising to 109 milliamperes on loud signals.

## Maximum Output

If the load is properly adjusted by choice of correct transformer ratio, the maximum undistorted output is 4,800 milliwatts: the correct ratio is that which makes the loud-speaker behave as a working load of 8,000 ohms across the whole primary. The total grid swing required, over the whole secondary of the input transformer, is 120 volts.

This being settled, we come to consider the previous stage. The highest available ratio for the inter-

\* Of course if there is only 200 volts available, the output power will be correspondingly diminished.

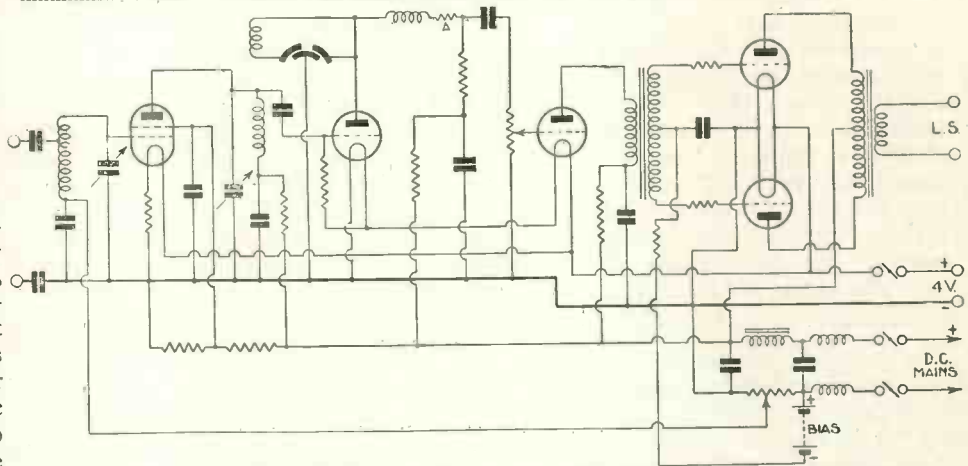

Fig. 3.—Schematic diagram of a set with 2-volt screen-grid valve, tuned circuit, 2-volt detector with reaction, resistance coupling, 2-volt low-frequency amplifier valve, push-pull transformer and power stage. This uses 200-250 volt mains for high-tension only

valve transformer is 1:5 for the Varley, the alternative being 1:3.5 for the Ferranti. This means that the previous valve must have an effective output of 24 volts in the one case, or about 35 volts in the other. Can this be got from the detector?

## Filament Supply

This depends on what valve we use. From a mains valve, just about; with a 2-volt valve, probably not. So one must think about the filament supply and choice of valves. Remember that we are at present discussing a set which is to use an accumulator for low-tension supply.

The two power valves call for 1 ampere each at 4 volts, so that obviously a fairly heavy battery will be needed. If we use a mains valve as detector, it will be an A.C. valve, taking another 1 ampere; if we use a 2-volt valve as detector, and then have to put in an extra low-frequency valve, the two will only call for .1 ampere, if we wire the filaments in series.

Also, the mains valve would call for a lot of thought to get enough power together with volume control (compare page 404 of May—the A-P-A Radio Unit), while the use of another valve as first low-frequency amplifier makes this easy. So probably this is the best way of arranging things.

This means that the arrangement of the set is as follows: Band-pass aerial circuit, 2-volt screened valve, tuned circuit, 2-volt detector with reaction, resistance coupling, 2-volt

low-frequency amplifier valve, push-pull transformer, power stage; and its schematic diagram will be more or less like Fig. 3. This calls for one or two remarks.

First, although it has four stages and five valves, both its output power and its range for first-class results will be just about the same as for the original three-valve A-P-A outfit. The maximum undistorted output will be about the same—5,000 milliwatts or so; and the range will be about the same, because the detector calls for rather less input than the A.C. valve, and the 2-volt screened valve will just fit this condition by giving rather less magnification.

Taking the outfit as a whole, more money will be spent on valves and low-frequency transformer, but less on smoothing equipment, rectifiers, etc.; the overall price will be very similar.

## Unusual Biasing

Looking at the schematic diagram, the extra resistor A in the detector-anode circuit is inserted to prevent over-loading the later stages while still getting the proper output from the detector to give linear rectification.

The arrangement for biasing is a little unusual. It is considered wasteful to get the 30 volts required for the last stage from the mains, and it would reduce the available anode volts too much; but to avoid having a potentiometer across the grid battery, 10 volts of the high-tension is dropped to give the variable bias for the screened valve.

# "A" QUALITY FROM D.C. MAINS—Continued

Many readers have asked for a D.C. version of P. K. Turner's A-P-A, which was designed to operate from A.C. mains. Look out in an early issue of "Wireless Magazine" for full details of an "A" quality amplifier for D.C. mains. This article discusses the possibilities and advantages of alternative schemes

The rest of the bias for the power stage comes from a battery, and that for the first low-frequency valve is got across the filament of the detector.

Now turning to system (3), the all-mains set, we are faced with a serious difficulty as to the last stage. There are two series of mains valves designed for D.C. work: the Marconi-Osram, each taking .75 ampere at 16 volts; and the Mazda, taking .5 ampere at 6 or 8 volts.

### Pentode Output

In each case the only power valve of the series is a pentode rated at 8 watts dissipation, and each of these pentodes has a maximum undistorted output of about 1,700 milliwatts, so that three of them will be required to give the same power as the one DO24 of the A-P-A. Fair results, especially in smallish rooms, will be got with two, and it is for the user to decide whether to use two or three.

Seeing that the power valves have practically the same performance in the two series of valves, I propose to consider the use of the Osram series, as they are more economical in heater supply.

It will, of course, be realised that these D.C. mains valves are used with the heaters connected in series, although the cathodes are connected up in the usual way. Further, as pentodes tend to give third harmonics rather than second when they distort, nothing is to be gained by arranging the last stage in push-pull; so the two or three power valves are connected in parallel.

The bias is approximately .12 volts, and the

required grid swing 24 volts, so that if an intervalve transformer is used, the effective output of the previous valve will have to be of the order of 6 to 8 volts swing as a maximum.

This, of course, is well within the power of the detector; in fact, we shall probably find that for linear rectification the detector must be run at a considerably higher output, so that we shall have to make arrangements not to use all that it gives.

So the general arrangement will be something like Fig. 4. One of our troubles is that the D.C. mains screened valve is not of the variable type, so we have the problem of the best method of high-frequency volume control.\* Fig. 4 actually shows two methods. There is a differential condenser to cut down the aerial input, and a variable screen-volt supply to cut down the magnification of the first valve.

At first sight the latter seems preferable, for control at the aerial simply reduces a near station to the equivalent of a distant one: the amplification is kept up to the full, so that valve noises, etc., are fully amplified, giving, perhaps, a noisy background.

But the screen-volts control has a disadvantage. The grid bias is quite small all the time, so that the large inputs from nearby stations may make the screened valve run into grid current, which means rectification, with its attendant possibilities of hum and cross-modulation. The final decision on this point is best

\* Since writing this an Osram variable- $\mu$  valve for D.C. mains has been announced.

left till the detailed design is being carried out.

Another point about Fig. 4 is the large number of resistors between the detector and the transformer primary—no less than five. Of these, B is the usual coupling resistor, and C a decoupler. D is the low-frequency volume control, and E is inserted (as already explained in connection with the A-P-A Radio Unit) to keep the response curve approximately the same for all positions of the volume control. A is provisionally inserted to enable the detector output to be kept up to its proper value without overloading the power valves. Its presence means that the maximum obtainable voltage on the transformer is only  $\frac{B}{A+B}$  times the effective maximum output of the detector.

### High-frequency Stoppers

Resistors F, in the grid leads to the power valves, are to prevent the possibility of high-frequency oscillations: they were inserted also in Fig. 3, and should be used whenever several modern high-efficiency valves are used in parallel or push-pull.

A tone-corrector circuit is shown: it may or may not be necessary, depending on the loud-speaker used.

The changes necessary to provide for two pentodes in the last stage instead of three are (1) a change in the output transformer ratio; (2) an increase of the value of resistors G and H, so as to maintain the grid and screen volts correct in spite of the decreased current; and (3) adjustment of the main heater resistor K.

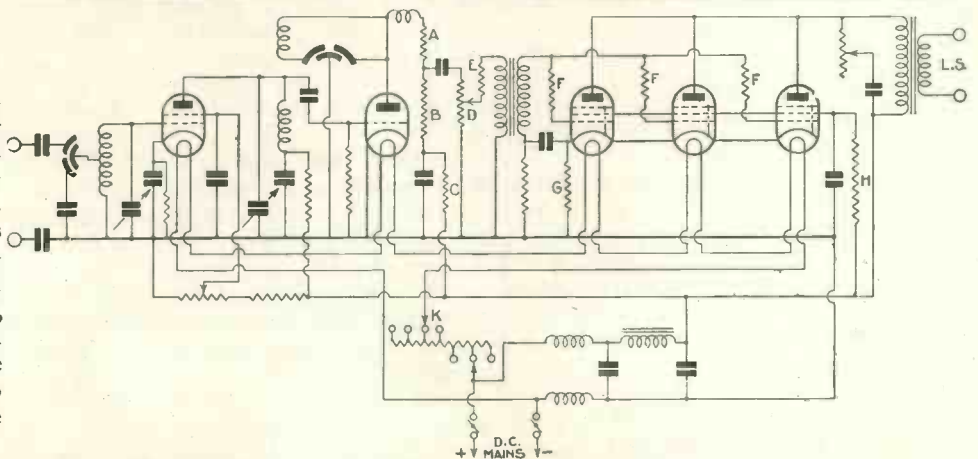

Fig. 4.—Schematic diagram of all-mains set for D.C. operation. There are two methods of volume control—a differential condenser to cut down aerial input and a variable screen-volt supply

# Are We Getting the Best from the Long Waves?

By J. H. REYNER, B.Sc., A.M.I.E.E.

LONG-WAVE programmes have saved many "Wireless Magazine" readers from boredom on a Sunday afternoon, while for dwellers in the more remote parts of the country long-wave reception is all that can be obtained with any satisfaction. Do we really pay enough attention to these wavelengths?

## Medium-wave Limitations

They were first developed in the days when the production of a large aerial power on medium wavelengths was not practicable. Any station intended to serve the whole country therefore had to operate on a long wavelength.

The more fortunate listeners who were situated in a town and who were therefore served by the ordinary programme came to regard the long waves as of little importance, and much of the design in the past has included long-wave reception, as a necessary evil, and not as something out of which really good reception can be obtained.

How many people, for example, have any idea of what constitutes a good long-wave coil? On the medium waveband most technically-minded people have fairly well defined ideas as to what constitutes an efficient coil, but for long-wave work we have a variety of different types of winding ranging from single-section hank windings to highly sectionalised windings, or even a single-layer solenoid wound with fine wire.

## Relative Efficiency

What is the relative efficiency of these various forms of winding, and how do they compare with a medium-wave coil?

I had occasion recently to make a number of tests on long-wave coils of various types which brought to

light several interesting facts, some of which will, I think, interest "Wireless Magazine" readers.

One of the tests consisted of the measurement of the high-frequency resistance of different forms of coils. These measurements were made at a wavelength of 1,600 metres, this being a convenient point in the middle of the long-wave scale, and actually all the coils were wound to have the same inductance so that the resistances obtained were comparable.

Some of the results are quoted in

The greater the number of sections the more efficient does the winding become; the final choice is usually a matter of expediency rather than efficiency.

The most striking feature about the coils, however, is the relatively low order of the resistance, compared with that which is obtained on the medium waveband.

The average medium-wave coil of to-day has a resistance of about 10 ohms at 450 metres. Its inductance will be about 180 microhenries, giving a ratio of .055 ohm

## LONG-WAVE COIL RESISTANCES

Coils all 2,250 microhenries: measured at 1,600 metres

Type of Coil	High-frequency Resistance (ohms)
Single-layer solenoid, No. 32 d.s.c., 2½ in. dia. . . . .	25
Igranic triple honeycomb coil . . . . .	30
Bunched winding, No. 34 d.s.c., in three slots, 2½ in. dia. . . . .	35
Leesona winding, No. 34 d.s.c., single section, 1¼ in. dia. . . . .	60
Bunched winding, No. 34 d.s.c., in one slot, 2 in. dia. . . . .	70
Bunched winding, No. 36 d.s.c., in one slot, ¾ in. dia. . . . .	90
Single-layer solenoid, No. 38 enamelled, 1¼ in. dia. . . . .	100

the table accompanying this article, and the information given is self-explanatory. The Leesona winding referred to is the well-known honeycomb weave which is often utilised in manufactured receivers, since it makes a convenient form of winding which is self-supporting.

The results show, firstly, that there is a wide variation between the different forms of coil and, secondly, that a multi-section winding with the windings in a suitable slotted former, or otherwise conveniently separated, constitutes the most efficient form.

per microhenry. On the other hand, quite an average long-wave coil has a resistance of only 50 ohms which, with an inductance of 2,250 microhenries is only about .022 ohm per microhenry, more than twice as good as the ordinary medium-wave coil.

For an equivalent performance we could stand a resistance of 1.25 ohms and none of the coils tested came anywhere near this value.

This state of affairs causes one furiously to think. It means that even the average long-wave coil is distinctly better than the medium-

# THE BEST FROM THE LONG WAVES—Cont.

wave coils used to-day and that with comparatively little trouble we can obtain a coil five times as good.

Is it fair to expect a coil to give its true performance if we adopt the same methods for the long-wave reception as we do for the medium waves?

Consider, for example, the question of the valve damping. Any



**TYPICAL DUAL-RANGE WINDING**  
In this coil the long-wave winding (seen at the top) is arranged in slots in the ebonite former

tuned circuit in the anode circuit of a valve is affected by the valve, which acts as a high resistance shunted across the circuit. It is customary on the medium waves to centre-tap the tuned circuit in order to minimise this valve damping.

Let us revert to our previous example of a coil of 180 microhenries inductance and a resistance of 10 ohms. This will tune to 450 metres with 316 micromicrofarads.

### Extra Resistance

It is possible to work out the extra effective resistance introduced into the circuit by the valve. (I have done this at the end of the article for those who are interested.) With a valve of 200,000 ohms resistance connected to the centre tap, the resistance is increased from 10 to 10.7 ohms, giving an increase of only 7 per cent.

In the circumstances the valve damping is negligible. It must be emphasised, however, that this is only true because the coil is relatively inefficient.

Consider now the case of the long-wave coil, and let us assume that here again we centre-tap on to the coil.

Working on the same figures as before, we find that a resistance of 50 ohms under normal conditions has been increased to 58 ohms, an increase of 16 per cent. What is more, in many circuits we do not trouble to tap down the coil on the long waves, but use practically the whole winding, in which circumstances the effective resistance of the coil rises to 85 ohms, or an increase of 70 per cent.

In other words, our present habit of treating the long waves in exactly the same manner as the medium waves is losing a good deal of efficiency, and there are two alternatives open.

One is to make the long-wave coils cheaper and nastier so that they come down to the level of the medium-wave coils as regards performance. Alternatively, we can go to a little more trouble with the long-wave circuit and really make proper use of the facilities at our disposal.

The tuning on the long waveband is often a little misleading because it appears rather flat. This seems to be opposed to the suggestion just put forward that long-wave coils are really much more efficient than is generally realised.

The answer to this is found in an examination of the tuning itself. Let us consider the same coils as before, namely, first of all a medium-wave coil of 180 microhenries, tuned to 450 metres. This will actually require a capacity of .000316 microfarad.

Suppose we increase this tuning capacity by 10 micromicrofarads, corresponding to about 3 degrees. Calculation shows that the wavelength will have changed to 457 metres, corresponding to a difference of just over 10 kilocycles.

Let us now consider the long-wave coil of 2,250 microhenries tuned to 1,600 metres, which again will require practically the same value of capacity (actually .00032 microfarad). If we increase the capacity again by 10 micromicrofarads we find that the wavelength increases to 1,625 metres, which only corresponds to a change of 3 kilocycles.

In order to obtain a change of 10

kilocycles we should have to go about 10 degrees instead of only 3 degrees as on the medium-wave band and it is this which gives the impression of flat tuning.

The number of possible programmes within the long waveband is thus strictly limited, but the reception of those programmes could be made much better than it usually is, and we ought to pay more attention to this aspect of our radio reception.

### APPENDIX

The effective resistance of a parallel circuit, tuned to resonance, is  $L/CR$  where  $L$  is in microhenries,  $C$  in microfarads, and  $R$  in ohms. For the medium-wave coil quoted this is 56,000 ohms approximately.

The valve resistance of 200,000 ohms across half the coil is equivalent to four times this value—800,000 ohms—across the whole coil.

The resistance of 56,000 ohms and 800,000 ohms in parallel is 52,500 ohms, which is equal to  $L/CR_1$ , where  $R_1$  is the effective resistance allowing for the valve damping.



**WITH APERIODIC PRIMARY**  
This Sovereign Super Selector coil has an aperiodic aerial winding. The long-wave winding, wound in slots, is seen at the bottom of the former

$L$  and  $C$  are the same as before, so that  $R_1$  is 10.7 ohms.

The same reasoning is used in the other examples. In the case of the long-wave coil, with the valve across the whole coil, we consider the 200,000 ohms across the whole circuit, which reduces the dynamic resistance of the long-wave circuit from 141,000 ohms to 83,000 ohms.



# SOMETHING ABOUT NOISE

There are some elementary facts about sound that every radio listener should know. This article gives an idea of the problems concerned with the purely aural side of radio reception, and is therefore of importance. It is written by an ex-B.B.C. engineer—

W. H. O. SWEENY

**W**HAT a subject to choose for an article! Yet, though most radio enthusiasts would indignantly repudiate any connection between the output from their loud-speakers and this title, there is a connection, and a close one, too.

The study of noise can become absorbingly interesting. Take any familiar noise—analyse it, split it up into its fundamental frequencies and its harmonics, or overtones—compare it with any other familiar noise—compare the levels, and so on *ad infinitum*. To the serious wireless experimenter, noise merits considerable attention.

## Interesting Facts

Such a subject could not possibly be treated fully in a short article of this nature and it is only possible, therefore, to pick out a few interesting facts for discussion.

The first important question is the effect of noise on the ear. Noises, as we know, vary enormously in character, some appearing low pitched and some high pitched. Now the ear is very sensitive indeed to a change of pitch, but any alteration in intensity has to be quite large before the ear perceives it.

Suppose that we deliberately manufacture or produce noise, and that we

have some method of measuring the amount of energy expended in doing so. We should find that we required greater energy to produce a very low-pitched or high-pitched noise than to produce one of medium pitch, assuming that a constant noise level was aimed at.

In other words, the ear is most sensitive to sounds which have a frequency of between 2,000 and 4,000 cycles per second.

With regard to changes of intensity, or loudness level, we should also discover another curious fact. If

we listened to a sound which was only just audible, we should find that to produce any appreciable increase in level, a considerable increase in intensity would be required, probably as much as 30 per cent.

“Intensity” is really a definition of loudness, but in this case the ear is not required to judge. A piece of apparatus specially designed for the job would be used. This has not the peculiar properties to which the human ear is subject, and measures the actual sound pressure in dynes, or mean pressure per square centimetre.)

If, however, we listened to a considerably louder sound we would find that to produce an appreciable increase in loudness a much smaller change in intensity would be



**PREPARING TO MAKE SOME NOISE!**  
A public-address engineer testing the loud-speaker installation at Wembley Stadium in preparation for a cup final. Moving coil units are used

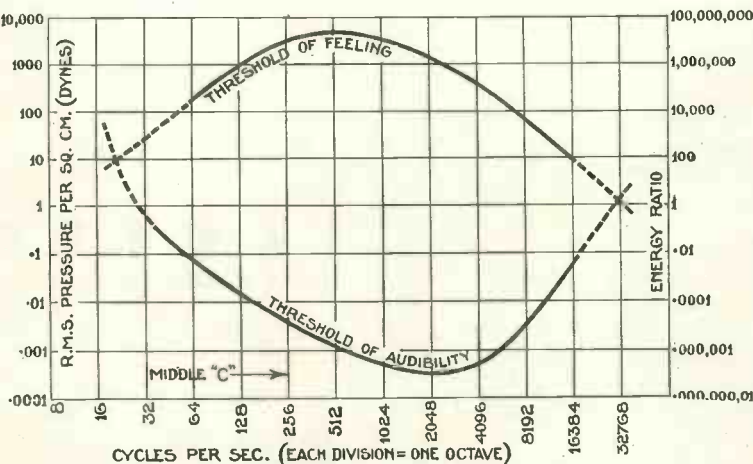

Fig. 1.—Lower curve shows the minimum variation of pressure required to make audible different frequencies. Thus any variation of pressure below the curve will be inaudible. Above the curve, and up to the upper one, the ear hears frequencies of increasing pressure. The top curve shows the point where pain is first experienced; above this curve, pain only is experienced. The area between the curves is known as the audibility area. Thus, from the curve, if we produce a tone of 512 c.p.s. (one octave above Middle C), at a pressure of 1/10 dyne, we should hear it easily. A tone of 32 c.p.s. (three octaves below Middle C) at the same pressure would be inaudible. Similarly, Middle C, at a pressure or intensity of 1,000 dynes, would sound very loud indeed, but a note two octaves lower at the same intensity would produce only a sensation of pain

# SOMETHING ABOUT NOISE—Continued

required, perhaps only 10 per cent.

We are now coming to the condition where any increase in intensity will not produce any increase in loudness level (as perceived by the ear, of course), but will result in a

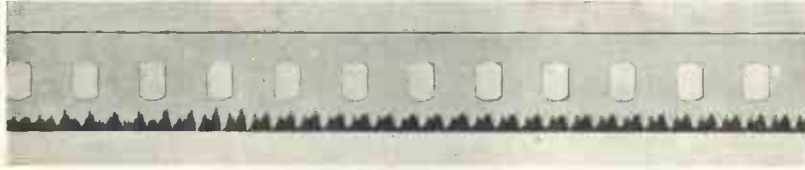

Fig. 2.—Piano Middle C. The fundamental frequency, as measured, is 265 c.p.s. The discrepancy between this and 256 c.p.s., the true Middle C, is due to the pitch of this particular piano having been raised to concert pitch. Analysing the track, it is seen that for the first .02 second after the initial hammer impact on the strings, the amplitude of the second harmonic (530 c.p.s.) was about 75 per cent of that of the first, or fundamental, the third (795 c.p.s.), fourth (1,060 c.p.s.), fifth (1,325 c.p.s.), and sixth (1,590 c.p.s.) having amplitudes approximately 60 per cent, 50 per cent, 40 per cent, and 20 per cent of that of the fundamental. After this, and up to the end of the first 1/15 second, the second, third, fourth, and fifth become more attenuated, while the sixth disappeared. At the end of one second (not shown in illustration owing to lack of space) the fifth had disappeared, the sound ultimately dying away in about five seconds, with the fundamental persisting after all harmonics had become too attenuated for recording

ticking or painful sensation in the ear.

All these facts, if plotted in the form of a graph, would show that at very high and low frequencies the sensations of feeling and hearing become merged together. For the benefit of those who are sufficiently interested, a graph is reproduced herewith (Fig. 1) showing all the facts we have just discussed.

It will be seen from the curves that more than 1,000,000 times as much energy is required to make a sound audible at 32 c.p.s. (cycles per second) as at 1,000 c.p.s., and more than 10,000,000 times as much as at 2,000 c.p.s.

It will be noticed that the curves have only been made full lines over a portion of their length. This has been done to show the limits of audibility. The average ear will not distinguish frequencies much below 32 or above 16,000 c.p.s.

## Unit of Loudness

Having proceeded so far, it must seem obvious that a unit of loudness is desirable. If we wish to distinguish in level between two sounds, we must have some convenient method. It is the peculiar property of the ear, mentioned above, which has influenced the selection of the unit of loudness. It has been found that the ear functions logarithmically; that is, if the ratio of the intensities of three sounds of the same frequency is 1,000, 100, 10, the ratio to the ear will seem to be about 3, 2, 1. An examination of the

curves in Fig. 1 shows that both the axes are divided logarithmically.

We define the unit of loudness as the decibel. Most people learnt about logarithms at school, and it should be easy to understand the

of the amplifier to the output power is 1/10,000, the gain of the amplifier expressed in decibels =  $10 \log_{10} P_1/P_2 = 10 \log_{10} 10,000 = 10 \times 4.0 = 40$  decibels.

If the voltage amplification of the amplifier is known, then the gain is given by  $20 \log_{10} v_1/v_2$  decibels. When the gain is expressed in decibels, a more accurate idea is obtained of the amplification, in so far as it affects the ear. Thus, though the ratio of the input to the output powers of the amplifier be 1/10,000 the sound does not appear to the ear to be 10,000 times as loud. On the contrary, it appears to be just about forty times as loud, an amount consonant with the gain of the amplifier, which is 40 d.b.

## Complex Frequencies

All the foregoing will perhaps explain to the reader in some measure just what the decibel is and what it means. Now, armed with this knowledge, let us examine once more the question of noise.

definition of a decibel. It is quite straightforward, and there is nothing to be afraid of.

Putting it first of all mathematically: "Two pure tones of intensity  $I$  and  $I_1$  are said to differ in loudness



Fig. 3.—Organ pipe Middle C. The fundamental measures 257 c.p.s., which agrees closely with the theoretical 256 c.p.s. The second harmonic is seen to persist at about 60 per cent, with a very slight trace of third harmonic. This condition remains constant

by  $n$  decibels, where  $n = 10 \log_{10} I/I_1$ ."

By using a logarithmic basis of computation, percentage increases are resolved into additive increments. It has been found that the minimum percentage increase of intensity which can be perceived by the ear is 10 per cent., and therefore the least perceptible increase in loudness is  $10 \log_{10} \frac{1.1}{1}$  decibels, or about  $\frac{1}{2}$  d.b.

To digress slightly, it should be observed that the decibel is used for indicating the gain of an amplifier. Thus if the ratio of the input power

Any noise, as we know, consists of a complex system of frequencies. There is first the lowest frequency or fundamental. Added to this are the harmonics or overtones. Let us take the simplest possible form of noise—

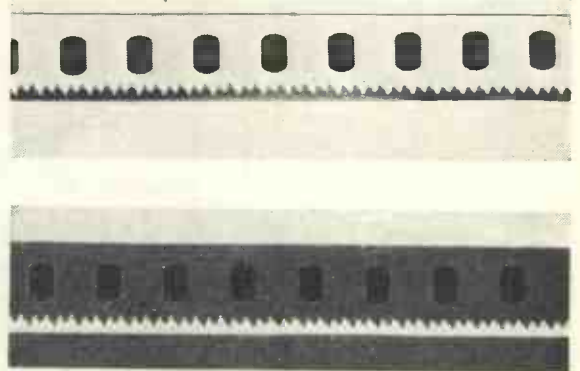

Fig. 4.—Tug-boat whistle. The frequencies present are seen, on measurement, to be 256 c.p.s., 450 c.p.s., and 600 c.p.s., 256 being the most predominant, the strength of the others descending in the order of enumeration. It appears that this noise could be reproduced by blowing simultaneously three whistles giving the above frequencies

# MEASURING SOUND INTENSITIES

a pure tone or whistle—and examine how the ear treats it.

If this pure tone is, for example, produced by a tuning fork in an open space, listening with both ears we can tell without much difficulty the location of the source of sound. The same thing applies to a familiar noise such as the slam of a door or the bark of a dog.

## One Ear Covered

Should we, however, be listening to a tuning fork with one ear covered, we should have some difficulty in locating it. This would seem due to the fact that when we are listening to the tone with both ears, the sound waves are deflected by one's head, thus causing one ear to receive them slightly in advance of the other. Thus, a difference of phase and intensity is produced, which gives to us a sense of direction.

This ability to convey a message unconsciously to the brain is not the only remarkable accomplishment of the human ear. Our ears are very complex pieces of apparatus, and have very complicated functions.

It is well known that if we listen to a particularly bad radio set, such as abandoned in the early days, we know that the loud-speaker is reproducing nothing below 300 cycles per second, yet we distinctly hear bass sounds, such as low cello notes and deep male voices.

These bass tones are not really there, but the ear, listening to the harmonics created by the missing fundamentals, re-creates them; hence, the fantastic claims to good reproduction made by the unsuspecting owners of receivers with a perfectly good bass cut-off.

Whilst on the subject of receivers and loud-speakers, the writer is reminded of an incident which was both amusing and instructive. A friend of his, an old lady, was listening to his moving-coil loud-speaker. At the time the set was delivering its maximum output (the output stage is capable of 3 watts undistorted speech power) and the lady suddenly exclaimed: "Why, that's nearly as loud as my crystal set at home!"

At first it was thought she was

joking, but the explanation, after a little thought, was soon clear. She was referring, without thinking in so technical a manner, to the actual acoustic power reaching her ears.

Thus, with her crystal set, practically all the power radiated from her headphones was used to excite her aural membranes. In the case of the loud-speaker, only a very small portion indeed of the radiated energy reached her ear drums at all.

This brings us to some sort of a conclusion that noise, or sound, is purely relative and what might be a very considerable noise under certain circumstances might, under others, seem quite a whisper. There is the proverbial example, of course, of the pin, dropped in a dead silent room, sounding like a bar of iron. The ear is really only capable of judging comparatively, not quantitatively.

Coming now to the actual frequencies involved in familiar noises, we should find it very difficult to obtain an accurate analysis by means of the ear. Even a trained ear can only approximate roughly. Take, for instance, a cartload of bricks dropping on to a road. Who could hope to analyse the resulting noise?

There are a number of methods available, all more or less compli-



A MODERN MOVING-COIL

One of the best permanent-magnet moving-coil loud-speakers ever placed on the market—the Amplion model MC6

separated peaks, and the harmonics, in the form of peaks spaced closer together.

Simple measurement and calculation will give us, in most cases, the fundamental, and one or two of the higher frequencies present. In a complex sound, such as the one described above, there are many fundamentals and many overtones and it would, therefore, be well-nigh impossible to pick out more than one or two.

For the benefit of those who are interested, a few representative examples are illustrated with some of the identified frequencies. A simple musical note, such as one played on the piano (Fig. 2), is easier to analyse, and the comparison of the same note played on an organ pipe will show the difference in the number of harmonics (Fig. 3).

The mathematical treatment of wave-form analysis is dealt with by what is known as "Fouriers analysis." This, however, makes use of higher mathematics,

and cannot be dealt with here.

With reference to the relative amplitude of the harmonics of different musical instruments, the lower ones are not always necessarily stronger than the higher ones. In the oboe, for instance, the fourth and fifth harmonics are stronger than the fundamental and in the clarinet, the eighth, ninth, and tenth harmonics are stronger than the second, third, fourth, fifth, sixth, and seventh.

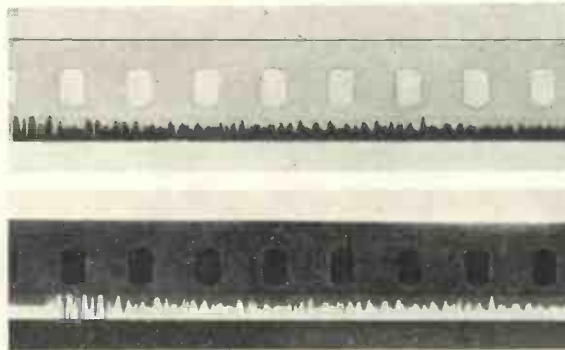

Fig. 5.—Handclap. Identifiable recurring frequencies—450 c.p.s., 1,800 c.p.s., 2,600 c.p.s., and 3,600 c.p.s. Generally speaking, the sound is too complex for measurement

cated. The writer has access, however, to a method which is rather rough, but which reduces the sound to a pictorial representation. That is, the method of recording a sound on to motion-picture film by means of the variable-area method. The recorded track, as has been explained before in "Wireless Magazine," takes the form of an irregular line, which shows the outline of the fundamental, in the shape of more or less widely

# The B.B.C. WEATHER FORECASTS



DAVID LYSTANER Makes Some Pertinent Suggestions

**I**F there is one small item in our programmes over which a little misunderstanding may exist, it is the weather forecast.

Right from the very beginning, weather forecasts have formed part of our programmes and for many years it has been an established custom to broadcast the daily forecast just before the first and second general news bulletins.

From the unflinching regularity with which forecasts have been broadcast to us it might be concluded that they form one of the most popular items in our programmes. But do they?

How often do you listen to the weather forecasts? If you happen to hear one by accident one evening, do you take it seriously, or do you indulge in the Englishman's prerogative of poking fun at anything connected with the weather?

Is there one solitary listener amongst your friends who takes a really scientific interest in the broadcast weather forecasts?

None of my friends take even the slightest notice of them, and I do not think they are exceptional in this respect. Why is it that our broadcast weather forecasts are so generally ignored?

## A Gift Horse

Probably the chief reason for the lack of appeal is that those forecasts are not specially compiled for broadcast. The B.B.C. obtains its weather forecasts direct from the Meteorological Department of the Air Ministry. Of course, it is never good policy to look a gift horse in the mouth, and the B.B.C. was wise, no doubt, in the early days to accept the official forecasts gratis.

But in almost every branch of

broadcasting progress has been rapid, wonderfully rapid. In the broadcast weather service, however, it would be difficult to detect any signs of progress. The weather forecasts are now no better, and no worse, than they were when broadcasting first began.

## Ideal Medium

Now, a broadcasting service is an ideal medium for the supply of weather forecasts to the general public. Forecasts printed in our newspapers may be anything up to fifteen hours old when they are first read. The broadcast forecast is never more than a few hours old when it is heard.

With the very much speedier issue by broadcasting, one might have expected a big increase in the popularity of our weather forecasts. Has there been any such increase in popularity?

Has there been any attempt, in the smallest way, to adapt the official weather forecasting service to the needs of those who might take the greatest notice of the forecasts, namely, the millions of listeners in the British Isles?

How could our broadcast weather forecasts be made more popular, and much more suitable for the needs of listeners? By the very simple expedient, one might suggest, of cutting out all the technical terms used at present. We could scarcely expect the B.B.C. to maintain a weather-observing and weather-forecasting service of its own for the benefit of its listeners, but we could expect the B.B.C. to have on its staff someone who was capable of putting the official weather forecasts

into simple language easily understood.

Possibly the high officials in the Meteorological Department of the Air Ministry insist that the official weather forecasts should be read out exactly as they are issued. If that be so, it is time such a short-sighted policy were brought to an end.

Listeners do not want to hear such terms as "depression," "anti-cyclone," "secondary," and "ridge of high pressure." To understand such terms properly it is necessary to study a book on elementary meteorology. How many listeners have the time or the inclination to study such a book?

The continued use of these technical terms in our broadcast weather forecasts has caused them to be ridiculed a little at times. For example, the "depression off Iceland" has become a standing joke.

## Simple Language

Would it be a very difficult task to translate an Air Ministry forecast into simple language before it is broadcast? Consider the following forecast. What sense does it convey to the average listener?

A depression remains near the Shetlands and a belt of shallow low pressure across Southern Ireland and Central England is moving southwards. Other depressions on the Atlantic are moving eastwards. Weather will be changeable with moderate or rather low temperature.

Suppose this particular forecast had been translated into simple, non-technical language in the following fashion:

Bad weather systems with cloud and rain are moving slowly southwards across the British Isles. When these bad weather systems have

# Rectifier Meters for A.C.

By J. H. REYNER, B.Sc., A.M.I.E.E.

moved to the Continent, other bad weather systems will move in from the Atlantic and so bring about a continuance of the present unsettled, cold weather.

Don't you think the forecast would then have been understood and appreciated by the vast majority listeners? Here is another example of an official weather forecast as broadcast to us. Can you make sense of it?

A complex depression over the Channel and Northern France is almost stationary and filling up, while pressure is rising over the British Isles. A new depression is indicated to the north of Iceland, and is likely to move southwards. Weather will be changeable, with showers and some bright periods.

## "Complex Depressions"

What does the idea of "a complex depression filling up" convey to you, and how far away is the north of Iceland as the weather flies?

Translated into simple language, however, the forecast would present no difficulties to us:

An irregular and not clearly defined bad weather system remains over the Channel and Northern France. The barometer is rising over the British Isles, but there is bad weather to the north which may travel southwards, causing changeable weather, rain and shine.

Let us take one further example; this time the forecast is one of those rare ones referring to fine weather. Here is the official version:

An anticyclone is situated to the north-west of the British Isles, and low-pressure areas over Southern Scandinavia, the Southern Baltic, and Germany are tending to spread westwards. Mainly fair or fine weather will continue, but cooler and cloudier conditions are probable in eastern districts.

## Simplified

Wouldn't you prefer the forecast in simple language as follows:

The extensive fine weather system over the British Isles persists, but there are signs of a break on the other side of the North Sea. Consequently, weather may become cooler and cloudier on our eastern coasts.

What are your own personal views on our broadcast weather forecasts? If a listeners' vote could be taken on the subject, I venture to say that the result would be a huge majority for the simple non-technical forecast.

UNTIL recently the experimenter who wished to measure alternating currents and voltages was seriously handicapped owing to the lack of suitable instruments. Meters for the purpose did exist, of course, but they were expensive, and the number of occasions on which they were used did not, as a rule, justify the expenditure.

The position has been made easier in recent years by the introduction of rectifier meters. The ordinary moving-coil instrument, which is the most reliable and accurate, is unsuitable for the measurement of alternating current because the movement of the pointer depends essentially upon the direction in which the current is flowing.

If the current is reversed the pointer moves in the wrong direction. Thus with alternating current going through the instrument the system will receive impulses first in one direction and then in the other, following one another with considerable rapidity, and the resultant effect on the system will be nothing, the pointer remaining stationary—with, perhaps, a very slight tremor.

If it were possible to rectify the alternating current so that it always flowed in one direction, then this difficulty would be overcome. True, the current flowing through the meter would be rapidly pulsating in character, but the inertia of the movement generally would absorb the minor fluctuations, causing the pointer to take up a position determined by the mean or average value of the current.

The introduction of the copper-oxide rectifier has made such a scheme practicable. Inside the meter case is incorporated a small metal rectifier which converts the alternating current into uni-directional current and the pointer moves over accordingly.

Such meters possess all the sensitivity inherent in moving-coil instruments so that readings of as little as .1 milliampere can be determined quite easily. This is considerably better than any moving-iron instrument of the ordinary commercial type.

The value of an alternating current

is taken to be equal to a steady current which would produce the same heating. In order to evaluate this, the strength of the current at any instant is squared (because the heating depends upon the square of the current) and the mean or average value of this squared current is taken.

This effective value of the current is not the same as the ordinary average value.

## Effect of Harmonics

In the rectifier meter we are measuring the average value, but if the instrument is calibrated on alternating current it will read perfectly satisfactorily as long as one is working with a pure sine-wave input. If the current contains any appreciable harmonics, the calibration is liable to be incorrect.

For example, if one is measuring the output from an amplifier in which the last stage is overloading, then the calibration will not be true and the meter will read high or low according to the type of distortion.

Within this limitation the meter is very satisfactory in use, and may be employed on power frequencies or audio frequencies as desired up to 5,000 cycles per second, after which there is a slight falling off due to the self-capacity of the rectifier.

When these meters were first made trouble arose due to variations in the internal resistance of the rectifier with temperature, which was found to produce very serious errors. It has now been found that by placing a small permanent shunt across the rectifier this error can be minimised and the meter is now quite a practicable device.

## Great Sensitivity

The pre-eminent advantage of the rectifier meter is its sensitivity. Instruments can be made giving a full scale deflection with only 1.5 milliamperes, so that a voltmeter can be made which draws only a very small load from the circuit under test.

It is, however, considerably more expensive than the moving-iron type, which is consequently more useful where extreme sensitivity is not required.

# THE LOW-FREQUENCY TRANSFORMER

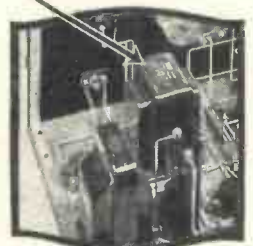

By PERCY W. HARRIS, M.Inst.Rad.E

**L**AST month, when talking over the main facts about low-frequency transformers in general, I pointed out one important difference between the mains transformer used to supply a high voltage for the rectifier and the transformer which we use after the detector for the purpose of coupling two valves together.

## Close to the Ideal

This is, that in the case of the mains transformer we have only one frequency—usually 50 cycles—to deal with, whereas in the intervalve transformer we have a range extending from below 50 to 6,000 or 7,000, and ideally up to about 10,000, cycles.

Another very important fact is that the mains-transformer current is drawn from the secondary, whereas in the intervalve transformer the secondary is practically "open" and only a very minute current flows in it. This alters results vitally.

While there is no perfect transformer on the market it is remarkable how close many of the best makes approach to this ideal and, indeed, if the response of the loud-speaker used was anything approaching that of the better transformers, radio would sound a great deal better to-day than it does!

In this article I want to discuss some of the problems which have to be faced in transformer design and how they have been overcome, for a knowledge of practical transformer design and a realisation of the problems the manufacturer has to face will, undoubtedly, help you in getting the best out of your set.

To begin with, we must imagine a certain set of conditions. We will assume, for example, that our receiver is perfect up to the detector—that is

to say, that the output from the detector valve is a faithful reproduction of the signals sent from the broadcasting station to which we are tuned.

We now desire to connect a low-frequency valve to the detector by means of a transformer and we aim at getting an equally perfect reproduction from the low-frequency valve, with, of course, a considerable gain in strength due to the additional stage added. The low-frequency valve is presumed to be properly biased and free from distortion in itself (the signal to be applied to it must be well within its power-handling capacity) and we must make a still further assumption that we have a loud-speaker which will reproduce all notes uniformly.

This is the third of a series of articles in which are discussed the various component parts of a receiver in a new and intimate way which will help to a better understanding of how every set works.

Last month Percy W. Harris dealt with iron-cored transformers in general and mains transformers in particular. Here he continues with an explanation of the problems of low-frequency transformer design and operation.

Readers of "Wireless Magazine" are invited to send their component queries to Mr. Harris, so that answers may be incorporated in future articles. Individual replies will not be sent, but readers are assured that every query will be taken into consideration in planning the future articles.

With these conditions met, we connect up the transformer in the usual way so that the plate current of the detector valve flows through its primary, while the secondary is connected so that any voltage changes across it are applied to the grid and filament of the low-frequency valve.

The transmission now starts at 50 cycles; let us see what must happen if we are to get a satisfactory signal.

## Voltage Changes

We have seen already that changes of current through the primary of the transformer bring about voltage changes across the secondary. We have also found that the voltage set up across the secondary is dependent upon the turns ratio; if the secondary has, say, four times as many turns as the primary and embraces substantially all of the magnetic field of the primary, the voltage set up across the secondary will be four times as great as that applied to the primary.

Further facts that we have learned are that as the current rises in the primary so the magnetic field grows up around this primary, this field resisting the growth of the current and tending to retard its fall.

The more rapidly you endeavour to change the frequency of the current the more actively will the growing field tend to resist this rise, which means that a given coil that offers very little opposition to the growth of a very low-frequency current may offer so much to a high-frequency current as to make the growth of the current virtually impossible.

Now see how these few facts (I have more to tell you about later!)

affect our desire to amplify the detector signals. Obviously, the number of turns in the primary must be fixed for a given transformer and this primary must carry the plate current to the detector valve. The opposition to the flow of the current in the primary comes from the ohmic resistance of the wire itself, which does not vary over the frequencies with which we are dealing, and from the choking effect of the inductance, which *does* vary with frequency.

### Effect of Impedance

Another important point which I have not discussed so far is the question of the most effective value of the impedance (impedance, by the way, as you may know, is the term we use to express the combination of the resistance of the coil to the flow of current due to the pure resistance and that due to the choking effect of the inductance) in order to get the most energy transferred from the detector to the first low-frequency valve.

But while I have not the space to go into that matter here we will assume that has been properly chosen. What we *want* to get is a primary which will give substantially constant energy transference for all the frequencies with which we are dealing. This only a few years ago would have seemed a practically insuperable difficulty.

First of all, then, the impedance must be reasonably high at our lowest frequency of transference and this means we must have lots of turns of wire. However many turns we have in the primary, we must have still more turns in the secondary if we are to have a step-up ratio.

### Fine Wire Needed

Let us assume for the moment that we are using a 3 : 1 step-up. In order that the transformer may be of reasonable size the wire we use must be very fine and the turns very close together. The primary winding in particular, however, must not be too thin, otherwise breakdowns will be frequent.

I ought to say at this point that breakdowns in transformers through actual melting of the wire due to an excess of current are extremely rare, most of the breakdowns being caused by corrosion of the very fine wire which may arise from moisture, perspiration from the finger of the coil-winding operator, corrosive

soldering flux, or many other causes. Too fine a wire is a nuisance and a worry to the transformer manufacturer and he has to avoid its use for many reasons.

The fact that the wire has to be very fine brings still one more trouble (you will wonder in a few minutes how transformers are ever made at all!) and that is due to self-capacity.

With thousands of turns of wire in layers, the total capacity distributed in this way between layers and between turns may be quite considerable—so much so, in fact, that the capacity so formed may act as a shunt for some frequencies (the higher the frequency, the greater the shunting effect), thus spoiling the response of the transformer for high frequencies.

The best transformers are very carefully wound so as to reduce the distributed capacity to a minimum,

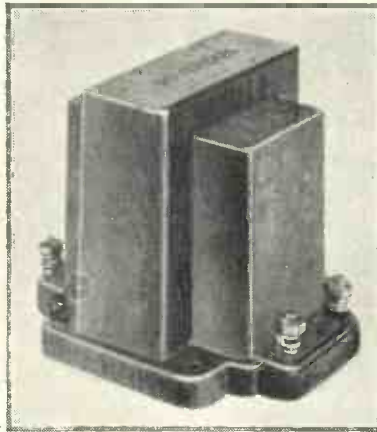

**A TYPICAL TRANSFORMER**  
Although most modern intervalve transformers are housed in bakelite cases they all have iron cores. This instrument is one made by the Sovereign people

for only in this way can one get a good overall response.

Seeing that we want the maximum number of turns in the primary and also seeing that there must be more turns in the secondary than in the primary, the maximum number of turns on the secondary winding is often an important determining factor in transformer design.

Having ascertained the size of the secondary winding and the number of turns in it, the turn number is divided by, say, three (if this is the step-up ratio) and we then get the maximum number of turns possible in the primary.

Here again we must guard against excessive distributive capacity, for both in the primary and the secondary

winding the combination of inductance and capacity will give a circuit of a definite frequency and this frequency may come right in the audible range and give an over-accentuation of certain notes due to resonance.

We now come to the question of the iron core. Owing to the very large number of turns of wire on the primary a very strong magnetic field is formed and as there is a limit to the field that can be formed at any given amount of iron it is not difficult to "saturate" the core when the primary current is on the large side.

### Current Limited

The inductance of a coil being dependent upon the number of turns and the iron circuit, we find that for a given transformer there is a limit to the primary current which can be satisfactorily used, and you will see by examining test reports of low-frequency transformers that the inductance of the primary varies appreciably with the value of the primary current passing through it.

If we want to use a large plate current and still maintain a good performance we must have quite a big iron core, for which reason "heavy-duty" transformers are much larger and heavier than the ordinary kind.

As the transference of energy in a transformer or, for that matter, in any other inductive winding, varies with frequency it will now be clear to you that unless some special precautions were taken the energy transfer through the primary of the transformer would be very poor at low frequencies and would increase in efficiency as frequencies are increased, giving a transformer curve rising rapidly.

### Top-note Response

Actually, the early transformers (and many cheap modern ones) were like this, giving very poor transfer energy at low notes and only becoming really effective as frequencies reached the thousand mark. After this, instead of steadily rising, the curves were found to fall off due to the shunting effect of the self-capacity in the windings.

The difference between a poor transformer and a first-rate one is largely a question of wire and iron.

A poor transformer with very little iron easily saturates even with the smallest detector current likely to be

# THE LOW-FREQUENCY TRANSFORMER—Cont.

passed through it; in order to economise wire, the number of turns is so few that the impedance at low frequencies is almost negligible, while so far as the secondary windings are concerned, these are wound in such a way as to have a large amount of self-capacity which effectively bypasses all the higher frequencies.

## Turned to Good Account

At one time, self-capacity in a transformer was thought to be a bane, but in recent years it has been turned to very good account by designing windings in such a way that a tuned circuit is formed with inductance and distributed capacity, the frequency to which it is tuned being so arranged as to level up the curve.

In an article of this kind I can only touch here and there on the high spots in transformer design, the idea of the series being to give you a general rather than a particular knowledge, but I think I have told you sufficient to show some of the problems and difficulties in designing transformers.

I have also told you enough to enable you to appreciate the very big step forward in inexpensive transformer design which has come about by the use of what is known as the "parallel-feed" system.

In one common form we have a resistance in the plate circuit of a valve, across which a voltage is set up by the signals in the detector circuit. This resistance, having no inductance, is substantially independent of frequency and the changes of voltage set up across it are applied through a large fixed condenser to the primary of the transformer.

## Blocking Direct Current

This large condenser offers a negligible resistance (I am using the word "resistance" here in a sense of opposition rather than in its conventional electrical sense) to the passage of the audio-frequency current, but it effectively cuts out the direct current, which now flows

to the plate of the valve through the resistance.

By cutting out the direct current from the transformer primary we get a much higher inductance for the same amount of iron, for there can be no possible saturation due to the direct current field.

The manufacturer has thus been able to reduce the size of his iron core and, as no direct current flows

one make of valve is very much better than another make, but that one *type* of valve is much better than another.

For example, if you have a very high-impedance valve and a moderately low-impedance primary the energy transfer at low frequency would be poor for the impedances of the valve and the transformer will only be comparable at the upper frequencies; at the lower, the impedance of the valve is much higher than the transformer.

## Changing Valves

If now we substitute for the high-impedance valve one of much lower impedance, the impedance of the primary will be comparable with that of the valve at the lowest frequencies and you will get a good bass response.

Only a high-grade transformer will give first-quality reproduction with a high-impedance valve and a change from a high- to a low-impedance valve will not make a great difference to the quality, only to the amplification. With the cheap transformers, however, an enormous change of quality is noticed when going from a high- to a low-impedance valve.

If, for example, you have a cheap transformer in the second stage of a detector and two low-frequency set, and you have a fairly high-impedance valve in front of it, you may be very dissatisfied with your bass response.

Substitute for this high-impedance valve one of much lower impedance and you'll notice that the strength and quality of the bass will come up very noticeably.

## A Final Point

A final point: don't forget that in the detector circuit the primary of the transformer is shunted by a fixed or variable condenser as a high-frequency by-pass. Alterations in value of this are found to alter the frequency response of the transformer, for it will affect the tuning or resonance point of the primary.

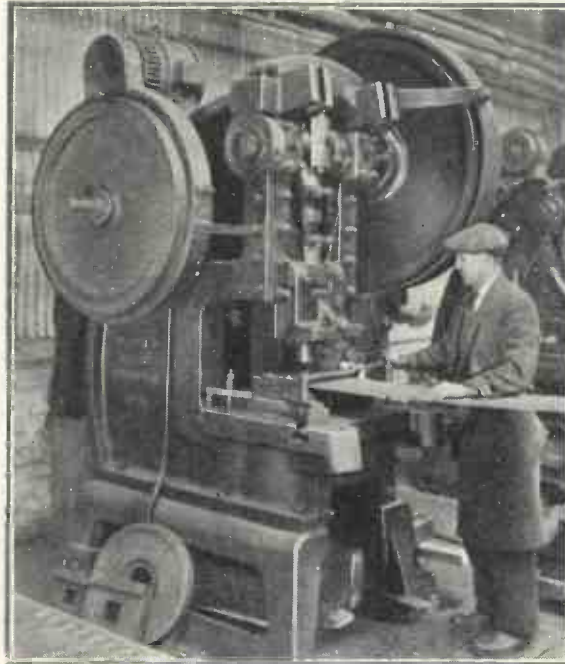

**TRANSFORMER CORES IN THE MAKING**  
This huge press is used in the Ferranti works at Hollinwood for stamping transformer-core laminations out of stalloy sheet. There is practically no waste

through the primary winding, the wire here can be finer than usual.

The reduction in the size of the core and in the size of the wire not only makes the transformer smaller in itself, but makes it easier to design with regard to the self-capacity, while the value of the coupling condenser can be chosen so as to give a resonance which raises the impedance of the transformer through the low frequencies which are so important.

Sometimes the transformer is joined in a normal way with separate primary and secondary, and sometimes is connected so as to give an auto-transformer effect.

In both the direct and the parallel-feed method the response given by a particular transformer is largely dependent upon the valve with which it is used. This does not mean that



# BROADCAST RELIGION

By WHITAKER-WILSON

RELIGION by radio has been one of the most-discussed subjects since quite early days. Not so much the *quality* of the broadcasts sent out from Savoy Hill and Broadcasting House as the *quantity*.

Presumably, most of the correspondents have given up trying to create any impression on the B.B.C.; there has, seemingly, been a distinct falling off lately in the number of letters—in the daily press, at all events.

## Obvious Answer

There are a great many people who think that religion should not be broadcast in any form. The obvious answer to that is the great mass of correspondence at Broadcasting House completely negating any such point of view. The religious services are amongst the most popular items in the whole week, and there is no getting away from the fact.

There can be no argument against broadcasting something (that cannot be said to do harm) so long as people want it, and *say definitely* that they want it. It is perfectly clear that simple services, either of the Established church, the Roman church, or any branch of Nonconformity, appeal to a large section of the community.

No amount of satire or sarcasm on the part of agnostics and atheists can alter that basic fact. So that any argument designed to persuade the authorities at Broadcasting House to make what so many think suitable changes in the Sunday programmes must take the fact into consideration.

Fully aware, then, of the tendency of the age, it becomes any critic to go warily. On the other hand, the B.B.C. policy at the present time lays itself strongly open to,

criticism, especially at eight o'clock on a Sunday evening.

If Broadcasting House had, in every department of its programmes, adopted the same sort of attitude it has patiently adopted regarding this one question of religious broadcasts, it is true to say that it would not have been the successful institution it unquestionably has been.

No reasonable person, however, can possibly accuse the B.B.C. of not listening to criticism.

Thousands of letters on every conceivable aspect of broadcasting are received each year, are carefully dealt with, and to a large extent are answered. Nobody can grumble.



**THE FIRST "WIRELESS PARSON"**  
The Rev. Dick Shepherd, whose services were relayed from St. Martin's-in-the-Fields, is one of the most popular "wireless parsons" this country has yet known.

Yet in this one question nothing seems to move the Director-General. At eight o'clock of a Sunday evening either you listen to a religious service or you do not listen at all, unless you

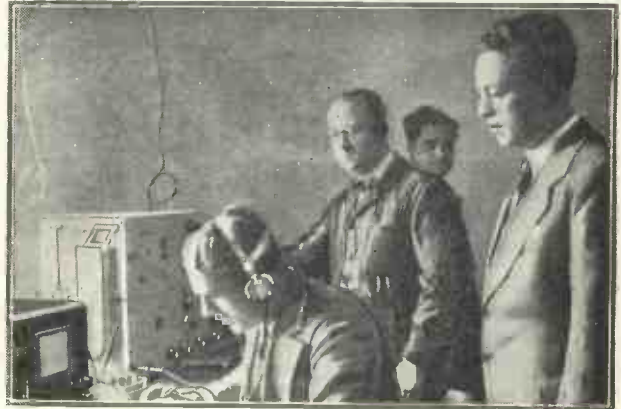

**THE POPE'S RADIO STATION**

Engineers at the recently-opened Vatican station making sure that the plant is in proper working order. Transmissions are made all over the world.

can "go abroad" for the evening.

If your set is not quite as selective as it might be you may find yourself wandering over the Continent without intending to, in which case you will find you are listening, on an adjacent wavelength, to a dance band, as likely as not. So that by enforcing religion the B.B.C. does not remove anything it must really disapprove of.

What I feel is the objection of most people is that the hour from eight to nine each Sunday evening is the one taken for this purpose. Of course, it is convenient enough for those who wish to hear religious matter, but how about (1) those who have already been to church and would like something else, (2) those whose tastes in any event lie in a different direction? Surely, it is reasonable to suppose that both these classes are entitled to be served?

## Futile Discussion

One of the most futile discussions I ever heard on the question of Sunday observance and non-observance was broadcast during July by Osbert Sitwell and W. S. Morrison. The former is the well-known novelist, the latter is M.P. for Cirencester.

## BROADCAST RELIGION—Continued

Those of you who heard the argument will remember that the scene was supposedly laid in a cinema theatre on a Sunday. The discussion throughout was over two points of view only: ought we all to go to church or should we be allowed to go to cinemas? The discussion was entitled "How Shall We Spend Our Sundays?"

### Absurd View

It seems quite reasonable to suggest that there are quite a number of intelligent folk who do not care to do either. The way the talkers dealt with the subject must have left listeners feeling there was no other way of spending Sunday. Such a point of view is absurd on the face of it.

That may not be the B.B.C.'s own policy; I do not suggest it is. On the other hand, it looks very like a modification of it. Giving the question of broadcast religion the widest scope and the strongest support, granting—emphatically stating, if you will—that the daily services are of the utmost help to old people, to invalids, even to the dying, the present policy of the B.B.C. is definitely narrow on this one point.

### Government Monopoly

Neither need it be forgotten—this is giving the B.B.C. yet another point—that broadcasting is more or less a government monopoly. Saying that is saying a good deal for the B.B.C., because there is a State

Church in England and, as the government acts on behalf of the State, by our constitutional laws the church must be upheld by the B.B.C.

So that in venturing to criticise a policy of this kind I have at least begun fairly and squarely.

The Continental Sunday is not recognised in England, and until it is there is no need for the B.B.C. to emulate Continental methods. That fact (well recognised at Broadcasting House, you may be sure) places the B.B.C. in yet a stronger position. It is a position, however, from which only a minority would really wish them to depart.

There can be nothing against good music on Sunday—nothing against good light music, for that matter. All that is really wanted is for the B.B.C. to recognise that Sunday is a great listening day.

I have always maintained that it should be a day for the best broadcasting, by which I mean the most outstanding types of broadcasting. Symphony and chamber-music concerts, recitals, both instrumental and vocal, good plays, and plenty of the lighter types of broadcast should be available at all popular hours for listening—together with, of course, religious services.

It seems that there is hardly a proper use of the regional scheme on Sundays. At eight o'clock nothing is broadcast from any station excepting a religious service. Surely, it is only a matter of arrangement to have these services broadcast in such

sequence that there is always an alternative?

I did hear that there was some sort of arrangement between the B.B.C. and the churches which prevented broadcast services clashing with Sunday evening services in the churches themselves. If that arrangement was really made, I submit that notice of its discontinuance should be given to the churches.

### Thinking People

The argument that people stay away from their churches in order to listen by their firesides must be as broad as it is long. It is difficult to persuade thinking people that the effect would be noticeable. It is more likely that religiously minded people fall into two classes—those who attend church, and those who listen to radio services.

Even if that is wrong there is still the question of those who do not want religious services. It is not a question—I humbly submit this to the Director-General's attention—of a majority giving way to a minority.

The church is in the minority. If it were not so, there would be at least five times as many churches in England as there are. The churches are not so well filled as to be able to dictate in the matter.

Yet, so far as listeners are concerned, the B.B.C. dictates in a very decided fashion. It virtually says: "You shall have religion *and nothing else, at any time we say you shall.*"

My submission to the Director-General is that this policy is unlike the *general* policy of the B.B.C., which has unquestionably a keen and laudable desire to offer a perfect service of entertainment and instruction. No other country offers half the variety the B.B.C. offers us.

### Protests on All Sides

Yet, in this one matter of religion, despite the protests on all sides, the B.B.C. has definitely refused to alter its point of view.

I submit the question to the Director-General of the B.B.C. once again. Will he consider a policy more in keeping with his general policy?

Definitely, will he permit an alternative programme on Sunday evenings, if only as an act of grace towards those whose opinions do not coincide with his own?

## THE WIRELESS ZOO

### THE PING

*The small mosquito, named the Ping,  
Can be a most provoking thing.*

*He pipes: "I want the Wireless now!*

*You turn those knobs? Do show me how!*

*Oh, Uncle,"—here he kicks my shin—*

*"When will the Children's Hour begin?*

*Why does this singer shout like that?*

*What do you mean 'He's very flat?'*

*You've turned it off, I want it on!*

*Look! Uncle, Uncle—why, he's gone!"*

LESLIE M. OYLER.

# RADIO AT OLYMPIA

What's New This Season :: A Review of the Latest Developments

**R**ADIO'S new season begins with this issue of "Wireless Magazine" and readers will naturally want to know what the manufacturers have to offer them in the way of sets and component parts. There has been feverish activity in factories all over the country for the past few months and at Olympia will be seen the fruits of these efforts.

## Nothing Revolutionary

On looking through the production programmes issued by the various manufacturers it is, perhaps, surprising to find that there is not a single really revolutionary development in radio technique to be recorded. The tendency is to get the very best out of known principles rather than to develop any radically new system.

This does not mean that no ad-

vance has been made since the last exhibition, but the developments are in details rather than in fundamentals. Although basically receivers remain the same, we can anticipate a greatly improved performance during the coming season.

As we prophesied a year ago, the super-het type of receiver has definitely come to stay—at least until the congestion of the European ether is cleared by a drastic reallocation of wavelengths by the broadcasting authorities, a thing that is not likely to happen for a long time to come.

The outstanding differences in the sets that will be presented to the public for the 1933 season are the inclusion of the variable-mu type of screen-grid valve and some form of tone control.

Variable-mu valves are a very definite advance on the ordinary type of screen-grid tetrode. They give much cleaner reception because they can amplify powerful signals without distortion and they also avoid a certain amount of interference between stations working on adjacent wavelengths.

It has been said that the variable-mu valve will revolutionise reception as much as did the screen-grid type when it was introduced some years ago—and that statement is not far short of the truth.

## Advantage of Tone Control

Tone control is not new, of course, but its present application has a further object than merely controlling the tone of the reproduction to suit the individual preferences of listeners.



The Ether Lord radio gramophone is one of the new models in the Hacker range. It is for A.C. or D.C. mains



This is the Celestion standard permanent-magnet moving-coil loud-speaker. Cabinet models are also obtainable



The Kabilock Beaufort radio gramophone cabinet will accommodate a base-board 18 in. wide by 16 in. deep. The design is attractive

## RADIO AT OLYMPIA—Continued

It is found in practice that when a tone-control device is adjusted to restrict the top-note response of a receiver a lot of high-pitched heterodyne interference is also cut out. Thus a tone control, when carefully used, can be utilised to cut out a lot of mush in reception.

### The Lesser Evil

Of course, it is not a desirable thing to restrict the treble reproduction in any way as the quality is thus spoiled to some extent, but it is thought that the evil of slightly lower quality in this respect is less than the evil of unrestricted heterodyne interference; most listeners know how annoying such whistles can be and will welcome any reasonable method of cutting them out or at least reducing them.

Still more of the larger radio gramophones are being fitted with an automatic record-changing mechanism—a real boon to those who can afford it. By this means half a dozen or so records can be selected beforehand, put on the machine and played through without being touched.

Assuming the average disc to give a playing period of five minutes, it is evident that a full half-hour's gramophone music can be had at a single loading. If only such a mechanism could be produced for a couple of pounds or so—how constructors would rejoice!

It is now the exception rather than the rule to find a commercial receiver that does not contain its own built-in loud-speaker. This is all to the good so far as the average set buyer is concerned. The manufacturer is able to take steps to see that the reproducer does match up properly with the output valve supplied with the set and the buyer is saved the trouble of having to choose a suitable instrument.

Moreover, in the case of mains sets at least, the cost of the set is practically the cost of the complete installation and the prospective buyer does not have to allow for "accessories" as he did only a year or two ago.

When you buy a set nowadays it only costs a very few shillings extra for the aerial and earth system to

complete the outfit—enabling you to enjoy all the benefits of broadcast reception.

For the past two years the man who could only use a battery set, either because he had no electric mains available or on the score of low initial cost, has been badly neglected by the set manufacturer.

### A Good Sign

It is with pleasure therefore that we notice several important manufacturers have stepped in and produced a number of excellent battery-operated receivers. The sets to which we refer are not of the portable type; they are the ordinary table type of instrument and in a number of cases incorporate moving coils

One particularly interesting development in battery-operated portable receivers is the production of six-valve super-hets, of which there will be two examples at Olympia. These sets have single-knob tuning and should prove very popular among those who want a set they can carry about easily from room to room and



(Above).—A neat pedestal receiver which will appeal to battery users, the Alba model 22. A balanced-armature loud-speaker is incorporated.



A new Exide 2-volt accumulator specially designed for use in receivers where height is limited

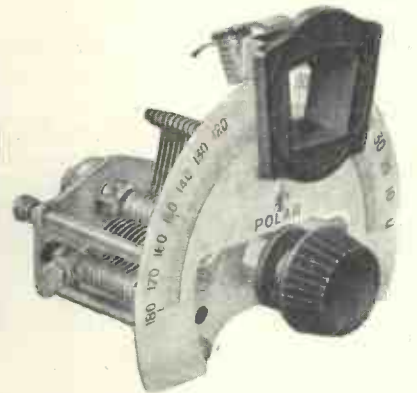

One of the existing lines to be continued by Polar is the slow-motion aperture dial. A bulb holder for illumination is provided



(Right).—The new Eddystone short-wave coils will plug into any standard valve holder. They cover a wave range of from 13.5 to 87.8 metres

# WHAT'S NEW THIS SEASON

which will get a good bag of foreign stations—very few listeners are content nowadays to be tied always to the British programmes.

We are also glad to see that the man with D.C. mains is now very much better catered for than he has been previously. There is now a fair selection of complete D.C. mains sets that have a performance comparable with their A.C. counterparts.

In spite of the "grid" system, there are still many large districts supplied with D.C. and there is no doubt that manufacturers have been losing considerable business by not catering more fully for the demands before this. Still, better late than never!

## Better Selectivity

From what we have seen of the sets for 1933—and we are now referring to both battery and mains models—we believe that the new instruments will be found to be considerably more selective than those of a year ago. Nearly every set

now has a band-pass aerial tuner, with its consequent advantage of sharp tuning with good quality of reproduction.

More and more commercial receivers are also calibrated directly in wavelengths. Some models have the names of stations marked in the appropriate positions on the tuning dials, but that is a development in which we see more objections than advantages. Stations change their wavelengths so frequently nowadays that such markings are more likely to be misleading than helpful.

Unfortunately, wavelength-calibrated sets cannot be produced with any degree of satisfaction for home constructors. Condenser manufacturers never know with what types of tuning coils their instruments will be used and therefore they cannot calibrate their dials in wavelengths.

To be a success condensers must be calibrated in conjunction with the actual coils with which they are to be used. There is one way out of the difficulty, we believe, and we hope in an early issue of "Wireless Magazine" to present constructors with

details of a new component that will overcome the difficulty.

At least one manufacturer is producing as a standard line a receiver that will go down to the short waves as well as receive on the medium and long wavebands. With careful design there is no reason why this problem should not be solved successfully, thus avoiding the necessity for adding adaptors to so-called "broadcast" sets for listening on the short waves. We believe that more manufacturers will follow the lead thus given.

## Sets for Overseas

We should like to see more really powerful short-wave sets for overseas conditions. "Wireless Magazine" is constantly receiving letters from readers in the Dominions and Colonies asking for short-wave sets that will reliably pick up the B.B.C. short-wave transmissions put out from Chelmsford.

Of course, there may be patent difficulties in the way, but there is no question that any firm that could produce a really first-class short-wave set, even at a comparatively



(Above).—A new four-gang condenser introduced by Polar this season, the Star model. The trimmers are fitted on the top

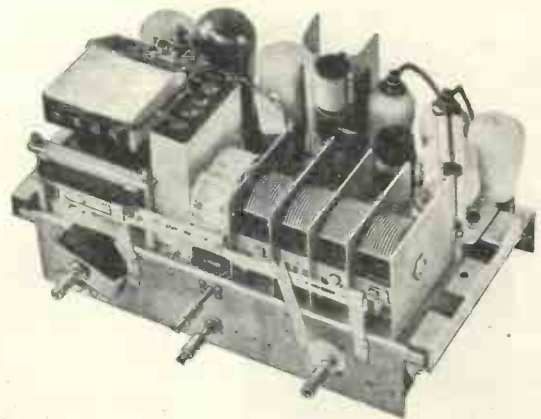

(Right).—Here is the chassis of the new Marconiphone model 256. The circuit is a seven-valve (including rectifier) super-het type



A new Kolster Brandes pick-up designed to minimise tracking errors. The unit is of moulded bakelite

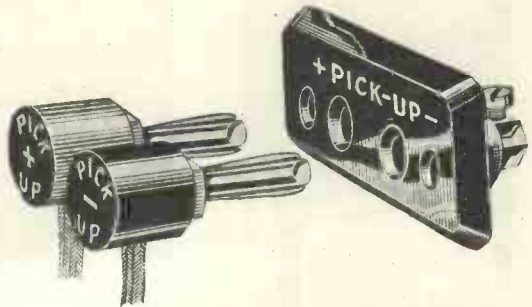

Belling-Lee have introduced a new twin socket strip. This handy gadget can be obtained with various engravings

# RADIO AT OLYMPIA—Continued



(Above).—The new Marconiphone model 93 permanent-magnet moving-coil reproducer is good value for money. The price is £4 10s.

(Right).—The Oldham 2-volt accumulator, type GL4, is assembled in a strong celluloid container

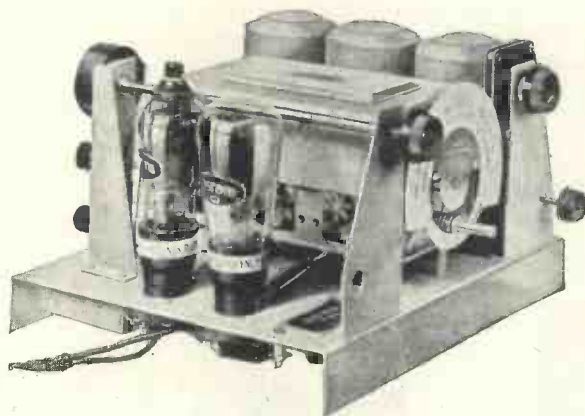

Here is a photograph of the Haynes Quality Five chassis. It is a fine example of modern technique



The Camco Popular radiogram cabinet is neat in appearance. It costs £3 15s.



The new Standard Telephones and Cables two-valver has many distinctive features

high cost, could sell thousands to temporarily exiled Englishmen.

Next let us examine the development of variable condensers. Here there has been considerable improvement in the design of ganged instruments. For years the Americans have been ahead of us in variable-condenser design, but Olympia will show that now we have caught up and can produce in this country condensers as good as any that have come across the Atlantic.

### Accessible Trimmers

More accessible trimmers are a feature of the new models, which are also much stronger and rigid than they were a few months ago.

In the low-frequency transformer field development has taken two paths. First we have the parallel-feed type of component with the necessary coupling parts enclosed in the same case as the transformer itself. This means that construction is simplified and the builder of the set is also certain of having the best values.

### Tone Compensation

The second development is the production of special transformers for simple tone compensation. This means that the constructor can produce for himself sets with all the advantages of tone control which were outlined when commercial sets were discussed at the beginning of these notes.

There are signs that the spaghetti type of fixed resistance is losing its popularity in favour of improved composition types that have the advantage of being solid and of carrying greater currents for given resistance values. The spaghetti resistance became popular because it was a cheap substitute for the old wire-wound resistance, which in many cases cost four or five shillings.

### Detailed Improvements

Spaghetts were never ideal from the mechanical point of view, but we must put on record the fact that the makers of these parts have paid great attention to detail improvements.

Variable resistances have also been

# WHAT'S NEW THIS SEASON

considerably developed since the last exhibition and there are now on the market several makes of good quality at reasonable prices. A few makers still produce the graphite type of resistance, but wire-wound resistances are the order of the day.

## Ganged Volume Controls

In some cases provision is made for ganging two or three potentiometers together so that several types of volume control can be obtained with single-knob operation.

Another development that has come to stay is the coupling of switches with potentiometers. In this way one knob on the front of a set can be made to perform two functions. For instance, it is common practice to combine a gram-radio switch with the radio volume-control potentiometer and the main on-off switch with the gramophone volume control. Thus two knobs can be saved on one set.

Few new valves are announced for the new season and for that everybody will be grateful to the valve manufacturers. We now have nearly all the types that can possibly be wanted; the exception that springs to mind is the battery variable-mu valve—more of this type are needed for the home constructor.

There is as yet no sign of the high-voltage mains type of valve being produced in this country—a development that is certain to come. With high-voltage valves the main supply can be applied direct to the filament without the need for any step-down transformer (in the case of A.C. sets) and without the need for a breakdown resistance (in the case of D.C. sets).

## More Valve Manufacturers

Several firms are starting the manufacture of valves for the first time, one or two being outside the "ring" and therefore able to offer their products at lower prices.

A welcome reduction has been made in the prices of dry metal rectifiers and even for large outputs it is now not very much more expensive to use a metal rectifier than it is to use a valve rectifier. We have never yet had a complaint from a "Wireless Magazine" reader that a metal



Here is a typical example of a Smith's accumulator. All batteries are supplied with carrying handles



The Lissen two-valve battery receiver is housed in an attractive modern cabinet. The set's simple to operate



(Above).—One of the wide range of Westinghouse metal rectifiers. This is the H.T.11 model which gives 500 volts at 120 milliamperes

(Right).—One of the new Ormond reproducers. This model is for use on D.C. mains and costs £1 10s.



A very handsome all-electric radio gramophone is the Ekco model RG23. External loud-speakers can be used with this model



Varley have announced several new models. This is the new three-valve receiver for A.C. mains. The cabinet design is very neat

## RADIO AT OLYMPIA—Continued

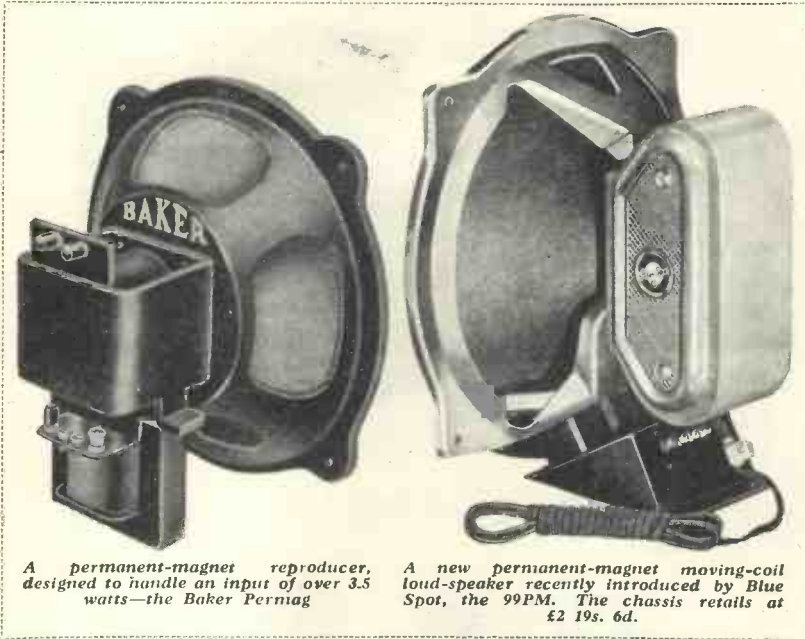

A permanent-magnet reproducer, designed to handle an input of over 3.5 watts—the Baker Permag

A new permanent-magnet moving-coil loud-speaker recently introduced by Blue Spot, the 99PM. The chassis retails at £2 19s. 6d.

rectifier has "worn out" or had to be replaced.

Mains transformers are nowadays much better made than they were a short time ago. There is a tendency to produce more shrouded models, a great advantage to the home constructor as it reduces the possibility of hum being induced into various parts of the circuit.

### A Sensible Idea

One firm has produced a range of mains transformers with fuses fitted to the side of the case—a sensible idea and one that will be appreciated because it saves the trouble and

expense of fitting separate fuses in the set.

Rotary transformers, or converters as they are more usually called, are gaining increased popularity among those who want to run big sets. These converters will give a constant source of high tension from any kind of mains or from accumulators if desired.

Of cabinets, the constructor now has a wide choice of attractive types. The midget type of receiver, that is a table cabinet with space for accommodating a loud-speaker, has come to stay. They have only one disadvantage and that is they will only take

(in most cases) the smallest types of moving-coil loud-speaker.

Those who want to use a loud-speaker with a diaphragm more than about 7 in. in diameter will have to house their sets in cabinets of the radio-gramophone type.

More and more radio gramophones are now being built and it seems certain that the "straight" radio set will soon be a thing of the past. The extra cost of making a set that will reproduce gramophone records satisfactorily is so small that even the poorest constructor can afford to build one of these instruments.

### Excellent Cabinets Available

The cabinet is the most expensive part of a simple battery-operated radio gramophone, but now there are excellent cabinets available for a price of about £3.

An interesting development in this direction is the production of table radio-gramophone cabinets. These have space for a motor and loud-speaker as well as the set itself, yet do not stand more than about 15 in. high when placed on the average table—a great convenience for those who live in modern small houses and flats and who cannot spare the floor space for one of the more orthodox types of case.

The ugly 3-ft. square baffle board is now replaced by a comparatively small box lined with slag wool and built to the specification of the B.B.C. engineers. These baffle-cabinets will interest experimenters in particular, for they can be used for

(Continued on page 260)

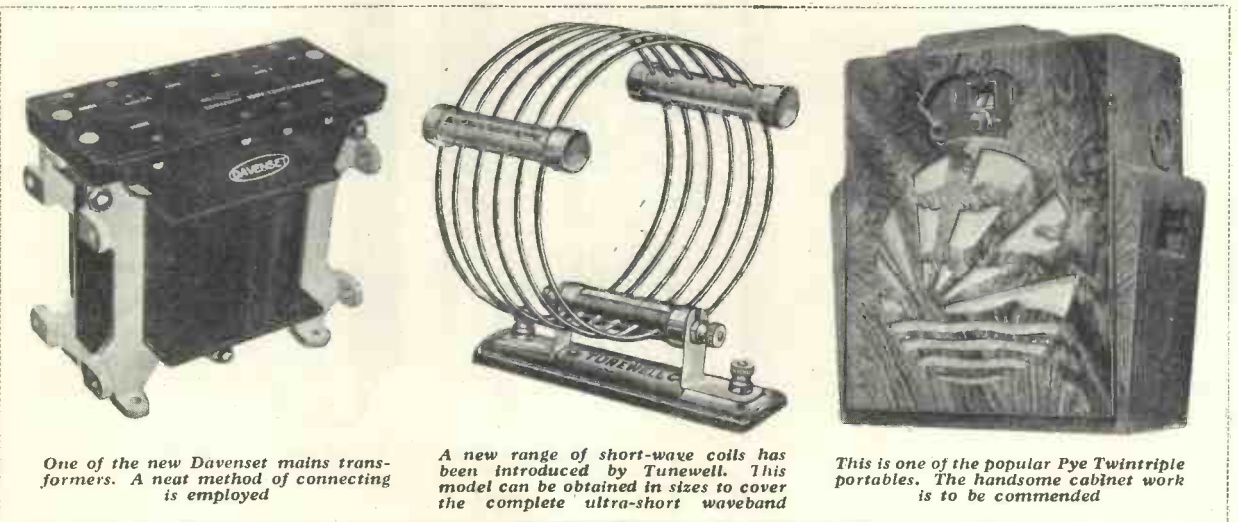

One of the new Davenset mains transformers. A neat method of connecting is employed

A new range of short-wave coils has been introduced by Tunewell. This model can be obtained in sizes to cover the complete ultra-short waveband

This is one of the popular Pye Twintriple portables. The handsome cabinet work is to be commended



# Musical News and Views

By T. F. HENN

**T**HIS month I am devoting some space to criticism of past programmes and suggestions for the future. Until the end of this month, I imagine listeners will probably find the programmes on the dull side through lack of variety.

The main musical broadcasts, as you know, are the Promenade concerts every weekday night and dance music, which is the sole monopoly of Henry Hall.

## Henry Hall's Chance

In the month of August there are twenty-seven weekday nights on which dance music is broadcast from 10.30 p.m. till midnight, and out of these the B.B.C. band is supplying us twenty-one. Mr. Hall has often asked for more time in the later part of the evening to show off his band, and now his wish has been granted; perhaps a trifle more than he had hoped for!

Anyway, the B.B.C. band is being put to a stringent test. Henry Hall has now to demonstrate his skill at variation and originality.

These twenty-one evenings will be remembered by the late dancers for a long time.

It has been suggested that the



*Songs by Quilter, Phillips and Lehmann were sung by Mary Pollock in a concert recently relayed from Cheltenham Spa*



*Alan Griff, a well-known Midland writer, reads his own short stories from Midland stations*

B.B.C. band is just beginning a campaign to get its foot in permanently for these broadcasts, in order that song-plugging might come to an end once and for all. Nothing of the sort is to happen.

The restaurants where the B.B.C. gathers its late dance-music pro-

grammes have sent their bands away for a month's holiday and so Henry Hall's chance has come. The B.B.C. band are taking their holiday—lasting a fortnight—in September. I think they will need it badly.

Dance-band enthusiasts will be glad to hear that arrangements have been provisionally fixed for Jack Hylton to broadcast again in November and Debroy Somers in December. Both of these shows will last an hour.

## Special Radio Revue

Also all listeners will be interested to know that Cicely Courtneidge is announced to appear in a special radio revue in October.

Three good programmes in three months which will be worth hearing.

A tentative date has been fixed for Philip Ridgeway to broadcast another of his shows again. This show will be heard in the late autumn.

You will remember the parade personally devised and produced by Philip Ridgeway last July. It was typical of the stuff that we are accustomed to hear from him. I was able to see and hear this show at Broadcasting House the first



*A favourite singer of light comedy numbers, Leslie Holmes has been heard in vaudeville from London*



*Nat Gould, a provincial tenor, has lately entertained in the Midland Regional Children's Hour*

## MUSICAL NEWS AND VIEWS—Cont.



One of the most famous of English violinists, Marie Hall, has been heard in recitals from the studios

night, and the second performance, which I heard at home, definitely helped to form an opinion.

I had a very comfortable seat at the back of the ultra-modern vaudeville studio—and a very nice place, too. Philip Ridgeway and company occupied the whole stage, while the chairman—not a man with a golden voice—shouted from the centre; his two hecklers, from Lancashire and Yorkshire, were on either side of the gallery.

### Splendid Talent, But—

There is some splendid talent among his artists. Many of the lady singers were first-rate and you will agree that the gentleman banjoist was excellent. But unbearable screeching spoils everything.

There is a good time between now and the next show. Let Philip Ridgeway take a broad tip that we would very much like to hear him and his company again, but we earnestly request him to leave his noise and noisy people outside at Oxford Circus.

### Studio Applause

There are two points connected with musical studio broadcasts which I particularly want to discuss. The first is the applause by members of the orchestra and studio audiences at the end of a concerto or song accompanied by the orchestra. I would like to know why listeners

are usually completely shut off when the studio people are applauding the artist for his or her good performance.

There was an instance of this on July 28, when Frank Mannheimer had finished playing the piano part in Weber's *Konzertstück* in F minor. The studio audience rightly applauded—the performance was excellent—but the control man was just a second or two late in switching off the million or so listeners at the other end.



Philip Ridgeway and Enid Stamp-Taylor are here seen singing "My Little Boy," a duet broadcast during the last Ridgeway Parade

Surely listeners are given the credit for appreciating classical music just as much as they do a vaudeville programme, where usually too much applause is allowed to flood the ether. I wonder when the B.B.C. will realise that atmosphere is everything in broadcasting.

The other point I have mentioned several times before. Now we are on the verge of another winter season another request might not be out of place. On Tuesday,



Two new radio comedians, Dean and Collinson, have made a hit with their schoolmaster and pupil sketches

Thursday, and Saturday of each week the National programme at London and provincial centres promptly shuts down at 10.30 p.m. and the Regionals and Daventry National proceed with the late dance music. I have no grouse about this late dance music, although I have wondered what percentage of listeners dance to it.

### Alternative Wanted

I am certain that more listeners would prefer an alternative to this. Years ago, in the good old days when even announcers were allowed a little freedom, we used to have from 5GB (now Midland Regional) a late orchestral concert as an experiment. I wonder if the results of the experiment were ever known?

The listener wants music to listen to at that hour of night, and I think the B.B.C. should provide it. If they can produce a reasonable argument why we should not have it, then I will withdraw my request.

### Instant Approval

An orchestral concert of the semi-classical type, or even a gramophone recital, would meet with the instant approval of fifty per cent of listeners. The B.B.C. has some brains somewhere, and I hope the brainy ones will give this request the attention it deserves.

I have been told of a programme

# ABOUT THE BROADCAST MUSIC YOU HEAR

difficulty which the programme organisers have solved. On September 7, in the Public Hall at Worcester, the famous Three Choirs Festival will be held. Sir Ivor Atkins will conduct the London Symphony Orchestra, and Florence Easton (soprano) will be the principal soloist. This concert will be broadcast.

## Classical Music

Now this programme comes under the heading of classical music, and as the B.B.C. must broadcast the Bach "Prom" from the Queen's Hall, and at the same time respect the listeners' demand for an alternative in the early part of the evening, the problem was not easy to solve.

Well, the B.B.C. has arranged it so that everyone will be satisfied. The National programme is to take the Queen's Hall concert, the Midland and North Regional the Worcester festival, and London Regional will radiate a military-band concert. This is between 8 and 9 p.m.

## Variety Programme

And, to make certain, a variety programme is to follow from London Regional later in the evening.

Listeners who read my advance details of "1895 Promenade Concert" revival—broadcast on August 1—will have noticed that they were



An unusual photograph of Henry Hall and the B.B.C. Dance Orchestra taken in one of the Studios at Broadcasting House. They are seen making a shot for a talkie film

wrong. Unfortunately in the bound copy of the original programmes, which I inspected at the B.B.C., the first three programmes were reversed. Hence the mistake in giving wrong details.

I have since had the opportunity of inspecting the right programme, and the conclusion I have come to is that in any case I should have misled my readers. The B.B.C. announced a replica of the 1895 "Prom," but only broadcast extracts—and not well-chosen ones at that.

Most of the items chosen are heard at regular intervals either in light orchestral or popular programmes of

classical music. For the benefit of readers who heard this concert I am giving a list of the items which, although typical of the early "Proms," were left out.

## Items Left Out

The items left out included Schloesser's grand march *L'Enfant de la Garde*, a grand selection of Carmen's Bizet, Glazounov's orchestration of Chopin's *Polonaise in A*, and Rossini's great song from "Barber of Seville," *Largo al factotum*.

During the next month there are three promenade concerts which I recommend you to make a point of hearing. On August 30 the first part of the programme will be devoted to Mendelssohn, and therefore needs hardly any comment. But to those who are only casual musical listeners I would especially remind them to listen to the overture to *A Midsummer Night's Dream*, Isolde Menges playing the *Violin Concerto in E minor* and the songs.

## Splendid Examples

The concerts on September 1 and 10 are splendid examples of the miscellaneous type, and you should certainly make a point of hearing them. On September 17 there is one very outstanding item in the Russian concert which is being broadcast. I am referring to Stravinsky's fantasia for orchestra entitled *Fireworks*.



A famous virtuoso and late Russian court violinist, Emilio Colombo, now of the Victoria Hotel, recently broadcast



Cyril Nash, a favourite in the Children's Hour, is giving a series of sketches entitled "Your Dog and Mine"

# How Radio Has Helped Home Talkies

by  
KENNETH ULLYETT

Some Interesting Systems of Synchronising Sound Reproduction with Home-film Projection

THE two ways of synchronising sound with film for a talkie are by means of a gramophone record running in synchronisation with the film, or by means of a photographic record of the sound-wave impulses on the side of the strip.

Commercially, these two ways are known as sound-on-film and sound-on-disc. The records previously used for full-size films were 18 inches in diameter and ran at only a third of the speed of a normal gramophone record. Since the beginning of the year the leading film combines have given up the sound-on-disc method and sound-on-film is now used practically exclusively.

Don't imagine without further consideration that when you come to the small film sizes used for home talkies the sound-on-disc method is of no use. The discs were scrapped for commercial work because of the despatch difficulties of making sure that each crate of films had its appropriate record; and then, of course, there was the trouble of breakages.

## Human Element

In theory there is the difficulty of synchronising for whereas the synchronisation is bound to be right with the sound-on-film method, human operation enters into the isynchronisation between the record and the film. In practice this is not at all difficult and the trained cinema operators do not find any difference in operation between the two methods.

There are a number of home-talkie systems, both for 16-mm. and 9.5-mm. film, which use records played through a gramophone pick-up and wireless-type low-frequency amplifier. In fact it is possible to

and speed being the principal factors. Not only is the film area much smaller, even with the 16-mm. size, than of the 35-mm. film used in commercial cinema work (which means that there is less space for the sound track at the side of the picture), but the film speed is less. This entails just the same difficulties as are experienced in trying to get good tone from a gramophone record running at only a half or quarter of the normal speed. In fact the difficulties are much greater for the speed, apart from being slow, is not regular.

## Economising Stock

The passage of the film in the average sub-standard projector is not smooth for a greater degree of flicker is tolerated than in cinema working, the idea being to run the film slower and so economise in stock.

The amount of apparatus needed

(Continued on page 214)

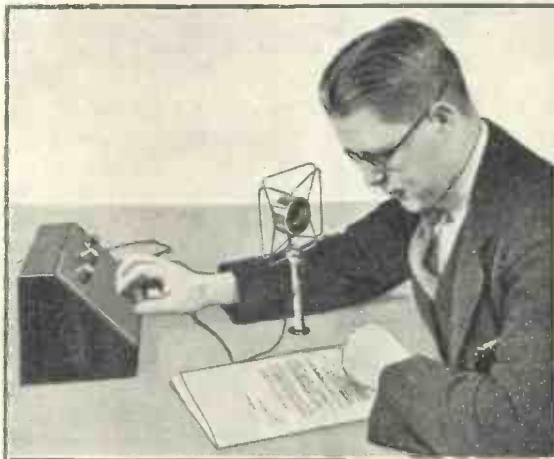

**MAKE YOUR OWN TALKIE**  
A simple gramophone home-recording apparatus can be used to record the sound side of a talkie film. The script should be carefully prepared beforehand

adapt practically every home-cinema projector to a talkie of this type.

There are many advantages, not the least of which is the ability to make films at home to synchronise with commercial records, even if it is not desired to go to the trouble of making special records on one of the numerous home-recording systems.

There have been many difficulties about using the sound-on-film principle for home talkies, the film size

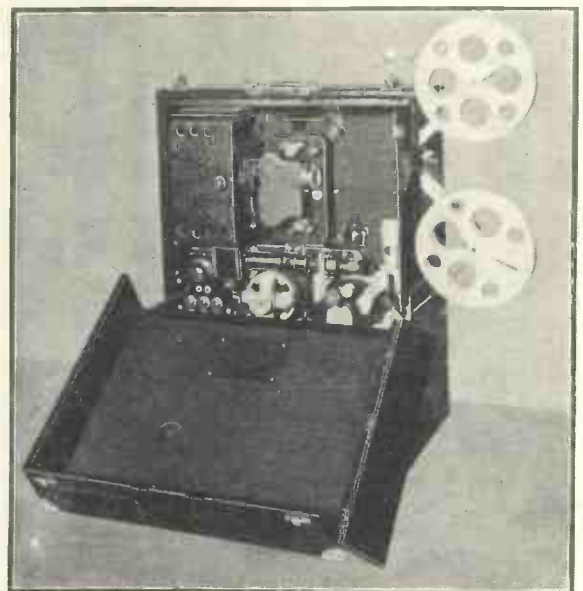

**A COMPLETE HOME-TALKIE OUTFIT**  
This is the new B.T.H. home-talkie projector. The case carries the driving motor, photocell and amplifier

# "HIS MASTER'S VOICE"

## at Olympia, STAND NO 55

(GRAND HALL)

In addition to the four new instruments illustrated, "His Master's Voice" will show at Olympia the following range of models for the new season:—

	PRICE
MODEL 501 <i>Transportable Radiogram</i>	25 guineas
MODEL 435 <i>De Luxe Radio Four</i>	17 guineas
MODEL 174 <i>Super-Power Speaker</i>	£7. 10. 0
MODEL LS7 <i>Universal Speaker</i>	£4. 15. 0
MODEL 116 <i>Record Player</i>	7 guineas
MODEL 117 <i>Auto-Record Player</i>	12 guineas
MODEL 553 <i>Auto-Electrogram</i>	42 guineas

Current models which have proved so enormously popular during the past season, and which have established a new standard in the reproduction of broadcast and recorded music, will also be continued.

Visit the "His Master's Voice" Stand—see and hear these instruments . . . examine the many improvements in the range. And whatever else you do, you must see the pre-release showing of the most wonderful industrial 'talkie' yet made. Demonstration Room D18. Free tickets will be obtainable at Stand No. 55.



## His Master's Voice RADIO — "True to Life"

The Gramophone Co. Ltd., London, W.1.



There is news in the "Wireless Magazine" advertisements

# RADIO AND HOME TALKIES—Continued from page 212



### WHY NOT USE ALUMINIUM RECORDS?

Another type of home-recording apparatus which can be used in conjunction with a film to produce a home talkie. This is the acoustic method of home recording

for a sound-on-film sub-standard plant is a little more than that for sound-on-disc reproduction, and it is a little more complicated as a photocell has to be used.

### Careful Research

It has for long been realised that if a successful sub-standard home-talkie projector is to be made, using the sound-on-film method, it will have to be the result of experiments by some organisation equally *au fait* with wireless problems in the way of high audio-frequency amplification and cinema problems in the way of stabilising the projector and getting good reproduction from the slower running film.

The British Thomson-Houston Co., Ltd., are making great headway with a new home-talkie equipment which is so nearly a cinema type of talkie in miniature that I think it merits a detailed description, for it shows you how to set about overcoming film troubles if you want to make up your own synchronised film projector.

### "Non-flam" Film

This B.T.H. apparatus uses the usual 16-mm. "non-flam" film—usual, that is, in the way of stock, but unusual in that a very narrow strip at the side is used for the sound record.

In commercial work the sound is recorded as a variable wavy line,

or as a variation in density of a narrow strip of film .07 in. wide. In the B.T.H. system the 16-mm. film has a .05-in. wide sound track. The 16-mm. film is .63 in. wide, and so there is quite a considerable area left for the picture in spite of the sound track. As a matter of interest, one picture frame of this talkie film is .348 inch wide and .3 inch deep, which is not much less, you see, than the picture size of an ordinary 16-mm. film without a

sound track.

The film runs at 36 ft. a minute, as against the speed of 90 ft. a minute for a commercial talkie, and

ground of motor or projector noise.

The projector runs at a higher speed on account of the talkie film, but there is a regulator and also a mask for the film gate, so that either type of film can be used. A little mechanical governor on the driving motor keeps the speed constant.

### The "Mute Head"

The film, of course, runs through two gates, one of which is known in film parlance as the "mute head" (because it is the silent gate and not that one dealing with the sound strip) and the other as the "sound head."

A special lamp shines through an optical system on to the sound strip, and the resulting varying beam of light is focused on to a photocell. This is placed at the side of the projector box, right against a three-stage amplifier using indirectly-heated valves and giving an undistorted output of 3½ to 4 watts.

There is a separate mains unit

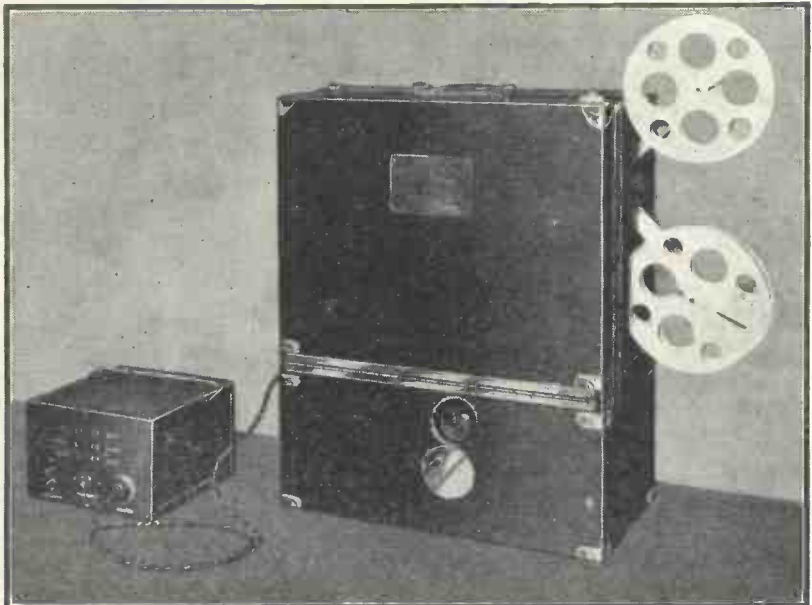

### READY FOR PROJECTION

The B.T.H.-home talkie apparatus with its separate resistance ready for projection. The case is soundproof to prevent the noise of projector mechanism being heard

so it is really remarkable that good tone is obtained.

The projector is mounted inside a sound-proof carrying case, together with the driving motor and the photocell amplifier. Only the big spools of film are supported on brackets outside, so that the case can be shut and there is no back-

and loud-speaker, all the power being obtained from the mains. There are switches for the driving motor, photocell lamp and photocell. The volume control is on the outside of the box.

About 360 ft. of the talkie film gives a 10-minute run, so that the

(Continued on page 216)

**TELSEN**

# TELORNOR

gives your home-built set the dignity and beauty of line of a commercial Radio Receiver

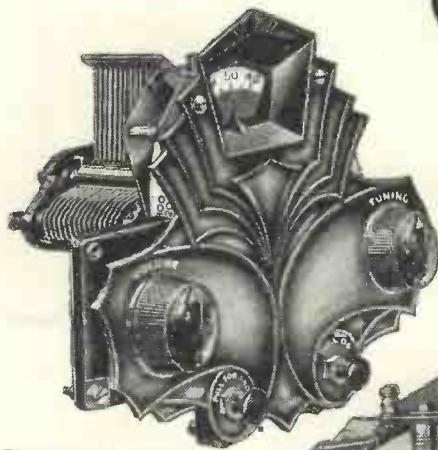
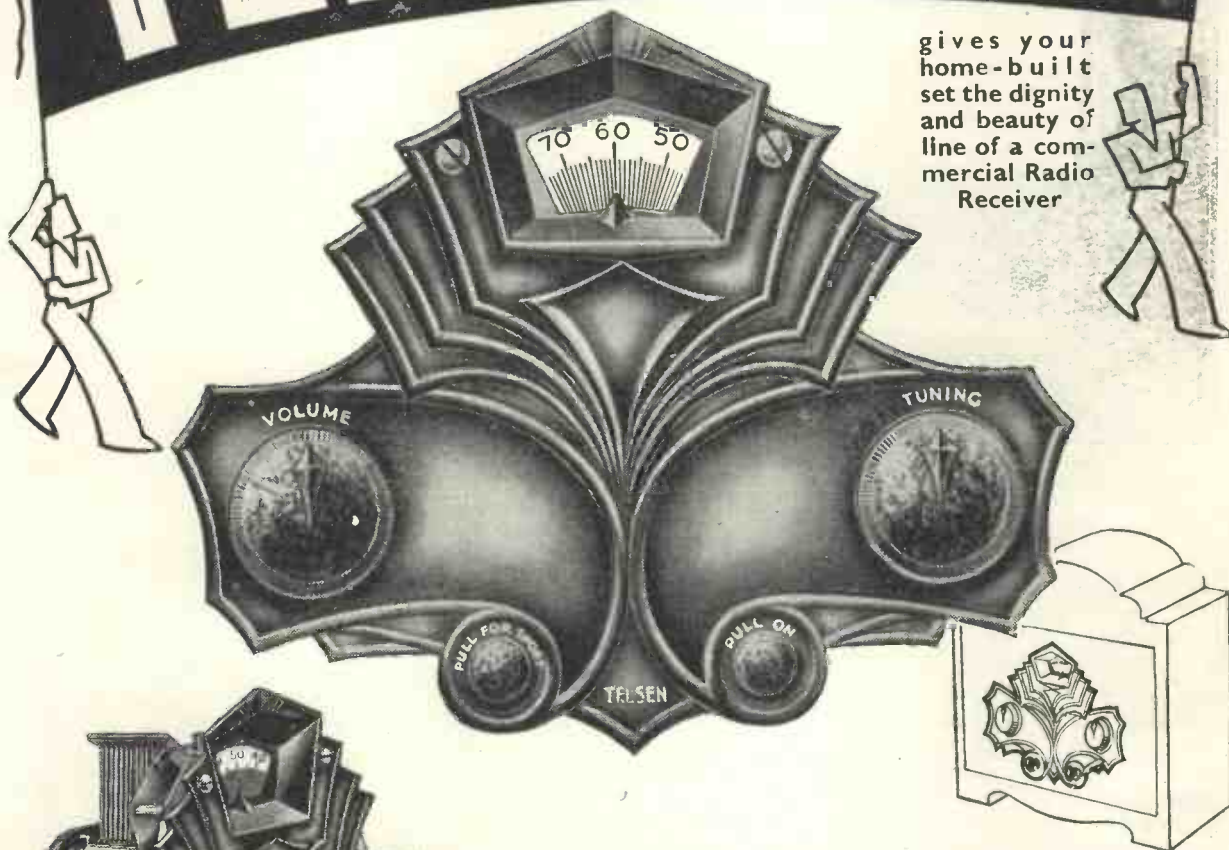

Three-quarter front view of the "Telornor"

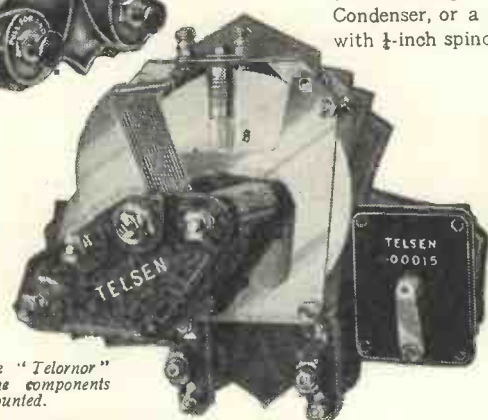

Back view of the "Telornor" showing how the components can be mounted.

The Telsen "TELORNOR" consists primarily of a variable ratio disc drive tuning control, and is supplied with an attractive escutcheon plate finished in oxidised silver. The tuning control knob is off-set on the escutcheon plate, which is also pierced to accommodate a standard Bakelite Reaction Condenser and two switches. A small bracket on the back of the chassis frame provides for the mounting of a Telsen .0005 Logarithmic Variable Condenser, or a standard "one-hole fixing" condenser with 1/4-inch spindle.

No. W. 206

**7'6**

**TELSEN**  
RADIO COMPONENTS

**GOOD RADIO IS A JOY FOREVER**

ANNOUNCEMENT OF THE TELSEN ELECTRIC CO., LTD., ASTON BIRMINGHAM

It helps us if you mention "Wireless Magazine"

# RADIO AND HOME TALKIES—Continued from page 214

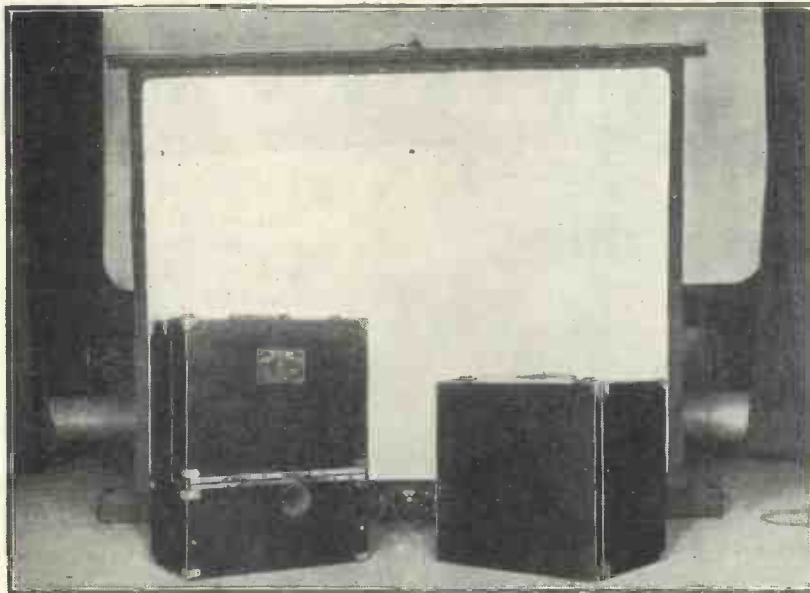

**A TRIO FOR TALKIES**

The B.T.H. equipment consists of the projector case, a combined loud-speaker and mains unit, and a folding portable screen, near which the loud-speaker should be stood to get a realistic effect

putting a heavy weight on the centre of the record, but this put such a strain on the driving mechanism that I had to scrap my first spring drive and make up another in which there was absolutely no backlash.

It is essential to use a good amplifier for otherwise the audience at one of these home-talkie "seances" will be straining not only to see the film clearly, but to hear the record properly. Good recording in many cases has helped me to make an entertainment of a film which is photographically poor.

## Film and Disc

It is quite easy to get proper isynchronisation with film and disc even when Pathé film is used, which has a notch at the start, and when you are not quite sure how long it will be before the film picks up the drive. All notches must be removed from the captions from Pathé films, of course, for otherwise the film will remain stationary while the record runs on.

expense of running a talkie of this kind need not be very heavy.

If you contemplate making up a home-talkie outfit on similar lines, then the lessons you can learn from this kind of gear are to screen the photocell, so that there is no interference from the driving motor brushes, and to fit a good mechanical governor to the driving motor, making sure that there is no loose movement in the claw mechanism of the projector.

### Increased Speed

You will have to increase the running speed to about twenty-four frames per second. It should be possible to get very good results with a photocell of the new type produced by Westinghouse, and I intend making experiments in this direction. A minor advantage is that the Westinghouse cell does not need a biasing voltage.

The sound-on-disc method is easy to set up as it is possible to get quite a good effect with dialogue records run in conjunction with films which you can take with your own camera.

The secret of getting good results with a sound-on-disc home-talkie outfit is to have a light turntable, driven at an absolutely positive speed by the projector. My first attempts were disappointing because the tone shifted up and down as it used to with the old phonographs, owing to the varying speed.

I found it possible to cure this by

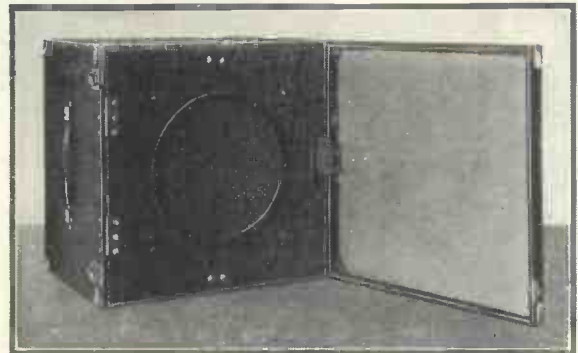

**THE TALKER OF THE TALKIE**

This is the speaker of the B.T.H. home-talkie equipment. The mains unit for the photocell amplifier is in the same case



**THE SOUND-ON-DISC SYSTEM**

An ordinary gramophone record can be played through an amplifier to provide a synchronised sound-background to a film

The thumb can be rubbed against the side of the turntable to slow it down a little and if you fit the volume control on a flex extension up by the pick-up arm, you can silently turn off the sound during film "stills" and readjust for synchronisation.

Just a final point. There are many commercial 10-in. records which can be made to synchronise with 30 ft. of home-"shot" Pathé film.



# TELSEN

# SCREENED TUNING COILS

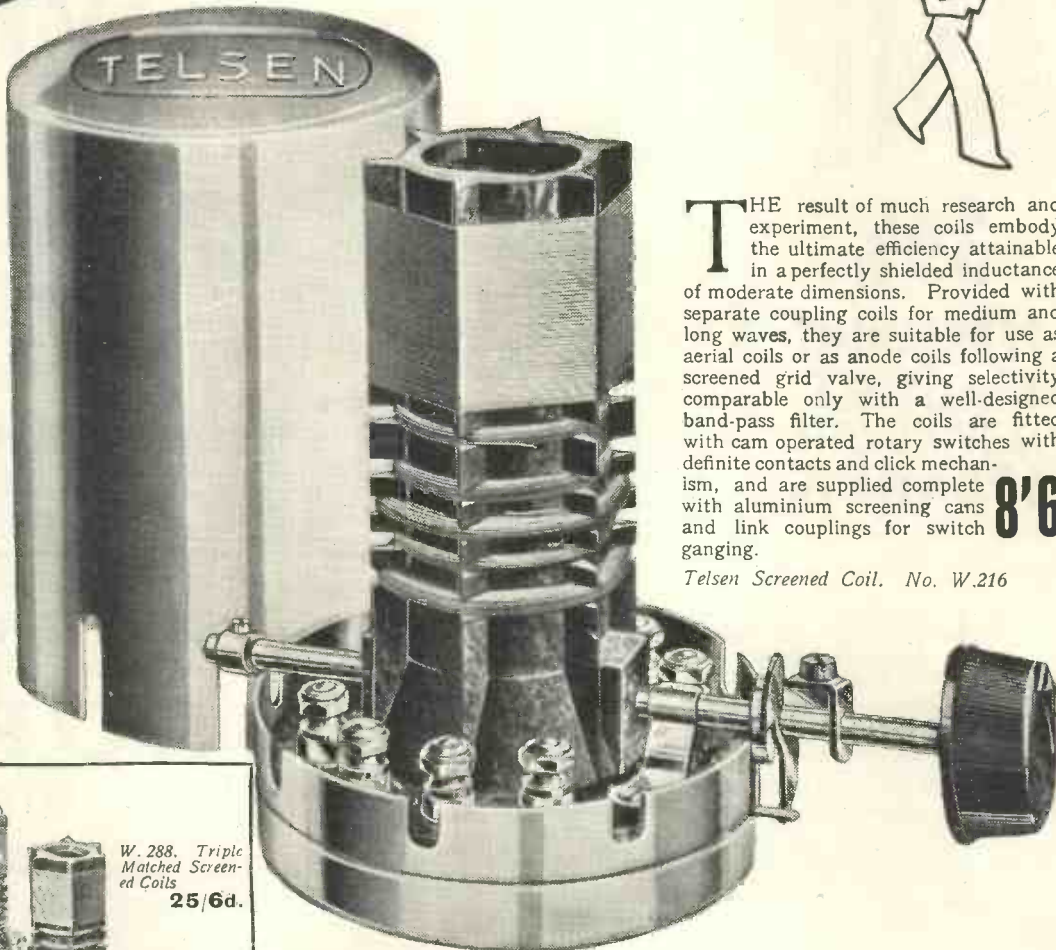
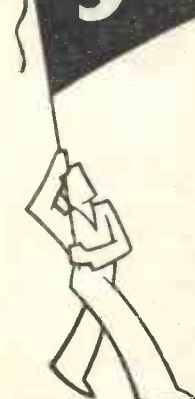

**TELSEN COIL SWITCH KNOB ASSEMBLY**  
Specially designed for use with the Telsen Screened Tuning Coils. The extension on the knob spindle fits over the switch rod supplied with the Coils, a firm coupling to the rod being ensured by tightening the small screw provided. The assembly is suitable for mounting to any standard thickness of panel, and includes a neat disc escutcheon. The knob is of the push-on type in Black Bakelite. No. W.218 **1/-**

**T**HE result of much research and experiment, these coils embody the ultimate efficiency attainable in a perfectly shielded inductance of moderate dimensions. Provided with separate coupling coils for medium and long waves, they are suitable for use as aerial coils or as anode coils following a screened grid valve, giving selectivity comparable only with a well-designed band-pass filter. The coils are fitted with cam operated rotary switches with definite contacts and click mechanism, and are supplied complete with aluminium screening cans and link couplings for switch ganging. **8'6**

Telsen Screened Coil. No. W.216

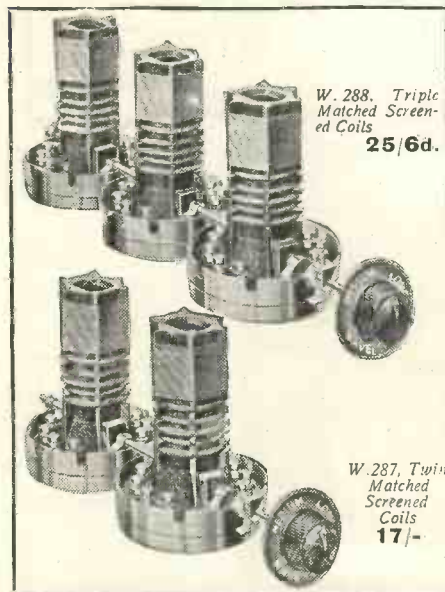

W. 288. Triple Matched Screened Coils **25/6d.**

W. 287. Twin Matched Screened Coils **17/-**

**TELSEN COIL SWITCH COUPLING ASSEMBLY**

When it is desired to mount two or more of the Telsen Screened Coils in a line parallel to the panel, and to control the wave-change switching by a single knob on the panel, this switch coupling assembly will be found indispensable. The link arms of the coupler are fitted over the switch rods of the coils, and adjusting slots are provided in the link bar to allow for the spacing of the coils varying from 3 in. to 6 1/2 in. The whole assembly has a neat nickel-plated finish, is perfectly smooth and positive in action, and free from the back-lash. **6d.**  
No. W. 217

# TELSEN

**RADIO COMPONENTS**

**GOOD RADIO IS A JOY FOREVER**

ANNOUNCEMENT OF THE TELSEN ELECTRIC CO. LTD., ASTON, BIRMINGHAM.

When replying to advertisements, please mention "Wireless Magazine"

# Now for the NEW AMPLION

39'6

**PERMANENT  
MAGNET  
MOVING COIL  
SPEAKER**

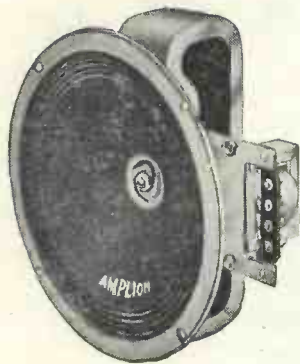

**H**ERE, at last, is the ideal Permanent Magnet Moving Coil Speaker—the one which experts will unhesitatingly recommend to their friends.

The Name is right!

The Price is right!

The Specification is outstanding!

So, too, is the Performance!

The magnet alone, of  $\frac{1}{8}$ -inch chrome steel, 2 inches wide, and standing  $8\frac{1}{2}$  inches high, weighs no less than  $6\frac{1}{2}$  lb., giving an intense field and ensuring great sensitivity.

The cone is entirely unaffected by damp, or even immersion in water, so that reproduction will not vary according to climatic conditions.

The speaker will handle 5 to 6 watts of undistorted A.C. in comfort.

The Silicon steel cored transformer is tapped to suit any type of Pentode, Power Valve, or Super Power Valve, also for Push-pull.

See this Super Speaker at

## STAND No 68

or let us send you fully descriptive leaflet No. 802.

**AMPLION (1932) LTD.**  
82/84 ROSOMAN ST.  
LONDON, E.C. 1

## MAKE USE

of our complete  
**SERVICE and**

# EXPERT ADVICE

Call at our extensive Show-rooms and let us demonstrate all the most modern and up-to-date Radio equipment. We hold the largest stock of wireless apparatus in London and can meet all your requirements. Our experts will advise and help you in your selection.

**WILL DAY, LTD.,**

19 Lisle Street, London, W.C.2.

Telephone: Gerrard 4476 (Private Exchange)

*Made by Craftsmen for Particular  
People*

## OSBORN RADIO CABINETS



**MODEL No. 226**

A Futuristic Design Radio Gramophone Cabinet, 3 ft. 4 in. high, 2 ft. 2 in. wide, 1 ft. 6 in. deep. Space for speaker is 24 in. by 10 in. Accommodation for the set and any type of gramophone motor, 24 in. by 12 in. high. Size of the baffle behind fret is 24 in. by 16 in. Special silk fabric is included.

**PRICES:**

Machined Ready to Assemble.  
Oak, £3 10s.; Mahogany, £3 15s.; Walnut, £4 10s.  
Assembled Ready to Polish.  
Oak, £4 10s.; Mahogany, £4 15s.; Walnut, £5 10s.  
Assembled and Polished.  
Oak, £5 10s.; Mahogany, £6 5s.; Walnut, £7 5s.

All models carriage paid.

**STAND 32**  
GRAND HALL,  
NATIONAL RADIO  
EXHIBITION,  
OLYMPIA,

AUGUST 19-27, 1932.

REGENT WORKS, ARLINGTON STREET, LONDON, N.1

SEND 3d. IN STAMPS FOR BEAUTIFULLY ILLUSTRATED NEW SEASON'S CATALOGUE

**CHAS. A. OSBORN (DEPT.)**

Phone: Clerkenwell 5695.

And at 21 Essex Road, Islington, N.1

Phone: Clerkenwell 5634

You will get prompt replies by mentioning "Wireless Magazine"

THE NEW

# DUBILIER

HIGH VOLTAGE

**DRY**

**electrolytic**

**CONDENSER**

Entirely sealed — no liquid — no leakage of Electrolyte — constant capacity — rapid reforming — low power factor. . these are the features of the new Dubilier High Voltage Electrolytic Condensers which have such a wide appeal to set constructors. These condensers are designed especially for use as smoothing condensers for rectifier, filter and decoupling circuits. They have a maximum working voltage of 450 peak.

- 4 mfd. Price 4/6
- 6 mfd. Price 5/-
- 8 mfd. Price 5/6



**DUBILIER CONDENSER CO. (1925) LTD., DUCON WORKS, VICTORIA RD., N. ACTON, LONDON, W.3**

*You will get prompt replies by mentioning "Wireless Magazine"*

More About the

# PERCY HARRIS RADIOGRAM

By PERCY W. HARRIS, M.Inst.Rad.E.

**I**N the August "W.M." I dealt with the constructional work of the new mains-driven radiogram, emphasising the simplicity of control. Used in the standard fashion the set gives a sharpness of tuning much in excess of that generally obtainable in many sets using at least one stage of high-frequency amplification, without the sacrifice of quality which so often accompanies sharp tuning.

### Sharpness of Tuning

This sharpness of tuning makes it advisable that the user should prepare a card giving the readings of the various stations he picks up, and if the reception of a maximum number of stations is required a tuning graph should also be prepared as a guide to the positions of the stations not yet found.

The procedure is quite simple and has often been described in "Wireless Magazine," while the card or calibration chart can be very con-

veniently kept under the lid of the gramophone top.

In addition to the normal manner of operating this receiver there are one or two other interesting ways in which it can be used according to the conditions under which you do your reception.

If all "Wireless Magazine" readers had the same size of aerial, if all lived the same distance from the same stations, and if all had the same tastes, the task of the set designer would be much simpler! As it is, one has to cater for a

variety of requirements and I always endeavour in my designs to give a reasonable latitude for individual control.

Take, for example, the man who lives sufficiently far away from a powerful station to be out of what may be termed the "swamp" area. A selectivity which would be hopelessly inadequate for, say, North London, the suburbs of Manchester (Continued on page 224)

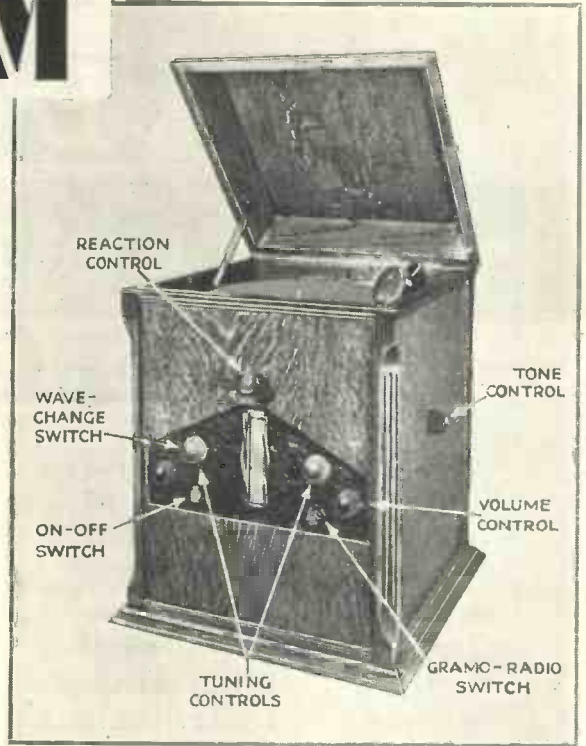

HOW THE CONTROLS ARE ARRANGED

This photograph shows clearly how the controls on the Percy Harris Radiogram are arranged. Note particularly the tone control on the side of the case. The turntable and pick-up can be seen at the top

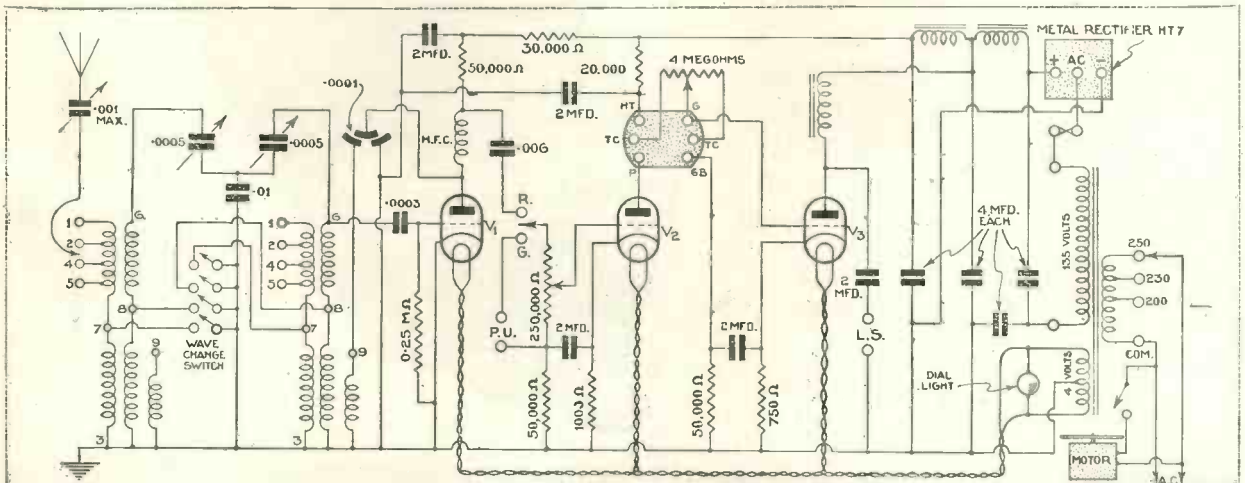

POWERFUL CIRCUIT FOR RADIO RECEPTION AND RECORD REPRODUCTION

The valve combination employed in the Percy Harris Radiogram is a detector followed by two low-frequency stages, the first being resistance-capacity coupled and the second transformer coupled. A special tone control is incorporated

**TELSEN**

**VARIABLE CONDENSERS and DRUM-DRIVE**  
Air-Dielectric

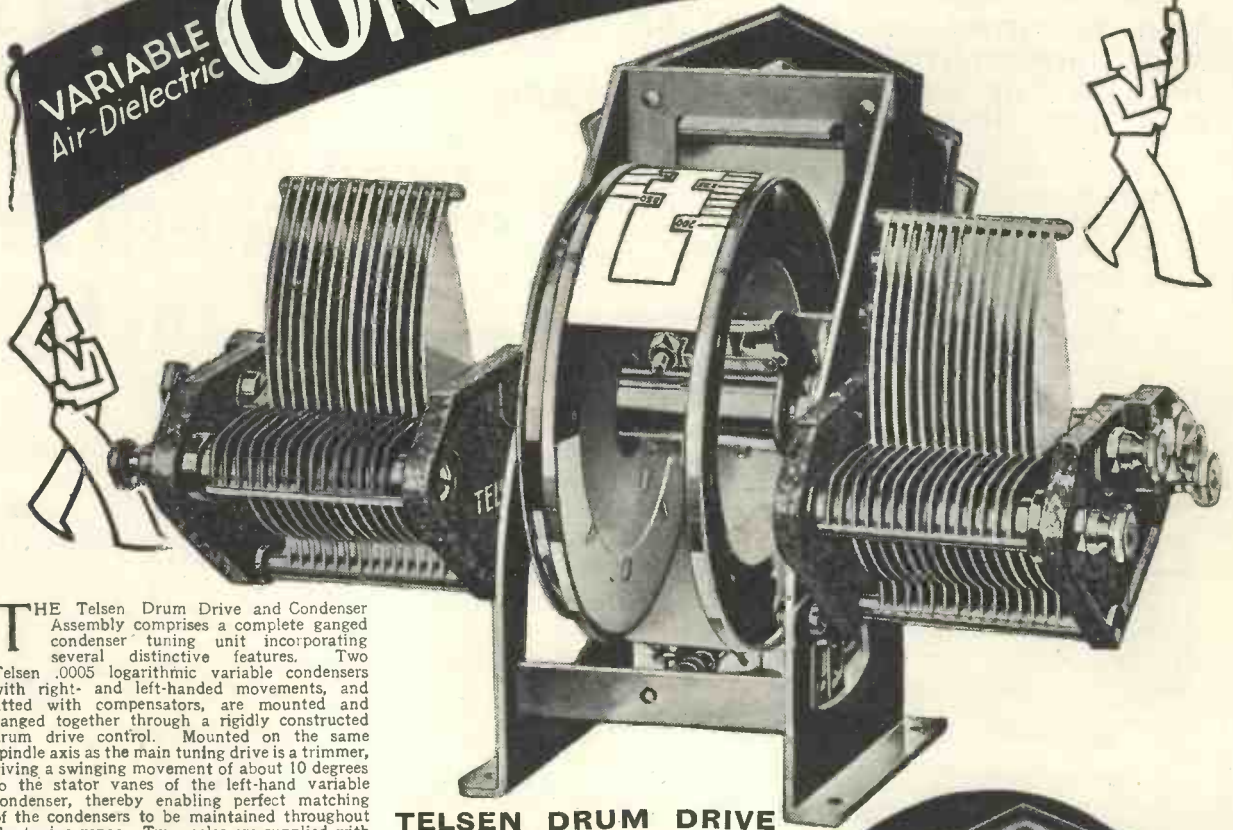

**T**HE Telsen Drum Drive and Condenser Assembly comprises a complete ganged condenser tuning unit incorporating several distinctive features. Two Telsen .0005 logarithmic variable condensers with right- and left-handed movements, and fitted with compensators, are mounted and ganged together through a rigidly constructed drum drive control. Mounted on the same spindle axis as the main tuning drive is a trimmer, giving a swinging movement of about 10 degrees to the stator vanes of the left-hand variable condenser, thereby enabling perfect matching of the condensers to be maintained throughout the tuning range. Two scales are supplied with the unit, one marked in wavelengths and one in graduations from 0-100. The scale is illuminated and has the additional advantage of being easily removable when it is desired to fit one of special calibration. The escutcheon is handsomely finished in oxidised silver, and knobs of the push-on type are fitted. Provision is made for panel and baseboard mounting, and a double-ended spanner is supplied free with the unit for fitting the variable condensers. Full instructions for mounting are included with every unit. The drum drive can also be supplied separately for mounting with any standard type of variable condenser. No. W.262.

**17½**

**TELSEN DRUM DRIVE**

Follows standard practice generally, but embodies several detail refinements, among which may be instanced the cord drive, arranged to reduce wear to a minimum and to prevent over-run, and the rocking stator trimmer, which gives a variation of 20°, and visual indication of setting. For use with Telsen screened coils, an extra scale, marked in wavelengths, is supplied free of charge. Illustration shows escutcheon, handsomely finished in oxidised silver. No. W.255. **8/6**



**TELSEN LOGARITHMIC VARIABLE AIR-DIELECTRIC CONDENSERS**

Built to give years of service. Frame is braced by three solid pillars, and the effective clamping of the vanes, each held at three points, makes distortion impossible. The rotor is also built into a rigid unit, the vanes being held at both ends. Generous bearings obviate backlash or end-plate. Models No. 260 and 261 (left-hand and right-hand movements respectively) incorporate a compensator (max. cap. 60 mfd.)

Model.	Cap.	Price	Model.	Cap.	Price
No. 130	.00025	4/6	No. 260		
No. 131	.00035	4/6	Left-hand movement with trimmer.	.0005	5/-
No. 132	.0005	4/6	No. 261		
			Right-hand movement with trimmer.	.0005	5/-

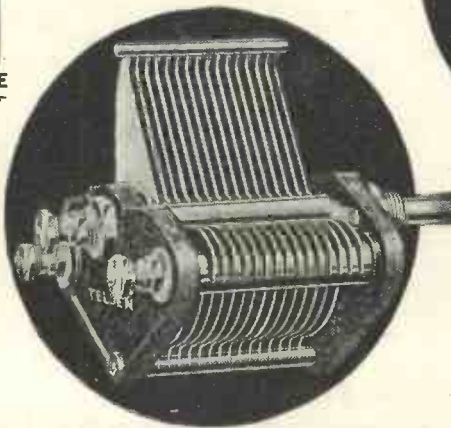

**TELSEN**  
RADIO COMPONENTS

**GOOD RADIO IS A JOY FOREVER**

ANNOUNCEMENT OF THE TELSEN ELECTRIC CO. LTD., ASTON BIRMINGHAM.

Please mention "Wireless Magazine" when corresponding with advertisers

# TRUE TONE CONTROL

Mr. Percy Harris says:—

**"THE MULTITONE . . . ONE OF THE MOST IMPORTANT ADVANCES YET MADE IN THE DESIGN OF COMPONENTS FOR HOME CONSTRUCTORS."**

The Multitone Tone Control Transformer improves the tone of any set. You simply substitute the Multitone for the present low-frequency transformer in your set.

Its response is then varied by means of a potentiometer, and any undesirable frequency distortion in the radio set, gramophone, or loud-speaker can be at once corrected.

**SPECIFIED IN THE PERCY HARRIS RADIO-GRAM**

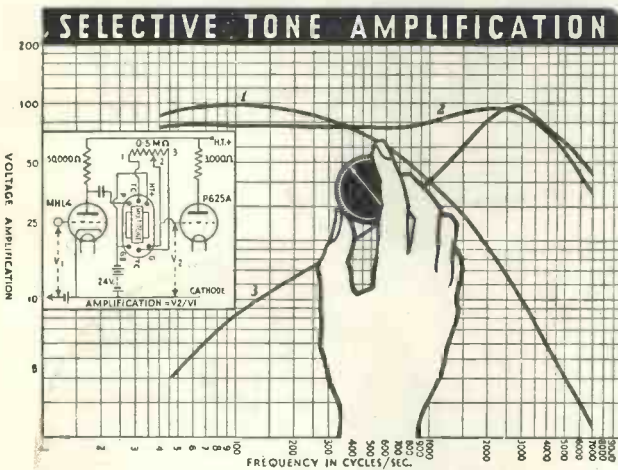

By changing the setting of the Potentiometer, the response-curve of the Multitone Transformer is progressively altered from a falling, through a level, to a rising characteristic. The limiting responses, and an intermediate level-response, are shown by these curves. When the response is level, the transformer ratio is 4:1. True Two-way Tone Control is immediately at your disposal on any set. In use, all that is necessary is to turn the Potentiometer until the desired overall response is obtained.



Any good Potentiometer exceeding 0.5 megohms can be used with the Tone Control Transformer, but the best results are obtained with the Multitone Graded Potentiometer (Price 3s. 6d.) which has been specially designed for this purpose.

Our booklet on Tone-Control will be sent post free on receipt of a post-card.

**17/6**

**MULTITONE**  
TONE CONTROL L.F. TRANSFORMER

MULTITONE ELECTRIC CO. LTD.

95/98, White Lion Street, London, N.1. Telephone: North 5063.

# THESE WEARITE COMPONENTS are specified for following Sets— "PROSPERITY THREE"



The Q.V.C. Volume Control and G.40 Mains Switch combined

## SCREENED H.F. CHOKE (H.F.P.)

Entirely enclosed in an aluminium "pot," which is provided with an earthing point, interaction between it and neighbouring components is eliminated. Suitable for all wavelengths from 15 to 2,500 metres.

Price **3/6**

The Wearite Choke (type H.F.O.) Price **6/6**

The Q.V.C. VOLUME CONTROL Silent in use—approximately square law—space-wound element (completely enclosed). Price complete (50,000 ohms), with type G.40 Mains Switch ...

Price **6/6**

100,000-ohms Volume Control with G.40 Main Switch.

Price **7/6**

Above is illustrated the combined Q.V.C. Volume Control and G.40 Mains Switch. In the component is seen an example of how Wearite components are adapted to the every need of the constructor—whether a standard part or a specialised design—Wearite can supply it.

## "PERCY HARRIS RADIOGRAM"

One WEARITE Screened H.F. CHOKE (H.F.P.) as described above. Price **3/6**

One VARIABLE RESISTANCE (Q.22), .25 meg. A robustly constructed component, silent in use. Price **4/-**

One WEARITE 4-WAY SWITCH (I.24) Complete with window-knob dial and bracket and "one-hole" fixing. Price **5/-** (Also made in 1, 2, 3, 5, and 6 way.)



The H.F.P. CHOKE

See the Complete Range of WEARITE COMPONENTS on **STAND No. 82**

Ask for full details of the new Screened Choke with armoured pigtail.

Write for special leaflets—and, if you have a technical problem, if it's components write our "Switch Section."

**WRIGHT & WEAIRE Ltd.,**  
740, HIGH ROAD, TOTTENHAM, N.17  
Tel.: Tottenham 3847/8/9.

# AN UP-TO-DATE COIL WITH UP-TO-DATE FEATURES

## TYPE TD

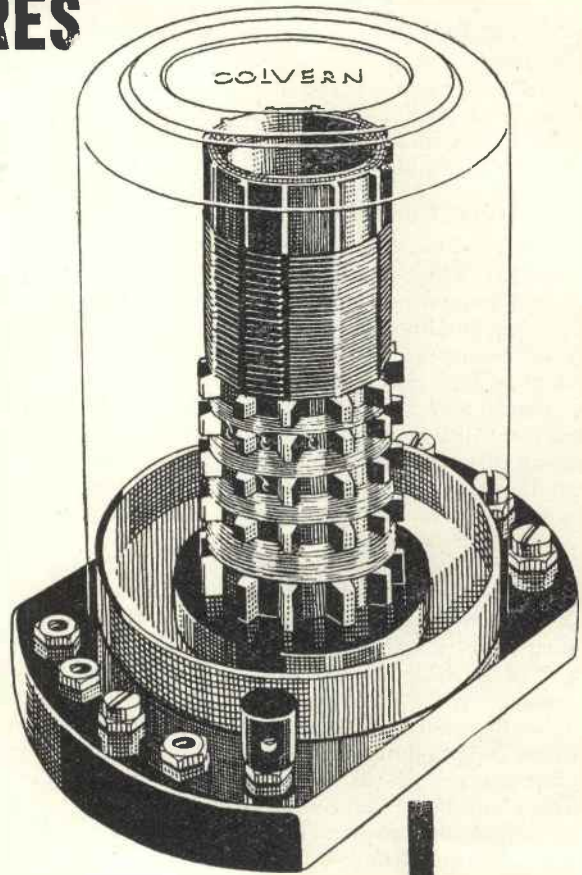

**TYPE TD,** an entirely new Colvern Coil, is designed to give super-selectivity on both long and broadcast wavebands. The coil is completely screened giving a very neat appearance and incorporates tapped aerial coupling and reaction, while the four alternative aerial tapings are arranged as sockets with a wander plug.

The first two tapings give aerial couplings similar to those normally employed but with greatly increased selectivity. Nos. 4 and 5 give a high degree of selectivity with weak aerial coupling—suitable for use in a "swamp" area.

A most important feature of this coil is that there is no break through on the long waveband from B.B.C. stations.

Price—Type TD— 8/6 each

Mr. Percy Harris chose  
Colvern Coils for the "Percy  
Harris A.C. Radiogram"

STAND NO. 245  
OLYMPIA  
AUG. 19 - AUG. 27

# COLVERN

LIMITED, MAWNEYS ROAD, ROMFORD, ESSEX

*You will get prompt replies by mentioning "Wireless Magazine"*

# PERCY HARRIS RADIOGRAM—Cont. from page 220

## Results on Test

**N**EATNESS and compactness, together with efficiency, are the main features of the Percy Harris Radiogram. The appearance of the set will certainly appeal to the lady of the house.

### Worst Conditions

A normal outside aerial was used for the test, which was carried out in South London in the middle of July, when conditions for receiving foreign stations are at their worst. Results on both medium and long wavebands were satisfactory. Although the list of stations accompanying this report is not large, it must be considered very satisfactory for the time of year, as only two hours were spent on the test.

We will talk about the results obtained on the medium waveband first. Selectivity is well above the standard for a set employing a circuit of the detector and two low-frequency type. The spread of London Regional does not interfere with the reception of nearby popular foreigners, such as Toulouse, Brussels, and Poste Parisien. London National had a spread of only 5 degrees on the dial.

In addition to the stations in the log, many others were heard, but are not included as they were not definitely identified.

By the way, the wave-change switch is tuned to the right for medium-wave reception and to the left for the long waves.

Very good results were obtained on the long waves. Sensitivity and selectivity were well up to standard. There was no trace of interference between Daventry National and

Radio Paris or Eiffel Tower. Of course, Zeesen was a difficult station to receive clear, but with great care in tuning it was possible to listen with only a minimum amount of background noise.

The variable tappings on the aerial coil should be tried to get the most efficient results. At the place of test, tapping No. 1 gave the best result, with adequate selectivity on both wavebands. On the local stations it was found necessary to make free use of the volume control, which is to be found in the bottom right-hand corner on the panel. On London Regional this control had to be turned down to minimum position to prevent overloading the output valve.

One of the chief features of this set is the apparatus for the electrical reproduction of gramophone records. This side of the set has been carefully arranged by the designer to give really first-class reproduction. The pick-up chosen is very good and no hum is audible when the electric motor is running. A good earth is, of course, necessary.

### Good Quality

The quality on both gramophone reproduction and radio is extremely good, mainly on account of the fact that one's personal whims are satisfied by the use of a tone-control transformer.

In conclusion I would say that this set will give good results from twenty or so stations with a quality that is sure to please most constructors. The set is ideal for family use.

*D. St. J.*

## LIST OF STATIONS RECEIVED

LONG WAVES		Station	Readings	
Station	Readings			
Hilversum	90 86	London National	42	37
Radio Paris	84 82	North National	50	47
Zeesen	78 76	Poste Parisien	55	52
Daventry National	75 75	Brussels, No. 2	60	57
Eiffel Tower	67 66	London Regional	63	60
Motala	62 60	Toulouse	67	65
Kalundborg	46 46	Midland Regional	70	67
Oslo	37 39	Söttens	71	68
		Rome	79	78
		Langenberg	82	81
		North Regional	84	83
		Brussels, No. 1	88	89
MEDIUM WAVES				
Trieste	36 30			

or the outskirts of Glasgow, may be ample for his purpose and he may well appreciate the additional strength of reception which the sacrifice of some selectivity will provide.

In the new radiogram, for example, he may be interested to try, in place of the lead which goes from the pre-set condenser to one of the terminals of the first coil, a slightly longer lead which can be taken from the same condenser across to terminals Nos. 1, 2, 4, or 5 of the second coil.

### Sacrifice of Selectivity

There will be some sacrifice of selectivity in this arrangement, but there will be gain of strength. Maximum strength will be obtained on terminal No. 1 of the second coil and minimum on No. 5. Tuning will now be effected solely on the second dial, reaction being used as before.

When using the set in this way it is, however, advisable to set dial No. 1 at zero, otherwise you may get a wave-trapping effect which will withdraw certain frequencies. Readjustment must also be made on the compression condenser, particularly if you have a large aerial.

So far I have made no reference to the use of various tappings on the first coil. In most cases you will join the aerial lead to terminal No. 1 of the first coil, but still greater selectivity (at the expense of signal strength) will be found on tapping on to No. 2, 4, or 5. On No. 5 probably the signal strength will be so much reduced as to make reception impracticable, but tappings Nos. 2 and 4 may be found useful on a very large aerial in districts where reception is particularly good.

### Tappings on Both Coils

In any case try experiments with the tappings on both coils, for somewhere or other on one of them you will find just the tapping to suit your particular condition and aerial.

And now a word or two about alternative valves. It will be noticed that in my last article reference was made only to the Mullard 354V and the Mullard 104V, two of the first type being used and one of the second. The reason for this is that automatic bias is obtained through resistors and the values given were

*(Continued on page 226)*



# TELSEN

## 10-1 & 1-1 COUPLING UNIT

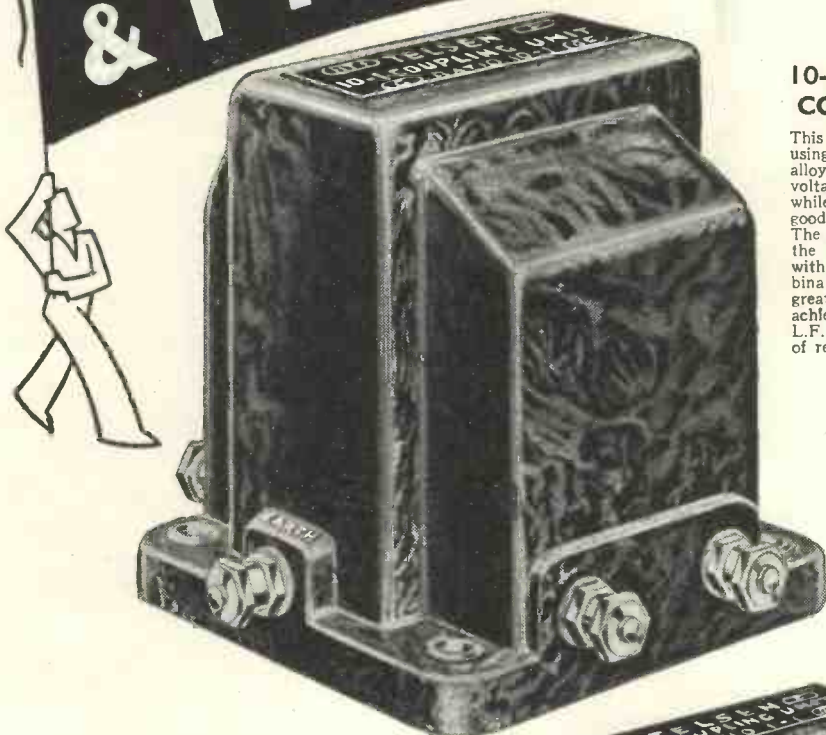

### TELSEN 10-1 INTERVALVE COUPLING UNIT

This is a filter-fed transformer using a high permeability nickel alloy core, which enables a 10-1 voltage step-up to be attained while preserving an exceptionally good frequency characteristic. The response is compensated in the higher frequencies for use with a pentode valve, this combination giving an amplification greater than anything previously achieved, equal to two ordinary L.F. stages, but with better quality of reproduction.



**12/6**

No. W.215

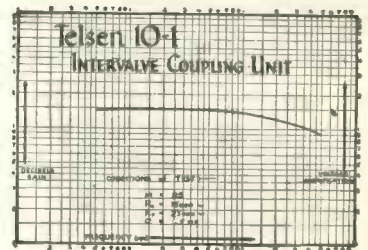

### TELSEN 1-1 INTERVALVE COUPLING UNIT

This is a modern development of the one-time deservedly popular R.C. unit. It incorporates a low pass filter feed in its anode circuit, thus effectively preventing "motor-boating," "threshold howl," and other forms of instability arising out of common couplings in eliminator and battery circuits. Used with an H.L. type valve it will give an amplification of about 20 and a perfect frequency response, at the same time consuming negligible H.T. current.

**7/6**

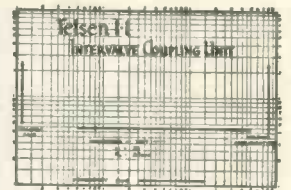

# TELSEN

**RADIO COMPONENTS**

**GOOD RADIO IS A JOY FOREVER**

ANNOUNCEMENT OF THE TELSEN ELECTRIC CO. LTD ASTON BIRMINGHAM.

Advertisers like to know you "saw it in the 'Wireless Magazine'"

# PERCY HARRIS RADIOGRAM—Cont. from p. 224

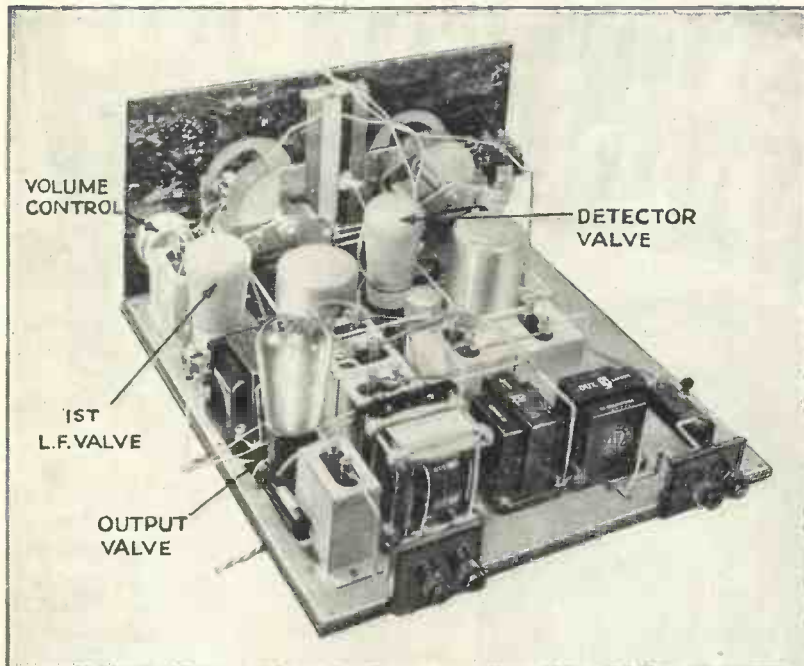

COMPLETELY ASSEMBLED AND READY FOR USE

Here is the Percy Harris Radiogram completely assembled and ready for placing in the cabinet. The mains gear is arranged separately in the bottom of the cabinet

## Components Needed for the Percy Harris Radiogram

### CHOKE, HIGH-FREQUENCY

- 1—Wearite screened, type H1P, 3s. 6d. (or Kinva).

### CHOKES, LOW-FREQUENCY

- 1—Funwell, type 30/50, 15s.
- 2—R.I. Dux, 17s. 6d. (for smoothing)

### COILS

- 2—Colvern, type TD, 17s.

### CONDENSERS, FIXED

- 1—Lissen .0003-microfarad, 1s. (or T.C.C., Dubilier).
- 1—Lissen .006-microfarad, 1s. 6d. (or T.C.C., Dubilier).
- 1—Lissen .01-microfarad, 2s. (or T.C.C., Dubilier).
- 5—Peak 2-microfarad, 1,500-volt test, 18s. 9d.
- 4—Peak 4-microfarad, 1,500-volt test, £1 7s.

### CONDENSERS, VARIABLE

- 2—Simplicon .0005-microfarad, type Star UK, (one right-hand and one left-hand), 10s.
- 1—Magnum .0001-microfarad differential reaction, 5s.
- 1—Formo pre-set .001-microfarad maximum, 1s. 6d.

### DIAL, SLOW-MOTION

- 1—Simplicon full-vision scale, type FVV, 13s. 6d.

### EBONITE

- 1—Beocol panel, 13½ in. by 7 in. by ¼ in., grained, 6s. 2d.

### FUSE

- 1—Magnum with bulb, 1s. 3d. (or Bulgin, Readi-Rad).

### HOLDERS, GRID-LEAK

- 1—Readi-Rad, 6d.

### HOLDERS, VALVE

- 3—Telsen five-pin, 2s. (or W.B., Lotns).

### METAL RECTIFIER

- 1—Westinghouse, type HT7, 17s. 6d.

### PLUGS AND TERMINALS

- 4—Belling-Lee terminals, marked: Aerial, Earth, L.S. (2), type B, 2s. (or Clix, Ealex).
- 1—Bulgin mains plug and socket, type F15, 4s.

### RESISTANCES, FIXED

- 1—Varley 20,000-ohm spaghetti, 1s. (or Magnum, Bulgin).
- 1—Varley 30,000-ohm spaghetti, 1s (or Magnum, Bulgin).
- 3—Varley 50,000-ohm spaghetti, 4s. 6d. (or Magnum, Bulgin).
- 1—Varley 750-ohm tag, 1s.
- 1—Varley 1,000-ohm tag, 1s.
- 1—Lissen .25-megohm grid leak, 1s.

### RESISTANCES, VARIABLE

- 1—Wearite .25-megohm potentiometer, type Q22, 4s.
- 1—Multitone 4-megohm potentiometer, 3s. 6d.

### SUNDRIES

- Glazite insulated wire for connecting.
- Length of rubber-covered wire.
- Length of twin flex.
- 1—Pair Bulgin panel brackets, type PB4, 1s. 3d.
- 1—Sheet of aluminium foil, 14½ in. by 14 in.
- 1—Bulgin Duplex needle cup, 2s. 6d.

### SWITCHES

- 1—Bulgin gram-radio, type S80, 2s.
- 1—Bulgin toggle on-off, type S80, 1s. 9d.
- 1—Wearite four-pole change-over with terminals, type 124, 5s.

### TRANSFORMER, LOW-FREQUENCY

- 1—Multitone, 17s. 6d.

### TRANSFORMER, MAINS

- 1—Heayberd type W25, £1 2s. 6d.

### ACCESSORIES

#### CABINET

- 1—Smith table radiogram (oak), £2 15s.

#### GRAMOPHONE MOTOR

- 1—Garrard Junior induction, type 202A, £2 18s. 6d.

#### PICK-UP

- 1—British Radiophone, £1 2s. 6d.
- 1—British Radiophone pick-up rest, 1s. 6d.

#### VALVES

- 2—Mullard 354V metallised, £1 7s.
- 1—Mullard 104V, 15s.

The prices mentioned are those for the parts used in the original set; the prices of alternatives as indicated in the brackets may be either higher or lower.

the right ones for those particular valves.

I do not wish it to be thought that other makes of valves are unsuitable for this receiver, or that there is some special and magic virtue about this particular and excellent make. Fortunately for the home constructor we have many excellent makes of valves on the market, but it is hopeless to expect to get proper results in a set using automatic bias when you use one make of valve with a resistance designed for another.

## Cossor Valves

If, for example, you wish to use the Cossor valves the correct types will be 41MHL for the detector and first low-frequency stage and the 41MP for the output. As far as the detector circuit is concerned no changes are necessary and the MHL can be immediately substituted for the 354V.

In the first low-frequency stage, however, the resistance should be 750 ohms in place of 1,000 ohms, while for the output valve the bias resistor should be 350 ohms as against 750 ohms, the decoupling resistances remaining the same.

The Cossor 41MH also makes a very good detector valve, I find.

There are a number of other makes of A.C. valves which will work excellently in this set, but before using them make sure that the bias resistor is of the correct value.

A simple rule to ascertain the correct resistor is to find out from the maker's leaflet the value of anode current flowing at 200 volts and the recommended grid bias for that voltage. Then multiply the bias figure by 1,000 and divide it by the anode current in milliamperes. This will give you the correct grid bias resistance in ohms.

## Makers' Figures

Take, for example, the Marconi or Osram MHL4. The makers' recommended grid bias at 200 volts is 6, the anode current for this voltage and bias being 7 milliamperes. Divide 6,000 by 7 and we get 857, therefore an 850-ohm resistor would suit.

If you use 1,000-ohm resistance the bias will be 7 volts instead of 6, which will be a little more than that recommended by the makers, but will do no harm.

# BRITISH RADIOPHONE

## 'Midget'

### TUNING CONDENSERS

**T**HE amazing selectivity of which the modern two-valve receiver is capable challenges many larger and more complicated sets, and it is for this reason that the British Radiophone "Midget" Tuning Condensers should be used in preference to all others for small sets.

Constructed with the high degree of accuracy associated with our name, the Radiophone "Midget" Tuning Condenser is particularly well adapted to small receivers.

The pressed steel end plates are rigidly held by four supporting pillars, and lacquered cadmium plating gives them a rustless and pleasing finish.

Best quality hard aluminium is used for the vanes, which are very accurately spaced and firmly fixed to the spindle and spacer bars by the unique method incorporating a jig employed in British Radiophone Ganged Condensers.

Hardened steel bearings are used, resulting in a very smooth, silent and positive drive, permanent in character and free from backlash. Noiseless operation is also assured by virtue of the flexible insulated pigtail, the ends of which are both clinched and soldered.

The Condenser is designed for one-hole fixing and is supplied with the necessary fixing nuts and washers.

**BRITISH RADIOPHONE "MIDGET" VARIABLE TUNING CONDENSER—TYPE 413—.0005 mfd. PRICE 6/-**

Complete with slow motion vernier drive

As specified for the Amateur Wireless "Mascot Two" shown below.

**RADIOLYMPIA  
STAND 93**

**IDEAL FOR  
THE SMALL  
RECEIVER**

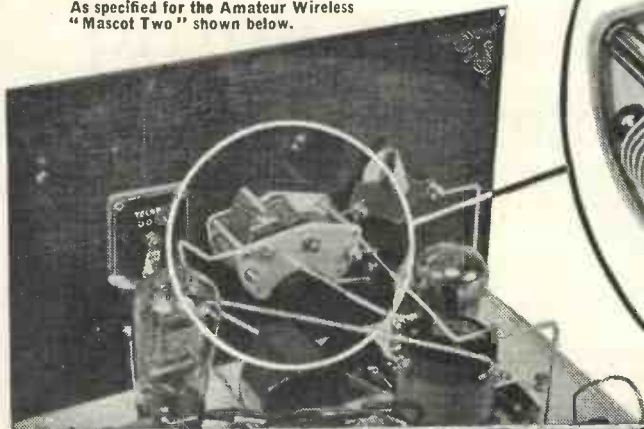
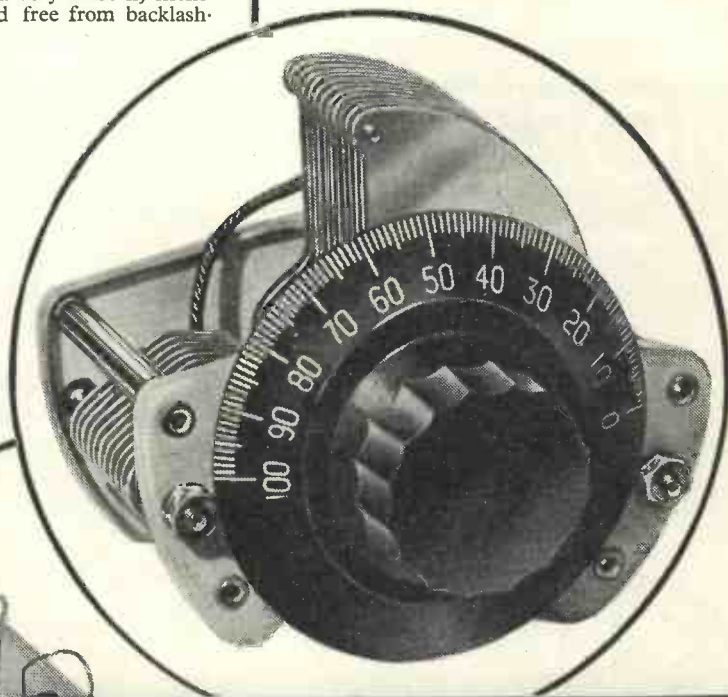

# RADIOPHONE

## GANGED CONDENSERS

Advertisers like to know you "saw it in the 'Wireless Magazine'"

Trying to "Buy British"

To the Editor, "Wireless Magazine."

SIR,—I am one of a small band of keen listeners and amateur constructors. Wireless is one of our few forms of entertainment. We have one grievance, however; it is this—SERVICE, or, rather, lack of it.

As an instance of our general experiences, I quote only one of my own. I have just completed the construction of W. James' 1932 A.C. Super 60. When I tell you that the order for the parts was dispatched to a London factor on February 9 last, you will realise what patience we have to exercise. This is by no means an isolated case.

[This letter was dated June.—ED.]

Service Must Improve

We all very much want to "buy British," but unless service improves I am afraid our orders will go to Continental houses, who have proved their superiority in "getting the stuff across."

If only our suppliers would try and imagine our inability to obtain our requirements locally and that in many cases our conditions of life are monotonous, they might give us more attention. Very often a knowledge of the mail days for Cyprus would have saved several days. Four or five weeks should be enough time in which to obtain delivery of our orders, but when, in some cases, it takes up to fifteen weeks it spells slackness, with a capital S.

I need not add that any assistance given will be much appreciated by all of us.  
Cyprus. Chas. Woods.

Egyptian Broadcasting

To the Editor, "Wireless Magazine."

SIR,—Your July issue contains some information regarding the Egyptian broadcasting system (page 684).

Being an old reader and wishing that your journal be fully informed regarding the above item, I beg to

put the matter right as follows:

1. The Egyptian Government has no longer a Khedivial sovereign. In virtue of a Royal Proclamation dated March 22, 1932, Egypt is governed by H.M. the King Fouad I. His Majesty visited your country in 1930 and the cordial reception which was made by the English people is still in our memory.

Three Other Stations

2. Among the local broadcasting stations, I may point out that Port Said Radio is rarely heard in Cairo, where three other stations are furnishing programmes for the whole day, namely:

- (a) Radio-Heliopolis Experimental, 500 watts, 270 metres.
- (b) Radio Szabo, 300 watts, 504 metres.
- (c) Radio Amir Farouk, 750 watts, 321 metres.

The first two stations transmit international programmes and the last one transmits Arabic programmes only.  
Cairo. J. R. Pardo.

# MOST IMPORTANT OF ALL

## what is Bulgin doing for the coming season?

This year Bulgin is making a greater progress stride than ever. Never before has a new season's programme listed such a phenomenally wide selection of new and original components. Pre-eminence in the Realm of Radio Components is reached by our productions for 1932-1933.

ON OUR STAND AT OLYMPIA YOU WILL SEE—  
the NEW Trans-coupler. The NEW Lightning Switch. NEW Mains Switches. NEW Chokes. NEW Transformers. NEW Fuse Plugs.

NEW Wall Jacks. NEW Volume Controls, etc., etc.  
Inspect them. Note advanced designs—sterling quality and price of these, the finest quality components in the world.

LEADERSHIP is clearly apparent in every page of the NEW AND ENLARGED CATALOGUE AND MANUAL 'B.' 80 Pages—Fully Illustrated. Send for copy N.W. Enclose 2d. postage.

STAND  
151  
OLYMPIA



Advertisement of A. F. Bulgin & Co. Ltd., Abbey Road, Barking, Essex.

Better service results from mentioning "Wireless Magazine" when writing to advertisers

# TELSEN CONDENSERS

**BAKELITE DIELECTRIC**



### TELSEN REACTION CONDENSERS

Improved type, of great rigidity and precise construction. The Rotor Vanes are keyed to the spindle, and fitted with definite stops. The vanes are interleaved with finest quality solid dielectric. A strong nickel silver contact makes connection to the rotor, and a positive connection is made to the stator vanes. Complete with knob.

Capacity .0003	No. W.188	<b>2/4</b>
" .00015	" W.189	
" .0001	" W.190	
" .00075	" W.191	<b>2/6</b>
" .0005	" W.192	



### TELSEN AERIAL SERIES CONDENSER

This component forms an ideal volume and selectivity control. The internal construction permits of an extremely low minimum capacity. Keyed externally on the spindle is a switch arm which connects with a contact on the fixed vanes when rotated to maximum position. This short circuits the condenser for maximum volume. The rotor movement is limited by definite stops. The vanes are interleaved with the finest quality solid dielectric, and solidly constructed throughout. Supplied complete with knob.

Capacity .0003 - - - W.205

**2/3**

### TELSEN Bakelite DIELECTRIC TUNING CONDENSERS

Redesigned on an entirely new principle, giving great rigidity with compactness and high efficiency. May be used with confidence where space is limited. The well-braced vanes are interleaved with a minimum of highest quality solid dielectric, ensuring complete accuracy of tuning. Supplied complete with knob.

Capacity No.  
.0005 - W.153  
.0003 - W.194

**2/6**



### TELSEN DIFFERENTIAL CONDENSERS

Capacity.	No.	<b>2/6</b>
.0003	W.185	
.00015	W.186	
.0001	W.187	

**TELSEN**  
RADIO COMPONENTS

**GOOD RADIO IS A JOY FOREVER**

ANNOUNCEMENT OF THE TELSEN ELECTRIC CO., LTD., ASTON, BIRMINGHAM.

Advertisers like to know whence the business comes—please mention "W.M."

# What is Parasitic Oscillation?

By J. H. REYNER, B.Sc., A.M.I.E.E.

A PARASITIC oscillation is one which occurs at an entirely different frequency from that which is being received. It arises in most unexpected places, and may either be a continuous oscillation, present

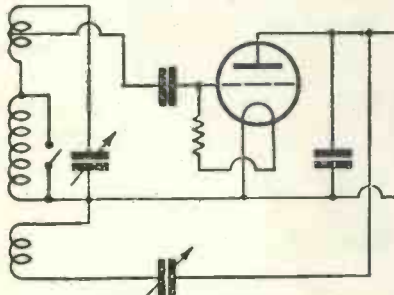

**SKELETON CIRCUIT**  
Circuit in which parasitic oscillation was experienced

the whole time, or it may be brought into being by the use of the ordinary reaction control on the receiver.

In the former case the receiver is "dead," and will usually receive no signals whatever. In the latter case the circuit behaves quite normally until the reaction control is increased, when it suddenly goes into oscillation with a click, but without making any appreciable difference to the signal which is being received.

In fact, the signal strength may be considerably reduced. If the reaction control is further increased the normal reaction effect will possibly come into play and the signal will gradually build up to the point of oscillation as usual.

## Centre-tap on Coil

A trouble of this latter type was experienced on the circuit shown. In order to minimise grid damping, the grid had been connected to a centre-tap on the medium-wave coil instead of to the end of the coil, as is usually done.

This made a material improvement in the selectivity without seriously affecting the signal strength and the circuit was good on the medium waves. Unfortunately, the long waves proved unworkable owing to the presence of this parasitic oscillation.

Investigations showed that this was due to tapping down the coil. If the tapping was taken at the end of the coil everything was quite normal, but as soon as the centre-tap was reverted to the parasitic oscillation made its appearance.

Removal of the reaction circuit overcame the difficulty, indicating that in some way this was resonating with some part of the grid circuit at a frequency much higher (that is, a much shorter wavelength) than the normal working range. The trouble could be cured by inserting a short-wave high-frequency choke in the reaction circuit. This checked any build up of current of the ultra high frequency corresponding to the parasitic oscillation, but it had very little effect on the ordinary signal.

Another solution, which was, perhaps, even simpler, was to wind the reaction coil with high resistance wire. No. 40-gauge Eureka wire was actually used; this gave a resistance of over 100 ohms and was apparently sufficient to damp out the high-

frequency parasitic oscillation, again without causing any serious effect on the medium wavelengths.

Other causes of parasitic oscillation are the use of symmetrical circuits in both grid and anode circuits. For example, if a valve has a centre-tapped coil in both grid and anode circuits there is a tendency for the system to oscillate at the frequency of one half of the coil tuned with its own self-capacity.

## Another Cause

Still another cause of parasitic oscillation is the use of long leads between the tuned circuit and the valve, particularly long cathode leads with modern A.C. valves. The inductance of the lead tunes with the self-capacity of the circuit to some short wavelength and quite a small coupling from the anode circuit is sufficient to generate a parasitic oscillation.

The remedy is to use short leads, or, if this is impossible, to insert damping resistances of a few hundred ohms in the grid leads.

## The Real Tonic

("There is nothing like the simple life for making one fit.")

—Extract from medical article.)

*I note with regret that the doctors have said  
That the cardinal way to be healthy and strong  
Is to live in the wilds and go early to bed  
And awake on the following morn with a song.*

*You have to be bold—to get close up to Nature—  
To go without boots and to live in a sack!  
Such tactics, they say, will develop your stature  
And stop you from getting unhealthy and slack.*

*You have to turn-in every night in a tent  
And rough it like cavemen, with plainest of food:  
Such methods of living undoubtedly meant  
That your body was getting the maximum good.*

*But none of 'em adds (I observe with displeasure)  
The need for including a "cure" for the mind  
As well as the body—I refer to that treasure  
The portable set, or a thing of that kind!*

C. P. P.

The **TELSEN**

# AJAX 3



Bigger . . . better . . . packed with valuable information from cover to cover—the new Telsen Radiomag is undoubtedly the finest radio sixpennyworth ever offered. For it

appeals to all—and all can profit by it. In simple language, illustrated by photographs and diagrams, and complete with three full-size 1s. blueprints, it tells you how to build the latest circuits . . . how to modernise your existing set . . . how to rectify little faults . . . how to get the best out of your set in every way. Get a copy NOW!

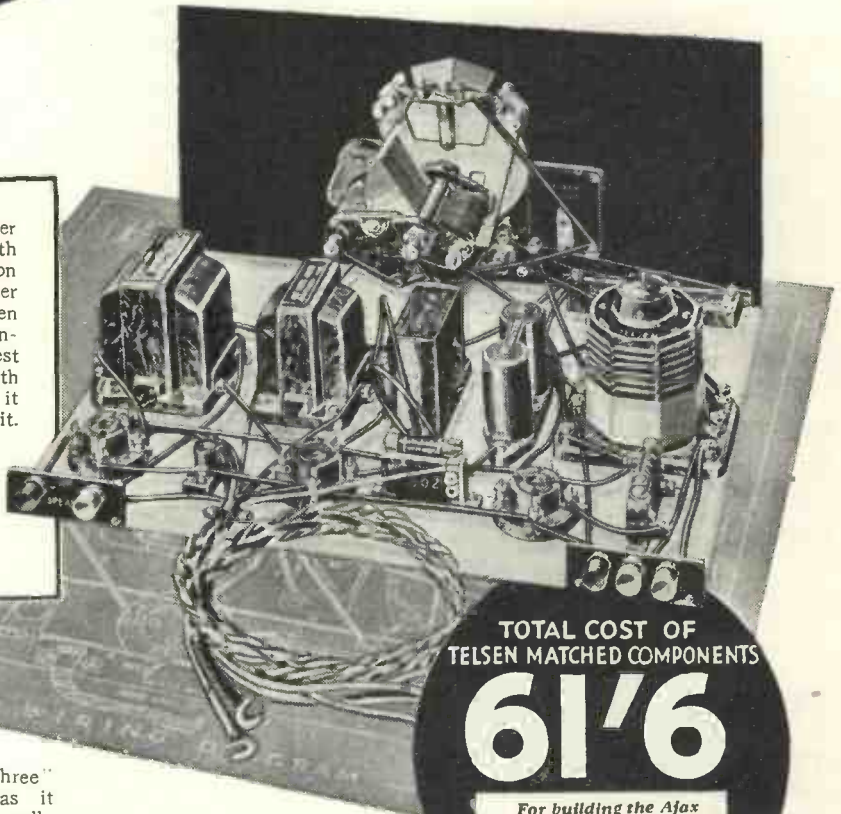

TOTAL COST OF  
TELSEN MATCHED COMPONENTS

## 61'6

For building the Ajax 3, including panel, baseboard, terminals, battery cords and all accessories.

A HIGHLY efficient "Straight Three" circuit, as easy to operate as it is to build, giving an exceptionally brilliant all-round performance with a low initial and upkeep cost, the range, power, selectivity and general quality of reproduction setting a new standard for receivers of this type. Free full-size 1s. blueprint, together with full constructional details are contained in the new issue of the Telsen Radiomag, which also gives full particulars of the improved and now all-embracing range of Telsen Radio Components at the still lower prices made possible by Telsen's enormous sale. Now on sale at all radio dealers and newsagents. Price 6d.



### CONSTRUCTORS' OUTFIT "TELORNOR"

Contains all the sundry requirements for the construction of the Telsen Circuits using the Telornor. Of these the "Triple 3," the "Ajax 3," and the "Nimrod 2" are excellent as examples. All are supplied neatly packed in a carton with instructions.

## 3'6

Included in the Outfit are the following components:

Specially cut and drilled crystalline finish panel, 14 in. by 10 in. Baseboard. Eight-way Battery Cord. Complete set of Wander Plugs suitably engraved, and Spade Terminals. Terminals for Aerial,

Earth and Loud-speaker. Engraved Terminal Strips. An ample supply of 22S.W.G. Tinned Copper Wire and necessary Sleeving for wiring up the set. A double-ended Spanner for mounting the single-

hole fixing components. A four-way Spanner for tightening up all terminal nuts. All the Wood Screws and sundry other small accessories contributing to the complete assembly of the finished Receiver.

# TELSEN

**RADIO COMPONENTS.**

## GOOD RADIO IS A JOY FOREVER

ANNOUNCEMENT OF THE TELSEN ELECTRIC CO., LTD., ASTON BIRMINGHAM.

Advertisers take more interest when you mention "Wireless Magazine"

# On the Crest of the Waves

RADIO NEWS FROM ALL EUROPE :: By JAY COOTE

## AUSTRIA

IN order to make themselves semi-independent of the Vienna programmes, Graz listeners have requested the authorities to re-erect in their neighbourhood the 20-kilowatt transmitter now operating at Rosenhuegel, shortly to be replaced by a much higher powered station.

The Ravag proposes to install a short-wave station at Vienna to be used for the relay of foreign programmes, including broadcasts from the United States, for the benefit of listeners in Europe.

## DENMARK

When the new 60-kilowatt Kalundborg transmitter is ready to take over the Copenhagen programmes the present 7-kilowatt plant will remain in use as a standby station in case of a breakdown. To replace the local Copenhagen broadcaster, a 10-kilowatt transmitter will be erected at Glostrup, some six to nine miles from the Danish capital.

## FRANCE

The 8-kilowatt transmitter specially built for the *École Supérieure* (Paris) has now been brought into daily operation. The French P.T.T. has officially stated that this station has been only temporarily erected and that a much more powerful transmitter is to be built on the outskirts of the French capital.

A small experimental station at Lyons, worked by students of the *École de la Martinière*, broadcasts every Thursday from 16.00 to 17.00 and on every first Thursday of the month from 22.00 to 23.00 B.S.T. The wavelength is 166 metres and the power 150 watts (aerial).

## GERMANY

The 1.5-kilowatt Cologne transmitter is shortly to be transferred to Hanover; it will work on its original wavelength of 227.4 metres.

During the coming autumn months Stuttgart will carry out a relay which should prove of inter-

national interest. Its own radio reporter will travel by aeroplane from his home city to Barcelona *via* Geneva and Marseilles, and will broadcast a running commentary during the trip. Efforts will be made en route to get into touch with a number of broadcasting studios and the two-way conversations will be relayed to the land stations. The Stuttgart, Geneva, Marseilles, Radio Toulouse, Barcelona, and possibly other transmitters will take part in the experiment.

On July 1, 1932, the total number of licensed listeners amounted to 4,119,531, including 412,177 free permits. As against April 1, this shows a reduction of 48,909 subscribers, the difference arising from the fact that, as the tax is collected monthly, listeners suspend payment during the holiday months.

Providing a set is only used for the reception of educational courses broadcast by the local transmitter the German authorities have agreed to reduce the listening tax to schools and kindred establishments from 2s. (at par) to 9d. per month!

A site for the new Berlin 60-kilowatt transmitter has been found near the Tegel military shooting ranges, and work has already been started on the buildings. It is hoped to have the station ready by the spring of 1933.

## HUNGARY

The high-power Budapest transmitter will start its initial tests in the autumn. As a "Broadcasting House" is also required, the authorities have begun the construction of eight studios, including a large concert hall to which the public will be admitted.

Under the call-letters HAF4C, the Budapest Radio Club of the Hungarian Technical High School, now carries out experimental broadcasts between 22.30 and 24.00 B.S.T. on 41.1 metres (7,296 kilocycles). Power, 65 watts.

## ITALY

The 20-kilowatt transmitter now nearing completion at Bari will be officially opened on September 6 by Signor Mussolini. Its wavelength has been fixed at 280 metres (1,071 kilocycles).

## NORWAY

Complete reorganisation of the broadcasting network is to be carried out during 1933-4 at a cost of more than a million kronen. The scheme calls for the installation of 2-kilowatt stations at Stavanger, Tromso, Arendal, Haugesund, Kirken and Kristiansund. Bergen is to be specially favoured with a 20-kilowatt transmitter.

## ROUMANIA

The Roumanian broadcasting company is considering the purchase of a transmitter at least equal in power to that now working at Warsaw. For the purpose of measurements, a 1-kilowatt experimental station is to be built at Blaj.

## RUSSIA

The 100-kilowatt Moscow-Stalin station operating on 424.3 metres has temporarily suspended its broadcasts, although but recently constructed; it is to be entirely overhauled with a view to raising its energy to 300 kilowatts.

## SPAIN

Dissension between the authorities at Barcelona and Madrid for the time being has successfully wrecked the proposed scheme for the reorganisation of broadcasting in Spain. Barcelona claims for the province of Catalonia a 60-kilowatt transmitter and refuses to allow the control of its radio activities to pass into the hands of the capital officials.

## SWITZERLAND

In view of the fact that the Bero-muenster station draws its programmes from three different cities—namely, Berne, Basle and Zurich—the authorities, according to a rota, close down each studio in turn for a period of fifteen days during the holiday months, thus granting the hard-worked staff a well-earned rest.



# 30 STATIONS GUARANTEED

## with the METEOR S.G.3

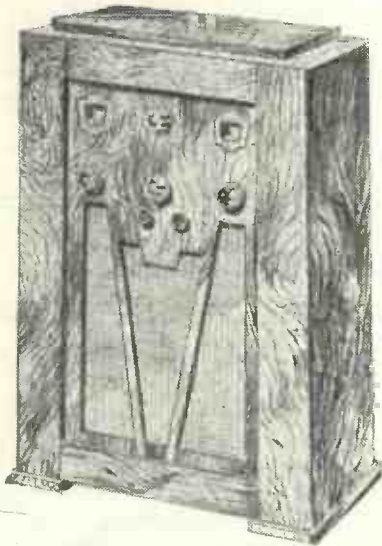

### "METEOR" S.G.3 KIT

Complete Kit, together with three Mullard Valves £5:7:6

or 10 monthly payments of 12/6

"METEOR" S.G.3 CABINET MODEL  
Beautiful walnut cabinet, fitted with Mullard P.M. Moving-Coil Speaker, and complete with Kit and valves.

£8:17:6

or 12 monthly payments of 17/-

A new chassis-type 3-valve Kit set covering ALL wavelengths - long medium and ultra short. The guaranteed reception of 30 stations is based on its performance under the very worst conditions. You may well expect to get double this number of medium and long wave stations as well as many on the ultra short wave band. The selectivity, too, is of the highest and the quality so superb that in order to do full justice to the set we have fitted the cabinet with a new moving coil speaker as used in receivers costing over 20 guineas.

For the constructor who wants something better!

To READY RADIO LTD.,  
Eastnor House, Blackheath, S.E.3.  
Please send me my FREE copy of the  
"METEOR" S.G.3 Book.

Name .....

Address .....

**READY**  
**RADIO**

Go to your radio dealer, or send coupon for your FREE copy of the METEOR S.G.3 book, describing and giving complete building instructions for this wonderful set.

# PROSPERITY THREE FOR BATTERIES—Cont. from page 150

which is combined the gramo-radio switch. When the knob of the potentiometer is turned as far as possible to the left the pick-up is automatically cut out of circuit and the receiver is ready for picking up radio signals. The control on the extreme right is the on-off switch.

### Operating the Set

The method of operating the set is quite simple, provided the adjustments are made in the right order.

For radio reception see that the knob of the gramophone volume control is turned as far as possible to the left; then switch on the set by means of the switch on the right. Next adjust the radio volume control on the left to about its middle position and turn the wave-change switch to the medium-wave position.

Now turn the main tuning knob until a reasonably powerful signal is picked up. At this stage the pre-set condenser in the aerial lead and the trimmer on the section of the two-gang condenser near to the front should be adjusted until the best signal strength is obtained.

The trimmer should be adjusted so that the tuning on the main dial is not too broad, as it will be if the aerial and tuned-grid circuits are not exactly in resonance. Note that

### MAKE A NOTE

that a special Autumn Double Number of "Wireless Magazine" will be published on Wednesday, September 21. In addition to all the usual features that make "Wireless Magazine" so popular it will also contain a free gift of the greatest value to all listeners who want to extend their logs of foreign stations. On no account miss your special

### FREE GIFT!

each time the pre-set aerial condenser is altered the trimmer on the two-gang instrument will have to be re-adjusted. The trimmer on the section of the twin condenser remote from the panel should be left right

out during the whole operation.

To receive on the short waves, turn the radio volume control to the left as far as possible and then turn the wave-change switch to one of the short-wave positions. Tuning is then carried out with the main control in the centre of the panel, reaction being applied in the usual way. The neutralising condenser in the aerial circuit should be adjusted to give the smoothest control of reaction.

### Canned Coils

The aerial and tuned-grid coils for the long and medium waves are of the canned type and the cans should be put in position before the set is operated. No can is used for the short-wave coil as it introduces too much damping and reduces the signal strength.

For gramophone reproduction the radio volume control is turned as far as possible to the left and the wave-change switch should be put in either the long- or medium-wave position, otherwise a powerful short-wave transmission may break through.

NOW . . . from the LYONS Laboratories . . .

**OUR**  
"B.A.T."  
TRADE MARK  
IS  
ALL THAT THE  
SLOGAN IMPLIES:  
**"BEST-AFTER-TEST"**

**A 100% BRITISH-MADE RESISTANCE WITH ALL THE QUALITIES YOU DEMAND!**

**FIXED RESISTORS**

• No matter what are the features you demand in the Resistors you use, you will find every requirement fulfilled in "B.A.T." (Best-After-Test) Resistors.

Their entirely new process of manufacture ensures that "B.A.T." Resistors are noiseless in operation, permanent in resistance value, and give really perfect voltage regulation. They are sturdily constructed and are definitely proof against surface flaking and the troubles it can cause. Perfect electrical connections are assured, the stout wire leads being heavily soldered to the resistor ends.

"B.A.T." (Best-after-Test) resistors are definitely guaranteed to be 100% British and are also guaranteed to be non-capacitative and non-inductive.

There are no finer Resistors made than "B.A.T.," a fact substantiated by their widespread use by the leading British Radio Manufacturers.

**1-Watt - 10½d.**  
**2-Watts - - 1/9**  
**3-Watts - - 2/9**  
**5-Watts - - 4/0**

**"OHMS' LAW WITHOUT TEARS."**  
 Send to-day for your free and post-free copy of our 2-colour, "Copyright," 16-page Art Booklet. Not a "Catalogue," but simple illustrations, with valuable circuits and "A.B.C." concerning the "mysteries" of Ohms, Volts, Amperes and Watts Dissipation. The Edition is limited.

**CLAUDE LYONS LTD.**  
 76, Oldhall St., Liverpool. 40, Buckingham Gate, S.W.1

The **TELSEN**

# JUPITER S.G.3

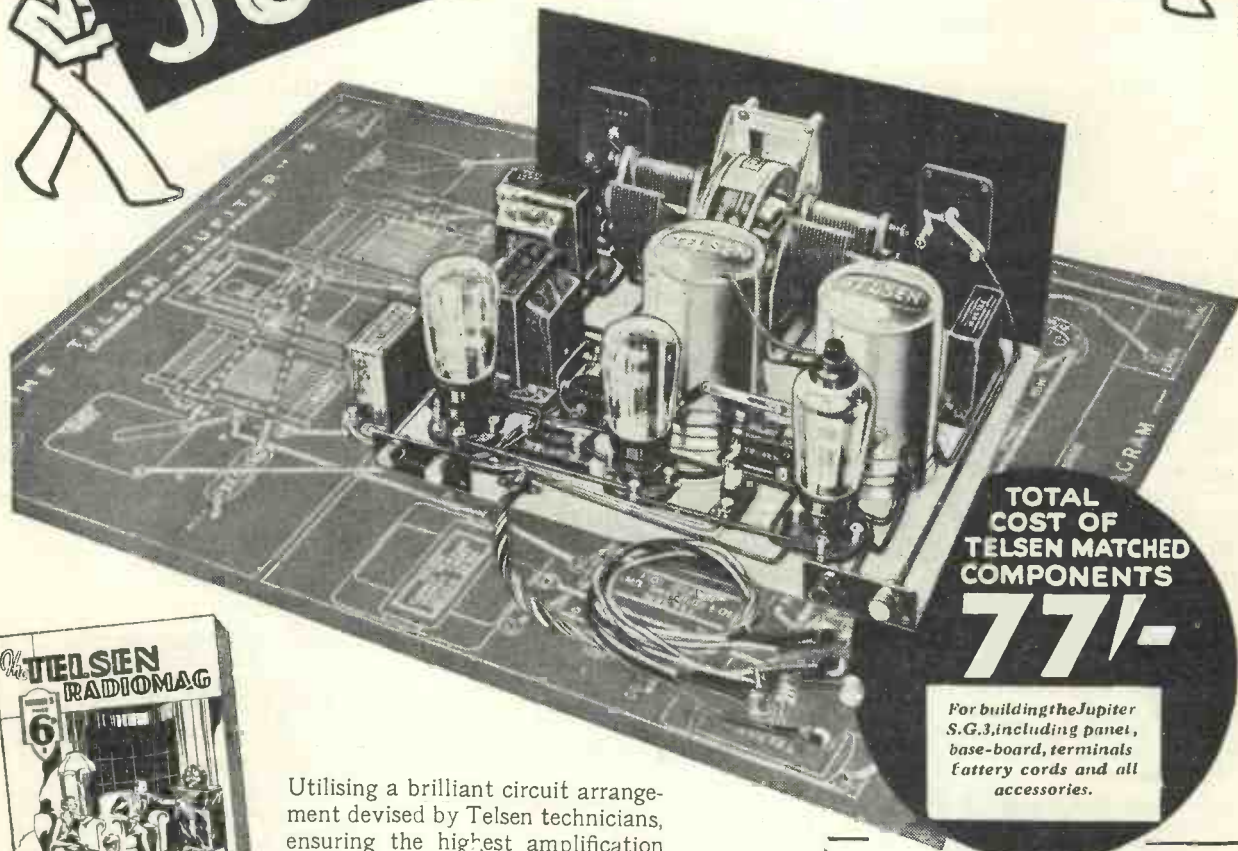

**TOTAL  
COST OF  
TELSEN MATCHED  
COMPONENTS**

**77/-**

*For building the Jupiter  
S.G.3, including panel,  
base-board, terminals  
battery cords and all  
accessories.*



Utilising a brilliant circuit arrangement devised by Telsen technicians, ensuring the highest amplification under all conditions, with extreme selectivity, exceptionally wide range and superb quality of reproduction.

Free full-size 1s. blueprints of this

and other Telsen circuits, together with full instructions and a wealth of interesting and valuable information, including particulars of the improved and now all-embracing range of Telsen Radio Components at the still lower prices, made possible by Telsen's enormous sale, are contained in the new, bigger and better issue of the Telsen Radiomag. Get a copy NOW—price 6d., from your radio dealer or newsagent.

# TELSEN

**RADIO COMPONENTS**

**GOOD RADIO IS A JOY FOREVER**

ANNOUNCEMENT OF THE TELSEN ELECTRIC CO. LTD. ASTON BIRMINGHAM.

**CONSTRUCTOR'S OUTFIT—  
DRUM DRIVE AND CONDENSER  
ASSEMBLY**

This is an invaluable accessory to the constructor building up any of the Telsen Circuits employing the Drum Drive and Condenser Assembly (e.g., the "Jupiter", S.G.3). The various components and accessories included are shown in the illustration above.

Cat. No. 219.

**3/6**

# EXHIBITS at OLYMPIA

## List of Exhibitors Arranged in Alphabetical Order

The eighth National Radio Exhibition will be held at Olympia (London) from Friday, August 19, to Saturday, August 27. The hours of opening are from 11 a.m. to 10 p.m. daily; the price of admission is 1s. 6d. There are more than two hundred exhibitors and many demonstration rooms

- |  |              |
|--|--------------|
| <i>Firm</i>  | <i>Stand</i> |
| <b>Ad-A-Grams</b> .. .. .  | 116          |
| <i>This firm are showing their attachment for converting a receiver into a radio gramophone</i>  |              |
| <b>Adey Portable, Ltd.</b> .. .. .   | 259          |
| <b>Alliance Radio, Ltd.</b> .. .. .  | 19           |
| <i>Two A.C. sets and a battery portable will comprise the main programme of this firm</i>  |              |
| <b>AMATEUR WIRELESS</b> .. .. .  | 7            |
| <i>You will be interested in this stand. All the latest "A.W." sets and blue-prints can be inspected</i>                                   |              |
| <b>Amplion (1932), Ltd.</b> .. .. .  | 68           |
| <b>Apollo Gramophone Co., Ltd.</b> .. .. .   | 214          |
| <i>A playing desk for battery or mains operation suitable for use with radio receivers is the main item of the Apollo programme</i>        |              |
| <b>Automatic Coil Winder &amp; Electrical Equipment Co., Ltd.</b> .. .. .  | 206          |
| <i>Slektun coils, high-frequency chokes and transformers will be on show here. An outstanding exhibit will be the Avometer test set</i>    |              |
| <b>Baker's Selhurst Radio</b> .. .. .  | 83           |
| <i>A complete range of moving-coil loud-speakers of every type and price. Make a point of hearing the super-power model</i>                |              |
| <b>Balcombe, A. J., Ltd.</b> .. .. .   | 128          |
| <i>A full range of Alba sets will be seen here. These comprise battery and mains radiograms, table and pedestal receivers</i>              |              |
| <b>Bell Piano Co., Ltd.</b> .. .. .  | 3            |
| <i>The chief item on this stand will be a mains three-valve receiver with pentode output. Also complete radiograms</i>                     |              |
| <b>Belling &amp; Lee, Ltd.</b> .. .. .   | 154          |
| <i>Bow-spring wander plugs, twin insulated plugs and sockets, and panel fuseholders are some of the new parts on show</i>                  |              |
| <b>Benjamin Electric, Ltd.</b> .. .. .   | 40           |
| <i>The speciality here is the Transfeeda, a new type of intervalve coupling with distinctive features. Also valve holders and switches</i> |              |

- |   |     |  |     |
|---|-----|--|-----|
| <b>Bird, S. S., &amp; Sons, Ltd.</b> .. .. .  | 158 | <b>British G.W.Z. Co., Ltd.</b> .. .. .  | 282 |
| <i>A complete range of Cyldon condensers will be on view. Condensers for transmitting will be included</i>                                      |     | <i>Dry batteries of every type ranging from the standard 60-volt to the 120-volt super-power</i>                               |     |
| <b>Bowyer-Lowe &amp; A.E.D., Ltd.</b> .. .. .   | 156 | <b>British Hard Rubber Co., Ltd.</b> .. .. .   | 220 |
| <i>A new pick-up and parallel-feed transformer are the main items on this stand. Also volume controls and electric playing desk</i>             |     | <i>A special show of Permcot non-discolouring ebonite. Also ribbed formers for coils and chokes</i>                            |     |
| <b>Bridger, R. O., &amp; Co.</b> .. .. .  | 280 | <b>British Ideal Patents, Ltd.</b> .. .. .   | 72  |
| <i>The main exhibit comprises Grantona Cones—made of special paper-pulp material—which are available in various sizes</i>                       |     | <i>Three set chassis will be shown with four alternative cabinets for each. Also switches and a new pick-up</i>                |     |
| <b>Britannia Batteries, Ltd.</b> .. .. .  | 126 | <b>British N.S.F. Co., Ltd.</b> .. .. .  | 18  |
| <i>Pertrix high-tension batteries and accumulators for every purpose are exhibited. There are special batteries for portables</i>               |     | <b>British Pix Co., Ltd.</b> .. .. .   | 43  |
| <b>British Blue Spot Co., Ltd.</b> .. .. .  | 35  | <b>British Radiophone, Ltd.</b> .. .. .  | 93  |
| <i>A new 66K loud-speaker unit and battery sets with variable-mu valves will interest visitors. Also inductor and moving-coil loud-speakers</i> |     | <i>Condensers of the standard and super-het type are the outstanding exhibits. Also pick-ups, switches, and potentiometers</i> |     |
| <b>British Ebonite Co., Ltd.</b> .. .. .  | 2   | <b>British Rola Co., Ltd.</b> .. .. .  | 45  |
| <i>Beacol panels and low-loss coil formers will be the principal feature</i>  |     | <i>Make a point of seeing the permanent-magnet moving-coil loud-speakers. There are D.C. models as well</i>                    |     |

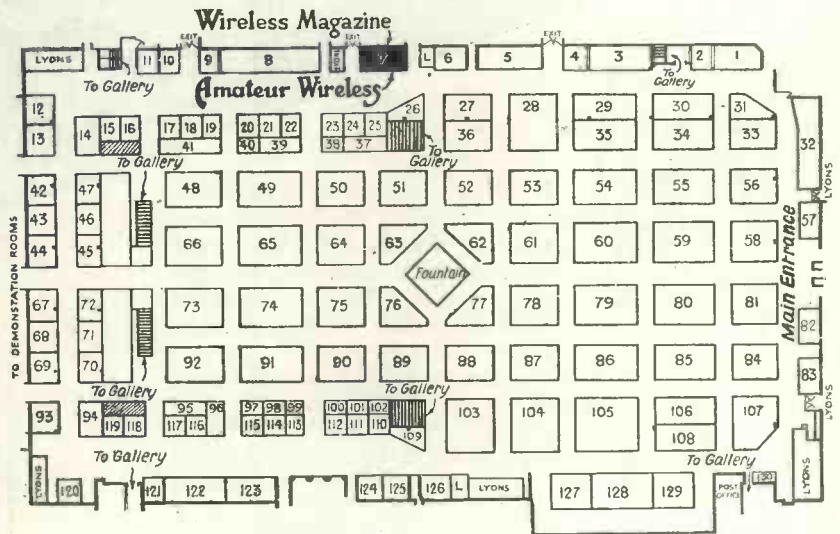

PLAN OF THE GROUND FLOOR OF THE GRAND HALL, OLYMPIA

- |  |  |     |
|--|--|-----|
| <b>British Broadcasting Corporation</b> 155A   | <b>British Thomson-Houston Co., Ltd.</b> .. .. .         | 119 |
| <i>Visitors will see the huge amplifier which supplies the music for every stand; also a large scale model of Broadcasting House showing interior detail</i> |  |     |
| <b>British General Mfg. Co., Ltd.</b> .. .. .  | <b>Brown Brothers, Ltd.</b> .. .. .                      | 240 |
| <i>The main exhibit will be the new band-pass coils. Also a range of transformers and high frequency chokes</i>  |  |     |
| <b>British Goldring Products, Ltd.</b> .. .. .   | <b>Brownie Wireless Co. of Gt. Britain, Ltd.</b> .. .. . | 78  |
| <i>An improved pick-up, a new loud-speaker unit and an ingenious needle cup should be seen by visitors</i>   |  |     |
| <i>Gramophone motors are the speciality. They are of the synchronous and induction types</i>   |  |     |
| <i>Trade only</i>  |  |     |
| <i>Complete receivers—in particular a four-valve screen-grid battery set</i>   |  |     |

(Continued on page 240)

# TELSEN

# H.F. CHOKES



### TELSEN BINOCULAR H.F. CHOKE

In H.F. amplification the performance of a choke is of supreme importance. The Telsen binocular H.F. Choke is called for wherever the highest efficiency is required. It has a high inductance of 250,000 micro-henries, low self-capacity, and a negligible external field, due to the binocular formation, making it the ideal choke for a high class circuit.

No. W.74

# 5/-

### TELSEN STANDARD H.F. CHOKE

The Telsen Standard H.F. Choke utilises the minimum baseboard space. It is designed to cover the whole broadcast band, has very low self-capacity, and is highly suitable for reaction circuits. The inductance is 150,000 micro-henries and the resistance 400 ohms. It has proved very popular and has been incorporated by set designers in many of the leading circuits.

No. W.75.

# 2/-

# TELSEN

## RADIO COMPONENTS

## GOOD RADIO IS A JOY FOREVER

ANNOUNCEMENT OF THE TELSEN ELECTRIC CO., LTD., ASTON, BIRMINGHAM

Better service results from mentioning "Wireless Magazine" when writing to advertisers

# YOU WANT "SOUND" QUALITY

The new principles—the unique features of the MoToR S.40 Unit give you the real "sound" quality of each instrument with a degree of sensitivity hitherto unachieved. From the



**YORK** A very attractive figured Walnut Cabinet, size 15 by 14 by 7 in., fitted with the new S.40 Unit (as illustrated) **52/6**

**WINDSOR** Magnificent figured Walnut Cabinet, size 16 by 15½ by 8 in., housing the S.40 Unit. Special method of suspension, with linen-finished cone and separate baffle. **69/6**

smooth high-pitched tones of the violin to the lightest tap of the drum, every note is there—clear, rich and pure. The secret lies in the patent compensating armature which marks a forward step in loudspeaker design, more revolutionary even than the moving coil.

**S.40  
27/6**

or complete chassis assembly with S.40 Unit and Cone, C.400 .. **39/-**

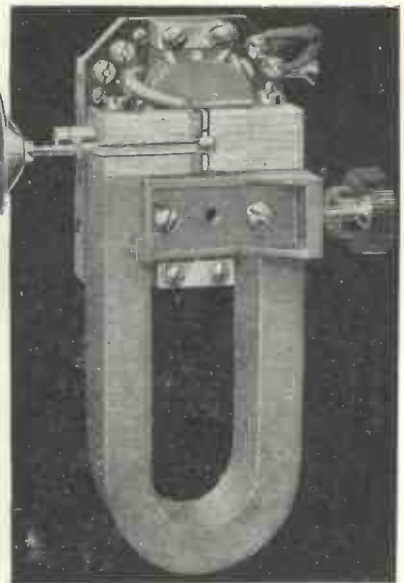

See and hear the new British made

## MOTOR UNIT

At our demonstration showrooms: **67 HAMMERSMITH RD.**

**Opposite Empire Hall, Olympia  
TEKADE RADIO AND ELECTRIC LTD  
147, Farringdon Rd., London, E.C. 1. Tel.: Clerkenwell 2486**

Fully Descriptive Pamphlet post free from

*a "Sound" choice by designer*

*of "Prosperity Three"*

In exclusively specifying "Sound Sales" Transformer, type H.8., for the "Prosperity Three," the designer has borne in mind the following points:—

**25/-**

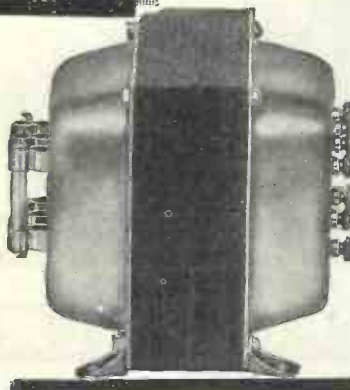

The great saving in current consumption afforded by this transformer which saves its cost in current economy.

The fact that it is the only transformer incorporating a fuse and combined tapping selector, thus complying with the I.E.E. regulations and those of various supply companies.

The special static shielding which definitely cuts out modulation hum. The dead-accurate layer windings, Silicon steel core—in fact, all that is latest and best in transformer design.

"Sound Sales" Transformers are consistently used and specified by the leading designers and technical periodicals. Hence our slogan—

**"SPECIFIED BY THE EXPERTS."**

Technical Specification:—H. 8 Shielded Super. Westinghouse Type. Primary 0-200, 220-240. H.T. Sec. 200-215. L.T. 2-0-2 volts at 4 amperes. D.C. Output 250 volts at 80 milliamperes. Using voltage doubler circuit with H.T.B. Rectifier. Valve Rectifier Transformers of similar design follow.

Why not write now for  
DESCRIPTIVE  
ILLUSTRATED  
PRICE LIST 'W'?

**SOUND SALES**



**"SPECIFIED BY THE EXPERTS"**

**SOUND SALES LTD., TREMLETT GROVE, HIGHGATE, N. 19.**

Telephone: Archway 1661-2.

Better service results from mentioning "Wireless Magazine" when writing to advertisers

# FACTS YOU SHOULD KNOW ABOUT THE MAZDA D.C. MAINS RANGE...



The Mazda D.C. mains valves are the only completely satisfactory solution to D.C. mains receiver operation. They overcome all the disadvantages of high running cost and low efficiency previously associated with D.C. receivers.

The new Mazda indirectly heated 0.1 amp. valves enable D.C. users to enjoy, at last, the range and quality given by A.C. receivers. No other D.C. mains valves are so economical.

The Range comprises:—

**THE DC 2/SGVM** a variable- $\mu$  screened grid valve giving results fully equal to its A.C. counterpart.

**THE DC 2/SG** is for those who wish to use an ordinary screened grid valve.

**THE DC 3/HL** for the detector stage.

**THE DC 2/P or DC 2/Pe**n for the output stage.

Full details of these and other useful Mazda types will be found in the Mazda catalogue, sent FREE on request.

Mazda valves are fitted by all the leading receiver manufacturers. All good radio dealers stock them.

LOOK FOR "EDDY" IN YOUR DEALER'S WINDOW



The amazing

# MAZDA THE BRITISH VALVES

STAND Nos. 75 & 230 RADIOLYMPIA

(Aug. 19-27)

## EDISWAN RADIO

## 100% BRITISH—Designed by British Engineers

The Edison Swan Electric Co. Ltd.



155 Charing Cross Rd. London. W.C.2

*Mazda Radio Valves are manufactured for The British*

*Thomson-Houston Co. Ltd., London and Rugby.*

v.165

There is news in the "Wireless Magazine" advertisements

# EXHIBITS AT OLYMPIA—Continued from page 236

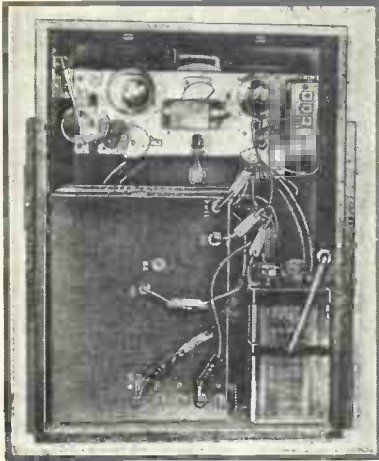

**COMPACT ASSEMBLY**

An interior view of the new Marconi-  
phone model 248, a two-valver supplied  
complete with batteries and loud-  
speaker

- Bulgin, A. F., & Co., Ltd.** ... 151  
*The home of gadgets. There are also switches, resistances, high-frequency chokes, low-frequency chokes and the Universal Transcoupler*
- Burgoyne Wireless (1930), Ltd.** 98  
*Consolettes and portable sets are here. See the Silver Seven A.C. super-het*
- Burndept, Ltd.** ... 46  
*Three receivers will constitute the*

- greater part of the Burndept programme. Also components, notably dials*
- Burton, C. F. & H.** ... .. 1
- Bush Radio, Ltd.** ... .. 72
- Cadisch, R., & Sons** ... .. 218  
*Trade only*
- Carrington Mfg. Co., Ltd.** ... 123  
*A comprehensive range of cabinets for every radio purpose in oak, walnut, and mahogany*
- Celestion, Ltd.** ... .. 127  
*Loud-speakers of every type at prices within everybody's reach. There is a new range of moving-coil reproducers*
- Cellgrave Co.** ... .. 290
- Chloride Electrical Storage Co., Ltd.** ... 61  
*The stand devoted to Exide accumulators and Drydex batteries. Also a range of electric torches*
- Churchman's, Ltd.** ... .. 288
- Cifel Products, Ltd.** ... 285  
*At this stand you will see two- and three-valve receivers, radio gramophones, fixed condensers and coils*
- City Accumulator Co., Ltd.** ... 249  
*A new radio gramophone for constructors is the main exhibit. Also a new mains transformer and low-frequency choke*
- Clarion Radio Valve Co.** ... 120  
*A range of valves for battery and mains use. Also rectifiers and American-type valves*

- Clarke, H., & Co. (M/c), Ltd.** 91  
*An outstanding exhibit here is the new range of Atlas receivers. Also mains units and components*
- Climax Radio Electric, Ltd.** ... 81  
*Two new A.C. sets, a radio gramophone, and a three-valver with band-pass tuning should be examined*
- Cole, E. K., Ltd.** ... .. 25 & 65  
*Consoles and radio gramophones with many exclusive features are to be seen. Also Ekco mains units*
- Columbia Graphophone Co., Ltd.** 86  
*Fifteen different receivers and radio-grams costing from £5 to £100. A stand to visit*
- Colvern, Ltd.** ... .. 245  
*The feature here will, of course, be coils. There will also be potentiometers, resistances, and switches*
- Concordia Electric Wire Co., Ltd.** ... 208  
*Wire for all radio purposes, especially shielded cable sleeveings and connecting wire*
- Consolidated Radio Co., Ltd.** ... 34  
*Rolls Caydon and Rees Mace sets of every type housed in very modern cabinet are well worth seeing*
- Cossor, A. C., Ltd.** ... .. 60  
*Several models of the popular Melody Maker and a full range of valves will be available for examination*

(Continued on page 242)

## ★ PRICE REDUCTIONS ★ LYONS' "B.A.T." SWITCHES STRONG-SILENT POSITIVE IN ACTION

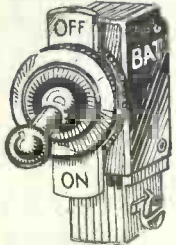

*These perfectly reliable and fully guaranteed switches are regularly specified by the "Experts." Made in numerous types for every radio purpose.*

**REDUCED IN PRICE AS UNDER**

No. 728 - S.P. On-off	was 2/-	Now 1/6
No. 728 - L.T. (1 in. Lengthroat) On-Off	" 2/3	" 1/9
No. 730 - S.P. with Terminals	" 2/3	" 1/8
No. 729 - S.P. Change Over	" 2/6	" 2/3
No. 161 - Semi-Rotary. On-Off	" 2/9	" 2/6
No. 2728 - Double Pole	" 3/9	" 3/3
No. 105 - New Type. 3 point On-Off	" —	" 2/-

### DOES YOUR SET SUFFER FROM "HUM" ?

Our "HUM-DINGER" (Regd. Trade Marks) is a small, neat, highly efficient component for suppressing "Mains Hum" in Receivers, Radio-Grams or Amplifiers (A.C. operated).

PRICE was 3/- NOW 2/6

Complete instructions with circuits with each one.

? Have you had your copy of our new publication "OHM'S LAW WITHOUT TEARS." Limited Edition. Send now. Post Free.

**CLAUDE LYONS LTD** 76 OLDHALL ST., LIVERPOOL  
40 BUCKINGHAM GATE, S.W.1

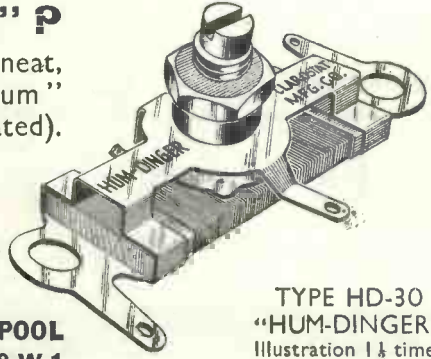

TYPE HD-30  
"HUM-DINGER"  
Illustration 1 1/2 times the actual size.



# FIRST IN THE PREFERENCE OF PRACTICAL MEN

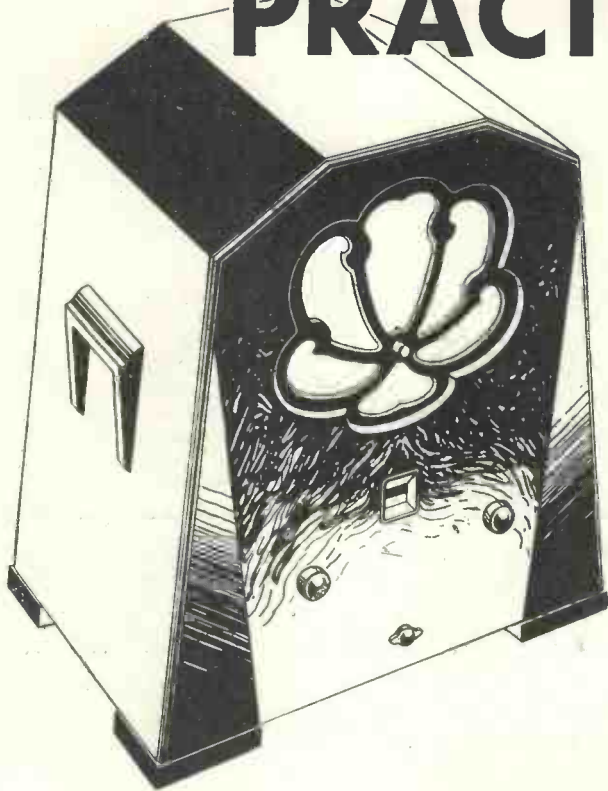

The new FERRANTI 7-Valve Super-Heterodyne was designed to satisfy the most critical of all audiences—the practical men who are able to test technical efficiency by their own exacting standards. Selectivity, reproduction, simplicity of operation—each feature has been tried and compared with an impartial mind—each has revealed definite points of superiority. Everywhere, the FERRANTI Super-Heterodyne is becoming recognised as the finest wireless receiver yet created. Among its notable developments is the new Tone Control, which enable the listener to obtain sharp, clear speech, and rich, mellow music — exactly adjusted to personal taste.

*Suitable only for 200/250 volts. A.C. Supplies having frequencies between 40 and 60 cycles.*

The design incorporates the most modern features, including INITIAL H.F. AMPLIFICATION, preventing interference with other sets; variable MU VALVES, providing the best form of volume control; GANGED CONDENSERS, giving one knob tuning; BAND-PASS COUPLING, ensuring high selectivity without loss of high notes; MOVING COIL SPEAKER, for high quality reproduction; TONE CONTROL, to provide sharp or mellow tone at will; ILLUMINATED WAVELENGTH SCALE, giving instant station identification; AUTOMATIC MAINS AERIAL DEVICE, enabling the Receiver to be easily moved from room to room wherever an A.C. light or power socket is available; and GRAMOPHONE PICK-UP.

SEE AND HEAR IT AT STAND **78**

RADIO EXHIBITION, OLYMPIA. AUG. 19th-27th

# FERRANTI

7-VALVE SUPER-HETERODYNE CONSOLE SET

RETAIL PRICE  
**22 GNS**

Or by Deferred Payments -42/- down and 12 monthly payments of 38/6.

FOR ILLUSTRATED LITERATURE, WRITE TO  
FERRANTI LTD., HOLLINWOOD, LANCS., or BUSH HOUSE, LONDON, W.C.2

*Advertisers like to know you "saw it in the 'Wireless Magazine'"*

# EXHIBITS AT OLYMPIA—Continued from page 240

- Dallas, J., & Sons, Ltd. .. 202  
*Trade only*
- Danipad Rubber Co., Ltd. .. 113
- Darwins, Ltd. .. 70  
*Cobalt-steel permanent magnets of all patterns for use in loud-speakers on show*
- Dayzite, Ltd. .. 209  
*Trade only*
- De La Rue, T., & Co., Ltd. .. 227  
*Trade only*
- Dew, A. J., & Co., Ltd. .. 217  
*Trade only*

- Electro-Dynamic Construction Co.; Ltd. .. 157  
*A rotary transformer, working from a 2-volt accumulator and giving an output of 150 volts, 15 milliamperes, suitable for battery sets should be inspected*
- Electrical & Radio Products, Ltd. .. 33  
*A complete range of radio gramophones, super-het receivers, and portables should be seen*
- Ensign, Ltd. .. 212  
*Trade only*

- Fay Home Recorders, Ltd. .. 255  
*Recording outfits for making records in the home are a novelty which should not be missed*
- Ferranti, Ltd. .. 78  
*An outstanding exhibit here is the new seven-valve super-het. Also other receivers, kit sets, electric clocks, and components*
- Five Point Products .. 252
- Flinders (Wholesale), Ltd. .. 241  
*Trade only*
- Formo (Arthur Preen & Co., Ltd.) .. 100  
*Formo have a range of new coils which should be seen. Also condensers, transformers, and miscellaneous components*
- Fraser Radio, Ltd. .. 253
- Fuller Accumulator Co. (1926), Ltd. .. 76  
*High and low-tension accumulators, high-tension and grid-bias batteries will be the features of an interesting stand*
- Fulltone, Ltd. .. 203  
*An all-electric radio gramophone with special features is the outstanding exhibit*
- Gambrell Radio, Ltd. .. 21  
*Super-het radio gramophones for A.C. and D.C. mains, and short-wave converters are the main items*
- Garrard Engineering Co., Ltd. 122  
*An interesting stand showing gramophone motors of every type and price*
- General Electric Co., Ltd. 105 & 109  
*The outstanding exhibit is the new Osram Thirty Three Music Magnet. Also a display of other receivers, Osram valves, loud-speakers, and batteries*
- Gilbert & Co., Ltd. .. 232  
*Trade only*
- Gothic Electrical Supplies, Ltd. 201
- Graham Farish, Ltd. .. 50  
*Wire-wound potentiometers, fixed resistances, and lightning arrestors form an interesting display*

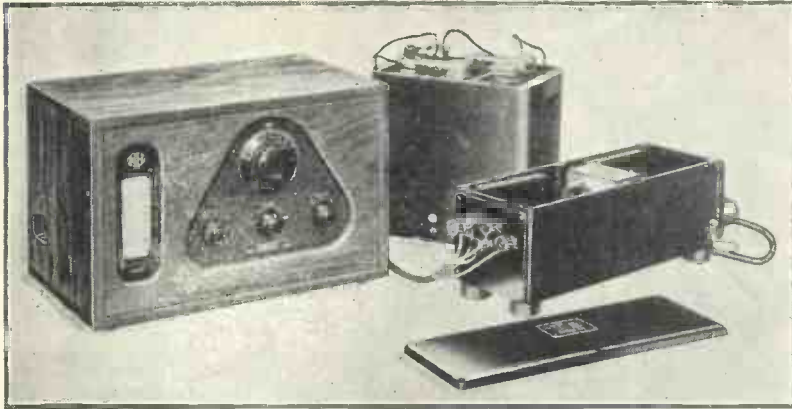

**CONSTANT HIGH TENSION FOR YOUR RECEIVER**

An M-L converter in use with a McMichael Colonial Supersonic receiver; this converter gives constant high tension from a low-tension battery or electric mains

- Dibben, Wm., & Sons, Ltd. .. 77  
*Receivers and loud-speakers in attractive modern cabinets will be exhibited*
- Dubilier Condenser Co. (1925), Ltd. .. 84  
*Outstanding features here are electrolytic condensers, also high-frequency chokes, resistances, and a complete range of condensers*
- Dulcetto Polyphon, Ltd. .. 235
- Dyson & Co. (Works), Ltd. .. 57  
*Mains transformers of every size and for every purpose should be inspected*
- Eagle Engineering Co., Ltd. .. 38  
*Two- and three-valve sets for A.C. and D.C. mains or batteries should be seen. Also a new range of loud-speakers*
- Eastick, J. J., & Sons .. 239  
*A full range of Ealex products including short-wave converters, frame aeriels, and plugs and sockets*
- East London Rubber Co. .. 211  
*Trade only*
- "Enconasign" Co., Ltd. .. 269  
*Trade only*
- Edison Bell, Ltd. .. 27  
*Edison Bell announce a surprise in their two- and three-valve sets. Also a new all-mains super-het*
- Edison Swan Electric Co., Ltd. 75 & 230  
*An interesting exhibit. Mazda valves and B.T.H. pick-ups will be the outstanding items*
- Electrical Devices Co. .. 47  
*Eldeco are showing their new six-valve super-het portables. Also more super-hets and short-wave adaptors*

- Epoch Radio Mfg. Co., Ltd. .. 41  
*Moving-coil loud-speakers of every type. Make a point of seeing the new Epoch receiver*
- Erie Resistor Co., Ltd. .. 4  
*Trade only*
- Ever Ready Co. (G.B.), Ltd. .. 63  
*A full range of Ever Ready high-tension batteries and accumulators is the feature of this stand*
- Faudels, Ltd. .. 234  
*Trade only*

- Formo (Arthur Preen & Co., Ltd.) .. 100  
*Formo have a range of new coils which should be seen. Also condensers, transformers, and miscellaneous components*
  - Fraser Radio, Ltd. .. 253
  - Fuller Accumulator Co. (1926), Ltd. .. 76  
*High and low-tension accumulators, high-tension and grid-bias batteries will be the features of an interesting stand*
  - Fulltone, Ltd. .. 203  
*An all-electric radio gramophone with special features is the outstanding exhibit*
  - Gambrell Radio, Ltd. .. 21  
*Super-het radio gramophones for A.C. and D.C. mains, and short-wave converters are the main items*
  - Garrard Engineering Co., Ltd. 122  
*An interesting stand showing gramophone motors of every type and price*
  - General Electric Co., Ltd. 105 & 109  
*The outstanding exhibit is the new Osram Thirty Three Music Magnet. Also a display of other receivers, Osram valves, loud-speakers, and batteries*
  - Gilbert & Co., Ltd. .. 232  
*Trade only*
  - Gothic Electrical Supplies, Ltd. 201
  - Graham Farish, Ltd. .. 50  
*Wire-wound potentiometers, fixed resistances, and lightning arrestors form an interesting display*
- (Continued on page 244)

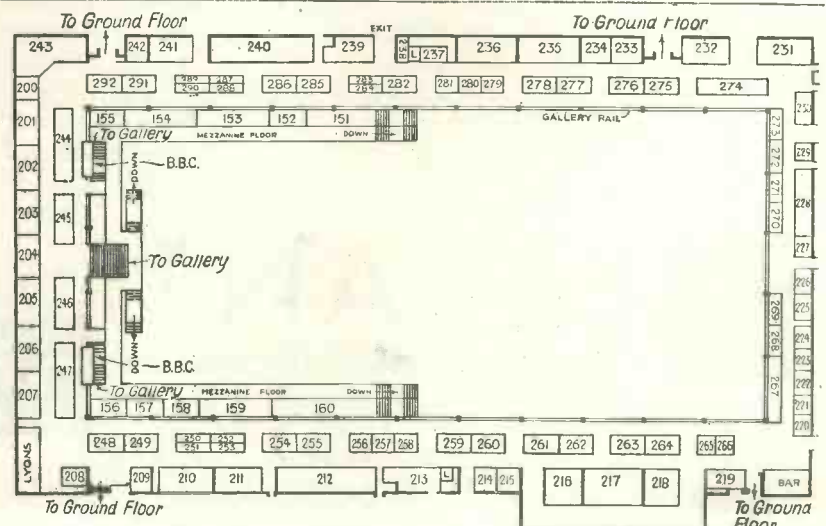

PLAN OF THE GALLERY OF THE GRAND HALL, OLYMPIA

# TELSEN

## DUAL-RANGE AERIAL COILS

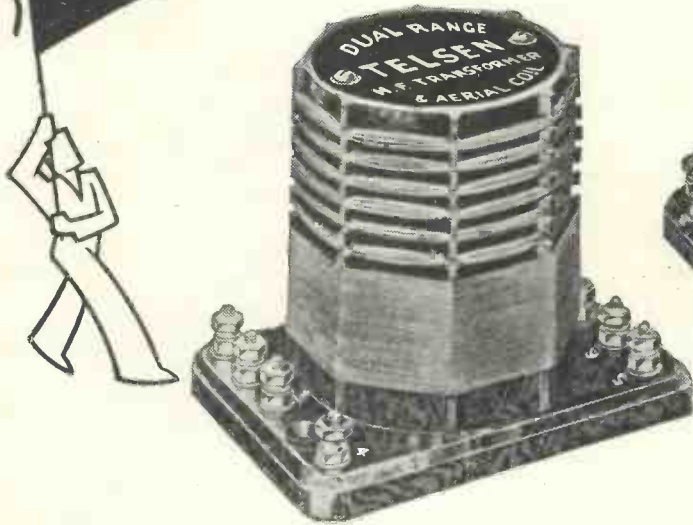

### THE TELSEN H.F. COIL

May be used for H.F. amplification with Screened Grid Valve, either as an H.F. Transformer or, alternatively, as a tuned grid or tuned anode coil. It also makes a highly efficient Aerial Coil where the adjustable selectivity feature is not required.

No. W.154  
**5/6**

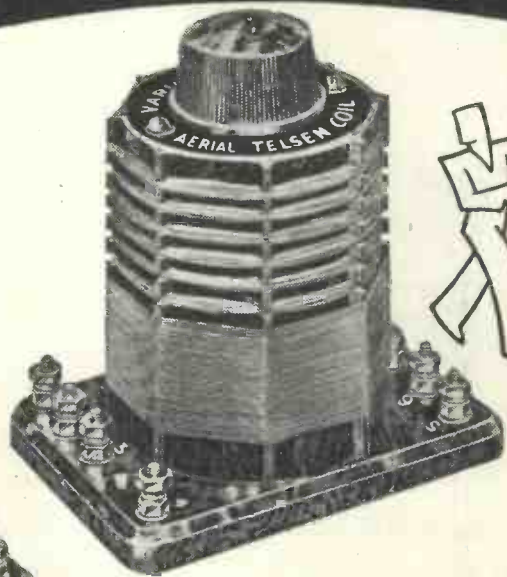

### TELSEN DUAL-RANGE AERIAL COIL

Incorporates a variable selectivity device, making the coil suitable for widely varying reception conditions. This adjustment also acts as an excellent volume control, and is equally effective on long and short waves. The wave-band change is effected by means of a three-point switch and a reaction winding is included.

No. W.76

**7/6**

### TELSEN COMBINED DUAL-RANGE SHORT-WAVE COIL UNIT

This unit for the first time brings the construction of short-wave receivers into line with the simplicity of modern practice. When tuned by a Telsen .00025 Condenser, a wave range of 20 to 80 metres can be covered by the operation of a switch, as in ordinary broadcast practice. The unit incorporates windings for aerial, tuning and reaction circuits, all coils being wound with stranded wire. The coil is also suitable for use with sets covering all wave bands with a .0005 Tuning Condenser. In this case the dual-range feature is not employed.

No. W.174

**4/6**



# TELSEN

RADIO COMPONENTS

**GOOD RADIO IS A JOY FOREVER**

ANNOUNCEMENT OF THE TELSEN ELECTRIC CO., LTD., ASTON, BIRMINGHAM

Advertisers take more interest when you mention "Wireless Magazine"

# EXHIBITS AT OLYMPIA—Continued from page 242

**Gramophone Co., Ltd.** 55  
The outstanding exhibit is a super-hot battery portable. Also de-luxe radio gramophones costing from fifty to ninety-five guineas

**Gripso Co.** 226  
Wander plugs and sockets, indicating switches and tags. Everything for the "finishing-off job" is on show



**A STURDY JOB**

A typical example of the mains transformers made by Tunewell Radio, Ltd.; an extensive range is available

**Grosvenor Electric Batteries, Ltd.** 42  
High-tension batteries of every size and shape, suitable for receivers and all portables are exhibited

**Gutta Percha Co. (Telegraph Construction and Maintenance Co., Ltd.)** 257  
Trade only

**Hacker, H., & Sons** 37  
High-class radio gramophones can be seen. They are for A.C. or D.C. mains

**Halford Radio, Ltd.** 117  
The outstanding exhibit is a super-hot chassis for A.C. or D.C. mains, incorporating a moving-coil loud-speaker

**Hambling, A. W., Ltd.** 224

**Hampton Radio, Ltd.** 12  
You should inspect the Hampton radio gramophone. Also a range of other all-mains sets

**Harlie Brothers (Edmonton) Ltd.** 31  
Every type of component for radio-gramophone experimenters is to be seen. There are two new pick-ups

**Haynes Radio** 17  
Two receivers of unusual interest to the technically-minded constructor form the principal exhibit

**Hayberd, F. C., & Co., Ltd.** 13  
Mains units and apparatus at reasonable prices should attract attention

**Hellesens, Ltd.** 221  
British made Hellesen batteries and fixed condensers are the outstanding features on this stand

**Henderson Wireless & Electrical Service** 215  
Trade only

**Henley's, W. T., Telegraph Works Co., Ltd.** 16  
The Solon electric soldering bit will cause interest

**Hillman Brothers** 210  
Trade only

**Hobday Brothers, Ltd.** 243  
Trade only

**Hunton, Ltd.** 271  
Trade only

**Hustler, Simpson & Webb, Ltd.** 30  
Three new receivers are on show here. The Mains Two for A.C. or D.C. mains should be seen

**Igranic Electric Co., Ltd.** 36  
Reliable components of every description, pick-ups and loud-speakers should attract the visitor to this stand

**Itonia, Ltd.** 216

**Jackson Bell Distributors, Ltd.** 11  
All-electric sets and radio gramophones with energised moving-coil loud-speakers comprise the exhibit

**Jackson Brothers** 204  
Several new types of J.B. condensers should draw you to this stand. See the new short-wave models

**Jewel Pen Co., Ltd.** 97  
Red Diamond ebonite panels are exhibited. Also switches, test prods, and crystal detectors

**Johnson Talking Machine Co., Ltd.** 228  
Trade only

**Junit Mfg. Co., Ltd.** 39  
Junit are making a feature of their synchronous electric clock. Valve holders and mains units are also to be seen

**Kalisky, S., (Aldgate), Ltd.** 236

**Kenwell Radio, Ltd.** 121  
A power pack giving high- and low-tension and grid-bias together with a moving-coil reproducer in a walnut cabinet is the main feature

**Keith Prowse & Co., Ltd.** 292  
This stand will be devoted to a display of the products of leading manufacturers

**Kolster Brandes, Ltd.** 54  
Fifteen different receivers, pick-up and tracking arm, and a complete range of batteries will comprise a show which will interest everyone

**Lamplugh, S. A., Ltd.** 99  
Loud-speakers will be the main feature. An outstanding model is the Silver Ghost

**Lancashire Dynamo & Crypto, Ltd.** 111  
You should be interested in the display of battery-charging apparatus

**Lawson & Raphael** 270

**Lectro Linx, Ltd.** 225  
The Clix panel terminal and chassis-mounting valve holder are two lines of interest. Also a complete range of terminals and wander plugs

**L. E. S. Distributors, Ltd.** 233  
Trade only

**Lissen, Ltd.** 59  
Here you will see a comprehensive range of components, receivers and batteries. Look out for the Skyscraper kit set

**Lock, W. & T., Ltd.** 101  
Some handsome radio cabinets will be found on this stand. The Lansdown, Salisbury, and Somerset are new models

**Loewe Radio Co., Ltd.** 223  
An outstanding exhibit is the Varitone loud-speaker. Also receivers, pick-ups, and general radio components

**London Electric Wire Co. & Smiths, Ltd.** 153  
Coils, chokes, resistances and transformers are the main exhibits. A new potentiometer will be shown.

**Lotus Radio, Ltd.** 64  
A three-valve band-pass de-luxe battery receiver should be noted for inspection. Also a wide range of accessories

**M.P.A. Wireless (1930), Ltd.** 95  
An A.C. receiver which tunes, controls volume, and switching all on one knob is an outstanding feature

**Magnavox (G.B.), Ltd.** 24  
You should make a note of seeing and hearing the dual-compensated loud-speakers which are claimed to give splendid results

**Mains Radio Gramophone, Ltd.** 102  
A feature here is the illuminated and calibrated station dial which is fitted to their all-electric radiograms

**Manufacturers Accessories Co. (1928), Ltd.** 237  
Trade only

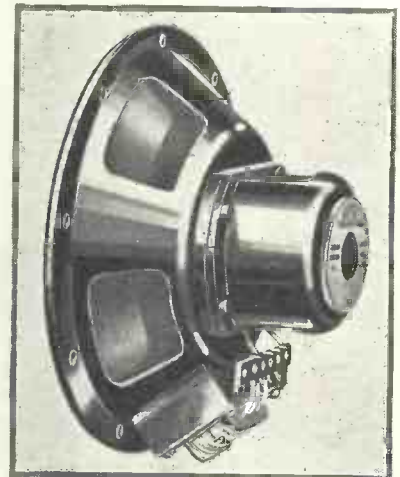

**MOVING-COIL REPRODUCER**

The Celestion model DC8 moving-coil loud-speaker; this instrument is of the energised type

**Marconiphone, Ltd.** 74  
A comprehensive show of receivers and radio gramophones of all kinds, loud-speakers, batteries, and valves; this is a stand which should not be missed

**McMichael, L., Ltd.** 58  
Here you will find the outstanding range of Duplex receivers. Also radio gramophones and the binocular high-frequency choke

(Continued on page 246)

# POLAR STAR CONDENSERS

## ACCURATE SPACING OF VANES OBTAINED BY PRECISION MACHINE ASSEMBLY

entirely eliminates the possibility of error in spacing—hence this guarantee: Polar "Star" Gang Condensers are guaranteed accurately matched to within  $\frac{1}{2}$  of 1%, plus or minus 1 mmfd. And their construction ensures that this accuracy will never vary.



Other outstanding features.

1. Trimmers always at constant value.
2. Strong spring journal bearings.
3. All-steel frame.

Stand 129 Olympia

Prices:

4 x .0005 - - - 34/-

3 x .0005 - - - 25/6

Special Super-het 27/6

Polar Drum Drive - 7/6

Polar Disc Drive - 5/-

Send for new Polar 36-page, fully illustrated catalogue 'S.2.'

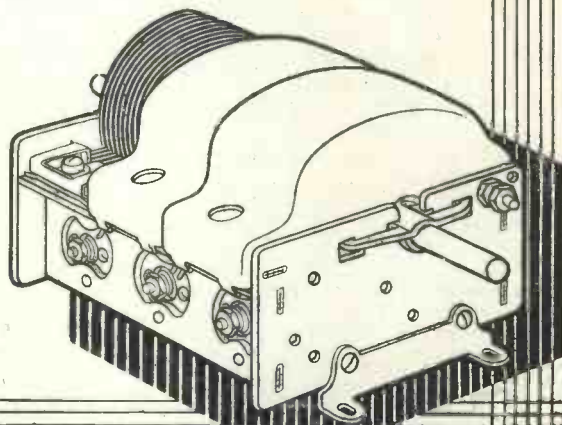

## POLAR

WINGROVE & ROGERS, Ltd.

188-9, STRAND, LONDON, W.C. 2.

Polar Works, Old Swan, Liverpool.

## A.C. MAINS USERS

SHOULD

RADIO EXHIBITION

OLYMPIA,

AUGUST 19th—27th.

VISIT  
STAND 89

AND SEE THE LATEST  
DEVELOPMENTS IN

**WESTINGHOUSE**

## METAL RECTIFIERS

—the only rectifiers to combine  
long life with high efficiency

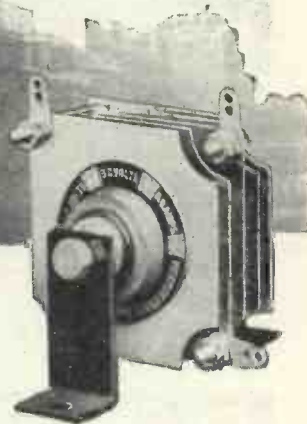

THE WESTINGHOUSE BRAKE & SAXBY SIGNAL CO., LTD., 82, YORK ROAD, KING'S CROSS, LONDON, N.1

When replying to advertisements, please mention "Wireless Magazine"

# EXHIBITS AT OLYMPIA—Continued from page 244

<b>Montague Radio Inventions &amp; Development Co., Ltd.</b> ... 49 <i>A four-valve portable and a three-valve transportable are the two sets in this year's Beethoven range</i>	<b>Osborn, Chas. A.</b> ... 32 <i>Here is a comprehensive selection of loud-speaker, radio and radio gramophone cabinets in many styles, including Queen Anne, Chippendale, and ultra modern</i>	<b>Portadyne Radio, Ltd.</b> ... 56 <i>Four models of the Portadyne programme will be on show. Three of them are for battery operation</i>
<b>Mullard Radio Valve Co., Ltd.</b> ... 79 & 248 <i>Stand 79 will be devoted to Mullard valves and Stand 248 to the "Radio for the Million" kit sets</i>	<b>Overseas Trading Corporation</b> 291 <i>The principal exhibit of this stand will be a range of Young accumulators</i>	<b>Powertone Products</b> ... 229 <i>The main feature will be the Powertone portable Special Superselective Five De-luxe. Also two other models</i>
<b>Murphy Radio, Ltd.</b> ... 28 <i>An outstanding Murphy model this season will be the eight-valve super-hot with automatic volume control. Also other receivers</i>	<b>Paroussi, E.</b> ... 238 <i>Metal screens and boxes, and aluminium foil for all radio constructors should be noted for an inspection</i>	<b>Priestley &amp; Ford</b> ... 213
<b>National Accumulator Co., Ltd.</b> 244 <i>A special feature here is the Dagenite tell-tale type accumulator. Also high-tension accumulators</i>	<b>Partridge &amp; Mee, Ltd.</b> ... 67 <i>A new 25-watt power amplifier will be on view. Also transformers, chokes, and mains apparatus</i>	<b>Primus Mfg. Co., Ltd.</b> ... 15 <i>Here you will see the new electrostatic loud-speakers for use with battery or mains sets. Also high-tension batteries</i>
<b>National Radio Service Co.</b> ... 200 <i>A firm who make a speciality of repairing and rebuilding receivers for the public and the trade</i>	<b>Partridge, Wilson &amp; Co.</b> ... 159 <i>If you are interested in mains components, this stand should be visited. Here will be found a complete range of mains transformers for use with metal and valve rectifiers</i>	<b>Pye Radio, Ltd.</b> ... 80 <i>A selection of Pye sets including three new models will be exhibited. This is a stand you should not miss</i>
<b>New London Electron Works, Ltd.</b> ... 48 <i>The outstanding exhibit on this stand is Electron copper wire for aerials</i>	<b>Peto Scott &amp; Co., Ltd.</b> ... 247 <i>This firm will supply kits of parts for the "Prosperity" sets. They are exhibiting a range of components</i>	<b>Philomel Radio Equipment</b> ... 279
<b>Oldham &amp; Son, Ltd.</b> ... 85 <i>The stand devoted to the Lively O range of accumulators and high-tension portables. There are batteries for portables</i>	<b>Pegasus, Ltd.</b> ... 94 <i>A new A.C. receiver employing all the latest refinements should be noted. Also two- and three-valve sets</i>	<b>R.C. Radio Electric, Ltd.</b> ... 222 <i>Three lines you should see: an instant pole finder, electric soldering bit, and a portable aerial</i>
<b>Ormond Engineering Co., Ltd.</b> 87 <i>Loud-speakers, condensers, and other radio accessories will be shown on this stand. You should pay a visit</i>	<b>Philips Lamps, Ltd.</b> ... 104 <i>In addition to a large range of receivers, Philips will be exhibiting their lightning arrestor and loud-speakers</i>	<b>Radio Gramophone Development Co., Ltd.</b> ... 92 <i>The R.G.D. Supersonic radio gramophone is one model at the show not to be passed over</i>
		<b>Radio Instruments, Ltd.</b> ... 90 <i>This well-known firm of component manufacturers will be showing transformers, chokes, coils, and mains apparatus. Also receivers and a new short-wave unit</i>
		<b>Radio Society of Great Britain</b> 242 <i>(Continued on page 248)</i>

## BETTER THAN MAINS and Cheaper than dry batteries

Available to all in town or country, C. A. V. Rechargeable High-Tension Accumulators provide the most perfect form of H.T. obtainable. They are quite silent in operation and produce none of the annoying crackling and humming noises so common with dry batteries and mains.

With recharging costing about 3/- per 120 volts three times a year, they actually cost less than dry batteries and if you have D.C. mains you can charge them yourself at a fraction of this cost. Our maintenance Booklet shows you how to do it.

To greatly improve reception and reduce running costs, therefore, change over to C. A. V. Rechargeable H.T. Accumulators at the first opportunity.

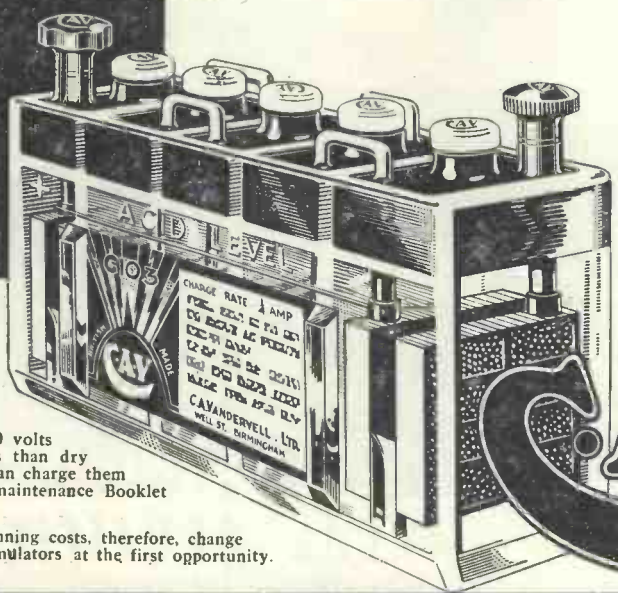

Send for free maintenance Booklet containing charging circuit diagrams and useful information on the charging and care of C. A. V. Radio Accumulators. Send a post-card to  
Department I.A.  
C. A. VANDERVELL LTD.,  
WELL STREET, BIRMINGHAM.

**OLYMPIA**  
Stand No. 246.



## RECHARGEABLE H.T. ACCUMULATORS

# TELSEN

# MANSBRIDGE AND MICA CONDENSERS

## TELSEN MANSBRIDGE TYPE CONDENSERS

These are made by the most advanced processes from the finest materials it is possible to obtain, and subjected during manufacture to a series of stringent tests under laboratory conditions. They are of the true Mansbridge type, self-sealing, non-inductive, and hermetically sealed. They are offered in two types, the capacities from .01 to 2 microfarad in Bakelite cases, and in blocks of 4, 6 and 8 microfarad in metal cases with soldering tags.

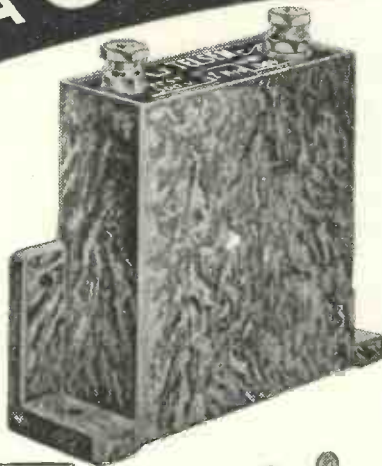

Cap. Mfd.	500 Volt Test No.	Price.	1,000 Volt Test No.	Price.
.01	W. 232	1/6	W. 239	2/6
.04	W. 230	1/9	W. 237	2/9
.1	W. 231	1/9	W. 238	2/9
.25	W. 229	2/-	W. 236	3/-
.5	W. 228	2/3	W. 235	3/3
1	W. 227	2/3	W. 234	3/6
2	W. 226	3/-	W. 233	5/-

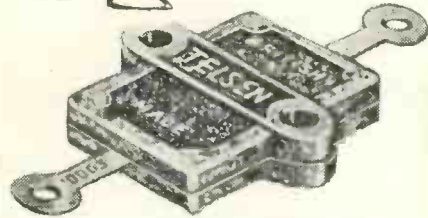

## TELSEN TAG CONDENSERS

This type is of extremely compact and sturdy construction. It may be mounted on either insulated or metal panels by utilising the two baseboard screw holes in the neatly designed moulded casing. The tags enable the condenser to be connected to any other component either directly or by soldering. H.F. losses are negligible. The capacity is stamped on the soldering tag.

Capacity.	No.
.0001	W. 207
.0002	W. 208
.0003	W. 209
.0004	W. 210
.0005	W. 211
.001	W. 212
.002	W. 213

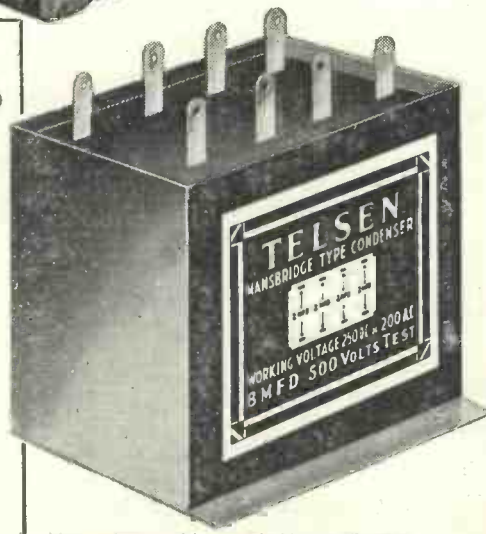

## TELSEN MANSBRIDGE BLOCK CONDENSERS

These are contained in metal cases finished in brown and with fixing holes. As with the other types of Telsen Mansbridge Condensers they are self-sealing, non-inductive and hermetically sealed. Three types, each made having total capacities of 4, 6 and 8 microfarads, each type being divided into 2 microfarad sections, so that several arrangements of capacity may be obtained. Neat and substantial soldering tags are provided for each section.

Cap. Mfd.	500 Volt Test Cat. No.	Price.	1,000 Volt Test Cat. No.	Price.
4	W. 175	5/6	W. 178	9/6
6	W. 176	8/-	W. 179	14/6
8	W. 177	10/6		

## TELSEN "MICA" CONDENSERS

The new Telsen "Mica" Condensers represent an important advance in technique. H.F. losses have been practically eliminated even in the larger capacities. In order to distinguish them from the earlier type, now to be discontinued, the new condensers are enclosed in a re-designed case which, while possessing all the adaptability of the previous one as to flat and vertical mounting, is of more attractive appearance. Grid leak clips may, as heretofore, be mounted in series or in shunt, and are supplied at no extra charge with capacities .0001, .0002, and .0003 microfarad.



Cap. Mfd.	No.
.0001	W. 240
.0002	W. 241
.0003	W. 242
.0004	W. 243
.0005	W. 244
.001	W. 245
.002	W. 246
.006	W. 247 ... 1/3



## TELSEN PRE-SET CONDENSERS

Very low minimum capacity, giving a wide range of selectivity adjustment when used in aerial circuit. Substantially made, easily adjusted and provided with locking ring. High insulation and low loss.

Max. Cap. Mfd.	Min. Cap. Mfd.	No.
.002	.00025	W. 149
.001	.000052	W. 150
.0003	.000016	W. 151
.0001	.000005	W. 152



# TELSEN

RADIO COMPONENTS

## GOOD RADIO IS A JOY FOREVER

ANNOUNCEMENT OF THE TELSEN ELECTRIC CO., LTD., ASTON, BIRMINGHAM.

There is news in the "Wireless Magazine" advertisements

# EXHIBITS AT OLYMPIA—Continued from page 246

- Ratcliff (Metals) Ltd., J. F.** ... 258  
Trade only
- Ready Radio, Ltd.** ... 106  
These popular kit people will be exhibiting a range of components. Also two battery-operated kit sets
- Redfern's Rubber Works Ltd.** 124  
Ebonite panels, polished on both sides, will be a new product introduced. Also a range of twenty different coil formers
- Regentone, Ltd.** ... 51  
An all-electric three-valve consolette will be an outstanding item on the Regentone stand

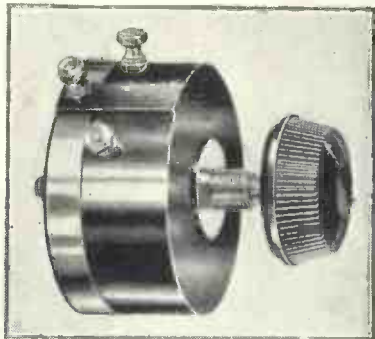

**WIRE-WOUND POTENTIOMETER**  
Varley's now make a range of wire-wound potentiometers, of which this is an example

- Reproducers & Amplifiers Ltd.** 69  
Loud-speakers of all kinds can be seen. Also cabinets to house loud-speaker chassis at £1 5s. and £2 5s.
- Roberts, John** ... 272
- Rotor Electric, Ltd.** ... 283
- Selecta Gramophones, Ltd.** ... 219  
Trade only
- Selfridge & Co., Ltd.** ... 274  
The leading sets and components will comprise the main exhibit. This is a stand of interest to prospective set buyers
- Siemen's Electric Lamps & Supplies, Ltd.** ... 88  
A new Full O'Power 45-volt super high-tension battery will be introduced. Also a complete range of dry cells
- Six-Sixty Radio Co., Ltd.** ... 52  
Six-Sixty will feature a new band-pass receiver in a handsome walnut cabinet with permanent-magnet moving-coil loud-speaker as well as valves
- Smith & Sons, S., (Motor Accessories), Ltd.** ... 130  
A complete range of standard accumulators in celluloid and glass containers. Also a new jelly-acid type and high-tension accumulators
- Smurthwaite, F. W.** ... 22
- Sovereign Products, Ltd.** ... 152  
Four new battery receivers will be introduced. Also a new range of components
- Spencer Radio, Ltd.** ... 14
- Standard Battery Co.** ... 26  
An assortment of radio products is to be seen. Meters, pick-ups, receivers, and rotary converters are the outstanding exhibits

- Standard Telephones & Cables, Ltd.** ... 107  
An interesting stand. An A.C. and battery two-valver, two moving-coil reproducers, and three types of A.C. valves will be the distinctive features
- Stratton & Co., Ltd.** ... 23  
The stand short-wave fans and overseas visitors should see. Every component for short-wave work and complete sets will be on show
- Sun Electrical Co., Ltd.** ... 231  
Trade only
- Swift Levick & Sons, Ltd.** ... 112  
Readers who are interested in making their own permanent-magnet moving-coil loud-speakers should see the magnets on show
- Stenibac, Ltd.** ... 256  
A comprehensive selection of radio cabinets in all styles, period and modern, are the main exhibits
- Sifam Electrical Instrument Co., Ltd.** ... 289  
A wide range of meters for all radio purposes will comprise the greater part of the display
- Shapland & Petter, Ltd.** ... 287
- Arthur Smith (Radio), Ltd.** ... 251
- Sylvex, Ltd.** ... 260
- Tannoy Products** ... 44  
A range of high-grade radio gramophones will be featured. Also public address equipment and mains units
- Telegraph Condenser Co., Ltd.** 53  
T.C.C. are continuing their wide range of fixed condensers and are introducing aqueous and dry type electrolytic condensers
- Telsen Electric Co., Ltd.** ... 66  
New components, notably screened coils, and a wide range of kit sets will be introduced by Telsen. See the new multi-purpose dial
- Terrytone Radio Products Co., Ltd.** ... 268  
An all-electric table model radio gramophone is the outstanding exhibit. Also four other receivers
- Thompson, Diamond & Butcher** ... 207



**COMPLETING THE KIT SET**  
Putting a completed Cossor kit set into its cabinet—a neat-looking outfit

- Tunewell Radio, Ltd.** ... 96  
Everything for the amateur constructor can be viewed. Components include transformers, coils of all types, mains apparatus and switches
- Ultra Electric, Ltd.** ... 73  
Receivers and radio gramophones of every sort and price are the feature. Also loud-speakers
- Unicfon, Ltd.** ... 250
- Univolt Electric, Ltd.** ... 115
- Vandervell, C. A., Ltd.** ... 246  
Accumulators and dry batteries for all radio purposes are to be inspected. Non-spillable accumulators are a feature of the exhibit
- Varley (Oliver Pell Control, Ltd.)** ... 160  
An outstanding exhibit is the new Rectatone low-frequency transformer for tone control. Also super-hot radio gramophones and components
- Watmel Wireless Co., Ltd.** ... 273  
Wire-wound potentiometers will be the chief components on show. Also resistances, coils, and chokes
- Westinghouse Brake & Saxby Signal Co., Ltd.** ... 89  
A range of metal rectifiers for high-tension and low tension will be seen here. A photo-electric cell should be noted
- Whiteley Electrical Radio Co., Ltd.** ... 108  
Mostly loud-speakers of the permanent-magnet type are here. Also new mains and knife switches
- Wilkins & Wright, Ltd.** ... 118  
A straight-line dial and super-hot ganged condensers are new lines which will be exhibited. Condensers of every other type will also be seen
- Wingrove & Rogers, Ltd.** ... 129  
Polar apparatus will comprise the show here. The new Star series of ganged condensers are an outstanding exhibit
- Wireless League** ... 265  
A society with aims and objects intended to take care of the listener's interests. You should pay them a visit
- WIRELESS MAGAZINE** ... 7  
The stand in the show you must not miss! Here you can see the new "Prosperity" sets and obtain advice on technical matters
- Wireless Retailers Association of Great Britain** ... 266
- Wright & Weaire, Ltd.** ... 82  
An extensive range of components, especially volume controls. Coils for the Super 60 series of "W.M." sets also are here
- Whiteley, Wm., Ltd.** ... 267  
A selection of sets and accessories by leading manufacturers will form the principal exhibit
- Wego Condenser Co., Ltd.** ... 284  
Apparatus designed to stop interference caused by electric motors will be seen. Also fixed condensers
- Yagerphone, Ltd.** ... 286
- Zetavox Radio & Television, Ltd.** ... 103



# The LISSEN SKYSCRAPER KIT 3

**POINTS THAT MAKE IT THE GREATEST KIT SET EVER PRODUCED!**

**1 METALLISED S.G. VALVE**

The Lissen Metallised Screened Grid Valve employed in the Skyscraper has such a small inter-electrode capacity that it provides an almost perfectly stable H.F. stage, with a magnification figure in excess of 1,000. The extreme range and stability of the Skyscraper is due to this valve and its perfect screening.

**2 PENTODE OUTPUT**

The Lissen Power Pentode Valve gives to the Skyscraper its brilliant tone, its amazing power . . . yet it uses no mere high tension current than an ordinary power valve. The current consumption of the Skyscraper is less than many ordinary 2-valve receivers.

**3 SHIELDED COILS**

These Lissen Shielded Coils are the result of months of research. They make the Skyscraper exceptionally selective, and one of the few sets free from "long-wave break-through."

**4 ALL METAL CHASSIS**

Notice the most expensive of commercial Radio receivers to-day and you will see that they have metal chassis . . . so does the Skyscraper at half the cost!



The Lissen Constructor's Kit! Up-to-the-minute in design—a year ahead in several of the specially created Lissen parts. What will it do? The metallised Screened Grid stage is so stable that you can push it to the limits of radio range—the Lissen Economy pentode output valve brings up the volume of distant stations until they sound like the local station. Shielded coils, matched and balanced—metal chassis with modern under-baseplate wiring—hairbreadth tuning with geared ball-bearing condensers—all these points and many more combined for the first time in a complete kit ready for assembly.

Many sets before this have given you a selection of stations—but never before has there been a home constructor's set to give you the Europe-wide, almost world-wide, range of the Lissen Skyscraper, and the mighty power of its pentode output—never such a set for getting entertainment value out of radio! So many alternative programmes are at full loudspeaker strength.



**89'6**

**PUT IT IN THIS CABINET—COMPLETELY SELF CONTAINED!**

**KIT INCLUDING VALVES**

You can buy the Skyscraper Kit, complete with valves, ready to build up and put into a cabinet of your own choice with perhaps your existing batteries and loudspeaker. But, better still, Lissen have provided a beautiful walnut Console Cabinet which contains not only the chassis and loudspeaker, but batteries and accumulator as well . . . making your Skyscraper a real self-contained receiver comparable in appearance with any expensive factory assembled set, and in performance easily outstripping previous receivers

Price, complete with walnut cabinet and loudspeaker, as illustrated, £6 5s.

**1/- CONSTRUCTIONAL CHART FREE**

A two-colour, lavishly-produced Chart giving full instructions for building the Skyscraper 3 has been published, price 1s. Get YOUR COPY FREE! Write direct to the factory, or ask your nearest radio dealer to get it for you

**EVERYTHING YOU NEED!**

**LISSEN LTD. WORPLE RD. ISLEWORTH. MIDDLESEX**

Mention of the "Wireless Magazine" will ensure prompt attention

**PERMANENT MAGNET  
MOVING-COIL SPEAKER**

**47/6**

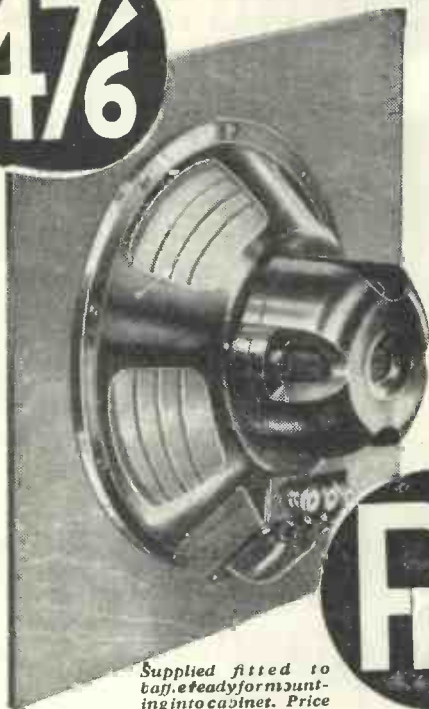

**P.P.M.**

*Supplied fitted to bag, & ready for mounting into cabinet. Price includes transformer*

**Designed by Experts**

... experts who have been responsible for some of the most outstanding loud-speakers of recent years—manufactured by a firm who specialise in the production of speakers that give unrivalled reproduction. These two facts have made this speaker the most outstanding achievement of the year. The P.P.M. Speaker incorporates an impregnated diaphragm and a patented twin suspension, permitting large cone movements without distress. The new patented cobalt content steel magnet produces a very high flux density. Easy payment terms: 10/- down and 6 monthly payments of 8/-. Unless otherwise specified, standard transformer supplied.

**National Radio Exhibition**  
**VISIT OUR STAND**  
**No. 127**  
**AND SEE THE FULL RANGE**  
**Come to our Demonstration**  
**Room No. 9**  
**AND HEAR THE FULL RANGE**

**CELESTION LTD.,**  
**LONDON RD.,**  
**KINGSTON-ON-THAMES**  
*London Showroom:*  
 106, Victoria St.,  
 S.W.1.

**CELESTION**  
*The Very Soul of Music*

**Specified for the  
"PROSPERITY  
THREE"**

Described in this issue.



**10/-  
DOWN  
AND BALANCE  
IN EASY  
MONTHLY  
PAYMENTS**

The famous "ATLAS" Mains Unit Model A.C.188 is yet again the designer's emphatic choice.

This wonderful model is now definitely specified to ensure the finest possible reception from the "Prosperity Three."

It provides two Variable Tappings of 0/100 and 0/120 volts and one Fixed of 150 volts. Output 25 m/A at 150 volts. L.T. Trickle Charger for 2, 4, and 6-volt Accumulators. Make sure of getting the finest value and performance by insisting on "ATLAS," winners of the Olympia Ballots in both 1930 and 1931. Ask your dealer or send Coupon for Folder.

**"ATLAS"  
MODEL  
A.C. 188**

For A.C. Mains 100/125 and 200/250v. 40/120 Cycles  
*Westinghouse Rectifier Guaranteed 12 months.*

**CASH PRICE:**  
**£6 - 0 - 0**



**"ATLAS" TAPPED CHOKE  
TYPE CPS.**

Designed for use as a pentode choke, the high inductance and generously designed windings make this component an excellent heavy-duty choke. That is why it is specified for the "Prosperity" Three, D.C. Model. D.C. Resistance, 385 ohms. Inductance with no D.C. 48 H., or with 60 m/a D.C. 30/35 H. Six Tappings.

**2/4**

**"CLARKE'S  
ATLAS"**

H. CLARKE & CO. (M/CR) LTD. George Street, Patricroft, Manchester. London Office: Bush House, W.C.2.

**POST THIS COUPON TO-DAY!**

MESSRS. H. CLARKE & CO. (M/CR), LTD.,  
 George Street, Patricroft, Manchester.

Please send me your Folder describing "ATLAS" Mains Units and Components.

Name.....  
 Address.....  
 WM/9.....

*There is news in the "Wireless Magazine" advertisements*

# Short Wave Enthusiasts!



# ANTINODAL SHORT WAVE RADIO

A Staggering Invention that makes reception as easy on the Short Wave bands as on all other Wavelengths  
The R.I. "Antinodal" Short Wave Reception system and components comprise:

## "ANTINODAL" SHORT WAVE COIL UNIT

Not merely a new coil but a scientific unit that revolutionises short-wave practice. List No. BY33. Base  $2\frac{1}{2}'' \times 3\frac{1}{4}''$ . Overall Height  $3\frac{1}{4}''$ . **6/9**

1. The "Antinodal" Short Wave Coil Unit, for incorporation in short wave receivers or a short wave adaptor.
2. The R.I. "Antinodal" Dual Purpose Valve Holder with screened lead, which enables the detector valve of an existing set to be utilized for a further stage of amplification (Price separately 3s. 6d.).
3. The R.I. "Antinodal" Short Wave Amplifier Adaptor—the first and only adaptor to utilise the existing detector valve in your set, thus not only enabling it to bring in short wave stations hitherto unobtainable, but actually giving additional amplification, the absolute essential to success in modern short wave reception.
4. The R.I. "Antinodal" Short Wave Three—a modern receiver which incorporates the "Antinodal" Coil Unit and brings in an amazing number of short wave stations eliminating "dead" spots, threshold howl and other s.w. troubles.
5. Full size Blue-prints of both the R.I. "Antinodal" Short Wave Amplifier Adaptor and the "Antinodal" Short Wave Three are obtainable from your dealer or from R.I. direct. Price 6d. each.



THE NEW R.I. CATALOGUE  
Indispensable to the constructor. Get your copy from us or your dealer. **FREE!**

## ANTINODAL SHORT WAVE AMPLIFIER ADAPTOR

is supplied complete in mahogany case ready for plugging into the detector valve holder of your existing battery driven set. **£4-10**  
Including Valve. List No. AY27.

Set Constructors can easily build it  
The "ANTINODAL" BROCHURE contains useful short wave information, diagrams of the "Antinodal" Set and Adaptor, and full list of parts required—ask your dealer or us for it.



See "Antinodal" Short Wave Radio AT OLYMPIA STAND 90

Main Hall Ground Floor



## A New Gang Condenser

**APPARATUS:** Star three-gang .0005-microfarad condenser, with trimmers.  
**PRICE:** £1 5s. 6d.  
**MAKERS:** Wingrove and Rogers, Ltd.

A GOOD condenser which we have tested recently is the new Polar three-gang type. This instrument is built up in a strong

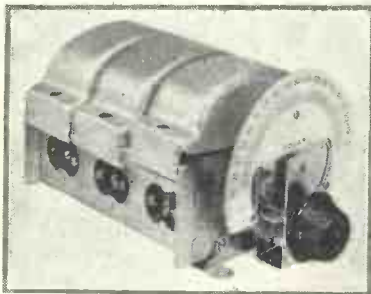

**GOOD THREE-GANG JOB**  
 This is the Polar Star three-gang condenser. A similar four-gang instrument is also produced

metal chassis with screening partitions between the individual sections of the condenser. The fixed vanes are suspended from the frame-work by means of insulating washers, while the moving vanes are locked

on to a hexagonal-shaped shaft. Split end plates are used to enable the sections of the condenser to be closely matched.

Mica-dielectric trimmers are provided, mounted in such a way that they can be adjusted from above. This is a good point and should facilitate the process of ganging the receiver. Each section of the condenser is provided with an individual cover with a hole at one end through which the trimmer can be adjusted.

A slow-motion friction-type drive can be obtained with the condenser, the reduction ratio being approximately 14-1.

A high-frequency resistance test was conducted on the condenser to find the equivalent series resistance introduced into a tuned circuit using the condenser. At 400 metres the resistance was found to be .9 ohm with the trimmer in the minimum position and 1 ohm when in the maximum position.

At 250 metres the values obtained were 2.8 ohms and 3.0 ohms respectively. These figures are quite satisfactory and the condenser will give efficient service.

The three sections were also very well matched together.

## PROSPERITY THREE FOR D.C.—Continued from page 156

clearly shown by the photograph on page 154. These two points hold good for all three versions of the Prosperity Three.

The operation of the D.C. set is similar to that of the battery version, and readers are referred to page 234 for the details. The controls of all three Prosperity sets are the same, so that there will be no confusion on the part of constructors.

As the electrolytic condensers are polarised, care must be taken to connect the main leads the right way round. For this purpose a pole-finder is recommended. The Instant pole-finder sold at 5s. by R. C. Radio-Electric, Ltd., will be found useful.

Readers of "Wireless Magazine" are specially invited to inspect the original models of the Prosperity sets on Stand No. 7 at Olympia, during the run of the National Radio Exhibition.

A model of the battery version of the Prosperity Three will also be on view in Selfridge's Somerset Street windows during the currency of this issue of "Wireless Magazine".

# For D.C. to A.C. and all Power Supply problems

## USE ROTARY

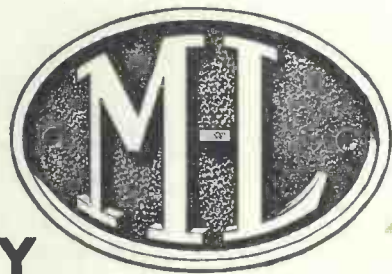

## TRANSFORMERS

D.C. to A.C. Rotary Transformers for operating A.C. Receivers and Radio-Gramophones from D.C. supplies. They are electrically and mechanically silent in operation and can be supplied complete with an anti-interference unit and sound-proof cover (as illustrated). Input: 12 to 220 v. D.C. Output: Up to 200 watts at 230 v. 50 c.

Also D.C. to D.C. Types for supplying H.T. Current to large Public Address Amplifiers, etc. Input: 12 to 220 v. D.C. Output: 300 v. to 1,000 v., etc. Solve your power supply problems with an M-L Machine; there are

**MODELS FOR EVERY REQUIREMENT.**

Get full details immediately, Post Free, from  
**ROTAX LTD., RADIO DEPT. 7, WILLESDEN, LONDON, N.W.10.**

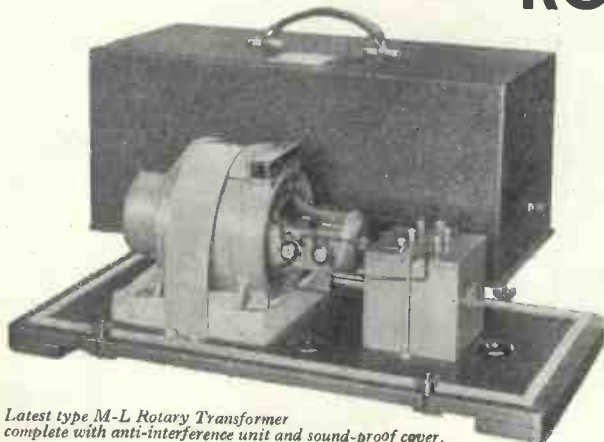

Latest type M-L Rotary Transformer complete with anti-interference unit and sound-proof cover.

When you send your order don't forget to say you "saw it in the 'W.M.'"

# NEW LINES and PRICE REDUCTIONS

**"R" Type Terminal reduced**



Now  
**2<sup>1</sup>/<sub>2</sub>d.**



(Patent)

**S.G. ANODE CONNECTOR**  
For S.G. or Pentode Valves  
**Now 4d.**



(Patent)

**NEW BOWSPRING WANDER PLUG.** All standard letterings  
**1<sup>1</sup>/<sub>2</sub>d.**

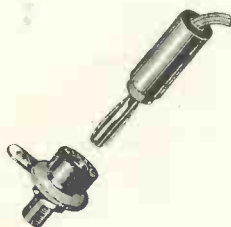

(Patent)

**NEW BANANA PLUG AND SOCKET.** Red or Black.  
Plug **2d.** Insulated Socket **2d.**

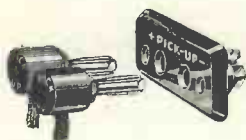

(Patent)

**NEW PLUG AND SOCKET STRIP.** Usual standard letterings  
**9d.**

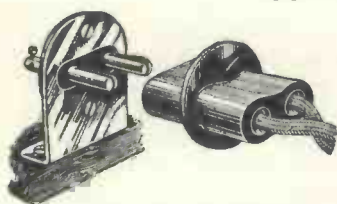

(Patent)

**NEW MAINS INPUT CONNECTOR.** **1/3**

Complete safety in use

**SINGLE SAFETY BASE-BOARD FUSEHOLDER.** Fuse carried in lid making shocks impossible. Complete with 1 amp. fuse **1/6**

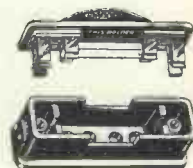

**SINGLE OPEN FUSEHOLDER.** With 1 amp. fuse **9d.**

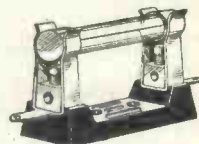

**PANEL FUSEHOLDER.** For panel mounting. With 1 amp. fuse **1/6**



**SPARE FUSES ARE SHOWN ACTUAL SIZE**

**LONG FUSE.** All ratings, 60, 150, 250, 500, 750 m/a. 1 amp, 2 amp, 3 amp.

**SHORT FUSE.** For Wanderfuse only. 60 and 150 m/a.

*Dealers will fit other ratings in any of these holders at the time of purchase.*

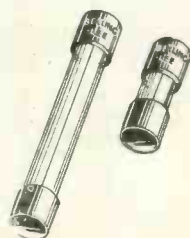

## BELLING-LEE

### FOR EVERY RADIO CONNECTION

*Advert of Belling & Lee Ltd., Cambridge Arterial Rd., Enfield, Mdx.*

*Advertisers like to know whence the business comes—please mention "W.M."*

# RADIO MEDLEY

\* A RADIO FAN'S CAUSERIE CONDUCTED BY BM/PRESS \*

## Olympia—1932

As a keen radio fan, you will, of course, try to visit the Radio Exhibition at Olympia if you possibly can. The show opens on the day this issue of "Wireless Magazine" is published (that is, Friday, August 19) and it remains open until Saturday, August 27.

It is thought by some that as the date has been brought forward by nearly a month the attendance will be poor, but I do not believe that will prove to be the case.

Radio has captured the public imagination and thousands will want to see for themselves just how the art has progressed and what value they can get for their money.

You certainly must make an effort to get to Olympia; if you do, make a special point of visiting the "Wireless Magazine" stand (it is No. 7), where I know you will get a warm welcome.

## A Year's Progress

I have just been looking through the October, 1931, issue of

"Wireless Magazine" to see what I wrote in these notes on the eve of the last Radio Exhibition. I mentioned the constructor's need of a boxed-up tuning unit that could be calibrated in wavelengths; how cabinets had replaced baffle boards for loud-speakers; something about a visit to the H.M.V. factory at Hayes, and also to the Kolster Brandes works at Sidcup; the growing popularity of the super-het and the mains aerial.

Since I first made the suggestion in these pages I have tackled a number of manufacturers on the question of producing a tuning unit that would contain both the coils and the variable condensers, all boxed up and sealed—and calibrated in wavelengths. My idea was that such a unit would avoid many of the ganging troubles so many constructors seem to meet.

I do not want to be too definite at this date, but I believe I can say that after a lapse of a year one manufacturer is about to produce such a tuning unit—but I do not think it will be any good looking for it at the Show. Still, do not overlook

the possibilities when, and if, such a "fixed-ganged" tuner does make its appearance on the market.

## Baffle-Cabinets

As regards loud-speaker cabinets, you must have seen by now the special baffle-box lined with slag wool that was announced recently. This particular box is made to the specification of the B.B.C. engineers. It is of such a size that it can be placed in the bottom of a normal radio-gramophone cabinet.

All the receivers at Broadcasting House are provided with such a baffle-box; the results are really excellent. If you are able to go to Olympia I think it will be worth your while to try and get a demonstration of a loud-speaker in one of these baffle-boxes.

## At Hayes Again

Once again I must record a very pleasant and interesting day spent at Hayes in company with His Master's Voice. I knew that H.M.V. was a big concern, but I was surprised to hear that at the peak of the rush season 7,000 hands are on the pay roll. What a responsibility for somebody!

As you will be able to see for yourself, the H.M.V. range is most imposing; there are some really fine de-luxe radio gramophones. I was glad to note that the playing desk with an automatic record-changer has been reduced in price. That is a gadget that should attract many constructors who want to make themselves a really useful present!

## Up to the Minute

Technically all the new H.M.V. sets are right up to the minute, of course. All of them incorporate variable- $\mu$  valves and most of them are fitted with a tone control. The advantage of the latter is that it not only gives a pleasing individual control of reproduction, but it also enables the operator to cut out many of the high-pitched heterodyne whistles that so often spoil reception.

(Continued on page 258)

## Ordeal by Microphone

*I give a broadcast talk to-night  
So I must pitch my voice just right ;  
It seems a very solemn thing  
That thousands may be listening,  
Women and men and girls and boys,  
I hope I'll make sufficient noise.  
To think of talking to that crowd,  
I hope my voice won't be too loud.  
I fear that I may cough or sneeze,  
I very oft do both of these.  
Supposing that I lose my notes ?  
I may start one of my bad throats,  
My voice be hoarse instead of clear.  
Will atmospherics interfere ?  
My knees are shaking, won't keep still—  
I hope that atmospherics will !*

LESLIE M. OYLER.

# The new LOTUS 2 VALVE RECEIVER

A straightforward circuit of proved performance incorporating a low-power detector, followed by a high output 4-electrode power valve giving 900 milliwatts A.C. output.

This set is fitted with a Magnavox full-size loud-speaker with provision for external speaker. There are two aerial tapplings with variable selectivity controls. Provision is made for mains aerial of highly efficient character, for flat dwellers and others for whom an outside aerial is inconvenient. The cabinet is specially attractive and made of selected Walnut.



**10 GNS.**

or on the extremely easy terms of 19s. 9d. down and 19s. 9d. monthly. D.C. Model is also available at 11 Gns. or 21s. 9d. down and 21s. 9d. monthly.

## The LANDMARK 3 KIT

has been designed to combine an efficiency equal to that of any bought receiver with a simplicity of assembly within everybody's ability. It is very compact and includes the world-famous LOTUS Components, which, for many years, have been acknowledged as unequalled for efficiency and reliability.

With the aid of the simple point-to-point wiring chart and full size print, anyone can construct the LOTUS LANDMARK THREE in a few hours.

In addition to being easy to construct, the LOTUS LANDMARK THREE has been designed for easy tuning. By following the simple instructions supplied you will be able to enjoy the pick of the British and continental broadcasts on a set you have built yourself. Price 39s. 6d.

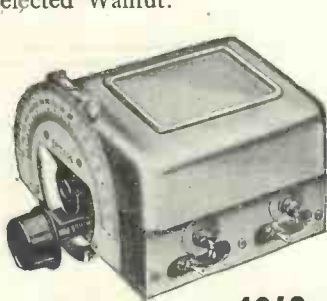

Lotus 2-gang Condenser **19/6**  
Lotus Dual Range Aerial Coil .. .. **5/6**

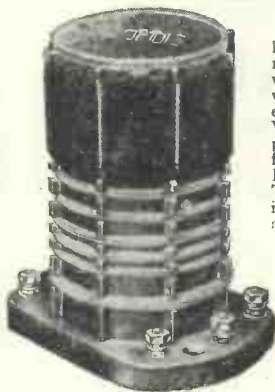

A Component is known by its performance. That is why LOTUS Components are so highly appreciated and so extremely popular. Every LOTUS Component is built to an exceptionally stringent standard and guaranteed. Next time ask for LOTUS.

### COUPON

To  
**LOTUS RADIO LTD., Mill Lane, Liverpool**

Please send particulars of Lotus guaranteed Sets and Components to

Name .....

Address .....

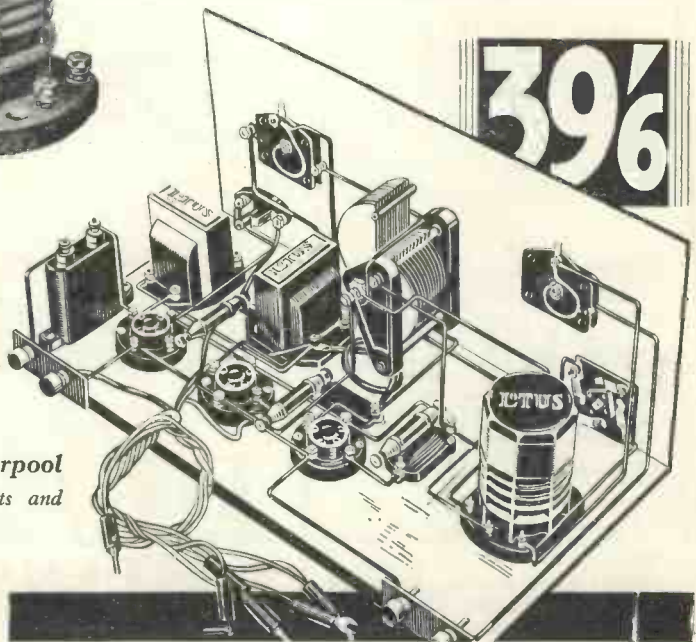

When you send your order don't forget to say you "saw it in the 'W.M.'"

**THE BEST SPEAKER  
YOU CAN BUY**

**BAKER'S  
'Selhurst'  
RADIO**

**PERMAG**

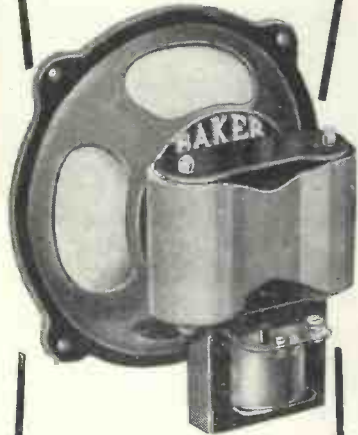

Don't miss it at the  
**RADIO  
EXHIBITION**  
STAND No. 83

This Permanent Magnet Moving Coil Speaker is the most highly efficient reproducer on the market to-day at its present price of 47/- WHICH INCLUDES Transformer AND a splendidly finished Cabinet—to hear it, is to buy it.

Write at once for our  
NEW FREE LITERATURE

**BAKER'S  
'Selhurst'  
RADIO**

Offices:  
89 SELHURST RD., S. NORWOOD, S.E.25  
Works and Demonstration Rooms:  
42 CHERRY ORCHARD RD., E. CROYDON  
Phone: Croydon 1818

**CLIX**  
FOR PERFECT CONTACT

Valveholder  
5 pin 9d.  
type

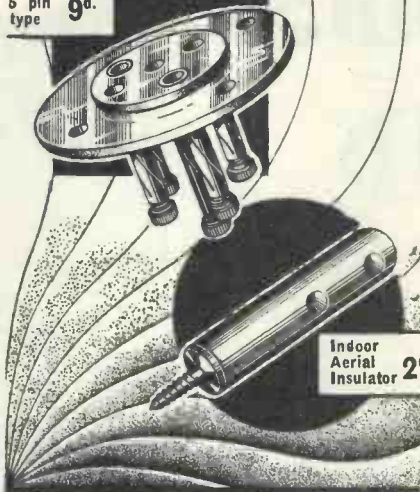

Indoor  
Aerial  
Insulator 2d.

**CLIX Chassis Mounting VALVEHOLDER**  
Sturdily built, skeleton type for mounting on metal, wood or ebonite. Turned Resilient Sockets give maximum surface contact with every type of pin—solid or otherwise. Easy insertion; the sockets moving laterally to centre themselves with valve-pins. 4 pin model—8d. 5 pin model—9d.  
Folder "W.M." Free. STAND 225  
Ask your dealer for "CLIX." RADIOLYMPIA  
Lectro Linx Ltd., 254, Vauxhall Bridge Rd., S.W.1

**PEAK** (British Made)  
Inductance Neutralised  
**CONDENSERS**

High Test Condensers at  
Low Prices

DESIRABLE in all SETS  
ESSENTIAL in MAIN SETS  
1,500 v. D.C. TEST

.1 mfd.	.. .. .	2/2
.25 "	.. .. .	2/4
.5 "	.. .. .	2/6
1 "	.. .. .	2/8
2 "	.. .. .	3/9
4 "	.. .. .	6/9

Used and recommended by all well-known set designers—See Percy Harris's Radiogram in this issue.

DELIVERY EX STOCK

Note and Compare Our Prices

WILBURN & CO.

23, BRIDE LANE, LONDON, E.C.4. Cent. 6994

Northern Agents:

W. ANDREW BRYCE & CO.

64, DAWSON STREET,  
BURY LANC.

**PEAK**  
**CONDENSERS**  
BRITISH MADE

The ACME of  
CHAFTSMANSHIP  
High Grade  
Radio Gramophone  
CABINET

of exclusive modern design, with record wells, hand-made and polished, on Queen Anne legs. Figured Oak 27 13 6 Figured Walnut or Mahogany 19 9 0 (Carriage Paid.) Illustrated Catalogue Free.

Cabinets made to order a speciality.

**GILBERT  
CABINET MAKER.  
SWINDON**



Estimates Free Estd. 1866

**WHY NOT?**

FIT A

**LIMIT**

RELIANCE

PICK-UP AND CARRIER

in the RADIO-GRAM  
YOU ARE MAKING

Acknowledged to be  
"First-class" in value,  
Tone and Workman-  
ship

No Needle Screw  
Turnover Head

Arm In-  
corporates  
a Rest

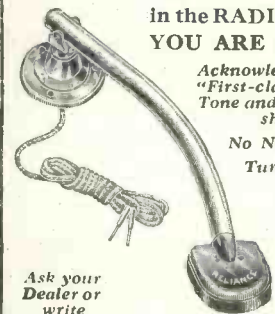

**15/6**  
each

Ask your  
Dealer or  
write

LIMIT RADIO LTD., 15/29 Windsor St., N.1

**YOUR OLD  
COMPONENTS**

are worth money. Sort out the spare radio parts you no longer require and advertise them in the "Miscellaneous Columns" of AMATEUR WIRELESS. You will be surprised how quickly they will be snapped up.

Your announcement will cost you 3d. a word. Send your list of parts, together with your name, address and remittance, to:

"Small Advertisement" Department,  
**AMATEUR  
WIRELESS**

58-61 Fetter Lane, London, E.C.



# SHORT-WAVE TRANSMISSIONS

from

## CHELMSFORD 5 SW

are easier to dial and better reproduced when your set is transformed or a new one built

with the

## LEWCOS<sup>Regd</sup> PRODUCTS

ILLUSTRATED ON LEFT

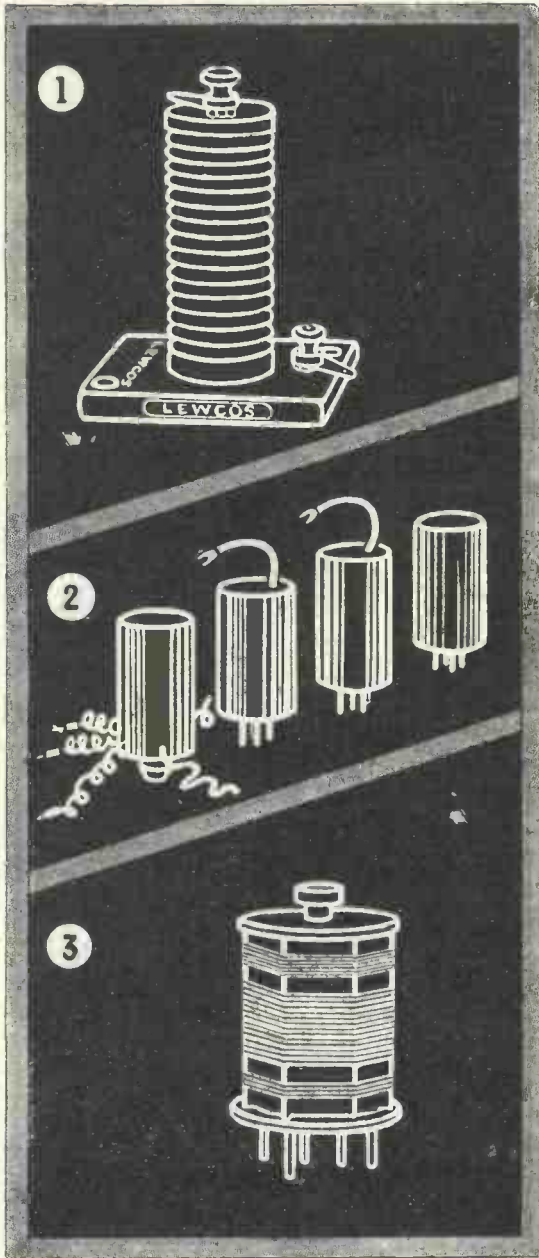

"... tests show that where high sensitivity is required in conjunction with flexibility and ease of manipulation, the Super-Het Receiver is the type to use—Results show that the Super-Het used in this test was several thousand times as sensitive as the simple detector—"

This is the experience of the *World Radio* expert when experimenting in connection with Short Wave transmissions.

Experts of many wireless journals have used and specified LEWCOS Components exclusively, and especially those illustrated above, for many of their most successful short-wave receivers. By using them when transforming your present set or building a new one, you will appreciate the increased power, selectivity, and "tone" LEWCOS components give.

We shall be pleased to send full particulars on application to the Radio Information Department.

### See them at the Exhibition!

The Lewcos Components illustrated above are:

- 1 THE SUPER H.F. CHOKE (TYPE 11), PRICE 6s. EACH.
- 2 THE SUPER-HET COIL KIT COMPRISING 1 OSCILLATOR, 1 I.F. TRANSFORMER WITHOUT PIGTAIL and 2 I.F. TRANSFORMERS WITH PIGTAILS (REFERENCE S.H.K. No. 1), PRICE 50s.
- 3 THE SIX-PIN SHORT-WAVE COIL SUITABLE WAVELENGTH RANGES IN METRES: 15-40 (REFERENCE A.M.S. 2), 20-75 (REFERENCE A.M.S. 4), 40-135 (REFERENCE A.M.S. 9), 90-250 (REFERENCE A.M.S. 25). Price 6s. each.

WE ARE EXHIBITING AT



Visit Our Stand Number 153

### LEWCOS RADIO PRODUCTS FOR BETTER RECEPTION

THE LONDON ELECTRIC WIRE COMPANY AND SMITHS LIMITED, CHURCH ROAD, LEYTON, LONDON, E.10

Advertisers like to know whence the business comes—please mention "W.M."

# RADIO MEDLEY—Continued from page 254

Last year you will remember the Gramophone Company had no stand in Olympia; they had an elaborate private "show" of their own just outside. This year they are inside.

In addition to a number of stands and demonstration rooms they will also have at the exhibition a private cinema theatre where a special film called "Voice of the World" will be shown. From what I have heard about this film it seems to be something that no radio fan should miss. I advise you to make a point of seeing it.

### "Voice of the World"

Since writing the above paragraph I have received further information about the His Master's Voice film that will be shown at Olympia. It has been made by New Era Productions, Ltd., who were responsible for *The Somme* and *Q Ships*. Among the famous radio and recording artists who take part in it are the London Symphony Orchestra, conducted by Dr. Malcolm Sargent, Ambrose and his Band, Mabel

Constanduros, Claude Hulbert, De Groot and his Trio, Peter Dawson, accompanied by Gerald Moore, and Florence Austral.

The closest co-operation has been given to the producers by the H.M.V. people, and among the many manufacturing scenes "shot" at Hayes are vast punch presses, automatic screw machines, chromium-plating baths, coil-winding mechanism, and testing gear.

### Three Wave Ranges

At present I can say nothing about Kolster Brandes; this year I am again going to a lunch at Sidcup. What I have been interested in, however, is the fact that K.B. are producing a standard set that will receive on the short as well as on the medium and long wavebands; something on the lines of the "Prosperity" range of sets described in this issue. It is a great convenience to be able to pick up short-wave transmissions without having to add an adaptor or alter one's set in any way.

I anticipate that many manufacturers will follow this lead next season.

### Super-het Advantages

Even though the super-het had gained enormous popularity among constructors by the time the last exhibition opened, very few commercial models were on show. This year things are quite different, and many firms will be offering fine examples of this type of circuit, which is regarded by many—and rightly, I think—as being the only solution to the problem of an overcrowded ether.

Mains aerials, which were only just being taken up a year ago, are now an almost universal fitting on mains receivers. Dubilier's are still producing their Ducon unit for this purpose, which should be more widely known among constructors. I believe the price has now been reduced to something like 2s. 6d.

Experience seems to show that a mains aerial is often more efficient than an indoor aerial; have you ever thought of trying one? You can use it, of course, even if your receiver is battery operated.

*(Continued on page 260)*

# Portadyne

## CHALLENGE ALL EXISTING IDEAS OF RADIO VALUE

Money buys more in the new Portadyne S.G. 4. CHALLENGER—a Receiver as modern as the minute—giving a performance far ahead of all similarly priced sets.

The All-British Portadyne CHALLENGER is full of exclusive features, among them being concealed and dust-proof controls, and Instantaneous Tuning which gets any selected station in 3 SECONDS. The Portadyne CHALLENGER'S range is enormous, its reproduction something new in faithfulness, its volume impressive.

Get to know more about this astounding new Receiver—it is the greatest value in the radio world to-day. Post the coupon now for fully illustrated details.

### CHALLENGER

**CASH PRICE £12.17.6**

**YOURS FOR 24/6** & 11 monthly payments of 24/6

Ask your dealer to demonstrate the new Portadyne B.M.C. . . . a Battery Receiver with Moving-coil Speaker and the tonal quality of a Mains Set!

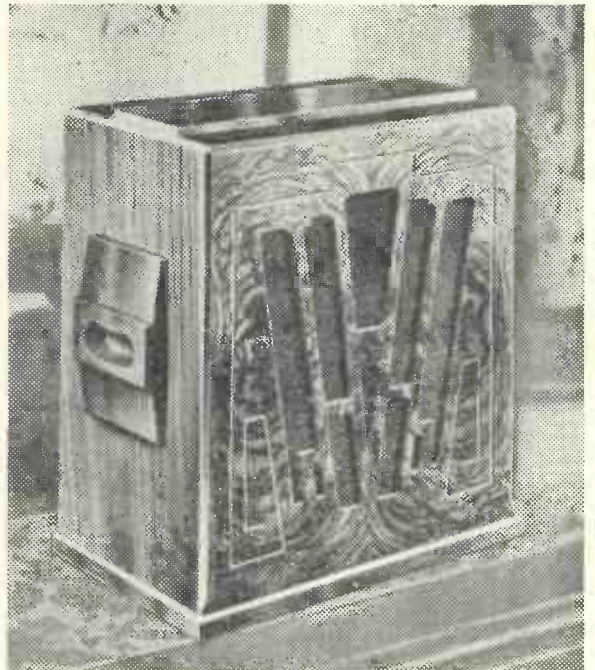

To Portadyne Radio Ltd., Gorst Rd., North Acton, London, N.W.10  
Details of CHALLENGER, please.

NAME.....

ADDRESS.....

# HERE ARE THE COILS YOU WILL NEED—

Specified for the  
"Prosperity Three"  
Battery Model,  
A.C. Model and  
D.C. Model.

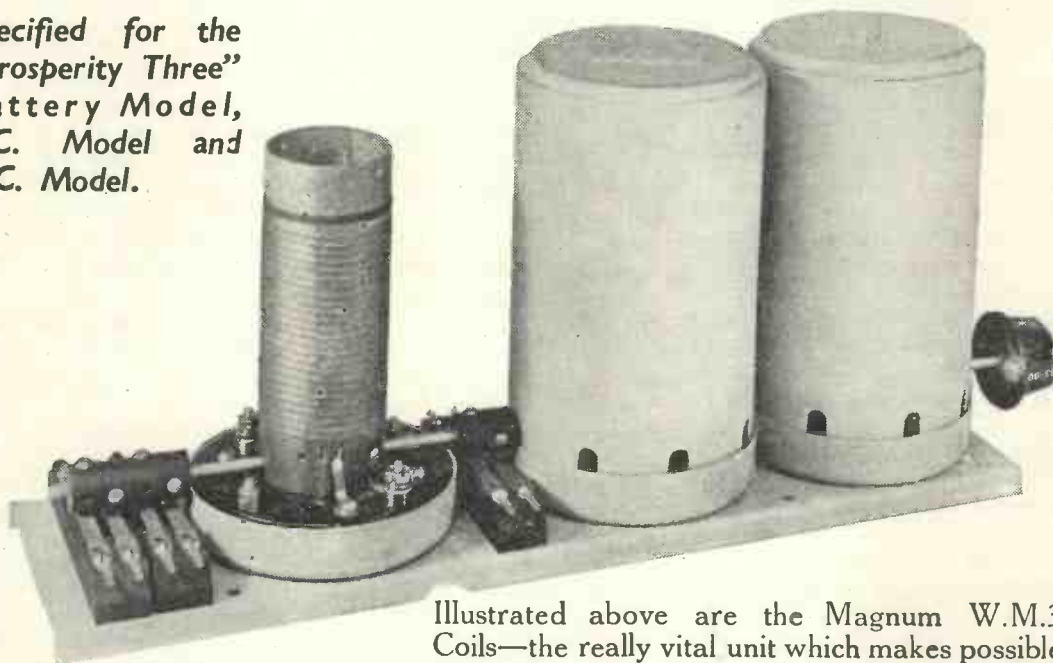

Illustrated above are the Magnum W.M.3 Coils—the really vital unit which makes possible the wonderful performance of the amazing new "Prosperity Three." No wonder they are specified for all three models! They enable you to cover the entire range of broadcast wavelengths from the ultra short waves to 2,000 metres by the operation of a single switch! They are extraordinarily selective, and are built with that care and thoroughness which is typical of all "Magnum" components. Send for your coils to-day. Per set **30/-** Complete with switch and baseboard

## OTHER FAMOUS MAGNUM COMPONENTS

**MAGNADENSERS.**—One Magnum .0001-mfd. differential reaction condenser has been specified for the "Percy Harris Radiogram." Price 5/-.

**MAGNUM SHORT-WAVE CONVERTOR** for both A.C. Mains and Battery Sets. Price, including coil 40/80 metres, cord and plug, 39/6. Extra coil if required, 18/40 metres, 3/- (not suitable where S.G. Detector is used). Model T for sets using British Valves. Model T.A. for sets using American Valves.

**STENODE**—The set that is years ahead. A brochure fully describing the latest Burne-Jones "Stenode" is now available, free on request.

# MAGNUM W.M.3. COILS

**BURNE-JONES & CO., LTD., MAGNUM HOUSE**

296, Borough High Street, London, S.E. 1 - Telephone: Hop 6257 & 6258

Scottish Agent:—Mr. Ross Wallace, 54 Gordon Street, Glasgow, C.1

Please mention "Wireless Magazine" when corresponding with advertisers

## RADIO MEDLEY—Continued from page 258

### Better Moving Coils

Several months ago I mentioned how impressed I had been by the moving-coil loud-speaker designed by P. K. Turner; he claims that it has a response of an octave higher and lower than any other model yet produced.

Now I learn from this well-known designer that he is making arrangements for this reproducer to be manufactured by the Automatic Coil Winder and Electrical Equipment Co., Ltd., so look out for it on Stand 206.

Apart from this special model, I think it will be found that there is a considerable all-round improvement in moving-coil instruments generally. Particularly will this prove to be the case with permanent-magnet models, which are now very much more sensitive than they used to be.

I have pointed out before the absurdity of using a cheap and insensitive loud-speaker with a small and probably inefficient set, but I think the case is now rather different.

### On 7 Metres

I have been greatly intrigued by the possibilities of 7-metre transmission, with which the B.B.C. is now experimenting. Unfortunately the transmissions are only being

put out in the afternoons when few listeners can take advantage of them. If the B.B.C. really wants to collect data from experimenters I am surprised that they have not arranged to make some tests during the evenings. Many keen fans would then be able to take advantage of them and the B.B.C. would be able to get reports from all quarters.

From the description of a 7-metre set elsewhere in this issue you will be able to see how simple and cheap a receiver for such wavelengths can be. We shall hear more about these ultra-short wave transmissions in the future.

### High-voltage Valves

In these notes some months ago I mentioned the possibilities of high-voltage mains valves of the Ostar-Ganz type. Now I learn that kits for building sets to incorporate these valves are about to appear on the market—they will probably be available by the time this issue of "Wireless Magazine" is published.

The valves referred to have the advantage that the full mains voltage can be applied across the filaments. Thus in the case of A.C. sets there is no need for a step-down mains transformer and in the case of D.C. sets there is no need for a break-

down resistance; in this way the construction of a receiver is greatly simplified.

I understand that, although the valves are still made in Austria, the parts used in the kits are British.

### Outdoor Radio

Last week-end I was camping on the South Coast, in a field where there were some dozens of tents. I did not take a radio set with me, but two other people had. It struck me what a pity it is that those who indulge in radio out of doors nearly always seem to use a receiver that has seen its best. I mean by this that the quality is usually what can only be described as execrable.

### Power Essential

For good results in the open it is essential to use a powerful set, and a good loud-speaker is also needed. In the case of both the installations to which I have just referred the results can only be described as bad—the sort of thing that so many dealers called "radio demonstrations" two or three years ago.

For the sake of others who cannot help hearing your set, please see that it is reasonably good if you are tempted to take it abroad!  
London, W.C. BM/PRESS.

## EXHIBITS AT OLYMPIA—Continued from page 208

trying out all kinds of loud-speakers. At Broadcasting House all the "pilot" receivers, which are of the console type, incorporate similar baffle-boxes to those now offered to the public—and very good the reproduction is.

Loud-speakers themselves have not undergone any revolutionary changes. Permanent-magnet models are much more sensitive than they were a year ago and can be safely used even with small battery-operated receivers.

### Extensive Range

There is a very extensive range of moving-coil loud-speakers of all types; the difficulty will be to choose the most suitable from among all those offered.

Inductor loud-speakers are still

popular among a certain number of listeners—particularly those who do not like the background obtained with some moving-coil instruments—and several good examples will be seen at the show.

A newcomer is the electrostatic type of reproducer. Perhaps we should hardly call it a newcomer, for it is really quite old. Still, the latest type to be put on the market offers several advantages that the older types did not have; in particular they do not need a very high polarising voltage. These loud-speakers should receive the attention of every listener.

In view of the growing popularity of short-wave reception—and in particular reception on wavelengths of the order of 7 metres—it seems likely that there will be a revival in the demand for headphones. Short-wave stations can be picked up on a

loud-speaker, it is true, but this restricts the range of a set considerably.

### More Stations on Phones

If three stations can be heard on a loud-speaker it is probable that thirty would be heard with headphones. For this reason it is surprising to find that only one or two firms are now manufacturing such instruments. We believe that before many months are passed there will be such an increased demand that several more manufacturers will have to start the production of headphones again—shades of the crystal receiver!

We are also of the opinion that more manufacturers should turn their attention to the production of short-wave gear. The B.B.C.'s experimental 7-metre transmissions have met with greater success than  
(Continued on page 264)



● Standard Model "All-in-One" Radiometer for Battery Sets only (shown above) Price **12/6**

# TRACK RADIO TROUBLES... EASILY.....

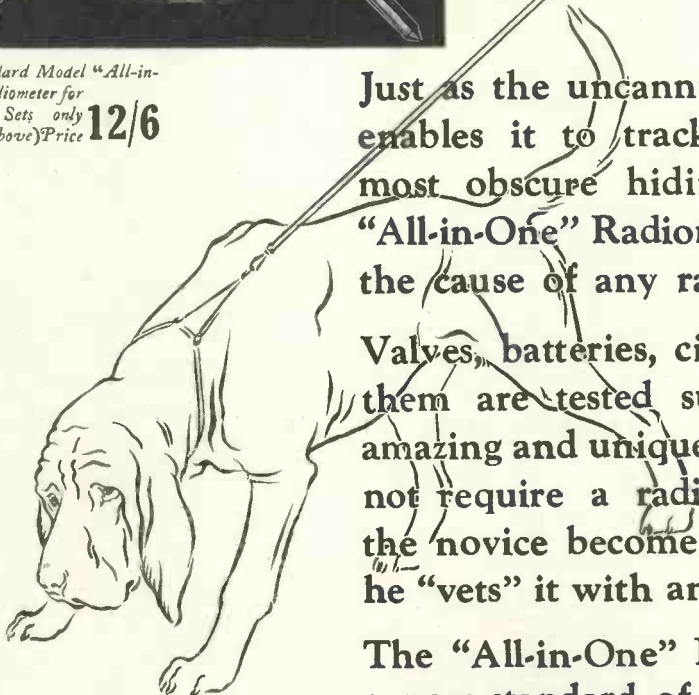

Just as the uncanny scent of the bloodhound enables it to track its quarry to even the most obscure hiding place, so the sensitive "All-in-One" Radiometer can trace and reveal the cause of any radio trouble.

Valves, batteries, circuits, components—all of them are tested surely and swiftly by this amazing and unique instrument. And it does not require a radio expert to use it. Even the novice becomes a master of any set when he "vets" it with an "All-in-One" Radiometer.

The "All-in-One" Radiometer ensures a new standard of radio performance from any set by the ease with which it tracks trouble. Ask to see it at any radio dealer's or electrician's.



● De Luxe Model for Battery Sets, Electric Receivers and Mains Units... **£2 2 0** (shown below)



## PIFCO ALL IN ONE RADIOMETER

If any difficulty write direct to:—PIFCO Limited, High Street, MANCHESTER

ΦA

YOU CANNOT GO WRONG IF YOU USE A "W.M."

# FULL-SIZE BLUEPRINT

## CRYSTAL SET

1931 Crystal Set *6d. post free* .. AW308

## ONE-VALVE SETS

*1s. each, post free*  
 Short-wave One-valver (ud.) .. AW327  
 Easy-to-Build One .. AW304  
 "B.B.C." One .. AW344  
 Portable Short-wave One .. AW354

## TWO-VALVE SETS

*All these 1s. each, post free*  
 Ever-tuned Regional Two (D, 1 Trans) .. WM241  
 Station-finder Two (D, Trans) .. WM243  
 Music-lover's Two (D, Trans) .. WM260  
 New Economy Two (D, Trans) .. WM265  
 Family Two (D, Trans) .. WM278  
 Economy A.C. Two (D, Trans) .. WM286  
 Screen-grid Two (SG, Trans) .. WM289  
 \*Two for Seven Metres (D, Trans) .. WM295  
 Forty-five Shilling Two (D, 1 Trans) .. AW250  
 Searcher Short-wave Two (D, Trans) .. AW259  
 Challenge Two (D, Trans) .. AW261  
 Loftin-White 2 (A.C. Set) .. AW263  
 Everybody's All-in 2 (D, Trans) .. AW273  
 Twenty-shilling Two (D, Trans) .. AW274  
 B.B.C. Selective Two (D, Trans) .. AW292  
 The Room-to-Room 2 (D, 1 Trans) .. AW298  
 Big-volume Two (D, Pen) .. AW309  
 Two Star 2 (D, Pen) .. AW315  
 The 25/- Two (D, Trans) .. AW330  
 Ten Station Two (D, Trans) .. AW336  
 Hiker's Two (D, Trans) .. AW345  
 Inexpensive A.C. Two (D, Trans) .. AW346  
 Midget Two (D, Trans) .. AW348  
 Mascot Two (D, Trans) .. AW353

## THREE-VALVE SETS

*All these 1s. each, post free*  
 Gramo-radio D.C. Three (SG, D, 1 Trans) .. WM196  
 De-luxe Three (D, RC, Trans) .. WM209  
 Five-point Three (SG, D, Trans) .. WM212  
 Falcon Three (AC Set) .. WM217  
 New Brookman's Three (SG, D, Trans) .. WM218  
 Five-point Short-waver (D, 2 Trans) .. WM223  
 Regional Three (SG, D, 1 Trans) .. WM236  
 Band-pass Inceptor (SG, D, Pen.) .. WM244  
 Ether Marshal (SG, D, Trans) .. WM247  
 Meridian Short-waver (D, RC, Trans) .. WM255  
 Five-Advantage Three (D, RC, 1 Trans) .. WM257  
 Everybody's Radiogram (SG, D, Trans) .. WM258  
 Double Band-pass Three (SG, D, Trans) .. WM259  
 Everybody's Radiogram (with Automatic Grid Bias) .. WM262  
 New Economy Three (SG, D, Trans) .. WM263  
 New Plug-in-Coil Three (D, 2 Trans) .. WM270  
 Transportable Three (SG, D, Trans) .. WM271  
 Multi-Mag Three (D, 2 Trans) .. WM288  
 Percy Harris A.C. Radiogram (D, RC, Trans) .. WM294  
 \*The Prosperity Three for Batteries (SG, D, Pen) .. WM296  
 \*The Prosperity Three for A.C. Mains (SG, D, Pen) .. WM297  
 \*The Prosperity Three for D.C. Mains (SG, D, Pen) .. WM298

A blueprint of any one set described in the current issue of the "Wireless Magazine" can be obtained for half-price up to the date indicated on the coupon (which is always to be found on the last page) if this is sent when application is made. These blueprints are marked with an asterisk (\*) in the above list and are printed in bold type. An extension of time will be made in the case of overseas readers.

Square-peak Three (SG, D, Trans) .. AW293  
 Universal Short-wave Three (SG, D, Trans) .. AW301  
 Olympian Three (SG, D, Trans) .. AW306  
 Tonality Three (D, RC, Trans) .. AW321  
 35/- Three-valver (D, 2RC) .. AW323  
 Baby Three (D, RC, Trans) .. AW324  
 World Wide Short-wave Three (D, RC, Trans) .. AW332  
 New Favourite Three (D, RC, Trans) .. AW334  
 Home Lover's All-electric Three (SG, D, Trans) .. AW335  
 P.W.H. Mascot (D, RC, Trans) .. AW337  
 Home Lover's Battery Three (SG, D, Pen) .. AW341  
 New Regional Three (D, RC, Trans) .. AW349

## FOUR-VALVE SETS

*All these 1s. od. each, post free*  
 Five-point Four (SG, D, RC, Trans) .. WM216  
 Ether Rover (SG, D, RC, Trans) .. WM266  
 Quadradyne (2SG, D, Trans) .. WM273  
 Double Band-pass Four (SG, D, RC, Trans) .. WM274  
 Economy Radio Gramophone (SG, D, RC, Trans) .. WM276  
 A.C. Quadradyne (2 SG, D, Pen) .. WM279  
 Ideal A.C. Home Super (Super-het) .. WM290  
 The Gold Coaster (AC Short-wave) .. WM292  
 Triple-tune Four (2SG, D, Trans) .. WM293  
 All-Europe Four (2HF, D, Trans) .. AW173  
 Stability Four (HF, D, RC, Trans) .. AW182  
 £3 3s. Four (SG, D, RC, Trans) .. AW303  
 £3 3s. Four (Improved Model) .. AW303A  
 Four-star Four (SG, D, RC, Trans) .. AW318  
 The 50/- Four (SG, D, RC, Trans) .. AW331

## FIVE-VALVE SETS

*All these 1s. od. each, post free*  
 Regional D.C.5 (SG, D, LF, Push-pull) .. WM252  
 Ideal Home Super (Super-het) .. WM280  
 Easytune 60 (Super-het) .. WM284  
 James Quality Five (2SG, D, RC, Trans) .. AW227  
 Britain's Super (Super-het) .. AW311  
 A.C. Britain's Super (Super-het) .. AW322  
 Mains section (1/-) .. AW322A  
 James Short-wave Super-het .. AW328  
 Simple Super (Super-het) .. AW340

## SIX-VALVE SETS

*All these 1s. 6d. each, post free*  
 Super 60 (Super-het) .. WM229  
 A.C. Super 60 (Super-het Radiogram) .. WM239  
 A.C. Super 60 (Super-het Table Model) .. WM245  
 Super 60 (with Wearite Base) .. WM249  
 Super 60 (with Lewcos Base) .. WM251  
 1932 Super 60 (Super-het) .. WM269  
 1932 A.C. Super 60 (Super-het) .. WM272

## SEVEN-VALVE SET

*1s. 6d., post free*  
 Super Senior (Super-het) .. WM256

## PORTABLE SETS

Super 60 Portable (Super-het) .. WM233 1/6  
 Home and Garden Three (D, RC, Trans) .. WM246 1/-  
 Town and Country Four (SG, D, RC, Trans) .. WM282 1/6  
 Everybody's Portable (Super-het) .. WM291 1/6  
 General-purpose Portable (SGD, RC, Trans) .. AW351 1/6

## AMPLIFIERS

*All these 1s. each, post free*  
 Radio-record Amplifier (DC Mains) .. WM183  
 Selecto Amplifier (HF Unit) .. WM210  
 D.C. Fader .. WM242  
 Quality Amplifier (D.C.) 1s. 6d. .. WM264  
 A-P-A (Public Address) .. WM275  
 A-P-A Radio Unit (SG, D) .. WM281  
 Economy Gramophone Amplifier .. WM277  
 A.C. Push-pull Amplifier .. AW291  
 Add-on H.F. Screened-grid Unit .. AW296

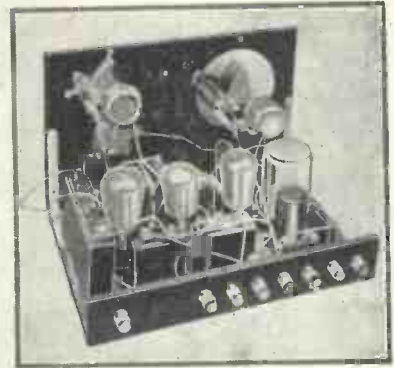

**A FINE STRAIGHT THREE**  
 The Multi-mag Three (D, 2 Trans) received over forty stations free of interference when tested in South London. It is very cheap to build

Universal Push-pull Amplifier .. AW309  
 "A.W." Record Player (LF, Push-pull) .. AW310

## MISCELLANEOUS

"W.M." Standard A.C. Unit .. WM214 1/-  
 "W.M." Standard D.C. Unit .. WM215 1/-  
 Super 60 A.C. Unit (for Battery Super 60) .. WM248 1/-  
 Simple Neon Oscillator .. WM251 1/-  
 Plug-in Adaptor .. WM267 1/-  
 Super-het Adaptor .. WM268 1/-  
 A Simple Mains Unit .. WM283 1/-  
 Short-wave Director (wavemeter) .. WM285 6d.  
 Voltage Regulator .. WM287 1/-  
 Choke Output Unit .. AW240 1/-  
 Simple Tester Unit .. AW246 -/6  
 "A.W." Improved Linen-diaphragm Speaker .. AW248 1/-  
 Handy L.T. and G.B. Unit for A.C. Mains .. AW254 1/-  
 Ohmic Coupled DX Unit .. AW255 1/-  
 Simple Gramophone Amplifier .. AW257 1/-  
 Novel Linen Diaphragm Speaker .. AW260 1/-  
 H.T. Unit for A.C. Mains .. AW262 1/-  
 Gramophone Tone Control .. AW264 1/-  
 H.T. Unit and Trickle Charger for D.C. Mains .. AW272 1/-  
 2-Watt A.C. Amplifier .. AW283 1/-  
 "A.W." Selectivity Unit .. AW290 6d.  
 B.B.C. Official Selectivity Unit .. AW294 6d.  
 A.C. Trickle Charger .. AW305 1/-  
 Amateur's Linen Speaker .. AW307 1/-  
 D.C. H.T. Unit .. AW312 1/-  
 Output Unit for Pentode Sets .. AW316 1/-  
 "A.W." Short-wave Adaptor .. AW317 1/-  
 Short-wave Plug-in Adaptor .. AW326 -/6  
 Super-het Short-wave Adaptor .. AW329 -/6  
 "A.W." Short-wave Adaptor .. AW339 1/-  
 Mascot Mains Unit .. AW350 1/-  
 "A.W." Trickle Charger .. AW352 1/-

Each blueprint shows the position of each component and every wire and makes construction a simple matter. Copies of "Wireless Magazine" and of "Amateur Wireless" containing descriptions of most of these sets can be obtained at 1s. 3d. and 4d., respectively, post free. Index letters "A.W." refer to "Amateur Wireless" sets and "W.M." to "Wireless Magazine" sets.

Send, preferably, a postal order (stamps over sixpence in value unacceptable) to

# Wireless Magazine

BLUEPRINT DEPT.,  
 58/61 FETTER LANE,  
 LONDON, E.C.4

# SPECIFIED for the PERCY HARRIS RADIO-GRAM



Still further proof of the technical efficiency and reliability of the new Tunewell Super Radio Components is this choice of Mr. Percy Harris for his Great Radiogram.

Build this fine receiver and remember the new Tunewell Components have been specially designed for Super-reception, and at the same time, to save your money.

Get the Tunewell "Guide to Super-Radio"—FREE—before you make your shopping list for any Set and see how you can have better radio—and how much you can save! The "Guide" contains—

**8 FREE BLUEPRINTS**  
including Kit Eliminator and All-mains Band Pass 3.

TUNEWELL L.F. CHOKE 15/-  
**STAND 96**

\* See the new range of Tunewell components and wonderful new Radiogram at Stand 96, Olympia.

## TUNEWELL Super-Radio Components

TUNEWELL RADIO LTD., 44, STATION ROAD, LONDON, N.11.

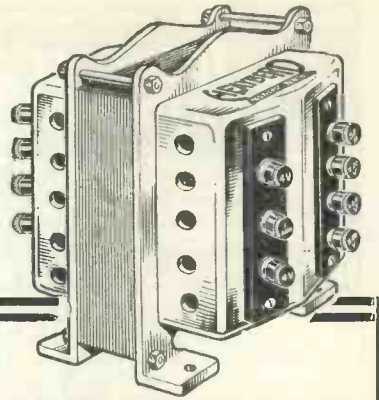

# 13 but NOT unlucky!

Thirteen is the number of the HEYBERD Olympia stand this year—and here you will find all that is modern in Mains Equipment. Heayberd present an Evolution in Mains Units, sturdy, rigid, modern design incorporating the very finest components and enclosed in a recessed panel on top—there are no projections! There are also Kits for Constructors wishing to build their own Mains Units and Chargers. Below are detailed a few of the latest Heayberd Mains Transformers that will be on show—No. W25 is the model used by Mr. Percy Harris in his A.C. 3-valve receiver.

HEYBERD W25 TRANSFORMER	
Secondary Tappings.	Rectified Output.
0—110 v. 70 m/A.	175 v. 25 m/A.
0—135 v.	200 v. 28 m/A.
L.T. 2 + 2 v., 4 amps. for 4 v. A.C. valves.	
Price	22/6

	Sec. Tappings.	Rect.	Rectified Output.
W. 33	240 v. 200 ma.	H.T. 9	300 v.,
	4 v. 5 amps.	A.C. valves	60 ma.
	4 v. 1 amp.	Power valve	
W. 34	150 v. 550 ma.	H.T. 10	200 v.,
	4 v. 5 amps.	A.C. valves	100 ma.
	4 v. 1 amp.	Power valve	
W. 35	300 v. 550 ma.	H.T. 11	500 v.,
	4 v. 5 amps.	A.C. valves	120 ma.
	4 v. 2 amps.	Power valve	
Prices:			
W. 33	35/-	W. 34	45/-
W. 35	65/-		

OLYMPIA  
**13**  
STAND

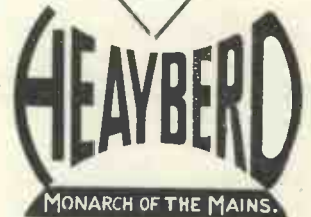

To F. C. HEYBERD & CO.,  
10 Finsbury Street,  
London, E.C.2.

Please send me full details of Heayberd Mains Units, Kits, Transformers, etc., illustrated with circuit diagrams. I enclose 3d. stamps.

Name .....  
Address .....

WMS  
POST THIS COUPON TO-DAY!

## ELECTRADIX NEW CATALOGUE NOW READY!



72 Illustrated Pages and New Price Reductions 4d

WILL SAVE YOU POUNDS

218, Upper Thames Street, E.C.4

Buy  
**AMATEUR WIRELESS**

**3<sup>D</sup> WEEKLY**

Famous makers' Offer! **£5** Radio Gram CABINET for **65/-**  
**7 DAYS' FREE TRIAL**  
10/- monthly if desired  
You save 35/-! A few only at makers' prices. Rich Brown Oak "Master Grand" (as made for Radio Press) earings paid. A fine Bargain. PHOTOGRAPHS and LISTS FREE.  
All Models from 35/- to £15  
Patent 8123 improved acoustics yields mellow, rich, full volume that your speaker is really capable of. Makers to:— (Radio-Press, B.B.O., 3,000 clientele)  
**PICKETTS** F. no Tone Cabinets (M.G.) Albion Rd., Bexleyheath, Kent

## "PERCY HARRIS'S RADIOGRAM"

SPECIFIES THE  
"KINVA" STANDARD SCREENED H.F. CHOKE

Inductance 105,000 Microhenries in neat oxidized case, a Little Super Choke. **3/-** Post Free

A NEW SCREENED CHOKE

For "Supers" is now ready **5/6**  
280,000 Mics. Price

**POSTLETHWAITE BROS.,**  
Kinver, Stourbridge

Mention of "Wireless Magazine" will ensure prompt attention

## BLUEPRINT COUPON

Valid only until Sept. 30, 1932 (or until October 31, 1932 for overseas readers)

### FOR ONE BLUEPRINT ONLY

If you want a full-size blueprint of any ONE of the sets constructionally described in this issue for half price, cut out the above coupon and send it, together with a postal order, to Blueprint Department, WIRELESS MAGAZINE, 58-61 Fetter Lane, London, E.C.4.

This coupon is valid for a blueprint of any ONE only of the following sets at the prices indicated:—

**THE PROSPERITY THREE FOR BATTERIES** (page 146), WM296, price 6d., post free.

**THE PROSPERITY THREE FOR A.C. MAINS** (page 151), WM297, price 6d., post free.

**THE PROSPERITY THREE FOR D.C. MAINS** (page 154), WM298, price 6d., post free.

**A TWO FOR SEVEN METRES** (page 166), WM295, price 6d., post free.

## INFORMATION COUPON

Valid only until Sept. 30, 1932 (or until October 31, 1932 for overseas readers)

If you want to ask any questions, cut out the above coupon and send it, together with a postal order for 1s. and stamped-addressed envelope, to the Information Bureau, WIRELESS MAGAZINE, 58-61 Fetter Lane, London, E.C.4.

Note that not more than two questions may be asked at a time and that queries should be written on one side of the paper only.

Under no circumstances can questions be answered personally or by telephone. All inquiries must be made by letter so that every reader gets exactly the same treatment.

Alterations to blueprints or special designs cannot be undertaken; nor can readers' sets or components be tested.

If you want advice on buying a set, a stamped-addressed envelope only (without coupon or fee) should be sent to the Set Selection Bureau, WIRELESS MAGAZINE, 58-61 Fetter Lane, London, E.C.4.

## EXHIBITS AT OLYMPIA

Continued from page 260

was anticipated and it seems certain that there will be great developments in the ultra-short wave field.

Some of the advantages of such transmissions are pointed out elsewhere in this issue of "Wireless Magazine."

### Improved Kit Sets

The season of 1933 will be notable for a still further increase in the number of kit sets offered to the constructor. Most of these are of the three-valve variety, of course, but they are much better propositions than similar sets that were put out a year ago. Several of them use variable- $\mu$  high-frequency valves and all of them are more pleasing in general appearance.

Television is "looking up" and at the time of going to press there are rumours that a well-known firm of radio manufacturers is going into the production of television receivers on a large scale; so look out for a new instrument at Olympia.

## IMPORTANT ANNOUNCEMENT

to wireless enthusiasts, dealers and manufacturers, and to all interested in the progress of radio!

### SCOTT SESSIONS & CO.

are now in production with the finest range of mains chokes and transformers on the market!

This department is under the supervision of Mr. N. G. R. Partridge, B.Sc. (Eng.), A.M.I.E.E., Chartered Electrical Engineer, who is always pleased to personally assist users in the selection of suitable mains equipment.

Send for **FREE** instructive Catalogue immediately!

### SCOTT SESSIONS & Co.

Mains Apparatus Dept.  
Kings Buildings, Dean Stanley Street, Westminster, S.W.1.  
Telephone: Victoria 5035.

General Wireless Department,  
1, Castle Terrace, Muswell Hill, N.10  
Telephone: Tudor 5326.

## INDEX TO ADVERTISERS

	A	Page
Amplion (1932), Ltd.	.. .. .	218
<b>B</b>		
Baker Salhurst Radio	.. .. .	256
Becker, Geo., Ltd.	.. .. .	134
Belling & Lee, Ltd.	.. .. .	233
Benjamin Electric, Ltd.	.. .. .	138
Forst, Chas., & Sons	.. .. .	138
British Blue Spot Co.	.. .. .	Cover 41
British Clarion Co., Ltd.	.. .. .	138
British General Manufacturing Co., Ltd.	.. .. .	128
British Radiophone, Ltd.	.. .. .	127
Bulgin, A. F., & Co., Ltd.	.. .. .	223
Burne-Jones & Co., Ltd.	.. .. .	259
<b>C</b>		
Carrington Mfg. Co., Ltd.	.. .. .	130
Celestion, Ltd.	.. .. .	251
Clarke, H., & Co. (M/cr), Ltd.	.. .. .	122, 250
Columbia Graphophone Co., Ltd.	.. .. .	Cover 1v
Colvern, Ltd.	.. .. .	223
Coscor, A. C., Ltd.	.. .. .	140
<b>D</b>		
Day, Will, Ltd.	.. .. .	213
Dublier Condenser Co., Ltd.	.. .. .	219
<b>E</b>		
Eastick, J. J., & Sons	.. .. .	114
Edison Swan Electric Co., Ltd.	.. .. .	237
Electradix	.. .. .	203
Eriusson Telephones, Ltd.	.. .. .	236
Ever Ready Co. (G.B.), Ltd.	.. .. .	115
<b>F</b>		
Ferranti, Ltd.	.. .. .	110, 111, 241
Fluxite, Ltd.	.. .. .	118
Forbat, Eugen	.. .. .	121
Forno Co.	.. .. .	131
<b>G</b>		
General Electric Co., Ltd.	.. .. .	106, 107
Gilbert, J. C.	.. .. .	236
Graham Farish	.. .. .	114
Gramophone Co., Ltd. The	.. .. .	213
<b>H</b>		
Hayberd, F. C., & Co.	.. .. .	283
<b>I</b>		
Igranic Electric Co., Ltd.	.. .. .	117
<b>J</b>		
Jackson Bros.	.. .. .	119
<b>K</b>		
Kolster Brandes Ltd.	.. .. .	121
<b>L</b>		
Lectro Linx, Ltd.	.. .. .	256
Limit Radio, Ltd.	.. .. .	255
Lissen, Ltd.	.. .. .	243
London Electric Wire Co., and Smiths, Ltd.	.. .. .	Cover 2, 257
London Radio Supply Co.	.. .. .	114
Lotus Radio	.. .. .	255
Lyons, Claude, Ltd.	.. .. .	234, 240
<b>M</b>		
Marconiphone Co., Ltd.	.. .. .	120
Mullard Wireless Service Co., Ltd.	.. .. .	109
Multitone Electric Co., Ltd.	.. .. .	222
<b>O</b>		
Ormond Engineering Co.	.. .. .	127
Osborn, Chas. A.	.. .. .	218
<b>P</b>		
Paroussi, E.	.. .. .	118
Partridge & Mee, Ltd.	.. .. .	118
Pertrix, Ltd.	.. .. .	131
Peto Scott, Ltd.	.. .. .	133
Pickett Bros	.. .. .	263
Pico, Ltd.	.. .. .	261
Portadyne	.. .. .	258
Postlethwaite Bros.	.. .. .	118, 263
<b>R</b>		
Radio Instruments, Ltd.	.. .. .	251
Ready Radio (R.R.), Ltd.	.. .. .	233
Reproducers & Amplifiers, Ltd.	.. .. .	137
Rothermel Corporation, Ltd.	.. .. .	135
Rotax, Ltd.	.. .. .	252
<b>S</b>		
Scott Sessions, G., & Co.	.. .. .	264
Siemens Bros.	.. .. .	134
Sound Sales, Ltd.	.. .. .	238
Stratton & Co., Ltd.	.. .. .	123
<b>T</b>		
Tekade Radio & Electric, Ltd.	.. .. .	238
Telegraph Condenser Co., Ltd.	.. .. .	122
Telsen Electric Co., Ltd.	.. .. .	215, 217, 221, 225, 229, 231, 235, 237, 243, 247
Tungram Electric Lamp Works, Ltd.	.. .. .	113
Tunewell	.. .. .	263
<b>V</b>		
Vandervell, C. A., & Co., Ltd.	.. .. .	246
Varley	.. .. .	125
<b>W</b>		
Westinghouse Brake & Saxby Signal Co., Ltd.	.. .. .	245
Whiteley Electric Radio Co., Ltd.	.. .. .	139
Wilkins & Wright, Ltd.	.. .. .	123
Williams & Moffat, Ltd.	.. .. .	134
Wilburn & Co.	.. .. .	256
Wiugrove & Rogers, Ltd.	.. .. .	245
Wright & Weaire, Ltd.	.. .. .	222