

# Wireless Magazine

NO. 67. AUGUST. 1930.

## NEW LODESTONE 3

**FOUND, An Alternative Programme**

**MAINS POWER for Your PORTABLE**

**GIVE US Better BRITISH SETS!**

**A "PEEP" at the NORTHERN REGIONAL**

**THE FOURSOME —A New Screen Grid Portable**

**14,000 Miles with a REINARTZ THREE**

**UNIVERSAL Push-pull AMPLIFIER**

**TESTS Before BUYING**

**OUTSPAN Short-way ADAPTOR**

**CONSTANT NEUTRALISING ON ALL WAVELENGTHS**



**W. JAMES'S 1930 BINOWAVE COILS ARE USED**

# PREDOMINANT IN ITS OWN SPHERE

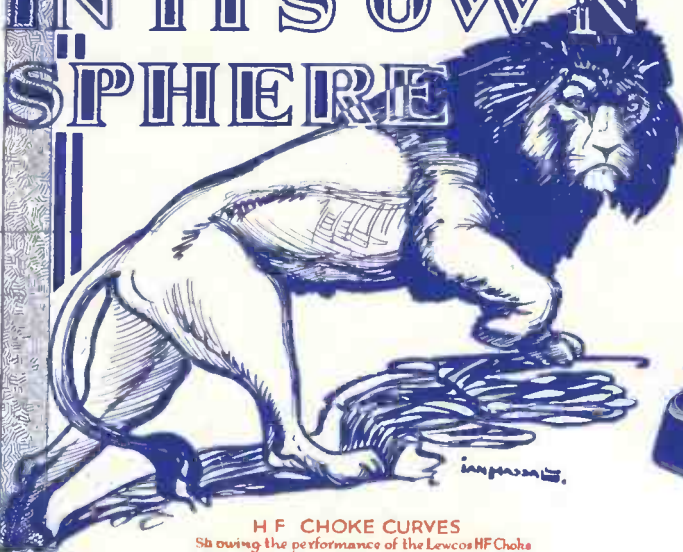

Actual Size

H F CHOKE CURVES  
Showing the performance of the Lewcos H.F. Choke compared with other makes

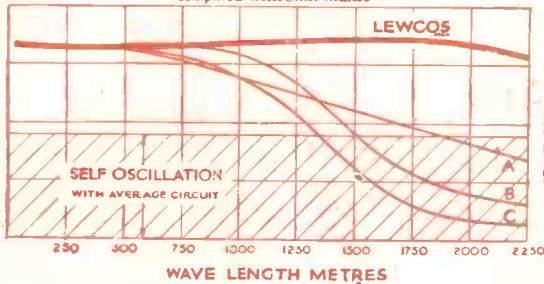

The Lewcos L.F. Transformer

## The LEWCOS H.F. CHOKE

"The High-frequency Choke is one of the most important components used in modern radio."

The above is quoted in Mr. J. H. Reyner's article on chokes in the June issue of this Journal, and, being true, it is essential, in order to obtain the most efficient results, to fit in your set a choke of unparalleled success—the Lewcos H.F. Choke.

The Lewcos Choke is "The most efficient choke we have tested" and "Its design places it in the front rank of high-class components," writes Industrial Progress (International) Ltd., of Bristol.

A fully descriptive leaflet, Ref. R.33, giving tested values, will be sent on request.

STOCKS HELD AT THE FOLLOWING BRANCHES:

BELFAST  
BIRMINGHAM  
CARDIFF  
DUBLIN  
GLASGOW  
LEEDS  
LIVERPOOL  
LONDON  
MANCHESTER  
NEWCASTLE  
NOTTINGHAM

THE LEWCOS LOW-FREQUENCY TRANSFORMER ILLUSTRATED ON THE LEFT IS SPECIFIED FOR THE "NEW LODSTONE THREE" RECEIVER DESCRIBED IN THIS ISSUE.

Full particulars will be sent on request.



THE LONDON ELECTRIC  
WIRE COMPANY AND  
SMITHS LIMITED,  
Church Road, Leyton,  
London, E.10.

LEWCOS RADIO PRODUCTS FOR BETTER RECEPTION

Editor:  
BERNARD E. JONES

Technical Editor:  
J. H. REYNER,  
B.Sc. (Hons.), A.M.I.E.E.

# Wireless Magazine

The Best Shillingsworth in Radio

Vol. XII :: AUGUST, 1930 :: No. 67

Research Consultant:  
W. JAMES

Assistant Editor:  
D. SISSON RELPH

## Fair Game

THE B.B.C. is always fair game. A host of publications with nothing much else to say find a fierce joy in attacking the B.B.C. and all it stands for, but we have ever held the opinion that while the B.B.C., like any other institution, has its faults, it is yet up against the most appalling task that ever confronted mortal man, and personally when doing our own little bit in the way of detailed criticism, we have always tried to appreciate its unenviable position.

If you wish to get a tiny idea as to how difficult its job is, just start the subject of the broadcast programme in any company you may happen to be in. You are unlikely to get any three members—perhaps any two—of the company to agree that they like any particular feature of the programme, although many will agree to dislike it.

But the B.B.C.'s task is to please a few million people and such a task is quite beyond human possibility, which does not mean to say that in consequence the B.B.C. must be exempt from criticism. It is a public institution; it expects criticism, but it has to be very chary in acting on it, because a critical minority tends to be noisy while a more or less satisfied majority is frequently dumb.

If there is one point, however, at which the B.B.C. has left itself more than usually open to attack, it is the alternative programme. The public will never understand why there should be a sermon from one station and exactly at the same time a sermon from another; why there should be vaudeville coming from one and light songs and dance music from another.

The true alternative programme is the B.B.C.'s way out of many of its difficulties; and the B.B.C. should, in my opinion, concentrate every energy on giving us that alternative at every moment of broadcasting time. You will read W. Hadfield Craven's article in this issue with amusement and interest. He criticises the timing of the programme—I don't pretend that everybody will agree with him—and then having as he says "exposed the illogicalities" he sets forth his own project of an alternative programme.

I know in advance that he will be "up against it." He is placing his sacrilegious finger on the Sunday programme. So would I if I thought I could do any good by so doing. The "alternative" programme just attempted on week days simply disappears altogether on Sundays, but Mr. Hadfield Craven will find that at this part of his project he will be opposing strong vested interests and although one of these days his rational idea will win out, it will not be yet awhile.

For the constructor we offer in our pages this month four or five particularly interesting examples. A four-valve portable, the Foursome, particularly suited to the beginner; the New Lodestone Three, based on a design evolved by W. James and appealing to people who still prefer three-electrode valves rather than the screened-grid type; the Universal Push-pull Amplifier, whose purpose is to assist a small set to get really good volume from a large loud-speaker; and the Outspan Short-wave Unit, with which any set with a stage or more of low-frequency amplification can be rapidly adapted for ultra-short wave work.

B.E.J.

## CONTENTS

	Page		Page
Valves to Use on Your Set ..	2	The Universal Push-pull Amplifier. Adaptable for Use with Any Set ..	49
Wavelengths of the World's Broadcasters ..	8	Nursery Rhymes Radio-vised! ..	52
In Tune with the Trade. By Fetter Lane ..	10	14,000 Miles with a Reinartz Three	53
Broadcast Identification Sheets. Compiled by Jay Coote ..	12	Half a Guinea for a Suggestion ..	53
Found, An Alternative Programme. By W. Hadfield Craven ..	15	Too Many Stations in the Argentine! ..	55
The Foursome. A Screened-grid Portable with Single Tuning Control ..	18	Results with the James Portable S.G.3. By W. James ..	56
Capt. Eckersley and the "Wireless Magazine" ..	22	Broadcast Music of the Month ..	57
Under My Aerial. Halyard's Chat on the Month's Topics ..	23	Reader's Report on "W.M." Three-valvers ..	59
When You Ask a Query ..	24	A Wireless Alphabet ..	61
The Inductor Loud-speaker. By D. Sisson Relph ..	26	Leaves from a Listener's Log. By Jay Coote ..	62
Cutting Out Hum on Your Mains Set ..	26	We Test Before You Buy:	
Making the 1930 Binowave Coils. By W. James ..	27	Philips Portable ..	63
Mains Power for Your Portable ..	31	Cecophone Battery Three-valver	64
The New Lodestone Three. Constant H.F. Neutralising on All Waves ..	33	Gambrell All-electric Two ..	65
A Talk About Talks ..	38	A Fuse Will Make Your Valves Safer! ..	66
The Poets Foretell Radio ..	39	The Outspan Short-wave Unit. Makes Ultra-short Wave Reception Possible with Almost Any Set	67
The Buyers. Verse ..	39	Two Well-known Soloists ..	72
Give Us Better British Sets! By Alan S. Hunter ..	40	<b>GRAMO-RADIO SECTION</b>	
Amongst the Radio Artistes. Caricatures ..	41	Around the Turntable. Records Reviewed by Whitaker-Wilson ..	74
Radio Parts Made from Powder! Professor Megohm Visits a Factory ..	42	What is the Pressure from a Pick-up? By J. H. Reyner, B.Sc., A.M.I.E.E. ..	77
A "Peep" at the Northern Regional. By Kenneth Ullyett ..	44	Soundbox Diameter ..	78
Overloading Your Detector ..	45	Running-out Grooves ..	78
The Earth That Wasn't! ..	45	Our Tests of New Apparatus ..	80
Amplifiers for Television. By H. J. Barton Chapple, Wh.Sc., B.Sc.	46	Buyer's Guide to Sets ..	81
Protecting Your Filaments ..	48	Notes and Jottings ..	82
A Hum Filter ..	48	Current Comments ..	84
		Reference Sheets. Compiled by J. H. Reyner, B.Sc., A.M.I.E.E. ..	86
		Index to Advertisers ..	88

Published by BERNARD JONES PUBLICATIONS, LTD., publishers of "Wireless Magazine" and "Amateur Wireless." Editorial and Advertisement Offices: 58-61 Fetter Lane, London, E.C.4. Telephone: City 3733, 3734. Telegrams: "Beejapee, Fleet, London." Published about the 23rd day of the month and bears the date of the month following. Subscription: Great Britain and Abroad, 15s. 6d. a year, post free (Canada only, 13s. 6d.) Contributions are invited and will be promptly considered.

Next Month: A Special Two-valver with Full-size Wiring Chart

Registered at the General Post Office for Transmission by Canadian Magazine Post



# Now you can improve your set

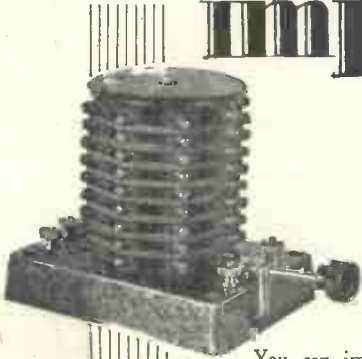

You can improve it cheaply, too. The new Watmel Universal Dual Wave Tuner is now ready. With this new Tuner you can obtain clear and uninterrupted reception without the use of a wave-trap.

Not only are circuits more selective with this tuner, but owing to the loose reaction coupling they are extremely stable.

Wave length range 200-600 metres and 1,000-2,000 metres—controlled by a 3-point switch with absolutely positive action.

Write for leaflet No. D/100, giving full details of how to incorporate this new Type 31 Tuner in any circuit.

The New Watmel Universal Dual Wave Tuner Type 31, PRICE

# 17'6

See test report in next month's issue

## WatMel

WATMEL WIRELESS CO., LTD.,  
Imperial Works, High Street, Edgware,  
Edgware 0323 M.C.9

# TESTS OF TIME

## Big Ben stands for...

... reliability and accuracy all the world over. It is a standard by which time itself is judged.

T.C.C. too, is a standard—a standard by which other condensers are judged—a standard of accuracy, reliability and dependability. The letters T.C.C. are an assurance of good service—recommended by experimenters, scientists and amateurs alike—the famous “condenser in the green case.” So, remember this, when next you ask for a condenser.

## STAGE BY STAGE

*this tester proves your valves & set*

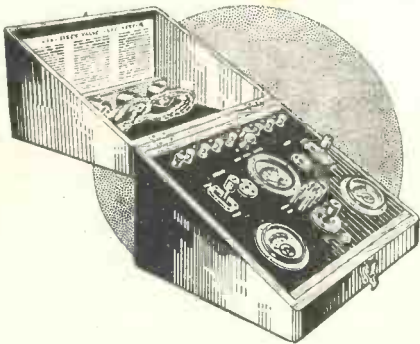

When you want to prove the performance of your set; when there are faults which you cannot locate; when you want to test it stage by stage—A.C. or D.C. Valves, batteries or H.T. Eliminators—for output, voltage, current and performance—use the SIX-SIXTY Valve and Set Tester. The SIX-SIXTY Valve and Set Tester saves time and money—you can get the highest pitch of performance without any costly experiments. Price £8 : 16 : 3.

## SIX-SIXTY VALVE & SET TESTER

Made by the makers of the famous Six-Sixty Valves.

Six-Sixty Radio Co. Ltd., Six-Sixty House, 17/18, Rathbone Place, Oxford Street, W.1. Telephone: Museum 6116-7.

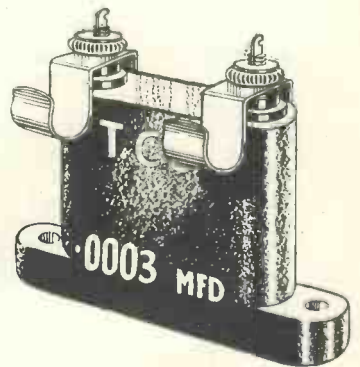

Illustrated above is a .0003 mfd. T.C.C. Upright Type Mica Condenser. Price 1/6 each. Other capacities in this type are made from .0001 mfd. to .25 mfd. Prices 1/6 to 18/-.

## BIG BEN

ADVERT. OF THE TELEGRAPH CONDENSER Co. Ltd. N. ACTON, W.3



1983

There is news in the “Wireless Magazine” advertisements

Make	Type	Impedance	Amp. Factor	Fila-ment Current	Mu-tual Con-duct.	Max. An-ode Volt.	G.B. at 100 volts	G.B. at 150 volts
<b>SIX-VOLT THREE-ELECTRODE VALVES—contd.</b>								
Marconi ...	LS5B	25,000	20	.8	.8	400	3.0 (at 200v.)	9.0 (at 400v.)
Lissen ...	HL610	21,000	25	.1	1.2	150	1.5	3.0
Cossor ...	610HF	20,000	20	.1	1.0	150	1.5	3.0
Cossor ...	680HF	20,000	27	.8	1.35	400	—	—
Mazda ...	HL607	15,200	20	.07	1.0	150	1.5	3.0
Six-Sixty ...	6075HF	14,700	17	.075	1.1	150	2.0	4.0
Mullard ...	PM5X	9,250	17.5	.075	1.2	150	3.0	4.5
Six-Sixty ...	D610	9,000	18.5	.1	2.0	150	—	4.0
Lissen ...	L610	9,000	18	.1	2.0	150	3.0	4.5
Mullard ...	PM6D	7,500	18	.1	2.0	150	3.0	4.5
Cossor ...	610LF	7,500	15	.1	2.0	150	3.0	4.5
Marconi ...	L610	7,000	15	.1	2.0	150	2.0	4.0
Osram ...	L610	7,000	15	.1	2.0	150	1.5	4.5
Marconi ...	DE5	7,000	7	.25	1.0	140	4.5	10.0
Cossor ...	680P	6,000	5.5	.8	.92	400	—	—
Marconi ...	LS5	6,000	5	.8	.87	400	20.0 (at 200v.)	50.0 (at 400v.)
Osram ...	LS5	4,000	5	.8	.83	400	6.0	10.5
Six-Sixty ...	610P	4,000	7.2	.1	1.22	150	6.0	10.5
Lissen ...	P610	4,000	8	.1	2.0	150	6.0	10.5
Marconi ...	DE5A	3,550	3.5	.25	.87	120	12.0	16.0 (at 120v.)
Mullard ...	PM6	3,550	8	.1	2.25	150	6.0	9.0
Cossor ...	610P	3,500	8	.1	2.28	150	4.5	7.5
Marconi ...	P610	3,500	8	.1	2.28	150	6.0	9.0
Osram ...	680XP	2,750	3	.8	2.3	150	6.0	9.0
Cossor ...	LS5A	2,500	2.5	.8	1.1	400	—	—
Marconi ...	LS5A	2,500	2.5	.8	.91	400	40.0 (at 200v.)	100.0 (at 400v.)
Osram ...	625P	2,400	7	.25	.91	200	6.0	9.0
Cossor ...	P625	2,400	7.5	.25	2.8	200	6.0	9.0
Lissen ...	P625B	2,000	7	.25	3.0	200	12.0	15.0
Mazda ...	P625	2,000	6	.25	2.5	250	6.0	24.0 (at 250v.)
Osram ...	P625	2,000	6	.25	2.5	250	6.0	12.0
Cossor ...	610XP	1,850	5	.1	2.5	150	12.0	22.5
Mullard ...	PM256	1,780	6	.25	3.25	180	9.0	18.0
Six-Sixty ...	625SP	1,600	5.8	.25	3.25	180	12.0	22.0
Marconi ...	P625A	1,600	3.7	.25	2.3	200	13.5	36.0 (at 200v.)
Mazda ...	P625A	1,500	4	.25	2.5	200	10.0	20.0
Osram ...	P625A	1,500	3.7	.25	2.3	200	13.5	24.0
Lissen ...	P625A	1,400	4.5	.25	3.0	200	13.5	24.0
Cossor ...	620I	1,400	3.2	1.6	2.3	400	—	—
Mullard ...	P256A	1,300	3.6	.25	2.6	200	—	—
Mazda ...	P650	1,300	3.5	.5	2.7	200	12.0	25.0

(Continued on page 6)

Make	Type	Impedance	Amp. Factor	Fila-ment Current	Mu-tual Con-duct.	Max. An-ode Volt.	G.B. at 100 volts	G.B. at 150 volts
<b>FOUR-VOLT THREE-ELECTRODE VALVES—contd.</b>								
Six-Sixty ...	410P	4,200	7.7	.1	1.85	150	6.0	9.0
Cossor ...	410P	4,000	8	.1	2.0	150	4.5	9.0
Dario ...	Hyper P	2,700	5	.15	1.8	200	12.0	17.5
Marconi ...	P425	2,300	4.5	.25	1.95	150	9.0	16.5
Osram ...	P425	2,250	4.5	.25	1.95	150	9.0	16.5
Lissen ...	P425	2,000	4	.15	2.8	150	12.5	19.5
Cossor ...	415XP	2,000	4	.15	2.0	150	12.0	22.5
Mullard ...	PM254	1,950	4.2	.18	2.1	150	13.5	22.5
Six-Sixty ...	420SP	1,950	3.5	.25	2.0	150	12.0	22.0
Mazda ...	P425	1,050	3.5	.6	1.8	150	14.0	26.0
Marconi ...	PX4	1,050	3.5	.6	3.3	200	1.5	30.0 (at 200v.)
<b>FOUR-VOLT SCREENED-GRID VALVES</b>								
Dario ...	SG	250,000	250	.075	1.0	200	—	1.5
Mullard ...	PM14	230,000	200	.075	.87	150	—	—
Six-Sixty ...	4075SG	220,000	190	.075	.87	150	—	—
Cossor ...	410SG	200,000	200	.1	1.0	100	1.5	1.5
Marconi ...	S410	200,000	180	.1	.9	150	1.5	1.5
Osram ...	S410	180	180	.1	.9	150	—	—
Lissen ...	SG410	180	180	.1	.9	150	—	1.5
<b>FOUR-VOLT PENTODE VALVES</b>								
Dario ...	Pent.	55,000	100	.15	1.8	160	6.0	15.0
Six-Sixty ...	SS4 Pent.	53,000	83	.275	1.55	300	10.0	14.0
Marconi ...	PT425	50,000	100	.25	2.0	150	4.7	7.5
Osram ...	PT425	28,000	62	.15	2.3	150	4.0	7.5
Mullard ...	PM24	27,000	60	.15	2.2	150	6.0	12.0
Six-Sixty ...	415PP	25,000	50	.275	2.0	300	6.0	10.5
Mullard ...	PM24A	22,500	180	.25	2.0	150	7.5	10.5
Lissen ...	PT425	20,000	40	.15	2.0	150	6.0	9.0
Cossor ...	415PT	20,000	40	.15	2.0	150	6.0	9.0
Mazda ...	425Pen.	—	—	.25	2.0	150	14.0	14.0
<b>SIX-VOLT THREE-ELECTRODE VALVES</b>								
Mazda ...	H607	90,000	40	.07	.45	150	.8	1.5
Cossor ...	610RC	60,000	40	.1	.66	150	—	1.5
Lissen ...	H610	60,000	40	.1	.67	150	1.5	1.5
Marconi ...	H610	58,000	42	.075	.7	150	1.0	1.5
Osram ...	6075RC	53,000	40	.075	.75	150	1.5	1.5
Six-Sixty ...	PM5B	30,000	30	.1	1.0	150	1.5	1.5
Mullard ...	HL610	30,000	20	.25	.67	150	1.5	3.0
Marconi ...	DE5B	30,000	30	.1	1.0	150	1.5	3.0
Osram ...	HL610	30,000	30	.1	1.0	150	1.5	3.0

# WHEN BUYING VALVES! REMEMBER!



**When the R100  
was lost in fog  
MARCONI VALVES  
gave her position  
through Wireless  
Direction  
Finders**

**Marconi Valves are used by Imperial Airways—  
B.B.C. Stations—Metropolitan Police—Trinity House  
Lightships and Beacon Stations—Croydon Control  
Tower, etc., etc. They are chosen for unflinching  
dependability.**

Perfect quality demands the best L.F. Valves, and remember—the first L.F. stage is as important as the output stage. Marconi Valves possess all the qualities needed for first L.F. stage efficiency—good magnification factor—low impedance—large grid face capable of handling a generous grid swing, so giving a magnificent undistorted output to the last valve. **These are the famous Marconi Valves which will improve first L.F. stage performance. L.210, 2 Volt; L.410, 4 Volt; L.610, 6 Volt; M.L.4, A.C. mains and indirectly heated.**

# MARCONI VALVES



Better service results from mentioning "Wireless Magazine" when writing to advertisers

# VARLEY FOUNDED ON QUALITY

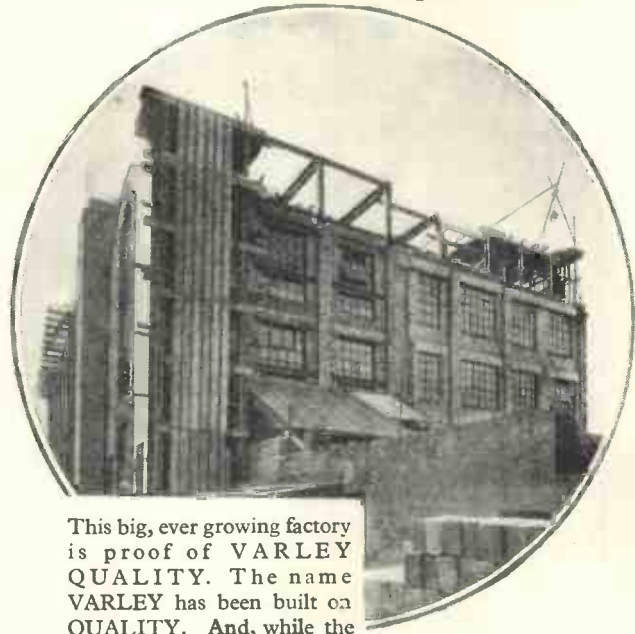

This big, ever growing factory is proof of VARLEY QUALITY. The name VARLEY has been built on QUALITY. And, while the Varley building grows, VARLEY All-electric Sets and Radio-Gramophones are being made in even greater numbers—and they still keep that quality which has made VARLEY famous. Varley quality is within everybody's reach. VARLEY All-Electric sets and Radio-Gramophones are now available on convenient Hire Purchase terms. Your dealer will demonstrate.

**All-Electric  
2-Valve Receiver**  
*(as illustrated)*  
**(A.C. or D.C.)  
16 Gns.**

*Marconi Royalty 15/-  
extra.*

**All-Electric  
3-Valve Receiver**  
**(A.C. or D.C.)  
25 Gns.**

*Marconi Royalty 20/-  
extra.*



*Advertisement of Oliver Pell Control Ltd., Kingsway House, 103 Kingsway, London, W.C.2. Telephone: Holborn 5303.*

Valves to Use in Your Set—Continued

Make	Type	Impedance	Amp. Factor	Fila-ment Current	Max. An-ti-con-duct. Volt.	G.B. at 100 volts	G.B. at 150 volts
<b>SIX-VOLT THREE-ELECTRODE VALVES</b>							
Marconi ...	LS6A	1,300	3	1.6	2.3	36.0 (at 200v.)	93.0 (at 400v.)
Osram ...	LS6A	800	3	1.6	2.3	400	—
Cossor ...	660T	—	2.25	4.0	2.25	500	—
<b>SIX-VOLT SCREENED-GRID VALVES</b>							
Six-Sixty	SS6075SG	210,000	190	.075	.9	150	—
Cossor ...	610SG	—	200	.1	1.0	150	1.5
Mullard ...	PM16	—	200	.075	1.0	150	—
Marconi ...	S610	200,000	210	.1	1.05	150	1.5
Osram ...	S610	—	210	.1	1.05	150	—
Marconi ...	S625	175,000	110	.25	.63	—	—
<b>FOUR-VOLT ONE-AMPERE A.C. VALVES</b>							
Mullard ...	S4V	1,330,000	1,000	1.0	.75	200	—
Six-Sixty	SS4SGAC	800,000	1,000	1.0	.75	150	—
Mazda ...	AC/SG	—	1,200	1.0	2.0	150	.5
Marconi ...	MS4	500,000	550	1.6	1.1	200	3.0 (at 200v.)
Osram ...	MS4	—	550	1.0	1.1	200	—
Cossor ...	MSG41	500,000	550	1.0	1.1	200	1.5
Mullard ...	S4VA	430,000	1,300	1.0	3.5	200	—
Marconi ...	MH4	—	35	1.0	1.5	200	3.0 (at 200v.)
Osram ...	MH4	23,000	35	1.0	1.5	200	—
Cossor ...	M41RC	20,000	35	1.0	1.75	180	3.0
Six-Sixty	SS4GPAC	14,500	35	1.0	2.4	180	3.0
Cossor ...	M41HF	14,000	25	1.0	1.8	180	3.0
Mullard ...	354V	13,500	25	1.0	2.5	180	4.5
Mazda ...	AC/HL	—	35	1.0	2.6	200	3.0
Marconi ...	MHL/4	8,000	16	1.0	2.0	200	6.0 (at 200v.)
Osram ...	MHL/4	—	16	1.0	2.0	200	6.0
Cossor ...	M41LF	7,900	15	1.0	1.9	180	6.0
Six-Sixty	SS4Det. AC	7,000	16	1.0	2.3	180	8.0
Mullard ...	164V	6,650	16	1.0	2.4	180	10.5
Cossor ...	M41P	5,000	10	1.0	2.0	180	7.5
Marconi ...	ML4	—	6	1.0	2.0	200	22.0 (at 200v.)
Osram ...	ML4	3,000	6	1.0	2.0	200	16.0
Six-Sixty	SS4PAC	2,850	10	1.0	3.3	180	8.0
Mullard ...	104V	2,650	10	1.0	3.5	200	10.5
Mazda ...	AC/P	—	10	1.0	3.75	200	12.0
Cossor ...	M41XP	2,000	4	1.0	2.0	180	19.5
Mazda ...	AC/PI	—	5	1.0	2.5	200	25.0

**BULGIN**  
RADIO PRODUCTS

FOR THE  
"OUTSPAN"  
SHORT WAVE ADAPTOR

**BULGIN S.W. Chokes** have a reputation unsurpassed for efficiency on all wavelengths from 8 to 80 metres. **3/- EACH**

**DECKOREM**  
4-pin Cable Plugs. New improved pattern, moulded in polished black bakelite. **2/- EACH**

Send for our 56pp. Catalogue. Enclose 2d. postage.

Obtainable from all the best dealers.  
**A. F. BULGIN & CO. LTD.,**  
9-10-11 Cursitor St., Chancery Lane, E.C.4.

A condenser cannot live to fail twice! A Hydra cannot fail to live throughout the lifetime of your set—and longer! Hydra condensers never fail—they do not leave our factory until we are satisfied of that!

**HYDRA**  
LOUIS HOLZMAN LTD.  
37 Newman Street, W.1  
Telephone: Museum 2641

**ELECTRIFY YOUR SET**  
WITH A  
**PYE ELIMINATOR**

**FOR £3:5:0** (Original Price £5)  
Cash with order or C.O.D., packing and postage free.

THESE efficient eliminators are suitable for A.C. mains of 200/250 volts, 40/100 cycles. They can be used with all portables and sets taking up to 20/30 milliamps. All these eliminators carry **THE FULL PYE GUARANTEE**, and are supplied complete with instructions, 10 feet of flex and an adaptor for connecting up.

Trade Enquiries Invited.  
We have also in stock every conceivable proprietary make of valves and components for the building and maintaining of sets and diagrams. Our show-rooms also contain a most varied selection of well-known receivers ready for demonstration.

Pay us a call, and inspect at your leisure our remarkable radio display. If this is not convenient, write for list giving full details and terms for everything connected with radio and gramophones. Records supplied post free.

**RADIO & GRAMOPHONES**  
245 TOTTENHAM COURT ROAD, W.1  
Telephone: Museum 0918



# BURTON AGAIN!

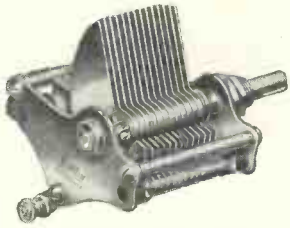

## "FOURSOME" PORTABLE

**BURTON SUPER METAL END PLATE CONDENSER**  
Designed to occupy a minimum of space. Without dial, .0005 **7/-**

## "OUTSPAN SHORT-WAVE ADAPTOR"

**BURTON BINOCULAR H.F. CHOKE**  
Designed to avoid peaks and external magnetic field. Covers a waveband of 50-3,000 metres. Price **5/9** each.

BurTon's well-known Variable Condensers have been specially selected for the "Foursome" Portable 4. The BurTon Binocular H.F. Choke is specified for the "Outspan Short-wave Adaptor" described in this issue. Place your confidence in BurTon Components!



# BURTON COMPONENTS

C. F. & H. BURTON, Progress Works, Walsall

## HEAR AND MARVEL

at the new Farrand Inductor Loud Speaker. Moving coil quality without its drawbacks **£3 : 12 : 6**. Amazingly natural tone. Ask to hear it.

**THE LATEST ELIMINATORS** and all-mains units specially made for portables and built-in sets from **£2 : 10 : 0** to **£6 : 0 : 0**.

**THE NEW BLUE SPOT UNITS** and chassis now in stock  
66 R unit, **35/-**  
Chassis, **15/-**  
66 P unit, **27/6**  
Chassis, **15/-**

**WILL DAY LTD**  
19 LISLE ST., LEICESTER SQUARE  
W.C.2

Phone : Regent 0921/22

# JUNIT

## 2 PUSH-PULL SWITCHES

Specified in the "Foursome" four valve portable described in this issue.

Price **1/6** each

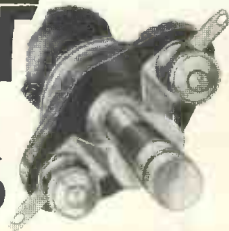

The JUNIT Manufacturing Co., Ltd.  
2 Ravenscourt Square  
London, W.6

Phone : Riverside 0274

# JUNIT

M.Cro4.

When replying to advertisements, please mention "Wireless Magazine"

# THEY'RE ALL JUDGED AGAINST THE HEGRA

OBTAINABLE FROM ANY DEALER

"It's nearly as good as the Hegra"—that is what hundreds of people say about many fine loud-speakers.

All over the country people are looking upon the New Hegra MAGNET DYNAMIC Loud-speaker as the finest yet produced—a speaker against which all others are judged.

The quality of reproduction is astounding, being equal to that of a moving coil, and yet no field energising current is required. It will handle with ease an input up to 4 watts. It costs no more than the ordinary cone type loud-speaker, but will give sufficient volume to fill a large hall.

CHASSIS FORM (as illustrated) **£2 16 0**  
IN POLISHED WALNUT CABINET **£5 10 0**

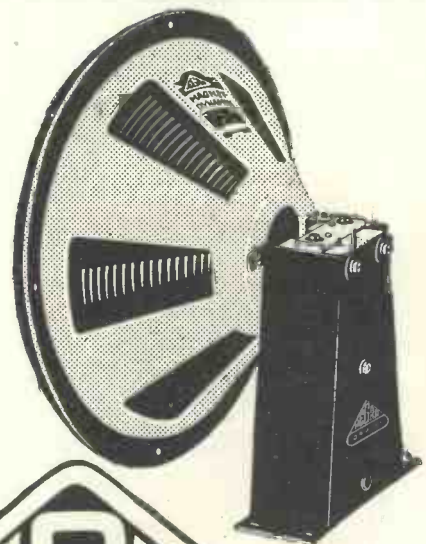

# WAVELENGTHS OF THE WORLD'S BROADCASTERS

Wave-length	Name of Station	Dial Readings	Country	Wave-length	Name of Station	Dial Readings	Country
16.6	Bandoeng (PLF)		Java	329	Grenoble		France
16.8	Huizen (PHI)		Holland	330	Petit-Parisien		France
19.4	Schenectady (W2XAD)		United States	332	Naples		Italy
19.8	Pittsburgh East (W8XK)		United States	335	Posnan		Poland
25.4	Vienna		Austria	338	Forest		Belgium
25.4	Rome		Italy	342	Brunn		Czecho-Slovakia
25.2	Pittsburgh East (W8XK)		United States	349	Barcelona (EAJ1)		Spain
25.53	Chelmsford (G5SW)		Great Britain	352	Graz		Austria
29	Radio Experimental (Paris)		France	356	London Regional		Great Britain
31.3	Sydney (2FC)		Australia	360	Stuttgart		Germany
31.28	Eindhoven		Holland	364	Algiers		North Africa
31.38	Zeesen		Germany		Bergen		Norway
31.5	Schenectady (W2XAF)		United States	368	Frederiksstad		Norway
31.6	Lynby		Denmark		Seville (EAJ5)		Spain
32.6	Paris, Eiffel Tower (FL)		France	370	Radio LL (Paris)		France
32.58	Sydney (2BL)		Australia	372	Hamburg		Germany
40	Doberitz (AFK)		Germany	377	Manchester (2ZY)		Great Britain
41	Radio Vitus		France	381	Lvov		Poland
49.7	Motala		Sweden	385	Radio Toulouse		France
49.7	New York (W2XAL)		United States	385	Wilno		Poland
50	Moscow (RFN)		Russia	386	Genoa (IGE)		Italy
58	Prague		Czecho-Slovakia	390	Frankfurt		Germany
67.6	Doberitz (AFK)		Germany	394	Bucharest		Roumania
80.2	Rome		Italy	399	Glasgow (5SC)		Great Britain
175	St. Quentin		France	408	Berne		Switzerland
200	Leeds (2LS)		Great Britain	408	Kattowitz		Poland
206	Antwerp		Belgium	413	Dublin (2RN)		Irish Free State
206	Budapest		Hungary	416	Radio Maroc		North Africa
210	Chatelineau		Belgium	418	Berlin		Germany
216	Beziers		France	424	Madrid (EAJ7)		Spain
219	Helsinki		Finland	424	Madrid (EAJ7)		Spain
221	Cork (IFS)		Irish Free State	436	Belgrade		Jugoslavia
225	Cologne		Germany	436	Stockholm		Sweden
227	Malmö		Sweden	441	Rome		Italy
231	Kiel		Germany	445	Rjukan		Norway
232	Nimes		France	447	Paris (Ecole Sup. PTT)		France
236	Bordeaux (Sud-Ouest)		France		Bolzano (IBZ)		Italy
238	Binche		Belgium	453	Klagenfurt		Austria
239	Nürnberg		Germany		Danzig		Germany
242	Belfast (2BE)		Ireland		Anlesund		Norway
242	Ghent		Belgium		Tromsø		Norway
244.7	Cassel		Germany		Porsgrund		Norway
244	Linz		Austria	459	Zurich		Switzerland
246	Schaenbeek		Belgium	462	San Sebastian		Spain
249	Juan-les-Pins		France	466	Lyons (PTT)		France
253	Gleitwitz		Germany	473	Langenberg		Germany
256	Toulouse (PTT)		France	479	Midland Regional		Great Britain
257	Hörby		Sweden	487	Prague		Czecho-Slovakia
259	Leipzig		Germany	493	Oslo		Norway
261	London National		Great Britain	501	Milan		Italy
263	Moravska-Ostrava		Czecho-Slovakia	509	Brussels (No. 1)		Belgium
265	Lille (PTT)		France	517	Vienna		Austria
266	Barcelona (EAJ13)		Spain	525	Riga		Latvia
268	Kaiserslautern		Germany	533	Munich		Germany
270	Kaiserslautern		Germany	542	Sundsvall		Sweden
272	Rennes		France	550	Budapest		Hungary
276	Königsberg		Germany	560	Augsberg		Germany
279	Bratislava		Czecho-Slovakia	566	Hanover		Germany
279	Copenhagen		Denmark	570	Freiburg		Germany
281	Innsbruck		Austria	680	Lausanne		Switzerland
283	Magdeburg		Germany	720	Moscow		Russia
283	Stettin		Germany	760	Geneva		Switzerland
283	Berlin		Germany	770	Ostersund		Sweden
287	Radio Lyons		France	800	Kiev		Russia
287	Montpellier		France	824	Svendlovsk		Russia
287	Swansea (5SX)		Great Britain	840	Nijni		Russia
287	Stoke-on-Trent (6ST)		"	934	Moscow		Russia
287	Sheffield (6LF)		"	1,000	Leningrad		Russia
287	Plymouth (5PY)		"	1,010	Basle		Switzerland
287	Liverpool (6LV)		"	1,060	Tiflis		Russia
288.5	Hull (6KH)		"	1,071	Scheveningen-Haven		Holland
288.5	Edinburgh (2EH)		"	1,073	Hilversum		Holland
288.5	Dundee (2DE)		"	1,073	Rostov		Russia
288.5	Bournemouth (6BM)		"	1,103	Moscow Popoff		Russia
288.5	Bradford (2LS)		"	1,153	Kalundborg		Denmark
288.5	Newcastle (5NO)		"	1,200	Boden		Sweden
291	Turin		Italy		Istanbul		Turkey
293	Kosice		Czecho-Slovakia	1,250	Reykjavik		Iceland
295	Limoges		France	1,251	Tunis Kaobah		North Africa
296	Reval		Estonia	1,304	Boden		Sweden
299	Hilversum (between 12.40 and 6.40 p.m. B.S.T.)		Holland	1,348	Kharkov		Russia
301	Aberdeen (2BD)		Great Britain	1,380	Motala		Sweden
306	Bordeaux (PTT)		France	1,411	Bakou		Russia
306	Zagreb (Agram)		Jugoslavia	1,446	Warsaw		Poland
309	Radio Vitus		France	1,500	Eiffel Tower, Paris		France
310	Cardiff (5WA)		Great Britain	1,554	Moscow (Kom)		Russia
313	Cracow		Poland	1,635	Midland National		Great Britain
315	Bremen		Germany	1,725	Zeesen		Germany
315	Marseilles (PTT)		France	1,796	Radio Paris		France
320	Dresden		Germany	1,875	Lahti		Finland
322	Göteborg		Sweden	1,935	Huizen		Holland
325	Breslau		Germany	1,961	Kaunas		Lithuania
					Ankava		Turkey



# The ORIGINAL Jelly Acid Battery

The popularity of the C.A.V. Jelly Acid Battery is not explained by the mere fact that it contains jelly electrolyte—there are other jelly electrolyte batteries! There are three reasons why the C.A.V. is the most effective non-spillable yet produced.

**The Jelly Acid.** Its composition is unknown outside our own laboratories. It maintains perfect contact with the whole of the plate surfaces, yet allows unrestricted gassing when on charge. It is chemically pure, and allows maximum conductivity.

**The Container.** Of special construction, contains a baffle plate and moistening pad, which serves the triple purpose of arresting acid spray during charge, feeding the electrolyte with moisture to maintain an even consistency, and definitely confines the jelly to the plate chamber.

**The Plates.** These have been specially developed to give the utmost possible capacity when used with C.A.V. Jelly Acid.

**The Whole.** The C.A.V. is the lightest, cleanest, and most compact non-spillable on the market. By avoiding cumbersome acid traps, the greatest possible capacity for bulk is obtained.



Obtainable from our Depots and Battery Agents throughout the country and from all Radio Dealers.

\* The "Foursome Portable" in this issue is designed to take the 2NS21, capacity 25 amps. Price 18s.



## Compact, Clean & Non-Spillable

We issue a useful booklet on the care and maintenance of C.A.V. non-spillable batteries. Would you like a copy? Free on request to Dept. I.4.

## Hear Radio Programmes at Their Best

Whiteley Boneham Loud-speakers are noted for their fidelity and signal strength.

The ALL Bakelite Model has added greatly to their reputation.

It is highly sensitive and has pure, mellow tone, while at the same time giving huge volume without a semblance of overloading.

Popularly priced at 42/-.

Hear it demonstrated at your Dealers.



42/-

**WB**

**WHITELEY BONEHAM & CO., LTD.,**  
Nottingham Road, Mansfield, Notts.  
Telephone: Mansfield 762. Telegrams: "Whitebon. Mansfield."  
London Office: 21, Bartlett's Buildings, Holborn Circus, London, E.C.4. Telephone: Central 8745 (3 lines)

# You get more

from your records when you use the

## NOVOTONE

Bass notes cannot be heard at their true value simply because they cannot be cut to their correct depth in the records. To make good these enormous losses, the Novotone was invented.

## Only with the NOVOTONE

can you get "Amazingly Realistic" reproduction

(Vide, "Music Trade Review")



16-PAGE BOOKLET FREE

Write dept. W/M

## GAMBRELL RADIO LTD.

6 BUCKINGHAM ST., STRAND, LONDON, W.C.2

## CLIX

CLIX-LOX ADJUSTABLE WANDER PLUG. Fits any socket. 2½d. each.

"SPRINGSCREW" WANDER PLUG. Vertical or Horizontal Insulators. 2d. each.

Plain or engraved insulators.

Write for full details of CLIX at VARIETIES

LECTRO LINX, LTD.

Prov. Pats. 254, Vauxhall Bridge Road, LONDON, S.W.1.

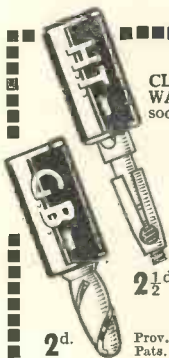

Buy

"Amateur Wireless"

3d.

Weekly

There is news in the "Wireless Magazine" advertisements

# IN TUNE WITH THE TRADE

FETTER LANE'S Review of Catalogues and Pamphlets

## Lewcos for Short Waves

WHEN you want a change from the ordinary programmes broadcast on the "standard" wavebands, have you thought of adapting your set for the very short waves? Such a course is simple with the special adaptor coils described in a leaflet just sent to me by the London Electric Wire Co. and Smiths, Ltd.

These coils are provided with six-pin bases and can be used in place of any split-primary coil immediately preceding the detector valve. They are specially suitable for such famous WIRELESS MAGAZINE sets as the Revelation Four, Five-pounder Four, and Exhibition Five.

With these special adaptor coils—there are aerial coils as well for those who want to build complete short-wave sets—you can cover the range from 20 to 130 metres. A proposition worth looking into, isn't it? **125**

## The Tannoy Way

I AM always amazed at the number of different models of mains units turned out by the firms which make such things. For example, from the Tannoy leaflets, issued by "Tannoy Products" I see that about a dozen types are available for different purposes.

Three of the newest lines are high-tension units—D.C. and A.C.—for portable sets and a trickle charger. All these Tannoy units use Westinghouse metal rectifiers, which is a big recommendation in itself.

If you are still undecided whether to run your set off the mains or not, you had better get the latest Tannoy leaflets—you will then decide to go all out for mains operation! **126**

## Sistoflex and Essellite

PERHAPS it is not going too far to say that these two products will prove the Scylla and Charybdis of the radio constructor, so great are their merits individually!

Sistoflex is a name that has been known in wireless for many, many years. It is a most useful insulated sleeving for covering leads in a set and can be had in all sorts of gay colours, which also have a practical value, because they can be made to indicate various circuits. With Sistoflex you cut the bare wire the right length and then slip the sleeving over afterwards.

Essellite is connecting wire already covered with insulating material of different colours and is sister to Sistoflex (pardon the pun!). Better get details of both and decide which to use for your next set. **127**

## Meet Mr. Full o' Power

YOU really ought to meet the jolly Mr. Full o' Power, of Siemens, for he has a most interesting proposition to make to all battery users—a new 60-volt job of the super-capacity type for 13s. 6d. The size is 11 1/8 in. by 3 3/4 in. by 7 1/8 in., and tappings are provided at 15, 30, 45, and 60 volts.

This Full o' Power battery has lived up to its name on tests and is just the thing for a set that is rather heavy in high-tension consumption. Fifteen milliamperes, I should say, is a discharge well within the safe limit of this battery. **128**

## Ingenious Igranic

WHEN I see all the leaflets that constantly come from the Igranic Electric Co., Ltd., I wish I were a printer and handled their business! As I write I have before me seven leaflets and folders dealing with the latest Igranic activities.

There is a 5-watt extra-stage amplifier, which would be most useful for a garden party; a complete A.C. two-valve set; a particularly neat on-off switch; a switch adaptor for putting a pick-up in circuit without altering the wiring of the set; a response corrector of record reproductions (this is specially worth looking into); an electric gramophone motor; and several models of pick-ups.

With these products you can make a really high-class radio-gramophone which would make all your friends envious—I know I should be! **129**

## SEND TO US FOR THESE CATALOGUES!

As a keen wireless enthusiast you naturally want to keep abreast of all the latest developments and this special feature will enable you to do so with the minimum of trouble and the cost of only 1/2d. for postage.

Here we review the newest booklets and folders issued by eight well-known firms. If you want copies of any or all of them just cut out this coupon and send it to us. We will see that you get all the literature you desire.

Just indicate the numbers (seen at the end of each paragraph) of the catalogues you want below.

My name and address are:—

Send this coupon in an unsealed envelope, bearing 1/2d. stamp, to "Catalogue Service," WIRELESS MAGAZINE, 58/61 Fetter Lane, E.C.4. Valid till Aug. 31

## For the Pye Portable

THERE seems to be no abatement in the demand for mains units for use in portables. I am wondering how long it will take portable-set manufacturers to drop that unhappy term and label their set "transportable," or, better still, "self-contained."

It is obvious that if you run your set off the mains it becomes a "transportable" instead of a true "portable," but never mind, we shall get sorted out sooner or later.

Now Pye are producing special A.C. mains jobs for their own popular "portables." They make an attractive offer of supplying one of these mains units for £1 down, "the price of a new battery." If you own a Pye set, ask for this leaflet. **130**

## Blue Spot 88

RADIO gramophones become more popular day by day and keen fans are always on the look-out for new grammo-radio gadgets. For this reason I was glad to receive the other day an attractive folder describing the Blue Spot 88 pick-up.

This neat gadget has a built-in volume control. Another useful feature is the fact that the business end of the pick-up can be turned through 180 degrees, so that a new needle can be conveniently inserted from above.

With each pick-up is supplied a template for the correct location of the instrument with respect to the turntable. Quite a useful idea, you will agree. **131**

## Do You "Lissen"?

I HAVE just spent a very interesting half-hour in looking through the latest batch of catalogues that Lissen have sent me. The name "Lissen" is very familiar to all home constructors, including myself, and their immense range embraces nearly every wireless component.

If you are thinking of making a set or want a gadget or two, you certainly ought to see these catalogues.

I have found from my own practical experience that all their goods maintain a high standard of efficiency, and I recommend you try them.

I would specially like to draw your attention to their leaflet concerning portable receivers. At this time of the year these sets are very useful for taking with you on a jaunt up the river or out in the car.

If you are interested write to Lissen, Limited, at Worples Road, Isleworth, Middlesex. **132**

# WESTINGHOUSE RECTIFIERS FOR HIGH-TENSION UNITS

200 volts  
100 m.a.



Type H.T.1  
75/-

150 volts. 50 m.a.



Type H.T.4 37/6

120 volts  
20 m.a.



Type H.T.3 21/-



## METAL RECTIFIERS

are unquestionably the most convenient and efficient rectifiers at present available for A.C. Mains working. That is why they are used in such large numbers by the leading set manufacturers

Also Type H.T. 2 350 volts.  
100 m.a.

and various low-tension types for all purposes

Full details of these Units and how to use them are given in our 32-page book "The All-Metal Way, 1930" which tells you all you want to know about A.C. Mains Units. Send 2d. stamp to:—  
THE WESTINGHOUSE BRAKE & SAXBY SIGNAL CO., LTD. :: 82 York Road, King's Cross, London, N.1

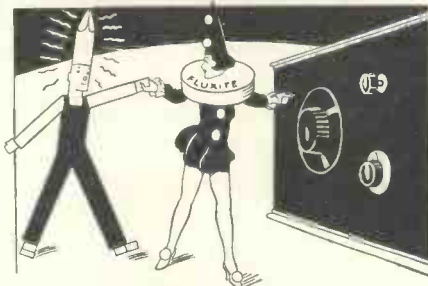

"We're Fluxite and Solder—The reliable pair, Famous for Soldering, Known everywhere! Wherever we go—We're invited to stay, For WE make Soldering Merely child's play!"

See that Fluxite and Solder are always by you—in the house, garage, workshop—anywhere where simple, speedy soldering is needed. They cost so little but will make scores of everyday articles last years longer! For Pots, Pans, Silver and Brassware; RADIO; odd jobs in the garage—there's always something useful for Fluxite and Solder to do.

**ANOTHER USE FOR FLUXITE.** Hardening Tools and Case Hardening. Ask for Leaflet on improved method.  
**FLUXITE SOLDERING SET.** Simple to use and lasts for years in constant use. Contains special 'small-space' soldering iron with non-heating metal handle; pocket blow-lamp, Fluxite, Solder, etc; and full instructions.

All Hardware and Ironmongery Stores sell Fluxite in tins, 8d. 1/4 and 2/8.

COMPLETE 7/6, or LAMP only 2/6.

FLUXITE LTD.,  
(Dept. 332)  
ROTHERHITHE, S.E.16

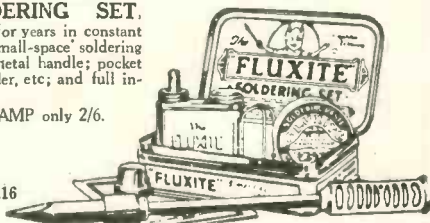

ALL MECHANICS WILL HAVE  
**FLUXITE**  
IT SIMPLIFIES ALL SOLDERING



**DARIO VALVES**

Best way to all Stations!

<b>DARIO PRICES</b>	Bivolt or Forvult
Universal	Super Power 7/6
Resltron	Hyper Power 9/6
Super H.F. } 5/6	Super Power Pentodion 18/6
Super Detector } 6/6	Dario Transformer, Ratios 3-1 or 5-1 5/-

**SCREENODION 15/6**

Write for Free Folder to

**IMPEX ELECTRICAL LTD.**  
Dept K., 538 High Road,  
Leytonstone, London, E.11

Mention of the "Wireless Magazine" will ensure prompt attention

# Broadcast Identification Sheets

For the benefit of readers we are publishing each month a series of panels specially compiled for the WIRELESS MAGAZINE by Jay Coote.

In these, readers will find a ready means of identifying foreign stations. To prevent any confusion in a.m. and p.m., the times are given on the Continental twenty-four-hour system. Example: 8 a.m. = 8.00; 8 p.m. = 20.00.

In the event of alterations in wavelength, power or call, a special panel bearing the alteration will be published at the earliest opportunity.

These identification sheets should be cut out and filed either alphabetically or in order of wavelength as they appear.



314 miles from London

**473m.**  
(635 kc.)

Power: 13 kw.

**LANGENBERG**

(Germany)

Standard Time: Central European.

Call: *Achtung! Achtung! Hier Westdeutsche Funkstunde Langenberg und die Gleichwellensender Koeln Muenster und Aachen.* Abbreviated between items: *Achtung! Koeln und Gleichwellensender.*

Interval Signal: Chimes from Cologne studio, repeated, *ad lib*, as under:



*ad lib.*

Closes down with *Deutschland Ueber Alles* (German National Anthem); Haydn's hymn, *Austria*.  
Common Wave Relays: 227 m. (1,319 kc.) Cologne (2 kw.); Muenster (0.5 kw.); Aachen (0.35 kw.).



596 miles from London

**281m.**  
(1,067 kc.)

Power: .75 kw.

**COPENHAGEN**

(Denmark)

Standard Time: Central European.\*

Announcer: Man.

Call (phonetic): *Karl-oond-borr Key-ob-en-harven.*

(When gramophone records are transmitted, titles are also given in the English language.)

No interval signal, but station opens and closes its transmissions with three strokes on a gong.

In the event of late broadcasts, a time signal and chimes are relayed at midnight (B.S.T.) from Copenhagen Town Hall.

Main Daily Programmes: B.S.T., 13.40, English talk (Sunday); 20.00, evening concert; app. 22.45, dance music (except Mondays and Thursdays); 23.00, English talk (Monday).

All transmissions are relayed by Kalundborg on 1,153 m. (260 kc.), 7.5 kw.

\* Coincides with B.S.T.

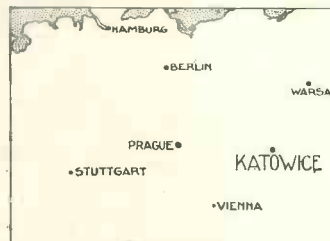

840 miles from London

**408m.**  
(734 kc.)

Power: 10 kw.

**KATOWICE**

(Poland)

Standard Time: Central Europe.\*

Announcer: Woman.

Call (phonetic): *Har-low! Har-low! Pols-key Rah-dee-o Kat-owe-vee-tsay* (also in French: *Allo Ra(h)dio Pologne Katowice*).

Interval Signal: Between items, a metallic sounding metronome. As relays are frequently made from Warsaw, Cracov, Wilno, and Posnan, so these individual signals are also broadcast in the course of the programmes.

Main Daily Programmes: B.S.T., 17.00, 20.00, and 21.00, concerts or relays from Warsaw; 23.00, The Letter Box (answers to foreign correspondents by microphone, Wednesday and Friday); on other nights dance music.

Closes down with Polish National Anthem (*Dombrowski Mazurka*) and good night in Polish and French.

\* Coincides with B.S.T.

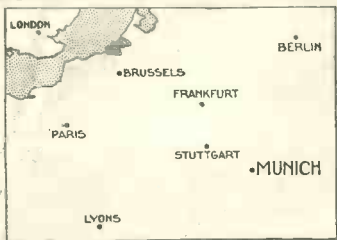

569 miles from London

**533m.**  
(563 kc.)

Power: 1.5 kw.

**MUNICH**

(Germany)

Standard Time: Central European.

Opening Call: *Hier die Bayrischen Sender Muenchen* (phonetic, Mewnschen), *Nuernberg* (Newrenbaerg), *Kaiserslautern* und *Augsburg*. Between items: *Hier Deutsche Stunde in Bayern*.

Interval Signal: Chimes, as under:



followed by a deep-toned hooter. Announcements are made in German only.

Main Daily Programmes: B.S.T., 06.45 (except Sunday), physical exercises; 12.30, light music; 16.25, afternoon concert; 20.00, evening entertainment; 22.30, dance music until midnight (Wednesday and Saturday).

Closes down with National Anthem and usual German formula.  
Relays: Kaiserslautern, 270 m. (1,112 kc., 0.25 kw.); Nuernberg, 239 m. (1,256 kc., 2 kw.); Augsburg 560 m. (536 kc., 0.25 kw.).



1,130 miles from London

**1,796m.**  
(167 kc.)

Power: 40 kw.

**LAHTI**

(Finland)

Standard Time: Eastern European (B.S.T. plus 1 hour).

Announcer: Woman.

Call (for Finnish transmissions): *Huomio! Huomio! taala Suomen yleis-radio Helsinki-Lahti*; for Swedish transmissions: *Giv akt, har Finlandsrundradio Helsingfors-Lahti*.

No special interval signal, but time indicated at 18.00, B.S.T., by one stroke on a gong.

Main Daily Programmes: B.S.T., 18.15, light music; 20.00, principal evening entertainment; 22.00, dance music (Saturday only). Usually closes down at 21.30.

Relays programmes from Helsinki (Helsingfors), which latter transmits on 221 m. (1,355 kc., 10 kw.).

Smaller Relays: Turku (Abo), 246 m. (1,220 kc.), 0.5 kw.; Bjorneborg, 218 m. (1,373 kc.), 0.8 kw.; Pietarsaari (Jakobstad), 246 m. (1,220 kc.), 0.25 kw.; Tampere (Tammerfors), 453 m. (662 kc.), 0.8 kw.; Viipuri (Viborg), 291 m. (1,031 kc.), 0.4 kw.

# Specified for the "LODESTONE 3"



**Igranic "Lokvane"  
Condensers**

.0005	Price	<b>10/6</b>
.0003	Price	<b>9/6</b>

The IGRANIC "LOKVANE" CONDENSER has again been specified by experts. This efficient Variable Condenser possesses several unique features, including specially mounted and rigidly locked vanes, and double self-aligning bearings, resulting in perfect electrical connection, constancy of performance, and complete reliability.

The IGRANIC L.F. TRANSFORMER, TYPE "J," is small, neat and handsome, but has a straight line performance and a purity and constancy of amplification far above any transformer in its priced class. Use it and enjoy truly magnificent magnification.

Write for particulars to Dept. J. 1056.



**Igranic Type "J"  
L.F. Transformer**

Ratio 3:1 and 6:1  
Price - **17/6**



**22/6  
saved!**

Save your Valves. It's the easiest thing in the world to connect your H.T. Battery to your L.T. terminals—the easiest thing in the world to blow your valves—an expensive pastime. If you'd rather be sure than sorry fit a 'Microfu'—it will blow as soon as the current is excessive; it fuses with extreme rapidity. Remember! it is backed by T.C.C., the very hallmark of reliability.

<b>PRICES</b>		<b>PRICES</b>
100-1000 milliamps, <b>1/9</b> each	BACKED BY THE T.C.C.	10 milliamps, <b>3/9</b> each
20-50 milliamps, <b>2/3</b> each		5 milliamps, <b>4/-</b> each

Advt. Telegraph Condenser Co., Ltd., Wales Farm Rd., N. Acton, London, W.3.



**It would be FATAL to lose CONTROL**

Barbed wire—trenches—dug-outs—a field set and a thin strand of wire.  
The difference between control and lack of control may spell life or death to an entire brigade.  
It's a far cry from No Man's Land to the comforts of your home.  
But even in your radio set . . . control plays a vital part . . . and it has been the privilege of CENTRALAB to furnish the volume controls of millions of radio receivers.  
Is your radio—CENTRALAB equipped?

[ Write for Free Booklet, "Volume Control Voltage Controls, their uses." ]

# Centralab

**THE ROTHERMEL CORPORATION LTD.,**  
24 Maddox Street, London, W.1.  
Phone: MAYFAIR 0578/9.  
Continental Sales Office:—  
**27, QUAI DU COMMERCE, BRUSSELS, BELGIUM.**

You will get prompt replies by mentioning "Wireless Magazine"

**CLEAN  
CELLS  
BIG  
CELLS  
yielding  
constant  
power**

THROUGH LONG PROGRAMMES—  
THROUGH MONTHS OF HEAVY USE  
THE SECRET PROCESS OF THE

**LISSEN**

**H.T. BATTERY GENERATES  
PURE CURRENT**

Every Lissen Battery is fresh when you buy it. The big cells are fresh, clean, and packed full of energy put there by the Lissen Secret Process. Through months and months of life the Lissen Battery will give you a steady flow of pure silent current. There is never a sign of ripple in it, never a trace of hum. Lissen Battery power is famous for its purity—it brings out every note of music, every word of song and speech in sharp and stereoscopic relief.

PRICES			
60 volt (reads 66) ...	7/11	60 volt (Super Power)	13/6
100 volt (reads 108) ...	12/11	100 volt	22/-
120 volt ...	15/10	4½ volt Grid Bias "	10d.
36 volt ...	4/6	9 volt " "	1/6
60 volt (For Portable Receivers)	7/11	16 volt " "	2/9
99 volt (For Portable Receivers)	12/6	4½ volt Pocket Battery	5d. each (4/6 doz.)
		Single Cell Torch Battery	4½d.



10,000 radio dealers sell it. Ask for Lissen New Process Battery in a way which shows you will take no other.

**LISSEN LIMITED,**

Worples Road, Isleworth, Middlesex.

(Managing Director: T. N. COLE)

Factories also at Richmond (Surrey) and Edmonton.

**MADE  
IN  
ENGLAND**



# FOUND—An Alternative Programme

**H**AS the opening of the second transmitter at Brookmans Park brought any nearer the true alternative programme?

I can well imagine the storm of derisive laughter that will meet this child-like inquiry. "Bah!" will say the Ham-Handed Henrys (or should it be Henriés?), "the alternative programme is a myth—a futile hankering after the unattainable—a promise made to be broken."

"Losh!" will exclaim the Oscillating Osberts, "is there still one sufficiently green to believe that the B.B.C. will ever be dug out of its rut?"

Well, ladies and gentlemen, there is one who, while mindful of the inestimable dignity of officialdom, is yet so perverse as to find a modicum of impish enjoyment in exposing illogicalities and asking pertinent questions. ("All right, Mr. B.B.C., IM-pertinent, if you will.")

## The B.B.C.'s "Nerve"

The point that has always struck me (the questionable grammar of this lapse into the first person will, I fear, betray the authorship of the above-named laudable sentiments) is that the B.B.C. have, to put it in a colloquially mild form, "got a nerve" to play about with long-established tradition in regard to the timing of "popular" entertainments.

Admittedly, if I be in London, Paris, or New York, I may partake of cabaret

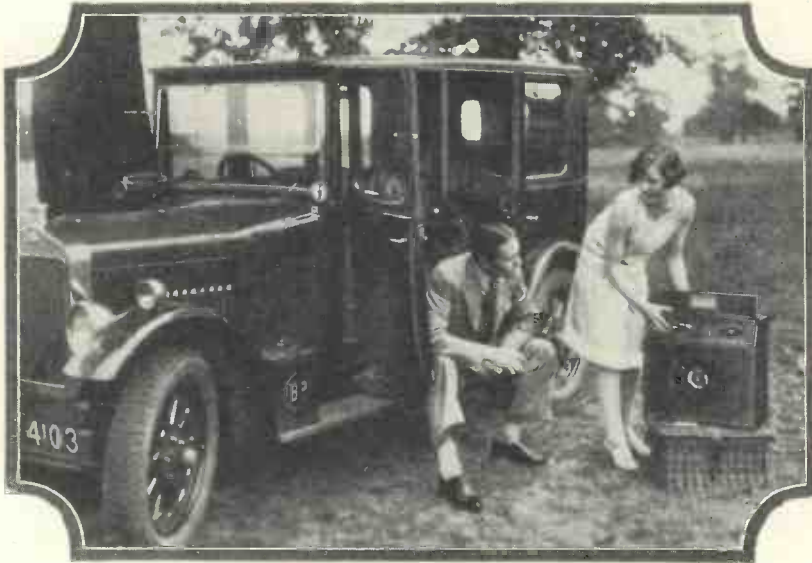

**SHE SHALL HAVE MUSIC WHEREVER SHE GOES!**

*Are you taking full advantage of radio out of doors this fine weather? A good portable will always give you good alternative programmes—but not from B.B.C. stations!*

during the hours when most good folk are a-bed, but do I, as a normal occurrence, wish to withstand the ordeal of (the average) revue or variety at around 10 p.m.?—albeit that revue or variety may only last for one hour.

The first and foremost illogicality of which I would accuse the B.B.C. in its programme making is its peculiar disregard for the fact that, when entertainment is provided in one's own home, hours should be more regular even than when one visits the concert hall or the theatre.

I wonder just how many places of amusement would sink and how many would swim if they were to pursue a policy of programme timing equivalent to that of the B.B.C.?

It would be all very well if they could draw on an audience that had never to think about getting up in the morning. We may treat ourselves to a late show once or twice a week and smilingly burn the candle

at both ends, but is not the B.B.C. above all a democratic institution? What justification has it for timing its items on what we might call an 'autocratic' plan?

Let us look at it this way. The average man returns from his day's work between 6 and 7 p.m. He has his evening meal, and then for between three hours and a half and four hours he amuses himself or expects to be amused. If

you prefer it—he rests.

Well, so long as his amusement is the antithesis of his day's work, it is rest; the newspaper man goes home to his garden—the gardener goes home to his newspaper.

## After the Day's Grind

Let us suppose we are the average man returning home from the day's grind. What do we find is on the wireless when we get in? If we happen to come home a bit early, we may just be in time for a spot of Chopin, or some other foundation-stone-layer of music.

Don't think that is simply the sneer of an unduly low-brow. I just ask you: Who, that is the keenest on music amongst us, feels ready to sit down and digest the intricacies of the great master along with his wife's latest culinary enterprise?

I think the keen music-lovers themselves will be the first to answer that they can no more do justice to Chopin while they are having their dinner than they can do justice to their chop

*Every listener is interested in the question of alternative programmes. In this article W. HADFIELD CRAVEN outlines a constructive proposal. If you like the idea he invites you to tell the B.B.C.!*

## Found—An Alternative Programme—Continued

while someone is rendering the classics.

The next item is a talk—on the programme I have before me as I write, the next two items are talks bringing the time up to 7.25. For upwards of an hour, therefore, we have had our dinner set, not to music, but to educational work (I am referring to the Foundations) and intellectual talks—there is going to be indigestion somewhere, and it's going to be of the B.B.C. programme.

### Too Late for the News

We have had plenty to talk about ourselves during this time; of our day at the office and our family's day at home, and how little Willie upset his milk all over the pram. Perhaps we might have been interested to hear the news—but that was given before we arrived.

Mark well, now, that had we dined in town we should have dined to music, but it would not have been music of an order that is expected to tax our intellect.

Rising from our meal and settling ourselves in our armchair, we are now treated to an interlude of tea-shop music, such as might have gone down well if accompanying our meal, but is usually found to be well-nigh nauseating if given undiluted.

This passes on to a concert of an hour and a half's duration, with several interesting orchestral items and innumerable others that we have all heard before and that do no more than engender yawns.

Miss So-and-so and Mr. Something-or-other pad out the performance with interminable groups of songs, to which similar remarks apply.

### Fat Stock Prices!

At nine o'clock we have the news. This is followed by a further talk, that may or may not be of interest at this juncture. But afterwards, from Daventry (the "home" station for millions, it must not be forgotten, as recent experience in the West of England has brought home to me very vividly) is the Shipping Forecast and Fat Stock Prices.

Why? Why? in the name of fortune. Words fail me—

At 9.30, or thereabouts—local stations having had in the meantime a spasm of pianoforte music—we start the programme. Perhaps

the B.B.C. will tell me that the programme started immediately after the Children's Hour, or even with the morning church service, but I fail to see it.

To me it has all been padding up to now—scraps of anything stuck in to bring us up to 9.30. At most one can say that there has been a one-and-a-half-hour homogeneous unit amid an otherwise heterogeneous mass of so-called entertainment.

That is always the feeling that it leaves me with, whether it is the B.B.C.'s intention or no. So now we start our concert, our revue, play, or whatever it may be. Well, all right—only if we had gone to a theatre or concert hall it would have begun at eight or soon after.

We go along merrily. Perhaps it is fine. Perhaps it isn't. I am not out to criticise the quality of programmes now, but their timing as bearing on the possibility of a true alternative; and I am taking a concrete example for my argument, though there may be others that concede a point or two to the B.B.C. and yet more that better illustrate it.

Then we come to a sudden stop. It is between 10.30 and 11.0—we are closing down now except for dance music. The star item—our programme proper, as I would have it—has lasted just about an hour. Shades of playgoers! Who would stand for a performance that began at 9.30 and ended at 10.30? albeit given a composite curtain-raiser since six.

I have set myself a job, have I not, when I start to go into the fatuity of the B.B.C.'s programme timing. It is good for all and anyone to experiment—that is the way progress is made. The B.B.C. might be expected to experiment (it will probably say that it has formulated the only type of programme possible for it)—it is the sponsor of a new form of entertainment (I suppose radio is feeling quite old since its offspring the talkies took pride of place as our youngest amusement).

But, whatever the considerations, has it any legitimate right to sweep away the timings that have been based on generations of amusement catering? Is not its duty more properly to modify the existing code to suit its own marvellous potentialities?

It will say it has done this. You and

I agree that it has not. If I go to a theatre, I go at 8 or 8.15 or 8.30, I see a good, bad, or indifferent show, and I come away at around 11. If I stay at home I want to have the same good money's worth and I want it at a time that is more to the convenience of my own armchair.

### Beginning Earlier

I want to begin at 7.15 or 7.30 and I want to finish at 10.15 or 10.30. To say that I do not pay theatre prices is beside the point. Then I will hear the latest news, and I will go to bed.

If I want to dance I will stay up, the same as I should have to if I went out to a dance. Once or twice a week (and the B.B.C. follows my time-table!) I will dance from 7.30 instead.

What is the true function of the alternative programme? There are a few of us bearded sages who remember the fuss and bother that accompanied the B.B.C.'s first few floundering years who know what is meant by that expression—what, at least, it shows the desire for.

I doubt if the younger members of the brotherhood and sisterhood of radio—hardened in the ways to which the B.B.C. has schooled them—will have the glimmering of an idea what it is all about. They may even say—as the B.B.C. would have them say—"Well, if I don't like what's on from Big Daventry I can always try the Little Feller."

And on how many such occasions does one get a really contrasted programme? Do you know why not? Because of all this scrappiness I have been talking about.

### Too Many Bits!

How can you get a truly alternative programme when your entertainment consists of a dozen (the actual figure from the programme I am taking as my example) different bits? Would that I were a mathematician to work out the number of combinations that would be required to find an alternative to that!

I believe that all that pleading we made with the B.B.C. for more variety has been construed by them to mean variety of this description!

What, then, is to be done? The London Regional transmitter is now in operation. As each new regional station is put into commission the

# A Special Article by W. Hadfield Craven

opportunity arises for providing a true alternative programme—the originators of the regional system intended that it should, but they have defeated their own ends, as exemplified in the working of 5GB.

## Improving the B.B.C.

They have defeated them because of this ridiculous time-table, and it must be pulled into shape before anything can be bettered. Let us try our hand at improving on the B.B.C. (we will ignore all times before 6 p.m. as irrelevant, and in any case we do not wish to deny it all opportunity of indulging in its beloved scraps):—

- 6-7 or 7.15 Dinner-time Music from Restaurant or Studio. (Dance band or light orchestra.)
- 7-7.15 or 7.15-7.30 News and Announcements.
- 7.15 or 7.30 Drama, Comedy, Revue, Variety, Symphony Concert, Light Orchestral Concert, Other Programme. (Ballads, Period Music, Celebrity Concert, Military Band, Organ, etc.) Talks, Dance, Outside Broadcasts.
- 10.30 (about) News and Announcements.
- 10.45 onwards Dance Music, Cabaret.

Now, then. In the above table I have mentioned practically every form of entertainment that is drawn on for broadcasting, and I have arranged each at its logical time in the day's routine. It is obvious that the first, the second, the fourth and the fifth groups would be common to all stations (except in such emergencies as special outside broadcasts).

## Theoretical Case

Now, let us assume that a certain district is served by a regional station and a low-power transmitter. When the regional transmitter is broadcasting any one of the items in the middle group, the low-power transmitter is broadcasting any other item in that group. Thus, to formulate a theoretical case:

Monday	Reg. Trans.	L.-P. Trans.
Tuesday	Drama	Military Band
	Symphony	Talks
	Concert	

Wednesday Variety

Thursday Organ and Choral Items

Friday Light Orch. Concert

Saturday Comedy Church Service

Sunday Appeals, etc.

Outside Broadcast (Speeches at dinner supplemented by Studio orchestra) Revue

Celebrity Concert

Dance Sunday Play (Relay or orchestra)

general rule, strictly confined to the one subject chosen for the evening. It would be permissible, of course, to supplement such awkwardly timed items as outside broadcasts with studio music (gramophone records?) as indicated in the second table.

## All Talks in One Night

Talks, it will be observed, all come together on one night of the week (the man who likes talks can then have his fill and he who doesn't can once and for all get away from them).

It is assumed that listeners to both stations will wish to be fairly cheerful on a Saturday; light fare is provided for one station, while the other has dance music throughout the principal time of the programme (the poor devil who must otherwise organise his radio dances when he ought to be dreaming may thus have a chance).

Finally, an alternative is provided to the Sunday church service in the form of such an item as the relay of a play from one of the Sunday play producing societies, a good orchestral concert or something equally diverse.

Even the most rigid religionist would hardly deny that intensive sermonising on a Sunday is not conducive to a wider spread of Christianity, but is rather a deterrent to the many who dislike having a subject thrust down their throats.

On the other hand, there is no reason whatever why any licensee who prefers to listen to a play or a band on a Sunday evening should not do so; he has paid his dues and the B.B.C. has no mandate to act as a national parson.

## Not a Hasty Conception

This project has been thought out over a long period by one who has had to do with the popular side of radio since its inception; there is nothing hastily conceived about it. I honestly believe that it would work, and that it is the only reasonable way in which the ideal of a true alternative programme can be arrived at.

All I ask is that if you, reader, like it, you will tell the B.B.C. so!

It is immaterial, of course, which station takes which programme; it is also purely arbitrary whether the stations that actually take up the



MISS ITALIA LISTENS-IN

*In Italy there is evidently no programme problem, judging from the expression on this listener's face!*

programmes are regional or low-powered or what-not.

Obviously to provide an alternative programme in any given district there must be two transmissions within the reach of any listener in that district, and the above names are used purely for convenience and as being more explicit than such terms as "A" and "B."

Let us now examine in detail some of the various points raised in this project.

It will be seen that the main item of the evening's programme consists of the transmission between approximately 7.15 and 10.30. This is, as a



# The **FOURSOME**

★  
**A SCREENED-GRID  
SET WITH SINGLE  
TUNING CONTROL**



*Portable sets have always been popular because they are completely self-contained, with aerial, batteries and loud-speaker all housed in the same case. The model described and illustrated in these pages has been specially designed by the WIRELESS MAGAZINE Technical Staff for those who need a set—probably for the use of the family generally—that is exceptionally simple to operate*

**M**ODERN valves and components have made the design of a portable—or more correctly, self-contained—radio set a different proposition from what it was a year or two ago.

Then it was essential to use four or five valves, with a number of tuned circuits. In a number of commercial models efficiency was sacrificed in the

*Simplicity of operation is a feature of this set, which has only one tuning control for the frame aerial. There is also a reaction knob*

interests of simplicity and many sets that should have been provided with two tuning controls had only one knob.

### **Alternative Programmes**

Now the position is somewhat different. Better components and more powerful broadcasting stations have made it possible to build a one-knob portable that will receive a number of alternative programmes—British and Continental—at good loud-speaker strength.

The set illustrated in these pages has four valves—an untuned screened-grid valve, detector and two transformer-coupled low-frequency stages.

This combination, it should be noted, is no more efficient than that of the James Portable S.G.3, described last month, but it has one less tuning knob and will be preferred in cases where the set is to be used mainly by some unskilled operator.

Tested in South London, the Foursome picked up both the Brookman's Park stations at great strength—both were loud enough for speech to be heard clearly at a distance of sixty yards in the open!

Not only was the volume particularly good, but there was no overlapping of the stations. Each could be tuned in quite independently of the other; indeed, the selectivity is unusually good and there is no feeling that one needs an extra tuned circuit to increase selectivity.

Long-wave stations were received equally well. Daventry 5XX was as loud as London Regional, if not louder. Good selectivity was again proved by the fact that Radio Paris, Daventry and Eiffel Tower could be received easily without mutual interference.

The general arrangement of the Foursome conforms to standard practice. In the lid is a wooden framework round which is placed the frame-aerial winding; this framework also acts as a support for the cone loud-speaker.

In the body of the cabinet are arranged the set itself and the high- and low-tension and grid-bias batteries. Everything is very easily accessible.

### **Straightforward Circuit**

Just as straightforward—to the initiated—is the electrical arrangement of the circuit. The frame aerial consists of two windings—one only is used for the long waves and the two in parallel for medium-wave reception.

Associated with the frame aerial and wound on the same former is a reaction winding which remains in operation on both wavebands.

Across the frame-aerial windings, which, of course, take the place of an ordinary tuning coil, is the usual .0005-microfarad condenser for tuning, the tuned circuit as a whole being applied across the control grid and filament of the screened-grid valve.

Every precaution has been taken to see that the shielded valve is stable in operation. In series with both the screening grid and anode leads are 600-ohm de-coupling

*Alternative programmes at good loud-speaker strength will be available almost everywhere with this set, which is extremely efficient for its type*

resistances with 1-microfarad by-pass condensers to filament negative.

In place of a tuning coil in the anode circuit of the screened-grid valve is a high-frequency choke. It is essential that this should be of high quality or results will be materially affected.

High-frequency voltage variations are set up across the choke by incoming signals and these impulses are fed to the grid of the detector valve through a coupling condenser, which also acts as part of a leaky-grid system.

For maximum efficiency of the detector valve a .0003-microfarad

*There are no special components in this set; all the parts can be obtained from most dealers without difficulty and at low cost*

condenser is placed between anode and filament negative to act as a by-pass for high-frequency currents.

It should be noted that reaction is applied to the screened-grid valve and not to the detector. The amount of feedback is controlled by a .0001-microfarad condenser.

The transformer couplings between the detector and first low-frequency, and first low-frequency and power valves, need no special comment.

Again, in the interests of stability, however, it will be noticed that a 100,000-ohm resistance is placed in the grid circuit of the last valve. This acts as a block for any high-frequency currents that may be fed from the frame aerial to the loud-speaker in the lid and so direct to the output circuit.

The .002-microfarad by-pass across the loud-speaker also helps to prevent this effect, which can cause serious trouble unless stopped.

All the components are quite standard and will be familiar to every constructor with the possible ex-

ception of the high-frequency choke-coupling unit, which may be new to some. This consists of a high-frequency choke, coupling condenser, and grid leak in a single unit.

If desired, this coupling can be made up of separate parts, in which case the condenser can be of .0003-microfarad capacity.

The actual layout of the set is similar to that adopted by W. James for his Portable S.G.3, described last month. The majority of the components, including those that have panel controls, are built up in the usual way on an ebonite panel and baseboard; this will be clear from the bottom photograph on page 20.

At right angles to the baseboard is another piece of wood on which are mounted the four valve holders. Connections from these holders to the components on the main "baseboard" are taken through holes in the latter. Such connections are indicated by dotted lines in the wiring diagram.

In these pages the layout and wiring diagram is reproduced at quarter-scale. If desired, a full-size blueprint (template, layout, and wiring guide combined) can be obtained for half-price (that is, 9d., post free) if the coupon on the inside back cover is used by August 31. Ask for No.

*Beginners in construction will find a full-size blueprint invaluable. This can be obtained for 9d. by using the coupon on the inside back cover*

WM206 and address your inquiry to Blueprint Dept., WIRELESS MAGAZINE, 58-61 Fetter Lane, E.C.4.

The first part of the construction to be undertaken should be the winding of the frame aerial and the mounting of the loud-speaker.

There are actually three separate windings to be made, the medium- and long-wave frames and the reaction winding. All are of No. 28-gauge double silk-covered wire and are wound in the same direction. A small space should be left between the windings as indicated.

### Mounting the Loud-speaker

No difficulty will be experienced in the mounting of the cone loud-speaker. Cut a circle of 5 1/4 in. radius out of a suitable piece of paper; then cut out a V-shaped segment of 35 degrees from the centre.

The edges should then be stuck, and when dry the cone should be fixed to the driving rod of the unit in the usual way. It is desirable to place a ring of felt between the paper cone and the loud-speaker fret.

Do not forget to mount in this part of the cabinet a .002-microfarad by-pass condenser for the loud-speaker and the wave-change switch for the frame aerial.

There is no need to describe in detail the actual assembly of the remainder of the components; their disposition will be clear from the layout.

When all the parts have been firmly fixed into position wiring up can be started. Here the blueprint will be of great help. On this (and on the reduced reproduction on this page) every wire is numbered separately, and the numbers indicate the best order of assembly.

The best plan is to

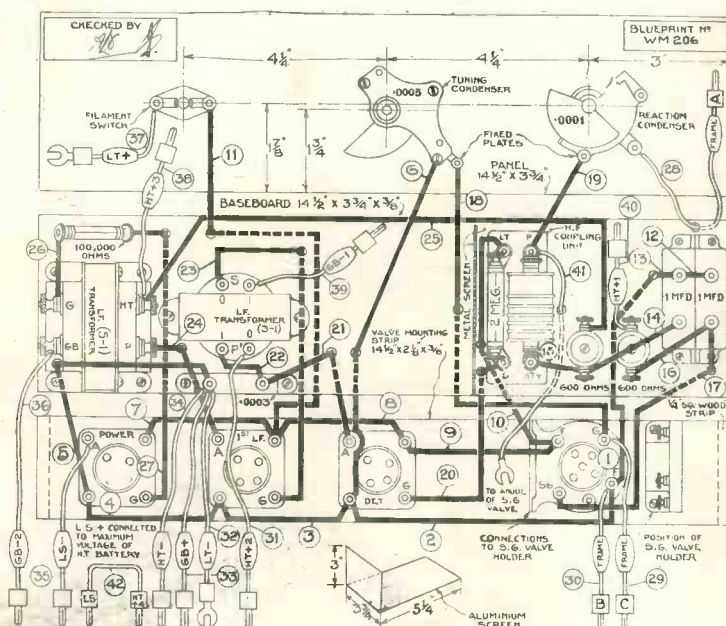

### LAYOUT AND WIRING DIAGRAM OF THE FOURSOME

*This is reproduced at quarter-scale. It can be obtained as a full-size blueprint for half-price (that is, 9d., post free), if the coupon on the inside back cover is used by August 31. Ask for No. WM206. Dotted lines indicate where leads pass through holes in the wood*

# The Foursome—Continued

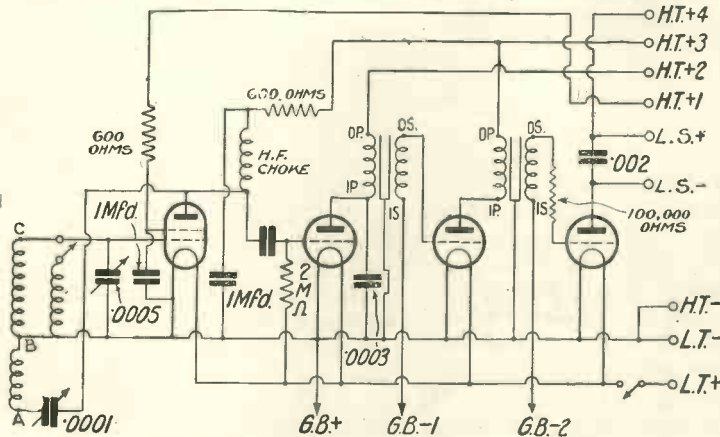

**CIRCUIT OF THE FOURSOME PORTABLE**

This set consists of an aperiodically-coupled screened-grid valve, leaky-grid detector, and two transformer-coupled low-frequency stages

make connection No. 1 and cross through that wire on the blueprint. Carry on with No. 2, cross that through, and so on in numerical sequence until all the wires have been connected. If this is done there is no possibility of making an error.

### Suitable Valves for the Set

Before the set can be put into operation the right valves must be chosen. Certain types are recommended in the list of components, but some more detailed remarks will be of help to the constructor.

Any good make of screened-grid valve will be suitable for the high-frequency stage.

For the detector and first low-frequency positions two medium-impedance valves will be all right. The detector may have an impedance between 20,000 and 25,000 ohms with an amplification factor of about 20.

Some operators may like to try a valve of much higher impedance and amplification in the detector position. A higher magnification will result in better signal strength, but the quality of reproduction may be affected to some extent.

For the sake of quality it is better to keep the impedance of the first low-frequency valve on the low side. A value of 15,000 ohms to 20,000 ohms will give a good compromise between strength and quality.

Of course, for quality, the power valve should have a low impedance, but the best kind of valve will take too

much anode current for economical working. Good results will be obtained with a valve of between 2,500 and 5,000 ohms impedance and the high-tension battery will at least have a chance!

The actual connecting up of the batteries will not prove difficult. The low-tension connections are obvious, while the grid bias should be applied in accordance with the maker's specifications.

### Conserving Battery Life

In all there are four high-tension positive tapings. The object, for the most economical working, should be to keep each tap at the lowest possible voltage consistent with good results and so conserve the life of the battery.

Taking the leads in order, H.T.+1 supplies the screen of the shielded valve. This should, therefore, be placed at about 50 to 60 volts in the battery. Several values should be tried until the best results are obtained.

Next comes H.T.+2, which feeds the anode of the detector valve. The voltage here should be adjusted to get smooth reaction on both wavebands; something in the neighbourhood of 80 to 90 volts should prove satisfactory.

The anodes of the screened-grid valve and the first low-frequency amplifier are fed at the same voltage by H.T.+3, which should be plugged in at a value of about 100 to 120 volts.

For the best results the voltage applied to the power valve, through H.T.+4, should be as high as possible, but with some valves it may be desirable to tap down to 100 volts or so in order to keep the anode current consumption within reasonable limits.

### Practical Trial

The best values for all the valves will soon be found after a little trial.

Perhaps the most important thing to remember in operating the set is that the back of the lid (when in its upright working position)



**SINGLE TUNING CONTROL**

These photographs show how straightforward is the construction of the Foursome, a portable with only one tuning control

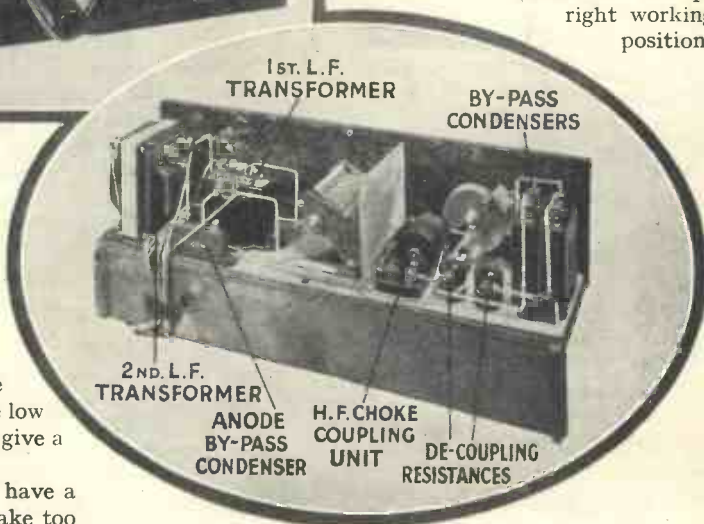

# S.G. Portable with Single Tuning Control

must be in line with the direction of the station it is desired to receive. Signals will be cut right out if the lid is at right angles to this direction.

The actual positions of the controls will be clear from the top photograph on this page. On the left is the on-off switch: in

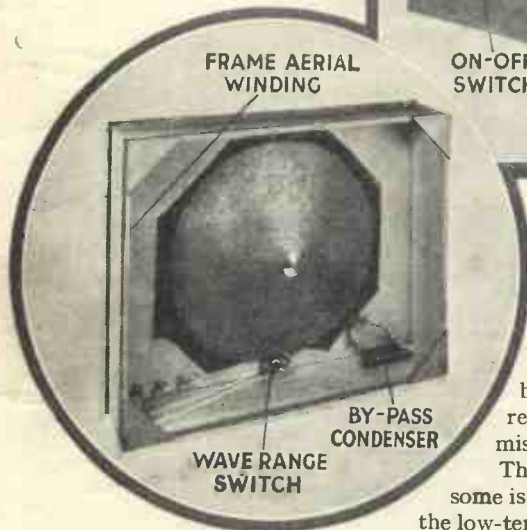
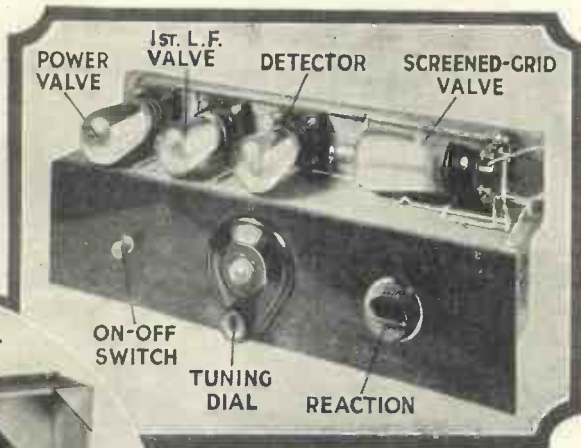

**VERY EASY TO TUNE**  
The simplicity of the controls on the panel can be judged by the photograph above. On the left are the loud-speaker and frame aerial

four months a new high-tension battery will be required.

Of course, those who are interested in the Four-some just as a completely self-contained set—and not literally as a portable—should take into consideration the desirability of running the set direct from the electric mains in the house.

On another page in this issue will be found an article explaining in detail how a portable can be operated in this way. If the set is run off the mains in this way it cannot, of course, be taken out of doors, for which purpose batteries will still be

reaction, has been set to a sensitive position; it should be readjusted for the best results as soon as a transmission has been picked up.

The maintenance of the Four-some is simple. Every week or two the low-tension accumulator will need recharging and once every three or

ordinary needed.

### Some Operating Hints

It has already been pointed out that when the set is in use the back of the lid must be placed in line with the station it is desired to receive. When a different station is required

the centre the single tuning dial; and on the right, the reaction control.

To receive on the medium wave-band, that is, between 250 and 500 metres, the frame-aerial switch, mounted in the lid, should be pulled out, while for long-wave reception it should be pushed in.

The set is switched on by pulling up the knob of the switch on the left of the panel.

Next, the reaction condenser should be adjusted until a slight rustling or hissing is heard from the loud-speaker.

### Verge of Oscillation

This state of affairs is difficult to describe. With the reaction at zero, the set will sound more or less "dead"; as the reaction knob is turned to the right, however, a "live" sound will be heard. This indicates that the set is on the verge of oscillation.

The reaction setting required to produce this result varies with the reading of the main dial. When the main reading is low the reaction knob can be set at a lower reading than when the main dial is adjusted towards the end of its travel.

Stations will be tuned in on the main dial without difficulty once the

## COMPONENTS NEEDED FOR THE FOURSOME

### CHOKES, HIGH-FREQUENCY

- 1—Graham-Farish multi-wave coupling unit, 7s. 6d.

### CONDENSERS, FIXED

- 1—Trix .0003-microfarad, 2s. (or Magnum, Watmel).
- 1—Trix .002-microfarad, 1s. 6d. (or Magnum, Watmel).
- 2—T.C.C. 1-microfarad, 5s. 8d. (or Lissen, Hydra).

### CONDENSERS, VARIABLE

- 1—Burton .0005-microfarad, 7s. (or Ready Radio, Lissen).
- 1—Dubilier midget reaction, .0001-microfarad, 5s. 6d. (or Cyldon, Bulgin).

### DIAL, SLOW-MOTION

- 1—Formo, type UD2, 3s. (or Brownie, Lissen).

### EBONITE

- 1—Trolitax panel, 1 1/2 in. by 3 3/4 in., 2s. 5d. (or Becol, Parfait).

### HOLDERS, VALVE

- 3—Formo, 3s. 9d. (or Magnum, Igranic).
- 1—W.B. Universal type, 1s. 3d. (or Junit).

### PLUGS AND SOCKETS

- 13—Clix wander plugs, marked: H.T.+1, H.T.+2, H.T.+3, H.T.+4, H.T.—, Bias—, Bias—2, Bias+, L.S.+ , L.S.—, and three plain, 2s. 2d. (or Igranic, Belling-Lee).
- 2—Clix spade tags, marked: L.T.+ , L.T.—, 4d. (or Belling-Lee, Lissen).
- 5—Clix sockets, 10d.

### RESISTANCES, FIXED

- 2—Berclif 600-ohm, 3s. (or Wearite, Ready Radio).
- 1—Graham-Farish 100,000-ohm, 2s. 3d.

### SCREEN

- 1—Parex, 8 1/4 in. by 3 3/4 in., 1s. 3d. (or Ready Radio, H. & B.).

The prices mentioned are those for the parts used in the original set; the prices of alternatives as indicated in the brackets may be either higher or lower

### SUNDRIES

- Glazite insulated wire for connecting, 8 yds. rubber-covered flex (Lewcos).
- 1/4 lb. No. 28-gauge d.c.c. wire for frame aerial.
- 1—Piece of Six-Sixty cone paper, 2s. 6d.
- 1—Benjamin turntable, 7s. 6d.

### SWITCHES

- 2—Junit on-off, 3s. (or Bulgin, Lissen).

### TRANSFORMERS, LOW-FREQUENCY

- 1—Igranic, type J, ratio 3 to 1, 17s. 6d. (or Philips, Burton).
- 1—Telsen Radiogrand, ratio 5 to 1, 12s. 6d. (or Igranic, Lissen).

## ACCESSORIES

### BATTERIES

- 1—Lissen 9-volt, standard type, 1s. 6d. (or Ever Ready, Siemens).
- 1—Lissen 100-volt, standard type, 12s. 11d. (or Ever Ready, Siemens).
- 1—C.A.V. 2-volt accumulator, 2NS21, 18s.

### CABINET

- 1—Trix, with frame for aerial and loud-speaker fret, £2 10s.

### LOUD-SPEAKER UNIT

- 1—Blue Spot, type 66K, £1 5s. (or Whiteley Boneham, Gecophone).

### VALVES

- 1—Mazda 215SG, £1 2s. 6d. (or Mullard PM12, Lissen SG215).
- 2—Mazda HL210, £1 1s. (or Mullard PM1HF, Lissen HL210).
- 1—Mazda P220, 12s. 6d. (or Mullard PM2, Lissen P220).

*Jungsoon*

*Ground wire 8/8*  
*TUNGSON*

## The Foursome—Continued

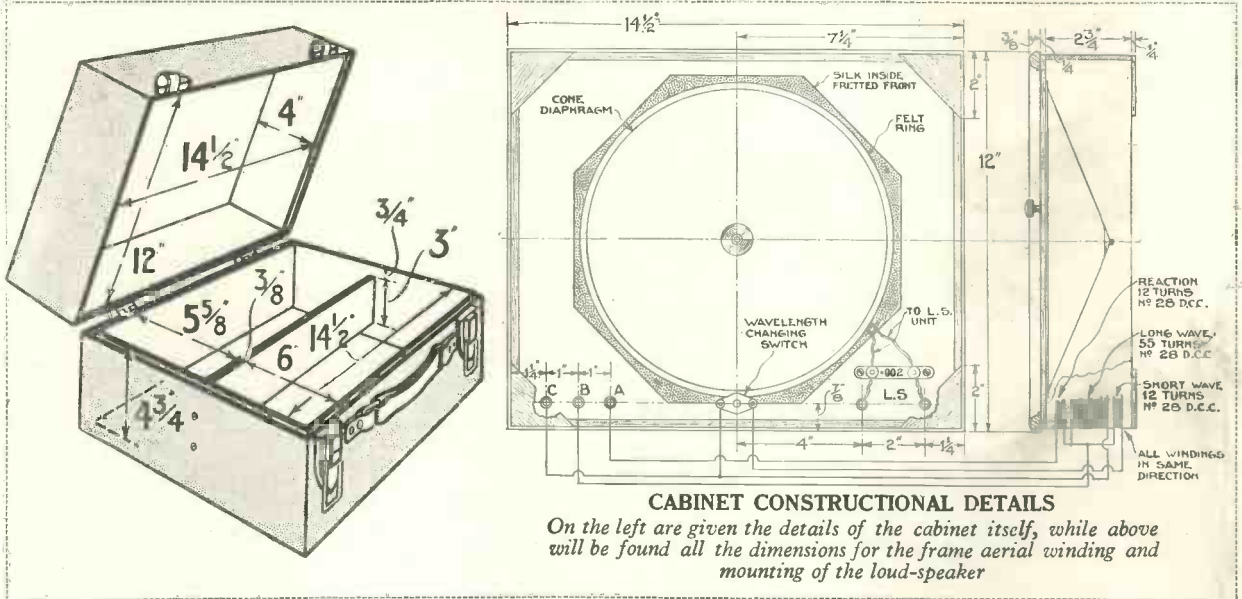

**CABINET CONSTRUCTIONAL DETAILS**

On the left are given the details of the cabinet itself, while above will be found all the dimensions for the frame aerial winding and mounting of the loud-speaker

It is, of course, necessary to turn the set round.

This is most conveniently accomplished by the use of a small turntable, on which the set can be swung round in any direction without difficulty.

A number of such turntables are available, and the use of one will

prove a great convenience and increase the utility of the set to a considerable extent.

Besides turning the set in the proper direction, it is also desirable to keep it as high up as possible. Out of doors a portable will always give better results at the top of a slope than in a valley.

Similarly, when used indoors it will usually be found that better results are obtained when the set is used in an upstairs room than when it is used on the ground floor.

If these points are remembered when the set is being operated the best possible results will be obtained for the locality.



A characteristic portrait of Capt. P. P. Eckersley, who recently recommended music dealers to read WIRELESS MAGAZINE

Capt. P. P. Eckersley

Officially Recommends

"Wireless Magazine"

AS all our readers know, Captain P. P. Eckersley, a late Chief Engineer of the British Broadcasting Corporation and one of the most outstanding personalities in the radio world, is now associated with the Technical and Research Department of the Gramophone Company Ltd., better known, perhaps, as H.M.V.

In this capacity he recently addressed the Music Dealers' Federation at their Blackpool conference.

He told dealers that they would be able to get the general implication of the design of a broadcasting receiver and the simple basis of all broadcasting

"by a study of such works as the B.B.C. handbook and the study of modern radio literature as exemplified by the WIRELESS MAGAZINE."

Praise from such a quarter is worth putting on record and, we believe, will be appreciated just as much by regular readers as it is by ourselves.



# UNDER MY AERIAL

*Halyard's Chat on the Month's Topics*

## A Novel Holiday

SEEN the van in your locality lately? The van? Yes, the Post Office Pirate Van. I'm sure you are just as interested in the travels of that mysterious van as I am.

According to recent reports it has visited Manchester, with the result that 4,000 new wireless licences were taken out within the month. Of course, all the 4,000 new licencees were not pirates. Perhaps only a few hundreds were wireless pirates in the strict sense of the term. Anyhow, 4,000 new licences in a month—£2,000—isn't bad business is it? That wonderful van must pay for itself many times over.

I should like to know the result of the van's visit to Newcastle, where the number of wireless licences per thousand population is very low.

George and I have come to the conclusion that we shall never see the van in our neighbourhood. The population is too small. Even if it caught out the whole of the listeners in the place (except George and me, of course) it would not prove a paying visit.

I've had a great idea about that Post Office van. Why shouldn't the Post Office offer holiday cruises for wireless listeners on their pirate-hunting vans? What a jolly wireless holiday it would be! Imagine the

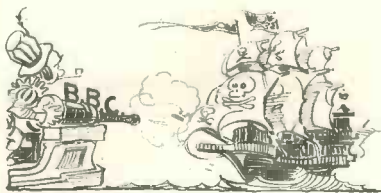

*A few hundreds were wireless pirates*

joy of the chase! Don't you think we ought to write to the P.M.G. about it? I am sure he would like his vans to pay better than ever.

## The Scottish Regional

What do our Scottish readers think of the changes which will be

brought about by the establishment of the regional scheme in their country? At present there are the four broadcasting stations in Scotland—Glasgow, Aberdeen, Edinburgh, and Dundee. Under the new scheme, the country will be served by the one big station and the four existing stations will be closed down.

A pretty sweeping change, so it seems to me, and I should think there will be a fair amount of opposition to the scheme. Even if Glasgow, Edinburgh and Dundee can be made to



*Distinctive programmes become the rule*

see that they will suffer very little by the change, I doubt if Aberdeen will be reconciled. In fact, it is quite worth gambling on that the Aberdeen transmitter will be retained.

Falkirk is supposed to be the place chosen for the new Scottish regional station. From a casual glance at the map, the choice seems to be a good one. Falkirk is about equally distant from Edinburgh and Glasgow, just over twenty miles in each case. Those two cities ought to be very well served by the new station.

If you look at a map showing the density of population in Scotland, you will see that the chosen site for the new Scottish regional station is right in the very centre of the most densely populated strip of Scotland. In consequence it looks as if the new station will have rather a serious wipe-out area.

Those of us who live in the southern portion of Great Britain may find the proposed Scottish regional station a much easier catch than Glasgow or Aberdeen. I doubt, though, if the new station will be of any great interest to us unless distinctive pro-

grammes become the rule there.

## The Workers

If you happen to read these notes when you are enjoying your holiday by the sea or in the country, I wonder if you would join me in giving a kindly thought to those members of the wireless industry who are just now working for us harder than ever they have worked before.

I refer, of course, to our designers and manufacturers. While we are enjoying to the full what we might call our holiday and lazy wireless season, these good technical folk are working with feverish haste to meet our desires of the forthcoming season which opens with the exhibition.

Have you ever thought how difficult is the work of these designers of complete sets and component parts? Ask yourself what new type of set, or what new component part you would like most of all next season. What is your answer? Ask your friends. What are their answers?

No matter how indefinite are our ideas as to what we shall demand next season, the designer and the manufacturer have to make some kind of a guess at what we shall demand. They must do something, and they must make plans to meet what they think will be our demands.

Pretty hard work isn't it, trying to

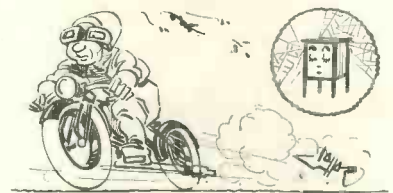

*Our lazy wireless season*

work out what we wireless folk shall want next season before we know ourselves? I feel very sorry for those members of the wireless industry who have to guess so hard and work so hard during the best part of the summer when the rest of us are enjoying our care-free holidays.

# Under My Aerial—Continued

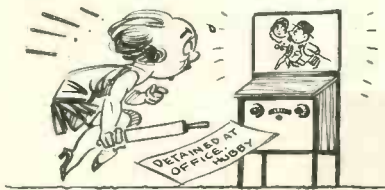

Television may give us the opportunity

## Less Bragging

Have you noticed that there is a lot less bragging about wireless nowadays than there used to be? George says it has been one of the chief features of the last two years that the wireless long bow has been left to lie in the junk room.

I am not quite certain that I should go as far as George in this matter, but I do think there is less inclination to brag about our deeds and doings these days than there used to be.

Possibly the reason for this very definite decline in bragging is that wireless has conquered the world as regards distance, and there is nothing left for us to brag about. A few years ago it was something of an achievement to pick up an American transmission direct.

I have one old friend who used to run the Stars and Stripes up to the top of his aerial mast the morning after the night he had successfully heard America. He does no such thing now. I doubt if he would bother to mention such a commonplace achievement.

Perhaps television may give us, in the near future, the opportunity to do great things in reception, with the result that we shall have something good to talk about amongst ourselves once again. I wonder!

## Schools

"Sometime during the next week or two, you might give me a hand with the school wireless set we installed, George," I said to my technical

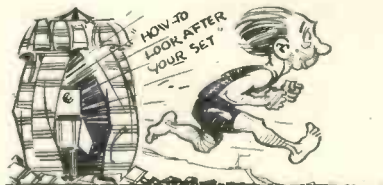

Holiday courses in wireless

adviser as we sat under my aerial in the garden last night.

"Has somebody been dropping

chewing gum down the loud-speaker spout again?" asked George.

"No, there's nothing seriously wrong with the set. I thought we might take the opportunity of overhauling the set during the holidays."

"Is our old friend the schoolmaster away then once more?"

"Yes, George."

"What's he doing this holiday?"

"Taking a short course of study in scientific subjects at one of the universities—I forget which."

"What an idea for a holiday!"

"I don't know, George. It seems to me to be a jolly good idea to keep yourself up to date in your work by taking a holiday course. I wish somebody would start holiday courses in wireless and allied subjects during the summer at some pleasant university town."

"Would you attend such a course during your holidays?"

"Certainly I would, George."

"Then you might put your name down for one of the rapid training courses now being given at the H.M.V. Mechanics' School, over at Hayes in Middlesex."

"But I am not a wireless dealer or mechanic, George, and I have no more need for practical training than you have."

"Oh! haven't you. What about that dud—"

"Be quiet, George. The idea I have in mind is a summer school for

listeners, a school in which we could be taught how to get the very best out of a wireless set, how to appreciate music, how to appreciate—"

"Children's hour."

"I was going to say wireless plays, George."

"Better get WIRELESS MAGAZINE to organise such a school. If you pull it off, put me down as a lecturer, not acting, mind you, but fully paid, with fuel, light, and lozenge allowance."

## Coincidence!

During the first week of my holidays, I saw a very curious thing,



Nobody had bothered about the aerial

which I think would have interested and intrigued you as much as it did me.

In the garden of the house in which I was staying, there was a single-wire aerial slung from the house to a mast at the end of the garden. About a third of the way down the garden the aerial wire passed over a small tree.

When this aerial had first been erected some years ago, the wire had

## When You Ask A Query

**M**ANY readers who send queries to the WIRELESS MAGAZINE overlook the simple rules connected with the service; in consequence, replies are delayed and trouble is caused all round.

The rules are few and simple. Their proper observance greatly facilitates the work of the staff at the WIRELESS MAGAZINE offices and delays are obviated.

In the first place, no questions can be answered personally or by telephone. Were we to answer all the inquirers who call at the "W.M." offices personally the whole time of the staff of the Information Bureau would be taken up by visitors. The same applies to telephone calls.

All inquiries must be made by letter, therefore, so that every reader gets exactly the same treatment.

Each inquiry, which must consist of not more than two questions, must be accompanied by the coupon always to be found on the inside back cover and a postal order for 1s.

A stamped addressed envelope should also be included and the whole sent to: Information Bureau, WIRELESS MAGAZINE, 58-61 Fetter Lane, London, E.C.4.

It greatly facilitates the answering of the large number of questions on all radio subjects received every day if correspondents write on only one side of the paper and are as concise as possible.

# Halyard's Chat on the Month's Topics

cleared the tree by a foot or more. Nobody had bothered about the aerial, however, since it had been put up, and the wire had sagged until it had ultimately rested on the fork of a small branch at the top of the tree.

Now this is the interesting thing I saw. The small forked branch on which the aerial wire rested was the only dead branch in the whole tree. What do you make of that?

The suggestion was made to me that either wireless currents or lightning had killed that one branch which was touched by the wire. Do you think that this was at all likely, or do you think it was merely a case of coincidence? I cannot see how the minute currents set up in an aerial could possibly damage a tree, but I can quite believe that lightning striking the aerial wire would kill the small branch.

## Perilously Near

When I returned home last Saturday afternoon from a jaunt in the country with my portable set, the first thing I saw was a length of beautifully bright new aerial wire down my next-door neighbour's garden.

Usually, there is something rather fascinating to me about a new aerial



*I am fearful of the new loud-speaker*

glistening and sparkling in the sunshine, but, as I looked at my neighbour's new aerial, I had very serious misgivings.

You see, up to last Saturday, my next-door neighbour has been content with a simple portable set and an indoor aerial, and I have had no cause to complain. Now, with an outdoor aerial running parallel to mine, and only a dozen feet away, I might possibly find my next-door neighbour something of a nuisance.

Of course, everything depends on the type of set in use. If my neighbour employs a non-reactive set I am safe, but if there happens to be a swinging reaction coil in his set then I'm jolly well for it.

Apart from possible radiation from my neighbour's aerial, I am fearful of the new loud-speaker. This fine summer weather drives listeners and loud-speakers out into the garden, and I know that, sooner or later, I shall have to suffer my neighbour's loud-speaker as I sit in my own garden.

What would you do if your next-door neighbour had a loud-speaker you disliked? Would you tune in your own set to the same programme and drown your neighbour's loud-speaker with your own, or would you just go out for a walk?

## A Pressing Fault

During the past week I have spent most of my wireless time rebuilding my three-valve portable set. This particular portable, with its detector and two low-frequency amplifying valves, first cousin to the popular Pedlar Portable Three in fact, has given me excellent service, and I have had it in mind for some months to rebuild the set.

In putting the actual receiver together again I used several new components and I felt as if I had done a really good piece of work when I had put the finishing touches to my task. You know the joy of testing a new set, don't you? Well! I anticipated a very pleasant hour with my remodelled and rebuilt portable. Result, when I switched on—not a sound.

In a very disappointed frame of mind, I hunted everywhere for the trouble. I tried three different grid leaks, different valves and different batteries. No result. You know how you feel on such occasions. I felt thoroughly desperate and I wished I had never touched the old portable, but had had the good sense to leave well alone.

Luckily, a meal-time intervened and when I went back to the set, I spotted the trouble immediately by pressing on the three valves in turn. It was the third valve holder that was

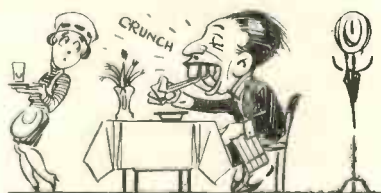

*The joy of testing a new set*

at fault. When I pressed on it 5XX came roaring in on the set.

Out came that faulty valve holder in quick time, I can tell you. Examination showed the spring grip of the grid socket to be too wide open to grip the valve leg. I put another new valve holder in place of the faulty one, and now my good old trusty portable is going better than ever it did.

## Remodelling A Cone

Have you ever tried to stiffen a loud-speaker cone? I have carried



*I took my new cone out of the oven*

out such a piece of work this last week in connection with the rebuilding of my portable set.

The cone in my portable was merely a thin paper affair blackened on one side. I thought it seemed rather flampy when I took it out and I decided to stiffen it up a bit somehow or other.

How did I do it?—Ah! I had one idea after another and in the end I did the work most satisfactorily. First of all I put sticky paste all over the inside of the cone. I thought that when the paste dried the paper would stiffen. However, when the paste was wet, I thought I might just as well put another thin paper cone inside the original one. I did so, and after I had placed the new cone in position, I put the whole thing in the oven to dry.

In half an hour I took my new cone out of the oven and I found it quite dry and very much stiffer than the original cone. It was a matter of a few seconds to fix the new cone in position and screw it to the rod of the loud-speaker unit.

Results are excellent with my new cone. I think I am getting a much better tone than before, a much deeper and rounder tone. George says it is my imagination and that there is no difference between the new cone and the old one. For once in a while, though, I think Master George is wrong.

# The Inductor Loud-speaker

Three Different Makes of the Farrand Dynamic Now Available

CONSIDERABLE interest is being taken by listeners everywhere in the Farrand Inductor loud-speaker, which was fully described in the June issue of WIRELESS MAGAZINE.

In my original article I stated that, so far as could be ascertained at the time, these loud-speakers could only be obtained from one firm.

Since then certain developments have taken place, as I anticipated, and it is now certain that at least one enterprising manufacturer will make the Farrand loud-speaker in this country.

## Patent Position

This loud-speaker can only be made under licence from the Farrand Inductor Corporation of America, whose agents in this country are Standard Telephones and Cables, Ltd., who, however, have no intention of selling direct.

S. A. Lamplugh, Ltd., are the first

By D. SISSON  
RELPH

British firm to take up the licence, and they are to be congratulated in their enterprise. I understand that their production will be available at the end of July.

As soon as a finished model is available it will be tested in the WIRELESS MAGAZINE Laboratories and further comments will be found in these pages. I understand that the chief difference between the Lamplugh model and the German production previously reviewed will be the total enclosure of the motor system in a metal casing.

The position at present is that Farrand Inductor loud-speakers are available from the following sources:

1.—From S. A. Lamplugh, Ltd., of Kings Road, Tyseley, Birmingham.

Their model will be known as the Silver Ghost and will be the first British-made Farrand. The chassis price will be £3 10s. and the cabinet model £6 10s.

2.—A. Brodersen, of 228 Goswell Road, E.C.1., will continue to supply the model made by the German firm N. and K. The chassis price is £3 12s. 6d. and the cabinet model £6 (provisionally).

## A Third Source

3.—A third firm, George Shaw and Sons, of Holmes, Rotherham, inform me that they are agents for a Farrand loud-speaker made by the firm responsible for Membra products. I believe that this is another German production; no prices are indicated.

During the course of the next few months it is likely that other firms will take up licences to manufacture in this country. Watch for announcements in these pages.

## Cutting Out Hum on Your Mains Set

DO you use A.C. mains valves—if so, is the reception quite hum free? It should be, of course, but there must be numerous instances where a slight humming sound is audible.

Personally, I know of nothing more calculated to annoy—in more ways than one. A friend steps in: "What is it humming?" he says. A hum is a bad thing to live with. It grows louder!

### Tracing the Trouble

How does one set about tracing it? First, disconnect the loud-speaker. If the hum is still heard a component is faulty and it is best returned to the makers. It may be a transformer or smoothing choke. Should the parts seem satisfactory, pull out the first valve, then the second, and so on in an endeavour to find which stage is causing the trouble. This test is not infallible. But you may find the detector stage is causing the trouble.

If it is, the high tension may not be properly smoothed; the centre tap to which the cathode is returned may

not be correct; or the valve itself may be slightly faulty. Should you be able to borrow a high-tension battery and connect it to the detector, you will be able to determine whether the hum arises from the valve or its cathode connection.

Quite often a so-called centre-tapped transformer is used, but the "centre" tap is not accurately placed. To test this, fit a potentiometer by joining its ends to the filament terminals of the detector and take the sliding contact to the cathode of the valve.

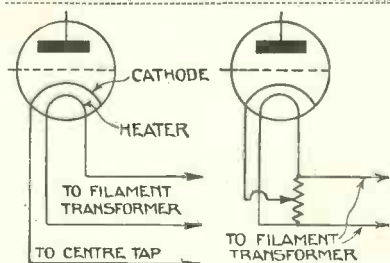

Method of taking cathode to potentiometer across mains transformer. The left-hand diagram shows the connections before the potentiometer is inserted

A position for the contact may be found where the hum is negligible or there will, in any event, be a point of minimum hum. A low-resistance potentiometer may be used or even a filament resistance provided its resistance is not less than, say, 15 ohms.

### Remove the Slider

The usual voltage is four, therefore the current will be about .25 ampere for 15 ohms. It will be necessary to remove the slider of the rheostat and to use a metal clip for the cathode contact.

A hum is usually to be found in the detector circuit, and it is only by systematically testing the circuits associated with it that the trouble can be located.

Sometimes the high-tension smoothing is not adequate and a further 2-microfarad by-pass condenser may have to be added. A lower voltage may help, but in any case, it is the better plan to test for one thing at a time.

W. JAMES.

# Making the 1930 Binowave Coils

By **W. JAMES**

**FULL CONSTRUCTIONAL  
DETAILS FOR  
THE AMATEUR**

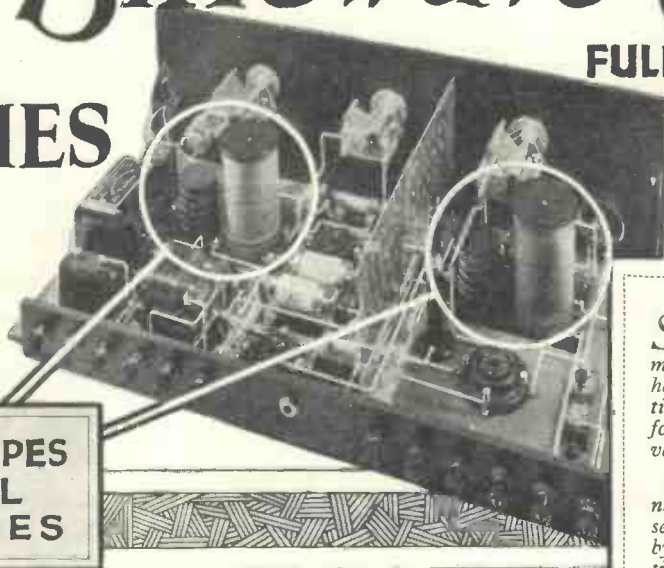

**THREE TYPES  
FOR ALL  
PURPOSES**

**T**HE tuning coils are essential parts of a wireless set, but it must not be thought for a moment that the coils can be considered just by themselves.

Every coil is used for a particular purpose and is, therefore, connected to certain parts in a set. One coil may be used to couple the aerial and

have certain characteristics and if they are not taken into consideration, the desired results cannot possibly be obtained.

Selectivity and magnification are the two chief characteristics involved. The coils, their actual position in the set, and the method of connecting them affect both and so, of course, do the valves and other parts associated with them.

### Restoring the Balance

So it happens that as valves and broadcasting conditions change, it is desirable to modify the coils, in order that the essential tuning characteristics may be preserved. Thus, if new valves come along and the magnification increases, we probably find that the selectivity is no longer sufficient. We therefore alter the coils or their connections and restore the balance.

The new valves may have a higher anode impedance than the older patterns. When they are used, the selectivity may be found excessive for the magnification and once again adjustment becomes desirable.

### Latest Modifications

Since my Binowave coils were first issued, various changes have taken place with the result that in order to preserve the balance as between

*SINCE* their introduction by W. James some eighteen months ago, the Binowave coils have undergone certain modifications to make them more efficient for use with certain types of modern valves.

They have been used in a large number of WIRELESS MAGAZINE sets with great success, as is proved by the number of letters of appreciation from readers that have been published about such sets as the

Brookman's Two,  
Brookman's Three,  
Brookman's Push-pull Three,  
Brookman's A.C. Three,  
Brookman's Four,  
and  
Lodestone Four.

There is now a type of Binowave coil for every type and impedance of high-frequency valve, and it is in the belief that during the coming season many more constructors will want to take advantage of them that we are publishing here complete constructional details of the three models.

Of the efficiency of the coils there can be no doubt. Reports of the reception of forty and fifty stations from owners of the Brookman's Three, for example, are common.

The construction of the coils is well within the capabilities of the average amateur. The clear diagrams in these pages make the arrangements of the windings quite clear.

By winding up one or more of these coils the reader will be able to convert an old and inefficient set into a really sensitive and selective outfit at comparatively small cost. Remember that sets with Binowave coils do not need wavetraps—they are selective enough without any such devices!

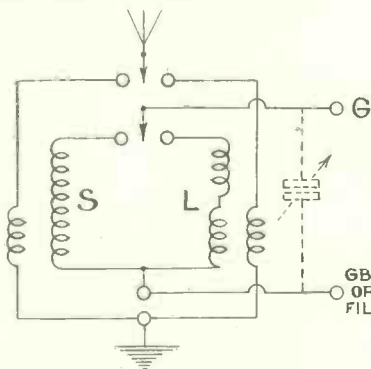

Fig. 1.—Theoretical connections of the type A Binowave coil for aerial circuits

the grid of the first valve and must, therefore, be so arranged that these two parts are effectively coupled.

Another coil may couple a screened-grid valve and a detector, or a further amplifying valve. In every case, the parts to which coils are connected

# Making the 1930 Binowave Coils—Continued

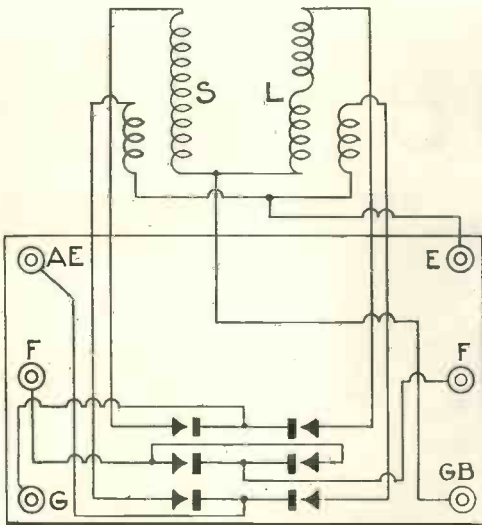

Fig. 2.—Diagram of the connections of the type A Binowave coil, which is arranged as a high-frequency transformer

selectivity and high-frequency amplification, I have found a few modifications of advantage.

The first coil is type A, and is an aerial-grid coupling coil. It has two sets of windings, one for the long waves and the other for the medium. They are mounted together on a base with a three-pole switch and have the usual terminals.

Desirable features of an aerial grid coil are: first, reasonably low losses in order that the maximum signal strength may be applied to the first valve and; secondly, coils of such proportions that the selectivity shall be suitable. Actually, the grid winding must be designed to cover the tuning band with a .0005-microfarad condenser, whilst the primary ought to be made to suit the aerial with which the set is to be used.

### Average Conditions

The same size of primary coil is not the best for all aeriels, neither is it the most suitable for all wavelengths within the range. One must therefore choose the best size of aerial winding (primary) for average conditions and assume that when the finest results are required the user will fit a pre-set condenser in the aerial circuit and so adjust it that, with his particular aerial, the best average results are secured over both wavebands.

When a good grid coil is used the aerial can always with advantage

be connected to a point on the coil, or to a separate primary, but, as this may be arranged for a normal outdoor aerial, it is possible that a user having a relatively small aerial will find that of the two possible connections, that is, to the primary or grid coil, the best results are obtained when the aerial is taken to the grid coil, or perhaps through a pre-set condenser.

In Fig. 1 are the connections of the Binowave coil type A. It should be noted that for the maximum efficiency throw-over switches are used. Thus the top part of the switch connects the aerial to the medium- or long-wave aerial coils, whilst the bottom part joins the tuning condenser to the medium- or long-wave grid coils. The connections of the coils to the switch and base are given in Fig. 2, whilst Fig. 3 shows the actual construction.

Essential points to note are that the medium-wave coils are wound on

a 2-in. tube of Paxolin, a straight winding being used, whilst the long-wave coils are arranged in a slotted former, the secondary being astatic.

A tube 4 in. long and 2 in. diameter is used for the medium-wave coil. The grid coil has 85 turns of No. 22 d.s.c., whilst the aerial coil has 25 turns of No. 38 d.s.c., put on at the earthed end of the grid coil and touching it. A former of ebonite, 2 in. long, 1 1/2 in. in diameter and having 5 slots 1/4 in. wide and 1/8 in. deep, is used for the long-wave windings. The bottom slot has 150 turns of No. 34 d.s.c. for the aerial.

### Astatic Winding

There are 105 turns of No. 34 d.s.c. in each of the other slots, two being wound in one direction and two in the reverse direction. This is one continuous winding and the diagrams will make matters clear. The ebonite base is drilled, and through the holes are passed the various leads which go to the switch and terminals.

A three-way double-pole switch is used, the centre contacts being wired for the filament circuit. These coils

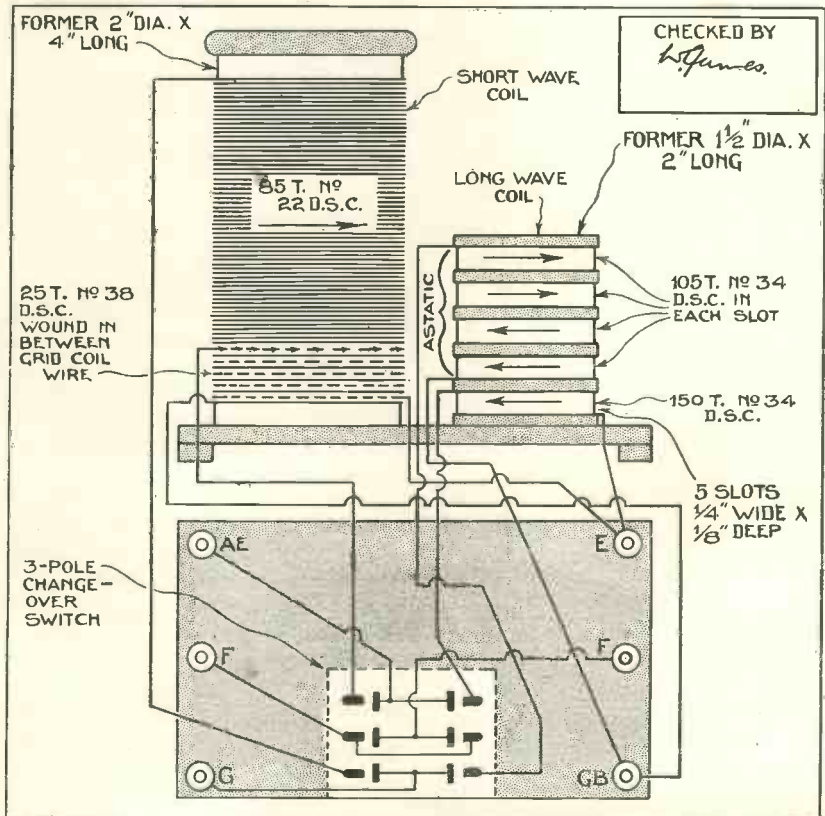

Fig. 3.—Actual constructional details of the type A Binowave coil for use in aerial circuits. The wave-change switch breaks the filament circuit in its mid-way position

# Modified Designs Explained by W. James

are designed to provide over the whole range the maximum of signal strength combined with the necessary selectivity, so far as is possible with fixed coils.

Finer wires could have been used to secure compactness, but at the expense of electrical efficiency, and it was thought desirable to aim at good results even though the size of the coil unit was made larger than most other varieties.

## Screened-grid Valves

For coupling a screened-grid valve to a detector or further amplifier we need a coil having characteristics such that good amplification is obtained with stability and at the same time a reaction winding must be fitted. A transformer coupling is the best form, with a primary to suit the screened-grid valve.

The coils ought also to be so arranged that magnetic coupling with the aerial coils is avoided or instability and poor amplification will be obtained. In the intervalve coil unit, therefore, known as type c, the

medium-wave coil is wound in the astatic style, whilst the long-wave coil is a plain one. The coils are thus arranged in the opposite fashion to those in the aerial unit.

Fig. 4 gives the connections. As before, the medium-wave coils are wound on a 2-in. tube, 4 in. long. At the bottom is the primary coil having 50 turns of No. 38 d.s.c., with a tap at the twenty-fifth turn. Next comes the grid coil, having 54 and 54 turns of No. 24 d.s.c. If the primary coil is wound in a clockwise direction, the first half of the grid coil is also in a clockwise direction, whilst the second half is anti-clockwise.

At the top is the reaction winding of 25 turns of No. 38 d.s.c., wound anti-clockwise. (See Fig. 5).

If the drawings are examined the direction of the windings will be clear. Both primary and reaction windings are

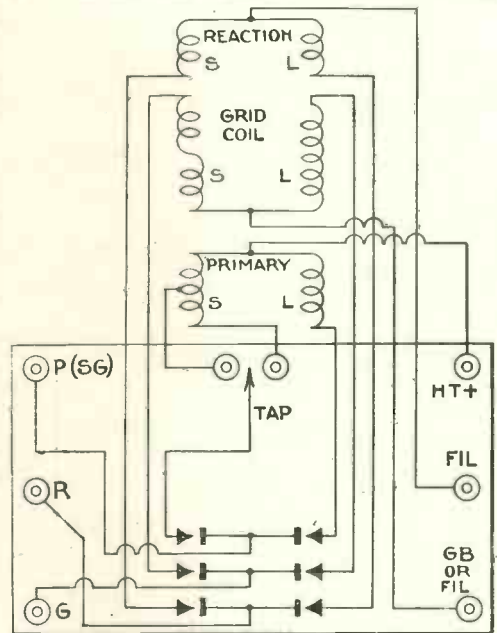

Fig. 4.—Diagram of the connections of the type C Binowave coil for use with screened-grid valves. This replaces the old type B coil

put on near the ends of the grid coil.

A slotted former of ebonite is used for the long-wave part and it has the same sizes as that used in the aerial coil. In the bottom slot is the primary having 220 turns of No. 38 d.s.c. There are 300 turns of No. 34 d.s.c. in the grid coil, 100 turns in each of three slots, all being wound in the same direction. In the top slot is put the reaction winding, 60 turns of No. 38 d.s.c. All windings in this long-wave coil go in the same direction.

## Special Points

The chief points to note about this unit are, first, that the secondaries are arranged to tune over the desired waveband and secondly, that the primaries are arranged to match average screened-grid valves.

These valves have widely different impedances, however, and I have therefore tapped the medium-wave primary so that the best results with the particular valve used may be obtained. The long-wave primary is not so critical and is not tapped.

Grid bias, screened-grid voltage, and also the value of the high tension all affect the impedance of a valve, but with a tapped primary it is possible to obtain the most useful results. With the anode of the

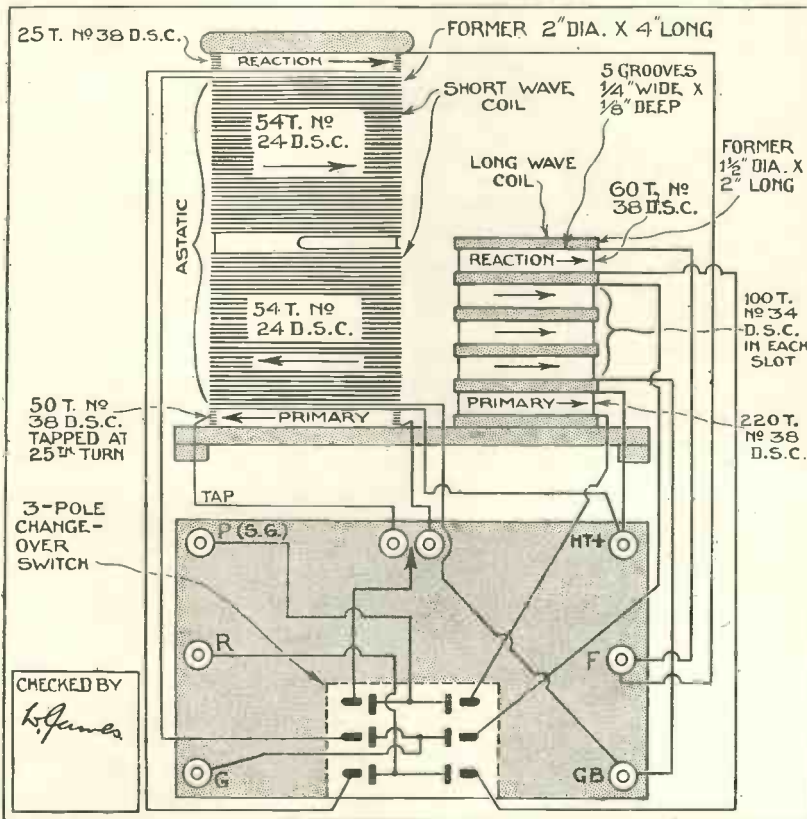

Fig. 5.—Actual constructional details of the type C Binowave coil for screened-grid valve sets. The medium-wave primary is tapped for the best results from different impedance valves

# Making the 1930 Binowave Coils—Continued

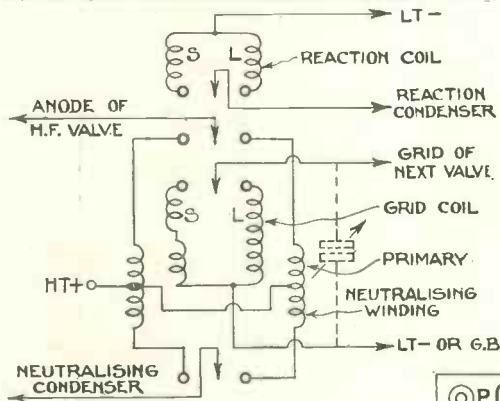

Fig. 6.—Theoretical connections of the type D Binowave coil for use with neutralised three-electrode valves

screened-grid valve connected to the tap on the medium-wave coil, the selectivity will be better and the signal strength less than when the full winding is used.

These coils are to be used with a .0003 microfarad (approximately) reaction condenser, it being possible to increase or decrease the capacity according to the valve used for detection.

### Three-electrode Valves

The coil unit used for coupling an ordinary (triode) valve for high-frequency amplification, where neutralising is essential, is known as type D. As a neutralising winding on both long- and medium-wave coils is needed, there are actually four windings in each coil, making eight in all.

Figs. 6 and 7 give the connections. All windings are as in the type c coil, excepting the primaries, which are, of course, wound for a valve of approximately 20,000 ohms, and have balancing windings. Thus the medium-wave primary is of 30 turns of No. 38 d.s.c. and the balancing winding has the same number of turns. There are 60 turns in all, wound in one direction, with a centre tap (Fig 8.)

### Long-wave Windings

For the long-wave primary and balancing windings a total of 150 turns of No. 38 is used, with a centre tap going to H.T.+. Actually we have 75 turns in the primary and 75 in the neutralising winding.

It will be noticed that the ratio of the primary and balancing windings is 1/1 in both instances and as the

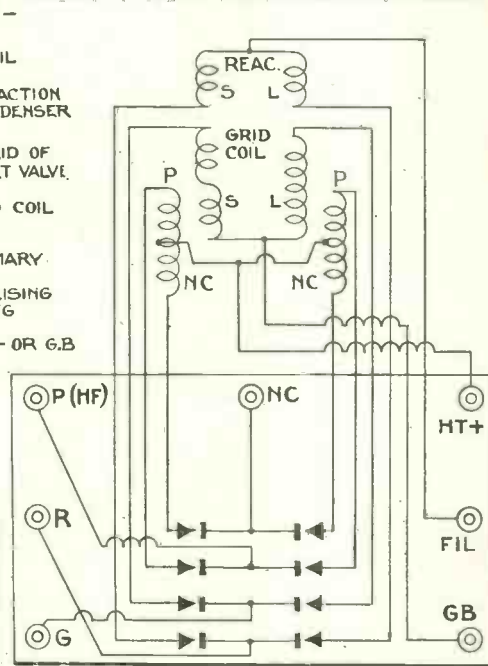

Fig. 7.—Diagram of the connections of the type D Binowave coil for neutralised three-electrode valves

two sections, one setting of the balancing condenser is correct for both long and medium waves. This is an important point, as once the balancing condenser has been set, there is no need to adjust it at any part of the tuning range, either on the long- or medium-wave ranges.

Good switches ought to be used for coils of the type described here as they are of the low-loss pattern consistent with their size.

Although the units are arranged with one winding in each astatic, it is necessary to use a simple form of shielding for the purpose of avoiding capacity effects. Owing to the sizes of the wires used, and to the ratios of the transformers, high magnification with exceptional selectivity is obtained.

The "Brookman's" series of sets which have 1930 Bino-

two parts are tightly coupled in the wave coils do not need wavetraps.

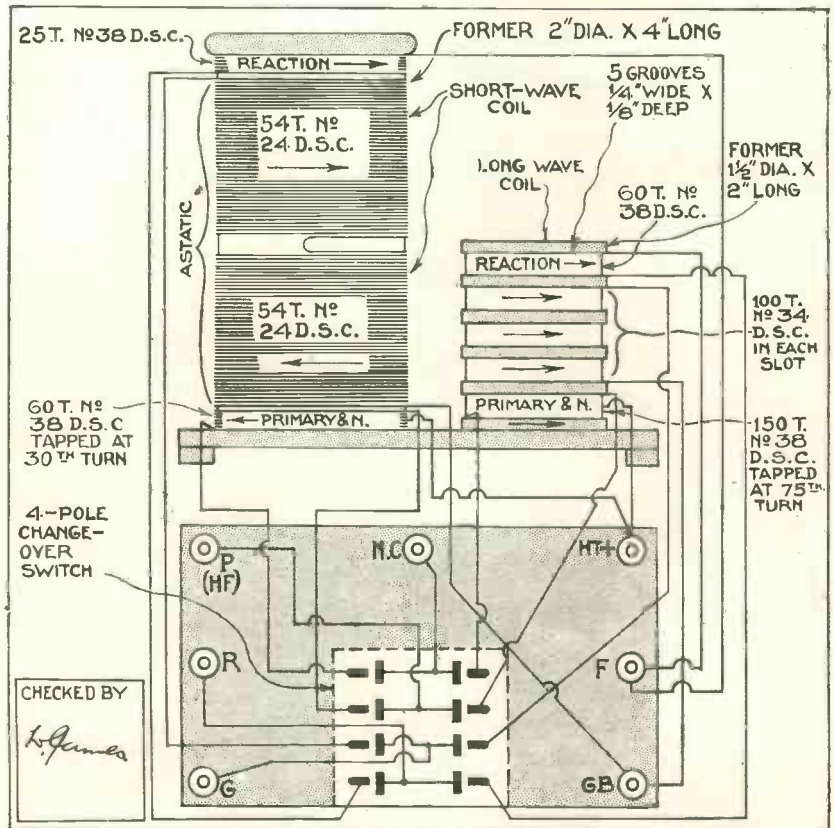

Fig. 8.—Actual constructional details of the type D Binowave coil. This is for use with three-electrode valves and gives constant neutralising on all wavelengths



# Mains Power for Your Portable

*How to fit and use combined high-tension units and trickle chargers, with special reference to Ekco and Regentone products*

TO take the place of batteries in portable sets, a new type of power unit has recently been produced. Suitable for A.C. or D.C. mains, these units will be very popular when their general application is more appreciated.

## Not Often Moved

The average user of a portable does not take much advantage of its mobility; as a rule, the portable rests on a table in the living-room, occasionally transported to the bedroom or garden.

In houses where battery-operated portables are so used there is every inducement to electrify them, always assuming that an electric-light supply is on tap. Where true portability is not desired so much as mains operation, the obvious solution appears to be an all-electric transportable; but on the score of expense, and also of expediency, a power unit in an existing portable designed for battery operation has big attractions.

The average portable set requires from 100

to 120 volts high tension, which can be supplied from a relatively inexpensive mains unit. The filament-current requirements of a portable are usually quite modest. Half an ampere total low-tension current is the rule. This, taken from a 30-ampere-hour accumulator, provides nearly sixty hours' reception for

each particular charge.

The simplest way of using mains to simplify the low-tension supply of a portable is to "trickle" charge the accumulator. For A.C. mains, metal rectifiers are designed for this job, or for D.C. mains an ordinary lamp will pass sufficient current to charge the battery at .25 to .5 ampere. If the charging rate is arranged so that it is nearly the same as the discharge rate of the accumulator it is easy to see that the trickle charger will be in commission for roughly the same number of hours as the set is used for reception. In practice the trickle charger keeps

## MAINS UNIT IN POSITION

*Here you see a Regentone combined high-tension unit and trickle charger fitted in a McMichael Super-range Transportable Four. This set was reviewed in the March issue of WIRELESS MAGAZINE*

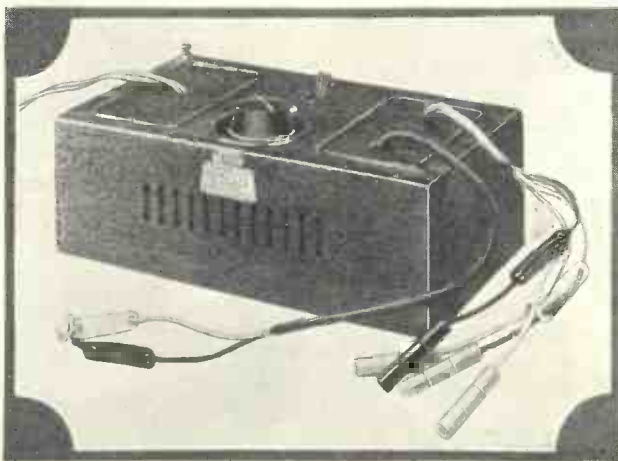
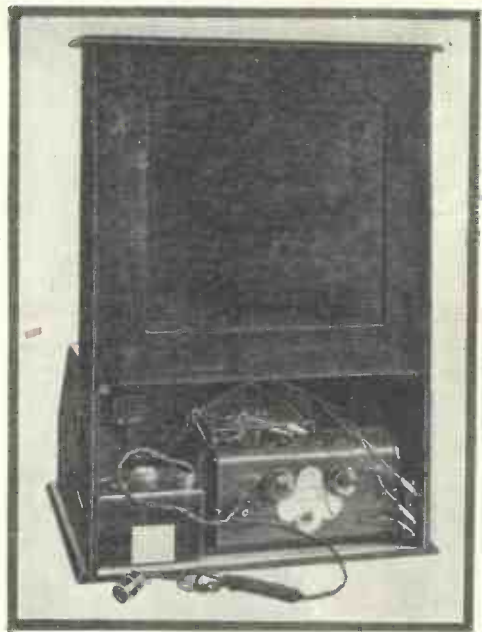

## NO LARGER THAN A HIGH-TENSION BATTERY

*The Ekco model CP1 high-tension unit and trickle charger for A.C. mains. Results of tests are on the next page*

the accumulator in a fully-charged condition.

The apparatus for supplying between 100 and 120 volts high tension and for charging the accumulator at, say, .5 ampere can be housed within a container no larger than the standard high-tension battery commonly used in portables. The power unit can

be used when the portable is at home, and replaced by a high-tension battery if reception is desired in places where there is no electric-light supply.

In considering the installation of one of these power units the portable-set user must decide from what point he proposes to draw his power. This is an aspect of mains working often overlooked. Not every living-room has a spare plug, nor have the other rooms in which the portable may be wanted.

## All Kinds of Adaptors

Fortunately, there are all kinds of adaptors, obtainable from the local electricity supply stores, that will help to solve the problem of where to plug in the power unit. The most useful adaptor is one that intercepts the electric-light bulb and its customary socket.

This type of adaptor has an additional socket and switch at the side, so that an extra plug, in addition to the bulb, can be inserted into one point. A switch on the adaptor provides for the occasions when the light is not wanted when the power unit is connected.

Wall plugs are convenient contact points for mains units; either power or table-lamp sockets can be utilised. Here again dual adaptors can be

## Mains Power for Your Portable—Continued

obtained for working both the unit and any other electrical appliance from a single point.

The idea of taking the electrified portable to a friend's house may suggest itself; this plan is quite reasonable if the friend's supply is similar to that for which the unit was purchased. An A.C. unit cannot be worked from D.C. mains and vice versa, although slight differences in voltage are provided for in most units.

We have been testing two of these

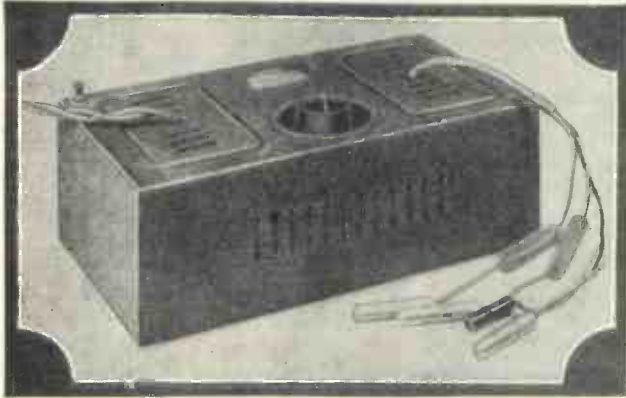

**A UNIT FOR HIGH TENSION ONLY**

*This Ekco model IV20 supplies high tension only and does not incorporate a trickle charger*

portable power units, and we are now able to give some working information. The first unit tested was the Ekco model CP1, which combines a high-tension supply of 120 volts and a trickle charger for the accumulator.

The mains, to which the unit is connected by a long, flexible lead, coming from the top of the metal container, are switched from the trickle charger to the high-tension supply by means of a small lever. Nearby is a voltage-control knob for an intermediate output providing a lower voltage than the maximum.

### Four Outputs

Altogether there are four high-tension output leads from the unit—a negative and three positives. The measured outputs correspond very closely to the maker's rating. The lead marked "SG" is suitable for connection to the shield of screened-grid valves, providing them with 70 to 80 volts potential.

The lead marked "0 to 120" is very useful for high-frequency and detector stages, where the total load is small. This output is variable

between zero and its maximum.

The lead marked "100 to 150" provides the main output, which varies according to the total anode current, which in turn depends upon the power valve. With a 200-volt input, the full 150 volts were obtained with a load of 15 milliamperes. Increasing the load to 20 milliamperes brought down the maximum output voltage to 125 volts.

The charging rate of the trickle charger was found to be .3 ampere for two, four, and six-volt accumulators.

Leads, clearly marked and of ample length, connect the charger output to the accumulator.

Underneath the unit are several tapings; one group is for varying the charging current to suit the voltage of the accumulator.

The plug with two-, four-, and six-volt sockets must be connected appropriately before any attempt is made to charge an accumulator.

A second set of three sockets is provided to make the unit suitable for three ranges of input voltages; 200-to-210, 220-to-230, and 240-to-250 volt inputs are covered.

Still another plug-and-socket arrangement underneath provides two distinct high-tension outputs. Here we should mention that in some portables the maximum output of this unit—125 volts at 20 milliamperes—might lead to instability, especially if designed for 108-volt batteries. For this reason a lower output can be switched in by the plug-and-socket arrange-

ment referred to. This provides 115 volts at 15 milliamperes, which is about the figure of many portables on the market. We consider this alternative output provision extremely useful.

### Other Models

Ekco model CP1 is listed at £6, and is made by E. K. Cole, Ltd., of London Road, Leigh-on-Sea. They have also produced model IV20, similar to model CP1, except that the charger is omitted.

This cheaper model is listed at £4 12s. 6d. Both units referred to are for A.C. mains only.

Another firm producing portable units is the Regent Radio Supply Company, of Bartlett's Buildings, Holborn, E.C.1. These Regentone units are available for both A.C. and D.C. mains. The A.C. model gives an output of 120 volts at 15 milliamperes. The charging rate for a 2-volt accumulator is .5 ampere, for a 4-volt accumulator .35 ampere, and for a six-volt accumulator .25 ampere.

### Output Terminal Block

Three entirely separate high-tension positive outputs are provided. Contact is made through a moulded block with shrouded metal sockets. The socket marked "V1" gives a variable output specially suitable for screened-grid valves. Socket marked "V2" also provides a variable output voltage, suitable for high-frequency and detector valves. Socket "P" supplies the maximum output of 120 volts at 15 milliamperes.

Neat switching arrangements for charging are a feature. The whole  
(Continued on page 72)



**ANOTHER COMBINED MAINS UNIT**

*This combined high-tension unit and trickle charger is a Regentone model, and can be used in almost any portable set*

# The New Lodestone Three

ALL  
THREE-ELECTRODE  
VALVES

CONSTANT  
NEUTRALISING  
ON ALL WAVES

BUILT BY  
THE "W.M."  
TECHNICAL STAFF

There is No Coil  
Changing with  
This Receiver

Based on A Design Evolved by W JAMES

IN spite of the apparent popularity of the screened-grid valve for high-frequency amplification, there is still a large number of enthusiasts who prefer the older three-electrode amplifier

### Constant Neutralising

Perhaps the chief reason why the three-electrode high-frequency amplifier has gone so much out of favour is that for efficient working its capacity must be balanced or neutralising—and up till now balancing carried out on the medium waves has not held good on the long waves and vice versa.

Now, however, W James, Research Consultant to the WIRELESS MAGAZINE, has developed a special type of Binowave coil with which it is possible to carry out a balancing operation that holds good over both medium and long wavebands.

So one of the greatest drawbacks to the use of the three-electrode valve for high-frequency amplification has been overcome by this new invention.

### Four-valve Design

In the May issue W James himself described the design and construction of a four-valve set based on the new principle. It was called the Lodestone Four, and comprised a three-electrode high-frequency amplifier, leaky-grid detector, and two low-frequency amplifying stages. It was built in answer to many requests for a dual-wave edition of the Touchstone.

The New Lodestone Three is a dual-wave edition of the set published under that name in March last

year, and consists of a high-frequency amplifier, detector, and power stage. It has been developed from the Lodestone Four by the "W.M." Technical Staff.

It should be emphasised that the whole merits of this set are centred round the tuning coils used—W James's famous 1930 Binowave types,

and long-wave secondary windings.

The switching is carried out by means of a single knob that has three positions, and, owing to the design of the coils, the wave-change switch on the aerial coil also incorporates the on-off switch for the filament circuit of the whole receiver.

Very much more complicated in

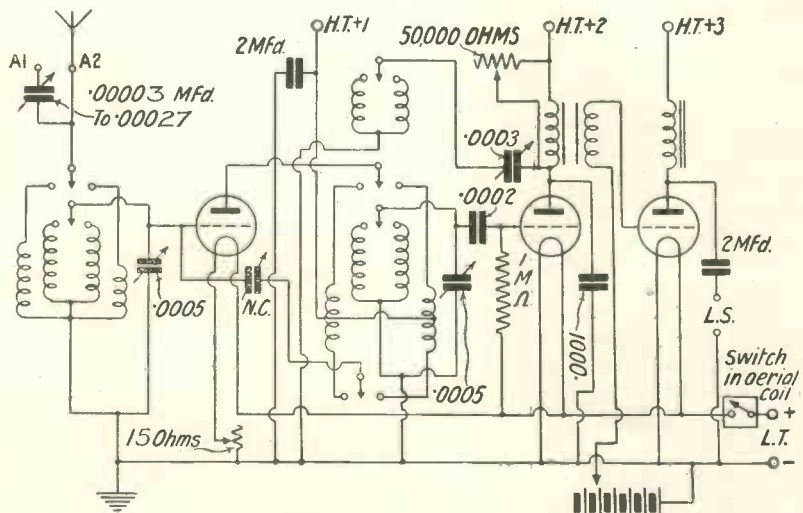

CIRCUIT DIAGRAM OF NEW LODESTONE THREE

The set comprises a neutralised stage of high-frequency amplification, leaky-grid detector and transformer-coupled power stage

which have been used with such great success in the whole range of "Brookman's" receivers.

Both aerial and high-frequency coupling coils are arranged as step-up transformers. The aerial coil—type A—is provided with four windings, a medium- and long-wave semi-periodic primary, and medium-

design—but just as simple in operation—is the high-frequency coupling transformer. This contains in all eight separate windings—primary, secondary, reaction, and balancing (or neutralising) windings for both the medium and long wavebands. Again, the switching of all eight windings is controlled by a single knob.

# The New Lodestone Three—Continued

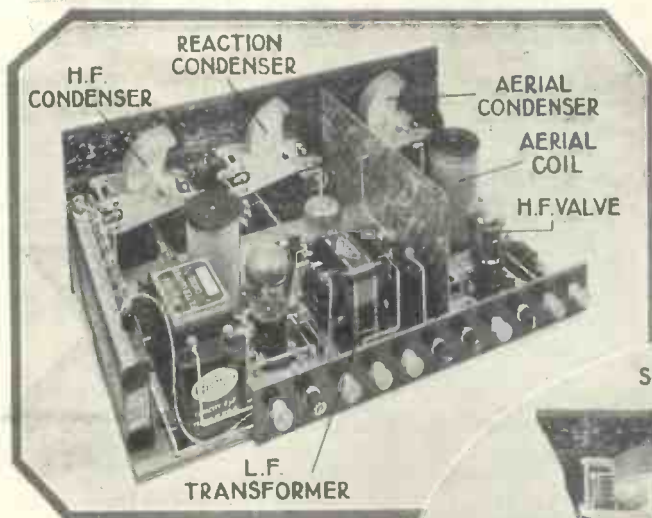

**POWERFUL—YET SELECTIVE**  
 Owing to its use of W. James's famous 1930 Binowave coils, the set is particularly powerful, yet selective enough for all ordinary needs

Although these 1930 Binowave coils are not so large as the famous Touchstone type of coils, they are, nevertheless, extremely efficient, giving sharp tuning and excellent signals.

### No Need for a Wavetrap!

Indeed, even when the set is used very close to Brookman's Park it will be selective enough to separate the two transmissions without the use of a separate wavetrap. In order to put the circuit in this condition, however, the set must be properly neutralised; this operation will be explained in detail later.

It has already been explained that the aerial transformer is fitted with a semi-aperiodic primary. Still greater selectivity, which can be varied to suit different local conditions, is obtained by the provision of two aerial terminals.

In series with one of these (A1) is a semi-variable condenser. The smaller the capacity of this is made, the sharper is the tuning, but the strength is also reduced. With a long and unselective aerial, therefore, this condenser is so adjusted as to give the desired compromise between selectivity and strength.

### Finding a Compromise

The second aerial terminal (A2) is connected directly to the primary winding. It will be suitable for use with very short aeri-als, or with medium aeri-als for long-wave reception.

Old hands will also realise, of course, that reaction acts as a valuable selectivity control when carefully used, but it will not often happen that conditions are so bad that the New Lodestone Three will not be selective enough without recourse to this procedure.

From the circuit diagram it will be seen that the secondary of each transformer is tuned by a .0005-microfarad condenser, whilst reaction is controlled by one of .0003-microfarad capacity.

The .0002-microfarad grid condenser and 1-megohm leak ensure a signal of good strength being

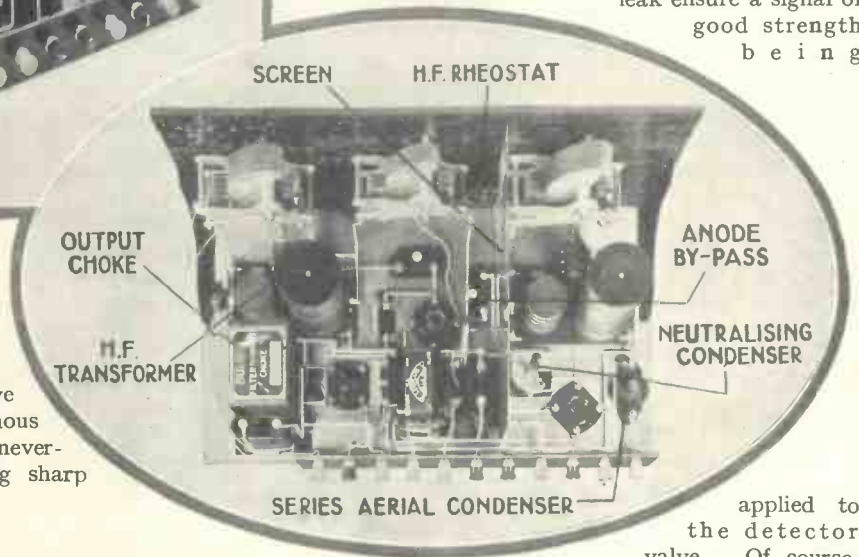

applied to the detector valve. Of course, the resistance of the grid leak can be higher, if desired.

In some cases rectification is improved by connecting a .0001- or .0002-microfarad fixed condenser between anode and filament negative of the detector valve. This condenser need not be incorporated until the last thing, because it is not needed with all valves. It should, however, be tried.

### TEN REASONS WHY YOU SHOULD BUILD THE NEW LODESTONE THREE

1. It is the first three-valver to have constant neutralising on both wavebands.
2. W. James's famous 1930 Binowave coils are used—a guarantee of good results.
3. A leaky-grid detector gives maximum sensitivity.
4. A high-ratio low-frequency transformer gives great volume.
5. Two separate volume controls are provided.
6. There is no coil changing for medium- and long-wave reception.
7. Almost any standard three-electrode valves can be utilised.
8. Operation is easy and certain.
9. The layout is clean and all the parts are easily accessible.
10. IT HAS W. JAMES'S FULL APPROVAL!

### Two Volume Controls

A further point of importance about the design is that two volume controls are provided—pre-detector and post-detector. The pre-detector control, which prevents overloading of the detector valve when strong signals are being received from a nearby station, takes the form of a rheostat in the filament circuit of the high-frequency amplifier. It should also be noted that this rheostat provides automatically a small amount of negative bias to the grid.

The second volume control is placed between the detector and power valve, and is used when signals are so powerful that the pre-detector control on its own is not enough to reduce them to the desired intensity.

# Constant Neutralising on All Waves

This control is a variable resistance of 50,000 ohms placed across the primary of the low-frequency transformer. As the value of this resistance is decreased, so in effect is the transformer short-circuited and the strength of signals is reduced.

As the relative settings of these volume controls are altered, so will the apparent selectivity of the set vary.

## Transformer Characteristics

For good quality of reproduction it is important, of course, to use a low-frequency transformer with a good characteristic and only a reliable make should be employed.

In the original set we have used a transformer with a step-up ratio of 1 to 5. This, of course, gives nearly double the amplification of the more usual 1-to-3 type and is of particular value where there is only one stage of low-frequency amplification, as in the case under consideration. It is quite satisfactory to use an even higher ratio than 1 to 5 if desired; suitable alternatives are 1 to 7 and 1 to 7.2.

## Choke Output

To complete the all-round efficiency of the design a choke-capacity output is provided. This helps to make the set stable and also protects the loud-speaker windings from possible damage due to the constant anode current which would flow through them otherwise when the set was switched on.

Apart from its electrical merits—it will already have become apparent that there are many—the New Lodestone Three is particularly suitable for beginners on account of its simplicity of construction.

## Two Knobs to Tune

The photographs show how simple is the layout of the set, and, in spite of the fact that there are seven knobs on the panel, it is only necessary to use two of them when searching for stations.

Across the top of the panel are arranged the aerial, reaction, and high-frequency con-

densers. The reaction condenser is provided with a vernier dial for easy reaction control when receiving weak distant stations. If desired, a small type of reaction condenser with a plain knob could be substituted.

Along the bottom of the panel the four small knobs are (1) wave-change switch from the aerial transformer, (2) filament rheostat, (3) volume control, and (4) wave-change switch for high-frequency transformer.

The actual layout of the parts will be clear from the diagram below but if this is not enough, WIRELESS MAGAZINE readers are offered a full-size blueprint for half-price (that is, 6d., post free) if the coupon on the inside back cover is used by August 31.

Address your inquiry to Blueprint

Department, WIRELESS MAGAZINE, 58-61 Fetter Lane, London, E.C.4, and ask for No. WM205.

The blueprint shows the exact position of every component, the positions and sizes of all the fixing holes to be drilled (it can be laid out on the panel and used as a template), and also the best sequence of wiring up, each connection being numbered.

## Easy to Build

It will be apparent that the method of construction is quite straightforward. The panel is first drilled and the appropriate components mounted on it. The whole panel assembly is next fixed to the baseboard by means of the panel brackets, after which the baseboard components are screwed into position. Lastly, the

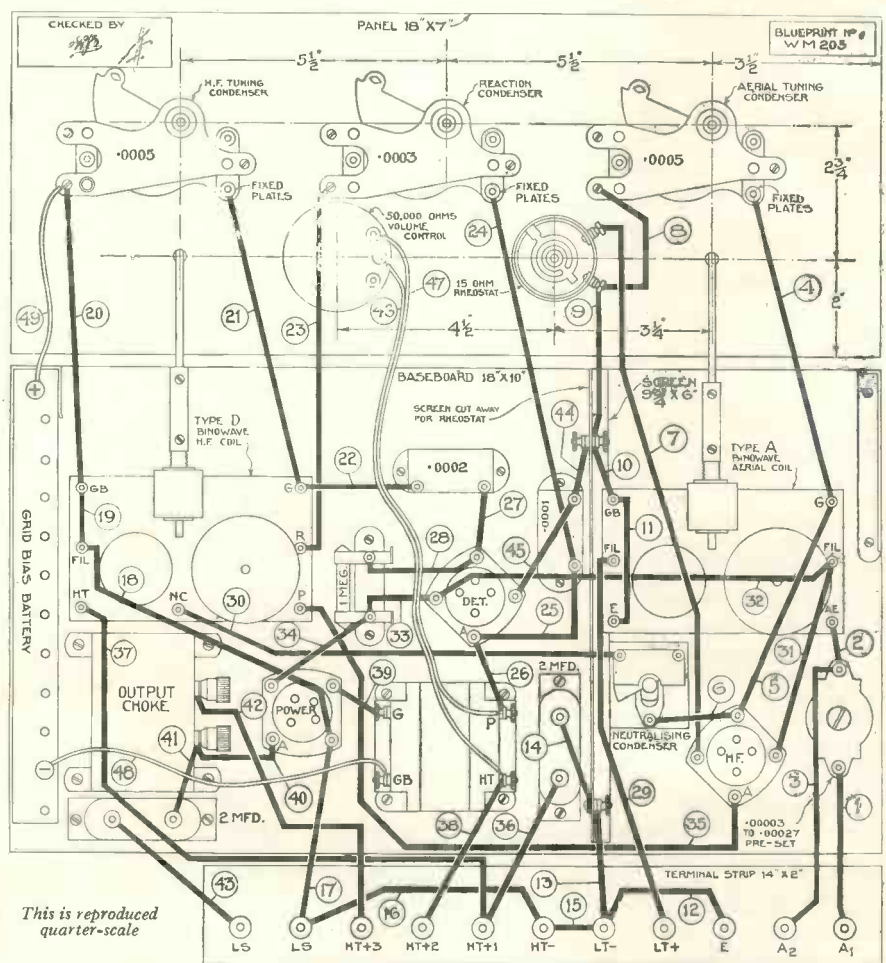

## LAYOUT AND WIRING DIAGRAM OF THE NEW LODESTONE THREE

For the small sum of 6d. this layout can be obtained as a full-size blueprint, under the special half-price scheme. Use the coupon on the inside back cover by August 31 and ask for No. WM205

# The New Lodestone Three—Continued

metal screen and terminal strip are fixed down

## Wiring Up the Set

As soon as all the parts have been firmly fixed into position wiring up can be started, and here the full-size blueprint will be found of great value. First complete the connection numbered 1 and cross that number through on the print. Proceed in this way until all the connections have been made.

If each number is crossed through as soon as the lead has been fixed into

found that good results could be obtained with an R.C. valve or one with an impedance as low as 12,000 ohms.

Almost the same remarks apply to the detector valve, although here, in view of the fact that a high-ratio transformer is utilised, it is better for the impedance to be too low rather than too high. A good all-round value would be 15,000 ohms, but it can vary between 10,000 and 30,000.

As ever, the choice of a power valve will probably prove the most

for this rate of discharge it is essential to use a double-capacity type of battery. Only in this way can economical running be assured.

It will be seen that separate high-tension terminals are provided for all three valves. Apply the following voltages for most standard valves: To H.T.+1 (high-frequency amplifier), 100 to 120 volts; to H.T.+2 (detector), 90 to 120 volts; and H.T.+3 (power), 100 to 150 volts. The last valve should also be provided with the proper grid bias as recommended by the makers

## Operating the Set

When all the necessary external accessories have been connected up the set can be put into operation.

It is important to remember that the wave-change switch for the first coil also incorporates the on-off switch for the whole set. Each coil switch has three positions; when the first switch is in its central position the whole set is switched off.

To receive on the medium wave-band turn both coil switches to the left; to get the long-wave stations turn both switches to the right.

At first both volume controls should be turned to the right for full volume. To reduce volume turn one or both to the left. Do not turn the rheostat right to the end of its travel, or the first valve will be switched off altogether.

One of the first things that must be done during the preliminary adjustments is the correct setting of the neutralising condenser. The practical procedure is as follows: Set the reaction condenser at zero and adjust the two main tuning dials until the local station is picked up. (The main dials will have approximately the same readings for any given wavelength.)

## Effect of Valve Capacity

When the dials have been adjusted for full volume switch off the high-frequency valve by turning the panel rheostat as far as possible to the left. The valve capacity will then come into play and signals will be heard, although not at the same strength as before.

To balance out or neutralise the valve capacity very carefully adjust the neutralising condenser (not the aerial pre-set condenser) on the base-board. A point will be reached where

## COMPONENTS for the NEW LODESTONE THREE

### CHOKE, LOW-FREQUENCY

- 1—Bulgin 20-henry, filter type, 12s. 6d. (or Parmeko, Ferranti).

### COILS

- 2—Wearite 1930 Binowave, types A and D, £1 14s.

### CONDENSERS, FIXED

- 2—Ferranti 2-microfarad, 6s. (or Lissen, T.C.C.).  
1—Watmel .0002-microfarad, 1s. (or Dubilier, Trix).  
1—Watmel .0001-microfarad, 1s (or Dubilier, Trix).

### CONDENSERS, VARIABLE

- 2—Igranic .0005-microfarad, type 2231/25, £1 1s. (or Jackson, Lotus).  
1—Igranic .0008-microfarad, type 2231/24, 9s. 6d. (or Jackson, Lotus).  
1—Igranic Preset, .00027-microfarad, type 2231/33, 2s. 6d. (or Lewcodenser, Formodenser).  
1—Bulgin neutralising, 35 micromicrofarads, type N6, 4s. 6d. (or Magnum, Jackson).

### DIALS, SLOW-MOTION

- 3—Ormond, type R/320, 10s. 6d. (or Igranic, Polar).

### EBONITE

- 1—Becol 18-in. by 7-in. panel, 8s. 3d. (or Lissen, Trolite).  
1—Terminal strip, 14 in. by 2 in.

### HOLDERS, VALVE

- 3—Benjamin Vibroholders, 4s. 6d. (or Whiteley Boneham, Lotus).

### PLUGS

- 2—Belling-Lee, marked G.B.+ , G.B.- , 7d. (or Igranic, Clix).

### RESISTANCE, FIXED

- 1—Lissen 1-megohm, with holder, 1s. 6d. (or Dubilier, Graham-Farish).

The prices mentioned are those for the parts used in the original set; the prices of alternatives as indicated in the brackets may be either higher or lower

### RESISTANCES, VARIABLE

- 1—Centralab 0-50,000 ohms, 10s. 6d. (or Rotorohm).  
1—Wearite 15-ohm rheostat, 1s. 6d. (or Geophone, Lissen).

### SCREEN

- 1—Parex, 10 in. by 6 in., 2s. 6d. (or Ready Radio, Magnum).

### SUNDRIES

- Glazite insulated wire for connecting.  
1—Pair Ready Radio panel brackets, 2s. 6d.  
Short length rubber-covered flex.

### TERMINALS

- 11—Burton, marked:—Aerial (2), Earth, L.T.+ , L.T.- , H.T.+3, H.T.+2, H.T.+1, H.T.- , L.S.+ , L.S.- , 4s. 7d. (or Igranic, Ealex).

### TRANSFORMER, LOW-FREQUENCY

- 1—Lewcos, ratio 5 to 1, type 22, £1 10s. (or Ferranti, 7 to 1; Igranic, 7.2 to 1).

## ACCESSORIES

### BATTERIES

- 1—Ever Ready 120-volt, type PP120, £1 7s. (or Hellesen type POSYP; Pertrix type 295).  
1—Ever Ready 16-volt, type GB2, 3s. 6d. (or Obeta, Lissen).  
1—Lissen 2-volt accumulator, type LN509, 13s. 6d. (or C.A.V., Oldham).

### CABINET

- 1—Pickett table model, £1 2s. 6d. (or Ready Radio, Camco).

### LOUD-SPEAKER

- 1—Celestion cone, type Z20, £7 15s. (or Philips, Marconiphone).

### VALVES

- 2—Osram HL210, £1 1s. (or Marconi HL210, Six-Sixty 210HF).  
1—Osram DFP215, 12s. 6d. (or Marconi H1.210, Six-Sixty 220F).

position there is no chance of an error being made

The next point that needs consideration is the question of suitable valves for the set.

## Best High-frequency Valve

For the best results the high-frequency amplifier should have an impedance between 20,000 and 30,000 ohms. It can, in fact, be of the "HL" type now produced by most valve manufacturers. There is considerable latitude, however, for with the Lodestone Four W. James

difficult point. All that can usefully be said here is that the power valve should be the best that can be run economically from the available high-tension supply.

A valve with an impedance in the neighbourhood of 2,500 ohms is desirable for the best quality of reproduction, but in many cases the anode-current consumption will be too great to be obtained from dry batteries economically.

Probably the lowest possible consumption will be in the neighbourhood of 10 to 12 milliampères, and

# Uses Three-electrode Valves Throughout

signals become quite inaudible or very much reduced in strength. This means that the valve capacity has been balanced out and that no feed-back of energy can occur to cause oscillation.

### Using the Set in the Ordinary Way

When the valve has been thus balanced the rheostat can be switched on and the set used in the ordinary way. If the set is neutralised at the top end of the medium

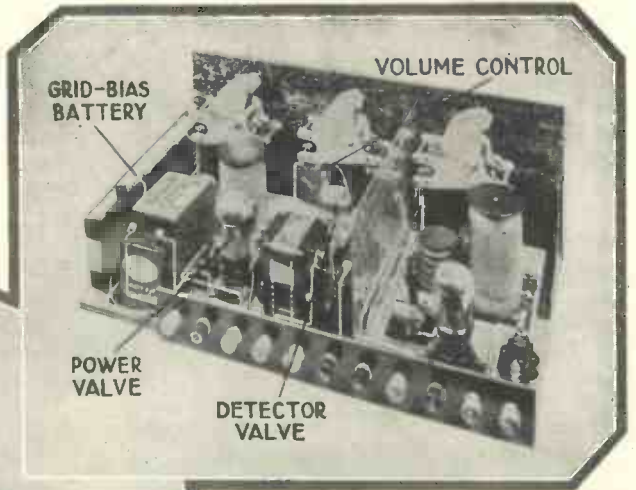
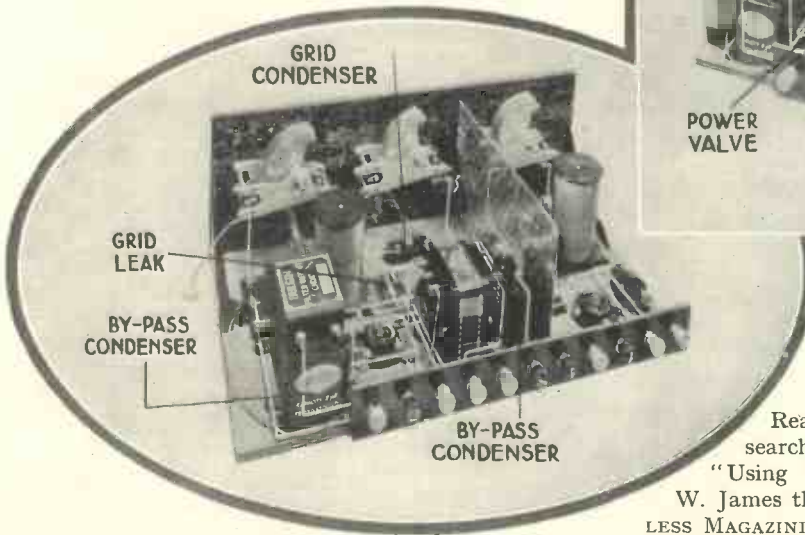

### INCORPORATES MANY REFINEMENTS

Two volume controls, a vernier knob for reaction adjustment and a choke-filter output are a few of the many refinements incorporated in the design.

Readers who intend to build the set and search for distant stations should look up "Using the Lodestone Four," an article by W. James that appeared in the June issue of WIRELESS MAGAZINE. Tuning charts were given with that article that will be equally applicable to the New Lodestone Three, which uses a practically identical aerial and high-frequency arrangement.

In conclusion, may we have the benefit of comments from all constructors who build up this set, so that we can pass them on for the benefit of others? Test reports from different localities are of great value to those who desire to build a new set.

waveband it may tend to oscillate lower down the scale. To avoid this try neutralising again on a comparatively low wavelength.

When the set has been neutralised on the medium waveband it will be ready for long-wave reception without any further adjustment than the movement of the two wave-change switches. There is no need to re-neutralise the set on the long waves.

It has already been mentioned that two aerial terminals are available to suit local conditions. Both of these should be tried until the best compromise between selectivity and volume is obtained.

### Revolutionary Design

We firmly believe that this set is revolutionary amongst three-valvers using three-electrode valves throughout. The 1930 Binowave coils are exceptionally efficient and excellent results are assured to all who build the New Lodestone Three.

Perhaps it is worth while to point out that the type D Binowave coil used as the high-frequency coupling in this set has been developed from those used with such great success by W. James in the Brookman's Two, Three, and Four—sets which have been the most popular ever described in these pages.

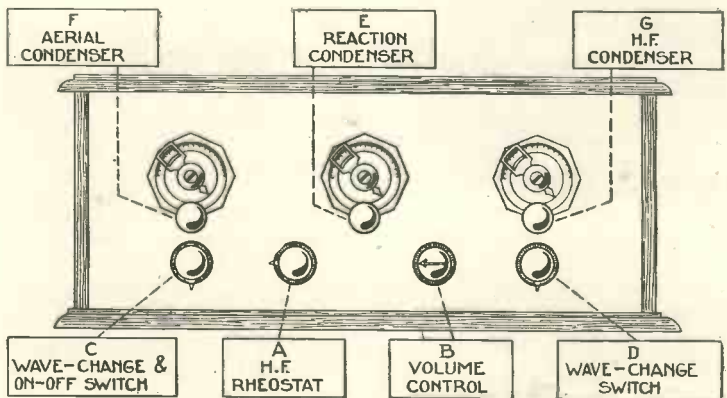

### HOW TO OPERATE THE SET

1. Turn A to right for maximum volume
2. Turn B to right for maximum volume
3. Turn both C and D to left for medium waves or to right for long waves (Set is switched off with C in central position)
4. Adjust E for best sensitivity
5. Turn F and G simultaneously at approximately the same readings to pick up stations

# A Talk About Talks

Are We Always Fair When We Grumble About Them?

"NOW, ladies and gentlemen," said the announcer, "we are going to have a talk by Professor P. de P. Puffyidge on——"

The voice from the loud-speaker ceased abruptly. Harold had switched off the set.

"Why did you do that?" asked April.

or ten bob on a book by the identical professor who would be talking to us at this moment if you hadn't switched off the loud-speaker in such a hurry!"

"That's possible," admitted Harold.

"And yet," I continued, "although you cheerfully go to the trouble and

rather interesting. Here are two people, who are probably typical of many thousands of listeners, and who don't care for broadcast talks. I should be interested to know why!"

"I don't know that I've ever thought out the exact reason," said Harold.

"Well, think it out now!" suggested April. "And in the meantime, I'll tell you why I don't often listen to talks on the wireless. It's simply that the subjects very seldom appeal to me."

"I suppose, April," I said, "you just glance through the day's programme, and when you come to a talk you say to yourself, 'Oh, a talk on so-and-so—that won't interest me!' and don't trouble to listen to it!"

"Of course I don't trouble to listen to what doesn't interest me!" snapped April.

"You said just now," I reminded her "that Harold was illogical or inconsistent or something of that sort in his attitude towards talks. Now it seems to me you're being just as bad yourself! How can you expect to arouse much interest in a subject if you never hear anything about it?"

"And moreover," I continued, "I shouldn't be at all surprised to find that about ninety per cent. of talk-haters are people who judge of the interest of a subject *before* hearing the talk on it, instead of afterwards!"

"But aren't you ever guilty of that?" queried April.

"Yes," I admitted, "I'm afraid I am, sometimes. But on the other hand I can say this: I've often started listening to talks on subjects of which, at the beginning of the talk, I have known practically nothing and cared less.

"Each time I've tried this experiment I've found, by the middle of the talk, that I have gained sufficient interest in the subject to make me want to hear the rest of what the speaker has had to say about it, and by the conclusion of the lecture I have become thoroughly interested."

"It had never occurred to me," said April, "to make myself listen



Courtesy of Marconiphone Co., Ltd.

Shall they switch off now that a talk has been announced?

"Because I simply can't stick talks!" replied Harold. "I like music on the wireless, and plays, and vaudeville sometimes, and maybe just a little poetry occasionally. But when the announcer warns us that we are in for a lecture on some obscure subject by a prosy old professor I always take the hint and switch off quickly!"

"But," I exclaimed, "you're awfully keen on reading—not merely novels and newspapers, but quite serious, scientific sort of literature. In fact, I shouldn't be at all surprised if to-morrow, say, you were to go and spend seven-and-six

expense of reading what he has written, you simply will not listen when you have an opportunity of hearing what the man has to say first-hand, so to speak, and at no cost apart from the almost infinitesimal one of running your set for a few minutes."

"Put that way, it *does* sound awfully illogical," remarked April. "Why don't you ever listen to talks, Harold?"

"Well, how often do you listen to talks?" retorted Harold.

"Not often, I admit," April answered.

"Now," I said, "this is getting



to the beginning of a talk about something that I wasn't a bit interested in, just on the chance that it might turn out to be really interesting after all."

"I contend," I went on, "that almost any subject can be made interesting to almost any intelligent person, provided that it is treated in the right way and by a speaker who is thoroughly qualified to handle it."

"Now, on the wireless you have a unique opportunity—or rather, series of opportunities—of hearing many of the most eminent men of the day speaking on subjects on which they are experts, and——"

"But it doesn't follow," April interrupted, "that because a speaker knows a lot about something he is necessarily capable of presenting his knowledge in a way that is likely to interest other people."

"That's true enough," I agreed, "but my experience of the majority of regular B.B.C. 'talkers' is that they seem to have an exceptionally happy knack of making their subjects interesting."

"Then you think that we who don't care much for talks never give the lecturers a chance?" suggested April.

"Of course you don't," I replied, "if you never listen to them! . . . But whilst we've been talking Harold has been thinking out his argument against talks, so let's hear it!"

"The point you raised just now," said Harold, "was that, if I'm willing to read what a certain man has written on a given subject, why won't I listen to what he has to say about it?"

"That was it exactly."

"Because," explained Harold, "I always find it much easier to concentrate on what I am reading myself than on what is being read to me. If, however, I do allow my attention to wander while I'm reading anything, I can always go back and read that part over again until I'm able to grasp it."

"Quite."

"But I can't do that with a broadcast talk. If I allow my attention to wander for a moment, so that I miss a little of what the lecturer has said, I can't obviously make him go back and repeat it!"

"No, of course not," I agreed.

"Again, if the speaker raises some rather complicated point which I cannot grasp at once, and I stop

to think over that point, I naturally tend to miss the next point.

"With a book it is quite different. If I come across a paragraph that I find difficult to follow I can read it over and over again, if I like, until I can appreciate exactly what the author means."

"Yes, I can see from your point of view," I said, "but I still think that broadcast talks are better than books or articles in certain respects. For instance, a speaker can often emphasise important points and give to his remarks the particular meaning that he wants to convey much more successfully than a writer can."

"Yes," replied Harold, "but I've got another criticism to make about

wireless talkers. Some of them gabble their talks, often on rather complicated subjects, far too rapidly for the average listener to follow properly."

"I agree with you there," I said. "The matter in a broadcast talk of twenty minutes' duration, or less, must often represent the result of hours and hours of study or practical experience on the part of the lecturer who gives the talk. Therefore, ordinary listeners who are not conversant with the subject can hardly be expected to take it all in as fast as the speaker can talk!"

"Perhaps not," said April, "but I think we've talked enough about talks. Let's switch on some music."

W. OLIVER.

## The Poets Foretell Radio

### The B.B.C. Sunday

Who backs his rigid Sabbath, so to speak,  
Against the wicked remnant of the week.

T. Hood: *Ode to Rae Wilson.*

### Radio Critics

To gild refined gold, to paint the lily,  
To throw a perfume on the violet.

Shakespeare: *King John.*

### The Silent Set

For every ill beneath the sun,  
There is some remedy or none:  
If there be one, resolve to find it,  
If not, submit, and never mind it.

Anon.

### The Announcer's Voice

The devil hath not in all his quiver's choice  
An arrow for the heart like that sweet voice.

Byron: *Don Juan.*

### The Revenge Oscillator

My sentence is for open war: of wiles  
More unexpert I boast not.

Milton: *Paradise Lost.*

### The Weather Forecast

Snowy, Flowy, Blowy,  
Showery, Flowery, Drowery,  
Hoppy, Croppy, Drowpy,  
Breezy, Sneazy, Freezy.

G. Ellis: *The Twelve Months.*

## THE BUYERS

They stood before the super-set  
Admiring every line;

"If only we had one like this,"  
Said she, "it would be fine!"

"I love those switches and that dial,  
Those little knobs—so funny!  
The only question, Georgie dear,  
Is—can we find the money?"

"I never saw a nicer set  
Than this one standing here—  
Oh, Georgie, pay attention now!  
Let's go and buy it, dear."

"What do you think a set like this  
Would run us into, pet?"

"Dear Georgie" raised an eyebrow then  
And grimly answered: "Debt!"

C. P. P.

# Give Us Better British Sets!

**B** RITISH wireless receivers as a whole are not a good advertisement for this country. To my mind, one of the most disappointing aspects of the annual radio exhibition is the parade of sets completely lacking in real production development. We have learnt to expect the same old box of tricks—a box instead of a cabinet and knobs tricky to operate.

## Practical Experience

During the past six months I have handled sets produced by all the leading British manufacturers. My convictions, right or wrong, are at least based upon practical experience. It has not been a particularly exhilarating time.

My biggest grouse is directed against the arbitrary limitation in the number of valves set makers have imposed upon themselves with remarkable unanimity. Three valves is the favourite number; one for high-frequency amplification, another for detection and the third for power amplification.

This is an admirable combination. But I suggest that it is more suited to the amateur-built than to the factory-built set. When an amateur builds a set, he can make his individual production give the maximum possible results. But the set manufacturer must always sacrifice some efficiency in the interests of production.

In defending their policy of producing small valve sets, the makers proudly exhibit the efficient British valve as their excuse. With such efficiency per valve stage, they say, we can fully satisfy the cheap-set market with a three-valver. This may be true, but the cheap set market is by no means the only market.

## Not Good Enough

For modern conditions, the three-valve set is not good enough. Ease of control and selectivity cannot be truly achieved by the methods now adopted by our set makers.

To cope with the present European broadcasting system, of which the B.B.C. is only a part, we must have real selectivity. Few will contradict the assertion that four tuned circuits are the minimum for modern con-

*Says ALAN S. HUNTER*

ditions. And since we cannot transfer energy from circuit to circuit without loss, amplification must be introduced at each stage.

Four tuned circuits imply three high-frequency amplifiers. So far as I know, there are only two sets on the British market employing a three-stage high-frequency amplifier. Both these are of recent introduction.

By introducing several stages of definite high-frequency amplification, the chief bug-bear of the average British set could be avoided—reaction. Some makers call it "volume," others "range," but it means the same thing. Reliance on reaction introduces a personal equation, which renders impossible any uniformity of performance.

Candidly, there is no design at all in a straightforward three-valve set turned out under factory conditions. But three high-frequency valves give one something to think about. The calibration of the four associated tuning circuits and their "ganging" for single-knob tuning is, I submit, a task worthy of a designer, as distinct from a component assembler.

## Waveband Handicap

We hear it said, quite often, that the dual wavebands in European broadcasting impose a severe handicap on set makers. But as one eminent set-designer has pointed out to me, it is actually more difficult to make a set tune over a waveband of 200 to 500 metres than 500 to 3,000 metres.

Multi-circuit tuning goes out of gang, so to speak, as the very high frequencies corresponding to the lowest wavelengths are approached. Separate long-wave circuits to cover the 1,000 to 2,000 metre range of wavelengths are comparatively easy to provide.

If we grant that the designer who knows his business can put into production a set with three high-frequency stages, controlled by a single knob, what are the outstanding objections? One is obviously the increased cost of production of such a set when compared with a straightforward three-valver. Another objection is

the increase in the running costs.

I believe we can draw a useful parallel here between radio and automobile development. The six-cylinder car of to-day is cheaper than the four-cylinder car of yesterday. The public are always prepared to support real development.

## Lower Prices to Come

I believe that the five- or six-valve set of to-morrow will be sold at a lower price than the mediocre three-valvers of to-day. To continue our parallel, six-cylinder cars cost more to run than four-cylinder cars, yet who is not prepared to offset this in view of the increased flexibility and smoother running?

Give a man a set that, by the turn of a dial, will provide him with a station per degree and he will gladly double his running costs. A lesson the set makers have yet to learn is that set buyers have money to spend.

In the potential set-buying group of listeners is obviously a high percentage of electric-light users. For this reason, set makers can logically devote considerable attention to the mains-driven set.

This year, every set maker has attempted to produce a mains model, but most have failed to take the fullest advantage of things. The power output equipment of the average mains set could be greatly improved.

Super-power valves in push-pull need not be confined to public-address systems. With power from the mains, there is no excuse for indifferent quality of reproduction.

Because I am an optimist, I look forward to seeing the set of the future as a self-contained musical instrument. Who could so designate the sets of to-day?

## Dodging Responsibility

The set makers, save in portables, dodge all responsibility for the last link in the chain—the loud-speaker. I hope to see sets with built-in loud-speakers, specially designed to match the low-frequency equipment.

The housing of these musical instruments is important. We must eradicate the soap-box variety of cabinet and introduce something worthy of British Cabinet making.

# AMONGST THE RADIO ARTISTES



Pauline Bindley—soprano



Raymond Newell—baritone

*Songs,  
Plays,  
Records  
and  
Humour*



Philip Wade, who takes part in studio plays

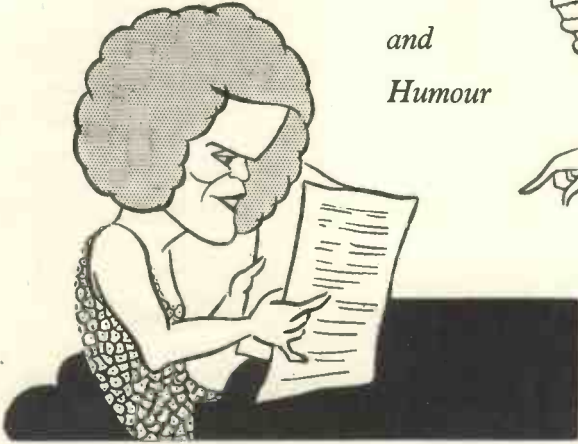

Florence Oldham broadcasts syncopated songs and makes gramophone records

*Special  
"W.M."  
Caricatures  
by  
ROBERTS  
and  
LISSENDEN*



Edmund Willard—actor



George Doshier—a baritone



Myles Clifton, a popular light comedian

# Radio Parts Made from Powder!

This month Professor Megohm and Young Amp visit another factory and see how bakelite mouldings are made. You will be interested in what they saw for many of the components in your own set are moulded in this way.

YOUNG AMP was in a quandary. He had just strolled up to the laboratory, and through the window could see Professor Megohm regarding with an abstract air a curious brown powder on a sheet of white paper in front of him. The Professor's brow was furrowed, and with his silvery hair gleaming in the light, he looked almost anguished.

## Solving the Mystery

Amp threw open the door of the lab, determined to find out what the mysterious powder was.

"Hello! You scoundrel!" said Megohm cheerily, as he observed the boy's presence, "what have you been doing with yourself lately?"

"Oh, just floating around," replied Amp. "But, I say, whatever is that stuff you've got there?"

"Why?" queried Megohm, still puzzled. "It's only bakelite powder."

"I thought it was poison, or something."

"It probably is; I've never tried it!" said the Professor, beginning to recover his equilibrium.

"What did you say it was, anyway?" asked the lad.

"Bakelite powder, my boy. Quite harmless."

Amp gazed at it, silent.

## For Makings Mouldings

"For mouldings," volunteered Megohm, seeing the boy's blank look.

"Oh, I see!" said Amp. "You mean for polishing them up afterwards?"

"Yes," Megohm responded sarcastically. "They mix it with treacle and apply it with a paint brush to get the polish. Don't you know how a moulding is made?"

"Fraid not," admitted the boy.

"You ought to, seeing the enormous number of mouldings that are used in wireless production to-day. Look at this set, for example," he continued. "The dials on these condensers are moulded, these valve holders are moulded, this high-frequency choke is moulded and the bases of the coils are all moulded."

"But," objected Amp, "do you mean to tell me that all those things are made out of powder, like you have there?"

"Yes," replied the Professor. "That powder has the property of changing its state under the combined application of heat and pressure. What we do is to make two steel moulds, which consist of blocks of stout steel having recesses in them. The mould is made in two halves, so that we can take it apart afterwards and remove the moulding. All we do is to fill the mould with a certain amount of powder, put on the top



A TYPICAL MOULDING  
The case of a fixed condenser moulded in green

half, place the whole thing in a suitable press, and there we are."

"Well, I never realised that," said the boy. "It sounds pretty easy."

"It is fairly straightforward when everything is worked out right, but it is a very critical process, for if everything is not correct the results will not be satisfactory. Would you like to see some mouldings being made, because if so we will run along and see Mr. Justso, and ask him to show us his plant."

Amp jumped up enthusiastically. "By Jove! Professor, that would be topping. Do you think he would?"

"Let's go along and see," replied the other, reaching for his hat.

A short ride brought them to Mr. Justso's works, where they were greeted by the great man himself. He proved to be a very jovial person, and expressed himself only too pleased to show the moulding operations.

## A Bewildering Array

Amp was taken into a room containing a bewildering array of presses of all shapes and sizes. Funny little pumps were gurgling away in one corner of the room, emitting weird noises at periodic intervals, while several men were busy inserting or removing the moulds from the presses. They inspected a simple press, first of all, producing a square moulded base.

Mr. Justso explained that the bottom mould had a recess cut in it, while the top mould had a projection which fitted down inside this recess, but left a clearance of about one-sixteenth of an inch all round, so that there was just space between the two moulds even when they were pressed up tightly together. Into the bottom mould Mr. Justso placed a quantity of black powder. He then picked up the top mould, first of all donning a large pair of leather gloves.

"Why do you do that?" asked Amp.

"Because it's hot," came the answer. "The presses are heated and the moulds absorb the heat and transfer it to the powder, for the correct temperature is necessary as well as the correct pressure, if the powder is to become properly plastic."

## Special Gas Jets

While he was talking, Mr. Justso had put the top mould in position, and he now carried the whole over to the press, where he pointed out to Amp the gas jets heating those portions of the press next to the mould. He then screwed the whole thing up, and after inspecting the thermometer inserted in the mould to make sure that the temperature was within the limits necessary, he applied the pressure.

As he did so one of the pumps in the corner complained loudly and this explained to Amp the curious grunting noises that he had heard coming from time to time from this corner. It was the special relief valve on the pump regulating the pressure to the predetermined amount.

### Astonishing Change

The mould was left in for about three minutes, after which the pressure was released, the mould withdrawn, and the top portion removed. There, inside, all bright and shining, was the base. The powder had completely changed from a dull, dirty-looking mixture to a bright shining base, with sharp edges and a brilliant finish.

Round the edges were certain little projecting pieces, where the moulding material had squeezed its way through between the joints of the mould. Mr. Justso called this the "flash," and proceeded to break it off, leaving the moulding sharp and clean.

Amp looked on fascinated. It seemed to him the most extraordinary thing he had ever witnessed.

"There you are, my lad," exclaimed Mr. Justso cheerily. "That's how it's done. Now let's come along and look at some others."

They passed on to another machine where a man was inserting little pellets of green-looking material into what looked like little cake tins. Mr. Justso explained that this was a multiple mould, in which several similar articles were turned out with one operation, at the same time.

### Six Jobs at Once

"We've got to leave the mould in the press for three minutes," he pointed out, "and if during that time we can turn out six jobs instead of one, we are so much better off."

"What are these green things, though?" asked Amp.

"Moulding powder," was the answer, "only here we make it up into little pellets so that it can easily be handled."

"But," protested Amp, "you used black powder last time."

"Well," was the whimsical reply, "you got a black mould, didn't you. This one's green!"

"Oh, then you can make it all sorts of colours?"

"Bless your heart, yes. All colours of the rainbow, if you like—all at once."

Amp watched the mould assem-

bled and put in the press; then, after due time, it was taken out and there inside were six small green knobs, looking most attractive and almost good enough to eat.

"How do you know how much powder to put in?" he asked, as they proceeded to another machine.

"That has to be weighed out very carefully," answered Mr. Justso. "If you don't get enough powder it won't completely fill the mould and you'll get a flaw, like this."

He picked up a piece of moulded material off the bench where in one place the mould was rough and not showing its usual high polish.

"What happens if you put too much in?"

"You bust the mould," came the uncompromising answer.

"Oo!" exclaimed Amp, much impressed. "You have to be pretty careful, then?"

"You bet! Here's another thing," went on Mr. Justso. "In this case we are inserting little metal pieces in the mould as we make it."

A boy was fitting small metal inserts into the mould itself. There were several small holes cut in the mould, and in each of these he fitted a little brass cylinder. Then he put in the correct pellet of powder into each recess (for this, another multiple mould), and finally transferred the mould to the press.

They all stood by and waited until it was "cooked," when on taking it out Amp saw that each of the moulds had a small metal centre piece in its correct position, with a tapped hole running through it.

Amp could say nothing; he was too intrigued with the whole business. His reverie was interrupted by Megohm, who had been walking silently a little in his rear. Indeed, Amp had almost forgotten all about him.

"Of course," said Megohm, "all these moulds are child's play to Mr. Justso. When we get a little farther on you will see some really complex moulds."

"Oh, yes," agreed Mr. Justso. "These are really quite easy ones."

So saying they passed through into another part of the shop, where some more elaborate presses were at work. Here the moulds were considerably larger and deeper. They were moulding all sorts of curious things, like coil formers, special cases, top plates for eliminators, many of them with a number of metal inserts included. Indeed the different

gadgets were so numerous as to leave Amp quite bewildered.

One of the moulds in particular claimed their attention for some time, for he simply could not see how the job could ever have been done. Yet, as he watched, he found that the moulding tool was made in several pieces, and was taken apart, bit by bit, in order to release the finished moulding.

"Well," interrupted Megohm at length. "I really must go, my boy. I have no doubt Mr. Justso will let you pay another visit one of these days."

"Any time you like," said Mr. Justso genially. "Let me know, first." And with that they had to leave, Amp very reluctant and still thinking the whole thing out very carefully.

As they were going home in the car Amp said: "What did you say the stuff was called?"

### Other Suitable Materials

"What I had was bakelite powder," replied Megohm. "But there are, of course, a number of other moulding materials suitable for different purposes. Bakelite is only one particular form. Many firms, indeed, have their own particular brand of powder which they consider the best, but the general principle is the same as you have seen this afternoon.

"The application of heat and pressure in the correct proportion results in the material becoming plastic and flowing completely into every crevice in the mould, so that it comes out the nice highly-polished product which you have seen."

### FREE ADVICE TO SET BUYERS

To take advantage of this service it is necessary only to mention (1) the maximum price and whether this is for a complete installation or the bare set; (2) where the set will be used; (3) what particular stations are desired; (4) whether a self-contained set (with or without aerial), or an ordinary set with external accessories is preferred; and (5) in the case of mains-driven sets, whether the mains are A.C. or D.C. A stamped addressed envelope for reply is the only expense

# A "Peep" at the Northern Regional

*Some Facts and Figures Concerning  
the B.B.C.'s New Broadcasting  
Station in Yorkshire*

By **KENNEIH  
ULLYETT**

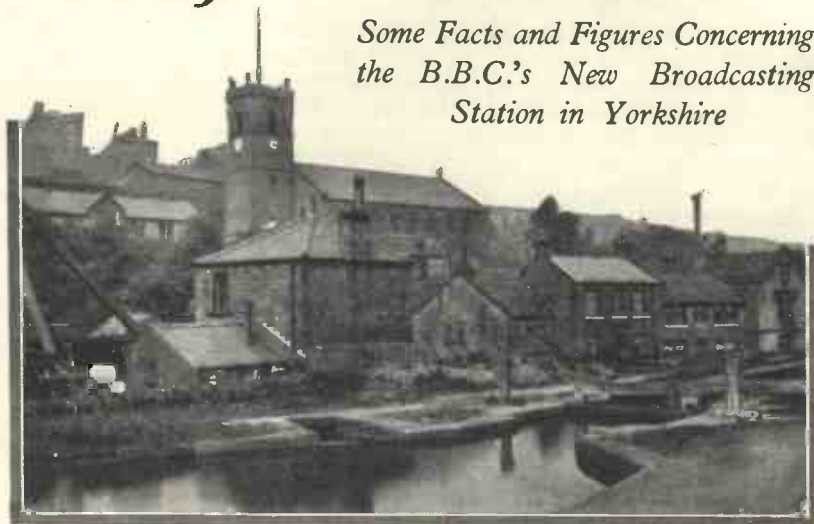

**THE SITE OF THE NORTHERN REGIONAL STATION**

*Here you see the church at Slaithwaite, the nearest town to the B.B.C.'s new station at Moorside Edge, in Yorkshire*

**W**ORK is proceeding apace on the new station at Moorside Edge, near Pole Moor, above Slaithwaite, on the Pennines dividing Yorkshire and Lancashire.

The aerials are in course of erection and it will not be long before the station bears evidence of being complete, from the outside at any rate!

### **Based on Brookman's Park**

This new Northern Regional station is based upon experience gained at Brookman's Park. The station building itself is arranged somewhat on the same plan as that of Brookman's Park, but is to be finished in red brick, it is understood, and not in the drab, ultra-modernist stone facings of the London headquarters.

Permission could not be gained from the Air Ministry to put up masts higher than 200 ft. at Brookman's Park, but Slaithwaite is not on, or, rather, under the regular air routes, and so three 500-ft. masts are being erected.

### **Wavelengths Allocated**

The wavelengths allotted are 479.2 metres and 301.5 metres, that is those at present owned by 5GB and Aberdeen. This means that there is a wavelength separation of 167.7 metres whereas the separation between the London Regional and National is only 95 metres, that is about half as much.

The higher-wave Moorside Edge transmission should have a gigantic service area, for the favourable wavelength, combined with the 500 ft. aerial and a maximum possible power of 50 kilowatts, should ensure plenty of punch.

Tests which were made in the early days, when the Moorside Edge site was being chosen, showed that the field strength is greater in the east-west direction than in the north-south.

Listeners in the neighbouring towns, Leeds, Bradford, Manchester, Huddersfield, Halifax and so on, all densely populated centres, will very probably have to recondition their sets or fit wavetraps as has had to be done by many southern listeners, with whom the Moorside Edge local listeners will be able to commiserate when they find their own conditions reminiscent of those obtaining in the London district at the opening of Brookman's Park.

*A difficulty that will be experienced is that the number of people in what will be the swamp area of Moorside Edge will certainly be very much greater than those close to Brookman's Park.*

Slaithwaite itself, the nearest town, has many factories and there are thousands of people living there. Moorside Edge is by no means the bleak, barren district that many southerners have supposed it to be.

There are houses quite close to the new station itself, and the residents there will certainly have a rough time of it when the transmissions start.

Huddersfield, with a population of approximately 110,000, is only about five miles away in a straight line; Halifax is only a mile farther away and has a population of approximately the same.

### **Manchester Studio**

Moorside Edge will derive the major portion of its programmes from the newly erected Manchester studio, while relays from London and other centres will be made by Leeds. The new Manchester studio and office block was first built when the regional scheme was conceived, and it was designed with the idea, later, of supplying programmes for the Northern Regional.

The Manchester studios are in a new building situated in Piccadilly, overlooking the Municipal gardens, in the heart of the city. The studios are over a bank, but the premises nevertheless are quite imposing and will bear comparison with London's forthcoming headquarters, Broadcasting House.

The main studio for use with Moorside Edge is a double-decker, and is at present the B.B.C.'s largest in floor dimensions; it measures 54 ft. by 35 ft. The extra height is obtained by utilising two stories of the building, and there is a gallery which is at present generally used by the studio audience.

### **For Plays and Vaudeville**

This double-decker is comparatively resonant and is well suited to large orchestral broadcasts. Its large size, however, is a great convenience in the production of radio plays and sketches and many of the longer vaudeville periods at present given, both through London and the Midland Regional, are carried out in this huge studio.

When Broadcasting House is complete, London will have its own double-decker (much better than the

## The Earth That Wasn't!

LIKE most other wireless enthusiasts, probably, I have been in the habit of switching off my set each evening *before* earthing the aerial and moving the earthing switch back to the "on" position each morning before switching on the set.

One evening recently, however, I happened to reverse the process and threw over the earthing switch while the set was still working. To my surprise, the operation of moving the switch had practically no effect: the music continued as before, apart from a very slight diminution in strength.

### Simple Explanation

What was the explanation of the mystery? Quite a simple one, as follows: I use two independent earth connections, separated from one another by several yards.

The earthing switch is connected to one of these earths, which is buried directly beneath the aerial down lead, and therefore provides a straight-line path to the ground for the benefit of any natural charges which may find their way to my aerial in thundery weather.

The set itself is connected to the other earth, which is not directly beneath the aerial, but which happens to be more efficient for reception.

Investigations disclosed the fact that the lead from the earthing switch has somehow become broken and had subsided in a tangle on the ground.

### Chance Find

How long it had been in that condition I do not know, but the chances are that the breakage would have passed unnoticed for an indefinite time had I not chanced to close the switch while the set was actually working, as the broken lead, being independent of the ordinary earth connection from the set, did not affect reception at all.

The moral of this experience is that any listeners who use independent connections for the purpose of earthing their aerials would be well advised to examine them occasionally to make sure that the supposed "earth" really is forming a path to earth!

W. O.

present studio No. 7 at Savoy Hill), and Moorside Edge will probably have most exclusive use of this double-decker.

The general-purpose studio measures 13 ft. by 16 ft., and is at present very much overworked in connection with the Midland Regional.

There is a small talks studio which has a novel system of decoration, very different from that usually favoured by the B.B.C.'s modernist decorators such as Oliver Bernard; in this new talks studio an attempt has been made to create a restful atmosphere.

### Control-room Arrangements

The Manchester station engineers are very proud of the dramatic control board and control-room arrangements, which in due course will be used in connection with Moorside Edge.

The control room has a different method of switching from that now in use at Savoy Hill. Post Office type phone plugs and jacks have long been

used by the B.B.C. for control room switching, but when the new Moorside Edge station comes into action it will be controlled by a much better system of key switches, and there will not be so much need for potentiometer faders at every switching point to prevent clicks being heard as the circuits are changed.

The cost of Moorside Edge will be somewhere about £150,000, that is about the same as Brookman's Park. It has not yet been decided whether the other Northern transmitters, including Newcastle, will be dismantled when Slaithwaite starts.

Apparently, although the B.B.C. travelling van engineers obtained much useful data on the Slaithwaite site before work was commenced on the station, there are still many little queries which cannot be solved until the first transmissions are "on the air."

Both the transmitters should be in full swing by 1931, but test transmissions will probably be heard before the end of the present year.

## Overloading Your Detector

WHEN reference is made to overloading, one usually immediately thinks of the last valve in the set. True, in the majority of instances the power valve can be—and often is—overloaded. But what about the first valve in the set, or the detector?

### Tuned to Local Station

Let us assume a shielded valve is fitted in the first stage and that the set is tuned to the local station. Then high-frequency voltages are applied to the grid of this valve. An average voltage might be .2—sometimes it is more, say .5 volt—and there are numerous instances, now that Brookman's Park is working, of the applied voltage exceeding 1 volt.

An ordinary stage of high frequency magnifies at least 40 times. Therefore the voltage set up across the output circuit tends to be 40 times the input, or, say, from 8 to 40 volts. I write "tends to be" advisedly, for we must remember that a valve is connected to the first stage.

If it happens to be a detector of the anode-bend type with ample grid bias, there is nothing to cause concern.

But what happens when the de-

detector is of the leaky-grid pattern? Clearly it must be overloaded. A heavy grid current will tend to flow—the grid condenser will collect a charge and be quite unable to discharge through the grid leak in time for the signal to be properly rectified. The result is bad distortion, for one thing, and reduced magnification, for another.

Not all high-frequency amplifying valves will deal with such a strong signal as indicated without distortion. Much depends upon the circuit connections, however, as it is possible that the full output voltage variations are not taking place in the anode circuit—such as when a transformer is used, for instance.

Too strong high-frequency voltages are troublesome, however, unless the set was specially designed to deal with them.

### Detector Distortion

Most ordinary sets fitted with a leaky-grid detector are not able to cope with H.F. voltages of more than moderate intensity, with the result distortion is introduced. A high-frequency circuit volume control is therefore a necessity for the purpose of reducing the voltages applied to the detector. W. JAMES.



TELEVISION EXPERIMENTERS AT WORK

Making adjustments to a vision set whilst watching the broadcast image

IN the last instalment (in the June WIRELESS MAGAZINE), I endeavoured to explain to you how it was preferable, but not essential, to use an anode-bend rectifier in the detector stage of the wireless set that is going to receive and resolve the vision signals and produce good television images.

We must now direct attention to the low-frequency side of the set, and find what points are of outstanding importance.

### For Best Results

In the course of my own experiments I have tried out a large number of different types of receivers, some of my own design, and others emanating from various sources. Both qualitative and quantitative tests have led me to the conclusion that for the best results resistance-capacity coupling holds the field.

When properly designed, the transformer, dual-impedance, choke-capacity, push-pull, etc., are all capable of delivering a very faithful output signal, but resistance-capacity seems to give that extra degree of improvement which justifies its place at the head of the list.

I am not alone in my conclusions

a starting point.

To reiterate a fairly well-worn statement which, however, very aptly describes the position as far as the low-frequency side is concerned, "distortion is avoided if the increased signal from the output stage differs from the original only in being greater in magnitude"

## Around the Scanning Disc

# AMPLIFIERS for TELEVISION

By H. J. Barton Chapple,  
Wh.Sc., B.Sc., A.C.G.I., D.I.C.

on this point and in any case the enthusiast is not bound to accept any statement that he reads, and will want to try out matters for himself; that is why I desire to give him a few ideas to serve as

negative side of the curve. Both the grid-bias voltages and actual plate voltages (not high-tension feed voltages), play an important part therefore, and must be watched carefully to see that the operative points are satisfactory

### Deceiving the Eye

It is a fairly well accepted principle that if a low-frequency amplifier is designed and constructed so that on test it does not deviate more than 10 per cent. from the ideal, then for television purposes the eye will detect no flaw.

The ideal is, of course, one in which every frequency is amplified to the same extent and this is wrapped up in the selection of valves and components which will function as a team.

The bare essentials of a resistance-capacity amplifier are shown in Fig. 1 Without tying the reader down to certain valves, it is not politic to give all the various component values. See that the coupling condensers are large, however, .1 microfarad mica being particularly suitable.

I have found it very useful to make the connections to the grid of the first low-frequency valve via a 5-megohm potentiometer of good quality. This acts as an efficient volume control without upsetting the image.

### Wire-wound Resistance

As a rule, a .5-megohm leak will be satisfactory for the second valve with a .5-megohm leak in the last stage. Since one must invariably employ a valve of the super-power class in the output position, a wire-wound resistance is

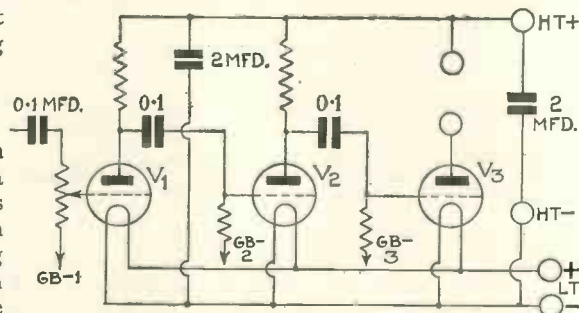

Fig. 1.—Bare essentials of a resistance-capacity amplifier

Put into other words, this is the same as saying that the output current in the plate circuit of each and every valve must be in direct proportion to the input grid voltage.

The grid must, in consequence, never assume a positive charge, and this can be guarded against by operating well within that part of the straight characteristic situated on the



better than the usual type of leak. The applied grid bias is anything from 20 to 40 volts, and above all, bear in mind that alterations to either high tension or grid bias must never be made without first of all switching off the low-tension supply and rendering the valve filaments inoperative.

**Suitable Combinations**

If you are a disciple of the LS5 brigade, then make v1 an LS5B with a 100,000-ohm plate resistance, v2 an LS5 with a 20,000-ohm power resistance, and v3 either an LS5A or an LS6A.

Do not imagine, however, that it is essential to use these rather "extravagant" valves for good results. One P650 or two P625's in parallel will be suitable for v3, while I have also got excellent images with the new PM256A in the v3 position.

The value of the high-tension voltage will bear largely upon whether you intend to work the neon lamp direct in the plate circuit of the last

valve or choke feed it. If the former, then 300 to 350 volts will be found desirable and remember, also, that the total consumption will be of the order of 30 milliamperes.

The high-tension source must therefore be capable of delivering the load desired.

In any case, it is a very wise plan to have a milliammeter in the neon circuit, so that the current can be adjusted and noted, to give the best results.

**Less Than 1½ Watts Needed**

With the Baird commercial Television now on the market, the makers suggest that the set to which it is coupled should be capable of delivering 1½ watts of undistorted output, but in practice this figure can be reduced and good results assured.

Reverting to the form of output, the simplest method is shown in Fig. 1, but raises the objection that about 350 volts is necessary. This can be reduced quite easily to 250 volts, but the high-tension source must now be capable of delivering at least another 20 milliamperes.

Fig. 2 shows one way of carrying this into effect. A choke output is used with an extra transformer, the neon lamp and synchronising coils

being joined in series and fed from a 250-volt D.C. source.

This can be the same source that feeds the amplifier or an entirely separate one, whichever is the more convenient. It is particularly useful to have a variable resistance of the heavy-duty compression type in circuit, as shown, as one can then vary the brilliancy of the neon lamp and incidentally the synchronising current pulses through the coils.

It is not always the brightest neon lamp that gives the best image, and the resistance, therefore, provides a very useful control and enables one to cut down the current demand to the barest minimum consistent with efficiency.

A slightly different output method is given in Fig. 3, a transformer being used with a separate high-tension

coils from a separate valve. This, of course, necessitates the extra coupling devices as well as the valve itself, while further high-tension current is demanded.

Personally, although from a theoretical standpoint the presence of

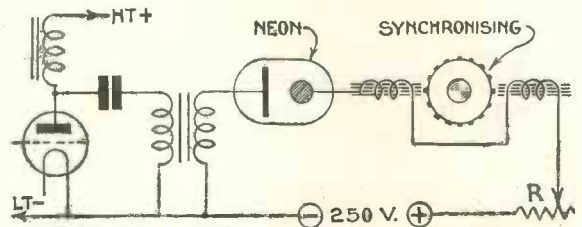

Fig. 2.—Choke feed with extra transformer, the neon lamp and synchronising coils being connected in series

iron-cored coils in the neon circuit is likely to cause frequency loss, in actual practice I do not consider that the quality of the image is impaired very much by the series working.

In case any readers would care to try this separate synchronising valve, however, the connections are given in Fig. 4. Resistance-capacity couple this valve in the manner shown, using a heavy-duty variable resistance to control the current through the coils.

**Use of Pentodes**

I have also conducted experiments with a pentode valve coupled direct to the detector stage (this in turn being preceded by a screened-grid high-frequency stage) and provided one is not a great distance from the Brookman's Park stations, adequate signal strength will be secured to work the Baird Television.

An Osram PT625 fully loaded, for example, will hold the picture steady and give a bright image with coils and neon in series, but the high-tension feed to this valve must be of the order of 450 volts in this case. The connections are given in Fig. 5.

Now, as I mentioned earlier, while a resistance-capacity amplifier of three stages is, in my opinion, the best for the television signals, no objection can be raised to other forms of coupling, for if properly designed and operated, they give very good television images.

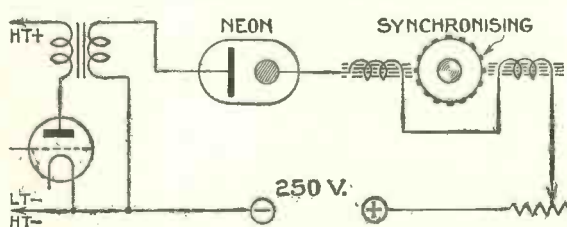

Fig. 3.—Output transformer used with separate high-tension source

source. The same high-tension supply as is used for the amplifier can, as in the Fig. 2 case, be used, provided it is capable of delivering the extra load without any serious drop in voltage.

There is still another alternative which finds favour in many quarters, and that is to feed the synchronising

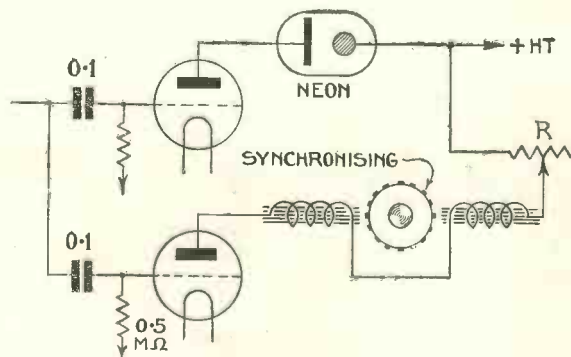

Fig. 4.—Arrangement of extra synchronising valve to operate the coils of the electromagnets

# Amplifiers for Television—Continued

For example, a resistance-coupled valve as the first low-frequency stage, preceded by an anode-bend detector and followed by two dual-impedance coupled stages, is quite satisfactory. Furthermore, a combination of resistance-capacity and transformer gives good results, although I think push-pull is to be preferred to transformer.

### Varying Opinions

In ordinary working we meet several cases where a certain standard of reproduction as represented by a good low-frequency amplifier joined to a first-class loud-speaker is praised by some people, but looked down on by others.

So in television, what constitutes a good image with certain people is deprecated by others. It is therefore advisable to try out

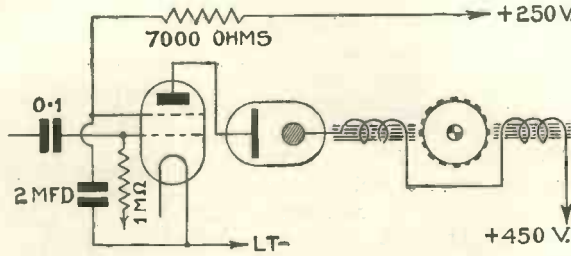

Fig. 5.—Circuit using pentode output valve

this way you will gain experience in the new art of looking-in.

Remember that the question of negative images is bound up in the low-frequency side as well as the detector stage, but as I have given the causes and cures before, this need not to be gone over again.

Those readers situated within normal range of the Brookman's Park transmissions will not require a high-frequency stage in their television receiver, but since we saw that the input to the anode-bend detector has to be reasonably high, there are many situations which demand high-frequency amplification.

I will deal with this question in my next article, for it is just as important as the low-frequency side for television work.

different types of amplifiers and see which suits your own requirements.

Note, also, that distortion in the amplifier is shown up by bright and dark vertical bands in the field and what may be termed a fluttering spiky appearance in the image. Make all your adjustments methodically, noting the effect of each change and recording it for reference purposes. In

## A Hum Filter

PRESENT-DAY mains units are on the whole reliable as regards smoothing and length of life, but now and again one hears of a case where a

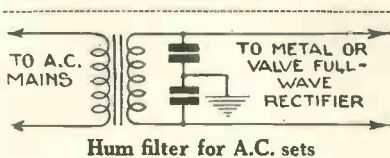

medium-pitched hum or noise comes through from the mains—and nothing can be more annoying.

In those rare instances where this trouble is experienced, I have found the simple filter illustrated of great value. Two condensers of about .1 microfarad each are used. They are connected together and to earth, whilst the outer terminals are taken to the terminals of the secondary winding.

### High-voltage Condensers

High-voltage condensers must be used, such as 500 volts A.C. test, but this will naturally depend upon the voltage of the circuit.

This scheme seems of no value with

half-wave rectifiers; in fact, the hum may be increased.

I have used it with mains units using both valve and metal rectifiers of the full-wave type and relief is invariably obtained. All kinds of queer noises are heard from some mains sets, but the filter will minimise them, though it does not assist the normal filtering at all. W. JAMES.

## Protecting Your Filaments

LOOKING through my box of "gadgets" the other day I came across a valve protecting device which was brought out in the days of 60-milliampere (or dry-battery) valves.

These valves had very fine filaments and were easily damaged by a momentary current in excess of the normal.

The usual flash-lamp bulbs available in those days afforded no proper protection and good fuses were not always available. One or two enterprising manufacturers, therefore, introduced safety devices of which the one I discovered was a specimen.

It comprised a fixed resistance shunted by a condenser and was joined in the high-tension battery circuit, usually between the H.T.—terminal of the set and the negative wander-plug socket of the battery.

### Current Restricted

Having a resistance of 1,000 ohms the current through a 120-volt battery is restricted to 120 milliamperes. Therefore, in sets having two or more valves the resistance prevented damage from occurring in the event of the H.T. battery being joined accidentally to the filament circuit.

The fixed condenser was used for

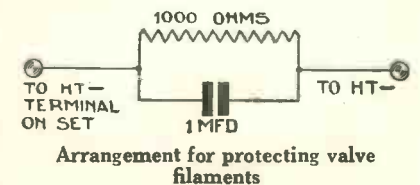

the purpose of providing an easy path for low-frequency currents, but it was not always successful, as howling and distortion used to occur.

W. JAMES.

# The Universal Push-pull Amplifier

Specially designed by the  
WIRELESS MAGAZINE  
Technical Staff

The large studio in Cologne used in conjunction with the Langenberg transmitter

At the present time there are in use many thousands of radio sets that meet every need as regards practical range, but which do not deliver sufficient output to give really good volume from a large cone or moving-coil loud-speaker.

The usual remedy in such cases is to scrap the old set and build a new one. Very often that is the best

*The special double-secondary transformer used in this amplifier enables both valves to be matched up without difficulty*

policy, but there are other cases when such a course is not only a waste of time and money, but also detrimental to results.

By far the best plan when great volume is needed only occasionally, and not as a general rule, is to build a separate amplifier that can be added to the existing receiver whenever desired.

## Boosting Up Output

It is for such cases that the WIRELESS MAGAZINE Technical Staff has produced the Universal Amplifier. This consists of a single stage of push-pull low-frequency amplification and can be added without difficulty to almost any radio set that needs boosting up at the output end.

Careful note should be made of the fact that this amplifier is not intended

to increase the range of any receiver to which it is added. It is intended solely to increase the power of stations that are already received at moderate strength.

Amateurs are only just beginning to realise that the power output obtained from a set—other things, being equal, of course—is controlled directly by the last valve.

For instance, suppose the power valve used in a set has an output of .5 watt at full load, then the use of two valves of the same type will give an output of 1 watt and the power output of the set will be doubled.

There are two points to note about this result.

In the first place, because the response of the human ear to sound volume is not a linear characteristic, the volume may not seem to be twice as great, although an increase will be noticeable.

Secondly, it is immaterial whether the valves are arranged in parallel or push-pull—the output in watts is just the same when two similar valves are used.

Each method of arranging the valves has its own advantages for different purposes. For use in the home a push-pull amplifier is usually the most satisfactory, because the results are good with comparatively low values of high tension. For this reason the

push-pull system has been adopted for the Universal Push-pull Amplifier illustrated in these pages.

## Three Special Points

There are three important points to remember in connection with push-pull amplification. They are:—

- (1) The grid swing that can be handled by the whole system is double that permissible for either valve on its own.
- (2) The output impedance is equivalent to the sum of the impedances of both valves.
- (3) For successful results two valves with identical characteristics are necessary—and these are very difficult to obtain.

Of these three points the first need only be taken into consideration when calculating what preliminary amplification is necessary to fully

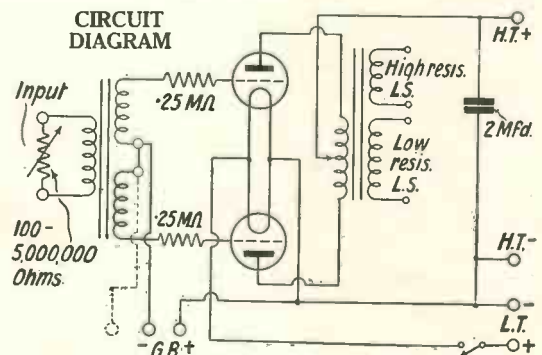

Quite straightforward, as you see, and provided with a volume control and high- and low-resistance outputs

# The Universal Push-pull Amplifier—Continued

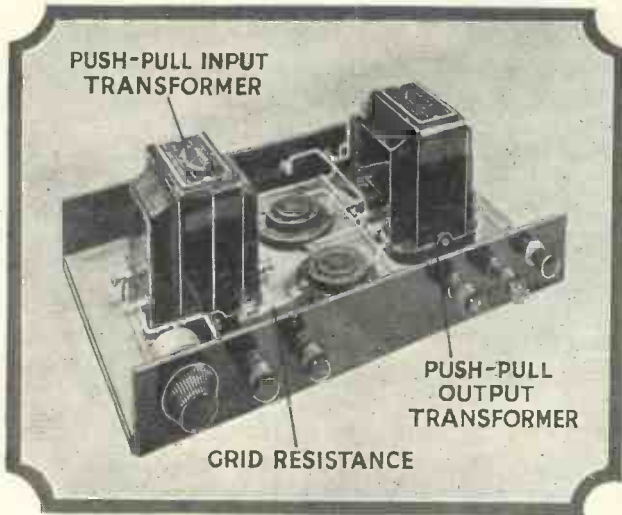

### EASILY HIDDEN AWAY IN A CORNER

The addition of this unit to a set need not mean extra straggling leads—it can quite easily be put inside a cupboard or under a table out of sight

load the push-pull amplifier, while the second can be ignored if a standard output transformer is utilised.

### Value Differences

The third point is one of considerable importance and is giving valve manufacturers a great deal of worry. The trouble is that, with most standard transformers, it is necessary to give both valves the same grid bias. That would be all right if the valves could be matched up exactly, but under modern manufacturing conditions that is practically impossible. This applies chiefly to very large power valves.

For example, the difference in bias required by two valves of the LS5A type may be as much as 20 volts. If the same bias is applied to both the anode currents will be different and the output will be slightly distorted.

This is not of particular importance when ordinary small power valves are used and these will be found quite satisfactory for all ordinary purposes.

### Special Transformers

Serious attempts are being made to overcome this trouble by the production of special input transformers having separate secondaries so that different grid bias can be put on the two push-pull valves. In the Universal Amplifier we have used such a transformer.

Even so, there is another practical

snag. To match up the anode currents of both valves, it is necessary to use a milliammeter in each circuit in turn and adjust the bias until the readings for both valves are identical. This point will be discussed more fully later on.

Before dealing with any more practical points, it will be as well to consider the actual circuit used for the Universal Push-pull Amplifier.

First, there is an input transformer, which is provided with a primary and two separate secondaries; that is, there are four terminals on the secondary side, instead of only three as on the usual push-pull input

terminal transformer, of course.

The dotted line shows how the second grid-bias tapping is taken, if separate bias is to be applied to the valves. The connection between the two inside terminals (in the circuit) is, of course, broken.

### Volume Control

Across the primary is a variable high resistance to control volume, which is at a maximum when the highest value of resistance is in circuit.

In series with the grid of each valve is a .25-megohm resistance. These resistances are to give stability and prevent oscillation. Their value is not of very great importance provided that they are the same.

On the output side, the two anode circuits are taken to a centre-tapped output transformer in the ordinary way. The particular model used in the Universal Push-pull Amplifier is provided with two secondaries, for use with high- and low-resistance loud-speakers respectively.

A 2-microfarad by-pass condenser is provided across the high-tension supply. This can be omitted if the unit is to be supplied from the mains.

An ordinary on-off switch completes the circuit.

### Simple Layout

There is no need for any special comment on the theoretical arrangement which is really quite straightforward.

The mechanical layout is also straightforward and simple. All the parts are arranged on a small baseboard provided with two terminal strips. If desired, a wooden or metal cover can be made to slip over the whole of the

gear and afford better protection.

No difficulty will be experienced in the construction. Wiring up will be facilitated by the use of a full-size blueprint. This can be obtained for half-price (that is, 6d., post free), if

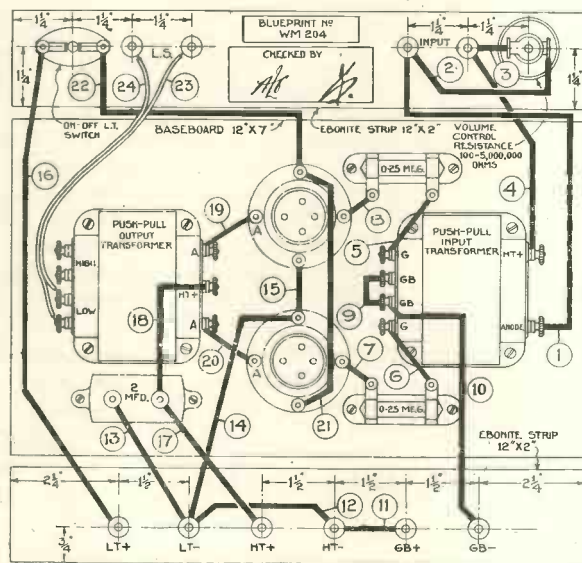

### SIMPLE TO ASSEMBLE AND WIRE UP

This quarter-scale layout and wiring diagram can be obtained as a full-size blueprint for half-price (that is, 6d., post free), if the coupon on the inside back cover is used by August 31

transformer that is available.

In the circuit the two grid-bias terminals are shown bridged across and taken to a common tapping on the grid-bias battery. This connection is the same as that of a three-

# Can Be Added To Any Existing Set!

the special coupon on the inside back cover is used by August 31.

Address your application to Blueprint Department, WIRELESS MAGAZINE, 58-61 Fetter Lane, E.C.4; and ask for No. WM204. A copy will be sent by return post.

On the blueprint, and on the quarter-scale wiring diagram reproduced in these pages, each wire is numbered separately in the best order of assembly.

*No matter whether your high-tension supply gives 120 or 400 volts, you will get excellent results from this amplifier*

The question of what valves to use in the amplifier depends almost entirely on individual circumstances. For normal purposes two valves of the 6-volt type taking a maximum anode voltage of 200 volts and with an impedance between 1,000 and 2,500 ohms will give all the output required for normal purposes.

### Restricted H.T. Supply

Unless one has pre-conceived ideas the choice of valves for such a purpose is somewhat of a puzzle, but not so difficult when the source of high tension is restricted in current output.

The best procedure is to find the maximum anode voltage and current available and pick the low-impedance

valves that will fit in with these conditions.

If batteries are to be used, at least the double-capacity type will be necessary, whilst in most cases it will prove more economical to use the triple-capacity type.

Whilst it is merely uneconomical to overload batteries, it is disastrous to overload a mains unit if this is the source of high tension. If a unit is rated at 180 volts 30 milliamperes, for example, it would be out of the question to use two valves requiring 20 milliamperes at 150 volts each.

The use of such valves would result in motor-boating in all probability and the life of the mains unit would be materially affected. Particular care should be taken to pick valves taking a total anode current well within the capacity of the supply.

It has been previously mentioned that it is desirable to so adjust the grid bias that the anode current is the same for each valve.

We have shown the unit arranged for common bias to both valves, because many constructors will not want to go to the expense and trouble of taking special meter reading. Actually with small power valves the risks of distortion are not very great, and the unit can be used as shown without any qualms.

Those who have a milliammeter already, or those who do not mind going to the additional expense of buying one—they are always a good investment and of great help on numerous occasions — are advised to fit an extra grid-bias terminal to the strip when assembling the unit and taking a separate connection to each "G.B." terminal on the input transformer.

The method of adjustment is to apply the bias recommended for the particular high-tension voltage. The milliammeter should then be inserted between the anode

## PARTS NEEDED FOR THE UNIVERSAL PUSH-PULL AMPLIFIER

### CONDENSERS, FIXED

1—Dubilier, 2-microfarad, 3s. 6d. (or Hydr Mullard).

### EBONITE

2—Terminal strips, 2 in. by 12 in.

### HOLDERS, GRID-LEAK

2—Ediswan, 2s. 6d. (or Bulgin, Dubilier).

### HOLDERS, VALVE

2—Lotus, 3s. (or Formo, Igranite).

### RESISTANCES, FIXED

2—Dubilier .25 megohm, grid-leak type, 5s. (or Lissen, Ediswan).

### RESISTANCE, VARIABLE

1—Clarostat, standard type, 10s. 6d. (or Regenstat, Volustat).

### SWITCH

1—Lotus on-off, type BS/20, 1s. 6d. (or Junitrix).

### SUNDRIES

Glazite wire for connecting.  
Length of rubber-covered flex.  
Baseboard, 12 in. by 7 in. (Pickett).

### TERMINALS

10—Belling-Lee, marked: LT+, L.T.—, H.T.+ , H.T.—, Grid+, Grid—, L.S.+ , L.S.—, Input+, Input—, 3s. (or Burton, Igranite).

### TRANSFORMERS, LOW-FREQUENCY

1—Varley push-pull input, type DP6, £1 5s. (including royalty).  
1—Varley push-pull output, type DP7, £1 4s. (including royalty).

The prices mentioned are those for the parts used in the original set; the prices of alternatives as indicated in the brackets may be either higher or lower

terminal of one valve holder and the primary of the output transformer (for instance, lead No. 19 on the wiring diagram), and the reading noted.

Next, the meter should be placed in the anode circuit of the second valve (lead No. 20), and the reading again noted. The grid bias can then be increased or decreased (to lower or raise the anode current respectively) until both readings are the same.

### Two Points to Note

Two points should be noted about this operation. The readings should only be taken when both valves are in circuit and the unit should be switched off entirely each time the grid bias is changed or serious damage may be done to the valves.

Little need be said regarding the external connections to the amplifier. To the input terminals should be connected the loud-speaker terminals of the preceding radio receiver.

It will not matter—indeed, it will be an advantage—if the set is already provided with choke-capacity output.

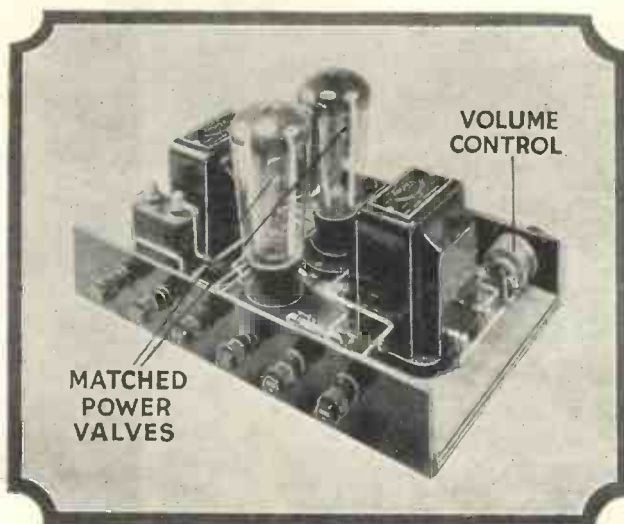

**JUST WHAT YOU HAVE BEEN WANTING!**

*This simple amplifier will give your set just that extra strength that will make all your friends envious!*

# The Universal Push-pull Amplifier—Continued

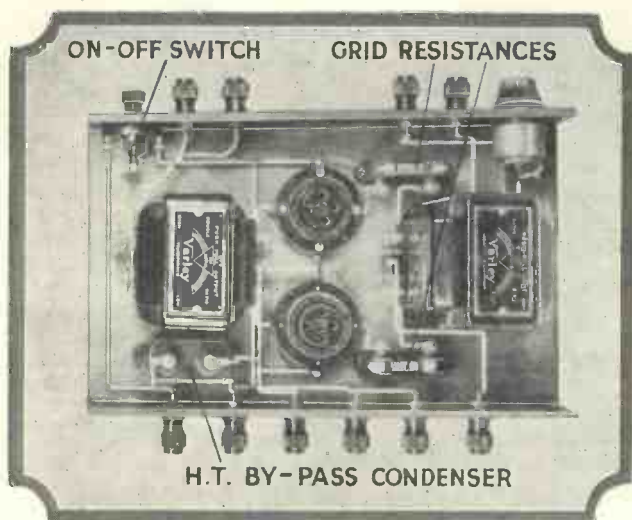

ONLY STANDARD PARTS ARE USED

There will be no difficulty in getting the components for this amplifier. Most dealers will have them in stock

as this will prevent the passage of a heavy direct current through the primary of the input transformer with consequent loss of inductance.

Should the high-tension and low-tension supplies for the amplifier be the same as that for the main set there is no need to complete the high-tension negative connection, as this

will already have been connected to low-tension negative in the main receiver.

It is most important to see, in this case, that high-tension negative in the main set is connected to low-tension negative, and *not* to low-tension positive, or the low-tension supply

*By adding this amplifier to an ordinary "pygmy" set, it will be turned into a real "giant." You will not be disappointed if you build it!*

would be short-circuited when the amplifier is connected.

With the observance of these few precautions the Universal Amplifier, used with the right valves, can be relied upon to give great volume without any distortion at all.

## Nursery Rhymes Radio-vised!

MY wireless cupboard is usually kept locked—valuable articles like valves and grid leaks cannot be too carefully treasured. But, recently, I found an alien among my tribe of components. I pulled out, what I thought was a blueprint of a wonderful new set invented by a wonderful new scientist, and in my hand was a copy of that literary treasure, "Mother Hubbard's Nursery Rhymes."

### Not Changed a Bit!

A slack moment allowed me to glance through it. And I was amazed—in fact, speaking as a wireless fan, and thus being particularly modern, I was disgusted—to find that, in all this welter of progress, nursery rhymes have not changed one bit.

This, of course, must be altered, so I have arranged with my publishers for the immediate issue of a revised version of these peripatetic old verses.

I append several examples of the contents, in the devout hope that you will help the week's good cause (my royalties) by purchasing a copy from the nearest bookstall (Haven and Dammit, fourpence ha'penny, nett).

Firstly:

SING A SONG OF RADIO  
Sing a song of radio,  
Batteries nice and high.

Four and twenty wavelengths,  
Dashing through the sky.  
Keep the set a-howling,  
'Till the programme's ceased  
And Big Ben's slowly chiming—  
The neighbours *will* be pleased!  
I think one verse will be enough.  
(So do I.—Ed.)

Next:

### LITTLE BOY BLUE

Little Boy Blue, come, tune up your set.  
The valves are alight in your new super-het.  
Where's Paris these nights? Or Rome?  
Or Madrid?  
Why, jumping about 'twixt your anode  
and grid!  
Ahem! Sorry! But when you've  
recovered, read:

### Make a Note of the Date!

"Wireless  
Magazine"  
for  
September  
will be  
published on  
Friday,  
Aug. 22nd.

### LITTLE JACK HORNER

Little Jack Horner  
Sat in a corner,  
Tuning in Dublin and Cork.  
He managed, he said,  
To get Oslo instead,  
So now he does nothing but talk!  
It's no use writing to the Editor for  
my address. Calm yourself with:

Mary, Mary, quite contrary,  
What do you hear, these days?  
Oh, tennis and talks, howls and squawks,  
Morse, atmospherics, and plays!

Finally, before you raise the matter  
in the Commons, please commit to  
memory:

### GOLDILOCKS

Oh, Goldilocks, Goldilocks,  
Won't you be mine?  
You shall not touch my set,  
Or go out to dine,  
But sit in a daze  
And hear my set's squeals,  
And I'll go round the station  
Until your brain reels.

Which is all. There is no need to  
sing a Te Deum. I am impervious to  
sarcasm. W. M. G.

### The Announcer

A man so various that he seemed to be  
Not one, but all mankind's epitome:  
Stiff in opinions, always in the wrong,  
Was everything by starts, and no-  
thing long.  
Dryden: *Absalom and Achitophel*.

# 14,000 Miles With A Reinartz Three

**Adventures in  
Radio on A  
Voyage to South  
America!**

*Every reader will be interested in this fellow-listener's account of his experiences with a simple "det.-2 L.F." set on a tramp steamer bound from London to Buenos Aires*

**F**ACED with a long voyage of 14,000 miles to South America and back on an old tramp steamer, I decided that to break the monotony I would take my wireless with me.

Thus, it came about that one fine morning, as the old tramp, *D.*, was clearing the London docks and starting off at half speed down the river, I was aboard unpacking my gear and thinking how best I could rig up the Reinartz "three" which I had finally chosen to take with me.

### **Greatest Difficulty**

My first and greatest difficulty was to find a suitable position for an aerial, but after consulting the Old Man over lunch, I decided to swing it between two ventilators on the boat deck some 40 ft. apart, and bring the lead-in through a deck ventilator to my cabin below.

An "earth" was soon fixed, with the aid of one of the engineers, to the steel bulkhead and by the time we were abreast of the Goodwins all was ready to connect up the set and get going.

It must be remembered that the set had no high-frequency stage, but was a straight three, with detector, Reinartz reaction, and two stages of low-frequency amplification.

My aerial was none too good, since its total length could only have been 60 ft., very little of which was clear of all obstruction. Another distinct disadvantage was that immediately above my cabin was Sparks, with his 2½-kilowatt transmitter. Before I connected up, therefore, I interviewed Sparks, who promised that for the rest of the voyage he would kick loudly on the floor of his cabin each time he started up his generator to transmit, and so prevent my being deafened, and possible damage to the set.

After dinner the first night a small party gathered in my cabin to hear the first performance. The chief engineer told me that I might just as well have brought a gramophone, as in two days we should be out

of range of all radio broadcasting.

My pride as a constructor was hurt, and I immediately layed him a wager of half a sovereign that I would receive broadcasting every night until we got to Buenos Aires—a rash bet that I immediately regretted.

The first evening, however, the set came up to expectations and we must have logged a score of stations on the little cone loud-speaker. Curiously enough Bournemouth, though only about fifty miles away, was one of the most elusive, while Belfast, Radio Toulouse, Rome, Radio Barcelona, and, of course, Langenberg and the high-power German transmitters were easily tuned-in.

The next night we rounded Ushant in the teeth of a gale and were under-

### **HALF A GUINEA FOR A SUGGESTION**

*When you have read all through this issue just sit back a minute and try to think of some subject of special interest to yourself that is not dealt with.*

*Then jot your idea down on a postcard and send it to "Suggestions," WIRELESS MAGAZINE, 58/61 Fetter Lane, E.C.4.*

*A prize not exceeding half a guinea each month will be given for the best suggestion for the title or subject of an article.*

*The closing date for this month's competition is August 31. There is no need to write a letter; a postcard will do.*

## 14,000 Miles with A Reinartz Three—Continued

going torment in the Bay. 5GB was still going strong and Cardiff, one of the worst stations from my previous experience, was the best of the low-power Britishers. The German Deutschsenders, mostly at a distance of 1,000 miles, were still at good strength.

The most extraordinary thing, however, was that not a sound could

entirely new aerial, stretching from the top of the mast above us straight down to the porthole of my cabin. This, though rather long, greatly improved reception.

5GB now came in at fair loud-speaker strength in broad daylight, and after dark Cardiff, Bournemouth, Rome, Vienna, and Prague were still at good strength.

After this night the strength of all stations weakened daily. A few French military stations could be heard working—we assumed in Morocco—but these were generally at poor strength.

The night we passed off Madeira, standing out of the sea like a ghost in the brilliant tropical moonlight, only the high-wave European stations could be easily received. The best of these were 5XX, Zeesen, Hilversum, and Radio Paris. On the low waves 5GB and Langenberg were still just audible.

The night after we had passed the dark and forbidding Cape Verde Islands we lost touch with the last European station, 5XX.

For an hour the next evening we turned our dials in vain, and just as I had given all up and was heartily cursing the day that I thought of bringing the poor little set with me, a faint carrier became audible.

After some minutes we were able to work this up to considerable strength and finally identified the station as WGY. Half an hour later he faded away and nothing more was heard that night, except the usual morse accompaniment from neighbouring ships and an occasional kick on the floor of the cabin above, when I hastily switched off and Sparks started up his generator and replied.

On the following night conditions were about as bad as could be; tropical lightning played all round the horizon and we were in the doldrums, which is usually one of the worst areas in the world for wireless reception.

After our usual rubber of bridge, we switched on and after only a few minutes' tuning, picked up the faint strains of a tango. Breathless, we waited for an announcement to identify our station. It came, drowned in a burst of morse and atmospherics.

Every time we waited the same thing was sure to happen, but the chief engineer only grudgingly con-

sented that we had picked up broadcasting, "for it might be one of the big liners testing their telephony transmitter with a gramophone record," he said.

Next evening we definitely picked up our first South American transmission. This was Pernambuco, and we agreed, after comparing our dial readings of the previous evening, that this was the station that we had received the night before.

### Chain of Small Stations

I was now quite confident that I had won my wager with the chief engineer, for all down the South American coast is a chain of small low-power transmitters, the largest of which are at Bahia, Rio de Janeiro, and Montevideo.

The next day we passed Fernando de Noronha, a small island off the South American coast, where the political prisoners of Brazil are exiled.

A few days later we drew in towards the coast, Montevideo being our first port of call. Up till now Sparks had been daily receiving the news broadcast from Rugby, but as we drew in to the coast this transmission completely vanished. The high-power transmitter at Bordeaux, however, could still be heard communicating with the Monte Grande station at Montevideo.

Two nights before we reached port came the first catastrophe, when I



### A FAMOUS ACTOR

Sir Barry Jackson was the founder of the Birmingham Repertory Theatre

be heard of Radio Toulouse, a station that can be tuned-in in Great Britain any night on a one-valver. Barcelona, at a distance of 700 miles in approximately the same direction, was coming in on the loud-speaker.

A wireless operator whom I met in Buenos Aires told me that he had had exactly the same experience, and a French listener in Biarritz recently told me that he could tune-in most of the low-power Britishers at greater strength than Radio Toulouse.

### Failure in the West

Evidently this transmission, though excellent in the north, is an absolute failure in the west.

The next night all stations had weakened perceptibly, except a Spanish one, and Sparks, with whom I had now become very friendly, advised me that if I was to keep the half-sovereign in my pocket I had better make some extensive alterations to the aerial.

Next day he and I, with the help of the chief engineer, erected an

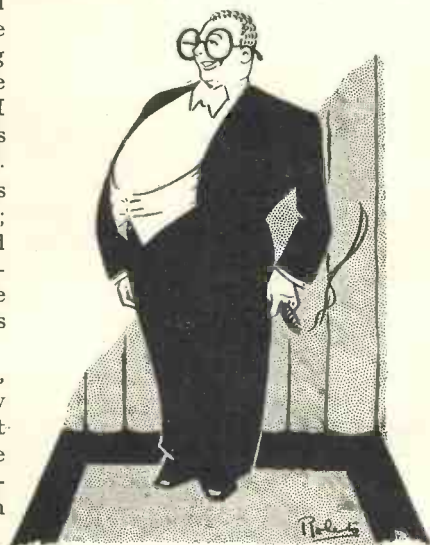

### WELL KNOWN IN CABARETS

This artiste, Rex Evans, takes part in B.B.C. revues



## Broadcast Conditions in South America

blew all my valves. Sparks, like a sportsman, produced three of his spares, which sufficed until I was able to purchase three very good American "tubes" in Buenos Aires.

We were now just south of Rio de Janeiro and receiving the excellent broadcasting station, which this beautiful city is fortunate enough to possess, at full strength. Several Argentine stations were also in range, the most powerful of which was LOY, a 2½-kilowatt station at Flores, a suburb of Buenos Aires. The two stations in Montevideo, namely, one owned by the General Electric Company, and the other by the newspaper, *El Dia*, were also coming in at good strength, but with poor quality.

### Up the River Plate

In dock in Montevideo no other transmissions could be heard but those coming from these two stations, and it was not until we cleared the city and had started up the River

Plate, or Rio de la Plata, famous for its storms, which are called pamperos, that we again heard the stations in Buenos Aires.

There are eight stations in Buenos Aires, all confined to a very narrow waveband; consequently with our unselective receiver their reception was difficult at close range.

Broadcasting in South America is exploited by various concerns for the purpose of advertising, and, in my opinion, very little trouble is taken to provide suitable programmes for the listener. There are small tango bands, which broadcast daily, and now and then a good outside broadcast; but, taken as a whole, one programme is exactly the same as another and lacks originality.

Since broadcasting in South America is still in the early stages of experimentation, listeners are more entertained by the novelty of a receiving set than by the programmes which it receives. This cannot go on for long, and I think that we shall



### POPULAR WITH DANCERS

*Hermann Darewski is too well known to need any introduction!*

soon see a general movement in South America for the control of broadcasting by the various Governments, thus providing stations with a definite financial backing. M. F.

## Too Many Stations in the Argentine!

THE Argentine listener should not suffer from lack of variety in programmes, if the number of stations he has to choose from is any criterion. In Buenos Aires alone there are sixteen different broadcasting stations operating on wavelengths between 210 and 433 metres.

However, the Argentine is not quite the broadcast listener's Elysium it might seem at first.

### Over and Over Again

Most, if not all, of the stations rely on gramophone records to supply the major portion of their programmes, and while it is better to hear a first-class gramophone record than an indifferent local artiste, it is inevitable that many of the records are heard over and over again from different stations.

Again, although the sixteen stations are never broadcasting at the same time, even six or seven stations on the ether within an area of a few square miles can cause considerable congestion. Even with the most selective receivers, it is impossible to separate some stations operating within a few metres of each other.

*Broadcasting conditions in other countries are always of interest to listeners everywhere. Here are some special notes about South America*

Personally, having so many stations to choose from, with ubiquitous human frailty I invariably fish around in search of the best items without going to the trouble of referring to the broadcast programmes, with the result that I don't seem to get anything!

Conditions in general are more like those existing in America than Britain, both as regards transmission and reception.

Stations are run on an advertisement basis, and although most of them are owned and operated by Spanish concerns, the programmes are divided fairly evenly between Spanish and English items.

Gramophone records of classical music and complete operas are very general, while there is an almost equal preponderance of American dance records and typical Spanish music.

The English-speaking Radio Club, or E.S.R.C., as they call themselves, consisting of a few hundred members, who contribute a peso (1s. 8d.) a

month to a common fund, enable the broadcast of a special English programme at intervals.

Short-wave reception is comparatively popular and the schedules of W2XAF, W2XAD, and Chelmsford 5SW appear in the papers as part of the regular broadcasting programmes.

Conditions for short-wave reception seem to be especially good. Chelmsford and the American short-wave stations are heard at comfortable loud-speaker strength, using three valves and an aerial a few feet long. Melbourne also is heard, but reception from that station does not come up to the others. Reception of morse stations, of course, is legion.

### Cheap Licences

A licence for a receiving set costs only 2 pesos a year, which is equivalent to 3s. 4d.; that, combined with the comparatively low cost of components and complete sets, has encouraged the rapid growth of broadcast reception, and altogether broadcasting has taken a firm hold in the Argentine, and is becoming increasingly popular each day.

H. C.

# Results with the James Portable S.G.3

A PORTABLE set is often able to put up a very good performance as regards range when the circuits are carefully adjusted. The condition of maximum sensitivity is fairly easily obtained, and exists when the aerial circuit is practically oscillating.

With little shielding and with various stray couplings, the aerial circuit may oscillate too readily. But, then, owing to the poor magnification obtained before the aerial circuit oscillates, the signals will be weak

**Further notes by the designer, W. JAMES. Constructional details were given last month**

voltage, as the actual value of the screen voltage affects the results according to the characteristics of the valve.

For the detector a voltage of about 90 is suitable, applied through H.T. +3, but this, too, may be adjusted. It is easy to run the set from a mains unit. Both D.C. and A.C. types are suitable.

Owing to the fact that there is only one high-frequency and one low-frequency stage, no motor-boating troubles are experienced — in fact, the results from the mains units tried were satisfactory in every respect. Some users may choose to run the set from a mains unit in the house and to fit a dry high-tension battery for outdoor purposes.

The mistake should not be made of charging the accumulator with the lid of the case

closed. Tiny drops of electrolyte may be carried off by the escaping gases and damage the parts of the set. It is necessary to leave the lid open or, better still, to remove the cell and to charge it outside the case.

Do not overlook the functions of the switches. That in the lid is for connecting the long- or short-wave frame aerial to the set, whilst that mounted in the centre of the panel switches the low-tension circuit as well as the anode coil. Therefore, to turn the set off this centre switch is placed in its mid position. When it is to the right or left the accumulator is connected to the valves and the anode coil is in circuit.

Systoflex ought to be used for protecting the wires which pass through holes in the metal panels and the wires must not be pulled too tight when wiring. It is possible that when fitting the set in its case the panel will bend a little, owing, perhaps, to its not having been fitted

quite square. If the wires were stretched the Systoflex might be cut through, but this cannot happen if good material is used.

Those who wind their own anode coil will find the actual winding of the long-wave part, which is of No. 40 enamelled wire, is not difficult if the job is proceeded with steadily. Any attempt to hurry will probably lead to the fine wire being broken, but it is surprising how strong No. 40 wire really is.

## Avoiding Kinks

Kinks are to be carefully avoided. The wire must therefore not be allowed to twist or it will soon be spoiled.

When tuning you will notice that the set may be made to oscillate gently by adjusting the reaction condenser and that oscillation ceases when the frame-aerial circuit is brought into tune.

Here, then, is a good method of tuning, for the two circuits may be kept in step over the whole wave range by this means. Not much change in the reaction condenser is needed to keep the set in a sensitive state, but the two tuning dials must be turned slowly.

Squeals will not be heard if the set is properly built and handled. Too much reaction will only tend to choke the circuits and is thus of no value. The set is most sensitive when the two circuits are exactly in tune and the aerial is just about to oscillate. Used in this way the set is a pleasure to handle.

## Tuning Not Critical

Tuning is not at all critical, but the selectivity is such that many stations can be brought in without interference. I have received a good number of stations with fair quality and the results are such that one feels the design is a very satisfactory one.

The quality of the reproduction, too, is above the average, due no doubt to the good transformer and power valve, and to the fact that only one low-frequency stage is used.

*Constructors of this set should also read the article "Mains Power for Your Portable" on page 31 of this issue*

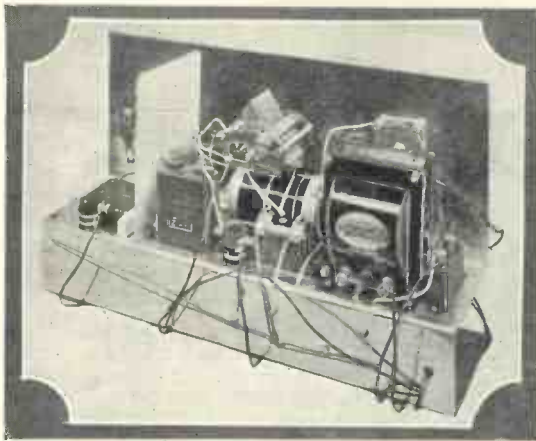

**MODERN METAL-CHASSIS DESIGN**

*This photograph shows the simple construction of the James Portable S.G.3*

and probably the set will be tricky to tune.

It is essential for the best results to shield the parts very carefully. Then the maximum of amplification will be obtained and owing to the build-up in the aerial circuit distant stations will be heard. The all-metal construction used was for the purpose of enabling high magnification with complete stability to be obtained.

## Complete Screening

Thus the anode coil and its tuning condenser are completely screened from the frame and the aerial-tuning condenser. Even the shielded valve has a screen, with the result that the set is very sensitive and easily handled.

I have given the most suitable high-tension voltages. That applied to the screen of the shielded valve, through tapping H.T. +1, should be approximately 60 volts, but do not forget to try a little lower or higher

# BROADCAST MUSIC

## *of the Month*

**N**ATURALLY a little lighter material has figured in the broadcast programmes of the past month, and the heavy orchestral programmes have been practically on the list of the "missing." The only one of any note was that performed by the Frankfurt Wireless and Bad Homburg Kursaal Orchestras, conducted by Constant Lambert, and relayed from Frankfurt on July 16. The soloist announced was the well-known pianist, Harriet Cohen, who might, I think, have chosen a more valuable work than the tiring

"book" was written by another fellow Co-Op, Austin Melford, and a star cast included Phyllis Neilson-Terry, Robert Atkins, Betty Chester, William Stephens, Florence Bayfield and Harry S. Pepper.

Late June also gave us many good light programmes, including one from the Birmingham studio with Tommy Handley in *Midsummer Musings*, Mabel Con-



Carmen Andija,  
Spanish singer



Bernard Ross,  
vocalist

many times with Sir Frank Benson's companies.

The Royal Covent Garden Opera season has given many relays this year, and the last night on July 4

provided listeners with a somewhat unhackneyed performance of *The Love of the Three Kings* by Monteverde, of which the third act is the best.

### Lighter Drama

One is also glad to note a lighter scheme of dramatic fare, and many people probably welcomed a performance of Anstey's famous play, *The Brass Bottle*.

The cast included Hector Abbas, the famous actor and translator of innumerable English, Dutch, French, and German plays. Other important plays included *The Silver King*, the time-honoured play by Henry



Midland  
Pianoforte  
Sextet

Symphonic Variations of Arnold Bax.

Music lovers, however, will look forward to the familiar Proms, which start at Queen's Hall on August 9, under the baton of Sir Henry J. Wood.

### Vaudeville Items

Vaudeville and lighter music have been fairly prominent. Many well-known concert parties have contributed, including the famous "Roosters," and the "Frills and Flounces," presented by the clever actor Charles Beanland and relayed from Leamington Spa, where the party were stationed in June.

An excellent light programme was that announced for July 3 and 4, presented by Melville Gideon, the composer and ex-Co-Optimist. The

standuros and Dorothy Summers in *A Day in the Country*, orchestral items by Sir Edward German, and a song-cycle, "Summer Sports," by Sir Herbert Brewer.

Of a light nature might be reckoned the fine performance from the studio of Shakespeare's *Midsummer Night's Dream*, in which many well-known people took part, including the famous actor and author, Rudolph de Cordova, who was persuaded to read the part of Quince, one which he has played

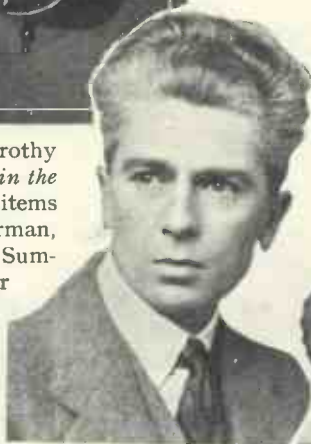

Vivian Langrish,  
pianist



Muriel Tookey  
of the Tookey Quartet

## Broadcast Music—Cont.



Charles Beanland,  
actor

Arthur Jones and Wilson Barrett, and *La Dame aux Camelias*.

A welcome change has been made with some of the solo performances. Again, variety and lightness have formed the

pianist of Manchester, heard throughout the week from July 6 at Manchester; and Patricia Rossborough, who makes a point of syncopated recitals. Another well-known Midland pianist is



Heddle Nash,  
tenor

Blowden Caerlon  
of the  
Cardiff station



Miguel Llobet,  
guitarist



Irene Brooke, who has been often heard in company with her sister, Una Truman.

outstanding features of many programmes. A famous guitarist, Miguel Llobet, figured in a programme in which he had the assistance of the

Spanish singer Carmen Andija. The programme consisted of typical Spanish music.

Jan Wien, who has appeared in several musical combinations, is a virtuoso banjoist. Some clever recitals have also been given by Gladys Ward, Ann Penn, and Mario de Pietro's Quartet.

Many good instrumental players have been heard, and it is certain that quartets, trios and smaller bodies of players sound to better advantage than the very large orchestras, the tone of which becomes rather blurred and harsh.

The Audrie Ford Trio, Zigeuner Ensemble, Slydel Octet and the Tookey Quartet, of which Muriel Tookey is a prominent member (the last is one of the earliest and best known of provincial players of chamber music), have all been heard to good advantage again this month. Mention should be made of the Midland Pianoforte Sextet, composed of highly trained musicians, whose excellent playing has been frequently heard through the Midland Regional station.

Amongst the pianists must be mentioned a young classical player, Vivian Langrish, who carried out a recent Foundations of Music series of recitals; Edward Isaacs, the blind



Harold Mills,  
violinist

Of the singers the number is legion. Many of the late B.N.O.C. members have been heard, including Gertrude Johnston, William Michael, and Walter Widdop.

The work of Heddle Nash, a wonderful tenor, Leonard Gownings, Bernard Ross, Herbert Simmons, one and all opera singers, and well known on the concert platform, need but little comment; in addition, they are all hardened broadcasters.

Other popular broadcasters are Winifred Fisher, Doris Gambell, Herbert Thorpe and Blowden Caerlon who have been heard again this month to good advantage.

It has been said that England is not fond of the violin,

but there is no doubt that it broadcasts well, and consequently has made the instrument far better known than would any single concert recital.

Albert Sammons, the great soloist and chamber music player, has been heard, also Angel Grande, the French violinist who made a triumphant English debut at a Prom. concert some years ago. The Midland programmes have featured Harold Mills with violin recitals,



Left:  
Edgar Lane,  
composer



Gladys Ward,  
recitals



Jan Wien,  
banjoist

# READERS REPORT

## // // on W.M. THREE-VALVERS

Here we publish reports on four WIRELESS MAGAZINE three-valve sets—the Inceptordyne, Inceptor, Community Three and Brookman's Three—which will be helpful to other constructors. Half a guinea is paid for each photograph published.

### INCEPTORDYNE

**M**OST enthusiastic are the letters we have received from readers regarding the Inceptordyne (WIRELESS MAGAZINE, February, 1930). Here is a letter from a Stoke-on-Trent constructor about his first radio set:

I have pleasure in enclosing a photograph of my Inceptordyne, the building of which has given me great delight and encouragement; my first set, although, during a long course of reading WIRELESS MAGAZINE, I have aspired many times in "mental" construction of such tempting bait!

#### Handsome Cabinet

You will notice that I was not content with just "the set," for I saw that WIRELESS MAGAZINE had "a special offer," and one good turn deserves another, so I determined to rig up decent accommodation for so worthy an object—hence my handsome radio-gramophone cabinet!

However, you will note one or two changes made in the suggested components. This was not with an idea to improving an already sound job, but to follow the demands of personal whims, for example, drum-dial condensers and "wood-finished" panel, etc.

Volume upsets a certain young inmate of my household, so reluctantly I had to forego the pentode valve, substituting an ordinary power which, strange to say, probably owing to my Marconiphone output transformer, which gives various ratios, has made little apparent difference to my reception. My speaker is a C12 Celestion and to me personally gives most pleasing quality of reproduction.

I regret not having fixed the valves and coils in their places before taking the snap, but nevertheless, you can see all is there.

#### Others Building It!

Although my baseboard is 25 in. long I feel I need every inch of it. Several of my friends, since seeing the set, have ordered up—the general usefulness of the Inceptordyne got them!

Later, I will send you my log of the set which I am busily, although easily, procuring.

The reproduction of gramophone records is amazingly good.

**F**OLLOWING is a report from an Evesham constructor:

Having recently constructed this set, it may be of interest to you to know the loud-speaker results obtained using a

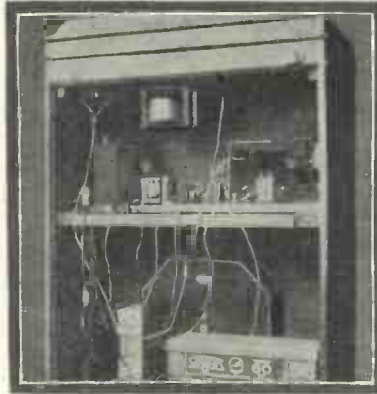

power valve instead of the pentode valve and a single-strand indoor aerial, 70 ft. long.

With the reaction condenser all out, all the B.B.C. high-power transmitters are heard at loud-speaker strength, the H.F. filament having to be dimmed on the two Daventry stations to prevent overloading.

With 5XX (forty miles away) silent, I have heard nine stations on the long wavelengths, Kalundborg and Hilversum being received clear of 5XX when the latter is working.

On medium waves my graph shows a total of over thirty of the main European stations received on the loud-speaker, and this total could easily be added to if required. Milan, Toulouse, and Turin are usually the most reliable signals.

The best results on the ultra-short waves have been Zeesen (loud-speaker strength), W2XAF, and one or two French stations, but my long earth lead affects the working of the set here.

Taking it all round, the Inceptordyne is what you claim for it, a really outstanding general-utility set, which is easy of construction and capable of good results, coupled with good quality of reproduction.

**A**N interesting log of stations received on the Inceptordyne has been received from a reader at Grangemouth:

While reading the "W.M." for this month I noticed a report on the Inceptordyne which is quite correct. The difficulty is that you get too many stations. However, I built the Inceptordyne rigidly to your instructions and, I think the results are really wonderful, I have a Blue Spot 4-guinea loud-speaker and an aerial about 60 ft. long and 35 ft. high.



#### A FIRST EFFORT!

These two photographs show the fine job a Stoke-on-Trent reader has made of his Inceptordyne, which forms the basis of a radio-gramophone

I append a list of stations which I have identified and there are lots I have not identified yet:—

#### Long Waves:

Lahti	Eiffel Tower
Radio Paris	Motala
Konigswusterhausen	Kalundborg
Daventry 5XX	

#### Medium Waves:

Budapest	Langenberg	Toulouse
Riga	Rome	Algiers*
Vienna	Berlin	Stuttgart
Milan	Katowice	London Reg.
Oslo	Berne	Barcelona
Prague	Glasgow	Goteborg
Midland Reg.	Frankfurt	

#### Loud-speaker Signals

There are various others which I have not identified yet and all are at loud-speaker strength. (\*I obtained this after Glasgow closed.)

**E**VEN as far away as Derry (Northern Ireland) the Inceptordyne is proving its utility:

I built the Inceptordyne receiver and it gives me great pleasure to say that the results have exceeded my expectations. I experience no difficulty in tuning in Glasgow or Radio Paris in daytime and, of course, Daventry and Belfast. After dark the dials are alive with stations.

"STATIONS too numerous to mention," is the comment of a Birmingham fan, who describes the Inceptordyne as "four sets in one":

May I add my thanks to the many others you will, no doubt, get for the Inceptordyne. I have had sets for about eight years, but this is the best yet. It is, in fact, a two-valver, three-valver, short-wave set, and "gramo" reproducer—four sets in one.

Except that I used a 21 in. by 7 in. panel, other parts are as specified.

Pending the erection of an improved aerial (outside), I have used an indoor

# Readers Report on "W.M." Three-valvers—Cont.

one. The stations received are too numerous to mention on the medium waveband; I have logged about four on the high band.

On the short waves I have not troubled much, but received Prague and two amateurs, all these, of course, on the loud-speaker (Blue Spot 66K). I have an internal speaker, and I also have another portable speaker (Blue Spot) for use in other rooms.

## No Interference

I almost forgot to mention that I can receive stations at 41, 42, 43, and 44 degrees on the dial without interference from the others. This, I think, proves its selectivity. Again thanking you and wishing you every success.

**A**N Inceptordyne built up in a Chummy Four cabinet is the interesting adaptation made by a reader at Wellington School:

I have built your wonderful Inceptordyne and am very pleased with the results. I enclose photographs of it. It is built in a Chummy Four cabinet, using Polar drum condensers and Pye differential reaction.

I have a Marconi output transformer on the floor of the cabinet; double-capacity batteries (Ripaults); Blue Spot loud-speaker; Cossor valves (except detector, which is Six-Sixty); and a Ferranti AF5 transformer.

I have a slight bit of trouble on the short waves as it is too selective.



## ANOTHER FIRST EFFORT!

Anybody can follow "W.M." instructions and full-size blueprints without difficulty. Here you see a Portsmouth reader's Inceptordyne.

The dial in the small panel on the right controls an *Amateur Wireless* Brookman's By-pass. This, of course, is not necessary for separating our own English stations, but is invaluable in sorting out some of the foreign stations that overlap each other.

The set is run on an L.T. accumulator and a Philips H.T. eliminator. Loud-speaker is a double-linen cone with Ormond unit, but this I still have to enclose in a case.

Turin Madrid Vienna  
Moscow

And several unknown stations.

Ultra-short Waves:

So far, beyond Morse, I have had no luck with these and should be glad to hear with what success other erectors have met.

## INCEPTOR THREE

**A**LTHOUGH now two years old, we have received an enthusiastic letter about the Inceptor Three (WIRELESS MAGAZINE, October, 1928) from a reader in Dorchester:

Having been faithful to the HF-det.-LF circuit for years, in spite of the mode for det.-2LF sets, I hailed with joy the advent of the screened-grid valve (previously I had been forced to cure instability by using very docile valves in the H.F. stage).

The only set I have built from a published design in any wireless journal is my present set, the Inceptor Three, and I can only say that if the new edition of this set, the Inceptordyne, is an improvement on its predecessor, the most discriminating radio constructor must be entirely satisfied. Personally, I have not yet found in which direction the Inceptor Three could possibly be improved.

## Tapped Coils

In my particular example of this circuit I am using two Ormond S.L.F. condensers, instead of the ganged ones specified originally, and Lewcox X coils (for selectivity).

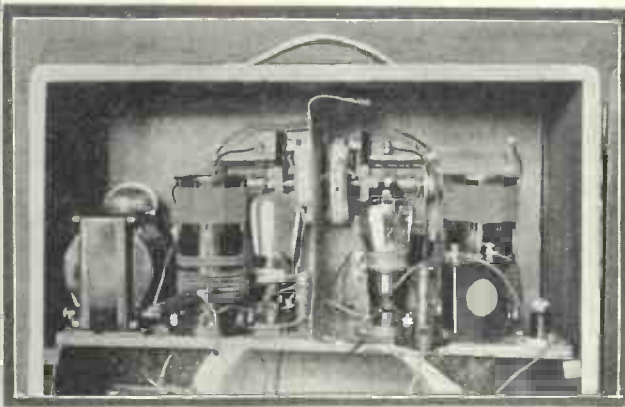
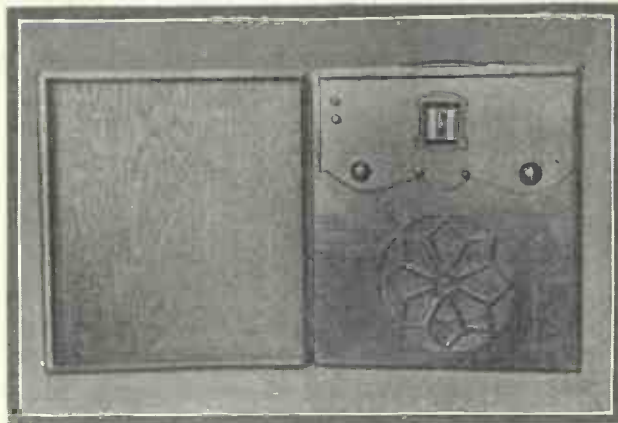

## A COMPACT AND EFFICIENT ALL-IN ADAPTATION

These two photographs show how the Inceptordyne has been built into an old Chummy Four cabinet by a reader at

Wellington School. His only complaint about the set is that it is too selective on the short waves!

It would be too laborious to give you a list of stations obtained. It is truly a wonderful set. Best wishes to "W.M."

**A**NOTHER reader at Portsmouth also built the Inceptordyne as his first effort at home construction:

I enclose snapshots of my Inceptordyne set, made up according to the diagrams and description in the February issue of WIRELESS MAGAZINE. I am absolutely pleased with the results, the number of foreign stations obtainable at full loud-speaker strength providing an infinite variety of programmes.

As both the set and cabinet are my first attempts at either wireless or joinery work, I am rather proud of the result. At the same time I feel very grateful to the "W.M." for providing me with such a circuit—incidentally, judging from my own effort, no beginner need be afraid of attempting the construction of a set with the "W.M." to guide him.

Long Waves:

Radio Paris Motala(?) Kalundborg

Medium Waves:

Cologne Barcelona Langenberg  
Belfast Frankfurt Oslo  
R. Toulouse Rome Milan

I run two loud-speakers at once, a Marconi cone and a horn-type Brown. The resulting tone is excellent, and instead of boring you with a long list of stations received, I will just state for the benefit of the sceptical that two loud-speakers are desirable in order to handle the volume of Toulouse, Rome and Oslo, etc., when the reaction condenser is almost at zero, and the L.F. valve is an ordinary power valve (my pentode rarely comes out of its box, as it is unnecessary).

Unlike the majority of your correspondents, I must plead guilty to possessing a very good high aerial, and a good supply

# Ten Constructors Give Unbiased Reports!

of H.T. off an Atlas mains unit.

I can honestly say this set of yours is the best I have ever constructed or handled; anything worth listening to is within its range from Algiers to Budapest, provided constructors will use only the best British parts. My experience as an experimenter since the first year of broadcasting has convinced me that cheap junk parts are fatal if you really want wireless as it should be obtained.

Thanking you for this really excellent design.

## COMMUNITY THREE

A SIMPLE receiver with detector and two low-frequency stages, the Community Three (WIRELESS MAGAZINE, November, 1929) is giving good results at Tufnell Park in North London. A reader living there writes:

I am just writing to let you know how pleased I am with the Community Three built from your November issue of last year.

I have cut out the pick-up switch as I had no need for this, but otherwise the set is standard.

At present, I think my H.T. amounts to about 30 volts, but even with this I can get the two B.P.'s, 5GB, 5XX, Radio Paris, and I have had Langenberg, Toulouse, Rome (?), Kalundborg, and one or two others as yet unidentified.

I might add that this is the first three-valver I have constructed, my previous set being a two-valver of a much boosted nature on which I could get the two B.P.'s together!

## Also for A Friend

However, I am making this fine three-valver up for a friend and will let you know the results obtained when finished, as his aerial and earth system is better than mine.

Once more thanking you for this very fine circuit and wishing your magazine every success.

## BROOKMAN'S THREE

LETTERS are received nearly every day from satisfied constructors of W. James's Brookman's Three (WIRELESS MAGAZINE, October, 1929). A typical letter from a Maidstone reader follows:

I wrote to you about a month ago concerning my Brookman's Three, and your technical department was kind enough to answer my letter. Since that time however, I have discovered that the cause of all my trouble is not the set, but a neighbouring printing works, and I feel that I owe it to you to tell you that the set is behaving marvellously.

## Astonishing Performance

In the few hours per diem when the local newspapers are not being printed, my set puts up a performance equal to many of the five and six-valve sets in the district; in fact, it surpasses some of them.

I append a list of stations received, all of which have been actually identified. There are many others, awaiting intelligible remarks on the part of their respective announcers!

In the matter of purity of reproduction I have never heard a better set. The result is helped, no doubt, by the double linen-diaphragm speaker (*Amateur Wireless* version) worked by a Blue Spot unit.

The only adverse criticism I would make is that more volume is desirable on all stations except London and 5XX. Possibly I expect too much of a "three," and so I propose to add another L.F. stage.

## STATIONS RECEIVED:

Flensburg  
Cork  
Cologne

Frankfurt  
Katowice  
Rabat

Münster  
Nürnberg  
Gleiwitz  
Leipzig  
2LO  
Barcelona  
Bratislava  
English Relays  
Turin  
Bordeaux  
Göteborg  
Barcelona  
2LO  
Stuttgart  
Hamburg  
Toulouse  
Genoa

Berlin  
Madrid  
Rome  
Langenberg  
5GB  
Oslo  
Milan  
Vienna  
Budapest  
Hilversum  
Kalunborg  
Motala  
Eiffel Tower  
5X  
Zeeseen  
Radio Paris  
Huizen

# A WIRELESS ALPHABET

By Leslie M. Oyler

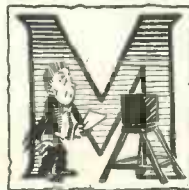

*for the Microphone, who can  
Intimidate the bravest man  
Who has not broadcast e'er before:  
It terrifies him more and more  
As there he stands with shaking knees*

*And feet that feel as though they'll freeze.  
Then, suddenly, it gives him aid,  
He finds his voice, is not afraid.  
There can be worse ordeals, I own,  
Than speaking through the Microphone.*

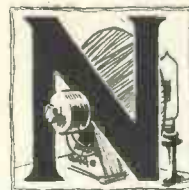

*for the Neon Lamp. We sing  
About the bulbs of early spring,  
He is a different bulb, one might  
Consider him a leading light.  
Though honestly I must admit*

*He has no scintillating wit  
He sheds a very pleasing glow,  
As many Televisors know:  
Thus what a Frenchman said was true  
"Chacun," he stated, "à son goût!"*

# LEAVES FROM A LISTENER'S LOG

APPARENTLY Bulgaria, one of the only European countries without a broadcasting system, is to become the possessor this year of a 10-kilowatt transmitter. It has not yet been definitely decided whether it is to be installed at Sofia or not, but everything points to the capital being chosen as a site for the first station.

## No Tenders Offered

Although two years ago attempts were made to bring some kind of radio organisation into being, the terms offered by the authorities to foreign concessionaires were such that tenders for the installations were not forthcoming.

Finally, a Bulgarian commission of experts was sent to Cologne and other cities to see what was being done in Germany, with the result that on their return their findings aroused the interests of the Sobranje and the Bulgars have decided to carry the matter through off their own bat.

With the prospect in the more or less near future of transmitters at Athens and other Greek cities by 1931 we should see every State in Europe on the radio map.

It is possible, of course, to become satiated with the programmes given out by near-by stations, but if we have the whole Continent to draw upon for wireless entertainments it would be unfortunate if from some source or other it were not possible to find throughout the day some broadcasts capable of tickling our jaded ears.

Possibly by the time these notes are in print you may have picked up signals from the new high-power transmitter erected at Strasbourg (France), for at time of writing I learn that every effort is being made to open it officially on France's national fête day, the famous and historic Quatorze Juillet.

## Double Power

The station is actually situated in the small town of Brumath, some eleven miles from Strasbourg, to which it is connected by cable; its nominal aerial energy is 12 kilowatts, but if necessary it can be boosted to almost double that power.

By JAY COOTE

It will operate on 345.2 metres (869 kilocycles). We must sincerely hope that, contrary to the bad habits of other French provincial relays, it will not depart from the straight and narrow but virtuous path, otherwise we shall find it in violent collision with Barcelona (EAJR) or with Brunn, both stations with which it can easily heterodyne.

In view of the fact that both French and German are generally spoken in Alsace and Lorraine, bilingual broadcasts will have to be made, but the latter language is the one which will be the most used.

Special pupinised cables are being laid down to link up Strasbourg with Paris in order that the capital programmes may be fed to the new transmitter. As it is the most up-to-date of the French stations its early activities should arouse considerable interest in the British Isles.

## International Malady

Officialdom is the same all the world over and France suffers from this malady to an intensive degree. Following a referendum it was decided by the French official studios that the long-drawn-out call of the State announcers was to be curtailed to the words: Radio Etat, namely just Paris, Lille, or Limoges Radio Etat.

Such an abbreviation was considered by listeners generally as a practical one comprising all the information necessary. Did the authorities accept the suggestion? Well, as usual they hummed and ha'd, expressed no opinion either for or against, called for reports from experts and acted in the way customary to Government officials.

This important matter, it appears, is now under consideration, for before such a drastic alteration can be carried out umpteen forms must be filled up, correspondence must be exchanged between State departments and formal assent obtained from the Cabinet Minister responsible for the supervision of the radio section of the French Posts and Telegraphs Administration.

To use an Irishism, I wonder what

colour the red tape is in France!

A reference to station calls must necessarily be associated with interval signals and I hasten to draw your attention to the fact that Vienna's patent metronome gadget is out of order and for the present has been sent back to the workshop.

It worked well and listeners were satisfied with it, because if you have heard it you will remember that the varying number of "tocks" indicated the duration of the pause between items.

## No Standing-by

By this means, instead of standing-by for a number of minutes in the hope that more music would be heard, you knew at once when the concert was due to start again.

There was nothing against this gadget from the practical point of view; it was withdrawn because the Vienna studio considered that it did not possess artistic qualities!

So now some poor engineer will have to rack his brains for a fresh method of filling up blank intervals without jarring the susceptibilities of the programme organisers.

Ljubljana, by the way, has launched an original foxtrot melody, under the title *Hallo, Radio Ljubljana*. It proved an immediate success when broadcast for the first time, and it has been suggested that it should be used "between the acts" as an alternative to the cuckoo obsession.

And, finally Poznan (Posen), to whom a metronome had been given to proclaim its presence on the ether, now follows its call *Radio Poznanski* with a short musical phrase of some sixteen notes.

## Pleasant Sound

The sound is a pleasing one recalling that little instrument—I believe it is known as Pan-pipe—which you have seen used so often by the owner of a Punch and Judy show.

You cannot mistake the signal if you pick it up; it is like no other in Europe. In this Poland has shown the same originality as she did in choosing that distinctive fanfare relayed from Cracow.



# We Test Before You Buy

*In this feature the Set Selection Bureau reviews every month some of the outstanding receivers at present on the market*



## PHILIPS PORTABLE

Maker: Philips Lamps, Ltd.

Price: £27 10s.

Power Supply: Batteries.

Power Consumption: H.T., 108 volts at 15 milliamperes. L.T., 2 volts at .5 ampere.

Valve Combination: Screened-grid high-frequency amplifying valve, detector, and two stages of transformer-coupled low-frequency amplification, with pentode output valve.

WELL known for their mains-operated sets, Philips Lamps, Ltd., have now introduced a portable, which is operated entirely from batteries. We have just finished testing this new portable. It has been added to our approved list as we think highly of its design and performance.

### Really a Transportable

The Philips portable, which would be more accurately designated transportable, is built on the upright plan, as distinct from the suit-case construction sometimes adopted. The cabinet work is unusually fine, a considerable improvement on the usual Philips set-containers, which are notable more for their utility than attractive appearance.

A strap on the top of the cabinet is provided for carrying the set, as from room to room. The long, narrow shape of the cabinet is an asset only appreciated when the portable is carried.

The turntable fitted on the bottom of the cabinet is quite an essential. Owing to the directional properties of the frame aerial inside, the cabinet must be swung round bodily when receiving different stations.

The layout differs a little from usual.

Batteries and valves are housed underneath the control panel, the loud-speaker being fitted at the opposite side of the cabinet. A hinged flap protects the control panel from meddlers; it can be locked when required, as can the flap over the battery compartment.

Control of the set has been simplified to the limit. A single thumb-operated disc is arranged for tuning. A lever provides medium- or long-wave tuning at will. A knob of ample size controls reaction, which builds up the strength of weak stations considerably.

The battery on-off switch is so designed that when the panel flap is closed the switch is pushed off. There are plug sockets for the connection of an external aerial and earth. For normal reception, the frame aerial inside provides ample

service without any external connection.

A pleasing feature of the battery compartment is that the accumulator, high-tension battery and grid-bias battery fit together exactly, without additional packing. Moreover, the battery compartment facilitates the withdrawal of the accumulator when it becomes necessary to re-charge it.

Above the battery compartment are the four valves. One is a screened-grid valve for high-frequency amplification; then there is a special detector, the Mullard PM2DT, designed to prevent microphonic noises, which sometimes develop in portable sets due to sound waves from the loud-speaker impinging on the bulb of the detector.

### Special Detector Valve

The special detector valve has an outer glass bulb surrounding the usual evacuated bulb containing the electrodes. Following this valve are the two low-frequency amplifiers, including a pentode for the output.

The Philips portable was first tested in London and later down in Sussex. In both tests, the long-wave stations were notable for their strength and clarity. During the summer months, we have to rely on the long waves for reliable distant reception. Stations above a thousand metres are less susceptible to fading and weakness during the summer, but more likely to suffer from atmospherics than the medium-wave stations.

Many stations were brought in during tests. Ease of operation should enable the novice to do just as well; in fact, better, because his experience will naturally be more extensive than ours.

### OUR FREE SERVICE OF ADVICE TO SET BUYERS

To take advantage of this service it is necessary only to mention (1) the maximum price and whether this is for a complete installation or the bare set; (2) where the set will be used; (3) what particular stations are desired; (4) whether a self-contained set (with or without aerial), or an ordinary set with external accessories is preferred; and (5) in the case of mains-driven sets, whether the mains are A.C. or D.C. A stamped addressed envelope for reply is the only expense

## We Test Before You Buy—Continued



### A FINE DESIGN

*These two photographs show clearly the compact and pleasing assembly of the Philips four-valve portable receiver, which gives particularly satisfactory results*

Down in Sussex, the Brookman's Park stations were received at great strength.

For modern conditions—high-power twin transmissions—the Philips portable is undoubtedly well suited. Its selectivity is exceptional for two tuned circuits. We are not often able to get Berlin clear of Daventry and Radio Paris, as was easily achieved during these tests. The London stations did not "spread" unduly.

Without going to the limit of reaction, distant stations were brought in at good strength. The Philips loud-speaker evidently suits the pentode output valve. Up to the point when distortion, due to the modest high-tension supply, sets in, quality is really good, superior to the average portable.

There is enough volume without distortion to fill an average-size living room. Even in the country, sufficient distortionless volume was available to overcome the noises of nature—and of passing motor cars.

It is not surprising, in view of the good quality, that the high-tension running costs are somewhat high.

### GEOPHONE BATTERY THREE-VALVER

Maker: The General Electric Co., Ltd.  
Price: £12, complete with valves.  
Power Supply: Batteries.

**Power Consumption:** High tension—130 volts 12.5 milliamperes; low tension—2 volts .4 ampere.

**Valve Combination:** Screened-grid high-frequency valve, detector, and transformer-coupled low-frequency valve.

**A**LTHOUGH British set makers are making a fine effort to develop mains-operated sets, they seem to be neglecting sets working from batteries. An electrified British Isles is still a long way off, although every day the Central Electricity Board's grid system is spreading. In the meantime, considerably more than half British listeners still have to rely on battery power.

Much could be done to improve

appreciably reduce the untidiness associated with old-fashioned receiving apparatus.

We found the high-tension battery space inadequate to accommodate double- or treble-capacity units. As the total anode-current consumption is about twice the economical rate of discharge of standard-capacity batteries, we cannot congratulate the makers on this battery compartment.

The makers are quite frank about the life of the high-tension battery supplied with the set. They indicate that four or five replacements per year will be necessary. We agree.

### Accumulator Box

A box is supplied to take a Gecophone 2-volt accumulator. This accumulator has a capacity of 30 ampere hours. As the low-tension current consumption is .4 ampere, the accumulator will give about 70 hours' service for each charge.

Batteries and valves are most accessible. By following the lucidly-worded booklet supplied with the set, the buyer should have no trouble in installation or maintenance.

For a three-valve set, the circuit employed is the best possible. It consists of a screened-grid high-frequency amplifying valve, followed by a leaky-grid detector, which is transformer-coupled to a small power valve. Such a circuit is well suited to modern conditions; the need, today is for selective tuning, a fair measure of high-frequency sensitivity, and a good-quality low-frequency amplifying arrangement.

Although two tuning circuits are implied by the use of a stage of screened-grid high-frequency amplification, a single knob controls the tuning. The two variable condensers are accurately ganged; the knob simultaneously operating these condensers also rotates a scale calibrated in wavelengths.

On the left of the scale are marked medium waves from 250 to 600 metres, and on the right, long waves from 800 to 2,000 metres. A centre division of degrees is added, presumably to fill in the gaps between the wavelength calibrations. The makers are to be congratulated on the tuning arrangement of this set. A hair line across the scale would have still further improved matters.

### Smooth Controls

The generally good design of the set is reflected in the excellence of the control panel. The knob for vernier tuning, the reaction-condenser knob, and the wavelength-range control are all commendably robust and smooth in action. The refinement of the controls is a welcome contrast to some of the shoddy panels previously noted.

The set was tested in south-west London. An outside aerial, having an



the quality of reproduction in battery sets. The anode-current consumption could be reduced. Selectivity could be improved and, in general, quite a lot of development work is waiting to be done by enterprising battery-set manufacturers.

The General Electric Co., Ltd., might draw upon its Wembley research laboratory in this connection. This firm must be one of the largest British producers of broadcast sets. Included in their wide range is the Gecophone battery three-valver, which has recently given satisfaction in laboratory tests. The price is very moderate, especially as the set is a very high-grade production, made from the best-quality materials.

The cabinet is of highly-finished mahogany, enhanced by an unusually handsome panel. This cabinet is made large enough to accommodate standard-capacity high-tension batteries, as well as the low-tension accumulator and grid-bias battery. Self-contained batteries

# Portable Four :: Battery Three :: Mains Two

overall length of just under 70 ft., was connected to aerial terminal A. Two other aerial terminals are provided for use where greater selectivity is wanted.

Midland Regional, at 76 degrees, was a strong signal, but some reaction was needed. The wavelength of this station is 479 metres; it came in at approximately this reading on the calibrated scale. To test the utility of the calibrations, Rome, on 441 metres, was tuned in. The dial was set just below the 450-metre mark. The lady announcer at Radio Roma confirmed the accuracy of the calibrations.

London Regional was, naturally, a very strong signal; it came in at 49 degrees. The volume control, which is really a vernier tuning knob, did not effectively reduce the excessive volume of the Regional station. This could only be done by de-tuning.

## Reaction for National

The National station needed some reaction for full loud-speaker strength. It came in at 10 degrees. Regional and National stations were just clear of each other.

The night of the test selected for this report was a bad one for long-distance reception. Under these circumstances, we usually fall back on the long waves. With the Gecophone set, we were not disappointed. Huizen, at 88 degrees, was a fair loud-speaker signal, using full reaction. Radio Paris was a full loud-speaker signal at 80 degrees. There was surprisingly little interference from Daventry, at 74 degrees, which was naturally very strong.

Eiffel Tower, at 62 degrees, was brought in at full loud-speaker strength clear of Daventry. Hilversum, at 35 degrees, was equally good.

## GAMBRELL ALL-ELECTRIC TWO

**Maker:** Gambrell Radio, Ltd.  
**Price:** For D.C. mains, £13 15s.  
For A.C. mains, £20.  
**Power Supply:** A.C. or D.C. mains (model tested is for D.C. mains).  
**Power Consumption:** 20 watts for D.C. mains.  
**Valve Combination:** Detector and one transformer-coupled stage of low-frequency amplification.

**I**N these days, first cost is very often the main consideration borne in mind by buyers of wireless sets. We, of the Set Selection Bureau, are often asked to suggest suitable mains-operated sets capable of all sorts of wonders in performance, but at retail prices far below those now ruling.

The reader of limited means wanting a mains set must be prepared for some restriction of range and, possibly, of volume. Two-valve mains sets offer freedom from battery worries, but they can be relied upon for the

reception of the local stations only.

With the growth of regional broadcasting, these simple sets can be installed at fairly considerable distances from regional centres. Listeners fifty miles from Brookman's Park or Daventry should be able to get good loud-speaker reception of the alternative programmes assuming they erect a reasonably good outside aerial. Greater distances would mean weaker reception.

The long-wave Daventry station, which relays the National programme, can be received on a simple two-valve set up to 100 miles. For this reason, the set-buyer should insist upon medium- and long-wave tuning, so that Daventry can serve as a stand-by.

We have been trying out the Gambrell two-valver for D.C. mains. It works very well, receiving Brookman's Park stations and Midland Regional stations quite clearly and free from interference.

In our test there was no background of hum from the mains. Reception was as free from extraneous noises as the best-behaved battery set.

At the end of a usefully long flexible lead, coming from the back of the set, is a plug-suitable for insertion into an electric-light socket. Not many people have unused electric-light sockets, although many have a convenient wall socket. Adaptors can be obtained from the local show-rooms of the electric-light company, suitable for connecting the plugs to the wall socket, or to the same point as the electric-light bulb.

The total consumption of the set is less than that of a small electric-light bulb. The average bulb is rated at 40 watts. This set takes only 20 watts on a 200-volt supply, and a little more on supplies between 200 and 250 volts.

A peculiarity of sets for D.C. mains is

that they will not work unless the plug is inserted in one of the two possible ways. If the set seems "dead" when everything should be working, the plug must be reversed in its socket. We are glad to see the makers emphasise this point in their instruction booklet.

The black crystalline finish of the wooden container of the Gambrell set is unusually dignified, though a little



## ATTRACTIVE AND EFFICIENT

*The Gecophone battery three-valve set is built into a substantial and handsome cabinet*

sombre. The control panel is pleasingly arranged and is not a bit confusing. A plainly-marked four-inch dial, with a large slow-motion control knob, is provided to tune the set to the wavelengths of the different stations within its range.

The scale is marked up to 180, one division for every two degrees. A small white spot at the top of the panel enables these divisions to be utilised for logging stations. We think that as the degrees on a dial are quite arbitrary, having no relation to the wavelength of the stations received, a more open scale of 100 divisions would be better.

## Single Tuning Circuit

The novice may wonder why wavelength divisions are not indicated in place of the usual degrees. In big sets this is sometimes done, but in a small set, such as the Gambrell two-valver, it is not possible. There is only one tuning circuit, the constants of which are determined by the particular aerial to which the set is connected.

The makers kindly supplied us with a chart giving the readings for the two Brookman's Park stations. But whereas their readings were 80 degrees and 5 degrees for Regional and National stations respectively, our readings were 102 degrees and 20 degrees. Our aerial was, obviously, shorter than the Gambrell

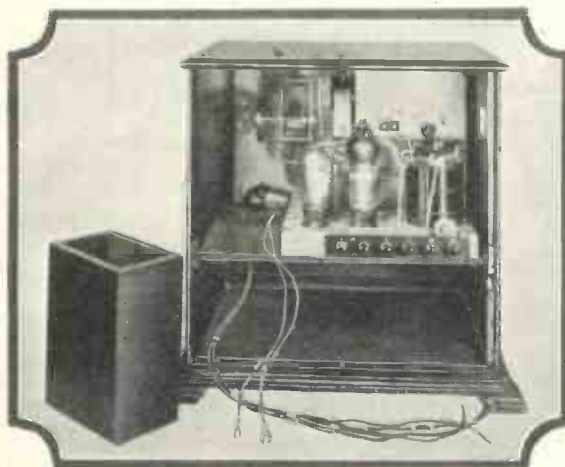

## NEAT AND BUSINESSLIKE ASSEMBLY

*Internally the Gecophone set tested this month is very well arranged and laid out. A metal chassis construction is employed*

## We Test Before You Buy—Continued

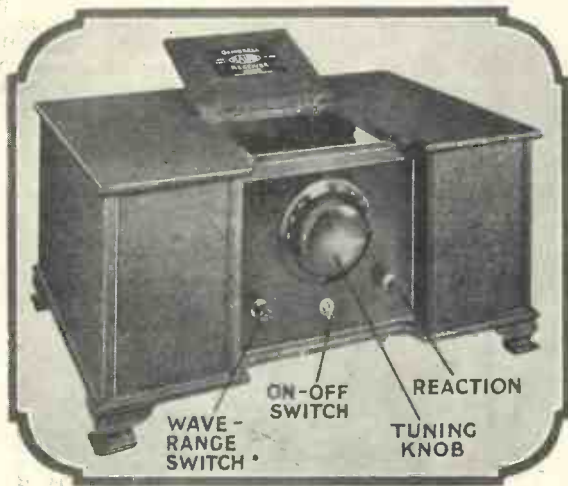

### A SIMPLE ALL-ELECTRIC SET

*There is nothing complicated about the controls of the Gambrell two-valver for A.C. or D.C. electric mains*

test aerial, so we needed more of the variable-condenser capacity in circuit.

The main dial of the set can be moved for quick changes of wavelength. This saves the tedium of many revolutions of the subsidiary slow-motion knob, which is

critical as the tuning, if not more so. Reaction is used, quite rightly, to increase the strength of signals handed by the detector valve to the note-magnifying valve. The tuning knob selects the station and the reaction knob determines

rather annoying when a rapid change of setting is required.

Below the main tuning control are fitted two small black knobs, one for wave-band changing, on the left, and the other for reaction, on the right. The function of these knobs is obvious, because they are clearly engraved. "For low waves pull" is the slogan on the push-pull switch knob on the left. No great imagination is needed to see that for medium waves this must be pushed in.

We should have preferred a larger reaction-condenser knob than is provided. We consider the adjustment of this control at least as

its strength—within limits, of course.

Tested on an average aerial in central London, the Gambrell set behaved well. London Regional came in at full loud-speaker strength, quite clear of the National, which was also excellent. Midland Regional was a fair loud-speaker signal using the maximum permissible amount of reaction.

### Long-wave Results

By pushing in the left-hand knob, the long wavelengths were explored. Davenry 5XX, doing the National programme, was good at 114 degrees. Radio Paris, at 140 degrees and Huizen at 160 degrees could be distinguished, but were not logged as reasonable loud-speaker signals. The set is designed for local-station reception, a function it performs admirably.

The set tested is suitable for D.C. mains voltages between 200 and 250 volts. It cannot be worked from 100-volt D.C. supplies, which still exist in certain localities. A plug on the terminal strip at the back can be inserted into one of three sockets, marked 200, 220, and 240.

Fuses in each mains lead provide an adequate protection against a sudden excess of current. All reasonable precautions for mains operation have been taken by the makers.

## A Fuse Will Make Your Valves Safer!

MODERN valves have such long lives that, when a sudden catastrophe extinguishes the filament, the set owner is pardonably annoyed. The "sudden death" of a valve or, worse still, of a batch of valves, is entirely preventable by the use of a fuse.

### Current Consumption

The filament of the average valve passes .1 ampere, unless it is a power valve, when the consumption is .15 to .25 ampere. This current rating is based on the assumption that 2, 4, or 6 volts, according to the type of valve, will be applied across the filament.

But if, by an accident that can quite easily occur, the voltage of the high-tension battery is applied to the filament, an excessive current flows and the filament is ruined. How easily this can occur is not always realised.

Let us consider a simple valve circuit. The high-tension battery is inserted between the anode of the valve and one side of its filament, across which is the accumulator, of 2, 4, or 6 volts. To complete the anode circuit, one side of the high-tension battery must, therefore, be connected to one side of the accumulator.

As the H.T. positive end of the battery is connected to the anode, it follows that the H.T. negative end goes to the filament. Usually, H.T. negative is taken to L.T. negative.

As one side of the high tension has to be connected to one side of the filament, it is easy to see how the remaining high tension must be kept away from the remaining low-tension connection. Assuming the standard connection of L.T.

negative to H.T. negative, the accidental insertion of the L.T. positive lead into the H.T. positive socket will cause the high-tension battery to be connected across the filaments of all the valves; an excessive current will flow and the filaments will be ruined.

Such a wrong connection can quite easily occur during experiments; and just as easily in a commercial set,

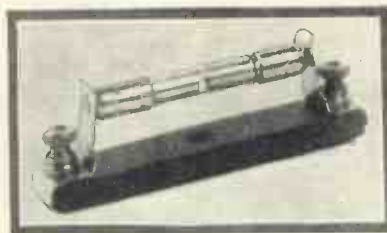

### A NEAT FUSE

*This photograph shows a Microfuse rated to blow at 100 milliamperes. It makes the valves in any set safe from accidental short-circuits*

especially in a battery-operated portable.

Accidents can be entirely prevented by the insertion of a fuse; in home-constructed sets the fuse should be put in between the high-tension and low-tension batteries, that is, between H.T. negative and L.T. negative.

In many commercial sets, particularly portables, there is no fuse. But the valves need safeguarding, because it is surprisingly easy for battery leads to stray to the wrong battery, particularly

when the accumulator is being taken out for re-charging.

The fuse should be inserted in the H.T. negative lead, coming from the set to the negative end of the high-tension battery. In the event of a wrong connection, this fuse will burn out before the current has time to rise sufficiently to ruin the valve filaments.

However the fuse is connected, it must be designed to burn out at a current value of not more than the current rating of the filaments. The fuse most useful for the average broadcast set has a current rating of 100 milliamperes.

With a lower current-carrying capacity, the fuse would be liable to blow on fairly high values of high-tension current consumption, even though all the connections were correct. If a fuse of more than 100 milliamperes is used, there is every possibility that, following a wrong connection, the filaments would blow before the fuse.

### Interesting Microfuses

One of the most interesting commercial fuses is the Microfuse. Made in the form of a cartridge, the Microfuse greatly resembles a grid leak in appearance. Some time ago, we tested several samples of this fuse, which is made under a special process whereby the fuse blows at intervals of between 1/1,000 and 2/1,000 of a second.

Instead of a fuse wire the Microfuse consists of a very fine layer of gold film, deposited on a glass surface. In this way it is possible to make fuses that will "blow" at as low a current value as 5 milliamperes.

A. S. H.

# The OUTSPAN SHORT-WAVE UNIT

*With the addition of this simple unit, designed by the "W.M." Technical Staff, any existing set with one or more stages of low-frequency amplification can be converted in a few minutes for reception on the ultra-short waves*

**G**REAT numbers of listeners who already have sets suitable for ordinary broadcast reception would also like to pick up trans-oceanic broadcasts, from the very ends of the earth, that are put out on ultra-short waves, but many are not inclined to go to the expense of a special receiver for the purpose.

## Capacity Effects

Unless specially designed, an ordinary broadcast receiver cannot usually be used for such work as it stands. Stray capacities play such an enormous part in short-wave reception that unless all the parts are specially arranged, nothing will be

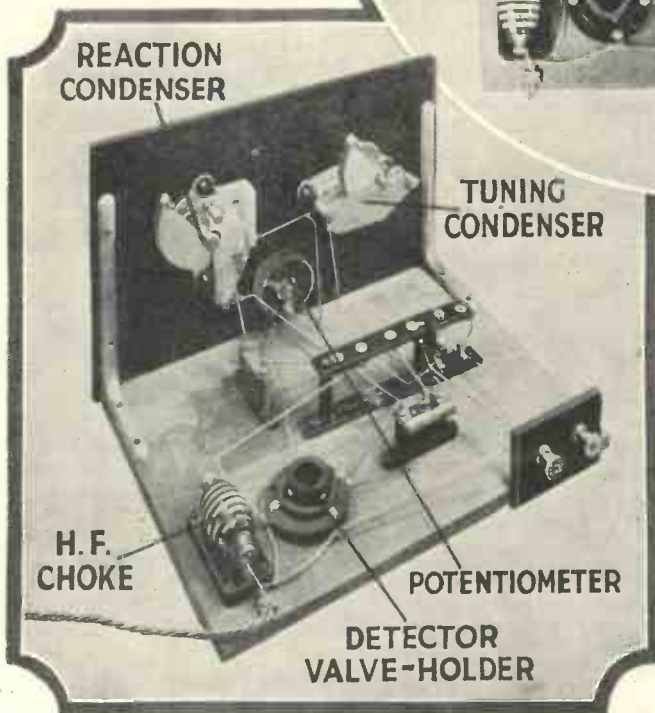
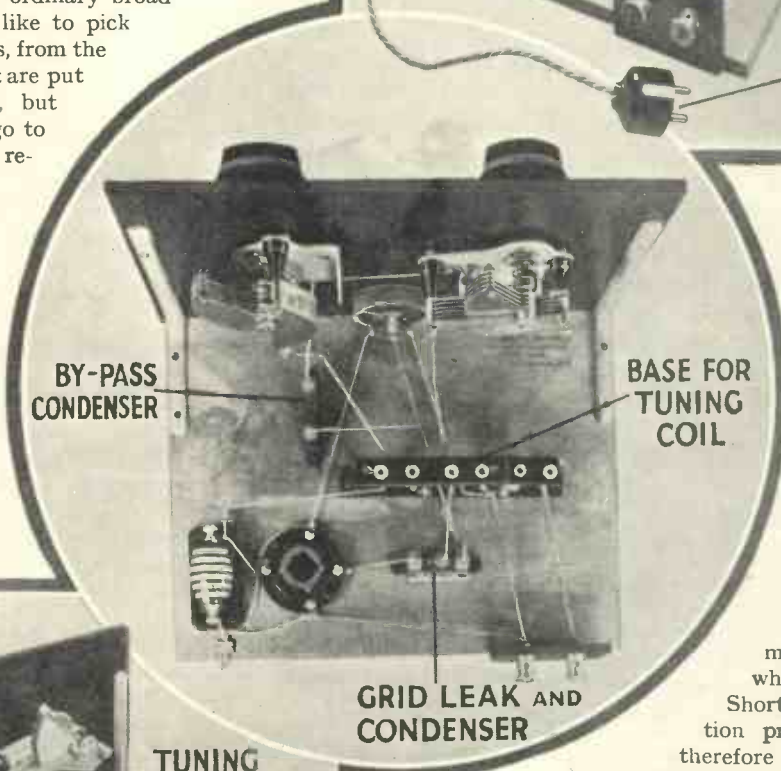
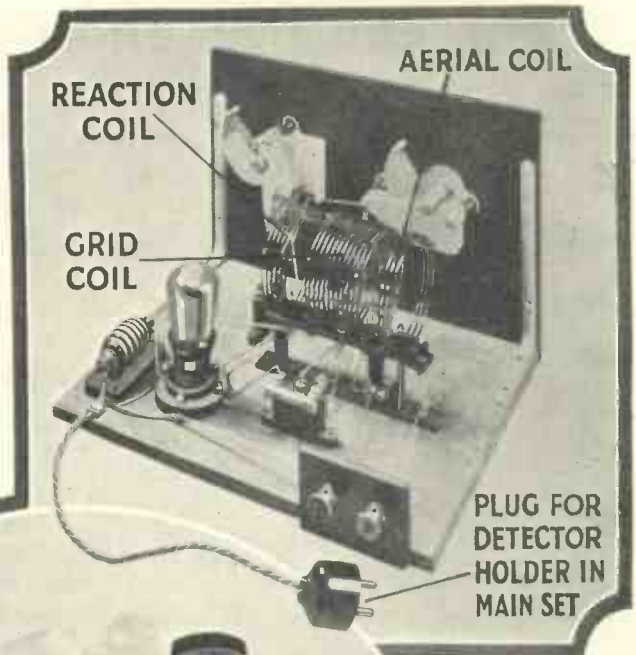

picked up at all.

It will be obvious that after the detector stage, short-wave reception is the same as reception on any other wavelength—we have only low-frequency modulations with which to deal.

Short-wave reception problems are therefore confined to the detector and any high-frequency stage that may precede it.

The object of the Outspan Short-wave Adaptor illustrated in these pages is to provide those who already have receivers incorporating one or more stages of low-frequency amplification with a ready and simple means of picking up the programmes transmitted from many parts of the world on wavelengths between 20 and 100 metres.

## Takes Place of Detector in Set

Briefly, the Outspan Adaptor is a short-wave detector unit which takes the place of the detector valve in the standard broadcast set, but utilises the low-frequency stages with which it is provided.

## COULD ANYTHING BE SIMPLER TO BUILD?

*Any beginner can successfully undertake the construction of this unit, as is evident from the photographs reproduced here*

# The Outspan Short-wave Unit—Continued

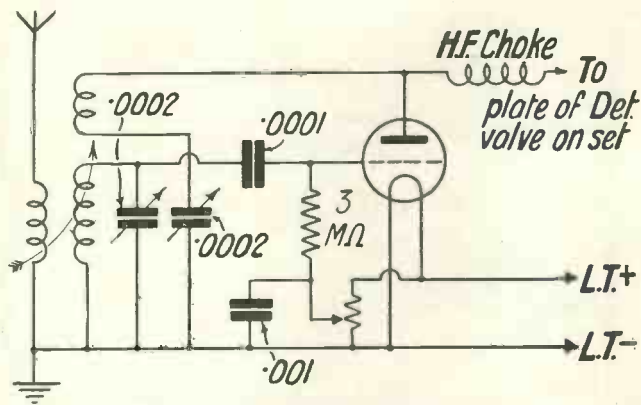

**CIRCUIT OF THE OUTSPAN SHORT-WAVE UNIT**

Everything is straightforward in this circuit, which is simply a single detector valve arranged for ultra-short waves

The cost is comparatively low and by its use an ordinary set can be converted into an efficient receiver for the ultra-short waves.

In short-wave reception (as distinct from medium- and long-wave broadcast reception) the aerial to be used is of considerable importance, for if it is too long it will be useless. Every aerial has a natural wavelength, and this must be lower than the wavelength it is desired to receive.

### Aerial Wavelength

Obviously, the natural wavelengths of aerials vary enormously. It is assumed that the average aerial conforming to the Post Office regulations (how little one hears about them now!)—that is, with a total length and height not exceeding 100 ft.—has a natural wavelength of about 150 metres.

For practical reception on short waves a 20 ft. to 30 ft length is ample. If the aerial is any longer it can be provided with a series condenser, preferably of the semi-fixed type with a maximum capacity of .0002 microfarad.

### Reducing Self-capacity

The effect of putting a condenser in series with an aerial is to reduce its self-capacity and, therefore, its natural wavelength; this makes it more efficient for short-wave reception.

In order to make them readily adaptable to any type of aerial, most short-wave tuners are nowadays provided with an aperiodic winding,

arranged on the leaky-grid principle, with a .0001-microfarad condenser and 3-megohm leak. If desired, other values of leak can be tried.

Furthermore, the detector is so arranged that the bias on the grid can be easily varied. This is accomplished by taking the return end of

which is coupled to the grid leak to the slider of a 400-ohm potentiometer connected across the low-tension supply. This system is adopted in the Outspan Adaptor, and, as will be seen from the circuit diagram on this page, the grid coil is tuned by a condenser of .0002-microfarad capacity.

For sensitivity the detector valve is arranged on the leaky-grid principle, with a .0001-microfarad condenser and 3-megohm leak. If desired, other values of leak can be tried.

Furthermore, the detector is so arranged that the bias on the grid can be easily varied. This is accomplished by taking the return end of

the grid leak to the slider of a 400-ohm potentiometer connected across the low-tension supply.

Maximum sensitivity is obtained with most valves when the grid is made slightly positive, but when the bias is too great reaction is liable to be too fierce.

In practice, therefore, the potentiometer is so adjusted as to make the grid sufficiently negative to produce the smoothest possible reaction effect

### Always A Critical Control

The importance of smooth reaction on an ultra-short wave unit cannot be emphasised too much. Reaction is always a critical control if used properly and on the short waves it requires the finest possible adjustment.

Indeed, tuning is so sharp between 20 and 100 metres on any set that the alteration of the reaction control may throw the whole set out of tune by a fraction of a metre and so lose a station that is about to be received.

Stability is therefore an important feature, and nothing that can be done to secure it is a waste of effort. It is for this reason that a .001-microfarad condenser is provided as a by-pass between the slider of the potentiometer and earth.

Reaction is actually applied on a modified Reinartz principle, the adjustment being made by a second .0002-microfarad condenser.

It should be noted that one side of both the tuning and reaction condensers is earthed. This avoids hand-capacity effects.

The output of the unit is taken through a high-frequency choke. This should have a low self-capacity for the best results.

### Simple Throughout

Analysed in detail, it will be seen that the Outspan Unit is very simple and straightforward, and can therefore be expected to give good results.

So far as the actual components are concerned, everything will be clear from the photographs on page 67. It will be clear from the top photograph how the tuning unit is arranged. On the right is the aperiodic aerial coil, which is mounted on a hinge so that the degree of coupling with the grid coil can be varied.

In the centre is the grid coil itself, (Continued on page 70)

### PARTS NEEDED FOR THE OUTSPAN SHORT-WAVE ADAPTOR

- CHOKES, HIGH-FREQUENCY**  
 1—Burton, binocular type, 5s. 9d. (or Lewcos, Wearite).
- COILS**  
 1—Eddystone short-wave inductance unit, with base, £1.
- CONDENSERS, FIXED**  
 1—T.C.C. .0001-microfarad, SP type, 2s. 10d.  
 1—T.C.C. .001-microfarad, upright type, 1s. 6d. (or Trix, Lissen).
- CONDENSERS, VARIABLE**  
 2—Utility low-loss, .0002-microfarad, 13s. (or Igranic, Polar).
- DIALS, SLOW-MOTION**  
 2—Utility Micro, type W181, 15s. (or Igranic, Polar).
- EBONITE**  
 1—Lissen panel, 12 in. by 8 in., 5s. 4d. (or Trelleborg, Becol).  
 1—Terminal strip, 3 in. by 2 in.
- HOLDER, VALVE**  
 1—Wearite, 1s. 9d. (or Trix, Cliz).
- PLUG**  
 1—Bulgin, multiple-cable type P9, 2s. 6d.
- TERMINALS**  
 2—Ealex, marked: Aerial, Earth, 9d. (or Belling-Lee, Burton).
- RESISTANCE, FIXED**  
 1—Lissen 3-megohm, 1s. (or Dubilier, Watmel).
- RESISTANCE, VARIABLE**  
 1—Lissen 400-ohm potentiometer, type LN93, 2s. 6d.
- SUNDRIES**  
 Tinned-copper wire for connecting.  
 Length of rubber-covered flex.  
 1—Pair Bulgin panel brackets, 1s. 6d. (or Camco, Ready Radio).
- The prices mentioned are those for the parts used in the original set; the prices of alternatives as indicated in the brackets may be either higher or lower*

# WHAT THE "JUNE" WIRELESS MAGAZINE SAYS!



ENTIRELY BRITISH MADE.  
Licensed under FARRAND & LEKTOPHONE patents.

*Wireless Magazine, June, 1930*

## Compact Field Gives Sensitivity

A great point in favour of the Inductor Dynamic Loud-speaker as compared with the moving-coil loud-speaker, is that, for a given magnetic flux the former is more sensitive than the latter, owing to the compact field.

Moreover, the weight of the armature system in the inductor instrument is only 4 or 5 grams, as compared with the 8 to 15 grams for the average moving coil. It is found that the inductor type gives excellent bass reproduction; the resonance has been estimated at 60 cycles.

## Good Value for Money

Compared with other types of loud-speakers available, the Farrand Inductor seems to me to be good value for money and will, in my opinion, become popular amongst discriminating listeners, who desire the best possible reproduction at a reasonable price.

## Definitely Supersedes the Moving-coil Speaker!

### The New LAMPLUGH "INDUCTOR" SPEAKER

This is the latest conception of the Inductor principle, invented by the American radio pioneer, Farrand, and is as great a step forward over present known types of speakers—whether balanced armature or moving coil—as the original cone was over the horn type. It possesses all the advantages of a moving-coil speaker, has a better response at the lower frequencies, and has none of the disadvantages associated with the M.C. type.

#### ADVANTAGES

There is no moving coil to pick up field current.  
There is no field excitation coil, therefore no introduction of hum from that source.

There is no heat generated.  
Requires no Rectifier, Transformer, Smoothing Condenser associated with Moving-coil Speakers on A.C. operated Sets.

Only a quarter the weight of a M.C. Speaker.

There is nothing to get out of order: it is beautifully finished and of robust construction.

#### AMATEURS

will realise at once the enormous saving in cost that the Lamplugh Inductor Dynamic offers without sacrifice in performance—which is indistinguishable from that of the finest M.C. Speaker. It must not be confused with the many Balanced Armature Movements on the market at the moment designed to give Moving-coil effect by artificial methods.

It's a  
"SILVER GHOST"

**Chassis Complete £3.10**  
**Cabinet Model .. £6.10**

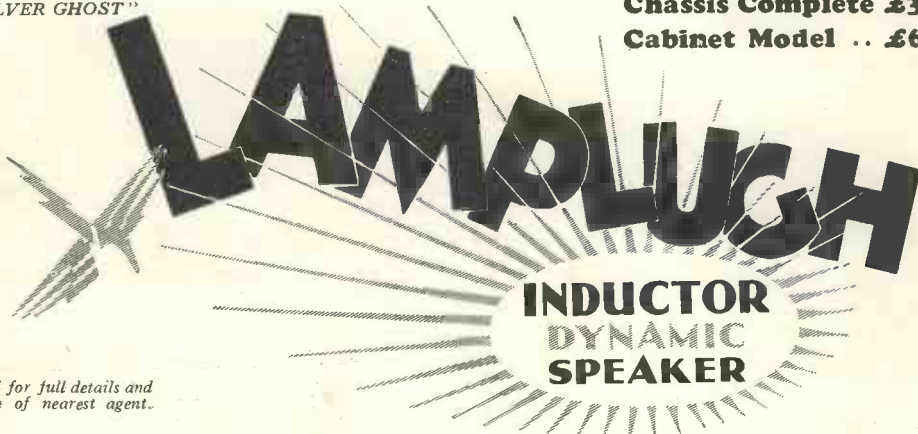

Send for full details and name of nearest agent.

**S. A. LAMPLUGH LTD., KINGS ROAD, TYSELEY, BIRMINGHAM.**

You will get prompt replies by mentioning "Wireless Magazine"

# The Outspan Short-wave Unit—Continued

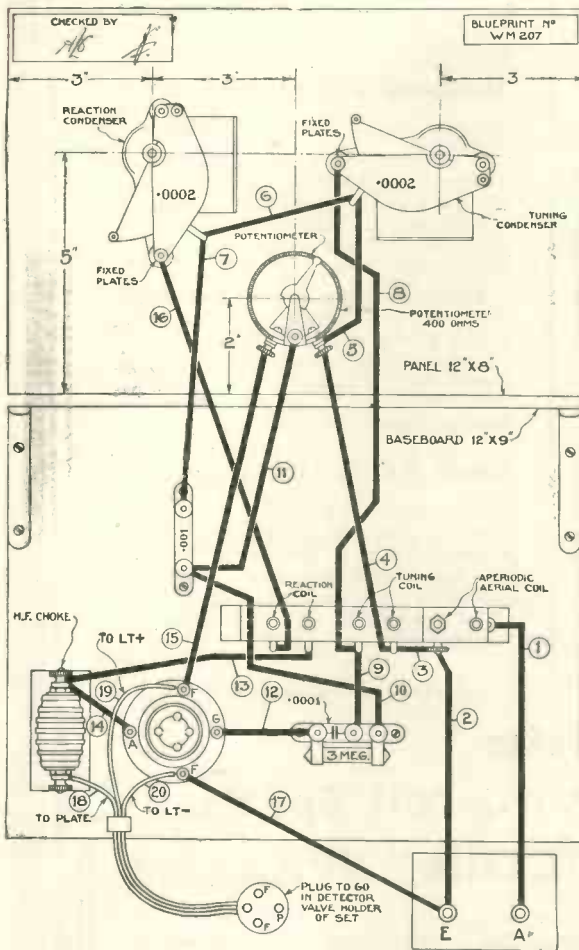

## LAYOUT AND WIRING OF THE OUTSPAN UNIT

This quarter-scale layout and wiring guide can be obtained as a full-size blueprint for half-price (that is, 6d., post free) if the coupon on the inside back cover is used by August 31. Ask for No. WM207

while on the left is the reaction coil. Actually, five coils are available with the particular make of unit used in the original set, and these cover a waveband of 18 to 90 metres.

### Low-loss Windings

All the coils are of the low-loss type, the turns being spaced by small pieces of ebonite. This avoids self-capacity in the former, and there is no short-cut for high-frequency energy to leak away before it has done any useful work in the set.

Not only are the coils themselves of the low-loss type, but the holder is also mounted well off the baseboard to minimise capacity effects to earth.

So sharp is the tuning on the ranges covered by the unit that it is

from the main set, insert the adaptor plug in its place, and use the valve as detector in the unit.

When estimating the cost of building this unit, therefore, the valve can be omitted for, in most cases it will be the one used in the ordinary broadcast receiver.

All the constructional details of the Outspan Unit should be clear from the diagram on this page, but if this is not large enough (it is reproduced at quarter-scale) a full-size blueprint can be obtained

almost essential, and certainly very desirable, to provide slow-motion dials for both the tuning and reaction condensers.

The output connections from the unit—there is only one output connection really, but the low-tension leads are included with it—are connected to a special four-pin plug that fits into the detector-valve holder of the set with which the unit is to be used.

It will thus be clear that the high tension applied to the anode of the detector valve in the Outspan Unit will be the same as that applied to the detector valve in the receiver, omitting the very small voltage drop produced by the high-frequency choke.

Moreover, the low-tension voltage will be unaltered.

Actually, the usual method of using the unit is to remove the detector valve

for half-price (that is, 6d., post free) if the coupon on the inside back cover is used by August 31.

To get one of these blueprints, send a postal order to Blueprint Department, WIRELESS MAGAZINE, 58-61 Fetter Lane, London, E.C.4, and ask for No. WM207. (In the case of overseas readers an appropriate extension will be made in the time limit for a half-price blueprint.)

### Actual Construction

Obviously, the first part of the construction is the drilling of the panel and the mounting thereon of the two variable condensers and 400-ohm potentiometer.

Next, the baseboard components should be firmly fixed in position as indicated.

Wiring up will not present any difficulties, because in the "W.M." diagrams and blueprints each wire is numbered separately in the proper order of assembly.

### Short and Direct Wires

Start with wire No. 1, and when this has been fixed in position cross through the number on the blueprint. Carry on in numerical order to No. 20, and it will be impossible to go wrong. All wires should be as short and direct as possible.

Leads Nos. 18, 19, and 20 are to be made with rubber-covered flex, and each should be kept long enough to reach comfortably to the detector-valve holder of an ordinary set when the Outspan Unit is in use.

(Continued on page 72)



VERNIER DIALS FOR FINE TUNING

There are only three controls on the panel. The two large dials are for main tuning and reaction respectively, while the bottom knob is for the potentiometer



# FERRANTI

## RADIO MEASURING INSTRUMENTS

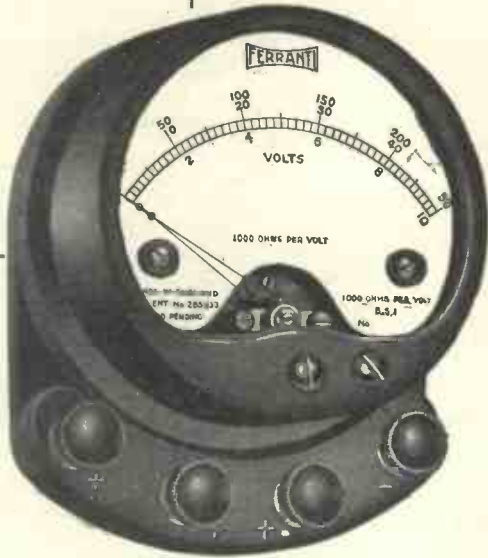

No better Meters of similar type are available AT ANY PRICE

**D.C. and A.C.**  
**Voltmeters, Ammeters, Milliammeters**  
**Combined Instruments.**  
**Prices from 35/-**

Accuracy: 1st Grade in accordance with the British Engineering Standard Specification No. 81.

Construction: Light and robust accompanied by unusually good damping.

Resistance: 200 or 1,000 ohms per volt precisely, according to type.

Scale: 110° 2½ inches long. Open, accurate, legible.

Write for List W406.

FERRANTI LTD.

HOLLINWOOD

LANCASHIRE



H.F. CHOKE. List No. H.F.O. Tuning range 10-2,000 metres. Self-capacity 3.5 m/mfd. Inductance 300,000 m/h. Resistance 200 ohms. Price 6/6

# WEARITE COMPONENTS

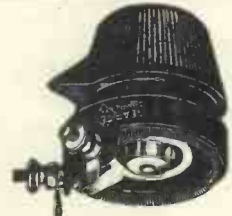

Rheostats, Potentiometers and Volume Controls

The 1930 BINOWAVE COIL is still achieving success. Either type A, C, or D. Price 17/-

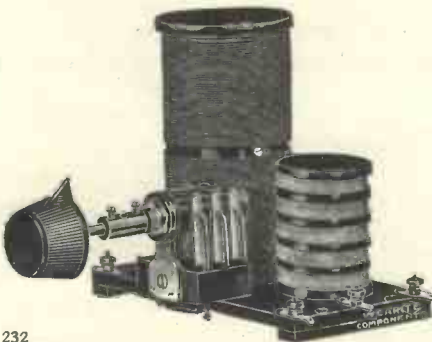

MAINS TRANSFORMER for "Radio for the Million" Orgola H.T. Supply Unit. Price 30/-

MAINS TRANSFORMER universal input 40-100 cycles. Output to suit your requirement. Type T.2. Price 37/6



Write for free Illustrated List.

**WRIGHT & WEAIRE, LTD.,**  
 740, HIGH RD., TOTTENHAM,  
 LONDON, N.17

Phone: Tottenham 3847-8

## The Outspan Short-wave Unit—Continued

Care must be taken in connecting these three flex leads to the special plug adaptor. The low-tension leads must be placed the same way round with respect to the anode and grid as in the set with which the unit is to be used.

### Practical Example

For instance, suppose that, looking at the detector-valve holder in the ordinary set, with the anode socket at the top and the grid socket at the bottom, low-tension negative is on the left and low-tension positive on the right.

In this case the two low-tension flex leads from the unit to the plug adaptor must be connected in the same relationship, so that when the plug is in position low-tension negative of the unit is connected to low-tension negative of the broadcast receiver.

Care should also be taken to see that the lead from the high-frequency choke in the unit is connected to the plate or anode socket of the plug adaptor and not to the grid socket.

### Suitable Valve

In most cases, as has already been suggested, the detector valve for use in the Outspan Unit can be that taken from the broadcast receiver. Its impedance will naturally depend upon the type of coupling used in the main set between the detector and the first low-frequency stage.

When using the unit it should, of course, be made quite certain—this remark is for the benefit of beginners only—that the plug adaptor is being placed in the detector-valve holder of the main set, and not in place of a high-frequency or low-frequency amplifier.

The actual operation of the unit will probably take some days to master, as the tuning is so critical on the ultra-short waves.

### Smooth Reaction Essential

The most important thing is so to adjust the anode voltage and the panel potentiometer that the set glides in and out of oscillation smoothly and without overlap as the reaction control is withdrawn.

With smooth reaction and sensitive fingers it is only a matter of luck as to what may be picked up on any particular evening. Sometimes

results are good and at others there is "nothing doing," no matter how many valves are employed.

Used under favourable conditions, America will be picked up without difficulty, and it should also be possible to receive Australia if listening is undertaken at the right time.

This unit can be specially recommended for use with sets normally

employing one or more low-frequency stages, such as the Brookman's Three, Fanfare Three, Celerity Three, Gleaner Two, Touchstone Four, and Dual-screen Five.

As soon as readers have had the unit going for a few weeks we shall be glad to have their comments so that we can pass them on for the benefit of others constructors.

## Two Well-known Soloists

Caricatured by LISSENDEN

Harriet Cohen, a distinguished British pianist, who first introduced the piano-forte music of Arnold Bax

Albert Sandler, the well-known violinist, is always appreciated by listeners



## Mains Power for Your Portable

Continued from page 32

unit is typical of Regentone practice—neat, robust, and convenient.

The makers of Regentone units are to be thanked for remembering that there are still many D.C. supplies in this country. The Regentone portable power unit for D.C. mains is suitable for supplies between 200 and 250 volts.

The maximum output of the high-tension section taken at the power tapping with an input voltage of 220 is 130 volts at 20 milliamperes. The charging rate for two-, four-, or six-volt accumulators depends upon the size of lamp used.

The method of using a combined unit for high-tension supply and trickle charging is different when the supply is D.C. To work the Regentone portable power unit with D.C.

mains a lamp, such as is utilised for normal illumination, has to be used. When using the unit for supplying high-tension current this lamp does not glow, but during the charging process it can sometimes be made to serve for illumination as well.

### Study the Instructions

A very complete instruction booklet is issued with each Regentone unit. We strongly recommend purchasers to study the instructions before attempting to operate the units.

We have tried both D.C. and A.C. Regentone units, and as a result of our tests can strongly recommend them. Prices are as follows: Regentone A.C. unit, £5 17s. 6d.; Regentone D.C. unit, £4 5s.

15/6  
3/-  
VERNIER DIAL

0005  
00035  
00025  
00015  
CAPS. DUAL GANG

FORMO-CONDENSOR

MAX.  
F 0001 2/-  
J 0003 2/-  
C 001 2/-  
H 002 3/-

2/9  
3/9  
CAP. 00015

4/6  
MID LOG LINE

DIFFERENTIAL

FORMO

MIDGET REACTION

0002  
0001  
CAPS

GOLDEN SQUARE, PICCADILLY CIRCUS, LONDON Gerrard 1863

## EDDYSTONE SHORT WAVE APPARATUS

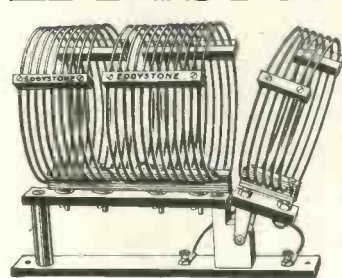

London Service Depot:  
WEBB'S RADIO ELECTRIC STORES  
164 Charing Cross Road, W.C.2

Sole Manufacturers:  
STRATTON & CO., LTD., BROMSGROVE STREET, BIRMINGHAM

**TYPE A.V. INDUCTANCE ASSEMBLY**  
This complete inductance unit for short wave reception consists of five interchangeable coils with mounting stand the range from 18-90 metres being covered efficiently with a .00015 condenser. The arrangement makes use of aerial, grid and reaction coils; the first named being variable to prevent blind tuning spots. Wound with well-spaced turns, entirely open core and low loss banana-type mounting pins, the short wave performance of the coils is unequalled. Full circuit details enclosed. Extra B.B.C. coils can be supplied.

**Price 20/- with Stand**  
Send for complete list (M) of short wave apparatus.

## BERCLIF THE BEST 5/- DUAL-ASTATIC H.F. CHOKE

(See CURVES last month)

De-Coupling Resistances  
(Specified S.G.3 Portable)  
600 ohms, 1/6 1,000 ohms, 2/-

NEW DUAL RANGE TUNER  
WITH REACTION - - 6/6

BERCLIF DUAL COILS, 15/-

Write for Lists :

**SIMMONDS BROS.** SHIRELAND ROAD  
S M E T H W I C K



## GREAT BRITAIN'S RADIO DOCTORS



(Officially approved as Wireless Repairers by the Radio Society of Great Britain and the Wireless League).

WIRELESS MAGAZINE and other sets constructed to specification, using your or our components.

Sets modernised, repaired or overhauled by experts.

Remember! We have satisfied customers in all parts of Great Britain, and in three Continents!

**G. SCOTT SESSIONS & CO.** (Tudor 5326),  
Muswell Hill, London,  
N.10

GREAT BRITAIN'S RADIO DOCTORS

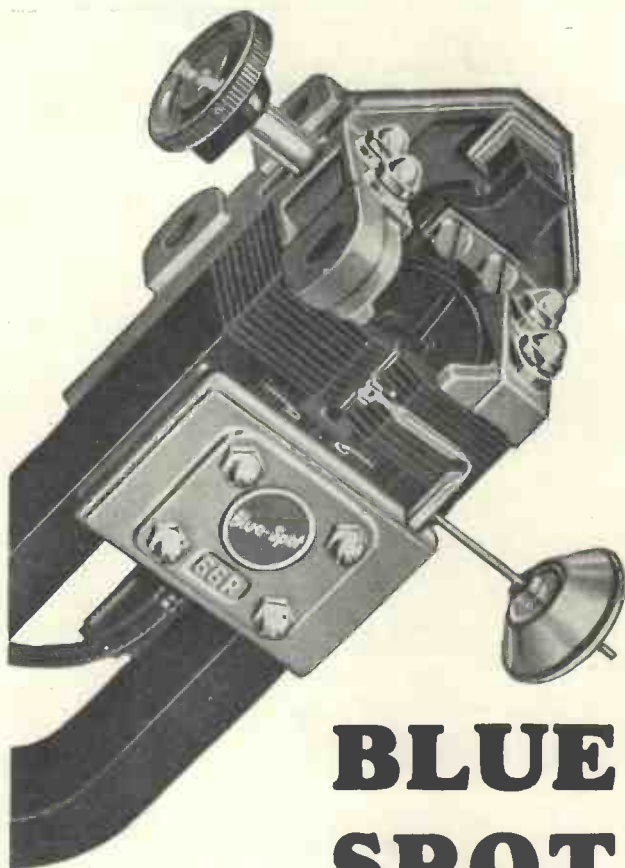

# BLUE SPOT 66R

## THE MASTERPIECE

Hear for yourself how this wonderful Unit creates a new standard of reproduction. Test it how you will—from grand organ to tin whistle, from orator to *siffleur*—everything comes through in a way that will amaze you.

**66R** is the World's finest Unit and Blue Spot's greatest achievement.

**35/-** from all dealers.

**F. A. HUGHES & CO., LIMITED**  
204-6 Great Portland Street, London, W.1

Distributors for Northern England, Scotland and North Wales:  
H. G. RAWSON (SHEFFIELD & LONDON) LTD., 100 LONDON ROAD, SHEFFIELD; 185 PRINCESS STREET, MANCHESTER

# Around the Turntable

REVIEWS of RECORDS by WHITAKER-WILSON, the "W.M." MUSIC CRITIC

## Classical Orchestral Music

Jagerchor, chorus and orchestra of the State Opera House, Berlin, 4s. 6d.

H.M.V. E557

Jagerchor is the Huntsmen's Chorus from Weber's opera *Der Freischütz*, of which I have already reviewed the overture as my thousandth record. This is very stirring and thoroughly characteristic of Weber. The soft effects of the male voices are really delightful.

Marche Slav, H.M. Grenadier Guards (d.s.), 4s. 6d.

COL DX59

This is Tchaikovsky, of course, and, although I do not care for him arranged for a military band, I must own that there are some very good effects. The Slavonic march is a fine work; I suggest that lovers of Tchaikovsky should ask to hear this.

Matrosenchor, chorus and Orchestra of the State Opera House, Berlin, 4s. 6d.

H.M.V. E557

This is the *Sailor's Chorus* from Wagner's opera *The Flying Dutchman*, and has for its companion the Jagerchor of Weber (see review). This is admirably produced. Those who have seen *The Flying Dutchman* should get this, and those who have not, should hear this record and then see the opera!

"Midsummer Night's Dream" (Mendelssohn), Berlin State Opera Orch. (d.s.), 4s. 6d.

H.M.V. C1883

Parts 3 and 4 (d.s.), 4s. 6d.

H.M.V. C1884

The recording is blotchy in this, which is so well played that, had the above fault shown itself in the opening, I should have placed it in the list of the month's best records. Even so, it is worth having, but you must understand that it is not perfect—not as good as H.M.V. has done and can do. The fourth side is the best. The *Wedding March*. The third side is very faulty from the recording standpoint.

## Light Orchestral Music

Carnival of Venice, Del Staigers, cornet, with Goldman's Band, 3s. H.M.V. B3425

The technique of the player is not beyond reproach; it seems to me that he has attempted too much. The variations are hurried and blurred. Not a good performance. The other side—*Napoli*—is decidedly better, though not perfect. A pity, for it is a jolly tune—well known, of course. Ask to hear it; you

may be more impressed with it than I am.

Humming a Song of Love, Phil Baker, accordion, 3s. H.M.V. B3438

H.M.V. is launching out this month with strange instruments. This is a pleasant affair. Very well played. On the other side Phil Baker plays *Happy Days are Here Again*. It is a record you must hear for yourself; I can scarcely presume to advise you on accordion solos, any more than I could on accordion pieces.

In a Persian Market (Ketelbey) Kneller Hall Band, 1s. 6d. STERNO 367

The opening of this seems queer to me from the tonal point of view, but the rest of the record is good enough. Sterno records have a good surface and are certainly worth the low price charged for them.

Les Cloches de Corneville, H.M. Coldstream Guards (d.s.), 4s. 6d.

H.M.V. C1880

Planquette's *Les Cloches de Corneville* is always popular. This is quite a good selection of its most taking tunes and excellently played, of course, by the Coldstreams. It makes a good military band record.

Leslie Stuart Songs, London Fire Brigade Band (d.s.), 1s. 6d. PIC 532

Quite a good selection, in the military band style, of well-known melodies by Leslie Stuart.

Liebesfreud (Kreisler), Teddy Brown, xylophone, with piano, 1s. 3d. BRDCST 563

I was greatly entertained by my Teddy playing Kreisler's *Liebesfreud*. I hope he has sent him a copy for review! On the other side he plays a hornpipe, which I much prefer for his particular style of beauty!

Looping the Loop, V. M. Gaston, xylophone, 1s. 6d. STERNO 371

From the musical point of view, this has little enough to recommend it—but the xylophone playing is very ably done and pleasant to listen to; the other side contains another xylophone solo called *Marionette*.

Morning, Noon, and Night, Athenaeum Symphony Orch. (d.s.), 2s. PIC 5037

This is a good light orchestral record. I imagine that Suppé appeals to most people. Imperfect recording blurs some of the string tone. I want Piccadilly to pay attention to their recording of violins; there is something not quite right, and yet the cello solo comes out quite well. Come on Piccadilly—keep up the standard!

Operatica, J. H. Squire Celeste Octet (d.s.), 4s. 6d. COL DX62

I am not going to tell you

what is in this; you should be able to name every tune in it. A good selection from the best-known operas always makes an enjoyable record. The tone of the violin is not without blemish here, but there is not much the matter with any of it.

O Sole Mio, Hawaiian Melody-makers, 1s. 3d. BRDCST 562

What with accordions, cornets, xylophones, guitars and mandolines, I am doing well in the orchestral line this morning! This is really attractive. I like *Mari, Mari* (on the other side) even better. Ask to hear these; I think you will be attracted to them.

Potpourri Overture, Ernest Leggett's Symphony Orch. (d.s.), 1s. 6d. STERNO 368

Very pleasant light music which everyone will enjoy; it is well recorded and well played. I strongly recommend the record.

Scotland's Pride, Band of H.M. Welsh Guards (ds.),

## THE THOUSANDTH RECORD

Der Freischütz (overture), National Symphony Orch. (d.s.), 2s. 6d. ZONO 5588

Had it not been the 1,000th, I should have given it prominence in the list of the month's best issues, for it is a splendid rendering of Weber's own favourite overture. The opera *Der Freischütz*, which is best translated *The Freeshooter*, won fame for Weber, and this overture still remains one of his best-known works. Having heard *hug thousand sides*, I humbly claim to know a good record when I hear it; this is good. Add it to your collection. W.-W.

2s. BRDCST 5163

This will appeal to northern readers; I advise those interested to ask to hear this. There is nothing the matter with it.

Trooping the Colours Regimental Band of H.M. Grenadier Guards (d.s.), 4s. 6d. COL DX44

This is an example of what can be done nowadays. The effects are extraordinarily well produced. The record contains the Parade, Assembly, Inspection, Troop, Present Arms, etc., all of which are very realistic.

## Grand Opera & Classical Arias

"La Boheme" (Puccini), Grand Opera Company, with orch. (d.s.), 2s. BRDCST 5161

Parts 3 and 4 (d.s.), 2s. BRDCST 5162

There are two complete records of this; quite worth hearing, though the voices are not wonderful. Still, it is something to have so much grand opera for four shillings. The recording is good all through.

O Star of Eve, Frederick Ranałow, bar., with orch., 2s. PIC 5044

His voice is, of course, excellent, and the whole thing is a good reproduction of Wagner's attractive aria from *Tannhäuser*. The only blemish is that the harp sounds a little out of tune—a way with harps when heard through a microphone. The other side is an attractive rendering of *Mephistophele's Serenade*, from Gounod's *Faust*. A good operatic record.

## Light Opera & Songs

All Thro' the Night, Barclays Bank Male Voice Choir, with piano, 4s. 6d. COL 577

A splendid choir, singing most expressively. I wish the piano part had been left out; either the instrument is a bad one or else there is something wrong with the recording, for the distortion is most marked. Surely we ought to have no distortion from a piano in these days. I think it is the recording that is the trouble, because I detect faults in the voice parts in *Cloud-capt Towers* on the other side. Anyhow the choir is good enough. Come on Columbia! More of Barclays, please!

All Through the Night, Blodwen Caerlon, con., with orch., 2s. PIC 5041

What a perfect tune this is; it sounds more attractive than ever to me sung in Welsh. Her's is a very appealing voice. The other side is *Cymra Annwylh*, which I like immensely; it is a real folk song of an exceedingly attractive nature. I recommend this record; it ought to become popular.

As Long as the Windows Face Your Way, Patrick Waddington, bar., with two pianos, 3s. H.M.V. B3440

From the English version of the "Folies Bergere" Revue, this is quite effective in its way, but his voice is so *toneless*. I am afraid he is one of those singers who thinks any old, thin will do for tone. It is a bad habit, and one which I hope all critics will militate against. Either sing your songs or let someone else try. In *Why Do You Suppose*, the lack of tone is irritating in the extreme. The songs, of their type, are effective enough; I suggest H.M.V. does both again with someone who can sing.

Aylesbury Ducks, Malcolm

# FRANKLIN

FULLY GUARANTEED CONDENSERS

1 MFD. 500v. D.C. test - 2/-  
1 MFD. 500v. A.C. test - 2/6  
1 MFD. 1000v. D.C. test - 3/4

Use them for a full 6 months and we will replace any which prove defective. Remember the name. At your dealers or direct from—

FRANKLIN ELECTRIC CO.  
187-189 Ilford Lane, Ilf rd. Essex  
Phone: Ilford 0281



## CABINETS for PORTABLES and other SETS

# TRIX

### PORTABLE Cabinet

Used in Foursome Portable set in this issue.  
Rexine covered, 30/- Solid hide, 22 10s.

ERIC J. LEVER (TRIX) LTD.  
8/9, Clerkenwell Green, London, E.C.1.  
\*Phone: Clerkenwell 3014/5.

### BU AMATEUR WIRELESS

3d. WEEKLY

# J.B.

# "CHASSIMOUNT"



The J.B. "Chassimount" is the newest and most efficient method of control for really modern radio sets. As specified for the "Overseas Five" the "Chassimount" consists of four .0005 J.B. Condensers mounted in one panel, each unit being efficiently screened and matched to within less than 1 per cent. Though costing less than separate controls, it will give equally good results, provided, of course, that it is used with accurately matched coils. There is no fear of "stray capacities" interfering with the selectivity—a balancing adjustment is provided to each unit. This J.B. "Chassimount" gives real selectivity—the selectivity you need for modern broadcast programmes.

Four Gang  
complete with  
Drum Dial **42/6**

## PRECISION INSTRUMENTS

Advertisement of Jackson Bros., 72 St. Thomas' Street, London, S.E.1.

Telephone: Hop 1837

McEachern, bass, with piano, 3s. **COL DB132**

A good voice but his words are lost entirely, as far as I can judge, though I can hear those of *The Driver of the 8.15* on the other side. What a stupid song this is; absolute drivel. I call it!

Brown Bird Singing, Megan Thomas, sop., 6d. **STERNO 373**

A poor-toned piano is rather a blemish in this—but Megan Thomas sings so well that I am not listening to the piano more than I can avoid. On the other side she sings, very pleasantly, another of Haydn Wood's melodies—I think of *You, My Sweet*.

(a) Clavelitos, (b) Estrellita, Amelita Galli-Curci, sop., with piano, 6s. **H.M.V. DA1095**

This is an amazingly clear reproduction of *coloratura* singing and is certainly Galli-Curci! I should have recognised her voice had I not read the label before putting on the record. On the other side she sings Alabieff's Russian Nightingale Song in which she displays her great powers ending on the *Fur' all!* A very fine record.

Drake Goes West, Joseph Farrington, bass, with orch., 2s. **PIC 5045**

Not a perfect production; Farrington sings as well as I should expect him to sing, but the tone of the record is not as good as Piccadilly can produce. The other is the *Admiral's Broom*—splendidly sung.

Hail De Crown, Paul Robeson, bass, with piano, 3s. **H.M.V. B3409**

Those of you who admire the Negro Spiritual type of melody cannot do better than ask to hear this. Robeson's voice is nothing to rave about, but he has an appealing way of singing. *Exhortation*, on the other side, is rather attractive and in a kind of recitative style. I liked the music; the words are rubbish.

I Feel You Near Me, John McCormack, ten., with orch. 6s. **H.M.V. DA1113**

A McCormack record is always a safe record, and this is no exception, though it is a pity he does not sing something better. Neither this nor its companion *A Pair of Blue Eyes* are worth, musically, the paper they are written on.

I'll Sing Three Songs of Araby, Herbert Thorpe, ten., with orch., 2s. 6d. **ZONO 5592**

This is a very good rendering of it; Thorpe takes the trouble to enunciate his words. The last time I heard a record of it, it should have been "I'll Sing Three Songs in *Arabic*" for all I heard of the words! On the other side he sings Somervell's *Gentle Maiden*, a pleasant, suave melody which shows off his good, round tenor quality. The orchestral accompaniment to both songs is excellent.

Little David, Play on Your Harp, Emory University Glee Club, 2s. **PIC 5047**

There is something contractually attractive about this male-voice glee; I like it very

much. The solo voices are good and the whole thing well carried out. The other side is the *Levee Song*. The Emory University Glee Club ought to make as many records as possible; they are well worth hearing.

"Merry Widow," soloists, chorus, and orch. (d.s.), 1s. 3d. **BRDCST 558**

The recording here is not up to Broadcast standard. The singing is good, though. Broadcast will do well to recall it and do it again.

Rebels Are Out, Douglas Graham, bar., with orch., 1s. 6d. **PIC 537**

This is from "Silver Wings." I like Douglas Graham's voice. Quite a good record.

Three Musketeers, Dennis King and chorus, with orch. (d.s.), 3s. **COL DB127**

Very well produced; the music is of a light character and pleasant to listen to. Dennis King's voice comes out admirably, and the chorus appears to have been well drilled. A good record.

Three Musketeers, Dennis King, bar., with Raymond Newell, Jack Livesey, Robert Woolard, and Musketeers, with orch., (d.s.), 4s. 6d. **COL DX58**

Quite an imposing record in its way; and to hear it—you may appreciate the light and melodious character of the music. There is a good deal to be said for records of this nature, which are a go-between serious and very light music.

Voyage in a Troopship, Band of H.M. Welsh Guards, with male chorus (d.s.), 1s. 3d. **BRDCST 564**

Another of these descriptive ventures; it is very good. The children, especially, will enjoy it.

With a Song in My Heart, Jimmy Cavendish, light ten. 1s. 6d. **STERNO 383**

The voice is pleasant enough, though I do not hear much *tenor* quality in it; the song is not good, however. The other side is another "sloshy" effort, called *Wind in the Willows*. I hate both!

### Organ Music

Crying for the Carolines, pipe organ, with vocal refrain 1s. 6d. **PIC 534**

Why a pipe organ? Don't all organs have pipes? This is a very ordinary cinema-organ record.

O Dry Those Tears, Essie Ackland, con., with organ 4s. 6d. **H.M.V. C1885**

I do not know who the organist is in this case, or what organ he played on, but neither is up to recording standard. Her voice is, however, well produced, though her pronunciation is a little faulty. I am writing as the record proceeds and my first impressions of the organ part are now confirmed. It sounds very bad in places; a pity, for she improves as she goes on. On the other side, the same people, apparently, render Tosti's *Goodbye*, which is a trifle

# Around the Turntable—Continued

better, but the organist has no idea how to play from a piano score; he wants lessons in transcription.

**Toccata in F** (from "Symphony No. 5"), Quentin M. MacLean, organ, 4s. 6d.

COL DX66

I think "symphony" rather a fine title for this rather extraordinary composition, although this movement is in toccata style. It is not uninteresting by any means and as an organ record has distinct merits; the pedals are excellent in places. One, however, gets a little weary of the incessant figure in the right hands. He plays the *Ride of the Valkyries* on the other side excellently. I am not fond of organ arrangements of works of this type—particularly of Wagner—but I confess to an admiration for some of this. I loathe the tone of the organ, though!

## Sacred Music

**Nazareth**, Scout Teddy James, with organ, 2s.

BRDCST 5164

This is the City Temple Organ. Scout Teddy's voice is not good enough for recording. On the other side he sings Adams' *Holy City* which bored me to extinction.

## Chamber Music

**Deep in My Heart, Dear**, Fritz Kreisler, violin with piano, 6s.

H.M.V. DA785

An attractive melody in waltz rhythm, played exquisitely by the world's greatest violinist. In a repeat of the tune Kreisler's double-stopping is something to wonder at. The *Indian Love Call* on the other side, is very attractive and has a delightful native flavour about it. It is worth having.

**Chanson Neapolitaine**, Cedric Sharpe Sextet, 3s.

H.M.V. B3429

D'Ambroseo's *Neapolitan Melody*, as played by this admirable sextet makes pleasant chamber music of a light type. It is a beautiful, flowing tune. The other side is not so good—it is an arrangement of Ronald's *O Lovely Night*, of which, I personally, am very tired. The record, however, is worth having for this side alone.

**Molly on the Shore**, Stratton String Quartet, 2s.

PIC 5033

This is always amusing; I like Percy Granger's music—he has some real artistic fun in him. The other side is Frank Bridge's version of *Cherry Ripe*, which is exceedingly attractive. The tone of the string is not, however, perfect in either record.

**Nocturne in E Flat Major, Op. 9, No. 2** (Chopin), Pablo Casals, 'cello, with piano, 8s. 6d.

H.M.V. DB966

When Pablo Casals plays the 'cello the whole world should stop to listen; there has been no 'cellist for a century anything like him. Here he plays—divinely—the favourite *E Flat Nocturne* of Chopin. The arrangement is fairly good, though not excellent, and I am not sure I

want any Chopin on a piano. On the other side he plays a prelude of Chopin; I have yet to learn which—but see separate review.

**Prelude** (Chopin), Pablo Casals, 'cello, with piano, 8s. 6d.

H.M.V. DB966

This is the other side of the *Nocturne in E Flat* (see review). The prelude proves to be No. 15 in *D Flat* and beautiful it sounds, even though transposition to another key—to suit the 'cello, of course—rather worried me at first. It is a fine record of something that should not have been played on a 'cello, but he plays it, and that is all about it; it is irresistible.

## Piano Solo

**High Society Blues**, Raie da Costa, piano, 3s.

H.M.V. B3450

This pianist has evidently both tone and technique; I wonder he does not aspire to something better than this work, which is neither here nor there on a piano. *Cryin' for the Carolines*, on the other side, comes to the same thing, pianistically speaking. But those of you who appreciate the type of music often played on two pianos in the vaudeville programmes should hear this; I think it will appeal to you.

## Humorous

### Records

**Bugginses Picnic**, Mabel Constanduros and Michael Hogan (d.s.), 2s. BRDCST 5166

Come on Miss Constanduros! Let us have something new! I suppose I am a little tired of your idiom. The record is clever, of course, but (as I say) try a new venture.

**Good Old General Guinness**, Jack Morrison, com., 1s. 6d.

STERNO 370

A pleasantly humorous song in a very decided rhythm. *Over the Garden Wall*, on the other side, is also pleasant to listen to, though not particularly funny. Both would make good foxtrots.

**Making a Talkie**, Clapham and Dwyer, with effects (d.s.) 3s.

COL DB134

Thoroughly characteristic of them; they squabble as usual and their effects do not tally with their description of them. I thoroughly enjoyed them. The second side is after they have had their lunch—very amusing.

**My Old Dutch**, Nobby Clark, cockney character, with orch., rs. 6d.

PIC 538

A pleasant voice sings the old favourite and *Our Little Nipper* on the other side. His diction is excellent.

**Sweet Carolina**, Clarkson Rose, com., with orch., 2s. 6d.

ZONO 5599

I never heard a more peculiar voice! The chorus is excellent and the humour not forced. Of course, the number is by no means new—none the worse for that, of course. The other side contains *The Empire Party*, a martial effort and rather amusing.

**You Die if You Worry**, Bobbie Comber, com., with orch. rs. 3d.

BRDCST 580

A race-scene; quite amusing, though by no means a "schreem," as they say in the offices here. The other side, *Back to Gay Paree*, is rather low in style. Sorry, but I can't honestly recommend this record.

## Dance Music

**Amey** (f), Debroy Somers Band, with vocal chorus, 3s.

COL CB83

This is an old number—or it seems to me that it is a chorus fitted to an old song. Some of the effects in it are good. I don't quite understand what it is all about; ask to hear it—perhaps you will make more of it than I can. The other side is the slow foxtrot *Ro-ro-rollin' Along*, now very popular.

**Alone in the Rain** (f), Nat Lewis's Dance Band, with vocal refrain, rs. 3d.

BRDCST 565

This is really excellent; I should have thought the opening was the London Symphony Orchestra! Good for Broadcast; a very good dance record, and orchestral sound! Other side, *Molly*.

**Bench in the Park** (f), Paul Whiteman and his orch., with vocal chorus, 3s.

COL CB86

A jolly tune from "The King of Jazz." On the other side is *Happy Feet*, from the same film.

**Cryin' for the Carolines** (s.f.), Riverside Dance Band, with vocal refrain, rs. 3d.

BRDCST 568

Very well produced; the recording is of the very best. An attractive tune in the slow foxtrot rhythm. The other side being *Beside an Open Fireplace*—also good.

**Eton Boating Song**, International Novelty Quartet, 2s. 6d.

ZONO 5595

This of course is well known; I am told that it is always played at the production of "Charley's Aunt." The International Quartet plays *The Chorister's Waltz* on the other side, which is a relic of by-gone days. Rather a pleasing record.

**If I Can't Have You** (f), Manhattan Melodymakers, with vocal refrain, 2s.

BRDCST 2565

Quite a good tune and up to Manhattan standard. Other side, *Goodbye to All That*.

**I'm on a Diet of Love** (f), Nat Lewis and his Dance Band, with vocal refrain, rs. 3d.

BRDCST 566

Everyone seems to be on a diet these days. This is a cheerful foxtrot tune which may become really popular. Other side, *Mona*, well produced.

**'Leven-thirty, Saturday Night**, Arcadian's Dance Orch., 2s. 6d.

ZONO 5603

Quite a virile tune and useful for dancing purposes—the sort of dance to put on after a sleepy waltz. The other side is the *Stein Song*, which is in one-step

rhythm. A very useful dance record.

**Lucky Me, Lovable You** (f), Jack Leon's Dance Band, rs. 6d.

PIC 543

Quite a good version of it, with *Sunshine of Marseilles* on the other side. A good dance band into the bargain.

**Oh-Oh-Oh-Oh-Oh-Oh!** (f), Bidgood's Broadcasters, rs. 3d.

BRDCST 569

An intelligent title to rather an amusing song, the sub-title being "What a silly place to kiss a girl." It goes near the vulgar mark, but there is nothing much to object to. On the other side is another amusing ditty, *We're Uncomfortable*. I think the record will sell! It is a trifle vulgar!

**Paris**, Bidgood's Symphonic Dance Band, with vocal refrain, 2s.

BRDCST 5165

Two good selections this and *Happy Days* on the other side. I am a little tired of both, but those of you who want these in concentrated form may be glad to know of the number.

**Puttin' on the Ritz** (f), Bert Maddison and his Orch., with vocal chorus, rs. 6d.

STERNO 376

From the film of that name, this is a rhythmical foxtrot, though not outstanding in the way of melody. *With You*, another foxtrot is on the other side. Both compositions sound to me as though the composer has been having too many late nights. *They are tired*.

**Should I?** (f), Manhattan Melodymakers, with vocal refrain, 2s.

BRDCST 2564

This, of course, is popular and I am not surprised; it is a pot tune. I also like the slow foxtrot on the other side, *The One I Love*.

**Stein Song** (six-eight), Rudy Vallee and his Connecticut Yankees, with vocal refrain, 3s.

H.M.V. B5834

I have reviewed this before; it is an excellent one-step and a welcome change from the eternal foxtrot rhythm. The other side is *Love Made a Gypsy out of Me*. An excellent dance record; I recommend it.

**There Will Never be Another Mary** (w), Manhattan Melodymakers, with vocal refrain, 2s.

BRDCST 2566

Another excellent Manhattan record. On the other side they do *Moonshine is Better than Sunshine*. I like all their records.

**Vagabond King** (w), Al Benny's Broadway Boys, with vocal refrain, 2s.

BRDCST 2568

Contains *Love Me To-night, Huguette, Only a Rose, and Some Day*. The other side, is the foxtrot *Ro-ro-rollin' Along*. A good production in every way.

**With You** (f), White Star Syncopators, with vocal refrain, rs. 6d.

PIC 547

The W.S.S.'s are good. On the other side is a useful dance version of *Puttin' on the Ritz*. It is a fairly good tune. *With you*, of course, has almost run its course by now.

## FOR SUCCESSFUL FOREIGN RECEPTION

THE STEWART CARDINAL BINOCULAR H.F. CHOKE has been scientifically designed to increase the efficiency of your foreign reception. Try one now in your receiver and you will be amazed at the improvement that this efficient choke will effect. See page 577 of the July issue of the "WIRELESS MAGAZINE" for the report made by the "WIRELESS MAGAZINE" Testing Department.

Obtainable from all good radio shops; if your dealer cannot supply you, write for particulars and name of nearest stockist.



**3/6**  
EACH

**STEWART**  
Engineering and  
Manufacturing Co.  
78 TURNMILL ST.  
LONDON, E.C.1  
Phone:  
Clerkenwell 1414.



ONLY  
**3/9**  
EACH

### The Choice of the Continental Programmes

depends largely on a smoothly controlled reaction. To obtain this fit the SOPRANIST Binocular H.F. Choke. This choke, specially designed for improving foreign reception, has a remarkably low self-capacity and consequently does not absorb low- and high-frequency currents.

Write for full details sent free on request.

**S. KALISKY (Aldgate), LTD.**  
75 Aldgate High St., E.C.3  
Phone: Royal 7457 & 7458

## "PAREX"

Products PAR-EX celligence

### "NEW LODESTONE 3"

Al. Screen 10" x 6", as specified, 2/-

### "THE FOURSOME"

Special Screen 8 1/4" x 3 1/4" - - 1/3

### "JAMES' S.G. PORTABLE THREE"

Special screening chassis, drilled and bent, with screens and foil, ready for use, 10/6

**DUAL COIL**; wound strictly to specification, 10/6

Special screen and foil for  
"INCEPTORDYNE," 5/6

Direct from

**E. PAROUSSI**  
10, Featherstone Buildings,  
LONDON,  
W.O.1.

Phone: Chancery 7010.

**ELEX**

**T.14 PLUGS AND SOCKETS**  
Socket 1d. Plugs 3d. 6 colours. Name plates, 40 kinds, 1d. Write for list P77.

J. J. Eastick & Sons  
Plug in parts 118 Bunhill Row, London, E.O.1

### DRY CELLS THAT SATISFY SPECIAL BATTERY OFFER

120 volt H.T. Batteries 12/- each  
100 volt H.T. Batteries 10/- each  
60 volt H.T. Batteries 6/6 each

The Best and Cheapest yet offered. Also send 1/2d. stamp for the "Leyton" Booklet to:-

**THE LEYTON BATTERY CO.,**  
305, CHURCH ROAD, LEYTON, E.10.



### TUBUS CONDENSER

Write for your copy of Test-Report & Illustrated Leaflet to  
FONTEYN & Co. Ltd.  
2 to 6, Blandford Mews,  
Baker Street - W.1.

## What Is the Pressure from a Pick-up?

By J. H. REYNER, B.Sc., A.M.I.E.E.

WHAT is the pressure applied by the point of a gramophone needle on the record itself? The needle tracks in its groove, and as the record rotates, the point of the needle beds down on to the bottom of the groove—or it should do at any rate—applying pressure on the circuit of the record itself.

The deviations in the track of the record cause the needle to move from side to side, so actuating the soundbox or pick-up so that the whole of the time the point of the needle must slide smoothly over the bottom of the track.

### Considerable Friction

There is clearly considerable friction at the point of contact, and according to the state of the track at the bottom of the groove so we shall get more or less scratch.

Some records possess more surface noise than others, the difference being due to two factors. Firstly, the recording itself has a great deal

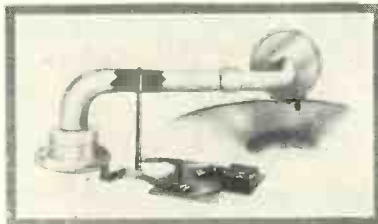

to do with it, for if the wax disc upon which the impression is first taken is not absolutely smooth, then the bottom of the track will not be smooth, and surface noise will be introduced.

The turning of the disc on which the impression is to be received is a matter of the greatest difficulty, and requires considerable skill and experience. The other reason is that in some cases it is desired to modulate the track less heavily in order to allow full play for transient phenomena, as for example, in a piano record, and this of necessity means that scratch or surface noise is relatively higher.

When one comes down to details however, I wonder how many people realise what the pressure on the point of the needle really is. Most people would say, I imagine, a few pounds, but a correspondent recently raised an interesting point when he suggested that the pressure was actually in the neighbourhood of several tons to the square inch.

Some measurements made to investigate the point confirmed that this is the case, and that the pressure on the point of the needle really reaches this extraordinary value.

### Diameter of the Point

One must know, of course, the approximate diameter of the point of a needle, and this is a matter which is not very easy to measure. As a result of microscopic examination of a number of needles, however, it appears that one could take a figure of three-thousandths of an inch as a fair value.

This, of course, is for a new

needle. A needle which has been played once wears flat on the end, so that the end-on view is oval instead of a circle, and from microscopic examination again it appears that the area of the point on a needle which has been used once is about twice that of a new needle of the corresponding type. This, of course, refers to a 12-in. record.

#### Average Weight

Now the weight of the average pick-up is of the order of four ounces. Some pick-ups are rather lighter than this, while others are heavier. We can take this as an average figure for the purposes of an estimate, so that the pressure on the point of the pick-up is obtained by dividing the said weight by the area of the point of the needle, on the assumption that the diameter of the point is three-thousandths of

an inch.

A simple calculation will show that if this is done the pressure comes to 15.8 tons per square inch

In these circumstances it is indeed not surprising that the needle point wears away to a certain extent. It is also easy to understand that if the needle is not capable of moving freely from side to side the wear on the record will be terrific.

Fortunately this point is being recognised and most of the pick-ups now made are capable of lateral movement to a considerable extent with relatively little applied force.

As long as the pressure is applied only to the bottom of the groove, and is not transferred to any serious extent to the walls, this normal pressure will not do any harm, but it is nevertheless a surprisingly high figure which few people would imagine exists.

## Soundbox Diameter

THIS note is in reference to the relation that should exist between the diameter of the diaphragm chamber of a soundbox and the length and the rapidity of flare of a horn to which it is attached. It applies equally to loud-speakers of the horn type and to gramophones.

#### Matching Up

You know there is a tuning relation electrically between capacity and inductance. When you get working with horns and soundboxes you find much the same sort of thing happening as you match your horn with a soundbox to get the best results.

Broadly speaking, the shorter the horn or/and the more rapid its flare, the larger should be the diameter of the soundbox in order to get the best results.

A few examples may save you a lot of trouble in experimenting. I have two gramophone or horn loud-speaker sound-boxes, one the largest size Amplion and the other the much smaller diameter Edison-Bell.

On a short rapid-flare horn 3 ft. long and opening out to 15 in. at the bell, the Amplion gives magnificent results with a gorgeous quality and volume in the deep bass. The Edison-Bell on this horn shows a thin wiry quality and defective bass.

On a 4 ft. 6 in. horn opening out

to 13 in. at the mouth there is little to choose between the two boxes except that the Amplion sounds backward and choked to a slight extent.

On the 4 ft. 7 in. Wonderphone horn opening out rapidly to 25½ in. the Amplion is splendid and the Edison-Bell not quite so good. On a horn 8 ft. 6 in. long opening out to 15 in. by 12 in. the Amplion is useless and the Edison-Bell quite the right thing.

Now for gramophones: On a Peridulci with its three-foot acoustic system opening out to 15 in. the best results are got with a 65-mm. soundbox. On the model 22 Chromogram Perophone I get the best results with a soundbox having a free diaphragm diameter of 1¾ in.

#### Large Cabinet Machines

On the Wonderphone having an acoustic system of about the same length, but more rapidly flared, I can use a 60-m.m. box with advantage. On large cabinet machines having eight or nine feet length in the acoustic system, considerably smaller diameter boxes are necessary.

It is very important that the soundbox should not be choked by a small diameter tone arm or its equivalent. Many tone arms are very faulty in this respect, 5/8 in. at the soundbox end is quite small enough.

H. T. B.

## Running-out Grooves

BY this phrase I refer to the groove in which the needle runs continuously after the playing of the record portion is finished.

Most gramophones are provided with automatic stops, but I do not know a single person who uses the device when playing records, even with a spring motor.

When an electric motor is used one soon learns to run it continuously and put the records on and off with the motor running.

#### Stopping by Hand

With a spring motor it is far easier to stop and start it as required than to bother with setting the automatic stop for each record.

H.M.V. machines are provided with an automatic stop that does not require setting when H.M.V. records only are used, but who uses one make of record only?

In order to suit this machine H.M.V. records have an eccentric running-out groove, which, of all devices of the kind, is the most objectionable, because when used on other than H.M.V. machines, and particularly when used with a powerful gramo-radio combination, the needle when running in it makes a most horrid grind-flop, grind-flop, grind-flop noise.

#### Less Noise

A less objectionable noise is made by the running-out grooves of Parlophone, Columbia, Decca, Brunswick, Broadcast, and the majority of the other makes of records in which there is a rapid run-in for a turn or two, after the music is finished, toward a circular running groove near the label.

But this groove needs watching, because there is always a certain roar from the loud-speakers when the needle takes the groove.

The only grooves one need not worry about are those that are purely a close continuation of the music groove, and such are found on Electron, Winner, Radio, and Beltona records.

They are substantially noiseless and one may please oneself whether the records be removed from the motor as soon as the music is finished or not.

Hurry on the day when all records shall be similarly made!

H. T. B.



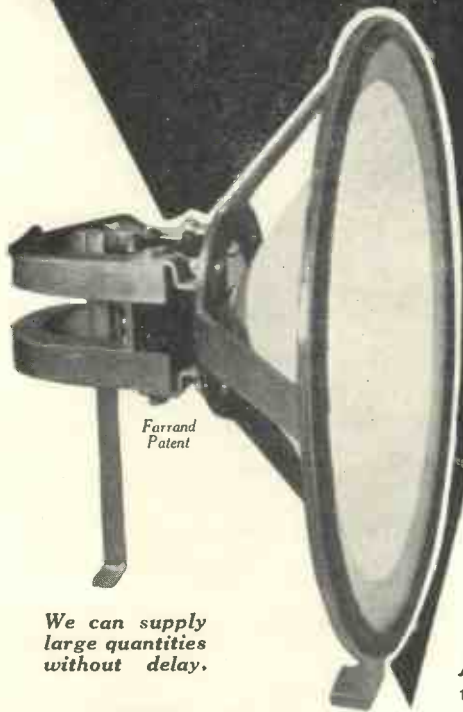

Farrand Patent

We can supply large quantities without delay.

## THE ORIGINAL N & K INDUCTOR DYNAMIC LOUD-SPEAKER

The N & K Original Inductor Loud-speaker not only equals the moving coil but improves on its sensitiveness, clarity and beauty of tone. Cheaper to buy, no power required, simple to operate, this speaker is by far the greatest advancement made in loud-speaker design. See what the "Wireless Magazine" says in the June issue.

The ORIGINAL N & K Speakers can only be obtained from us. Call for a demonstration or ask your dealer.

**£3 10 0**

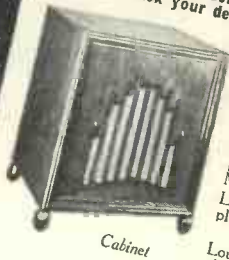

Cabinet

- Prices:**  
 Loud-speaker Unit complete with chassis, **£3:10:0**  
 Loud-speaker Unit complete in Artistic Cabinet, Oak, **£6 : 6 : 0**  
 Loud-speaker Unit complete in Artistic Cabinet, Mahogany, **£6 : 16 : 6**  
 Loud-speaker Unit complete on Baffle, Screen, Oak, **£6 : 10 : 0**  
 Loud-speaker Unit complete on Baffle, Screen, Mahogany, **£7 : 0 : 0**



Baffle Screen

Full details free on request from:  
**A. BRODERSEN,** Demonstrations & Showrooms now at  
 11 Northampton Sq., Goswell Rd., E.C.1. Phone: Clerk.723

# Let Your Friend Enjoy the "Wireless Magazine" Too!

The interest and pleasure which you derive from the "Wireless Magazine" will be greatly enhanced if you can discuss its monthly articles with a friend who is also familiar with its contents.

In order that anyone you know who is interested in wireless but is not yet a reader of the "Wireless Magazine" may become acquainted with it, a complimentary copy

will be sent to him gratis and post free, if you will kindly complete the attached coupon, or if you do not wish to mutilate your copy, send your request on a p.c. The "Wireless Magazine" leads the way in Radio.

**FILL IN THIS COUPON NOW** 

*"The Best Shillingsworth in Radio" Tells You Every Month All You Want to Know About Recent Progress in Radio Design—Look Out for Another Fine Sixty-feature issue on August 22!*

To the Publisher "Wireless Magazine," 58/61 Fetter Lane, E.C.4

Please send a specimen copy of the "Wireless Magazine," free and post free, to my friend:

My own name and address is:

Put this coupon in an unsealed envelope bearing 3d. stamp

# Our Tests of New Apparatus

\* Tested in the "Wireless Magazine" Laboratory \*

## Wates Double-cone Chassis

TWO diaphragms are utilised in the Wates double-cone assembly, marketed by the Shaftesbury Radio Co. at a price of 11s. 6d.

These two diaphragms, made of a material resembling heavy grease paper, measure 11 in. and 6 in. in diameter. The two cones rest freely at the periphery on rings of felt, stuck down to the wooden framework of the assembly.

The seams of the cones are carefully stuck together and radiate from the centre in spiral form.

Most of the standard cone units on the market can be fitted to the chassis. For our tests, a well-known unit, mounted on a narrow strip of wood, was fitted to the framework. Although a locking screw is provided, we did not find it necessary. The whole assembly was used in conjunction with a 2-ft. baffle.

The results as obtained from a standard three-valve set were quite pleasing, considerable volume being handled without any tendency to rattle. The chassis can be recommended to give good musical quality and clear speech.

## Franklin Condensers

IT seldom pays to economise in the purchase of large-capacity paper dielectric condensers; for the electrical

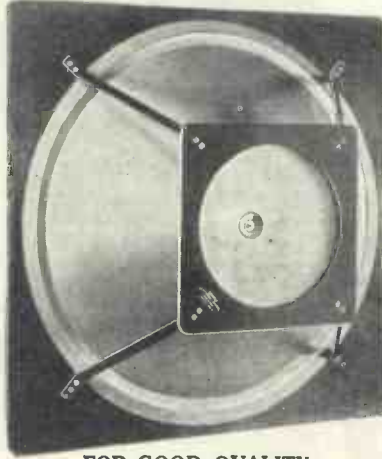

FOR GOOD QUALITY

The Wates double-cone chassis will appeal to those who require good musical reproduction at low cost

strain to which these parts are subjected in a mains unit may be considerably greater than the normal voltage.

It is, consequently, advisable to use condensers tested at voltages twice or even three times as high as the normal working voltage.

Unfortunately, both the price and physical dimensions of these components rise almost in proportion to their voltage test, and it is largely for this reason that a high-voltage mains unit is such an expensive item.

We have recently tested several Franklin paper condensers made by the Franklin Electric Co.

One of these condensers has a capacity of 2 microfarads and is rated at 700 volts. It is housed in a metal case measuring only 1 3/4 in. by 1 3/8 in. by 2 1/4 in. high, including terminals. Another sample condenser, having a capacity of 1 microfarad, is rated at 650 volts and is housed in a case measuring 1 3/4 in. by 1 in. by 2 3/8 in. high, including 3/8 in. soldering tags.

To test these claims, which, for the size of the component, are somewhat high, the condensers were connected in the most onerous position of a mains unit supplying an actual voltage of 550 D.C. To make the test still more severe, the mains were switched on and off at frequent intervals, but no signs of a breakdown were observed.

Unfortunately we cannot give a life test of these components; yet it seems likely that, from the manner in which they withstood the laboratory tests, that they are suitable for use in any normal circuit.

## Add to the Tonal Value of your Gramophone by fitting a LIMIT SOUNDBOX

You will notice wonderful results from your old machine.



Bayonet, H. M. V., Continental and Columbia Fittings

10/6

in Fancy Case. Any gramophone dealer can supply

Limit Engineering Co. Ltd. Albion Street, King's Cross, N.1

Buy AMATEUR WIRELESS 3<sup>d</sup> WEEKLY

**"VIBRANTI" BOARD**

(Patent No. 20900)

**The SUPER BAFFLE**  
For QUALITY REPRODUCTION

24 in. square, 1/2 in. thick.

Fret Panel and Ornamental Moulding are cut from the main board—positively avoids rattle and distortion due to loose joints.

The ONLY one-piece Baffle of attractive appearance obtainable.

Oak finish	9/6	Oxidised Silver	10/6
Mahogany finish	Each.	Oxidised Copper	Each.

Fittings for converting into an ideal screen are now obtainable supplied in Oxidised Silver or Copper at 5/3 per set.

From C. BORST & SONS,  
306-308 Euston Road, London, N.W.1

**EVERY SCREENED-GRID VALVE WANTS IT**

PRICE 6d.

Write to us for Belling-Lee Handbook "Radio Connections."

Just unscrew the ordinary metal terminal and plug on the Belling-Lee Safety Anode Connector. A neat spring makes quick, efficient contact, and the whole socket is completely insulated. Even if it flicks round and touches metal screens, wiring, etc., it can't "blow" the valves.

**BELLING-LEE**  
FOR EVERY RADIO CONNECTION

Advertisement of Belling & Lee, Ltd.,  
Queensway Wks., Ponders End, Mdx.

for N&K Farrand  
INDUCTOR  
LOUDSPEAKERS

consult E.M.C.

HANDMADE GRAMOPHONES  
11 GRAPE ST. LONDON WC2

FULL TRADE DISCOUNTS

**P.B.**  
RADIO CO.

EVERYTHING RADIO SUPPLIED WITHOUT DELAY on Easy Payments or C.O.D. Carriage Paid on all Orders. WRITE NOW.

35 OXFORD STREET, LONDON, W.1

Phone: Gerrard 3548. Telegrams: Equipregim, London.

Please mention "Wireless Magazine" when corresponding with advertisers

# BUYERS' GUIDE TO SETS

In this table we give details of all the new season's sets that have so far passed through the WIRELESS MAGAZINE Laboratory tests. All can be thoroughly recommended in their several classes.

For the convenience of set buyers the table has been arranged with receivers in order of price, so that it is

only a moment's work to find what sets within the prescribed price range have proved themselves satisfactory.

From month to month this list will be extended, so that readers may keep themselves informed of the sets that are satisfactory in performance under modern conditions.

Maker	Model	Type	Price	Power Supply	Valve Combination	Test Report
Pye Radio, Ltd.	Model 232	Table Cabinet	£4 17s.	Bat	D, P	February, 1930
Rothermel Corporation, Ltd.	Short-wave Converter	—	£5 17s. 6d.	Bat	D	November, 1929
London Electric Wire Co. and Smiths, Ltd.	Lewcos Chassis	Kit Set	£7	Bat	SG, D, P	December, 1929
Lissen, Ltd.	S.G.3	Kit Set	£7 7s.	Bat	SG, D, P	November, 1929
A. C. Cossor, Ltd.	1930 Melody Maker	Kit Set	£8 15s.	S.C. Bat	SG, D, P	January, 1930
Edison Swan Electric Co., Ltd.	Standard Bat. 3	Table Cabinet	£9 12s. 6d.	Bat	SG, D, P	January, 1930
Pye Radio, Ltd.	—	Portable	£19 19s.	S.C. Bat	2HF, D, LF, P	May, 1930
Kolster-Brandes, Ltd.	K.B.163	★Table Cabinet	£10 15s.	Bat	SG, D, Pen	May, 1930
Burdnapt Wireless (1928), Ltd.	Screened Ethophone	Table Cabinet	£11 8s.	Bat	SG, D, Pen	January, 1930
Ferranti, Ltd.	S.G.3	Kit Set	£12	Bat	SG, D, P	December, 1929
General Electric Co., Ltd.	Battery 3	Table Cabinet	£12	S.C. Bat.	SG, D, P	August, 1930
S. G. Brown, Ltd.	Type A	Kit Set	£12	Bat	SG, D, P	December, 1929
Philips Lamps, Ltd.	2502	Table Cabinet	£12 10s.	Bat	SG, D, Pen	February, 1930
E. K. Cole, Ltd.	Ekco P.2	★Table Cabinet	£12 17s. 6d.	A.C., D.C.	D, Pen	June, 1930
Igranic Electric Co., Ltd.	A.C.2	Table Cabinet	£13	A.C.	D, Pen	May, 1930
Marconiphone Co., Ltd.	Model 39	★Table Cabinet	£13	Bat	SG, D, P	January, 1930
Gambrell Radio, Ltd.	All-Electric 2	Table Cabinet	£13 15s.	D.C.	D, P	August, 1930
Garnett Whiteley & Co., Ltd.	S.G.P. Set	★Table Cabinet	£13 15s.	S.C. Bat	SG, D, Pen	February, 1930
Edison Bell, Ltd.	Maison Three	★Transportable	£14	S.C. Bat	SG, D, Pen	April, 1930
General Electric Co., Ltd.	Gecophone S.W.3	Short-waver	£15	Bat	SG, D, P	December, 1929
Kolster-Brandes, Ltd.	K.B.169	★Table Cabinet	£17 10s.	A.C.	SG, D, Pen	January, 1930
Varley (Oliver Pell Control, Ltd.)	A.P.1 and A.P.2	★Table Cabinet	£16 16s.	A.C., D.C.	D, P	January, 1930
Columbia Graphophone Co., Ltd.	Model C	Portable	£17 17s.	S.C. Bat	2HF, D, 2LF	July, 1930
Kolster-Brandes, Ltd.	K.B.103	Portable	£18 18s.	S.C. Bat	SG, D, LF, P	November, 1929
Marconiphone Co., Ltd.	Model 55	Portable	£18 18s.	S.C. Bat	2HF, D, LF, P	April, 1930
Dorian Wireless Co.	Super S.G.4	Portable	£19 19s.	S.C. Bat	SG, D, LF, P	June, 1930
E. K. Cole, Ltd.	Ekco-Letric	Table Cabinet	£21	D.C.	SG, D, Pen	December, 1929
Edison Swan Electric Co., Ltd.	D.C.3	★Table Cabinet	£21	D.C.	SG, D, P	June, 1930
Gambrell Radio, Ltd.	S.P.3D.C.	★Table Cabinet	£22	D.C.	SG, D, Pen	November, 1929
Marconiphone Co., Ltd.	Model 44	Table Cabinet	£22 10s.	A.C., D.C., Bat	2SG, D, P	November, 1929
Philips Lamps, Ltd.	2514	★Table Cabinet	£23	A.C.	SG, D, Pen	February, 1930
General Electric Co.	BC3030	Table Cabinet	£25	A.C.	SG, D, P	November, 1929
Graham Amplion, Ltd.	253	★Table Cabinet	£25	Bat	SG, D, 2LF	July, 1930
Varley (Oliver Pell Control, Ltd.)	A.P.3 and A.P.4	★Table Cabinet	£26 5s.	A.C., D.C.	SG, D, P	April, 1930
Ferranti, Ltd.	A.C.3	★Table Cabinet	£27	A.C.	SG, D, P	May, 1930
L. McMichael, Ltd.	Super-range Four	Transportable	£27 6s.	S.C. Bat.	SG, D, LF, P	March, 1930
Philips Lamps, Ltd.	Portable 4	Portable	£27 10s.	S.C. Bat.	SG, D, LF, Pen	August, 1930
Igranic Electric Co., Ltd.	Neutrosonic Short-waver	Table Cabinet	£28 7s. 6d.	Bat	SG, Super-het	March, 1930
Lissen, Ltd.	Radio Gramophone	★Console Cabinet	£30 to £49	A.C., D.C., Bat	SG, D, P	October, 1929
Radio Instruments, Ltd.	—	Transportable	£30	A.C.	SG, D, P	March, 1930
Edison Swan Electric Co., Ltd.	—	★Transportable	£31 10s.	A.C.	SG, D, LF, P	April, 1930
Columbia Graphophone Co., Ltd.	304	Table Cabinet	£33	A.C., D.C., Bat	3SG, D, P	March, 1930
Selectors, Ltd.	—	★Portable	£33 12s.	S.C. Bat	SG, D, LF, P	February, 1930
Marconiphone Co., Ltd.	Model 56	★Table Cabinet	£35	A.C.	3SG, D, P	June, 1930
Philips Lamps, Ltd.	Model 2511	★Table Cabinet	£37 10s.	A.C.	2SG, D, Pen	November, 1929
Gramophone Co., Ltd.	520	★Console	£75	A.C., D.C.	SG, D, 2LF	July, 1930

## EXPLANATIONS OF ABBREVIATIONS

A.C.= Alternating-current Mains ; Bat.= Batteries ; D=Detector ; D.C.= Direct-current Mains ; L.F.= Low-frequency Valve ; P=Power Valve ; Pen=Pentode ; S.C.= Self-contained ; SG= Screened-grid Valve ; and ★=set is provided with device for electrical reproduction of gramophone records.

# H & B

## KIT SERVICE

### NEW LODESTONE THREE

Complete kit of specified parts as used by the designer. Together with panel drilled, H. & B. screen, baseboard, screws and full-size blueprint. **CASH PRICE £8 7 0.**  
H. & B. screen for Lodestone Three, 2/- post free.

### FOURSOME PORTABLE

H. & B. special kit of components contains all specified parts, panel drilled and full-size blueprint. **CASH PRICE £4 3 6.**  
4 Mullard or Mazda valves as specified, £2 16 0 extra.  
Blue Spot 66K unit, 25/- extra.

**FOURSOME PORTABLE CABINET** beautifully finished, in oak, including all fittings, frame aerial frame, and turntable. **CASH PRICE £2/6 extra.**

Foursome cabinet as above with aerial wound and fitted with the celebrated Six-Sixty speaker unit and cone. **CASH PRICE £3.**

**ANY PARTS SOLD SEPARATELY.**

H. & B. can supply screens and cabinets for any set described in the radio journals. **Get our quotation first. Quality is guaranteed.** We construct any set with the parts purchased from us free of charge. Detailed lists of any kits sent upon request. *All orders sent post free.*

**H. & B. RADIO CO.**  
34, 36, 38 BEAK ST., REGENT ST., W.1  
Gerrard 2834.

## Notes and Jottings

READERS will learn with regret that Captain Round's third article on the problems of recording arrived too late for inclusion in this issue. Look out for it next month; he makes some interesting revelations.

Constructors of the Staminator, the A.C. mains unit described in the July issue of WIRELESS MAGAZINE, should note that the three 4-microfarad and three 2-microfarad should be of the 500-volt A.C. type. The price for the 4-microfarad condensers is 18s., and for the 2-microfarad condensers is 10s.

The WIRELESS MAGAZINE Technical Staff are particularly pleased with the results they are obtaining with a new two-valver. It is more than usually efficient for its type and will be fully described next month. The September issue of WIRELESS MAGAZINE, by the way, will be published on Friday, August 22.

Very great interest has been taken everywhere in the high-frequency choke tests carried out by J. H. Reyner and detailed in the June and July issues. By the way, it should be noted that the D.C. resistance of the Ashley choke should be 280 ohms, and not 800 ohms, as stated on page 467 of the June issue.

Owners of Celestion loud-speakers will be interested to know that the *Daily Mirror* (Mirror Grange) van which is touring the country is fitted with Celestion loud-speakers and amplifying gear. Look out for it on your holidays.

Interesting announcements concerning a new range of Telsen low-frequency transformers can be expected shortly. Constructors should keep their eyes open.

Details of revised prices of Ferranti push-pull transformers can be obtained from the makers. Two additions to the range are intended specially for auditorium work generally.

Mullards announce a new A.C. screened-grid valve, type S4VA. This has an impedance of 430,000 ohms and an amplification factor of 1,500. It should prove of interest to those with mains-operated receivers.

Those veterans of public-address work, the Marconiphone Co., Ltd., were again responsible for the installation used at the Hendon R.A.F. pageant. An entirely new type of amplifier was employed, and in all there were in use nearly sixty moving-coil loud-speakers with exponential horns.

*Radio Record* is the title of a film dealing with the care and maintenance of radio sets that can be borrowed by any radio or scientific society. Full details can be obtained from Ensign, Ltd., of 40 Shaftesbury Avenue, W.1.

At the trials of the new White Star liner, *Britannic*, a Marconi radio-telephone outfit was used to enable the engineers and technical experts at sea and on shore to keep in constant touch with each other.



**NEED NO ATTENTION**  
**MORE VOLUME**  
**GREATER SELECTIVITY**  
from **£3-15-0** (complete)

**CHEAPER THAN DRY BATTERIES**

for your **PORTABLE OR TRANSPORTABLE RADIO RECEIVER**

Write for particulars to—  
**TANNOY PRODUCTS**  
1-7 DALTON ST., S.E.27

## The James Portable S.G.3

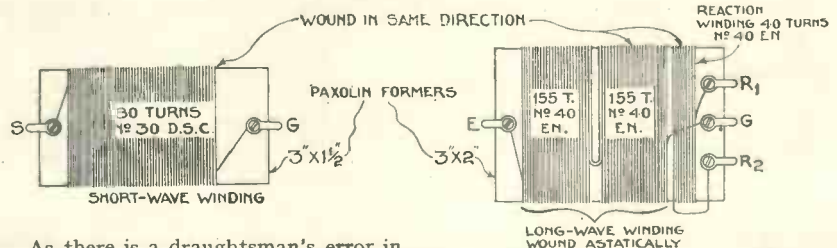

As there is a draughtsman's error in the diagram of the coil of the James Portable S.G.3 published on page 555 of the previous issue, we are giving here a corrected drawing.

Constructors should also note that the

switch needed is a Wearite two-pole rotary model, price 3/6.

In addition to the firms mentioned last month, this coil can be obtained from E. Paroussi.

# REGENTONE D.C. or A.C.

## "PORTABLE" COMBINED UNITS (H.T. with L.T. Charger)

**A.C. MODEL—The First**  
 This is the Model which has given such satisfaction in Portables of practically every make and every type.  
**MODEL W.5. Incorporates Westinghouse Metal Rectifiers on both H.T. and L.T. Sides.**  
**SIZE: 9" x 5" x 3½". OUTPUT: 120 Volts at 15 m/a.**  
**TAPPINGS: H.T. 2 continuously variable (1 S.G.) and 1 Power.**  
**L.T.: Trickle Charger for 2-, 4- or 6-volt Accumulators.**

Price **£5 : 17 : 6**

Model W.6. H.T. only **£4 : 5 : 0.**

Either of the above models is available for 25 cycles at an increase in cost of 10/-

**THEY FIT  
 INSIDE  
 ANY  
 PORTABLE**

*Equally suitable  
 for all popular  
 2-, 3-, and 4-valve  
 Receivers*

**D.C. MODEL—The Only**  
**SIZE: 9" x 5" x 3½". INPUT VOLTAGE: 200-250 volts.**  
**H.T. OUTPUT: 130 volts at 20 m/a.**  
**H.T. TAPPINGS: 2 continuously variable (1 S.G.) and 1 Power.**  
**L.T.: Trickle Charger for 2-, 4- or 6-volt accumulators, without any alteration whatever to existing wiring.**

Price **£4 : 5 : 0**

H.T. only **£2 : 15 : 0**

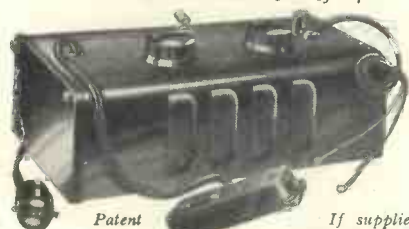

Patent Pending Design Registered.

If supplied with 'Xtra Point Lamp Holder and Plug 4/6 extra.



Patent Pending Design Registered.

Ask your dealer for demonstration or call at our London Showrooms. ILLUSTRATED LEAFLET GIVING FULL PARTICULARS ON APPLICATION. Leading Set Makers' opinions in our new Free Booklet—from your dealer or from us.

REGENT RADIO SUPPLY CO. 21, Bartlett's Bldgs, Holborn Circus, London, E.C.4 Telephone, Central 8745/7

## IN RADIO QUALITY COUNTS —

Parmeiko Apparatus is backed by an ideal—THE BEST, REGARDLESS. Skilled designers supervise the production of every part. Skilled workmen, supported by the latest machinery, turn the finest quality materials into apparatus fit for laboratory use. Each Transformer, Choke and Eliminator that leaves our works has passed the most exacting tests with honours, and bears our guarantee against defect.

*Buy* **PARMEKO**

Write for price list of Wireless Mains Apparatus

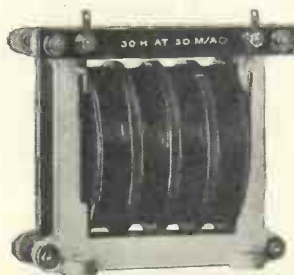

Use PARMEKO Components in your next set, and see the difference—there is a PARMEKO Transformer and Choke for every set featured in the technical press, and if that is not enough we will gladly make to your own specification.

## PARTRIDGE & MEE, LTD.

26 DOVER STREET, LEICESTER

74 NEW OXFORD STREET, LONDON, W.C.1

## "AMATEUR WIRELESS" HANDBOOKS 2/6 each net

Of all Newsagents and Booksellers, or 2/9 post free from Cassell and Company, Limited, La Belle Sauvage, London, E.C.4

### The Shielded Four-Electrode Valve

Theory and Practice  
 By Captain H. J. Round, M.C.  
 Captain Round is one of the greatest authorities in the world on radio science and practice, and his book is a complete guide to the principles under which this latest and most remarkable valve should be operated.

### Wireless-Controlled Mechanism

For Amateurs. By Raymond Phillips  
 This book is an illustrated guide to the making and using of short-range wireless control apparatus, and it has been written so simply that it can be understood by any enthusiast possessing an elementary knowledge of wireless.

### The Short-Wave Handbook

By Ernest H. Robinson (5YM)  
 Describes in very simple language the wireless apparatus used in short-wave work, shows how to make it and how to use it, and explains the technical principles with which the beginner will need to become acquainted.

When you send your order don't forget to say you "saw it in the 'W.M.'"

## Make Lotus Coils & Condensers your choice!

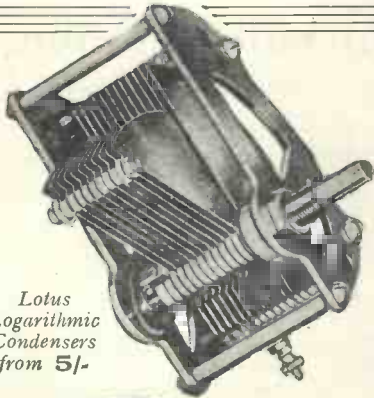

Lotus  
Logarithmic  
Condensers  
from 5/-

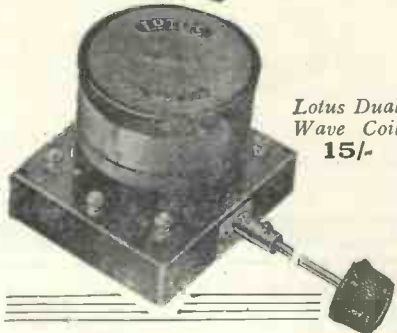

Lotus Dual  
Wave Coil  
15/-

Lotus Coils and Condensers are designed to last and to give maximum efficiency during their lifetime.

Illustrated here is the Lotus Logarithmic Condenser, which is available in all capacities. These Condensers are truly logarithmic, and have chemically cleaned brass vanes and end plate.

Lotus Dual Wave Coils, also shown, embody in one unit tuning and reaction coils and serve the same purpose as the four coils which were previously required.

Every Lotus Component is thoroughly tested before it leaves the factory.

Write for full range of Lotus Components and Catalogue.

# LOTUS COMPONENTS.

Garnett, Whiteley & Co. Ltd.

Lotus Works, Mill Lane, Liverpool.

Caution

# CURRENT COMMENTS

## PHYSICS AND WIRELESS

IN his presidential address to the Institute of Physics, Dr. Eccles, F.R.S., stressed the importance of the work done by the pure physicist (as distinct from the engineer) in the development of radio technique. As an instance he mentioned that the first application of the piezo-electric crystal as a high-frequency resonator was due to work carried out in 1917 by Langevin in France, and Rutherford in England, in connection with supersonic underwater signalling.

Subsequent experiments in the Finsbury Technical College carried out about the same time, but independently of similar researches by Nicholson, of New York, led to the production of the first piezo-controlled thermionic oscillator.

This "marriage" of mechanical and electrical oscillations ranks as a development of outstanding importance in modern radio practice. It is being more and more widely used to control and stabilise the carrier waves employed in broadcast transmission as a means of minimising overlap in an already overcrowded ether.

## LIGHTNING AND "SPARKS"

The spark obtained from an induction coil has generally been regarded as similar to a flash of lightning—though on a much smaller scale. Recent investigations, however, have shown that the identity breaks down under close examination.

The spark from a coil is found to consist of two discharges flowing in opposite directions and at different velocities. On the other hand, a flash of lightning always takes place in one definite direction, and is such that the discharge carries positive current only.

This accounts for a peculiar phenomenon first pointed out by the famous French astronomer Flammarion. He noticed that an animal killed by the spark from an induction coil decomposed more quickly than one killed by lightning. The reason is that in the former case there is a double destruction of the tissues, first by the positive and again by the negative discharge, whilst with lightning the tissues suffer but once.

## SELENIUM RECTIFIER

The development of the modern alkali-metal cell, which depends upon the Hallswachs or photo-electric effect, has to a large extent replaced the use of selenium for light-sensitive work. A new application has, however, been found for the "moon element" as a dry rectifier in place of the ordinary copper-copper-oxide combination.

A coating of selenium spread over nickel-plated discs forms an efficient rectifier for A.C. current, giving an output of 1 ampere at 4 volts, so that it can be used for filament heating or for recharging a battery. Heating of the element only serves to decrease the "reverse" current, so that there is no

tendency for the rectifying action to fall off with prolonged use.

## LARGE-SCALE TELEVISION

A little over two years ago J. L. Baird succeeded in reproducing images on a screen 4 ft. square. Recently the General Electric Co. televised a distant play on a screen rather more than double this surface area. Transmission was by line wire from the company's laboratory some miles away from the theatre, where the performance was witnessed by a large audience. Definition was clear and free from flicker—apart from an occasional tendency to "float," owing to slight imperfections in the synchronising mechanism.

From the technical point of view the transmission is noteworthy on account of the size of the received pictures. The field of view at present given by the standard Baird televisor measures about 2½ in. by 3 in., and is restricted to the head and shoulders of one or two performers, or at the most three. In the latter case the performers are so closely grouped together that only very limited movements are possible.

## CATHODE-RAY TELEVISION

In this connection it is interesting to note that the late Mr. Campbell Swinton, F.R.S., investigated the problems of television and pointed out the extraordinary difficulties which attended the development of any system depending on the use of mechanically moving parts, such as rotating discs.

As an alternative he proposed the use of cathode rays for analysing the picture into its component parts at the transmitting end, and also for reassembling the signal elements in correct order on a viewing screen in reception. A cathode ray has no appreciable mass or inertia, so that it can be manipulated to traverse a picture or viewing screen at enormous speed.

By one of those curious coincidences which often occur in the field of invention, a very similar suggestion was put forward about the same time by Professor Rosing, of Petrograd, working along independent lines. In both cases the main object in view was to overcome the inherent limitation in speed which attaches to any purely mechanical system.

In order to reproduce, say, a cricket match at Lords with any degree of clearness, Mr. Campbell Swinton calculated that the received picture should measure at least 10 in. by 16 in.; whilst, if individual players are to be recognised, upwards of four million signal elements would need to be transmitted in each second.

In his view nothing of this order could ever be attained by using mechanically moving parts, though it might be possible, if we could employ the vastly superior agency of electrons, which are the most mobile things at present known to science.

MORTON BARR.

**WATES  
DOUBLE CONE  
CHASSIS**



12" and 14" Model

★ The Chassis Supreme. The two wonderful cones giving tonal purity, volume and realism that makes the old fashioned single cone type obsolete. Scientifically constructed to give an absolutely true rendering of every note. They fit all popular units.

Warning! To ensure satisfaction insist upon the Wates Double Cone Chassis, Patent No. 309,214.

**Prices:**  
12 in. Chassis with supporting leg, £11/6  
14 in. Chassis with supporting leg, £12/6  
20 in. Chassis, supporting leg not fitted, £17/6  
20 in. Chassis complete with Wates Star Unit in Oak Cabinet, £4:10:0  
Mahogany, £4:15:0

Above are complete with universal bracket. Universal bracket and silk lined fret supplied separately.

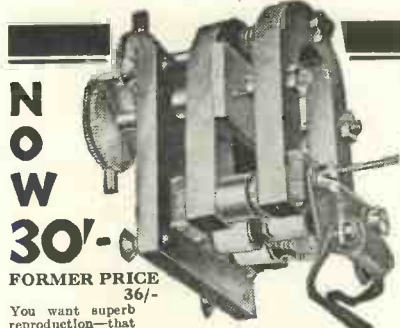

**N  
O  
W  
30/-**

FORMER PRICE 36/-

You want superb reproduction—that means the Wates Star Unit. And here is your chance to obtain this wonderful unit. Take advantage of this offer now and enjoy the superlative reproduction of this remarkably fine unit.

**WATES  
STAR  
LOUD SPEAKER UNIT**

OBTAINABLE FROM ALL DEALERS OR DIRECT.  
**THE STANDARD BATTERY CO., (Dept. W.M.)**  
184-188 BHAFTESBURY AVENUE, LONDON, W.C.2  
M.B.

To house your SET!

or  
**RADIO-GRAM**  
BUILT LIKE A PIANO

Note "Patent" Baffle Chamber

The outcome of seven years' experiments followed by exceptional demand—leading Experts—Famous Engineers—3,000 users.  
Direct from Craftsman's bench to your home. You may have **ON APPROVAL FREE TEST**, and return at our expense if you wish to part with it. Prices run from £5-5-0 (or £10 to £15-15-0 for Exclusive models) Cash or Easy Payments.  
Photographs and full particulars FREE.  
**FICKETT'S**, Radio Furniture Makers (M.G.)  
Albion Road, Bexleyheath, Kent.



**EBONITE  
PANELS**

ARE CONSISTENTLY  
RECOMMENDED FOR  
WIRELESS MAGAZINE  
CIRCUITS

When building your "New Lodestone Three" receiver, see that the ebonite panel carries the BECOL Trade Mark. It is the guarantee of the highest quality in ebonite.

Sole Makers:  
**THE BRITISH EBONITE CO., Ltd.**  
HANWELL, W.7

**THE DIX-ONEMETER**

It has Two Clear Scales with Mirror for Accurate Reading: only 6 Terminals, but 50 Ranges



Now 50/- only  
A remarkably low price for a meter worth £10.

For Novice or Expert.  
Test Booklet Free.

Cabinets for Portables  
We have a wonderful  
**SUITCASE  
PORTABLE CABINET**

Just what you want for the "Foursome" described in this issue.

LIST OF RADIO BARGAINS OF EVERY TYPE SENT ON APPLICATION.

**ELECTRADIX RADIOS**

218 Upper Thames St., London, E.C.4. Tel: City 0191

**ROTOR-OHMS**

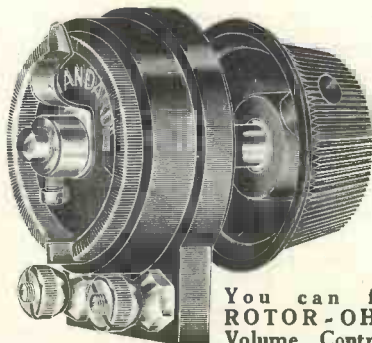

You can fit  
**ROTOR-OHM**  
Volume Controls

with the greatest confidence because they are standardised by the most important manufacturers in Great Britain, and specified by the designers in almost all circuits where ultra-smooth control of volume is desired.

TWO TERMINAL ROTOR-OHM 5/9  
Ohms 400, 1,500, 2,000, 5,000, 10,000, 20,000, 25,000, 50,000, 70,000, 100,000, 200,000, 250,000, 500,000, 1 megohm, 2 megohms, and 7 megohms.  
POTENTIOMETER TYPE 6/6

**ROTOR ELECTRIC LIMITED**  
2-3 Upper Rathbone Place, London, W.1  
Telephone: MUSEUM 2641-2642

**RAYMOND'S**

OUR ONLY ADDRESS  
**27 & 28a LISLE ST.**  
LEICESTER SQUARE :: LONDON, W.1

ESTABLISHED 7 YEARS

The Recognised Firm for  
**KITS OF PARTS**

The "FOURSOME"  
**SG PORTABLE**

Complete Kit, Valves, Batteries, and Cabinet included £11:15:0

Less Valves and Batteries £7:5:0

All Components as Specified.

**UNIVERSAL  
PUSH PULL  
AMPLIFIER**

Complete Kit of Parts as specified.

£3:10:0

Carriage Paid.

The **OUTSPAN  
SHORT WAVE  
UNIT**

Complete Kit of Parts as specified.

£2:10:0

Carriage Paid.

**THE NEW LODESTONE 3**

Complete Kit, Valves and Batteries included £11:2:6

Less Valves and Batteries £7:10:0

All Components as specified.

DO YOU WANT A PORTABLE?

We hold always in stock Ormond, Halcyon, Pye, McMichael, Philips, G.E.C., Amplion. Demonstration at any time. Many cheap models at less than Ten Pounds.

**EKGO UNITS**  
D.C., 29/6, 39/6; A.C., 39/6 upwards. Good stocks.

**REGENTONE**

D.C., 45/-, 78/-; A.C., 65/- upwards. Supplied on Easy Terms. Write for List.

**TRIOTRON**

H.F., Det., R.C., 4/11 each. Power, 6/9, 2 v. or 4 v. Post 4d. (3 post free). Loud - speaker Units, 8/11, post 6d. extra.

SPECIAL BARGAINS TO CALLERS. COME AND SEE US WHEN IN TOWN. WE SAVE YOU MONEY

**THE ORIGINAL FIRM  
27 & 28a LISLE ST.**

UNTER ENTIRELY NEW MANAGEMENT

Advertisement of K. Raymond, Ltd.

There is news in the "Wireless Magazine" advertisements

# Atencion! Achtung!

Country after country,  
**FRENCH, GERMAN,  
DUTCH,**

All at full Loud-speaker  
strength and of splendid  
quality with the

## LODESTONE THREE

### PRICE LIST OF ALL THE CORRECT PARTS

	£	s.	d.
1 Hand-polished oak cabinet with 10 in. baseboard	1	10	0
1 Ebonite panel 18 in. x 7 in. drilled	6	0	
2 Ready Radio .0005 variable condensers	9	0	
1 Ready Radio .0003 variable condenser	4	6	
3 Ormond slow motion dials R/320	10	6	
2 Wearite 1930 Binowave coils, 1 type A, 1 type D	1	14	0
1 Lewcos L.F. transformer 5-1	1	10	0
1 Bulgin L.F. choke 20 henry	12	6	
3 W.B. valve holders	3	9	
2 Dubiller 2 mfd. fixed condensers	7	0	
1 Trix .0002 fixed condenser	1	0	
1 Trix .0001 fixed condenser	1	0	
1 Igranic pre-set condenser .00027	2	6	
1 Bulgin neutralising condenser N.6	4	6	
1 Lissen 1 megohm grid leak and holder	1	6	
1 Wearite 15 ohm rheostat	1	6	
1 50,000 ohm Rotor-ohm	6	6	
1 Ready Radio standard screen	2	0	
1 Pair Ready Radio panel brackets	10		
1 Terminal strip 18 in. x 2 in.	1	8	
11 Belling-Lee terminals	2	9	
2 Belling-Lee wander plugs	6		
1 Set Ready Radio non-soldering connecting links	2	6	
3 Valves as specified	1	13	6
Screws, plugs, flex, etc.	1	6	
<b>TOTAL</b>	<b>£10</b>	<b>10</b>	<b>3</b>

ANY OF THE ABOVE COMPONENTS CAN BE SUPPLIED SEPARATELY IF DESIRED

**KIT A LESS VALVES AND CABINET £7.6.9**  
OR 12 EQUAL MONTHLY PAYMENTS OF 13/6

**KIT B WITH VALVES LESS CABINET £9.0.3**  
OR 12 EQUAL MONTHLY PAYMENTS OF 16/9

**KIT C WITH VALVES AND CABINET £10.10.3**  
OR 12 EQUAL MONTHLY PAYMENTS OF 19/6

#### READY RADIO IMMEDIATE DESPATCH SERVICE

To Inland Customers. Your goods are despatched post free or carriage paid. Cash with order. If desired you can avail yourself of the C.O.D. system on orders over 5/-.

To Overseas Customers. All your goods are very carefully packed for export and insured, all charges forward.

Write, Wire or 'Phone

1930 Illustrated Catalogue 1/-, post free

# Ready Radio

159, BOROUGH HIGH STREET  
LONDON BRIDGE, LONDON, S.E. 1  
Telephone: Hop 5555 (Private Exchange)

# Reference Sheets

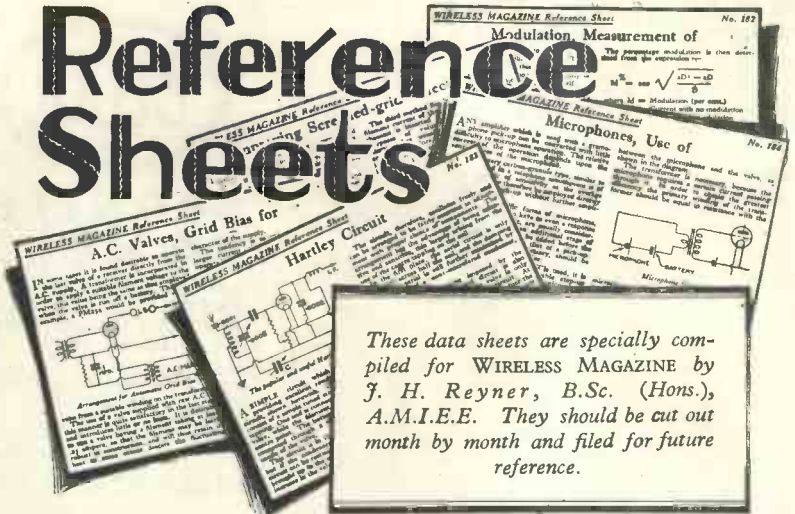

These data sheets are specially compiled for WIRELESS MAGAZINE by J. H. Reyner, B.Sc. (Hons.), A.M.I.E.E. They should be cut out month by month and filed for future reference.

### WIRELESS MAGAZINE Reference Sheet

No. 196

## Frame Aerials, Arrangements of

THE modern portable receiver is, of necessity, a dual-range instrument, and it becomes desirable, therefore, to use a frame capable of tuning over both wavelength bands. The use of a medium-wave frame only, with a loading coil for the long waves, is now considered poor practice. There are various ways in which the results may be achieved.

The medium-wave frame should consist of a single layer of reasonably thick wire, such as No. 22 gauge. Alternatively Litz wire may be used if desired. The long-wave frame should be wound on in sections in order to reduce self-

capacity, and a two- or three-section frame will serve the purpose admirably.

Where the frame is a simple tuning circuit, one can either short out the long-wave portion, or place the sections in parallel. In the latter case it is desirable to leave the medium-wave frame hanging on to the grid end, as this adds a small capacitative pick-up on the long waves.

In the same way the short-circuiting of the long-wave section should also be carried out on the grid end, as this often gives an improvement: This is not an infallible rule, however, and both possible connections should be tried.

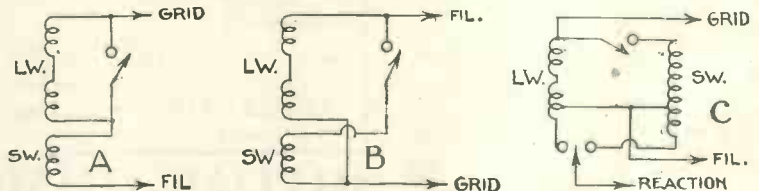

Typical frame-aerial switching arrangements

### WIRELESS MAGAZINE Reference Sheet

No. 197

## Power Output, Determination of

APPROXIMATE formulae have been given for the determination of power output with simple three-electrode valves. These formulae are limited in their application, being based on assumptions which are only approximately correct. The most satisfactory way of determining the power output from any valve is by a graphical method.

For this purpose it is necessary to plot the anode-current anode-voltage characteristic of the valve at various grid voltages. Such a characteristic is drawn out for a PM256A valve in Sheet No. 198. The working point on this characteristic is then chosen according to the anode voltage and anode current in use. In the case considered this was 200 volts, with 30 volts grid bias.

If the grid voltage is altered the anode current will change. The voltage on the anode of the valve is the H.T. voltage, plus or minus the voltage on the external circuit. Under actual operating conditions, this may either oppose the H.T. voltage, causing a reduction in anode voltage, or it may be added to the H.T. voltage, causing the total anode voltage to reach, perhaps, double the normal value. We can determine the manner in which the current varies by drawing a "load line."

This line is drawn at an angle such that the voltage where it cuts the voltage axis, divided by the current where it cuts the current axis, is equal to the impedance of the load in the external circuit of the valve. Then the point where this load cuts the various curves shows the anode voltage and current under operating conditions.

For distortionless working the distance PQ from P to the zero grid bias line (see Sheet No. 198) should equal the distance PR from P to the characteristic corresponding to twice the grid bias. If the resistance is made very large, so that the load line is relatively flat, this condition is easily complied with, but the power output is small.

In practice it is accepted that 5 per cent. of second harmonic distortion can be tolerated, and the condition for this is that the distance PQ shall be 11/9 of the distance PR. This usually occurs when the external impedance is two or three times the valve resistance.

Having chosen a suitable load line to fit the characteristic, the power output is then:

$$\text{Power} = \frac{E I}{8}$$

Where E= voltage corresponding to ZR (in Sheet No. 198)  
I= current ZQ



# Amateur Wireless

The Best  
Wireless  
Weekly

**B**ECAUSE you like the WIRELESS MAGAZINE for its expert detailed constructional articles and the many interesting phases of wireless which it so admirably presents, you cannot but like "AMATEUR WIRELESS."

The WIRELESS MAGAZINE, as you know, leads the monthlies: "AMATEUR WIRELESS" is foremost of the weeklies.

Every issue of "AMATEUR WIRELESS" contains remarkably useful constructional articles, helpful contributions on receiving and transmitting, novelties and new developments, and—finally and particularly—the best possible news service.

Take "Amateur Wireless"  
each week and get the  
best results from your set

**3**<sup>D.</sup>  
Every  
Thursday

## INDEX TO ADVERTISERS

B	PAGE
Belling & Lee, Ltd. . . . .	80
Borst, Charles, & Sons . . . . .	80
British Ebonite Co., Ltd. . . . .	85
Brodersen, A. . . . .	79
Bulgin, A. F., & Co. . . . .	6
Burton, C. F., & H. . . . .	7
<b>D</b>	
Day, Will, Ltd. . . . .	7
<b>E</b>	
E.M.G. Hand-Made Gramophones . . . . .	80
Eastick, J. J., & Sons . . . . .	77
Edison Swan Electric Co., Ltd. . . . .	Cover iv
Electradix Radios . . . . .	85
<b>F</b>	
Ferranti, Ltd. . . . .	71
Fluxite, Ltd. . . . .	11
Fonteyne & Co., Ltd. . . . .	77
Formo Co. . . . .	73
Franklin & Co. . . . .	75
<b>G</b>	
Gambrell Bros., Ltd. . . . .	9
Garnett Whiteley & Co., Ltd. . . . .	84
<b>H</b>	
H. & B. Radio Co. . . . .	82
Hegra . . . . .	7
Holzman, Louis . . . . .	6
Hughes, F. A., & Co., Ltd. . . . .	73
<b>I</b>	
Igranic Electric Co., Ltd. . . . .	13
Impex Electrical, Ltd. . . . .	11
<b>J</b>	
Jackson Bros. . . . .	75
Junit Manufacturing Co., Ltd. . . . .	7
<b>K</b>	
Kalisky, S. (Aldgate), Ltd. . . . .	77
<b>L</b>	
Lamplugh, S. A., Ltd. . . . .	69
Lectro Linx, Ltd. . . . .	9
Lever, Eric J. (Trix), Ltd. . . . .	75
Leyton Battery Co. . . . .	77
Limit Engineering Co., Ltd. . . . .	80
Lissen, Ltd. . . . .	14
London Electric Wire Co. & Smiths, Ltd. . . . .	Cover ii
<b>M</b>	
Marconiphone Co., Ltd. . . . .	5
<b>P</b>	
Paroussi, E. . . . .	77
Partridge & Mee, Ltd. . . . .	83
P.B. Radio-Co. . . . .	80
Pickett Bros. . . . .	85
<b>R</b>	
Radio & Gramophones . . . . .	6
Raymond, K. . . . .	85
Ready Radio . . . . .	86
Regentone . . . . .	83
Rothermell Corp., Ltd. . . . .	13
Rotor Electric, Ltd. . . . .	85
<b>S</b>	
Scott Sessions, G., & Co. . . . .	73
Simmonds, Bros. . . . .	73
Six-Sixty Valve Co., Ltd. . . . .	73
Six-Sixty Wet Battery Co. . . . .	85
Stewart, J. . . . .	77
Stratton & Co., Ltd. . . . .	73
<b>T</b>	
Telegraph Condenser Co. . . . .	3, 13
Tulsemere Manufacturing Co. . . . .	82
<b>V</b>	
Vandervell, C. A., & Co. . . . .	9
Varley . . . . .	5
<b>W</b>	
Watmel Wireless Co., Ltd. . . . .	3
Westinghouse Brake & Saxby Signal Co., Ltd. . . . .	11
Whiteley, Boneham & Co. . . . .	9
Wright & Weaire, Ltd. . . . .	71

## Power Output, Determination of

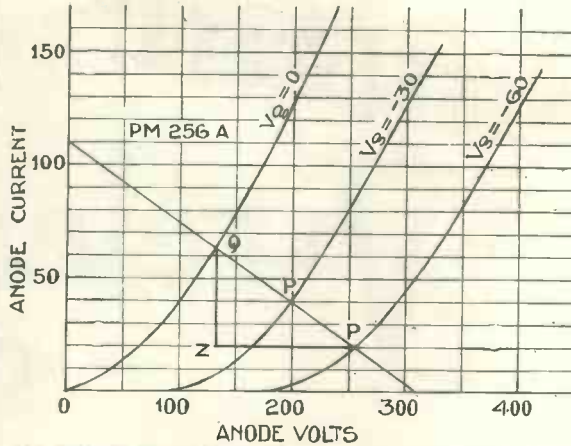

THE curve shown herewith gives the anode-voltage anode-current characteristic of a PM256A valve. The "load line" QPR is so drawn through the operating point P that QP is 11/9 times P.R. This is the condition for 5 per cent. of second harmonic distortion. In the figure this corresponds to a resistance of 2,800 ohms.

The power output, as determined from the formula given in Sheet No. 197, is then 700 milliwatts. Actually this valve is capable of taking a slightly greater grid swing.

Taking a "load line" for a power valve

## A.C. Valves, Grid Current in

IT is not always appreciated that the modern A.C. valve using an indirectly-heated cathode has one property essentially different from the customary battery valves, namely, that grid current starts to flow at a small negative voltage.

The grid-current characteristic of a typical A.C. valve is appended and it will be seen that at zero volts the grid current is quite appreciable.

With the customary battery-driven valve this current only begins to flow at about zero volts, or sometimes at a small positive voltage, so that in a high-frequency circuit it is possible to connect the return direct to the L.T.—with little loss of efficiency.

With an indirectly-heated valve, on the other hand, it is essential to use grid bias on the H.F. valve, and at least 1½ volts should be employed, so that with a grid swing of a reasonable value there is no danger of running into grid current. If the receiver is to be used close to a powerful station, then more grid bias than this must be employed, but it is usually found that the signal strength begins to fall off if more than about 3 volts grid bias is employed.

The practice of connecting a gramophone pick-up directly across the grid and filament of the detector valve, which is sometimes adopted with battery valves, is quite inadmissible with an A.C. valve, for although tolerable quality may result with a battery valve the distortion with an A.C. valve would be very marked.

Typical grid-current characteristic of A.C. mains valve

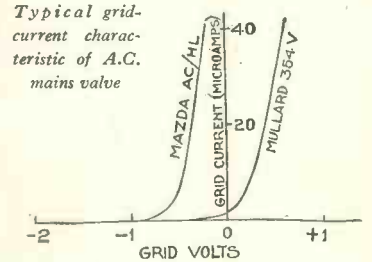

## Index to Sheets Nos. 152 to 200

A.C. Valves, Grid Bias for . . . . .	181	Ohmmeters . . . . .	172
Grid Current in . . . . .	199	Pentode Rectifiers . . . . .	150
Aerials, Best Shape of . . . . .	170	Power Output . . . . .	156
Frame . . . . .	196	Meaning of . . . . .	165
Battery Discharge Curves . . . . .	158	Determination of . . . . .	197, 198
By-pass Circuits . . . . .	176	in Halls . . . . .	169
Capacity Coupling, Variable . . . . .	173	Power Transformers, Load Taken by . . . . .	152
Conductors, H.F. . . . .	163	Increasing Voltage on . . . . .	189
Cranked Tone Arm . . . . .	190	Push-pull v. Parallel . . . . .	160
Converters, D.C. to A.C. . . . .	167	Rectifiers, Pentode . . . . .	159
Detector Input, Permissible . . . . .	161, 162	Resistance, Measurement of . . . . .	172
Direct Coupling . . . . .	187	Negative . . . . .	192
Dynatron, S.G. Valve as . . . . .	186, 192	Resonance, L.F. . . . .	174
Filters, L.F. . . . .	180	Rotary Converters . . . . .	167
Frame Aerials, Arrangements of . . . . .	196	Smoothing of . . . . .	168
Gramophone Speed, Importance of . . . . .	179	S.G. Valve, as Dynatron . . . . .	186
Hartley Circuit . . . . .	183	Negative Resistance of . . . . .	192, 193, 194
H.F. Conductors . . . . .	163	Improving Selectivity of . . . . .	185
Leakage, Prevention of . . . . .	157	Stability with . . . . .	175
Transformers, Design of . . . . .	164	Selectivity, Improvement of . . . . .	185
Ignition Systems, Interference from . . . . .	188	Stability in H.F. Circuits . . . . .	175
Inductance of L.F. Transformers . . . . .	191	T.U. Conversion Tables . . . . .	153, 154
L.F. Filters . . . . .	180	Transformers, H.F., Design of . . . . .	164
Resonance . . . . .	177	L.F., Inductance of . . . . .	191
Transformers, Inductance of . . . . .	191	Power, Increasing Voltage on . . . . .	189
Microphones, Use of . . . . .	184	Load Taken by . . . . .	152
Milliammeters, Condensing of . . . . .	178	Valve Voltmeter . . . . .	166
Modulation . . . . .	155	Volume Control . . . . .	195
Measurement of . . . . .	182	Grading of . . . . .	171
Negative Resistance of S.G. Valve . . . . .	192		



# The first . . . INDIRECTLY HEATED PENTODE

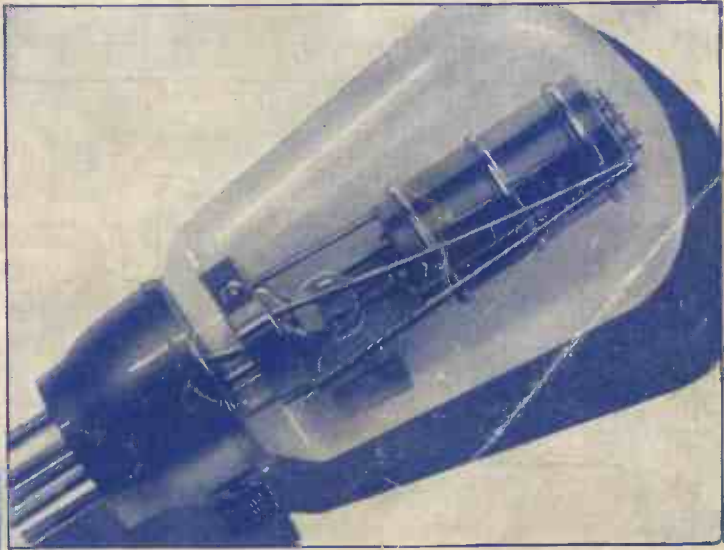

**EDISWAN  
LEADS  
AGAIN  
WITH THE  
MAZDA  
AC/PEN**

**T**HIS new power output valve marks an important step in the history of Radio. The indirectly heated Cathode absolutely prevents hum, and the AC/Pen is the most sensitive pentode in existence.

With a grid swing of only ten volts it will give wonderful results when used with a good cone speaker, and is ideal for operating a moving coil speaker such as the R.K.

**PRICE 30/-**

*The Amazing*

# MAZDA RADIO VALVES

### CHARACTERISTICS

Filament volts	...	...	...	4.0
Filament amps (approx.)	...	...	...	1.0
Anode volts (max.)	...	...	...	250
Auxiliary Grid Volts (max.)	...	...	...	200
Mutual A.C. conductance (mA/V)	...	...	...	2.2



THE EDISON SWAN ELECTRIC CO., LTD.  
Radio Division,  
1a Newman Street, Oxford Street, W.1  
Showrooms in all the Principal Towns