

CAPTAIN ROUND ABOLISHES THE HOWLER!

Wireless Magazine

EDITOR: BERNARD E. JONES

TECHNICAL EDITOR: J.H. REYNER, B.Sc. (Hons.) A.M.I.E.E.

VOL. 6, No. 34.

NOVEMBER, 1927

1½

*A Half-price Blueprint
for every Reader*



*The Five-guinea
Three*

“SHORT-WAVE” AND “MAINS” SETS IN THIS ISSUE

RADIO REVOLUTIONISED

- not a booklet
- not a Blue print

But
a wonderful
new system of
set building

HERE is news of the utmost importance to everyone who wants to enjoy the new B.B.C. Alternative programmes. The makers of Cossor Valves have evolved a revolutionary system of Set-building. Absolutely no skill is required—yet perfect results are guaranteed. Even if you don't know the first thing about Radio you can build the wonderful Cossor "Melody Maker" (the first Set to utilise these new principles). Soldering is abolished—technicalities have been eliminated—success is certain. It costs you nothing to get full details of this new system—post the coupon to-day.



Free

Post the coupon to-day
for your copy of
How to build the

Cossor "Melody Maker"

To A.C. Cossor, Ltd., Highbury Grove, London, N.5

Please send me free of charge one copy of
"How to build the Cossor 'Melody Maker'"

Name.....

Address.....

WM

LISSEN TRANSFORMER



BESIDES being the most efficient transformer on the market, the new LISSEN can be used with equal success as an L.F. Choke. You merely connect the O.P. and I.S. terminals together.

Acclaimed by tens of thousands as the finest amplifying transformer and preferred by LISSEN themselves (all the previously high-priced LISSEN transformers were withdrawn in its favour), it has only been possible to sell the new LISSEN for 8/6 because—

FIRSTLY: The immense facilities of LISSEN have been concentrated on the production of this one type.

LISSEN LIMITED, 500-520, FRIARS LANE, RICHMOND, SURREY.

SECONDLY: This transformer, like all LISSEN products, is sold direct to the retailer, and so wholesalers' profits are cut out.

WE MAKE THIS OFFER. If within 7 days of purchase you can find any transformer or choke—at any price—which you prefer to LISSEN, you can return the latter and your money will be refunded.

Turns ratio 3 : 1. Resistance Ratio 4 : 1.

Amplifies fully every note, every tone, every overtone, every harmonic. Guaranteed for 12 months.

You can use 3 in cascade.

*Managing Director:
THOMAS N. COLF.*

L. 284

2 Special Numbers of

Amateur Wireless

The issue now on sale dated
October 22 contains a

FREE 32 - page Booklet
“20 Best Valve Sets & How to Make Them”

Profusely illustrated with photographs and diagrams

The issue on sale on October 27
dated October 29 will contain a

FREE Full-size Blueprint of
“Robert’s All-wave Four”

Suitable for American Short-wave Reception,
B.B.C., Daventry Stations, and Continental
Stations. Essentially designed to permit the use
of existing apparatus, i.e., standard components.

**Don't miss these splendid
Gift issues. Usual price, 3d.**

KEYSTONE COMPONENTS

—used by all discriminating constructors

Keystone "Midget" Condenser

Ideal for the many positions where a small capacity condenser is required. An aluminium shield prevents hand-capacity effects, and a special taper bearing gives a beautifully smooth movement. Accurately designed and rigidly constructed. Capacity 0.001 mfd. Price 5/6

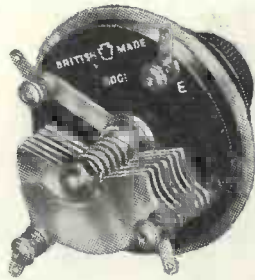

Keystone Neutralising Condenser

Used in all the popular circuits this season. These condensers have been designed by experts, and they are suitable for neutralising the electrode capacities for all types of valves. Very low minimum capacity. The wide spacing of the vanes renders accidental "shorting" impossible. Very well made from best quality material and beautifully finished. Board mounting 5/- Panel mounting 6/3



Keystone Universal Logarithmic Condenser

The new Universal Logarithmic Condenser is the last word in condenser design. It is mechanically perfect, and its selectivity is extraordinary. It has a patented vernier capacity adjustment. Two or three can easily be ganged together to form a double or triple gang.

Prices: .0005 Single 13/6 Twin Gang 27/6 Triple Gang 42/-
 .0003 " 12/6 " " 25/6 " " 38/6

Send for Illustrated Catalogue "W.M." describing these and many other components.

PETO-SCOTT Co. Ltd., 77, City Rd. London, E.C.1. Branches: 62, High Holborn, London, W.C.1. 4, Manchester Street Liverpool. 29, Old Town Street, Plymouth.



Your HOME Radiola!
 taking your Set and Batteries Complete.
 In many Artistic Models Beautifully Finished.
 SENT ON APPROVAL.
 Lists Free.

From **£5 5 0** Picketts Cabinet (M.G.) Works. Bexleyheath.
 Cash or Easy Payments.

WE DO NOT TALK ABOUT SUCCESS—WE GUARANTEE IT.

Guarantee.

I hereby guarantee that I will provide each Student of The Bennett College with tuition until he has passed the examination for which he has enrolled.
 I further guarantee to provide all the necessary books free of charge and undertake that no further fees will be required other than those stated on the form of enrolment.

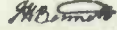

F.R.S.A., M.I.Mar.E., A.I.Struct.E., M.B.I.P.S., etc.
 (Governor), THE BENNETT COLLEGE, SHEFFIELD.

We Give a Written Copy of this Guarantee to every Student.

Having helped thousands of others to achieve success and advancement, it may be possible that we can help YOU.

I am assisted by a large and expert staff, and the advice we give is sound. If we cannot help you we will say so; if we can we will tell you how.

We have FREE booklets setting out the possibilities in connection with each of the subjects shown in the lists; send for the one in which you are interested, or ask for MY PRIVATE ADVICE, which also is free. You incur no obligation.



Most Moderate Charges. Payable Monthly.	EXPERT TUTORS FOR EVERY DEPARTMENT.	Have You ANY Ambition?
--	-------------------------------------	------------------------

WE TEACH ALL THE FOLLOWING SUBJECTS:

COMMERCIAL	COMMERCIAL—Con.	TECHNICAL—Con.
Accountancy	Secretaryship	Marine Eng. B.O.T.
Advert. Writing	Workshop Organisation	Mathematics
Salesmanship	TECHNICAL	Matriculation
Army Certificate Courses	Applied Mechanics	Metallurgy
Auctioneering and Estate Agency	Architectural Drawing	Mining
Auditing	Building Construction	Mine Surveying
Banking	Clerk of Work's Duties	Motor Engineering
Book-keeping	Boller Engineering	Naval Architecture
Civil Service	Boller Making	Pattern Making
College of Preceptors	Chemistry	Post Office
Commercial Arithmetic	Civil Engineering	Examinations
Company Law	Concrete and Steel	Quantity Surveying
Costing	Draughtsmanship	Road Making and Maintenance
Economics	Electrical Engineering	Sanitation
English and French	Practical Mechanical Engineering	Shipbuilding
Executorship Law	Engineering Costing.	Structural Engineering
Foreign Exchange	Quantities and Specifications	Surveying and Levelling
General Education	Foundry Work	Surveyors of Works, R.E.
Modern Business Methods	Heat Engines	Telegraphy and Telephony
Police Entrance and Promotion Courses	Internal Combustion Engines	Town Planning
		Wireless Telegraphy
		Works' Managers' Course

WE SPECIALISE IN PREPARATION FOR ALL EXAMINATIONS.

We Teach By Post In All Parts of The World

Note Address: The Bennett College, Dept. 173, Sheffield.

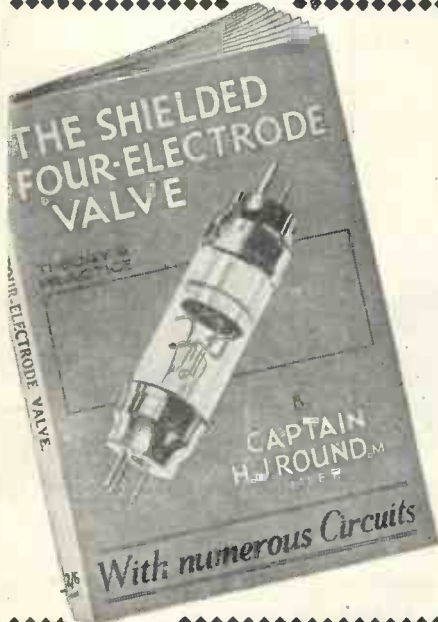

The ONLY authoritative book on the New Valve

The Shielded Four-electrode Valve

By CAPT. H. J. ROUND, M.I.E.E.

NOW on Sale at all Booksellers, etc.

Get a Copy To-day **2/6**

NEW LISSEN LINES

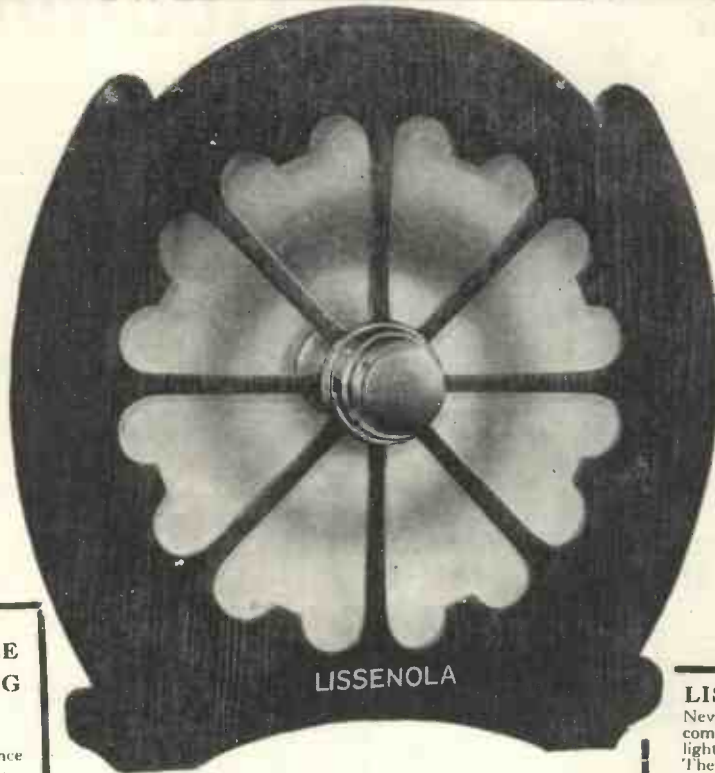

LISSENOLA

LISSEN REVOLUTIONISING CONE

A combination of horn and cone in the same loud-speaker

29/6

Fills in the missing note.

LISSEN RESISTANCE CAPACITY COUPLING UNIT

Provides a complete Resistance Capacity Coupling Unit. Includes two LISSEN Fixed Resistances and one LISSEN Mica Condenser. Values incorporated have been selected as the most suitable for general use, but the resistances are easily interchangeable. May be mounted upright or flat **4/-**



LISSEN COILHOLDER

Fine degree of control to permit of extremely selective tuning. Gear ratio selected as the best for all practical purposes. Big knob for comfortable finger grip and wide range of movement with one turn. No slip or backlash, coils will not move as the result of their own weight. No flexible connections to break. Moving block on the right-hand side, but may easily be changed over to left-hand side by following the simple instructions enclosed with each coilholder.

Model A, with 2-in spindle **4/6**

Model B, with 5-in spindle **5/6**

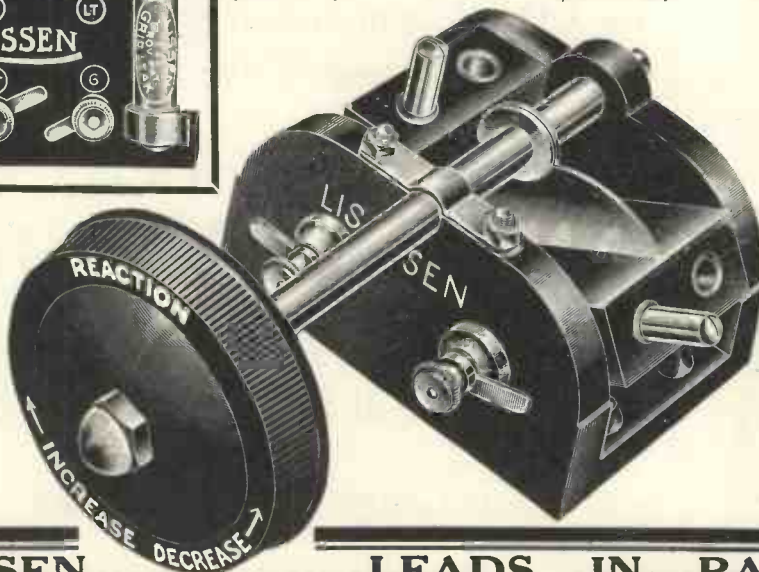

LISSEN HEADPHONES

Never before was it thought possible commercially to make headphones so light and, at the same time, so sensitive. These headphones are so light they may be worn throughout an evening without the wearer realising they are on the head. Cords will not twist or tangle, but will always hang straight down, no matter how the head may be turned, moved, or twisted. The two earpieces are extremely sensitive and both are exactly matched in impedance. They settle at once into comfortable positions, and may be secured there by the single movement of a special **8/6** ball joint.



LISSEN LIMITED
Friars Lane, RICHMOND,
SURREY

Managing Director: Thos. N. Cole

LISSEN

LEADS IN RADIO PARTS

A Glance Through This Issue

THIS is the first opportunity of an editorial word with my readers since I met so many of them at the National Radio Exhibition at Olympia. It was a great show and the enthusiasm of the constructors who visited our stand and commented on ourselves, our sets, and our blueprints was wonderful.

Our staff thoroughly enjoyed themselves in meeting so many hundreds—actually thousands—of readers and friends and in exchanging notes at first-hand with so many who had built and used WIRELESS MAGAZINE sets.

THOROUGHLY ENJOYABLE TIME

Yes, it was a thoroughly enjoyable time, but, even so, we are all grateful that there is only one wireless exhibition each year in London!

We found that a very keen interest was taken in the sets on view on our stand, notably the Exhibition Five, which now takes its place among the classics and of which we are giving further particulars this month, and the Johnston "mains" sets, which are this month the subjects of two articles, "Using the House Mains with Safety," and "The Mains-fed Two."

In this issue are two sets absolutely different from one another in their appeal, but each meeting certain expressed needs. One of them, which we have christened the Five-guinea Three, is an attempt to take components which you may have in an existing set and put them in their place in an up-to-date circuit, the idea being that many a reader is growing tired of a set that has been giving him service for a couple of years or so and would like to use its parts, with perhaps a few new ones, in building a receiver on more modern lines.

OTHER SPECIAL SETS

Our other special set is the Dominions Short-wave Three, designed by our Constructional Staff in preparation for Empire short-wave broadcasts, which, in spite of certain disappointments, must come soon.

Capt. Round, as keen as ever on the double-grid valve, is offering a new solution of the howler problem, and J. Godchaux Abrahams is courageously telling us what we can learn from German broadcasting.

We are fond of saying that we have the finest broadcast service in the world, and I heard an American visitor at the exhibition dinner given by the Radio Manufacturers' Association comment on that claim.

"Of course, you say that," he said, with a slight drawl, "there's nobody here to contradict you." By the time he had finished his speech we were not quite so certain of our superiority. Good as we are, we still have much to learn and shall always have. The Americans and the Germans are extraordinarily fertile people, and the British Broadcasting Corporation will have to think and work very hard in maintaining their service at high standard.

CONGRATULATIONS

Finally, may I heartily thank all those readers who have sent congratulations on the marked success of the WIRELESS MAGAZINE. Whether a reader's letter is complimentary or otherwise, as long as it is honest and appreciative, we are delighted to have it. Some of the kindest letters I get come from readers in the Dominions, where WIRELESS MAGAZINE sets are becoming more and more popular.

By the way, the half-price blueprint scheme has proved a remarkable success and at the moment I will only remind you that you can get a blueprint of ANY of this month's sets in return for the special coupon* and half the ordinary price.

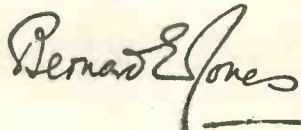

*This coupon is on page 111 of the cover.

Vol. VI
No. 34

Wireless Magazine

NOV.
1927

CONTENTS

Happy Holidays with the Countryside Four! .. 279	Which Would You Choose? .. 296
How I Would Abolish the Howler! By Capt. H. J. Round .. 280	A New Flexible Wire .. 296
Outside Broadcasts .. 288	Short-wave Topics .. 297
Under My Aerial .. 289	Sir Henry Wood: An Impression .. 297
	The Chaos in the United States .. 299

Dominions Short-wave Three - 283

Anode Resistances .. 299	Miss Ruby Helder: An Impression .. 305
High-frequency Chokes .. 299	Aerial Developments .. 305
What Can We Learn from German Broadcasting? .. 300	The Spartans of Sparrowtowne .. 306
Langenberg: A Page of Photographs .. 301	The Sixth Year of Broadcasting .. 308
The Gresham Singers: An Impression .. 303	No Stage "Ban" in America .. 309
Using the House Mains with Safety .. 304	

Five-guinea Three - - - 292

Ionic Emitters .. 310	Sandy and Television .. 323
Half Hours with the Professor.—9. A Chat About Eliminators .. 311	The American Lorry Driver .. 323
Debroy Somers' Dance Band .. 313	What Schoolgirls Think of Wireless .. 324
How S.B. is carried out .. 314	The World's Largest Transmitting Valve .. 325
Assisting Navigation .. 321	The Gullible Novice and the Interfering Stranger .. 325
What Readers Think of Our Sets .. 322	

Range Extender - - - 317

New L.F. Circuits. By J. H. Reyner, B.Sc. (Hons), A.M.I.E.E. .. 326	Broadcast Music of the Month .. 335
The Big Valve .. 331	Empire Broadcasting .. 337
Automatic Calling Devices for Ships .. 332	The Exhibition Five Takes Its Place Amongst the "Classics!" .. 338
Your Radio Notebook! .. 332	The New Mains Valves .. 340
Are We Expecting Too Much of Television? .. 333	Radiation or Induction? .. 341
	The Marcuse Transmissions .. 341

Mains-fed Two - - - 328

Autumn Developments .. 342	Radio Beacons to Aid Ships! .. 354
More About the Auto-selector Four .. 344	Catalogues and Pamphlets .. 355
Questions Simply Answered .. 350	Novelties and New Apparatus .. 358
New Valve Markings .. 352	The World's Broadcasting .. 359
A Marconi Royalty Concession .. 352	Continental Notes .. 362
"Control" and "Balance" in Broadcasting .. 354	Fixed Condensers .. 363
	"Wireless Magazine" Service .. 364
	Reference Sheets .. 366

Published by BERNARD JONES PUBLICATIONS, LTD., publishers of "Wireless Magazine" and "Amateur Wireless." Editor: Bernard E. Jones. Technical Editor: J. H. Reyner, B.Sc. (Hons.), A.M.I.E.E. Editorial and Advertisement Offices: 58-61, Fetter Lane, London, E.C.4. Telephone: City 3733, 3734. Telegrams: "Beejapee, Fleet, London." Published about the 25th day of the month and bears the date of the month following. Subscription: Great Britain and Abroad, 15s. 6d. a year, post free (Canada only, 13s. 6d.). Contributions are invited and will be promptly considered.

THE GUARANTEE OF THE PERFECT TERMINAL

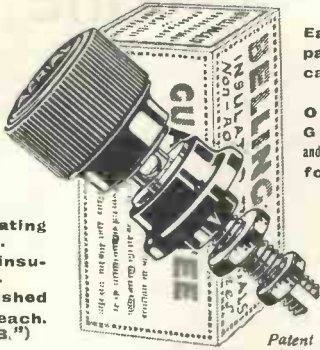

Each terminal packed in a carton with a printed **ONE YEAR'S GUARANTEE** and instructions for mounting.

Non-rotating name.
Bakelite insulated.
Highly finished
Price 9d. each.
(Type "B.")

THE BEST DESIGNED TERMINAL IN THE WORLD.

Other types available

- Type M. Nickel-plated Metal with non-rotating name 6d.
- Type R. Small with insulated head and rotating name 3½d.

ALL TYPES SUPPLIED IN 30 DIFFERENT LETTERINGS

**BELLING-LEE
TERMINALS**

Obtainable from all Dealers, or in case of difficulty send your order to us, enclosing your Dealer's name and address.
**BELLING & LEE, Ltd., Queensway Works,
PONDERS END, MIDDLESEX.**



**THE ORIGINAL
Prize Winning
LOW LOSS
FORMER**

Look for Trade Mark

THE BECOL ORIGINAL WINNING LOW LOSS FORMER incorporated in sets that have taken GOLD MEDAL, 1st, 2nd, 3rd and 4th Prizes.

Packed in cartons, 3 in., 4 in., 6 in. lengths, up to 36 in. lengths.
Refuse Imitations.



Registered Trade Mark

The LATEST

Send for particulars of our 4 and 6 contact Formers with bases. Entirely new design. PANELS ready for use. GUARANTEED, BRANDED, in cartons

The British Ebonite Co., Ltd.
HANWELL, LONDON, W.7

Buy Best Batteries

**Maintained
Prices**

4.5 POCKET LAMP BATTERY
5d. each 4/6 dozen

High Tension

Grid Bias	1/3 each
S.T. 60 volt	73 ..
S.T. 100 volt	12/-
T.C. 60 volt	7/6
C.S. 60 volt	8/6
C.S. 90 volt	12/-
C.S. 100 volt	13/6
S.C. 60 volt	14/6
S.C. 72 volt	17/-

"Cordesia" Pocket Lamp and High Tension Batteries are specially manufactured for the purpose for which they are required.

In the Composition of the Mixture and Electrolite, the greatest possible care is taken to obtain the maximum storage capacity. In this their own patented mixture of Manganit plays an important part. Result—Under strict Union Tests "Cordesia" Batteries have proved "The Best." An Eight Weeks Old Battery, under continuous Test of 6,000 Ohms, having given 390 Hours Effective Power equivalent to 296 m.a.h.

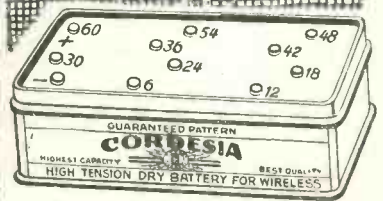

**BUY
BEST BATTERIES
CORDESIA**



Cash Prize Awards for Our Simple Photographic Competition

Happy Holidays with
the Countryside Four!



(Below) On the Norfolk Broads.



(Above) A happy caravan camping party enjoying the Countryside Four.

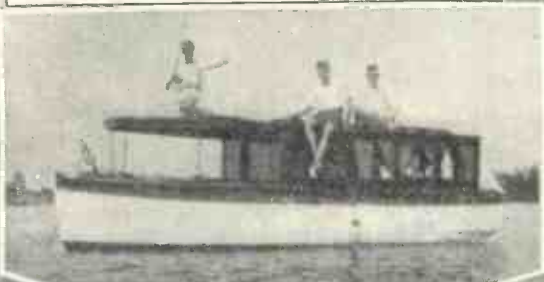

OWING to the bad summer we have had, the entries for the photographic competition in connection with the Countryside Four were disappointingly few in number and not particularly good in quality, except for one or two outstanding exceptions.

For this reason we have decided to award only the first three prizes, and the following are the prize-winners:—

FIRST PRIZE, £15:
Mr. S. E. Platt, of Leek, Staffs, for the top right-hand photograph.

SECOND PRIZE, £3:
Mr. S. T. Henshaw, of New Edlington, Doncaster, for the lower right-hand photograph.

THIRD PRIZE, £2:
Mr. A. H. Murray, of Harborne, Birmingham, for the bottom photograph.



BOTH of the top photographs of the Countryside Four in use were submitted by Mr. S. E. Platt. That on the right is "tooth-brush drill to music." The photographs were taken while caravan camping in Scotland and Yorkshire. "I have never failed to secure satisfactory loud-speaker reception from either Daventry or the local station," says Mr. Platt.

Mr. Henshaw's two photographs show the Countryside Four in use on the Norfolk Broads, where it worked splendidly in spite of a bad sidecar journey from Doncaster to Lowestoft. "All my friends say how much they enjoyed the holiday with having the wireless; in fact, the weather being bad, it made what would have been a miserable holiday a happy one."

Mr. Murray's photograph shows "Kilkenny Girl," the famous greyhound, sapling with its mistress, Miss Winifred Murray, listening eagerly for the alternative programme from 5GB.



HOW I WOULD ABOLISH THE HOWLER!

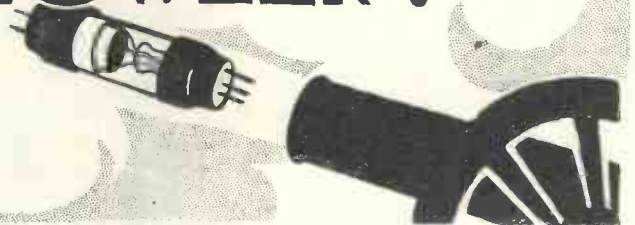

An Exclusive Article by Capt. H. J. ROUND, M.I.E.E.

I DO not really know whether the howler is still the nuisance that he was, because I am so near to 2LO that I seldom hear one on London's wavelength and I rather fancy the strength of 2LO deters the man with a simple reaction detector set trying for foreign stations.

Sufferers in Distant Places

On Sundays, outside of B.B.C. programme hours, I get a taste of

critical on any adjustment except the tuning and that only one knob—and it is really the fault of the designer and inventor that he cannot give the ordinary man a piece of apparatus equally effective but less dangerous to neighbours at a similar price.

I have to confess it, but frankly I have used the self-heterodyne method myself for searching when everything else fails, carefully, of course, and only for a few seconds, for I

effectively the same efficiency for weak and strong signals—every other type of receiver falls off rapidly in efficiency as we decrease the input. It is also the only receiver which has a practically perfect tuning curve but, of course, it is essentially only useful for telegraphic work—reception of telephony, although not impossible by its means, is too difficult for amateurs

"Please don't do it!"

But for the purpose of finding the station we want to receive it is of tremendous value—and once we have the tip the station is there we can struggle with other methods to make the music audible. But, "Please don't do it" stands in our way—for if we do our neighbours suffer and the B.B.C. advertise our district.

The real solution of the difficulty is to find out some means of oscillating without doing any damage to our neighbours, and I propose to show how—at not too much expense—all the advantages of the self-heterodyne can be obtained without radiation and, in fact, a circuit with even more power than the self-heterodyne can be obtained.

Bad Radiation

The simple circuit shown in Fig. 1 is very well known and there is no doubt whatever—we have too much evidence in that direction—that if this circuit is used in the oscillating condition it will radiate badly. Exactly how far its effect will carry

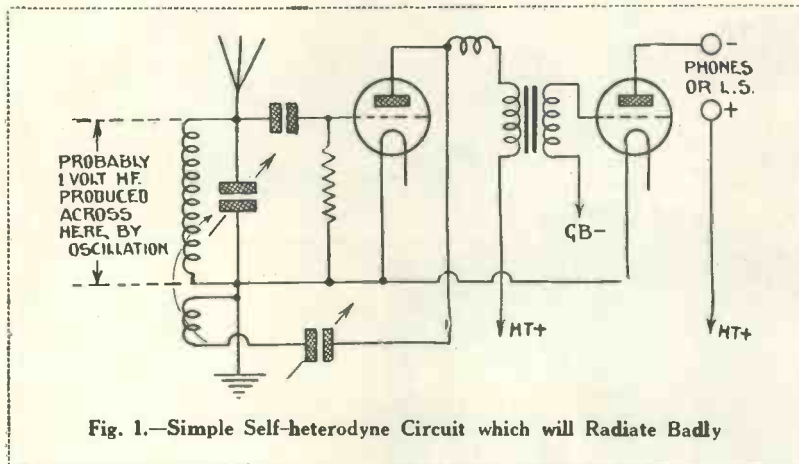

Fig. 1.—Simple Self-heterodyne Circuit which will Radiate Badly

what those in places more distant from a powerful transmitter have to suffer.

I have, however, great sympathy for these energetic searchers for carrier waves, for the self-heterodyne is probably the most delightfully simple and effective piece of apparatus we have.

One valve, any old volts, nothing

would not care to have the name of my street sent out from 2LO. It never fails to give me at least the position on the tuning dials where I must search by less dangerous methods.

The self-heterodyne receiver, aside from its slightly more complicated relative, the independent heterodyne, is the only receiver which has

I do not know, but to those with sensitive receivers the effect will be felt over several miles.

Preventing Radiation

Many attempts have been made to prevent this radiation so as to enable the method to be employed, but the only one which had some success was the employment of a neutralised stage of H.F. in front of the oscillating detector and this method was not entirely successful for a variety of reasons—one reason was that it undoubtedly complicated the tuning, and the second reason was that if the neutralisation was not entirely complete radiation was still produced.

In the shielded valve, however, we have a means of preventing radiation if we care to employ it, and we can obtain results just as good as the self-het rodyne without any addition of adjustments, and if

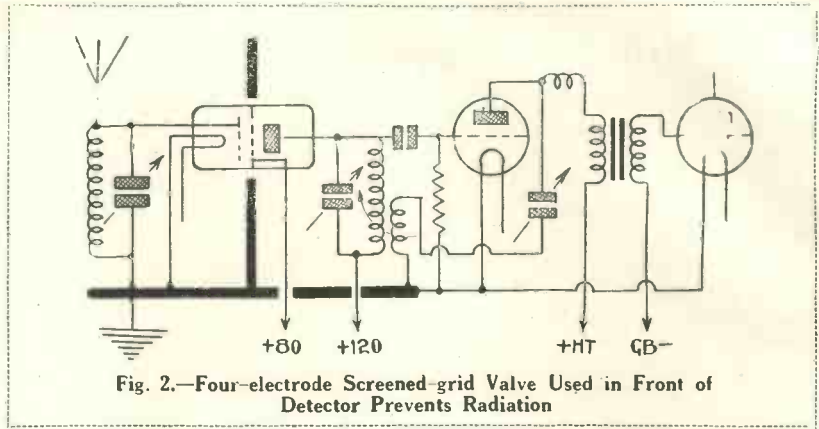

Fig. 2.—Four-electrode Screened-grid Valve Used in Front of Detector Prevents Radiation

reaction coil set at too tight a coupling, but the best results are obtained when the reaction is very nearly at the point of stopping.

In this condition the oscillation strength is undoubtedly quite small, but actually in practice it is impossible to search quickly and hold the reaction on the edge all the time, so that we must assume that a man operating a set, even if he is careful—and some will be very careless—is liable at times to produce comparatively strong currents in the aerial.

As a rough estimate I should think that a value of 1 volt across the aerial inductance is about aerial thirty feet high this current will give a signal at 200 yards away of about the same strength as Bournemouth in London—a disastrous strength for those trying to receive with good receivers in the same neighbourhood.

Four-electrode Valve

Now suppose we insert a four-electrode valve as a high-frequency stage before the detector, as shown in Fig. 2. The reaction and resulting oscillation are still produced in the grid circuit of the detector and this oscillation can only get back to the aerial through the capacity of the valve.

With an ordinary triode, whose capacity may be anything up to 20 centimetres with its leads, a very large proportion of the oscillating voltage of the detector grid coil will get back to the aerial, but with the shielded valve the effective capacity between the plate and grid is not likely to be more than .1 of a centimetre.

A simple way of estimating how much of the voltage of the grid coil gets back to the aerial is illustrated in Fig. 3, where I show how the one volt we had previously assumed across the oscillating coil has to be

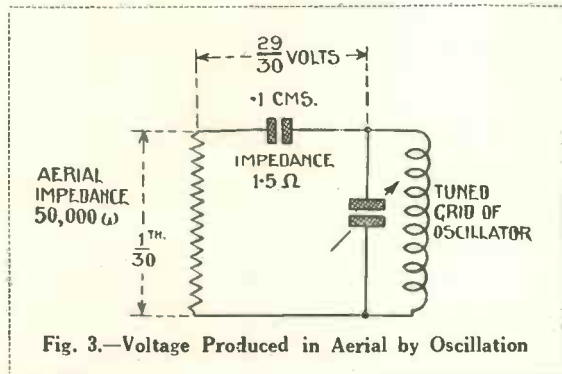

Fig. 3.—Voltage Produced in Aerial by Oscillation

necessary we can greatly increase the efficiency without any serious danger of radiation trouble.

Before, however, we devise the necessary apparatus to produce this effect with the four-electrode valve, let us consider the simple circuit of Fig. 1 and analyse its action a little. As is well known to those operating a circuit, it is never wise to have the

the voltage which is liable to be produced, and this in an average aerial would give an oscillating current of something like a milli-ampere.

I will not guarantee, of course, that even more than this will not be produced, but one volt is quite a reasonable figure and a very rough estimate indicates that with an



How I Would Abolish the Howler! (Continued)

split up between this valve capacity and the aerial impedance.

I will not go into the question of how this aerial impedance can be obtained, but it is actually equal to the resistance which, placed across the aerial inductance, would represent all the aerial losses, and a figure of 50,000 ohms would not be far off the mark. We see, therefore, that across this 50,000 ohms only $1/30$ th of

recalculation with a diagram similar to Fig. 3, where the 50,000 ohms is replaced by 1,700 ohms, shows that the voltage induced back from the oscillator will now be one-thirtieth of what it was before, which will give an aerial current somewhere in the neighbourhood of a microampere, which will have no effect whatever on the very nearest neighbour with an "ultra-superdyne."

the magnification of the valve to about the same amount. The set (shown in Fig. 4) now becomes definitely a one-knob set, no attention being paid to the aerial circuit at all, but it should be noted, of course, that the tetrode for best results should be mounted through its usual shielding case, as the main object of the experiment is to keep the aerial circuit and the grid attached to it electrically separate from the oscillating circuit. This type of shielded valve is designed to require the outside shielding for maximum effect.

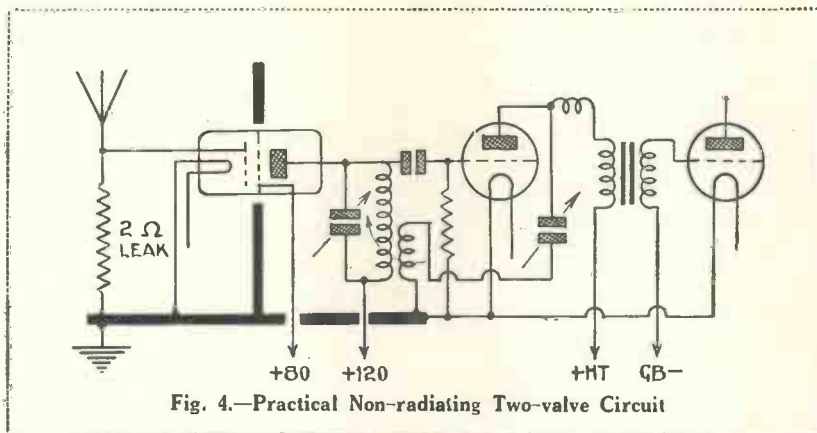

Fig. 4.—Practical Non-radiating Two-valve Circuit

a volt will be given. Thus the aerial current is now reduced to one-thirtieth of a milliampere, which will not have a range of more than 20 or 30 yards from the aerial.

Range Amplification

Of course, now the tetrode will be giving us a large amplification and we have a far more sensitive receiver with most of the properties of the self-heterodyne and very much less tendency to radiate, but we have a two-knob device, which is a distinct disadvantage. The magnification given by the tetrode is about thirty, so that we can afford to reduce our signals to one-thirtieth of their value and still have a result as good as the original self-heterodyne.

Suppose we shunt the aerial coil with a non-inductive resistance of a much smaller value than the imaginary 50,000 ohms with which it was shunted before. If we put across it, say, a resistance of 1,700 ohms we shall damp our aerial down very excessively and its tuning will be very flat, so that in effect the aerial tuning will hardly be necessary.

The sound that we shall hear will now be the same strength as the original self-heterodyne, but a little

Of course, this is rather a round about way of getting the result, for to take a tuned circuit with a good low-loss condenser and a good Litz-wound coil and drown it with a shunt resistance is not the cheapest possible way of arriving at these results, but it may suggest a useful idea to those who would like something more sensitive than the self-heterodyne, but with one condenser sufficiently flat in tuning to be neglected over narrow ranges, because to meet this case it is easy to put in a shunt of an intermediate value between 1,700 and 50,000 ohms

Practical Arrangement

For those who would be quite satisfied with a sensitiveness the same as the self-heterodyne, the arrangement of Fig. 4 will be satisfactory, where the direct volts induced in the aerial from the signal are applied to the grid of the tetrode, a grid leak being applied to the tetrode for adjustment of its bias only.

One-knob Set

As the magnification of the induced voltage obtained by tuning an aerial is about thirty, this is balanced, in a case where the aerial is not tuned, by

Little Harm Possible

I doubt, however, if very little harm will be done even if the valve is mounted in the crudest way. The aerial current will again be of the order of one microampere when the oscillator is oscillating up to one volt and no harm whatever can be caused to neighbours.

The extra cost of this apparatus will be comparatively small, one valve at 22s 6d., and one valve holder and a grid leak, say three or four shillings. The set will give you some considerable advantages over the self-heterodyne aside from its non-radiating properties.

Zero-beat Reception

The oscillation produced will be much steadier in frequency because aerial sway will no longer be present and it will be very much easier to test out and experiment with that very interesting condition of reception roundabout the just-oscillating condition which is commonly called zero-beat reception.

Zero-beat reception will enable you to get distant stations with intelligible speech and music easier than by normal reception although of course the quality will not be irreproachable.

I think the nicest piece of apparatus would be the complete arrangement of Fig. 2, with a shunt-controlled by a switch across the aerial inductance. The shunt could be about 10,000 ohms, and with this connected, safe searching for carrier-waves could be done—then, when one is found, the oscillation can be stopped and the switch opened, thus giving full sensitivity for telephone reception.

There can be no doubt that short-wave Empire broadcasting will come in a very short time and those "Wireless Magazine" readers who build the Dominions Short-wave Three will be well prepared to get the best of what is going. In any case there are already a number of interesting (and regular) short-wave broadcasting transmissions that can be heard without difficulty

The Dominions Short-wave Three

Designed, Built and Tested by the "Wireless Magazine" Technical Staff

Get Ready Now for Empire Broadcasting!



Inserting coils in the Dominions Short-wave Three

VERY great interest indeed is being taken at the present time in short-wave broadcasting, although as yet there are very few "programme" transmissions being made on wavelengths below 100 metres. But the possibilities of the inauguration of a scheme of Empire broadcasting in the near future have had the effect of turning the attention of ordinary broadcast listeners—as distinct from real experimenters—to this side of reception.

"W.M." Short-wave Sets

From time to time the WIRELESS MAGAZINE Technical Staff has described the construction of special short-wave receivers in these pages, but all the issues in which such details were published are out of print, and we know that in describing the Dominions Short-Wave Three in this issue we shall be satisfying the needs of a large number of readers.

A constructional article is not the place in which to discuss the problems of short-wave reception and it will suffice to remind readers that the chief and most important point is to over-

come the effects of stray capacities between adjacent components and also in the wiring itself!

Considerable Experiment

The set about to be described has been laid out with great care, and a considerable amount of experiment has been carried out to obtain a compact and yet efficient wiring arrangement that is free from harmful capacity effects.

One result of the detrimental effect of even minute stray capacities in short-wave work is that, unless it is absolutely essential, high-frequency amplification is avoided, for, of course, stray capacities are of far greater importance in the high-frequency side of a set than in the low-frequency stages.

In the Dominions Short-wave Three no high-frequency amplification is

used, but readers should not immediately jump to the conclusion that it will have no range; it is no exaggeration to say that this receiver, used under normal conditions anywhere in the British Isles, will bring in a number of American broadcasting stations on the loud-speaker.

Low Cost

The fact that for ordinary work high-frequency amplification is not essential means that an efficient short-wave receiver can be put together at comparatively low cost. A detector valve with reaction followed by one or more low-frequency valve stages (depending upon whether headphone or loud-speaker reception is desired) will be found quite satisfactory and the Dominions Short-wave Three described in this article comprises this combination. Jack switching is provided so that a detector and one stage of low-frequency amplification or detector and two stages of low-frequency amplification can be used as desired. The cost of building the receiver is not great.

A glance at the circuit diagram will show that the arrangement is

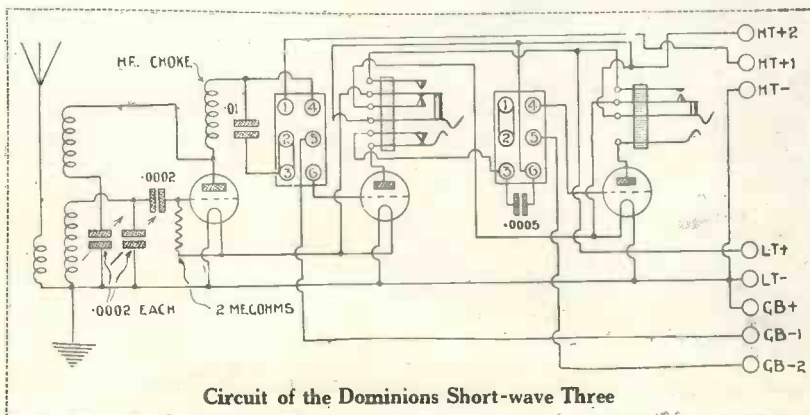

Circuit of the Dominions Short-wave Three

The Dominions Short-wave Three (Continued)

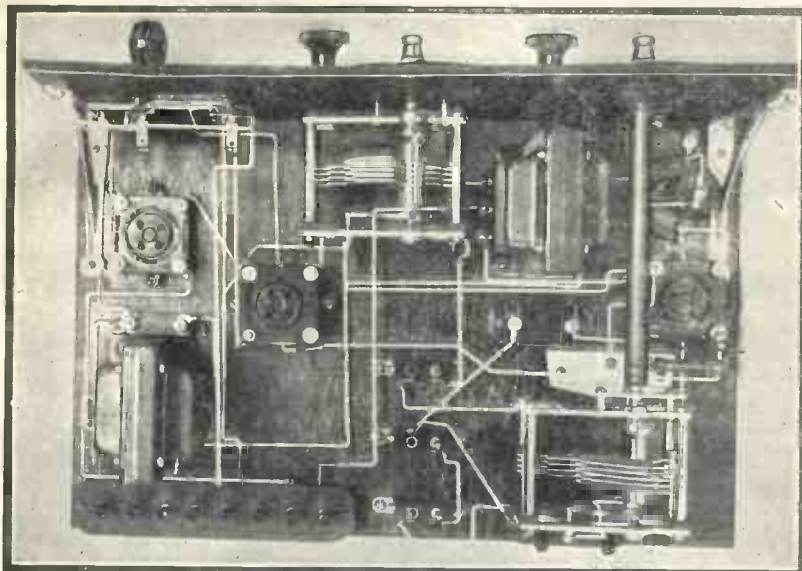

Plan view of the Dominions Short-wave Three

quite straightforward. The aerial tuner consists of two plug-in coils mounted close together in adjacent holders. The first acts as an aperiodic aerial coil, while the second acts as a secondary; this is tuned by a .0002-microfarad variable condenser. Reaction is obtained by means of a third plug-in coil, the amount of feed-back being controlled by another .0002-microfarad variable condenser; this arrangement gives a very fine control of oscillation.

Cutting Out H.F. Currents

In order to prevent harmful high-frequency currents which might cause trouble in the low-frequency end, to leak through to the circuit, a high-

frequency choke is placed in the anode circuit of the detector valve. It should be emphasised that this component must be specially suitable for *short-wave* work or its inclusion is a waste of time and money.

The first low-frequency stage is coupled to the detector valve by a balanced inductive arrangement, which gives a step-up ratio of $1\frac{1}{2}$ to 1. (Alternatively an ordinary low-frequency transformer coupling can be used, and the connections for this are shown in a separate circuit diagram. In this case the transformer can have a step-up ratio of 3.5 to 1).

If a plug is pushed into the jack immediately following this first low-frequency valve, the second stage is

cut out of circuit and the filament of the last valve automatically switched off.

Between the second and third valves an ordinary low-frequency transformer coupling is used, and this has a step-up ratio of 3.5 to 1.

Plug-in Tuning Coils

For the sake of convenience, plug-in short-wave coils have been used so that the receiver can readily be adapted for use on any particular band of wavelengths for which coils are available. As a matter of fact, if coils of the normal sizes are employed this receiver will be found to be perfectly suitable for ordinary broadcast reception on the higher wavelengths.

A new type of low-loss condenser, with an extended spindle to reduce hand-capacity effects to a minimum, is used for tuning the grid coil. This is supplied with a special bracket for mounting the condenser itself well clear of the baseboard and can be clearly seen in the photographs reproduced in these pages.

No Base-board Losses

The valve holders have been mounted on short lengths of ebonite tube to keep them well clear of the baseboard so that no losses can occur through any conducting qualities that the wooden baseboard may possess.

Some short-wave sets look like experimental receivers, but the Dominions Short-wave Three has the appearance of an ordinary broadcast receiver—and is none the less efficient because of that. It is a set that (when short-wave broadcasting is started with in the Empire officially and that, it may confidently be expected, will be in the not-too-distant future) can take its place amongst any house furnishing scheme without exciting undue comment.

Simple to Operate

That there is nothing difficult about the operation of the receiver will be more readily appreciated after a glance at the photographs of the front of the set. There are only two controls, one for tuning the grid coil and the other for controlling reaction. The two jacks, for using two or three valves, can hardly be termed controls in the ordinary sense.

Following is a complete list of the

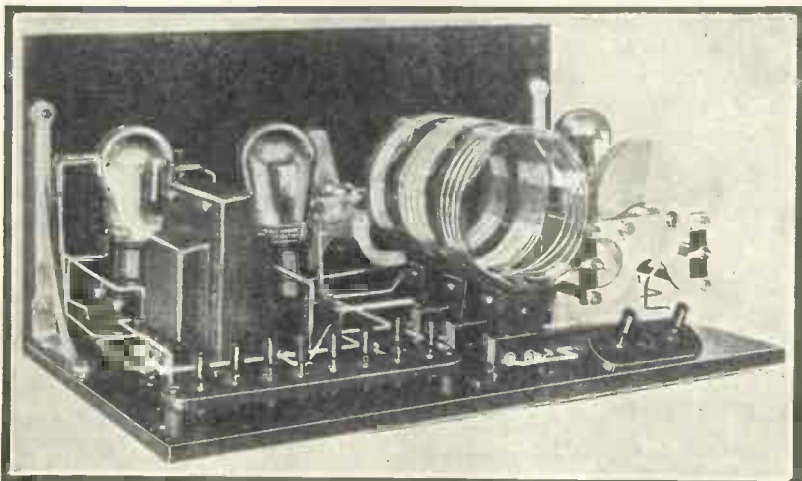

Rear view of the Dominions Short-wave Three with valves and coils in position

A Simple and Efficient Receiver

components required for building the Dominions Short-wave Three :

Ebonite panel, 16 in. by 8 in. (Becol or Will Day).

.0002-microfarad special short-wave variable condenser with extension shaft and aluminium bracket (Cyldon Short-wave or any ordinary condenser, such as Cyldon, Ormond or Peto-Scott with home-made extension shaft and supporting bracket).

.0002-microfarad special short-wave condenser without extension shaft, (Cyldon Short-wave or any ordinary condenser, such as Cyldon, Ormond or Peto-Scott).

2 straight-line-frequency L.F. transformers (R.I. and Varley or two ordinary untapped transformers, such as R.I. and Varley, B.T.H. or Gecophone of ratio approximately 4 to 1).

2 anti-microphonic valve holders (Benjamin or Lotus, Precision, W. and B.).

Anti-microphonic valve holder with combined 2-megohm grid leak (Benjamin or Lotus).

3 single coil holders (Lotus or Lissen).

.01-microfarad fixed condenser (Dubilier or Lissen).

.0002-microfarad fixed condenser (Dubilier or Lissen).

.0005-microfarad fixed condenser (Dubilier or Lissen).

6-point jack (Lotus or Igranic, Ormond).

4-point jack (Lotus or Igranic, Ormond).

Loud-speaker or headphone plug (Lotus or Igranic, Ormond).

2 terminal strips, 7 in. by $1\frac{1}{2}$ in. and 3 in by $1\frac{1}{2}$ in. (Becol or Will Day).

High-frequency choke (Wearite, or Bulgin)

2 vernier dials (Igranic or Ormond).

10 small plugs and sockets, 4 red and 6 black (Lectro Linx).

Pair of panel brackets (Carrington)
Cabinet and baseboard (Carrington)

In each case the component used in the original receiver is mentioned first, and it is particularly recommended that the parts employed in the original set should be used if at all possible.

Full-size Blueprint Available

Before beginning the construction of the receiver readers are recommended to obtain a full-size blueprint, which will be found to facilitate the work of building the receiver. This blueprint can be obtained for half the normal price (that is, for 6d. post free) if the coupon on page iii of the cover is used before November 30. Ask for Blueprint No. WM39 and address your inquiry to Blueprint

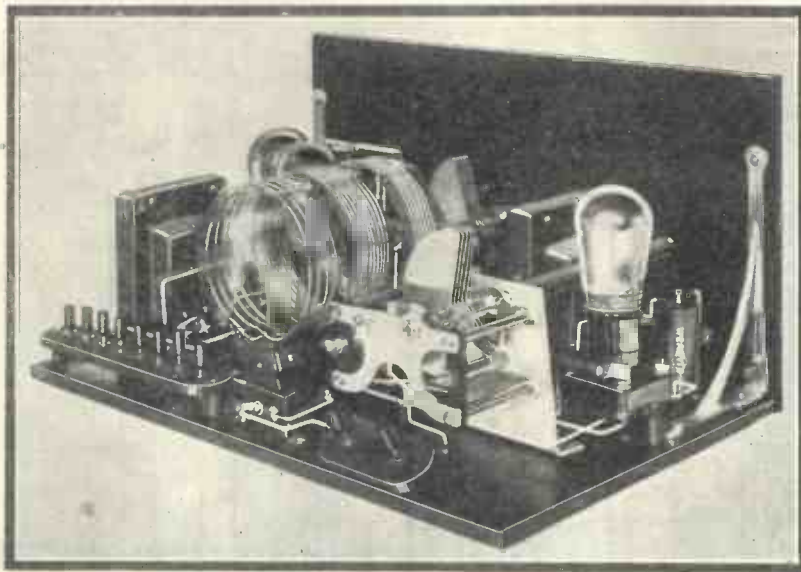

Rear view of the Dominions Short-wave Three

Dept., WIRELESS MAGAZINE, 58-61 Fetter Lane, E.C.4.

It should be pointed out that although a blueprint is very useful, its use is not absolutely essential, all the necessary details being reproduced on a smaller scale in these pages.

The first operation to be undertaken is the drilling of the panel, after which the components can be screwed into position. Next fix the panel to the baseboard by means of the brackets and place the baseboard components in position. There is plenty of clearance everywhere and no difficulty will be encountered even by the novice.

When all the components have been

fixed into position, wiring up can be started and this will be greatly facilitated by frequent reference to the full-size blueprint or smaller wiring diagram reproduced in these pages.

Lettered Terminal Points

A glance at either will reveal the fact that each terminal point is marked with a small letter of the alphabet. All those points marked with like letters should be connected together, in alphabetical sequence. Thus all those points marked *a* should first be connected with one wire or as few wires as possible; then all those points marked *b*; and so on until wiring is completed.

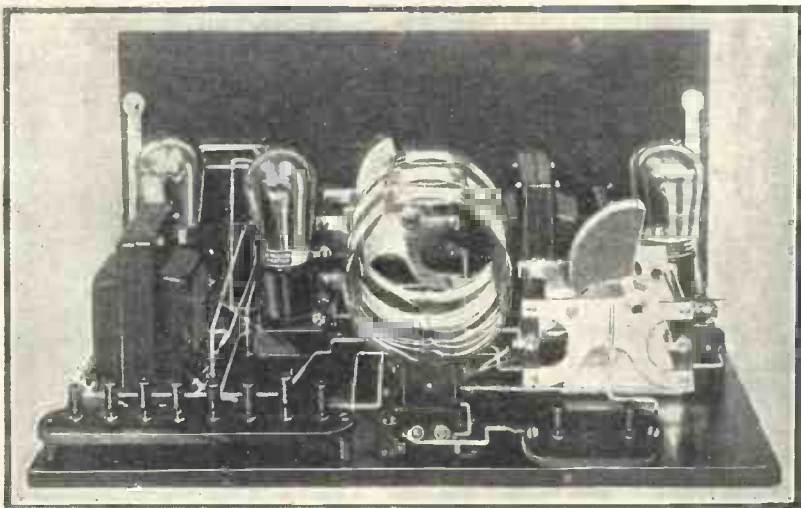

This view of the Dominions Short-wave Three shows the general layout

The Dominions Short-wave Three (Continued)

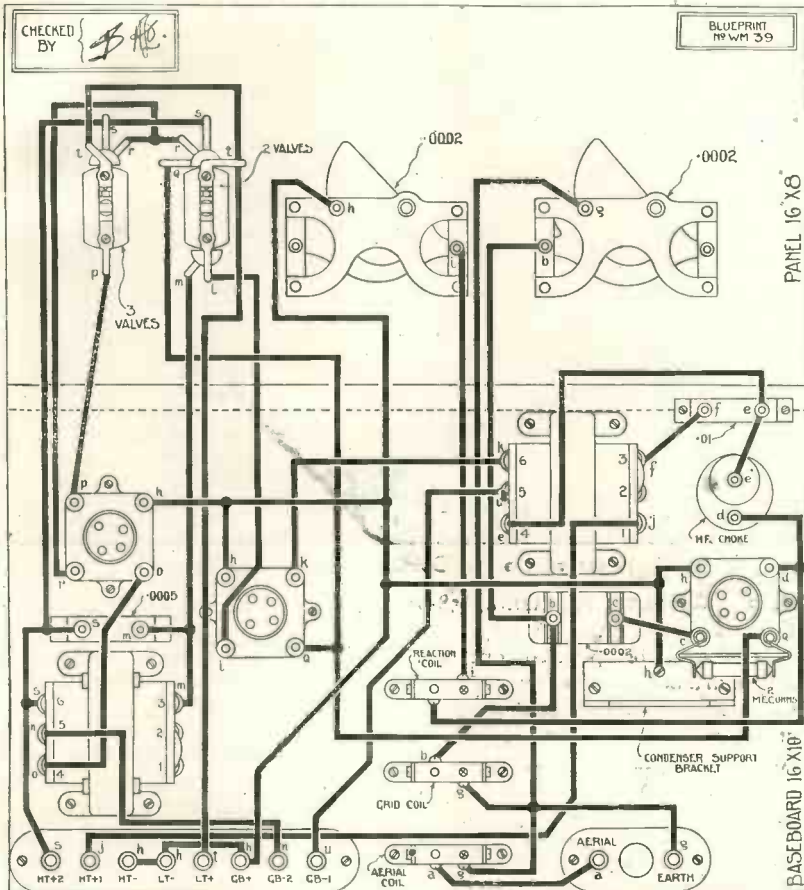

This layout and wiring diagram can be obtained as a full-size blueprint (No. WM39) for half-price, that is 6d. post free, if the coupon on page iii of the cover is used before November 30

If the special balanced inductive arrangement of the first low-frequency transformer is used, the detector valve can have an impedance between 30,000 and 100,000 ohms. If an ordinary transformer of approximately 4 to 1 step-up is used, however, the impedance of the detector valve can be 20,000 to 30,000 ohms.

First L.F. Valves

The first low-frequency valves should have an impedance of the order of 15,000 ohms, while the last valve can be a power amplifier with an impedance in the neighbourhood of 8,000 ohms or less.

To the battery plugs connect flexible rubber-covered leads of convenient length (that is, do not make them too short) and connect up and tap off the required voltages.

To H.T.+1 apply a voltage of about 60, and to H.T.+2 of about 120, the grid bias with most valves should be about 6 to 9 volts.

Tuning-in a Station

When all the external connections have been made, a start can be made with tuning-in. Plug the loud-speaker or phones, if you prefer them for searching, into the right-hand jack on the panel (this automatically switches on three valves) and adjust the right-hand (reaction) dial until that slight breathing or hissing is heard that indicates that the receiver is on the point of oscillation.

Next search very carefully with the left-hand dial for carrier waves, at the same time manipulating the

If the alphabetical sequence is followed, the wiring will be built up from the bottom upwards automatically and awkward crossings will be avoided.

Making a Rough Test

As soon as the wiring has been completed a rough test should be carried out and for this purpose valves and coils should be placed in their respective holders. Instead of terminals use has been made of plugs and sockets for making battery and other external connections; such plugs and sockets are cheaper than terminals and are quicker to manipulate.

For reception over the band of wavelengths from 20 to 70 metres (which includes the most important American short-wave stations) the following Igranic coils are suitable: Aerial coil, 2; grid coil, 4; reaction coil, 6 or 9. Using coils of these sizes 2XAF was heard on the original receiver at the following dial settings: Grid tuning, 32.5; reaction, 25 degrees.

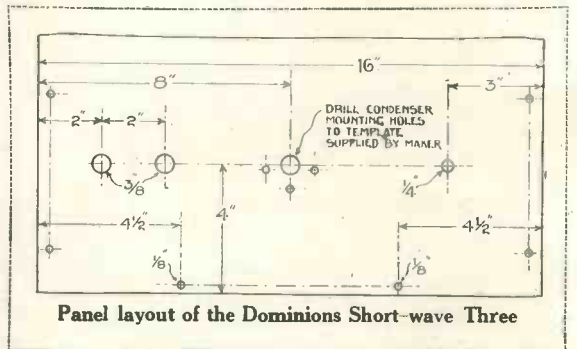

Panel layout of the Dominions Short-wave Three

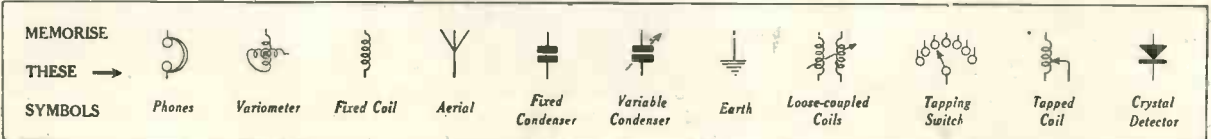

Be Ready for Empire Broadcasting!

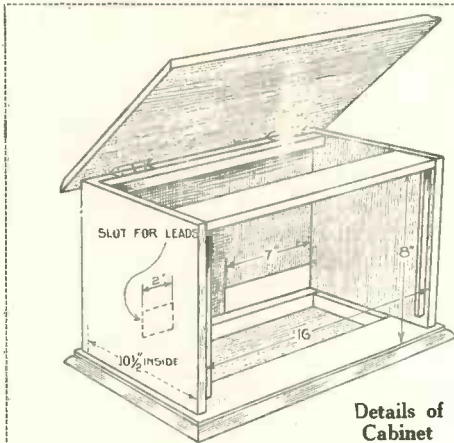

Details of Cabinet

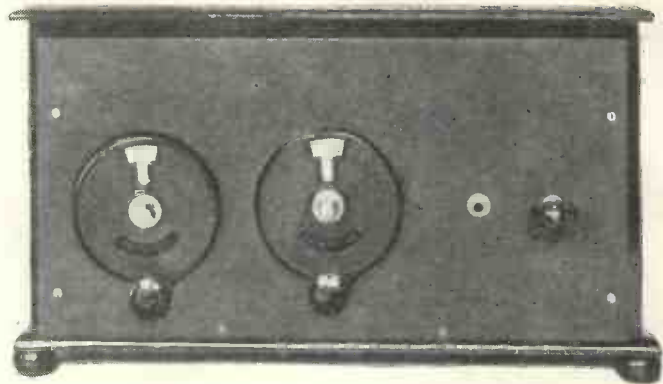

Front View of the Dominions Short-wave Three

reaction control if necessary. Tuning on wavelengths below 100 metres is exceptionally critical and great care must be taken not to turn the dials so quickly that stations are "passed over."

It may be emphasized here that a reasonably short aerial (say, not exceeding 30 feet in length) will give a better chance of success than a long one.

If the aerial does exceed 30 ft. in length and cannot be conveniently shortened in practice it is recom-

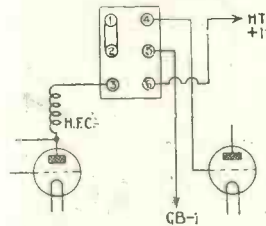

Alternative Circuit for First Low-frequency Coupling

mended that a .0002-microfarad fixed condenser be placed in the aerial lead; this has the effect of shortening

the effective length of the aerial.

As has been mentioned previously, the Dominions Short-wave Three is quite suitable for working on the normal band of broadcasting wavelengths if the appropriate coils are used. For wavelengths between 300 and 500 metres try the following coils: Aerial, 25; grid, 60; reaction, 35.

For the reception of ordinary medium-wave broadcasting, an aerial of the normal size can, of course, be used.

To the Editor "Wireless Magazine"

SIR,—A few lines of appreciation, I feel, are due to your magazine's excellent receiver, the 1927 Five. Reading your copies as they came to hand, I became more and more impressed with the claimed merits of this set, and finally, four weeks ago, decided to build. Now, I have no option but to put my name to the list of satisfied users of this wonderful circuit. It is a great set. Here are the reasons why it pleases me.

I am situated not quite three miles from station 4QG, working on 385 metres, and pumping 5,000 watts of energy into the air, and with the aid of a simple wavetrap can entirely remove all traces of this station and receive 3LO, Melbourne, on 371 metres, nearly 1,000 miles away, at full loud-speaker strength—so much so, that I very seldom use the second audio valve, it is too loud for the house, but with the four valves it is simply perfect—tone, stability, and ease of control being all that could be desired.

Of course, 7ZL, Hobart; 1YA, New Zealand; 3AR, Melbourne; 5CL, Adelaide; 2FC, Sydney; 2BL, Sydney; 2KY, Sydney; 2BE, Sydney; and 2VE, Sydney, and several low-power stations in the south are always available—on the loud-speaker—and I have not yet connected a pair of headphones to the set!

More Praise for the 1927 Five!

The set is so good that as soon as possible I am going to add a detector and oscillator, as per your America Seven, in January's issue, and see if I can raise "Li'l' ole New York" from this side of the earth.

Wishing you and your publications the success they deserve, and again thanking you.—ROYSTON G. McFARLANE (Toowong, Brisbane, Australia)

SIR,—Allow me to extend to you my heartiest congratulations on your design of the 1927 Five. I have been interested in wireless for about eight years, and can honestly say that it is the best set I have ever made or handled, the reaction control being of particular use in the reception of interstate stations, none of which is nearer than 450 miles.

The best piece of DX work accomplished by the set up to date is the reception of one of the stations at

Manilla, which is usually picked up after the Adelaide station has closed down.

Two departures from the original design were made, the use of back-of-panel vernier dials, and resistance-coupling instead of transformers.

Attached is a list of the stations heard, together with their power and wavelengths, the two higher-power Melbourne stations being about twelve miles from the receiver. The aerial system consists of two wires spaced 5 ft. apart, 50 ft. high, and a total length of about 130 ft., the ground connection being 20 square ft. of zinc buried six feet down:

		Metres	Watts
3AR	Melbourne	484	5,000
2FC	Sydney	442	5,000
5CL	Adelaide	395	5,000
4QG	Brisbane	385	5,000
3LO	Melbourne	371	5,000
2BL	Sydney	353	5,000
3UZ	Melbourne	319	100
5DN	Adelaide	313	500
2GB	Sydney	316	3,000
2KY	Sydney	280	1,500
3DB	Melbourne	255	500

This list includes all the A and B class stations with the exception of 6WF, Perth, which works on 1,200 metres, but is usually so badly interfered with by static that it cannot be followed.—CECIL C. WARING (Canterbury, Victoria, Australia).

Winter Once Again Heralds the Transmission of Many More

Outside Broadcasts

WITH the return of winter, running commentaries of football matches, the first of their kind, enter upon their second year. Many people look upon these descriptive talks as comprising the whole of "outside broadcasts."

The precise definition of an O.B. is, however, any programme where the microphone is not in the studio. This embraces Proms, the ceremonial

shouting breaks in upon an important phrase, and causes much trouble if it does not actually spoil it.

Reiss microphones are generally used, and their outstanding characteristics are a very long "reach" and an extremely faithful reproduction of even the slightest variations of tone. The commentator is usually somewhere among the crowd to obtain the best view he can, and the engineer

the commentator himself picks up the shouts, especially if it is situated in a "popular" part of the ground.

Short-range Microphone

The solution of the problem lies in the invention of a short-range microphone, which will pick up nothing except the voice. The "effects" could be brought in by a Reiss as at present. Unfortunately such de-sensitised instruments as have been made have given the human voice a boxed-up tone, robbing it of the personal characteristics which individualise a speaker.

One very interesting specimen recently designed by the B.B.C. is reminiscent of a war-time gas mask, since it is suspended a few inches from the mouth by a head gear. Its range was certainly short, but it was found difficult to make the transmission of good quality. Once this last point has been overcome, running commentaries from popular sports venues will be more evenly balanced.

By Land-line

Every outside broadcast has, however, to be taken by land-line to a transmitting station, and during this stage the engineers are merely on-lookers. If the land-line proves unsuitable for this kind of work, the best they can do is to request the postal authorities to change it for them.

Land-lines are one of the problems that have to be considered on their own merits for any particular O.B. since in different parts of the country they vary very considerably in broadcasting quality. A line need not be bad for conversation when it is quite unsuitable for the transmission of music owing to frequent "cut-offs." Noisy lines have occasionally to be cleared up within a few minutes of a broadcast, and sometimes improve, or the reverse, as a programme proceeds.

F.R.



Reginald Foort, the New Gallery Kinema organist

opening of the Menin Gate. Sandler's Orchestra from The Grand Hotel, Eastbourne, and even those very old friends, the Savoy Orpheans who, under Debroy Somers, gave listeners their first taste of modern dance music.

New Phase Likely

But although this is not actually an anniversary, yet O.B.'s are considered in some quarters likely to enter on a new phase, particularly in the matter of microphones.

Up to the present, the big difficulty has been to balance the crowd noises in a running commentary with the voice of the commentator, so that the latter may always be pleasantly audible. Frequently a round of

engaged in fading in the various "mikes" is in another place better suited for fixing up his apparatus.

When an exciting incident crops up, the commentator describes it as quickly as he can, but his colleague, being out of sight, and following the progress only through his earphones, of necessity loses a second or so before he can fade the "mikes" bringing in the shouts of the spectators. In this way his first words are often lost, and before there is time to repeat them, if this happens to suggest itself, something further has occurred.

But this is not the only way in which the description may be marred by these outbursts. The Reiss is so sensitive that even the one used by

MEMORISE THESE SYMBOLS



Crystal Detector



Aerial



Earth



Headphones



Fixed Condenser



Variable Condenser



Fixed Coil



Coil with Slider



Coupled Coils



Variometer



Wires Joined



Cross Wires not joined

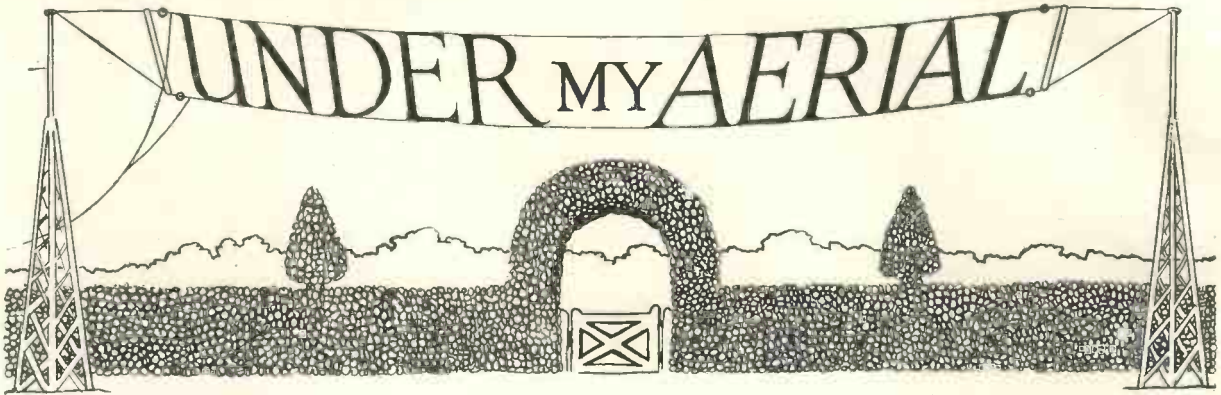

World Broadcasting

DON'T you think it is high time we wakened up from our typically British apathetic attitude towards the infinite possibilities of a system of Empire or even world broadcasting?

I certainly thought so recently when I read through a fascinating article on this important subject in an American wireless periodical.

The writer of the article I have in mind said that, when it comes to telling the rest of the world about the greatness of America and its achievements, wireless has as yet a great and important duty to fulfil.

He drew an interesting parallel between the motion-picture industry in America and American wireless, in the course of which he boldly stated that American motion pictures have Americanised the world and that the world has learned more about America, its customs, its institutions, and its civilisation from the motion picture than from anything else.

Now, in order to exert a similar international influence with wireless, this writer made it clear that, in his opinion, the entire civilised popula-



High time we wakened

tion of the globe, no matter where located, should be in a position to listen every day to American wireless programmes.

To provide the world with American broadcast transmissions, this writer put forward a plan for the erection of five super-stations of immense power. Four of these stations would be placed at the

corners of the United States, and these four corner stations would work on the beam-transmission system.

The station at the north-east corner would cover Europe and Africa, the station at the south-east corner South America, the station at the north-west corner Asia, and the station at the south-west corner Australasia. The fifth station, an all-round broadcasting station, not a beam station, would serve the United States and, of course, Canada.

Rather a scheme, isn't it, ingenious enough to take your breath away, what?

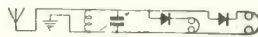

What about it then?

An Empire Scheme

If an American writer can put forward such a fine scheme of world broadcasting, don't you think that we ought to be able to reply with something of the same kind from this side of the Atlantic?

What about it, then? Shall we go in for a double, treble, or some higher-ble super-station at Daventry which will tell the whole world of the greatness of Britain and the British Empire? We have the Rugby station as some kind of a start for such a scheme.

As an alternative, we might work out our scheme in terms of beam transmissions from England. There are, or soon will be, efficient beam-transmitting stations in England transmitting to North America, Australia, South Africa, India, South America, and Egypt.

Looking at a map of the world, it seems to me as if we have, in the above-mentioned beam transmissions, the basis of as fine a scheme for broadcasting to the whole world as could possibly be devised.

Our North American beams could be made to cover the whole of North America. Our Australian beam could be made to cover Australasia, our South African beam Africa, our Indian beam Europe and Asia, and our South American beam Central and South America. We should scarcely want the Egyptian beam.

George has a beaming scheme up his sleeve. It consists of two twenty-four-hours-a-day-continuous-programme-revolving-beam transmitters, one at the North Pole and one at the South Pole, the stations revolving on the earth's axis so as to throw their beams always along the daylight zone. I can't imagine a wireless engineer wanting to live at the North Pole or the South Pole, though.

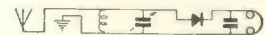

Playful

Here is a schoolboy's somewhat imaginative account of what hap-



Playful!

pened one night behind the scenes at Double OL:—

6.30 p.m.—Big Ben.

6.31 p.m.—Pianoforte solos, Miss Macadam-Noyes; ceremonial fantasy "Pass the Mustard," Baron de Beef; one-step, "Cheese It," Camembert.

6.30 p.m.—Miss Macadam-Noyes forcibly detached from the pianoforte and the loud pedal levered back to zero position.

Under My Aerial (Continued)

- 6.51 p.m.—Stale news. Copyright by Queen Anne.
 6.58 p.m.—Weather forecast number six.
 7 p.m.—Madame Rustivocaliano, The Lady Bass, "Oh! that I were a Dove," Cooie; The animals went in one by one, Bryant and May.
 7.10 p.m.—Orchestra. Unfinished symphony; Impositions; Masters.
 7.30 p.m.—The orchestra went out to have one.
 7.31 p.m.—Talk by Professor Face-Fungus, on "Catwhiskers."
 8.30 p.m.—The Orfun Band synco-pated until further notice.
 8.32 p.m.—Further notice.
 8.45 p.m.—A perfectly new joke broadcast by accident. Four transmitting valves went. Closed down for the night.

What do you think of the above? Rather naughty, isn't it? My school-master friend wonders how you would like to have to teach thirty such rascals.

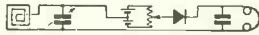

November

November, month of fog and rain, plus a threat of snow in the



November

further outlook, has brought with it so many important wireless events in the past few years that I have been wondering what the present November has in store for us in the way of wireless developments.

Do you happen to remember that the first serious attempt at broadcasting on a large scale was made in the month of November? It was so, and the year was 1920, the occasion being that on which the Westinghouse Company, at Pittsburg, U.S.A., broadcast the presidential election results.

Coming to our own country, you will, of course, remember that the British Broadcasting Company was formed in November, 1922, and that the London, Manchester, and Birmingham broadcasting stations all came into operation that same month.

I am not quite certain, but I think I have a note somewhere that the first prosecutions under the new Wireless Act, for using a wireless set

without a licence, took place in November, 1925.

Another event which took place in November, 1925, and of which I have very clear recollections, was the publishing strike which caused my *Amateur Wireless* to reach me late on the only occasion I have ever known it to be late.

Yes, November has undoubtedly been a most important month in the history of wireless. Will it keep up its record in 1927, I wonder?



Here's an interesting bit of news,

Peru

"Here's an interesting bit of news from Peru," said George to me the other evening.

"Peru? Let me see now," I replied, "that's where the bark comes from. Funny how you can remember those South American countries by what comes from them. What's the news from Peru, George?"

"The Peruvian Government has been compelled to adopt wireless as the official means for telegraphic communication within the country."

"Compelled, George, why?"

"Line telegraphy has proved too expensive in upkeep, because of the ants, the spiders, and the monkeys."

"Now then, George——"

"Yes, sir, the big Peruvian ants look upon wooden telegraph poles as toothsome morsels. They eat those poles up at something like the rate a rabbit eats a lettuce leaf. Why, they've even been known to bite the poles down, carry them off, and store them in the long run in their burrows."

"What about the spiders, George?"

"The Peruvian spider, sir, which spins a complicated web about twelve feet in diameter, got into the way of using the telegraph line as an upper support for its web. Result: telegraph lines earthed at many points."

"And now the monkeys, George."

"Ah! there's a very interesting story about the Peruvian monkeys.

Do you know, sir, those Peruvian monkeys appear to have had the grandest games of follow-my-leader you ever heard of along those telegraph lines. Great-grandpapa Monkey would set off on a fifty-mile swing along the telegraph lines and the whole darned family of some hundreds would follow him.

"You can imagine the effect on morse when a few hundred monkeys were hanging from the wire with one hand and relieving the surface tension with the other. The ants and the spiders upset things pretty badly, but it was the Peruvian monkey which put the finishing touch to line telegraphy in Peru."



Earwigs

Have you ever run up against earwigs in large quantities in connection with your wireless work? No, I am not trying to make a crude joke about listeners who use headphones. I mean the real thing, the creepy, crawly insect earwig.

My aerial mast, which is just a rough pole from which the bark has never been removed, has been in a tree at the bottom of my garden for over three years.

When my aerial rope broke, not so long ago, and I had to let the mast down from out of the tree to get at the pulley, I thought the occasion a good one for an inspection of the mast.

I found the mast in good condition



Have you ever run?

but, as the bark on the lower half of the mast was very loose, I decided to pull it off. As soon as ever I pulled off the first peice of bark I saw the earwigs.

There seemed to be swarms of them, and, by the time I had taken off all the loose bark, I must have seen hundreds of these funny insects, which one usually associates with an inverted flower-pot at the top of a stick near a dahlia in autumn.

It was all so very unexpected to be

Halyard's Chat on the Month's Topics

suddenly switched from wireless to entomology in that fashion.

The result of my encounter with the earwigs was a resolve never to stand under a rough wireless mast fixed in a tree while somebody else pulls the bark off the mast.

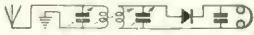

The Winter

What I should like you to tell me more than anything else about wireless at the moment is the kind of wireless winter you are planning for yourself for the winter that is now upon us.

Do you intend to devote the long evenings to D.X. work of an ambitious character, or do you intend to confine your attention to the reception of our excellent British broadcasting stations?

I have an idea that the majority of our wireless experimenters will concentrate on the alternative transmissions of our home stations this winter rather than on big-distance work.

Problems on the reception of the two Daventry alternatives, 5XX and 5GB, might provide you with many an entertaining evening during the coming dark months.

For example, you might try to devise a scheme of your own whereby the turn of a switch in your set would take you over from 5XX to 5GB, or vice versa. Such a scheme is, perhaps, out of the question where there are high-frequency amplifying valves, but if you live within three-valve range (detector valve followed by two low-frequency amplifying valves) of Daventry, you might have a shot at the problem. With a circuit

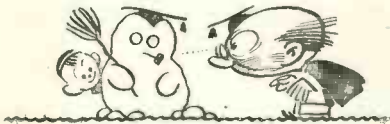

The Winter

like the Reinartz, where the coils are fixed, the thing can be done fairly simply.

Experimental work on the two Daventries, with a little work on the other British stations thrown in now and then for a change, might easily keep you busy throughout the whole winter.

Helping the Schools

Have you by any chance seen a copy of the B.B.C. programme of transmissions to schools for the school year which has just begun?

My schoolmaster friend lent me his copy of this interesting publication, and, when I had looked it through, I felt as if there was nothing I should like better than to spend my winter afternoons going to school by wireless.

With regard to these school transmissions, the B.B.C. authorities are fully alive to the fact that broadcast



reception in a school must be really good in order to have the desired effect. My schoolmaster friend thinks that reception in a school must be much better than the average reception in the home.

When a school is in difficulties over its broadcast reception the teacher is at liberty to write to the B.B.C. for advice and assistance. Sometimes, in extreme cases of difficulty, the B.B.C. is able to send an engineer to the school.

Requests for visits from an engineer are, however, too numerous for them all to be compiled with, and the B.B.C., in the pamphlet referred to above, recommends teachers to arrange with a local expert for the maintenance and periodical overhauling of the school set.

Is there a school using wireless in your neighbourhood? If so, do you think they would be glad of your help and advice now and then? It is worth thinking about, for I am certain that, if you could lend a helping hand to a school over its wireless set, you would thoroughly enjoy yourself, and you would see results on a larger scale than you are used to seeing in the home.

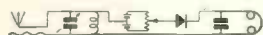

Listeners' Hours

Have you the least idea how many hours of listening you put in during the course of a week? Is it round

about fifteen, or twenty, or thirty, and does it vary from season to season?

If I were asked to make a guess at the average number of "listening" hours per week of the average listener, I should say fifteen. I am well aware that the enthusiastic beginner sometimes puts in two or three times that number of hours per week though.

Some British listeners have claimed a record of twelve hours listening per day, but this substantial figure is dwarfed by—yes, you are quite right—American figures recently issued regarding the hours put in by listeners on the other side of the Atlantic.

Over there, it is claimed that one listener out of every hundred puts in a hundred hours of listening per week. Think of that now, fourteen hours of wireless per day, leaving only ten hours for sleeping, eating and working.

What astounded me, however, about these new American figures on hours of listening was that one listener out of every thousand over



Listeners' Hours

there, uses his receiving set for more than a hundred and forty hours per week, that is for more than twenty hours per day.

It sounded such an utter impossibility to me that I consulted George about it. George was puzzled for a while and then he said:

"I expect they go to bed at night with the phones on and call it listening, and have the loud-speaker going all day."

"Why the loud-speaker in the daytime?" I asked.

"For the same reason that the loud-speaker is more popular than the phones in America."

"And what is that, George?"

"You can't wear phones comfortably and chew gum at the same time."

HALYARD.

Look out next month for some good Sets—amongst them the 1928 Five, the old 1927 Five brought right up-to-date.—Ed.

Many thousands of listeners have really old-fashioned sets of which many of the components can be re-built into a modern circuit. The Five-Guinea Three is a simple and efficient receiver so arranged that components already in the constructor's possession can easily be adapted. It comprises a neutralised high-frequency amplifying stage, a detector, and a low-frequency amplifier, transformer coupled.

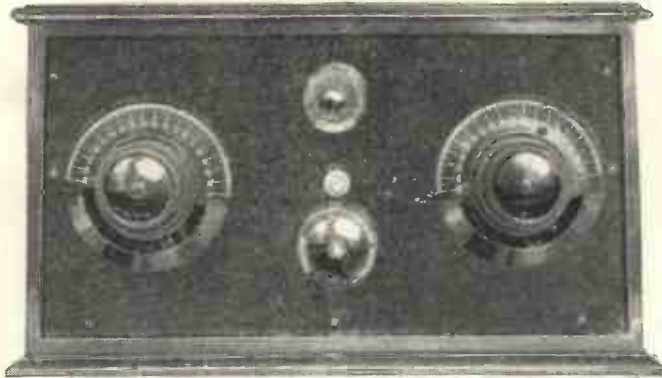

The Five-guinea Three is neat in appearance.

THE FIVE-GUINEA THREE

Specially Designed, Built and Tested by the "W.M." Technical Staff

RIGHT at the start, we may as well say, quite frankly, that we do not claim this set to be the most efficient three-valve receiver that it is possible to design.

Re-building Old Sets

Use has not been made of the latest components, but in producing this receiver the WIRELESS MAGAZINE Technical Staff has had in mind rather the requirements of many thousands of listeners who have old-fashioned sets that can be brought up-to-date by dismantling them and using the old components in a modern circuit.

The Five-Guinea Three gives every owner of a three or four year old

receiver the chance to remodel it on modern principles in order to get better results. For this reason the layout has been so arranged that alternative components can be accommodated without difficulty.

At the same time it is also an efficient receiver that can be built up by those desiring a simple set at a cost of approximately five guineas, and as such it will appeal to many readers who do not wish to spend a large sum in order to receive a good selection of programmes on the loud-speaker.

From the circuit diagram it will be seen that the circuit is very simple. A tapped coil is used for aerial tuning, as this arrangement gives great

selectivity with no increased complexity in operation, while the high-frequency coupling also makes use of a plug-in coil. This coil is centre-tapped so that the high-frequency valve can be neutralised with the simplest and most satisfactory way. Ordinary magnetic reaction is applied to this tuned-anode coil by the use of a two-way coil holder. For the low-frequency coupling use has been made of an ordinary low-frequency transformer.

Cheap Adaptation

It will be readily appreciated that most old-fashioned receivers already incorporate many of the parts required and that for a very small sum an out-of-date set can be easily adapted to modern conditions.

Many listeners, for instance, have complete sets of tapped plug-in coils which they have hesitated to "scrap" in favour of more recent tuning arrangements. Now there is no need for them to bother—they can adapt their existing parts to the design of the Five-Guinea Three, and get the best that is going.

Standard Practice

A glance at the photographs will show that the set follows standard modern practice as regards layout, but this purposely has not been cramped and existing parts will, in most cases, be found easy to accommodate.

In the original receiver built up by the WIRELESS MAGAZINE Technical Staff, of course, old parts were not

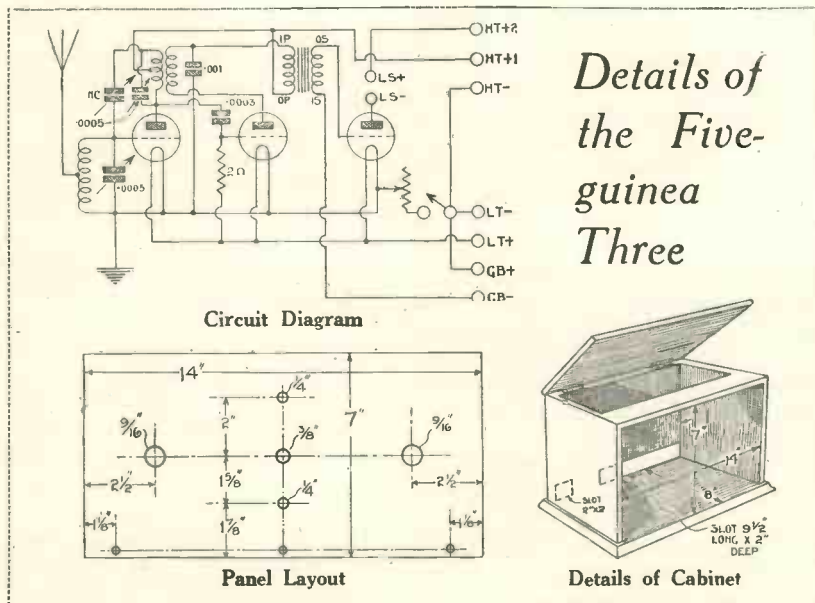

Details of the Five-guinea Three

used and only components of good quality have been incorporated. At the same time, value for money has been considered and the constructor of limited purse may be assured that in building the Five-guinea Three he will be getting the best possible value for his money.

Loud-speaker Results

Nobody will deny that the receiver is neat in appearance and although, as was stated at the beginning of this article, no claim is made that this is the *most* efficient three-valver it is possible to design, yet it is very efficient for its type and will be found quite satisfactory for those who are content with receiving a moderate number of stations on the loud-speaker.

On the left of the panel is the dial for the aerial tuning condenser, while the condenser for tuning the anode circuit is placed on the right. Between the two are mounted a master rheostat for all three valves (top), an on-off filament switch (middle) and the control for the two-coil holder (bottom), operation of which varies the coupling of the reaction coil to the tuned-anode coil.

A glance at the photographs showing the back of the receiver will show the general layout of the components on the baseboard. Looking from the front of the panel (in the plan view) it will be seen that the socket for the aerial-tuning coil and the holder for the high-frequency valve are mounted directly behind the aerial-tuning condenser on the panel. In the centre is the two-way coil holder with the detector-valve holder immediately behind it and the baseboard-mounting neutralising condenser on the left. Behind the anode-tuning condenser on the panel are the low-frequency transformer and the holder for the low-frequency amplifying valve.

Components Required

Following is a complete list of all the components required for the building of the Five-guinea Three, but it is expected that many constructors will already have a large number of suitable parts in their possession:

Ebonite panel, 14 in. by 7 in. (Redferns or Will Day).

2 .0005-microfarad square-law variable condensers (Utility or Dubilier, Peto-Scott).

15-ohm rheostat (Lissen or Igranic).

On-off switch (Lissen or Lotus, Benjamin).

3 antimicrophonic valve holders

Valves to Use in the Five-guinea Three

Make	H.F. Amplifier			Detector			L.F. Amplifier		
	2-v.	4-v.	6-v.	2-v.	4-v.	6-v.	2-v.	4-v.	6-v.
B.T.H. ...	B21	—	B4H	B22	—	B4H	B23	—	B4
COSSOR ...	210 H.F.	410 H.F.	610 H.F.	210 Det	410 Det	610 Det	220 P	410 P	610 P
EDISWAN ...	ARDE H.F.	GP4	ES5 H.F.	DR2	GP4	ES5 L.F.	PV2	PV4	PV5
MARCONI ...	DEH 210	DEH 410	DEH 610	DEL 210	DEL 410	DEL 610	DEP 240	DEP 410	DEP 610
MULLARD ...	PM1 H.F.	PM3 H.F.	PM 5X	PM1	PM3	PM5	PM 252	PM 254	PM 256
OSRAM ...	DEH 210	DEH 410	DEH 610	DEL 210	DEL 410	DEL 610	DEP 240	DEP 410	DEP 610
SHORTPATH	SP18 G	—	DE50	SP18 G	—	DE 50	SP18 RR	—	SP55 RR

(Precision or Lotus, Benjamin, W.B.)

Low-frequency transformer (Lissen or Formo, G.E.C., Peto-Scott).

2-megohm grid leak with clip (Lissen or Dubilier).

Single coil holder (Lotus or Peto-Scott, Lissen).

2-way coil holder (Lissen).

Baseboard-mounting neutralising condenser (Peto-Scott or Wearite).

.0003-microfarad fixed condenser (Lissen or Peto-Scott, Igranic).

.001-microfarad fixed condenser (Lissen or Peto-Scott, Igranic).

Panel brackets (Collett).

2 terminal strips, 10 in. by 2 in. and 2 in. by 2 in. (Redferns or Will Day).

11 terminals marked:—Aerial, Earth, H.T.+1, H.T.+2, H.T.—, L.T.+ , L.T.—, G.B.+ , G.B.—, L.S.+ , and L.S.— (Eastick).

2 slow-motion condenser dials (Utility or Igranic, Peto-Scott).

2 dial indicators (Bulgin or Belling-Lee).

Cabinet and baseboard (W. & T. Lock).

10 ¼-in. wood screws (Economic Electric).

24 ½-in. wood screws (Economic Electric).

8 ¾-in. wood screws (Economic Electric).

6 ½-in. 4B.A. brass screws with nuts (Economic Electric).

Glazite for wiring and 1 ft. flex.

It should be noted that in each case the particular component used in the original set and allowed for in the layout is mentioned first.

Full-size Blueprint

As is the case with all WIRELESS MAGAZINE sets a full-size blueprint drilling guide, layout, and wiring diagram is available. By using the coupon on page iii of the cover, a copy can be obtained for half-price

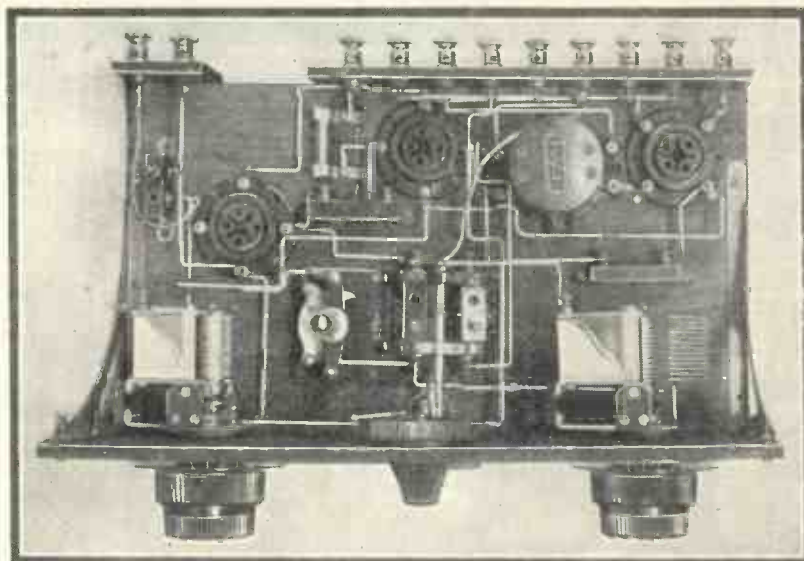

Plan view of the Five-guinea Three, clearly showing disposition of components

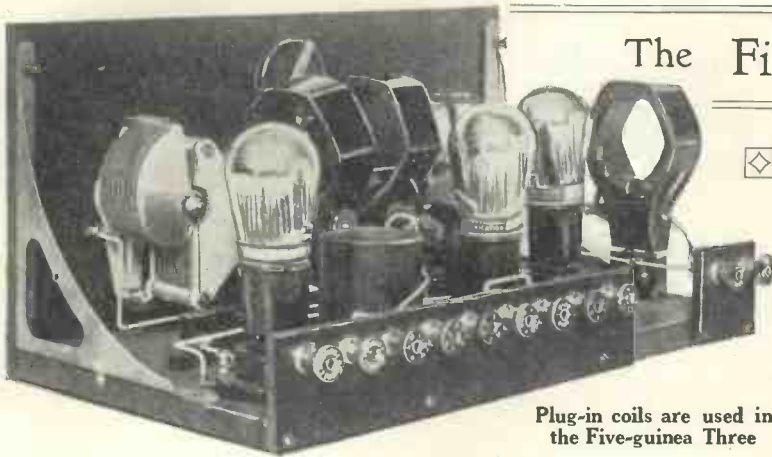

The Five-guinea Three (contd.)

Plug-in coils are used in the Five-guinea Three

(6d. post free) up to the end of November. Ask for blueprint No. WM29 and address your enquiry to Blueprint Dept., WIRELESS MAGAZINE, 58/61 Fetter Lane, E.C.4.

Adapting the Blueprint

Although the drilling holes are intended only for the actual components used in the original receiver, any constructor will be able to adapt the blueprint to his own requirements and will find it an invaluable aid in laying out and connecting up his set. Of course, a blueprint is not absolutely essential, and all the essential details are clearly reproduced in these pages.

For the constructor who is adapting an old set, the first thing is to pick out suitable components he already has, before buying the necessary extra parts. In this connection it may be said that a .0003-microfarad variable condenser is quite suitable for tuning the anode circuit (although the wavelength range will be rather limited with one set of coils), while almost any low-frequency transformer can be used.

Mounting the Components

As soon as all the necessary parts have been got together, the panel should be laid out and drilled as required. When this has been done,

mount the panel components and fix the panel to the baseboard by means of the brackets. Now lay out the baseboard components, keeping as closely as possible to the original arrangement illustrated in these pages.

When satisfactorily arranged and when everything has been fixed firmly into position, wiring up can be started. And here the full-size blueprint will be found invaluable in saving time and trouble whatever

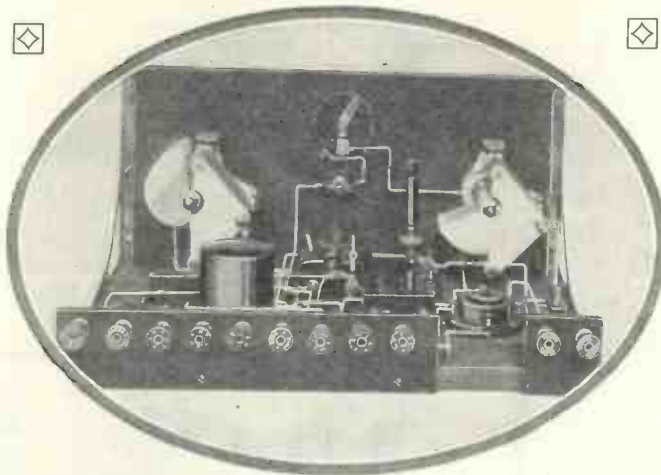

The lay-out of the Five-guinea Three is not cramped in any way

alternative components have been utilised.

A glance at the blueprint or the wiring diagram reproduced in these pages will show that each terminal point is marked with a small letter of the alphabet; these small letters indicate the *order* in which wiring should be carried out in order to get the best results.

Thus all those points marked *a*

should first be connected together with one wire or as few wires as possible; then all those points marked *b* should be connected; and so on throughout the alphabet. It is important that wiring should be carried out with the sequence indicated.

Making a Rough Test

As soon as all the wiring has been completed the set is ready for a rough test. Insert in the aerial-coil holder a No. 50 or 60 tapped coil and attach the flexible lead from the aerial terminal to the tapping terminal on the coil. In the tuned-anode coil holder (on the left looking from the front of the set) place a No. 75 centre-tapped coil and attach the flexible lead from the terminal on this to the H.T. end of the L.F. transformer primary. A No. 35 or 40 coil (not necessarily tapped) will be found suitable for use as reaction in the remaining coil socket. (It should be noted that these sizes refer to the reception of the London station or other B.B.C. stations working on about the same wavelength; whenever in doubt as to the best coils to use always consult the manufacturers' lists, remembering that both aerial and anode coils are tuned by .0005-microfarad variable condensers.)

It is not essential to use a tapped aerial coil, although this will give considerably increased selectivity. If an ordinary coil is used,

however, the flexible lead from the aerial terminal should be connected to the screw marked *a* on the coil holder (see wiring diagram or blueprint).

Suitable Valves

As regards valves, operators are recommended to consult the list given in these pages. In general the high-frequency amplifier should have

Half-price Blueprints of Any Set Described in This Issue—

Simple and Cheap, Yet Efficient

an impedance of the order of 20,000 to 40,000 ohms; the detector valve should have an impedance of 15,000 to 30,000; whilst the last valve (low-frequency amplifier) should have an impedance in the neighbourhood of 8,000 ohms or less.

Battery Condensers

To H.T.+1 connect a voltage of approximately 50 or 60 volts, while to H.T.+2 a voltage of about 100 to 120 should be applied. The amount of grid bias required depends upon the type of valve used in the last stage, but in general a voltage of 6 to 9 will be found suitable.

After connecting all the necessary batteries, loud-speaker, aerial, and earth, turn the knobs of the variable condensers until any weak carrier wave is picked up. This should be accomplished with the reaction coil as far away from the anode coil as is possible.

The next step is to neutralise the high-frequency valve so that no feed-back occurs and thus oscillation is prevented. Neutralisation can be accomplished without switching off the filament of the high-frequency valve; just adjust the neutralising condenser on the baseboard until the carrier wave becomes quite inaudible.

After this the reaction control can be used in the ordinary way, but not more than is absolutely necessary.

Satisfactory Neutralising

Some readers may wonder what is the use of neutralising the valve when reaction is incorporated in a magnetic form, but in practice it is found to work quite satisfactorily and the reaction coupling can be varied to a surprising extent without affecting neutralisation. If oscillation does occur a very slight readjustment of the

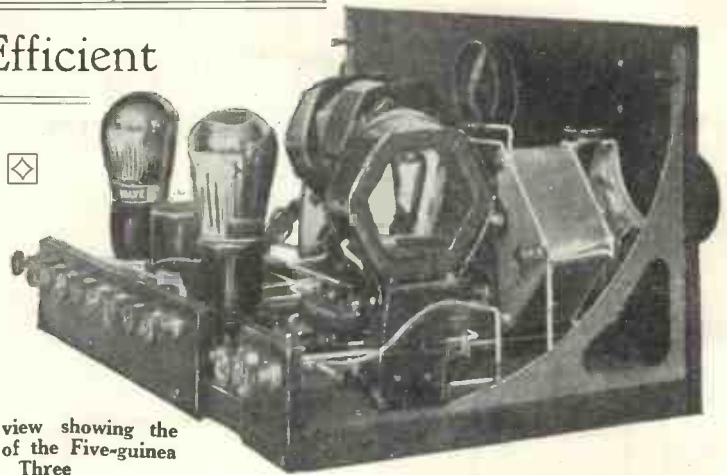

Another view showing the neatness of the Five-guinea Three

neutralising condenser will put matters right.

Final adjustments can be made by manipulating the filament rheostat and the grid-bias tapping.

On test we have found this set to give remarkably good results, especially in the matter of quality—in spite of the fact that use has been made of the cheapest British transformer on the market. Readers who build the

Our Great Exhibition Success!

EVERYBODY is agreed that this year's radio exhibition was a phenomenal success, and no reader of the WIRELESS MAGAZINE who visited our stand at Olympia could fail to be impressed by the enthusiasm which the Exhibition Five and the Screened-grid Three provoked.

From morning till night our stand was inundated with visitors enquiring about particular points of this and that set, and our Technical Staff was kept fully occupied throughout the whole week of the Exhibition in answering all kinds of questions.

Large numbers of readers who had already bought their current issue of the WIRELESS MAGAZINE took advantage

of the opportunity that the show gave them of obtaining their half-price blueprint without the need of sending for it by post.

The sale of blueprints for all kinds of receivers passed all records, and there is no doubt that there will be many thousands of homes which will, this winter, be made brighter thanks to their having a WIRELESS MAGAZINE receiver in use.

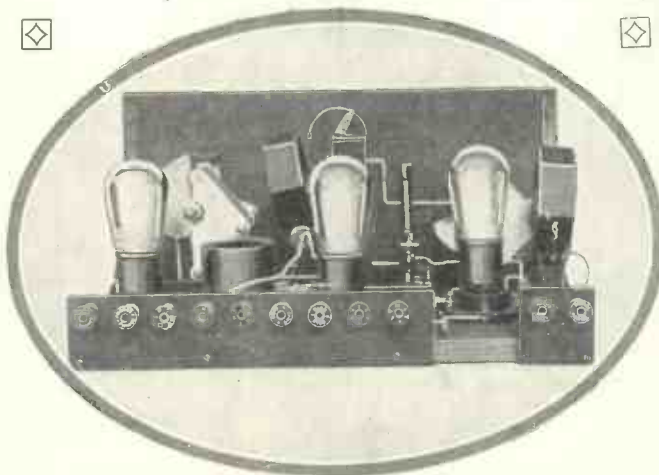

The Five-guinea Three with valves and coils in position

Five-guinea Three will find that, although not having absolutely the best that present-day radio technique can give them, they have a set that is surprisingly good and they will not be disappointed in the results obtained.

The wiring diagram of the Five-guinea Three is shown on the next page

—Just Cut the Special Coupon Off page iii of the Cover

The Five-guinea Three (Continued)

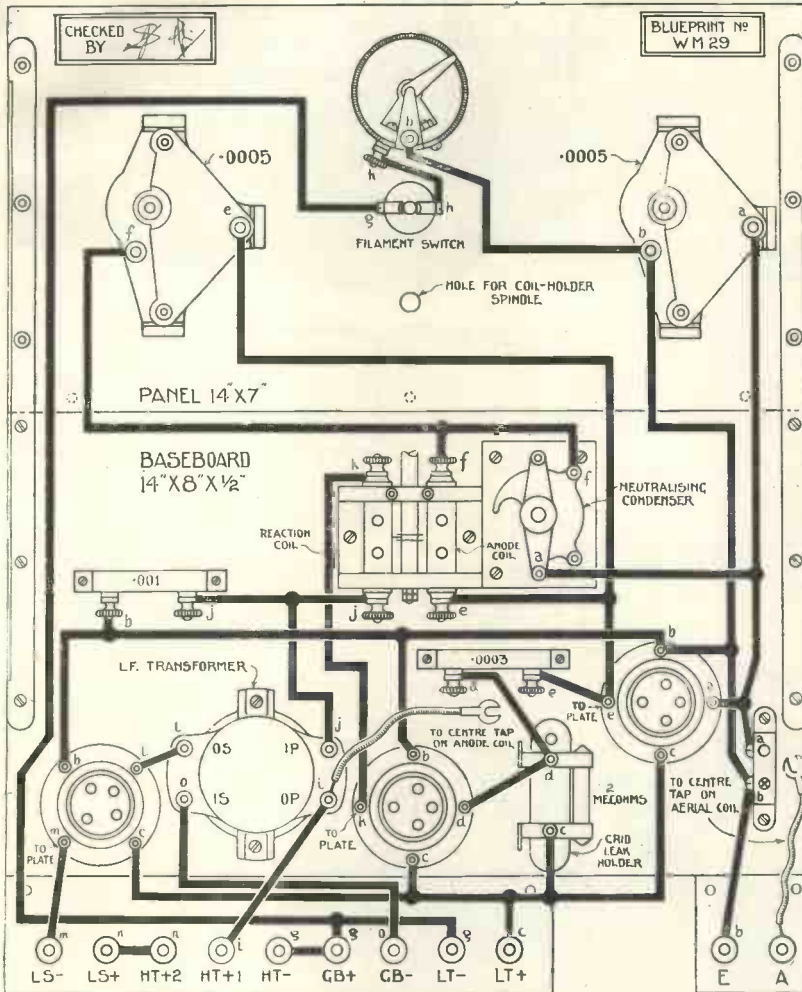

Layout and Wiring Diagram of the Five-guinea Three. This can be obtained as a full-size blueprint (No. WM29) for half price (6d., post free) if the coupon on page iii of cover is used before November 30

sheet before him and smiled wryly. Those familiar closely printed lines could give him no inspiration.

He knew what his conscience bade him do. Follow the harder road, the road that led to the heights, the road he had always boasted he would follow. The other way was soft, comfortable, even amusing, but it meant the end of his superiority.

He felt his wife's gaze upon him. She smiled.

"Well, which is it to be?"

The words seemed to nerve him in a strange manner.

By George! he would be honest and do the right thing.

"To-night," he said firmly to his guests, "to-night, I think we'll try the dance music from 5GB instead of 2LO's chamber concert."

J.A.D.

A New Flexible Wire

A NEW type of electric cord, which will no doubt find its uses in wireless construction, has been invented by a Hungarian engineer. Its peculiarity is that it will act in the same way as a push-button switch when pinched or squeezed at any point along its length.

This ingenious effect is produced by plaiting the actual conducting wires of the "flex" into a loose braid, the wires being normally separated by an elastic non-conductor or insulator, but so arranged that they make contact when a decided pressure or pinch is applied to the cord.

Immediate Stoppage

The new conductor has already found useful applications in connection with complicated machinery where any unexpected hitch may threaten sudden danger to the operator. Immediate stoppage is ensured by pinching the cable in any position, or by pressing it with the knee or elbow, an obvious advantage over the use of the ordinary switch fixed in some position which in the moment of emergency may be out of reach. Laid under a carpet or stair-covering, the cable may serve either to actuate a burglar alarm or to give immediate automatic warning of the approach of a visitor.

B. A. R.

Which Would You Choose?

WHAT a decision to make! And yet William Thomson knew he must make a decision soon, within the next few minutes. Each moment lost could never be made up.

One way lay the old safe path, one that he had traversed a thousand times before. Despite its seeming dullness, compared with this new possibility, it would save his self-respect. He knew it was what his neighbours expected him to do.

Even now he noticed curious glances being directed towards him for his obvious indecision, glances of impatience.

Was little Chamings laughing at him? Thomson felt he was. He knew if he deserted his high principles he could no longer be contemptuous of Chamings. At least, Chamings had the courage of his convictions.

He looked again at the crumpled

5YM, the Well-known Experimenter, Writes on Special—

SHORT-WAVE TOPICS

AT last, after many years of striving, it seems likely that short-wave enthusiasts will be able to abandon the favourite and familiar detector and "one-step," and add a stage of radio-frequency amplification that will really work on 100 metres and below. At any rate there are, at the moment, two possible ways of doing it. One is already highly successful and employs ordinary valves. The other employs the new screened-grid four-electrode valve. This development seems to me to be the most outstanding feature of the present short-wave situation and so I mention it first.

What Is the Good?

You may ask me what is the good of radio-frequency amplification when we can already hear signals from all over the world by using a simple detector followed by one stage of audio-frequency amplification.

My answer is that, in the first place, anyone who has spent hours on end trying to read R2-1 signals from the other side of the earth will welcome anything, even if it is just a trifle more complicated to tune, that will give him those signals at R5-4. And that is what the most developed of the two new methods will do "right now."

In the second place those who like to listen to long-distance telephony will be glad of something that will give them all the short-wave telephony stations at such strength that most of them can be taken on a loud-speaker with only the three valves.

L.F. Not Much Good

Audio-frequency amplification, when it is more than one step, is not very successful for the reception of short waves. It seems to magnify noises, both those from the ether and those from the set, to a greater extent that it magnifies the actual signals. This can be got over, to a certain extent, by the use of resistance-capacity coupling: but even this does not effect a complete cure for the evil, which is chiefly due to

the fact that the set has to be worked in an extremely sensitive condition.

And there we come to another benefit of a stage of radio-frequency amplification. The detector need not be worked quite so close to the oscillation point, which means both a

gain in stability and a lessening of noises.

Recently I have been having some curious and disappointing experiences on 23 metres. After doing very little
(Continued on next page)

Sir Henry Wood of "Proms" Fame

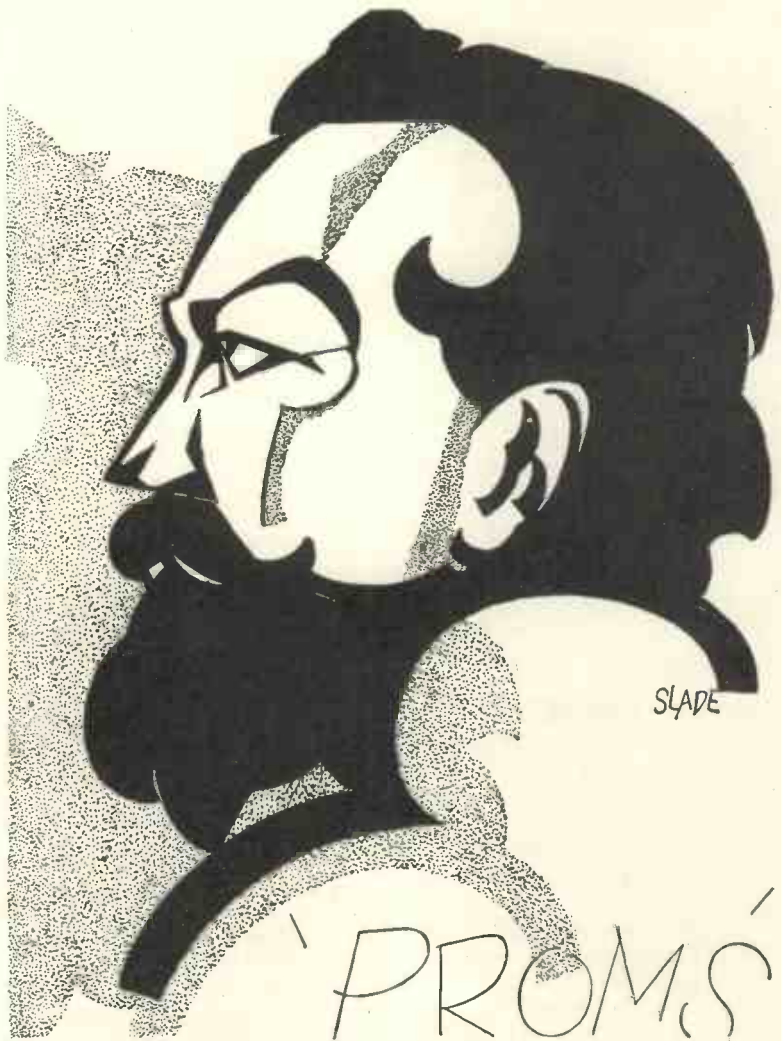

Slade's impression of the famous conductor who has proved one of the greatest assets to the broadcast programmes

Short-wave Topics (Continued)

actual transmitting during the so-called "summer" months, I decided to go all out for some prolonged 23-metre tests, to try and determine what really is the best form of aerial for this work.

In the spring I had found this wavelength most interesting and highly successful for working both North and South America. I went to it with every confidence and worked six stations the first two nights, all between 11 o'clock and half an hour after midnight (B.S.T.).

Four Appointments

I made four appointments for the next ten days, one for the following night. When I say four appointments, I mean that I arranged with four stations to be ready for me at a fixed hour on certain nights, one one night and another on another night. When I sat down to the key to keep the first of those appointments there was not a sound to be heard from any N.U. station. The night was completely "dud" for as long as I cared to keep my watch. The same conditions obtained for about nine days and then all my appointments were broken.

Then came another couple of good nights and, ever hopeful, I arranged some more tests. But I was done down again, which shows how uncertain a thing this short-wave work is, even when you are using medium-high power, for an amateur. Of course had I had two or three kilowatts I could have blazed through; but 50 watts was no good at all.

Empire Broadcasting

So we have empire broadcasting, at last, though it is, at present, in the hands of an amateur, as I prophesied it would be a month or so ago. There isn't a better man to tackle the job than 2NM and we are all very "bucked" with him and glad that he making a "do" of it.

But it is a hefty job for an amateur to tackle and only a man with a very great deal of knowledge, and fairly well fixed with this world's goods,

could have undertaken it. Without a doubt "Gerry" Marcuse is the best known amateur in the world and one of the best-loved in the fraternity, for his genial character and good sportsmanship win him a host of friends wherever he goes.

I sometimes wonder if the amateur

START WITH A CRYSTAL SET!

At very small cost you can build yourself an excellent crystal set to receive, in many cases, more than one programme. Here are three that have recently been described in the "Wireless Magazine." Full-size blueprints can be obtained for 6d. each, post free:

TWO-PROGRAMME CRYSTAL SET, p. 109, September, 1927. (Blueprint No. WM25).

HI-LO CRYSTAL SET, p. 526, July, 1927. (Blueprint No. WM18).

FONOTROL CRYSTAL SET, p. 418, June, 1927. (Blueprint No. WM14).

Address all your enquiries to Blueprint Dept., "Wireless Magazine," 58/61 Fetter Lane, E.C.4

transmitters of Great Britain all realize how much they owe to "Gerry" for the privileges they now enjoy in the way of facilities for an extended enjoying of their hobby.

Very few of those who do short-wave work now attempt to get the necessary feed-back from plate to grid of the detector by means of a swinging

Don't Forget Your Half-price Blueprint—Use the Coupon on Page iii of the Cover

reaction coil. Even with the well-made modern coil holders the method is altogether too "kittle" on the shorter waves, though it can be used all right down to about 100 metres.

The favourite method is to use one of the several adaptations of the idea of fixing the reaction coil and controlling the feed-back by means of a variable condenser. This necessitates the use of a high-frequency choke coil in the plate circuit, which is liable to bring a certain amount of trouble in its train because it has a definite wavelength and harmonics of that wavelength stop oscillation.

Two Solutions

There are two ways of getting over this. One is by dividing the choke into two portions and connecting the middle point to the filament of the valve through a small fixed condenser. The other is by removing the choke altogether and substituting for it a resistance of between 25,000 and 50,000 ohms.

For sets employing transformer coupling to the output valve I prefer the latter method. I have found it highly successful down to as low as 8 metres—and there are no blind spots in the tuning anywhere.

For the first time the short-wave enthusiast found a very great deal to interest him at the National Wireless Exhibition. In former years short-wave sets or short-wave coils or other gadgets were hard to find. This year a number of manufacturers were making a special feature of them.

A Selection

It is not possible here to mention all the good things there were to be seen, but the Bowyer-Lowe Co., Ltd., had not only their already well-known short-wave receiver, but also some remarkably good lines in valve holders and chokes, Eddystone and Collinson's Precision Screw Co., were showing excellent short-wave coils, the latter being particularly taking in appearance and, as I know from experience in performance also.

I think the exhibit which attracted me most was that on the Igranic stand, for not only was there a very beautiful short-wave transmitter, but a short-wave receiver with a stage of H.F. amplification.

Are You Building the Exhibition Five?

The Chaos in the United States

THE map accompanying this article shows the number of broadcasting stations in each state of the United States of America. Compiled from the latest available list of six hundred and eighty-six broadcasting stations, the map is of special interest in view of the attempt which is now being made to reduce the chaos in the American ether.

For the sake of comparison, a map of the British Isles is drawn in the figure to the same scale as that used for the map of the United States.

Over 700 Stations

Other recent estimates of the total number of broadcasting stations in the United States give over seven hundred such stations, but it is probable that a considerable number of portable transmitting stations of indefinite location are included in those estimates.

Taking the United States as a whole, the number of broadcasting stations works out at about one for every 4,400 square miles of land area. The most interesting point about this figure perhaps, is that it is practically

the same as the corresponding figure for Great Britain, which has twenty broadcasting stations for its 88,000 square miles of land area.

It will be readily seen, however, from the map given herewith that the broadcasting stations in the United States are by no means evenly

one broadcasting station to every two million people.

Of course, the chief consideration in the matter of the number of broadcasting stations which should be in existence is the number of ten-kilocycle intervals in the frequency band available.

U.S. Frequency Band

In the United States, the latest scheme assumes a frequency band from 1,500 to 550 kilocycles, or, in wavelengths, 200 to 545 metres. In this frequency band there are only ninety-six ten-kilocycle intervals. At present, in the United States, there are seven hundred broad casting stations in a band of frequencies in

which there should only be ninety-six.

Small wonder then, that the new Federal Radio Commission of the United States has under consideration, as its *first* attempt to free the American ether from its present chaotic condition, a plan to reduce the number of broadcasting stations to one half the present number.

E.H.C.

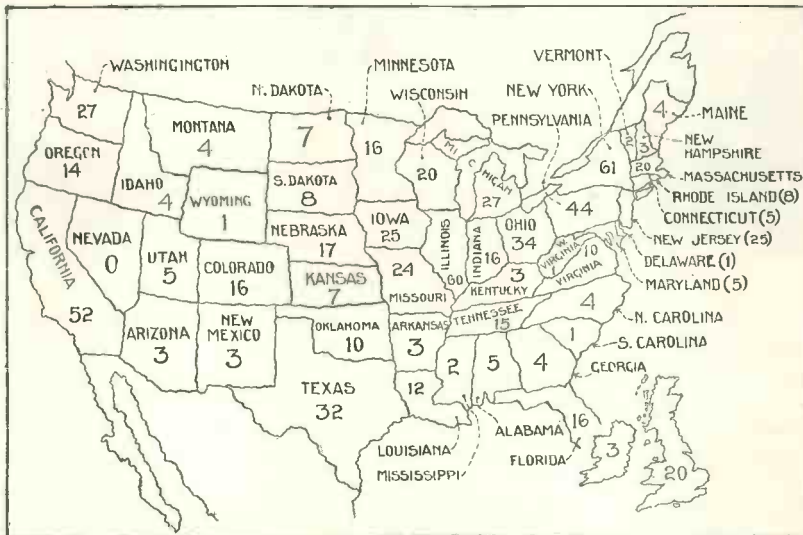

Map of the United States and Great Britain showing the relative distribution of broadcasting stations

distributed over the whole land area. In fact, more than two-thirds of the stations are crowded into the eastern half of the area.

Using population figures as the basis of comparison, we get the following interesting result: In the United States, there is one broadcasting station for approximately every hundred and fifty thousand people. In the British Isles, we have

Things to Know About

Anode Resistances

These are the resistances used in the plate circuits of valves, coupled by the resistance-capacity method, and usually have values between 80,000 ohms and a million ohms.

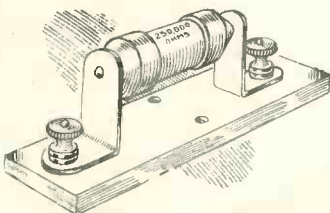

They are usually made up in the form of damp-proof "cartidges" fitted with a pointed metal cap at each end as shown here.

Things to Know About

High-frequency Chokes

High-frequency choke coils are used when it is desired to prevent the passage of oscillatory current while allowing direct current or alternating current of low frequency to flow easily.

They consist of a large number of turns of wire (usually fine) wound so that the whole coil has a high inductance and a low self-capacity. In the type shown in the illustration the wire is wound in a number of well-spaced slots cut in an ebonite former.

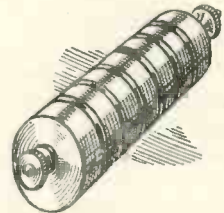

An Article of Interest to Every British Listener : By J. GODCHAUX ABRAHAM

ALTHOUGH the B.B.C. is senior to the parent syndicate of the German Reichsfunk by roughly one year—an appreciable period in the history of broadcasting—there is little doubt that such cities as Berlin, Hamburg, Frankfort-on-Main, Cologne and Stuttgart have so rapidly developed their individual organisations and extended their programmes that to-day they have already caught up the British pioneers, and in some ways broken fresh ground on their own initiative.

From a study of the programmes broadcast by the main German cities, and a careful comparison with our own, I am inclined to think that we can learn something from them.

This is not stated in a spirit of carping criticism, for it must be patent to all that the most difficult work to be accomplished was that effected by the B.B.C. in the early days, when a special organisation had to be set up to meet totally new requirements in the world of entertainment, and for which there existed no precedent.

It is equally true that other European countries, realising the benefits which radio could bestow on the masses, faithfully copied, at least during the first two years, the programmes provided for us by our home organisation. In every instance our "imitators" were able to profit directly by our experience, and in this manner were considerably assisted in adapting their resources to the requirements of their nationals.

Extended Activities

Gradually, week by week, month by month, the B.B.C. has extended its original activities and, on an average, now gives to the listening public wireless entertainments during some twelve hours of the day, but apart from a weather forecast transmitted at 10.30 a.m. for a period of a



View of the Frankfort Broadcasting Station

few minutes, but few home stations are on the air before noon.

On the other hand, the Germans have realised that there exists a demand for radio transmissions at earlier hours of the morning, and it will be found that studios such as those of Berlin, Hamburg and Frankfort-on-Main provide music, entertainments and news bulletins for their subscribers from 9.0 a.m. onwards—in some instances even earlier.

News Bulletins

If a comparison of the news bulletins be made between the English and German organisations, both as to number and duration of broadcasts, it will be noticed that on this side whereas such items are given out but twice daily, in the course of the evening transmission the Reichsfunk broadcasts to its listeners early morning summaries of topical events, and follows these up by intermittent transmissions at various periods throughout the day. Admittedly some of these contain but little apart from Stock Exchange quotations and market prices, but it is still a matter of conjecture whether such information might not be of interest to the British public.

Pre-lunch transmissions have been made in the past by the B.B.C., not so much perhaps for the entertainment of private listeners, as for demonstration purposes by the trade.

Such broadcasts are recognised by the Germans as of *absolute necessity*, having proved themselves of considerable utility. On some days, for these purposes, gramophone records alone are transmitted. The time chosen for these broadcasts being the one at which the shops and stores are thronged with customers and the fact that the dealers thus have radio transmissions at their disposal for trying out receiving sets to prospective buyers, has been found invaluable to the German radio industry, for the sale of gramophone instruments, and records.

It might further be stated that morning transmissions, be they of orchestral or mechanical music, must provide enjoyment to numbers of patients in hospitals or nursing homes who, in the ordinary course, are not able to listen to the later evening concerts. In most of these institutions the day begins at an early hour, and conversely 8 p.m.—the time at which the main broadcast featured by the B.B.C. usually starts—is the one which medical authorities usually choose for the "close down" of their wards or private sick rooms.

Unfulfilled Aim

For this reason only the installation of wireless receivers and headphones, in hospital, although in every respect a laudable effort, does not fulfil its ultimate aim; for the present at least, the patients, except for the midday lunch transmission, do not get the benefit of the best concerts broadcast during the day.

It must be agreed that, on the whole, the lectures to schools and the children's hour are but of minor interest to invalids or the sick in hospitals, and from this point of view I consider that the Germans have adopted a policy which must have met with general approval.

(Continued on page 302)

LANGENBERG-

THE GERMAN HIGH-POWER BROADCASTING STATION

This huge station—the "5XX" of Germany—is very well received in this country. It works on a wavelength of 468 metres.



Small studio at Cologne used for Langenberg transmissions.

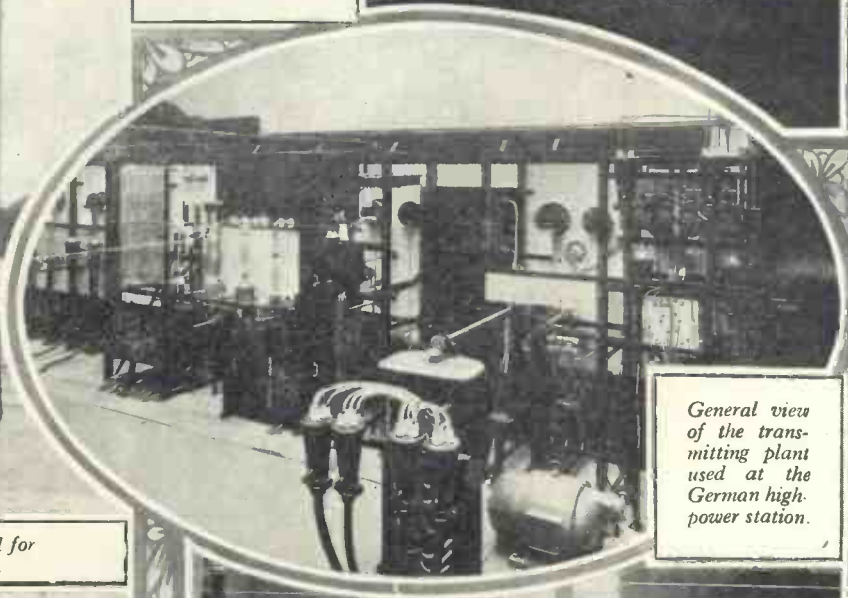

General view of the transmitting plant used at the German high-power station.



Trenches for the elaborate "earthing" system used at Langenberg.

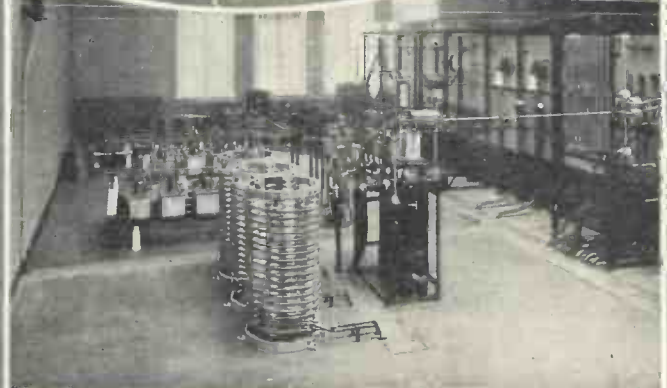

Another view of the huge transmitter, which uses a power of 25 kilowatts.

What Can We Learn from German Broadcasting? (Continued)

Most of the instructional and educational talks in that country have been expunged from the locally transmitted programmes, and have been handed over *en bloc* to an association entitled Die Deutsche Welle to be handled through the high-power long-wave station of Königswusterhausen, thus leaving the medium-power transmitter almost free for programmes of a more entertaining nature.

On the whole the German morning transmissions are mainly devoted to subjects concerning housekeeping, of interest to the housewife, as it is realised that at these hours, the male adult and the juvenile members of the family being busy elsewhere, the feminine portion of the household is equally entitled to recreation.

Following the usual "lunch" music, and during the afternoon, at a time when the lady of the house has friends at her "kaffee-klatsch," a broadcast is usually made from the local studio of kitchen recipes, hints on the upbringing of the family—not to say on the management of husbands—and a short review is also given of plays and other outside entertainments; a few chapters of a new book may be read; society "titbits" are related; and much is done to keep the German woman *au fait* with social news or any developments concerning her welfare. The average *hausfrau* spends but few moments of her time in reading the daily paper.

Children's Hour

On the other hand in most of the radio programmes you will find that the children's hour, contrary to our practice in England, is far from being a daily feature. The German gymnasium and Real-schule are scholastic institutions run by the State, where education is carried out on the intensive principle; the hours of attendance are long—in the summer months

classes may begin as early as 7.30 or 8 a.m.—and the boys and girls are burdened with such an amount of homework that on most days it is a matter of impossibility for them to listen to radio broadcasts before the evening meal.



A new German loud-speaker disguised as a pedestal table

Entertainments for children, therefore, are broadcast either on Saturday or Sunday afternoons. There is no broadcast to schools, as carried out by the B.B.C. from the local stations; in Germany all tuition in languages and courses of lectures are transmitted through the Königswusterhausen high-power station.

"Solid" Entertainment

If a study be made of a number of German radio programmes, the reader will be struck with one noticeable feature, namely, that the main evening broadcast, which usually starts at 8 or 8.30 p.m., constitutes solid entertainment for some two hours; it is continuous, and neither interrupted nor broken up by short topical or other talks. As a rule, the final news bulletin is given at a late hour, and almost without exception immediately before the studio goes over to some outside source for its dance transmission.

The later broadcast of the news bulletin possesses the great advantage of enabling the responsible authorities to include in their summary items which could not have reached them

at an earlier hour, and on many evenings, for my own information, I have turned to continental stations for supplementary details regarding matters which, owing to the earlier hour, could only be scantily dealt with by the home transmitters.

In my opinion, the "unit" style of programme, during the evening, without interruption by extraneous matters, provides more satisfaction than the "jazz" form of entertainment. If, on this particular night, the programme does not contain items capable of appealing to one's taste, other distractions may be found elsewhere; in the case of a mixed programme where it is desired that at odd times the receiver should be switched on it will be found that unless careful note has been made of the times,

many of the desired numbers will be missed, to the general regret of the entire household.

With the German stations, generally, when talks are broadcast, they follow successively between 6.30 and 7.30 or 8 p.m., leaving the licence holder the option of listening to them or not, as he pleases, without any risk being run of any loss of the main portion of the evening's entertainment.

The conditions governing the organisation of programmes for the various transmitters differ greatly between this country and Germany, inasmuch as in the United Kingdom most broadcasting arrangements for its twenty-two stations are made at the Savoy Hill headquarters. This centralisation of effort compels the B.B.C., in particular for its S.B. transmissions, to make up fixed programmes some considerable time in advance of the dates of transmission.

Local Entertainments

In Germany, apart from specific simultaneous broadcasts which are considered of national interest, the

A Special Article by J. Godchaux Abrahams

bulk of the entertainments are arranged by the local studios, and consequently considerably more initiative is allowed to the individual organisers. Such a policy allows more elasticity, and the studio is not bound to time to the same degree as our own stations.

Relays

Relays to the "broadcaster" of local fetes, topical events, dramatic performances and other outside occurrences are encouraged and, notwithstanding the fact that an entertainment for an evening may have been provisionally decided upon, should any event take place which is deemed of greater interest to listeners, the studio does not hesitate to scrap a portion of its programme for the inclusion of more up-to-date transmissions.

In the matter of operatic performances the German stations enjoy advantages which unfortunately are not within the grasp of the B.B.C. Most German cities of any importance possess an opera house subsidised by the tax payers, and considerable use is made of this asset. There can be no question of mere excerpts of a composer's work, the opera on every occasion being broadcast in its entirety as presented to the audience.

Such cities as Berlin, Hamburg, Frankfurt-on-Main, Leipzig, Stuttgart and Munich run an opera season during ten months of the year; the fact that a performance is broadcast is not considered prejudicial to the box-office returns. From the earliest days of radio the German authorities have realised that a theatre can only be filled to the extent of its seating capacity, and that great publicity for future performances can be gained by

a radio broadcast to the overflow and unseen audience.

In this country, when the B.B.C. desires to relay from a theatre, it is only allowed to do so in small doses; this equally applies to operatic performances, and if the work is to be presented *in toto*, the Corporation must perforce present it in its own studio. Such a transmission, however well prepared, cannot possibly vie in production and finish with a performance staged at a permanent opera house in which the work is part of a thoroughly rehearsed repertoire, for which, in most instances, a special cast has been engaged for the entire season.

Half-price blueprints of any sets described in this issue can be obtained by using the coupon on page iii of the cover

In many ways, no doubt, the B.B.C. has been handicapped in its development of operatic broadcasts, for on these lines we possess no national or municipal opera houses from which trained singers can be drawn.

In the matter of orchestras, although our cities do not offer anything approaching the number available to the German broadcasting stations, we still possess artistic combinations in every way comparable to the best continental efforts. Our symphony concerts, and the Queen's Hall "Proms" to which the B.B.C. has very happily endowed a new lease of life, are unanimously and enthusiastically praised by continental wireless and musical circles.

Further, in respect to the broadcast of dance music, no comparison is possible, as without doubt our transmissions of such items are *hors concours*. Both 5XX and, more recently, 5GB have been held up to the individual European stations by their listeners as a standard to be achieved. The Savoy Havana, Orpheans, Jack Hylton, and other bands nightly on the air are accepted patterns by most *Tanzkapelle* in Germany, on which it is hoped they will be modelled. In this feature of the day's programme we excel, as would bear witness any radio fan who takes the trouble to make a round of the continental broadcasters.

Although it is an accepted fact that "comparisons are odorous," I think that from time to time an unbiased review of the continental programmes is a wise step to adopt. The B.B.C. has acted as an enthusiastic pioneer in European broadcasting; it has made considerable progress and has achieved much. Although, to a certain degree, the Germans have imitated our best features, they have devoted considerable thought to the preparation of their radio programmes, in some instances they have developed them on original lines, and fresh ideas have been evolved which have benefited their individual organisations.

Learning from Others

We may have been first in the field, we may have effected most of the donkey work, but many active competitors have since arisen to wrest away our laurels; to-day it is possible to learn something from their efforts and achievements.

J. GODCHAUX ABRAHAMS.

Meet the
Gresham
Singers!

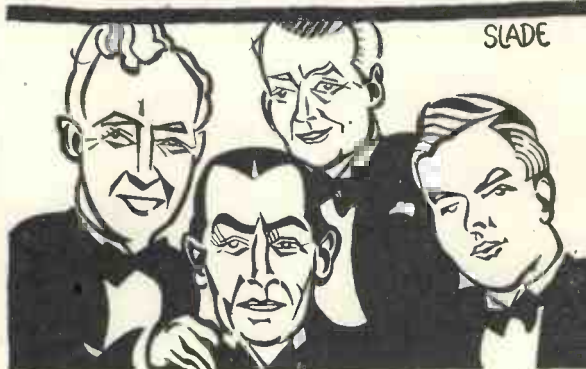

Slade's impressions
of the group of
Artists that has
so often charmed
listeners

You Will Get No Shocks if You Read This Article on—



Using the House Mains With Safety



There is no danger if you take a few simple precautions

THERE are undoubtedly very great advantages in deriving the current required for a wireless set directly from the electric-lighting mains, instead of using batteries, and this method of working is likely to become very popular in the near future.

Uncertainty

Doubtless many more people would at present be using the mains for wireless purposes were it not that they are rather afraid to do so because they know very little about electricity, and are not sure of what danger they may run in interfering with the lighting supply or of what precautions they should take in order that the mains may be used for wireless purposes in safety.

That there is *some* danger they are made aware by the occasional reports of fires being caused by some defect in a lighting system and even of people being killed by a shock from a domestic lighting supply. Such cases are, it is true, very few and far between and can only happen under *extraordinary circumstances*.

Precautions

Still, it is a decidedly risky proceeding to interfere with the mains in any way unless one is well aware of what one is doing and unless certain elementary precautions are taken.

This article is intended to reassure those people who are still hesitating to make use of their mains in order to provide the current for their wireless sets by enlightening them upon the above-mentioned points. The

chief risks may be classed under three headings—that of short-circuiting the mains, that of a fire being caused by the overheating of a conductor, and that of receiving a shock.

Short-circuiting the mains is not likely to have any serious consequences beyond causing a certain amount of inconvenience. If the mains are short-circuited, of course, an excessive current will flow, but only for a very short space of time as the house wiring system is always well protected by fuses. One of these

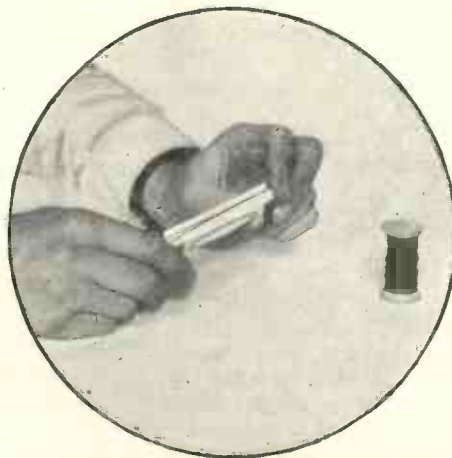

If a house fuse is by any chance "blown," its replacement is a matter of a few seconds only

fuses will "blow," thus cutting off the current until the fuse is replaced. Until the fuse is so replaced some or all of the lights in the house will be extinguished.

Short-circuiting the mains, of course, consists of providing a path of very low resistance between one main and the other. If, when connecting the mains to the set, they are allowed to touch each other a short-circuit will take place, but short-circuits can

also be caused in other and less obvious ways.

Earthed Main

In the case of many D.C. supplies one of the mains, either the positive or the negative, is often earthed. Earthing the other main will then cause a short-circuit. If the positive main is earthed and if the H.T., L.T., or both H.T. and L.T., are being derived from the mains it will be impossible to earth the L.T. circuit of the set in the usual way without causing a short-circuit.

In such cases the earth lead to the set usually has a large-capacity fixed condenser inserted in series with it. This condenser offers but a negligible impedance to the oscillatory currents flowing in the aerial but effectively prevents the D.C. from the mains flowing through the earth lead.

Besides this, in such a case, it is important to insulate carefully all parts of the set itself from earth. Also, if a series aerial condenser is not used, the mains may be short-circuited by allowing the aerial to come into contact with an earthed object.

A.C. Transformer

If the set is being worked from an A.C. supply, a transformer is, of course, interposed between the set and the mains but this does not obviate the risk of a short-circuit. For if the secondary of the transformer is shorted it is equivalent, in the results, to a short-circuit of the primary circuit in that an excessive current will flow.

Now many battery eliminators take

considerably less current from the mains than the house wiring is designed to carry. When this is so, there is no need to rely on the house fuses for protection in the case of a short-circuit. A fuse can be inserted in series with each of the leads between the set and the mains, and if these fuses can only just carry the current required by the eliminator they will, in the case of a short-circuit, blow out and at once prevent further trouble.

Accessible Position

If they are placed in an accessible position near the set it will not matter if they blow frequently as it is far better to have the slight trouble of replacing them than to have the house lights suddenly extinguished.

The risk of a fire being caused by using the mains for wireless purposes depends upon the possibility of a conductor being raised to red heat by the passage of an excessive current through it. Owing to the existence of the house fuses, already mentioned, there is no danger of any of the house wiring becoming too hot.

But in the construction of a set or a battery eliminator to be worked from the mains, care should be taken to see that every lead is of *ample cross-section with regard to the amount of current it will have to carry*. Here, again, the use of suitable fuses between the set or eliminator and the mains will prevent an abnormal current from flowing in any part of the set.

Possibility of Shocks

But when we come to consider the possibility of an experimenter receiving a shock while endeavouring to attach his set to the lighting mains we find that fuses offer no protection at all, for the amount of current which can do serious harm, or even cause death, by its passage through the human body is exceedingly small.

But against this must be set the fact that the body is but a very poor conductor so that its high resistance offers a very good measure of protection. Also it is *very seldom indeed* that a really good connection is accidentally made between any part of the body and a conductor carrying an electric current. And, in any case, even should a "live" wire accidentally be grasped in most cases the body of the person touching it will only form a "shunt" circuit (or be in parallel with a portion of the circuit proper)

so that only a small proportion of the total current may actually flow through the person's body.

The above facts explain why apparently similar electric shocks have such varying results in different cases. The resistance of the body varies greatly in different persons and even in the same person at different times. Much depends upon whether the hands (if it is through the hands that contact is made) are

Miss RUBY HELDER



"The Lady Tenor"

clean, dirty, greasy, wet, or dry, upon whether contact is made with only one or both mains and, in the former case, whether the other main is earthed, the material of which the person's shoes are made, and many other factors.

In practice a shock from 200- or 250-volt mains cannot sometimes be felt, more often it produces a slightly unpleasant sensation, while in rarer cases it is more severe in its effect and, very exceptionally indeed, has even been known to kill.

In order to minimise what danger there is when experimenting with the mains the experimenter should first ascertain everything possible about the nature of the supply. Whether it is A.C. or D.C., the voltage, and

whether one, and if so which, of the mains is earthed. Then before making any alteration whatever to the house wiring he should put the main switch of the house (to be found near the meter, in most cases) in the off position.

If the house wiring has not to be altered, as when there is a spare lamp-socket to which connection can be made with an adaptor, care should be taken always to remove the adaptor from its socket before doing anything to the set which may entail the risk of a shock.

G. N.

Aerial Developments

FOLLOWING on the success of the beam system, inventors are giving renewed attention to the problem of aerial design, particularly for transmission. The use of horizontal loops, in which the aerial proper consists of a closed circuit suspended at a considerable height above the ground, and parallel with it, results in the production of polarised waves which have proved most successful for long-range working.

Experiments are also being carried out with parallel lines of horizontal wires, suspended high above the ground. The effect here is very similar to that achieved by the beam aerial system, except that the radiation is directed upwards at a considerable angle to the surface of the ground.

High-angle radiation of this type is particularly suitable for long-distance working on the shorter wavelengths, extraordinary distances being covered with a relatively small input power.

Fading

Ways and means are also being sought for preventing "fading," a drawback which is common to all short-wave working where the bulk of the radiated energy travels directly upwards to the Heaviside layer, and not along the surface of the earth. Attempts are being made to overcome reflection losses by introducing deliberate high-speed variations either in the wavelength, or in the direction, or on the plane of polarisation of the emitted waves.

B.A.R.

Further Developments Evolved by—

The SPARTANS & SPARROWTOWNE

PROFESSOR HICCOUGH'S INVENTIONS

PROFESSOR HICCOUGH had not disappointed his colleagues. The Big Thing, his latest and greatest achievement, had been transported to the meeting hall as promised, the great secret was revealed, and his audience sat spellbound as

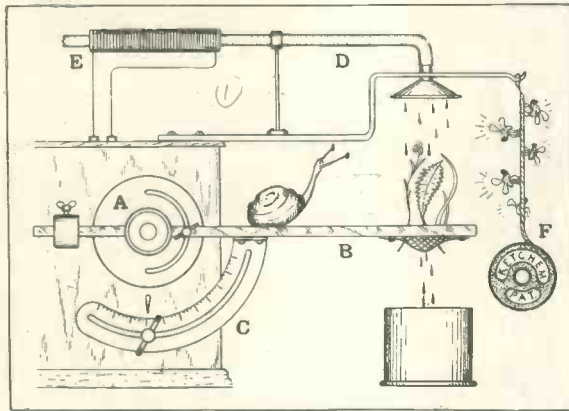

Fig. 1.—Super Snail Slow Motion

they listened to the thunder rumbling out the whys and wherefores of the great Super-new-trod-dyne receiver. What a set! Easily ten years ahead of any other, and even Clatterton and Walloph—who could take a few years off any set in a couple of hours—had never dreamt of such glory.

Now the input of the average mind is strictly limited, and it has therefore been necessary to dissect The Big Thing in order that it may be understood. Dished up *en masse* you would find the various intricacies impossible, but by studying each part separately you will at least be able to form a rough idea of the unprecedented qualities of the complete assembly.

Dissection No. 1 (Fig. 1): A super snail-slow-motion device for a variable condenser. The usual reduction gear arrangement had never appealed to the professor; he was of the opinion that in order to obtain the true slow-motion effect one must get back to nature and employ the one and original slow-mover—the common snail.

This he accomplished in the manner shown in the sketch, where A represents a special dial which is provided with a radial slot and attached to the

condenser spindle, B a light wooden lever swivelled to the condenser spindle and locked in any position between 0 and 180 degrees by means of a bolt and fly-nut, C a metal scale-quadrant attached to the under side of the lever. D a small water supply

pipe, E a heating resistance worked from the accumulator inside the set, and F an ordinary fly-paper. One end of the lever is fitted with an adjustable counterweight, and the other end is bored and fitted with a copper gauze cup which holds a few fern leaves, etc.

The snail is placed on the lever close up to the receiver, the fly-nut on the quadrant is slackened, and the counterweight adjusted until a perfect see-saw effect is obtained. The fly-nut on the dial is then slackened, and the condenser roughly tuned by hand. The fly-nut is again tightened, so that when the snail "walks the plank" the lever is very slowly lowered under his weight, and consequently

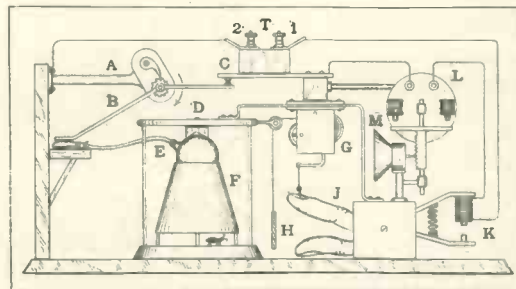

Fig. 2.—Improved Automatic Safety Fuse

the condenser dial is slowly revolved. When the tuning is sufficiently sharp the fly-nut on the quadrant is tightened and the snail removed. The snail, of course, is induced to move towards the herbage by the refreshing artificial summer shower, which is accompanied by a soft

breeze supplied by the buzzing flies.

Dissection No. 2 (Fig. 2): A remarkable step forward in the design of L.T. fuses for preventing valve blow-outs when carelessly connecting the H.T. battery to the filaments. In this case necessity was the mother of invention, for the professor, being very absent-minded, had blown out so many good valves that he had been obliged to place a standing order with a local firm to deliver three new valves regularly every morning with the milk. One morning the bill arrived, and it was then that he first became interested in safety fuses.

The various parts of the device are as follows: A is a metal arm carrying a small pawl and ratchet, the latter being integral with a contact arm B which is normally placed in contact with a point on a second arm C; D is a small glass case containing the bulb of a rubber "plate lifter" E, which is wedged between the top of a funnel F and the top of the casing; G is a small clockwork motor; H is a small dark-slide or screen; J-K is an electrically operated artificial finger and thumb; and L is a very sensitive electromagnet which operates the diaphragm of a small microphonic horn M.

The business end of the plate lifter is placed under the lower end of the contact arm B, and a full-grown flea is placed inside the case directly under the mouth of the funnel. The terminals T1-T2 are connected in series with one of the L.T. leads so that the normal L.T. current flows via points K, L, C, B and A without being interrupted in any way, but if the H.T. current

should pass these points then obviously something will happen.

Briefly, the contact B-C is broken and all valves saved. In order to follow things through, let us imagine the device being filmed at the cinema by the special slow-motion projector. This is what we should see: First, the

H.T. current exciting the sensitive magnet L, which draws a serrated blade across the microphone pin and causes the horn to emit a noise resembling a snore. Immediately the flea turns towards the snore, and next we see the magnet K slowly closing the finger and thumb.

At the first jerk the finger actuates a trigger which releases a catch in the clockwork motor, and the screen H is hurled upwards. The flea, then spotting the finger and thumb slowly but surely closing down upon him, loses his nerve and hops.

Note.—The professor had made careful measurements of the micro-horsepower of fleas' hops at heights ranging from 1½ in. to a yard and a half, and it was found that the greatest speed (or otherwise force) was attained at the height of 6 in. The lower part of the bulb E was therefore set about 6 in. from the base of the casing.

We have seen that the flea hops away on seeing the finger and thumb; he kicks off in the usual way, intending to perform the same old disappearing trick; but no sooner is he in top gear than he butts heavily against the bulb. The "lifter" on the other end of the tube is immediately inflated, the lower part of the arm B is raised, and consequently the upper part lowered, and thus the contact B-C is opened.

At the same time the ratchet revolves in the direction of the arrow, and so the contact is kept open by means of the pawl, which now prevents the arm from returning to its original position.

Dissection No 3. (Fig. 3):

An anti-blast loud-speaker attachment, or otherwise an automatic cut-out for eliminating the effect known as blasting. The main parts of the device comprise a toy balloon A, two contact strips B and C, an adjustable teasing-cup D, which is fitted to one end of a rod delicately swivelled in a prong attached to the ebonite support carrying the contact strips and the terminals T₁-T₂; a special catswhisker E, which is attached to the other end of the rod; a bow F, with a doh-flat violin string; and a small clip G carrying a piece of sugar.

The inflated balloon is supported between two celluloid cups, and the projection on the lower cup forces the strip B hard against the strip C. The terminals are connected in series with one of the loud-speaker leads, the bow

F is placed close up to the loud-speaker horn, and a healthy wasp or bee is perched on the top of the balloon so that he may amuse himself with the sugar.

The rest is simple; all goes well until the loud-speaker begins to blast—the string then vibrates violently and the catswhisker becomes dislodged. The teasing-cup then falls upon the wasp; he becomes annoyed, and, being malicious, thrusts his sting into the balloon which, in rapidly deflating allows the strip B to spring clear of the strip C, and thus the loud-speaker closes down.

Dissection No. 4 (Fig. 4): "We have seen how snails, flies, fleas and wasps can be made to help further the grand science of radio; now what about a nice mushroom?" With these words the professor demonstrated what he considered to be the most interesting section of the assembly—the sleep-and-forget switch, a simple device which permitted anyone to go

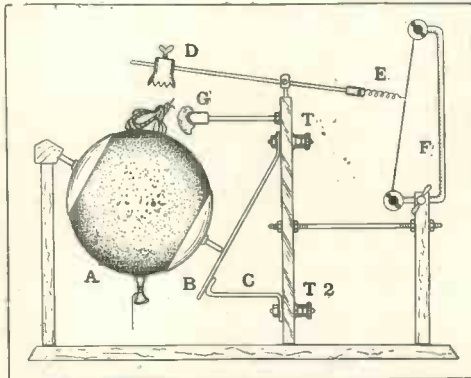

Fig. 3.—Anti-blast Loud-speaker Attachment

to bed and forget to earth the aerial and switch off the accumulator.

As will be seen from Fig. 4, the parts are few and simple. An insulated frame is fitted with five terminals and three short and two long contact strips, the latter being hinged under the nuts of the terminals D and A so that they make gravity contact with the strips attached to terminals C and B. The lower hinged strip is fitted with an ebonite rod, and the legs of the frame are pressed firmly into the ground immediately above a sprouting mushroom.

Note.—The professor had carefully timed the growth of all kinds of mushrooms, and had at last found the one particular variety which, when show-

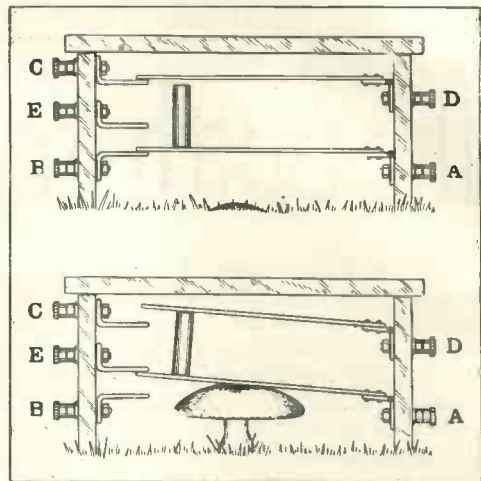

Fig. 4.—Sleep-and-Forget Switch

ing signs of growth at 7 p.m., would be approximately full-grown between 11.30 p.m. and midnight.

The aerial lead-in is led out to the device and connected to terminal A, and a lead from terminal B is led into the house and joined to the aerial terminal of the receiver. Terminal E is connected to earth, and terminals C-D are connected in series with one of the L.T. battery leads. After tuning—in the set, the operator may go to bed and listen-in in comfort; there is no need for him to worry about turning out to turn off the set at midnight—the mushroom does all this for him.

The lower sketch shows how it all happens. The mushroom first raises the lower (aerial) strip, and so the aerial is disconnected from the set and connected directly to earth. At the same time the accumulator is switched off by means of the ebonite rod which, having also moved upwards, lifts the upper hinged strip and thus opens the L.T. circuit.

Dingleberry warmly congratulated the professor, and at a given signal the entire company raised three husky cheers. All agreed that this particular gadget alone would be a boon and a blessing to men, as well as to spring poets who would now find something new to write about. The meeting was then closed, the programme for the following month being fixed as usual.

OSWALD J. RANKIN.

You can obtain a half-price blueprint of any set described in this issue by using the coupon on page iii of the cover.

B.B.C. Officials Discuss the Prospects for

The Sixth Year of Broadcasting!

THE completion next month (November) of the fifth year of broadcasting forms a fitting opportunity for the officials of the B.B.C. to indulge in a little introspective stocktaking. The chief fact that at once emerges in their minds, as no doubt it will in the minds of listeners, is that broadcasting remains to-day very much what it has been at any time during these five years.

Potentialities

From the chrysalid state when, as the Director General, Sir John Reith, says, there were no sealed orders to open, the commission was of the scantiest nature and very few knew what broadcasting meant or what it might become, the organisation grew to Gargantuan proportions and, having proved its worth, was vested with such power and influence as might well have caused incalculable harm if they had been wrongly used and if those to whom the service has throughout been entrusted had not remained fully conscious of their responsibilities.

Governing bodies might come and go, directors give way to State nominees, the manufacturer stand in surprised contemplation of the machine that he helped to create; but the broad policy which supplied the motive force of broadcasting remained practically unchanged.

Detail Improvements

In detail, naturally, vast improvements have been introduced. Take for instance, the mechanics of transmission. The progress in that field has been almost incredible although to most of us it has come to be regarded as a matter of course, not productive of startling revelations. The reason is obvious. No concrete opportunity exists of comparing the quality of transmission as it was five years ago with what it is to-day.

One of the older service engineers at Savoy Hill remarks on this point: "We know the rather primitive apparatus that we used in 1922, but we cannot define in a way that the majority of listeners would understand the results we got. Memory's

a poor guide for the purpose of actual comparison between the transmission of yesterday and that of to-day. Transmissions are better than they used to be; but if the necessity arose we could only show how much better they actually are, were we able to set up a 2LO equipped with the original apparatus and put out from it a programme identical with and simultaneous to one from the present 2LO.

"Then, in the end, we could not devise a means of enabling the listener to cut out that one station while he was listening to the other, so the actual degree of improvement, while it might be shown by means of a graph, could not be demonstrated in the one way that would really impress the listener in Mayfair or Tooting."

Fatalistic Progress

But engineering progress is in a way fatalistic. Even now the development engineers, in their new home at Clapham Common, are concentrating a good deal of attention on the problems of sound distribution. At Basing Park, one of the stately houses of England, is a music room which scientific measurements have shown to be ideal for the diffusion of radio frequencies. When similar conditions can be incorporated in a broadcasting studio, allied with microphonic evolution, definite changes will be brought about in the principles of transmission at its source.

To this problem, one of many which the development section must solve as a prelude to the regional scheme, the B.B.C. directs attention merely to show that more, much more, is involved in the work of improving the service than the ambition to se-

cure this or that artist because the fee which he demands is higher than that paid to any who have gone before.

American Relays

Then outside the research room experiments must be continued with the reception of American programmes at different points and through more and more delicate degrees of filtration until the B.B.C. is itself satisfied that the act of rebroadcasting is a programme service of material value to the listener, instead of a novelty measured purely by the fact that the cacophonous noises that are transmitted have been received over a distance of several thousand miles.

It is, indeed, the definite opinion at Savoy Hill that the problem of international and inter-Empire wireless, technically, is bound up in reception rather than transmission. Hence these short-wave reception tests during the coming winter will go hand in hand with the short-wave transmission tests which are to be carried out at Chelmsford with the co-operation of the Marconi engineers, who have played no inconspicuous part in the development of the science of broadcasting.

Alternative Programmes

As regards the provision of alternative programmes, it would be a mistake to look upon the work of 5GB as the attainment of a sort of broadcasting millennium. So much has been heard about the scheme of regional stations since the B.B.C. celebrated its fourth anniversary in 1926 that many people are inclined to become agitated over what they consider unconscionable delay in "getting down to brass tacks."

But it should be emphasised that in a new departure like this, where the expenditure of large sums of money is inevitable, the first steps must be taken very slowly, and before the expenditure is incurred it must be clear beyond all doubt that every factor in the scheme is right. Throughout the tests on 5GB, Savoy Hill,

(Continued on page 310)

Let us know what results you are getting with your "W.M." receiver!

Miss Fay Marbe, the Well-known American Actress, Explains Why There Is

"No Stage Ban" in America

THE war between the theatrical managers and the B.B.C. is one of the biggest surprises I have ever had. In America not only does a show consider it a first-class advertisement to broadcast, but it actually pays a high fee to be allowed to do so. Radio companies receive as much as £1,000 for the use of their microphones for an hour!

Enhanced Standing

Any play enhances its standing by being transmitted over the ether. Yet, as far as I have been able to see in my short stay in England, there is a feeling that radio is ruining the stage and concert platform. I am told that while the public can hear a song or turn in the comfort of their own homes they will not go out into the night for their entertainment.

Whether that is so I cannot tell. Across the Atlantic, though, the reverse is the case. For us to hear a person is not enough; we want to see him as well. I myself have been told this hundreds of times in letters I have had from listeners.

Perhaps, too, we are more of a "going-out" nation. Home life is almost non-existent in our cities. Houses and flats are merely places to sleep in, to store belongings, or receive letters. We take most of our meals out, and when we do stay indoors it is usually at someone else's house. Thus wireless, even if it had the help of television, could do no harm at all worth mentioning to the theatres.

New Ground Broken

As a matter of fact, it has broken entirely new ground for the box-office. There are miles and miles of country not reached by railroad or served by telephone; where even newspapers penetrate but irregularly. The inhabitants used to obtain their amusement from magazines, of which

there are hundreds more than in England.

But as soon as radio brought to their homesteads an hour or so of a show on Broadway, with the infectious laughter, and clapping and cheering, they came under the spell of city life. And now they make their regular journeys to the nearest theatre to see what they have selected as the best of the shows relayed to them.

Of course, radio is somewhat different in my country. We have several companies, all working independently of one another, and none of them associated with the State in any way. They derive quite a lot of their income from the fees paid to them by the theatres. They also put on programmes of their own, and because of the competition between them, have to obtain the very best artistes and numbers. The high terms they make with the stage enables them to pay big money for these. Five hundred dollars for fifteen minutes in the studio is what I received myself.

You probably think the whole business is terribly involved; an actress hiring the microphone on one occasion to advertise a show, and being paid to broadcast on another. But the point with a theatrical venture is that there are so many of them for the public to choose from that mere advertising alone is not sufficient. So we give "free samples"—for that is what it amounts to.

We take what we consider to be the best act, and after announcing what the play is, who is in the cast, and where the house is, and so on, switch it on. The same thing is done with our football, baseball, boxing matches, and concerts. And the results certainly justify the extra



Miss Fay Marbe, who recently broadcast from London

expenditure. In fact, "radioed" is the hall-mark of nearly every form of entertainment now.

A Circle

Then if the appeal to the ear is successful the public not only patronises that theatre, but later on wants to hear the same people over the wireless again. This time the situation is reversed, and the radio companies have to pay the particular star they are interested in. And because of the intense competition the fee is high—that of the highest bidder, of course. Thus we have a circle, with equal benefits to both interests as far as I can see.

This competition makes American broadcast programmes vastly different from English ones. Even the announcing is affected. For instance, when I was at 2LO a little while ago I was introduced thus: "Miss Marbe, the famous musical actress . . . will now give some songs from her repertoire. Miss Marbe." But when I was "radioing" regularly every week in New York it was something like this: "Gee! Do you know who has come in?" Then would follow a whole heap of flattering remarks about me—how I was dressed and so on—keeping up the surprise until in the end they got to my name.

Less Dignity

There is not that dignity that characterises British broadcasting. The whole thing, I am sorry to say, is a money-making business. Whenever some prominent person comes to New York all the companies are struggling to get him into their studios. And they indulge in publicity just as much as any theatre or picture-house.

Another vital difference is in the two attitudes to advertising. Here not one word which can possibly be construed into an advertisement for some firm is allowed to be spoken. There, any manufacturer or salesman may hire the microphone for a period simply by paying for the privilege. This is a very valuable source of income to radio.

The B.B.C.'s way of conducting a programme appeals to me very much indeed, and I like it because it is workmanlike, interesting, and carries dignity. I hope sincerely to be given the opportunity of broadcasting again in your country.

Ionic Emitters

DR. C. H. Kunsman has succeeded in utilising alkali and alkaline-earth metals as "ion" emitters when combined with an iron "catalyst," the action being very similar to that by which electrons are liberated from thoriated tungsten. The mixture from which the ions are produced can be coated on to a filament and mounted in an evacuated bulb.

Former methods usually necessitated the presence of gas, whilst the emission fell off rapidly with time. The new "catalyst" is, however, steady and capable of giving a prolonged supply under ideal conditions for observation.

Singly-charged Atoms

The liberated ions have been shown under examination to consist of singly-charged atoms. It is interesting to speculate upon the possible advantages of using an ionic stream, in the future, as a substitute for the electron stream, which at present endows the three-electrode valve with its many outstanding virtues.

The Sixth Year of Broadcasting!

(Continued from page 308)

has been perfecting its conception of a national service. Rash experiments with high-power stations would impair the service as a whole.

Each year brings its own story of achievement in the field of programme entertainment; but in its essentials, each year's story differs to a very small degree from its fellows. At one time it is the first British performance of Rimsky-Korsakov's opera *Kitesh* under the conductorship of Mr. Albert Coates,

may be anticipated, increasing in number and interest as music agents and organisations generally, following the example of the Hall orchestra, withdraw their edicts against broadcasting.

Removing Differences

Perhaps the most satisfactory of possible developments in broadcasting, and one which would be assuredly the most welcome to the B.B.C. and listeners, would be the fulfilment of the policy of Savoy Hill, which is to secure a conclusion to the differences with related or impinging interests.

It is a deplorable state of affairs when we find those interests trying to undermine broadcasting by bans and edicts, while the B.B.C., in self-protection, must plan to provide, independent of hostile interests, material of the very kind which could be furnished from the resources of those same interests. Such a conclusion could have been reached long ago, without damage to anyone.

Useful Ally

The experience of the theatres proved it and the experiment at the Queen's Hall confirmed it. Indeed, working arrangements with many interests—the Press, the Church, music publishers, organisers of opera and so forth—have shown that broadcasting can be made a useful ally instead of a rival interest.

Let us hope that the sixth year of broadcasting will not be allowed to pass without a similar rapprochement with the music-halls. B.B.C.

There can hardly be a single reader of the WIRELESS MAGAZINE who has not heard of the 1927, Five, the classic receiver that was first described in our October, 1926, issue. This set has given excellent service to literally thousands of listeners and next month we shall give details of an adapted design that has been brought right up to date. It will be known as the 1928 Five and will use almost the same components as the old 1927 Five. Order your copy now!

WHO WAS THAT ?

The Editor of the "Wireless Magazine" has made arrangements to assist readers who are in difficulty over the identification of broadcasting stations they receive.

Each query should give as many particulars as possible (such as time, date, wavelength, language, and distinctive call or signal) and should be accompanied by the coupon on p. iii of the cover and a fee of one shilling (postal order or stamps).

Address each query to "Station Identification," "Wireless Magazine," 58-61 Fetter Lane, London, E.C.4.

that provides the outstanding musical attraction.

In another year, Mme. Tetrezzini and M. Paderewski broadcasting from the studio, are events of supreme importance. This year, studio performances of such plays as *The Chinese Puzzle*, will have been given. In previous years we have had *The Yellow Jacket*, *The Little Michus* and plays of like character. National Concerts of 1926, and Promenade Concerts of 1927, are natural expansions of the concert performances at King George's Hall, Covent Garden Opera House and elsewhere, which were the forerunners of the larger series.

And so the story of broadcasting will continue to unfold itself in the year to come, the sixth year, with its own studio broadcasts and relays from outside halls, the latter, it

Half Hours with the Professor



9.—A CHAT ABOUT BATTERY ELIMINATORS

THE Professor was sitting down! Actually sitting down in his laboratory in the most comfortable chair which the aforesaid institution possessed, his long, thin legs stretched out in front of him, his eyes shut and a pleasant smile on his face; he appeared to be listening with the greatest pleasure to an orchestral selection which seemed to fill the room.

Unusual Attitude

Young Amp rubbed his eyes. In the first place, it was most unusual to find the Professor in an attitude of repose, while secondly, although there were a number of loud-speakers in the room, he could not for the life of him say which one was producing the music. Consequently, he listened spellbound until the end of the piece.

"Very bong," grunted the Professor when the item had been brought to a close.

"Said he, knowing the language," interposed the boy with a malicious grin.

"Why Amp, I never noticed you," exclaimed Megohm. "What do you think of that anyhow?" he proudly asked.

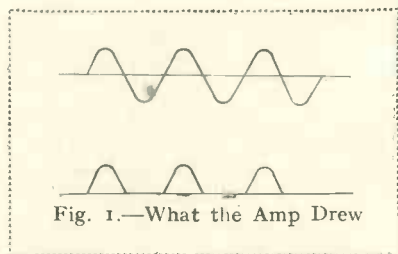

Fig. 1.—What the Amp Drew

"Stord'nary," was the laconic response. "Which loud-speaker were you using?"

"The whole lot."

"What, that moving-coil one as well?" asked Amp wondering what on earth was the matter with the Professor.

"Yes, as a matter of fact, that by itself is very good, and has a most

intimate effect, but I found that by introducing several others having different characteristics all round the room I was able to make the music seem as if it came from nowhere."

"Everywhere, I thought," Amp said with his eyes twinkling, "but how do you connect them up?"

"They all come off a small distributing board," Megohm answered, "with a volume control on each, so that I can blend them; but that's

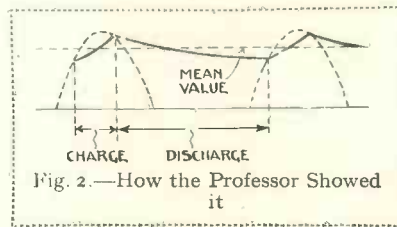

Fig. 2.—How the Professor Showed it

not the real point. Could you notice any hum?"

"What sort of hum?" asked Amp, sniffing vigorously. "Oh, you mean an audible hum! No, I couldn't hear anything."

"No," agreed Megohm, "there was practically none. Yet I was working that set from the A.C. mains with an eliminator."

"By jove, Professor, that was pretty good," exclaimed the other, "most of the eliminators which I have heard have had quite a nasty hum, at any rate when the music stopped, although you might not notice it much when it was on."

"That is so. I have, as a matter of fact, given quite a lot of time to getting this right, but I think it is pretty well there now."

"And that was why you were having forty winks on the strength of it, I suppose," said the Amp, slyly. "But," he went on hurriedly, before the Professor had time to say anything, "I never can see how an eliminator can work."

"Why not?"

"Well, there seems to be such an awful amount of hump to get rid

of. I mean—" here he looked about him, as if at a loss as to how to explain his point.

Megohm pushed a piece of paper in front of him, and the boy fished out a grubby pencil and proceeded to elaborate his idea.

Backwards and Forwards

"I mean an alternating current flows backwards and forwards like this, doesn't it, Professor?" Here he drew the top curve shown in Fig. 1. Megohm nodded. "If you put it through a rectifier," went on the boy, "you knock out all the bottom wave."

"Using a single-wave rectifier."

"Yes, I meant that," said the other. "You can make a rectifier work quite well with one valve only, can't you?"

The Professor nodded.

"Well," resumed the boy, "I don't quite see how you can ever get anything like a decent direct current out of a series of bumps like that. I have some idea that you put smoothing circuits afterwards, but it seems to me that they have a mighty lot of work to do."

"If you are going to look at it like that," smiled Megohm, "the problem does appear a little difficult,

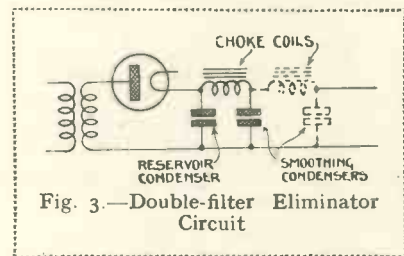

Fig. 3.—Double-filter Eliminator Circuit

but as a matter of fact, you must consider the rectifier and the smoothing circuit—or any at rate a part of it—together. Let us look at the matter again. You have a rectifier which supplies you with pulses of current in the way you have just explained, but across this you put a large condenser."

The Amp nodded.

Half Hours with the Professor (Continued)

"Now the effect of that condenser is to store up the current received from the rectifier. Each pulse of current received from the rectifier charges up the condenser while, on the output side, we take off current in a more or less steady form."

"Oh," remarked the boy, thoughtfully. "I had not looked at it in that manner."

Deal of Difference

"No? Well, you see, it makes a good deal of difference. Let us suppose that the condenser is already charged to a certain voltage. We connect across it our set which acts as a high resistance so that the condenser will discharge slowly through the resistance. If there is no energy coming in, then the condenser would gradually discharge completely, and the set would gradually cease to operate. Look here," he broke off. "I will show you."

He switched on the receiver which he had just been listening to and once more the studio was flooded with music. "Now listen," he said, and he switched on the eliminator. The music still continued for two or three seconds, during the first second of which the strength was hardly reduced at all. Then it began to tail away and finally rapidly died away to nothing.

"That," said Megohm, "shows how the reservoir condenser in the rectifier circuit was providing the necessary high-tension current for appreciable time after the input had been switched off. In the same way, we shall find that it takes a small fraction of time for the reservoir condenser to charge up again after the eliminator is switched on. Listen!"

Here he switched on the current once again, and there was an appreciable interval of time before the signals grew to their proper value.

"Gee," said the Amp, "that is very interesting; but you must have a pretty large condenser there."

"I have. As a matter of fact, it has a capacity of 8 microfarads, while there are two other condensers each of 4 microfarads following it in the smoothing part of the circuit. Now you will be able to appreciate how the reservoir condenser, following the rectifier, manages to smooth

out the fluctuations to a considerable extent. During the period when a pulse of current arrives on the rectifier the condenser charges up a little, and its voltage will rise slightly. During the dead period, we are taking current from the condenser steadily so that its voltage falls slightly. If the condenser is of a suitable size, however, the drop in voltage is only quite small before the next pulse of current arrives. So that, really, the action is more of this nature."

Here the Professor drew the diagram shown in Fig. 2.

"We have a more or less fixed steady voltage, and the voltage on the condenser rises a little above this mean value during the charging period and falls a little below it during the discharge period. This has reduced the state of affairs to a steady voltage with a very much smaller ripple superposed and this ripple can easily be dealt with by a system of chokes and condensers."

"That's what they call a smoothing circuit, isn't it?" interrupted the other.

"That is so. The one I am actually using here is a double filter like this." Here he drew the diagram shown in Fig. 3. "We take the current from the reservoir condenser, through a choke with a condenser connected across the other side of the choke to earth. A second choke and condenser are also used in this case and these practically eliminate the ripple."

"Is that actually possible?" queried the boy, "or is it simply a matter of reducing the ripple to a very small amount?"

Little of Each

"It is really a little of each," said Megohm. "The choke coils offer a very high impedance to the ripple, which is alternating in character while, of course, they should present very little resistance to the passage of the steady current.

"This is obtained by making them actually of a low D.C. resistance. Any ripple which does get by the first choke, however, has an easy path back to earth through the smoothing condenser. In most cases, this is all the smoothing that is necessary, but in this particular case where I wanted very good results, I

added another filter circuit consisting of a choke and a condenser, which still further suppressed the ripple."

"Then the ripple currents flow through the condensers, is that it?"

"Exactly, any ripple current which does force its way through the choke has a quick short-circuit path back to earth through the smoothing condensers, so that there is a combination of suppression of the ripple by means of the choke and short-circuiting of any remaining ripple through the condensers."

"Can I have a look at your eliminator, Professor?" asked the Amp.

The Eliminator

"Certainly, my boy, here it is over here." So saying, he led his enquirer to the end of the bench to a black metal case. He proceeded to remove some screws and lifted off the lid, showing the arrangement inside.

The Amp watched him do this and asked why a metal case was used.

"To eliminate direct induction from the transformers and chokes," was the reply. "You have a 50-cycle alternating current passing round the transformer, which sets up magnetic fields. These, in turn, may easily affect any transformers or chokes in the low-frequency amplifier of the receiver.

"Unless the eliminator is cased up in a metal box, connected to earth, it must be placed at a considerable distance from the set in order to avoid any hum and many eliminators which have reasonably satisfactory smoothing circuits are nevertheless rendered very poor in operation owing to the fact that this precaution is not adopted."

Young Amp nodded, scratching his head and drinking it in as he usually did. Then he went to have a look at the set itself and picked out the transformer, rectifier and the chokes and condensers of the smoothing circuit.

"What awfully large condensers you use," he remarked at last. "Whatever is the capacity of this one?" he continued, pointing to one in particular.

"That is only 8 microfarads" responded Megohm, "but it is of a large size, owing to the fact that it

(Continued on page 364)

An Impression of Debroy Somers' Band



[Having seen his bandsmen as I have drawn them Debroy Somers has fled!—Slade.]

How S.B. is Carried Out

—with Particular Reference to the Northern Centre

SINCE the opening of the Daventry station there has been little outward show of extension by the B.B.C.'s engineering department. But there have been developments of a less spectacular, but very useful, character. In probably no direction has there been such an advance as in the technique of relaying.

Much Improved Quality

We have only to compare the quality of the "S.B." transmissions of to-day—particularly over long distances, such as London to Aberdeen—with our memories of similar relays of two years ago, when the broadcast was sometimes unrecognisable owing to the noisiness of the line, to realise what progress has been made.

At the London station the landlines which carry "S.B." transmissions out to the provincial stations are corrected, or doctored up, by adding to them inductance and capacity so that they will give an equally good response to all speech-current frequencies between 50 and 8,000.

Each line is artificially made to have a straight-line frequency—a perfect line. This shows what efforts are made to ensure that the landline link between London and the provincial transmitter shall not impair the quality of the broadcast.

"Sub-relay Stations"

But the improvement already made is probably due more to the provision of S.B. distribution centres (or "sub-relay stations," as the B.B.C. calls them) than to this latest development of line correction. Moreover, these centres have not only improved the quality of relayed broadcasts and substantially decreased the amount

of landline noise, but they have made the S.B. system less unwieldy.

The long waits between one section of the programme and the next, while the S.B. engineers in London anxiously did the switching for a score of stations, have been banished. The system has been decentralised and speeded up.

Originally, of course, each station was connected by one or more lines direct to London, with one or two exceptions, such as Swansea. The drawback to this was the immense length of the lines, particularly if a transmission was being relayed from a provincial station to all other stations. If, for instance, a talk was S.B. from Newcastle to all stations, it had to

the efficiency of the working of the S.B. system.

The opening of the Gloucester sub-relay station has incidentally made the Leeds centre the most important—in point of the number of its charges—in the country, the groups being:

LEEDS	Glasgow (and to Scotland and Belfast). Manchester (and to Liverpool). Newcastle. Hull. Sheffield. Bradford. Leeds transmitter.
LONDON	Gloucester (and to the West). Daventry. Nottingham. Bournemouth. London transmitter. GLOUCESTER Cardiff. Swansea. Birmingham (and to Stoke). Plymouth. GLASGOW Aberdeen. Edinburgh Dundee. Belfast. Glasgow transmitter.

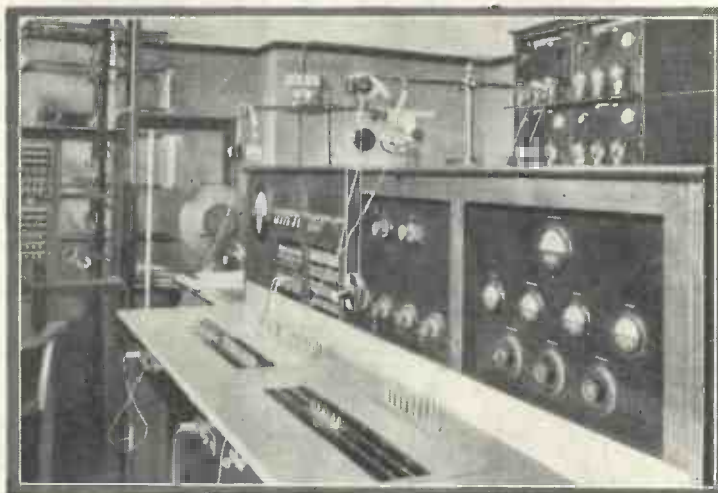

Combined S.B. and Corrector Desk at the Gloucester "Sub-relay" Station

travel 250 odd miles to London and was then distributed, in some cases having to go more than as far again before reaching its destination—on its journey to Glasgow, for instance.

To-day such a broadcast is saved that futile journey south, being sent to Leeds and thence to Glasgow.

Similarly, in the western group, an S.B. item from Cardiff now goes to Birmingham (for instance) via Gloucester, a short distance compared to its one-time route via London.

It is obviously easier to look after six circuits than twenty. The grouping of the broadcasting stations into four groups has done much to improve

to Dublin. A line between Manchester and Stoke links the Leeds group up to the Gloucester group, so that there is an alternative route in the event of breakdown on either side.

As the Gloucester and Glasgow centres operate similarly to that at Leeds a description of the latter will make the working of these sub-relay stations clear. The description will presume, in the first place, that a programme is being relayed from London to all stations. Fig. 1 shows the stages through which the broadcast passes.

The line from London (we will

ignore control and spare lines and presume only one line, for the music) comes at the Leeds station to a Post Office distribution box. This is not shown on the diagram of the circuits, Fig. 2. All the lines radiating from Leeds are brought to this box and are then connected, via a B.B.C. distribution board, to the S.B. board (which is actually a desk). The lines could be taken direct to the desk

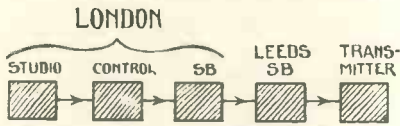

Fig. 1.—Stages through which Broadcast Item Passes

but the insertion of the distribution board makes them more "get-at-able" in the event of breakdown.

London Line

At the S.B. desk the London line, bearing the incoming broadcast, is plugged to the input of a correction amplifier. There are six of these three-valve amplifiers, and during an S.B. to all stations only one is in use. If two relays are going on—say London to Manchester, and Newcastle to Glasgow—at the same time, two correction amplifiers will be in use, one on each incoming line.

Everything possible is automatic. Suppose the operator decides to use correction amplifier No. 2. When he plugs the London line to the input of that amplifier (a jack on his desk) he also works relays which switch on the high-tension and low-tension currents (six volts and 200 volts respectively) to correction amplifier No. 2, switching on its valves, which connect its output back to the desk.

The output is here connected to a strip of ten jacks in parallel. One can tell how many stations are being fed direct by Leeds by the number of plugs in this strip. In the case of a full S.B. from London there are five plugs, corresponding to 2ZY, 5SC, 2LS, 5FL, 5NO, and 6KH. If there were two different London programmes and some stations were relaying

one and some the other, three plugs might be in one strip of parallel jacks connected via a correction amplifier to one London line, and two plugs in another strip, connected via another correction amplifier to a second London line.

Bank of Amplifiers

The wires from the five plugs go to a bank of three-valve amplifiers. There are two amplifiers each allotted to the use of Manchester, Glasgow, and London, two spares, and one each to the other northern stations. This is clearly shown in Fig. 2.

In the case of a full S.B. only one amplifier is in use for each station, of course. But if two separate programmes were being sent to Glasgow, for example—say one programme to be broadcast by Glasgow itself, and another to be sent on to Aberdeen—then both 5SC amplifiers would be in use, one dealing with one programme and the second with the other.

The London amplifiers are used in the event of a broadcast being relayed to London, as distinct from relaying from London, as in an S.B. such as we are considering.

The outputs of these amplifiers go to the distribution board and thence to the P.O. distribution box where they are connected to the appropriate lines, radiating to the stations being fed.

Fig. 2 also shows the circuits at the Leeds-Bradford broadcasting station as an example of what happens after the relayed broadcast has left the Leeds distribution centre. The control shown might equally well be that of any other northern station except that the Leeds-Bradford control

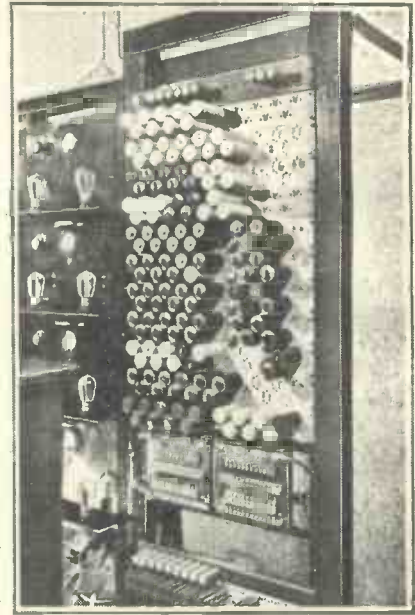

More of the Apparatus at the Gloucester Station

room supplies two transmitters.

The incoming line from the S.B. centre is brought to a distribution board which also bears the outgoing lines to the transmitters and also lines to churches, cinemas, and so on, used for outside broadcasts when the station is not relaying.

Distribution Board

It then goes to an input switch-board. The line from the transmitter comes to an output board and thence to the output of a two-valve amplifier, whose input is wired to a plug. By inserting this plug into the input board socket (A in Fig. 2) where the S.B. centre line terminates, the circuit is completed from the London microphone, via the S.B. centre, to the transmitter.

Now let us see what happens when this plug is inserted. Presume that it is a few minutes before 6.30 p.m. and all stations are preparing to relay the time signal from London. London connects the microphone through to Leeds. The Leeds operator connects the London line to the input of a correction amplifier, the output of this amplifier to the parallel jacks on his desk, and five plugs in these to the inputs of

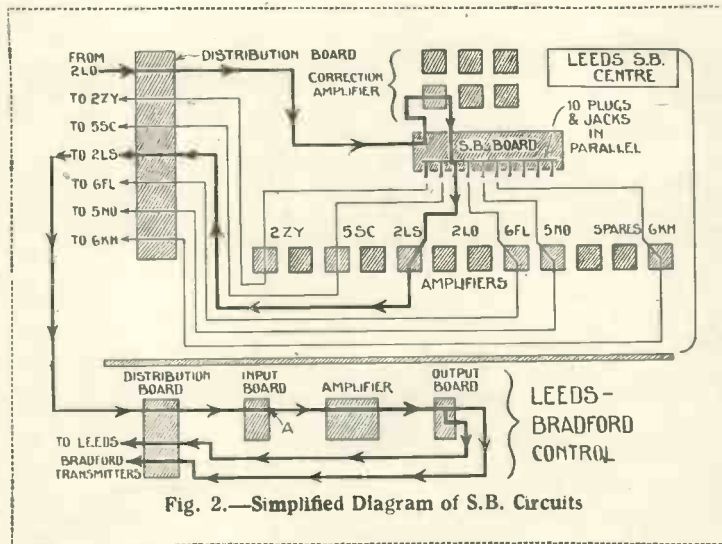

Fig. 2.—Simplified Diagram of S.B. Circuits

How S.B. is Carried Out (Continued)

five amplifiers. But that is all he does.

Remote Control

The Leeds engineer—let us continue to take this as an example—now comes on and inserts his plug at A. This connects his broadcasting apparatus to the line from the S.B. centre and also works relays at the latter. These relays connect the end of the line to the output of the Leeds amplifier at the S.B. centre and also switch on the H.T. and L.T. supplies to that amplifier. Similarly all stations fed by the Leeds S.B. centre switch on their own amplifiers in that centre by remote control in this way. The advantage of this automatic system is particularly evident if one considers such a position as this.

Newcastle, let us say, has been giving a local programme. At 9.30 p.m. it is due to "go over to London." Throughout the evening all other stations are relaying the London programme. A few minutes before 9.30 p.m. the Newcastle programme ends and the control engineer immediately moves his plug A from the socket in the input board in which it has been inserted (connected to the local studio microphone) to the socket where the line from Leeds terminates.

This automatically operates the Newcastle amplifier at Leeds, but Newcastle listeners are not suddenly given the end of the programme now concluding at London, because the Newcastle plug is not among those in the strip of parallel jacks carrying the London programme on the desk at Leeds.

"Fixing Up" Newcastle

But now, when he hears this part of the London programme end, the Leeds S.B. operator merely puts the Newcastle plug along with the other four in the strip and his work is done—in a fraction of a second. He is saved the work of switching on the Newcastle amplifier and connecting its output to the Newcastle line, because the Newcastle engineer has already done that for himself, by remote control.

Fig. 2 is, of course, merely a diagram to indicate the method of working at the S.B. centre. It does not pre-

tend to show anything like the circuits in use. In addition to the music lines to the various stations there are, in almost all cases, control lines, used by the engineers.

There are, from Leeds, three lines to London and to Glasgow, one to Newcastle, and two each to all other stations in the group. All these lines come, via the P.O. distribution box and the distribution board, to the desk. The maze of wire in the interior of the desk, what with these lines and the inputs and outputs of the various amplifiers, wires to the various relays and so on, can be imagined.

Extra lines are put in as required. Thus in the event of an outside broadcast—say from York Minster—to all stations, the line from York (in this case) would come to the desk and would be coupled up to a correction amplifier and then to the strip of parallel jacks. In this case there would be six plugs in the strip, as London would be taking the broadcast as well as the northern stations.

Electrical Relays

The relays are mounted on a rack alongside the amplifier rack, which is behind the operator as he sits at the desk. There are between 80 and 100 relays in use. The system has, in fact, been made automatic, as far as is practicable. For instance, if Manchester, say, should be relaying at 7.0 p.m. and at that time he is not doing so, either because he has failed to plug in on the line and so operate his amplifier at Leeds, or because the relays which do this have failed, the Leeds operator is immediately informed of the fact by the appearance of a signal light under the Manchester jack in the strip of jacks in use.

All ringing—for control purposes—between stations is done by lights, operated by relays. The relays depend, of course, on the earth as one side of their circuit between the distant station and Leeds. Should the earth be a bad one and the relay not operate its work can be done manually.

Before him the operator has keys for ringing any station he wishes to speak to (a hanging telephone is in use), for putting a loud-speaker in and out of circuit, for enabling him to listen across any line, and for

testing the resistance of any line, by putting a battery and voltmeter in series with it. Other meters on the desk indicate the voltage of the amplifier H.T. (200), and L.T. (6), and relay (24) supply currents.

Constant Strength

The operator's headphones are on the secondary of a transformer, so there is no click and no diminution of strength of any programme he may switch across. Should two stations ring him on their control lines at the same time he can key so as to speak to both of them at once. At busy times this is frequently necessary.

There are many safety devices of an ingenious nature. Should the operator plug in accidentally on the S.B. circuit a relay prevents him actually cutting the line and a warning light goes up. Should the H.T. supply to any amplifier fail a buzzer calls the operator to attention and a red light appears on the amplifier affected.

Apart from all this, of course, stations are quick to complain if their transmission suddenly ceases! They also complain if there is any defect in the quality of the broadcast, and the tone on any line can be raised or lowered by a knob on the amplifier on that line.

Fuses—and a Bell

Next door to the relay rack are the fuses. Should an L.T. fuse go, the attention of the operator is drawn to the fact by the ringing of a bell. He can tell which fuse it is by the fact that when it burns out the fuse topples over and a little white bead can be seen leaning outwards. The burning out of an H.T. fuse causes a buzzer to go off and a red lamp to light on the amplifier effected. All these devices are operated automatically by relays.

The supply currents come from an adjoining room where the banks of accumulators are accommodated. The H.T. is supplied from a 200-volt 10-ampere-hour battery with a discharge rate of 2 amperes; L.T. from a 6-volt 400-ampere-hour battery discharging at 90 amperes and relay current from a 24-volt 80-ampere-hour battery with a 15-ampere discharge rate. W.A.B.

Specialy designed, built and tested by the "Wireless Magazine" Technical Staff—and approved of in principle by Capt. H. J. Round, M.I.E.E.—this unit, which makes use of one of the new screened-grid four-electrode valves that gives great amplification without oscillation trouble, converts an existing set that incorporates no form of high-frequency amplification into a powerful receiver that can be operated without difficulty.

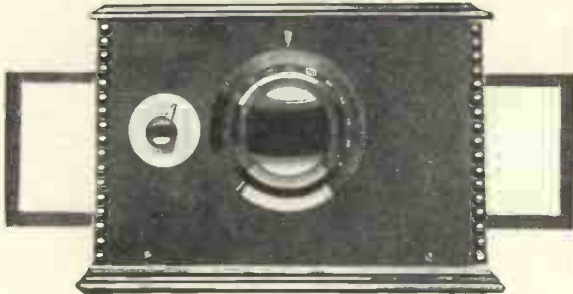

The RANGE EXTENDER

Adds Range and Volume to Your Detector and L.F. Set at Low Cost.



At the present time there are in use all over the country thousands of valve receivers that incorporate no form of high-frequency amplification, and consequently their range is restricted and, in many cases, their selectivity not of a very high order.

For Existing Receivers

This "range extender" has been specially designed by the WIRELESS MAGAZINE Technical Staff for use in conjunction with receivers that include only a detector and one or more stages of low-frequency amplification. Added to any such existing set it will enormously increase the range and volume.

Use is made of one of the already famous screened-grid valves developed by Capt. H. J. Round, one of our foremost radiotechnicians, and the circuit and general layout of this unit has been approved by him in principle.

As a large number of WIRELESS MAGAZINE readers who have followed Capt. Round's articles on the subject in these pages will be aware, the new valve gives a very high degree of high-frequency amplification—something in the neighbourhood of thirty or forty, depending upon the particular conditions obtaining—without the necessity of employing any of the usual means of neutralising to prevent self-oscillation.

The valve is, by virtue of the extra "screening" grid, what may be termed self-neutralising and there are no difficulties in its use even by inexperienced operators if the details given in this article are carefully followed.

Arrangement of the Screened-grid Valve

Reproduced in these pages are photographs which show the general appearance of the valve, which is of the tubular type. The filament and control grid are connected to three pins at one end of the valve, while at the other end are two pins connected to the screening grid and anode respectively.

CIRCUIT DIAGRAMS

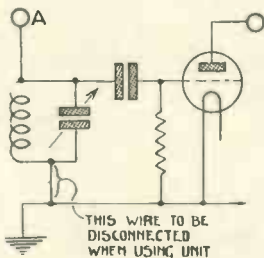

The earth connection on the existing receiver must be removed before connecting up the Range Extender

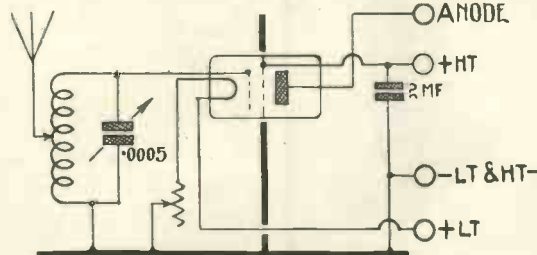

Circuit of the Range Extender

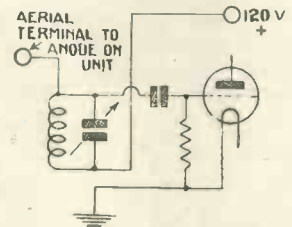

Aerial terminal of existing set is connected to "anode" terminal of Range Extender as indicated above.

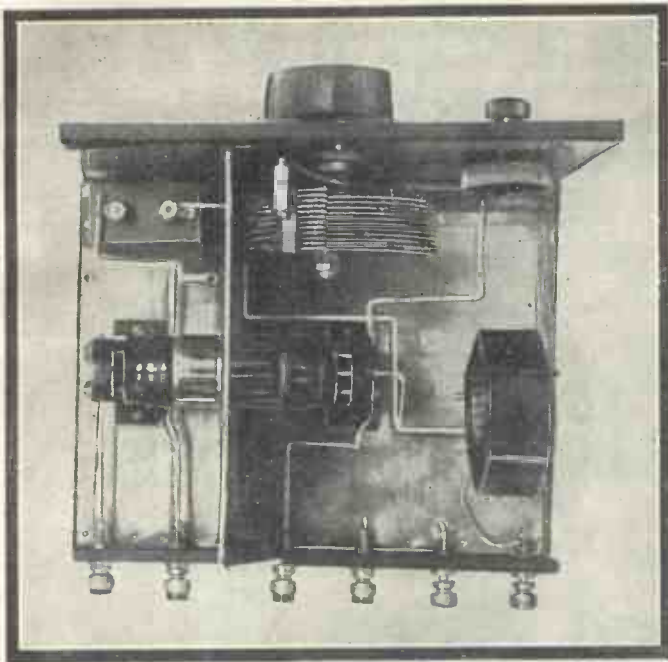

The screening grid is placed between the usual control grid and the anode, and effectively prevents any feed-back occurring if a positive potential of about 80 volts is applied to it.

Not for Sets Incorporating H.F.

It is not recommended that the Range Extender, as this unit has been named, should be used in conjunction with any set already incorporating a stage of high-frequency amplification. It could be so used, but unless great care was taken in operating, complications would be likely to arise.

The unit is intended only, as has been stated previously, for use with receivers of which the first stage is a detector valve and in such cases it will be found to add enormously to the range and volume of the existing set.

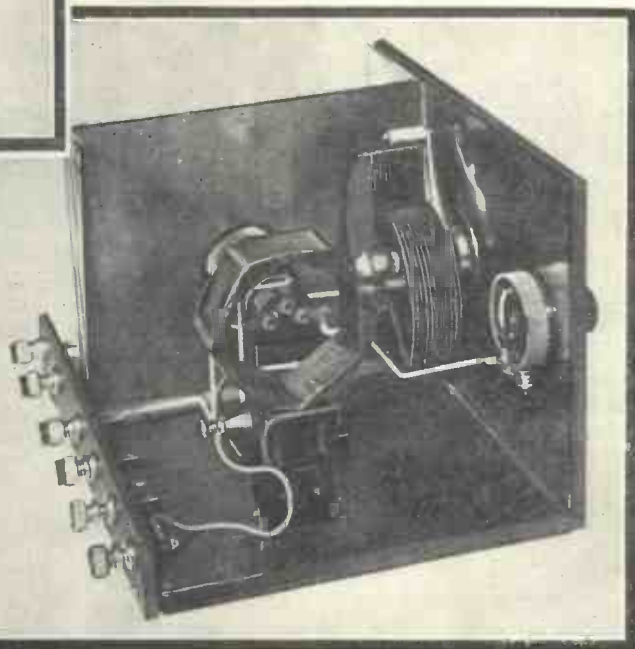

(Top, left)—Plan view of the Range Extender showing screened-grid valve and aerial coil in position

(Above)—Another view showing special aerial coil

(Below)—Detailed view of special valve holder used

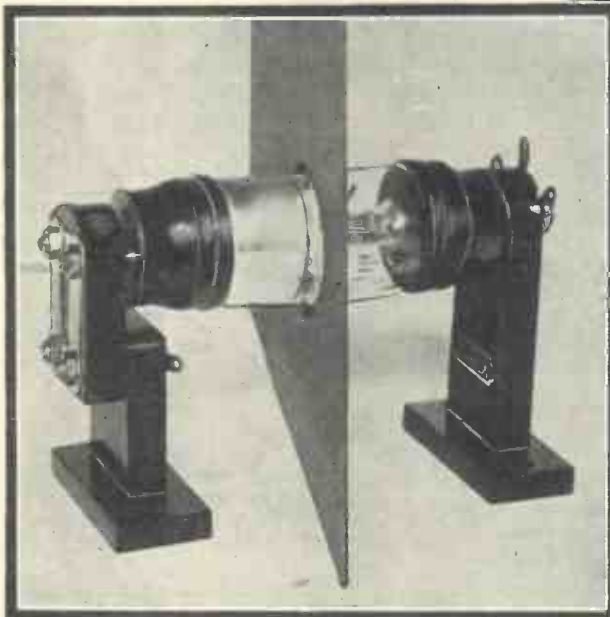

valve holder the valve is used in a very efficient way, as the screening of the special grid is continued externally without any breaks. From the photographs it will be seen that one part the valve holder (on the left-hand side from the back of the panel) is made in two sections. The top part is easily removable and allows the valve to be withdrawn from the hole in the screen without difficulty

No Difficulty in Constructing Screens

The construction of the actual screen presents little difficulty. The front screen is held against the panel by the condenser and rheostat, while the bottom part is tacked down to the baseboard by means of small thin nails. The vertical dividing screen is soldered to the panel and baseboard screens; this is a very simple

Adds Range and Volume at Low Cost

operation if reasonably clean copper sheeting is used.

Alteration to Existing Receiver

It may be emphasised that no great constructional alterations are necessary in the existing set, the earth connection merely being broken from the grid-return lead of the detector valve. This will be explained in detail when operating is dealt with.

Components Required for the Unit

For the construction of this simple Range Extender the following parts will be required :

- Ebonite panel, 9 in. by 6 in. (Becol or Peto-Scott).
- Copper screen (City & General).
- .0005-microfarad square-law variable condenser with dial (Igranic or G.E.C., Raymond).
- Single coil holder (Lotus or Lissen, Magnum).
- 30-ohm rheostat (Precision or Igranic, Lissen).
- Screened-grid valve holder (Paroussi).
- 2-microfarad fixed condenser (Dubilier or Lissen).
- Terminal strip, 9 in. by 1½ in. (Becol or Peto-Scott).
- 6 terminals marked:—Aerial, Earth, L.T. +, L.T.—, H.T. +, Anode (Belling-Lee).
- 4 ¼-in. wood screws (Economic Electric).
- 4 ½-in. wood screws (Economic Electric).
- 4 ¾-in. wood screws (Economic Electric).
- Dial indicator (Bulgin or Belling-Lee).
- 24 ¼-in. thin nails for fixing screen to baseboard.
- Cabinet and baseboard (Artcraft).
- Glazite for wiring and 1 ft. flex.

It should be noted that the particular components used in the original set and allowed for in the layout are in each case mentioned first.

Before beginning construction the amateur is advised to obtain a full-size blueprint layout, drilling guide and wiring diagram. This can be obtained for 6d. post free, if applied for before

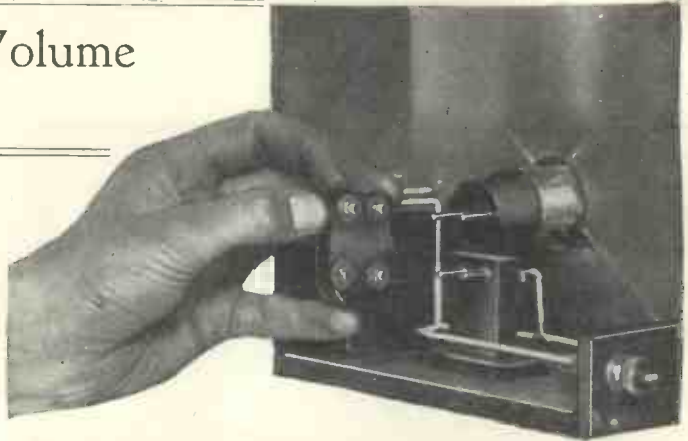

This photograph shows how the special valve holder is manipulated for removing the valve

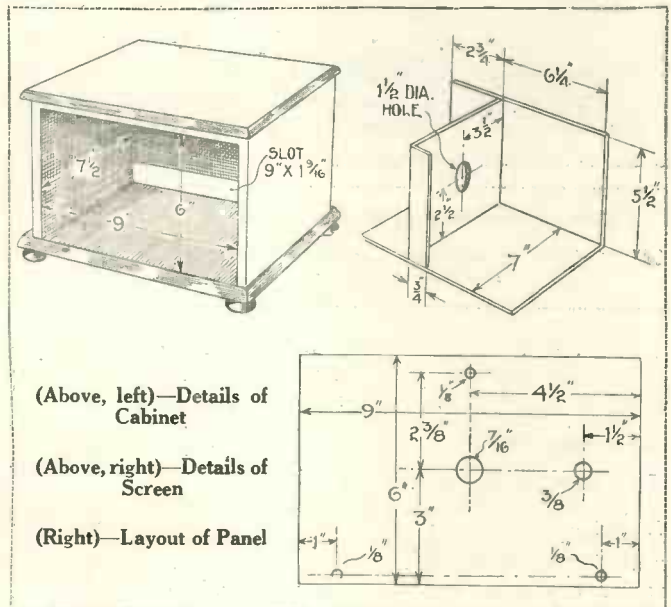

(Above, left)—Details of Cabinet

(Above, right)—Details of Screen

(Right)—Layout of Panel

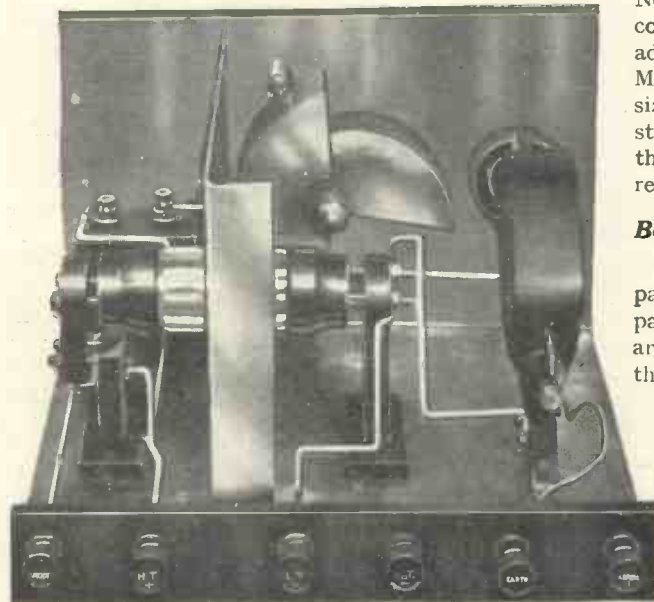

View of the completed Range Extender

November 30 and the coupon on page iii of the cover is used. Ask for Blueprint No. WM 38, and address your inquiry to Blueprint Dept., WIRELESS MAGAZINE, 58-61, Fetter Lane, E.C.4. Although a full-size blueprint is a great convenience to many constructors its use is not, of course, essential and all the necessary details for the building of the unit are reproduced in these pages.

Beginning Constructional Work

The first operation is to drill the front, screen and panel for the condenser and rheostat. The bottom part of the screen can then be tacked to the baseboard and the panel screwed in position. Before mounting the variable condenser it is desirable to solder the vertical dividing screen into position.

As soon as the screens are completed all the components can be mounted in the ordinary way. It should be noted that both the variable tuning condenser and the rheostat are both "earthed" to the panel screen. Care should also be taken to

The Range Extender (Continued)

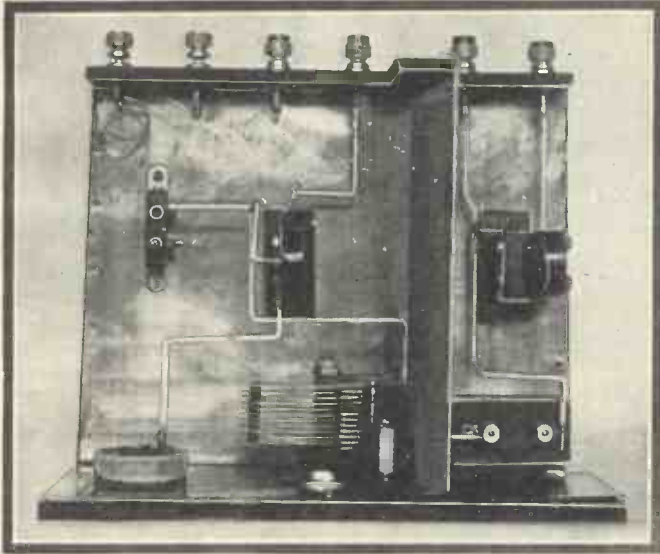

(Above)—Plan View of the Range Extender

(Right)—View of the Range Extender showing valve and coil in position

terminal marked "anode" on the Range Extender to the aerial terminal of the existing set. (Thus it will be appreciated that there is only one lead from the Range Extender unit to the existing set.)

Before finally making this connection, however, it is necessary to make one alteration to the existing set. In the ordinary receiver, as every WIRELESS MAGAZINE reader must know, the filament end of the tuning coil is connected to earth. Before doing anything else it is necessary to *break* this connection. In other words, it is necessary to have the earth terminal on the existing set connected to the L.T. and the filaments of the valves, but *not* to the aerial-tuning circuit. This point is made clear by the

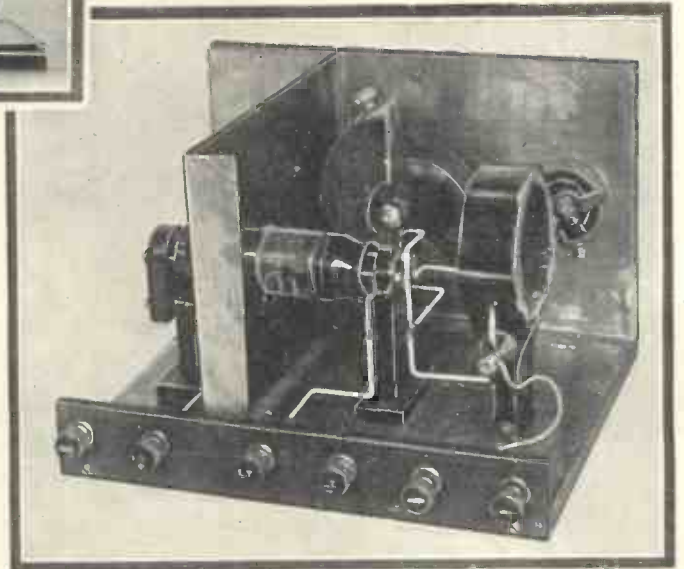

see that the two parts of the special valve holder are mounted on the right sides of the dividing screen.

Connecting Up

Reference to the blueprint or wiring diagram reproduced in these pages will greatly facilitate the connecting up of the unit. A glance at either will reveal the fact that each terminal point is marked with a small letter of the alphabet; these small letters indicate which points should be connected together and in what order.

Thus all those points marked *a* should first be connected together with one wire or as few wires as possible; then all those points marked *b* should be connected; and so on until wiring is completed.

Rough Test

As soon as this part of the construction has been completed a rough test can be carried out. The screened-grid valve should be placed in the holder and a No. 40 or 60

tapped coil in the aerial-coil socket for the reception of London. The use of a tapped coil in the aerial circuit does increase selectivity, but

an ordinary coil can be used if desired. In this case the flexible lead from the aerial terminal is connected to the socket marked *a* on the coil holder (see blueprint or wiring diagram).

Now connect up the terminals on the Range Extender, beginning with the aerial and earth. Across L.T. + and L.T. - connect a 6-volt accumulator, tapping off at the proper point if 2- or 4-volt valves are used in the main set (at the time of going to press, screened-grid valves are issued only in the 6-volt class). To H.T. + apply a voltage of about 80 and get ready a lead to connect the

diagrams reproduced in these pages.

As soon as this earth lead in the existing set has been disconnected, the lead for the range extender can be connected to the aerial terminal of the main receiver. The end of the coil and condenser which was connected to earth should now be brought out to a terminal connected to the H.T. battery at about 120 volts.

It must be remembered that the aerial coil of the main set has now become the tuned-anode coil of the Range Extender, and for this reason
(Continued in third col. of next page)

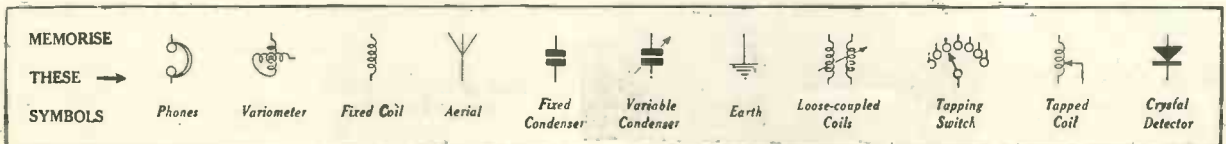

The Range Extender *(continued)*

Layout and Wiring Diagram

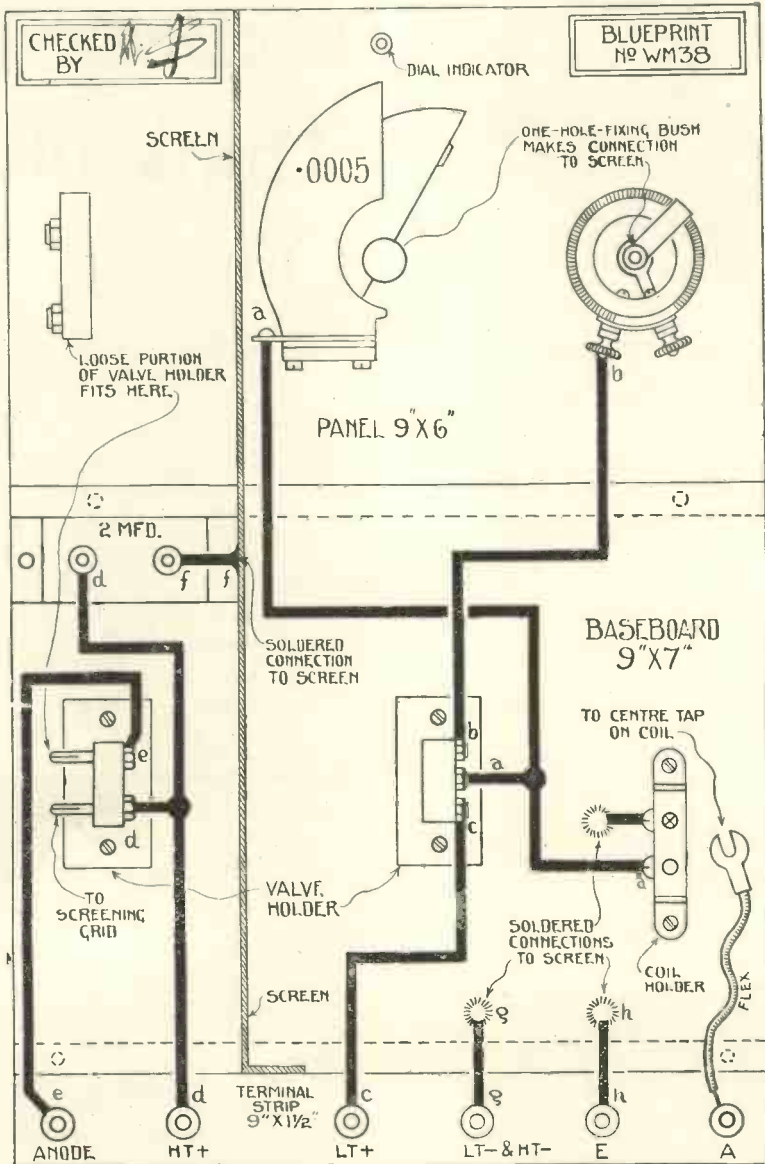

This layout and wiring diagram can be obtained as a full-size blueprint for 6d., post free, if the coupon on page iii of the cover is used before November 30. After that date the normal price of 1s. will be charged. The number is No. WM38

it must be a little larger than it would need to be for aerial tuning.

When everything has been connected up satisfactorily, both sets can be switched on. In order to tune in a transmission it is necessary to manipulate the tuning controls on both Range Extender and receiver at the same time. If the main set is fitted with reaction control, this will not need to be advanced so far as is the case when an aerial and earth are used directly on the receiver.

Do not expect at once to be able to operate the complete outfit as easily as you could the old receiver on its own; it will take time to get used to the new controls.

Adjusting for Best Results

Pick up some transmission that is not too strong and adjust the various controls until the very best results are obtained. First vary the rheostat on the Range Extender to make sure that the screened-grid valve is working on the most efficient part of its characteristic curve. Next adjust the reaction control on the main receiver (if one is fitted) and retune the anode condenser (the old aerial condenser of the main receiver).

A few hours' manipulation of the outfit will show the operator what is the best procedure to get the best results. It will be found that the addition of the Range Extender to a two- or three-valve receiver will increase the range and volume to an astonishing extent.

We ourselves have found the arrangement especially efficient and it is to be recommended to everybody who wants a more powerful receiver but who does not want to dismantle an existing set.

Assisting Navigation

AS forecast in these pages some months ago, new directional stations are now being erected at various points around the English coast to assist marine navigation. The first wireless beacon to come into regular operation, under the supervision of Trinity House, is located on Round Island near the Scillies. It transmits signals automatically at pre-determined intervals, under the control of a master clock, on a wavelength of 1,000 metres.

A.R.B.

A NEW WIRELESS BOOK YOU MUST NOT MISS!

Everything you want to know about the new screened-grid four-electrode valve is explained in

The Shielded Four-electrode Valve

by
Captain H. J. ROUND, M.I.E.E.

This book, which is published jointly by Cassell and Co., Ltd., and Bernard Jones Publications, Ltd., costs 2s. 6d.

ORDER A COPY FROM YOUR NEWSAGENT NOW!

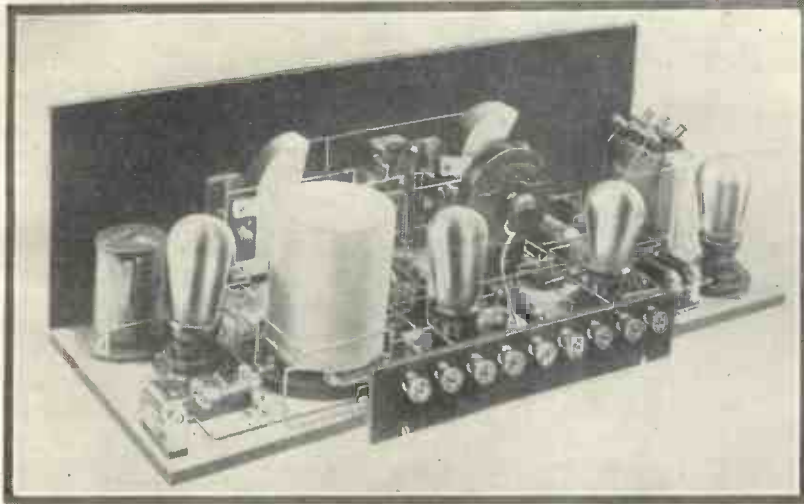

Rear View of the Revelation Four—an efficient yet straightforward receiver that employs no “stunts.” A full-size blueprint is, of course, available.

Revelation Four

July, 1927, p. 497.

Finest Four-Valver

To the Editor, “Wireless Magazine.”

SIR,—It is really a pleasure to inform you of the great success which I have had with the Revelation Four. It is without doubt the finest four-valver I have heard or made.

I have dial readings written down before me and either I or my wife can tune any station that may be asked for without trouble. It is really wonderful; and I am only too pleased to let any one hear it, and I thank you very much.—E. W. LUNT, (Rochdale).

(Mr. E. W. Lunt has received the following stations on the loud-speaker: Daventry, Liverpool, London, Berlin, Langenberg, Daventry Experimental, Dublin, Rome, Manchester, Leeds, Bradford and Newcastle.—ED.)

Far and Away the Best

SIR,—When I read the description of your Revelation Four, I decided to build it at once although I had got very tired of trying “wonderful new circuits” none of which equalled the set I regularly use consisting of loose-coupled aerial, detector and three stages of resistance-coupled L.F.

It is only fair to say that Ventnor is an exceptionally bad place for reception, in addition to being close to Lloyd’s wireless station at St. Catherines and a sufferer from much shipping morse. I have found any B.B.C. stations very difficult to get at loud-speaker strength (except Bourne-mouth and Daventry) even with a 6-valve super-het (which I discarded on account of the disagreeable background).

I had to wait three weeks for a suitable H.F. choke and reaction condenser, but these arrived yesterday morning and I tried the Revelation Four out last night. The first trial greatly disappointed me

and I was vexed to find that there was much interference from St. Catherines even on Daventry’s wavelength. I have therefore inserted another aerial coil. The results I have obtained this afternoon have surprised and delighted me. 2LO came in at a loud-speaker strength that I have never got before, even on the 6-valve super-het and even Cardiff, a most difficult station here, came in respectably. Daventry and Paris are beautiful, astonishing volume and wonderfully pure tone; no interference from St. Catherines.

I thought you might like to hear my first impressions and my opinion that it is far and away the best circuit I have tried out of dozens, including several “classics.” I am looking forward to this evening’s tour round the Continent.—HAROLD E. BAESANO (Ventnor).

Best—Without Exception

SIR,—Some few weeks ago I wrote you with regards to my set, the Revelation Four. I have now given this set a thorough testing on Canvey Island, Essex.

I am going to say that *without* exception it is the finest four-valver I have ever had the good fortune to construct.

Loud-speaker radio is available nearly all day, from say 10.30 a.m., from some station or other. The number I have received is far in excess of your list, and all on the loud-speaker: phones are never used.

The aerial consists of 100 feet of wire, 12 feet above the ground. Insulators, etc., were not used, insulated wire being preferred.

I am at the present moment listening to a very excellent programme from Dortmund.

A word will not be out of place as to the simplicity of control—a child could operate it, on D.X. work. I am using 2-volt valves and very excellent they are.

I would strongly advise any of your readers who require a really first-class set for the coming winter to go ahead with the job; they will be delighted with the results.

What Readers Think of Our Sets

A Selection of Letters

In conclusion I will say that every word you print regarding this set is dead correct and more so.

I have built sets of every description, from big super-hets to crystals, but the Revelation Four, in my opinion, is THE set for the man who wants the goods.—FRANK T. BERRY (London, S.E.1.).

One-dial Two

August, 1927, p. 28.

Ideal Set for the Home

SIR,—I am writing to inform you of the success of your One-dial Two, which I have constructed from the August issue of WIRELESS MAGAZINE.

It is without doubt the ideal set for the home, giving ample volume without distortion.

Several of my friends have remarked that they were quite sure it was a three-valver owing to its loud-speaker power and purity.

I substituted a sort of very hard red mahogany for the ebonite panel and this, being quite leak-proof under test, proved to be as good if not superior to ebonite.

My aerial being only 72 ft. long necessitated my taking three turns off a No. 50 coil for the aerial and using a No. 60 for reaction. This proved to be best after trying all ways.

2LO, 5GB, and Langenberg come through on a Lissenola unit attached to a gramophone at extraordinary volume and many other continental stations are received at fair strength. I never use earphones.

It is as well to mention that I use corrugated-iron sheets riveted in seven places sunk to a depth of 5 ft.—hence the cause of my shortening the aerial owing to its previous liveliness.

Needless to say after this success I am constructing a Revelation Four and will give you my results when I have had time to fully test the set.—LEONARD W. COLLINS. (Billericay).

Sandy and Television

By RICHARD CAROL

"SCOTLAND for ever," I cries dramatically, bursting into the parlour wi' considerable elan, as they say, an' waving hilariously a newspaper I'd had presented me jist two days auld. Ye can guess hoo dramatic the gesture was seeing it dis-lodged Joanna, the cat, frae its favourite perch on the dresser.

"Ha, ha," I laughs decoriously, for I canna abide Joanna which is a parasite though Maggie's got a great affection for him. Ay, it's a him, alas a wee mistook in genders we made at the christening.

"Ha, ha. Scotland for ever!"

"There's naeboddy contradicting ye as far as I can hear," says Maggie, continuing to darn ma pants wi' pink wool and considerable aplomb.

"Wumman," says I, the scorn fair wobbling in ma accents, "is yer national pride defunk, and romance putrefied in yer bosom?"

"Ye've been at The Highland Laddie again, Sandy, that's what *you've* been."

"Would that I had," says I, wi' dole.

"Weel, what bee's bumm-ing in yer bonnet noo?" says she still suspicious. Maggie's an awfu' suspicious body, ye ken.

"A Scots laddie has jist invented television. Think o' that, television, Maggie, TELEVISION! And he's a Scot tae."

"I gathered as muckle frae yer remarks. But what in the name o' Jupiter's 'television'? Is it a disease?"

"Disease, wumman? Yer ignorance is truly abysmal. Television is . . . weel, television, as ye might say . . . to put it simple, Maggie, it's seeing things that isna there."

"I thought as muckle. Ye *have* been at The Highland Laddie. And it's as bad as that, Sandy. Seeing things that isna there. Put oot yer tongue and let's see what it looks like."

"Ye're daft, wumman," says I,

maintaining ma politeness wi' considerable effort. "I kennt what it would be when I tried putting such a comlicated thing into language for *your* mentality. Hooever, I'll essay again. It's sending pictures through the etherial waves, pictures o' cows and horses and folks and such like, etc., sae that onybody that's got the ither part o' the invention which has been invented, as I think I tellt ye, by a braw Scots laddie, can see that cow or horse etc., jist as

patience and filling ma pipe at the same time jist in case, "I was jist gi'eing ye examples. Dae ye no' see the amazing possibilities o' the discovery? In less than nae time ye'll be able to sit here and listen to the man ower the wireless telling ye hoo mony different kinds o' slugs there are in Britain and ye'll be able to see him, watch his mooth open and shut; ay Maggie, and if he's gotten a lisp ye'll maybe see the tip o' his tongue come forrit every time he says 'thlugs.' Is that no' wondeful?"

"I canna say I'm ower anxious to see yon man havering aboot slugs and bluebottles. But ye ken the gowk wi the squeaky wee voice? I canna abide him. I'd like to see *him*. Would the telewhat'sitsname dae *that*?"

"It would," says I wi' pride, the inventor being a Scots laddie.

"I'd like that, then. I'd put ma tongue oot at him, twice, ay, I would. Would he be able to see me dae that?"

"Na," says I, dejected at her debased mentality. "It would be jist like putting oot yer tongue at Lord Nelson there ower the matle-piece. But," I proceeds boldly, "jist consider the possibility o' listening to prima donnas and seeing them work their *wulas* at the same time."

"I've heard that prima donnas are awful fat," says Maggie shaking her heid dolorously, "and if I seed her, a fat wumman jist like Mistress Broom, it would spoil it all."

"There is that," I admits reluctant. "But of course, ye ken, that's jist one use o' the new invention. Think o' its agricultural possibilities. Picture to yersel the shepherd trudging up the snow-covered mounts to see if his sheep is surviving, miles and miles he'll gang and find them no' bad at all. That, Maddie, is a picture o' the past.

(Continued on next page)

The American Lorry Driver—



—must have a "radio" with him!

if it was in the room wi' him."

"I canna see muckle sense in a invention like that. What dae I want wi' an auld cow in the room wi' me? It's daft."

"Ye're all wrong, Maggie.. It's jist the picture ye'll be seeing."

"Weel, and what will I be wanting to see the picture o' an auld cow for when I can see hunders in the fields. And onyway I'm no' particular anxious to see cows—nor horses neither."

"Ma conscience, wumman," says I, praying to the guid Lord to gi'e me

Sandy and Television

(Continued from preceding page)

"Wi' this new invention all he'll ha'e to dae is sit in his ain hame and ha'e a bit look at his television apparatus. He'll turn a bit knob till he's tuned in, maybe Bulloch Hill. And there afore his eyes will be the sheep and shepherds. 'Ay,' says he to hisel, looking hard at them, 'ye're loking fine,' and off he'll gang to his bed or maybe sit doon and dae a cross-word puzzle. Or he'll say 'Na, I dinna like the look in *your* eye,' and off he'll gang to minister to its needs. Ye see Maggie, there'll be an amazing saving o' time."

"Which he'll spend nae doot at The Highland Laddie," intersperses Maggie. "As far as I can see, it'll be guid for the publican and naebody else. They'll all be there seeing if they can see sheep and cows and such like which doesna need their attention. I shouldna be surprised if he's got something to dae wi' the idea. He kens fine that the mair time a man has to spare, the

mair he'll be at The Highland Laddie."

"Maybe aye, maybe no'," says I wi' dignified indifference, "but the fack remains that soon we'll jist be able to turn on oor televisions and see onybody onywhere at any time."

"What! Dae ye mean it would be possible for me sitting here to see you and Angus and Andra and all the rest o' yer baboon companions indulging in a committee meeting at The Highland Laddie?"

"I believe," says I, ma elation vanished, "that it would be possible, alas."

"It's no' a bad idea, this telethingummybob. A Scots laddie, ye said, did ye no'?"

"Ay, alas," says I.

Ay, inventions is nae doot a power for guid, allowing shepherds to play dominoes instead o' chasing after sheep that are feeling fine and such like, but—they've got their bad side, ma conscience, they have.

What Schoolgirls Think of Wireless : *By a Teacher*

SUBSEQUENT to my previous article which dealt with a boy's idea of wireless, I have investigated, by means of another essay, the opinion of girls on this subject.

It seems that the latter not only state their likes and dislikes with equal clarity when compared with boys, but their reasons are more satisfactory in regard to the fact that their point of view is based on a closer scrutiny of the question.

Little Mothers

Many of them are little "mothers" in their care of younger brothers and sisters and, no doubt, as they spend more time at home than boys, wireless is a more important factor in their lives. Certainly their opinions are very decided and can be readily understood by all adults whose knowledge of the younger generation is the result of child study.

In comparing the opinion of boys with that of girls the difference was, in some instances, very marked. The "hooter," garden hints and morse, described by several boys as distasteful, were not mentioned at all by the girls. On the other hand, only one or two of the former discussed the difference between a loud-speaker and earphones, whereas the latter were almost unanimous in asserting their antipathy to earphones which, according to one girl, "sometimes make your ear ache."

Moreover, the scientific aspect of wireless claims the attention of girls more than of boys. One writer stated that "the greatest thing of all is that it is a step forward in the history of the world," and several pupils in attempting to explain how a set was worked commented on the wonder of the invention.

Again, more girls than boys con-

sider the usefulness of wireless to mankind: "It is of great benefit to people who are alone in the house," remarked one writer, and another stated, "It is very very helpful for a ship in distress."

In several instances comments were made relating to the SOS calls for the relatives and friends of people dangerously ill. Many emphasised the educative aspect; this was stressed by one scholar who did not, however, forget the amusing side when she wrote: "I specially like a man talking about other countries because we can learn a lesson from them, and sometimes they tell us an amusing joke."

Few Dislikes

The dislikes of children in regard to programmes were not very pronounced in this series of essays, although a small number were in agreement with the writer who said, "The weather and news are not very nice to listen to." And another pupil said more than she realised when she stated, "I do not like hearing about the weather because it is so dull."

Dramatic appreciation is evident in the case of some scholars. This was particularly the case with the essayist who related that, "One night we heard where Saul asked a witch to call up Samuel. When Samuel came, it was ghastly."

The most notable paragraphs relating to the pleasurable side of wireless were the following varied comments: "On a rainy day it is nice to sit down and listen to the wireless and forget all about the rain outside." "I like to listen to the Children's Hour because you can understand more than some of the other things." "I like listening to the jazz band because it is jolly, and it makes people cheerful and happy and then they think of better things." "When the bands come on we are all silent as mice because we all like to hear Jack Hylton's band."

Important Factor

In hearing the voice of the children one cannot help but realise that wireless is a most important factor in their lives, from both an educative and a pleasurable point of view. And although no thoughtful individual would expect all programmes to appeal to the younger generation, there can be no shadow of doubt that children in the vast majority of cases experience many happy moments when they listen to first-class orchestral music.

The World's Largest Transmitting Valve

Used in an American Broadcasting Station

WGY, the General Electric Company's broadcasting station at Schenectady, N. Y., normally uses a power of 50 kilowatts. The power amplifier part of this transmitter contained, until recently, eight 20-kilowatt water-cooled valves, connected in parallel.

These eight valves have now been superseded by a single 100-kilowatt valve, which can be seen at the right of the accompanying illustration, which also shows one of the eight 20-kilowatt valves used in the older installation, and a spare being examined by an engineer.

Eight foot Filament!

The new valve, complete with its water jacket, stands 7½ feet high, and weighs approximately 100 lb. The tungsten filament is 8 feet long and about one sixteenth of an inch in diameter. To heat it requires 6½ kilowatts of power.

Out of its water jacket the valve stands 5 feet high. Two-thirds of this height consists of a copper envelope, which, besides containing the electrodes, acts as the anode, or plate. The upper third of the valve is made of glass, and the junction between the glass and the copper is made by a special process to ensure that the joint shall not only be mechanically strong, but also vacuum tight.

Cables for Filament Current

The glass bulb is 22 in. long and, like the copper envelope, 4 inches in diameter. Two heavy copper cables convey the filament current through the glass at the top of the bulb, and connect to heavy tungsten rods which connect in turn to the filament itself, through the pinch.

The filament itself consists of three lengths of tungsten wire, each roughly 16 inches long, thus forming six parallel filament spans. These pass within the grid and meet at a common suspension point at the lower end of the tube. As may well be imagined, these wires require to be put under considerable tension, and this is done by means of a heavy spring to which the wires are attached at the bottom suspension point.

The grid is cylindrical in shape, and wound in a spiral.

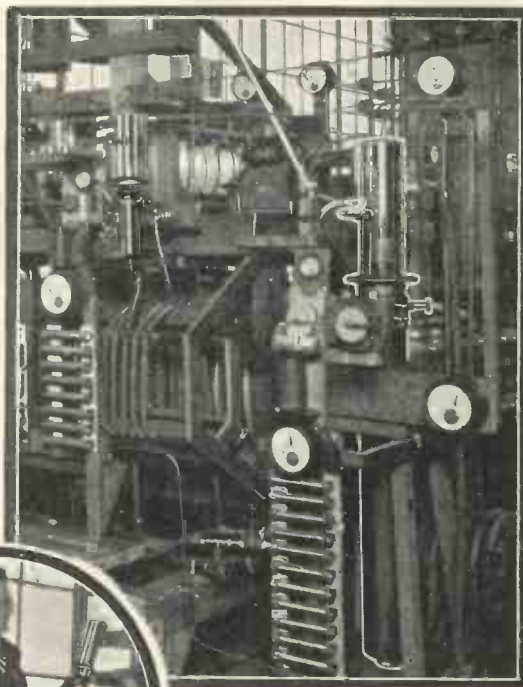

Its overall length is 3 feet 5 inches. It is specially strengthened in a new and unique manner, being braced on a structure of molybdenum and tungsten, the bracing used being similar to that used in bridge construction. In this manner a maximum of strength is provided with a minimum of metal.

A minimum of metal in the grid structure facilitates the process of exhaustion and ensures that the valve will not go "soft" at a later date, due to the release, under working conditions, of occluded gas.

The grid connection is brought out through the wall of the glass bulb through a special seal.

Special Water Cooling

A uniform flow of water round the plate of the valve is necessary to prevent unequal heating, and to this end a special form of water jacket has been designed. It consists of an ordinary water jacket within which is a second flexible jacket which directs the flow of water on to the anode. Further, as can be seen in the photograph, an air blast is directed upon the copper glass seal, to prevent overheating at this point.

The Gullible Novice and the Interfering Stranger

A YOUTHFUL Student, who devoted many Hours to the Study of the Science without Wires was once wishful to obtain a Sufficiency of Joos without having Recourse to his Joos-stora, a Valuable be desired to hoard against a Day of Want.

And it came to pass that on one Eventful Morning he encountered a Man with whom he held converse, as it appeared that the Stranger was

versed in the Arts of the Magic by which Amps of Joos could be obtained from the Store the Town freely placed at the Disposal of its Citizens—against Payment.

Wending their way back to the Home of the Student, after the Sun had set, the Learned one practised this Magic with the result that an Outcry arose from many Rooms, for the Abode, which had been full of Light, was of a sudden encompassed

by Darkness, as it were Night, and the Novice, to allay the Wrath of his Sire, was forced to borrow Oil Lamps from his Neighbours, the while the Interfering Stranger passed without the City Walls.

MORAL: Services tendered by strangers are oft open to suspicion—or, as the Physician saith to his Slave: "Heed not the Advice of Busybodies, but follow the Blueprint." J. G. A.

Every Keen Experimenter Will Be Interested in This Article on—

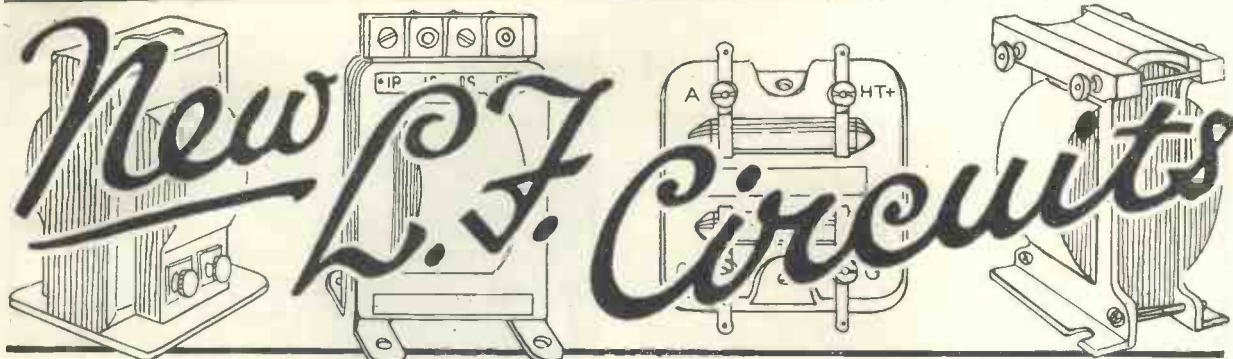

By J. H. REYNER, B.Sc. (Hons.), A.M.I.E.E.

ONE is inclined to regard the low-frequency side of the receiver as more or less stereotyped. The amplification is usually obtained by one of three methods and, apart from improvement in the actual technique of these particular methods, there appears, on the face of it, to be little ground for improvement.

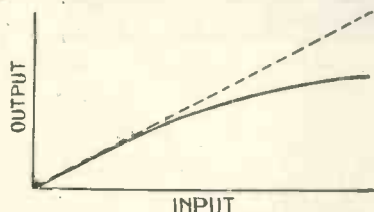

Fig. 1.—Relation of Amplifier Output to Input.

Low-frequency circuits are usually either transformer-coupled, choke-coupled, or resistance-coupled. The general characteristics of these three systems are fairly well known, but it will be of interest to review them briefly.

It must be remembered first of all that the actual amplification obtained over the whole stage is made up of two portions. There is the amplification obtained from the valve itself, which depends upon the relation between the external anode impedance and the internal impedance of the valve. The higher the external impedance is, the more nearly does the total amplification approach the theoretical amplification factor of the valve. The amplification so obtained is then multiplied by the effective step-up ratio of the coupling device,

Present Methods

Apart from the question of amplification, however, we usually view the various methods with regard to

their faithful amplification of the various frequencies. In order to obtain distortionless reproduction all frequencies should be amplified equally, and any departure from this ideal condition will lead to some amount of distortion. It may not be very noticeable, particularly to a non-critical ear, but nevertheless such distortion is present.

The principal difficulty is the amplification of the low tones. A transformer-coupled arrangement has a comparatively high "cut-off" due to a relatively small primary impedance at frequencies of 50 or 100 cycles per second, but it has the advantage of a step-up so that the overall amplification is fairly large.

A choke-coupled arrangement has a lower "cut-off" owing to the fact that the impedance of the choke can be made larger, but there is no step-up so the amplification is somewhat less. This is to some extent off-set by the fact that a choke can be used with a valve having a higher impedance

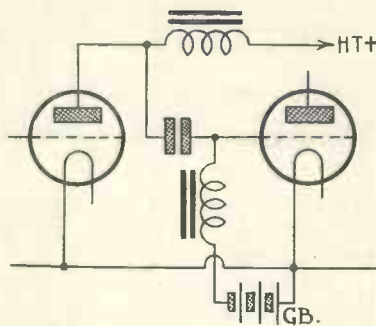

Fig. 2.—A.P. Donle's Form of L.F. Coupling

and consequently a higher amplification factor.

As far as frequency response is concerned the resistance-coupled arrangement gives the best results of the three, but here again, no step-up

is obtainable, while there is a further disadvantage that the high-tension voltage must be increased to two or three times its normal value in order that the correct voltage may be applied to the valve.

The presence of a resistance in the anode circuit causes a steady drop in the potential, and this must be made up by an increase in the high-tension voltage. Unless this is done the anode voltage on the valve is too small and the grid swing which the valve can handle is limited so that distortion may arise from this cause.

Amplitude Distortion

There is another form of distortion, however, which is little known, and that is due to the lack of what may be termed the proportional amplification. Naturalness in music is not made up purely and simply of satisfactory response to the various frequencies, but also to the various intensities. An orchestral piece is made up of an alternation of loud and soft passages. Moreover, one particular instrument may be required by the composer to emphasise some particular theme while the remainder of the orchestra is playing an accompaniment of some form.

If the music, as reproduced, is to sound natural, then we must be able to bring out the light and shade in the transmission, otherwise the music will seem flat, and there will be a difference between the actual music and the reproduction which will be a little difficult to define, but which will, nevertheless, be present.

Varying Amplification

Now the average form of amplifier, whether transformer or impedance-coupled, does not give the same amplification on different strengths of signals. The curve shown in Fig. 1 illustrates this point. Up to a certain

value of signal strength the output is more or less proportional to the input, but beyond this point it will be seen that the curve flattens out and the increase in response is not by any means proportional to the increase in signal strength. The same applies to resistance or choke coupling.

Consequently the loud passages in any transmission are not given their correct value with the normal form of amplifier and conversely the soft passages are given more than their true value. Thus, the balance between the soft and loud passages in a transmission is not adequately maintained, and a certain amount of unnaturalness is being introduced into the reproduction from this source. It is hardly distortion as we usually know it, but nevertheless the music is not being reproduced exactly as sent out.

Dual-impedance Coupling

A system of coupling recently devised by the well-known American engineer, H. P. Donle, is claimed to overcome this defect. He employs a modification of the ordinary choke-coupled amplifier, but instead of utilising a resistance leak to stabilise the grid of the succeeding valve, a second choke coil is used. This choke coil must, of course, have a very high impedance, as it is virtually in parallel with the choke in the anode circuit, but he found that by suitable design of this choke he was able to get some very definite improvement in reproduction (See Fig. 2).

The curve shown in Fig. 3 illustrates this point, and gives the amplification obtained in terms of the input in a similar manner to that shown in Fig. 1. It will be observed in this case that the falling off in the curve towards the larger amplitude is not by any means so marked as in the

previous diagram, and although the curve is by no means the straight line that one requires for an ideal condition, yet nevertheless it is a very definite step towards this end.

In a typical amplifier of this type the anode choke would be of the order of 150 henries inductance, while the grid choke would be about 200 henries, or more if possible. This would give a net effective anode impedance round about 100 henries, which would have a very good frequency characteristic. Following a 30,000-ohm valve, "cut-off" here would occur a little below 100 cycles, and the amplification of frequencies as low as 40 or 50 cycles would still be quite high.

At the same time, owing to this dual-impedance effect, the amplification on strong signals is more or less

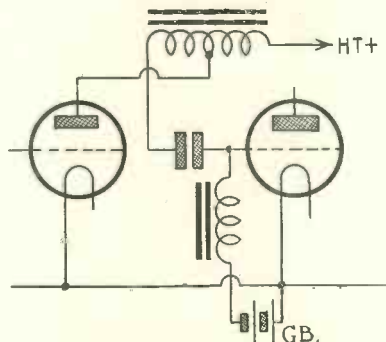

Fig. 4.—Auto-transformer Arrangement

proportional to the increased signal strength so that the strong and weak passages in the transmission have their proper relationship.

This system, however, suffers from the disadvantage common to all impedance-coupled arrangements, namely, that the amplification obtainable is that of the valve alone and no step-up effect is produced. If one could combine the advantages of the dual-impedance arrangement with the step-up effect normally obtained in the transformer, then the results should be very promising.

This can be done by using an auto-transformer arrangement. Difficulties are introduced, of course, somewhat similar to those encountered in ordinary transformer design, but they are not troublesome to the same extent because when the auto-transformer is used, the primary winding acts as a portion of the secondary winding, which means that the wire is utilised more effectively.

A circuit incorporating such an

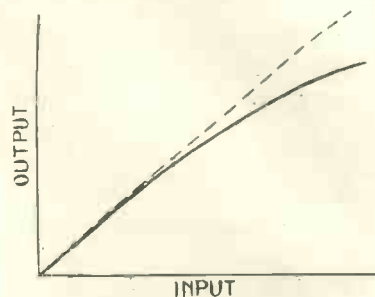

Fig. 3.—Response Curve of Donle Coupling

arrangement is shown in Fig. 4. It will be seen to comprise an auto-transformer in the anode circuit, the voltage developed across the full winding being transferred through a large coupling condenser to the grid of the next valve. In order to preserve the proportional amplification an impedance leak is employed between the grid and the grid-bias point.

Some experiments have recently been conducted at the Furzehill Laboratories in order to examine the claims which are made for these various systems. Although this question of non-proportional amplification on differing signal strengths sounds feasible, we considered it desirable to test the matter quite definitely and to ascertain whether the greater proportionality claimed for dual-impedance systems was really marked.

The results were encouraging and indicated quite definitely that this claim was no mere stunt. A certain strength of signal was taken as a standard and the voltage at the end of the amplifier was measured. The overall amplification in the various cases was naturally different, but these were all reduced to the same scale for this particular standard signal. The effect of varying the intensity of the signal input was then observed, and the results were all plotted on a comparative basis.

Definite Comparison

When this is done the curve shown in Fig. 5 results, whereby a definite comparison between the various systems can be obtained. The amplification on weak signals is rather less in the case of the dual-impedance-coupled system, but on stronger signals it is relatively greater, the whole curve being more nearly a straight line than is obtained by either of the other two systems.

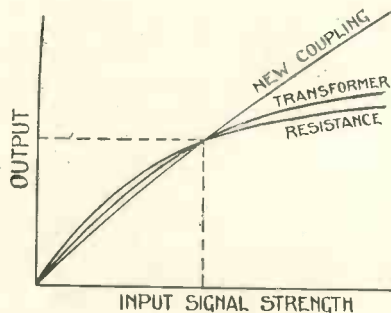

Fig. 5.—Comparison of Response of Various Types of Amplifier

Taking its low-tension, high-tension, and grid-bias supplies straight from the mains, this set will be a boon to those who have direct-current lighting supplies in their houses. The system used is the simplest form of mains working yet evolved and will give entire satisfaction. It is suitable for mains of which the voltage is between 200 and 250 volts. The whole receiver can be constructed at very low cost.



The Mains-fed Two

Designed, Built and Tested by the "Wireless Magazine": Based on a Circuit Invented by J. F. Johnston, of the "W.M." Staff

IN the last issue of the WIRELESS MAGAZINE a three-valve "all-from-the-mains" set built on the "Simpler Wireless" system invented by J. F. Johnston was described. Reports to hand from readers show that under ordinary conditions this set is capable of giving really excellent loud-speaker results at distances up to 70 miles at least from a main station and up to 150 miles or more from the Daventrys.

Two Valves Enough

Therefore, some people may consider that the set is more powerful than it need be for the reception of the local station at comparatively short range and that two valves would be enough for their particular requirements.

True, nothing is saved in the running costs by cutting down the number of valves to two (anyway the running cost is practically negligible even with three valves) but the cost of a valve is, of course, saved.

Consequently, we are now describing a two-valve set, built on the "Simpler Wireless" principle, and suitable for loud-speaker work up to distances of 20 or 25 miles from a main station under average conditions. Those readers who live beyond this distance or those who require very great volume should, of course, build the three-valve set described last month

Looking at the circuit diagram of the two-valver and tracing out the filament circuit, beginning at the positive end, there is first a 400-ohm potentiometer wired, however, as a variable resistance. That is, a connection is taken from one end of the winding and another from the slider, leaving the other end of the winding free. This resistance serves to control the filament current supplied to the valves and, within

210 and 250 four strips should be employed.

After the resistance strips comes the filament of the second valve and then, connecting the filaments of the two valves together, is a 400-ohm potentiometer. The position of the slider of this potentiometer controls the grid bias applied to the last valve.

Between the filament of the detector valve and the negative main is a 50-ohm potentiometer. If a 50-ohm filament resistance is available it may, of course, be used as a potentiometer by soldering a connection to one end of the winding. However, the Igran Company now supply 50-ohm potentiometers for the purpose.

Anode-bend Detection

The detector valve is, as usual in these sets, an anode-bend rectifier and reaction is obtained by employing a centre-tapped coil and reaction condenser. One half of this coil is connected between the grid of the detector valve and the slider of the 50-ohm potentiometer, the other half being connected between the potentiometer slider and one side of the reaction condenser. The other side of the reaction condenser goes to the plate of the last valve. The value of the reaction condenser is .0001 microfarad.

The plate of the first valve and the



The Mains-fed Two

limits, enables the set to be adjusted for electric-light supplies of different voltages.

The next three resistances shown in the circuit diagram consist of 400-ohm resistance strips connected in series. These three strips should be used if the supply voltage is 200 to 210 volts, but for voltages between

grid of the second arc, of course, connected directly together. They are also joined to one end of an L.F. choke coil, the other end of which goes to the slider of the potentiometer between the filaments of the two valves. The loud-speaker is connected up by means of a plug and jack, the jack being placed between the plate of the last valve and the positive main.

Components Required

A list of the components required for the set is given here :

Ebonite panel, 9 in. by 6 in. (Peto-Scott or Raymond).

.0003-microfarad variable condenser with dial (Cyldon or Dubilier, Formo).

Panel-mounting reaction condenser (Ormond or Peto-Scott).

2 400-ohm potentiometers (Igranic).

Dial indicator (Bulgin or Belling-Lee).

2 antimicrophonic valve holders (Lotus or Benjamin, Precision, W.B.).

Single coil holder (Lotus or Lissen, Raymond).

50-ohm baseboard-mounting potentiometer (Igranic).

Phone plug and jack (Lotus).

3 400-ohm resistance strips (Igranic).

Low-frequency choke (Lissen or Formo).

1-microfarad fixed condenser (Lissen or Dubilier).

.0002-microfarad fixed condenser (Lissen or Dubilier, Igranic).

2 terminals marked: Aerial, Earth (Belling-Lee).

Length of flex and lamp-socket plug (Economic Electric).

2 $\frac{1}{4}$ -in. wood screws (Economic Electric).

Ebonite strip, 1 in. by $\frac{1}{2}$ in.

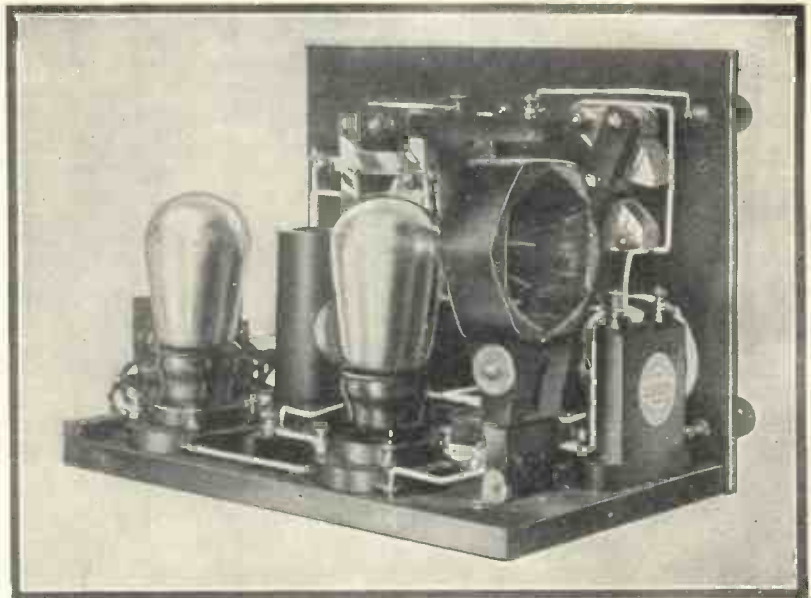

View of the Mains-fed Two with Valves and Coil in position

14 $\frac{3}{4}$ -in. wood screws (Economic Electric).

Glazite for wiring.

Cabinet and baseboard (Peto-Scott).

It should be noted that the particular components used in the original set and allowed for in the layout are in each case mentioned first.

Constructors, whether beginners or experienced amateurs, will find that the building of this set is very greatly facilitated by the use of the full-size blueprint layout, drilling guide, and wiring diagram that is available, if only because it obviates the necessity for marking out the panel. Send 6d. to Blueprint Dept., WIRELESS MAGAZINE, 58-61 Fetter Lane, E.C.4, and ask for Blueprint

No. WM37—not forgetting to enclose the coupon on page iii of the cover. If this is not used before November 30 the normal price of 1s. will be charged.

It should be understood, of course, that although the full-size blueprint is very useful to have, it is not absolutely essential and all the necessary particulars are included in these pages.

Special Points in Wiring

There are only a couple of points in the wiring up which require special mention, after which everything is perfectly straightforward. If possible one of the new Igranic 50-ohm potentiometers should be used between the negative main and the filament of the detector valve.

If, however, a 50-ohm filament rheostat has to be used it will be noticed that only two terminals are provided. One of these makes connection with one end of the winding and the other with the slider. It will therefore be necessary to solder the remaining connection to that end of the winding which is not provided with a terminal.

Resistance Strips

The assembly of the resistance strips is clearly shown in one of the photographs, but it should be explained that the strips which the Igranic people are supplying to the public measure three inches between the centres of the holes whereas those we used measured only two inches. The new strips are, however, wound with thicker wire and are so

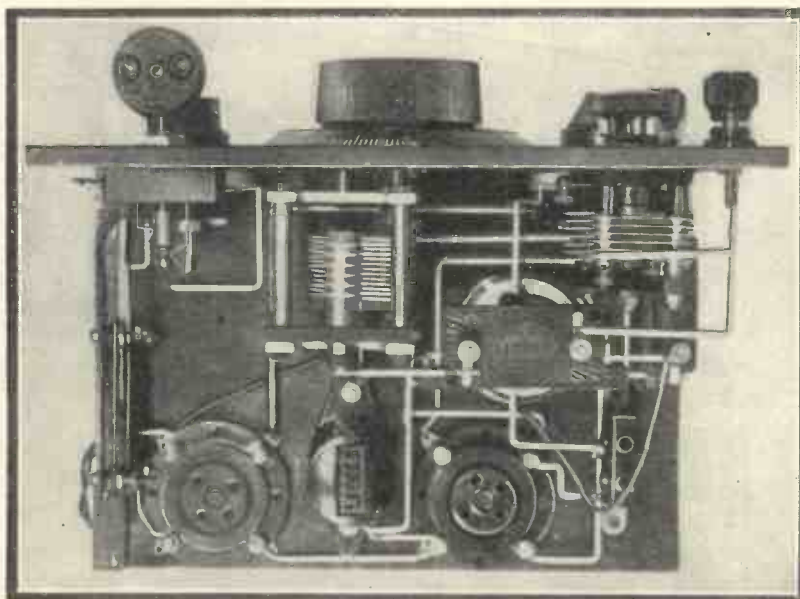

Plan-view of the Mains-fed Two, showing Disposition of Components

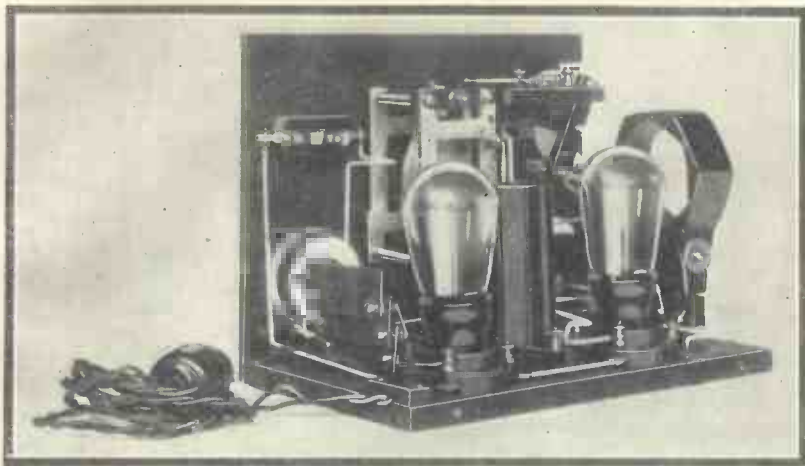

View of the Completed Mains-fed Two

better able to stand up to their work without getting too hot and the ends of the windings are clamped down beneath eyelets so that it is easier to make good and secure connections than it was with the old strips.

The strip assembly is built up as follows: Each of the strips, except that which will be the top one, has two extra holes drilled in it, one at each end on the opposite side of the strip to that on which the eyelets are placed.

Screwing Them Together

A 4B.A. screw is passed through each of the eyelets in the strips which have not been drilled and a nut is placed on each screw and is screwed down hard against the fibre. The projecting ends of these two screws are then passed through the holes that have been drilled in another of the resistance strips and the second strip is clamped to the first by two more nuts. This procedure is carried out until the three or four strips (as the case may be) have been fastened together. The strips are, of course, spaced from each other by the nuts and each screw makes connection with one end of one of the windings.

After the strips have been assembled they are to be connected together in series and the two extreme ends of the 12,000 or 16,000 ohms resistance so formed are connected one to the filament of the last valve and the other to the filament-current control resistance, the right-hand potentiometer mounted on the panel looking at the front of the set.

A small strip of ebonite, with a groove filed on the underside, is used to clamp the flex leads down to the baseboard.

As soon as all the components have been placed in position wiring can be

started, and here the work will be greatly facilitated, if the constructor is not quite at home with a theoretical circuit diagram, by frequent reference to the wiring diagram or blueprint.

A careful observer will notice that

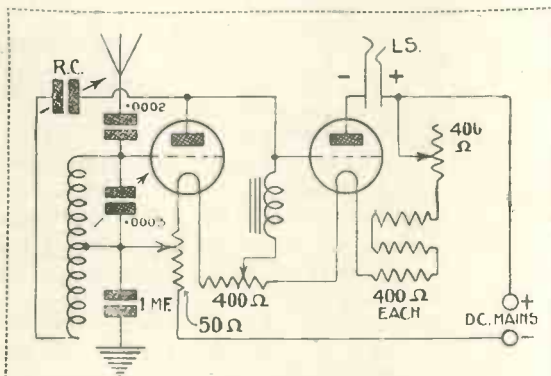

Circuit of the Mains-fed Two

each terminal point on the wiring diagram is marked with a small letter of the alphabet: these indicate the order in which wiring should be carried out, all the points marked with like letters being connected together. Thus all those points marked *a* are first connected together with one wire or as few wires as

Suitable Coils to Use

As a guide to the coil sizes required a No. 75 centre-tapped coil will usually be found suitable for the lower broadcast band and a No. 250 centre-tapped coil for 5XX. The coil sizes may, however, vary slightly in different cases.

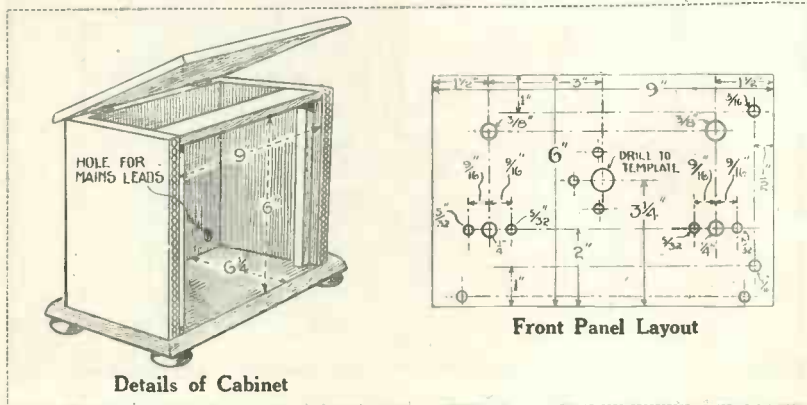

Details of Cabinet

The Mains-fed Two (continued)

possible; then all those points marked *b* are connected; and so on through the alphabet until the wiring is completed.

The valves used in this set must each, of course, have a filament current consumption of .1 ampere, but the filament voltages required are immaterial. It is not even necessary that both the valves used should require the same filament voltage. The detector valve should have a medium to high amplification factor, while a low-impedance power valve should be employed in the last stage.

When trying out the set it will probably be found that an earth connection is not required. If one is used, however, the fixed condenser in the set, connected between slider of the 50-ohm potentiometer and the earth terminal will prevent any short-circuit even though the positive house main be earthed. Similarly the series aerial condenser acts as a protection against a short-circuit should the aerial become accidentally earthed.

Takes All Its Current from D.C. Mains

Tested Out of Cabinet

The set should first be tested when out of its cabinet, and for the purpose of adjusting the grid bias correctly the knob and spindle should be temporarily inserted in the 50-ohm potentiometer mounted on the base-board. This potentiometer can then be set for best rectification, taking care not to touch any "live" part of the set. Once this potentiometer has been set it will not require any further alteration. The knob and spindle can then be removed and the set placed in its cabinet. *Thereafter the set should never be removed from the cabinet while the mains are*

still connected to it.

When the set is being operated the windings of the potentiometers and the resistance strips will get warm. This need occasion no alarm as, if the various connections are correct and the correct number of resistance strips are used for the voltage of the particular supply, there will be no danger whatever of the wire getting too hot.

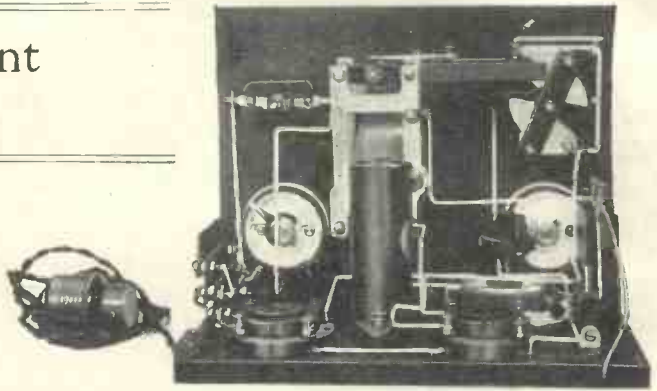

Rear View of the Mains-fed Two

The Big Valve

"DO you know where the world's biggest valve is to be found, George?" I asked my encyclopedic scientific adviser during a discussion on valves last night.

"That's an easy one, very easy; in America, of course," he replied.

"Right, George, but where in America?"

"No idea."

"I'll tell you then, George. The world's biggest valve is to be found at Schenectady."

"Call it 2XAG, old man, it's less strain on the tonsils."

"This monster valve, George, is seven feet high. In other words, it is as tall as you, George, with your silk hat on."

"A bad simile, Mister Halyard, the only use I put my silk hat to these days is to keep leaky accumulators in it. No more will it encircle my medium-to-high brow, lest I suffer



Strain on the Tonsils

from acidity of the head as well as from acidity of—"

"That will do, George. Listen again. The world's biggest valve weighs seven stone. Two of them would balance you, George."

"Glad to know my weight in valves. I thought that was about the figure."

"It takes ten horse-power to light the filament, George."

"Gee!"

HALYARD.

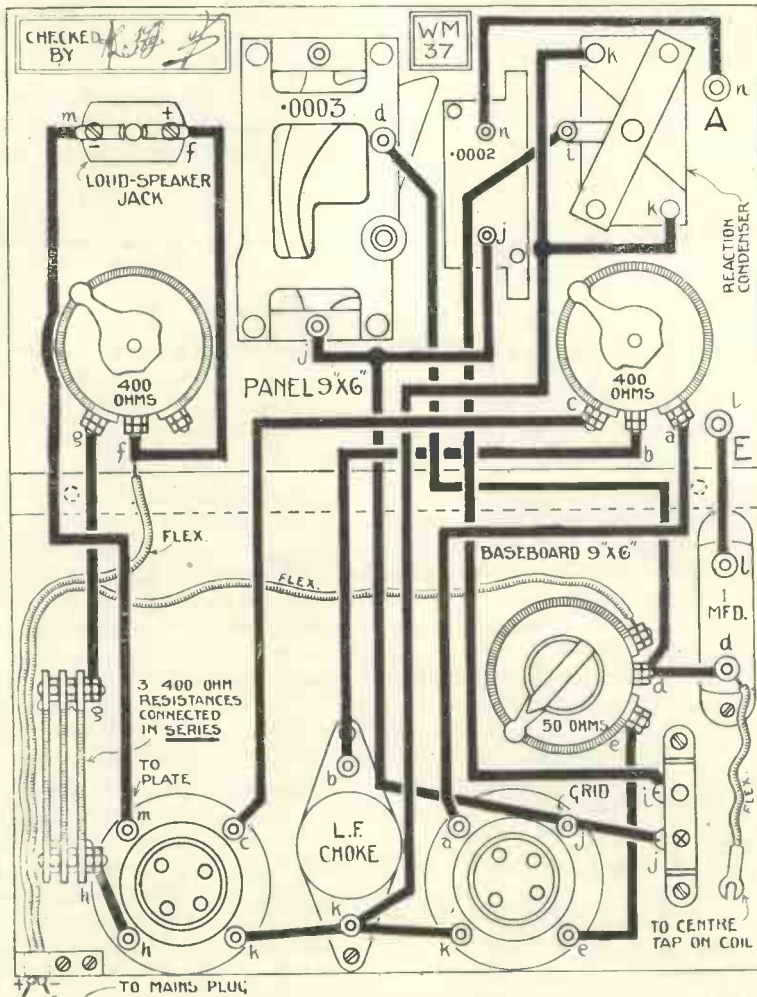

This layout and wiring diagram can be obtained as a full-size blueprint for 6d., post free, if the coupon on page iii of the cover is used before November 31. It is No. WM37

Making the Seas Safer by Means of

Automatic Calling Apparatus for Ships

THE problem of devising a relay capable of responding automatically to a distant wireless "call" is by no means an easy one. Yet there exist, on paper at all events, many ingenious solutions, ranging from the comparatively simple device of utilizing a crystal detector to rectify the initial carrier wave of a broadcast station and so start-up a valve receiver, to the more complex relays designed to respond only to a definite sequence of dots and dashes.

Selective Devices

Selective devices of the latter type have been employed, for instance, to navigate an aeroplane or submarine entirely by distant wireless control. By responding to one sequence of signals the craft can be turned to port, whilst a different sequence will turn it to starboard. Similarly it has been proposed to install on board ship a relay designed to respond only to a

particular call sign, so that all messages preceded by the given "call" are automatically recorded.

Main Difficulty

The main difficulty with the more sensitive relays is to prevent them from responding to atmospheric and other casual disturbances in the ether, which are liable to give rise to false alarms. In the calling apparatus that is now being fitted by the Marconi Co. to ships carrying only one wireless operator, this source of trouble is avoided by using a robust form of relay which is only set into action after the receipt of a series of three long dashes, each of four seconds duration, separated by intervals of one second.

This, in fact, is the recognised fore-runner of the SOS appeal, so that the wireless operator, even if off duty, is recalled to his cabin by the automatic ringing of an alarm

bell in time to receive the subsequent message.

Should the initial call be wrongly sent, the relay is re-set to zero ready to receive the signal when correctly transmitted. The effect of fortuitous atmospheric is similarly nullified. Provision is also made for any want of skill on the part of the calling operator by arranging the relay to respond to dashes having a duration of from three to five seconds, with intervals varying from one-fifth to two seconds.

Two Ships at Once

The apparatus will respond even if two ships are calling for assistance at the same time and on the same wavelength. The receipt of the distress call rings simultaneously alarm bells located on the ship's bridge, in the wireless cabin, and in the W/T operator's sleeping quarters. B. A. R.

Your Radio Notebook!

EVERY wireless enthusiast who is at all keen on original experimenting should keep a notebook. This advice has been handed out time and again to experimenters, but of those who take the advice only half of them carry it out at all efficiently, and a notebook to be really useful must be properly kept up—edited, one might say—and indexed.

I have several notebooks as I am interested in many branches of radio and keep a separate book for each subject. The books are all similar. They measure 6-in. by 4 1/4-in. by 7/8 in. and have stiff red covers looking just like small novels so that they look quite well on the book shelf. Most stationers stock them at sixpence each.

On the backs I print the titles: "Television," "Wireless Control," etc. Then comes the title page with the date the notes were commenced. The index must next be prepared by lettering twenty-six pages at the end

of the book A to Z, a page for each letter.

The book is now ready to receive its notes and these should be written up on one side of the page only. There is thus a clear page for writing down any cross references and for putting down anything referring to the subject matter on the page opposite which you gather at a later date.

Short articles from journals may be neatly cut out and stuck in the book with a trace of paste at the top of the page only and a reference as to the origin of the cutting made on the page opposite. If an article interests you, but is too long to be cut out, write up a short synopsis in your notebook and give full particulars as to where you can refer to the article.

Number the pages as you complete them and enter up the headings or titles in the index.

If a page of the index becomes full, continue on a page that is not used so much. For example, sup-

posing you have filled up the page lettered "E." At the bottom of the page write "E continued in Z" or any other page that, according to the subject of the book, you think will not be used much.

Every experimenter should have a rough notebook handy when he is experimenting for jotting down results, condenser settings, coils, valves, etc., which information may be transferred to and neatly written up in the permanent notebook or calibration chart.

A third type of notebook that I find extremely useful is really an index of all the books and periodicals I have. It is a stiff covered book having the edges of the pages cut away with "A to Z" printed on them.

Titles of articles and books that interest me are written in the book under the appropriate letter with full references and perhaps a few remarks on the subject matter. E. J. L.

Mr. J. L. Baird, the Scots television worker, is seated on the left.



Are We Expecting Too Much of Television?

An Exclusive Article by
T. THORNE BAKER,
F. Inst. P., M.I.R.E., F.R.P.S.

SEVENTEEN years ago the writer of this article went over to see Professor Ernest Ruhmer in Berlin, to obtain from him his latest views of the prospects of television. Professor Ruhmer was lying sick from an illness from which he never recovered, and had just invented a new form of acidulated jet microphone for wireless telephony—the three-electrode valve had not then been discovered.

Most Experienced Physicist

Professor Ruhmer was at that time one of the physicists most experienced with selenium cells, and had succeeded in sending views of letters of the alphabet and of simple stencil designs by means of a bank of selenium cells forming a sort of mosaic. By a modification of this mosaic method, Denes von Mihaly has succeeded in sending with a few watts really creditable wireless images of the human face—so good that one cannot help wondering why he does not further the work and provide us with a really simple solution of this all-absorbing problem.

Mr. J. L. Baird

In this country J. L. Baird has successfully shown that recognisable images can be transmitted by wireless, and in America Francis Jenkins has transmitted simple silhouette images by wireless, which can be seen on a little screen attached to an ordinary wireless receiving apparatus.

But the writer fears that the great general public has been led to think that in a few months anyone who has a few pounds to spare will be able to

watch on that little screen attached to their receiver pictures in natural colours of the Derby, the boat race, the Opera at Covent Garden, and so on.

Television of this delightful type will not be achieved *for years*, if ever. And in this article I am going to try to show just why such claims are not only dishonest, but detrimental to the progress of what is undoubtedly a coming science. The man who says that real television in its widest sense is almost realised cannot be aware of the facts.

Sixteen a Second!

Television means sending one picture after another as fast as one picture follows another in the cinematograph, that is, at the rate of sixteen pictures a second. A photograph sent by wireless at present takes about ten or fifteen minutes. To send such a picture at television speed means speeding up the process ten thousand times. Even then we get only the somewhat deteriorated result obtained by the best wireless systems, which is after all only in black and white and *not in natural colours*.

It has taken electrical inventors eighty years to learn how to send photographs in ten minutes by telegraphy. Let us see just what is wanted to enable the television enthusiast to send his picture ten thousand times as fast.

There are three known types of element by which light can be turned into electricity. In transmitting an image we have to exchange the varia-

tions of light and shade into variations of intensity, or in time, of an electric current. There is the selenium cell, which will change in resistance to a fraction of the normal when illuminated. There is the photo-electric cell, which responds to light much more rapidly but produces exceedingly feeble currents requiring great amplification. And there is the thermopile, which generates electric currents from the effect of light of practically any wavelength from the ultra-violet to the infra-red—as indeed do some types of photo-electric cell.

Sensitivity Factor

But every element of this type has a sensitivity factor, which might be termed a figure of merit. In order to transmit the number of signals in a sixteenth part of a second that are required to analyse or build up a good image, the light-sensitive element must be capable of responding to changes in intensity of light well within one sixteenth second divided by that number. Thus if 100,000 distinct signals were required to build up an image, an exposure to light of

$$\frac{1}{1,600,000} \text{ second would have to suffice to cause the reaction in the light-sensitive cell.}$$

A hundred thousand signals to make one picture is a very reasonable estimate. Newspaper pictures are made with half-tone screens which break them up into approximately 2,500 dots per square inch. A small photograph three inches square would thus embrace over 20,000 dots, each

Are We Expecting Too Much of Television? (Con'inued)

of which would require its own signal to be telegraphed. A picture of a race or sports event to be represented in really good detail might thus take easily the hundred thousand signals, or for sixteen pictures a second the 1,600,000 signals mentioned.

Monochrome

Not only must the photo-electric cell respond to light with the necessary rapidity, but all the moving parts of the transmitting and receiving apparatus must work with the same order of rapidity. The results will then of course be *in monochrome*, or black and white only. To transmit in colours three times as many signals per second would be needed.

Selenium has come to be regarded as useless for practical television, on account of its sluggish action. It is quite incapable of responding to a million and a half changes in light intensity per second. The photo-electric cell, however, is an element without inertia. A flash of light lasting only a millionth part of a second suffices to cause electrons to be emitted from the cathode. With such surprising speed is the photo-electric cell able to do its work that it has recently been used in some famous experiments for measuring the duration of light pulses and the length of light quanta. It has thus come to be looked upon as the sine qua non of any television transmitter.

Only the "Eye"

The photo-electric cell is, however, only the *eye* in a highly complicated system. What it sees, that is, the electric currents it generates in response to the succession of light changes, as the various tiny portions of the subject are thrown upon it by the lens of the television apparatus, must be made to control some form of wireless transmitter, and that transmitter must of course send the million or so signals per second out from the antenna.

But is it possible to work with a system having one complete wave or cycle only per signal? Probably five or ten waves would be required to carry the *modulations* in light intensity. Take five as a minimum. Five million signals per second would thus mean a maximum wavelength

of sixty metres, and this would be the maximum wavelength available.

Seven Wavelengths

Alexanderson in America has proposed to use seven different wavelengths simultaneously, all round about twenty metres—an excellent idea, but one involving seven transmission circuits and equally seven circuits at the receiving station, with of course, the necessary distributing device for each set of signals to pass to the correct unit of the receiving apparatus.

Let us assume that a means has been devised to transmit the signals to the receiving instrument. The latter must be able not only to pick them up, but to convert them into light again. The function of the television receiver is to change the wireless signals it detects into tiny spots of light which it throws in lightning-like succession on to the viewing screen, each spot of light being of the correct intensity and falling into its right space. Clearly, this means the most accurate synchronism between sending and receiving apparatus. Synchronism means the use of synchronous motors or some other synchronising device, requiring yet another wireless circuit.

Rapid Rate

Then also, whatever unit is employed to turn the electric currents of the receiver into light again, must be capable of the same exceedingly rapid rate of working. The modern trend seems to be to control the intensity and the mechanical path of a beam of cathode rays which is projected upon a fluorescent screen. The cathode rays will "work" fast enough, and no particular difficulty is offered here.

The reader of this article may be forgiven if he is beginning to think that I am suggesting the difficulties of television are more or less insuperable. What I wish to emphasise is the magnitude of the problem. Whatever the magnitude, there is one man who has shown us something. J. L. Baird has attacked both the resolution of the image and the mechanical difficulties of synchronism with such success that he is able to project the image of the human face, that is a subject requiring a fraction only of the

number of signals per second that would be necessary to transmit a sports or theatrical subject.

But where a principle has been established, no one can predict in these days of rapid scientific accomplishment how soon it is going to develop into perfect success. A host of other workers in various parts of the world are attacking the problem, and send out prophecies or claims from time to time.

For the Amateur

I still think that the simple system of selenium devised by Denes von Mihaly, which undoubtedly transmits recognisable faces with a minimum of apparatus or cost, is the one most likely to be within reach of the amateur. But it will never show the boat race on an apparatus within reach of the average amateur's pocket!

Many years ago the wildest and most mischievous claims were made for radium and what it would do. Radioactive industries *have not yet recovered from the bad effects of these claims*. We do not want television to suffer in the same way. Wild claims, even merely unjustifiable claims, alienate public sympathy and public support. The public, indeed, know too much of practical science to be misled for long, and the continual promises, especially of certain of the foreign experimenters, is creating an unfortunate impression, whilst others still wait for the day when they can watch the Cup Tie final and the latest revue on a screen on their mantle-piece, using just their ordinary aerial and receiver, at an extra cost of a few pounds for the whole outfit.

Much Still to be Done

This article has been written to indicate the immense amount of work that must be done before such a state of affairs can be hoped for—the tremendous labours of those plucky enough to go on fighting to achieve what must one day be a magnificent success.

LOOK OUT FOR THE
1928 FIVE
NEXT MONTH

Broadcast Music of the Month

REVIEWED BY STUDIUS

THE marked success of the classical programmes provided by relays of the Promenade Concerts has given abundant proof that there is a large audience for this type of



Miss Sidonie Goossens, harpist of the Queen's Hall and 2LO

People's Palace, Mile End, London, will meet with equal success, judging by the programme put forth for the first one on November 14—one devoted to Wagner's works and conducted by Mr. Percy Pitt, with two of the finest of the British National Opera Co.'s artistes, Miriam Licette and Walter Widdop, as soloists



Miss Astra Desmond, the famous contralto

music, so that it is not surprising therefore that the B.B.C. have taken steps to ensure the supply of still more high-brow music.

In consequence the famous Hallé Orchestral Concerts of Manchester, which were not allowed to be broadcast last year, have raised the taboo put on broadcasting and at least eight of their concerts will be heard, the first one taking place on October 27, under the conductorship of Sir Hamilton Harty.

Programme Alterations

The commencement of these concerts at 7.45 p.m. has caused many alterations in the programmes, the chief being the cancelling of talks on a rather dull subject, "The Foundations of Music," which have bored many listeners for some time.

Of the musical value of the Hallé concerts there is little need to dilate; sufficient that they have weathered the storm of time and war, and held their sway in the heart of the great manufacturing city.

Special praise is due to the Manchester broadcasting station, also, for its commemoration of the birth of the famous French composer, Saint-Saens. Probably few modern composers have had such marked influence on musical literature as this composer, and though credit is given to him only for his compositions, he was also a great organist and pianist as well as conductor, one of his triumphs being the conducting of the Queen's Hall Orchestra itself.

Miss Kathleen Moorhouse

An admirable choice for the soloist in his violoncello Concerto in A minor was made in Miss Kathleen Moorhouse, the brilliant young cellist of Hallé Concerts and a member of the Edith Robinson Quartet.

An outside broadcast, also of provincial interest, was the Symphony Concert conducted by Sir Henry Wood and relayed from the City Hall, Cardiff, to Cardiff station. An outstanding feature was the engagement of Harold Williams, the Australian baritone singer of the B.N.O.C., and Isabel Gray, a pianist, who was heard from 2LO very prominently earlier in its history.

There is no doubt also that the series of National Concerts of the



Miss Mary Allan, the well-known actress

From Bach to Malcolm Scott is a wide step in entertainment, yet both are kings in their own spheres. The variety side of the B.B.C. programmes has improved during this month, and with a little more elimination of the negroid element and syncopated attacks on the piano, excellent effects should be obtained.

Variety Stars

Naturally, variety stars are of interest, especially to those scattered at far distances from the metropolis, and to whom actual sight of the artiste is not likely to be possible. Hearing, therefore, Ella Shields in her time-worn ditty of "Burlington Bertie," prior to her long tour in America,



Mr. Elliot Dobie, Scottish singer

Broadcast Music of the Month (continued)



Mr. Frederic Collier, B.N.O.C.,
singer

was probably an event to many listeners: Malcolm Scott, whose sketch, *The Woman Who Knows*, has always proved a big draw from his vantage on the variety halls, must also have had welcome.

Nelson Keys, the actor, and Neil Kenyon, the Scottish comedian, have both aroused particular interest. Familiar broadcast entertainers are Flotsam and Jetsam, who have toured many of the stations this month; Miss Mabel Constanduros, whose latest sketch is a humorous orchestral feature, *Oh Listen to the Band*; Walter Williams, a clever light comedian; and Ann Penn, the latter a "discovery" of the B.B.C. who has since made a marked success on the big variety halls.

Improvement Amongst the Singers

Two other star artists are Carl Brisson, the actor, who makes his film debut in the big Wardour production, *The Ring*, and Miss Mary Allen, a brilliant young actress, who found herself well suited for the microphone.



Mr. E. H. Green, speaker

'An improvement, too, has been found amongst the singers of the month. This is due in no small measure to the engagement of operatic stars and artists accustomed to the management of big halls. Articulation and diction are accordingly strong features. Many of the singers are members of the B.N.O.C., the finest operatic organisation that we have, and we have heard from the Birmingham studio the oratorio, *The Creation*, with Gertrude Johnson and Robert Radford as soloists.

Frederic Collier, another opera star, the well-known prima donna Raymonde Amy, and Astra Des-



Mr. Harold Williams, B.N.O.C.,
artist



Max Anton,
artist and writer

mond, the famous contralto, have also been heard. The provinces, too, give us many fine singers and these have been heard mainly through the help of the new station, 5GB. Amongst them must be mentioned Miss Florence Oldham and Alma Vane, heard from Cardiff as well as other stations. John Thorne and Arthur Wilks have sung to the best advantage, as also has the Scottish singer, Eliot Dobie. The latter has become a household name to many music lovers, not only by his wireless work, but by his many fine records of famous Scottish ballads.

Outstanding Operatic Performances

The performance of opera has become a standing part of the B.B.C.'s work, and apart from the relaying of the B.N.O.C.'s performances on their autumn and winter tour, the first of which was *La Boheme*, relayed to 5GB from the King's Theatre, Edinburgh, it is intended to produce many of the less familiar operas.



Miss Florence Oldham, famous
provincial singer

Few ordinary opera-goers realise the wealth of music that is to be found in such lesser known works such as *Bastien and Bastienne* (Mozart), Gluck's *Armida*, *Penelope* (Ferrers), or *The Barber of Bagdad* (Cornelius).

Amongst the lesser operatic performances may be mentioned a repetition of *The Dogs of Devon* with Gladys Palmer, Joseph Farrington and Kingsley Lark as principals.

World-famous Soloists—"Outside" and "Inside"

The big orchestral concerts gave opportunities of hearing world-famous soloists, but many brilliant artists have also been heard from the studios, among them being Georges Roth, a member of the Hungarian Quartet, himself a brilliant solo violoncellist.

Miss Sidonie Goossens, late harpist to the Queen's Hall Orchestra, and now permanent artist of the 2LO



Mr. Neil Kenyon,
Scots comedian

WE ARE
ALWAYS
INTERESTED
TO HEAR
READERS'
VIEWS -

Reviewed for the "W.M." by Studius

Symphony Orchestra, also paid a visit to Liverpool for the fine Civic Week celebrations. Special features of the programme on this occasion were the "Serenade" (Tchaikowsky) and "St. Paul's Suite for Strings" (Gustave Holst). The solo singer on this occasion was Miss Dorothy Silk, the famous singer of Bach arias.

Some Well-known Speakers

This month has been conspicuous, however, for its speakers, starting perhaps with the speech of Prince Henry at the opening of the extension of the North Staffs Royal Infirmary from Stoke-upon-Trent, and including the sporting speeches of Eugene Corri and Bohun Lynch from the ring-side of Albert Hall at the Baldock v. Smith contest; a clever speech by Sir Arthur Salter, Director of the Economic and Financial Section of the League of Nations at the Conference broadcast from Bournemouth; and the speeches of Viscount Allenby and the Duke of Beaufort from the Red Lodge Bristol, the occasion being the dinner of the Royal Colonial Institute given at the Red Lodge, which is the headquarters of the Savage Club.



Mr. Arthur Wilks, Tenor

Amongst other speakers may be mentioned Mr. E. H. Green, who lectured on hockey; Max Anton, the Scottish writer and dramatist; and Mr. Fred Weatherley, whose songs have been household words for more than fifty years.

High Order of Dance Bands

The dance bands still continue to be of a high order. Amongst the best may be mentioned the Kettner Five, led by Geoffrey Gelder; Debroy Somer's Band; the London Radio Dance Band under Sidney Firman; and the fine restaurant bands at the Hotel

Victoria of Emilio Colombo; and at the Hotel Victoria of Camille Couturier.



Miss Raymonde Amy, prima donna

Empire Broadcasting

THE initial stages of long-distance broadcast transmission from the Mother country to the Colonies appear to be beset with difficulty. In spite of the success already achieved by the Dutch station at Eindhoven in relaying short-wave broadcast programmes over a range of several thousand miles our own B.B.C. authorities appear reluctant to follow suit, chiefly on the ground that the standard of reception has not yet been sufficiently developed to justify the expense incurred.

Unconvincing Argument

This argument is hardly convincing. Short-wave reception is a commonplace amongst the more advanced amateurs, and manufacturers are fully competent and quite prepared to market the necessary type of receiving set as soon as the demand for it arises. This will inevitably follow on the inauguration of an Empire broadcast service, but hardly before.

Another difficulty has arisen in respect of copyright fees. Artists before the microphone naturally look for some additional compensation when catering for a deliberately enlarged audience. This, however, is merely a matter for amicable agreement between the parties concerned.



Mr. George Rot, member of the Hungarian Quartet A.B.

—ON ANY QUESTION RELATING TO WIRELESS IN ANY CONNECTION



Mr. Carl Brisson, the popular actor



Miss Anne Penn, mimic



Mr. Walter Williams, light comedian

Another Successful "Wireless Magazine" Receiver

The Exhibition Five Takes Its Place Amongst the "Classics!"

Pointing out some of the features of the Exhibition Five to interested spectators at Olympia



During the National Radio Exhibition held at Olympia at the end of September many thousands of interested visitors inspected the Exhibition Five shown on the "Wireless Magazine" stand.

Everybody who saw it was impressed by its simplicity and by the fact that only standard parts are used in its construction.

Already we have sold literally hundreds of blueprints and scores of orders are still coming in by each post.

If you want the best and most efficient all-round five-valver yet produced you cannot do better than build the Exhibition Five.

TO say that a set of which it publishes details is the best and most efficient of its kind yet produced is a claim that any radio periodical can make—time and public opinion are the two factors that decide whether or not the claim was well founded.

Last month the WIRELESS MAGAZINE Technical Staff made the claim, in these pages, for the Exhibition Five that it was confidently believed to be the best and most efficient all-round five-valver produced this year. We still believe that statement to be true in the broadest sense—and many hundreds of readers are agreeing with us.

Enthusiasm at Olympia

Nobody who visited the WIRELESS MAGAZINE stand at the National Radio Exhibition could fail to be impressed by that great amount of enthusiasm that the set aroused amongst spectators. By day and night a constant stream of keen amateurs came to look at the Exhibition Five to see for themselves exactly what kinds of sets the WIRELESS MAGAZINE does produce.

And for the benefit of those readers

who *did* see the Exhibition Five at Olympia we can say that the only thing that was different about this set from others built in the WIRELESS MAGAZINE Constructional Department was that the screens were a little cleaner than those sometimes used at Fetter Lane! The wiring was not specially arranged for the Exhibition and conformed to ordinary WIRELESS MAGAZINE standards in every respect.

Hundreds being Built

We have evidence that many hundreds of listeners are building,

or are about to build, this fine receiver, and we know that not one of them will be disappointed in the very least with the results obtained.

Full-size Blueprints

Those who failed to take advantage of our special half-price blueprint scheme last month can still obtain copies, but only at the normal price, that is, 1s. 6d. post free. Ask for Blueprint No. WM33 and address your enquiry to Blueprint Dept., WIRELESS MAGAZINE, 58-61 Fetter Lane, E.C.4. During a fortnight (these particular pages are going to

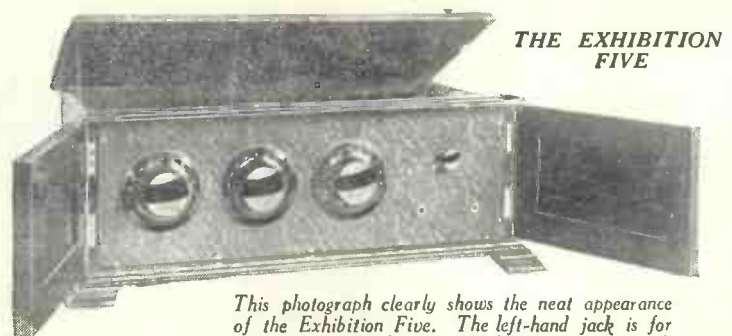

This photograph clearly shows the neat appearance of the Exhibition Five. The left-hand jack is for three valves, while the right-hand jack is for all five valves.

press early in October) we have sold literally *hundreds* of these blueprints, but our stocks have been completely replenished and readers can obtain copies without any delay.

Standard Parts Used

Perhaps the chief point of interest about the Exhibition Five to the average amateur is the fact that only *standard* parts are used in its construction—parts that can be obtained without difficulty at almost any wireless dealer's. Not only are standard parts used, but they are arranged in a perfectly straightforward way that cannot present difficulty even to the novice.

Aid to Wiring Efficiency

A point about the use of a blueprint of a set of this kind that many constructors overlook is the help it is in wiring up. They say to themselves: "Oh, I've made lots of sets; I can wire up all right from a circuit diagram." True, but a circuit diagram does not indicate the best wiring sequence for the particular layout adopted and the constructor

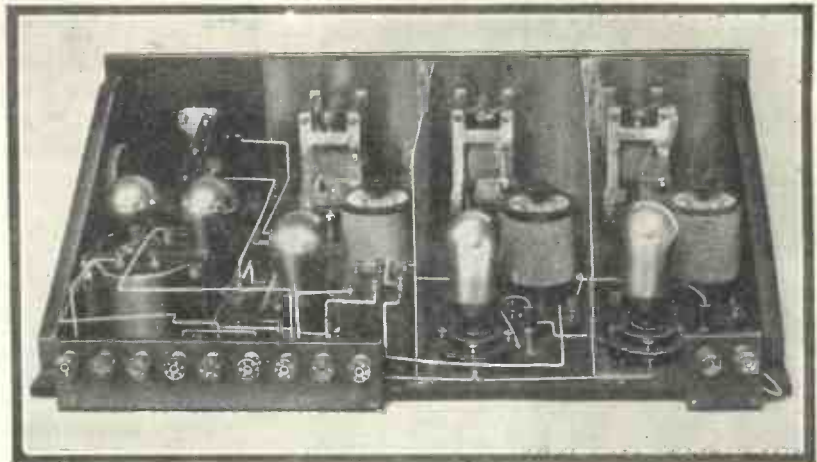

Rear View of the Exhibition Five. Any standard six-pin coils can be used, but those of the binocular type are especially recommended. The number of the full-size blueprint is No. W.M.33, price 1s. 6d. post free.

Every WIRELESS MAGAZINE blueprint and wiring diagram is lettered in this way from the original receiver, which has been wired by our Technical Staff for the best and most efficient results. We have done the "donkey work" on all the receivers described in these pages: take advantage of that when you build a WIRELESS MAGAZINE set.

purpose—if it is often desired to listen to a nearby transmission—is to pull out the plugs from the sockets soldered to the copper screen close to each high-frequency valve holder and connect the aerial to No. 1 terminal of the second high-frequency transformer base.

Extra Aerial Terminal

In constructing the set it is, of course, simple to make the large terminal strip an inch longer and mount on it an extra terminal which can be permanently connected to No. 1 terminal on the second high-frequency transformer base.

If four valves are required it is only necessary to connect the aerial to No. 1 terminal of the first high-frequency transformer base and switch out the first valve.

Summarised, the combinations that can be obtained from the Exhibition Five without any elaborate switching are as follows:

One Valve

Detector.—Aerial to No. 1 terminal of second H.F. transformer base; first two valves switched off; phone plug in left-hand jack.

Two Valves

High-frequency Amplifier and Detector.—Aerial to No. 1 terminal of first H.F. transformer base; first valve switched off; phone plug in left-hand jack.

Three Valves

Two High-frequency Amplifiers and Detector.—Aerial to main aerial terminal; phone plug in left-hand jack.

(Continued on page 368)



Another "Wireless Magazine" set that attracted considerable attention at Olympia was the Revelation Four, shown on the Lewcos stand. It was described on page 497 of the July issue.

may find that he has put in a wire that prevents his getting at something underneath.

Lettered Wiring Prints

The use of the full-size blueprint of the Exhibition Five (or, for that matter, the wiring diagram on page 201, of the previous issue) will obviate any such difficulty. The small letters against each terminal point are so arranged that if the leads marked with like letters are wired in proper alphabetical sequence the wiring will be built up gradually from the *bottom upwards*, thus building up a neat and efficient wiring system.

At Olympia many interested persons made enquiries regarding the selectivity of the Exhibition Five. They were all reassured when they were told that the twenty-two stations mentioned in the test report on page 202 of the previous issue were received in one evening at full *loud-speaker strength* in Kensington, 1½ miles from the London station. An ordinary outside aerial was employed and no extra wavetrap, or any trick of that kind, was used.

Others asked what was the best way of switching out the two high-frequency amplifying valves for local-station reception. The best way of adapting the set for this

Many readers of the "Wireless Magazine" who live in houses supplied with alternating current will find the new mains valves described in this article of particular interest to them. They can be substituted for the valves in any existing set, and, by means of a special transformer, take their filament current straight from the mains. No alteration to the internal wiring of the existing receiver is necessary.

The New Mains Valves

Some Particulars of the Latest Solution to the Filament-supply Problem

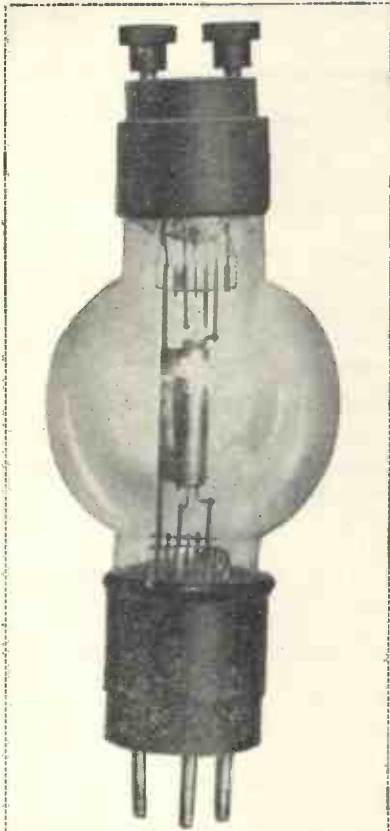

One of the new Cossor Mains Valves

small battery is now required for running even a multi-valve receiver.

But manufacturers have gone a step further and are now providing us with special valves of which the filaments can be heated directly from the house-lighting supply. There are a number of such valves now on the market, but of particular interest are those just put out by A. C. Cossor, Ltd.

Advantage of the New Valve

The chief advantage of the Cossor valve over its contemporaries lies in the fact that it can be inserted in any existing receiver without the need for altering any of the internal filament wiring. It is necessary only to short-circuit the external low-tension terminals of the receiver in order to make the filament circuit continuous.

A glance at the photograph reproduced on this page will give a good indication of the general appearance of the valve. It is almost spherical in shape and is provided at the bottom with the standard four-pin connections, use being made, however, of only one filament pin, the other pin being left free.

At the top of the valve is an ebonite cap on which are mounted two terminals. These are connected to a source of alternating-current supply at a pressure of six volts,

obtained from the secondary of a transformer wound to suit the particular mains of which use is to be made.

The internal construction of the valve does not follow standard Cossor practice and the arrangement of the electrodes is quite different from the usual valve made by this particular firm.

The "heart" of the valve is a double silica tube. A wire is lead from one of the top terminals, up one of the tubes, is then looped over the top of the tube and brought back down the other tube to the second terminal on the ebonite cap. This constitutes the heater element and takes a current of one ampere at six volts.

Nickle and Oxide Coating

A nickel coating is deposited on the outside of the silica tube (see detailed sketch reproduced in these pages) and this is coated with the same substance as used for the well-known Cossor "kalenised" filaments in ordinary valves. A lead is taken from the nickel tube and its associated

EVER since broadcasting began one of the chief problems in reception has been a means of supplying valve filaments with power with the minimum of trouble and expense. In the old days bright-emitters entailed the use of large and expensive accumulators which had to be frequently carried to and from a charging station.

First Dull-emitters

Later the first dull-emitters made their appearance and the same accumulators gave considerably longer service. More recently we have had available really economical dull-emitter filaments and only a very

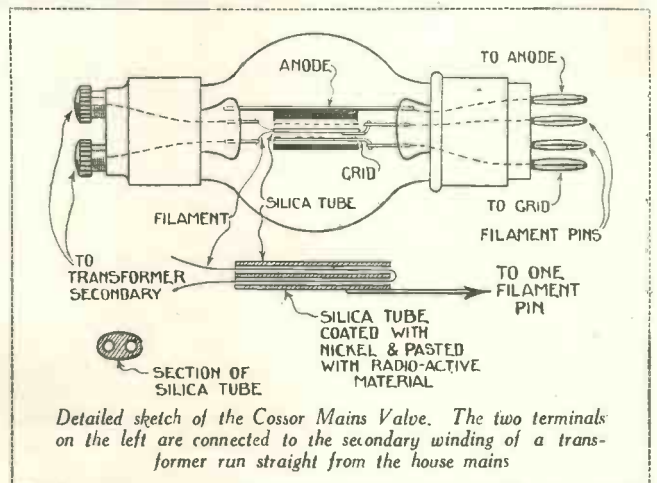

Detailed sketch of the Cossor Mains Valve. The two terminals on the left are connected to the secondary winding of a transformer run straight from the house mains

oxide coating to one filament pin, this cathode taking the place of the ordinary valve filament in any existing circuit.

It will be appreciated that unless the external L.T. terminal of the existing set were short-circuited the filament circuit would be broken.

Ordinary Anode and Grid

The cylindrical grid and anode are placed round the cathode in the ordinary way.

As has already been mentioned, the chief point of interest about these valves from the listener's point of view is that they can be used to replace the valves in any existing receiver. When they have been placed in position the terminals on the ebonite caps are all connected in parallel and taken to the secondary of a special transformer which converts the mains voltage to a working voltage of six volts. Such special transformers are supplied by the manufacturers of the valves.

The only alteration to the existing set that has to be made is to short-circuit the low-tension terminals with a piece of wire.

One of the photographs reproduced in these pages shows two of the new Cossor valves used in the "Centre-tapped Two," recently described in *Amateur Wireless*. The short-circuiting wire across the L.T. terminals can be clearly seen, the other terminal having been left disconnected for the sake of clarity. This photograph also shows how the top terminals of the valves are connected together.

Excellent Results

On test these valves, which are made of five different types to suit all purposes, have been found to give excellent results, a slight trace of hum only being audible when a number of valves are used together.

It is interesting to note that on switching on the cathode takes a few seconds to heat up and signals are not heard for a period of something like fifteen seconds. On the other hand when the heater is switched off signals continue to be received

for half a minute before finally fading right out!

Five types of valves for different purposes will be available and approximate details of these are given below:

High-frequency Amplifier and Detector.—Type M61 H.F.; impedance 20,000 ohms; amplification factors 20.

Low-frequency Amp'ifier.—Type M62 L.F.; impedance 10,000 ohms; amplification factor 10.

Power Amplifier.—Type M61 P; impedance 5,000 ohms; amplification factor 5.

Super-power Amplifier.—Type M61 S.P.; impedance 2,800 ohms; amplification factor 3.5.

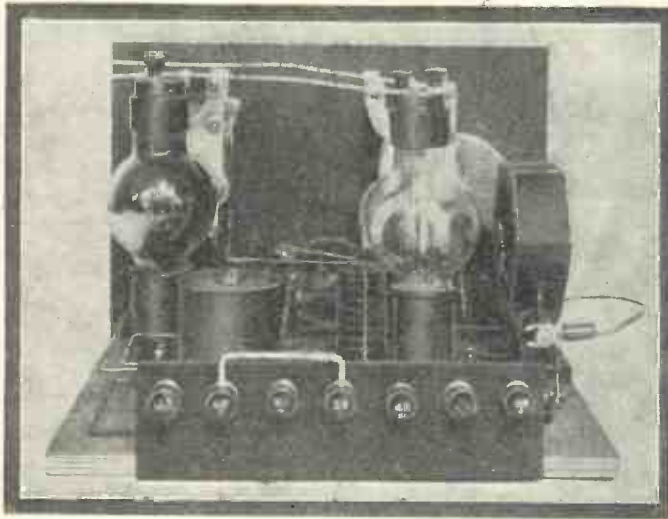

Two of the new Cossor Mains Valves in use in an "Amateur Wireless" receiver—the "Centre-tapped Two"

Resistance-capacity Amplifier.—Type M61 R.C.; impedance 80,000 ohms; amplification factor 50.

These valves will be a boon to many WIRELESS MAGAZINE readers who are fortunate enough to have their houses supplied with alternating current, for their use makes an L.T. accumulator quite unnecessary.

You can get a full-size Blueprint of any set described in this issue for half-price by using the Coupon on page iii of the cover.

Radiation or Induction?

AN interesting light is thrown upon powers of wave penetration by a series of experiments recently carried out by A. S. Eve and D. A. Keys, of the Washington Bureau of Mines in a mile-long tunnel near Montreal. Signals on a wavelength of 40 metres could not be detected when only a few hundred feet inside the tunnel.

A 400-metre wave gave better results, detection being maintained along the whole length of the tunnel through an overhead "ceiling" of 700 feet of limestone. Longer wavelengths up to 10,000 metres gave even better readings.

Small Distances

As, however, the distances involved in prospecting operations by radio are much less than the longer wavelengths mentioned above, it is probable that the results which have already been secured in practice may be due to induction effects rather than to true radiation. B.

The Marcuse Transmissions

EMPIRE experimental transmissions have been carried out at considerable expense by that well-known amateur, Mr. Gerald Marcuse, who operates station 2NM. The first test to Australia unfortunately met with only partial success, owing to a temporary breakdown of the generating plant. The moral, of course, is that the B.B.C. should themselves take the matter in hand, and not allow the success of the scheme to be jeopardised by lack of funds and proper equipment.

Finally there is no necessity for the B.B.C. to have a complete cut-and-dried scheme for linking together the whole of the Empire by a broadcast service, before at least putting their hands to the plough. B. A. R.

Specially Reviewed for "Wireless Magazine" Readers

Autumn Developments

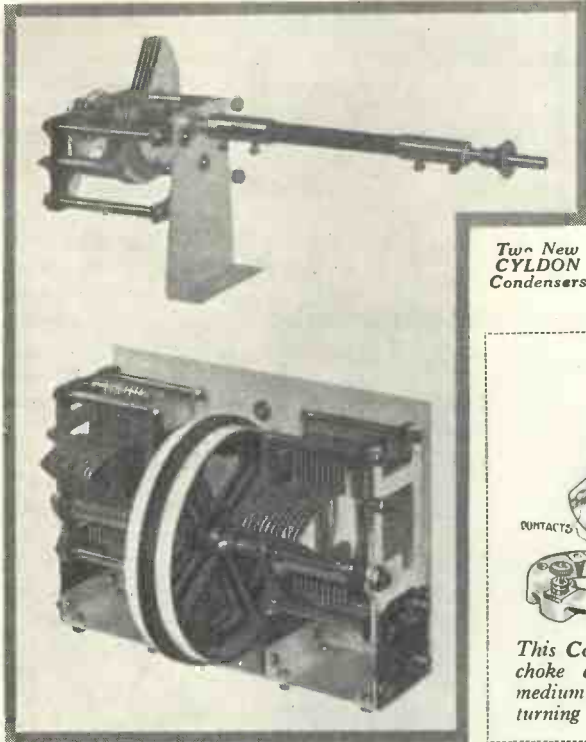

Two New
CYLDON
Condensers

A neat resistance - capacity coupling unit, with valve holder combined, is being made by the B.T.H. people. The base is moulded from the familiar chocolate - coloured insulating material and the valve-holder is made anti-microphonic by being mounted in a rubber fitting.

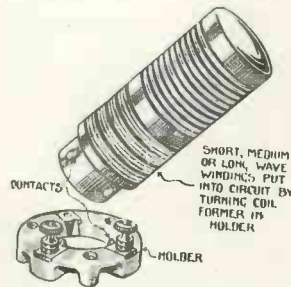
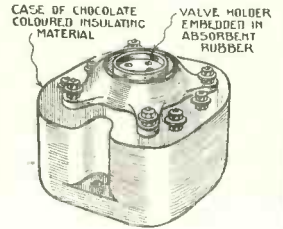

This Collinson high-frequency choke can be used for long, medium, or short waves by turning it round in its mount.

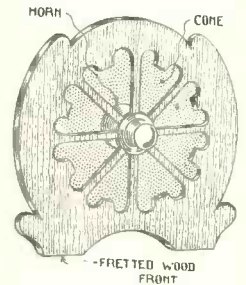

The latest Lissen production is a combined horn- and cone-type loud-speaker.

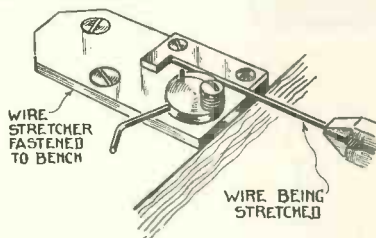

Many constructors will find a use for this Wearite wire-stretching device.

Another interesting resistance-capacity coupling unit is that manufactured by Mullard. It includes a device that prevents high-frequency currents from passing on to the next valve, thus obviating any chance of possible distortion. Its neat appearance can be seen from this sketch.

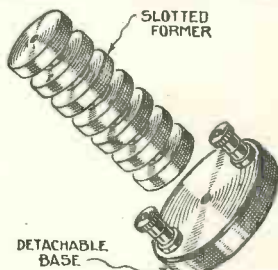
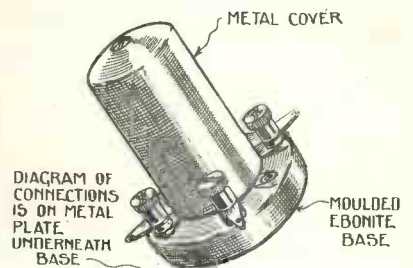

To meet the needs of home constructors, Redfern are producing a high-frequency choke former which can be wound to suit any wavelength.

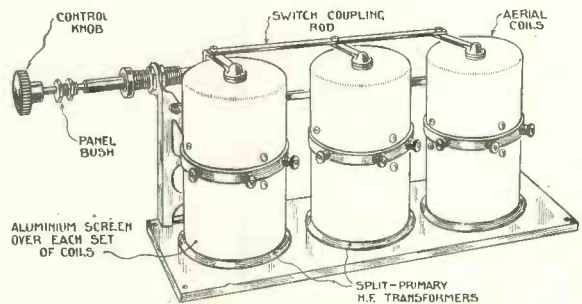

Coil changing for the long and short waves is obviated by this Lewcos double-decker tuner, which incorporates both high- and low-wave coils.

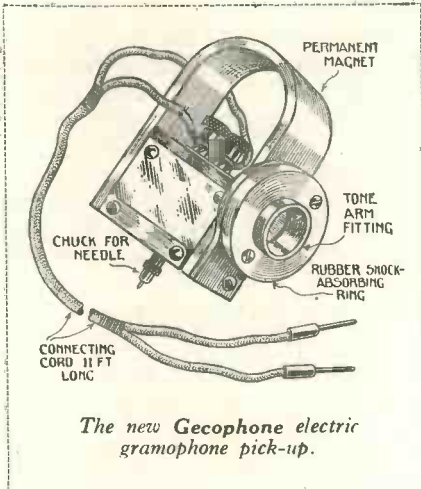

The new Gecophone electric gramophone pick-up.

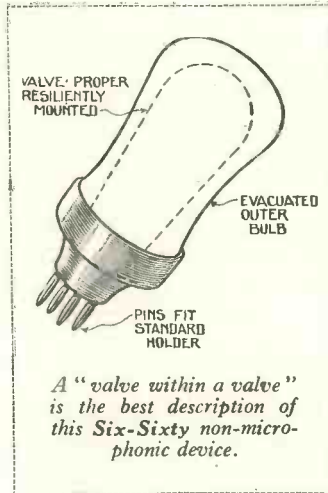

A "valve within a valve" is the best description of this Six-Sixty non-microphonic device.

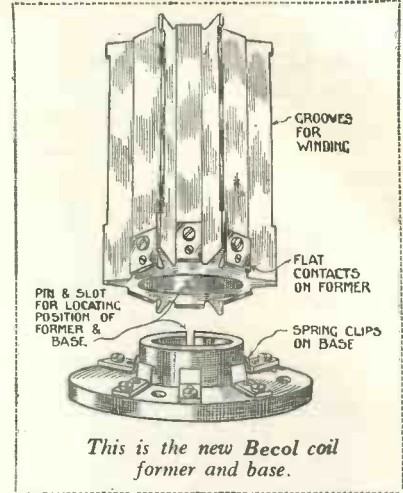

This is the new Becol coil former and base.

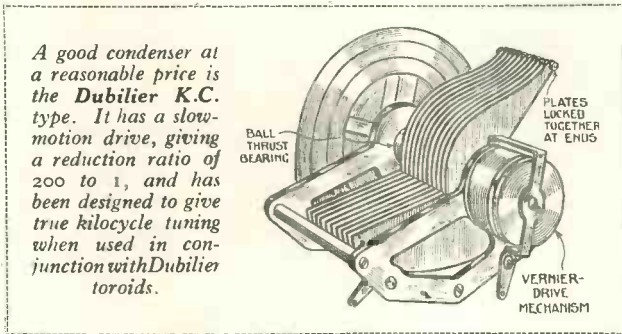

A good condenser at a reasonable price is the Dubilier K.C. type. It has a slow-motion drive, giving a reduction ratio of 200 to 1, and has been designed to give true kilocycle tuning when used in conjunction with Dubilier toroids.

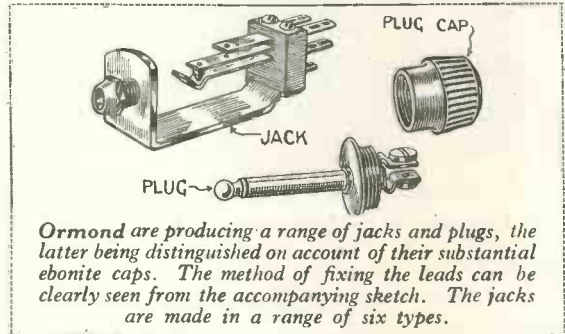

Ormond are producing a range of jacks and plugs, the latter being distinguished on account of their substantial ebonite caps. The method of fixing the leads can be clearly seen from the accompanying sketch. The jacks are made in a range of six types.



Extra large zincs, pots, and sacks are now made by the Wet H.T. Battery people for use with multi-valve sets.

Readers who desire to obtain further particulars of the new gadgets illustrated in these pages should get into touch with the manufacturers concerned. Mention of the WIRELESS MAGAZINE will bring prompt replies and all the information required.

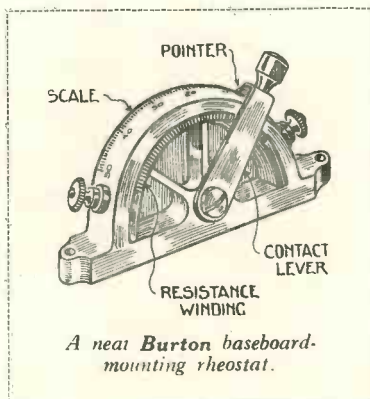

A neat Burton baseboard-mounting rheostat.

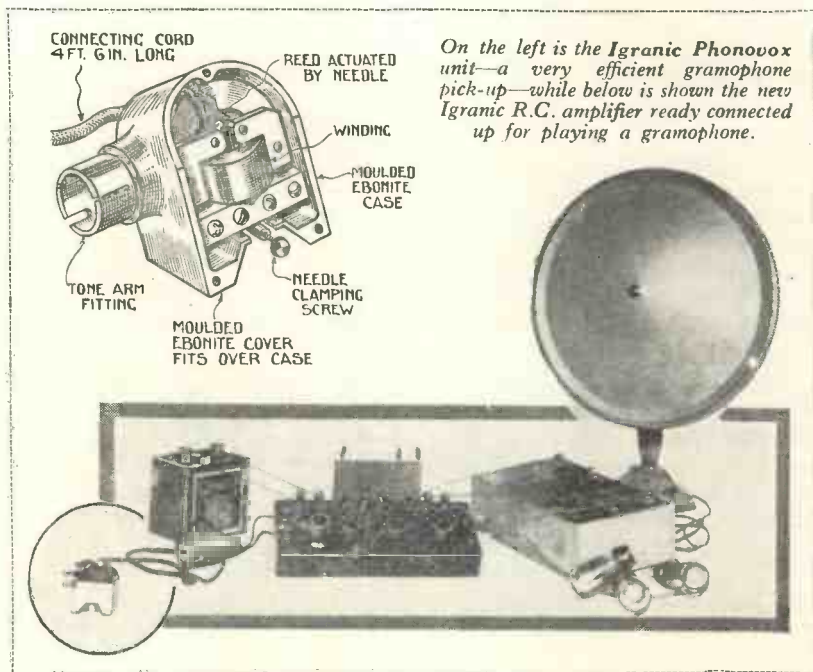

On the left is the Igranic Phonovox unit—a very efficient gramophone pick-up—while below is shown the new Igranic R.C. amplifier ready connected up for playing a gramophone.

Last month we published particulars of a new receiver designed by J. H. Reyner, B.Sc., A.M.I.E.E., which has aroused considerable comment on account of its advanced design. This month some further constructoral and operating details are given. The set is an ideal family receiver (for full description see page 187 of the October Issue).

More About the AUTO-SELECTOR FOUR

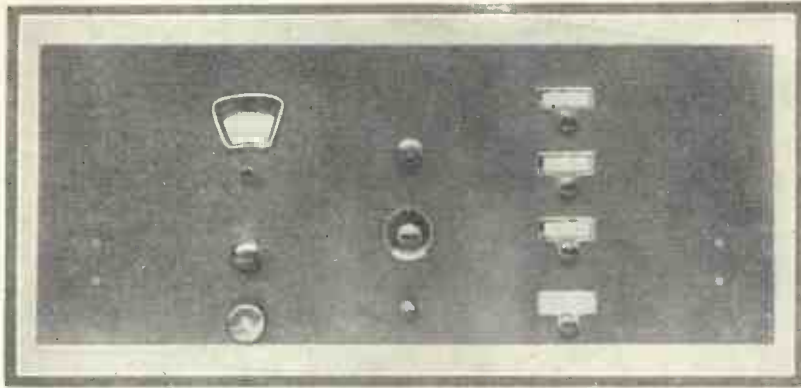

Front view of the Auto-selector Four, showing arrangement of the controls

Designed, Built and Tested
by J. H. REYNER,
B.Sc., A.M.I.E.E.

in for preliminary adjustment. Having got the condensers approximately balanced, find a distant station, a matter which will present no difficulty, and then balance up finally on this distant signal.

Trying Reaction Control

Then try the reaction control and notice whether the set oscillates more easily at the top of the scale or at the bottom. If it oscillates more readily at the top, increase the setting of the neutralising condenser slightly, while if the reverse is the case, the neutralising condenser setting should be decreased. In this way the reaction demand on the receiver can be adjusted to be practically constant, when the various stations will be tuned-in by simply rotating the single dial.

Balanced and Neutralised

It should also be found that if everything has been carried out correctly the circuit remains balanced and neutralised on the long waves, so that simply pulling out the range switch changes the connections over and the various long-wave stations
(Continued on page 346)

JUDGING by the comments at the National Radio Exhibition, the Auto-selector Four appears to have supplied a long-felt want. The idea of being able to select the three principal stations by the simple pulling out of a knob appears to be what many people have been waiting for, while the possibility of changing over to an actual variable tuning control in order to receive other stations renders the utility of the arrangement considerably greater.

Simple in Practice

Unfortunately, owing to the care which had to be taken in the layout in order to minimise the loss of efficiency, the resultant arrangement had a somewhat complicated appearance. In reality the arrangement is one of considerable simplicity.

Illusion of Complexity

The removal of the bank of semi-fixed condensers immediately destroys the illusion of complexity, for it will then be seen that the set consists simply of two pairs of coils situated on each side of the gang condenser, while the low-frequency portion of the receiver is on the right-hand side.

If the matter is treated in this light there can be little difficulty in making it up, and I strongly recommend intending builders of the set to

wire up the set as completely as possible without the semi-fixed condensers in position. Little difficulty should be experienced in following out the connections and obtaining accurate and symmetrical wiring.

Indeed, the receiver can be tested without the automatic portion in position, and this is almost a desirable method of procedure. By handling the receiver as a simple gang-control H.F. circuit, bearing in mind the operating notes given last month, the performance of the receiver can readily be gauged.

It will be remembered that the first adjustment is that of balancing the gang condenser roughly, the neutralising condenser being placed approximately one-third of the way

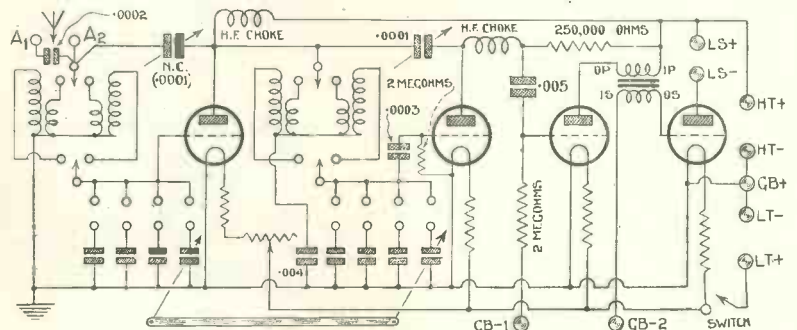

Circuit of the J. H. Reyner's Auto-selector Four

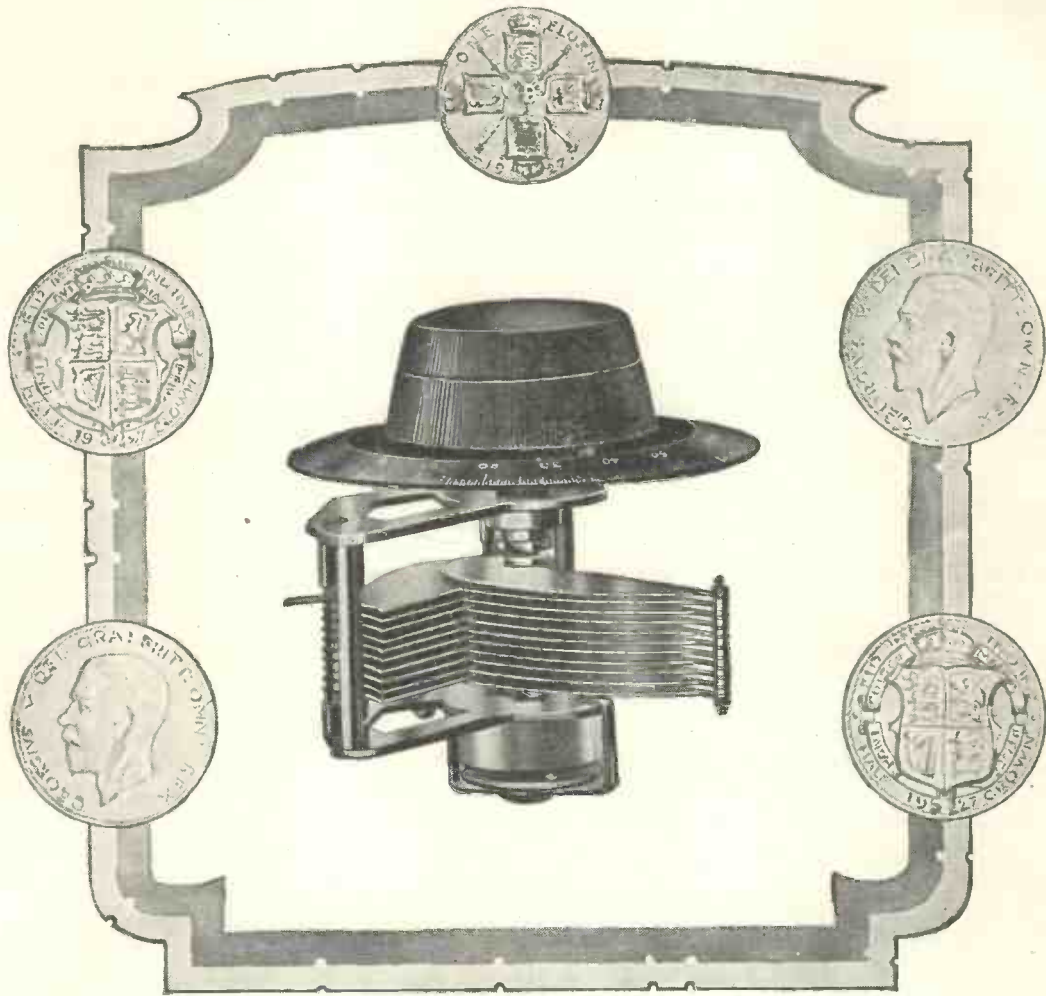

Twelve Shillings

The climax of our long and specialised experience in condenser manufacture has been reached in the K.C. Variable Condenser shown above. Both electrically and mechanically, this is a perfect instrument in which the elimination of losses and the provision of selective tuning have been the two features chiefly held in view.

Both stator and rotor vanes are of heavy gauge brass, separated by accurately turned spacers. The stator vanes are insulated by bakelite pillars held in compression, and the rotor vanes are connected to the frame—these features making for extremely low losses.

When used in conjunction with either of the DUBILIER Toroids, this Condenser will give true kilocycle (S.L.F.) tuning. This means that radio stations will be received—not crowded together at one end of the scale, but evenly spread out throughout the dial readings. One-hole fixing is provided and the instrument as a whole is beautifully finished.

Our new and improved methods of manufacture have enabled us to produce this Condenser at the extremely modest price of 12/-, and the enthusiasm which has already been accorded to it on all hands proves clearly that the DUBILIER K.C. Condenser will take up its rightful position as the premier variable condenser of the new season.

One-hole fixing. Max. Capacity 0.0005 mfd. Slow motion reduction 200 to 1



More About the Auto-selector Four (Continued)

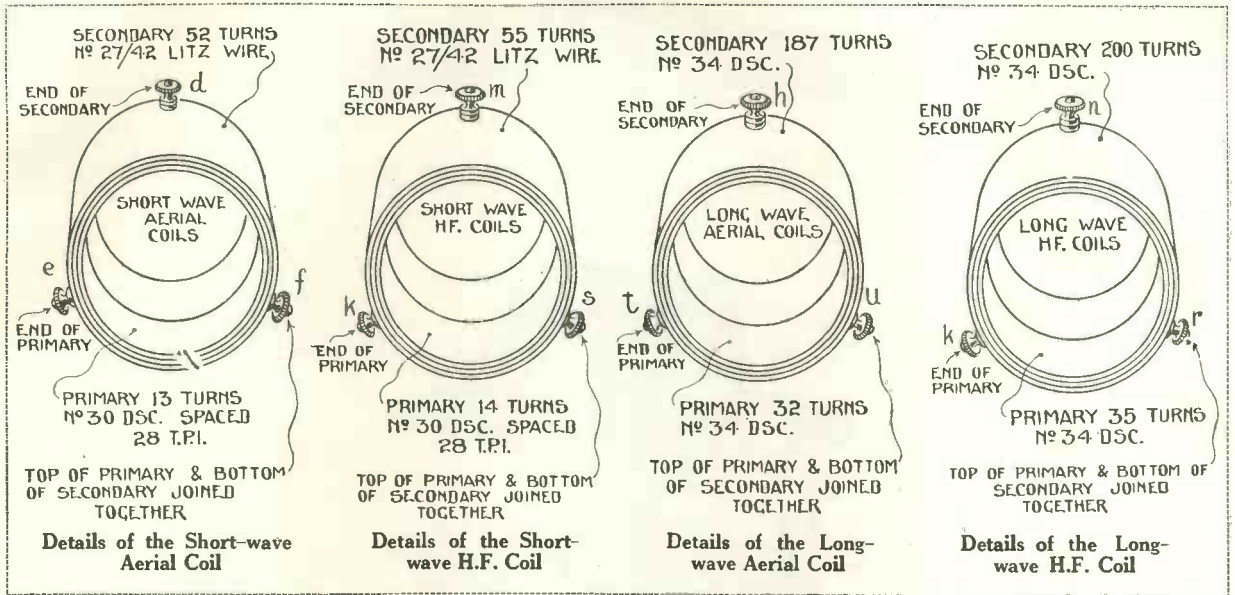

can all be received without difficulty. It may be that the reaction demand is not so constant on the long wave, but as the stations here come in with considerable power in the majority of cases it is not necessary to have a critical reaction adjustment.

Automatic Portion

When the receiver has been tested out in this manner and is working satisfactorily, then the automatic portion of the receiver can be placed in circuit and wired up. This is a simple matter of connecting the fixed plates of the disc condensers to the appropriate terminals on the push-pull switches.

In order to save any possible trouble it is a good idea to test the contacts on these switches before actually incorporating them in the circuit, or, at any rate, before finally

wiring them up. With the knob pulled out, the two terminals away from the panel should be connected together and the two terminals on the front of the panel also connected together, both these circuits being disconnected with the knob pushed in.

If this is in order, then wiring up the condensers to the switches, in accordance with the blueprint or wiring diagram given, is a simple matter and can be carried out in a few minutes.

Easy Tuning-in

The tuning-in of the required stations is then a matter of a short time only. Push in the bottom knob marked "Variable Control" and pull out the top knob. Rotate the moving plate of the two appropriate condensers (that is, one on the aerial circuit and one on the H.F. circuit), until the required station is heard.

Owing to the fact that no dials are provided, this may be a little difficult at first, but since only the stronger stations are intended to be received in this manner, this does not prove a serious disadvantage.

Adjusting Second Circuit

Having adjusted the first circuit in this manner, the knob may be pushed in and the second knob pulled out. This circuit can then be turned to 5GB or whatever alternative station has been chosen, and finally the third circuit can be adjusted in the same manner. It is obviously necessary when receiving 5XX to alter the range switch so that the circuit is changed over to the appropriate coils. This change-over is *not* done automatically by the push-pull selector switch.

(Continued on page 348)

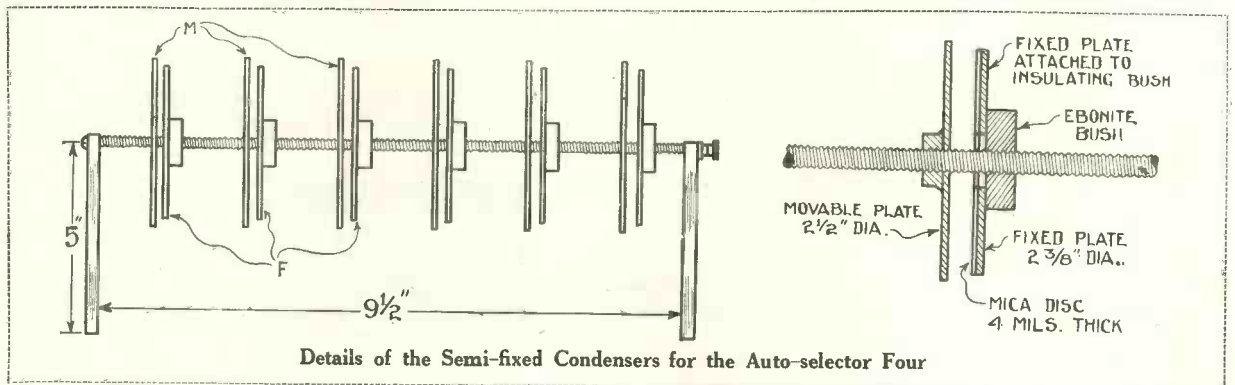



**IGRANIC
L.F.
CHOKE
(Type G)**
Price - 27/-



**IGRANIC UNIVERSAL
HIGH RESISTANCE
(Variable) - Prices 5/- to 6/6**



**IGRANIC "C.C." (Choke
Capacity) OUTPUT UNIT**
Price - 21/6



**IGRANIC WIRE-WOUND
SHIELDED RESISTOR**
Prices - 4/6 to 7/6



**IGRANIC ABSORPTION
WAVEMETER**
Price £2 : 13 : 6 (without coil)



**Read about
these new
IGRANIC
Radio Devices
in the
latest
IGRANIC
Catalogue**

A Copy will be sent to you
free on application to J312



IGRANIC ELECTRIC CO., Ltd.,
149 Queen Victoria Street, London.

WORKS: BEDFORD.

BRANCHES:
Birmingham Bristol Cardiff Glasgow
Leeds Manchester Newcastle

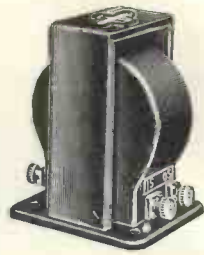

**IGRANIC
L.F.
TRANS-
FORMER
(Type G)**
Price 30/-



IGRANIC H.F. CHOKE
Price - 5/-

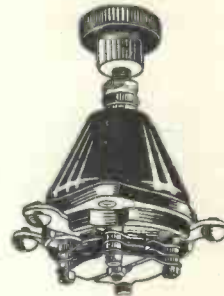

**IGRANIC VERNIER
BALANCING CONDENSER**
Baseboard Type - Price 4/-
Panel Type - - Price 5/6

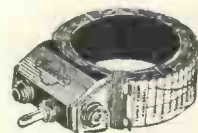

**IGRANIC TAPPED TRIPLE
HONEYCOMB
INDUCTANCE COILS**
Prices - 3/9 to 6/3



**IGRANIC FILAMENT
TRANSFORMERS**
Price - 30/-

More About the Auto-selector Four (Continued)

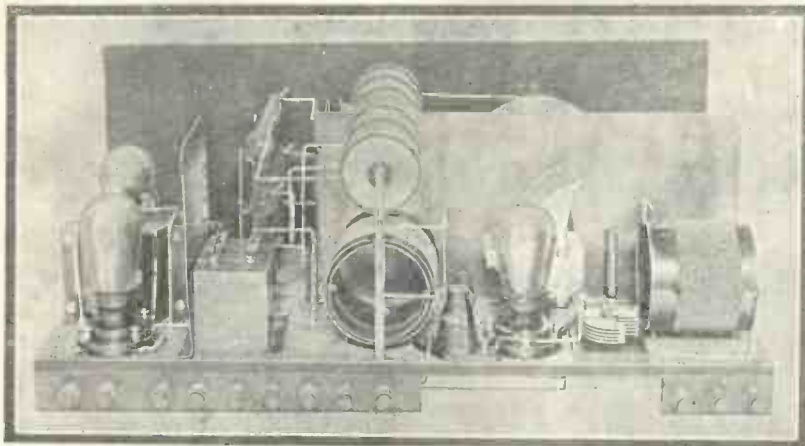

Rear View of the Auto-selector Four

As I explained last month, the use of special coils in this receiver was essential owing to the necessity for careful matching so that the range-changing facilities would be obtained without difficulty and also due to the fact that a high degree of amplification was necessary if the gang-control circuit was to function satisfactorily.

Sharper Relative Tuning

A two-circuit tuner is more difficult to gang than a three-circuit one, because the relative tuning on each circuit has to be sharper and the actual amplification per stage has to be greater. Thus, we cannot afford quite so much lack of balance as is possible with a three-circuit arrangement. In order to avoid any difficulty due to this cause, therefore, highly efficient coils were used for the purpose.

The transformers are of a special type, but for the benefit of those readers, however, who wish to make up their own coils, I am giving actual details of the windings in this article.

Primary on Threaded Former

The details are shown diagrammatically, the particular point being that the primary winding is wound on a threaded former so that the turns occupy the same relative position along the former as the secondary winding. This is a most important point and contributes very largely to satisfactory operation of the receiver. Unless this is done, the neutralising adjustment will not hold good over the full tuning range.

The bank of semi-fixed condensers for the automatic portion of the

receiver can also be made up by the reader if he desires. Details of this portion were not given last month because many readers do not possess the facilities for screw work, but

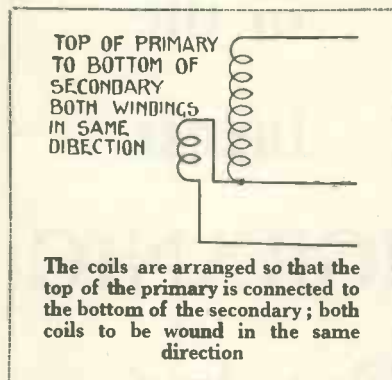

the particulars are given herewith so that if any difficulty is experienced in obtaining the condensers, they can be made up by the individual reader.

The condensers themselves each consist of two discs mounted on a threaded rod. The larger disc, which is $2\frac{1}{2}$ in. in diameter, is actually in contact with the rod and as it is rotated it travels along the rod due to the presence of the screw thread. The smaller disc, which is $2\frac{3}{8}$ in. in diameter, insulated from the rod by being mounted on an ebonite bush and it is also fixed so that it will not rotate. The metal disc itself is covered with a piece of mica 4 mils (.004 in.) thick. This is stuck to the metal with a very thin layer of suitable adhesive compound.

Unless this precaution is taken, the maximum capacity of the condenser

will not be sufficiently high. Simple rotation of the larger disc then causes it to move closer to or farther away from the fixed plate, and thus the necessary variation of capacity is obtained.

Common Spindle

As all the moving plates are connected to L.T., they are connected to a common spindle running through the whole bank, while individual connections are taken from the six fixed plates which are insulated from the common spindle. This gives the simplest arrangement that can be obtained which will give the necessary performance.

If any reader wishes he can, of course, use other types of semi-fixed condenser. There are one or two makes of compression types of condenser, such as the Formo densor and the Igranic compression condenser. The difficulty with such components is that the minimum capacity is rather high (of the order of .00015 microfarad with a .0005 microfarad condenser). My preliminary experiments indicated that this limited range was a disadvantage and therefore I developed this special form of condenser which has quite a low minimum. On the whole therefore, the use of the specified condenser is preferable.

In Manufacture

The particular firm specified in connection with this special semi-fixed condenser have been unable to supply them, and constructors should note that Wright & Wearie, Ltd., now have them in production. They are also the manufacturers of the special coils.

WHO WAS THAT ?

The Editor of the "Wireless Magazine" has made arrangements to assist readers who are in difficulty over the identification of broadcasting stations they receive.

Each query should give as many particulars as possible (such as time, date, wavelength, language, and distinctive call or signal) and should be accompanied by the coupon on p. iii of the cover and a fee of one shilling (postal order or stamps).

Tungstone's Accessibility opens the "Sealed Mystery" Box of the Motor Car No Necessity to Buy a Tungstone twice in a Lifetime

as Spare Partially First Charged Plates perpetually replace used Plates. Any Battery from 6 to 5,000 amps., First Charge only Four Continuous Hours. Read Special Articles in this Booklet
TUNGSTONE DE LUXE HIGH TENSION, FITTED WITH PATENTED EQUIPMENT FOR CHARGING on 12-16 Volt LOW TENSION PLANT.

First Charge completed in the Short Period of 12 Continuous hours. Re-charges in 7 hours
The practical advantage of Tungstone's exclusive feature of BALANCED PLATES, in combination with Low Tension Charging Plant Equipment, guarantees that the First Charge and all Re-charges are fully completed, consistently and reliably, which the present-day long period charging cannot guarantee and never secures, the basic fault necessitating heavy costs for repeated re-charges at short intervals.

FIRST CHARGING RISKS ENTIRELY ELIMINATED.

Battery Troubles Solved

10 HORSE POWER STARTER KICK

The ONLY Car Starting Portable Storage Battery in the World

TUNGSTONE

REGD TRADE MARK With Plate Grids and Paste PATENTED
made of Pure Lead

Accumulator

Telephone: Central 8156 (4 Lines) Telegrams: Typity Fleet London

3, ST. BRIDE'S HOUSE, SALISBURY SQ., FLEET ST. LONDON E.C.4

Revolution
after **50 years** Stagnation
OF THE
World's Battery Practices

NO SULPHATION. All Parts Replaceable

FIRST CHARGE ONLY

Four Hours

For any STORAGE BATTERY from 6 to 5,000 amps.

Post Free
Copy for
Asking.

112 pages
Illustrated
Pocket Battery
Guide.

Special Articles
on
Modern Battery
Construction
and
Weaknesses.

Send Postcard
to the
Tungstone
Accumulator
Co., Ltd.,
St. Bride's House,
Salisbury Square,
London, E.C. 4,
where Daily
Demonstrations
are given.

B

Two-valve
Circuit

Use of
Potentiometer



Microphone
Connections
Transformer
Cores
Filament
Protection

Two-valve Circuit

Q.—Could you let me have a theoretical two-valve circuit embodying the following features: detector with reaction and L.F. resistance-capacity-coupling between the valves?—G. L. B. (Cheltenham).

A.—Here is the circuit diagram for which you ask. The method of applying

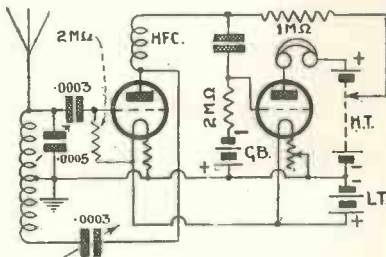

Two-valve Circuit

reaction, a form of Reinartz, is probably the best to use when a stage of R.C. coupling follows the detector valve. A centre-tapped coil is used, half of this being included in the grid circuit of the detector valve. For good results much depends upon using a really efficient H. F. choke in the detector-plate circuit.

The values are given in the diagram on the assumption that a high-impedance high-amplification valve is used in the detector stage and a fairly low-impedance valve, or a small power valve, in the second position.—N. G.

Use of Potentiometer

Q.—How does a potentiometer enable the voltage applied to, say, the grid of a valve to be adjusted?—G. C. J. (Eltham).

A.—A potentiometer, in the case you mention, would consist of a resistance of 300 or more ohms, provided with a sliding contact and connected across the L.T. leads of the set. The voltage of the L.T. battery would then be applied across the ends of the potentiometer winding but, on account of the high resistance of this latter, very little current would flow through the winding. For instance, with a 300-ohm potentiometer and a 6-volt L.T. battery the current would be 20 milliamperes. For higher resistances or lower voltages it would be correspondingly less.

Now the full voltage of the L.T. battery will exist between the negative and positive ends of the potentiometer winding, half the voltage between the negative end and the centre of the winding, and so on. By moving the sliding contact to a suitable position, therefore,

any desired voltage, up to the total voltage of the L.T. battery, may be tapped off and applied to the grid of a valve.—P. C.

Microphone Connections

Q.—I intend to use a valve amplifier, in conjunction with a microphone and loud-speakers, to enable me to relay speech to a distance. I understand that the small current required by the microphone can be obtained from the L.T. battery of the amplifier instead of using a separate battery for supplying the microphone circuit. If this is so please show me how to do it.—B. C. D. (Hampstead).

A.—A diagram of the connections you mention is given on this page. One side of the microphone is connected to one end of the primary winding of the microphone transformer and the other side of the microphone to L.T. positive. The other end of the transformer primary is connected to one end of the transformer secondary and this junction is also connected to L.T. negative. The other end of the secondary is connected to the grid of the first valve of the amplifier.—F. N. D.

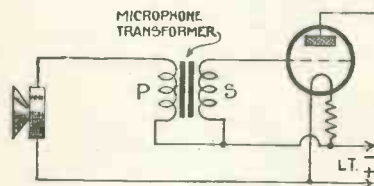

Microphone Connections

Transformer Cores

Q.—The cores of L.F. transformers are always built up of a number of thin sheets of iron. Why is this done and what is the objection to using solid iron cores?—F. K. (Accrington).

A.—Iron is a conductor of electricity and the core of a transformer, of course, lies within the varying magnetic field

set up by the currents flowing in the two windings. Now when a conductor is situated in a varying magnetic field currents are induced in the conductor. This, of course, is the principle on which a transformer works—the varying field of the primary causing corresponding currents to flow in the secondary. But just as the energy of the currents in the secondary is drawn from the primary circuit so would the energy of any currents flowing in the core be drawn from both primary and secondary windings.

The idea of constructing the core of a number of thin laminations is to restrict, as far as possible, the amount of energy wasted in causing unwanted induced currents to flow in the core. As each lamination is insulated from the next induced currents are not able to flow as freely through the core as if this latter were solid.—N. F.

Filament Protection

Q.—I understand that it is possible to protect the filaments of valves from being burnt out owing to the current from the H.T. battery being accidentally allowed to flow through them by connecting a suitable resistance between the negative terminal of the H.T. battery and the H.T. negative terminal of the set. How can I find the proper value for this resistance?—D. C. P. (Leicester).

A.—The value for the protective resistance can easily be found by dividing the total voltage of the H.T. battery by the correct filament current, in amperes, of the lowest consumption valve in the set. For instance suppose you have a 100-volt H.T. battery and the lowest consumption valve used is of the .1 ampere type. Divide 100 by .1 and the answer is 1,000. Therefore the protective resistance, in this case, should have a value of 1,000 ohms.

It should preferably be non-inductive and should be shunted by a large-capacity fixed condenser of, say, not less than .5 microfarad capacity.—F. N.

When You Are In Difficulty—

It does not matter whether your knotty problem is a theoretical or a practical one—in either case the Technical Staff of the "Wireless Magazine" is ever ready to help you out of the difficulty. Just write your query out on one side of a sheet of paper (this small point saves us time and enables us to send an answer quicker) and send it with the coupon on page iii of the cover, a stamped addressed envelope and a fee of 1s. (postal order or stamps) to:—Information Bureau, "Wireless Magazine," 58-61, Fetter Lane, London, E.C.4.

New development in six pin coils!



BINOCULAR Coils are the latest Lewcos development in six-pin coils. They are interchangeable with the popular types and can be used in a standard Lewcos Screen, although for use in multi-stage receivers they are sufficiently fieldless without screening. All dealers can obtain them for you.

Supplied in the following ten types:
 SPLIT PRIMARY TRANSFORMER.
 SPLIT SECONDARY TRANSFORMERS
 REINARTZ TRANSFORMER.
 SPLIT SECONDARY TAPPED PRIMARY
 AERIAL COIL.
 Full particulars and prices sent on request.
The LONDON ELECTRIC WIRE CO. & SMITHS, LTD.
 Playhouse Yard, Golden Lane, London, E.C.1

LEWCOSS Binocular Coils

Registered Trade Mark

Patent No. 277876

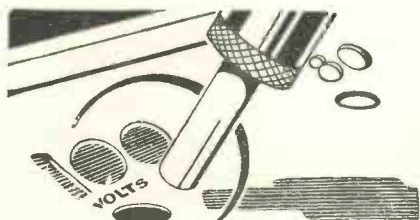

HOW CAN YOU KNOW

NEW MODEL
 High resistance
 4,000 ohms. 9/6
 Double Reading.
 Robust Construction.



STOP risking damage to batteries and valves! Take the advice of your Battery maker and use a Sifam Radio Meter. These dead-beat, unconditionally guaranteed meters give accurate readings of H.T. and L.T. and ensure exact control essential to obtain "perfectly balanced" reception.

Sifam Meters trace distortion, locate faults, and banish the annoyance of sudden breakdowns.

Ask your dealer to show you the complete range. Saves pounds in battery repairs and brings a new pleasure to tuning.

The Sifam Book free from

SIFAM ELECTRICAL INSTRUMENT CO., LTD.
 Dept. M., 10a, Page St., Westminster, London, S.W.1.

TEST YOUR SET TO-NIGHT
 WITH GUARANTEED
RADIO SIFAM METER
 And it won't let you down tomorrow!

IMPORTANT

WHY PAY MORE WHEN YOU CAN BUY THE
 WORLD'S BEST ANTI-PHONIC LOW LOSS VALVE
 HOLDER ?

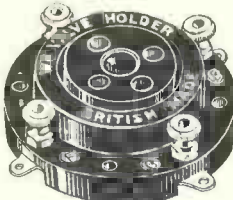

The W.B.
 Complete with Terminals
 AT 1/9 EACH

As used in the Cossor "Melody Three," the Wireless Magazine "Exhibition Five" and other well-known sets described in the Wireless Press. Send for illustrated lists.

Obtained from all Dealers or direct from the Manufacturers:
WHITELEY BONEHAM & Co., Ltd., Nottingham Rd., MANSFIELD, NOTTS

CUT THIS OUT FOR CABINETS



and post to us for new FREE list illustrating Cabinets as shown in "Wireless Magazine," etc., etc.

NAME

ADDRESS



(Write in block letters please.)
CARRINGTON Mfg. Co., Ltd.,
 Camco Works, Sanderstead Road,
 South Croydon.

Telephone: Croydon 0283 (2 lines).

New Valve Markings

Correspondence Re'lating to the Artic'e that appeared on p. 10/ of the September Issue

To the Editor, "Wireless Magazine"

SIR,—The standardisation of valve designations by the manufacturers would be extremely welcome to all users of their products, and I was glad to see the suggestion put forward in the September issue of WIRELESS MAGAZINE by Mr. D. Sisson Relph for ending the present confusion. The method of including the A.C. resistance is of particular value.

I have one adverse criticism to make, if I may be so allowed. A name such as 25V18 would be quite sufficient for a set designer writing for a paper, or for an article on the theory of couplings, but it would be often, if not usually, desirable to refer to some particular make of valve, and this makes the name excessively long.

I suggest that the exact filament voltage is unimportant, and that it is necessary to know only the size of battery required. As the accumulator is almost universal for lighting filaments the figures 2, 4, and 6 suffice, and we can use the method employed for certain Marconi, Cossor, Burndept and other valves. That is, 306 will mean a valve taking .06 ampere at 3 volts.

One could then refer shortly to a Cossor 410-20, or an Osram 215-6½, while my hypothetical set designer would merely omit the maker's name.

I venture to suggest that this method is better than using three groups of figures plus a name when required. Moreover Roman numbers are not easy to read quickly. It is an axiom in library cataloguing that Arabic numerals only should be used.

I should value the opinion of Mr. D. Sisson Relph and of your readers on this proposed method.—P. R. LESLIE (Fallowfield).

[As most manufacturers make valves of almost identical characteristics there is little need to mention a particular firm by name, and my scheme is intended to obviate this by designating every essential characteristic of a valve in a way that could be universally adopted.

Now that so many sets do not incorporate any form of filament control it is particularly desirable that the user should know the filament voltage rather than the battery voltage. There are still on the market valves that take 3 volts and if these were used as 4-volt valves direct from a 4-volt battery there would, of course, be serious trouble.—D. SISSON RELPH].

SIR,—We have read with interest the article entitled "New Valve Markings You can Understand at a Glance," which appeared in the September number of the WIRELESS MAGAZINE.

We should like to say that in our opinion the suggested marking is sound technically, but we are afraid would prove far too cumbersome for the ordinary individual to understand easily.

The inclusion of an indication of one of the valve constants, either M valve

or impedance, in the nomenclature is certainly an advantage to those who understand such terms and, we believe, is adopted in a nomenclature used by Phillips of Holland, where the M value is indicated.

The matter has been very carefully thought out and, in our opinion, the most useful information which can be given to a user is the filament current and volts, using a letter to indicate

whether the valve may be of high amplification factor ("H" valve), moderately low impedance ("L" valve) or loud-speaker power valve ("P" valve). The only disadvantage of this at the moment is, of course, the confusion which exists between the designations "H" and "H.F." which are not necessarily synonymous.

Of course, the ideal way to designate a valve would be similar to that of a lamp. In the latter case a man goes to a shop and asks for an "Osram 240-volt 60-watt" or such like, but we are yet a long way off that ideal in valves, designation of which is of course complicated by difference in characteristics apart from filament characteristics.—GENERAL ELECTRIC CO., LTD., (Magnet House, Kingsway, W.C.2).

A Marconi Royalty Concession

An important concession to buyers of new valve sets is announced by Marconi's Wireless Telegraph Co., Ltd. As is well known, a royalty of 12s. 6d. per valve holder is payable to them on every receiver, but under the new scheme a listener buying a new set to take the place of an old one will be credited with the amount of royalties he has already paid.

In order to claim this credit, it is necessary to fill up a form (see example below) and to return the licence plate attached to the old set.

Thus a listener already possessing an old three-valve set can buy a new five-valve receiver, and pay the royalty on only two valves; that is, he has only to pay a new royalty of 25s., as against 62s. 6d., a saving of 37s. 6d.

The concession also applies to a buyer of a new set containing the same number of valves as the old one.

October 13, 1927

To Marconi's Wireless Telegraph Co., Ltd.,
Marconi House, Strand, W.C.2.

Gentlemen,

1. I have in my possession a (A) three valve broadcast wireless receiving Set, No. (B) 90435, constructed by (C) The Expert Radio Company, and I hand you herewith Licence Plate No. 4321, which was attached to such set.

2. I am anxious to get a (D) five valve set in order that I may get the full benefit of the alternative broadcasting programmes now available.

3. In the price of my existing set I have paid the appropriate royalty to Marconi's Wireless Telegraph Company, Limited, namely, (E) £1 17s. 6d.; and in consideration of your crediting me with that sum upon my purchasing the larger set referred to in paragraph 2 of this letter I undertake that I will not sell or part with the set referred to in paragraph 1 of this letter unless I previously obtain from Marconi's Wireless Telegraph Company, Limited, a fresh Licence Plate for attachment to such set and pay to that Company the appropriate royalty.

I am, Gentlemen,

Yours faithfully,

Usual Signature - - - W. M. Reader,

Full Christian Names and Surname William Marcus Reader,

Address - - - Aerial Villa, Inductance Lane,
Lower Tapping.

Occupation - - - Independent.

EXPLANATORY NOTE.

- (A) Insert number of valves.
- (B) Insert number of existing set.
- (C) Insert name of manufacturer of existing set.
- (D) Insert number of valves desired in set now being purchased.
- (E) This is 12s. 6d. on a one-valve set; £1 5s. on a two-valve set; £1 17s. 6d. on a three-valve set; and so on.

Wherever you are

with the ORMOND Self-Contained Set there are the artists



—invisibly present, requiring only the simplest operation to evoke their immediate response. Speech, song or instrumental music, anywhere at anytime, you can have perfectly reproduced if you possess an

ORMOND Self-contained Receiver

—the simplest, the handiest, the most attractive portable you could wish for. You can take it from room to room, carry it to your friends houses, or make it entertain you outdoors if desired. No trailing wires but entirely self-contained, a simplicity of control is the greatest feature, with perfect reproduction under average conditions from a main B.B.C. station within 30 to 40 miles and 400 miles of Daventry.

A simple switch gives a choice of short or long wave-bands, and the set is fitted with an ORMOND loud speaker.

Demonstrations may be given at any of the leading wireless dealers or at our showroom —address below.

**Complete with accessories
and ready for immediate use,**

£24 10 0

Marconi Royalty,
£3 2 6

Catalogue No. R/203

*Write for illustrated
descriptive leaflet*



199-205 PENTONVILLE ROAD, KING'S CROSS, LONDON, N.1

Telephone: Clerkenwell 9344-5-6

Telegrams: "Ormondengi, Kincross"

FACTORIES: WHISKIN STREET AND HARDWICK STREET, CLERKENWELL, E.C.1

Continental Agents: Messrs. Pettigrew & Merriman, Ltd., "Phonos House," 2 & 4 Bucknall St., New Oxford St., London, W.C.1

Every Listener Will Learn Something from This Article on

“Control” and “Balance” in Broadcasting

THERE is a department at the B.B.C.'s headquarters corresponding to the joint offices of producer and stage manager in a theatre. This organisation attends to the presentation to the public of all sounds delivered into the microphone for transmission.

Rehearsals

No item in any programme is put on without first of all being rehearsed. Thus, the “control” or “balance” department forms an idea of how best to treat it. Perhaps the soloist (if that be the number) has to stand slightly nearer than most people; perhaps at some point or points in the song it has to be “biffed up a bit,” or the reverse may be true in both cases.

Such rehearsals are going on all day at 2LO, and it is unnecessary to say that all members of this department are musicians. The whole thing is a question of musical knowledge. It is obviously necessary that they should know how every item

should be rendered, and, in the case of an orchestral selection, the exact interpretation a particular conductor puts upon it. This alone means that they have to be extremely well-read musically.

Then, further, they must know all the usual snags in the various items. A very simple snag in a song is a rising phrase. With some people the tendency is towards an increase of sound volume on the final note. Unless this is anticipated and toned down there will be “blasting.”

The big trouble is that nothing definite can really be said until the actual transmission comes through. I asked the head of this department if there were no rules which governed the taking up of positions in the studio. He was emphatic that it was entirely an individual matter.

Individual Positions

Looking into the studio at that moment, I saw an announcer with his lips scarcely a foot away from the microphone, a soprano five feet off,

a piano (solo) about ten, and a tenor six or seven. But these figures mean little, if anything. Although two voices may be classified as being identical, and although they may render the same number, the controller would not be at all surprised to find that, for some reason or another, the second required a slightly different position from the first.

Moving While Singing

A certain lady who was rehearsing in another studio just then was arranging to change her position while singing. To begin, she stood about three feet off, but as her song increased in strength toward the end, she had to move another six or seven feet away to get it over properly. The studio makes a difference, too. Tommy Handley's distance in one is four feet, but only in that one.

In practice there are limits, but in between them are millions of positions, and it is just a matter of expert

(Continued on page 356)

Radio Beacons to Aid Ships!

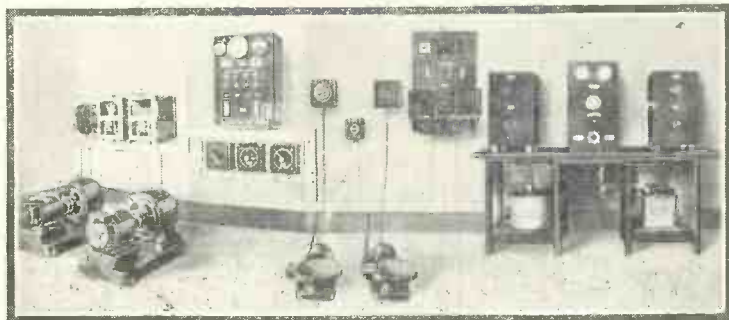

Situated on Round Island, in the Scilly group, a new beacon radio transmitter, working on a wavelength of 1,000 metres with a power of half a kilowatt, has just been put into commission by Trinity House. The apparatus was designed and installed by the Marconi Company.

The station will be used for sending out automatic calls to ships at regular intervals, thus enabling them to take directional bearings at a range of 70 to 100 miles.

Catalogues and Pamphlets

Unless otherwise stated readers can obtain copies of any of the catalogues reviewed here free of all charge by mentioning the "Wireless Magazine."

WE have received from the General Electric Co., Ltd., Magnet House, Kingsway, W.C.2, a booklet of twenty pages, excellently illustrated and printed, which gives particulars of their receivers, from the Junior Crystal Receiver, at 16s., to the eight-valve super-heterodyne at £63 15s. Details of portables and loud-speakers are also given.

Leaflet No. 83, received from Philips Lamps, Ltd., Philips House, 145 Charing Cross Road, W.C.2, gives particulars of the wide range of chargers and eliminators produced by the firm. A new dual-purpose charger is particularly noticeable.

Two neat little folders descriptive of their components have been sent in by the Benjamin Electric, Ltd., of Brentwood Works, Tottenham, N.17.

A booklet received from S. S. Bird and Sons, Cyldon Works, Sarnesfield Road, Enfield Town, Middlesex, contains graphs relative to the performance of Cyldon condensers. The graphs are good.

A number of leaflets, giving interesting information and performance graphs of their audio-frequency transformers, have been sent in by Ferranti, Ltd., Hollinwood, Lancs.

C. A. Vandervell & Co., Ltd., have sent us some leaflets on their H.T. and L.T. accumulators and radio receivers. The units are well made.

A number of interesting types of accumulators and current rectifiers for charging them are produced by Afr Accumulators, Ltd., 120 Tottenham Court Road, W.1. They are described in some leaflets we have received from the manufacturers.

The Marconiphone Co., Ltd., 210-212 Tottenham Court Road, W.1, have sent in a number of fully illustrated booklets describing all the apparatus produced by them, from accumulators and supply units to valves and receivers.

The Note

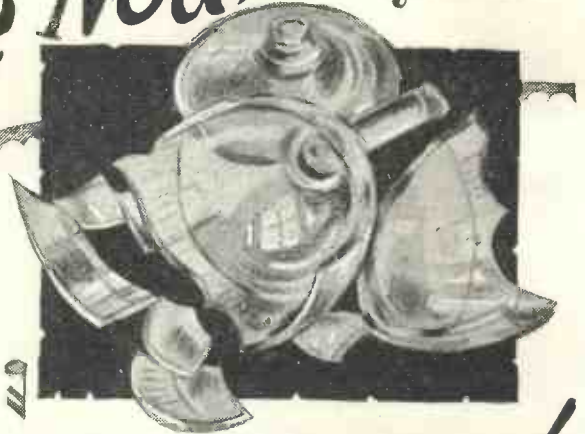

THAT SMASHED THE GLASS!

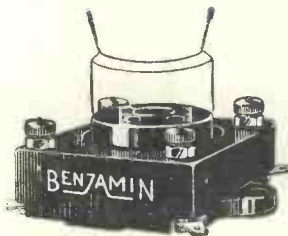

BENJAMIN Clearer-Tone Anti-Microphonic VALVE HOLDER

Make sure that the anti-microphonic valve holders you buy are Benjamin, because in these alone you get these 5 essential features:—

- (1) Valve sockets and springs are made in one piece with no joints or rivets to work loose and cause faulty connections.
- (2) Valves are free to float in every direction.
- (3) Valves can be inserted and removed easily and safely.
- (4) Valve legs cannot possibly foul the base-board.
- (5) Both terminals and soldering tags are provided.

Price 2/- each

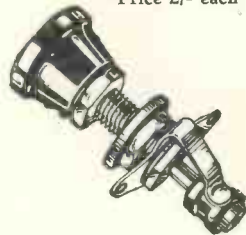

BENJAMIN BATTERY SWITCH

A sturdy positive action switch for high or low tension. It's OFF when it's IN, thus preventing the accidental turning on of current. Single contact. One-hole fixing.

Price 1/- each

There is a story told of a famous singer that he could sing a certain note into a wineglass and smash it into fragments by the vibration.

This is an extreme instance of the damage vibration can do. Nearer and dearer to you is the damage vibration does to the delicate filaments of your valves.

Every time a lorry rumbles past your house a wave of vibration travels to your radio set. Every time you walk across the floor another wave is sent.

The only way you can thoroughly stop vibration reaching the filaments is to fit Benjamin Anti-microphonic Valve Holders.

The smallest shock and vibration is quenched by the wonderful one-piece springs. Microphonic noises are entirely eliminated. The life of the valve is trebled at least.

BENJAMIN

ANTI-MICROPHONIC VALVE HOLDER

PRICE 2/- EACH.

THE BENJAMIN ELECTRIC LTD.

Brantwood Works, Tariff Road,
Tottenham, N.17.

“Control” and “Balance” in Broadcasting (Continued)

judgment, coupled with experience, to find the most suitable one. Too close a position causes “blasting,” while, on the other hand, being too far away gives too weak a transmission for crystal-set reception.

A few average figures may be cited, but they must be taken in the same way as it is said in history that 1600 is a “central date” for William Shakespeare. A reader will be about a foot or eighteen inches from the microphone, a soloist a matter of a few feet, depending entirely upon the strength of voice and nature of the solo, an orchestra slightly farther removed, and a piano for a solo between twelve and fifteen.

Orchestral Arrangement

The individual arrangement of an orchestra is usually fiddles, woods, and basses in front, with the last slightly farther back, piano another foot or so to the rear, and the drums a couple of extra feet again.

The human element is a very big factor, and it is interesting to note that “mikes” themselves are included under this heading, for they too have their good and bad days. Even though a rehearsal has taken place, and a suitable distance discovered, it by no means follows that this will not have to be altered when the actual performance is given. The voice may quite unconsciously alter or, again, the controller may have counted on the soloist “warming up” quicker or slower than he does.

The whole process of controlling is divided into two distinct parts. There is always someone on the spot, in the anteroom about four feet square, which looks into the studio through a “window” cut in the wall, and there is someone also upstairs in what is known as the control room. The first attends to the delivery into the microphone and the second to the re-delivery into the ether.

Calling in Advice

This anteroom has two pairs of earphones, so that the controller can call in advice if he so desires. It has

also a microphone for announcing purposes in case of need. Above the window is a telephone “bell” connecting him directly with his colleague upstairs. This “bell” consists of a metal cap which is held up by an electric magnet. When the receiver is lifted at the other end the current is cut off, and the cap drops on its hinge with a clap sufficient to attract attention without being loud enough to penetrate the glass windows.

Between the numbers the controller steps into the studio to arrange

TEDDY BROWN



This famous xylophone exponent recently received His Majesty's hospitality

his artists. When any alteration becomes necessary during the performance, he uses his discretion as to how to affect it. Every artist facing the microphone can easily see the window, so that one who is well used to the procedure can interpret a wave of the hand to a fair degree of accuracy. An altogether strange person may have to be gently pulled into position. It is plainly a delicate business, and great care has to be taken not to cause any disturbance.

Upstairs the process consists in turning a knob as aural judgment dictates. Most pieces of music have some portions which are too loud for transmission and others which are too soft. Consequently, all musical numbers have to be sent out on a smaller range of sound volumes; the soft parts are louder than they would be in a public hall and the loud parts are softer. But if attention were concentrated merely on these, many fine musical effects would be completely ruined. Although loud parts have to be softened, yet they must appear to preserve their relative strength. The creation of this illusion is the work of the control room.

Splitting Up a Note

The methods employed are many and involved, but I will give one, which should be interesting to listeners. Many crescendos end on notes of impossible strength, and one way of securing the illusion (not the only way, and not necessarily used in every case) is to split it up into a number of smaller crescendos, at the end of each of which the strength is immediately dropped.

The next begins on a note which is actually softer than the concluding one of the last crescendo, but as it ends on a stronger one the effect is that of increasing loudness. When the last one is reached the start is again made on a softer volume, which allows room for a final crash to convey the proper climax.

Controller's Score

The controller attending to this follows all the music from his own score, which he has probably marked at various places from his observations at the rehearsals. He and his colleagues are on duty during every broadcast.

In this respect the control and balance department falls into line with many other people on the staff of the B.B.C., concerning whom considerably less is known than the importance of their work deserves.

F. R.

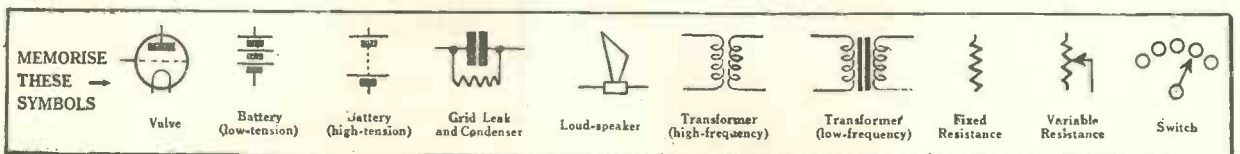

THE BEST IN THE WEST

Do not fail to call at our showrooms to hear a demonstration of the MOVING COIL LOUD SPEAKER.

All parts in stock. Complete set - £6 16 3
It will also pay you to hear a demonstration of the marvellous apparatus for electrical Gramophone reproduction.

Every type of pick-up can be demonstrated upon request. Brown, Igranic, Marconi, Celestion, etc.

NEW LINES IN STOCK.

THE NEW DUBILIER K.C. CONDENSER 12/-
THE NEW BURTON S.L.F. CONDENSER
.0005 6/- .0003 5/9

SPECIAL BURTON VERNIER DIAL - 5/-
SPECIAL TYPE PAREX VALVE HOLDERS FOR
CAPT. ROWNDE'S SCREENED VALVE - 4/6
A FEW ONLY LEFT. AMPLIFEX AERIAL
LOOPS

The finest Loop Aerial ever devised (originally
£3 10 0). To clear 30/-

WILL DAY LTD. (Dept. W.M.)

19, Lisle St., Leicester Sq., LONDON, W.C.2.

Telephone: Regent 4577. Telegrams: "Titles, Westrand, London."

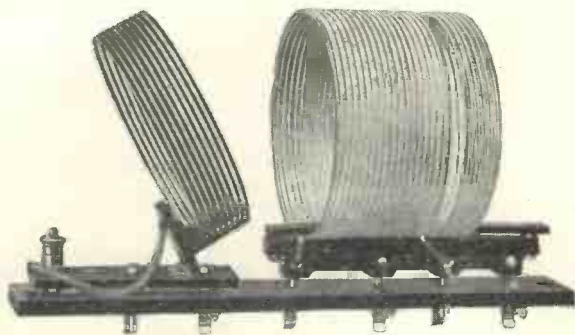

Interchangeable

Supplied in a set of four, with one suitable aerial coil covering the full wave-band. Mounted on low dielectric strip, fitted with six pins. A base is provided carrying six spring contacts.

PRICE
35/-

Approximate tuning range with .00015 mfd. condenser:
Coil A: 10 to 17 metres.
Coil B: 17 to 34 metres.
Coil C: 34 to 70 metres.
Coil D: 60 to 130 metres.

COLVERN VALVE HOLDERS for the new Screened-grid Valves, give a choice of four positions - 4/6

THE COLLINSON PRECISION SCREW CO LTD.

PROVOST WORKS, MACDONALD ROAD, WALTHAMSTOW, E.17

CLIX

Rainbow Terminal

**"Meets the
Needs of
Every
Lead"**

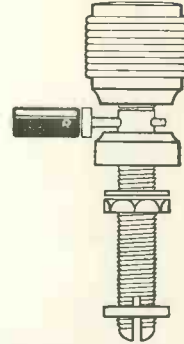

You can't make any mistakes with Rainbow Terminals—no more "blowing" expensive valves, damaging accumulators and exhausting batteries by mixed up leads and short circuits. You connect by colour, with every lead wearing a neat identity ring corresponding in colour to the terminal head.

In 9 distinctive colours for Low Tension, High Tension and Grid Bias Batteries Loud Speaker, etc.

Complete Terminal with nuts and washers and coloured identity ring for affixing to pin or spade connector.

5d.
each.

CLIX PARALLEL PLUG

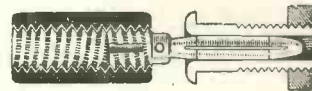

Coloured Identity Rings are now available for this extraordinarily useful fitment.

Parallel Plug and Socket complete with **3½d.**

Identity Rings only ½d. pair.

each.

Users of Wet H.T. Batteries should note that ordinary Wander Plugs are unsuitable for their purpose. Ensure perfect fit and obviate grinding away sockets by using Clix Parallel Plugs.

Clix Products have banished wireless worries for thousands. Obtainable from all Wireless Dealers.

LECTRO LINX LTD.

254, Vauxhall Bridge Road, Westminster, S.W.1

Telegrams: "Trolinx, Churton"

Telephone: Victor a 5120

All Tests Are Conducted Under the Personal Supervision of J. H. Reyner, B.Sc. (Hons.), A.M.I.E.E., at His Furzehill Laboratories

Trying a component under actual reception conditions

Novelties and New Apparatus

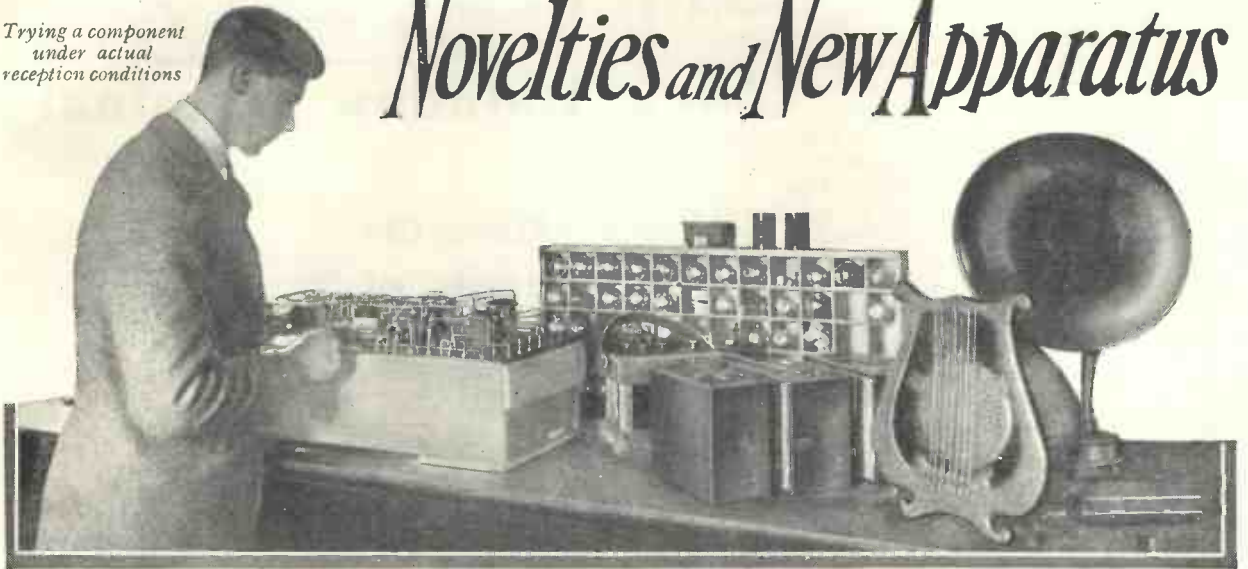

Lotus Remote Control

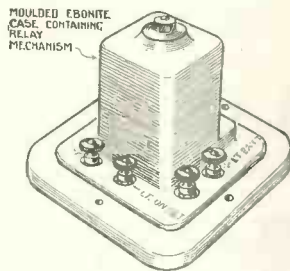

was no tendency for the contact points to stick even when handling a current as high as 4 amperes. The complete equipment for wiring up two separate rooms costs 30s., which strikes us as being a very reasonable figure for so reliable an instrument.

The address of the manufacturers is, Garnett, Whiteley & Co., Ltd., Broadgreen Road, Liverpool.

to each other, whilst it becomes rapid if they are moved farther apart. Such a system is generally the most satisfactory for obtaining a fine control of reaction near the point of oscillation.

The component takes up little room and can be fixed to the baseboard or panel as desired. It should prove useful to readers.

The address of the General Electric Co., Ltd., is Magnet House, Kingsway, W.C.2.

Gecophone Coil Holder

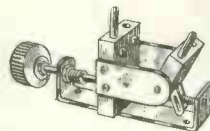

THE design of a coil holder which is compact, but yet possesses ample and sensitive movement presents considerable difficulty. The makers have evolved a holder which possesses a number of advantages over the old-fashioned type.

The movement of the Gecophone two-way coil holder consists of a threaded rod which can be rotated by means of a small insulated knob. A metal block meshes with the rod and has two projections which fit in a specially designed guide cut in a metal attachment: this is rigidly fixed to the moving coil holder.

The holder is constrained to rotate at a given centre: but the speed of rotation is governed by the pitch of the threaded spindle and also the position of the guide relative to the spindle.

It has been arranged that the movement is slow when the coils are near

Wates Voltmeter

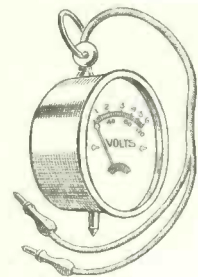

THERE is always a demand for an inexpensive voltmeter which will read accurately low-tension voltages up to 6 volts and high-tension voltages up to some value above 100 volts. With such an instrument, the amateur is enabled to look after his high- and low-tension supply.

The Wates voltmeter gives two ranges, one from 0 to 6 volts and the other from 0 to 120 volts. The higher-range scale is engraved in red and readings on this scale are taken by connecting the red

(Continued on page 360)

THE Lotus remote-control wiring system is supplied with all equipment necessary for obtaining remote control in two separate rooms. The equipment consists of a very neat and efficient relay: two Lotus wall jacks complete with plugs and 21 yards of 4-strand wire for making connections to various rooms in the house.

The relay itself is actuated by the filament battery which may vary from 2 to 6 volts. When a loud-speaker or pair of telephones is inserted into one of the jacks, which may be fixed in some remote place, the relay points are constrained to make a contact, and the filament circuit of the valve receiving set is automatically switched on.

The current taken by the relay varies from 16 to 48 milliamperes, according to whether a 2-, 4-, or 6-volt accumulator is employed: thus the instrument is very economical in use.

When placed on test, the relay functioned satisfactorily; a 2-volt filament battery gave ample power for operating the armature, and on no occasion did the points fail to open or close at will. There

THE WORLD'S BROADCASTING



Wave-length in Metres.	Station.	Call Sign.	Wave-length in Metres.	Station.	Call Sign.	Wave-length in Metres.	Station.	Call Sign.
158	Beziere	—	309	Marseilles	—	438	Bilbao	EAJ9
200	Biarritz	—	312.5	Newcastle	5NO	441.2	Brunn	—
201.3	Joenkoeing	SMZD	315.8	Milan	—	450	Rome	1RO
204.1	Gefle	—	319.1	Dublin	2RN	454.5	Stockholm	SASA
217.4	Luxemburg	—	320	Rennes	—	—	Paris	PTT
223.9	Leningrad	—	322.6	Paris	Radio Vitus	461.5	Oslo	—
230	Juan-les-Pins	—	—	—	—	462	Barcelona	—
236.2	Stettin	—	—	Breslau	—	—	Catalana	—
238	Bordeaux	—	329.7	Königsberg	—	468.8	Langenberg	—
241.9	Münster	—	333.3	Naples	—	477	Kharkov	—
252.1	Bradford	2LS	337	Copenhagen	Radio-raadet	478	Lyon-la-Doua	—
—	Bremen	—	—	—	—	483.9	Berlin	—
—	Montpellier	—	340.9	Paris	Petit Parisien	491.8	Bournemouth	6BM
—	Kalmar	SMSN	—	—	—	500	Aberdeen	2BD
254.2	Kiel	—	344.8	Barcelona	EAJ1	—	Como	—
260	Toulouse	—	348.9	Prague	—	—	Tromso	—
268	Strassburg	8GF	353	Cardiff	5WA	502	Porsgrund	—
272.7	Sheffield	6FL	357.1	Falun	—	508.5	Brussels	—
—	Cassell	—	—	Graz	—	517.2	Vienna	Radio Wien
—	Klagenfurt	—	361.4	London	2LO	—	—	—
—	Danzig	—	365.8	Leipzig	—	535.7	Munich	—
—	Nottingham	5NG	370	Paris	RadioLL	556	Budapest	—
273	Bordeaux	—	370.4	Bergen	—	—	Augsburg	—
—	Limoges	—	375	Helsingfors	—	—	Saragossa	—
277.8	Leeds	2LS	—	Madrid	EAJ7	—	Hamar	—
278	Grenoble	—	379.7	Stuttgart	—	577	Freiburg	—
280	Oviedo	—	384.6	Manchester	2ZY	588	Zurich	—
283	Dortmund	—	—	Radio Toulouse	—	675	Moscow Popoff	—
286	Lille	—	394.7	Hamburg	—	750	Geneva	HB1
288.5	Edinburgh	2EH	400	Cork	6CK	1,060	Hilversum	HDO
291	Radio Lyon	—	—	Seville	EAJ5	1,100	Basle	—
294	Stoke-on-Trent	6ST	—	Madrid	Radio Espana	1,153	Kalundborg	—
—	Swansea	5SX	—	—	—	1,250	Königswusterhausen	LP
294.1	Dundee	2DE	—	Mont de Marsan	—	—	—	—
—	Hull	6KH	—	Plymouth	5PY	1,320	Motala	—
—	Innsbrück	—	405	Salamanca	EAJ22	1,450	Moscow	RDW
297	Liverpool	6LV	405.4	Glasgow	5SC	1,600	Daventry	5XX
—	Agen	—	408	Reval	—	1,750	Paris	CFR
—	San Sebastian	EAJ8	411	Berne	—	1,800	Norddeich	—
300	Bratislava	—	416.7	Gothenburg	SASB	1,865	Koscice	—
—	Cartagena	EAJ16	418	Bilbao	EAJ11	1,950	Scheveningen	—
303	Nuremberg	—	428.6	Frankfort	—	2,650	Paris	FL
306.1	Belfast	2BE	434.8	Fredriksstad	—	—	—	—

Tests of Novelties and New Apparatus (Continued)

lead to the positive of the battery; whilst the lower range, marked in black, is read by connecting the black lead to the positive.

The current consumption on the full measurable voltage is approximately 30 milliamperes, which is quite satisfactory for a testing meter of this type, although, obviously, it should not be left connected across a high-tension battery. The instrument is totally enclosed in a metal case, and is neat and well finished. Readers should find many uses for such a meter.

It is marketed by the Wet H.T. Battery Co., of 12 Brownlow Street, High Holborn, W.C.1.

Peerless Resistor

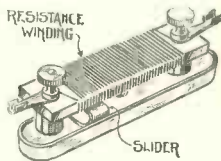

THIS consists of a flat strip of insulating material carrying a resistance winding which is bent into a half circle and held in a small metal stamp. A metal strip, making contact with the resistance winding, rotates on a pivot at the centre of the circle so that the amount of resistance in circuit can be varied between zero and maximum. Terminals are provided at each end and a definite off position is available if it is desired to switch the valve completely out.

Two holes are provided in the stamping forming the base whereby the component may be screwed down to a baseboard or fitted at the back of a panel as required. These holes, however, are not directly accessible, it being necessary to apply a screwdriver at an angle, and although this can easily be done, we think this is a point on which the design could be improved.

The particular sample was rated at 6 ohms and was found to have a resistance of a little over 7 ohms, giving an ample margin of safety. The contact between the moving arm and the resistance was good and the whole instrument is well finished. It sells at the low price of rs. 3d. and should prove attractive to many constructors.

The address of the makers is the Bedford Electrical & Radio Co., Ltd., 22 Campbell Road, Bedford.

Trix H.F. Choke

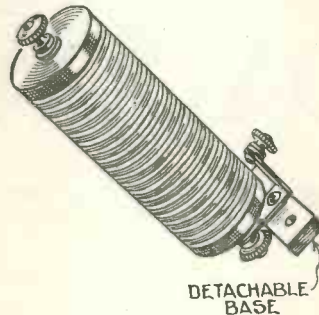

THE Trix H.F. choke comprises ten sections, these sections being wound in alternate slots in a barrel type of former, the intervening slots being left vacant. The winding is of enamelled-covered wire, each section being further covered with a layer of green silk in order to protect the windings from damage.

Connections are brought out at the two ends and a special bracket is provided which carries a small ebonite arm whereby the choke may be mounted on a baseboard or panel, as required. The overall length of the instrument is 4 in., the diameter being 1 in.

On test we found that it chokes effectively over a range of 200 to 2,000

metres without any sign of peaks, and it is therefore suitable for use in normal sets.

Trix components are made by E. J. Lever, of 33 Clerkenwell Green, E.C.

Formo Log Condenser

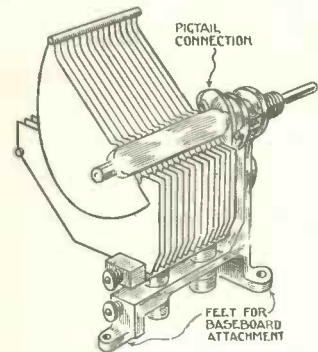

THE advantages of a logarithmic condenser have perhaps not been fully realised by many readers. Whilst the spacing out of various stations is satisfactory with such a condenser, it has the great advantage, by nature of its design, that the dial readings of two or more condensers may be synchronised so that they have the same reading at different wavelengths although the actual capacity of the individual condensers may be different.

In addition to simplifying the performance of tuning a multi-dial receiver, it makes even more practical the ganging of a number of high-frequency tuning stages, where the discrepancies occurring in different coils may be overcome by correctly setting each condenser on one wavelength; the settings will then be correct for other wavelengths in the same tuning range.

It is most important that the shape of the plates in such a condenser should be exactly correct, otherwise there is little advantage in utilising this type. We have recently tested a Formo log condenser and find that, allowing for a parallel capacity of 25 micro-microfarads in the circuit, the condenser accurately obeys a logarithmic law.

The mechanical details of the condenser are similar to the well-known S.L.F. condensers of this make, with the exception of a new bearing. This is of a robust nature and is provided with a felt pad which makes the motion very pleasant. Finally, the condensers are well finished, inexpensive and can be thoroughly recommended.

The Formo Company's address is Crown Works, Cricklewood, N.W.2.

SERVICE

Whatever it is you want to know—features of a particular circuit, advice on choosing a receiver, or help in identifying the source of a transmission—the staff of the "Wireless Magazine" can be of assistance. It will greatly facilitate the service, however, if the following rules are observed.

Ask not more than two questions at a time, written on one side of the paper only, and send them, together with a stamped addressed envelope for reply, the coupon on page iii of the cover and a fee of 1s., to:—Information Bureau, "Wireless Magazine," 58-61 Fetter Lane, E.C.4.

Take advantage of our special blueprint scheme—a half-price blueprint of any set described in this issue by using the coupon on page iii of the cover



FORMO
ARTHUR PREEN & CO. LTD.

LOG (or mid-line)
CONDENSER

Mounts either Panel or Baseboard.

*00035
*00025
*0005

10/6 each

The most Scientific Condenser yet produced. Perfect in every detail of construction and performance.

THE FORMO HANDBOOK. 1/- Post Free. (Liberal discount to Retailers).

A fully illustrated and well compiled book on the construction and uses of Radio Apparatus, including BLUEPRINTS of THREE-VALVE "TRUE-SCALE" Set (proportional amplification) and TWO-VALVE TWO-RANGE Set.

THE FORMO COMPANY, Crown Works, Cricklewood, N.W.2

Phone: Hampstead 1787. Full Catalogue Free on request.

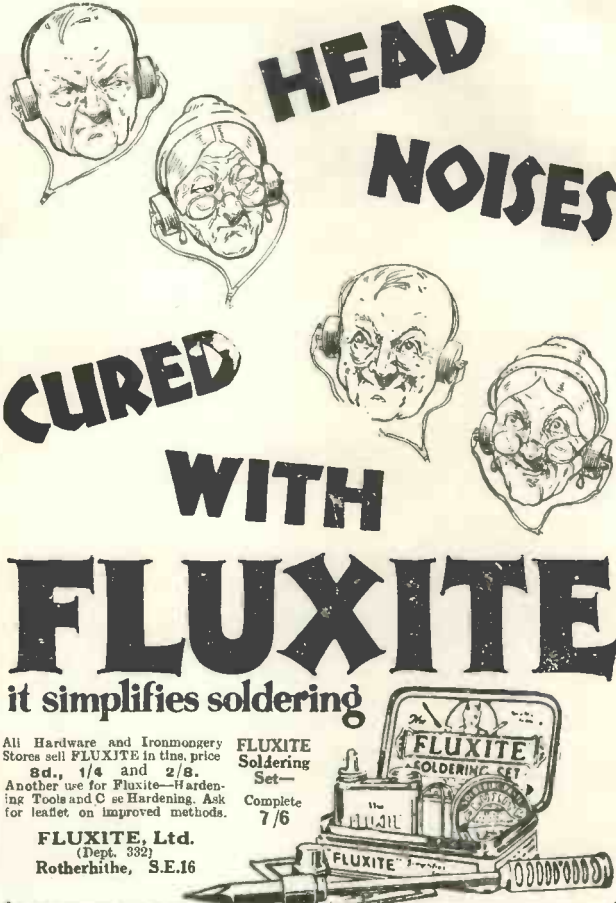

HEAD NOISES

CURED WITH FLUXITE

it simplifies soldering

All Hardware and Ironmongery Stores sell FLUXITE in this price 8d., 1/4 and 2/8. Another use for Fluxite—Hardening Tools and Case Hardening. Ask for leaflet on improved methods.

FLUXITE Soldering Set—
Complete 7/6

FLUXITE, Ltd.
(Dept. 332)
Rotherhithe, S.E.16

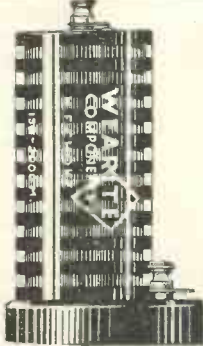

WEARITE COMPONENTS

AUTO-SELECTOR FOUR

Coils per Set	58/-
Semi-fixed Condensers	10/6
Screens per pair	7/-

H.F. CHOKE
As used in the "Dominions Short-wave" Set described in this issue

Wrig't & Weaire Ltd.,
740, High Rd. Tottenham, N.17
Phone Tottenham 3132

PRICE PER SET
3/6
HIGHLY POLISHED 4/6

THE "PAREX" VALVE HOLDERS
(Pat. Appl. For—Reg. Design.)

As used in the H.F. Unit described in this issue, and as supplied to the manufacturers of the

New Screened Valves

SCREEN FOR ABOVE UNIT,
5 $\frac{1}{2}$ by 6 $\frac{1}{2}$ 2/6 each.

Ready to fix on Baseboard.

E. PAROUSSI
10, Featherstone Buildings,
High Holborn, LONDON, W.C.1.
Phone: Chancery 7010.

REFINEMENT IN RADIO

L&P "HIGH-LOW" COILTUNER

Price complete **14/6**
Price without Scaled Reaction Indicator **11/6**

1. No Coil-changing for High Waves.
2. Enables perfectly balanced reaction, both Reinartz and Magnetic.
3. Alternative Base-board or "one-hole" Panel mounting.
4. Scaled Reaction Indicator facilitates "Logging."
5. Back-lash impossible.
6. Automatic wear "take-up."
7. Unconditionally guaranteed.

From all good Dealers or direct from:—
London & Provincial Radio Company Ltd., Colne, Lancs.

THERE IS NO SUBSTITUTE

For utmost efficiency



The C.E. PRECISION FLOATING VALVE HOLDER maintains the high standard of efficiency and value associated with the name. It is anti-capacity and non-microphonic, and judging by the ever-increasing demand, it is preferred by radio enthusiasts. Comparison is the only real test and you will find by actual comparison that this valve holder shows obvious points of superiority.

There are also the famous C.E. PRECISION Rheostats, Sectionally Wound Fixed Resistors, H.F. Chokes, etc., etc. Write for full list of components. If obtainable, please send us the name of your dealer.

C. EDE & CO., LTD., BYFLEET, SURREY

2/- EACH
Telephone: Byfleet 2215.
Telegrams: "Edeprecise, Byfleet."

Write for full list of components and circuit diagram of **THE ORCHESTRAL THREE**



FOR some unknown reason, for which no satisfactory explanation can be found in the French wireless Press, the broadcasting movement in France is making but slow progress in comparison with the developments now taking place in neighbouring countries.

French Radio Bill

The fact that the French Government, in the hope of reducing the present state of chaos, passed a radio bill some nine months ago, and arrogated unto itself a state monopoly of the wireless telegraphy and telephony services, does not appear to have given an impetus to either official or private enterprise.

Recently, on the occasion of the official opening of the new little PTT transmitter (for which, although the Ministry of Posts and Telegraphs has supplied all the necessary plant, the studio will be indebted to a local association for the bulk of the material broadcast), it was stated that urgent steps were being taken to provide France with an adequate network of transmitters, a promise which thrice previously has been made to French radio fans.

Rumours concerning the construction of six or seven medium-power transmitters have been current in France since the beginning of 1927 but, up to the present, the only additions which have been made to the PTT system are the Lille, Rennes, Limoges and Grenoble stations; of these three, the first alone is operating nightly.

Other Transmitters

Sites for the erection of other transmitters include Bourges, Château-Thierry, Montpellier and Toulouse, but little has been done, so far, in beginning work on these transmitters.

Generally speaking, the French listener complains that, apart from Radio-Paris, and in certain circumstances, Eiffel Tower, for interesting wireless transmissions he is compelled to turn to foreign countries. On the whole, it may be said that unless

the French listener is within a few kilometres of Paris, or Toulouse, reception on a crystal set is out of the question, and for his wireless entertainments he must rely on such high-power stations as Daventry, for which in view of the distance, he is compelled to use a multi-valve receiver.

Apart from two capital stations, and that of Radio Toulouse—an independent concern which seems to monopolise wireless activities in Southern France—the bulk of the

countries are all contemplating the installation of high-power stations, if they do not already possess them, the Frenchman is showing a justifiable anxiety; the promise of a super-power transmitter in the neighbourhood of Paris, the rumours regarding the construction of regional transmitters in the country, and the prospect so often put forward of a coordinated broadcast service, have kept him patient for some months.

More Local Stations

Unless some steps are now taken to provide French listeners with an efficient system, I should not be surprised to see a further batch of small local transmitters spring up, like mushrooms in the night, and nobody but the state could be blamed for the confusion such a policy would eventually cause.

* * *

From information I recently received from Spain I am left under the impression that during the coming winter season we may anticipate a larger number of simultaneous broadcast programmes emanating from Madrid.

Spain, apparently, is seriously thinking of putting her radio house in order, and a new law, which may have been passed by the time these lines are in print, will empower the state to lease out all broadcasting services to one concessionaire.

Union Radio Group

I do not know which of the individual programme companies will be favoured with the monopoly, but in any case, the capital city will undoubtedly become—as it should be—the G.H.Q. of wireless administration. The Union Radio group of transmitters has steadily made its influence felt throughout the country, and little by little has drawn into its net the principal broadcasting stations. From all appearances, this organisation will rule the Spanish broadcasting system in the near future.

(Continued on next page)



Built on an aluminium chassis and incorporating a special type of loud-speaker, this M. P. A. radio set comprises an entirely self-contained three-valve

French stations are of low power, and none but the listeners in their immediate area can secure the benefit of their entertainments.

It is true that plans have now been put forward for a 5-kilowatt transmitter to be erected at Nœs but, from what I am told by friends on the Riviera, the reason is more closely associated with the attraction of foreign visitors to the shores of the Mediterranean than with the supply of a service to the inhabitants of the district.

With the news that neighbouring

Things To Know About

FIXED CONDENSERS

FIXED condensers are used in wireless sets when it is desired to allow the passage of alternating or fluctuating current, but not direct current, or sometimes to allow the passage of H.F. currents, but not of L.F. currents.

A condenser consists essentially of two metal plates separated by insulating material called the dielectric. When it is desired that the condenser should have a large capacity several metal plates, divided into two groups, are used.

The plates are interleaved so that every alternative plate belongs to the

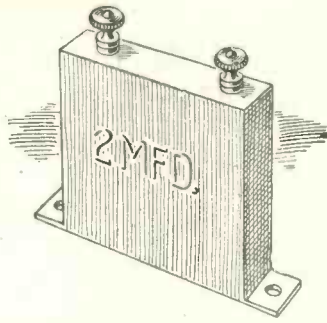

same group. All the plates belonging to the same group are connected together and to a terminal mounted on the containing case.

As a matter of fact, any sound reorganisation which may be the outcome of the step taken by the government can only work out to the advantage of both home and foreign listeners. Not only would the capital programmes benefit by the change, but an immediate result would be a saner distribution of wavelengths.

For those who suffer from that D.X. feeling, which seems to prevent some people from enjoying a transmission unless it is at least 500 miles or more distant from their homes, I can recommend an interesting search, namely, that of the Russian broadcasts.

Moscow: Komintern

Moscow itself, with its Komintern station on 1,450 metres, is now presenting but little difficulty, but more patience is required to tune-in to Moscow-Popoff on 675 metres, which on Saturday usually relays a performance from the opera house or to Leningrad, on 223.9 metres.

However, the latter on a power of some 10 kilowatts is again testing out some new plant on about 1,000 metres, almost nightly between

11.30 p.m. and 1 a.m. The call is given fairly frequently: "Allo! Allo! Lenin(g)rad," and on some nights for the purpose of experiments it also takes a portion of an operatic performance given at its main opera house.

Slow Announcement

Some listeners to Moscow Komintern may have been puzzled by a broadcast which is given out very slowly by an announcer, and might be mistaken for some elementary educational talk. As a matter of fact it is the news bulletin, dictated at a slow pace in order to allow a transcription to be made of the items for the benefit of the members of the working men's clubs and rest houses. Although the sentences are not repeated, pauses are made at intervals and punctuation signs are fully given.

You may hear the word: "Tsapetaiya" (comma) fairly frequently, and at the end of each phrase: "Totschka" (full stop). This may help to identify the transmitter as during the broadcast of these local items, the station call is not often given. JAY COOTE.



Two No. 3 cells used with new detachable...

Obtain wonderfully improved reception at less cost. All parts are BRITISH MADE and the BATTERY itself is home assembling—silent in action—permanent. No charging required. All parts are replaceable and the Battery can be assembled from 90 volts upwards in an hour or so. Write for Our Booklet. Everything is explained from Assembling to Spare Parts.



Install once & for all A STANDARD WET H.T. BATTERY

Prices of Popular Models: 60 cell 91 volt No. 1 cell (7 milliamps) Battery, with detachable terminals, \$1/5/1. 72 cell 108 volt No. 2 Sac Battery (14 milliamps), with detachable terminals, \$1/17/3. 84 cell 126 volt No. 3 Sac Battery (30 milliamps), with detachable terminals, \$3/9/6. Trays for above, 7/-

Free advice given as to best battery for your set on hearing number and type of valves SPECIAL: Carriage paid on orders of 10/- or over. Deferred terms arranged.

Wireless in every room this Winter!



THE LOTUS REMOTE CONTROL enables you to listen-in in the dining-room, sitting-room, bedroom, kitchen—everywhere, anywhere—simultaneously and without interference with each other.

Simply place the Lotus Relay near receiving set, wire to rooms desired and connect with Wall Jack and Plug. No technical knowledge is needed.

The same volume of sound throughout. The last one to switch off automatically disconnects the set. Suitable for any valve set.

FREE! Write to the address below for **FREE BLUEPRINTS AND INSTRUCTIONS** explaining how two rooms can be wired in half an hour.

<p>Complete Outfit for Wiring Two Rooms: 1 Lotus Radio Relay, 2 Lotus Relay Filament - Control Wall Jacks, 2 Lotus Jack Plugs, 21 yards Special 4-Strand Wire.</p> <p>30/-</p> <p>Each Additional Room 7/6</p>	<p>Made by the makers of the world-famous Lotus Valve Holders, Coil Holders, Jacks, Switches, and Plugs.</p>
---	--

From all Radio Dealers

THE LOTUS REMOTE CONTROL

(Dept. W.M.11) Garnett, Whiteley & Co., Ltd.
 Lotus Works, Broadgreen Road, Liverpool

WET H.T. BATTERY Co. 12-13, BROWNLOW ST. HIGH HOLBORN, W.C.1.

OMNORA LTD

THE SET BUILDERS SUPPLY STORES

BUILD THE "DOMINION SHORT WAVE THREE" DESCRIBED IN THIS ISSUE

	£	s.	d.
1 Mahogany Cabinet, 16 in. by 8 in.	1	4	0
1 Ebonite Panel, 16 in. by 8 in. by 1/4 in., ready drilled	0	10	6
1 Baseboard, 16 in. by 10 in.	0	2	6
1 Terminal Strip, 7 in. by 1 1/4 in. by 1/4 in., ready drilled	0	1	0
1 Terminal Strip, 3 in. by 1 1/4 in. by 1/4 in., ready drilled	0	0	6
10 Clix Sockets	0	0	10
10 Clix Plugs (5 red and 5 black)	0	1	8
3 Benjamin Valve-holders	0	6	0
3 Single Coil-holders	0	5	3
2 R.I. Varley S.L. Super Transformers	2	10	0
1 Dubiller Condenser, .0005, type 620	0	3	0
1 Dubiller Condenser, .01, type 620	0	4	0
1 Dubiller Condenser, .0003, and Grid Leak, type 620	0	5	6
1 Wenrite H.F. Choke	0	6	6
2 Cyldon Condensers, .0002, with extension spindles	1	11	0
1 Lotus Jack, No. 5	0	3	0
1 Lotus Jack, No. 4	0	2	6
1 Lotus Plug	0	2	0
2 Igranite Slow Motion Dials	0	15	0
10 Mounting Bushes, as described	0	1	0
Connecting Wire and Sundries	0	4	3
	29	0	0

Any of the above components supplied separately as desired. Lists dealing with "Wireless Magazine" Constructional Sets are now ready, and will be sent post free on application.
 Note.— Where a complete set of components is purchased together, the Marconi Royalty of 12/6 per valve-holder is payable.

Omnora Ltd., Home Construction Specialists,
 258 New Cross Road, London, S.E.14.
 Phone: New Cross 1273

Half Hours with the Professor

(Continued from page 312)

has to stand up to an extra large voltage. That particular condenser is the reservoir condenser. Remember that the voltage delivered from the rectifier arrives in a series of pulses and it is clear that the peak value of the voltage will be considerably greater than the average.

Special Condensers

"Actually, in this case, it is over 350 volts. Now the ordinary condenser is only tested to 300 volts, and therefore it might easily break down in use. We have to use special condensers, in consequence, which are deliberately tested on a circuit at a higher voltage. That particular one is tested at 600 volts D.C., so that there is an ample factor of safety."

"Is that always the case with eliminators, then?"

"Yes, you always have that peak value of the voltage to consider, and it has been laid down by various committees who investigate these matters that any condenser should be tested at a D.C. voltage of at least twice that which it is called upon to handle in practice. A 300-volt condenser, therefore, will only be suitable where the voltage on the secondary of the transformer supplying the rectifier is less than 150 volts. Most eliminators require more than this in order to obtain the necessary voltage output and, in consequence, special condensers should be used tested at higher voltage. Unless this is done, there is a danger of breakdown."

Still More Questions

"Well, Professor," said the Amp, "I have had a most enjoyable conversation. There are heaps of questions I still want to ask you, and perhaps one day you will tell me more about it, but I shall have to leave it for a time." With which remark he stumbled out of the laboratory, leaving his usual trail of havoc.

The Professor smiled sadly, repaired the damage and resumed his work.

"WIRELESS MAGAZINE" SERVICE

Full-size Blueprints

By using the coupon on page iii of the cover, every reader of the WIRELESS MAGAZINE can obtain a full-size blueprint of any receiver described in this issue up to the end of November for HALF PRICE. After that date the normal prices will be charged, namely, (1) crystal sets, 6d.; (2) sets up to three valves, 1s.; (3) sets with more than three valves, 1s. 6d. These prices include postage in each case, whether the blueprint is bought under the half-price scheme or not.

Information Bureau

TECHNICAL QUERIES

A charge of 1s. is made for answering technical queries; not more than three should be asked at once. The coupon on page iii of the cover and a stamped addressed envelope should be sent with the query.

BUYING RECEIVERS

This service also covers advice regarding suitable proprietary receivers to suit the particular conditions and needs of readers. The rules above outlined apply in this case also.

Station Identification

Arrangements have been made with the leading authority on foreign broadcasting matters in this country to answer questions relating to the identification of particular transmissions. As many details of the reception as possible should be given. Each query should be accompanied by a fee of 1s., a stamped addressed envelope, and the coupon on page iii of the cover.

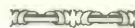

ADDRESS:

58/61

Fetter Lane,
 London, E.C.4

D's for D.E.s

DAIMON. The L.T. Battery made by the most experienced battery firm in Europe. Half the size! Half the weight! Double the service! Yet see how moderate the prices are:

TYPE K - 2/- each
TYPE G - 4/6 "

Also H.T. Batteries 60 volts, 10/6
 100 volts, 17/6

From all good dealers or direct —
S.D.H. MANUFACTURING CO.
 Colinale Avenue, Hendon
 LONDON, N.W.9

daimon



TREBLE DUTY TERMINALS

You cannot buy a more useful terminal

36 indications

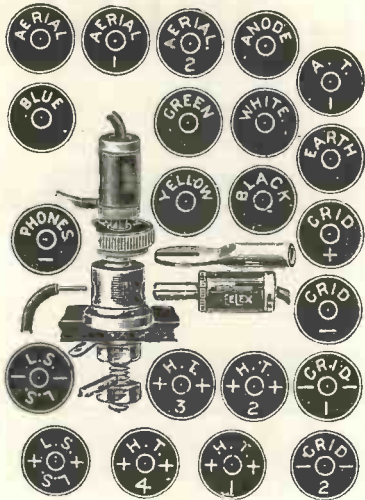

ZDS, ZDP, ZDI.



Insulated Spades, Pins and Eyes Red or Black. 2d. each

EELX Standard Plugs and Sockets and Accessories are the Mecca of the Radio World—all parts interchangeable.

T14 Plug 3d Insulated sleeve, 6 colours.

Name Plates, Price 1d. each.

T 14 Socket 1d. each.



2 D.W., 2d. each red, black or green sleeve

-T 13 Phone end, 2d. each.

EELFX Moisture Retaining Earth

A bigger and more effective area. 4/- each. Post 9d.

Standard Socket, Jack Spring, 1d.

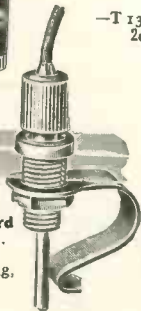

Feel Safe—Be Safe

Eelex Safety Switch 6in. Tube. Price 5/6 Postage 6d

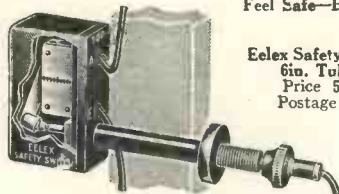

12 in. tube, 1/6. 18 in. tube, 1/6. Complete List W.M. 11 on application

J. J. EASTICK & SONS,
Eelex House, 118, Bunhill Row, E.C.1.
Phone: Clerkenwell, 9282-3

A Countryside Four Note

ONE or two cases of difficulty have arisen in connection with the Countryside Four, owing to instability and bad hand effects. One of these cases was recently investigated by J. H. Reyner, who reports that the trouble was due to a defective grid leak, the value being between two and three times its correct rating.

This apparently small discrepancy was sufficient to cause the circuit to become completely unstable, so that no amplification could be obtained from the high-frequency valve and it was almost impossible to obtain any results whatever.

New Grid Leak

The substitution of a 2-megohm leak for that originally inserted in the receiver immediately stabilised the set and it worked in the correct manner, bringing in London, 5GB, and Daventry at good loud-speaker strength on the frame alone at Elstree.

If any reader experiences difficulty with the receiver due to instability and apparent lack of all sensitivity, this is a point which should be investigated.

Reference Sheets (A Correction)

Sheet No. 21—Selectivity

OWING to a printer's error, the formula given in this sheet was incorrectly given. It should read:

$$\frac{R}{L} = 4 \pi (f_1 \omega f_2)$$

$$\sqrt{S \beta^n}$$

AS

WIRELESS MAGAZINE
is the best of monthlies

SO IS

AMATEUR WIRELESS
the best of weeklies

Every Set has a Story to tell—

A story of indifference in the matter of components—and poor results. Or of scrupulous care in the choice of all essentials—and reception that is a source of great pleasure and a pride! When you buy components, buy "Utility," the proved best on all cardinal points—design, material, and finish. Then your set will tell story number two. always!

USE

Utility
GUARANTEED
COMPONENTS

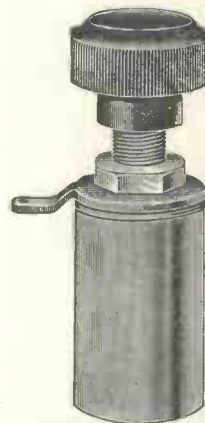

"Utility" on and off SWITCH

An efficient main switch for cutting off L.T. supply. Push-pull design, and 12-point contact to minimise resistance. One-hole fixing. Nickel-plated finish.
Price - 2/-

"Utility" NEUTRODYNE CONDENSER
To mount either above or below the baseboard. Rigidly made, ball-bearing spindles, and enough tension to prevent accidental upset. Detachable key-handle.
Price 5/- each

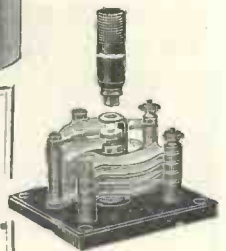

"Utility" MICRO-DIAL
A new model, with an aluminium dial and hair-line cursor for easier reading. Reads clockwise, or anti-clockwise.
Price 7/6 each N.B.—Not intended to displace our plain model—this is still listed.

"Utility" CHANGE-OVER SWITCH
Very low capacity and compact dimensions. Rubbing action, self-cleaning contacts. Six sizes supplied: 1, 2, 3, 4, 5, and 6 contacts respectively. Lever pattern, from 3/6 each; knob pattern from 3/-.

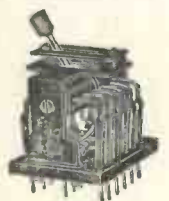

Write for List and see the goods at your local dealers

WILKINS & WRIGHT LTD.
"Utility Works," Kenyon St.
BIRMINGHAM

WHY NOT BUILD THE "FIVE-GUINEA THREE"

as described in this issue.

List of Components required:

1 Ebonite Panel, 14in. by 7in. (Redferns).....	5	8
2 .0005 Variable Condensers (Utility)	19	0
1 15-ohm. Rheostat (Lissen).....	2	6
1 On-off Switch (Lissen).....	1	6
3 Antiphonic Valve-holders (Precision).....	6	9
1 L.F. Transformer (Lissen).....	8	6
1 2-meg. Grid Leak with Clip (Lissen).....	1	6
1 Single Coil Holder (Lotus).....		8
1 Baseboard-mounting Neutra. Cond. (Peto-Scott).....	5	0
2 Lissen Conds. 000 ¹ and .001, fixed	2	0
1 Pair of Panel Brackets.....	1	0
2 Terminal Strips, 10in. by 2in. and 2in. by 2in. (Redferns).....	1	6
11 Eastick Terms., suitably marked	4	1
2 Slow-motion Dials (Utility).....	15	0
2 Dial Indicators (Bulgin).....		6
1 Oak or Mahogany Cabinet and Baseboard.....	15	0
4 doz. Wood Screws and 6 4BA Screws and Nuts.....	1	6
2 coils Glazite and 1ft. Flex.....	1	9

£4 13 5

Send for Price Lists of "Range Extender" and "Mains-fed Two," also described in this issue. Full Price Lists of sets described in previous issues of this Magazine and others are available, free.

Any of the above Components can be supplied separately. A Marconi Royalty of 12/6 per valve-holder is payable when a complete set of parts is ordered.

Any set built to order. Send us type or name of set, and we will quote.

CITY & GENERAL RADIO CO. LTD.,
79, CANNON STREET, LONDON, E.C.4.
TELEPHONE: CITY 9280.

5 Catalogues FREE



All lines obtainable from best dealers

Latest Components Illustrated

A.F. BULGIN & CO
9, 10, CURSIOR ST. CHANCERY LANE, E.C.4
TRADE DECKO MARK

DIGBY'S CABINETS

WRITE FOR NEW
16 PAGE CATALOGUE

F. DIGBY, 9, BANBURY ROAD,
SOUTH HACKNEY, LONDON, E.9
PHONE: CLISSOLD 5458.



THE TAYLEX
WET H.T. BATTERIES
SOLVE ALL H.T. TROUBLES
Self-charging, Silent, Economical

Jars (waxed)	Zincs	Sacs
2 1/2 x 2 1/2 in. (new type)		
1/3 doz.	1/2 doz.	1/8 doz.
Sample doz. (18 volts) 3/6, post 9d.		
Sample 6d. BARGAIN LIST FREE		
Amplifiers—1-valve 19/-	2-valve 30/-	
2-valve All-station Set £4		
Approval willingly		

B. TAYLOR, 57 Studley Rd., Stockwell, London

"Wireless Magazine" REFERENCE SHEETS



Compiled by J. H. REYNER, B.Sc., A.M.I.E.E.

Month by month these sheets can be cut out and filed—either in a loose-leaf folder or on cards—for reference.

The sequence of filing is a matter for personal choice. In a short time the amateur will be able to compile for himself a valuable reference book.

WIRELESS MAGAZINE Reference Sheet

No. 31

No-load Current

THE current taken by the primary of a transformer working off the mains is a complex quantity, the phase of the current relative to the voltage depending upon a variety of factors. When no load is being taken from the secondary of the transformer, there is, nevertheless, a small current which flows in the primary winding in order to set up a magnetic field in the iron core. If any load is connected across the secondary circuit, this magnetic field is disturbed, and in order to bring it back to its original value, additional current flows in the primary winding, so drawing energy from the mains.

This power current, as it is called, is quite independent of the original magnetising current, which still continues to exist, so that the total current in the primary winding of the transformer is made up of these two currents both existing together.

On no load, however, that is, with the transformer running idle, there is no power component but simply the magnetising current. Under such conditions the transformer acts as almost a pure inductance, so that this current

is nearly 90 degrees out of phase with the voltage. In such circumstances, no power is drawn from the mains, for power can only be consumed when the current is in phase with the voltage. With a given current the power consumption gradually increases from zero to a maximum as the phase difference is reduced from 90 degrees to zero.

In a commercial transformer the windings have a certain resistance, and there is also a small loss due to hysteresis and eddy currents in the iron, to overcome which a small expenditure of power is necessary. This results in the no-load current being not quite 90 degrees out of phase with the voltage.

In a good transformer, however, this power component of the current is very small and, with the small transformers used for battery eliminators and the like, it is often not sufficient to operate the meter. Thus, although an ammeter connected in the circuit will show an appreciable current, the power consumption is small owing to the fact that such current is nearly 90 degrees out of phase with the voltage.

WIRELESS MAGAZINE Reference Sheet

No. 32

Saturation

ONE of the problems which confronts the designer of low-frequency transformers, whether for power purposes or for inter-valve coupling work, is that of the saturation of the iron core employed. The magnetic effect obtained in a circuit containing iron depends on the permeability of the iron. (See Reference Sheet No. 28). The permeability is not a constant quality, but depends upon the magnetising force applied, which in turn is proportional to the current in the winding and the number of turns, and is thus rated in terms of the ampere-turns.

As we increase the ampere-turns, the magnetic field increases rapidly at first, but begins to tail off after a time, giving an effect similar to that illustrated in the figure, which is known as "saturation."

On the steep part of the curve it will be clear that a given change in the ampere-turns produces a very much greater change in the

magnetic strength, but when the curve has become nearly horizontal, the change in the magnetic field is very little greater than the change in the magnetising force producing it.

In such circumstances it is clear that the iron will have little effect and, in fact, to all intents and purposes, can be removed. Now the inductance of any iron-cored choke or transformer winding depends upon the change of magnetic effect for a given change in current. Obviously, to obtain the most efficient conditions, we want to work on the steep part of the magnetisation curve, where the alteration in magnetic effect for a given change in ampere-turns is greatest. If, on the other hand, the conditions are such that saturation sets in, then the inductance of the coil will be very little greater than if the iron core was completely removed, in which case it would have a value of the order of one-fiftieth of its normal inductance.

This point is particularly important in low-frequency work. If we have a smoothing inductance in a battery eliminator, carrying a current which saturates the iron, then the inductance will be quite small and the smoothing effect will be lost. Similarly, if the primary winding of an inter-valve transformer saturates, the inductance will be seriously reduced and the low tones will be cut off.

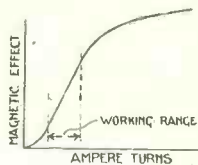

Saturation Curve

WIRELESS MAGAZINE Reference Sheet

No. 33

Interference Elimination

A SOURCE of interference which is often troublesome in super-het receivers is due to direct pick-up on the frame aerial of signals outside the normal broadcast band. If such signals coincide with the frequency to which the intermediate transformers are tuned, then seri-

ous "long-wave pick-up" will result, and this is often very difficult to overcome.

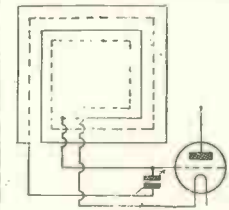

Double-wound Frame Aerial

A simple system for overcoming this, which was first suggested and patented by P. W. Willans, is to use a double-wound frame as shown in the figure.

The frame in question is wound in two equal sections, the two halves being in opposition. The tuning condenser is connected across one-

half of the frame only, while the whole frame is connected across the grid and filament of the first valve of the receiver. Any signal, of whatever frequency, will set up voltages in the two halves of the frame, which are equal and in opposition. Normally, therefore, the two voltages will cancel each other out and the resultant voltage applied across the grid and filament of the valve will be nil. At the frequency to which the frame is tuned, however, a resonant voltage will be developed across one-half of the frame owing to the fact that it is tuned by the condenser. This resonant voltage will be many times as great as the induced voltage picked up by the frame, so that in this case the two halves of the frame will not balance each other out. There will be a strong preponderance of the signal to which the frame is tuned and this will be applied to the amplifier.

This system does not interfere with the directional properties of the frame in any way, and is particularly useful in the case of super-het receivers. It has also some application to the elimination of spark interference, particularly in coastal districts. Spark signals act as a shock to the aerial system, and in such cases the tuning of one-half of the frame does not come into operation to the same extent.



The latest Polar product shown for the first time at the Exhibition

A SUPERB two-valve set of similar design to the famous Polar III, with polished mahogany cabinet and front panel.

Will operate a Speaker with outside aerial at distances up to 60 miles from a main Broadcasting Station.

It is extremely simple to operate.

The finest material is used throughout and the Polar Components embodied are the Cam Vernier Condenser and the Coil Unit.

PRICE set only .. £6.0.0 (Royalty extra).

Complete equipment, including Amplion Speaker A.R. 65, £10.17.6 (Royalty extra).

Polished mahogany battery or eliminator pedestal box for Polar II or III .. £1.5.0

Have you decided to make your own set? Make it a famous POLAR III

Envelope with full details, including Blue Print, constructional and operating data, photographs, drilling template, general notes, etc.

PRICE 2/-

Cabinet and all necessary parts cost only .. £6

Polar III complete with coils for two ranges £9 (Royalty extra).

Of all Radio Dealers.

Wingrove & Rogers Ltd.

Proprietors of the Broadcasting Business of Radio Communication Co., Ltd.

Arundel Chambers Strand - W.C.2

LIVERPOOL MANCHESTER GLASGOW NEWCASTLE-ON-TYNE

WIRELESS MAGAZINE Reference Sheet

No. 34

Coupling Condensers

THE size of the coupling condenser to be used in a resistance- or choke-coupled circuit is largely determined by the size of the grid leak employed. The voltage from the preceding valve is applied across the coupling condenser and grid leak in series, and the proportion of the voltage developed across the grid leak is that which is actually applied to the succeeding valve. In order to ensure that this shall be large, the impedance of the condenser must be low at all frequencies which the amplifier is called upon to handle.

The impedance of the condenser, however, varies with the frequency and becomes increasingly high as the low frequencies are reached. This effect ultimately tends to produce a cut-off, where the amplification from the stage falls away. In order to maintain adequate quality and preserve the full advantage of the resistance coupling, it is necessary to ensure that this cut-off does not occur below 50 cycles per second.

It is possible to work out the value of the condenser, such that this shall be the case for various values of grid leak. The value of the grid leak is determined, in the first place, by the value of the anode impedance, for in order to maintain the full amplification from the pre-

ceding valve the grid leak must be at least four times as great as the anode impedance.

The curves given with this sheet show the minimum value of coupling condenser in order that the amplification at 50 cycles shall be not less than 90 per cent. of the maximum amplification. These curves have been plotted giving the minimum values of capacity for one, two and three stages.

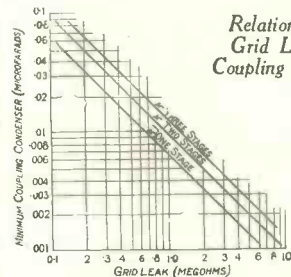

Relation between Grid Leak and Coupling Condenser

WIRELESS MAGAZINE Reference Sheet

No. 35

Four-electrode Valve

DEVELOPMENT in valves has been centred for some time around obtaining a high amplification factor with a relatively low impedance. This was found particularly difficult when amplification factors of 40, 50, or more were required for with the usual type of valve, the impedance rose to a prohibitive figure with normal values of high-frequency voltage.

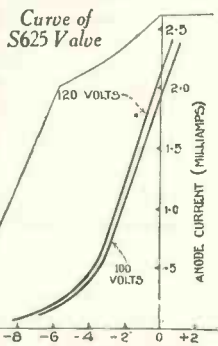

only twice. If the amplification factor was increased still more, the impedance rose very rapidly.

A solution to the problem has been found in the use of four-electrode valves. By interposing a second grid between the normal grid and the plate or anode of the valve, and maintaining this at a fairly high steady positive potential, the impedance of the valve may be kept within limits, while the amplification factor can be considerably increased.

The figure shows the characteristics of the new S625 valve, at 120 volts on the plate, with 80 volts on the outer grid. This will be seen to have a steep slope, and actually the amplification factor at zero volts on the inner grid is 70, with an impedance of 120,000 ohms.

If the inner grid is given a negative bias of 3½ volts, the impedance rises to 300,000 ohms and the amplification factor rises to 135. It will be observed that these figures are nearly proportional, indicating that high values of amplification factor are obtainable with reasonable values of impedance.

The S625 valve has the additional advantage that the presence of the outer grid between the normal grid and plate acts as a screen and minimises, to a great extent, the capacity feedback which usually exists between the output and input circuit of the valve.

THE READY RADIO SUPPLY CO.

The Radio House for the Amateur Constructor
41 NEWCOMEN ST.,
LONDON BRIDGE, S.E.1.
PROMPT AND RELIABLE.

Write to-day for price lists of components for circuits described in this issue.

- (1) Five-Guinea Three
- (2) Mains-Fed Two
- (3) Range Extender
- (4) Dominions Short-Wave Three

RADIO CONTROL CLOCKS

Can be set to switch your set on and off automatically at any time you wish. Is also a reliable timepiece. A boon to invalids. Buy one and save your batteries.

ONLY 10/6 POST FREE.

Order from your Fireside
ALL products displayed in this issue supplied at advertised prices POST FREE.

We specialise in radio components for all "Wireless Magazine" Circuits.



LAKER STEEL MASTS

are 100 per cent. efficient

They are made by engineers and supplied to H.M. Government, the B.B.C., and to Colonial and foreign stations throughout the world. There are 50,000 "Laker" Masts in daily use. By mass production we are able to offer a wonderfully efficient and handsome Steel Mast at the extraordinarily low price of 22/6 complete, as illustrated. Send 1s. extra for part carriage. We pay the rest. Buy a Laker Mast for good reception.

LAKER STEEL MASTS,
BECKENHAM, KENT
30ft. STEEL MAST 22/6

TRADE MARK "RED DIAMOND"



THE RECOGNISED DETECTOR FOR ALL CIRCUITS USING CRYSTAL RECTIFICATION.



RD 40 2/- Shield for same 6d.

By Insured Post 2/3 or 2/9 with shield. Can be mounted on brackets or through panel. Once set always ready. Not affected by vibration. Each one is tested on broadcast before despatch, and is perfect. Of all high-class Radio Dealers or Sole Makers:—

JEWEL PEN CO., LTD.,

(Radio Dept. 48 21-2 Gt. Sutton St., LONDON, E.C.1)

The Exhibition Five Takes Its Place Amongst the "Classics"!

(Continued from page 339)

Detector and Two Low-frequency Amplifiers.—Aerial to No. 1 terminal of second H.F. transformer base; first two valves switched off; loud-speaker plug in right-hand jack.

Four Valves

High-frequency Amplifier, Detector and Two Low-frequency Amplifiers.—Aerial to No. 1 terminal of first H.F. transformer base; first valve switched out; loud-speaker plug in right-hand socket.

Five Valves

Two High-frequency Amplifiers, Detector and Two Low-frequency Amplifiers.—Aerial to main aerial terminal; loud-speaker plug in right-hand jack.

Other Points of Interest

These are doubtless other points of interest about the Exhibition Five that constructors will find for themselves. We invite comments on our receivers; we get remarkably few grumbles and any constructive criticism helps us in designing still better sets for WIRELESS MAGAZINE readers.

If you do build the Exhibition Five—and if you want a five-valver you cannot do better—will you look upon it as the personal invitation of the Editor to write and tell him what you think of it? Thank you!

Index to Advertisers

	PAGE
Belling & Lee, Ltd.	278
Bernard Jones Publications, Ltd.	278
Cover iii, 274, 275	
Benjamin Electric, Ltd.	355
Bennett College, Ltd.	275
Bird (Sydney S.) & Sons ...	Cover iv
British Ebonite Co.	278
Bulgin & Co.	366
Carrington Mfg. Co., Ltd.	351
City & General Radio Co.	366
Collinson Precision Screw Co., Ltd.	357
Cordesia Batteries ...	278
Cossor (A. C.), Ltd.	Cover ii
Day, Will, Ltd.	357
Digby, F.	366
Dubilier Condenser Co., Ltd.	345
Eastick, J. J., & Sons ...	365
Ede, C., & Co., Ltd.	361
Flu-vite, Ltd.	361
Fornio Company ...	361
Garnett, Whiteley & Co., Ltd ...	363
Griffin, A.W. & Co.	368
S.D.H. Manufacturing Co.	364
Igranic Electric Co., Ltd.	347
Jewel Pen Co., Ltd.	368
Laker, J. & J., Co.	368
Lectro Linx, Ltd.	357
Lissen, Ltd.	273, 276
London Electric Wire Co., and Smith's Ltd.	351
London & Provincial Radio Co.	361
Omnora, Ltd.	364
Ormond Engineering Co., Ltd.	353
Paroussi, E....	361
Peto-Scott Co., Ltd.	275
Pickett's Cabinets ...	275
Ready Radio Supply Co.	368
Regent Radio Supply Co., Ltd.	368
Sifam Electrical Instrument Co.	351
Taylor, B.	366
Tungstone Accumulator Co., Ltd.	319
Wet H.T. Battery Co.	363
Whiteley, Boneham & Co., Ltd.	351
Wilkins & Wright, Ltd.	365
Wingrove & Rogers, Ltd.	367
Wooldridge Radio Co., Ltd.	368
Wright & Weaire ...	361

DEPENDABLE
BATTERY ELIMINATORS

REGENTONE

for
AC and DC MAINS

Behind each Regentone Instrument there lies 4 years' specialised experience

MAINS UNITS, MAINS RECEIVERS, COMPONENTS

Send for Illustrated Catalogue

REGENT RADIO SUPPLY CO.

SHOW AND DEMONSTRATION ROOMS:
21 Bartlett's Buildings, Holborn Circus, E.C.4
Cent. 9661

**EVERYTHING RADIO
ON
ASYTERMS**

WOOLDRIDGE RADIO CO. LTD.
26 LISLE ST., LEICESTER SQ.
LONDON, W.C.2.

BUY
AMATEUR
WIRELESS
3d.
WEEKLY

CATWHISKERS & CRYSTALS ABOLISHED

Everlasting FIXED DETECTOR. Guaranteed Indefinitely. Fixed Permanent Detector and Stabilising Unit. No Batteries required with Crystal Circuits. Indispensable for Reflex Circuits. Specified for the Two Programme Crystal Set Sept. Wireless Magazine. From all dealers, 2/6, or post free from Patentees, 2/8.



Pat. No. 265,469

A. W. GRIFFIN & CO., Manufacturers, REDDITCH

Blueprints of the Best Sets of the Year

from 6d. to 1/6

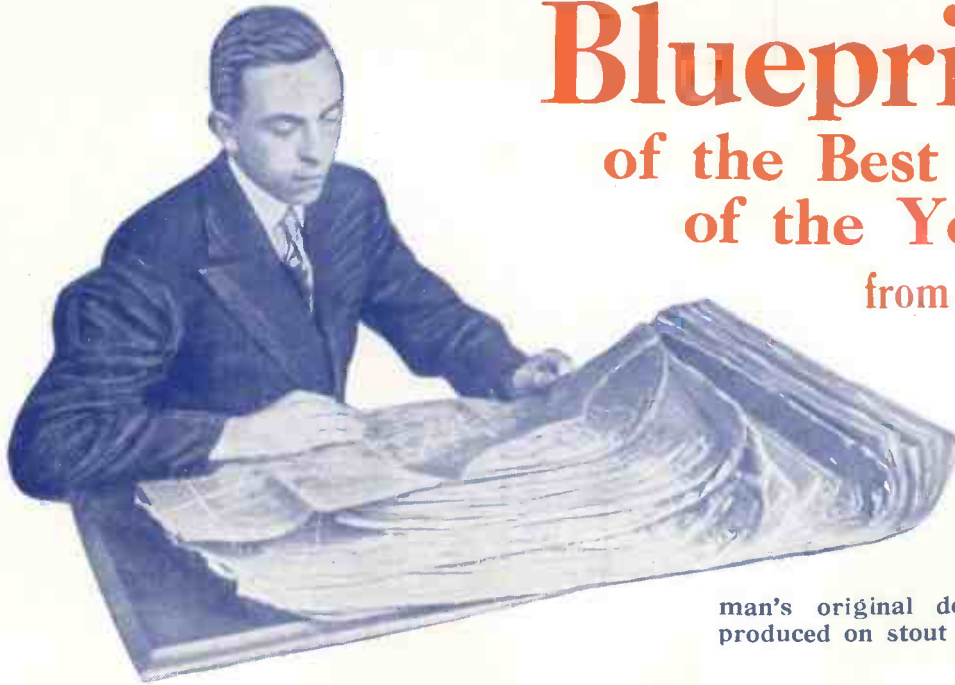

Each one is a full-size photographic contact print, from the draughtsman's original design, and is produced on stout paper.

	Price, post free	
	No.	s. d.
ONE-VALVE SETS.		
One Valver for Frame Aerial	M.W.4	1 0
One-valve All-wave Reinartz	A.W.2	1 0
All-in-all One Valver	A.W.13	1 0
Hartley DX One-valver	A.W.27	1 0
Alpha One*	W.M.26	1 3
TWO-VALVE SETS.		
All-broadcast Two*	W.M.5	1 3
Safeguard Two	A.W.3	1 0
Two-valver embodying K.L.1 Valves	A.W.5	1 0
One-control Two	A.W.6	1 0
Wide World Short-wave Two	A.W.11	1 0
All-wave Two Valver	A.W.15	1 0
Loftin-White Two*	W.M.20	1 3
Reinartz Two	A.W.21	1 0
Remote-control Two	A.W.23	1 0
One-dial Two	W.M.23	1 0
Empire Short-wave Two	A.W.28	1 0
"Next Step" Receiver—2 valver	A.W.34	1 0
Girdle Two*	W.M.30	1 3
Centre-tap Two	A.W.42	1 0
Mains-fed Two†	W.M.37	1 0
THREE-VALVE SETS.		
One-knob Three	W.M.3	1 0
Continental Three	W.M.7	1 0
Shielded Searcher	W.M.8	1 0
Victory Three	A.W.9	1 0
Regulator Three	A.W.12	1 0
M.C. Three, with copy of "Amateur Wireless" giving full instructions	A.W.1	7
Hi-mu R.C. Three*	W.M.9	1 3
M.C.3 Star	A.W.16	1 0
Wave-catcher Three	W.M.19	1 0
Excelsior Three	A.W.20	1 0
Split-primary Three	A.W.24	1 0
Lighthouse Three	A.W.29	1 0
Everything for Purity	A.W.33	1 0
Modern Tuned Anode Three	A.W.35	1 0
Tetrode Three—for Shielded Valve	A.W.36	1 0
Alternative programme Three	A.W.38	1 0
A "Mains" Three Valver	W.M.34	1 0
Screened-grid Three	W.M.21	1 0
Five-guinea Three†	W.M.29	1 0
Dominions Short-wave Three†	W.M.39	1 0
Simple Wireless Three-valver	A.W.41	1 0

* With copy of "Wireless Magazine," complete.

† Supplied at half advertised price, until November 30th, if coupon at the foot of this page is used.

	Price, post free	
	No.	s. d.
FOUR-VALVE SETS.		
Paradyne Four	W.M.2	1 6
M.C. Four	A.W.1	1 6
Distance Getter	A.W.10	1 6
Household Four	A.W.17	1 6
DX Four	A.W.18	1 6
Revelation Four	W.M.24	1 6
Auto-Selector Four	W.M.35	1 6
All-purpose Four	A.W.43	1 6
"A.W." Gramo-radio	A.W.40	1 6
FIVE-VALVE SETS.		
1927 Five	W.M.6	1 6
Two-volter's Five	W.M.11	1 6
Individual Five	A.W.25	1 6
Exhibition Five	W.M.33	1 6
SIX-VALVE SETS.		
Nomad Six	W.M.31	1 6
SEVEN-VALVE SETS.		
Simpladyne Seven (Super-het)	W.M.22	1 6
AMPLIFIERS.		
All-broadcast Amplifier	W.M.15	1 0
Two-valve D.C. Mains Amplifier	W.M.16	1 0
PORTABLE SETS.		
Springtime Portable Two-valver	W.M.12	1 0
Countryside Four	W.M.17	1 0
Motorists Portable (four-valver)	A.W.14	1 6
M.C. Three Portable	A.W.22	1 0
Handy Three	W.M.27	1 0
Holiday Portable (three-valver)	A.W.32	1 0
Club Portable (three-valver)	A.W.30	1 3
CRYSTAL SETS.		
Crystal Set for the R.C. Enthusiast	W.M.13	6
Fonotrol Crystal Set	W.M.14	6
Hi-lo Crystal Set	W.M.18	6
Two-Programme Crystal Set	W.M.25	6
Alternative-programme Crystal Set	A.W.39	6
MISCELLANEOUS.		
Loud-speaker Tone Control and Filter Unit*	W.M.1	1 3
Heterodyne Wavemeter	A.W.7	1 0
Made-to-Measure Wave Trap	A.W.19	1 6
Gramophone Amplifier	W.M.32	1 0
New Current Supply Idea	A.W.26	1 0
DX One-Valve Unit	A.W.37	1 0
Range Extender	W.M.38	1 0

WIRELESS MAGAZINE

Blueprint Service, 58/61, Fetter Lane, London, E.C.4

THE CYLDON RANGE

CATERERS FOR THE CONSTRUCTORS EVERY NEED

Free!

TEMPRYTES



Temprytes ... each 1/6
Mounts ... 1/-

SHORT WAVE CONDENSERS



Extension rod, bracket, panel bush and nut, with spindle. 3/6 per set.

.0001 ... 14/6
.00015 ... 15/-
.0002 ... 15/6
.00025 ... 16/-
Complete with bracket, etc., as shown.

Fourteen months ago the design of the "Cyldon" Log Mid Line Condenser was completed in the "Cyldon" laboratories, and a few months later a world wide demand was being successfully catered for. To-day every condenser manufacturer at home and abroad is introducing a Logarithmic or "Log Mid-Line" Condenser.

In many cases the shape of the "Cyldon" Log Mid Line vane has been copied, but the secret of the TRUE LOGARITHMIC CONDENSER lies in the design of vane and framework, and not merely in the shape of the vane alone.

LOG. MID-LINE CONDENSERS

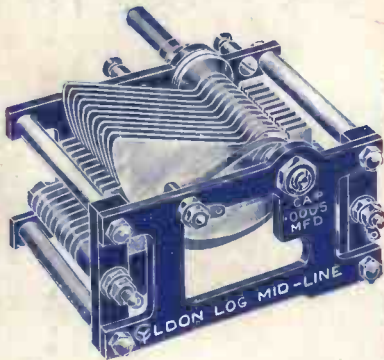

.001 ... 19/-
.0005 ... 15/6
.0003 ... 14/6
.00025 ... 14/-
.0002 ... 13/6

We strongly and urgently advise every constructor who requires a true logarithmic condenser to insist on seeing a copy of a "curve" (taken by any laboratory of repute) of any condenser offered as a logarithmic, "Log" or "Log Mid-Line." Your sure safeguard at all times is to insist on "Cyldons," and to make quite sure that the imprint "Cyldon Log Mid-Line" is clearly marked on the end plate.

BEBE REACTION CONDENSERS

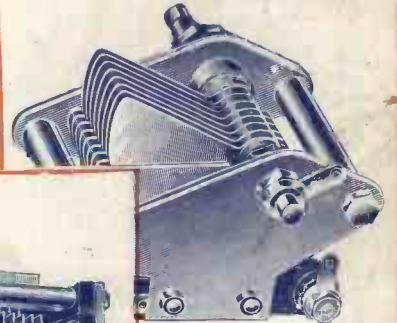

.0001 ... 7/6
.00015 ... 8/-
.0002 ... 8/6
.00025 ... 9/6
.0003 ... 10/6
Complete with knob and dial.

THUMB CONTROL CONDENSERS

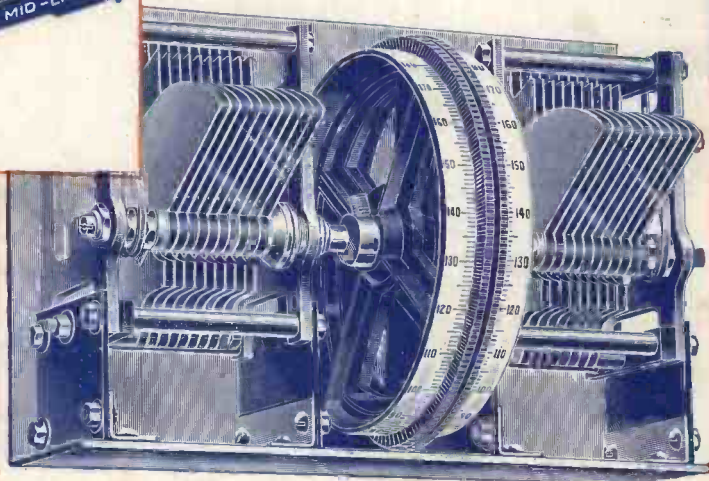

Single .0005 £1/2/0 Twin Gang £2/7/0 Triple Gang £3/9/6

See full list for all capacities. Shielded and semi-shielded Models.

Everything you will want to know about Condenser design is explained in plain and non-technical terms in our booklet, "Concerning Variable Condensers." Write for a free copy to-day.

Please send me FREE and POST FREE copies of your booklet "Concerning Variable Condensers," a catalogue of the "Cyldon" range of variable condensers, and a Tempryte chart.

(PIN YOUR NAME AND ADDRESS TO THIS COUPON).

SYDNEY S. BIRD AND SONS, LIMITED

"CYLDON WORKS," SARNESFIELD ROAD, ENFIELD TOWN, MIDDLESEX
Sole Australian Agent: E. V. HUDSON, 55-57, Charlotte Street, Brisbane, Queensland
Contractors to the B.B.C., H.M. Royal Air Force, H.M. Office of Works, and all the leading manufacturers of quality receivers
Telephone: ENFIELD 0672 Telegrams: CAPACITY, ENFIELD