

"As Good a Set as Money Can Buy"

NEW EDITION OF THIS FAMOUS SET

Wireless Magazine

14

Edited by
Bernard E. Jones

Vol. 3, No. 14.

March, 1926

*A New Edition of
a Most Successful
Four-valver*



*See Within for
Full Constructional
Details and Free
'Structograph' Coloured
Plate and Blueprint*

The World's Greatest Magazine of Wireless

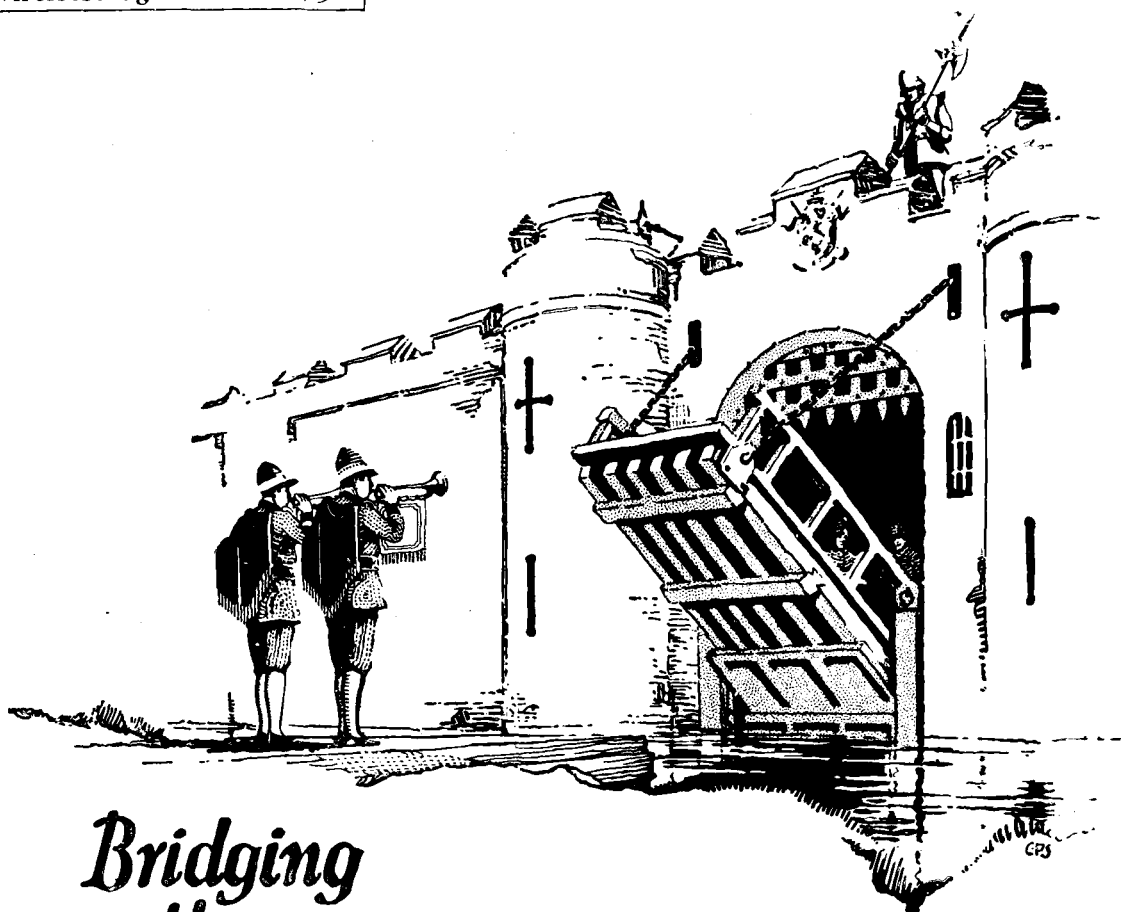

Bridging the gap

Among the many specialised requirements of the Wireless Experimenter, the need undoubtedly exists for a condenser designed to give an unbroken tuning range when a "change-over" is necessary from series to parallel working. With an ordinary variable condenser a gap occurs in the wave-length range at the point where the "change-over" is necessary.

The Duwatcon, however, has been specially designed to overcome this difficulty. It is so constructed that when used in the series position its *normal* maximum wave-length is obtained at about 120' on the scale. Further rotation of the knob, however, causes a further increase in the wave-length until, when the movement is completed at 180°, the wave-length is slightly greater than that which would be obtained by switching the condenser to "parallel" and turning the knob to zero again.

Positive connection to the moving plates is secured by means of a phosphor-bronze strip—a special feature found in all Dubilier Vanicon Variable Condensers.

Specify Dubilier

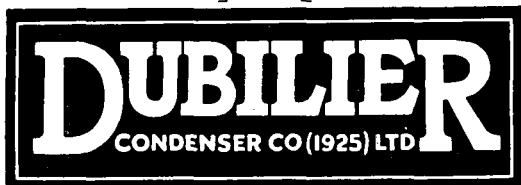

ADVERT. OF THE DUBILIER CONDENSER CO. (1925) LTD., DUCON WORKS, VICTORIA RD., NORTH ACTON LONDON, W.3. PHONE: CHISWICK 224-23

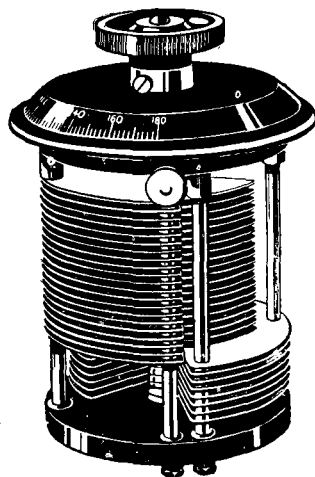

The Dubilier Duwatcon Variable Condenser. Capacity 0.0007 mfd. Price 30/-

E P S. 168

In writing to advertisers, please say you saw the advertisement in THE WIRELESS MAGAZINE.

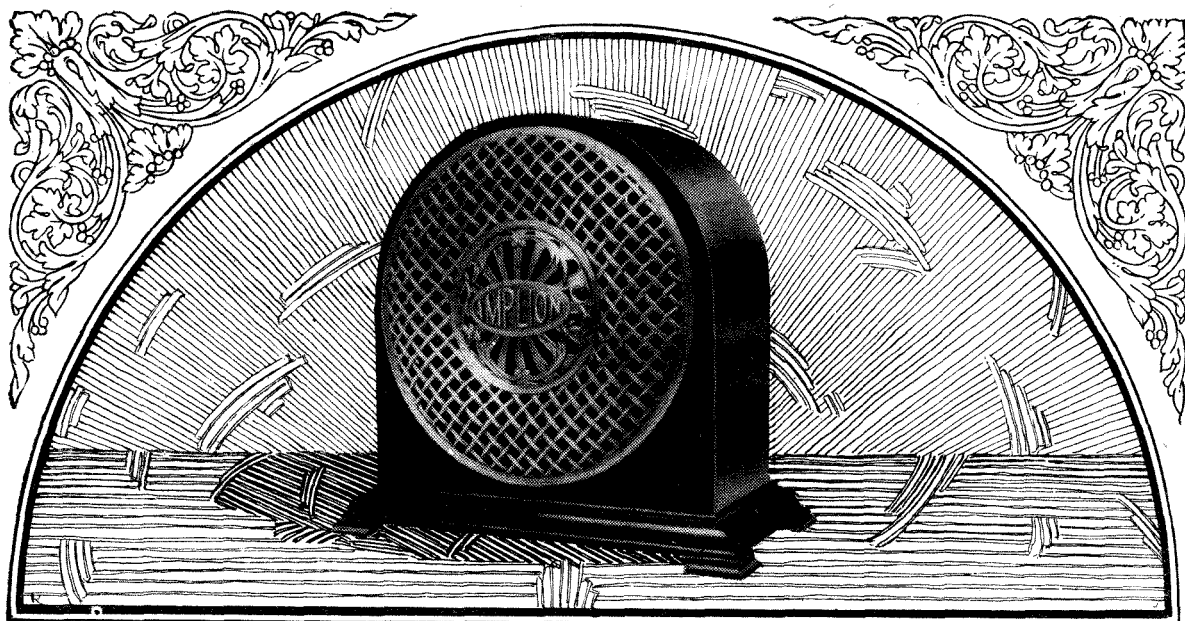

RADIOLUX AMPLION

The Natural Tone Loud Speaker

Pure, smooth, natural tone and realistic reproduction combined with artistic appearance and compact form are qualities which render this unique amongst con-

temporary instruments. Totally different in design, in appearance and in results, the Radiolux Amplion is a revelation in loud speaker quality.

*The
World's
Standard*

AMPLION

*Wireless
Loud
Speaker*

Available in two sizes and in various distinctive finishes from all AMPLION STOCKISTS, Radio Dealers or Stores.

Patentees and Manufacturers:

ALFRED GRAHAM & CO. (E. A. Graham), Crofton Park, S.E.4

Demonstrations gladly given during business hours at the AMPLION Showrooms: 25, Savile Row, London, W.1; 79, High Street, Clapham, S.W.4; 10, Whitworth Street West, Deansgate End, Manchester; and 101 St. Vincent St., Glasgow.

**FOR THE FIRST TIME IN LOUD SPEAKER HISTORY
SCIENCE AND ART GO HAND IN HAND**

In writing to advertisers, please say you saw the advertisement in THE WIRELESS MAGAZINE.

**Can You beat this
for value in Loudspeaker Sets ?**

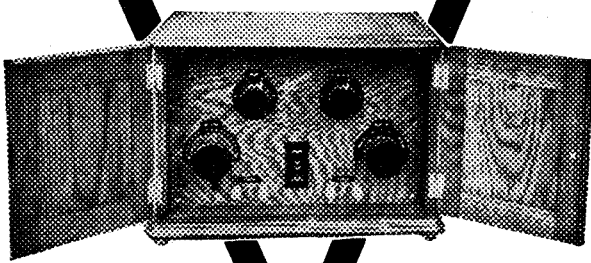

FOR £7 10s. you can become the possessor of probably the finest 2-valve Loudspeaker Receiver on the market—the Ericsson Family Loudspeaker Receiver.

Gives pure loudspeaker reproduction of amazing volume and tone, 25-30 miles from any main B.B.C. station and 150 miles from 5 X X.

Contained in a beautifully fitted polished oak case, with lift-up lid, all coils and valves enclosed against dust or damage, nickel-plated fittings, switch for changing from 'phones to loudspeaker. All terminals at back, out of way. Hooked up to a Senior Super Tone Loudspeaker (63/-), or a Junior (32/6), you get radio at its best. Write to-day for Lists.

Write for illustrated literature treating on other sets (crystal and valve), loudspeakers, headphones, components, etc.

Agents everywhere.

**THE BRITISH L. M. ERICSSON
MFG. CO., LTD.,
67/73 Kingsway, London, W.C.2.**



CAXTON 4-VALVE CABINET

Made for Editor of Wireless Magazine for Set "As good as money can buy" described in issue February, 1925.

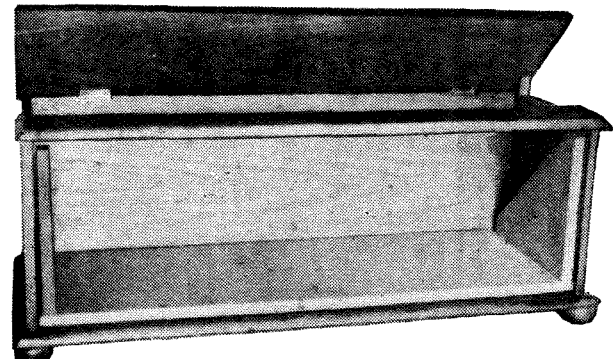

Cash with Order. Fumed Oak ... **£1 5 0**
or Real Mahogany polished ... **£1 14 0**

With detachable recess fitted Base Board to mount 21 in. by 7 in. panel to slide out of Cabinet front. Extra 10/- with two beaded front doors totally enclosing fitted panel.

Cabinet overall length 22½ ins. Width 8½ ins. Height 9 ins. Polished with the new enamel that gives a glass hard surface that cannot be soiled or scratched.

SENT FREE.—Catalogue of standard Wireless Cabinets in various sizes and woods. Special Cabinets made to customer's orders.

PACKED AND DELIVERED FREE IN U.K.

CAXTON WOOD TURNERY CO., Market Harborough

**¶ A clear explanation
A startling prophecy**

**Talks About
Wireless**

By SIR OLIVER LODGE

Who would not wish to read what the famous scientist has to say regarding the most wonderful and most entertaining phenomenon of the present time? Sir Oliver Lodge's book is at once authoritative and suggestive. It comprises not only a survey of wireless from the earliest discoveries down to existent conditions, but also arresting prophecies of possible future achievements.

"A book simply written and popularly presented by one of the foremost minds of the day; both beginners and advanced students all the world over will eagerly peruse this book."

DAILY GRAPHIC



Extra crown 8vo, 276 pages, with a number **5/-** of Illustrations in the Text. Cloth. **net**

Cassell's, Publishers, London, E.C.4

In writing to advertisers, please say you saw the advertisement in THE WIRELESS MAGAZINE.

Your
radio set
can be
improved
by using

B.T.H. VALVES.

Made in England

Insist on
B.T.H. the
Best of All

The British Thomson-Houston Co. Ltd.
Crown House, Aldwych,
London, W.C. 2.

SIX TYPES

R	0.7A. 4v. 8/-	B3	0.35A. 1.8v. 14/-	B4	0.25A. 6v. 22/6
B5	0.06A. 28v. 16/6	B6	0.12A. 28v. 22/6	B7	0.06A. 6v. 24/6

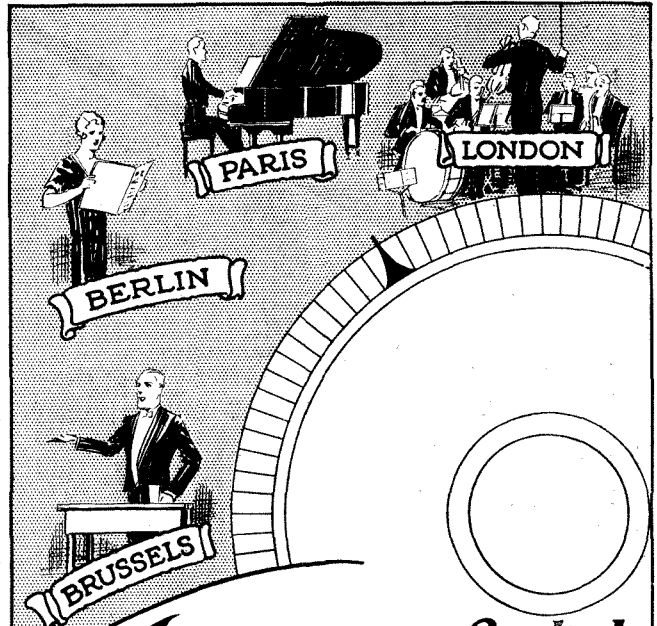

Just a turn of a dial-
gets the entertainment
that suits your taste

*Simplicity
is the
Keynote
of
the*

The remarkable selectivity of the FREED-EISEMANN Neutrodyne receiver, together with its range and power, pure reproduction and simplicity in handling has made it the most popular receiving set in America. Tuned on the famous neutrodyne principle, oscillation cannot take place, and the selectivity is such that stations separated by only 2 or 3 metres can be brought in at full power without heterodyning! Think what this means. Simply arrange your dial readings in accordance with your chart and the station you want (and no other) comes in at full strength. Ask your dealer for a demonstration or kindly send (on postcard) your name and address.

FREED-EISEMANN NEUTRODYNE WIRELESS RECEIVER

NOTICE TO AMATEURS.

A special box of F.E. Neutrodyne component parts to build a complete 5 Valve Set with Blue Prints and Instruction Book.

Send for particulars.

Sole Concessionaires and Manufacturers for the British Isles.

DE LEEUW & CO., Ltd., Sentinel House,
Southampton Row, London, W.C.

Telephone: Museum 8340.

DISTRIBUTORS:

The Western Counties Electrical and Engineering Co., Princes Street, Yeovil. E. A. Gardner and Sons, Brewer Street Works, Maidstone. Doughty's, 10, Whitefriargate, Hull. Brook Shaw, Norfolk Street, Sheffield. W. Brown and Co. (Engineers), Ltd., 89, Douglas Street, Glasgow. James Lowden and Co., Ann Street, Belfast. S. and E. Collett, 23, Catherine Street, Salisbury. Marshall and Co., 41, Carlisle Road, Manningham, Bradford. The Wallwin Company, Birmingham Road, Warwick.



N R 20—"THE FINEST RADIO RECEIVER IN THE WORLD"

In writing to advertisers, please say you saw the advertisement in THE WIRELESS MAGAZINE.



THE GLORY CORNER

This is the Glory Corner at the Bennett College. We give it that name because it contains in bundles about **One Hundredweight** of letters which we have received from Grateful and Successful Students. We keep all these thousands of unsolicited testimonials as a fountain of inspiration and because we are really proud of them. Having helped thousands of others to achieve success and advancement, it may be possible that we can help YOU. I am assisted by a large and expert staff, and the advice we give is sound. If we cannot help you we will say so; if we can we will tell you how.

We have **FREE** booklets setting out the possibilities in connection with each of the subjects shown in the lists; send for the one in which you are interested, or ask for **MY PRIVATE ADVICE**, which also is free. You incur no obligation.

Have You ANY Ambition?

We guarantee tuition until successful. Most moderate charges, payable monthly. All text books free. No extra fees.

EXPERT TUTORS FOR EVERY DEPARTMENT

<p>COMMERCIAL</p> <ul style="list-style-type: none"> Accountancy Advert Writing Salesmanship Army Certific. Courses Auctioneering & Estate Agency Auditing Banking Book-keeping Commercial Arithmetic Commercial Law Company Law Costing Economics English and French Executorship Law Foreign Exchange Modern Business Methods Secretaryship Workshop Organisation 	<p>TECHNICAL—Contd.</p> <ul style="list-style-type: none"> Chemistry Civil Engineering Concrete and Steel Draughtsmanship Electricity Engineering Foundry Work Internal Combustion Engines Marine Engineering Mathematics Mechanics Metallurgy Mining Mine Surveying Motor Engineering Naval Architecture Pattern Making Quantity Surveying Sanitation Shipbuilding Structural Engineering Surveying and Levelling Telegraphy & Telephony Town Planning Wireless Telegraphy Works Managers' Course
---	---



Yours sincerely,
H. Bennett

ENGINEERING DICTIONARY—PART ONE FREE
To extend the name of the Bennett College we are publishing an Illustrated Encyclopaedic Dictionary of Engineering, Civil, Motor, Elect., Mech., etc. You may have Part I FREE. Send for Part 1 to-day. You are under no obligation.

WE SPECIALISE IN PREPARATION FOR ALL EXAMINATIONS IN CONNECTION WITH THE ABOVE SUBJECTS.

Note Address—THE BENNETT COLLEGE, Dept. 173, Sheffield.



WE TEACH BY POST

‘The proof of the CON-DIT is in the circuit,’ says CLIXIE



“Our postbag’s full these days of enthusiastic letters about CON-DIT,” says CLIXIE. “Enthusiasm’s a thing that many folk distrust, so I’m quoting a restrained one from Northumberland which I think is all the more convincing for its very restraint.

“Will you please send me another 2/- worth of H.F. Condit in a roll—it will save so much packing for so small a quantity. I have just wired up a single valve set with this Condit and find it a distinct improvement on anything I have used.”

“CONDIT is copper tape curled up into the form of a split tubing (=16-gauge wire). There you have the reasons for that ‘distinct improvement’—two highly polished conducting surfaces and the minimum of capacitive metal.

“Prove it on your circuit.”

RADIO CON-DIT

(P. Patd.)

The H.F. CONDUCTOR

Per packet of six 2-foot lengths **2/-**
Per coil of 12 feet

Obtainable from all Wireless Dealers or direct from the Patentees:

AUTOVEYORS LTD., 84 VICTORIA STREET, LONDON, S.W.1

The Boy’s Book of Wireless

ERNEST H. ROBINSON

By the aid of this splendid book all boys can gain a thorough knowledge of what Wireless is and how it works.

With over 150 illustrations. 5s. net.

Cassell’s

Two New “Amateur Wireless” Handbooks

Loud Speaker Crystal Sets

How to Make and Manage Them

Working instructions are given on the building of a number of highly efficient crystal sets with which particularly loud signals have been obtained. Also the making of an attachment for simple connexion to any existing wireless set is described with full details, being well illustrated. 2/6 net.

A Wireless Man’s Workshop

J. HARTLEY REYNOLDS

The author, a practical home constructor and a well-known wireless expert, possesses the happy knack of imparting knowledge in simple, easily understood sentences. There is a wide range of general wireless information throughout the book which all readers will appreciate. Fully illustrated. 2/6 net.

Cassell’s  London, E.C.4.

In writing to advertisers, please say you saw the advertisement in THE WIRELESS MAGAZINE.

You want THE BEST!

When buying coil holders, Ask for "Lotus" and you will get the best.

LOTUS Coil Holders

are made from Bakelite mouldings with nickel-plated fittings, they are an ornament to any set and they give the best results. MOVING BLOCK CANNOT FALL.

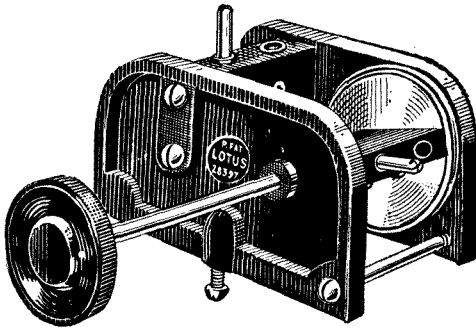

There are two types of "Lotus" Coil Holders.

For outside Panel Mounting, Two way 7/6, Three way 10/6. For Inside Baseboard Mounting, 6-inch handle. Two way 8/6, Three way 12/6.

The Vernier Movement is actuated by three sets of enclosed Precision Cut Gears, representing a reduction of 8 to 1.

TESTIMONIAL

"I should like to take this opportunity of saying how glad I am that I fitted your coil holder. I can now, without any other alteration to my set (Det. L.F.), receive 6 stations with comparative ease, where before, tuning in of 3 was an achievement."

GARNETT WHITELEY & CO., Ltd.
Lotus Works, Broadgreen Road,
LIVERPOOL

100,000 RUGS GIVEN AWAY

This Phenomenal Offer is made to the readers of "Wireless Magazine," March 1926. On receipt of P.O. for 12/6 we will forward direct from our looms to your address one of our "Prudential" Brussels Real SEAMLESS BORDERED (Guaranteed Genuine Bargains)

CARPETS

Carriage
1/-
Extra.



12/6

Repeat Orders received from the Royal Palace, Stockholm. Established over half a century.

F. HODGSON & SONS, Importers & Merchants, Woodsley Rd., Leeds

12/6 Remarkable Testimonials
Forth Avenue, Garden Village, Levenshulme, May 11.
Mr. W. L. Stanton writes—
"Send me one of your Prudential Brussels Carpets and Rug. I was interested to see that one of your customers stated she had a carpet from you 19 years ago that was not worn out. You can also state that I have now in my bedroom one in fairly good condition which I bought at your place well over twenty years ago."

Suitable for Drawing-room, Dining-room, Bedroom, etc. Handsomely bordered in thirty Turkey patterns and fashionable self shades of Crimson, Greens, Blues, and Art Colourings, to suit all requirements and LARGE ENOUGH TO COVER ANY ORDINARY SIZED ROOM. These Carpets with FREE RUGS will be sent out as Sample Carpets, showing you the identical quality we supply. They are made of material equal to wool and being a speciality of our own, can only be obtained direct from our looms, thus saving the purchaser all middle profits. Over 400,000 sold during the past 12 months. Money willingly refunded if not approved. Thousands of Repeat Orders and Unsolicited Testimonials received. With every carpet we shall absolutely give away a handsome Rug to match.

GALAXY ILLUSTRATED BARGAIN CATALOGUE of Carpets, Hearthrugs, Embroidered Linen and Cotton Bedspreads, Quilts, Table Linens, Bedsteads, Linoleums, Blankets, Curtains, Copper Kerbs, Fire Brasses, Cutlery, Tapestry Covers, &c., Post Free, if when writing you mention "Wireless Magazine," March, 1926.

EFESCA

Popularity Competition

FIRST PRIZE

SECOND PRIZE

THIRD PRIZE

£100 £50 £25

And 25 Consolation Prizes of £1 each

1. EFESCA REGENERATIVE AERIAL TUNER.
2. EFESCA L.F. TRANSFORMER TYPE "B."
3. EFESCA SQUARE LAW CONDENSER.
4. EFESCA AERIAL TUNER.
5. EFESCA ANTI-CAPACITY SWITCH.
6. EFESCA VERNISTAT.
7. EFESCA HIGH FREQUENCY TRANSFORMER.
8. EFESCA DISC FIXED CONDENSER.
9. EFESCA DUAL RHEOSTAT.
10. EFESCA SPEECH AMPLIFYING TRANSFORMER TYPE "C."
11. EFESCA TAPPED H.F. REACTANCE.
12. EFESCA MICRO-METER DETECTOR.
13. EFESCA VARIABLE REACTION COIL.
14. EFESCA SERIES PARALLEL CONDENSER.
15. EFESCA VARIABLE GRID LEAK.
16. EFESCA ANODE TUNER.

Catalogue No. 560 describing these Components, Post Free on application.

Enter now!

WHAT YOU HAVE TO DO

We are offering the above prizes to discover the order of popularity of the 16 Efesca Components listed on the left. To enter for the Competition, all you have to do is to fill in Entry Coupon below in accordance with instructions, and post this, together with the box of any one of the components mentioned, to

Competition Department,
Falk, Stadelmann & Co., Ltd.,
83-93, Farringdon Road,
LONDON, E.C.1.

Vote in space "A" for your own favourite component. Forecast in spaces 1 to 16 below what you think will be the result of the voting.

RULES AND CONDITIONS.

1. The decision of the Judges must be accepted as final and legally binding.
2. No member of the staff or works of Messrs. Falk, Stadelmann & Co., Ltd., will be allowed to enter this Competition.
3. The Competitor whose list most nearly agrees with the order of popularity as determined by the votes in space "A" will be awarded the first prize irrespective of what component he himself votes for in space "A." The next nearest will receive the second prize, and so on.
4. Write your full name and address clearly in the space provided and send the coupon with the box from any of the Efesca Components illustrated on this leaflet to: Competition Department, Messrs. Falk, Stadelmann & Co., Ltd., 83-93, Farringdon Road, London, E.C.1.
5. No correspondence will be entered into with regard to the Competition.

SEND YOUR ENTRY TO-DAY!

The Box of any one of these 16 Components must accompany this Coupon.

NAME _____ ADDRESS _____

SPACE A

I record my vote for No. _____ as the most popular component.

1st.	2nd.	3rd.	4th.	5th.	6th.	7th.	8th.
9th.	10th.	11th.	12th.	13th.	14th.	15th.	16th.

I enclose Box from undermentioned Component. LEAVE BLANK

Component _____

In writing to advertisers, please say you saw the advertisement in THE WIRELESS MAGAZINE.

There's life in the family now!

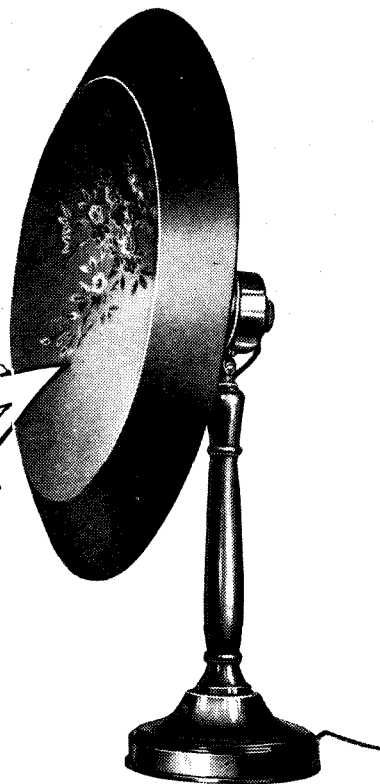

WHAT a difference broadcasting has made to family life; for indoor days no longer bore, but are filled with brightness and gaiety now that all the charm of radio music, song and interest is available through the medium of a good receiving set and loud speaker.

Greater still becomes the charm with the supremely perfect Sterling "Mellovox," the latest and most popular hornless type of loud speaker. A perfect reproducer, artistic in appearance and ample in volume for all home requirements.

Hear the "Mellovox" at your Radio dealer's, then add the pleasures of true reproduction of broadcasting to the family circle.

Write for Publication 439

STERLING
MELLOVOX
Loud Speaker.

THE MARCONIPHONE COMPANY LTD.

Sole Agents for **STERLING TELEPHONE & ELECTRIC CO., LTD.**

Registered Office: Marconi House, Strand, London, W.C.2

Head Office: 210-212 Tottenham Court Rd., London, W.1

Branches: Aberdeen, Bristol, Birmingham, Belfast, Cardiff, Cheltenham, Dublin, Glasgow, Lee, Liverpool, Manchester, Newcastle, Nottingham, Southampton, Swansea.

STERLING "MELLOVOX" HORNLESS LOUD SPEAKER

In brown, blue, mauve or black with gold floral diaphragm. PRICE 48/-

"MELLOVOX" LOUD SPEAKER & LAMP SHADE COMBINATION
£4 4 0

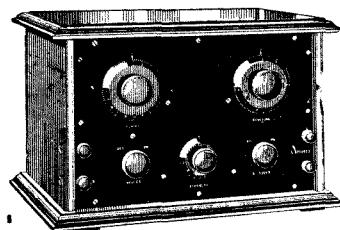

MARCONIPHONE TYPE 31

3-Valve Receiver fitted with coil for B.B.C. range only
£14 0 0

Royalty, extra (nett)
£1 17 6

Excellence in loud speaker reproduction and ease of manipulation are the chief considerations in this model. The circuit consists of a single tuned detector valve, with controllable reaction, followed by two stages of low frequency amplification. It is designed to operate a loud speaker under normal conditions at 150 miles range. Wave-range is from 300-3200 metres by means of interchangeable coils, those supplied as standard covering broadcast range (300-500 metres) or Daventry range (1600 metres).

In writing to advertisers, please say you saw the advertisement in THE WIRELESS MAGAZINE.

The Wireless Magazine

for March, 1926

(Vol. III, No. 14)

CONTENTS

The Valve As Watch-dog Chaotic Radio! By J. Godchaux Abrahams	112	The A B C of the "Super Het." A special article illustrated by 11 photo- graphs	148	Impartial Advice	170
A Farewell Impression of the Savoy Havana Band	120	Our Pride in Wireless	153	Can Highbrows and Low- brows Convert One Another?	171
"Jazz Banned"! By J. H. Squire	127			A Portable Aerial	171
				Just What Is A Good Aerial?	172

AS GOOD A SET AS MONEY CAN BUY (New Edition) p. 121

Gadgets, Hints and Tips	129	When Felix Listens-in	153	Broadcast Music of the Month	174
Under My Aerial. The Chat of the Month	130	When Hams First Talked Across the Herring Pond. By a Canadian Amateur	154	"We Are Now Going Over to the Savoy Hotel. . . ."	186
Novelties and New Appar- atus Illustrated and Described	134	The Wireless Hour. A poem	156	What the Reader Thinks	188

THE HOUSEWIFE'S CRYSTAL SET p. 143

Freak Directional Effects	136	What Wireless Means to the League of Nations. An exclusive article by Sir Eric Drummond, K.C.M.G.	157	At 2, Savoy Hill, W.C.2	190
Mush!	137			Questions Simply Answered	192
The Story of a Joke. By "Thermion" of Amateur Wireless	138			Continental Notes	194
				Below the Broadcasting Belt	196

THE ALL-AMERICA SHORT-WAVE ONE-VALVER p. 166

Broadcasting Patients Out of Bed! Interview with Sir Bruce Bruce-Porter	139	Plate Voltages	158	An Improved System of Wiring	198
How Many Broadcasting Stations?	142	Series or Parallel?	158	The World's Broadcasting Catalogues and Pamphlets	200
		How to Identify the Spanish Stations. A special article	159	For the Wireless Bookshelf	203

THE TRUE-TO-LIFE THREE-VALVE AMPLIFIER p. 176

A Curious Valve Fault	145	Lander's Other Planet	161	Binding Cases	203
Blake Boanerges' Banter	146	Wireless Fem'ininities	164	Jottings on the Month's Progress	204
Controlling Your Valve Filaments Efficiently	147	Charging Your Accumu- lators at Home	165	The Buyers' Guide	208

Announcements.—THE WIRELESS MAGAZINE, edited by Bernard E. Jones, is published about the 25th day of the month, and bears the date of the month following. One Shilling Net. Subscription rates are 15s. 6d. a year, post free; Canada, 13s. 6d. a year, post free. Contributions, accompanied by stamped and addressed envelopes, are invited. All editorial communications should be addressed to The Editor, THE WIRELESS MAGAZINE, La Belle Sauvage, London, E.C.A. Subscriptions should be addressed to The Publisher, THE WIRELESS MAGAZINE.



THE VALVE AS WATCH-DOG

ILLUSTRATED
BY MAJOR C.
FLEMING
WILLIAMS

Scientists are turning their attention to the possibilities of the valve for purposes other than the reception of wireless signals. In this article our contributor, who has made a special study of the subject, discloses some astonishing uses to which the valve has already been put.

APART from its distinctive character as an amplifier and detector of wireless signals, the thermionic valve is admittedly the most sensitive relay device known to modern science, and as such is now being widely utilised for many ingenious purposes far removed from that for which it was originally invented.

Automatic SOS Alarms

For example, one finds various instances in which a valve is employed on what may be termed sentinel or watch-dog duty, amongst which perhaps the best-known illustration is the ordinary calling-up apparatus used at sea for automatically ringing an alarm bell upon the receipt of an SOS or other emergency call.

Here the watch-dog valve is constantly on duty—whether the wireless operator is in his cabin or elsewhere. As soon as a certain pre-

arranged sequence of signal impulses is received, an electromagnet in the plate circuit of the valve causes a special balance-wheel to swing with increasing amplitude until one contact, carried by the wheel, touches a second or fixed contact, and so rings the alarm bell to attract the attention of the operator.

The peculiar sensitivity of a back-coupled valve, particularly when adjusted on the threshold of oscillation (or when actually oscillating), can similarly be utilised as a burglar alarm.

Fig. 1 shows a valve with the plate and grid circuits back-coupled at R so that sustained oscillations are generated. A polarised relay in the plate circuit is set so that the normal current passing through the valve under the given conditions of adjustment keeps the contacts of the alarm circuit open.

Coupled to the plate circuit is a separate absorber circuit as shown,

which is tuned to the frequency generated by the oscillator and so represents a constant load on the valve.

Part of the windings of the absorber circuit are, in fact, laid around the safe or strong-room to be protected; or part of the capacity of the circuit may be made the natural capacity-to-earth effect of a safe mounted on insulated supports.

The entry of an unauthorised person into the strong-room, or the handling of the insulated safe, consequently alters the natural capacity, and therefore the tuning of the absorber circuit as a whole.

The result is the ringing of a distant alarm bell, which may be located in the caretaker's room or in the nearest police station.

Thief Detector

The same type of apparatus, fitted with a sensitive galvanometer, in place of the relay shown, might be used as an automatic device for detecting the presence of metal articles hidden away in the clothing of workmen leaving factories.

Or with suitable modifications it might even be employed for prospecting the subsoil for minerals, or for indicating the presence of pipes or other metal articles buried in the ground.

Fig. 2 shows another circuit arrangement that has been suggested for use either as a fire or burglar

Fresh Possibilities of the Modern Aladdin's Lamp

alarm. The valve is arranged to be plugged in direct to the ordinary house mains, carrying either direct or alternating current, the filament supply being fed through a suitable resistance in the former case or from a step-down transformer in the latter.

Light-sensitive Cell

A tuned oscillator circuit, comprising inductance and capacity, is inserted between the grid and filament on one side of the valve. On the other side a lead is taken from the grid to the inside of the room to be protected, where a potassium cell or other light-sensitive device is arranged in circuit with series and shunt resistances R. The value of the resistances is adjusted so that the valve is on the threshold of oscillation.

In the event of fire, the effect of the illumination of the potassium cell renders it conductive, the accumulated negative charge on the grid of the valve is released, and oscillations are set up in the tuned circuit. The value of the plate-current supply to

the valve alters and the relay is promptly operated to ring a distant alarm.

By placing the potassium cell inside a strong-room or safe the effect of opening the door by an unauthor-

ized person would automatically expose the cell to light, and an instantaneous warning of the event would be registered by the relay as before.

One of the most serious dangers that the miner has to face is the presence of fire-damp, or methane gas. Fire-damp percolates through the surrounding strata and collects in the borings until it forms a highly explosive mixture with the surrounding air. Many appalling disasters in the history of coal-mining have been due to accidental explosions arising from this cause.

Another peril to miners arises from the presence of choke-damp—or carbon dioxide gas—which, though not so violent in its action as fire-damp, has also accounted for many lost lives.

Gas Warning

The arrangement illustrated in Fig. 3 is intended to act as an automatic sentinel, giving an audible warning of the presence of either of these destructive agencies.

The plate and grid circuits of the valve shown are, in effect, back-coupled through the intermediate link formed by a pipe, which acts as a resonator. The tuned-plate circuit A contains an electromagnet M which vibrates a diaphragm P (closing one end of the pipe) at a steady rate.

The impulses so set up in the column of air inside the pipe are

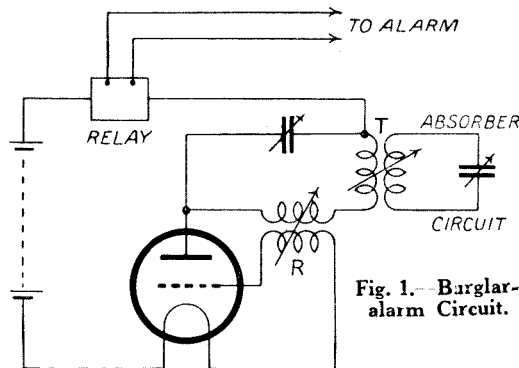

Fig. 1.—Burglar-alarm Circuit.



This drawing shows how valve apparatus may be used in mines to give warning of the presence of fire-damp, the miner's worst enemy.

THE VALVE AS WATCH-DOG (Continued)

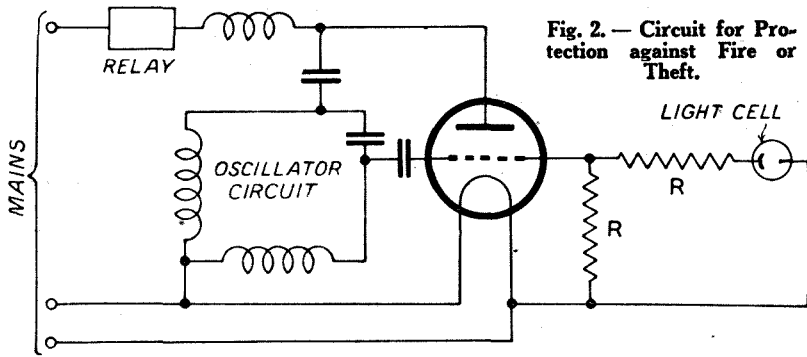

Fig. 2. - Circuit for Protection against Fire or Theft.

of a receiving valve, the output circuit of which contains a relay adapted to close the contacts of a local alarm.

On the Track

Mounted permanently on the track, as shown in the lower part of the diagram, is an oscillating circuit comprising two coils, A₁, B₁, so located that when the switch K is closed, the coil A₁ picks up energy (as the train passes) from the coil A, and transfers it *via* the coil B₁ back to the coil B of the receiving valve.

The latter is thereby energised and the relay is operated, either to ring an alarm or to drop an indicator visible to the driver; or it may be arranged to release the air-brake so that the train is automatically stopped.

The switch K is under the control of a distant signal cabin, either by being linked up to the ordinary track-side signal, or by means of an independent line. So long as the switch K is open, the track circuit A₁, B₁, cannot act as a coupling link between the oscillator and receiver on the train; but as soon as the switch K is closed, to indicate "danger," the passage of the train automatically operates the alarm or brake in the manner just described. B. A. R.

received by a microphone T at the other end, and, in turn, give rise to current fluctuations in the circuit X coupled to the grid or input coil of the valve.

Once the system has been adjusted there is a constant reaction between the grid and plate circuits of the valve. As the pipe has a natural note, similar to that of an organ pipe, it may be said to form a tuned-circuit coupling between the input and output circuits of the valve.

The natural note depends, however, upon the density of the gas inside the pipe, and the adjustments are made for a pure-air content. If fire or choke damp is present in the shaft, it enters through perforations made in the pipe, and changes the density of the contained air.

Natural Resonance Altered

The natural resonance of the enclosed column of gas is accordingly altered, the coupling between the plate and grid circuits is thrown out of tune, and the valve ceases to generate oscillations.

As soon as this happens the plate-current value changes as before, and an electromagnet Z in the high-tension circuit operates to close a contact K and so ring a distant alarm.

Fig. 4 illustrates diagrammatically one of the many ways in which wireless methods are being applied to railway signalling. The apparatus shown in the upper part of the diagram is carried on the train, the coils A and B being slung under the carriage just above the track. The coils are separated by a magnetic screen so that normally one cannot affect the other.

Circuit in Oscillation

The circuit containing the coil A is maintained in oscillation by any suitable means, such as a valve. The circuit containing the coil B is coupled to the input

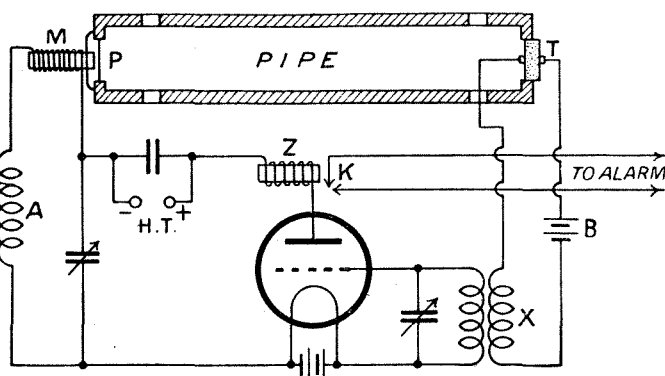

Fig. 3. - Circuit for Fire-damp Alarm.

ordinary track-side signal, or by means of an independent line. So long as the switch K is open, the track circuit A₁, B₁, cannot act as a coupling link between the oscillator and receiver on the train; but as soon as the switch K is closed, to indicate "danger," the passage of the train automatically operates the alarm or brake in the manner just described. B. A. R.

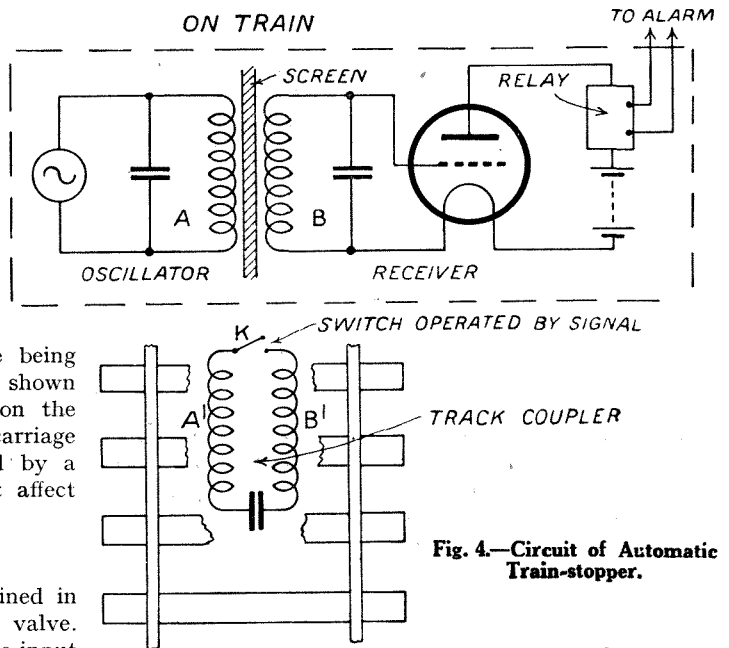

Fig. 4. - Circuit of Automatic Train-stopper.

"CHAOTIC Radio," due to sheer lack of organisation, is the only term which can be aptly applied to the broadcasting situation in France. Although concerts had already been broadcast from the Eiffel Tower and from a small station erected at Levallois - Perret by the Compagnie Radiola as far back as 1922, progress in France has been very slow, and she possesses to-day fewer broadcasting centres and a far less efficient service than any of the other European Powers.

For some unaccountable reason, although broadcasting *per se* appealed at the outset to most European nations, the French Government did not see its way to establish a similar service in France, and most of the pioneer work has been left to private enterprises, which in their turn have been compelled to pay all the expenses inherent to such transmissions and consequently have been hampered by the lack of any fixed revenue derived from the listening public.

Pulling Down the Eiffel Tower

Had it not been for the advent of wireless telephony the Eiffel Tower, which for thirty-six years has been standing on the Champ de Mars as a Paris land-mark, would have been pulled down towards the end of 1914. At the outbreak of war the French military authorities requisitioned it from the Municipality of Paris for the establishment of one of France's most important wireless stations.

In 1922, still under military control, experimental musical transmissions were broadcast from the Eiffel Tower in addition to the usual

CHAOTIC RADIO!

An exclusive and authentic article by J. Godchaux Abrahams, revealing the true state of the broadcasting situation in France.

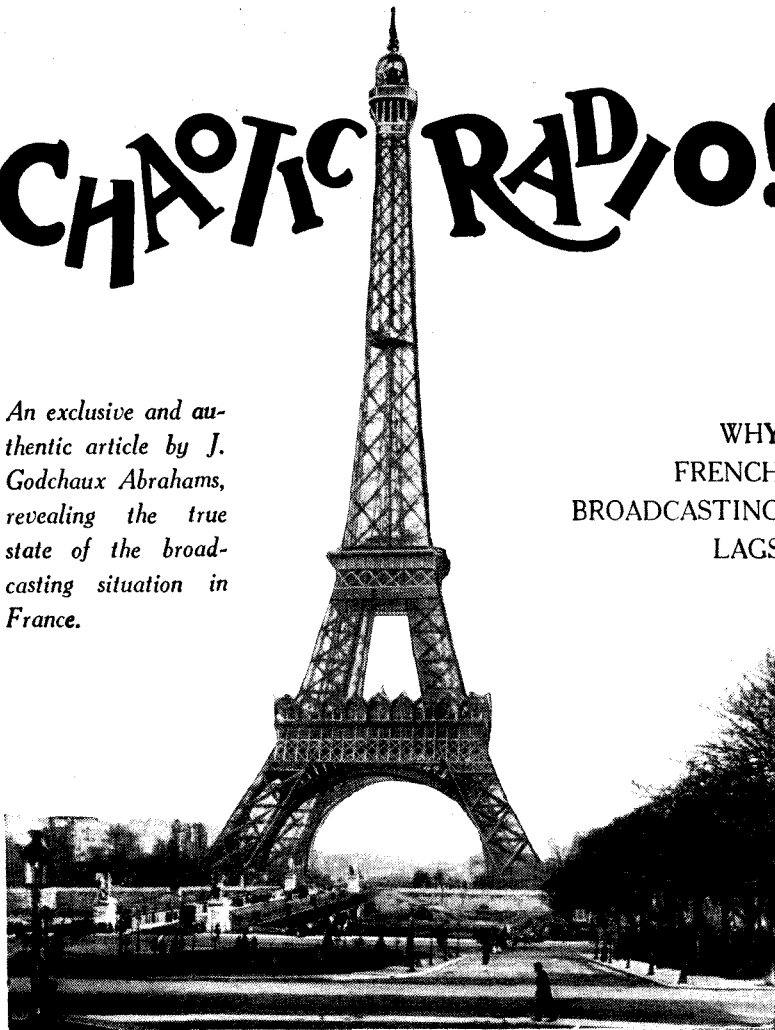

A View of the Eiffel Tower.

WHY FRENCH BROADCASTING LAGS

telephony, meteorological, and market reports.

Later, a small club of wireless enthusiasts got together, and from that moment concerts were regularly given out on certain days of the week. The expenses for running these transmissions were covered by subscribers, but it was found that the income obtained in this manner was not adequate for the work which the organisers wished to undertake. M. Maurice Privat, the present director of the Eiffel Tower broadcasts, was anxious that France should possess a station equal to any installed in neighbouring countries, and it is through his influence that the programmes have recently been considerably extended.

Even to-day the income enjoyed by the Association des Amis de la Tour Eiffel is but small, and most of the artists and contributors to the programmes are unpaid, having offered their services free. It is an

unfortunate state of affairs, as in these circumstances it is impossible to provide listeners with very much else but second-rate talent, and it may be said that the Eiffel Tower is for the present only used as a jumping-off platform for little-known artists or composers in the Paris musical world.

A feature which has been inaugurated during the afternoon transmissions is the *Journal Parlé*—the vocal newspaper—which, instead of being a news bulletin as adopted by most broadcasting stations in Europe, is purely a commentary with more or less biased opinions on the day's topics.

A newspaper entitled *La Parole Libre* is also published once a week for the purpose

of advertising the Eiffel Tower entertainments and the artists or speakers contributing to them. The paper fully justifies its title, inasmuch as in its columns will be found lengthy diatribes levelled against its chief Paris broadcast competitors.

Although of recent date, by agreement with the Administration of Posts and Telegraphs, the Eiffel Tower has been admitted to its little brood of relay stations, it is a matter of conjecture in French wireless circles whether the service given by this station can endure, as it is compelled to rely for its programmes solely on the good-will of publicity-seeking volunteers.

Radio-Paris

Of the privately owned broadcasting stations in Paris, our old friend Radiola (Radio-Paris) is the only one which actually possesses a regular licence from the State, and although the Cie Française de Radiophonie for

Chaotic Radio! (Continued)

the enjoyment of this privilege is mulcted into several hundred thousand francs a year, the concession is a purely temporary one, and strictly limited in scope. Radio-Paris, with a view to improvement, has erected at Clichy a transmitter capable of putting out 15 kilowatts, but permission to use it has never been granted by the State.

Little State Encouragement

As already mentioned, but little encouragement, if any, has been given by the French Government to privately-owned wireless enterprise; broadcast publicity is strictly forbidden, and the prohibition closes to the station the main source of revenue.

It is true that the Cie Française de Radiophonie is interested in the sale of wireless receivers and components, but the recent appeals made by this station for voluntary subscriptions and donations from listeners in France and abroad tend to prove that the operating of the Clichy station and Paris studio has constituted an onerous burden to the organisers.

The meagre income vouchsafed to the company from royalties prevents both improvement and development of the programmes, and for many of them Radio-Paris is also compelled to rely on outside organisations; for example, the Association of French Radio Amateurs, L'Union des Grandes Associations Françaises, "Radio Art et Pensée," from newspapers as *Le Matin*, *L'Ere Nouvelle*, *Radio-Téchnique*, *Radio Magazine*, or again from industrial concerns such as Maison Française de L'Appareillage or the Cie des Lampes Metal (valve manufacturers).

Drastic Measures Needed

Unless drastic measures are taken to assist this station, it is very doubtful whether the company can see its way to continue daily transmissions of any magnitude; as it is, the afternoon programmes, on several days a week, have been cut down to a minimum.

Perhaps of all the stations at present operating in France, Radio Toulouse is the one which most regularly sends out an extensive programme and which in many ways can be compared to our own home broad-

casters. Much of the success achieved by the station is due to the indefatigable energy of its organisers, La Radiophonie du Midi, who, realising from the start that if programmes were to satisfy listeners a regular income was essential, started at the outset with a vigorous publicity campaign and by this means roped in, as supporters and financial "backers," a great number of associations, both of a private and semi-official nature, as well as business houses in the area.

It may interest readers to learn that Radio Toulouse is actually assisted financially by roughly thirty different municipalities, borough and parish councils, by the Federation of the South-west of France Radio Associations, a further seventeen amateur wireless clubs, 183 local agricultural societies, the Automobile Club du Midi, a group of grain growers, Chambers of Commerce, local newspapers, factories, and commercial firms of every description. Veiled publicity must of a necessity play an important part in its transmissions.

Operating for Ten Months

Radio Toulouse has now been operating for about ten months, and the organisers have realised that if the service is to be developed, or even kept to its present standard, steps must be taken to place the enterprise on a sound financial basis.

L'Ecole Supérieure des Postes et Telegraphes, at Paris, was the first French station to effect transmission on short waves. This station is the exclusive property of the Post Office and was installed in the first instance by this government department for the use of students attached to the staff college. For some time it was entirely devoted to its original purpose, but on February 27, 1923, PTT gave the first public-theatre broadcast, namely, a relay from the Grand Opera House of Wagner's *Master Singers of Nuremberg*.

Owing to the fact that the station is State-owned, it possesses the advantage of being able to utilise at any moment, and for any period of time, the Post Office land-lines, a valuable asset which it has jealously monopolised.

Moreover, its official status in Paris carries with it the privilege of relaying performances from any or all of the state- or municipal-subsidised theatres, and for the same reason it can make good use of any or all ceremonies taking place at the numerous *mairies* (town halls) in Paris or in the provinces, and bolster up its programmes with lectures given by professors at the Sorbonne University.

Chain of Relay Stations

The French Government—or at least that portion of it controlling the Ministry of Posts and Telegraphs—is anxious that broadcasting should become a State monopoly, and in order to curtail possible developments on the part of privately-owned companies, L'Ecole des Postes is installing, as rapidly as its financial means will permit, a chain of relay stations in the provinces, such transmitters to be connected to Paris by land-lines.

Stations of relatively small power and, generally speaking, of poor quality, have already been permanently installed at Marseilles, Lyons, Toulouse and Bordeaux, also temporarily at Grenoble and Dijon, and the extension programme will include such cities as Lille, Strasburg, and Angers.

To all appearances the installation of transmitters in the last centres will depend mainly on the possible activities of private wireless clubs or associations, as it is not a mere coincidence that Lyons and Toulouse should have been chosen by the PTT for their first relays. Such a step was taken for the only reason that competitive stations were already under construction in those districts.

No Revenue from Listeners

Here again, for the present, the Paris PTT station and its relays receive no revenue from listeners, and if the programmes are studied it will be found that apart from the facilities mentioned—of relays from theatres, University, and town halls—the organisers, to secure a continuity of transmissions, are compelled to rely on concerts offered to them by such associations or clubs as Les Auditeurs de T S F, or the Renaissance Française, or from in-

The "Wireless Magazine" Map of French Broadcasting Stations

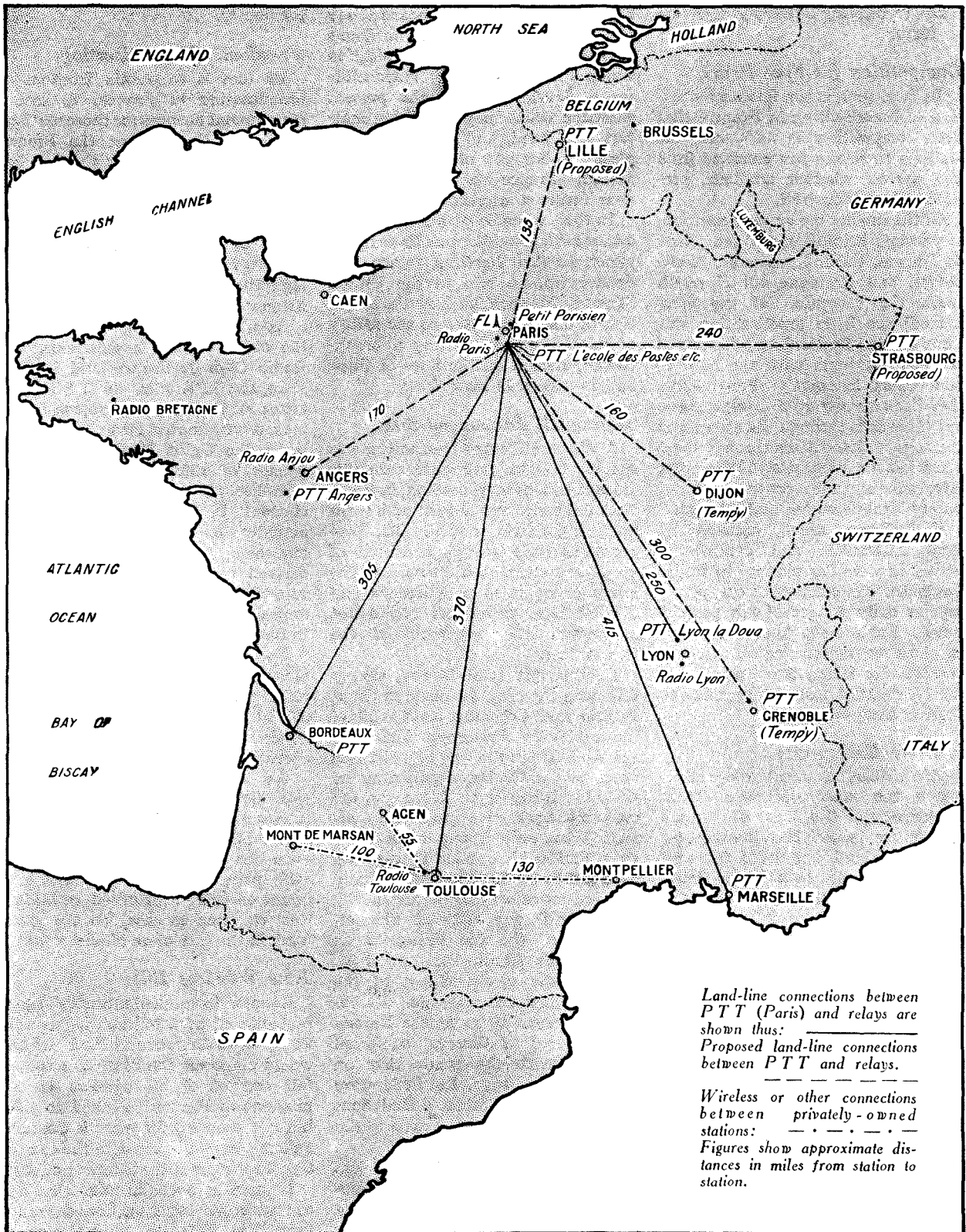

Chaotic Radio! (Continued)

dustrial concerns, with a view to publicity, as the Phillips Valve Company, Hydra Dry Battery Works, and so forth.

Competition for Free Items

In fact, such is the financial situation of broadcasting in France, that keen competition exists among the stations to secure *free* concerts from any source, whether amateur, professional or industrial.

Of the smaller fry we may mention, in passing, Radio-Lyon, Agen, Mont de Marsan, Caen, Normandie, Montpellier, and Bretagne, all of which (with the exception of the first-named) are little broadcasting stations erected by local associations of wireless amateurs with the help of benevolent listeners. Fungus-like, they have sprung up over-night, sent out their calls through the ether, and then either closed down through sheer inanition, or presented at irregular intervals anæmic programmes of purely local character and interest.

Radio-Lyon, alone, assisted by local authorities and commercial houses in a similar manner to Radio Toulouse, was enabled to organise a regular daily service of fair proportions; Radio Agen limits its transmissions to meteorological reports and weather forecasts obtained from the Pic du Midi observatory, and one short concert weekly.

Run by Enthusiasts

Montpellier, a small 100-watter, relays the more energetic Radio Toulouse, and the Mont de Marsan transmitter, when broadcasting (at time of writing it has closed down for repairs), simply acts as a loud-speaker for the Radio Club Landais. It is run by a few enthusiasts, and prides itself on the possession of a good-quality gramophone.

Believe me, I do not criticise the poorness of the programmes given by the French stations in any carping spirit; under present conditions obtaining in France the organisers cannot do better. My sole aim is to marshal facts, to describe the present state of affairs, and to show the true causes of the inefficient and unsatisfying service offered to the French listening public.

If, up to the present, I have made no reference to the station of *Le*

Petit Parisien, it is not because it is the least important of the French broadcasters. By no means; my reason for not mentioning it until now is because it is this organisation which has been mainly responsible for a development in the present situation which may well bring matters to a head, and secure a complete upheaval of the present system—France may witness in the near future a wireless renaissance.

In 1923, when Senator Paul Dupuy, owner of that well-known Paris newspaper, *Le Petit Parisien*, returned to France from a trip to the United States of America, he drew the attention of his co-directors to the utility of purchasing or erecting a broadcasting station on the lines of those he had visited in New York.

Bi-lingual Announcements

A Western Electric transmitter was quickly bought, and since 1924 this station has been providing listeners both in France and abroad with three or four concerts weekly. The programmes have always consisted of vocal or instrumental items, and the announcements in both French and English have never left any doubt as regards the ownership of the transmitter.

But Senator Paul Dupuy, closely following the progress made in Great Britain and Germany, soon realised that little was to be expected from the French State in the way of assistance or support to the broadcasting movement in his country. Moreover, the transmitting licence granted to his station was only partly renewed in 1925, and in his opinion it was "up to him" to take the initiative if any decisive move was to be made.

Senator Dupuy, with M. Platrier, Director of the Cie Française de Radiophonie (Radio-Paris), and M. Tabouis, the vice-president of the Union Internationale de Radiophonie, known to us as the Bureau International of Geneva, conferred together, with the result that on November 21, 1925, La Fédération Française des Postes d'Emissions Radiophoniques was successfully launched.

This association of private wireless transmitters comprised: Radio-Paris, *Le Petit Parisien*, Radio-Toulouse, Lyons, and also took under

its protective wing all the other little mushroom "radios" mentioned previously.

Freedom of Broadcasting

Its aim is to obtain freedom of broadcasting in France, to secure government licences for those stations which for the present the French State has classed under the heading of *illicit transmitters*; to establish a scale of royalties payable to authors and composers for the broadcasting rights of their works; and, generally, to regularise all matters affecting the wireless transmitter or listener.

At about the same time two of the older wireless associations, the Radio Club de France, and La Sté Française d'Etudes de T S F, the latter alone numbering 10,000 members, amalgamated into one common body, the Union Radiophonique de France, of which the ambition is to subsidise all desirable broadcasting stations in that country. It is actually engaged in a publicity campaign, the income for which is derived from a yearly membership subscription of 10 francs; it is appealing for voluntary donations to further the cause.

Up to the present the Eiffel Tower alone has not responded to its appeal, most probably owing to its semi-official standing, namely, a military wireless station working in close cooperation with L'Ecole de Postes.

We therefore find in France to-day two distinct groups of divergent interests; on the one hand the State represented by P T T, and its relays—on the other, a band of enthusiastic private broadcasters who are intent on being legitimised, or failing this, threaten to carry on the good work in the face of an official veto.

New Wireless Bill

Events have undoubtedly been precipitated by a bill laid before the Chamber of Deputies in Paris, which would empower the State to assume full control of all wireless transmissions in France. Linked to this bill is a proposal for what is deemed an exaggerated increase in the tax to be collected from the listening public.

It must be borne in mind that up to time of writing these lines the only formality which the owner of receive-

An Exclusive Article on French Broadcasting

ing apparatus in France was required to fulfil was a simple registration at a local Post Office, the fee for which was nominal, namely, 1 franc. Supervision, however, has been, and still is, exceedingly lax; there are very many thousands of listeners who have not troubled to secure licences.

Extra Sources of Income

The French Government, in its search for extra sources of income, appears to have noticed that broadcasting in other countries has assumed such proportions that a big revenue is obtainable from the general public.

The Bill which it is now proposed to pass in France would authorise the taxation of all receiving apparatus on a much higher scale than has hitherto been the case. For the first year the sum of 60 francs is to be charged on all single- or multi-valve receivers, a reduction of 10 francs on the amount being made for subsequent years; for ordinary crystal sets the tax will be 20 and 15 francs.

As it is well known that the French nation is, as a whole, against any direct taxation, the Bill provides a clause whereby as a deterrent, in the event of any default, the possessor of a set may be fined ten times the annual licence fee.

In addition, an extra tax of 2 francs per unit will be collected by the post and telegraph authorities on every receiver sold by manufacturers or dealers, and here again penalties of from 100 to 1,000 francs can be inflicted; in fact, should any individual be convicted on two counts, the fine may be increased threefold.

Private Enterprise in Danger

The French wireless world is entirely adverse to the adoption of such a policy, as it is felt that the acceptance of this new Bill would not only ensure the monopoly of broadcasting to the Post and Telegraph department, but that such a measure would undoubtedly lead to the annihilation of all private enterprise; it would mean the closing down of every broadcasting station at present operating in France with the exception of those now in the possession of the State.

As usual in all questions which affect a home policy, party politics play an important rôle but, unlike participators in such discussions in the United Kingdom, in France the contesting parties do not stop at "personalities," and violent arguments are put forward, regardless as to whether the statements made are substantiated or purely fictitious,

DO YOU WANT TO BUY A SET?

We shall be glad to advise you as to which types of sets are the best for your personal use.

Tell us how much, roughly, you wish to spend; where you are situated; what stations you wish to receive; whether you intend to use phones or a loud-speaker, and we will advise you as to the general lines of sets that will answer your purpose.

Send your enquiry with coupon (p. iii cover) and stamped addressed envelope to—

"Buyers' Advice Bureau,"

**THE WIRELESS MAGAZINE,
La Belle Sauvage, E.C.4.**

for the purpose of swaying public opinion.

In this respect, it may be mentioned that supporters of the Government have not hesitated to spread reports to the effect that the International Bureau, a scheme of British origin, was started not with the idea of co-ordinating and regulating broadcasting in Europe to the benefit of all countries, but that the main object in view was the reduction of the number of transmitters in all countries, the preference to be given to those stations connected directly or indirectly with the Marconi Company and affiliated associations.

Moreover, it is affirmed that the adherence of the French State to such an organisation would inevitably lead to a monopoly held not by the French Government, but by the "Big Four," the *deus ex machina* of the movement, as, so it is said, has been the case with wireless telegraphy!

Recently it has even been openly averred that the International Bureau would not deal with the French Government and that in order that France should not be excluded from the international concert, all steps are being taken to induce that State to grant to the Compagnie Française, or failing this to the new French Federation of Private Transmitters, a liberal concession and a fully-authorised licence.

Legality Challenged

But, on the other hand, certain quarters have challenged the legal character of the bill which it has been proposed to bring into force. It appears that, according to French law, any tax collected in respect of wireless receivers or components could only be devoted to public funds, and that, without special legal authority no part of this income could be paid over to the transmitters.

In view of France's financial difficulties it is hardly likely that such authority would be voted by the Chamber of Deputies and the Senate.

The new French Federation may therefore proclaim that it requires no subsidy from the State but that, on the contrary, the impetus it will give to the broadcasting movement will help to replenish France's impoverished coffers; that a tax, of which the amount is debatable, should be levied and that all which is needed is authority to broadcast and the right to secure a revenue from publicity.

State Monopoly

It is not known whether the French Government is sufficiently strong to secure the legalisation of this new Bill against the strenuous opposition of individual concerns backed by influential political parties, but apparently in view of a possibility that the monopoly *might* pass to the State, and that the Government *might* feel inclined to buy the present existing transmitters, several small organisations have clubbed together with a view to resuscitating broadcasting stations in the hope that they will be later acquired by the State at a remunerative price!

Chaos, indeed!

A FAREWELL IMPRESSION OF THE SAVOY HAVANA BAND

SLADE



It has been officially stated that no longer will these popular musicians be heard by wireless, inasmuch as they will not broadcast after February 27. In the centre is Ramon Newton—you have heard him sing the chorus!

Structograph Coloured Plate and Blueprint for this Set FREE with This Issue



Designed, Built and Tested by the "Wireless Magazine."

IN the first issue of THE WIRELESS MAGAZINE there was described a four-valve receiver, under the title "As Good A Set as Money Can Buy," that has enjoyed a huge popularity, not only in this country, but also in places as far away as Australia, New Zealand and China.

Criticism

We have had criticism—criticism is the weather vane of popularity—both constructive and destructive, but the former heavily outweighs the latter; and it is this that decided us to describe improvements upon the original receiver in the September issue of THE WIRELESS MAGAZINE.

As time goes on, however, components improve and new ideas are evolved as to how the perfect receiver should be designed, and it is with these latest improvements that the new edition of "As Good a Set as Money Can Buy" is here described for the benefit of our readers.

Little change has been made in the theoretical arrangement, with the exception of the last stage of low-

frequency amplification (originally transformer-coupled), which is now coupled by a choke-capacity unit. Provision is made for the switching in or out of circuit of the high-frequency amplifying valve, the polarity of the reaction coil being reversed at the same time. Another switch cuts out the last stage of low-frequency amplification when this is not required.

Thus the operator has the choice of using two, three, or four valves, making the set suitable for the reception of all stations on the phones or on the loud-speaker.

Referring to the theoretical circuit diagram it will be seen that the tuning system consists of an inductance tuned by a variable capacity, the H.F. oscillations received at the aerial being passed on to the grid of the first valve, where they reappear in an amplified form in the plate circuit.

In this latter circuit are connected another inductance and variable capacity, which, when tuned to resonance with the amplified oscillations, pass them by a shunt circuit

through a small fixed condenser to the grid of the detector valve.

Rectification is then performed by this valve, in the plate circuit of which the H.F. oscillations are cut in half, so to speak, forming small unidirectional impulses which vary in amplitude.

If the crests of all the impulses plotted on paper were joined together, a wave-form would be obtained identical to that passing through the microphone at the broadcasting station.

Reaction

In order to give the "boosting" effect to the original oscillations in the aerial circuit, a coil connected in the plate circuit of the detector valve is coupled to the aerial tuning coil. This "boosting" effect, known as reaction, is extraordinarily efficient, and by it the reception of far-distant stations is thus rendered possible.

After passing through the reaction coil, the impulses traverse the primary of a low-frequency transformer, producing similar impulses in the

As Good A Set As Money Can Buy (Continued)

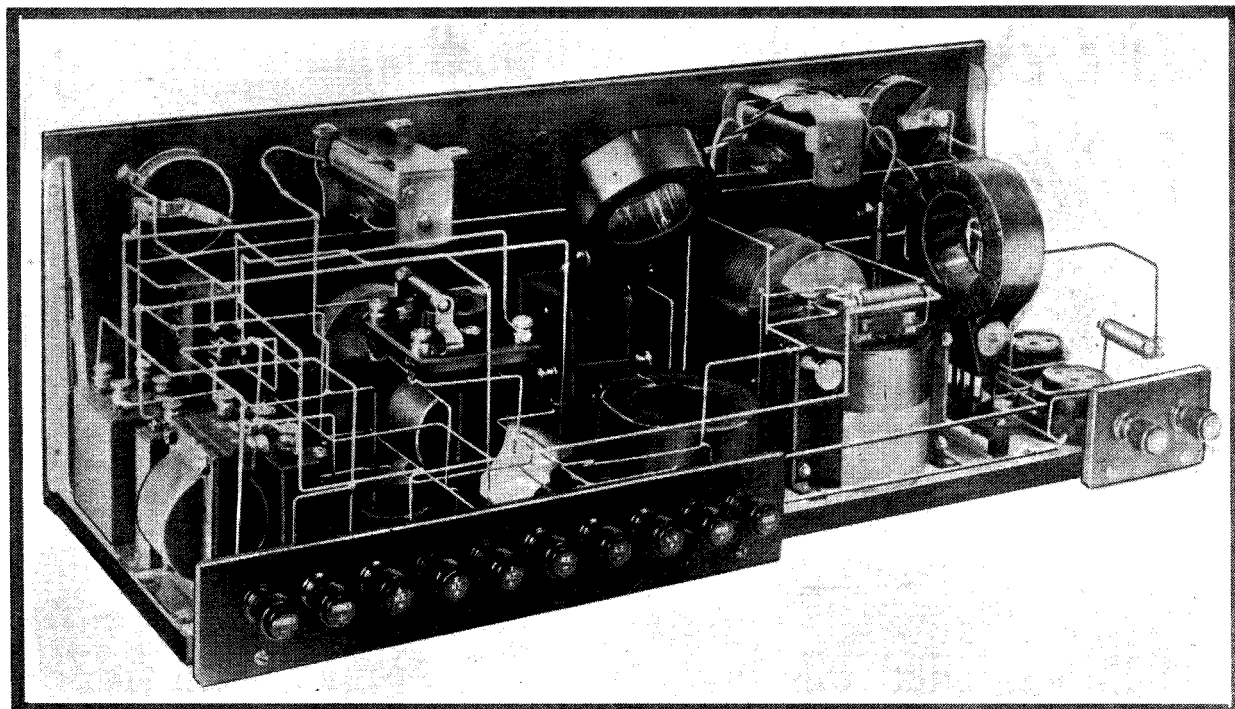

This photograph shows the arrangement of the components in new edition of As Good a Set as Money Can Buy Four-valver.

secondary, but at a much higher voltage. Further amplification takes place in the first low-frequency valve, and, if necessary, still further amplification may be performed by the last valve, in the plate circuit of which is connected a low-frequency

choke coil shunted by a large-capacity fixed condenser. The loud-speaker is connected in series with the choke coil.

This method of connecting the loud-speaker prevents the actual H.T. battery current for the valve

passing through the loud-speaker windings, thus minimising the danger of either demagnetising the magnets or burning-out the windings.

A master rheostat is provided so that, after the valves have been adjusted individually to their correct

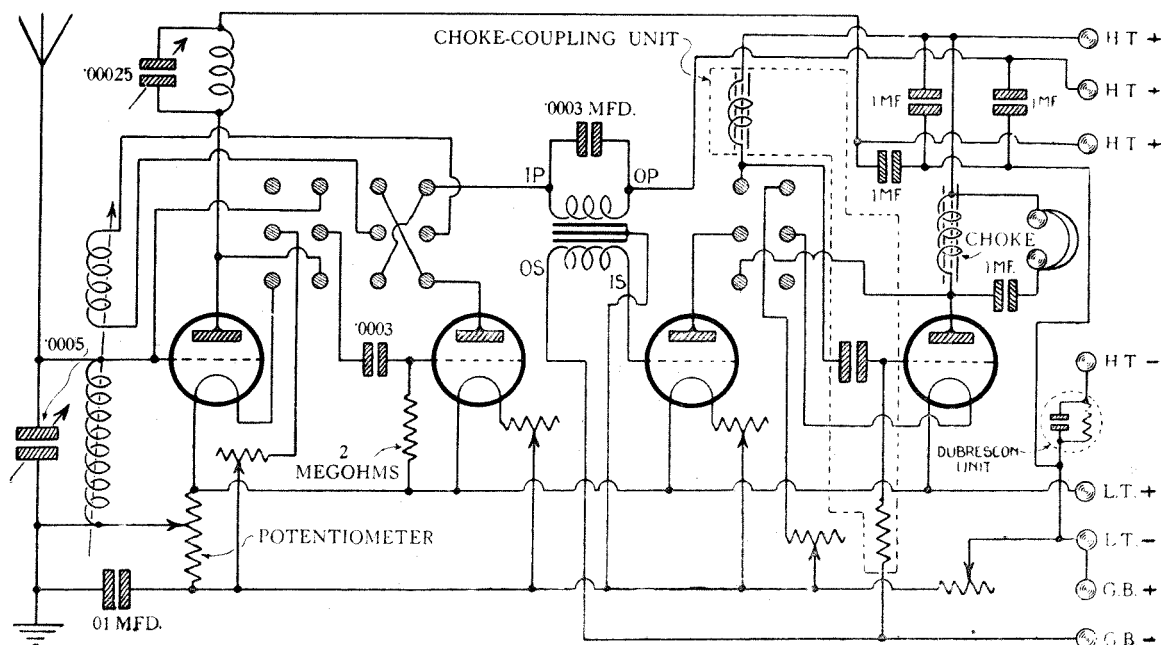

Circuit diagram of new edition of As Good a Set as Money Can Buy.

New Edition of Our Famous Four-valver

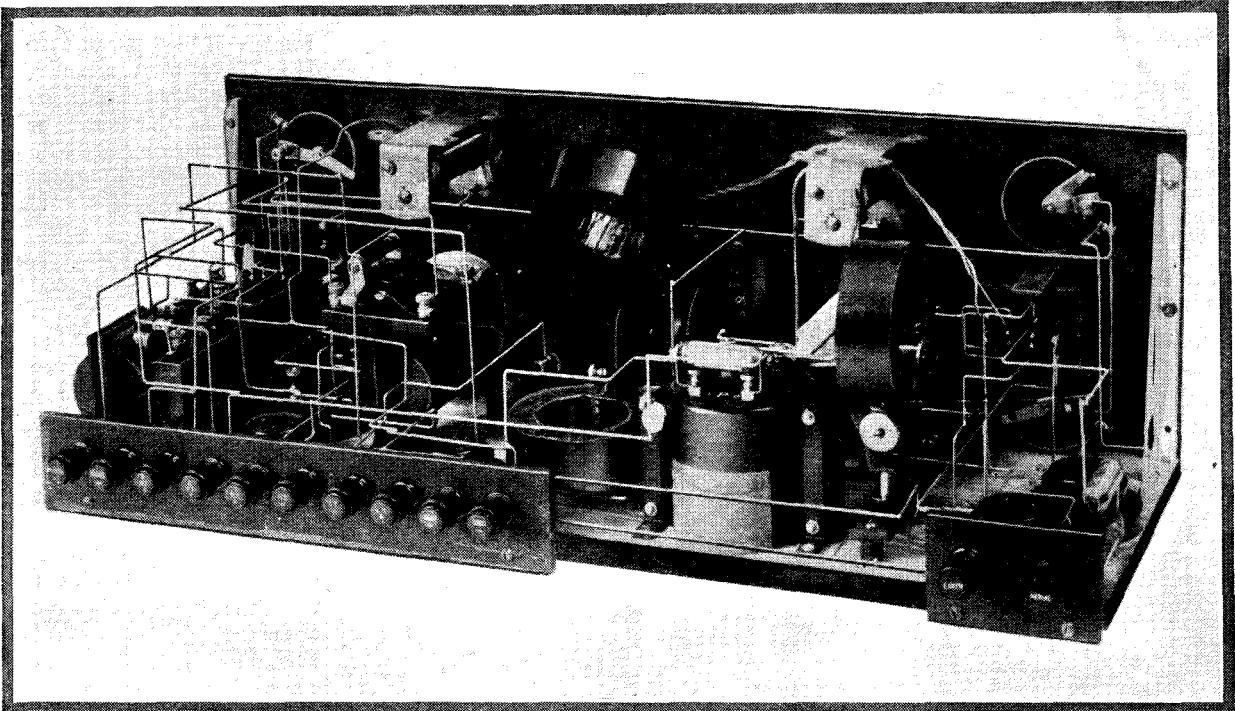

Another photograph showing the wiring of the new As Good a Set as Money Can Buy.

filament temperatures, they can be all controlled by the one rheostat.

On the high-frequency side a potentiometer is connected across the L.T. battery so that the potential on the grid of the first valve can be regulated. If any tendency is shown

for the H.F. valve to oscillate, the adjustment of the potentiometer will, by damping, keep the oscillation in check.

A full list of the components is given on p. 124, together with the manufacturers' names. If good

results are to be expected, we strongly advise our readers to keep to this list. Our experience with a few of the original receivers that we have tested for some fault has shown that the necessity of using high-grade components is very essential;

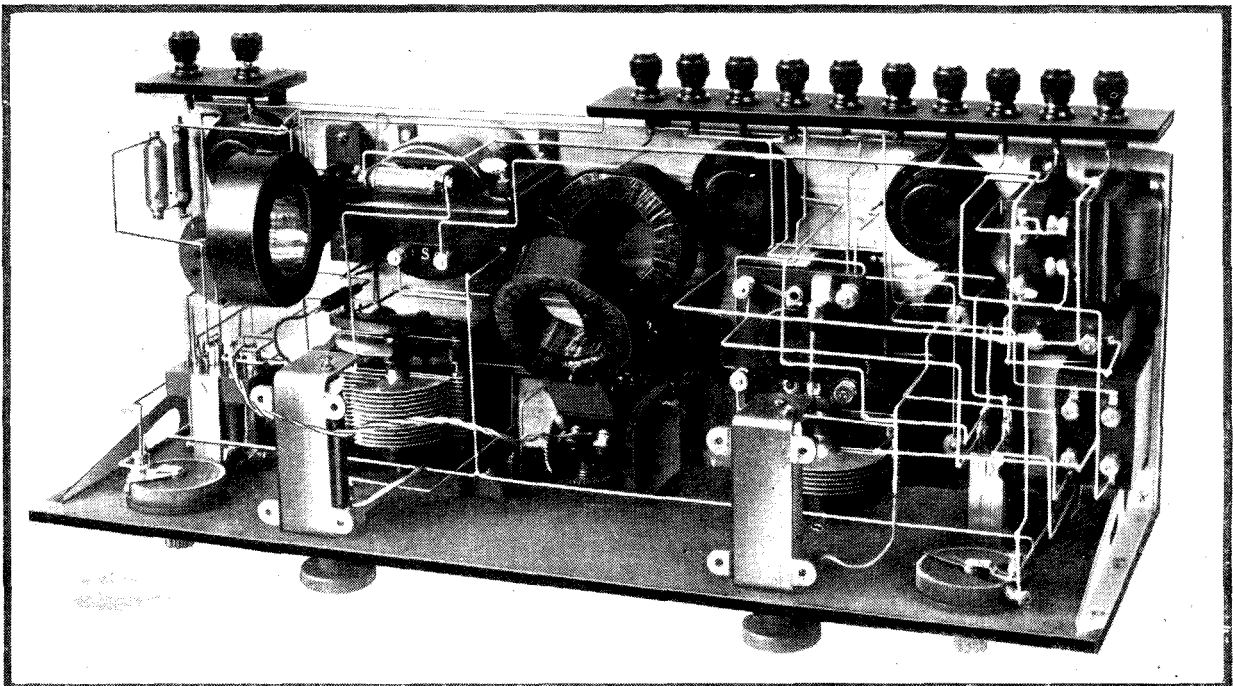

Photograph showing layout of baseboard of new As Good a Set as Money Can Buy.

As Good A Set As Money Can Buy (Continued)

remember that a set is no better than its worst component:

Radion panel, 21 in. by 7 in. by $\frac{3}{8}$ in. thick (American Hard Rubber Co.).

.0005-microfarad variable condenser with vernier (Dubilier Vanicon).

.00025-microfarad variable condenser with vernier (Dubilier Vanicon).

4 filament rheostats, 35 ohms each (Lissen).

Double-pole change-over switch (Burndept).

Four-pole change-over switch (Burndept).

4 anti-microphonic baseboard-mounting valve holders (Burndept).

Potentiometer (Marconiphone Velvet).

Master rheostat (Marconiphone).

L.F. transformer, ratio 4 to 1 (Marconiphone Ideal).

L.F. choke-coupling unit, 2nd stage (A.J.S.).

L.F. choke (A.J.S.).

4 1-microfarad fixed condensers (Dubilier Mansbridge).

Panel-mounting two-way coil-holder (Hirst Bros., Oldham).

H.T. safety device (Dubilier Dubrescon).

2-megohm grid leak (Darco).

2 .0003-microfarad fixed condensers (Wates).

12 terminals (Belling and Lee).

2 ebonite terminal strips, 11 in. by 2 in., and 3 in. by 2 in.

.01-microfarad fixed condenser (Paragon).

Fixed coil holder (Athol Engineering).

Fixed coil-holder ebonite mounting strip, 3 in. by $\frac{3}{4}$ in. by $\frac{1}{4}$ in. thick.

Ebonite tube, $3\frac{1}{2}$ in. long by $\frac{3}{8}$ in. diameter.

Panel-mounting brackets (Pranco).

Wood baseboard, 21 in. by 7 in. by $\frac{1}{2}$ in. thick.

Special cabinet (Caxton Wood Turnery Co., Market Harborough).

The first step in the construction is the drilling of the panel, which is standard size, and therefore requires no cutting. For this purpose the special blueprint drilling template (given free with this issue) should be used.

Symmetrical Layout

A glance at the photographs of the completed receiver will show that the components are symmetrically laid out on the panel, that is, the left-hand half of the panel is identical to the right-hand half. Hence, if

we have a template which shows the positions of holes to be drilled through one half of the panel, by reversing the template the positions of the holes on the other half will be indicated. Such a template is supplied with this issue of THE WIRELESS MAGAZINE.

To drill the panel, place the blueprint template exactly over the left half of the panel and mark through the centres of the holes to be drilled on to the panel by means of a sharp steel point. Now remove the template and, reversing it, place it on

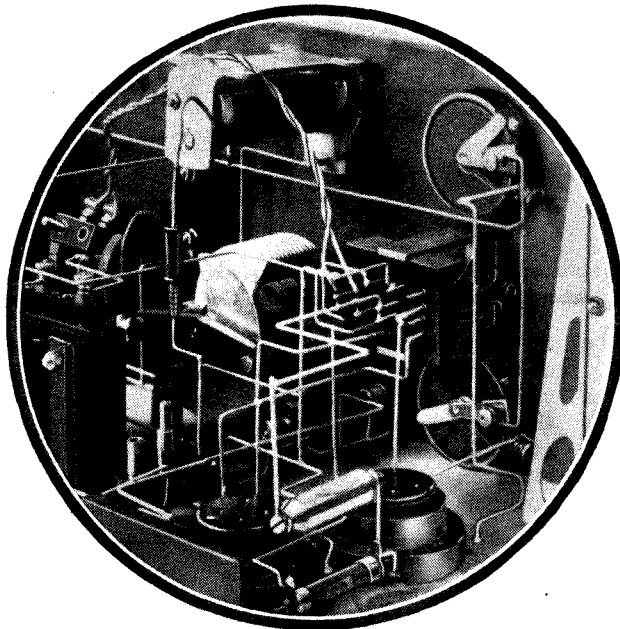

Wiring of Switch for cutting out H.F. valve.

the right half of the panel, marking through all the hole centres as before, taking special care with those necessary for the fixing of the .00025-microfarad variable condenser.

The fixing holes for both variable condensers are diagonally placed, so if the holes are reversed the condenser will be upside down. It is necessary, therefore, to mark the holes for the condenser in question in exactly the same manner as for that on the left-hand side. For this purpose read the special instructions on the blueprint.

The positions of the components mounted on the panel will be seen at a glance from the photographs and the Structograph wiring diagram. In the centre of the panel, at the bottom, the two-way coil

holder is mounted in such a manner that the fixed coil lies parallel to and about $\frac{1}{2}$ in. above the baseboard, whilst the moving coil, controlled by a dial and knob on the panel, is capable of movement in an arc of a circle the plane of which is perpendicular to the panel.

Variable Condensers

On each side of the two-way coil holder a variable condenser is mounted, the .0005-microfarad on the left. Above the condenser are fixed the potentiometer and the master rheostat, the potentiometer being mounted directly above the larger variable condenser. At the extreme ends of the panel are seen the lever switches, with a filament rheostat above and below each.

Having mounted the components just mentioned on the panel, this can be put aside and attention turned to the baseboard, on which the remainder of the components are fixed. An idea of their disposition will be obtained from the Structograph coloured plate. It will be seen that the set is particularly compact.

On the extreme left of the baseboard, looking from the front, two valve holders are mounted, one behind the other, together with the cylindrical grid condenser and leak. Next to the valve holders the fixed anode-coil socket is mounted on a piece of ebonite 3 in. long by $\frac{3}{4}$ in. wide, screwed to the baseboard but separated from it by two $\frac{1}{2}$ -in. ebonite distance-pieces cut from ebonite tubing.

The low-frequency transformer is mounted beside the fixed-coil socket, care being taken to leave plenty of room for the circular movement of the reaction coil mounted in the centre of the panel.

On the extreme right of the baseboard the choke-capacity unit (for preventing current from passing through the loud-speaker) is mounted, together with the H.T. shunting condensers and the Dubrescon safety device. Directly behind the anode

Two, Three, or Four Valves At Will!

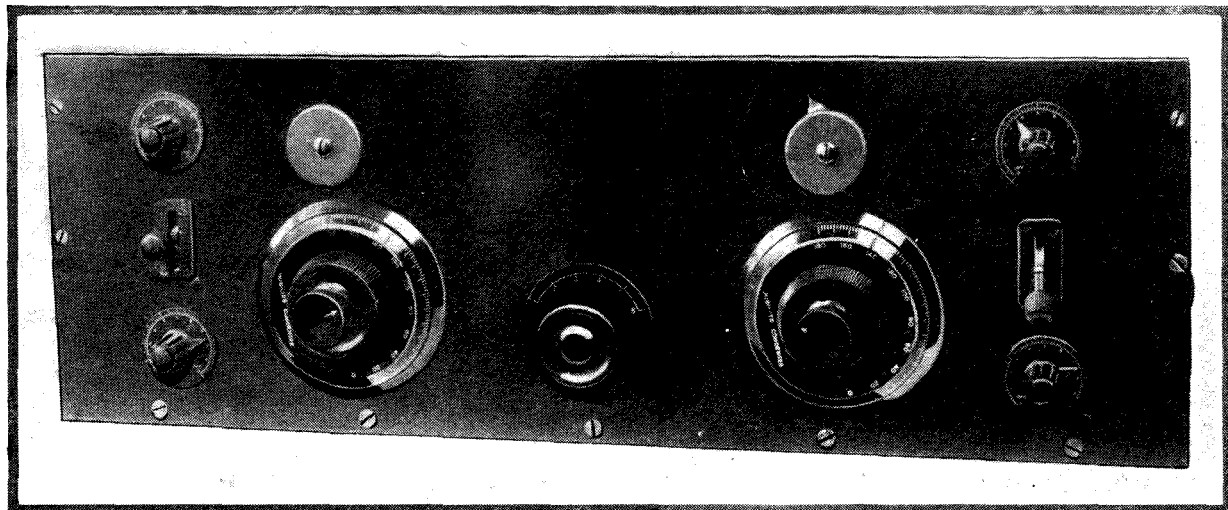

Photograph showing panel of new As Good a Set as Money Can Buy.

tuning condenser is mounted the A.J.S. intervalve choke-coupling unit and the remaining two valve holders.

The larger terminal strip, carrying the phone, H.T., L.T., and grid-bias terminals, is screwed to the back edge of the baseboard on the right, the smaller strip with aerial and earth terminals being mounted at the left-hand edge (still looking from the front).

It so happens that the Wates fixed condenser, supplied with brass clips, can be actually fixed to the two primary terminals of the low-frequency transformer, the leads to which may be attached to the

terminal screw on each end of the condenser. All the other small fixed condensers, and the grid leak, are held in position by the wiring, and need not be fixed by screws to the panel or the baseboard.

From a glance at the photographs it will be appreciated that the wiring of the set requires great care, especially with regard to the switches, which render the connections rather complicated. By carefully following the Structograph coloured wiring diagram, however, the possibility of making a mistake is small. In the wiring diagram, connections are shown in three systems of colouring. All the grid circuits of the four valves

are shown in black, the filament-lighting circuits in red, and the plate circuits in red and white.

For convenience in wiring it is better to start with the filament-lighting circuit, shown in red, otherwise access to the filament rheostats and valve holders, mounted on the panel and baseboard respectively, will become extremely difficult owing to the net-work of wires formed round them.

As a guide to the order in which the components should be wired, each terminal of every component has been marked in the Structograph coloured plate with a small letter of the alphabet. It will be

Cabinet Dimensions.

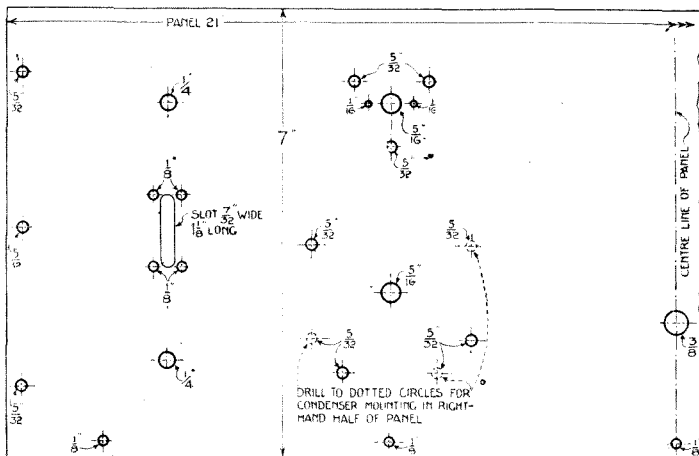
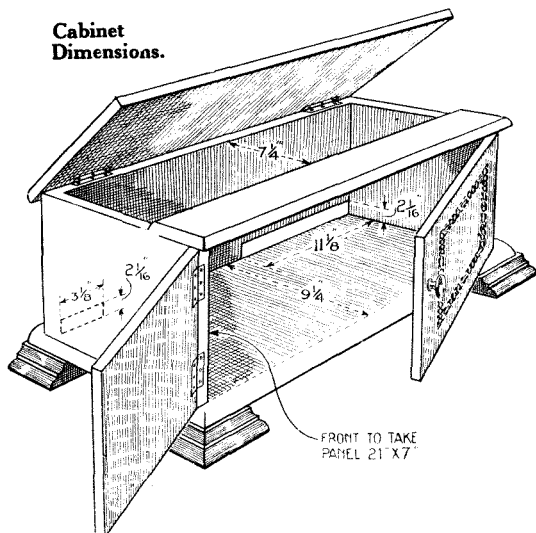

Panel Layout (left-hand side).

As Good A Set As Money Can Buy (Continued)

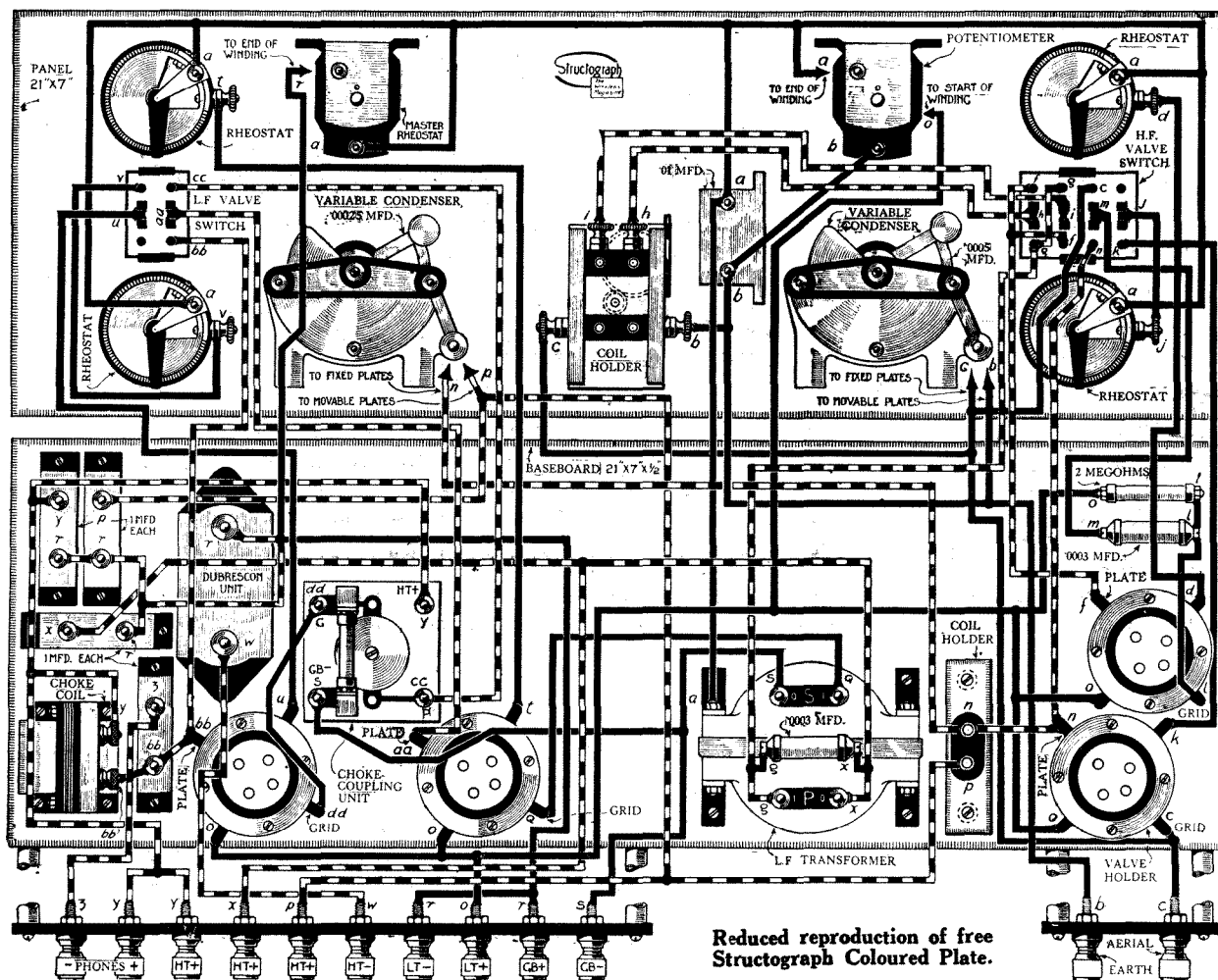

Reduced reproduction of free Structograph Coloured Plate.

noticed, for instance, that some terminals are marked *a*. All the terminals so marked should be the first to be connected together with one wire or as few wires as possible. Next, all the terminals marked *b* are joined together in a similar manner; then those marked *c*, and so on.

Flex Connections

Connections to the master rheostat, potentiometer and moving reaction-coil socket are made with short pieces of flex, thus giving these components freedom of motion.

Plenty of room should be allowed for the insertion of the valves and coils into their respective sockets, and it should be particularly noted that the reaction coil is capable of movement without fouling any of the wiring.

The wiring being completed, the

set may be given a preliminary test. First of all, in order to see that there is no danger of the valves being burnt-out by a wrong connection between the H.T. and L.T. circuits, plug three coils into the coil holders and four valves into the valve holders. Turn each filament rheostat to its maximum position and see that both the H.F. and last L.F. valves are in circuit.

Now connect the L.T. accumulator to the H.T. terminals, the negative terminal of the accumulator to the negative of the set, and the positive of the accumulator to each of the three positive terminals on the set in turn. If any mistake has been made in wiring, the fact will be demonstrated by the lighting-up of the valve filaments.

In the original set we found that several of the complaints concerning distortion were entirely due to the

use of unsuitable valves. We cannot emphasise too much the necessity for using valves specially made for the function they are intended to perform. This rules out general-purpose valves.

For a 6-volt accumulator the following series is recommended; DE5B for the H.F. and detector stage, with a DE5 for the first L.F. stage, and an LS5A for the last stage. With the components specified such a combination of valves will give powerful distortionless amplification.

Coil Sizes

For ordinary broadcast reception Lissenagon coils Nos. 35 or 50 (aerial), 75 (anode) and 60 (reaction) will be required. For Daventry and Radio-Paris coils Nos. 150, 200 and 200 will be suitable.

(Continued on page 158)

"Jazz Banned!"

:: A Special Article by
:: J. H. SQUIRE,
:: Leader of the Famous
:: Celeste Octet



MANY members of the dancing world are up in arms at my statement that the Celeste Octet, of which I am director, has not played a single note of jazz since its engagement with the B.B.C. eighteen months ago.

What I Know About Jazz

I am asked, by those who have taken me to task, what I can know of fox-trot music and the fox-trot if my combination never plays jazz. In good time I'll tell you what I know about these products of the dancing world—and it will surprise some of you.

Rather am I proud than abashed at the furore which has greeted my statement.

Proud because I have the courage of my convictions that popular classics, lightly interpreted on a string combination, would find a place in the hearts of the public as readily as jazz, and have the same universal appeal as jazz and so-called "symphonic syncopation."

Unabashed because when I resolved at the inauguration of the Celeste Octet that jazz should be banned, it was not because I held myself aloof from jazz or failed to recognise its merits for dancing.

Many bands have set out with equally firm resolutions concerned with banning jazz, but have gradually weakened under stress of public

opinion and criticism, and eventually acceded to the demand for jazz and supplied it. But although I have often been asked to vary my programme with jazz, and have even been severely upbraided for banning it, I have remained undaunted throughout and stuck to my guns. In fact, I venture to say that not a few dancers have become as endeared to listening to the popular classics as to their beloved jazz, and disporting and contorting to its syncopations.

After all, because the public favours one particular type of music which happens to suit the style of dancing in vogue at the moment is no proof that it is unresponsive to the appeal of music on a higher plane—no more than it is proof that because an orchestra discourses one particular class of music it is not able to play music in another category and is unable to appreciate the merits of other types.

It is only the shallow hide-bound lowbrows who have ears for naught but jazz, and shut off their sets with a derisive "Oh, that stodgy high-brow stuff" when something besides "Alabama Bound" is heard on the wireless.

I banned jazz as a personal experiment, for my own satisfaction of a test of public taste, and not as a protest of its uselessness. I like jazz. I have seen it born and bred. I have watched its growth and helped

its development. I appreciate its limited merits and recognise its cleverness.

Jazz is a commendable product, if only for the universal appeal it has achieved. It has certainly "got there." It has wonderful rhythmic qualities, and a cheerful appeal, although chief among the various reasons for its universal adoption is its power to reflect in dancing the national mood of the moment.

Secret of Its Success

The secret of its success is that, life being essentially rhythmic, jazz is just the rhythm to which we live at the moment—a mirror of these times when men and women around us are living a bit beyond themselves—the natural sequence of release from the shackles of a world struggle and hideous strife. Jazz is reactionary—hectic and primitive, vibrating dormant chords of the human frame that remained untouched till the stress of war stirred them. Jazz is the nation's temporary safety-valve.

Then why have I banned jazz? I can imagine you are asking in your minds. I have already admitted that jazz is a good thing—but you can get too much even of a good thing. I have had it where jazz is concerned. And here lies the reason for my banning it.

I will relate an interesting story of my association with jazz.

"Jazz Banned"! A Special Article by J. H. Squire

I was in the jazz and dance band business long before the present generation had ever heard the magic word *ragtime*, let alone its descendant jazz, its family of one-steps, fox-trots, blues, and its last-born, the Charleston.

Twenty Years Ago

Twenty years ago I was in the office of a newly-launched publishing firm in New York. One day a quiet and unassuming youth of eighteen years or so walked in and showed us a song which he proposed calling "Dorando," and which contained topical references to the celebrated Marathon race of America which had just been won by an Italian of that name.

The song was tried over and the youth was offered twenty-five dollars for his composition.

That youth was Irving Berlin—the now famous King of Ragtime, and writer of many of the most popular jazz melodies of to-day.

This incident really marked the birth of jazz, for "Dorando" had a syncopated strain which is peculiar to jazz. There are many movements in the greatest symphonies that are syncopated, yet on no account could they be called jazz. But any or all of them can be made into jazz by the simple expedient of accentuating that beat which the natural laws of rhythm require to be unaccented.

That is the secret of jazz and the secret of its modern appeal—it is inverted, faked rhythm finds response in the topsy-turvy and artificial rhythm of national life to-day.

Some time after the episode in the New York office I came to England and began to work on a jazz catalogue for a company which foresaw money in the syncopation novelty for Britain, although up to this time jazz had never been heard in this country. Then one day I was talking to a Jewish comedian who agreed to come and hear one of the new syncopated songs I was cataloguing, and finally he consented to sing it. It became the rage, and ragtime had then established itself.

The title of that song was "Yiddle on your Fiddle"—one of the first ragtime items to sway the feet of dancers in this country.

Later the New York company sold

their catalogue to an Englishman who is now head of one of the most famous music publishing companies in the world. The first song sent to him was "Alexander's Ragtime Band," out of which a fortune was made.

It was just after this that I organised the first jazz band ever to play in this country, although it was not called a jazz band—still,

Leader of the Celeste Octet.



Mr. J. H. Squire.

jazz was a designation to come as a description of music that was syncopated. The band performed at a little night-club off Regent Street. This was in 1912.

In 1917 I had three jazz bands playing in London, and then went into partnership with a friend; together we started what is now the largest jazz band agency in this country. Two years later I bade farewell to my partner—and have never played a single note of jazz since.

Why? Because I wearied of it! As proof that you can tire even of the exhilarations of jazz, if you are constantly associated with it, I offer the following test. Play on the piano or whatever instrument you favour, "God Save the King." Play it fifty times over—never varying the rhythm. Then play some other tune in the same rhythm, and continue to do this for five or six hours, which is the period of time of performance which the modern dance orchestra averages.

By the time you have completed this experiment you may realise why I have banned jazz.

The monotony of rhythm is maddening and, despite the merits of

jazz in moderation, I fear it is killing itself by sheer repetition. Jazz melodies may be different in time and tune, but the rhythm of them all is identical. Whether it is a one-step, waltz, fox-trot, Charleston or blues that is being played in the modern ballroom, the rhythm of the music is basically, jazz—or in other words manufactured rhythm always of the same calibre.

It was a pleasure for me to get back after this to themes into which one played the rhythm as one felt it. It is so much more natural. If music deteriorates, and its rhythm is manœuvred, then dancing to it must also, of necessity, deteriorate, and the expression of such music appear adulterated.

This accounts for the lack of natural expression and the artificialities of the steps and movements of modern measures. How many dancers can dance a Strauss waltz, for example? Not many I fear, for here would be rhythm that would call for individualistic expression of the music. That would be too strenuous a procedure for the modern pleasure-seekers, all slaves to universal rhythm that has by repetition so closely bound itself up with the people that its expression in dancing has become mechanical and effortless—typical of the lethargic, blunted disposition of the world to-day.

Stagnation

We have fallen into a state of stagnation. It is easy to perambulate a partner to a monotonous rhythm and meander willy-nilly round the room to a monotonous fox-trot which, although it has compensations in its lilt, lacks true inspiration. So why bother about the difficulties and mental effort entailed in dancing Strauss or Waldteufel, says the world.

It was because of the apathy of many of the people to all but jazz, and my inherent faith that despite these outward signs there lay latent a full and real appreciation of nobler themes, that eighteen months ago I gave the order "jazz banned."

I have proved my faith was not misplaced, and to-day even the most hardened jazz-jugglers thank me for the refreshing change I have brought about in the world of music.

Gadgets, Hints and Tips

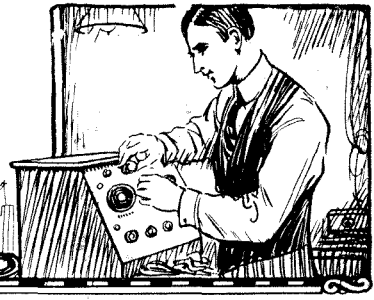

Improved Coil Holder

THIS device is intended to reduce the number of tuning controls to a minimum. By rotating the knob the right-hand coil holder is revolved

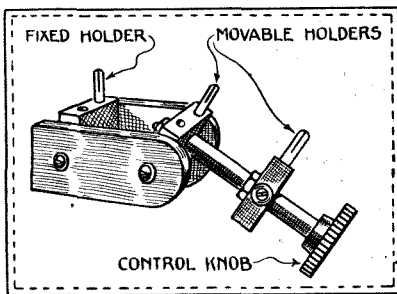

Details of Coil Holder.

in relation to the centre coil holder, and by moving the knob up and down, the centre coil holder, with its tuned moving coil, can be moved backwards and forwards in relation to the fixed coil holder.

The whole operation can be performed at the same time with one hand, leaving the other free for condenser tuning, etc.

The diagram illustrating this is self-explanatory.

H. J. T.

Simple Dial Indicator

A NEAT method of fitting a dial indicator to the condenser, variometer or rheostat dial of a set is shown by the illustration.

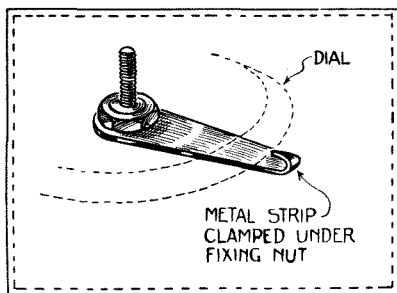

Fixing of Dial Indicator.

A strip of metal, preferably aluminium, is cut wide enough to take a $\frac{3}{8}$ -in. diameter hole at one end, while the other end is shaped to a

point and bent back level with the marked edge of the dial.

The indicator is fixed in position by clamping under the one-hole fixing nut of the instrument.

F. D. N.

Panel-protecting Tool

WHEN wiring up a set difficulty is often experienced in preventing hot flux and molten solder from falling on to the panel, where it is liable to cause faulty working of the apparatus if not thoroughly cleaned off.

This is a troublesome job which (especially when components are placed in close proximity) is often difficult to carry out.

By making use of the panel pro-

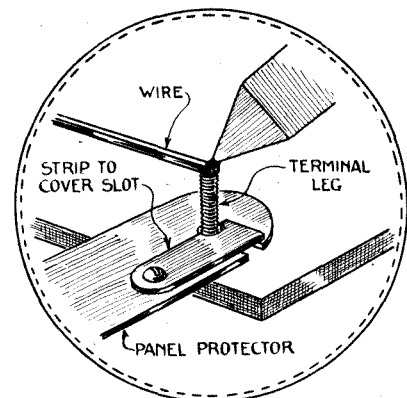

Method of Using Tool.

jector shown in the illustration, the liability of flux and solder falling on and sticking to the panel is obviated and clean work results.

The tool consists of a metal strip measuring about 3 in. by $1\frac{1}{2}$ in., with a slot $\frac{5}{32}$ in. wide at one end. A second strip, $1\frac{1}{2}$ in. by $\frac{3}{4}$ in., is secured by means of a small screw and nut so that it can be swivelled to cover the open slot when the tool is in use.

T. H. B.

Testing Crystals

THE device shown in the illustration saves a lot of time when experimenting with different crystals. A tie clip, the jaws of which have been

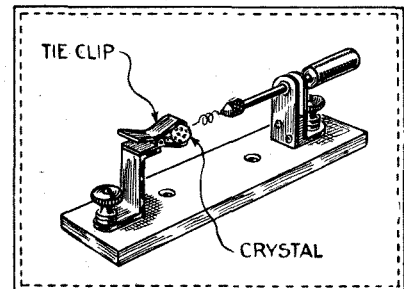

Device for Testing Crystals.

bent by a pair of pliers until they are able to hold a piece of crystal, is soldered to a piece of brass strip bent as shown in the diagram. R. G. H.

Preventing Lead-in Losses

EFFICIENCY is often lost in receiving sets owing to the nearness of the lead-in wire to the side of the house. A simple method of obviating this is shown in the accompanying illustration.

A tent peg and a piece of cord are required. These are fixed so as to pull the lead-in wire at least 3 ft. away from the house.

If the wire is not of the insulated type, two or three small porcelain

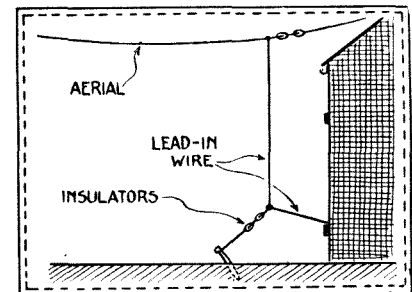

Method of Preventing Lead-in Losses.

insulators should be inserted in the cord as shown in order to prevent leakage of current to the ground.

T. S. M.

Are you binding your WIRELESS MAGAZINES? See an interesting announcement on p. 203.

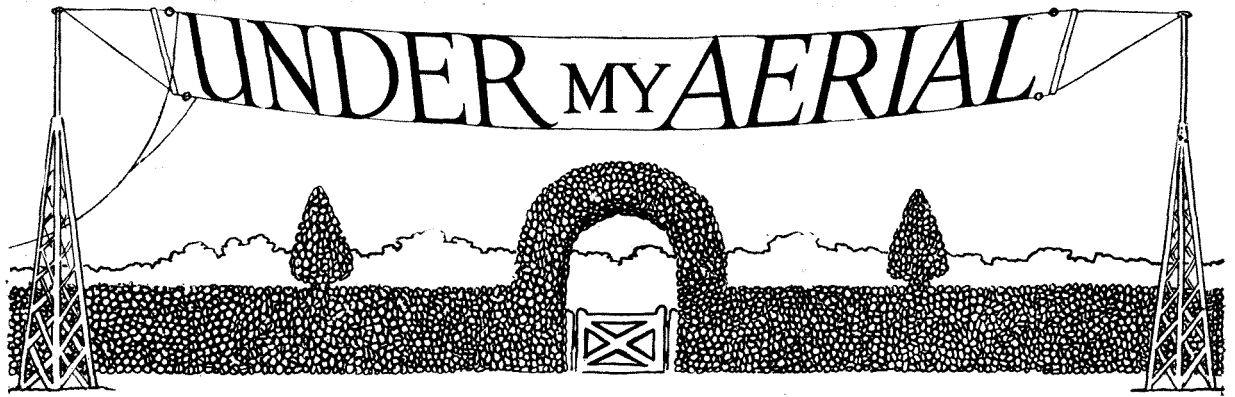

Wavelength Changes

IT seems to me as if there has been a lot of unnecessary talk in certain quarters on the possibility of changes in the wavelengths of our broadcasting stations.

I should imagine that the majority of receiving sets in use at the present time employ plug-in coils as their tuning inductances. Where such is the case, there need be no fear of changes in wavelength. Should the wavelength band be extended in the one direction of 200 metres and to 600 metres in the other direction, I can foresee no difficulty in getting the additional plug-in coils demanded by these extensions.

The wireless enthusiasts who would be hit rather badly by an extension of the broadcast-wavelength band



Plug-in Coils.

would be those in whose sets the coils are fixed and are hidden away somewhere "in the works." Still, I think a good many of us are capable of taking out a coil and removing a few turns of wire in order to get down to 200 metres.

Getting up to 600 metres might be a little more difficult with the one broadcast coil, but it could be done by replacing the variable tuning condenser by one of higher maximum capacity.

I wonder if the Radiophone Bureau at Geneva is likely to suggest that the high-power station at Daventry be given a wavelength in the 200-600 metres wavelength band. Such a recommendation would cause a high-power commotion no doubt, but, if acted upon, would tend to simplify our broadcast receiving sets.

Where the K Comes From

In my explanation of the origins of the call-sign letters allotted to our broadcasting stations, I came a cropper over the K in the call sign 6 K H for Hull, and I am indebted to those readers who were kind enough to send me the correct explanation.

The name Hull, it appears, is really an abbreviation, the full name of the city being Kingston-upon-Hull. K H, then, is about the best possible call sign which could have been chosen for this relay station. My admiration for the Post Office gentleman who picks these call signs is even greater than I previously expressed.

I am a little surprised, though, over my failure to elucidate the origin of the call sign for Hull. My acquaintance with this city is considerable, for a most important member of my family lives there, and Hull possesses a league football team.

What has football got to do with it? You may well ask such a question. The answer is that, in those far distant school days when I learnt geography, I paid greater attention to those towns with famous football teams than to the other towns in the country. I knew all about the towns with the big football clubs, for had I not visited them in imagination many times with my own particular favourite football club?



My own particular football team.

How could you expect me to be otherwise than perfectly satisfied with Hull for the name of the city whose football team was known as Hull City?

I put this last question to my Hull relation, and the reply I got was to the effect that there is another kind of football and in that other kind of football there is a club called the Hull-Kingston Rovers.

I don't seem to have done very well over this Hull business.



5 B I and 2 M C ?

One of my correspondents on the subject of the origin of the call signs for our broadcasting stations points out that the Birmingham and Manchester stations derive their call signs from the experimental transmitting stations which originally occupied the sites of the transmitting stations now used in connection with broadcasting in those cities.

Personally, I think it was rather a



A Call Sign.

pity to retain those old call signs and not let the Post Office call-sign expert have his say.

What would your choice of a call sign for Birmingham be? Don't you think 5 B I would have been a pretty good choice? If you think we have enough B's at present, in B D, B E and B M, you might like the suggestion 5 I R.

As far as Manchester is concerned, I am sure we could not do better than 2 M C, but I *would* like to know what the Post Office expert would have chosen for Birmingham and Manchester if he had been given a perfectly free hand.



Those Numbers

I am afraid that I cannot offer a very definite solution to those

readers who desire an elucidation of the mystery underlying the choice of the number prefix in the call signs of our broadcasting stations.

A casual glance through the call signs allotted in the various countries of the world will reveal the fact that certain numbers appear to be the exclusive property of one or two particular countries.

Thus, in Europe, France shows an almost exclusive right to the number 8 in the call signs of its amateur transmitters. Switzerland has taken to the number 9, Germany to the two numbers 4 and 7, and Holland to the numbers 0 and 2.

In our own country we use only the three numbers 2, 5 and 6. I am afraid I can advance no theory as to why these three particular numbers



Those Numbers.

were chosen in the first place by our Post Office officials.

Norway shows a preference for the two numbers 1 and 4. Denmark uses 7 and 8. Finland uses the three numbers 2, 3 and 5, while Belgium makes use of the five numbers 1, 3, 4, 5 and 6. Italy, on the other hand, seems content with the number 1.

Amateurs in the United States make use of the numbers 1, 2, 3, 4, 6, 8 and 9. In Canada the numbers 1, 2 and 3 are in general use. Brazil uses the numbers 1, 2 and 5, while Mexico and Cuba use the number 2.

Australian amateurs use the number 3, and in New Zealand the number 4 is in use.



Your Licence Number

How do you like the new plan which has been adopted for building up a Request Programme?

According to the official information on the matter, the idea is to pick out four or five licence numbers at random and broadcast those numbers during some particular week. Those whose licence numbers have been broadcast will be asked to make suggestions from which the Request Programme items will be selected.

Quite an idea, isn't it? Do you know that I was not even aware that my wireless licence had a number. However, it has, and I have made a note of my licence number on the

first page of my pocket book so that I can refer to it whether I am listening-in at home or elsewhere.

My old experimental licence had a reference number of this kind:



Your Licence Number.

A number of five figures followed by the word "of" and the last two figures of the year in which it was issued. Such a licence number would scarcely be suitable for broadcasting.

My new licence has a different kind of number altogether. There is a letter and then a number of six figures. Some of the new licence numbers must consist of a letter followed by a number with seven figures in it.

I wonder if the B.B.C. folk have a shrewd idea as to the way our licence letters and numbers are allotted in the various Post Office districts. It won't be much use if Bournemouth calls out the licence number of a crystal user in Aberdeen.



Weak Links

It is a strange thing how the weather seems to make it its own peculiar business to show up the weak links in our wireless chains. I dare say you are as familiar as I am with the pranks rain can play with an aerial system, and I am sure you would agree with me when I say that the wind takes a fiendish delight in working away at the weak spots in our aerial masts and ropes.

When the weather does break one of the weak links in your wireless chain and so put you to a lot of trouble, you can derive a certain amount of comfort from the fact that the weather treats everybody alike in wireless from the biggest pots right down to the very smallest in



Weak Links.

the world of aerial- and earth-enware. Didn't the weather show up the weak link in the chain of simultaneous broadcasting when King Winter held the country in his icy

grip? Snowstorms and high winds played havoc on more than one occasion with the Post Office land-lines connecting our broadcasting stations, and so put a stop to the simultaneous broadcasting which was being carried out.

I wonder if the broadcasting stations will be issued with a regulation receiving set next winter for use when the land-lines used in simultaneous broadcasting are blown down. Sounds rather a scheme to me—wireless to the rescue of wireless.



Forecasts for Farmers

"Funny thing, farmers are actually asking to have weather forecasts broadcast to them," I remarked to

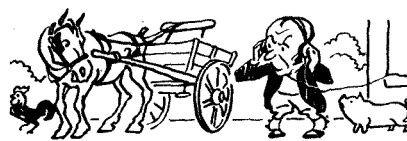

Waiting for his weather ration.

my meteorological friend the other evening.

"Why funny?" he demanded in reply. "I have always maintained that farmers have more horse sense than any other section of the broadcast community. I expect they act on the weather forecasts and do not make them the subject of bewhiskered jokes as you do."

"The farmers are asking for the morning weather forecast to be broadcast at 8 a.m. instead of at 10.30 a.m. as at present," I went on. "Well, they can't have them at 8 a.m.," said my meteorological friend, authoritatively.

"Why not?" I asked.

"The morning observations at the weather-reporting stations round the coast are only made at 7 a.m., and there isn't time to get the reports in and charted on the map by 8 a.m. Even if it could be done in winter, it could not be done when summer-time is in force, for the morning observations are taken at 8 a.m. summer-time."

"So the poor farmer will have to wait until 10.30 ack emma for his daily weather ration."

"Yes, unless he has a forecast at 6 a.m., based on the weather observations taken at 1 a.m."

"Do they take weather observations at 1 a.m.? How perfectly awful! Fancy getting up at that unearthly hour only to find that the

barometer had fallen and broken the further outlook."

"Not a bit worse than getting up to listen-in to America in the small hours of the morning and hearing nothing but atmospherics and the howls of the oscillators, Mr. Wireless-Man."



The Children's Hour

Do you ever listen to the children's hour from your local or some more distant broadcasting station?



Wireless Aunts and Uncles.

I very often do so, for I find that, during this particular "hour" of our broadcast transmissions, it is an easy matter to identify the different stations I happen to pick up.

Even if you do not happen to know the names of the aunts and uncles at the various stations, you can frequently get a clue as to the identity of the station you are listening to from the addresses of the children to whom birthday and other messages are spoken.

I rather like to ask my wireless friends if they listen to and enjoy the children's hour. Some of my wireless friends enjoy the children's hour and say they do. Others of them enjoy the children's hour but say they do not, and I know more than one old fogey who denies ever having listened to the children's hour.

A week or two ago I enjoyed the children's hour from one of our main broadcasting stations better, I think, than any other broadcast item I have listened to for months.

It so happened that I was in the studio of that broadcasting station during children's hour. If you really want to enjoy the children's hour take my advice and try to get an invitation to the studio of a broadcasting station for the time devoted to the little people.

I cannot tell you all I saw, and I cannot tell you all I thought of the aunts and uncles at my broadcasting station, but one of the uncles there was quite the jolliest uncle I have ever seen, and another uncle, in Oxford trousers, was so young that he did not appear to me to have got beyond the nephew stage.

A Silent Set

Some people really do have strange notions about the ease with which faults can be located in a wireless set. Here is a letter I recently received from an old acquaintance whose home is a hundred miles from me as wireless waves travel.

DEAR HALYARD,

I have built a five-valve set, one of the very best sets it is possible to build, so I am told. The two high-frequency valves are transformer coupled, and the coupling used for the two low-frequency valves is that known as resistance-capacity coupling. The fifth valve is, of course, the detector valve.

It is a beautiful set. The trouble with it, though, is that I cannot get a sound out of it. I have checked the wiring over and over again and I am sure it is correct. I expected to get America with the set, but I cannot even get the local B.B.C. station. What is the trouble, do you think?

I am sorry I cannot send the set to you to see, but, with the cabinet, it is far too heavy and bulky to send on a train journey. Please reply as soon as you can.

Rather a hatful, a letter like that, isn't it? I wonder how you would have replied to it. At first, I thought of telling my friend that he might try making the *third* valve the detector valve instead of the *fifth*, but I finally sent a letter in which I enumerated seven or eight likely faults, and in which I strongly recommended my friend to get some



A Silent Set.

experience with a simple one-valve set before tackling his five-valve silent set again.



Those Sunspots Again

Have you had a good look at the new sunspots yet? Within the last few months several new groups of spots have appeared on the sun's surface and some of these spots, so it is said, are large enough to be seen with the naked eye.

Take my advice though, and don't you go looking for sunspots with your naked eye or you will be seeing spots for a good deal longer than you bargained for.

You know all about the sunspot

cycle, how the number and size of sunspots increase steadily from a minimum to a maximum and then decrease to a minimum again, there being about eleven years between any two successive minima.

The last sunspot minimum was in 1924, and it is a strange coincidence, and one to which sufficient attention has perhaps not been drawn, that broadcasting started about the time of the last sunspot minimum.

The next sunspot maximum is scheduled to occur in 1929, and even now, in 1926, there is great talk of

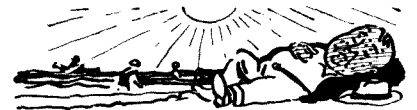

Sunspots.

the bad effect of sunspots on broadcasting. Frequently it has been stated that attempts to pick up American broadcasting in this country have been less successful this year than last year, and even less successful than the year before.

What will happen in 1929 it is impossible to say. Some of us might refuse to renew our wireless licences because of the difficulty experienced in picking up America.

If your wireless reception shows a steady and persistent deterioration during the next three years, you are quite at liberty to blame sunspots. Personally, I shall purchase a new high-tension battery.



A Dear Cheap Switch

I have just completed a three-valve set in which the high-tension battery is stowed away snugly in a cupboard at the back of the cabinet.

When I designed the set I thought it would be a good idea if I had a small tumbler switch on the panel, by means of which I could switch the high-tension battery on and off. The small tumbler switch I bought for the purpose was listed as an "American" switch.

I saw I was in for an awkward job as soon as ever I examined that little switch carefully, but I started manfully to mount it on the panel. I had to cut a curiously shaped hole in the panel to allow freedom of movement to the lever of the switch and the moving part underneath. In addition I had to bore four holes through the panel to secure the face plate of the switch by means of

bolts and nuts to the front of the panel.

After I had carried out all this fiddling work in connection with the mounting of the switch, I wired up the set and screwed the panel to the cabinet.

With the usual flutter of excitement, I carried out my first tests with the set. Not a sound did I get. I suspected the switch and I pressed hard on the lever. Immediately, telephony roared in on the loud-speaker, but it stopped when I took my fingers off the switch.

There was nothing for it but to take out the switch. I did so and replaced it with a circular tumbler switch of ordinary pattern and of a size large enough to cover up the holes made in the panel for the other switch. It was a most difficult job wiring up to the new switch.

No more cheap tumbler switches for me, thank you. They may be cheap in price, but they are dear



I suspected the switch!

when you reckon the amount of time it takes to mount and dismount them.



Making a Loud-speaker Horn

There are not many things in wireless over which I have been set fast, but this last week I have had a most exasperating time trying to construct a horn for a loud-speaking unit I recently purchased.

A most businesslike template for constructing the horn was supplied with the loud-speaking unit, and the printed instructions were both explicit and precise.

My first difficulty was in obtaining the thick cardboard required. I visited three stationer's shops, but the best cardboard I could get for the purpose was far too thin. However, I got over that difficulty by sticking two sheets of the cardboard together. All very well was that, until I began to cut the double sheet, and then—just *you* try cutting a double sheet of cardboard and see if *you* can get an even edge

After much effort, I managed to cut out the four pieces of cardboard from which the loud speaker horn was to be built. My mathematical

friend called these funny-shaped pieces of cardboard the development, but I think he must have got his photography mixed up with his formulæ that time.

When I began the attempt to stick the four cardboard sections of the "trumpet" together, the fun began. I stuck and I unstuck. I got three sections stuck together nicely

CAN YOU COIN A NAME ?

Everybody knows that the term **broadcast waveband** means that range of wavelengths extending from 250 to 500 metres. Some people call these wavelengths "short," but here confusion arises; other people know as "short" all those wavelengths below 250 metres.

In order to avoid misunderstanding it is desirable to have a name for the band of wavelengths from 0 to 250 metres. Therefore the reader of THE WIRELESS MAGAZINE who coins what is, in the Editor's opinion, the most suitable name will be presented with the All-America One-valver built in our Constructional Department and described on page 166 of this issue.

Entries addressed to:
"Waveband Name,"

THE WIRELESS MAGAZINE,
La Belle Sauvage, E.C.4,
and accompanied by the coupon on page iii of the cover, should reach us by March 27.

Get on your cap of ingenuity straight away!

only to find that the fourth section would not fit in its appointed place. My fingers were covered with gum. I gummied a newspaper to the dining-room tablecloth and I gummied the printed instructions to the newspaper hard and fast.

Finally, in extreme exasperation, I dropped the three quarters finished trumpet on the floor and kicked it

savagely across the room. Whereat the cat swore at me and left home in a hurry to join the local broadcasting chorus, I suppose.

I like any kind of constructional work in wireless, but making a loud-speaker horn from cardboard is the limit—by gum.



Accumulator History

The appearance on the British market of a new type of accumulator with several novel and distinctly original features serves to remind us how few progressive changes have been made in the construction and composition of the accumulator since its invention over sixty years ago.

Some electrical instruments are improved almost out of recognition within a few years of their invention. Others are quickly superseded by new



Flat plates in those days.

inventions. Few electrical instruments progress at the comparatively slow rate at which the accumulator has progressed.

According to our records of such things, the accumulator was first invented in 1860. Twenty years later, the process of making accumulator plates, and they were flat plates in those days, was simplified. A later improvement was the substitution of lead grids for the former flat plates.

It is rather remarkable that the only accumulator which is in general use amongst wireless enthusiasts is the original lead-sulphuric acid accumulator.

The great American inventor, Edison, has invented another type of accumulator in which the positive plates are built up from flake nickel and nickel hydroxide, and in which the negative plates are of iron oxide with mercury held in steel pockets. The liquid in the Edison accumulator is caustic-potash solution.

I wonder whether the reason why the Edison accumulator has never come into general use is because the requisite nickel is required for the making of the American "silver" coins.

HALYARD.

Novelties and New Apparatus

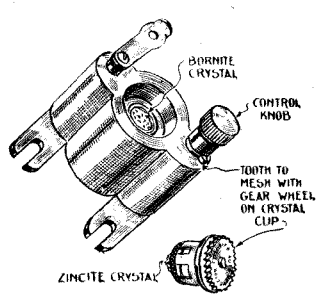

By turning the control knob of this detector the crystals are brought together, separated, partly turned and brought together again. The top crystal cup is kept in position by a pivoted spring, through a small hole in which a letter on the cup appears, thus making it possible to find the same sensitive spot as many times as desired. The manufacturers are the North Eastern Instrument Co. Ltd., of Durham Rd., Low Fell, Gateshead-on-Tyne.

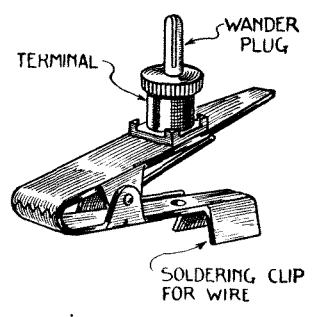

Comprising as it does a screw-down terminal, wander plug, and spring clip, this new Trix gadget will be appreciated by many amateurs who work with experimental receivers. The maker is Eric J. Lever, of 33, Clerkenwell Green, E.C.1.

Yet another dual rheostat has been added to the list of those already on the market—the latest is the Gecophone Universal, manufactured by the General Electric Co. Ltd., of Magnet House, Kingsway, W.C.

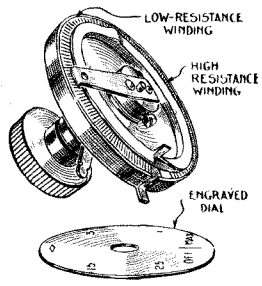

The two halves of the rheostat winding contain wires of different resistances, one half being for use with dull-emitters and the other half with bright-emitters.

For further particulars write to the makers, mentioning the "W.M."

Of particular interest to those listeners who have to keep their sets in dark corners of a room, this Decko panel-lighting lamp will come as a boon. In the case of a valve set the

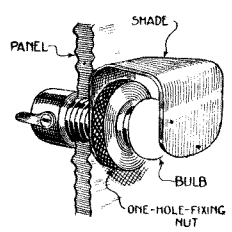

lamp is lit from the accumulator, but a dry battery is necessary in the case of a crystal set. These lamps are supplied by A. F. Bulgin & Co., of 9-11, Cursitor St., E.C.

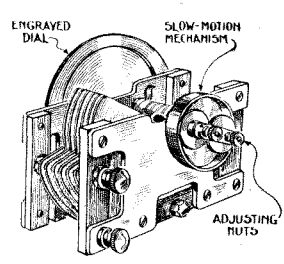

The latest Ormond low-loss square-law type of variable condenser is fitted with an elaborate slow-motion frictional device for the fine adjustment of capacity. The amount of friction is adjustable by means of two threaded nuts.

These condensers are made by the Ormond Engineering Co., Ltd., of Pentonville Rd., King's Cross, N.1.

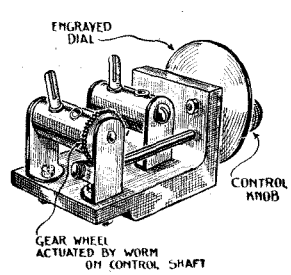

A feature of this Gecophone back-of-panel vernier coil-holder is that the dial is so engraved that the relative positions of the two coils can be read off in degrees.

Gecophone components are made by the General Electric Co. Ltd., of Magnet House, Kingsway, W.C.2.

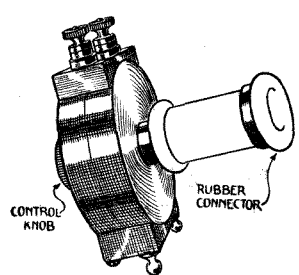

Neat in appearance, this Ultra loud-speaker unit will be appreciated by those listeners who desire to convert their gramophones into loud-speakers, or who are not afraid to tackle the manufacture of their own horns.

The address of the Ultra Electric Co. is 661-663, Harrow Rd., N.W.

Simple and robust in construction, there is nothing in the Lotus anti-microphonic valve-holder that can be easily damaged—that much is clear from the illustration.

The manufacturers of these neat components are Garnett, Whiteley & Co. Ltd., of Broadgreen Rd., Liverpool.

It will be seen from the illustration that the spring connections are pressed on to the ends of the valve sockets.

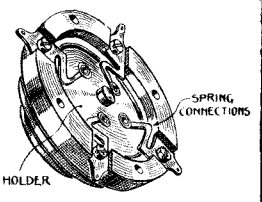

Illustrated and Described

Having the appearance of ebonite because of its black finish, the substance on which these coil plugs and sockets are mounted is really porcelain. Known as the Tiger coil mount, this device can be easily kept free from dust by the use of a damp rag.

The makers are the Athol Engineering Co. of Cornet St., Hr. Broughton, Manchester.

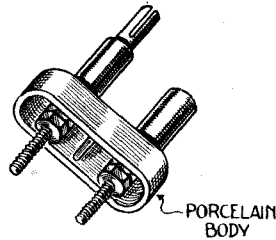

Provided with a proper vernier scale, the Erla Verni-dial makes possible the adjustment of a tuning condenser within very fine limits. It is a simple operation to take a reading accurately to the first place of decimals.

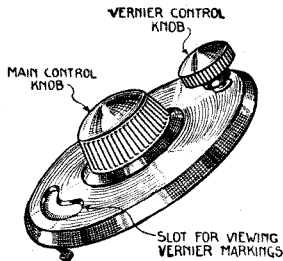

These dials are supplied by C. G. Vokes & Co., of 38, Conduit St., Regent St., W.1.

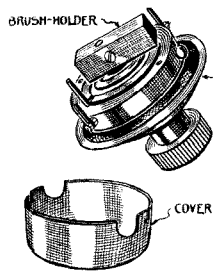

This Marconiphone resistance is not intended either as an anode resistance or as a grid leak, but as a general control resistance for use across L.F. transformers and across the reaction coil. Its maximum resistance is 40,000

ohms. The address of the Marconiphone Co. Ltd., is 212, Tottenham Ct. Rd., W.1.

For further particulars write to the manufacturers, mentioning the "W.M."

This rheostat can be used with either bright- or dull-emitters.

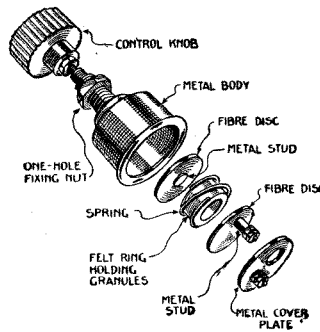

This dissected drawing shows the parts of the latest type of the well-known Microstat filament resistance. A number of refinements have been made in this device, and the latest models are considerably better made than those at first put on the market.

Microstats are made by Wates Bros., Ltd., of 12-14, Gt. Queen St., Kingsway, W.C.2.

Nowadays, although not absolutely essential, it is certainly desirable to be able to adjust all tuning condensers within fine limits. The Decko knob illustrated here gives both direct and geared (slow) drive to any spindle to which it is attached.

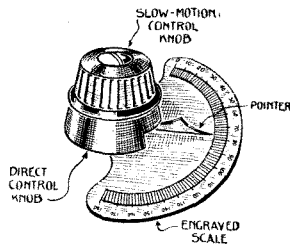

The manufacturer is A. F. Bulgin & Co., of 9-11, Cursitor St., E.C.4.

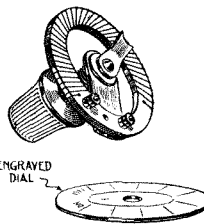

With the resistance wire wound on the former diagonally so that the moving contact cannot slip down between consecutive turns, this Ella Varic rheostat has a very smooth motion when being adjusted.

These rheostats are one-hole fixed.

Lionel Robinson & Co., of 3, Staple Inn, Holborn, W.C. supply these resistances.

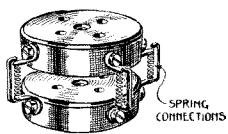

The use of dull-emitter valves makes it desirable for the home constructor to take some trouble over the choice of valve holders. A neat form of anti-microphonic valve holder is made by Bretwood, Ltd., of 12-18, London Mews, Maple St., W.

A feature of this valve holder is that the spring contacts have a rubbing effect on the valve pins as the latter are pushed in and pulled out, thus keeping everything clean and ensuring a good contact.

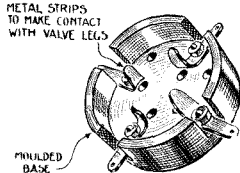

The makers are the H.T.C. Electrical Co., of 2, Boundary Rd., S.W.12.

Used with a .0005-microfarad condenser in parallel, this Multidyne Blue Spot coil has a wavelength range of from 400 to 5,300 metres. The coil is built up in separate sections, which are brought into circuit as required by means of a switch; there are no dead-end losses.

The concessionaires for these coils are Lindalls, Ltd., of 66, Lombard St., Birmingham.

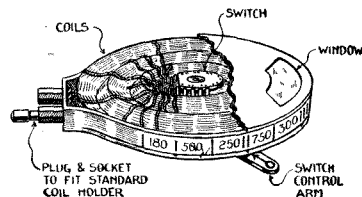

Freak Directional Effects

THERE is no branch of wireless in which the unexpected is so likely to occur as in directional wireless. In fact, if I may state the matter in the form of a deliberate paradox, everyone who is engaged in any kind of wireless directional work is constantly expecting the unexpected to happen.

Many and rude are the shocks received by the new recruit to this field of wireless. It may seem a simple enough matter to obtain a bearing of a transmitting station by just turning a small knob and taking a reading from a graduated scale, but the main problems of direction-finding have little or nothing to do with operating skill. The best operator in the world is powerless against certain phenomena of the physical universe about which we have as yet only the scantiest knowledge.

Errors

For instance, when the bearing of a fixed transmitting station shifts from North to West in the course of a few seconds, it is hardly likely that the operator is to blame. Yet this is only a minor example of some of the errors that are constantly experienced in connection with directional work. There are authentic cases on record in which the bearing of a fixed station moved round the compass three or four times in about a quarter of an hour. Fortunately, it has been possible to establish the fact that these very "violent" errors only occur at certain periods, and—well, "forewarned is forearmed."

There is another kind of error, however, which is more or less constant—even though it may only amount to a few degrees. It is frequently found, for instance, that the apparent bearing of a fixed station differs constantly by a few degrees from what is known to be its correct

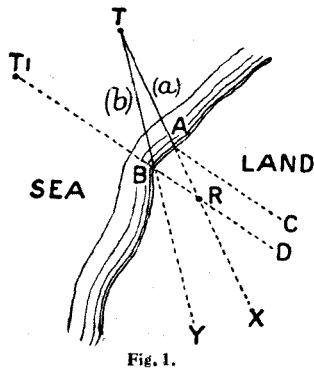

Fig. 1.

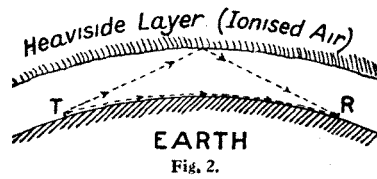

Fig. 2.

Fig. 1.—Bending of Waves over Coast Line.

Fig. 2.—Reflection of Waves by Heaviside Layer.

bearing. That is to say, direction-finding stations record constant false bearings in certain instances. A brief explanation of the causes of these two common types of error may help to dispel some of those groundless fears which the amateur is all too prone to entertain with regard to the efficiency of direction-finding apparatus.

Coast Refraction

Dealing with the latter case first, the constant errors that are sometimes experienced are due mainly to the phenomenon known as "coast refraction." In other words, when a coast line intervenes between a transmitting station and a receiving station the waves from the former are "bent" out of their original course before they reach the latter. This bending, or refracting, effect occurs when the waves are passing over the coast line. The effects of refraction in connection with light waves are well known, of course. If you immerse part of a stick in water the stick will appear, from most viewpoints, to be bent. This is due to the fact that light waves travel more rapidly in air than in water.

Bending Rays

The rays of light which are reflected from the immersed portion of the stick therefore experience a change in velocity on leaving the water, and this change in velocity results in a bending of the rays.

The particular rays that strike the eye give the impression of having come direct from the immersed por-

tion of the stick, of course; but as they have actually been bent in their passage from the water to the air, the impression is a false one.

The refraction that occurs in the case of wireless waves passing over a coast line is brought about by

an exactly similar process. The velocity of wireless waves passing over the earth's surface is affected appreciably by the changes that are found in the constitution of the earth's surface at different places. This may seem at first sight to contradict the established fact that wireless waves travel through the ether, and not through the earth; and that, moreover, wireless waves travel at a constant velocity of 186,000 miles per second. But it must not be forgotten that light waves are also ether waves. In fact, the only difference between light waves and wireless waves is a difference of length. Both are electromagnetic waves, whose natural medium of propagation is the ether.

Faster Over Sea

The explanation of this apparent contradiction lies in the fact that the phenomenon of refraction is due in both cases to secondary effects, e.g., absorption. In the case of wireless waves it is now definitely established that their velocity over sea is anything from two to five per cent. greater than their velocity over land. And it is this difference in velocity, of course, that gives rise to the bending effect that occurs when waves have to pass over a coast line, i.e. from sea to land, or *vice versa*. Fig. 1 illustrates this effect quite clearly. T is a transmitting station at sea. R is a receiving (direction-finding) station on land. Two rays, marked (a) and (b), are shown emanating from the transmitter. If it were not for the intervention of the coast line, these two rays would travel in straight

lines—i.e., in the direction denoted by TX and TY respectively. As it is, however, they strike the coast at the points A and B, and, owing to the reduction that occurs in their velocity, they are bent out of their courses in the direction of C and D. Thus the ray that sets out from T in the direction of the receiving station never strikes the receiving aerial; it is deflected in the direction of C. The ray that ultimately reaches the receiving station is the one that strikes the coast at B. Owing to the angle at which this ray impinges on the receiving aerial, however, the transmitting station is made to appear to lie in the direction of T₁.

Action of the Sun

The more violent errors to which reference was made in the beginning of this article are mainly due to what is usually termed "night effect." The worst manifestations of trouble from this source take place during the transition periods from daylight to darkness—i.e., at sunrise and sunset. This is due to the varying conditions of the atmosphere at these times. In its normal condition air is an insulator and has practically no effect on the wireless waves that pass through it. Under certain circumstances, however, it becomes conducting, and there is always a level of atmosphere, high up above the earth, which is in a constant state of ionisation.

Heaviside Layer

This is known as the Heaviside layer, and, under certain circumstances, it acts as a reflector of wireless waves in the manner suggested in Fig. 2. It will be seen, in this case, that there is a double path (direct and indirect) afforded to the wave. This is a factor which is frequently responsible for large errors in bearings. The greatest errors, of course, are usually experienced during the period of active de-ionisation—i.e., around sunset time. The rapidly changing conditions of the atmosphere when de-ionisation first begins give rise to almost every conceivable kind of freak effect. As previously mentioned, fixed stations have been known to waltz around the globe three or four times in almost as many minutes during these periods. Fortunately, "the worst is soon over" and the wanderers return quickly to their former positions.

M. E.

MUSH!

EVERYBODY wants to hear the evening chimes of Big Ben, the nation's timepiece, says a wireless authority. And nobody wants to hear the morning chimes of the alarm clock, the nation's rude awakener, on a dark winter's morning, says Angelina.

A well-known firm of wireless manufacturers is producing phones at the rate of 12,000 a week (Hear, hear).

Reception of broadcasting with loud-speakers in a Glasgow park was heard well for a distance of 200 yards despite the noise of passing traffic and the jingle of the collection money in the pockets of the audience.

At the present moment there are 535 broadcasting stations operating in the United States. Gee! They've got more broadcasting stations than railway stations, sure.

Nearly 600 convicts at Parkhurst have been entertained by a wireless concert. It is believed that the whole 600 of them are in favour of a larger type of cell with more open grids and a regular issue of acid—drops.

Barcelona, E A J I, works on 324 metres. A special kind of nut is required in sets designed to receive this station. By the way, all the broadcasting stations in this part of Europe derive their power from Spanish juice.

Strange that an American station should have broadcast the "Pied Piper." We thought they got rid of all their "rats" when they introduced prohibition.

Recitals of poetry are figuring in the Spanish programmes now. Presumably they must have something bloodcurdling whilst bull-fighting is out of season.

The announcement of Capt. Bruce Bairnsfather's last play caused people to ask when Old Bill is going to be broadcast. They are behind the times—our tailor has been broadcasting old bills for years now.

A scientist assures us that we have not yet heard the last word in wireless. With so many surplus women in the world it will be surprising if we ever hear the last word on anything.

A large and powerful wireless station has been erected in China, where the insulators come from. The location of this station is near Peking, and its name will be Peking. As the English language will be used at this new Chinese station, the first operator there with a humorous turn of mind will probably answer a call as to what station is on the ether by saying "S'Pekin speakin'."

A Dublin schoolboy only 16 years old has listened to W B Z for two hours on a home-made set. Serve him jolly well right if he got whacked at school the next day for going to sleep in the geography lesson.

What some of the wireless letters mean:—

R. Right. L. Left. C. Centre. L.F. Low Freak. H.F. High ditto. L. A hush word. I.P. 'Ip pip hurrray. O.P. 'Op it. I.S. An auxiliary verb used in grammatical amplification. Pronounced like the *usi* in business. O.S. An 'orse, often spelt with a double s.

The 2 L O Military Band broadcasts regularly from 2 L O says a wireless paper. Funny. We should have thought that they broadcast regularly from any other station than 2 L O.

A suggested modulation scale:—

- M. 1. Speech clear.
- M. 2. Speech clipped a little.
- M. 3. More than 5 hiccoughs per minute.
- M. 4. Speech indistinguishable.
- M. 5. As drunk as a lord.

First Listener-in: "Good gracious, that's a dog surely."

Second Ditto: "No, it's only one of the Barking amateurs transmitting speech."

From 2 L O an ordinary London taxi-driver has been giving his opinion of the London traffic. All we want now, to brighten up the programme, is an ordinary bus-driver's opinion of an ordinary taxi-driver.

A writer in THE WIRELESS MAGAZINE has been explaining how to learn Morse easily. But it seems a dashed dotty idea to learn it at all.

Belgian listeners are holding a conference to discuss the tax on aerials. We bet the tax will be cussed as well as discussed.

Critics are saying that the B.B.C. programmes are too heavy. So are most plum puddings, but people like them all the same.

The STORY of a JOKE

By THERMION, OF AMATEUR WIRELESS



THIS is the true story of a joke which promises to break all records for sheer hardiness. Though it has travelled almost all over the world and has been translated into heaven knows how many different languages, it is still going as strong as ever, and not a week passes without its bobbing up in one form or another and moving thousands to mirth.

First Loud-speaker

In the early days of *Amateur Wireless* (June, 1923), a correspondent wrote to me suggesting that something might be made of the fact that Adam was the first person to possess a loud-speaker. This inspired an "On Your Wavelength" paragraph in *Amateur Wireless* dealing with those who claimed to have invented wireless.

In it I showed that though many developments had taken place in the eighteenth and nineteenth centuries there could be no manner of doubt that Shakespeare's Prospero had conducted broadcasting by means of an Ariel, whilst to find the first wireless enthusiast we must go back to Adam, from whose spare parts a loud-speaker was made.

That was the beginning of it. A few weeks later the loud-speaker part of the joke was "lifted" by several American papers, from whose pages it was re-lifted by some of our English contemporaries. Having thus crossed and recrossed the Atlantic the joke decided to see the world. It crossed the Channel and invaded Europe, appearing with or without illustrations in the journals of a dozen different countries. It voyaged round the British Empire, adorning the pages of Dominion and Colonial papers. It went to the Far East, being, so I am informed, translated with suitable alterations into Japan-

ese. And all the time it kept on being passed round in the train, the office and the smoking-room as the "latest wireless story."

One of its finest achievements was in 1924 during a return visit to the States. A monthly paper over there offered a substantial prize for the best and most original wireless joke. It went in—and won!

Then it got into the daily papers in this country, occupying the place of honour as the bright spot on the gossip pages. Having done good service here it travelled once more across the Herring Pond where it was promptly fallen upon by numerous perpetrators of strip cartoons, to whom it came as a godsend.

In picture No. 1 they drew Bloggs entering a wireless shop. In No. 2 he is seen selecting a receiving set. In No. 3 the salesman is offering a loud-speaker. "Not on your life," says Bloggs in No. 4, "I have got one at home already." There is a little inset picture of Mrs. Bloggs, and the salesman is seen falling flat on his back with asterisks and exclamation marks flying from his head in the approved strip-cartoon manner.

Getting Into Its Stride

You would have thought that its career would now have been ended. Certainly I both thought and hoped so. Not a bit of it. The thing had hardly got into its stride. It became the revue comedian's most certain means of bringing down any house. When politicians adopted the voice amplifier as an aid to open-air speaking the deathless joke saw its opportunity, and took it.

It returned to journalism and had an extensive career, usually in illustrated form, in the weeklies. Whenever listeners were asked by editors to send in funny radio stories the

joke was sure to be there, and in not a few cases it was given the palm as the funniest original (!) effort.

Naturally it was altered a little in form from time to time. Biggs would ask Jiggs whether Marconi invented the loud-speaker. Jiggs would say that he did not know, and Biggs would finish him off by informing him that Adam had a trumpetless model constructed from his spare components. Or Baggs would ask Jaggs if he had a wireless set, and Jaggs would reply that he had at any rate a loud-speaker.

In the States

In such forms as these it went particularly well in the States, largely because they are in the habit of calling the loud-speaker a loud-talker there, which as you will see fits in very well.

I really began to think that the joke must be dying in the autumn of 1925, for I had neither seen it in print nor heard it by word of mouth for nearly a month. That shows that even I had underestimated its vitality. Just the other night whilst I was reading an evening paper in my club after a hard day's toil, a fellow member came across the room and slapped me on the back. "I say, old chap," he said with a beaming smile, "I've got a really new wireless joke for you. Do you know who was the first wireless . . . ?"

Upon recovering consciousness some minutes later I told the story of the joke to those who were administering first aid. And now that you know it, please refrain from working off the joke on the next man that you see. For all you know he *might* be "Thermion," and "Thermion" is carrying a life preserver now in his coat pocket.

Sir Bruce Bruce-Porter's Opinions on the Curative Value of Broadcasting given in An Interview to Frederic M. Delano.

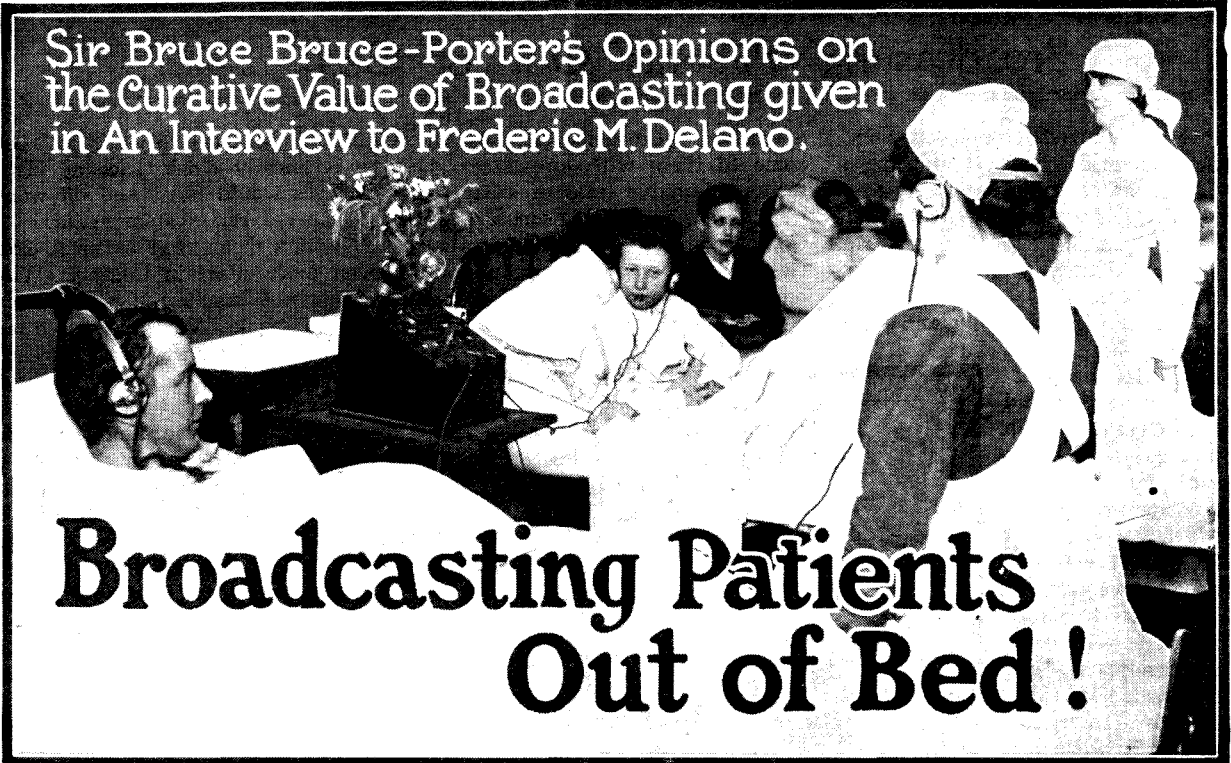

Broadcasting Patients Out of Bed!

"WE are all of us possessed with two kinds of mind—the thinking, or conscious, and the lower, or subconscious," remarked Sir Bruce Bruce-Porter, in opening the interview. "These two parts of a mind are to be found in every normal human being or higher-type animal. The conscious mind is that mind with which we direct to the best of our ability our actions, our ideas, and, in fact, our lives.

"With this conscious mind we do our mathematical calculations to arrive at some decision, we develop our theories, and we control our actions to bring about certain desired results."

Subconscious Mind

The subconscious mind, according to Sir Bruce, seems to be rather for the primary registration of sensory impressions, and for the control of those many reflex (involuntary) actions which cause us to take our hands away from a hot stove which we have touched, even before we know whether we are burned badly; or to automatically dodge when we hear a bullet fly overhead, though the missile is past and almost through with its flight by the time we have made this involuntary motion.

The subconscious mind will register sounds to us when we are so absorbed in a book that we are taking no notice

of our surroundings; and if the sound persists, it is often capable of breaking into our consciousness and disturbing our reading. Often-times then it irritates us, and we undergo a distinctly unpleasant emotion until the sound has either died out or we have recognised what it is, and more or less adjusted our conscious minds to it.

It is this subconscious mind that seems to be the cause of our nightmares, too, says Sir Bruce. It is one reason why patients in hospitals are apt to dream a great deal, at a time when they should be enjoying a complete and unbroken rest.

They have some wound, some painful organic trouble, or other disturbing condition. They drop off to sleep, and a slight twinge, often so brief as to have vanished by the time the patient would normally be entirely awake, creates a flash of subconscious thought.

Since most of the patients coming into a hospital are suffering from shock, through the effect their accident, operation, or illness has had on their minds, these subconscious thoughts turn into fear-inspiring nightmares.

The patient is wide awake, startled, and mentally upset—perhaps unable to get back to sleep, if he is in a very nervous condition. This counts

against his rapid recovery, because it increases his irritability, creates nervous disorders, and thus causes actual toxic poisons formed by these sharp emotions to be passed into the system.

War-wounded

The wounded soldiers coming back from the war showed this to a degree, as any hospital staff doctor will testify. They had left fields of battle, ghastly soul-wrecking carnage, inconceivable uproar of guns and bombs, mind-shattering nervous strain and tension. Their minds were filled with all the conditions of the battlefields, and they came straight to a hospital ward, where they were surrounded by other war-wounded, having had no chance to get any of the calmer ideas that a clear view of the normal surroundings would have produced.

Whenever, for example, they were awakened by the sound of a motor-cycle roaring through the streets, they immediately thought they were up at the front undergoing another dose of machine-gun fire. Their subconscious minds leaped out and tricked them into spending wakeful unhappy hours, because there was no "background" save of horror.

The essential thing, then, was to replace these terrifying "sound memories" by more soothing ones,

Broadcasting Patients Out of Bed (Continued)

Sir Bruce believed. Music was found, of course, to be the most soothing of all, and the phonograph was of great aid in supplanting the roar of battle with the peaceful strains of waltzes, or the exhilarating and stimulating notes of jazz.

Then came broadcasting, and a new chapter had been opened for the treatment of the sick and convalescent. For a phonograph must be heard by all; and sometimes there will be a few who do not like what the others do—a source again of what we try to avoid, irritation. With wireless, headphones can be provided for those who wish to listen; but those who do not, are not obliged to hear anyway something which might grate on their nerves severely.

Wireless can also supplant the increasing uproar of the city streets to the average hospital patient, as Sir Bruce has pointed out; where a steady stream of traffic, with consequent blowing of horns, screaming of brakes, and thunder of motors will gradually begin to wear on a sick person's nerves, he can put headphones on, and at once muffle the outside troublesome sound and replace it by soothing and interesting sounds.

Patient's Reaction

He is bound to react to this by a relaxation of his whole nervous system, and resultant rest which he would not be able otherwise to get.

"It must be remembered that all patients are egoists," smiled Sir Bruce. "As Sir Richard Quain so aptly remarked, you must learn that the wart upon milady's nose is far more important than the cancer of her poorer neighbour! Sick people are always thinking of themselves. They have little chance to do otherwise; what with a group of would-be sympathetic (and

actually a little idiotic) friends, who come to them with long faces and recount horrible tales of what they went through with this sort of operation, or what they heard about the frightful complications of someone else; or who put on longer faces yet, and then, with a little sort of

him. If he tried to read, he would be physically tired twice as fast—his eyes would hurt, and off would go the nervous system again.

Visitors mean that he must exert even more effort in talking. Wireless is not insulted if you do not answer back. Visitors are often-

times tiring because of a lack of sympathy (of character, not of kindness); but a patient cannot tell them to go home. Wireless he can either change from one programme to another, or he can shut it off entirely.

He is taken out of his morbid condition until he is ready to sleep; and then he has a pleasant background of music or lectures to fill his subconscious mind when he is slightly roused by twinges of pain, so he is that much more apt to avoid nightmares.

"One of my patients," declared the doctor, "an elderly woman, had been bedridden for a long time, and would probably be, we saw, for the rest of her days. I persuaded her to get a wireless set with which she could bring in the London station, and some from the Continent. She said after a short while that 'it brought her back into the world again.' A phonograph was useless to her, because it always played the same tunes. The uncertainty of wireless she found brought life to her, and as unpleasant things were never broadcast, she could spend her day listening-in. It brought back the element of expectancy!"

Greatest Value

This brings forth the possible, even probable, greatest value that wireless can have in the hospital or sick room. The patient, as said before, is more or less completely segregated from the world, and from all the life of the city. He sees a few friends, who tell him stories of things that



Broadcasting relieves the tedium of long hours spent in bed.

moan in the voice, tell the poor bedridden soul how badly he is looking, and so forth."

A sick person in a hospital, having a large amount of time with nothing to do, and not having the energy to produce healthy thought, naturally dwells on the morbid. He is sorry for himself, and feels so completely out of the world that he builds this abused and sorry feeling up even higher, until oftentimes he gets into a state of depression which may retard him for an appreciable time in his recovery.

If he is given healthy recreation he has a chance to break away from this morbid introspection, and take an interest in affairs. And here wireless plays an all-important part!

Listening is actually far less tiring than any other form of amusement; because when a man listens, if the sounds soothe or bore him, he can drowse off to sleep. If they irritate him, on a wireless set, he can turn off the set, or take off the headphones and put them away from

An Interview with Sir Bruce Bruce-Porter

have happened. He hears a few phonograph records, pieces that have been played long ago and on purpose for that record. The actual human touch is missing. It is frankly mechanical, and it is therefore less inspiring.

Human Society

A human being needs the company of humans—society, in the larger sense—to get the greatest enjoyment out of things. Just as men rarely drink save when with other men, so they cannot get the full joy out of an orchestral piece which has been played long before by some people in a studio, and is now being brought out by a mechanical apparatus.

But let a patient listen in to the Savoy orchestra, for example, with all the people in the great ballroom actually dancing. He can hear the exhilarating strains of the jazz, which he knows is being played by living people just at that moment.

He hears the steady, rhythmic scrape of feet, and can realise that those are his fellow creatures dancing and enjoying themselves. (Even if we can't dance, we often love to sit outside and look on.)

And then he hears the music stop, and a great roar of applause. He hears the hum of voices, the movements of the orchestra—perhaps a couple pass close to the microphone and he catches a few phrases — “ Jolly music, isn't it ? ” “ Yes, awfully—I say, do you know that latest Charleston step—look—”

The patient has ceased to be a poor cooped-up being in a hospital—he is for that moment living among gay faces, pretty women, beautiful clothes. He can picture himself

there, among them, one of them—the picture, of course, of his own favourite dancing place being conjured into his mind. Wireless has for the time taken him out of the hospital, brought him like some obedient genie back into the life of the normal healthy world. His morale has improved tremendously.

It may be opera that he likes—perhaps he can get one of the latest revues being broadcast straight from the theatre. He may suddenly gain a keen interest in distant stations, and have the thrill of lying in his white bed and listening to a quartet in Paris, a solo in Berlin, the military band in Madrid, or an instrumental piece from Brussels. He may follow a course of lectures, a class of some sort.

But the important effect of wireless (and its vast superiority to any other form of entertainment for hospitals) is that the patient is not a segregated mortal, cut off from all

dolorous callers, but are taken part in by him. When the callers come, he has something to offer too—he can listen to them discuss things, or he can discuss things with them, which have actually happened that day. He has begun to take an interest in outside life, and his morbid interest in himself wanes, to be replaced by a healthy interest in wireless.

Cheering the Nurses

Wireless will also help to keep the nurses in a better frame of mind, since they can get in touch with the outside world during their leisure hours, by means of a loud-speaker. This is a humane effect, rather; though indirectly it has its beneficial influence on the patient. Many of the hospitals in London to-day are installing wireless sets—in fact, there is a regular wave of this work going on throughout England.

In London, actual results by the application of the broadcast programme have apparently proven once and for all the right of the receiving set to claim its place among hospital appliances and installations. Several wireless firms are making special portable sets to sell to patients for hospital use.

“ Then your belief is that wireless is only beginning to be appreciated from the curative standpoint, and that it really has a great future in this line ? ” I asked Sir Bruce.

“ I, personally, look forward to the time when every

patient will be supplied with his wireless set,” he answered emphatically, “ or at least his set of headphones, just as he is to-day supplied with bed, garments, or meals. And I hope then to see the percentage of early convalescences and cures definitely and permanently increased.”



Listening to a wireless programme keeps little convalescent patients out of mischief!

intercourse with his fellow men, and feeling that the world and life are whirling on without him. Instead, he is able *actually to take part in the life of the world*, and to become a member of human society.

The events that happen around him are not recited to him by

How Many Broadcasting Stations?

ACCORDING to an official statement of the B.B.C., it should be possible to arrange seventy main broadcasting stations on the European broadcast wavelength band of from two hundred and fifty to six hundred metres.

I have been making a few calculations based on the above statement, and I find that seventy stations between the limits of two hundred and fifty metres and six hundred metres would tax the selectivity of our sets very severely.

Kilocycle Separation

The first thing I suppose one would note with regard to the above official statement is that it conforms to the generally accepted idea that a minimum separation of ten kilocycles is necessary between two broadcasting stations in order that beat-note interference may be avoided.

Here is the calculation:—A wavelength of 250 metres corresponds to a frequency of 1,200 kilocycles. A wavelength of 600 metres corresponds to a frequency of 500 kilocycles. Subtracting 500 from 1,200 gives us 700 kilocycles.

Dividing 700 by 70, the proposed number of European stations, gives us 10 kilocycles, the minimum separation figure for the avoidance of beat-note interference.

At the present moment the differences in kilocycles between our main broadcasting stations are as follows: Cardiff and London 28, London and Manchester 28, Manchester and Bournemouth 17, Bournemouth and Newcastle 35, Newcastle and Glasgow 31, Glasgow and Belfast 29, Belfast and Birmingham 56, and Birmingham and Aberdeen 20.

Closest Stations

Now the three stations which are the closest together in this table, and which are, generally speaking, the most difficult to separate from each other when tuning-in a receiving set, are London, Manchester and Bournemouth.

The difference between London and Manchester is 28 kilocycles. Between Manchester and Bournemouth the difference is 17 kilocycles.

Now on a square-law variable condenser dial in my most selective set London comes in on division 36, Manchester on division 39, and Bournemouth on division 41. The condenser has a capacity of .0003 microfarad, there are 100 divisions on the dial and there is a fine-adjustment vane.

If there is to be a European broad-

THE HELPING HAND

of THE WIRELESS MAGAZINE is ever ready to come to your aid when you are in difficulty over any wireless trouble, whether practical or theoretical.

Just write your query out on a piece of paper (write on one side only, please!) and send it, together with the coupon on page iii of the cover and a stamped addressed envelope to:

The Editor,

THE WIRELESS MAGAZINE,
La Belle Sauvage, E.C.4.

In the ordinary way a reply will be posted to you the same day that we receive your question. Moreover, this special service is

QUITE FREE!

casting station for every ten kilocycles on the broadcasting wavelength band, there will be a station between London and Manchester and another between Manchester and Bournemouth. That is to say, I shall have a station for every degree over a portion of my tuning condenser dial. Can I tune-in those stations without interference?

I very much doubt it, unless I take my set about with me to various parts of the country.

I showed my calculations on the number of European broadcasting stations and the kilocycles to be shared between them to my mathematical friend, who is, as usual, on holiday.

After looking through my work, my friend with the wonderful figure head took his pipe out of his mouth, looked at me searchingly for a couple of minutes and then said:

"It's all wrong, you know."

"What do you mean, it's all wrong?" I asked.

"There is an error in your calcula-

tions, an error which is very frequently made."

"I'm sure there is not. I went through the work three or four times."

"The division by seventy is wrong."

"But dash it all, man, seventy into seven hundred is ten."

"Granted."

"Well, it's right then."

"No, it is not right."

"How can it be wrong?"

What Was Wrong

"You should have divided by sixty-nine."

"Sixty-nine?"

"Yes, sixty-nine, not seventy."

"But there were seventy stations."

"Agreed, therefore you should have divided by sixty-nine."

"Can't see it."

"Listen, then. Suppose I put down four matches so that the distance between the first and fourth is a yard. How many inches apart are the successive matches?"

"Nine."

"Wrong again. They would be twelve inches apart. I'll show you."

I hate tricks with matches, but my mathematical friend convinced me that the distance apart of successive matches was twelve inches.

"One at Each End"

"Four matches, divide by three," he explained as he took up the matches and put them back in the box. "One must not overlook the fact that there is a match at each end."

"Another little mistake you have made is in the number of divisions on your condenser dial. You say there are a hundred. I think if you count them you will find there are a hundred and one division marks on your condenser dial. There are, of course, just a hundred spaces between those division marks."

After I have finished this paragraph, I am going to write to Uncle Arthur at Geneva and ask him to see that there are seventy-one broadcasting stations in Europe instead of seventy. You see it is such a lot easier to divide by seventy than by sixty-nine.

AERIAL.

This Set Has Been Specially Designed by "The Wireless Magazine"

The Housewife's Crystal Set



WE have heard pæans of well-deserved praise of listening-in from the tired business man, from the invalid, from the lonely farm household, from the adolescent student. But rather curiously, few eulogiums seem to come from the person who ought to benefit most of all—the housewife.

Monotonous Housework

Housework is for the most part condemned as monotonous. "While I happen to be one of those who think it contains as much variety as most careers, I do recognise its loneliness," says a housewife. That is where wireless can be such a sociable influence.

The housewife with the right viewpoint—the willingness to find interest within, as well as outside, her work—soon discovers how many daily "chores" can be done to the accompaniment of wireless. She begins to re-plan her day so that certain jobs shall coincide in time with the broadcast programme.

Numerous preliminaries to cooking—silver cleaning, furniture polishing, dusting, mending, knitting, ironing—can all be done to the inspiring accompaniment of music or a talk.

Described in this article is a crystal set which has been designed specially for the housewife's use, and which incorporates the features necessary for trouble-free reception. The variometer used is of the usual moulded type, and the crystal detector used is one of the new Polar type.

This consists of two plug sockets into which fit the crystal cup and

of the contact arm are made of ebonite, while the metal parts are nickel plated, and this, in conjunction with the Belling-Lee ebonite terminals and variometer dial, gives the set a very ornamental appearance.

A novel feature of the detector is that, instead of one big crystal being mounted in the cup, there are a large number of very small crystals so mounted as to present a uniform flat surface to the light metal spring which takes the place of the more conventional catwhisker. In practice this novel combination gives sensitive yet stable rectification with very simple adjustment.

Components Required

Following is a list of the components used in the construction of the set:

Ebonite panel, 9 in. by 7 in. by $\frac{1}{8}$ in. (American Hard Rubber Co.).
Nickel-plated dial indicator (Decko).

Atlas variometer (Clarke and Co. (Manchester), Ltd.).

Polar crystal detector (Radio Communication Co.).

4 ebonite engraved terminals (Belling and Lee).

.002-microfarad fixed condenser (Paragon).

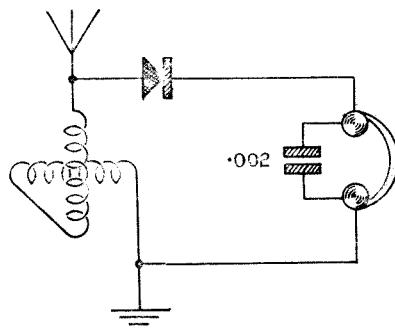

Circuit Diagram of Crystal Set.

contact arm. The whole detector takes up very little space. Both the crystal cup and contact arm are easily replaced, so that when the crystal loses its sensitivity or the contact arm wears down either one or both can be replaced with the minimum of trouble.

Both the crystal cup and the knob

The Housewife's Crystal Set (Continued)

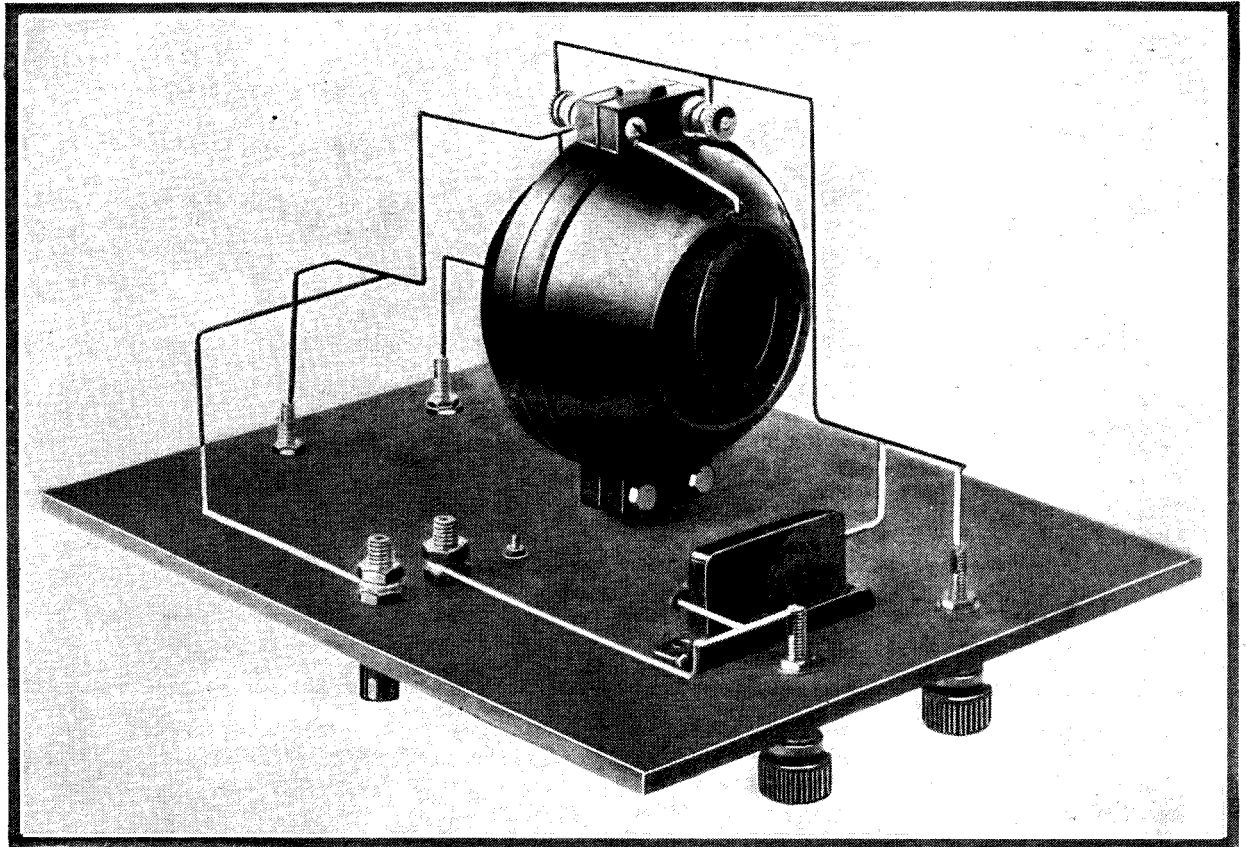

This photograph shows clearly the wiring of the Housewife's Crystal Set.

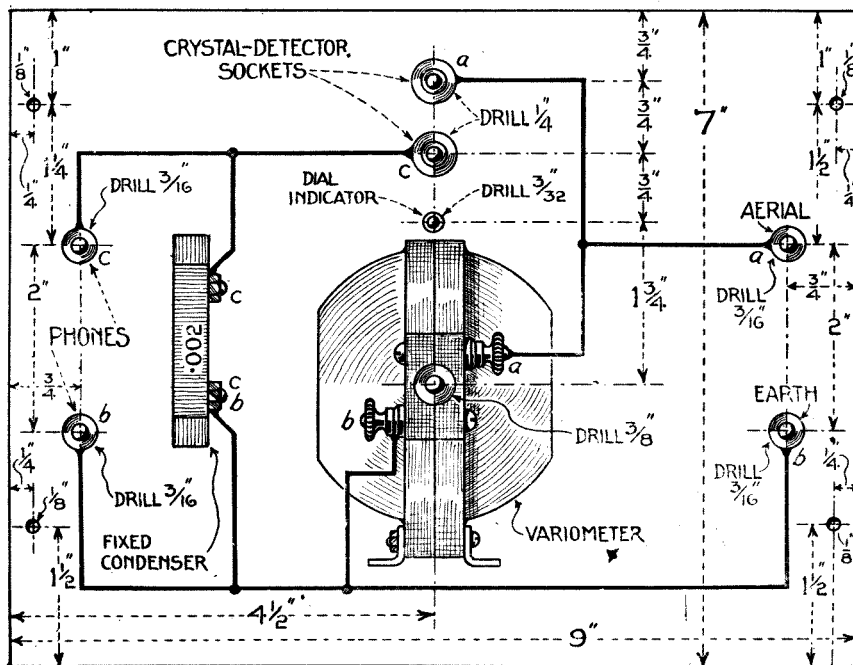

Combined Panel Layout (half scale) and Wiring Diagram of the Housewife's Crystal Set.

Cabinet, 9 in. by 7 in. by 6 in. deep (Unica Cabinet Co.).

The ebonite panel is a standard size, and will not require any trimming or rubbing down, so that the drilling of the necessary holes can be started as soon as the components have been obtained.

The drilling should be carried out in accordance with the drilling diagram shown. As only twelve holes are required, drilling should present no difficulties.

Fixing the Variometer

Unless the constructor possesses a $\frac{3}{8}$ -in. drill, the centre hole for fixing the variometer by the one-hole-fixing method can be made with the largest drill available, and then carefully enlarged to the correct size with the end of a file.

Having drilled the holes, the components can be mounted as

Designed by "The Wireless Magazine" Technical Staff

shown in the photographs and wiring diagram. The .002-microfarad fixed condenser is held in place by the wires connected to the phone terminals and is not screwed down to the panel.

Wiring

When the components have been fixed in position wiring can be carried out with No. 16-gauge round-section tinned-copper wire, in accordance with the circuit diagram or wiring diagram, after which the panel is ready to be screwed into the cabinet by means of four countersunk brass screws.

To maintain the appearance of the panel these four brass screws can first be dipped into some flux and then touched with a hot soldering bit to tin them, so giving them the appearance of nickel-plated screws. The set is now ready for use, and an aerial, earth and pair of phones can be connected to the appropriate terminals.

The local station is tuned-in by lightly resting the contact spring of the detector on the crystal and turning the dial until maximum signal strength is obtained. Re-

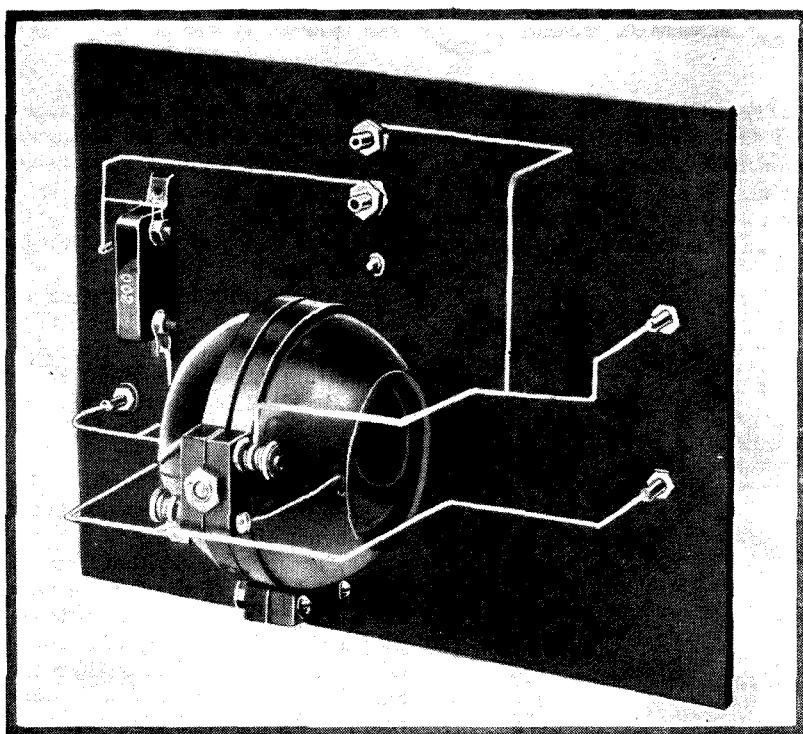

Another photograph of the Housewife's Crystal Set, showing the wiring and disposition of the components.

adjustment of the detector to find the most sensitive position will complete the operation of this simple and efficient crystal set.

A CURIOUS VALVE FAULT

When Dust Gets Into the Base

A RATHER unusual fault in a valve, and one which is extremely difficult to locate, is that caused by dust ascending through the holes in the base.

Holes in Base

In some makes of valves these holes, where the wires pass through to the legs, are much larger than the actual wire. The result is that after a valve has been in use on a set for some time—and especially on an exposed set—dust begins to collect inside the valve base, and on the under side of the sealing-in tube.

Leakage

Here it fills in the space between the plate, grid and filament wires, and consequently, since the electrical pressure between the plate and filament leads is anything from fifty volts

upwards (depending on the amount of H.T. used), a continual "creeping" or leakage is taking place.

This results in a very annoying and persistent crackling in the phones,

for which one is apt to blame the H.T. battery.

Base Removed

In the writer's case the trouble was only located after much searching, but was quite easily remedied. The wires were unsweated from the valve legs, and these, with the ebonite base, removed, giving complete access to the under side of the sealing-in tube.

Stopping up the Holes

The dust on this was then removed with a small camel-hair brush, the base replaced and the wires resoldered to the valve pins. The holes were stopped with a little paraffin wax.

On trial the valve was found to be completely cured, and has now run for months without a single unwelcome sound.

D. W. M.

CAN YOU COIN A NAME?

Everybody knows that the term **broadcast waveband** means that range of wavelengths extending from 250 to 500 metres. Some people call these wavelengths "short," but here confusion arises; other people know as "short" all those wavelengths below 250 metres.

In order to avoid misunderstanding it is desirable to have a name for the band of wavelengths from 0 to 250 metres, and to any reader of THE WIRELESS MAGAZINE who coins what is, in the Editor's opinion, the most suitable name will be presented with the All-America One-valve built in our Constructional Department and described on page 166 of this issue.

Entries, addressed to "Waveband Name," THE WIRELESS MAGAZINE, La Belle Sauvage, E.C.4., and accompanied by the coupon on page iii of the cover, should reach us by March 27. Get on your cap of ingenuity straight away!

Blake Boanerges' Banter

ALTHOUGH an obscure person, I find myself to be the target of numerous correspondents. I am grateful. I am even flattered. I mean to say that I am grateful when they send me samples, and flattered



Lady X. presents her compliments, and would I tell her how to erect an aerial on her caravan.

when they ask my advice. Having been privileged to use up many weary columns of the periodical Press in the course of my busman's holiday, that is, writing about wireless, I have reaped the harvest.

It is like trawling. The net brings up all kinds—good, bad, and indifferent. I have an affection for them all (even the gentlemen who wish to lend me any sum up to £40,000) except the cranks.

When I consider some of the people who are walking this fair island without a keeper I shudder. Some are being pursued, they tell me, by enemies who injure them by wireless; others are having their premises burned by high-power wireless stations; many, oh! many, have inventions to sell, while others require me to perpetrate free advertisements for their goods.

But those I love best ask for my advice. That is fame, or something like it.

When I realise that Jno. Brown, of Mulberry Haugh, Wharfedale-on-Trent, ignoring the Q. and A. columns of the wireless journals, eschewing the special laboratories and research departments devoted

to unravelling wireless worries, takes up his pen to address me and even expresses the hope that his missive (seven letters, meaning "epistle") will find me as it leaves him—well, what can a fellow do but warm towards him?

Jno. of the wilds has a wireless set—evidently a wild one. He tells me that all he hears in the telephones is a "grating noise like stone being sawed." Hard luck! though I expect Michael Angelo would have been entranced.

Will I tell him what to do, as he made it himself and does not know very much about it?

Casting my imagination toward Wharfedale, etc., I see that the poor fellow has wound an aerial inductance with a natural frequency of about a million metres, and has constructed an H.T. battery with ball-bearing connections. I send him a list of reputable manufacturers and hope for the best.

Lady X. presents her compliments, etc., and would I tell her how to erect an aerial on her caravan? Answer: Wire, insulators, step-ladder and faith!

When Mr. P. does so-and-so his receiver says "Plop plop." I am familiar with "glug glug" and with

bogged buffalo emerging from its wallow. The only answer I can make is, "Don't do it," an Eckersleian reply.

One of these days I shall draw up a schedule of "Strange Sounds: Their Significances," and mail a



In the odd moments between talks about Russian boots and bobbed hair.

copy when requisite. But first I shall have to visit the Zoo, the B.B.C. noise department, and the House of Lords while Lt.-Com. Kenworthy is explaining their amplifying system to them. Meantime, my letterbox is open to all and sundry.

* * * * *

Talking of "troubles" reminds me of next-door's tragedy. I don't know how Wilkins knew I am engaged in wireless matters for daily bread; perhaps it was my spats—or my aerial. Anyhow, he sent his wife round to mine, and in the odd moments between talks about Russian boots and bobbed hair she found time to convey the news that "the set" was quite dud. You know what I mean. That is, the receiver refused to function as requisite, and all that.

I heard the news without enthusiasm, and after a little coaxing went next door. I played with the set, shoving the condenser this way and that in the approved professional style, with bedside manner irreproachable, and said, "I guess its your H.T." Then I backed out and went to bed. They bought a new



Wilkins with whiskers bristling with rage.

"teuf teuf," but "plop plop" is double-Dutch. Possibly it is the voice of the Lesser Gasbill admonishing its young, or the sound of a

H.T. battery, and the wives met again.

In I went. "Oh, it's your L.T., I guess. Look at those accumulators. Faugh!" I said, and went in to bed. That was a new L.T. battery up their sleeves.

There was another "at home" a few days later, from which emerged the fact that the set was still obstinate and dumb. I had another try. "Rotten earth," I said, had a whisky, chucked the maid under her chubby chin and retired in good order. You ought to see our's.

No good! The distaff sides coincided once more and out of a discussion of winter furs there crept the awful truth that "the set" said nix. So after inquiring about the whisky to my satisfaction, I again approached the brute.

"I've spent £5 17s. 9d. already, since you first came in," said Wilkins. "I can go to £10, then I pass. What in blazes is up?"

"How many more bottles of it, have you?" I thought. Then aloud, "What about your valves? Are they DP 6's? No! I thought not. My goodness, some of you people do expect something." I liquidated the idea and retired. Nothing like educating 'em.

Up Against It

Then I came up against it properly. Wilkins without whisky. Wilkins with whiskers bristling with rage. I sneaked in and sat down before the brute, dry as a bone.

"I'll fix it this time," I said. "I'll make an examination from earth to aerial and nobbie the

beggar!" Wilkins crouched nearer, intent as a pup over a spider.

"That's £9 17s. 6d.," he said, under his breath. Then I got it. He had connected the telephones to A and E, and the aerial and earth to T₁ and T₂. Quite a rotten bloomer. Never dreamed of looking there.

"When did you connect this gadget up?" I asked.

"February 18th," he replied. "B'gum! Hark to the Savoyeans. Tah, tah, tee, tum tum. Thanks awfully, o' man."

When I got home I asked my wife if she knew anything about February 18th.

"Why, that is the date they were married," she said.

And so—well, there you are, brethren.

Controlling Your Valve Filaments Efficiently

THE correct temperature of valve filaments is very important in wireless work, and individual control on a multi-valve set is very desirable.

Take the case of a three-valve set—H.F., detector and L.F. All three valves require separate adjustment of filament brilliancy, for example, bright, not so bright and rather brighter; or bright, brighter, brightest. It requires a considerable amount of time and skill to adjust the various rheostats to their best positions.

In the hands of broadcast listeners, and even the "lesser" experimenters, this operation is so lengthy that more often than not patience gives out and excuse is accepted that reception is not quite so good.

Others, realising that they have not the patience to try for maximum results every time, adopt the simple expedient of inserting a switch and setting the rheostats permanently at their proper values.

This method has disadvantages. The set is only working at maximum efficiency whilst the battery maintains a constant voltage, so that for maximum results the accumulator must be charged frequently.

A much greater disadvantage, however, is that the filaments when cold momentarily take many times more current than their maximum

carrying capacity. They get hot and limit the flow before the current passes long enough to burn them out, but they do not escape permanent damage.

This damage is much more pronounced in coated valves (D.E.s) than in ordinary ones. Under the influence of the push of the excess current and the pull of high tension on the plate the electrons become so active that they cannot wait

a resistance of five or six ohms is left in the circuit, and the ordinary rheostats then fixed at their best working values. The few ohms left in the master resistance may be cut out as the battery voltage falls, thus making use of a complete discharge.

The usual rheostats need never be touched except when, by constant use, the characteristics of the valves become changed.

This method is adaptable to bright or dull-emitters, or a mixture of both, by choosing a suitable resistance value for the master rheostat.

When changing over from bright to dull-emitters this arrangement is even still more efficient and economical.

Indeed the same rheostats may be retained and the additional resistance required obtained from the master rheostat.

Eight to ten ohms (the usual resistance on bright valves) give ample range for individual control, while owing to low resistances these rheostats used in this way have almost a vernier effect.

Thus by adding one rheostat instead of changing three we obtain greater efficiency, easier control, and may confidently expect a very appreciable increase in the lives of the valves.

G. M.

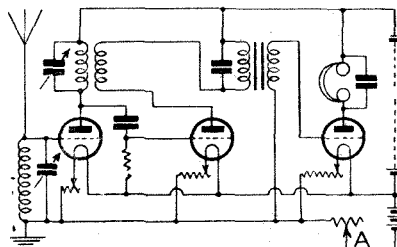

Method of Connecting Master Rheostat.

to be released, but take some of the coating along with them.

This rapidly reduces the amount of electronic emission available and incidentally the life of the valve.

In practice, the arrangement shown in the diagram is found to be excellent. Here we have the usual filament controls all governed by a master rheostat.

When D.E. valves are used this rheostat should be turned on until

The A.B.C. of the "Super Het"

An article by J. F. Johnston explaining in simple language the supersonic-heterodyne method of reception

THE most outstanding feature of the year 1925, from the wireless amateur's point of view, is the remarkable way in which the "super het" has come into prominence and gained popularity on this side of the Atlantic. The circuit, of course, is not really new as it has been fairly widely used in the United States for some years.

In 1921

The first occasion on which the "super het" attracted any serious attention from British amateurs was during the Transatlantic tests of December, 1921. Up to that time no amateur signals had been sent across the Atlantic. The previous year there had been a determined attempt by amateurs in the British Isles to pick up signals sent out at pre-arranged times by amateur stations in the U.S.A., but the result had been complete failure.

The Americans were convinced that the negative results of the tests were due solely to the unsuitability of British apparatus, and for the tests arranged to take place at the end of 1921 they sent over an eminent American amateur just to show us that Transatlantic reception *was* possible.

This American brought with him two receivers, one consisting of a detector valve with anode circuit tuned (to obtain a regenerative effect) followed by two L.F. valves, and the other a ten-valve "super het." It was explained that, if possible, the reception would be carried out on the detector and L.F. set, which represented the standard American amateur receiving equipment. The "super het" was "just in case."

Suitable Location

The American searched the British Isles for the most suitable place at which to erect his station and finally fixed on Ardrossan, on the west coast of Scotland. The tests were carried out and he was successful, but it was found necessary to use the "super het."

Incidentally many British ama-

How the "super het" first attracted attention in Britain, how the advent of dull-emitter valves has helped its development, and how it overcomes the disadvantages of ordinary high-frequency amplification on short wavelengths are points dealt with in this article, which is accompanied by photographs and particulars of many of the best-known "super het" sets now on the market.

teurs were also successful, and they all used straight circuits. In one case six stages of tuned H.F. amplification, a detector valve, and four transformer-coupled L.F. stages were used, as well as a local oscillator, making twelve valves in all. In another case reception was successfully carried out on three valves, detector and two L.F. stages. The tests were carried out mostly on wavelengths around 200 metres.

Excellent Results

The results obtained by the American were, however, so excellent that British amateurs began to pay serious attention to the possibilities of the "super het." Many of those who could afford it started to build such receivers for themselves. But at that time several serious obstacles lay in the way of the "super het" becoming really popular over here.

In the first place few people wanted to lay down the amount of money needed to buy ten valves all at once, and even so the problem of supplying the filaments of ten bright-emitters was not easily overcome. Again, as broadcasting had not started in Europe, no one but the very enthusiastic experimenter cared to make the necessary outlay for the pleasure of listening to commercial and amateur stations sending messages in morse.

Now things are entirely different. Valves are cheaper, and dull-emitters can be obtained, ten of which consume less current than was required by one of the old bright valves. So many broadcast stations are working that a very sensitive and selective set is required in order

to receive even the majority of them at will.

In return for the initial expense of an eight- or ten-valve receiver there are an enormous number of really excellent programmes available. At the same time it is a great advantage to many people to be able to carry out long-distance reception without the necessity for an outside aerial.

Advantages of H.F. Amplification

Having seen how the "super het" was introduced into this country and how the initial objections to its popular use have been swept away, let us turn our attention to the receiver itself and see what advantages it possesses over "straight" long-distance sets.

Theoretically H.F. amplification is essential for satisfactory long-distance working. L.F. amplification can greatly magnify signals which have already been properly "detected" and can bring up to fair strength signals which would otherwise be quite inaudible.

But in order that the detector valve shall be able to do its work in an efficient manner it is necessary that signals should have a certain minimum initial strength before being applied to its grid.

High-frequency amplifiers magnify the actual oscillatory currents which the on-coming electric waves cause to flow in the aerial. In a way the effect of a H.F. amplifier is to bring a distant station nearer. At least the oscillatory currents are made stronger just as they would be if the distance between the transmitting and receiving stations had been decreased. Theoretically any station, no matter how distant, could be received if sufficient stages of H.F. amplification were used.

Limit of H.F. Amplification

However, there are so many practical objections to the use of H.F. amplification on short wavelengths that it is now very seldom, if ever, used for wavelengths below

(Continued on page 152.)

**STANDARD TELEPHONES
AND CABLES SEVEN-VALVE
"SUPER HET" RECEIVER**

(Standard Telephones and Cables,
Ltd., Bush House, Aldwych,
W.C.2)

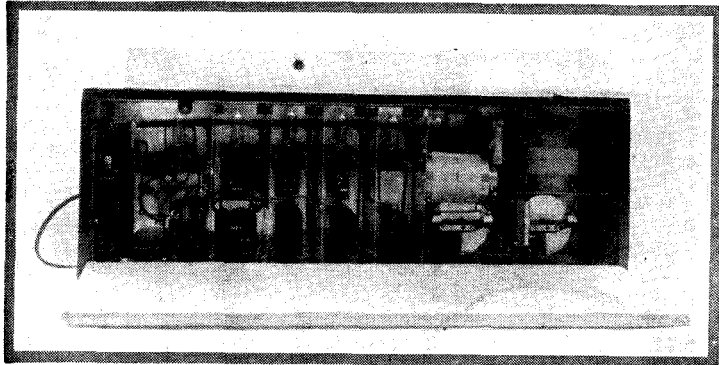
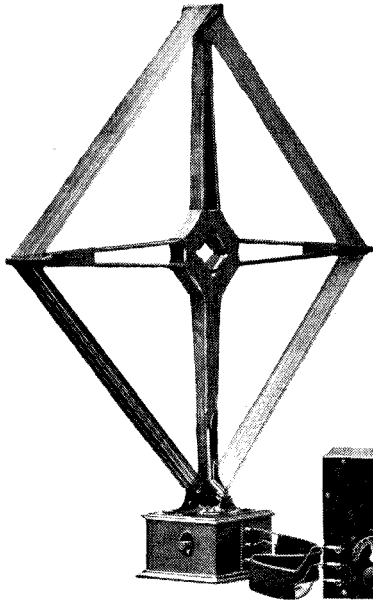

All that is necessary to operate this set (model 44,002, made by a company that was formerly known as the Western Electric Co., Ltd.), are an 8-volt filament battery and a 45-volt H.T. battery. The filaments of the valves are connected in series and the total current consumption is only .25 ampere.

Two tuning condensers are provided and by means of a simple switching arrangement the set will receive on any of the following bands of wavelengths: 300 to 500 metres, 600 to 1,300 metres, and 1,200 to 3,000 metres.

Great selectivity is claimed to be a feature of the set, and a station can be completely "lost" if one of its tuning adjustments is wrong by as little as half a degree. For this reason a calibration chart is supplied with each set, so that it can be tuned directly to any desired wavelength.

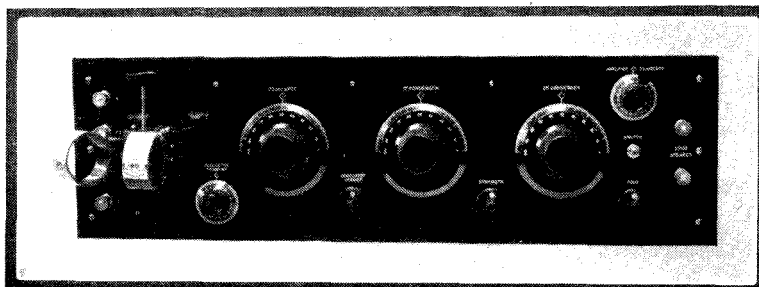

**IGRANIC SIX-VALVE
"SUPER HET" OUTFIT**

(Igranic Electric Co., Ltd.,
147, Queen Victoria St.,
E.C.4)

The components for this set are supplied as a complete outfit for assembly by the home constructor, and the fact that they can be built up to make a very neat receiver is shown by these photographs.

Variation in wavelength range is obtained by the use of different oscillator coupling units, three of which are manufactured; in this way the range of the set can be extended from the broadcast band of wavelengths up to 4,500 metres.

Either a frame or an ordinary outdoor or indoor aerial can be used, as desired.

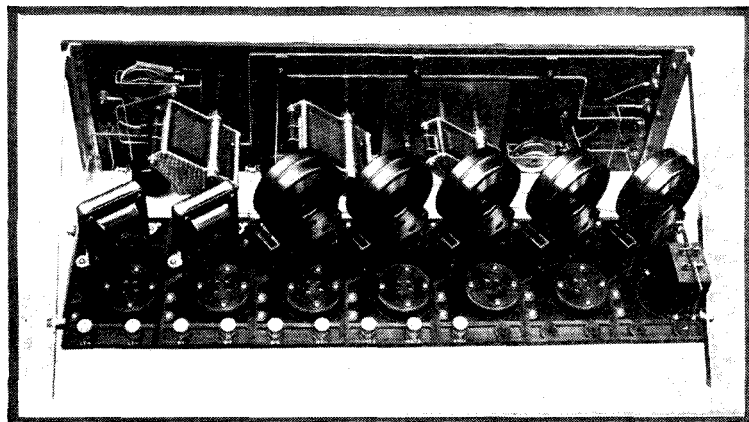

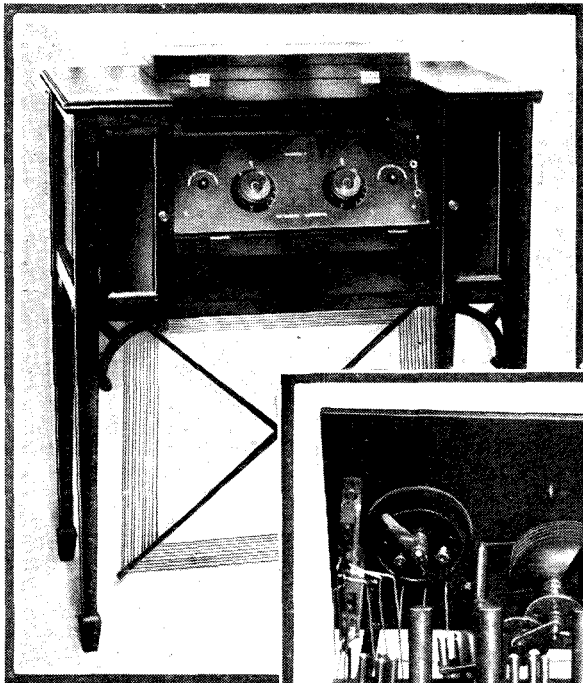

**HART-COLLINS EIGHT-VALVE
ORTHOSONIC SPINET RECEIVER**

(Hart Collins, Ltd., 38a, Bessborough St., S.W.1.)

Calibrated before it leaves the works, each Hart-Collins "super het" is supplied with a chart that shows the positions of the two controls for reception on different wavelengths—a point that is appreciated by an inexperienced operator.

It will be noticed that the aerial is accommodated underneath the cabinet, thus making the receiver quite self-contained. Both low- and high-tension batteries are housed in the cabinet, the loud-speaker (the mouth of which is seen just above the panel) being particularly inconspicuous.

Dull-emitter valves are employed, and either seven or eight can be used at will by means of a switch. The normal wavelength range is from 250 to 520 metres, but higher wavelength transmissions can be received by the addition of suitable coils.

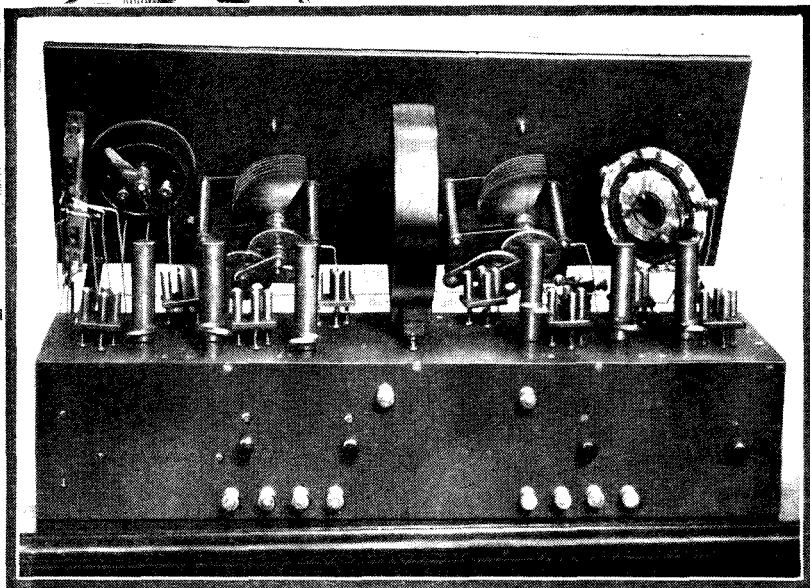

**BURNDIPT SEVEN-VALVE ETHODYNE
"SUPER HET" SET**

(Burndept Wireless, Ltd., Aldine House, Bedford St., W.C.2.)

In order to cover adequately all the broadcasting wavelengths, two frame aerials are used with this set; the smaller is suitable for transmissions on wavelengths from 250 to 550 metres, while the larger receives over a range of wavelengths from 1,000 to 2,000 metres. The internal tuning is altered by operating a simple key switch.

The valves used are of Burndept manufacture, different types being chosen for the special functions they have to perform, thus giving the most efficient results from the combination. The sixth and seventh stages are special power amplifiers, the last being put in or out of circuit at will by means of a switch.

Apart from this switching of the power amplifiers another volume control is incorporated enabling the intensity to be adjusted to the degree most desirable under any special condition. For instance, it is possible by means of this control to receive a broadcasting station only a very few miles away without overloading the loud-speaker.

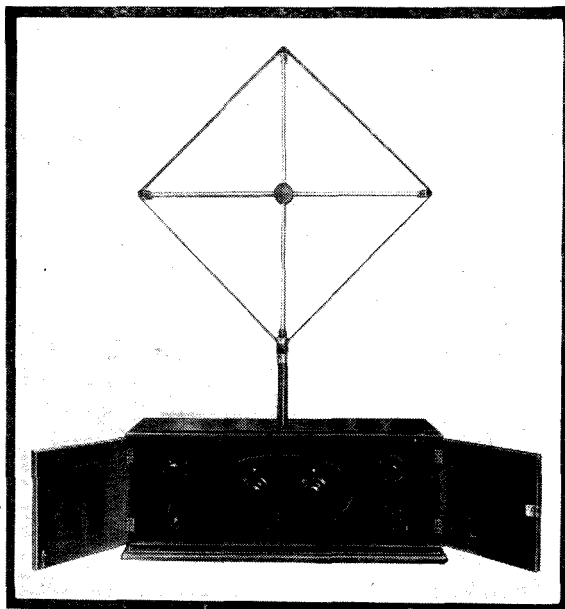

**B.T.H. PORTABLE THREE-VALVE
"SUPER HET"**

(British Thomson-Houston Co., Ltd., Crown House, Aldwych, W.C.2.)

This set is entirely self-contained and will give loud reception of main B.B.C. stations at a distance of 30 to 40 miles (100 miles in the case of the Daventry station). A considerable increase in range can be obtained, however, by using a special coupling coil in conjunction with an ordinary aerial-earth system.

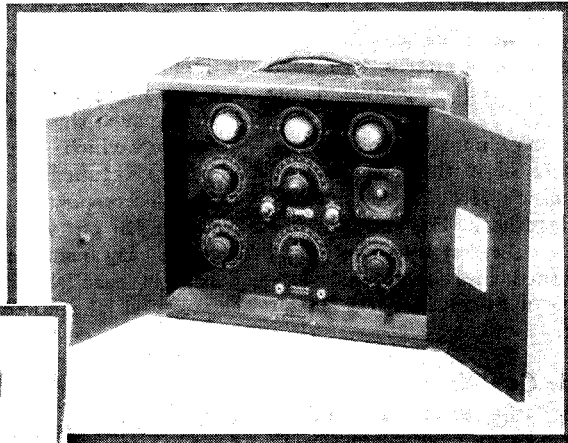

The weight of this set is 23 lb. and the overall dimensions are 13 in. high, 16 in. wide and 6 in. deep.

In order to facilitate the setting of the frame aerial in line with the direction of the station it is desired to receive, a compass is mounted on the top of the case.

Each set is supplied complete with valves, batteries and a pair of phones. The standard finish is leather cloth.

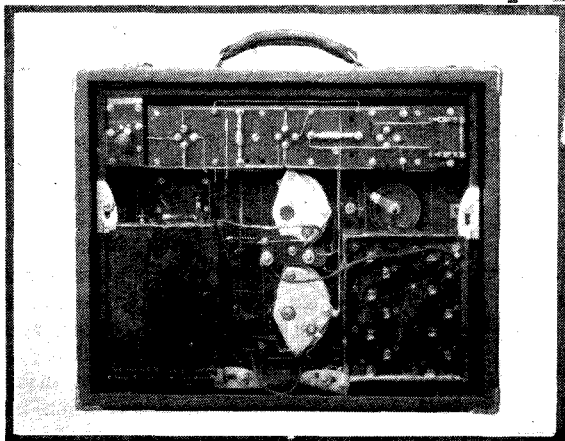

**GECOPHONE EIGHT-
VALVE "SUPER HET"
RECEIVER**

(General Electric Co., Ltd., Magnet House, Kingsway, W.C.2.)

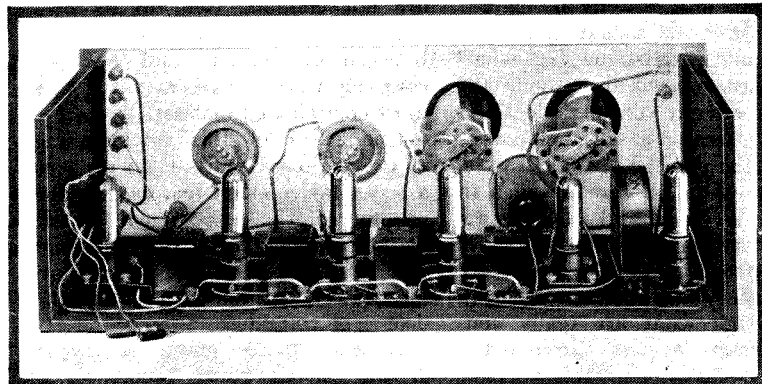

By manipulating two tuning controls and plugging-in suitable oscillator coils the Gecophone "super hets" (there is also a six-valve model) can be operated on any wavelength between 200 and 3,000 metres. Each set is supplied with frame aerial, valves, batteries, phones and loading coils.

Gecophone "super het" units are also sold in kits for those amateurs who wish to build up their own receivers.

The A B C of the "Super Het" (Continued)

250 metres, while on the band of from 300 to 500 metres two such stages are generally considered the practical limit.

Let us examine these objections. On the face of it there are several ways in which H.F. stages may be coupled together. For our purpose they can be divided into two broad classes, tuned and aperiodic couplings. We will consider the latter type first.

Aperiodic Couplings

Although the term "aperiodic" is often used (the word means "untuned," or without any particular electrical "period") such couplings are really tuned to about the centre of the waveband over which it is desired to receive, but steps are taken to make the "tuning" extremely "flat." This is done by the introduction of damping in some form or other, often by winding the coils with resistance wire.

The first result of this procedure is to reduce greatly the amplification obtainable as the damping causes much of the signal energy to be dissipated.

In any case the coils of the transformer, anode resistance, or whatever device is used to provide the coupling, offer a considerable "impedance" (really a self-explanatory word) to the passage of the currents. But however much care is taken in spacing the leads and components of the set some capacity must always exist between them. Therefore some of the energy will choose rather to leak through what are really condensers than to pass through the coupling device.

As the facility with which oscillatory currents can pass through condensers increases with an increase in the frequency of the currents, so the losses due to capacity will become greater as the wavelength dealt with becomes shorter. (Of course, a shorter wavelength means a higher frequency).

Tuned Intervalve Couplings

Systems of tuning the intervalve couplings aim at overcoming the above difficulty. It is well known that oscillatory currents will flow more readily in circuits tuned exactly to their particular frequency. Now, in order that we may have a tuned

oscillatory circuit, capacity as well as inductance is necessary. Therefore we can make the inductance of the coupling such that, together with the capacity which necessarily exists already, a tuned circuit is formed which corresponds to the lowest wavelength on which we wish to receive. By using a variable condenser in parallel with the inherent capacity of the circuit we can tune

Another article next month will explain how the "super het" changes the wavelength of received signals so that they can be amplified efficiently by several tuned or even untuned high-frequency stages.

it to a band of wavelengths the breadth of which will depend upon the size of the variable condenser. (There are, however, reasons why this should not be too large).

One difficulty disposed of (partially, at any rate) and another immediately crops up. The inherent capacities which we have mentioned are not confined each to its own particular circuit, but exist also between one circuit and another, coupling them together in a really most complicated manner.

One effect of this intercoupling of the various circuits is to produce a regenerative effect just as does the coupling of the reaction coil to the aerial or anode coil. In the former case, unlike the latter, we are unfortunately not able to control the degree of coupling.

By carefully designing the layout of the set we could reduce these stray capacities to such a low value that the coupling effect would be insufficient to produce oscillation were it not for the fact that very little coupling indeed is necessary to produce oscillation when both the plate and grid circuits of a valve are tuned to exactly the same wavelength.

This is, of course, due to the ease with which oscillatory currents flow in circuits tuned to their frequency, a well-known fact and one which we have already mentioned.

It will be seen that all the above trouble is due to two things: the existence of capacity in and between the H.F. circuits and the shortness of the wavelength. The effect of

decreasing the first or increasing the last would be exactly the same—to lessen the effect of the coupling.

It should also be noticed that the capacity losses in the case of aperiodic couplings mentioned above might also be reduced in the same way. This follows because oscillations of a given frequency could not pass so easily through smaller capacities while oscillations of a lower frequency (that is, a longer wavelength) would be less able to leak through the same capacities.

Reducing Stray Capacities

The stray capacities are, or should be, already reduced to a minimum in every H.F. circuit so that further reduction of these is out of the question. There remains the wavelength which might, at first thought, be considered to be dependent upon the transmitting station only, and beyond the control of the receiver.

The conclusions which might be drawn from the above theoretical consideration of the subject are fully borne out in practice. H.F. amplification of signals on wavelengths longer than 1,500 metres is a comparatively simple matter. Several stages of either tuned or aperiodically-coupled amplification may be carried out quite efficiently provided reasonable care is taken. Of course, the leads and components must be well spaced even when dealing with long wavelengths as the same considerations with which we have dealt in connection with short waves still apply, though in a much less degree.

Changing the Wavelength

Few broadcasting stations transmit on long wavelengths, but this fact need not be a bar to efficient H.F. amplification of the signals from such stations. An eminent American inventor many years ago devised the really audacious scheme of receiving the signals from a short-wave station, changing them to long-wave signals, amplifying them in comfort, and finally receiving them on a detector valve in the usual way.

He not only put forward this amazing suggestion, but proved that it was possible to carry it out—and produced the "super het," the receiver which *does it*. As to which more next month.

OUR PRIDE IN WIRELESS

ON many occasions when our crystal set has burst into a particularly elaborate trill, we have looked at each other and murmured, with the superior wisdom of those to whom the final word of progress has been revealed: "Now, what would our grandparents say if they heard this?"

Tolerant Exaggeration

It is an attitude of tolerant exaggeration which has found expression throughout the ages, whenever one generation has gone one step farther than its predecessor.

The same question was put when Montgolfier sent up his first bag of hot air; when the "Rocket" ambled on its initial trip from Stockton to Darlington; and when gas first replaced oil lamps in our homes.

Always the same question: What would our grandparents say?

Now, the answer is an easy one. We have all, since we acquired that magical box of tricks—a wireless receiving set—which brings us into instant touch with the tongues and brains of the whole world, had occasion to entertain, by its means, some persons who have never heard a broadcast programme. Whatever such persons said may be taken as a fair illustration of the way in which it would have struck our grandparents.

What did these friends say? Well, in my own case, I confess to a great deal of disappointment. Apart from such exclamations as "Wonder-

ful!" "Marvellous!" "Incredible!" at one end of the mental scale down to "Lumme! Whatever will they be a-doing of next?" at the other end, I have not heard a single remark which proved that the candidates for initiation were aware that they were up against the newest and greatest force for good that this world of ours has known.

It sounds like a sneer on my part, but, believe me, it is not, for I confess that when I placed the headphones in position for the first time the only great thought which bubbled to the surface of my brain was "Well, I'm d—d."

It is a curious fact that when one thinks of one's ancestors one usually visualises them as a set of rather dull, rather stodgy, old fogies. On the other hand, when we talk of posterity there immediately flashes across our mind a vision of an active young world filled with "men of the iron jaw" and super-efficient young women.

Cumulative Effort

This is just about as reasonable as to recall yesterday as all dusk and to hope for to-morrow as all sunrise. As a matter of fact the progress from yesterday to to-day was never a leap, but a step, and the last one which we have ascended was only made possible by all those others so truly laid before it.

We should not boast of the glittering weather-cock whilst patronising those who built the foundations,

the supporting walls and the high steeple.

There is a widespread idea—perhaps a subconscious one—that progress is in the nature of an automatic evolution from bad to better and finally to best, advancing at a steady rate as certain and resistless as the tides or the march of the seasons. This is quite a mistaken view. What we know of the more advanced amenities, facilities and advantages of our present civilisation is of very recent origin.

Time and Space

How many people realise that from the dawn of history until little more than a hundred years ago the quickest method of transport and communication at our disposal was the horse? It is only in the last century that we have curtailed time and space and only in the past ten years that we appear to have banished them.

There is every likelihood that the rate of progress is being accelerated for some time to come, and those discoveries and facilities upon which we preen ourselves to-day will seem obsolete and clumsy to our grandchildren. How long will it be before we are the grandparents expected to rhapsodise on the cleverness of new inventions! If we are still amongst the living, we shall not like it.

We may be entitled to be proud of our achievements, but we certainly should beware of *swank*.

JAY COOTE.

WHEN FELIX LISTENS-IN—Photographed by Harold Mills.

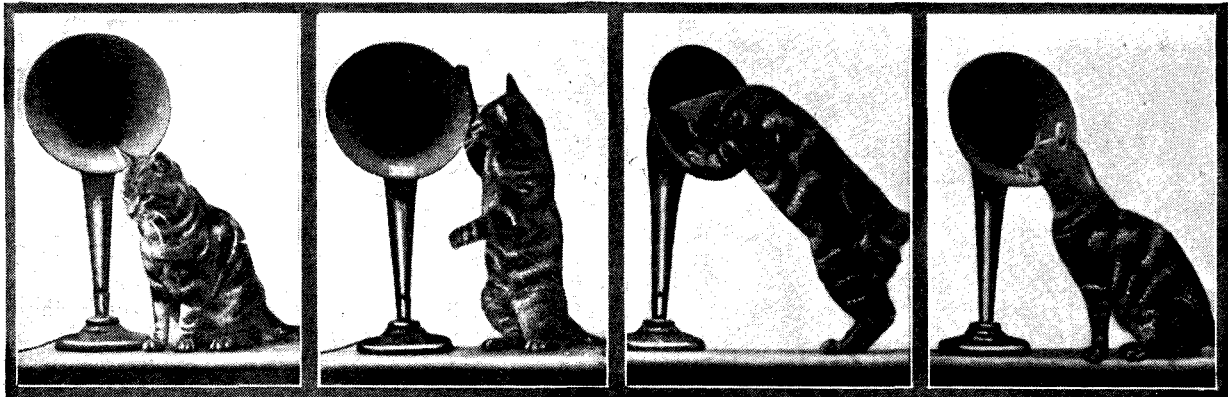

Anticipation

Realisation

Investigation

Admiration

When Hams First Talked Across the Herring Pond

A Special Article by
MAJOR W.C. BORRETT,
of C1DD, Halifax, Nova Scotia

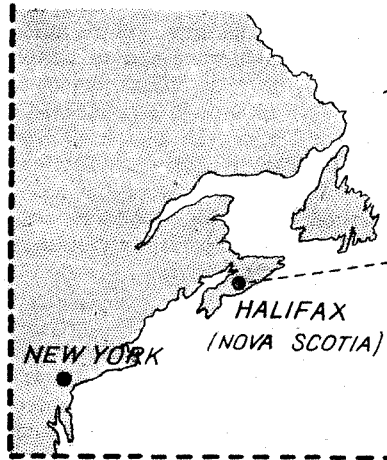

Halifax to London,
3,800 Miles

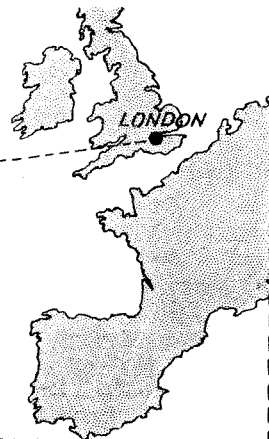

Major W. C. Borrett, of amateur experimental station C1DD, Halifax, Nova Scotia.

IN Canada an *amateur* in the wireless game is one who takes part in transmitting and the experimentation connected with it. The common term applied to such an amateur is *ham*; it is firmly established and the amateur wireless operators of Canada and the United States delight in the nickname. The man who listens to broadcast music is known as a *BCL*, which stands for *broadcast listener* and, while he is an amateur, he is certainly not a ham, and therefore it is necessary to make a distinction when referring to him.

Little Telephony

I might also explain here that the amateurs of Canada and the U.S.A. do not use telephony to any extent, and, in fact, their licences do not allow them to do so on the wavelengths that are used for international two-way communication between amateurs. Telephonic communication must be carried out on a higher wavelength, on which it will not interfere with other amateurs operating on telegraphy.

When it is known that there are some thirty thousand amateurs in Canada and the U.S.A. it can be well understood that telephony, if not well done, would be the cause of much interference, and therefore it is not welcomed in the amateur ranks. While many of the hams have the

equipment, we feel that the commercial broadcasting stations are looking after that part of wireless very well and that there is not much to be gained in knowledge of special benefit by a bunch of amateurs cluttering up the already much filled ether with a lot of chatter which can be said just as well on telegraphy with much less power.

Another point also that tends to stop the amateur using telephony is the fact that it is against our regulations to use a gramophone for broadcasting except for testing during the middle of the night.

I make these explanations to answer the questions of many English amateurs as to why we will not use telephony to work with them in our tests. We like to hear them using telephony and to hear their

English accent, which is such a relief from so much American announcing to a Canadian's ears, but I am sure that it would please us a whole lot more if the English broadcasting stations would use some extra power, and special items, if possible to suit the difference in time, and let us hear some of the excellent programmes that are given the English public on the regular broadcast wavelengths.

Hams' Work

Having made these few explanations I will proceed to tell you of the work of the amateurs, or hams as we call them, as I know it from personal experience. No doubt you have heard many an amateur calling CQ from these parts; that is the call he gives when he wants to get into two-way communication with some other amateur. It is the story of the result after one or two of such calls that I want to tell you about.

During December, 1923, a celebrated French amateur, Leon Deloy, of Nice, having just returned home from a visit to the United States, had made special tests on a wavelength of about 100 metres with the American amateur station 1 X W (belonging to Fred Schnell, traffic manager of the American Radio Relay League), and on a certain night had arranged to try two-way communication. Most

of our work up to that time had been on 200 metres, and it was very doubtful at that time whether they would be successful.

It was my good fortune to be home on the night that they were to make this test. I was preparing to go out, as a matter of fact, when the test came off, and was shaving when my telephone rang and a friend of mine, Mr. Arthur Greig, of Canadian amateur station C I B Q, told me that he had just tuned-in a Frenchman calling U.S.A. If any of you have heard America you know the thrill that goes up and down your back when you get such D X. for the first time in your (wireless) life.

I enquired what wavelength they were on and found that the Frenchman was on about 100 metres. I shall never forget the excitement that evening. I rushed to my receiving set and tore off turns and turns from the secondary coil of my receiver. I had no idea what number of turns I should need to receive on the unheard-of wavelength of 100 metres in those days.

Luck was with me, however, for as soon as I stuck the coil in and gave the secondary condenser a slight turn, I heard that never-to-be-forgotten 25-cycle fluttery note of F 8 A B calling U I X W. I had been lucky enough to listen-in to the first amateur two-way working across the herring pond.

I might tell here for the benefit

of married wireless amateurs a little story in connection with this event. All the time that I was listening-in, my wife was dressing and calling out to me to hurry up as we were expected

While we were glad to hear the Frenchman, both my friend and myself were determined to get hold of an Englishman as soon as possible, and we spread the news next day to some ten Halifax amateurs.

It was not long before the whole ten were tearing their sets to pieces and the race began. Who would be the first to work an Englishman? C I B Q soon settled that question for it was only a matter of a few nights when he had been in two-way communication with G 2 O D, the station of that now celebrated English amateur, Mr. E. J. Simmonds, of Gerrard's Cross.

The rest of us, who had not quite

out to play bridge and, while I arrived at the bridge party just in time, I don't think I shall ever be forgiven for the rotten game that I played that night. All I could think

so much power as I B Q, struggled on, and it will give some idea of our enthusiasm when I tell you that I called up every night until around 2 a.m. until February 11, 1924,

when to my great pleasure I was answered by G 2 N M, Mr. Gerald Marcuse, of Queen's Park, Caterham, who told me that my signals were strong.

Among the pioneer English stations that I heard during those wonderful nights were the following: 2 K F, Mr. Partridge, of London; 2 S Z, Mr. Goyder, of Mill Hill School; 5 B V, Mr. Ryan, of Wimbledon; 2 S H, Mr. Hogg, of London. I cannot remember any

others at present. All the above should have their names placed high in the roll of amateur wireless fame, and heading the list should be 2 O D and 2 N M who, by their untiring

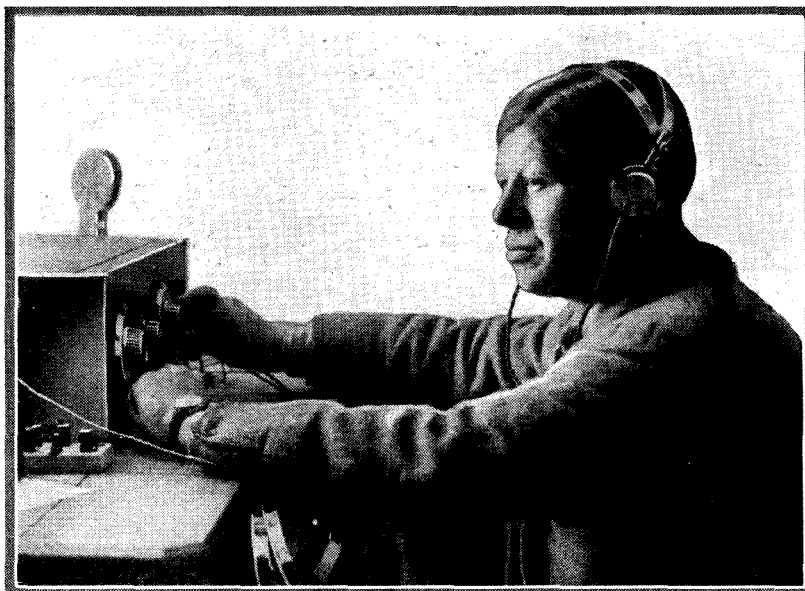

A well-known English amateur: Mr. Gerald Marcuse, of G 2 N M, Caterham.

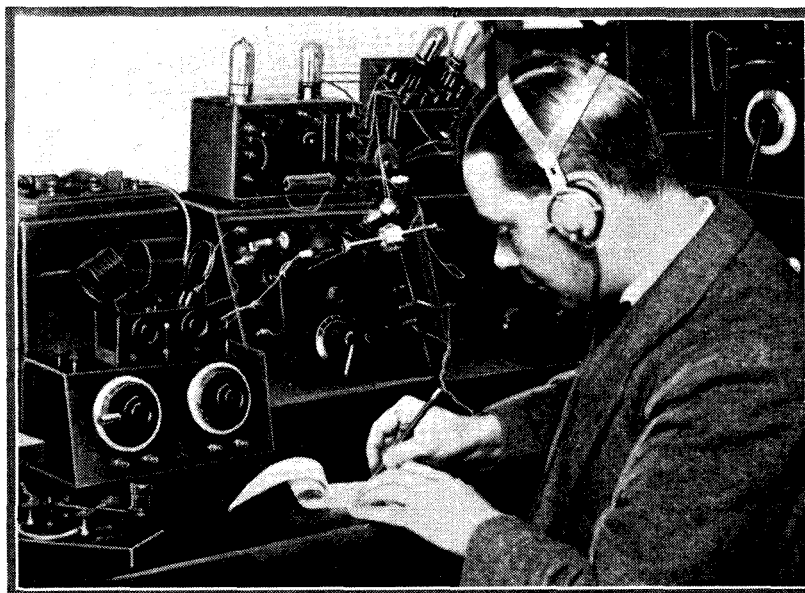

Another well-known amateur: Mr. E. J. Simmonds, of G 2 O D, Gerrard's Cross.

of was the fluttery note of F 8 A B sending dah-dah-dah-dit-dit dit-dah dah-dit-dit-dit.

That evening was the start of much work and alteration in my sets.

When Hams First Talked Across the Herring Pond (Continued)

An Article by a Well-known Canadian Amateur

efforts, pushed their signals through for months without missing a single night, and encouraged us to try night after night to connect with them.

By March, 1924, five out of ten amateur stations in Halifax district had held two-way communication with the Old Country, and as a mark of distinction we formed a society called the Royal Order of Transatlantic Brasspounders, or R.O.T.A.B. for short, of which only those who had held two-way communication across the Atlantic could become members. All members were allowed to put the word R.O.T.A.B. on the cards which are sent to stations they have had two-way communication with, or have heard, and to-day there are many cards going all over the world with the word R.O.T.A.B. printed on them.

Night after night the whole ten stations in Halifax would "come on the ether" and call as follows: C Q C Q G C 1 D D 1 D D 1 D D to try and hook an English station, and before the year was up Halifax had 100 per cent. Q S O with England.

It will be noticed that in between the C Q and the station call of 1 D D the letters G C are used. This is a scheme that has turned out to be very useful. All Canadian stations have the letter C before the call, and all English stations have the letter G before their call; by sending C G all English stations know that it is a Canadian station calling C Q and trying to get in touch with England.

By this system we are able to recognise what countries are "on the air" among the amateurs, and if we have any tests or messages for

any special country we can immediately get attention in the direction we want.

Wireless Friendships

From these first two-way tests with England many friendships have sprung up. G 2 O D and C 1 B Q were like brothers in a very short

time to create a feeling of comradeship between Canadian and English wireless enthusiasts than these two-way tests.

In these early days I often wondered what the fellow at the other end was like, and it has been my privilege since then to see most of you English amateurs in person.

By dint of constant working we got to know what each man thought about different subjects in wireless, and it was surprising how near to my imagination the different English amateurs turned out to be, from the idea of them I had formed from a good many contacts by wireless.

At times I would get the idea that one would be old and another young, and I must say that in this point I often got the wrong idea. Whatever I thought, however, it made me all the more anxious to see them, and one night in contact with G 2 N M I suggested to him that I would like to see him in person, and a few nights afterwards, when I called C Q G C 1 D D, great was my joy when I got hold of 2 N M again, and he announced that he was sailing for Canada in a couple of weeks' time and would call to see me.

The story of how we met and how we went to visit some famous U.S.A. amateurs, and further work accomplished by the R.O.T.A.B.'s since those memorable days is another story.

I advise everybody interested in wireless, if they want a real thrill, to learn the international Morse code, get a licence and give us a call. As the amateur says in telegraphy, Q R V Q T C ?

THE WIRELESS HOUR

*AT night, when all the pirates bold are killed
And all the crew at last are safe in port,
And all the noise and all the racket stilled,
The wireless ones arrive to hold their court—
That is to say, the Captain dons his phones,
His merry men are lying fast asleep,
Dreaming, no doubt, of Death and bloody bones,
And other things that cause the flesh to creep.*

*The Captain listens-in to wondrous waves
That never broke upon a sandy shore,
He hearkens to a melody of laves
He never on a voyage heard before.
Outside a mast, that never sailed a sea,
Rears its head bravely to the stars,
Who knows, the "Captain's call" may one day be
A message o'er a wavelength straight from Mars!*

*'Tis pleasant thus to sit, when all is still,
And marvel at the magic of this age;
When out of nowhere comes ecstatic thrill,
And man is borne on music from his cage.
In hall or cabin, place him where you may,
Wireless links the peasant and the prince;
The stars look down on both, the sun by day,
Ever since this world began—and since.*

*And now what shall the wizards next "announce?"
Shall it be real "vision"—what a scream!
O master, do not that dire fate pronounce,
Pray leave your humble servant to his dream;
Big Ben booms out the hour, the die is cast,
And straightway Captains all must shed their phones.
"Good-night, everybody"—comes the wireless message last
And so to bed, to dream of Bernard, beg pardon,
Davy Jones.*

PHILIP AUSTIN.

time, and it was very interesting to listen to them discussing technical details of different types of transmitters, receivers, etc., over a distance of nearly 3,000 miles.

Correspondence by Letter

In addition to the many friendly chats and tests that we held by wireless, we would send letters following up some point that had been mentioned; nothing did more

An Exclusive Article by Sir Eric Drummond

What ... THE LEAGUE Wireless Means to OF NATIONS

WIRELESS and the League of Nations are both in their youth. They were born at approximately the same time, and are growing and developing on somewhat the same lines. Assuredly their fruitful co-operation will make for the peace of the world.

Rapid Progress

How rapidly civilisation has travelled! Only a few centuries ago Columbus took three months to reach America. A century ago it took weeks to send news to the Far East. To-day information can be put "on the air" in London, received in New York, re-transmitted and heard in London in the space of seconds.

It is not easy, even for those who serve the cause of peace, to realise the enormous new force that now makes for better understanding between peoples, on which peace ultimately must depend. Before it, distances and time almost cease to have importance. People hear of each other and know each other. Before such contacts war recedes to a distant background. The full development of wireless must render international co-operation, and therefore the task of the League, infinitely easier.

Up till now, the League of Nations has perhaps hesitated to take up any position with regard to wireless. The science is so new and the developments so rapid that there has been a natural tendency to wait until the situation becomes clearer. Despite this, however, the League is following developments with the utmost interest and sympathy.

The first incident involving the good relations between nations in which wireless played its part with the League of Nations was in connection with the recent Greco-Bulgarian frontier crisis. At that time, hours before word had appeared in the Press, wireless information was picked up in Geneva which gave

League officials the first intimation they had had of the seriousness of the crisis and allowed certain preparations to be made which measurably advanced the peaceful action of the League.

The value of a few minutes of time in such a crisis can be fully appreciated if I say that the necessary telegrams, sent because of League intervention, instructing the opposing forces to cease any hostile action, arrived less than two hours before the moment when a clash would have occurred.

The League's second use of wireless is in the establishment, for the first time in history, I believe, of an almost instantaneous information service whereby the outbreak of plague or other serious epidemic disease in any Far Eastern port is immediately made known to all neighbouring administrations, who are thus put on their

guard against any ships from the danger areas.

Under this system all Far Eastern port authorities send in regular reports of diseases to a central League bureau created at Singapore with the aid of the Rockefeller Foundation.

Combined Reports

These reports are each week brought together into one, telegraphed to the French wireless station at Saigon (in French Indo-China), and from there broadcast throughout the Far East and wireless to France, telegraphed to Geneva, and in turn distributed through the European ports. Thus an opportunity is afforded to check the spread of disease almost from its source.

Thirdly, this year for the first time, certain speeches at the Assembly of the League of Nations were broadcast throughout Europe. The Prime Minister of France, Monsieur Painlevé, made his opening speech not only to the Assembly, but to many thousands of people who listened-in in other countries. Sir Austen Chamberlain, British Foreign Secretary, was also broadcast, and there can be little doubt



Sir Eric Drummond, K.C.M.G., Secretary General to the League of Nations.

Much has already been written about wireless as an aid to peace, but it is seldom that one so well qualified to express an opinion on the subject as Sir Eric Drummond, K.C.M.G., Secretary General to the League of Nations since 1919, can be persuaded to make his views public.

Throughout his career Sir Eric has been closely connected with international affairs. He entered the Foreign Office in 1900 and held positions as private secretary to the Under-secretary of State (1906-1910); to the Prime Minister (1912-1915) and to the Foreign Secretary (1915-1919) until he joined the staff of the League of Nations.

In this article Sir Eric throws new light on the question of wireless and world peace. He makes public for the first time, we believe, facts regarding what wireless has already done in the smoothing of international crises.

that as the years go on more and more of the debates will go out "over the air."

Transmitting Facilities

One problem which occupies us at the moment is the provision of proper wireless transmitting facilities for the new Assembly Hall. This building, which is being planned for the representatives of sixty-five nations with some 1,000 journalists, will undoubtedly be the centre of some of the most important of international debates. Every effort is to be made, therefore, to make it thoroughly modern in all respects, particularly as regards loud-speakers, acoustics and wireless.

The future of wireless is a matter on which speculation can run wild.

I myself, however, can foresee the day when many League conferences and debates will be put forth on the air; when many important declarations will go forth from Geneva. One can even imagine that extraordinary sessions of the Council might be held by direct wireless between statesmen in different capitals.

International Relations

We can really hardly estimate the change that may be made in international relations if people in various countries become accustomed not only to the thoughts but even to the actual voice of the statesmen of other countries. All we can say at the moment is that we are at the beginning of a new era at whose potentialities we can hardly guess.

whilst if the voltage is too low there may be distortion in the low-frequency side of the set.

Where there are separate high-tension positive leads for high-frequency, rectifying and low-frequency valves it is most important to find the correct plate potential for each.

On the high frequency side we must combine sensitiveness with stability; the detector valve must rectify without distortion, and the note magnifier must give a large volume of sound combined with purity. If an hour is spent in experimenting with plate potentials it will often lead to a marked improvement in results.

J. H. R.

As Good A Set As Money Can Buy

(Continued from page 126)

When these accessories have been placed in position the set can be placed in its cabinet. Slots should be cut in the back of the cabinet through which the terminal strips may project (the makers may do this if the cabinet is obtained from them).

Operating the Set

Having connected the batteries, phones, aerial and earth to their appropriate terminals, tuning is accomplished by slowly turning the two variable-condenser dials in the same direction, at the same time keeping the set from oscillating by judicious adjustment of the potentiometer setting and the coupling of the reaction coil.

When the local station has been tuned-in adjustments of all the controls should be made. Thus the best H.T. and grid-bias voltages should be found by experiment, and the four filament rheostats should be adjusted until the valves are working efficiently at the lowest possible filament temperature. Once this adjustment has been made further adjustments may be carried out by the master rheostat alone. If the set refuses to oscillate when the coupling between the anode and reaction coils is tightened and when the potentiometer slider is at the negative end of the resistance winding, the leads to the reaction coil should be reversed. If this has no effect a larger reaction coil should be tried.

For the reception of the local and

neighbouring stations it may be found that the H.F. valve is unnecessary, in which case it should be switched out of circuit.

In comparison with the original set—which, by the way, is still giving excellent service and receives both European and American stations—the new edition gives decidedly better reproduction using the last stage of amplification, whilst the sensitivity is slightly increased. It has been found, too, that the ability to cut out the H.F. valve is a great improvement over the original.

Although the array of controls on the panel appears rather formidable, the operation of the set is delightfully simple once all the necessary adjustments have been made.

PLATE VOLTAGES

NOT everyone realises that a considerable improvement in reception may often be effected by experimenting a little with the plate voltage of the valves in the receiving set. If you use a common high-tension busbar for all the valves in the set a compromise voltage which enables all to give pretty good results must be found.

Experiment will show that though this is usually not very critical there is a best point at which stability signal strength and quality are all satisfactory.

Too high a voltage may lead to instability and poor rectification,

SERIES OR PARALLEL?

SHOULD the aerial tuning condenser be placed in series or in parallel with the coil in conjunction with which it is used? This is a question which cannot be answered in one word.

For reception upon broadcast wavelengths it is usually preferable to have the condenser in series with the tuning inductance, especially in crystal and in single-valve sets, for in this case the potentials applied to the rectifier are greater than they would be if the condenser were in parallel.

With multi-valve sets containing one or more stages of high-frequency amplification it is often better to place the condenser in parallel for medium-wave reception, since when it is in series the set may become rather unstable.

For long-wave work with either type of set the parallel condenser is to be preferred since it gives a greater range for a given inductance coil.

With any set which is used for reception over a fairly wide band of wavelengths the best tip is to provide a series-parallel switch so that the condenser may be used in either position at will.

J. H. R.

Now that the police have rounded up a big West End burglary gang perhaps they will turn their attention to something really useful and run in a few oscillators.

A RETAILER says that shoddy apparatus has been the cause of many a set-back to the trade. And it has caused retailers to have some of their sets back, too.



How to Identify the Spanish Stations

NIGHTLY, whilst our home stations are working, and also long after they have closed down, the British listener will have captured one or other of the many Spanish broadcasters who carry on their transmissions until well into the early hours of the morning.

Although it may be said to their credit that most, if not all, of the stations now operating in the Iberic Peninsula regularly repeat their respective calls before the transmission of each item in the programme, it would appear from the numerous inquiries sent to THE WIRELESS MAGAZINE that amateurs, in view of the foreign announcements made, have some difficulty in identifying the individual transmitters.

Repeating Call Signs

As a basic rule, it may be taken that in every instance the Spaniard, when making an announcement, repeats the call letters allotted to him. These are, for Spanish stations, E A J, followed by a number, but this, unless the listener is acquainted with the Spanish pronunciation of the alphabet, is not recognisable.

Let it be remembered that what will be heard for E A J sounds *ay ah khota*, followed by some figure up to, for the present, 22, but by the time these notes are published it is quite possible that more will have been added to the number.

Of all the transmissions heard in the United Kingdom, I think it may be safely stated that those from San Sebastian head the list. There should be no difficulty in identifying this broadcasting station, as it will be found—perhaps unfortunately for some of us—in the immediate neighbourhood of the Cardiff “wave.”

The studio is apparently under the management of a lady announcer who, without exception, gives before every item, not only the call letters, figures and name of the city in which

the transmission is made, but also the actual geographical position of the transmitter. You cannot fail to hear *Aqui Estacion San Sebastian, installada en el Monte Igueldo*.

But this lady is not the only female announcer in Spain.

In Madrid there are now three stations working, namely: Radio Iberica (E A J 6), Union Radio

one, and for that reason the respective calls are frequently given: E A J 6, making it quite clear that you are hearing *Radio Iberica*; E A J 7, that you are listening to a concert given by *Union Radio*; and E A J 4, that the station is run by the *Lamparas Castilla* works.

Turning to Barcelona, we find two stations, namely: Radio Barcelona (E A J 1) and Radio Catalana (E A J 13)—the former works on 324 metres, and the latter, a more powerful station, on 460 metres. Their calls are distinctive, inasmuch as E A J 1 mentions the name of the city, and E A J 13 styles itself *Radio Catalana*.

Barcelona

Barcelona (E A J 1) makes a speciality of operatic relays from *El Gran Teatro del Liceo*, and of concerts from the celebrated Werner Hall in that city. If, therefore, you pick up a transmission which is obviously an outside broadcast, you need have no hesitation in crediting it to the Hotel Colon station. Moreover, at 6.50 p.m. nightly, except on Sundays, a news bulletin is broadcast.

Catalana, on the other hand, sends out a time signal nightly in morse at 7.10 p.m., the initial letters of the station (R C) being mentioned in the call. Apart from this, on very many evenings you will hear such favourite dances as “I Miss My Swiss Miss,” and “Tell Her in the Spring Time,” from that studio, sung in English and accompanied by the Andersson Jazz Orchestra.

Again in Bilbao we meet with competition—E A J 9 and E A J 11, but these stations work on very different wavelengths, the former on about 315 metres and the latter on 418 metres. E A J 9 is run by the *Radio Club de Vizcaya* and announces itself as *Radio Carlton*, thus advertising the name of the hotel in which it is situated. On the other hand,

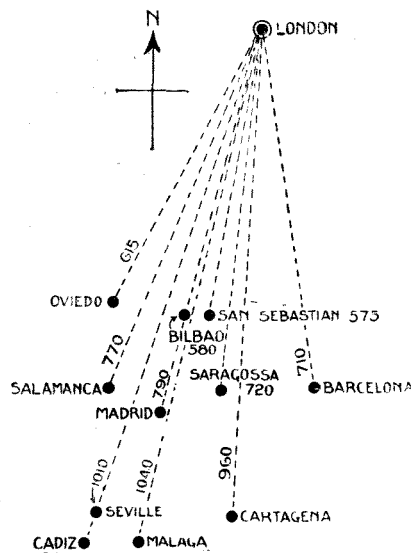

Diagram showing distances and directions of Spanish stations from London.

(E A J 7), and *Lamparas Castilla* (E A J 4). For a short period, in order not to interfere with each others' transmissions, these broadcasters arranged a time schedule by which, according to a rota, each station took in turn the afternoon, evening, and night concerts, leaving the morning and midday hours free to all for special broadcasts.

For some reason or other difficult to fathom, Radio Iberica appears to have seceded from the *tria juncta in uno*, and now transmits on its own from 9.30 p.m. until midnight or later, daily.

The competition, however, between the three stations is a severe

How to Identify the Spanish Stations (Continued)

E A J 11 calls *Radio Vizcaya (Vithcaya)*. Although competitive as regards programmes, they do not interfere with each other in respect to broadcasting hours, as E A J 9 works from 7 p.m. until 10 p.m., when E A J 11 "takes the air."

Should you not pick up the call—which is hardly likely—any reference to *El Pueblo Vasco*, the Bilbao newspaper, which supplies the news bulletin, or to any announcements referring to *El Gran Orquesta Moderna*, will stamp the transmissions as being that of E A J 11.

as we find a transmitter E A J 5 (357 metres) run by the local Radio Club, and another E A J 17 (300 metres) by a private company. Here again, considerable stress is laid upon the respective calls, the former station intimating in every case that the entertainment broadcast is by the *Radio Club Sevillano*, whereas E A J 17 merely calls itself *Radio Sevilla*.

Transmissions do not completely overlap, as

daily between 9 p.m. and 11 p.m. Its call sign is E A J 22 (355 m.).

As already stated, there is a possibility that further transmitters may appear on the scene,



A crowd listens to an open-air broadcast of the Barcelona Municipal Band from E A J 1. Two microphones can be seen hanging from the trees. Inset shows operator controlling part of the apparatus in the street.

Cadiz

Cadiz, fortunately for us, only possesses one station, E A J 3, and its call is quite conventional: *Radio Cadiz (Cadith)*. It is not regularly heard in the British Isles, as its power is but moderate, but it is useful to know that it transmits daily from 7 p.m. to 9 p.m., and again on most days of the week from midnight until 1 a.m. for the purpose of tests.

Personally I have logged this station by patiently waiting for it at 7 p.m. and noting the curious opening signals, made by the ticking of a metronome.

Competition also exists in Seville,

the 300-metre broadcaster only works from 7 p.m. to 10 p.m. daily, and the Radio Club transmits from 9 p.m. till midnight or 1 a.m. the following morning.

Finally, we must mention a newcomer, namely: Cartagena (E A J 16) which is now daily broadcasting concerts from 7 p.m. to 10 p.m. on 335 metres. The call cannot be misunderstood; it is *Radio Cartagena (Car-tar-gay-na)*.

Salamanca

At Salamanca there is a 500-watt transmitter, which has recently been erected, and is said to be testing

and it might be useful to mention some probable "starters":—

E A J 12 (345 metres) Radio Club de Asturias.

E A J 19 (400 metres), Oviedo.

E A J 23 (325 metres), Saragossa.

E A J 25 (325 metres), Malaga.

You must bear in mind that the wavelengths are not definitely fixed.

The ether is already crowded, but still they come!

J. GODCHAUX ABRAHAMS.

CAN you coin a name? If so, you may win the All-America Short-wave Three-valver described in this issue. See announcement on p. 145.

LANDER'S OTHER PLANET

A Story by
J. R. McPHIE

Illustrated by
GRAHAM SIMMONS

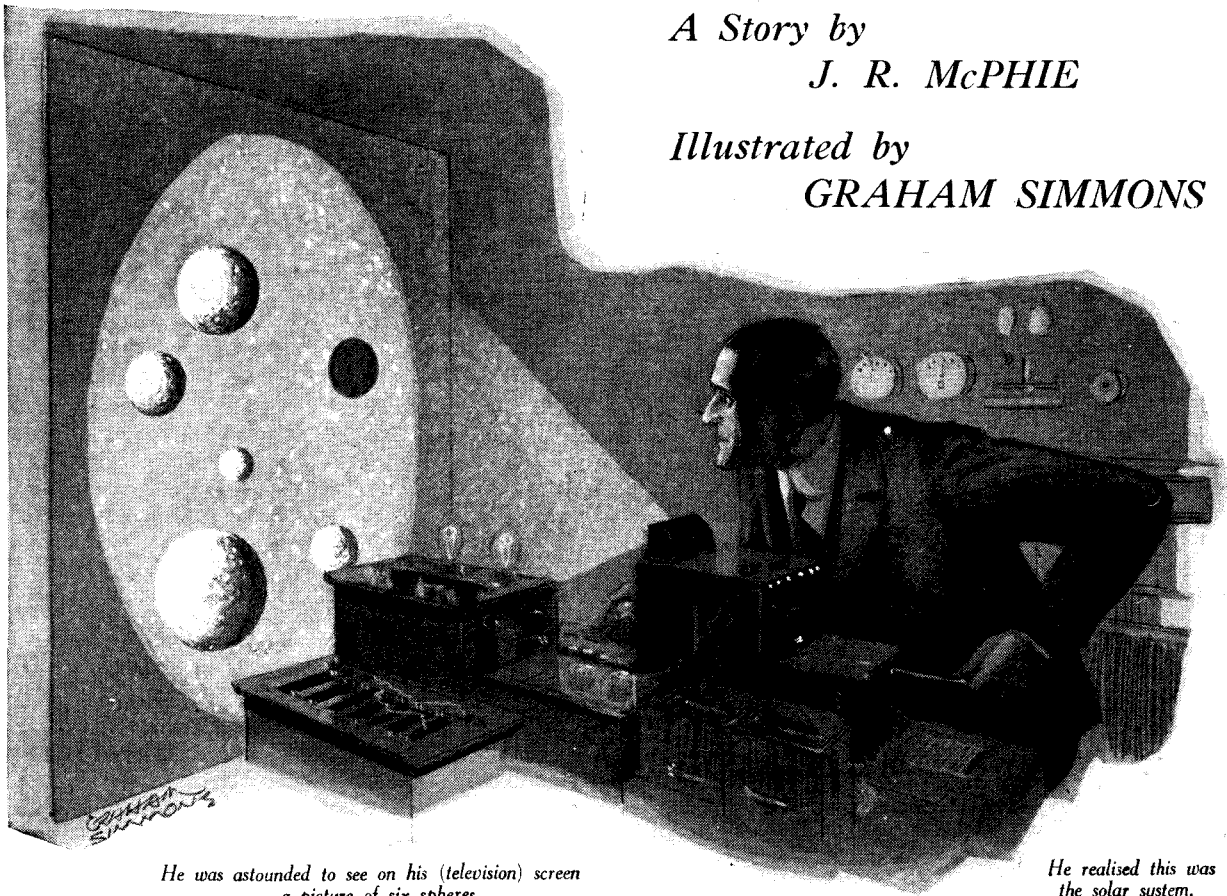

He was astounded to see on his (television) screen a picture of six spheres.

He realised this was the solar system.

MANY people think Lander a romantic liar when he tells them of his experiments. I know the man; I have known him for many years. I have watched the slow but sure development of his powers as an experimenter, and I believe him. During the many lonely years of his solitary life as a secret experimenter he has developed a strange and uncanny instinct for finding new and untrodden paths in physics.

For many years now his attention has been given to electric waves, and like a few other physicists he is groping a long way ahead of the published work on this subject. Possessed of ample means, he has chosen to spend them in research. In order to avoid electrical disturbances and for his own privacy he has lived now for some years in a small wooden bungalow high up on a mountain on an island in the Hebrides, the name of which for

obvious reasons I am not at liberty to disclose.

While the attention of most experimenters in wireless was given to short waves, Lander's attention remained on very long waves, and when carrying out some experiments in conjunction with an experimenter in New York and another in British Columbia, he had been told by each of them at odd times that his signals were so extremely feeble as to be very doubtful. He had made careful inquiry of these workers as to the times of these occasions, and he had satisfied himself that on at least three of them he had not been transmitting.

After his work with these collaborators had finished, his mind persisted in wondering how it could have happened that they had thought they were receiving signals from him at times when he was not sending. He thought it too improbable that any other worker had been trans-

mitting on the same long wavelength, but decided to try to find if it was so by occasionally sending and tuning for reception on the wavelength he and the other two had been using.

At his first attempt he picked up very feeble signals, but by careful amplification he satisfied himself he was not mistaken. To his surprise, after trying all he knew, he failed to get any reply to his own signal of inquiry, while he continued to pick up the old signals of which he could make neither head nor tail.

He had in his laboratory apparatus fixed up for sending and receiving pictures by wireless, very similar to the arrangements of several other experimenters, and based on the well-known property of selenium of changing its electrical resistance under the influence of light.

He had never had very keen interest in this particular little department of work, for he had early seen that distance did not present any

LANDER'S OTHER PLANET (Continued)

special difficulty in transmitting or receiving crude pictures by wireless, but that tremendous mechanical difficulties would have to be overcome before really good pictures could be received on a screen, and his interest was too much occupied in other directions to allow him to devote time to overcoming merely mechanical difficulties.

One day while picking up the mysterious and exasperatingly meaningless signals, he, in a jocular spirit, connected up his receiving set with his television apparatus, and was astounded to see on his screen a picture of six small spheres.

He realised at once that this was a picture of the solar system, including our sun, Mercury, Venus, our earth, our moon, and Mars, as seen from some other planet. He became greatly excited, and in his excitement doubts began to assail him as to whether our solar system would look like that from outside.

After wasting half a minute he remembered he had an atlas and that probably it contained a rough diagram of the solar system. As quickly as he could he sought and found the now valuable atlas, and was tremendously relieved to find that the picture on his receiving screen corresponded fairly with the atlas diagram as to relative positions and sizes of the planets. Undoubtedly a picture of our solar system was being transmitted from some planet and he had been lucky enough to pick it up.

Suddenly he awakened to realisation of the fact that he was wasting precious moments in star-gazing, and he knew what he must do. With all the speed he was able to command he made a copy of the picture he had received and began the special preparation of a copy for transmission. Scarcely had he begun when, to his consternation, the picture disappeared from his screen.

Calling himself a fool, he quickly sent out his old signal and was overjoyed to see the planet picture again appear on his receiving screen. Clearly the picture senders thought that someone had picked up their wave, and he began to think of what their feelings must be when he returned their picture and they thereby knew it had been taken up. In great excitement he finished the copy

ready for sending, and as he transmitted it he whistled. Within a few minutes the picture went from off his receiving screen, but quickly a similar picture appeared on it—a similar picture with the addition of a rough drawing of two human figures shaking hands.

Here was indisputable proof of the fact that his return picture had been received, and congratulations for him. Clearly the copy of the planet picture with the added hand-shaking figures had been prepared beforehand in anticipatory hope of reception. Within a few minutes, this picture was replaced on his screen by a similar picture with a number of dancing figures added. Next appeared a simple drawing of a sunset and a man getting into bed, and Lander realised it was 4 a.m.

Tired though he was, he was too excited to sleep, and, wandering out on the mountain side, he watched the sun rise with greater interest than he had ever felt before, watched the pale moon fade out of sight and wondered in which direction and how many millions of miles away moved the planet which was Mother Earth to the men with whom he had talked.

After he had slept about six hours he ran down in his two-seater to the little town of the island, some seven miles away, and called on the rector of the academy.

I attach great importance to this call as the strongest possible proof of the veracity of Lander's statements. When Lander asked for the loan of any and every book on astronomy the academy or the rector possessed, the latter jokingly asked if he was thinking of wirelessing to Mars. Why should Lander, in the midst of his absorbing work on wireless, stop to study astronomy? That, however, is not the only question difficult to answer if Lander departed from the truth.

Why ever should he have borrowed from the rector a couple of those old-fashioned books designed to teach little children to read which run: A is for Ark which saved Noah from the flood, B is for boy so bonny and blithe, and so on?

I ask you now: What did Lander want those little books for?

Of course he used them to teach his "other planet" friends his own

language, by the only expedient at his disposal—by pictures. Why even the rector of the academy tumbled to it when I told him Lander had been receiving and sending pictures to some unknown planet. Yes! this thing is true. I haven't a shadow of doubt of Lander myself.

The transmission of the alphabet by the little pictures illustrating the large capital letters attached was the work of a couple of days. Work on small simple words occupied another week, it seems, and then the other people went right ahead in command of our language. What's that—difficulties about sounds? Not at all. Sounds were not necessary. They exchanged pictures. Look here! is AND not a picture in the sense in which we are using the word as much as a drawing of a dog? Well then—besides, they did transmit and receive sounds, just as we do in wireless, of course.

As for the music they transmitted to Lander, he says it was finer than anything he'd ever heard on earth.

I'm not clear that they ever talked to one another in the ordinary way. I have no recollection of any definite statement by him that they did—but given time, it would be an easy matter. Unfortunately it was just time that was limited.

It took valuable time, of course, for the Planetarians to explain to Lander that when he had picked up their signals and they his, their planet had long passed the point in its orbit nearest to the Earth. Their planet had been at its nearest distance to the Earth twenty-five years earlier. They had been signalling regularly for thirty-seven years in the hope of response. No wonder they danced for joy when they learned someone had picked them up.

When they explained to Lander that their planet was travelling away from the Earth, and that in all too short a time they would be out of possible range, and would not be within range again during the lifetime of the youngest of their signallers, Lander worked feverishly night and day to learn all he might of them. His nights were spent in sending and receiving, and his days, except for three or four hours snatched for sleep, in preparing what to say and how to say it in the night time. He

A Story of the "Possibilities" of Television

had quickly learned that he could not pick them up in the day time. Devoutly he cursed his own folly in working alone.

He did send urgent calls for a helper, but he was afraid to spend much time in this way, and his messages were treated as the bad joke of some foolish person. The Planetarians had not, of course, any knowledge of our system of time, nor he of theirs, but when Lander learned that the time of their planet in making one circuit of its orbit is more than the lifetime of its inhabitants, he persistently and systematically questioned them as to their span of life.

He made out that the average life of a Planetarian is about one hundred and twenty of our years, and that he is in his mental prime at the age of ninety in our time. Lander spent too much time listening to their wonderful music, which is not very surprising if it is really as beautiful as he said. They were curious to hear samples of ours, and he succeeded in re-transmitting a few of our broadcast programmes.

On receiving their first sample of jazz music, they explained to him that as far as they could make out there was nothing wrong with their receiving instrument, and yet they heard a lot of most curious noises. They asked if it was possible that something was wrong with Lander's instruments.

They were anxious to see pictures illustrating applied science on our earth, and Lander sent them pictures of aeroplanes and airships. The Planetarians asked what birds were shot with the appliances carried by the aeroplanes and assumed by them to be guns. Then, of course, Lander had to explain that the pictures were of fighting planes, and this surprised the Planetarians exceedingly, for it seems they finished with war five hundred years ago. Much time was wasted by them in their questions about war on our earth, and Lander sent them pictures of tanks and warships and submarines.

Then for some reason Lander wanted to know if they had any records that their ancestors had ever used poison gas in war, and this led them to waste more time in sending searching questions concerning the mentality of our people.

Our readers will most certainly agree with J. R. McPhie, the author of this story, when he says that "many people think Lander a romantic liar"—but life is a poor thing without romance.

Everybody is aware that the "possibilities" outlined in a story of this type are really outside the bounds of possibility when considered in the cold, unsympathetic light of logic.

Our personal hopes and aspirations have little connection with logic, however, and we derive a large part of our mental satisfaction from thinking of the things "that might have been"—such things, in fact, as Lander "discovered."

They had never used poison gas, or aeroplanes or steamships in war. They had got rid of war before they had developed much skill in engineering or attained much knowledge of chemistry or physics. I think Lander is rather disappointing as an inquirer into the ways of life of people on another planet.

Whatever does it matter to us that we have communicated a few facts concerning ourselves to a more highly developed people? Think of what it would have meant to us if Lander could have learned how they got rid of war and what their present social system is.

He gathered they had not had "race" differences for a thousand years. They had records of "race" differences, but how did their ancestors get rid of them? I wish we knew. What's that? Cross-breeding! Nonsense! We know enough to know there is more chance of retrogression than progress in that direction. They could not understand Lander's references to nations; apparently they have never had separate nations as we have them among people of the same race. Just think how much simpler and quicker that must have made their social and mental development. The consoling thought out of it is surely this: if humanity on our planet fails to make progress, if it goes bust in another appalling war—there is another planet on which the race goes steadily forward, and of course there are probably others.

The most disappointing thing is

this: Lander was, he says, just about to learn how they manage about the question of population, when the planet got out of range, and Lander sat down and wept—yes, wept, or so he says anyway, and I can quite believe he did—I would have done so.

If you tell Lander what you think of him for learning so little when he had such a chance, he says it was not his fault, but the fault of the younger members of the staff of the Planetarians.

Only a couple of days before he lost touch with them, he had a message from their chief asking him not to transmit any more pictures of our women. Their chief explained that he had found that the younger members of his staff had wasted precious time when on duty in asking for and receiving pictures of our most beautiful women. Of course, it would have been difficult for Lander to refuse, because he did not know which individuals asked for more pictures of our women.

He says he didn't send many, because in fact he couldn't find many in the town. Enough, it appears, were sent to cause mischief, because their chief said the wives of his staff made complaint to him. I suppose they were jealous. The Planetarians had deliberately set about breeding for brains in place of beauty a couple of hundred years earlier. What are their women like? Ah! I asked Lander that question, but he doesn't know. He confessed he had been sufficiently curious to ask for pictures of their women, and the reply he got was that their women were seldom photographed. No member of their staff had a photograph of a woman relative or friend, and none of their womenkind would lend a photograph for transmission. Their women at least are still human.

Why doesn't Lander publish a book about his experiences and what he learned? Well, you see, as I have already told you, hardly anybody believed him when he told them about it, and he shut up like an oyster, and went to America to seek a millionaire to put up money for some experiments he has projected, but which will entail the expenditure of more money than he can afford to throw away.



THERE'S no doubt—I say it with sorrow—that we women have a bad habit of painting the lily. I mean, we will insist on adorning things about the house intended purely for use, things whose usefulness is lessened by the decorations (so-called) we impose on them.

Pink Ribbon

Witness the bows of pink ribbon our mothers loved to tie round picture frames—themselves wickedly placed on the piano top, where they interfered with playing—and our own passion for concealing the telephone with the daintiest of crinolined dolls. Charming, if it were not that the phone is essentially to save time, which the careful removal of a fragile decoration only wastes.

But curiously enough, there doesn't seem to be a single woman about who has yet realised the decorative possibilities of the wireless set. It's positively heartrending! Ugly black wires, in their pristine blackness and ugliness, festoon our walls; the wireless cabinet remains severely unadorned save by its own high polish; the headphones are monuments of utility without ornament.

* * * * *

Making Wireless Pretty

For the sake of the feminine reputation, my sisters, we mustn't let this go on. Think of all that might be done. Those wires, for instance! They could be entirely concealed with double-frilled ribbons, garter fashion, in gay colours, or Christmas paper festoons might hide their nakedness.

Lace frills would be eminently becoming, not only to the head-

phones, but to our own faces when we wear them; they could be secured (the frills, I mean, not the faces) with a dab of seccotine. Even the crystal would do us more credit in a dainty crochet cover, and how charming the valves would look if we painted them to match the woodwork of the room!

* * * * *

Most of us are fully alive to the great joy and value of broadcasting to the invalid or old person who may be bedridden or, at any rate, seldom able to go out, and there are probably few chronically sick folk nowadays who are not provided with some sort of receiving set.

Blessing to the Blind

But I've come to the conclusion that it's often overlooked what an even greater blessing wireless can be to the blind. And I don't mean merely those who have always been sightless, but the many old folk who have lost, with advancing years, the power to read and sew.

Old age has brought them at the same time an increased leisure, which is only too apt to become an increased boredom.

I think of an elderly relative of mine, now dead, who became half-blind after sixty-five, and would coax young nieces to stay with her largely for the sound of their cheerful voices, and so that she would have someone to read to her and to manipulate her pianola—she adored music.

But nieces were few and busy, and she could not afford a paid companion. How the music, the talks and the news daily provided by the B.B.C. would have kept her interest

alive and stimulated her keen old mind!

Thankoffering for Sight

The truly blind, too. Nobly the programmes supplement their few and terribly expensive Braille books as a means of keeping mentally in touch. Again, broadcasting must be invaluable in the teaching of blind children. I fancy the College for Blind Girls at Chorley Wood, a courageous school I once had the pleasure of visiting, must find that the school transmissions make its task easier.

Can't we all, as a thankoffering for our sight, resolve to see that one blind or semi-blind person we know is given the boon of wireless? If the cost is too much to be met individually, a group can club together.

The other day an old bedridden man, who will never work again, was dumbfounded with gratitude to receive a crystal set for which his former office companions had had a whip round. Even greater kindness, they came and fixed it up for him.

Done in this way, the tax per person is one that even the poorest of us can meet.

* * * * *

Woman Behind the Job

"The Man Behind the Job" series of interviews recently run by the Manchester station, in which the interviewee threw interesting light on his particular livelihood, how he entered it, its trials and advantages, had an appealing human note. I'm hoping the Manchester authorities will follow them up with a similar series of interviews with typical women chosen from various callings.

Personally, I'd love to hear the philosophy of life of the charwoman who blackleads my grate, of the society lady whose life is a round of parties and of the trim girl at the hairdresser's who waves my shingle.

Loss of Spontaneity

The only difficulty about interviews before the microphone (as I found when I took part in one at 2 LO) is that they necessarily lose spontaneity from having to be prepared and written out beforehand. This is essential to ensure that nothing shall be said contravening the conditions on which the B.B.C. monopoly is granted, but it is not always easy to give conviction to a conversation which is being read aloud from typescript. A. M. M.

Charging Your Accumulators At Home

How to make a Direct-current Charging Board

AS a result of the extensive use of accumulators in wireless sets, a great many methods of charging one's own batteries from the home current supply have been described from time to time in wireless periodicals.

This article, therefore, takes for granted that the governing principles of charging accumulators from direct-current supply are generally understood, and concerns itself more particularly with the apparatus required.

The rather formidable-looking and somewhat expensive gadgets which have found their way on to the market for this purpose no doubt lead many people to assume that the process involves a cash outlay of fair proportions. This is not so at all.

Provided, of course, that the current supply is direct, and not alternating, no more than about two shillings need be expended upon the necessary fittings. All that need be purchased are:—One two-way switch—either tumbler or knife—the former preferably, two screw terminals, two wireless spade terminals, and a few odd pieces of wire.

Having decided first of all at what point in the circuit the charging apparatus is to be inserted, and having tested for polarity, proceed as follows:—

Obtain a wooden pattress, about 7 or 8 in. long by 4 in. wide, on which the switch and terminals are to be mounted. Lay the switch on this and mark out the positions where the wires will require to pass through to the terminals, and afterwards bore the necessary holes (three in num-

ber). Reference to the diagram, Fig. 1, will explain matters more clearly.

Charging-board Layout

A is the tumbler switch, and B1, B2 the screw terminals, for which also two holes will require boring in the pattress. On unscrewing the top of the tumbler switch there will be found inside three terminal screws, two on one side and one on the other. The negative lead is attached to the single terminal on one side of the switch c, whilst in the terminal d two wires are inserted: one the positive lead and the other a short length running to the screw terminal B1. From the third and remaining terminal e, a short length of wire is run to the terminal B2.

F1 and F2 are the two spade terminals connected to short lengths of flex—in reality, extensions of the terminals B1 and B2, shown in the diagram, Fig. 1, over the terminals of the accumulator, to which they are connected during charging.

Switch Operation

A study of the diagram will show that, when the switch knob is pressed down, the U-shaped piece inside bridges across the gap between the terminals c and d, thereby putting the charging apparatus out of action. When the switch knob is lifted upwards, the opposite U-shaped piece bridges across the gap between the terminal e and the bottom portion of c, which puts the accumulator in series with the lighting circuit.

It should be particularly observed that the tumbler switch must be of the two-way, and not the common one-way type.

In a provincial newspaper a short time ago, the writer observed a wireless article dealing with this particular subject.

"Ordinary Tumbler Switch"!

One of the instructions given was that "an ordinary tumbler switch" should be obtained. As no definite details were given as to the exact kind required, it is to be presumed that many unsuspecting readers of that

article would purchase a one-way switch, and then afterwards wonder why it was that the accumulator, as soon as put on charge, began to generate heat and give off a pungent odour—a short-circuit of course, the reason being that when an ordinary one-way switch is used, it must be thrown open before connecting the accumulator, otherwise the latter will discharge itself through the closed switch.

Persons initiated in these matters would not allow this to occur; but when it is realised that short-circuiting an accumulator for even momentary periods is very harmful, it will be understood how necessary it is to avoid this occurrence.

Labels

For convenience, a neat label on which the words "On Charge" are written, can be affixed to the pattress underneath the switch, and a similar one, bearing the words "On Lights," affixed over the top; that is, if the switch has been mounted exactly as shown in the diagram.

The terminals B1 and B2 should be marked "Positive" and "Negative" respectively, and if necessary, to prevent harmful interference with the apparatus, the extension leads F1 and F2 may be detached when the accumulator is not being charged.

Although the use of a two-way tumbler switch as described is certainly the best method, it is quite

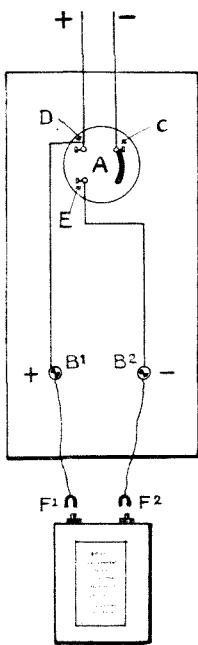

Fig. 1.—Connections to Charging-board.

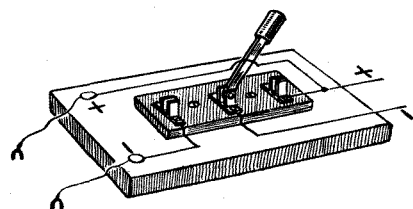

Fig. 2.—Connections to Knife-pattern Switch.

possible to employ a single-pole double-throw switch (knife pattern), such as is used extensively for wireless work.

The connections in this case would be as shown in Fig. 2.

T. W.

This Set is Offered as a Prize in a Simple Competition (See announcement on p. 145)

The All-America Short-wave One-valver

Specially Designed, Built & Tested
by "THE WIRELESS MAGAZINE"

Having a wavelength range of approximately 20 to 100 metres this one-valve set is especially suitable for use by those enthusiasts who want to receive Transatlantic stations.

In one evening this set (in London) received a number of transmissions from North and South American stations—and its name is therefore not an exaggeration. The set is simple to build, is economical in cost and is easy to operate.



As announced on page 145 this set (complete with special low-capacity type of valve) is offered as a prize in a simple competition for which you can enter.

Some confusion of thought arises when referring to "short" waves, as different people attach different meanings to the word "short." It is desirable to have some name for the range of wavelengths up to 250 metres—if you can think of one this set is yours.

A GREAT many receivers will tune down to 20 metres, or even lower, and the reception of C.W. by them on wavelengths of this order leaves nothing to be desired. The reception of telephony on such short wavelengths, however, is a very different proposition, requiring a smooth control of reaction which will allow the set to be brought up to the most sensitive point without any tendency to burst into oscillation.

Telephony at Its Best

To be heard at its best telephony must be tuned-in with the set in a non-oscillating condition, and not to the "silent point" of the carrier wave.

Apart from the fact that in such conditions reproduction is always distorted on short waves, it is especially difficult to hold the silent point, the slightest movement of the dials producing howls and squeals.

Cabinet Dimensions.

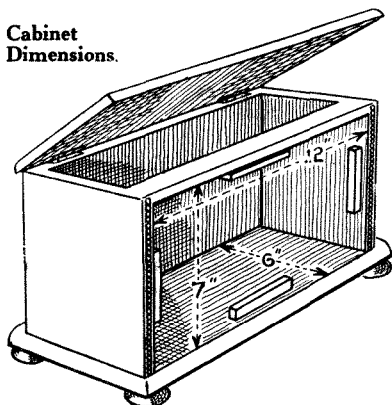

The only thing to do is to so carefully adjust reaction control that the set can be brought up to the point of oscillation and no more.

With regard to the types of circuit suitable for short-wave reception there are only a few that have been found to be satisfactory, of which the straight circuit having a semi-aperiodic aerial, tuned grid and reaction coils is perhaps the best. Such a circuit is used in the short-wave one-valve set here described.

Use is made of a special low-capacity detector valve designed to work on a plate voltage of approximately 20 volts, and having a filament consumption of .2 ampere at a pressure of 3 volts maximum. The anode-grid characteristic curve of this valve shows excellent rectifying properties, having a pronounced bend at the lower portion of the curve.

The tuning system consists of a grid coil of eight turns of wire spaced approximately $\frac{1}{4}$ in. apart, and held in position by three pairs of thin ebonite clamping strips. At each end of the grid coil is mounted a smaller moving coil, one of which—the semi-aperiodic aerial coil—consists of a few turns of thick wire, whilst the other—the reaction coil—has more turns of a smaller gauge of wire. The whole forms an efficient and most selective tuning system, having a wavelength range of approximately 20 to 100 metres.

In the following list of components those already mentioned

are repeated to make a complete record:

- Ebonite panel, 12 in. by 7 in. by $\frac{1}{4}$ in. (Lowenadler.)
- 8 terminals. (Trix.)
- .001-microfarad fixed condenser. (Paragon.)
- Ultra short-wave tuner. (Pranco.)
- .0005-microfarad variable square-law low-loss condenser. (Igranic.)
- 1-microfarad fixed condenser. (Dubilier-Mansbridge.)
- .01-microfarad condenser. (Paragon)
- Potentiometer. (T. C. Ball.)
- Filament rheostat. (T. C. Ball.)
- Clips for D E Q valve. (General Electric Co.)
- Osram D E Q valve. (General Electric Co.)
- Cabinet. (Unica Cabinet Co.)

No Baseboard

All the components are mounted on the panel, for which purpose the former should be arranged as shown in the wiring diagram and photographs. Altogether twenty-four holes are to be drilled through the panel,

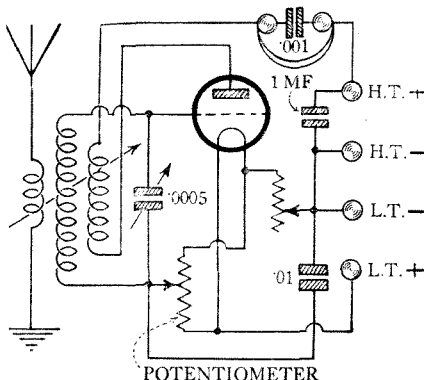

Circuit Diagram of One-valver.

A Set that has Received North and South American Stations

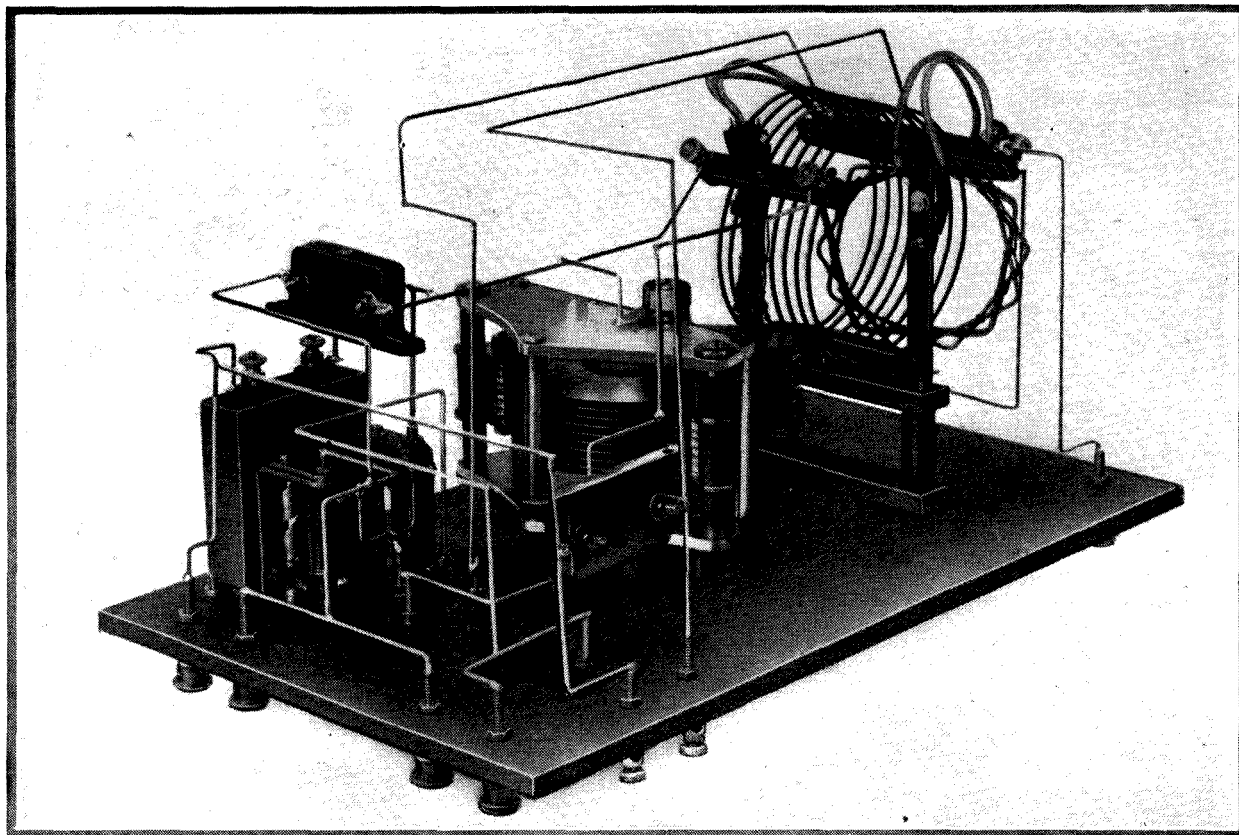

This photograph shows clearly the disposition of components in the All-America Short-wave One-valver.

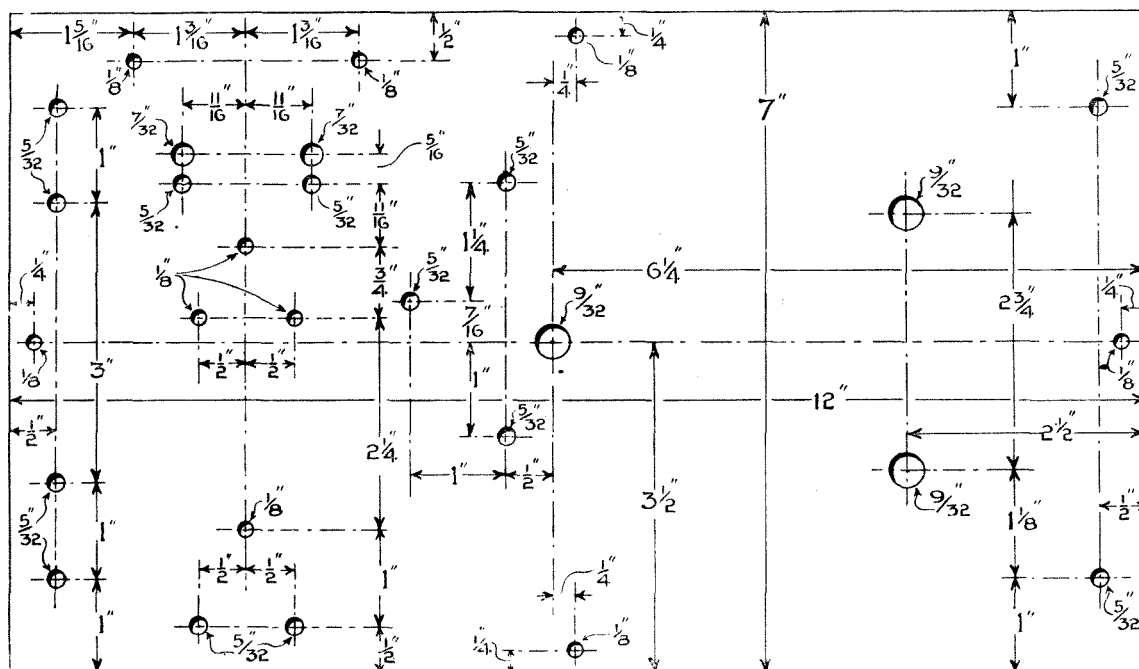

Half-scale reproduction of the panel layout of the All-America Short-wave One-valver.

The All-America Short-wave One-valver (Continued)

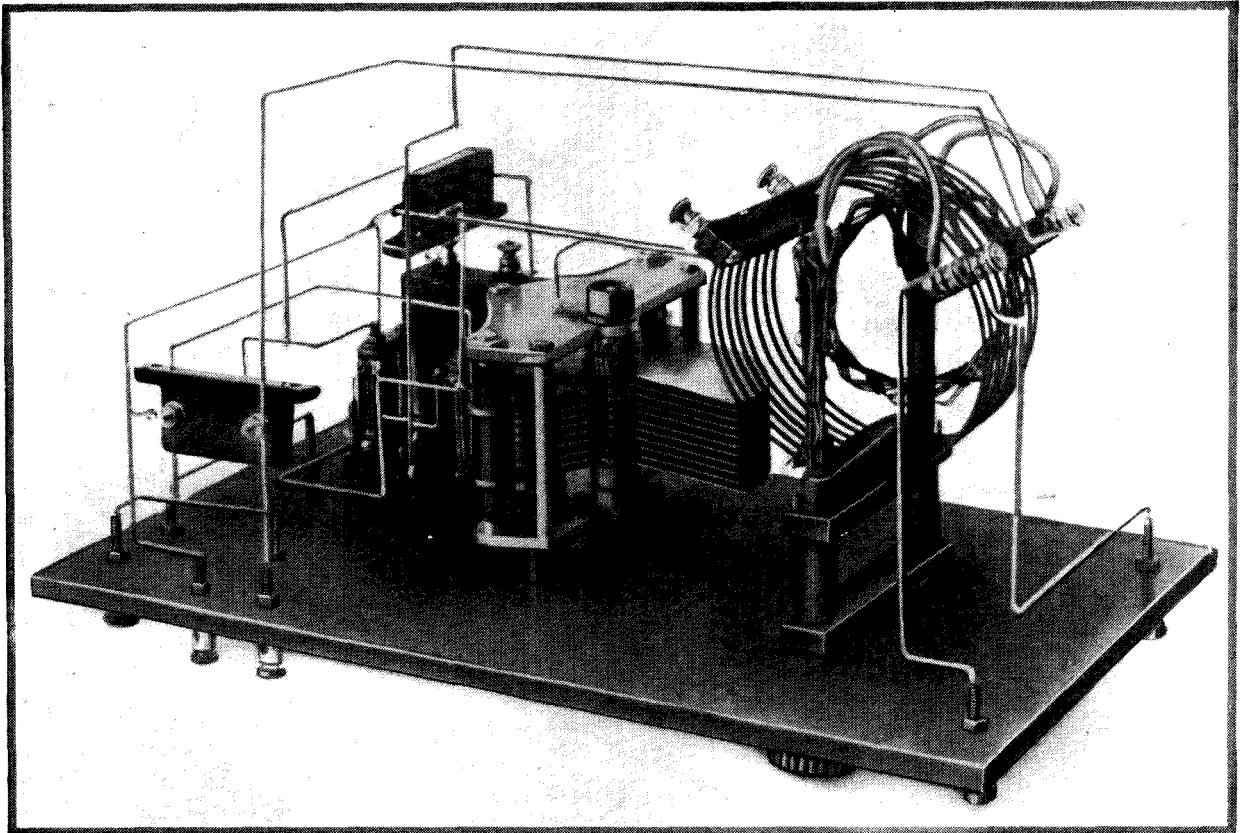

Another photograph of the All-America Short-wave One-valver wired up ready for use.

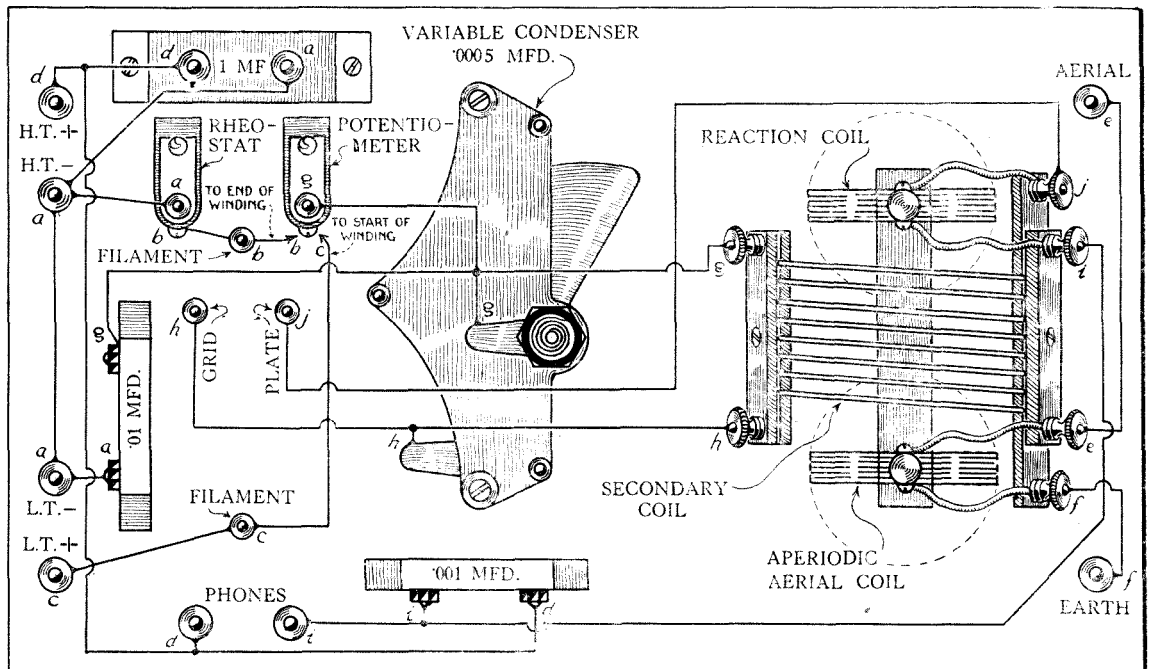

Wiring Diagram of the All-America Short-wave One-valver.

If You Would Like This Set Turn to page 145

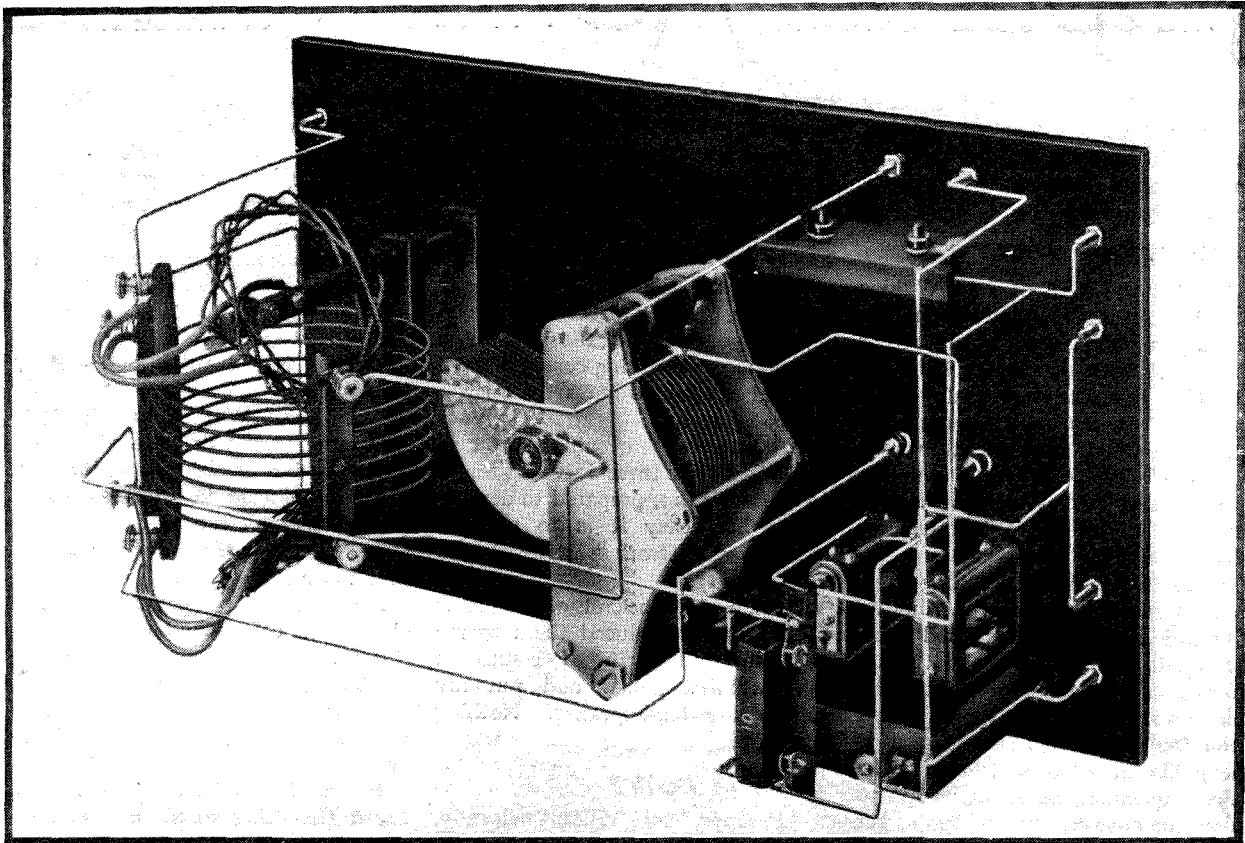

Another photograph of the wiring of the All-America Short-wave One-valver.

excluding those for fixing the panel in the cabinet.

Those holes required for bolting the variable condenser and the valve clips to the panel must be carefully drilled in the correct positions. A drilling diagram is given showing the centre and sizes of all the holes.

Tuner Mounting

The tuner is mounted on the left of the panel in such a manner that the two controls are mounted one above the other. The variable condenser is mounted centrally, whilst the valve clips, rheostat and potentiometer are fixed to the right of the panel.

As is the case with all short-wave receivers, the wiring has a distinct bearing on the results obtained. Each wire should be carefully placed in such a position that it is at a reasonable distance from all other wires. This remark applies specially to plate and grid connections.

The wiring, however, is very simple, and if carried out in conjunction with the wiring diagram should present no difficulty.

A suitable cabinet for this receiver can be obtained from the Unica Cabinet Co., but for those who wish to construct the cabinet themselves, a dimensioned sketch is given.

The aerial used in testing this set was a 15-ft. length of copper wire (No. 14 gauge) hung vertically, the top end being at a distance of about 40 ft. from the ground. The lead-in to the test room was of the same gauge wire, 20 ft. from the side of the house, this being horizontal; the aerial was in the form of an **L**.

The earth was of the same size exactly, but in the form of an inverted **L**, directly beneath the aerial.

Using this arrangement, K D K A was received at 11.45 p.m. one evening recently at excellent strength, the addition of two low-frequency valves bringing in the transmission on a large loud-speaker. On another evening at about the same time one low-frequency valve was sufficient to work the same loud-speaker.

In the early hours of the morning a number of United States and also four South American amateurs, work-

ing on C.W. on about 45 metres, were received at good phone strength.

These results compared very favourably with a standard short-wave receiver used extensively for reception on the lower wavelengths.

The next test was on an aerial of the usual amateur type, 60 ft. long and 40 ft. from the ground, the usual water pipe earth being used.

Better Results

Curiously enough the results obtained were better than those on the special short-wave aerial, K D K A (East Pittsburg) being loud enough to work four pairs of telephones.

The condenser dial reading for this station was 56°. This should remain fairly constant for all aerials, as aperiodic coupling is used. The aperiodic aerial coil was always kept tightly coupled to the secondary.

The plate voltage used throughout these tests was 45 volts, with a filament voltage of 2.9. The potentiometer control was rather critical and should be carefully adjusted when listening to a weak station.

Impartial Advice *: A Story with a Moral*

"IS a high-frequency valve really worth while?" asked Wilkins, as he pulled a chair close up to mine and perched himself expectantly on the edge of it.

Quiet Fellow

That is the kind of man Wilkins is. A quiet little fellow, with hair getting a trifle grey and rather thin, and with spectacles half-way down his nose, he is quite delightful when he is not asking questions about wireless. But the things he wants to know on that subject would keep THE WIRELESS MAGAZINE full of sound, instructive, inconclusive stuff for a year.

When he first started asking questions, I suspected him of reading up "Questions Simply Answered" beforehand, and trotting out the inquiries in the hope of taking his wireless friends down a peg. But I soon found that his simple soul is incapable of such a trick. If he asks a question, he really wants to know the answer, but he likes to get the same advice from at least three different people before he adopts it. And perhaps that is not such a bad plan, if one is not really keen on experimenting.

So when he put his innocent question about a high-frequency valve I tried to answer it, with the result that within five minutes I was involved in a simple, non-technical, easy-as-ABC discourse designed to explain not only whether H.F. is worth while, but whether potentiometers, tuned-anodes, variable grid leaks, H.F. transformers, reaction on the aerial, Reinartz circuits, and loose couplings are worth while, with reasons and diagrams.

"Borrow a Set"

"Look here, Wilkins," I said at last, "what you ought to do is to borrow a set with an H.F. valve and try it out. I will lend you one with pleasure."

He glowed with gratitude.

"I wonder," he said, "if you could spare an evening to come round and test it with me. As a matter of fact, I have never actually handled anything but a crystal set."

I felt it would break his gentle

heart to refuse. He had made up his mind, he told me, to buy, or make, or otherwise acquire a loud-speaker set, but he knew so little about the technicalities that he would very much like to place himself in my hands.

"And by the way," he added hopefully, "which of the commercial sets do you consider the best value for money, everything considered?"

I did not try to guess the answer to that question.

A couple of evenings later I hauled a simple three-valve set round to Wilkins's flat, prepared to demonstrate how easy it is to produce sweet sounds from a well-behaved loud-speaker.

He picked up the ends of two pieces of flex and introduced them to me as aerial and earth. I connected up, twiddled knobs, and put my ear to the loud-speaker. Nothing happened.

Aerial or Earth?

"Perhaps," said Wilkins helpfully, "that aerial wire is really earth. I've forgotten. It didn't make much difference which way I fastened them on the crystal set."

"You did get results on the crystal?" I inquired.

"Oh, yes—quite often," he replied.

So I examined the leads. They ran side by side, neatly held in position by the same staples, along the skirting board, up the side of the doorpost, and out into the hall. Thence, I learned, the aerial lead ascended into the loft, and so did the earth lead—to join the pipe that supplied the water tank.

I am afraid I rather spoiled the neatness of Wilkins's handiwork, but when I had finished my work of destruction we did get signals.

Wilkins and Mrs. Wilkins stood round in admiring attitudes.

And then, without warning, the set swooped into the most appalling oscillation. I screwed down the potentiometer, loosened the coils and dimmed the valves. It stopped, but the signals faded almost to nothing. Cautiously I tightened things up again, and once more the

loud-speaker gave forth melody—for about two minutes.

Then, as before, it howled like an Atlantic liner in a fog, and finished up by reproducing a faint smattering of some continental station, with our local transmission in the dim distance.

A Neighbour?

"Have you a neighbour——?" I asked.

"Oh, yes," Wilkins said quickly. "The man next door has a wonderful set, with five or six valves, that no one can manage but himself. His aerial runs over the roof just above mine. Do you think he is making that noise?"

I admitted the possibility, and plugged in coils for the high-power station.

"The man in the flat below has a set, too," Wilkins added. "He uses valves and crystal combined and gets top-hole results."

He need not have spoken. We heard the other man's crystal and catwhisker in altercation as soon as we tuned-in; but not even a score of scratchy crystals could have been responsible for the din that came from the set a moment later.

"Do you think that could be an electric train passing?" Wilkins suggested.

Mrs. Wilkins was gradually becoming less appreciative. I could see that she had no high opinion of my set or my skill in working it. Even on the higher wave a near-by oscillator was doing his worst.

Coming Into Its Own

And then, during a lull in the transmission, the loud-speaker really came into its own. In a voice louder than anything we had heard (except the howls), it inquired:

"Are you tucked up comfortably, Ethel? I'll bring in your bread and milk soon."

Silence. Then a rustling noise, and:

"All right, mum. I wish the Savoy bands would start."

Wilkins looked rather shocked. Mrs. Wilkins was awed.

"That was Mrs. Pavey's voice," she said, in a whisper.

"Another neighbour," I hazarded, "who uses a crystal set and talks from one part of the house to another through his telephones."

Wilkins paled a trifle.

"I'd no idea," he stammered. "I—I'm afraid I told them of that trick!"

We switched off and played three-handed bridge. But I could see that Wilkins was undaunted. Per-

haps he hankered for the dance music that was due according to the programme, or maybe it was the array of knobs and dials on the panel that fascinated him.

"It was awfully good of you to come," he said as we parted. "I'm still undecided, but, you know, in spite of the difficulties, I'd like to have something that would reproduce music or a song when we are in the

mood. Now if I should decide to get a set, what sort would you recommend?"

I did not hesitate to advise him on the point.

"For your immediate locality," I said, "I don't think you could beat a Columbia instrument, or one made by the His Master's Voice people, with a tasteful selection of records." H. P.

CAN Highbrows AND LOWbrows CONVERT ONE ANOTHER?

THE attempts of musical highbrows and lowbrows to convert each other never cease. Both advance cogent arguments, but seem to overlook entirely the psychological aspect of the question.

Trained psychologists say that the difference between the chamber-

control (often too much so for their good.)

Whereas those who have insufficient opportunity to lavish their emotions and who do not attempt to control them, respond thankfully to the emotional exuberance of dance music and popular songs.

and it's long odds that, simply through this psychological change, jazz bands will have infinitely less popularity ten years hence than they enjoy to-day.

The emotionally well-balanced person (rarer than one supposes) who finds the need both to lavish and

A PORTABLE AERIAL FOR INDOOR OR OUTDOOR USE

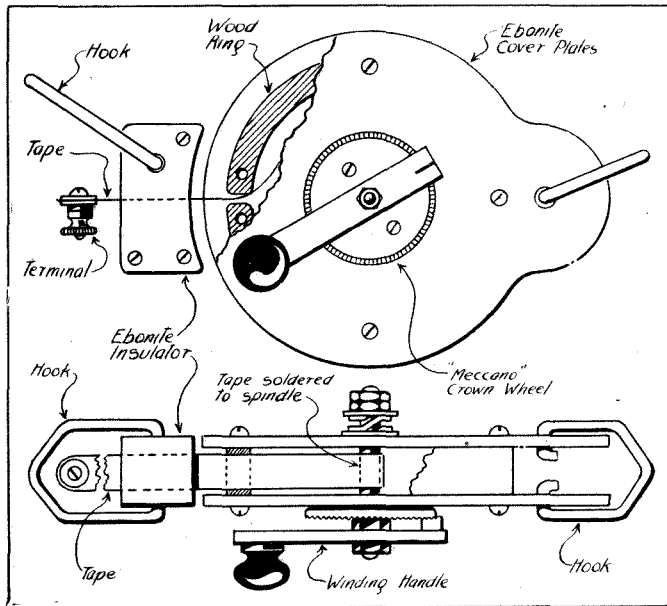

A portable set is useful even in winter, for with it one can spend many interesting evenings in the home of people who are yet without sets.

The greatest problem is that of obtaining a reasonably good aerial, but the difficulty is overcome easily by using the device shown here.

The side cheeks of the bobbin should be of ebonite, but wood can be used if desired. The "aerial" itself consists of a length of ordinary copper tape.

music enthusiast and the jazz fan is a difference in emotional make-up.

Put very roughly and non-technically, highbrow music, which is restrained and complex; makes an irresistible appeal to folks who have their emotions repressed and under

War unleashes and disorganises many emotions; hence the period following a war is always marked by great enthusiasm for informality and spontaneity in music, particularly dance music. This gradually dies down as the war emotions subside,

to control his feelings, is the "middle-brow," who enjoys most forms of music but does not want an excess of any one kind. If we were all well-balanced the B.B.C. would not find it difficult to please all listeners with a single programme. A. M. M.

Just-What-is

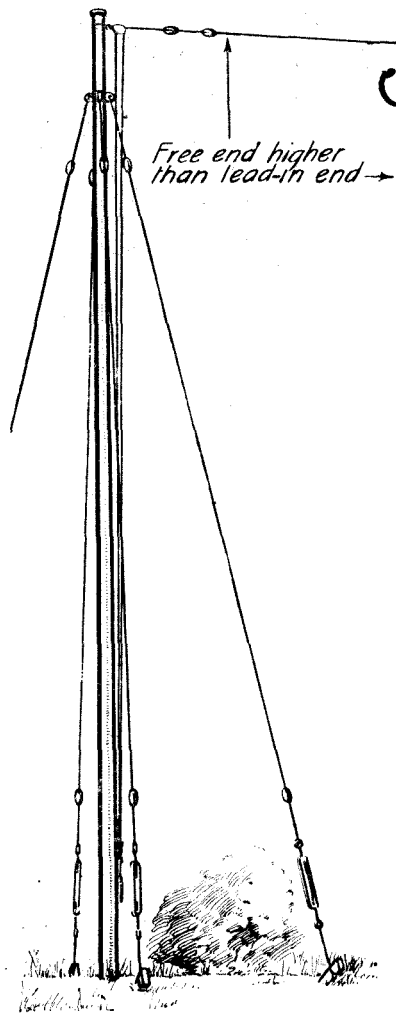

AND, when used in conjunction with a good aerial, it should be possible to receive all British transmissions and most of the Continental stations." How many constructional articles contain that sentence?

The statement is quite clear, but it is conditional. In a great many cases too much attention is paid to the claim and too little to the condition. Providing the local station can be received satisfactorily, it is so easy to assume that one's aerial is "good."

The majority of amateur aerials are *bad*! Decidedly so. This is not always the amateur's fault, as it is seldom possible to erect an ideal aerial in a situation not specially chosen for the purpose. Even so, many people, either through ignorance or indifference, fail to make the best use of the facilities available to them.

The reason for having an aerial at all is to enable energy to be collected

from the ether. The more energy that can be collected the better, so efficiency in this respect is important.

Energy exists in the ether in the form of electromagnetic waves. That is, there are electric and magnetic strains, the electric strain being vertical to the surface of the earth and the magnetic strain parallel to it. It is the electric strain with which we are most concerned. In free ether the strain must exist for ever as the energy stored up in it can only be dissipated in a conductor of electricity.

If such a conductor is placed within the field of strain the energy is transferred to the conductor, in which it flows in the form of an electric current.

What an Electric Strain Is

This sounds very technical, but can be easily explained by saying that an electric strain consists of a series of points at different electrical potentials. In the absence of any conducting path between the points no current can, of course, flow. But if two of the points are joined by a conductor current flows along it from the point of high potential to the point of low potential.

The electric strains with which we are concerned are, as has already been said, vertical to the surface of the earth, so the further above the earth a point in the wave is situated the greater will be the difference between its potential and that of a point at the bottom of the wave which is, of course, situated on the ground.

Therefore, in order that as great a difference of potential as possible may be established between the free end of the aerial and earth the aerial must be high. The higher it is the greater will be the potential differences. The ideal aerial would therefore be a vertical wire of infinite height.

But in order that the aerial circuit may be tuned to the same frequency as the station it is desired to receive the permissible capacity of the aerial is limited. This capacity, of course, depends upon the amount of wire in the aerial. There can be little doubt that, for reception on wavelengths between 300 and 500 metres, a perfectly vertical wire about 200 ft. high would be the ideal aerial. Such an aerial is, of course, quite impracticable in most cases.

If practical considerations limit the extreme height of the aerial to between 30 and 50 ft. (as they nearly always do) a considerable portion of the aerial must be horizontal or nearly so. However, on the principle of approaching the ideal as nearly as possible, whenever the upper portion of the aerial is slanting with respect to the ground, the free end should be the higher. Further reference will be made to this later.

When the top part of the aerial is almost parallel to the ground, a 200-ft. wire would have much too great a capacity to be suitable for reception on the broadcast band. This follows because the capacity of a condenser increases as the plates are brought nearer together. In this

case, of course, the aerial wire forms one plate and the earth the other.

No resentment need be felt at the P.M.G.'s limit of 100 ft. as this is usually the greatest length that can be used efficiently for reception on the broadcasting band of wavelengths.

From the foregoing it might be expected that a perfectly horizontal top portion to the aerial would be of no use as each end of the horizontal portion would appear to be at the same potential. This is not quite true in practice as the tops of the waves bend over when they have travelled some little distance from the transmitting station, owing to the tops of the waves moving faster

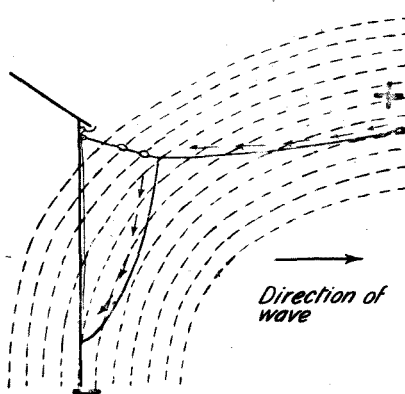

Fig. 1.—Correct Position of Down-lead.

a Good Aerial?

than the bottoms, which are, in a sense, retarded by the ground over which they travel.

To get the very best results from a given station it is therefore best to have the free end of an inverted L aerial pointing away from the desired station. This directive property is not, however, very marked in the majority of cases.

It is important to see that the currents produced in the aerial by the relaxation of the electric strain in the ether are all in the same direction. When an aerial slopes steeply downwards from the free end to the set there can be no doubt that this will be the case, but when a large portion of the aerial is almost horizontal it may happen that the currents produced in one part of the circuit oppose (and neutralise) those produced in another part. Figs. 1 and 2 illustrate this point.

The electric strain is shown diagrammatically (it is difficult to draw a wireless wave), with the top bent over as described. It will be understood that each succeeding point from the positive sign to the negative sign is at a potential negative in respect to the point behind it and positive in respect to the point in front of it.

Fig. 1 shows an aerial with the down-lead taken from the lower end of the "flat" portion, which is also the house end. The aerial currents are all in the same direction.

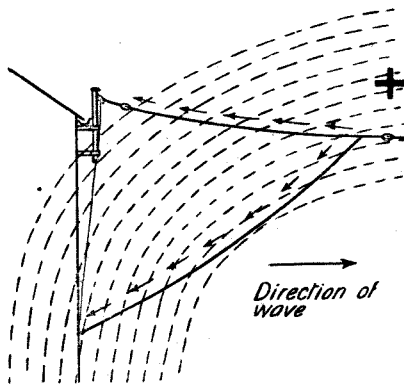

Fig. 2.—Wrong Position of Down-lead.

In Fig. 2 the end farthest from the house happens to be the lower end of the "flat" portion and the down-lead has been taken from the lower end as suggested earlier. It will be seen that in this case the currents in the horizontal portion tend to neutralise those in the down-lead. So the former rule can now be amended by saying that in the case of an inverted L aerial the down-lead should be taken from the lower end of the flat portion, and that this end should be the house end.

We have seen how an aerial may be erected so that the greatest possible amount of energy will be collected from the ether. There are very many aerials which fulfil all the foregoing conditions and are yet very poor.

It is not enough to collect a large amount of energy. This energy must be safely conducted to the set and there used to the best possible advantage. Often the energy is collected only for a great proportion of it to be released again or dissipated in various ways.

Lost Energy

Energy may be lost either by being radiated from the aerial or by being dissipated in the resistance of the aerial circuit itself. The latter source of loss will be considered first. As it is the more obvious, so it should be the more easy to overcome.

The outside wire is a permanent fixture. It will not be convenient to take it down and re-erect it very often. Thus there is all the more reason why there should be no possibility of undue resistance existing here. Having bought the aerial wire, go over it carefully and make sure that each strand is continuous

from end to end. A single broken strand may greatly increase the aerial losses.

Having made sure of this point, erect the aerial without cutting the wire (except, of course, if it is longer than is required for aerial and down-lead).

The popular type of lead-in tube gives rise to the possibility of two more poor connections, one outside the house and one inside. It is far better to remove the brass rod and to run the down-lead, still in one continuous length, through the tube and straight to the aerial terminal of the set. Two small corks may be plugged into the ends of the tube for the purpose of holding the wire stationary and to prevent water from running

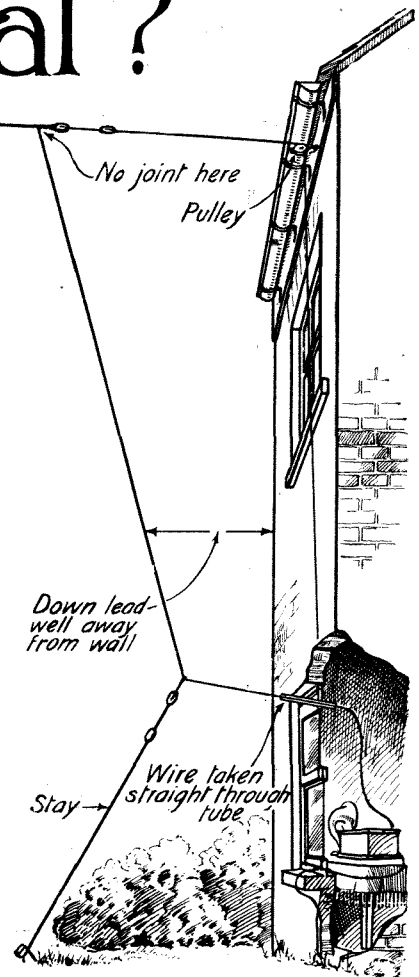

down the wire into the house in rainy weather.

Losses due to radiation are neither so easy to detect nor so simple to remedy as are those due to resistance. When oscillatory currents are flowing in the aerial electric waves will inevitably be radiated. These waves, of course, represent so much lost energy as far as the receiver is concerned.

Such radiation will, however, only be slight providing there are no conductors in the vicinity of the aerial.

The aerial should, therefore be erected as far away from telegraph, telephone, electric light, and other wires as possible. If the aerial must of necessity pass close to such wires its direction should be as nearly as possible at right angles to that of the wires.

It must also be borne in mind that, where high-frequency currents are concerned, the walls and roofs of houses are semi-conductors and the aerial or down-lead should not be brought nearer to them than is absolutely necessary.

BROADCAST MUSIC OF THE MONTH



Mr. Ralph de Rohan.

DURING this last month we have been particularly well served when the broadcast was allowed to continue without interference from the studio and the dance bands and orchestras of the big hotels and theatres contributed to relieve the boredom of the studio performances.

Bands

In addition to those of the Savoy, which have done yeoman service, such bands as those of Bert and Sid Firman at the Carlton Hotel and Cavour, respectively, Signor Emilio Colombo at the Hotel Victoria, M. Camille Couturier at Frascati's and the Trocadero, Fryer's band at the Rialto, De Groot at the Piccadilly, Pietro's and Alfredo's bands, the New Princes Toronto, and (one of the best) Jack Hylton's band have been broadcast, and it is plain that there is little cause for dissatisfaction.

Jack Hylton's band, which has been heard at the Kit Kat Club as well as at the Piccadilly Hotel and the big variety theatres, was started by Mr. Hylton originally with the aid

of six ex-service men, and a very speedy success caused him to increase gradually until there are now thirteen members; this is by no means an unlucky number for Mr. Hylton, as the latest recruit is a brilliant oboe, saxophone and clarinet soloist, so that one might almost call the number fifteen.

To maintain a true balance the vocalist is one of the biggest factors in the programmes of all stations, and it is only right to say that the B.B.C. have not only endeavoured to get really well-known artists, but to retain those who have proved themselves thoroughly capable of singing as artistically before the microphone as they do on the concert platform, and this is by no means as easy as it sounds in cold print.

It is impossible to give in restricted space the long list of artists whose names must instantly leap to one's mind, but amongst them must certainly be reckoned Miss Anne Thursfield, whose many recitals at Wigmore and Æolian halls, London,

early established her amongst the distinguished artists of the day.

Miss Thursfield inherits the art of singing, for both her mother and grandmother were professional singers before her. Her studies in Brussels, Lausanne, Berlin and London have given her a knack for cosmopolitan interpretation, and a marked clarity of diction that has proved invaluable for broadcasting.

Provincial Artists

The provinces have heard many of the artists known to their own particular districts—Miss Winifred Ascott, for instance, one of the best-known singers of the Bournemouth station.

Mme. Gertrude Edgard, who has sung at all stations, especially those of the north, in addition to being a singer is a brilliant pianist, and as such made her first appearance at the age of eight. But as a soprano vocalist she has travelled all over the world, and in South America played conjointly with Josephine Grazioli, one of the finest harpists in that country.

During the war Mme. Edgard performed at the Odéon, Paris, and represented England in the Concert of the Allies; she also performed at a special concert in celebration of King George, in Santiago, Chili.

Miss Winifred Fisher was one of the earliest of our broadcast stars. Originally intended for a dancer, she

joined the Royal Academy of Music and the possession of a fine voice was quickly revealed.

Heard again recently was Miss Dorothy Robson. She,



Mr. Willie Rouse.



Miss Anne Thursfield.



Mr. Harry Hopewell.



Miss Winifred Ascott.



Mr. Stuart Robertson.



Miss Diana Webster.



Sir Walford Davies.



Mme. Gertrude Edgard.



Mr. Sydney Coltham.

too, began in another branch of music, originally studying the violoncello in Paris. Relinquishing this for singing, she studied in Vienna and was to have appeared at the German Court Theatre when war broke out.

Returning to England, she became prima donna with the Carl Rosa company until 1917, when she returned to concert work, only returning to the operatic stage to sing in the Mozart Festival at the "Old Vic" two or three years ago. She is a capital broadcaster, possibly by reason of that wide experience.

Another popular wireless singer at the Bournemouth station is Miss Diana Webster, who had but just begun her musical career when interrupted by the war and, instead of continuing her training, she bravely took up V.A.D. work, serving as a cook in a military hospital. In 1919, however, she was able to resume her artistic work, and that she has justified that training is indubitable.

Miss Evelyn Fryer is another favourite singer at Bournemouth. She has a fine contralto voice, and spent a great part of her early life in the Malay States, so that when she

first started to sing it was in the Malay tongue. Her first appearance was made at the Winter Gardens under Sir Dan Godfrey, since when she has sung at different times throughout the southern districts.

On the masculine side, too, vocalists have been of a high standard. Mr. Harry Hopewell, who is particularly well known at the Manchester station, was born in Nottingham and destined for the lace trade. His solo work as a boy in the church choirs eventually brought him to the Royal Academy of Music. Later he became solo baritone at Manchester Cathedral, and subsequently adopted concert work as his profession.

Mr. Stephen Williams, another favourite bass-baritone at Manchester, is a well-known pianist and composer, too, and in the former rôle was the first artist to accompany himself at the Manchester station. He is also a leading musical critic for one of the London dailies.

Mr. Sydney Coltham, who has been most frequently heard this month at many of the stations, sang first in Canterbury Cathedral at the age of eight and was soon promoted to solo boy.

Mr. Coltham's voice was unique inasmuch that it never "broke," and although at 14 he was unable to sing treble solos, the following year found him singing in the treble clef. Few

(Continued on page 195)



Mr. Jack Hylton.



Miss Dorothy Robson.



Mr. Harry Burley.



Miss Helen de Frey.

Mention, too, must be made of Miss Amy Samuel, known up in the North, Miss Olive Franks and Miss Helen de Frey, who has recently again accompanied the Vladimoff Balalaika Orchestra.



Miss Evelyn Fryer.



Mr. Gilbert Stacey.



Miss Winifred Fisher.



Mr. Herbert Carruthers.

The True-to-life Three-valve Amplifier

This is the set (designed, built and tested by "THE WIRELESS MAGAZINE") that has been presented to the Stillness Road L.C.C. School as part of their prize for our "Reason Why" Competition

THAT it shall give absolutely true-to-life reproduction is the most essential thing about an amplifier intended for the more complete enjoyment of the broadcast programmes.

And in the amplifier described here the Technical Staff of THE WIRELESS MAGAZINE have combined both transformer and resistance-capacity low-frequency couplings to produce a set capable of giving very powerful but at the same time pure amplification.

A low-frequency transformer is used to couple the detector to the first amplifying valve, while the second and third amplifying valves are resistance-capacity coupled. Many readers will have noticed that when only one amplifier of the transformer-coupled type is used the results are quite satisfactory as regards purity, but with a second transformer-coupled amplifier added to increase the volume, the purity as a rule suffers.

By using one transformer-coupled stage of amplification, and following this with two resistance-coupled amplifiers, it is possible to obtain the volume of two transformer-coupled amplifiers.

The amplifier shown in the photographs can be used with a crystal set, or with a valve detector.

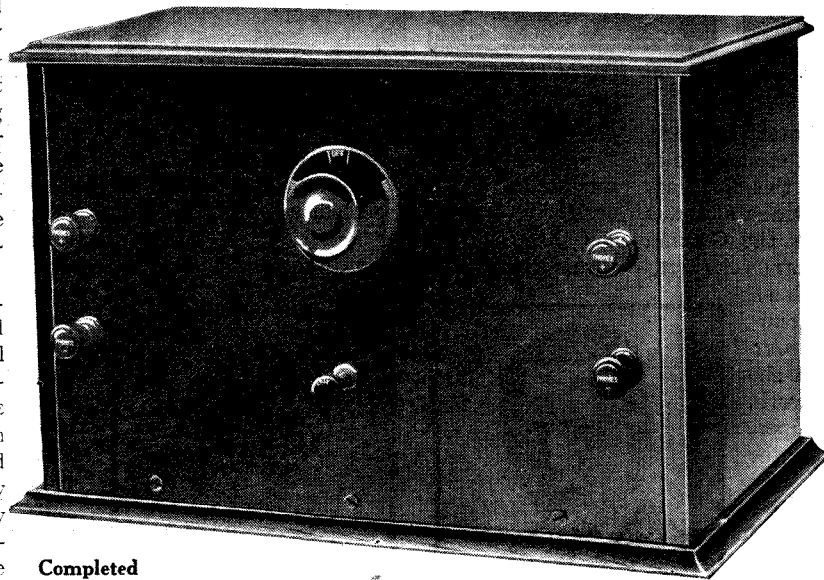

Completed True-to-life Three-valve Amplifier.

duced impulses at higher voltages to flow in the secondary windings. These impulses are then applied to the grid circuit of the first amplifier valve and, due to the amplification performed by this valve, amplified impulses flow in the plate circuit.

In this plate circuit, and also in that of the second valve, there are the two coupling resistances. Since these are in series with the plates of the valves and H.T. +, a steady

An important point to note is that in the amplifier H.T.— and L.T.— are connected together, so these connections are necessary in the detector-valve circuit, otherwise the accumulator is short-circuited.

current flows through them which causes a potential difference to be set up between the ends of the resistance windings.

Any variations of the plate currents, such as would be caused by a change in grid voltages, will also cause variations in the current flowing through the resistances in the plate circuits, and these in turn will cause variations in the potential difference between the ends of the resistances. It is these potential differences which are applied to the grids of the second and third amplifying valves.

Referring to the circuit diagram, it will be seen that

in addition to the high resistances in the plate circuits of the first and second valves there are two grid leaks and condensers. The fixed condensers are partly

(Continued on page 178)

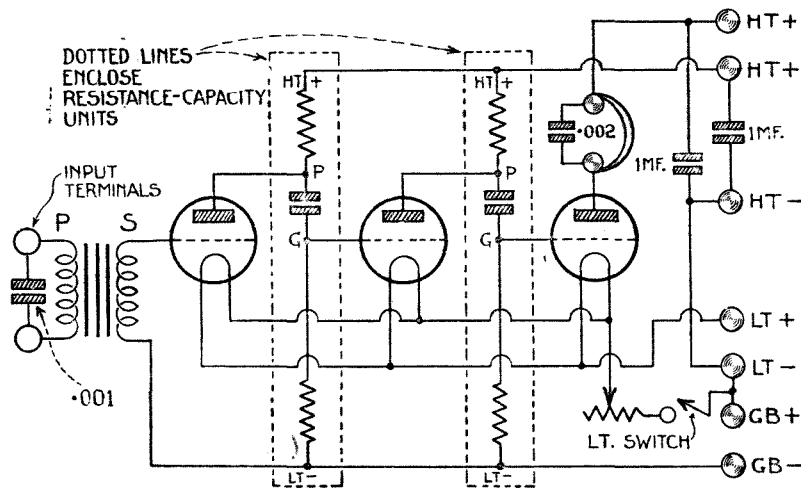

Circuit Diagram of the True-to-Life Three-valve Amplifier.

The action of this amplifier is briefly as follows: The low-frequency impulses, passed by the crystal or valve detector, flow through the primary of the low-frequency transformer, causing in-

LISSENIUM

We tell you how to build your own Loud Speaker,

NOBODY would keep on using telephones when it is now possible to build a large loud speaker quickly and easily at such little cost.

First you get the new LISSENOLA—the sound-reproducing mechanism of this is concentrated so powerfully that the unit is so sensitive it can be used on a small set, so big it will take the loudest signals and high voltages without any trace of dithering or resonating. By large production methods you can buy it for a RECORD LOW PRICE, but we ask you to compare price last of all.

With each LISSENOLA there are enclosed clear instructions which tell you plainly how to build a horn. There is also enclosed to further help you a FULL-SIZE EXACT PATTERN OF APPROVED HORN—nothing is left to chance—YOU START BUILDING WITH THE ASSURANCE THAT YOUR FINISHED LOUD SPEAKER WILL COMPARE WITH THE BEST AND MOST EXPENSIVE MODEL. We ask you, before buying, to

MAKE THIS TEST:

Go to your nearest dealer—ask him to put on the most expensive loud speaker in his stock—then put the horn on the LISSEN UNIT—keep the input voltage the same, no matter how high—

AND SEE IF YOU CAN NOTICE ANY DIFFERENCE

You ought to have the LISSEN REED also (patent pending, and sold separately for 1/-). This adapts the LISSENOLA to carry any cone or similar diaphragm working on the reed principle. The LISSENOLA also fits any gramophone, turning it into a radio loud speaker—you thus have all alternatives of loud speaker reproduction available to you—

**AND AT AN UNHEARD
OF LOW PRICE.**

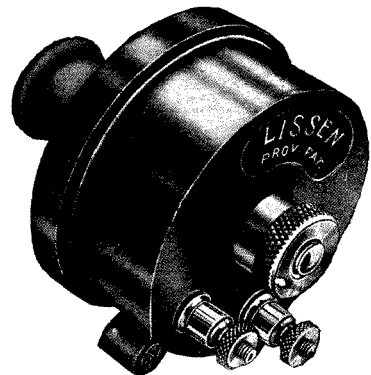

LISSENOLA
LOUD SPEAKING UNIT
(Patent Pending)

13'6

If with Lisssenola Reed 14'6

Your dealer will gladly demonstrate—if he is out of stock, send postal order direct

LISSEN LIMITED

LISSENIUM WORKS,

500-520, Friars Lane, Richmond, Surrey

Phone : Richmond 2285 (4 lines).
Grams : " LISSENIUM, PHONE, LONDON."

You can work wonders with the LISSEN REED and LOUD SPEAKING UNIT

In writing to advertisers, please say you saw the advertisement in THE WIRELESS MAGAZINE.

The True-to-life Three-valve Amplifier (Continued)

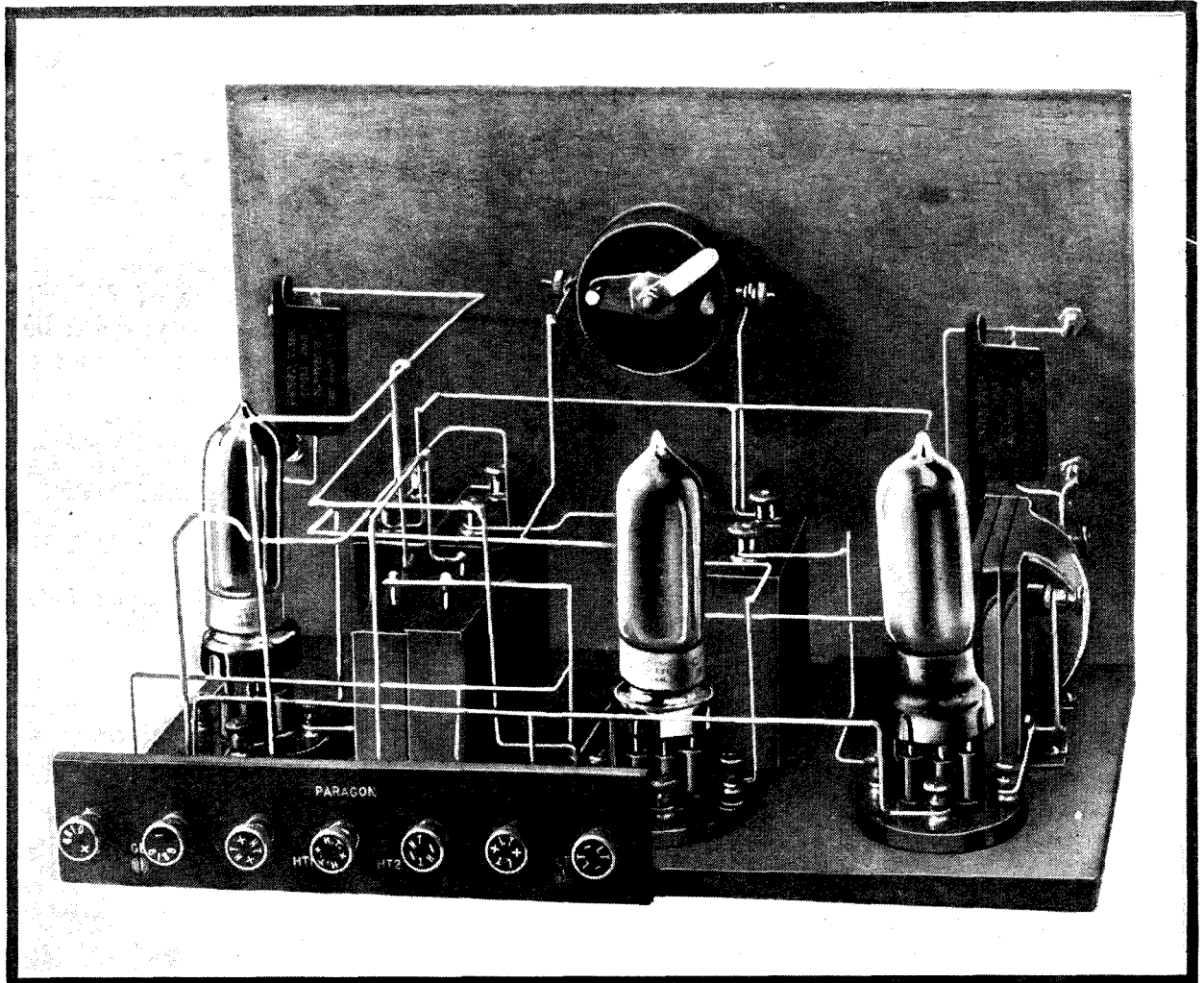

Photograph of the True-to-life Three-valve Amplifier showing Wiring and Disposition of Components.

necessary to insulate the grids from the H.T. battery, and the leaks allow the negative charges on the grids to flow away.

Grid Bias

Ample grid bias is provided so that the large voltage swings do not make the grid positive, so causing grid current to flow and introduce distortion.

It will be noticed in the circuit diagram that the coupling resistances, grid leaks and condensers are enclosed by dotted lines indicating that use is made of complete coupling units containing the components enclosed by the dotted lines.

Turning to practical considerations, the following components will be required to build this amplifier. The actual makes of components used in the original set are specified,

but other makes of good quality may be used:—

Cabinet of dimensions shown. (Aston & Mander.)

Hard wood baseboard, 7 in. wide by 12 in. long by $\frac{1}{2}$ in. thick. (Aston & Mander.)

Ebonite panel, 12 in. by 8 in. by $\frac{3}{8}$ in. thick. (American Hard Rubber Company.)

Engraved terminal strip, 7 in. by $1\frac{1}{2}$ in. by $\frac{1}{4}$ in. thick. (Paragon.)

7 terminals. (Belling Lee.)
4 ebonite engraved terminals, two "phones" and two "input." (Belling Lee.)

2 1-mfd. fixed condensers. (T. C. C.)
.001-microfarad fixed condenser. (Paragon.)

.002-microfarad fixed condenser. (Paragon)

2 resistance-capacity units. (Fuller.)

Shrouded L.F. transformer. (Energco.)

3 baseboard - mounting valve holders. (General Radio.)

Dual rheostat. (Ediswan.)

Single-pole pull-push switch. (Trix.)

Baseboard Mounting

It will be seen from the photographs that the bulk of the components are mounted on the baseboard. This simplifies the construction to a large extent, as only nine holes have to be drilled on the panel, including those for the panel-fixing screws.

From the panel layout and drilling diagram the correct positions of the rheostat, filament switch and terminals can be seen as well as the positions of the necessary holes.

(Continued on page 180)

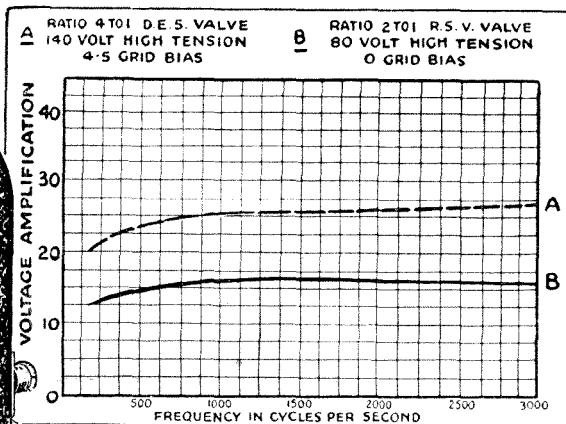
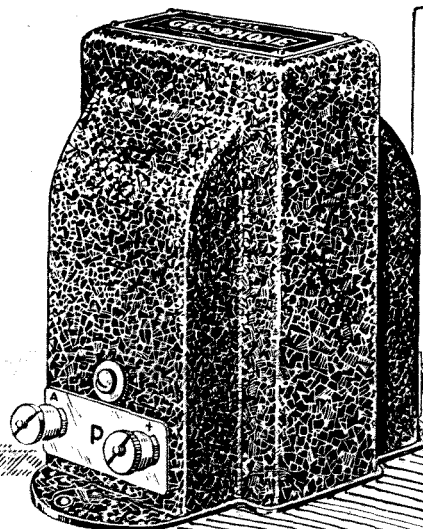

Points of Superiority!

High insulation between primary and secondary prevents leakage and ensures maximum amplification.

The whole is contained in a drawn metal case, providing adequate shielding.

Primary of high inductance provides even amplification over the main range of audio-frequencies.

Connections conveniently made to slotted terminals.

Distortionless!

A new GECophone Transformer of outstanding merits and efficiency

Years of working experience in the manufacture of telephone transformers by The General Electric Co., Ltd. lie behind the new GECophone Low Frequency Transformer—a unique guarantee of perfect design. Already it is acknowledged the supreme radio transformer—trustworthy, super-efficient and absolutely distortionless!

Cat. No. B.C. 720.
RATIO 2 to 1. Recommended for use with general purpose valves, such as OSRAM types R., D.E.R., D.E.3., etc. **22/6**

Cat. No. B.C. 725.
RATIO 4 to 1. Recommended for use with low impedance valves, such as OSRAM types D.E.4., D.E.5., or D.E.6. **25/-**



(Registered Trade Mark)

Low Frequency TRANSFORMER

Your wireless dealer sells it!

The True-to-life Three-valve Amplifier (Continued)

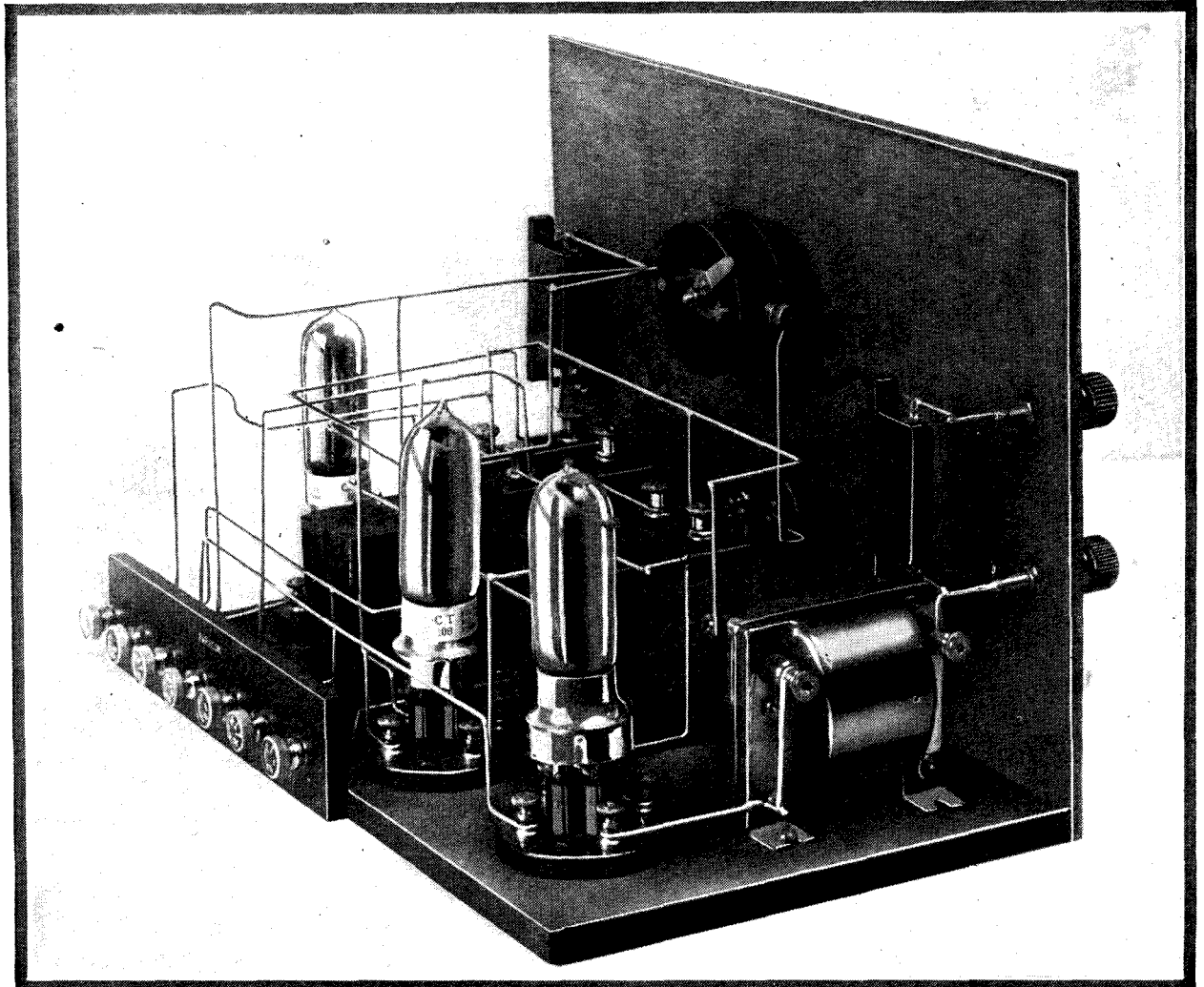

Another Photograph of the True-to-life Three-valve Amplifier showing Wiring and Disposition of Components.

Laying-out the Baseboard

When this part of the work has been finished the panel can be laid aside while the components are mounted on the baseboard. The baseboard layout shows the approximate positions of the various components and, as the arrangement of the latter has only been arrived at after experiments to find the best positions, the plan should not be altered in any way.

The terminal strip is fixed to the baseboard by means of two countersunk screws in the position shown, that is, on the left-hand side looking at the back of the baseboard. Before this strip is fixed in position, however, the seven nickel-plated terminals are screwed tightly into the holes drilled in the terminal strip.

The low-frequency transformer and

the two resistance-capacity coupling units are now fixed in the positions shown. The transformer is fixed by four brass screws which clamp the four slotted feet firmly to the baseboard. The two resistance-capacity coupling units are fixed by means of bolts countersunk from the under side of the baseboard, which screw into threaded holes in the containers of the units. The makers supply a drilling template for this purpose.

All that remains to be done is to fix the three valve holders and the two reservoir condensers to the baseboard, the former being mounted by means of brass screws as shown.

When the ebonite panel has been screwed to the baseboard by three countersunk screws, the wiring of the amplifier may be started. It will be noticed from the wiring diagram that

each terminal is lettered, the idea being that all terminals lettered *a* are joined together first, then all those marked *b*, and so on.

If this plan is followed no mistakes should be made in wiring, as might occur if the set is wired straight from the theoretical diagram.

By-pass Condensers

The two by-pass condensers across the input and phone terminals are held in position by the wiring and are not fixed to the panel or baseboard. The wire used for this set was No. 16-gauge tinned-copper wire.

If the foregoing instructions are carried out, and reference is made to the various photographs and drawings, there is little chance of failure.

When the set is completed it may
(Continued on page 182)

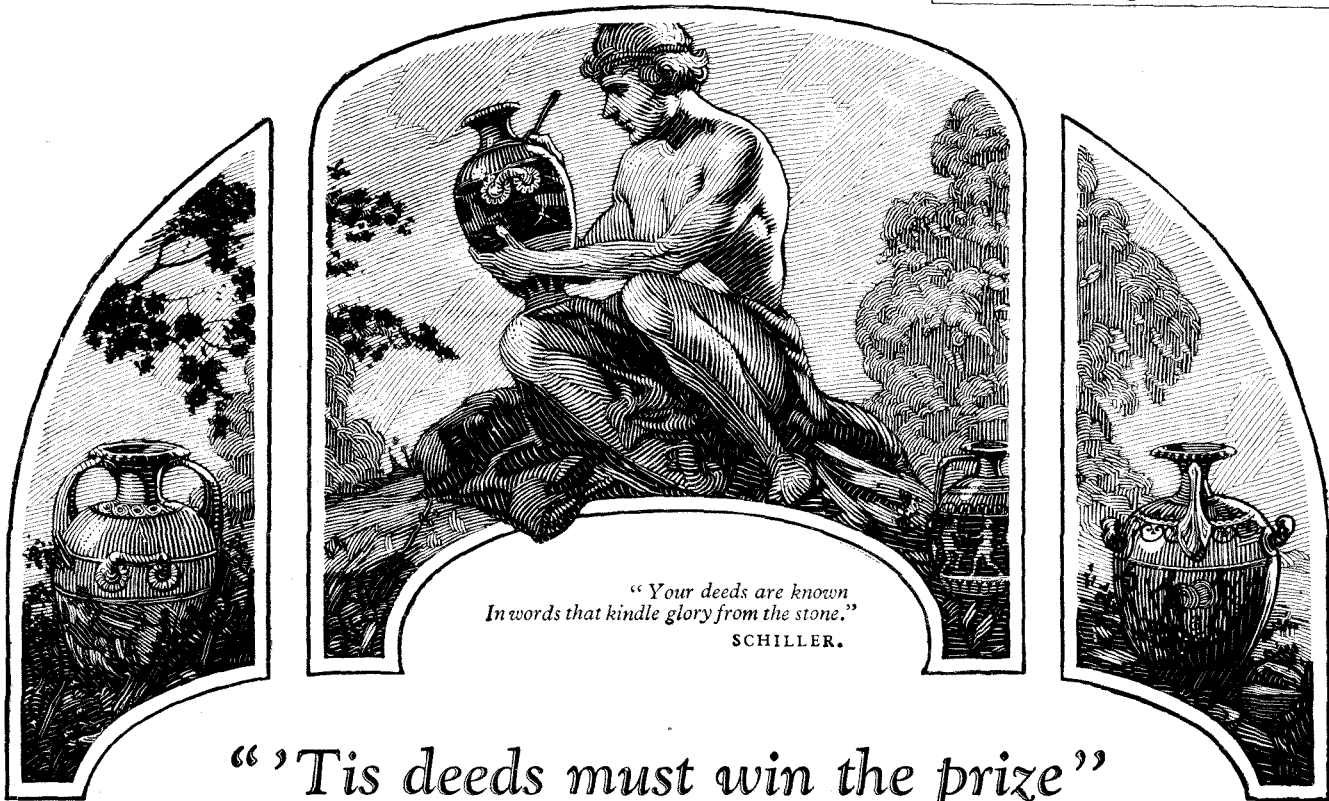

*"Your deeds are known
In words that kindle glory from the stone."*
SCHILLER.

" 'Tis deeds must win the prize "

IN years to come, when the story of the Valve is written, certain developments will stand out like landmarks and win imperishable fame for their inventors.

First, the discovery of the electron theory. Later, Dr. Fleming's great contribution to the cause of Radio—the original two-electrode valve and the father of all valves. Afterwards, the addition by Dr. Lee de Forest of the grid, which resulted in the three-electrode valve. And then Valve development halted for several years. A long straight filament enclosed by a spiral grid—the whole being surrounded by a tubular anode.

This was the standard Valve until the year 1922. Obviously it had many disadvantages. A large proportion of its electron emission inevitably escaped from each end of the anode and served no useful purpose. This clearly caused a very serious loss in efficiency.

The spiral grid—owing to its lack of rigidity—was a fruitful cause of microphonic noises. The straight filament—tightly stretched to prevent sag—readily fractured and the Valve became useless. In 1922 there appeared a new Valve—one destined to win immediate recognition—the Cossor.

For the first time there was used in any Valve an arched self-supporting filament. A grid so rigid as to be utterly vibration-proof. And a hood-shaped anode which enclosed practically the whole of the electron stream. All of which were entirely original and exclusive features.

In three short years Cossor has triumphantly vindicated that its unique principles of design are correct. More than one of its features have been adopted by other makers. But Cossor users are not misled—for Cossor results are obtainable only by the combination of *all* these features.

For 2-volt Accumulators.

- W.1. For Detector and L.F. use - 14/-
Consumption : .3 amp.
- W.2. (With red top) For H.F. use - 14/-
Consumption : .3 amp.
- W.3. The Loud Speaker Valve - 18.6
Consumption : .5 amp.

For 2, 4 or 6 Volts.

- W.R.1. Similar to W.1 but with special resistance which can be short-circuited when not required - 16/-
- W.R.2. Similar to W.2 but with resistance as above - 16/-

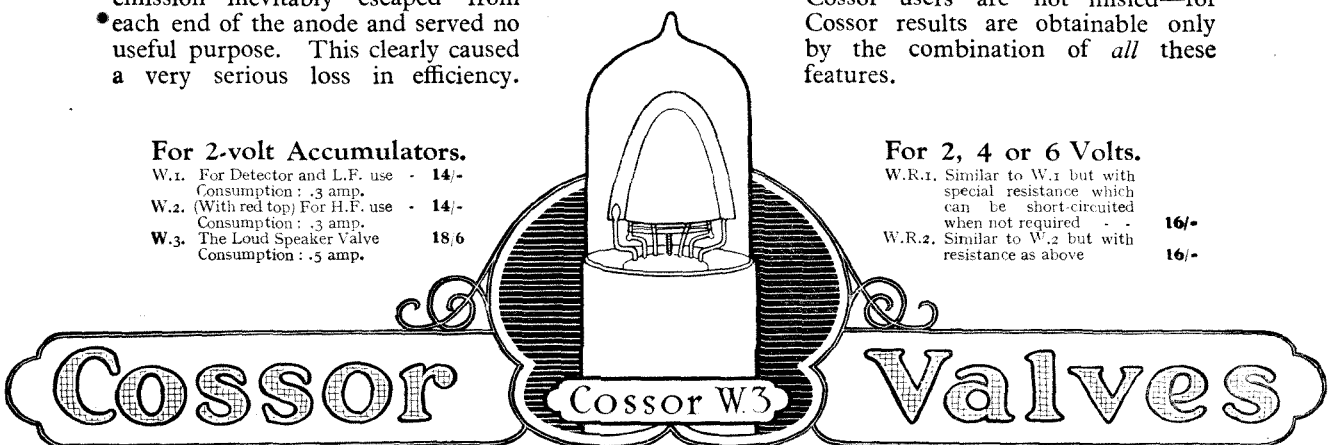

Cossor

Cossor W3

Valves

A. C. Cossor, Ltd., Highbury Grove, N.5

Gilbert Ad. 4351

In writing to advertisers, please say you saw the advertisement in THE WIRELESS MAGAZINE.

COMBINED PANEL AND BASEBOARD LAYOUT AND WIRING DIAGRAM OF THE TRUE-TO-LIFE THREE-VALVE AMPLIFIER (Reproduced half scale)

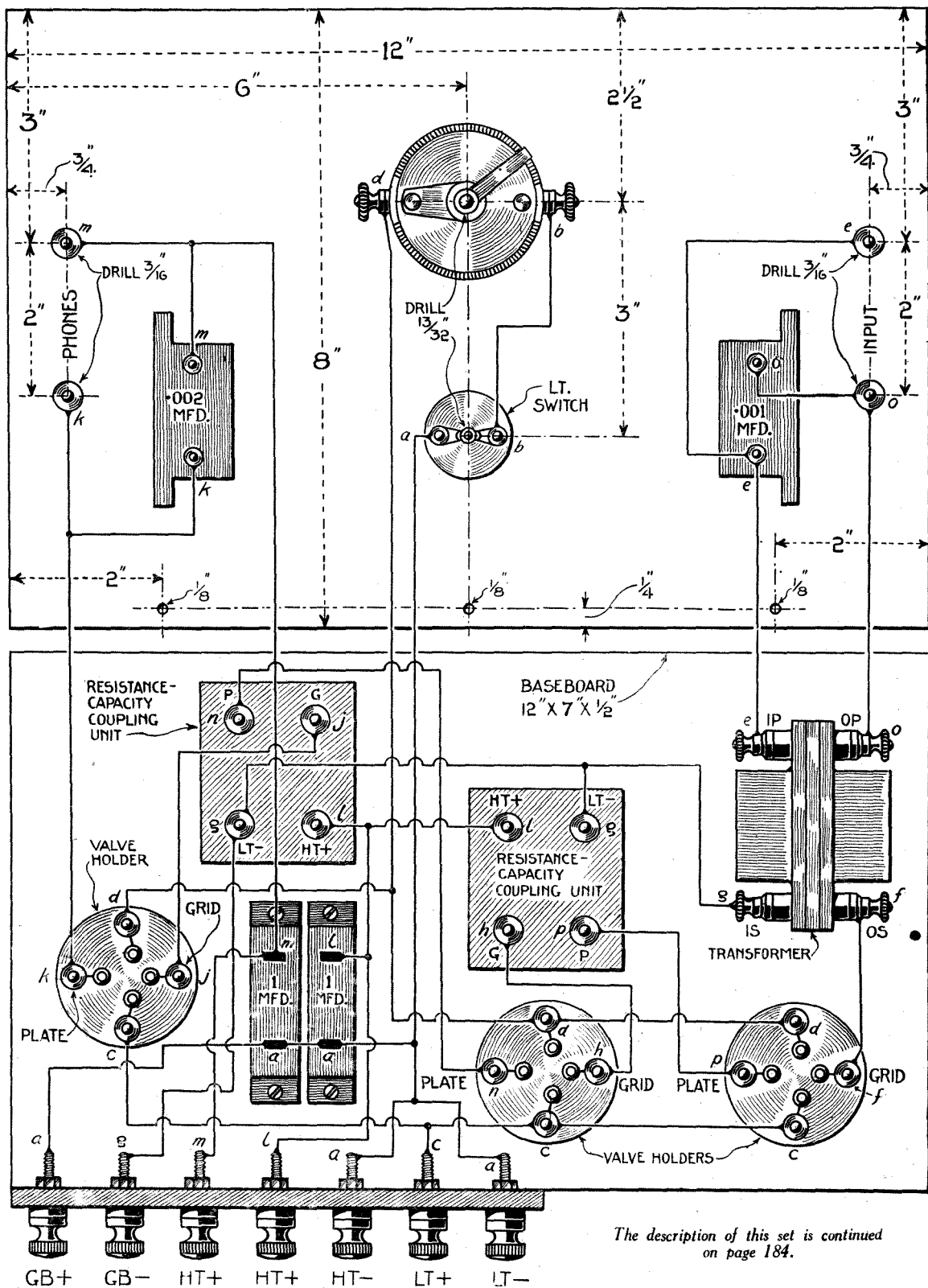

The description of this set is continued on page 184.

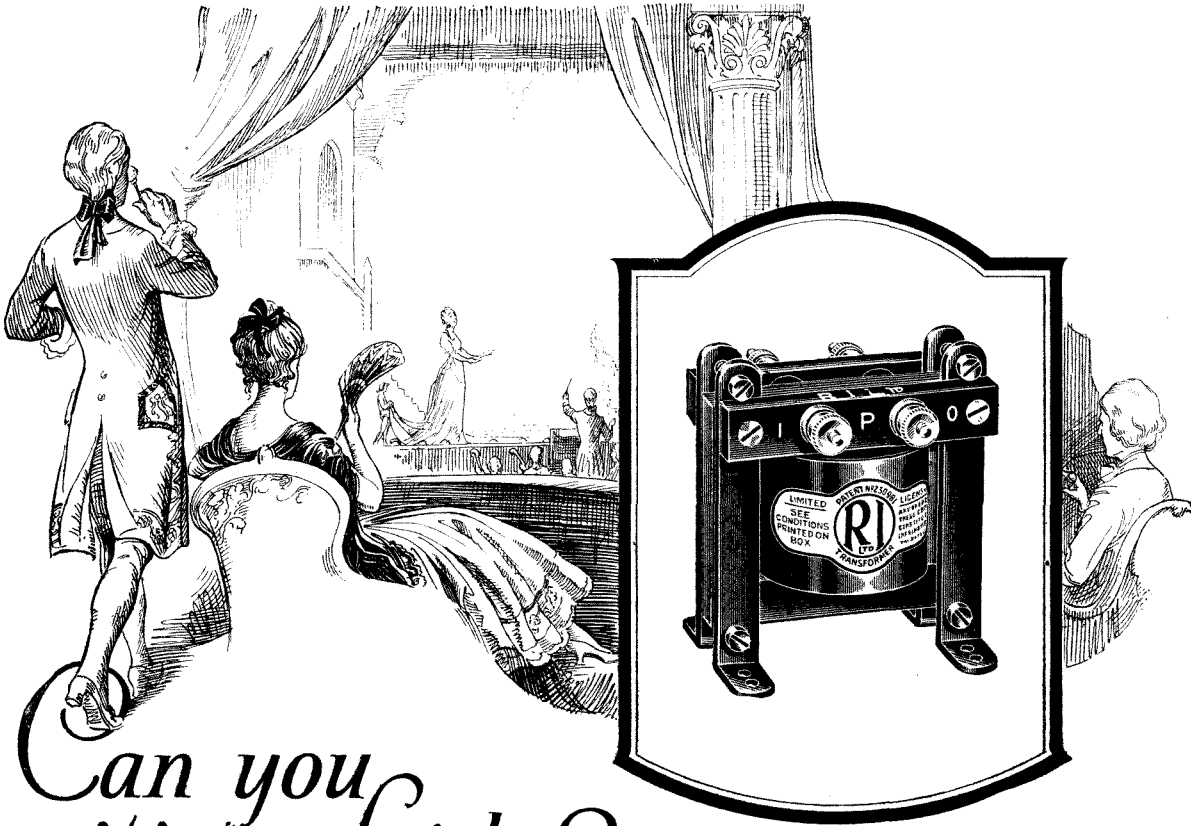

Can you criticise fairly?

WHEN the artist is perhaps hundreds of miles away, putting his whole soul into his effort, before an unresponsive microphone, are you sure you can fully appreciate his performance, and weigh it up fairly?

Are you sure that your set is not letting you down? Transformers play a very important part in wireless reproduction. They have a very responsible job. Over half a million listeners have given this job to the R.I. Transformer. They are in a position to criticise fairly. Word for word, note for note, they receive the broadcast as the artist would have them receive it. Not the slightest inflection is lost, not the faintest intonation is marred.

Because of this the R.I. Transformer satisfies both listener and broadcaster.

Will you let it satisfy you?

Price 25/-

Write for the R.I. Blue and Gold Catalogue.



THE MARK OF BETTER RADIO

Advt. R.I., Ltd., 12, Hyde St., New Oxford St., W.C.1.

P.C.20

In writing to advertisers, please say you saw the advertisement in THE WIRELESS MAGAZINE.

The True-to-life Three-valve Amplifier (Continued)

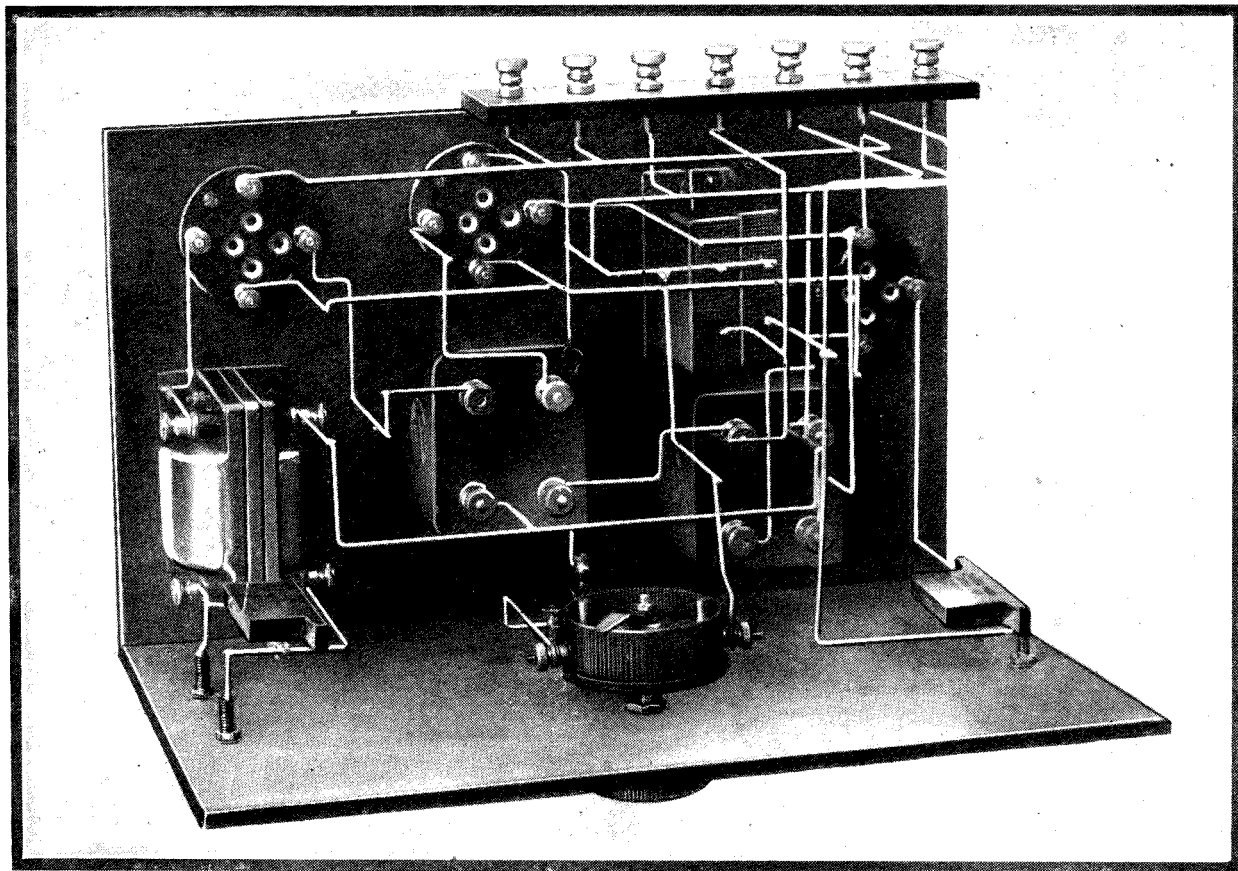

This Photograph clearly shows the Arrangement of the Components on the Baseboard of the True-to-life Three-valve Amplifier.

be tested out in conjunction with a valve detector or crystal set. The phone terminals of the detector set are connected to the input terminals of the amplifier and the loud-speaker is connected to the phone terminals.

The first H.T.+ terminal supplies the high-tension voltage to the last valve, and when connecting up the batteries it is advisable to apply a smaller H.T. voltage to this terminal than to the second H.T.+ terminal, as the latter must necessarily be high, owing to the voltage drop due to the plate resistances. General-purpose valves may be used, but the best results will be obtained by using high-impedance valves in the second and third stages, such as Osram DE₅B's.

When all the batteries have been connected up, and valves inserted in the holders, the filament switch can be pulled out and the rheostat turned on until the valve filaments are at a suitable brilliancy.

Provided everything is correctly

connected up the loud-speaker will work at full strength. If any distortion is present it is probably due to incorrect values of high-tension and grid-bias voltages.

H.T. Voltage

If insufficient voltage is applied to the plates of the last two valves they will not be operating on the straight portions of their character-

istic curves. This can be prevented by applying approximately 150 volts or more and ample grid bias. When the correct battery values have been found, the amplifier will be found to be very simple to operate, as there is only the switch to pull out and the filament rheostat to turn on.

It will be found that the volume given by this amplifier is equal to that of a two-stage transformer-coupled amplifier, while the purity of reproduction is all that could be desired.

Cabinet Dimensions.

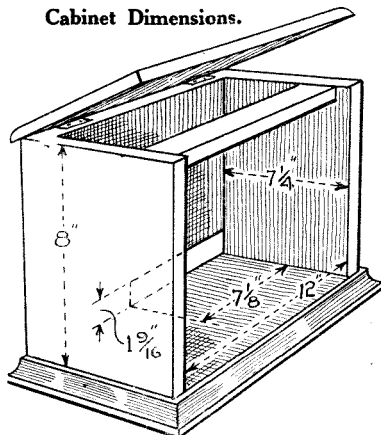

EASIER SOLDERING

A GOOD many people grumble about the trouble of soldering. This is nearly always caused by putting the bit into the flame.

If when heating a bit a piece of old iron tube is put into the fire and allowed to get red hot and the bit inserted inside this to heat, no trouble will be experienced in tinning the bit.

H. G. L.

The choice of 40 leading Manufacturers !

This is the unique position held by Pacent Radio Essentials in America—surely an eloquent proof of their very high quality and efficiency. Why not make IGRANIC-PACENT RADIO ESSENTIALS your choice also? Igranice enterprise has made it possible for you to obtain these distinctive components from your usual wireless dealer—at prices within the reach of every radio constructor. The Igranice Electric Co., Ltd.,

are exclusive manufacturing licensees in Britain, and the addition of IGRANIC-PACENT RADIO ESSENTIALS to the comprehensive range of Igranice Radio Devices gives you a wide choice of the world's best radio components. Here are illustrated and described three components of the range. If you would know about them all, write for our Booklet P 40.

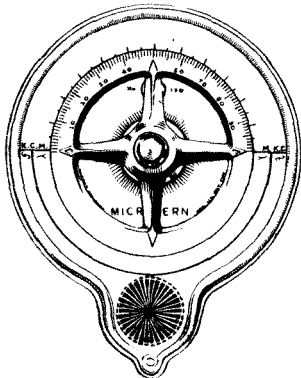

THE IGRANIC-PACENTER MICROVERN

A combined operating knob and vernier control which can be fitted to any variable condenser, variometer, variocoupler or other tuning device. Fitted with a slow motion mechanism with a reduction ratio of 5 to 1, possessing unique features. No gears are used and there is no backlash or alteration to tuning when the hand is removed from the knob.

The outside diameter is 4 1/2 in. and the dial acts effectively as an electrostatic shield, preventing hand capacity effects. Stations can be recorded with pencil by name, wavelength or frequencies and the records easily and clearly erased with a damp cloth.

Quickly mounted on a spindle by tightening one set screw, and a small brass bolt secures it in place on the panel. Suitable for 3/8 in. or 1/2 in. diam. Spindles.

Prices:

Silver Finish 8/6
Gold Finish 8/6

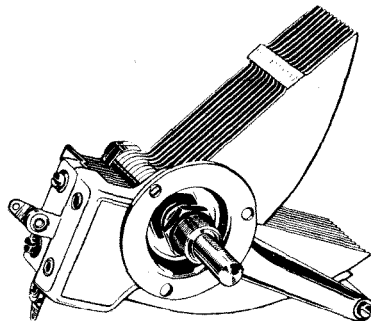

THE IGRANIC-PACENTER TRUE STRAIGHT LINE FREQUENCY VARIABLE CONDENSER

The Igranice-Pacenter True Straight Line Frequency Condenser distributes stations equally over the dial because they are spaced according to frequencies.

Fixed and moving plates are of brass, riveted together and soldered. Only two small pieces of insulating material are used, and these are so placed that the absorption losses are negligible. Substantial dustproof bearing gives a smooth movement which greatly facilitates accuracy of tuning.

The condenser is designed for single or three-hole mounting as desired.

Price00035 mfd. 14/6
Price0005 mfd. 18/6

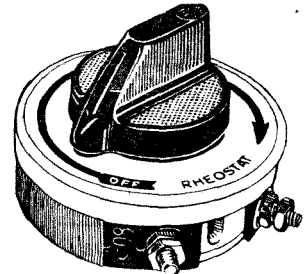

IGRANIC-PACENTER PORCELAIN RHEOSTATS AND POTENTIOMETERS

(Patent No. 238462.)

Low price, pleasing appearance and a smooth, reliable contact—these are some of the features of the Igranice-Pacenter Porcelain Rheostats and Potentiometers.

The special method of construction greatly facilitates mounting and preserves the original accuracy of adjustment.

Rheostats:—

Resistance.	Current Carrying Capacity.	Price.
6 ohms	1.5 amps	2/6
10 "	1.0 "	2/6
20 "6 "	2/6
30 "5 "	2/6
50 "3 "	2/6

Potentiometer:—

400 ohms25 "	2/6
-----------------	--------------	-----



include Honeycomb Duolateral Coils, Variable Condensers, Fixed Condensers, Filament Rheostats, Inter-valve Transformers, Variable Grid-Leaks, Variometers, Variocouplers, Coil Holders, Potentiometers, Combined Instruments, Vernier Tuning Devices, Anti-microphonic Valve Holders, Switches, Stand-off Insulators, Knobs and Dials, etc. etc., also the Igranice Supersonic-Heterodyne Receiver Outfit.

All carry the IGRANIC guarantee.



include the Super "Audioformer," Porcelain and Bakelite Rheostats and Potentiometers, the True Straight Line Frequency Variable Condenser, the Elegant Microvern Dial, the Balcon, the most complete line of Plugs, Jacks and Switches in the world, Jack Name-plates, the Radiodyle, the Radiofile, etc.

The IGRANIC Instructional Carton

contains a comprehensive, fully illustrated descriptive handbook, full-size general arrangement drawings, wiring diagrams and drilling template for constructing a six-valve Supersonic Heterodyne Receiver, according to the Igranice design. Obtain a copy from your dealer.

PRICE 2/6.



Exclusive Manufacturing Licensees of PACENT Radio Essentials.

149, QUEEN VICTORIA STREET, LONDON.

Works :
ELSTOW RD., BEDFORD.

Farewell Reflections * on a Famous Announcement—

“We Are Now Going Over to the Savoy Hotel

OUTSIDE the little farmhouse the sleet is falling heavily and it is bitterly cold. In the open hearth crackles and hisses a huge log fire, and a well-trimmed lamp sheds a soft, warm radiance all over the black-beamed room.

In the room, apart from the light from the fire and the lamp, is another glow. A glow so faint is this that it is hardly a glow at all, and from somewhere near it comes the sound of a voice: “To-day’s anniversary . . .” it begins.

Dance Music !

“Oh! bother ‘to-day’s anniversary,’” someone in the room exclaims—a girl’s voice this—“isn’t it half-past ten yet? Wish they’d cut out ‘to-day’s anniversary’ and get on with the dance music. I’m dying for a dance, aren’t you?”

“Rather,” replies someone else, a man this time; “we haven’t long to wait now. I’d like to go to the Savoy; wonder what it’s like there? I’ve been wanting to go ever since we got this wireless outfit.”

“One minute, please,” comes the announcer’s voice out of the loud-speaker. Instantly all is commotion in the room. Chairs and tables are pushed hurriedly to one side, the hearthrug and carpet are rolled up. Just as the bustle and scurry finishes, from the loud-speaker again comes the announcer’s voice: “We are now going over to the Savoy Hotel for dance-music until midnight. . . . Good night, everybody, good night.”

* * * * *

The Savoy ball-room is neither too large nor too small. It is seldom that the floor is uncomfortably crowded, and yet, even before it gets full, it loses none of its intimacy through over-spaciousness. The word “perfect” is the only one that can be applied to the floor.

Beautifully sprung, it is laid with such precision that not even the slightest of blemishes spoils its surface, and it is kept with such

care that one would imagine not even the daintiest of feet in the daintiest of shoes had ever touched it.

In shape it is a nicely proportioned oval, and at either end are the raised platforms for the bands.

A great deal of artistry has gone into the decoration of these, for their backgrounds are delightfully arranged and carried out. The platform on which the famous Savoy Orpheans play is backed by a set-piece shaped after the style of a Gothic arch. Down the centre a heavy curtain is draped. Concealed electric bulbs impart a soft radiance round the edges of the “arch” and have a most pleasing effect on the dark blue-and-gold colour scheme.

The platform at the opposite end, which is used by the Savoy Tango band, is almost a scene in miniature. The rear is an iron grille backed by a blue sky over which a soft and perfectly distributed light is shed, no indication as to its source being visible. A flowering tree completes the picture.

In Terms of Gaiety

The rest of the ball-room is coloured cream and is illuminated by a number of large pink-shaded chandeliers of unusual but pleasing design. The walls are practically nothing but mirrors—small squares of mirror-glass set in a moulded framework. Surrounding the oval of the floor, on either side, is a large carpeted space on which small tables and chairs are arranged; while behind these, on a raised foundation, are prettily covered settees. Truly does the ball-room at the Savoy speak to one in terms of gaiety!

While the ball-room begins to fill about 10 p.m., it is about midnight when the fun is at its highest. It is then a charming and interesting sight.

The Savoy is, perhaps, London’s most fashionable ball-room. There you will see many with names to conjure with in the worlds of business,

art, literature, what you will. But sssh! There will you often find notabilities in the sphere of music! For is not the Savoy the home of musical dance-music? Syncopation here is expressed in its highest and newest form. Many go to listen who do not or cannot dance.

All are there to enjoy themselves, and enjoy themselves they do, with a right good will. The whole atmosphere is permeated with laughter and happiness: it is bright and it is cheerful. On with the dance!

Modern Eve

Here everyone is looking their best. The men in faultless evening dress—“tails” are *de rigueur*—the women, a whole book would not describe them. Modern Eve, slim and shingled, looks her best when at the dance. The girls whose voices and claps are heard over the microphone are all just as the listeners imagine them to be. Short-skirted, silk-stockinged; their heads a mass of curls or as smooth as a man’s, dressed simply and mostly unjewelled; they are nothing if not natural.

* * * * *

Out of the loud-speaker, together with the strains of the Orpheans, boomed out the last stroke of midnight from Big Ben. “How quickly the time seems to fly,” said the girl; “I want to go on all night.” “Yes, the lucky people in town are still at it, I expect,” her companion said. “There’s a little event I hope we’ll have to celebrate very shortly, and”—softly—“I’d like to take you there for it.”

What she said was drowned by the noise of the wind and rain outside—but that night she dreamed of a wonderful dinner on a table for two, of a gaily decked ball-room, and someone more than a mere dancing partner, of music she had heard but musicians she had never seen.

And hearing is sometimes believing—even wireless hearing. H.

* It is officially announced that the Savoy Bands will not broadcast after February 27.

Things of the past

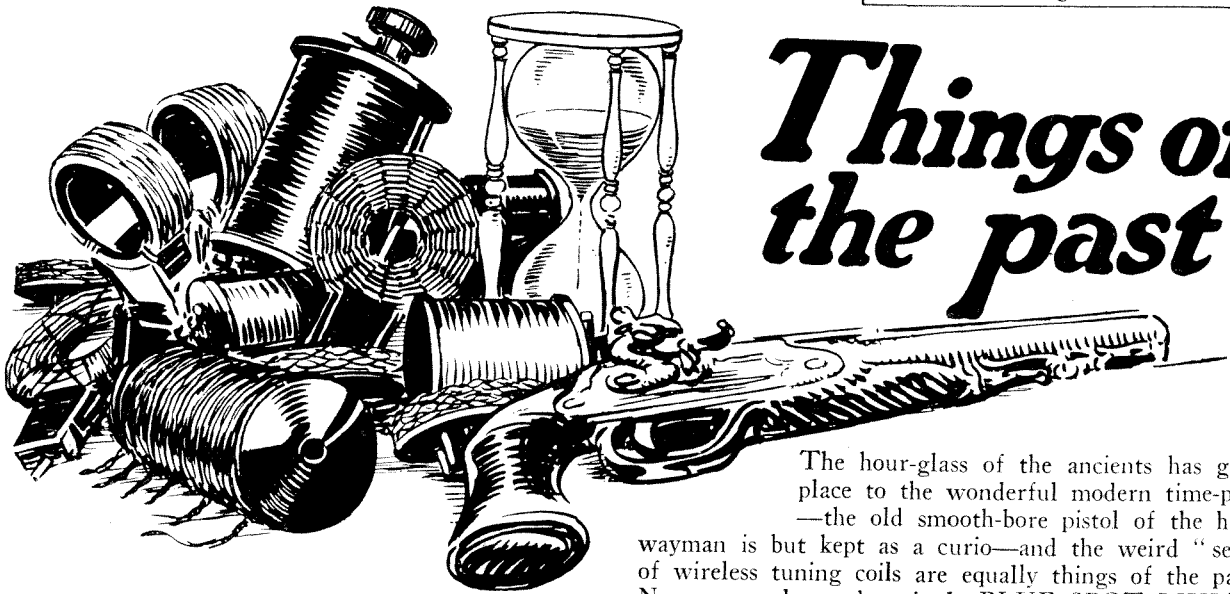

The hour-glass of the ancients has given place to the wonderful modern time-piece—the old smooth-bore pistol of the highwayman is but kept as a curio—and the weird “sets” of wireless tuning coils are equally things of the past! Now you only need a single BLUE SPOT MULTIDYNE COIL for any and every wavelength.

Fit a

“BLUE SPOT” MULTIDYNE ALL-WAVE COIL

(Three Provisional Patents)

The BLUE SPOT MULTIDYNE COIL is not a tapped coil—it incorporates a series of entirely separate coils that give the desired wavelength and the right inductance values by a simple turn of the switch. Instead of a series of plug-in coils of various wavelengths, for different stations, the BLUE SPOT MULTIDYNE brings the world within your range without ever changing coils. Replace those obsolete sets of coils with a simple BLUE SPOT MULTIDYNE, and you will *never* have to buy another Coil.

**Wavelength Range 150 to 5,300 metres
—and NOT A TAPPED COIL!**

NO DEAD-END EFFECTS

Price 13/6 only



In case of difficulty in obtaining, write to-day to

**LINDALL'S LTD. (Dept. W)
LOMBARD ST., BIRMINGHAM**

Phone: MID. 596. Telegrams: "LIFELIKE, Birmingham."

Agents for London & British Colonies : Barker & Co. (Supplies) Ltd., 59/60, Chancery Lane, London, W.C.2.

In writing to advertisers, please say you saw the advertisement in THE WIRELESS MAGAZINE.

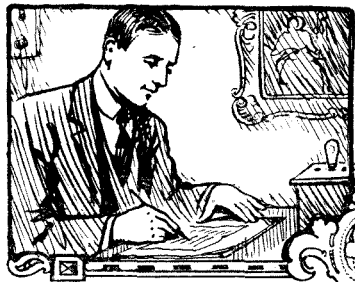

What the Reader Thinks

Strong British Valves

To the Editor of "The Wireless Magazine."

SIR,—I was interested to read Mr. Martin's letter in the February issue of THE WIRELESS MAGAZINE, as I recently had a similar accident.

My Dutch four-electrode valve had the two grids touching and filament broken, but a British valve, although it crashed with such force as to break a piece off the pinch, lit up and is good as ever!

I think this speaks volumes for the workmanship in British valves.—H. GRIMMER (Bayswater).

Testing a Set!

SIR,—Recently my Polar Twin set caught fire and looked as if it was badly damaged; the bulbs of the valves were deformed and the cabinet charred. But I replaced the valves and tested it; it worked as well as ever, and there was not the slightest decrease in signal strength. I think this accident is a fine example of the high standard of the Polar equipment.—R. D. BLACKWELL.

Broadcasting Modulation

SIR,—Lately I have been touring the ether with my six-valve set and have received most of the principal European and English stations, as well as a few American.

I found that, contrary to general opinion, on the whole Continental modulation compared favourably with that of the B.B.C.; that of Rome, Brussels, Berne, Oslo, Madrid and Elberfeld was equal to, if not better than that of the British stations. I thought that that of P T T, "Le Petit Parisien," Toulouse, Zurich, Vienna and most of the German stations was not far behind, though the transmissions of many of the smaller stations (such as Lyons-La-Doua) are not at all good. The American stations are not so good as the B.B.C., though not bad.—J. M. PENTON (London, W.).

Curious Experiment

SIR,—I have recently had quite a novel experience with a valve contained in a portable one-valve set made for use on board a steam trawler.

While carrying the set it was accidentally dropped. Later it was found that the valve had been rendered apparently useless. One end of the filament had become detached from its support and had fallen on to the grid of the valve. Rather than discard the valve, I put the low-tension supply across one side of the filament and the grid. I found that the filament would light, but at abnormal brilliancy.

Have you any interesting comments or suggestions to make on any phase of wireless that will interest other readers of THE WIRELESS MAGAZINE?

If you have, then write them briefly on a piece of notepaper (write on one side only, please) and address them to The Editor.

To the writers of the letters published each month we award valves. This month's letter-writers will each receive a Cleartron valve; next month's writers will be sent a Cossor valve each.

I used the plate of the valve as the grid and the isolated filament support as the plate.

Daventry came in at almost the usual phone strength, although I was unable to log any other stations under these conditions. The valve lasted for several hours before it eventually burnt out.—W. DALE (New Cleethorpes).

Identifying Foreign Stations

SIR,—When picking-up foreigners, which have now become so numerous, I find it dreadfully difficult to say with any amount of certainty which station it really is, and unless they are accomplished linguists, many must experience a similar difficulty, even including the users of wavemeters.

Is it not possible for the International Wireless authorities to devise some call sign, say of a single syllable, or a number, which could be easily understood by all listeners?—A. J. GURNER (Newton-le-Willows).

Our Cover Designs

SIR,—I have recently fallen a victim to your bow and spear. My surrender is complete. I shout your praises.

It was not ever thus—indeed my conversion has only just been effected—and it commenced when I braved your covers and tentatively nosed between 'em. "I came to scoff. I remained to pray." Not even the covers can shake my allegiance now.

For it was the covers that put me off. Think of the effect on a wireless enthusiast, who likes to fancy himself among the highbrows, of that Bedouin fellow taking his wireless and family for a joy ride on a camel. It shouted at me from a book-stall on a remote station in Wales so loudly that it frightened the bob back into my pocket, and I faced a long journey with a *Fishing Gazette* rather than be seen in its company.

And then there is that bald-headed butler in jazz trousers and bedroom slippers drawing the cork of something bubbly. What a picture for a would-be scientist!

They are not "experimental"-looking enough. I do not mind being classed among the "amateurs,"—but MAGAZINE! What a word! It suggested too much the short-story-pass-the-time atmosphere.

And that's how matters stood until I was asked to build As Good A Set As Money Can Buy, when I overcame my repugnance, shaded my eyes, and got past the binding.

Now I am busy buying up back numbers—covers and all. I salute you. I am yours.—A. G. LETTY (Sutton Coldfield).

[Perhaps Mr. Letty likes this month's cover better?—Ed.]

Tramcar Noises

SIR,—I am using a two-valve set and loud-speaker, and my house is about 100 yd. from a tramcar route. Up to about a week ago I had been greatly troubled by roaring noises in the loud-speaker every time a tram passed the house.

I tried every possible means that I knew of to stop this trouble, but of no avail—it roared just the same. I had just about given up the idea of ever curing it when I was looking through a back number of your paper and found that another of your readers had been troubled with the same thing, and had stopped it by using a counterpoise earth.

I set to work and made one underneath my aerial and was rewarded with an absolute absence of roars and crackles.—P. PONCIA (Birmingham).

Lightship Transmissions

SIR,—Searching the ether recently I was surprised to hear "Ah, well, I think I'll see about a bit o' dinner nah; over an' dahn." I found I was on a wavelength of about 250 metres, and afterwards learned that recently lightships have been fitted with wireless-telephony instruments working on this wavelength.

On another day I again picked up a conversation, and heard that a ship had gone aground in the early morning (eventually refloating), how the Wold lightship fired numerous rockets before attracting attention, and how the Cromer lifeboat put out in answer. I was listening to a lightship on the Haisboro' Sands.

I wonder if other coastal listeners are aware of this new interest afforded them.—T. W. B. COOPER (Sheringham).

THE FIRST WIRELESS LOUD SPEAKER WAS A BROWN



IF ever there is a Loud Speaker on which is lavished the most painstaking and persistent care it is the Brown Q—recognised as the Loud Speaker de luxe. Every part which goes into its construction is subjected to a microscopic scrutiny. Innumerable tests during every stage of manufacture are employed to

ensure the tone perfection for which the Brown Q is so justly famed. And finally each one is tried out on actual Broadcast reception by a sound expert. Such individual effort is more costly, but in the Brown Q fidelity of reproduction outweighs consideration of price. *In all resistances, £15 15 0.*

Retail Showrooms: 19 Mortimer St., W. 1. 15 Moorfields, Liverpool. 67 High St., Southampton.

**S. G. Brown, Ltd., N. Acton,
London, W. 3**

Depots (Wholesale only): 13 Bushy Park, Bristol. Cross House, Westgate Road, Newcastle

BRITISH

Brown

THROUGHOUT

In writing to advertisers, please say you saw the advertisement in THE WIRELESS MAGAZINE.

A Page Specially Contributed by B.B.C. Officials.



Handling the Post: The B.B.C. receives an average of 2,000 letters each day.

IN his evidence before the Broadcasting Committee one of the witnesses dealt with the technical side of musical transmissions and said that the effect produced by a large orchestra in a concert room could not be reproduced by a loud-speaker in an ordinary sitting-room. That is to a large extent a matter of opinion and turns to a considerable extent on the type of apparatus used at the receiving end. It was suggested also that the harmonium or organ transmits as a "nasal snarl." This statement may be labelled as incorrect.

Variation in Instruments

There is as much variation in instruments as there is in receiving sets, and some beautiful organ music is provided for listeners, notably that of Mr. Wolstenholme from the National Institute for the Blind, Mr. J. E. Humphreys from St. Mary-le-Bow, the Canterbury Cathedral organ, and several others.

Something of a travesty of instrumentation would be produced if the suggestion were adopted that, to get the true effect of a drum in a wireless transmission, something else must be used. The assertion was that the note of the proper pitch, *pizzicato* on the violoncello, gives an identical effect in the wireless telephone with that heard in the concert room when a drum is struck. One wonders how many, or how few, listeners would reconcile the tap of the drum with any note on the 'cello, or vice versa.

Broadcast music is judged only by what is heard by the receiver, and no B.B.C. musical director concerns

himself merely with what is heard in the studio.

The further suggestion that a large proportion of orchestral music needs re-scoring with a view to its transmission by wireless is a totally impossible one and does not take into account the orchestral colour as used by the composer. It might, on the other hand, be desirable that some of the foremost composers of the day should provide specially-written music for broadcast, but they would probably need to acquire a knowledge of the technique of broadcasting.

It is a rather bold assertion that the soprano voice with an "excessive" tremolo is extremely popular in the concert room, whereas in broadcasting it is hopeless. The latter point is correct, but such voices are just as objectionable in the concert room. The broadcasting of gramophone music, described as little short of an insult to the listener, is, on the contrary, welcomed by a large number of listeners. "This secondhand stuff," as it has been described, is frequently the broadcasting of new records which are transmitted for the benefit of listeners who are anxious to be kept abreast of the latest gramophone productions. With the improvements which have been made in the manufacture of records, many of them undoubtedly produce an excellent effect.

The witness suggested that it was generally the policy of the B.B.C. with regard to its musical programmes to be afraid of the first-rate, and to regard it as something special and unpopular which must

be compensated for by the inclusion of a large amount of third-rate stuff. The bulk of music broadcast in the programme as popular was said to be simply bad music. This statement was incorrect. Among excellent composers who have written specially for the B.B.C. may be mentioned Edward German, Arthur Wood and Norman O'Neill.

* * * * *

Lest any accusation of political predisposition should be brought against the B.B.C., let it be stated as emphatically as possible that we strive as a public service to avoid transmitting anything in the nature of political propaganda. When, on special occasions, political matter has been broadcast, the balance has been kept as even as possible by placing the broadcasting facilities at the disposal of various parties for the circulation of more than one point of view.

Applications from Minor Parties

That course, however, has its dangers, as we found on one famous occasion, when, as the result of broadcasting political speeches by three party leaders, applications were received from several minor parties to broadcast.

These remarks are called forth by criticisms recently directed against the broadcasting of speeches by the President of the Board of Trade and the Chancellor of the Exchequer. Sir Philip Cunliffe-Lister, in a public speech which was broadcast, put up a plea to Britons to buy British goods in connection with the British Shopping Week.

CLEARTRON DULL Emitter VALVES

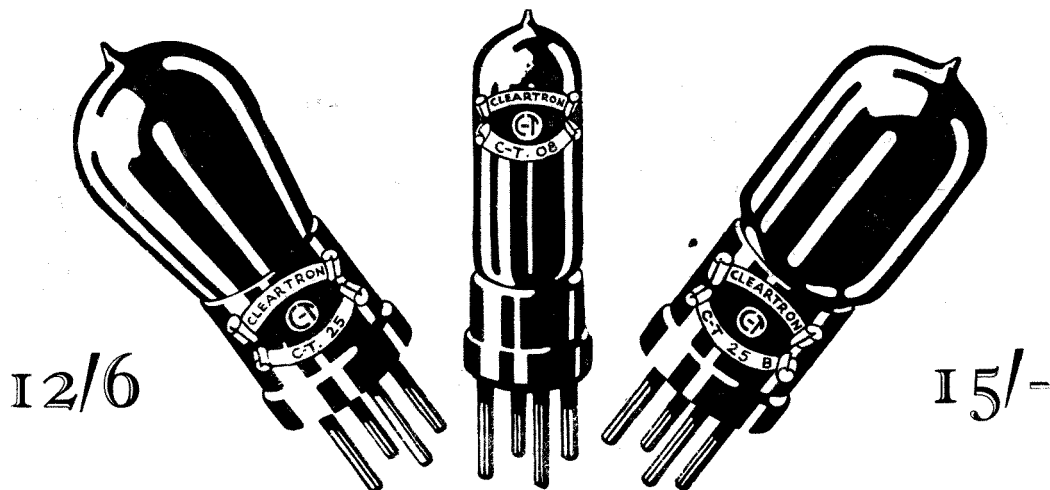

BRITISH MADE

It has been brought to the notice of CLEARTRON RADIO LTD. that persistent rumours are being circulated to the effect that their valves are assembled in Birmingham from components made in the United States and imported to this Country. CLEARTRON RADIO LTD. wish it to be clearly understood that such statements are entirely without foundation, and this Company have every intention of taking whatever steps may be necessary to protect their interests.

CLEARTRON RADIO LTD. is a British Company, fostered in British interests by British capital. The CLEARTRON valve is, and always has been, built of British material by British labour in the Birmingham factory.

CLEARTRON RADIO LIMITED

1, CHARING CROSS, LONDON; AND BIRMINGHAM.

'Phone: Regent 2231/2.

'Grams: "Cleartron, Westrand, London."

Agency enquiries invited.

*America's foremost
valve made in Bri-
tain's newest factory*

CLEARTRON

BRITISH  MADE

*with British bases
for British sets and
sockets.*

Service Advertising.

In writing to advertisers, please say you saw the advertisement in THE WIRELESS MAGAZINE.

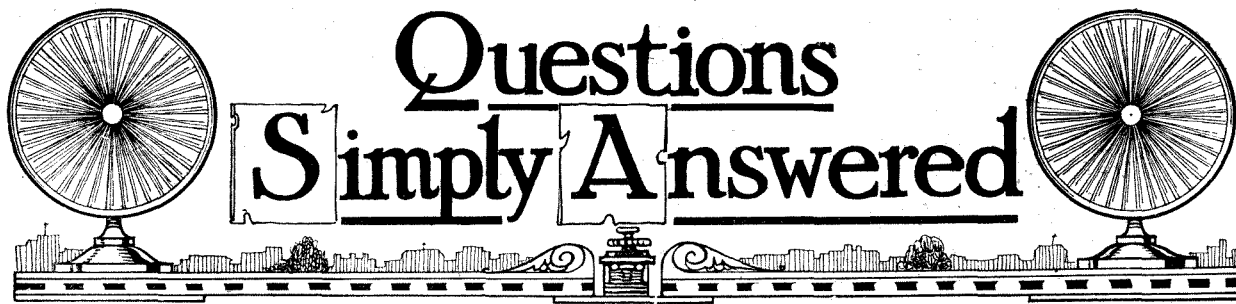

Split Frame Aerial

Q.—How can I construct a split frame aerial suitable for a supersonic heterodyne receiver?—J. D. (Bristol).

A.—Build a frame having diagonals three feet long and wind on 16 turns of No. 20-gauge copper wire, spacing the turns half an inch apart along the diagonals.

Tap at the centre or eighth turn, connecting one half of the frame between grid and —L.T. of first valve. The other end is joined through a small reaction condenser to the plate of the first valve.—L. A. C.

Reaction and "Super Hets"

Q.—How can I add reaction to a supersonic heterodyne receiver? I use a frame aerial.—F. T. (Kent).

A.—Obtain a small neutralising condenser having a maximum capacity of 20 micro-microfarads. Connect one side of this to the plate of the first detector valve and the other side to one side of the reaction coil. The other end of the reaction coil should be joined to negative low-tension.

The reaction coil should be variable with regard to coupling to the grid coil of the first valve.—K. D.

Life of Dry-cell H.T. Battery

Q.—What is the normal life of a standard-capacity H.T. battery when used with a three-valve set for about 3 hours per day?—J. C. (Dumfries).

A.—It is difficult to state what the normal life would be owing to the many factors that need consideration. If ordinary general-purpose valves are used and grid bias adjusted to ensure minimum H.T. current consistent with good signal strength then the battery may last for eight or nine months.

It must be understood, however, that the battery must not be subjected to intense climatic variations. Keep it in a cool dry place and do not reduce its capacity by continuously testing with a low-resistance voltmeter.—K. L. M.

What Set to Build

Q.—I live on high ground about 25 miles from London and wish to receive both London and Daventry at good loud-speaker strength. I should like to receive other stations on phones if possible. What type of set do you advise?—H. G. (Bishop's Stortford).

A.—A set consisting of an H.F. detector, and an L.F. valve is advised. Such a receiver is described in No. 11 of THE WIRELESS MAGAZINE.—B. T.

Polarity of D.C. Mains

Q.—How can I ascertain the polarity of my lighting mains, which are direct-current?—P. M. (Dorset).

A.—Attach two flexible wires to the main fuses (house side) and dip them in a tumbler containing water and vinegar. Keep the wires a fair distance apart and mark that lead on which most bubbles appear the negative lead.—L. A. C.

"Super Het" Receivers

Q.—Is it possible to receive both long- and short-wave stations with a "super het" receiver? By long waves, I mean such stations as 5 X X and Radio-Paris.—F. G. (Putney).

A.—Yes, it is possible to receive such stations as 5 X X on a "super het" receiver. It is necessary to use plug-in coils for tuning purposes, the coils for the local oscillator being interchangeable and variable as regards coupling.—L. A. C.

Calibration Difficulties

Q.—I am attempting to calibrate my receiver for the different stations, but cannot do so as I never seem to obtain the various stations on the same settings twice in succession.

I use a wavetrap loosely coupled to the aerial system in addition to loose-coupled aerial tuning with the Reinartz system for reaction on the aerial coil.

I cannot understand the reason for this variation, and should be glad if you could solve the difficulty.—A. L. (London).

A.—By employing a loosely-coupled wavetrap you automatically alter the tuning of your aerial system with each variation in trap-coil coupling.

You should make a note of the angle of coupling between the trap and aerial coils for each station and also between the aerial and secondary coils.

Additionally you should not exceed the reaction limit, as internal oscillation of your receiver will mean entirely different settings for stations whose normal settings are known.

At present there is no point in calibrating a receiver, as many of the stations are now undergoing a slight but nevertheless definite change in wavelength to avoid interference. These changes are recommended by the authorities at Geneva, who notify the Press when definite wavelength changes are under consideration.—L. A. C.

Charging Accumulators

Q.—I wish to charge my L.T. accumulators from D.C. house-lighting mains of 110 volts. The charging rate, as specified by the makers, is 2½ ampere. What lamps shall I use to pass this current through my cells?—J. S. (Lancs).

A.—You should employ carbon-filament lamps. Wire a 50-candle-power and a 32-candle-power lamp in parallel, and connect them in series with the accumulator and one of the lighting mains.—M. J.

YOU CAN'T SOLVE IT ?

You don't know to where that connection should go or why your set works well one day and badly the next ?

Well, why worry ? We keep a staff specially to solve such problems as yours. Let them have your queries.

Replies to queries of general interest are published each month on this page, but every querist is answered direct by post.

Please observe the following conditions :

Ask one question at a time ; write on one side of the paper only ; attach to your query the coupon on cover iii, and send it with a stamped addressed reply envelope to : The Editor, THE WIRELESS MAGAZINE, La Belle Sauvage, London, E.C.4.

Remember Our Query Service is Free!

Fixed-condenser Values

Q.—What are the best values for the fixed condensers usually placed across the primary of an L.F. transformer, and also across the loud-speaker terminals?—S. R. (Surrey).

A.—The values for such condensers are governed by the make and type of transformer and loud-speaker employed, and also by the design of the amplifier.

The condenser across the transformer may be any value between .0005 microfarad and .002 microfarad, whilst that across the loud-speaker may be as large as .008 microfarad.

The best values need to be found by experiment for individual receivers.—L. A. C.

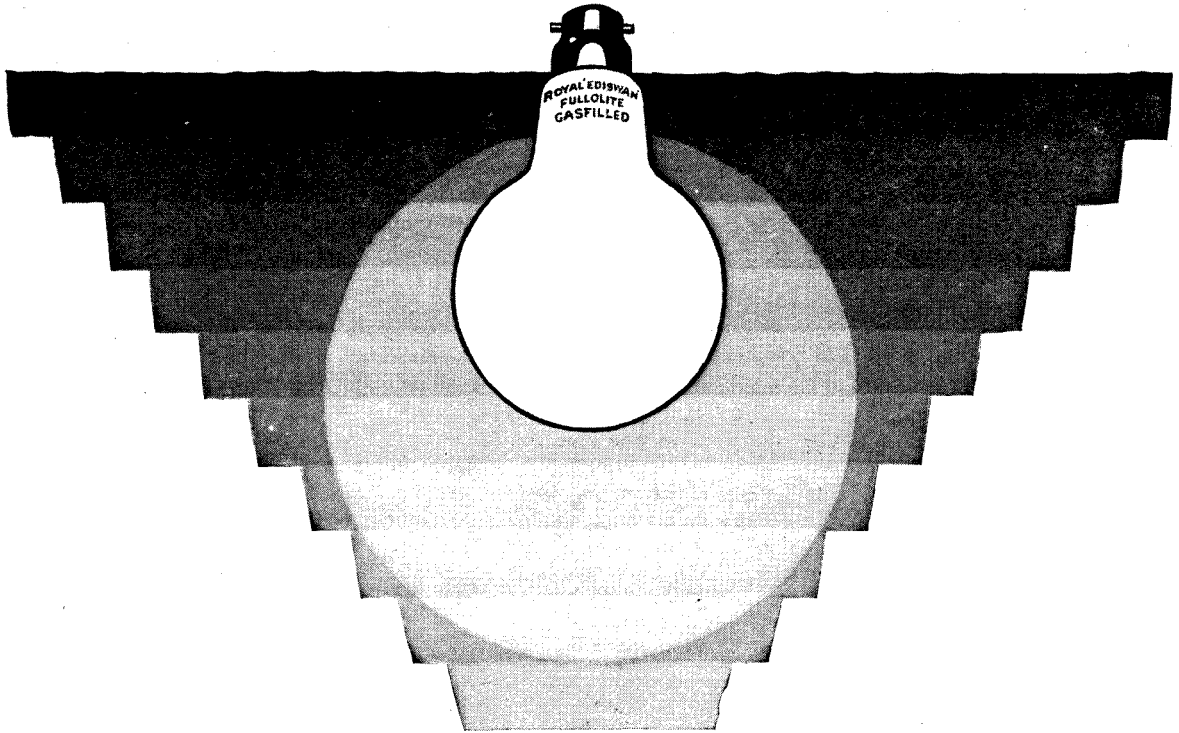

LONGER DAYLIGHT IS NO REASON FOR NEGLECTING ARTIFICIAL LIGHT

—is, in fact, good reason for giving more attention than ever to your lamps. Eyes that are accustomed to more daylight need an artificial light as close to sunny daylight as is possible.

fit "ROYAL
EDISWAN
FULLOLITE
- LAMPS

and see things in a Clearer Light!

Royal "Ediswan" Fullolite Lamps have genuine opal glass bulbs (not merely white-sprayed ordinary bulbs) which give perfect diffusion, and eliminate all risk of eye-strain. Further, an inner protective layer of clear glass provides an absolute safeguard against the "browning" effect of electric light on genuine opal glass. Decorative, dustproof and economical.

IN ALL VOLTAGES: AT ALL ELECTRICIANS.

Fully Licensed under Patents No.'s 23765/12, 10918/13, and others.

In writing to advertisers, please say you saw the advertisement in THE WIRELESS MAGAZINE.

Continental Notes

German Developments
Spanish Transmissions
Education by Wireless

YOU may remember that when, in these notes, I described a holiday I spent last summer in the Rhineland, I stated that wireless in that region was taboo. Of course, with the departure of our occupying armies, this veto has been raised and broadcasting has taken those regions by storm.

Responsible Body

In any case the Reichsfunk, the German body responsible for the service in that country, had already brought these ether concerts to the notice of the Rhinelanders by the erection of the Elberfeld and Dortmund stations, situated just outside the occupied territory.

Now plans are being made for the installation of a new high-power station. It is stated that it will develop almost 10 k.w. in the aerial circuit and, if such is the case, there should be no difficulty in feeding the entire Rhineland by the one transmitter.

According to the latest reports, it has not yet been decided whether this transmitter will be installed on the Hahnerberg, quite a substantial hill in the vicinity of Elberfeld, or whether it would be wiser to erect it at Cologne or at some point nearer to Mayence and Coblenz. It is feared that with a station at Cologne, although of high power, the further smaller towns in the Trier district would be outside crystal range.

In order that the broadcaster may feed a wide zone, including not only the recently evacuated British area, but also the remainder of the occupied territory in the neighbourhood of Wiesbaden, Mayence and Coblenz, it would be advisable to select as site for the station the small town of Caub on the Rhine.

Modified Plans

Before the project is actually carried out there is every likelihood that some modification will be made to the original plans, and it is mooted that an alternate scheme could also be considered, namely, the installation of the main transmitter at Cologne or Dusseldorf with a 1½-k.w. relay at Caub or at some other suitable spot.

* * * * *

Although I must candidly admit that from all appearances the bulk of the Spanish programmes seem to be composed of dance music, I must say that in my nightly potter around Europe, I almost invariably finish up in the land of the toreador. The broadcasting service to listeners in the Iberic Peninsula is assured, as you are no doubt aware, by various individual private undertakings, and where two transmitters have been installed in one and the same city, there has arisen keen competition between the rivals.

In a way, although in some instances detrimental to good reception, such an arrangement provides a certain variety in alternate programmes at the disposal of the public. Competition in broadcasting, as in all other services, must undoubtedly prove an incentive, and the Spanish stations appear to be constantly on the look out for fresh sensations to give to their subscribers.

Relayed for Six Months

For a period of roughly six months Radio Barcelona (E A J I), by virtue of its contract with El Gran Teatro del Liceo, has been able to relay from this famous theatre large chunks of operatic performances given by well-known artists, and I, in London, consider myself an habitué and season ticket holder.

Radio Catalana (E A J 13), a rival concern not to be outdone, has taken almost nightly dips into many music halls and variety theatres, and by this means has not only given pleasure to its local fans, but has afforded distant listeners an insight into the night life of Barcelona.

In my many wanderings with my "super het" I have frequently heard the vociferous applause accorded to some local feminine star, and as encores are generously conceded, these transmissions last until the early hours of the following morn.

* * * * *

I wonder whether, in the more or less remote future, we shall witness the closing down of elementary and secondary schools. This idea may at first strike you as utopian, but recent broadcasting developments would certainly tend that way. For some considerable time the B.B.C.

have been extending their educational courses for the benefit of schools, but it must not be forgotten that the same lectures can prove of considerable utility to stay-at-home listeners.

Wireless Education

During the last month or so Germany, having realised the great advantages of teaching by wireless, has, through its Ministry of Education and a special committee formed for the purpose, daily broadcast through the high-power station of Königswusterhausen, for both beginners and advanced students, full courses in the English, Swedish, and Spanish languages.

But, *das Vaterland* has gone one better, for by payment of a very small fee, the students may send up their exercise books to the head office where they will be corrected by special officials. The scheme is being extended insomuch as similar branches will be shortly opened in most of the German cities, and a series of lectures suitable for popular consumption will also form part of the programme.

It must be borne in mind that with a power of 10 k.w. Königswusterhausen can be picked up in most parts of Germany on comparatively small sets, and for this reason the educational course is available to a very wide section of the population.

Universal Self-educator

So, when you come to think of it, if this scheme were to be carried a few steps further, and lessons were broadcast during all hours from a high-power station, there is really no reason for which self-education, eventually, could not be adopted in all homes.

* * * * *

I have recently been listening to the Stockholm transmissions, or failing that, to one of its many relays. The Swedish Broadcasting Company does not lack enterprise, and a feature which has been recently encouraged is that of bringing to the microphone some of the foreign celebrities who may be on a visit to that country.

From what I can gather, the English language must be very popular in that part of Scandinavia.

JAY COOTE.

Broadcast Music of the Month (Continued from page 175)

people know that he is also a clever violinist.

Other singers include Mr. Harry Burley, well known in the Midlands, and Mr. Steuart Robertson, who has sung in all the operettas produced at the Manchester studio.

Mr. William Anderson, the operatic star of the B.N.O.C. and other opera companies, needs no comment.

Instrumental Side

The music of the month has brought us many famous instrumentalists, including Sapelnikoff, the pianist; Catterall, violinist; and the Philharmonic Pianoforte Quartet, which comprises those well-known artists Charles Kelly, Paul Beard, Frank Venton and Hohann Hock.

Miss Irene Scharrer was announced to give her farewell performance prior to a long American tour, while fine work has been done by Mr. Herbert Carruthers, the musical director of the Glasgow station.

The provinces always show to advantage. At Bournemouth, conducting the Royal Bath Hotel Orchestra which is so frequently relayed, is Mr. Gilbert Stacey, a brilliant pianist, singer and composer, as well as conductor.

For the rest, each station has proved its mettle, both on the entertainment and on the educational sides. For the latter, most interesting work has been done by Sir H. Walford Davies, in his talks to schools on music.

Entertainment Side

On the entertainment side we have been well served by reason of the excerpts from real theatrical productions. *Mercenary Mary*, *The Blue Kitten*, *Betty in Mayfair* have all been announced, in addition to the Radio Radiance revues, which ended late in January, and "The Offenbach Follies."

Individual artists, such as Donald Calthrop, Sir Harry Lauder (last month), Mr. Willie Rouse, and that clever Scotsman, Mr. R. I. Stephenson, not heard frequently enough, Vivian Foster, Vicar of Mirth, as well as Mr. Ralph de Rohan, can be commended for their fine work.

STUDIUS.

FELLOWS WIRELESS



BUY BY POST
SAVE 6/8 IN THE £1

Order all your wireless requirements from us by post. We can supply you with everything from an insulator to a five-valve cabinet set. The quality of our goods is entirely beyond reproach; the cost is low because you can only obtain goods direct from us, and this saves you the middleman's profit. You can have every confidence in ordering by post, because all our goods are sent on SEVEN DAYS' APPROVAL against cash, packing free, carriage forward (unless postage is stated). Take advantage of this unique offer, fill in the coupon below, and post it to us to-day. If the article you want is not shown here write for our 40-page illustrated catalogue free.

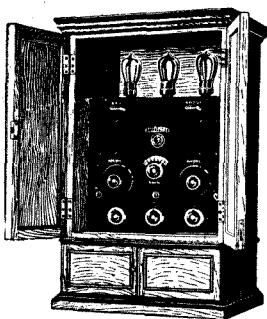

THE FELLOPHONE THREE-VALVE GRAND.

One of the outstanding successes of the Fellows Company. An ingenious circuit arrangement obtains for it the full power and range of a four-valve set at the far lower initial cost and running expenses of an ordinary three-valve set. Its handsome cabinet, which is fitted with folding doors, provides an exceptionally attractive setting for it and eliminates entirely the untidiness usually associated with wireless sets. The set complete comprises H.T. Battery, 6-v. Accumulator (25/-), 1 pair of Headphones (11/6), 3 Louden Valves (4/6 each), Aerial and Insulators (3/6). Marconi Royalty paid.

Set only **£11:17:6** Set complete **£14:10:0**

THE LITTLE GIANT TWO-VALVE SET.

Easily the cheapest and most efficient two-valve set on the market. Combines ease of operation, simplicity of tuning and extreme selectivity. Has given entire satisfaction to thousands of listeners. Set complete includes H.T. Battery (9/-), 6-v. Accumulator (20/-), 2 Louden Valves (4/6 each), Aerial and Insulators (3/6), and FELLOWS JUNIOR LOUD SPEAKER as illustrated (19/6). Marconi Royalty paid.

Set only **£3:15:0**
Set complete **£6:15:0**

WRITE FOR 40 pp. ILLUSTRATED CATALOGUE FREE

All Fellows apparatus can be inspected and purchased at 20, Store St., Tottenham Ct. Rd., W.C. (Phone: Museum 9200), 34, Bridlesmith Gate, Nottingham, & Dominions House, Queen St., Cardiff.



Price

55/-

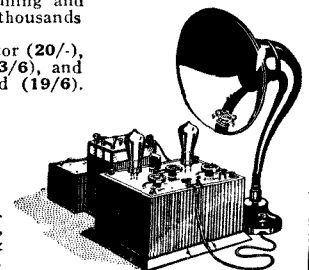

which tells you how you can save 6/8 in the pound on all your wireless requirements. The above sets can be obtained on Deferred Payments. Write for full particulars.

TO THE FELLOWS MAGNETO CO., LTD.,
Cumberland Avenue, Park Royal, Willesden, N.W.10.

Herewith Remittance Value.....

Please forward me.....

on conditions as per your advertisement.
Name

Address

Please write clearly in BLOCK LETTERS and register Cash or Treasury Notes.

W.M. March.

E.P.S.200

In writing to advertisers, please say you saw the advertisement in THE WIRELESS MAGAZINE.

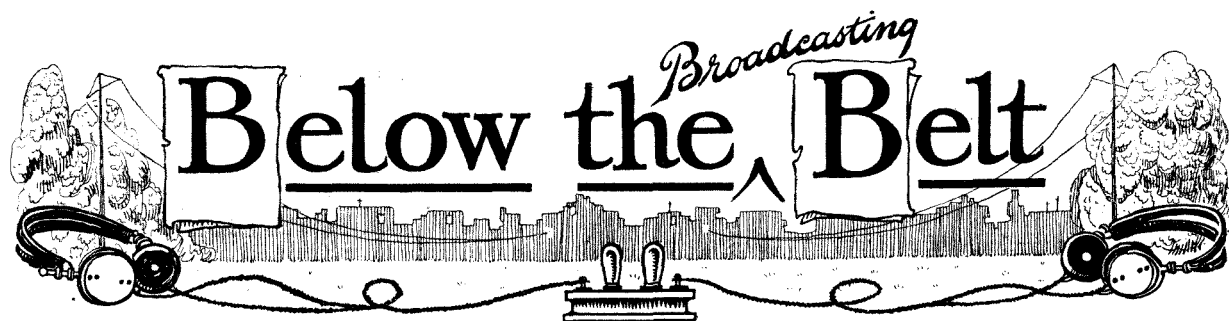

THOUGH the development of short-wave working has operated to keep alive the interest of the amateur transmitter throughout the year by making long-distance working possible in most seasons and throughout all the hours of the twenty-four, the winter is really the D. X. season, and we are now approaching the end of six months of highly intensive work. Conditions have been very "patchy." The month round about Christmas, for instance, being remarkable for the poorness of communication between this country and the United States.

Crowding the Ether

Though the number of really active stations is not nearly commensurate with the number of licenced transmitters appearing in the public directories there are quite sufficient to crowd considerably the ether during those times when the majority can find the time to get "on the air."

Naturally enough most stations are active during the week-ends, and the frightful amount of jamming and QRM on the narrow 44 to 46 metres band which is allotted to those British amateurs who are taking part in the world tests are sending many of the weaker-power brethren back to the 90-200 metres band for week-end working.

Those low-power stations which do manage to get through on Sunday mornings and afternoons must be very skilfully handled, for on low power nothing but a perfectly clear and steady note can penetrate through the "saw and file" noises which some Continental nations seem to think the best for covering distance.

As every transmitter knows, the question of getting a good note is not an easy one on 45 metres and below. Difficulties crop up which do not make themselves apparent above 90 metres. The curious thing

is that methods which seem to work at one station do not work at others. Thus each amateur uses the methods which he finds the best, and one man's experience is of very little use to the majority of his fellow experimenters, except on very broad and general lines.

The shorter waves still, round about 5 metres, are being explored by a few hard-working amateurs who have special permits. Excellent work has been done by 5 TR and 2 V W, the former being practically the pioneer.

GROWING CIRCULATION— AND A MORAL

As we go to press with this page—only a few days after the publication of our previous issue—we learn from the Publisher that the February WIRELESS MAGAZINE is already out of print. This will mean disappointment to very many readers who, in spite of repeated advice, will not order their copy to be supplied regularly. The demand for the WIRELESS MAGAZINE is advancing by leaps and bounds. Quality tells. Do order your copy and prevent disappointment!

The very short waves behave in an even more extraordinary way than the 20- and 40-metre waves, it seems. They can be heard for a distance of about five miles, and then they seem to completely disappear. What the experimenters want to know is, "Where do they reappear again?" and there is need for a band of listeners dotted all over the country equipped for reception on these very short waves so that the experimental work can be carried out properly.

* * * * *

Judging from the correspondence which I receive in connection with my experimental transmissions there seems to be a dearth of wavemeters amongst stations used simply for short-wave reception. It is quite usual for correspondents to ask me to let them know my exact wavelength, "in order that I may calibrate my receiver."

Of course, I am able and willing to supply the desired information; but I would suggest that a wavemeter is really a necessity for short-wave work, even if the station is only equipped for receiving.

The reason why receiving stations are not provided with this necessary piece of apparatus is, doubtless, that any form of heterodyne wavemeter is expensive to buy and difficult to keep calibrated owing to the fact that frequency alters with any alteration of valve, filament heat or anode voltage. Such meters can be built at home for about the cost of a single-valve set; but the difficulty is in the calibrating and this is often quite outside the capabilities of the constructor.

Fortunately the development of wireless science has brought us the "absorption" meter which requires no batteries or valves, and which can be made very cheaply. Such meters are now on the market, properly and accurately calibrated at prices ranging between £2 and £5. I have recently had the opportunity of examining two meters of this class, both extremely well made and both accurate to something under 1 per cent.

Neon Tube

The cheaper model is provided with a neon tube for the benefit of transmitters. The tube will glow when in resonance with the transmitter on powers as low as five watts. The normal range of the instrument is from 15 to 200 metres, but an additional wavelength unit can be obtained to carry the range up to about 600 metres.

The other meter is also suitable for both receiving and transmitting. In this case a hot-wire milliammeter is included in the circuit and the exact point of resonance is indicated by the needle. A meter of either type would turn the uncertainty of the average amateur receiver into absolute certainty. 5 Y M.



The Open Door to Radio Enjoyment!

HERE is Radio in its most delightful form. All you need for perfect Loud-speaker reception, under the control of *one knob*, with set, batteries and accumulator housed in a highly-finished oak cabinet—in itself a worthy addition to the *furniture* of any room.

For those without knowledge of the intricacies of "wireless," Polar-Twin opens the door to a world of new delights. Through the Loud-speaker it gives the innumerable pleasures of Broadcasting—and all that is necessary to operate the set is simply to switch it on!

If you live within 60 miles of a main Station (or within 120 miles of Daventry) Polar-Twin will bring in the host of performers always ready for your entertainment. Set the tuning dial once and for all, then just switch on and off. That is all!

Write for the Polar-Twin Folder to-day.

Complete Installation includes Polar-Twin Receiver; 2 Mullard Polar D₃ Valves; 2 H.T. Batteries, 66 v. each, and plug; 1 C.A.V. 2 v. unspillable accumulator, completely charged; 1 short-wave Coil Unit; Daventry ditto; 1 Ampion A.R. 38 Loud Speaker and the necessary connecting wires. Royalties paid. **£12 12s. 0d.**

Cabinet de Luxe. Cabinet in highly finished dark oak, to house the Polar-Twin set, its batteries and accumulator. **£1 7s. 6d.**



This remarkable set has given one user Dance Music on the loud speaker from a station 400 miles away! Polar-Twin Receiver will usually give full Loud Speaker reception of a number of stations, while all B.B.C. and many Continental Stations have been reported to be within head-phone range. Careful tuning will, under favourable conditions, bring in American programmes.

POLAR-TWIN gives you Fine Music, Loudspeaker Volume, Long Distance Reception when required—under One Knob Control POLAR-TWIN is simplicity itself!

Write for name of nearest Polar Service agent, who will freely demonstrate any Polar Receiver.

Wireless Operators still Wanted.

There are now vacancies on our Sea-going Staff for Junior Wireless Operators, trained on our apparatus. Youths of good education, preferably between 17 and 25 years of age, wishing to enter the Wireless Profession, should communicate with the Managing Director, London Radio College, 82-83, High Street, Brentford, Middlesex, who will be pleased to furnish particulars of the training course necessary to qualify for our Service.

RADIO COMMUNICATION CO., LTD., 34/35, NORFOLK STREET, STRAND, W.C.2

In writing to advertisers, please say you saw the advertisement in THE WIRELESS MAGAZINE.

An Improved System of Wiring

SHOWN by the illustration (Fig. 1) is a system of wiring horizontal panels which in its results has proved considerably superior to the orthodox method.

Capacity Effects Eliminated

Capacity effects are entirely eliminated while multiplicity of crossing leads is obviated. At the same time wiring is considerably

simplified with provision for separate high-tension leads for each anode and also for grid bias. Even then it will be seen in Fig. 1 that wires cross each other in one place only.

All components are mounted on the panel with leads hanging down to the batteries, housed underneath as marked by arrows in Fig. 1. There are only four terminals on the panel. These are for the aerial,

mulator is apt to have deleterious effect upon the wiring.

Common Leads

Although the H.T.—, L.T.—, and G.B.+ leads are shown in the diagram as attached to the earth terminal, it would generally be more convenient to solder them to the wiring in such a way that they fall vertically over the batteries.

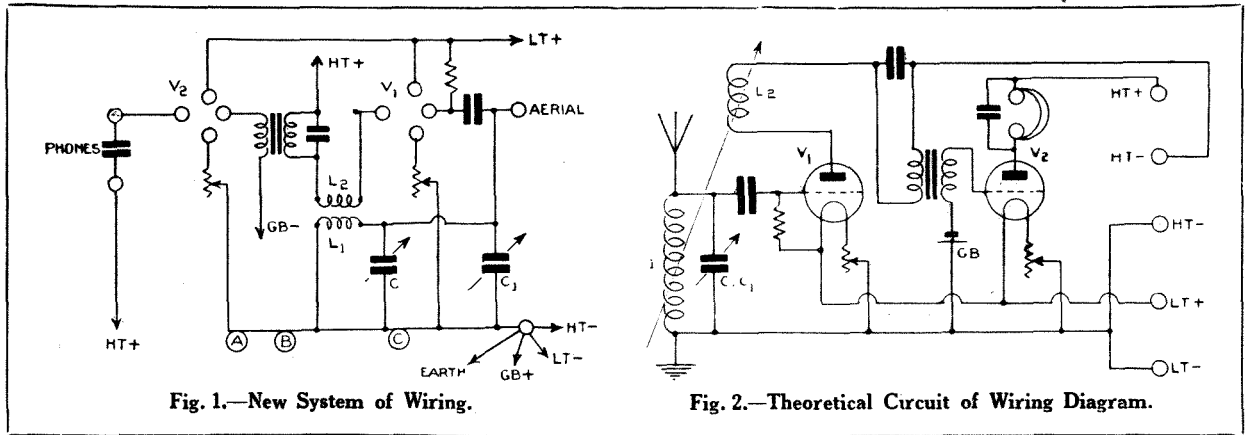

Fig. 1.—New System of Wiring.

Fig. 2.—Theoretical Circuit of Wiring Diagram.

simplified, and the only point to be watched is the matter of confusing the down leads, a point which can be safely attended to by using sleeving of different colours for the three batteries.

As will be seen from the theoretical diagram (Fig. 2), the circuit is a perfectly straightforward one composed of a detector valve and one stage of low-frequency ampli-

fication, although the earth one must be of the composite type of which there is a variety on the market.

The set as built in this fashion is extremely selective and very much more sensitive than when laid out in the regular fashion.

Where batteries are thus housed in the set, dull-emitters and dry batteries should be used, as an accu-

in this way the H.T.— lead might be soldered to fall from the point A, the grid-bias + to the point B, and the L.T.— to the point C as marked in the diagram, the batteries thus lying as follows:

L.T. battery under the detector valve, the grid battery under the transformer, and the H.T. under the amplifying valve.

G. W. D.

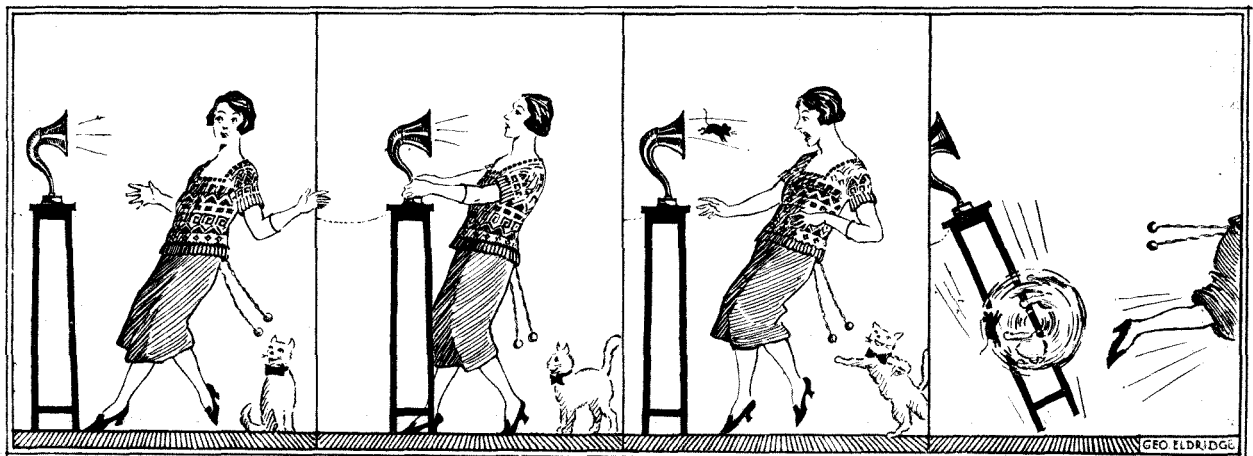

Something must be wrong

at 2 L—

O!

!!!??!!??!!

KEEP YOUR WIRELESS
SET IN "TUNE"

Osram Valves

for Broadcasting

The G. S. C. - your guarantee

"BELLING-LEE" PATENTED Indicating Terminals

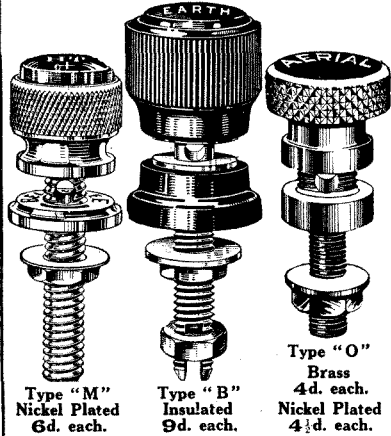

Type "M" have red and black *non-rotating* engraved tops.
Type "B" are polished black bakelite with *non-rotating* engraved tops.
Type "O" is the original indicating terminal in which the name rotates.
All Popular Wording supplied.
 Obtainable from or through all radio dealers, or in case of difficulty write to
BELLING & LEE, Ltd.,
 Queensway Works, Ponder's End, Middlesex.

That Book you want!

Foyles can supply it. Immense stock (second-hand and new), on Wireless, other Technical, Scientific and all other subjects.
 Write for Catalogue 567 (free), mentioning requirements. Books sent on approval.

Books Purchased.
FOYLES
 121-125 Charing Cross Road, London W.C.2.

REPAIRS SETS PHONES TRANSFORMERS

Officially Approved by Radio Association.
ALL WORK GUARANTEED.
LOWEST RATES. 24 HOUR SERVICE.
JOHN W. MILLER, 68, Farringdon Street, E.C.4
 Phone: Central 1950.

If you have a bad cold, a twinge of rheumatism, a touch of neuritis or sciatica, or that feeling of depression suggestive of coming ills.

SWEAT IT OUT OF YOU

by means of the Gem Portable Turkish Bath Cabinet. The process is delightful and invigorating, the cost is trifling, the results are sure.
 Strongly recommended by physicians and health authorities. Illustrated Booklet post free.

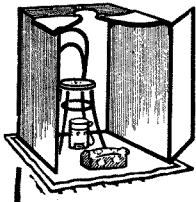

THE GEM SUPPLIES CO. LTD.
 (Desk W.M.),
 67, Southwark St.,
 London, S.E.1.

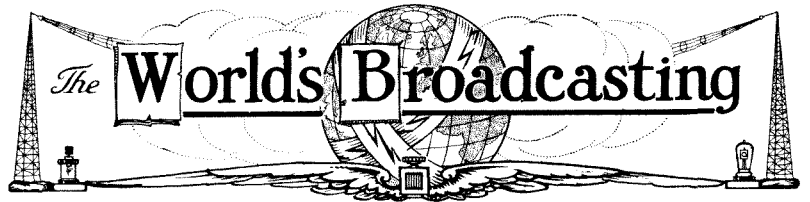

Wave-length in Metres.	Station.	Call Sign.	Wave-length in Metres.	Station.	Call Sign.
186	Montpellier . . .	—	373	Madrid . . .	E A J 7
195	Seraing . . .	—	375	Moscow (Radio Peredacha) . . .	—
205	Liège (Radio Central) . . .	—	378	Manchester . . .	2 Z Y
218	Orebro . . .	—	380	Warsaw . . .	—
221	Karlstadt . . .	S M X C	382	Oslo . . .	—
230	Kiel . . .	—	383	Bilbao (Radio Vizcaya) . . .	E A J 11
233	Uleaborg . . .	—	386	Bournemouth . . .	6 B M
241	Stettin . . .	—	390	Dublin . . .	2 R N
250	Eskestuna . . .	—	392	Madrid . . .	E A J 6
253	Nijni Novgorod . . .	—	392.5	Hamburg . . .	—
259	Elberfeld (relay) . . .	—	397	Graz (relay) . . .	—
260	Norrkoeping . . .	S M V V	404	Newcastle . . .	5 N O
262	Brussels . . .	—	410	Bordeaux . . .	—
265	Joenkoepping . . .	S M Z D	410	Munster . . .	—
270	Malmö . . .	S A S C	410	Stuttgart . . .	—
273.5	Cassel (relay) . . .	—	422	Glasgow . . .	5 S C
277	Bremen (relay) . . .	—	425	Rome . . .	1 R O
280	Radio Lyon . . .	—	428	Stockholm . . .	S A S A
280	Toulouse . . .	P T T	440	Belfast . . .	2 B E
283	Dortmund (relay) . . .	—	443	Radio Toulouse . . .	—
285	Liège (Radio Wallonie) . . .	—	446	Stuttgart . . .	—
288	Gothenburg . . .	S A S B	450	Moscow (Trades Union Council) . . .	—
294	Dresden . . .	—	452	Leipzig . . .	—
297	Hanover (relay) . . .	—	458	L'Ecole Sup. . .	P T T
300	Bilbao . . .	E A J 9	460	Barcelona (Radio Catalana) . . .	E A J 13
300	Seville . . .	E A J 17	462	Königsberg . . .	—
301	Sheffield . . .	6 F L	467	Linköping . . .	—
304	Stoke-on-Trent . . .	6 S T	470	Frankfort-on-Main . . .	—
308	Bradford . . .	2 L S	475	Riga . . .	—
311	Liverpool . . .	6 L V	479	Birmingham . . .	5 I T
315	Berne . . .	—	480	Lyon-la-Doua (relay) . . .	—
318	Helsingfors . . .	—	482	Swansea . . .	5 S X
318	Radio Agen . . .	—	485	Munich . . .	—
320	Milan . . .	—	495	Aberdeen . . .	2 B D
321.5	Leeds . . .	2 L S	505	Berlin (Vox Haus) . . .	—
322	Trollaattan . . .	S M X Q	515	Aalesund . . .	—
323.5	Nottingham . . .	5 N G	515	Zurich (Höngg) . . .	—
324	Barcelona . . .	E A J 1	522	Helsingfors . . .	—
324.5	Edinburgh . . .	2 E H	530	Vienna (Radio Wien) . . .	—
325	Gefle . . .	—	545	Sundsvall . . .	S A S D
331	Dundee . . .	2 D E	546	Buda-Pesth (Csepel) . . .	—
335	Cartagena . . .	E A J 16	561	Jyvaskyla . . .	—
335	Hull . . .	6 K H	576	Berlin (Vox Haus) . . .	—
338	Plymouth . . .	5 P Y	750	Brünn . . .	O K B
340	Copenhagen . . .	—	760	Geneva . . .	H B 1
340	Madrid . . .	F A J 4	940	Leningrad . . .	—
340	Nuremberg (relay) . . .	—	1,010	Moscow (Popoff) . . .	—
340	Varborg . . .	—	1,050	Hilversum . . .	H D O
344	San Sebastian . . .	E A J 8	1,160	Ryvang . . .	—
348.5	Lausanne . . .	H B 2	1,200	Boden . . .	S A S E
351	Marseilles (relay) . . .	—	1,250	Karlsborg . . .	—
353	Bergen . . .	—	1,300	Königswusterhausen . . .	L P
353	Cardiff . . .	5 W A	1,450	Moscow . . .	R D W
355	Salamanca . . .	E A J 22	1,600	Davenport . . .	5 X X
357	Seville . . .	E A J 5	1,750	Radio Paris . . .	C F R
358	"Le Petit Parisien" . . .	—	1,800	Norddeich . . .	K A V
360	Cadiz . . .	E A J 3	1,955	Amsterdam . . .	P C F F
360	Tamafors . . .	—	2,650	Eiffel Tower . . .	—
364	London . . .	2 L O			
370	Falun . . .	S M Z K			

Some of these wavelengths may have been altered before the next number of THE WIRELESS MAGAZINE is published. But under the heading of "Broadcast Telephony" a similar list of European broadcasting stations is published in AMATEUR WIRELESS every week, and you can keep yourself up to date from that.

In writing to advertisers, please say you saw the advertisement in THE WIRELESS MAGAZINE.

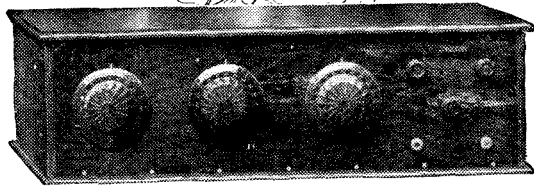
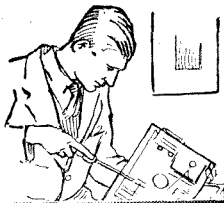

Build the wonderful new RADION NEUTRODYNE

SOON everyone will be building Neutrodynes. For long-distance reception and perfect stability there is nothing to equal them. The new Radion Book (post free 6d.) gives fullest constructional details of the magnificent 5-Valve Neutrodyne illustrated above. Send for a copy to-day, you'll find complete in-

structions also given for building three other unique and efficient Receivers at low cost, a 1-Valve Set, a two-Valve Amplifier, and a self-contained Loud Speaker Set. If your Wireless Dealer cannot supply you with this Book, send 6d. to us and we will post you a copy immediately.

Panels RADION Dials

American Hard Rubber Company (Britain) Ltd.

Head Office: 13a Fore Street, London, E.C. 2
 Depots: 120 Wellington Street, Glasgow, 116 Snow Hill Birmingham.
 Irish Agents: 8 Corporation Street, Belfast

G.A. 4373

Build Your Own Set

We specialize in all Components for the Home Constructor, including the Distortionless Three-Valve, Step-by-Step Super Het. One-Valve Amplifier, One Control Crystal Set, The Round-the-World Short-Wave Three-Valve, A Long-Range Two-Valve, A Family Four-Valve for the Loud-Speaker, A Low Loss Crystal Set, also "As good a set as money can buy" Four-Valve (new edition), Three-Valve Amplifier, the Housewife's Crystal Set, and One-Valve for K D K A as described in this issue.

LISTS ON APPLICATION.

OMNORA LTD., SPECIALISTS IN WIRELESS APPARATUS.
 288, Borough High St., London S.E.1



TIGER SINGLE COIL HOLDER for panel mounting

No. T.C. 101.

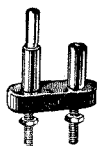

Perfect insulation, only best English porcelain used Brass fittings.

Price 9d. each.

ATHOL ENGINEERING CO., Seymour Road, Crumpsall, MANCHESTER.

Every Switch—

TRIX

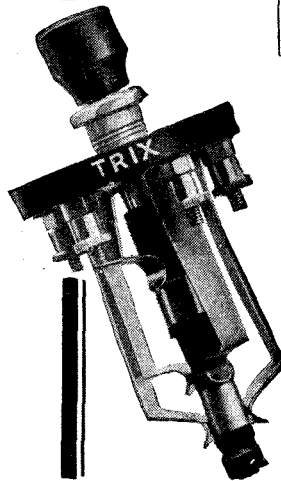

TRIX SWITCHES

like other TRIX parts are rapidly gaining a reputation for sound workmanship and high finish combined with moderate prices, and are becoming widely used in the best sets. The insulation is best quality ebonite and all metal parts are plated.

The TRIX 5-POINT

switch shown above combines the functions of change-over and on-off switches. It will be found most useful for switching an L.F. stage. Well built and with terminals as well as soldering tags. No. 270. Boxed with diagram of connections ... **3/6**

TRIX SWITCHES

have
Terminals
One Hole Fixing
Nickelled Parts
Neat Boxes

TRIX ONE-WAY is a sturdily made little pull and push switch that will switch your set on and off and make reliable contact every time.

No. 179.

It costs only **1/3** in a box.

TRIX TWO-WAY has four contacts and works two circuits independently.

No. 189.

In a box for **1/9**

TRIX VALVE GRIPS

mount directly on your panel and form the most efficient valve holder possible. Valve pins are entirely air spaced. Price per set of four, complete with soldering tags, screws and template, No. 16 8d.

TRIX LEVER PATTERN

is for those who prefer a toggle switch to the push-pull variety. Price with nickelled indicating plate. No. 264 **1/6**

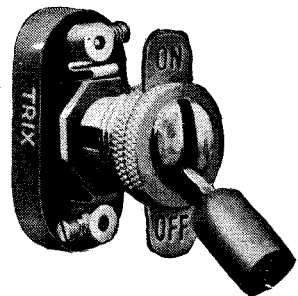

Obtainable from all Dealers. Factors, Trade and Shippers from
ERIC J. LEVER
 33 Clerkenwell Green, London, E.C.1

In writing to advertisers, please say you saw the advertisement in THE WIRELESS MAGAZINE.

Catalogues and Pamphlets

All readers should write for these catalogues, which will be sent gratis and post free if "The Wireless Magazine" is mentioned.

EVERY reader should make a point of writing for a copy of the Marconi-phone log book that has just been issued. Containing spaces for logging stations and making general notes, this book is worthy of a place in every amateur's pocket; a copy can be obtained free on application to the Marconi-Phone Co., Ltd., 210-212, Tottenham Court Rd., W.1, if THE WIRELESS MAGAZINE is mentioned.

The latest catalogue of Gecophone products contains several circuit diagrams and pages of valve data. A copy can be had on application to the General Electric Co., Ltd., Magnet House, Kingsway, W.C.2.

A new booklet, issued by the Chloride Electrical Storage Co., Ltd., Clifton Junction, nr. Manchester, contains full

instructions for the use and care of L.T. batteries.

Particulars of "super het" receivers (including a portable eight-valve model) are given in a pamphlet received from Peter Curtis, Ltd., 75A, Camden Rd., N.W.1.

High-class American components are described and illustrated in a new catalogue, copies of which can be had from A. F. Bulgin & Co., 9-11, Cursitor Street, Chancery Lane, E.C.4.

Gecophone components, accessories and sets are fully described in a new catalogue obtainable from the General Electric Co., Ltd., Magnet House, Kingsway, London, W.C.2.

Sarbolt aerial insulators are the subject of a leaflet issued by the Hatton Supply Co., Hatton, Middlesex.

The Blackadda system, a new method of constructing wireless receivers, is explained in a booklet obtainable from the Blackadda Radio Co., Ltd., 48, Sadler Gate, Derby.

A new catalogue, which fully describes a wide range of components and kits, can be had from A. F. Bulgin & Co., 9-11, Cursitor Street, Chancery Lane, E.C.4.

W. & T. Lock, St. Peter's Works, Bath, have recently issued a new booklet dealing with all types of receiver cabinets.

Particulars of Rotax H.T. and L.T. batteries are contained in leaflets issued

by Rotax (Motor Accessories), Ltd., Rotax Works, Willesden Junction, London, N.W.10.

Full particulars of the new M.L. Dimic coils can be had on application to L. McMichael, Ltd., Wrexham Road, Slough, Bucks.

The characteristic curves of the various Cossor valves are published in the new booklet obtainable from A. C. Cossor, Ltd., Aberdeen Works, Aberdeen Lane, Highbury Grove, London, N.5.

The Terry four-valve receiver is fully described in a pamphlet obtainable from Herbert Terry & Sons, Ltd., Redditch, England.

Round-the-world Short-wave Three-valver

IN the circuit diagram of the Round-the-world Short-wave Three-valver (on p. 9 of the February issue) a 2-microfarad fixed condenser is shown connected between the H.T. — and L.T. — terminals. This condenser should, of course, be connected between the second H.T. + terminal and L.T. —.

Owing to a printer's error the size of the panel for the Long-range Two-valver was given in the list of components on p. 58 of the February issue as 12 in. by 8 in., instead of 12 in. by 9 in. This slip is not likely to have caused much inconvenience as the proper size was clearly shown on the layout diagram.

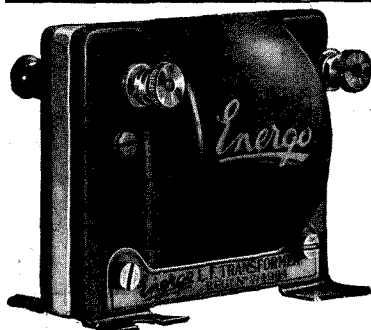

Have you read page 176?

- Ratio 1-3, 19/6
- Other Ratios, 21/-
- Ratio 1-5, 21/-
- Open type, 15/-

All good Dealers stock them.

There are many other "Energo" products — all equally good. Ask your Dealer to show you the famous "Energo" Coils and H.F. Transformers or send direct to us for illustrated lists.

Energo PRODUCTS, LIMITED,
181, James's Street, E.C.1.
Telegrams: "Energotrad, Smith, London."
Telephone: Clerkenwell 7360.

LOOK TO THE AERIAL CONNECTION

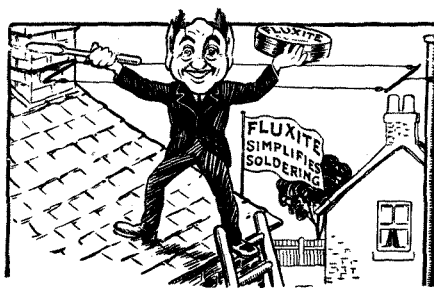

You may have a tip-top aerial and a fine set, yet if the lead-in connection is faulty the results will be poor. The best way to attach the lead-in to the aerial is to twist the wires thoroughly together and solder with FLUXITE.

SOLDER WITH FLUXITE FOR THE MINIMUM EFFORT AND THE MAXIMUM EFFICIENCY.

Ask your Ironmonger or Hardware Dealer to show you the neat little

FLUXITE SOLDERING SET

It is perfectly simple to use, and will last for years in constant use. It contains a special "small-space" Soldering Iron with non-heating metal handle, a Pocket Blow-lamp, FLUXITE, solder, etc., and full instructions. Price 7/6. Write to us should you be unable to obtain it.

Price 7/6



FLUXITE SIMPLIFIES SOLDERING

All Hardware and Ironmongery stores sell FLUXITE in tins, price 8d., 1/4, and 2/8.

Buy a Tin To-day.
FLUXITE LTD. (Dept. 332), West Lane Works, Rotterhithe, S.E.16

ANOTHER USE FOR FLUXITE.
Hardening Tools & Case Hardening
ASK FOR LEAFLET on improved methods.

In writing to advertisers, please say you saw the advertisement in THE WIRELESS MAGAZINE.

For the
WIRELESS
BOOKSHELF

"The Wireless Annual for Amateurs and Experimenters."

CONTAINING information of use to the amateur, no matter how great or small may be his interest in the hobby, "The Wireless Annual for Amateurs and Experimenters" (published by Hiffe & Sons, Ltd., London, price 2s. 6d.), contains a list of the amateur transmitting stations in all parts of the world. The list is as complete and up to date as it is possible to make it, and will, without doubt, appeal to all amateurs to whom the reception of distant stations is of interest.

Included in the publication are special articles by writers well known in the world of wireless, whilst the informative matter covers such subjects as valve data, faults and their remedies, and the regulations covering both receiving and transmitting licences.

A feature of interest to home constructors is the inclusion of a classified list of manufacturers and the apparatus marketed by them.

BINDING CASES AND INDEX
 FOR
 "WIRELESS MAGAZINE"
 NOW READY

IN response to hundreds of requests we have prepared binding cases and indexes for Volumes 1 and 2 of THE WIRELESS MAGAZINE. Volume 1 includes issues 1 to 6 and Volume 2 issues 7 to 12.

The binding cases, in cloth and of an attractive colour and design, will be welcomed by all those readers who have kept their issues for binding.

The price for one binding case and index with title page is 2s. 6d. (post free, 2s. 9d.), and these can be obtained through your local newsagent, or direct from the office of THE WIRELESS MAGAZINE, La Belle Sauvage, Ludgate Hill, E.C.4.

DURABILITY



ON the Thames Embankment stand 186 tons of red syenite—a dual memorial to British seamanship and ancient Egypt's innate love of sculpture. The romantic story of Cleopatra's Needle is well-known. How it lay for centuries at Alexandria until shipped to England in 1878. Even then its adventures were not ended. A tempest sprang up and the little ship with its precious burden—but for the skill of the crew—would have foundered. For two thousand years this fine old monument has successfully braved the ravages of Time.

Durability, too, is a special feature of every Eureka Transformer. With its coppered steel case and its hermetically protected contents, a Eureka is fully equipped to resist the ravages of Time. Even moisture—the deadliest enemy that any Transformer has to face—is powerless against the Eureka. It is the last Transformer you ever need buy.

Eureka Concert Grand . . . 25/-	No. 2 . . . 21/-
Baby Grand, Nos. 1 and 2 . . . 15/-	Reflex . . . 15/-

EUREKA

Advertisement of Portable Utilities Co., Ltd., Fisher Street, W.C.1

G.A. 4363

Notings on the Month's Progress

IN an official statement of progress made during the past year the B.B.C. draw attention to the future possibilities of the high-power station at Daventry as a centre for international broadcasting.

At Keston

As part of the same general scheme the experimental and research station at Keston (in Kent) has been fitted with specially selective apparatus for receiving and relaying foreign programmes, together with up-to-date directional equipment for tracing the source of any outside interference with the transmissions from any of the British stations.

An agreement has already been entered into with the Radio Corporation of America for the interchange of programmes with the numerous stations controlled by that company.

This may be regarded as a preliminary step to similar agreements with other leading foreign organisa-

tions, which will, it is hoped, lead in the near future to a constant interchange of British, Continental and American programmes, with Keston and Daventry as the pivotal points for reception and transmission respectively.

* * * * *

By making use of a cathode-ray oscillograph, Professor Appleton and Messrs. Dye & Kipping have recently succeeded in reproducing visible indications of the wave-forms of electrical oscillations at frequencies ranging from twenty thousand to nearly two hundred thousand cycles per second.

These results are obtained by applying both the radio-frequency to be measured and a locally generated oscillation to two pairs of deflecting plates, arranged at right angles, so as to exercise a combined control over the ionic stream from a cathode-ray tube.

The local or "time base" fre-

quency is arranged so that it continually traces out a rapidly repeated path. The radio-frequency waves are therefore continually reimposed one on the other, and form a kind of stationary wave-system, which can be photographed or even observed directly on a suitable fluorescent screen.

Analysing Lightning

In addition to giving a visual indication of the actual wave-shape of the fundamental and harmonic frequencies generated by a valve oscillator, it is possible to use the same methods in analysing the wave-form of lightning and other similar atmospheric discharges.

Finally, by applying grid-filament input voltages across one pair of deflecting plates and plate-current variations across the second pair the oscillograph can be arranged to reproduce automatically the standard

(Continued on page 206)

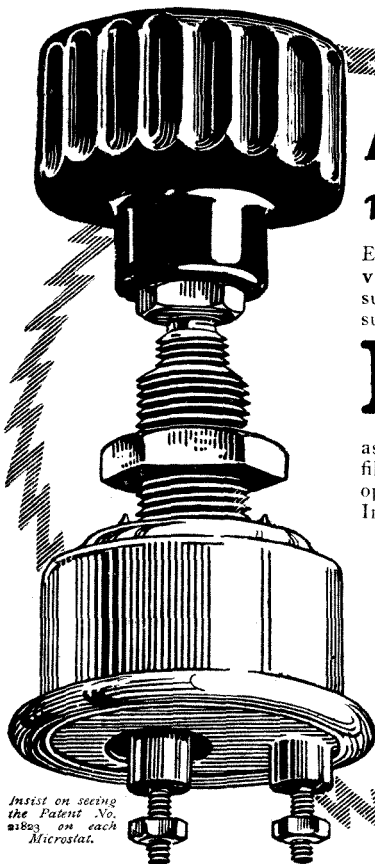

Insist on seeing the Patent No. 11823 on each Microstat.

How to reduce your valve costs by 25% to 50%

Every wireless expert admits that nothing shortens the life of your valves so quickly as switching on and off—the sudden heating and the sudden chilling playing havoc with the delicate filaments. If you substitute a

MICROSTAT

(FILAMENT RESISTANCE)

as a master switch instead of the ordinary snap or pull-push type, the filament is heated gradually and cooled gradually. Just as easy to operate, and costs no more.

Incidentally the master rheostat gives you even finer filament control.

Your dealer stocks Microstats. If any difficulty, write direct to:

WATES

BROS., LIMITED.

Head Office: 13-14, Great Queen St., Kingsway, W.C.2

'Phone: Gerrard 575-576.

'Grams: "Zywateseng, Westcent."

Works: LONDON & BIRMINGHAM.

Save these

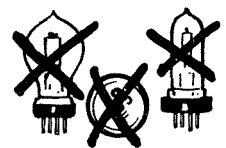

Price **2/9**

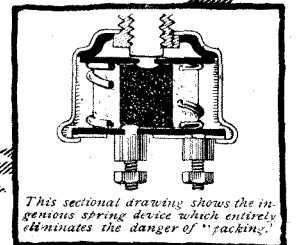

This sectional drawing shows the ingenious spring device which entirely eliminates the danger of "packing."

In writing to advertisers, please say you saw the advertisement in THE WIRELESS MAGAZINE.

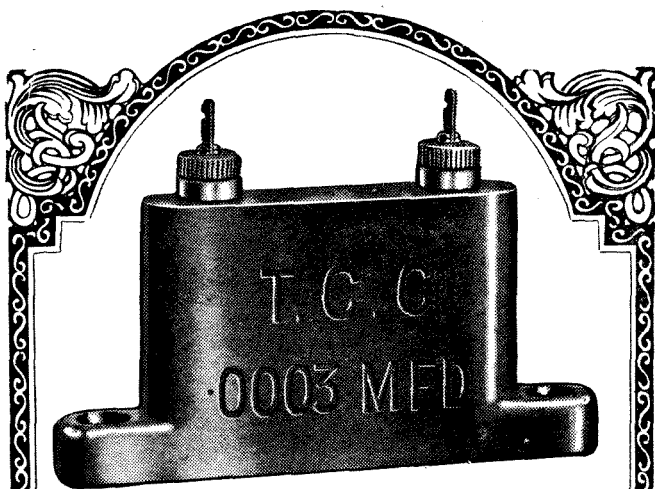

The new T.C.C. Mica Condenser

Here is the latest T.C.C. production—an accurate mica Condenser in a green moulded case with duplex terminals. Owing to its convenient shape it takes up very little room on the panel, and because it is sealed from below instead of from above it is proof against the heat of the soldering iron. For those who do not wish to solder their connections, a convenient milled head is provided to ensure a perfect electrical contact.

*No need to ask if it is accurate
—the name T.C.C. guarantees it.*

Every T.C.C. Condenser—whether Mica or Mansbridge—has to pass so many tests before it is released for issue that its accuracy within a very small percentage of error is a foregone conclusion.

Your fixed Condenser—on which so much depends—is one of the least expensive of all the components you buy. The difference in cost between one of doubtful reputation and a genuine T.C.C. may only be a copper or two yet the differ-

ence in results may be phenomenal. Experts say that the majority of faults in home-built receivers are traceable to the use of inferior and badly insulated condensers.

If your own Set is not giving the results you should expect, suspect the condensers—substitute T.C.C. Mica (for small values) and T.C.C. Mansbridge (for large values) and you obtain a permanent insurance against Condenser breakdown.

Prices:

No. 33, all capacities between '004 and '001 mfd. 2/4

No. 34, all capacities between '0009 and '0001 mfd. 2/4

From all Wireless Shops

T.C.C. Mica Condenser

Advertisement of Telegraph Condenser Co. Ltd., Kew, Surrey.

G.A. 4382

The Electron Co., Ltd., Triumph House, 189, Regent St., London W.1.

In writing to advertisers, please say you saw the advertisement in THE WIRELESS MAGAZINE.

Figures to Remember

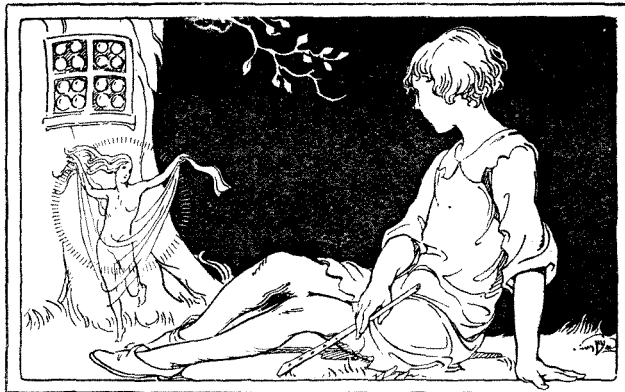

PETER PAN

... to be remembered

for the pleasure he gives, he has given, he will give. Besides, there is the charm of his eternal youth. You want your valves to give you pleasure, to satisfy you; you would like them never to grow old. None will give you longer life or better service than 660 Valves. You have a wide range to choose from, and each valve is specially designed to carry out its particular job.

There's the S.S.2 (Red Disc)—a 2-volt valve for H.F. Amplification, suitable as a detector when followed by resistance or choke. Or again, the S.S.2 (Green Disc)—for L.F. Amplification—just the valve you want for small and medium-sized loud-speakers.

Now let's consider the question of economy. These valves have a current consumption of only .3 amps, and further, work at such a low temperature that the life of the filament is immeasurably increased—surely economy in the true sense.

And this is only the beginning of our interesting story. The S.S.3 Valves have a current consumption of only .06 amps, while with the S.S.7—a wonderful Dull Emitter Power Valve, current consumption .1 amps—no glow from the filament is visible when operating at the correct voltage.

For long life, good service, perfect tone, insist on 660 Valves.



S.S.2 L.F.

(Green Disc)

Voltage: 2 Volts.

Consumption: 3

amps.

Price 14/-

Write for leaflet
S.S.1.7. for full
particulars.



BETTER BY SIX TIMES SIXTY

JOTTINGS ON THE MONTH'S PROGRESS (Continued from page 204)

valve characteristic curve under actual working or "dynamic" conditions as distinct from the somewhat unsatisfactory "static" method recommended in the textbooks.

* * * * *

Regulating Ether Traffic

In a recent lecture before the Institute of Electrical Engineers, Captain P. P. Eckersley, dealing with the growing problem of interference between existing broadcasting centres, stated that the only feasible remedy in his opinion was to cut down the present number of stations and to equip the survivors with higher power.

At the same time, considerable relief could be secured by setting apart a certain number of specific wavelengths on which any number of stations could work simultaneously.

Provided these stations were carefully calibrated so as to work on the exact wavelength allotted, no heterodyne note would be audible. More-

over, for ranges up to approximately one-tenth of the distance separating two such stations (presuming each to be working on the same power), the transmitted programmes would not interfere, particularly in the case of crystal reception.

As the crystal listener is still largely in the majority, stations working on the same wavelength could be used as sub-centres for radiating items of local interest, and this would provide further "elbow room" for the remaining super-power centres.

* * * * *

It is well known that certain rectifying valves, such as the Tungar, will continue to operate, once they have been "warmed up," even after the filament current has been cut off. The same principle underlies an ingenious form of valve oscillation-generator recently designed by the Western Electric Co., in which a cathode, or dummy filament, is located at each end of the glass bulb together with two intermediate grids.

One of the filaments is provided with a heating battery, which is, however, only utilised as a "starter" and is then cut off. The electron emission from the first or heated filament is rapidly built up by back-coupling with the adjacent grid, until the impact of the electron stream against the second or distant cathode causes the latter to heat up and become an electron-emitter.

Reversing Connections

If now the cathode or plate circuit connections are reversed, the secondary emission will be directed against the first filament, and will in turn raise its temperature to such an extent as to render the heating battery unnecessary.

In practice the two end-electrodes are connected across an alternating-current source, which automatically reverses the plate-cathode circuit, so that after the starting battery has been switched on for a few seconds the whole system becomes self-supporting.

B. A. R.

Another "LOTUS" Product

The LOTUS VALVE HOLDER

Anti-Microphonic

Patents Pending

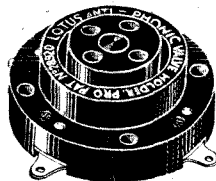

The delicacy of your Valve filaments are subject to microphonic elements from numerous sources. The LOTUS Buoyancy Valve Holder has been specially designed and constructed to counteract and dissipate these disturbances and will, by its original and unique spring construction, absorb any shock, protect your valves, and eliminate all microphonic noises.

PRICE **2/3**

The LOTUS VALVE HOLDER

is scientifically designed and made by the manufacturers of The LOTUS VERNIER COIL HOLDER

Obtainable from all reliable Radio Dealers.

Bakelite Mouldings,
Nickel Silver Springs and
Phosphor Bronze Valve
Sockets.
Nickel Plated.

Valve Sockets and Springs
are locked together by a
mechanical process, making
a definite and permanent
connection.

GARNETT, WHITELEY & CO., LTD.,
Lotus Works, Broadgreen Road, Liverpool.

"TRELLEBORG" GENUINE EBONITE

Used in the construction of the One-Valve KDKA Receiving Set, and also the Crystal Set, described in this issue.

"Trelleborg" Ebonite is genuine Ebonite. It is widely used in the execution of Post Office and Admiralty contracts, easily conforms to the specification of the British Engineering Standards Association, and has been successfully tested at the National Physical Laboratory.

Apart from standard Sheets, Rods, Tubes, etc., there are 32 stock size panels in $\frac{1}{4}$ " and $\frac{3}{16}$ " thicknesses with Polished, Matt or Red Mottled surfaces; each panel is enclosed in a carton of distinctive design, with price and size plainly marked.

Ask your dealer for the interesting literature about "Trelleborg" Genuine Ebonite and price folder, or write us direct.

TRELLEBORG EBONITE WORKS

London Office:

Audrey House, Ely Place, Holborn Circus, E.C.1.

Telephone: Holborn 1825-6.

Depôts throughout the United Kingdom and Ireland.

In writing to advertisers, please say you saw the advertisement in THE WIRELESS MAGAZINE.

GREAT SUCCESS OF THE LOWFORMA

This set, embodying a LOWFORMA erected by the Technical Staff of the "Wireless Magazine" and fully described in the February issue (1926), has received the K D K A (East Pittsburg) 62 metres transmission, at Loud Speaker strength on a 21 ft. indoor aerial in London.

THE LOWFORMA

is a valuable unit which can be utilized in the erection of numerous Crystal and Valve Sets, frequently securing 50% BETTER RESULTS

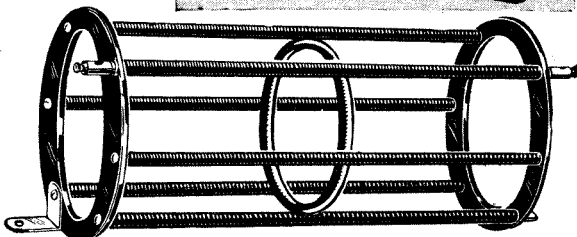
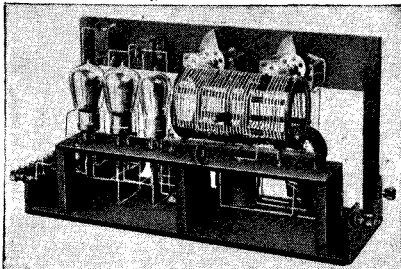

Prices, 3 1/2 in. diam. by 5 in. long, 4/9, 6 in. 5/-, 7 in. 5/6.
OF ALL DEALERS. In case of difficulty write the makers

A. H. CLACKSON, Ltd., Dept. H.,
Head Offices, 119, Fleet Street, London, E.C.4

WHY

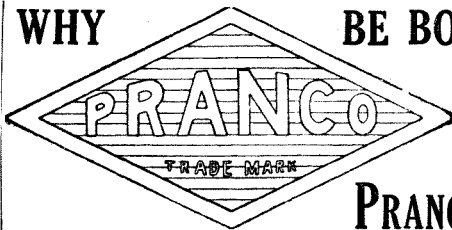

BE BOTHERED!

with
PLUG-IN COILS
when you can
get better results
for half the price
with

PRANCO TUNERS

as described in this issue in the

KDKA Ultra Short Wave One-Valve Receiver

Made in Four Types.

Metres.

BROADBAND - 200-1700

Price **19/6** each

BROAD-CASTING - 200-550

Metres.

SHORT WAVE - 50-200

ULTRA

SHORT WAVE - 15-80

Price **10/-** each

Postage and packing 9d. **ULTRA SHORT WAVE RECEIVER.**

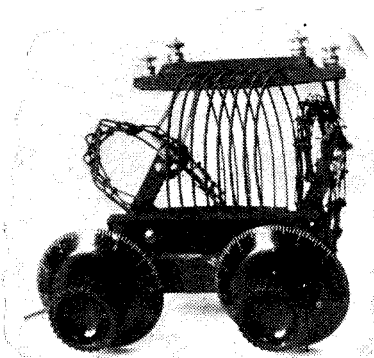

PERANNE & CO., LTD., Diamond Works,
Regent's Park Rd., Church End, Finchley, London, N.3
Phone: FINCHLEY 52. Sole Manufacturers and Patentees.

The Latest AMERICAN WONDER

A remarkable SHORT WAVE TUNER

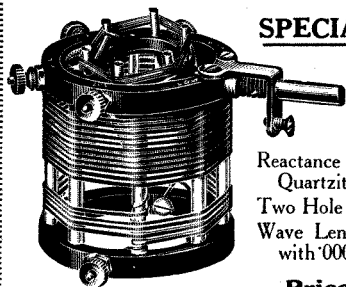

SPECIAL FEATURES:

- Wound on Quartzite Formers.
- Spaced Flat Copper Ribbon.
- Reactance wound on Low Loss Quartzite Rotor.
- Two Hole Fixing to Panel.
- Wave Length 25 to 100 Metres with 0005 Condenser in parallel.

Price **36/-** each.

Will suit Short Wave Receiver Circuit, as described in the last issue of THE WIRELESS MAGAZINE.

Send 6d., to cover cost of postage, for our Latest International Catalogue. (Mention this Magazine.)

WILL DAY Ltd. (Dept. A)

The Real Radio Supply House,
19 LISLE STREET, W.C.2.

Phone: 4577 Regent.

Telegrams: Titles, Westrand.

In writing to advertisers, please say you saw the advertisement in THE WIRELESS MAGAZINE.

BUILD YOUR SET INTO THIS CABINET

Every constructor would appreciate one of these Handsome Solid Oak Cabinets. Charming design, sound construction and utility all combined. Made on mass production lines, hence the low prices. Take panels up to 13 by 18. They enhance the appearance and treble the value of any set. Lists free. Write to-day.

Model			
A.	22 1/2"	inside, Plain panel.	Oak £4 15 0
C.	22 1/2"	.. Jacobean £5 10 0
A.	25"	.. Plain £5 5 0
C.	25"	.. Jacobean £5 15 0
C.	30" £6 15 0
A.	22 1/2"	.. Plain ..	Mahogany £7 5 0
A.	25" x 16"	Oak Table	... £1 7 6

Carriage paid and packed free. Money returned if not satisfied.

MAKERIMPORT CO. (Dept. 25),
Melville Chambers, 50a, Lord St.,
Liverpool



The Service Battery

GUARANTEED 12 MONTHS
REPUTATION 20 YEARS

SPECIAL.
2 v. 66 a. for D.E. Valves, fully charged, 12/6 p-st free.

	AMPERES			
2-volt	44	66	88	110
4-volt	8/-	10/-	12/-	15/-
6-volt	16/-	20/-	24/-	30/-
	24	30/-	36/-	45/-

Dispatched 1st charge. CARR. PAID within 24 hours to your door on no-objection terms. 8 1/2" Cells 2 Non-Corrosive Terminals per Cell, Ebonite Separators, Non-Frothing and Practically Unspillable.

60 volt. 1 v. v. Cell separately sealed and removable. Tapped every 6 vol s
H.I. with Wander Plus. P-st free

Adjustable carrier, takes all size, 2.6 each.
SERVICE BATTERY CO., 8, Service House,
44, Upper Marylebone Street, LONDON W.1.

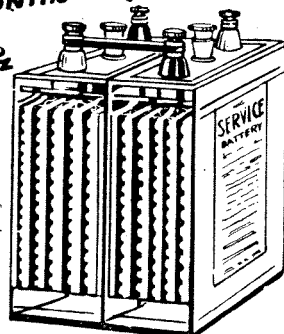

British
Made.

BETTER THAN THREE

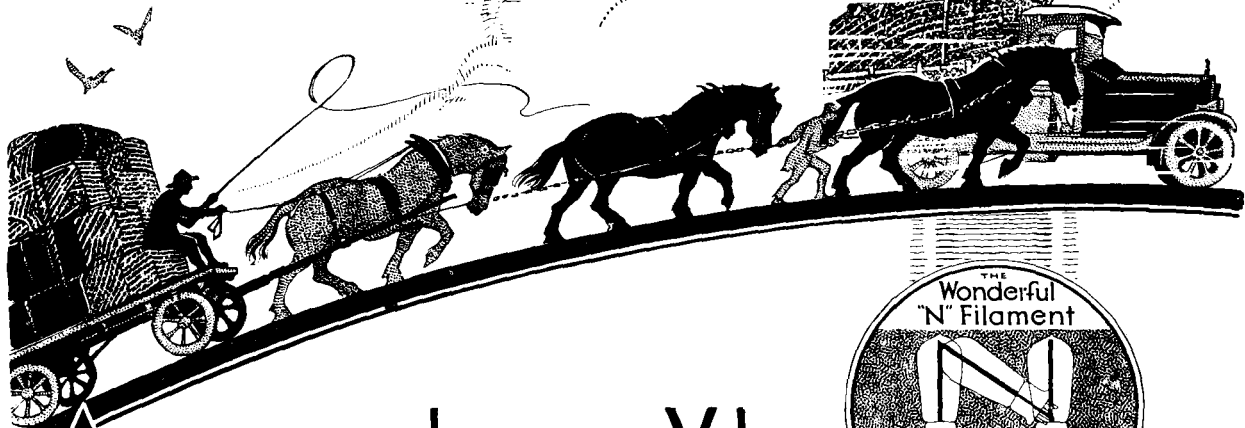

A new general purpose Valve with the wonderful "N" filament

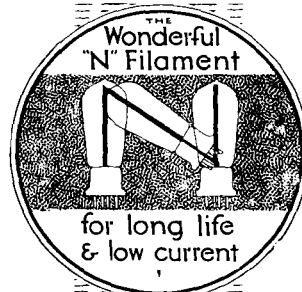

YOU can now have the advantages of the unique "N" filament for every valve in your receiver!

The New P.M.3

1. Better than three "R" type valves because the ample proportions of the "N" filament are equivalent to three ordinary filaments.
2. Requires ONLY ONE-TENTH AMPERE filament current. A saving of over 85% of your accumulator energy giving each charge SEVEN TIMES THE LIFE.
3. Is so economical of heating power that no sign of glow can be discerned.
4. Will operate from either dry cells or accumulator. From 3 to 4 Volts may be used with perfect safety.
5. Free from all microphonic disturbances.

The P.M.3 16/6

Suitable for all stages of amplification in any circuit.

THE IDEAL COMBINATION for any receiver — P.M.3. valves followed by a P.M.4. for POWER AMPLIFICATION with loud speakers.

The Finest Loud Speaker Valve the P.M.4. 22/6

GET ONE FROM YOUR RADIO DEALER.



Mullard

THE MASTER VALVE

ADVT.—THE MULLARD WIRELESS SERVICE CO. LTD., BALHAM, LONDON, S.W.12.

In writing to advertisers, please say you saw the advertisement in THE WIRELESS MAGAZINE.



Always sure of a good "Reception"

FOR over 40 years PLAYERS have been producing Tobacco and Cigarettes in ever-increasing quantities to meet a popular demand. Their resources are such that at all times the choicest and finest growths of matured Virginia leaf are at their command.

The pipe Tobacco is 100% Virginia made by hand into plugs—Navy plugs—properly and carefully cut into convenient slices, and is delightfully cool and easy smoking.

The Cigarettes are full size, Old Virginia Tobacco, and the Medium Navy Cut may be had with or without Cork Tips.

The manner of their packing, the outcome of long experience, ensures their reaching the smoker with all their freshness and purity unchanged.

PLAYER'S NAVY CUT Tobacco and Cigarettes

P 1258 A



Reg. No. 154,011.

