

All England on One Valve!

1/-
net

The Wireless Magazine

Edited by
Bernard E. Jones

VOL. 1, NO. 4.

May, 1925



With Free Blueprint and Free Wiring
Diagrams in Colours

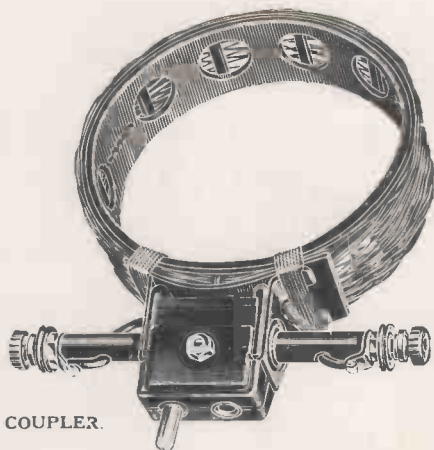

IGRANIC UNITUNE
APERIODIC FIXED COUPLER.

For Transatlantic and other short wave reception —this is the ideal Coupler

The Unitune Aperiodic Fixed Coupler has been specially introduced to provide an efficient means of receiving very short wavelengths, and has successfully overcome most of the difficulties usually encountered. It combines many of the advantages of both direct and loosely coupled methods of tuning without their attendant disadvantages.

The aerial coil is aperiodic and is responsive to all wavelengths within certain limits. The secondary winding should be shunted by a variable condenser of .0005 microfarads, and is calibrated for various wavelengths with given values of capacities in parallel. These wavelengths remain constant no matter what the dimensions of the aerial may be. Both windings are of the Honeycomb Duolateral formation, thus reducing the self-capacity of the coupler to a minimum.

Under these conditions, the maximum available potential is impressed on the grid of the first valve, resulting in a high efficiency.

Another difficulty met with in short wave reception is in obtaining reaction effects or a state of oscillation of the receiver, and this is entirely overcome by using the Unitune Aperiodic Fixed Coupler.

It may be used in any ordinary receiver employing standard coil holders.

Unitune Minor for 80—180 metres, price 7/6. Unitune Major for 300—600 metres, price 9/—.

Write for List Z461.

IGRANIC RADIO DEVICES

include :

Honeycomb Duolateral Coils, Fixed Condensers, Filament Rheostats, Intervalve Transformers, Variometers, Vario-couplers, Bi-plug Coil Holders, Tri-plug Coil Holders, Battery Potentiometers, Vernier Friction Pencils, etc., etc.

All carry the IGRANIC guarantee, and are stocked by all reputable dealers.



149, Queen Victoria Street, London.
Works : BEDFORD.

Branches:

BIRMINGHAM : 73-74, Exchange Buildings. CARDIFF : Western Mail Chambers. GLASGOW : 50, Wellington Street. LEEDS : Standard Buildings, City Square. MANCHESTER : 30, Cross Street. NEWCASTLE : 90, Pilgrim Street.

These are the foundations of a BETTER set



IGRANIC
"E" Type Transformer.

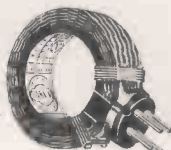

IGRANIC
High Frequency Transformer.



IGRANIC-FRESHMAN
Fixed Condenser.



IGRANIC
Honeycomb Duolateral Coil.

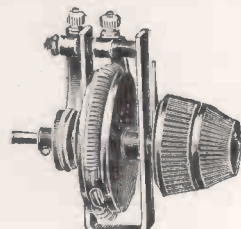

IGRANIC
Rheostat (Vernier type).

In writing to advertisers, please say you saw the advertisement in THE WIRELESS MAGAZINE.

The AMPLION RANGE

NO Loud Speaker manufacturers in the world can offer a range comparable with the series of AMPLION models marketed by the House of Graham.

There is an AMPLION for every purpose, and to suit every purse, from the Dragonfly—a real "Baby" Loud Speaker—to the big concert and demonstration models.

Made by the originators and principal manufacturers of loud speaking telephones, the AMPLION has not been hastily devised to meet a sudden demand, but represents the highest development in Loud Speaker construction.

Backed additionally by the famous Service of the House of Graham which guarantees unconditionally every instrument sold, the AMPLION is everywhere and for every purpose the BEST as well as the CHEAPEST.

Obtainable from AMPLION STOCKISTS and Wireless Dealers everywhere.

The World's Standard **AMPLION** Wireless Loud Speaker

For Better Radio
Reproduction

"Dragonfly"
Baby Amplion
A.R. 102
25/-



"New" Junior
De Luxe A.R. 114
£3 5 0



"Concert" Dragon
Model A.R. 23
£8 10 0

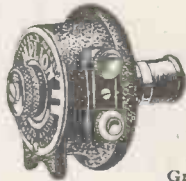

Gramophone
Adaptor
"Standard"
Model A.R. 67
£2 2 0

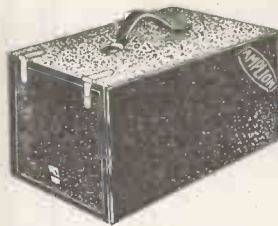

Portable complete with
Collapsible Stand for use
both in and out of doors
A.R. 61 £6 6 0



"New"
Junior
A.R. 111
£2 10 0



"Swan-Neck"
Table Model
A.R. 15
£6 0 0



Standard
"Dragon"
Model A.R. 19
£5 5 0



Gramophone
Adaptor "Con-
cert" Model
A.R. 35 £3 0 0

ALFRED GRAHAM & CO. (E. A. GRAHAM),
St. Andrew's Works, Crofton Park, London, S.E.4.
Demonstrations gladly given during broadcasting hours at—
West End Showrooms: 25-26, Savile Row, W.1. Suburban Showrooms: 79-82, High Street Clapham, S.W.4.

In writing to advertisers, please say you saw the advertisement in THE WIRELESS MAGAZINE.

**It makes a
wonderful
difference**

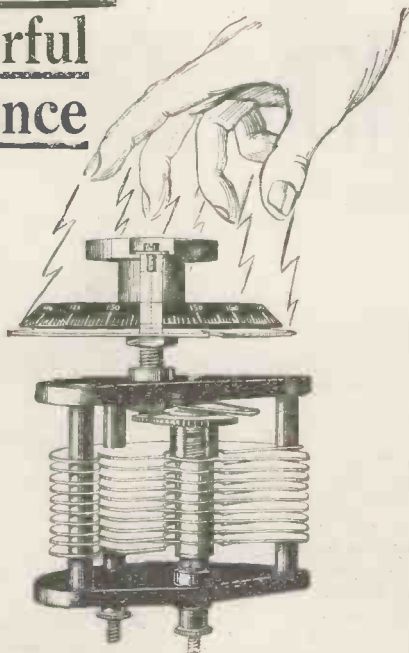

Congratulations continue to pour in from users of the "Fulstop" Variable Condenser.

FROM SOUTH CROYDON.

"We had a long experiment last night with your Fulstop Condenser and brought in 12 distant stations that other condensers would not look at."

ORMSKIRK.

"I tried one of your .0005 Condensers a few weeks ago and it has proved so satisfactory that I am discarding a more expensive .0003 condenser for yours."

LIVERPOOL.

"I replaced the 'Fulstop' in my set and in half an hour had tuned in thirteen stations. I also find it easy to get London and Bournemouth, quite separate from Manchester, which I have never managed before. This speaks volumes for the condenser."

"May I therefore once again express my satisfaction and appreciation for your condenser and method of business, which compare so favourably with other firms. A satisfied customer is the best advertisement possible, and I shall always be pleased to recommend you to others."

.001 . . . 13/6 | .0003 . . . 10/3
.0005 . . . 11/3 | .0002 . . . 9/6

PROTECTED THROUGHOUT THE WORLD.

Stocked by most Wireless Dealers, but if you have any difficulty in obtaining, write to

J. H. NAYLOR, LTD., WIGAN



VARIABLE CONDENSER.

Guaranteed to Abolish Hand Capacity

In writing to advertisers, please say you saw the advertisement in THE WIRELESS MAGAZINE.



THE WORLD'S GREATEST TRANSFORMER

Over 500,000 in use.

9/6
Ratio 5 to 1
for first stage
Amplification.

9/6
Ratio 3 to 1 for
second stage
Amplification.

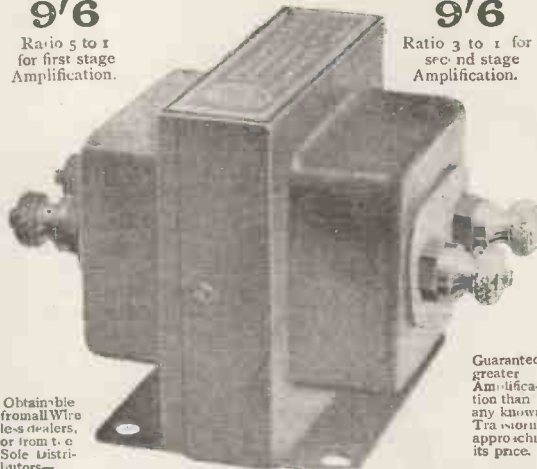

Obtainable from all Wireless Dealers, or from the Sole Distributors—

Guaranteed greater Amplification than any known Transformer approaching its price.

THE WHOLESALE WIRELESS CO.,
103 FARRINGDON ROAD, LONDON, E.C.1

Mr. A. Vandam, Caxton House, Westminster, S.W.
Representative for Export.

Telephone: Clerkenwell 5317.



Two Useful "Amateur Wireless" Handbooks

Simple Crystal Receiving Sets and How to Make Them

Compiled from the pages of "Amateur Wireless," this handbook deals in a simple, straightforward manner with the making of a number of crystal sets. With 114 illustrations.

Simple Valve Receiving Sets and How to Make Them

This handbook, which is compiled from the writings of many contributors to "Amateur Wireless," seeks to show in close detail, and with the aid of 112 illustrations, how to make and operate about ten different types of valve sets.

each **1/6** net

or 1/9 post free from the Editor "Amateur Wireless,"
La Belle Sauvage, - - - London, E.C.4.



CRYSTAL

Extraordinary Results. Most sensitive for Crystal Circuits and most stable for Valve-Crystal Circuits.

Obtainable from Wireless Dealers at 1s. per tube, or direct from VALVE RENEWAL Co., 4/5, Mason's Avenue, Coleman Street, E.C.2.

Outdoor Joys are nearly here

Bright days ahead! Tennis, the river, garden parties, flannel dances — radio plays its part in all of them with broadcast music, song and interest. *Get ready now!*

If you have radio equipment already, see that it embraces all that is necessary for your particular outdoor needs in pavilion, veranda or garden.

There are good reasons for choosing Sterling apparatus. First because no exaggerated claims are made for it, and secondly because of its world-known reputation for efficiency and convenience.

Your radio dealer is ready with advice and demonstration if required.

Particulars of the instruments illustrated

I. STERLING "BABY" LOUD SPEAKER. Gives ample volume with a three or four-valve set for all usual requirements and a reproduction that is consistently faithful and pleasing in tone. **PRICE 55/-**

II. STERLING "DINKIE" LOUD SPEAKER. The little fellow with the loud voice. Can be conveniently taken anywhere. With a three-valve set "Dinkie" will reproduce broadcasting clearly, loudly and in perfect tone. **PRICE 30/-**

III. STERLING "ANODION-ONE." A highly efficient one-valve receiver giving splendid results on head phones often at considerable distances under favourable conditions. Complete with B.B.C. coil, but without accessories. **PRICE £7:7:0**

At your radio dealer



Ask your dealer for a copy of Sterling publication No. 364c.

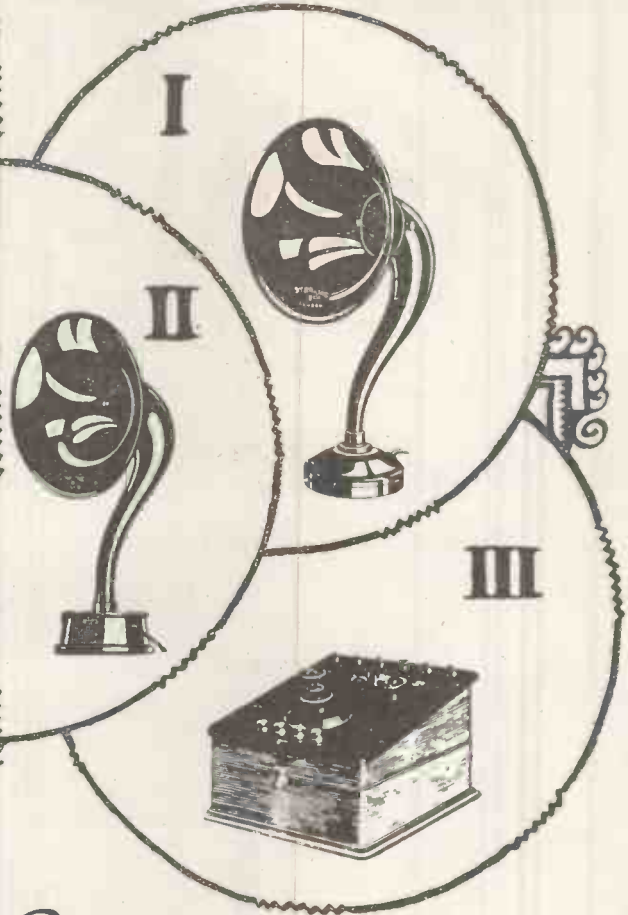

Get
**STERLING
RADIO**
for the outdoor days



Advt of **STERLING TELEPHONE & ELECTRIC CO. LTD.**
210-212, TOTTENHAM COURT ROAD, LONDON, W.1
Works: DAGENHAM, ESSEX.

The only synthetic **CRYSTAL**

TUNGSTALITE

BRITISH MADE

*guaranteed -
for perfect reception*



BLUE LABEL
1/6

From the Wireless Press, the Daily Press, & from every class of Wireless Enthusiast, all over the World, there continues to flow an uninterrupted stream of Tribute - in recognition of the boon conferred by "Tungstalite" on the whole of the Radio Public -

GOLD LABEL
2/-

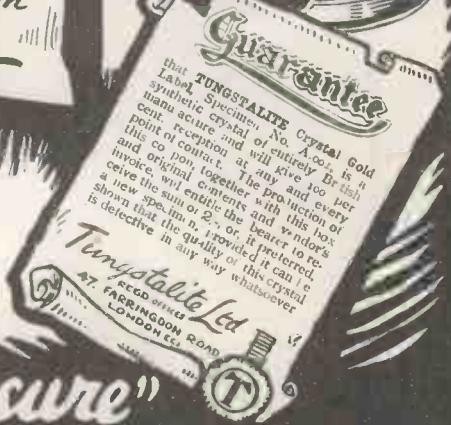

Secure your specimen to-day—
from any Radio Dealer or from
TUNGSTALITE LTD.,
London: 47, Farringdon Rd., E.C.1 Leeds: 41, Call Lane,
Phone: Holborn 2551. Phone: Leeds 21375.

*"The
Pleasure of a Treasure"*

In writing to advertisers, please say you saw the advertisement in THE WIRELESS MAGAZINE.

May, 1925

Dave Burnaby, Co-optimist ;
his set and control fork



Announcements.—THE WIRELESS MAGAZINE, edited by Bernard E. Jones, is published about the 25th day of the month and bears the date of the month following. Price One Shilling Net.

Contributions are invited ; if accompanied by stamped addressed envelopes they will be promptly considered. All editorial communications should be addressed to The Editor, THE WIRELESS MAGAZINE, La Belle Sauvage, London, E.C.4.

CHIEF CONTENTS

	PAGE		PAGE		PAGE	
"I Want to Broadcast" . . .	370	Stories of Early Broadcasts By WILLIAM LE QUEUX	415	Can We Learn from the American Amateur? . . .	420	
Under My Aerial. The Chat of the Month	373	Summer-time Aerials . . .	417	Practical Coil Winding . . .	422	
The New Stations. By CAPT. P. P. ECKERSLEY.	379	Choosing the Loud-speaker .	418	Re-radiation	423	
Wavelets	383	The Reservoir Condenser .	419	Broadcast Music of the Month. With 23 Photo- graphs	424	
At 2 Savoy Hill, W.C.2 Contributed by the B.B.C.	384	SPECIAL HOME- CONSTRUCTOR SETS In This Issue			Above and Below Stairs. A Page Drawing by RENÉ BULL	427
Wireless Femininities . . .	385	PAGE			Neutrodyne Points	431
Radio and the Rustic. By F. W. THOMAS	388	An Armstrong Super- regenerative One- valve Set. ("All England on a Frame Aerial with One Valve!"). A Blue print Panel-drilling Template and a Coloured Wiring Diagram Given Free	366	Absolutely for the Novice!	432	
Novelties and New Appara- tus of the Month	391	Crystal Set Construc- tion in Successive Pictures	386	Wireless Woodwork . With 17 Illustrations	436	
Economy in High-tension Batteries	395	Building a Power Amplifier	392	How to Receive America. By F. L. HOGG	442	
The Wonders of the Electric Current	396	A Loud-speaker Three-valver for the Family. A Coloured Wiring Diagram Given Free	428	Modulation	448	
Proof Conclusive! A Story by CAPT. FRANK H. SHAW	398	The Long-distance Experimenter's Crystal Set	446	Cousin Crysta's Corner. A Page for the Boys and Girls	450	
More Power to Your Crystal	402			For the Wireless Bookshelf	452	
Wireless Term - inological Inexactitudes	403			Abolishing the Filament Battery	452	
Youth Will Be Served! . . .	404			Below the Broadcasting Belt	454	
Long-distance Aerials	405			Novelties and New Appara- tus Described	456	
Valve Circuits You Can Try	407			Our Cross-word Puzzles . . .	458	
Tenpence a Week!	408			Continental Notes	460	
Crystal Considerations	409			What the Reader Thinks . . .	462	
Gadgets, Hints and Tips . . .	410			The World's Broadcasting . . .	464	
Why Some Transformers are Inefficient	412			Questions Simply Answered . .	466	
Those Accumulators	413			Why I Prefer the Gramo- phone	468	
Wiring the House for Phones	414			Jottings on the Month's Progress	470	

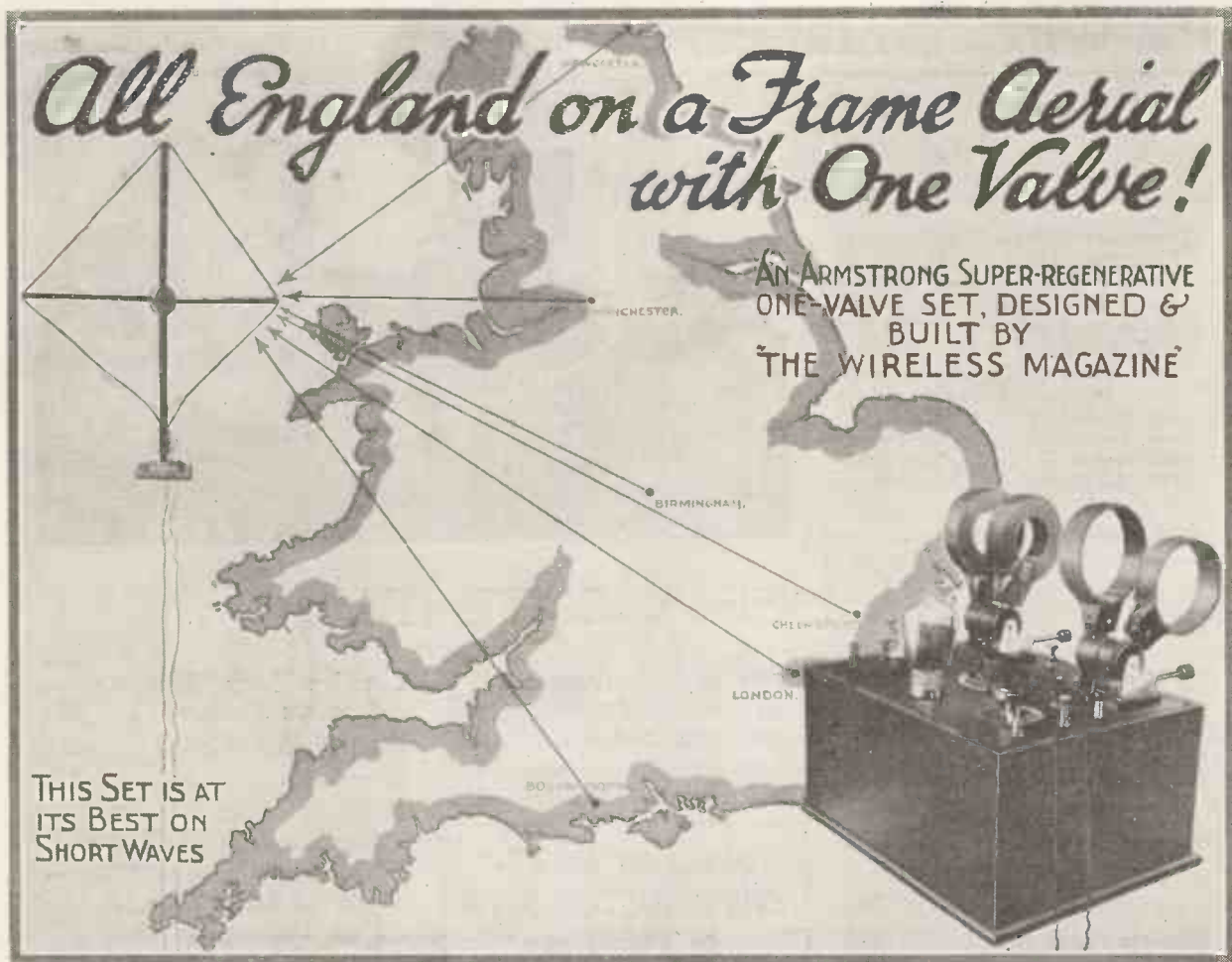

TO get all the English broadcasting stations on a one-valve receiver used with a frame aerial may seem rather a bold claim, but this can be done with the set here described.

The first circuits tried were of the simple reaction type. They worked fairly well, but with these there was insufficient volume for comfortable headphone reception. Moreover, the circuits were unstable and difficult to tune accurately.

Stable and Easily Tuned

We therefore turned our attention to super-regenerative circuits and found one that was at once stable and easily tuned. The circuit finally adopted was of the Armstrong super-regenerative type.

This circuit, especially as a one-valver, has not had much support in this country, as it is often associated with a high-pitched squeal, difficult to eliminate.

The set we built is quite silent in working, thus greatly facilitating the picking-up of distant stations. A

feature of the set is its sensitivity on the short waves, an excellent point when the large number of foreign broadcasting stations working on wavelengths from 200 to 300 metres is taken into consideration.

An examination of the photographs will show that this set is no more difficult to build than an ordinary straight-circuit one-valver. A list of the necessary components follows:

- One ebonite panel, 12 in. by 9 in. by $\frac{1}{4}$ in. (St. Helen's Cable Co.).
- Two two-way coil holders (Lissen).
- One .001-microfarad (variable) condenser (Lissen).
- Two .002-microfarad condensers (Lissen).
- One .0003-microfarad condenser (Lissen).

Given Free in this issue are a Coloured Wiring Diagram and a full-size Blueprint Panel-drilling Template of this set.

- One .0003-microfarad condenser (variable).
- Eight terminals.
- One valve holder (Athol).
- One variable grid leak (Lissen).
- One filament resistance (Igranic).
- Tinned-copper connecting wire.
- Four concert coils (Igranic).
- One 1,250 and one 1,500 Igranic.

Wiring and Mounting

The wiring should be carried out to conform as closely as possible to that shown by the diagram, owing to the extreme trickiness of the circuit.

No difficulty should be found in mounting the components if they are similar to those shown in the photographs. Holes will have to be drilled in the panel near the coil holders to allow the connections to be made to them.

The operation of the receiver depends on the long-wave circuits. If these are not working properly the set will be useless, and operation will be accompanied by the same

(Continued on page 368)

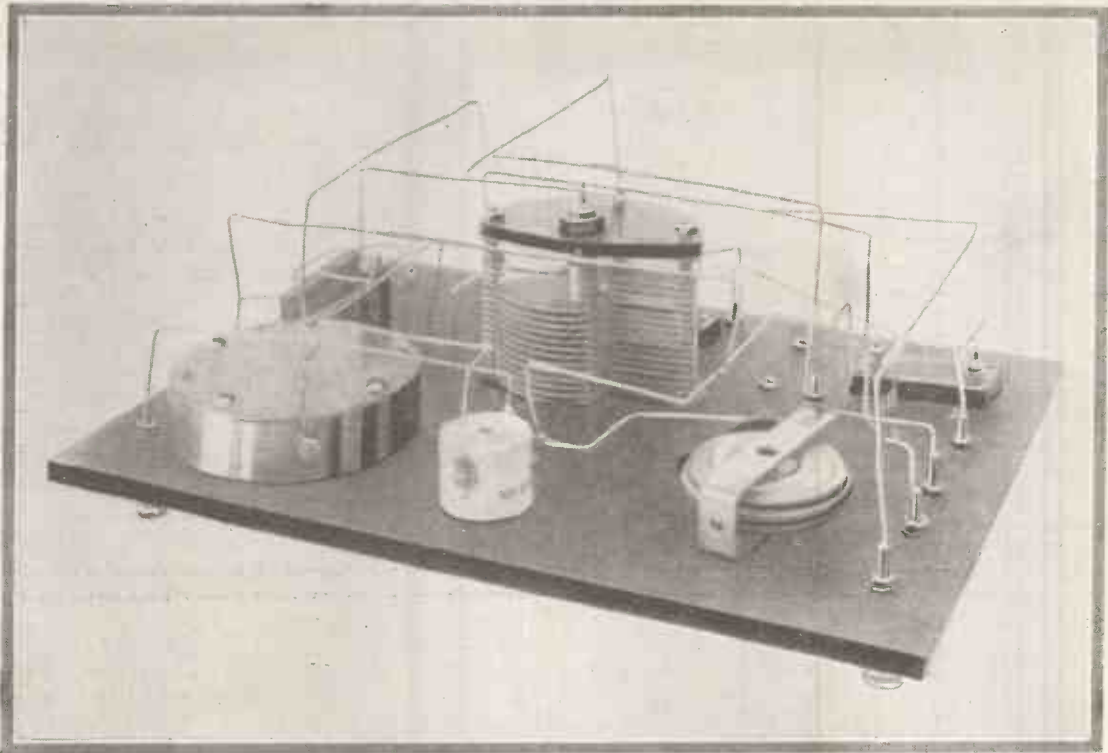

Few Components are needed to Construct **this Armstrong One-valve Super-regenerative Set**, but what there are should be of good quality.

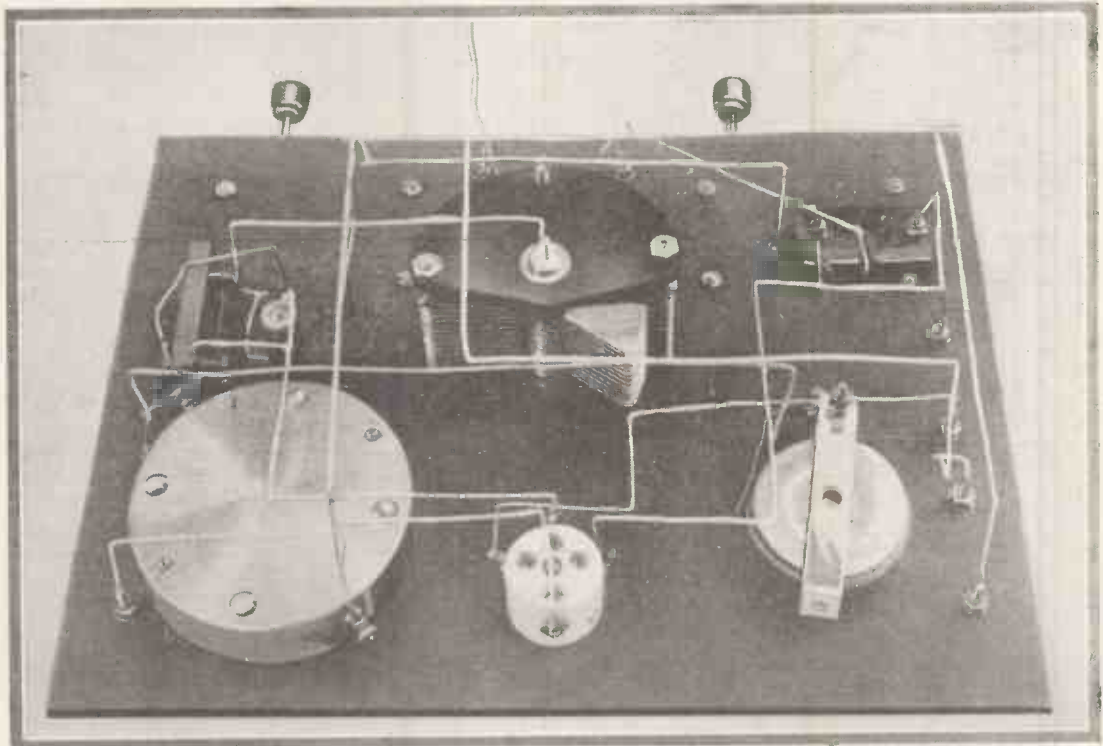

This Photograph, and the one above, shows in detail the Wiring of the Single-valve Set that will receive All England!

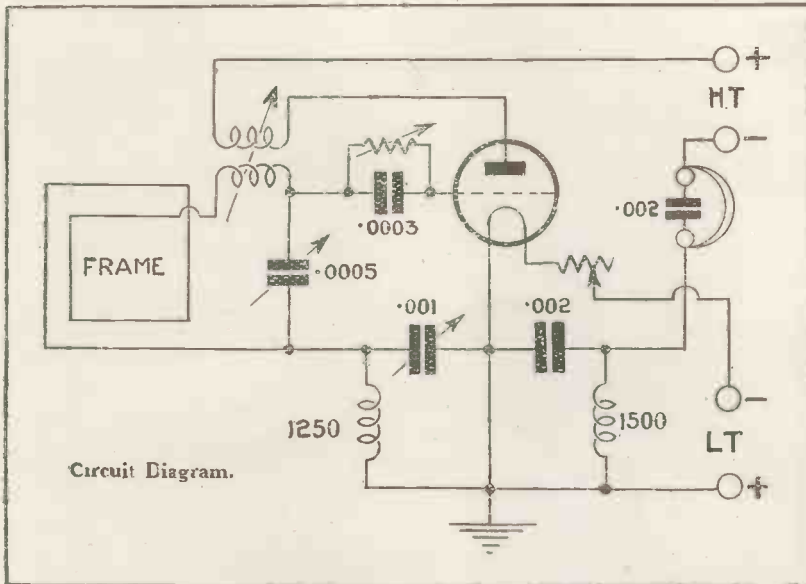

(Continued from page 366)

disturbing noises that have always been associated with a super-regenerative circuit.

The grid coil is a duolateral of 1,250 turns, and is shunted by a .001-microfarad variable condenser. Once this condenser is adjusted it need not be again touched.

The plate coil consists of 1,500 turns, and is shunted by a fixed condenser of .002 microfarad capacity. This coil is so placed that the coupling between it and the grid coil can be easily varied.

The phone condenser should have a capacity of .002 microfarad, whilst the high-tension voltage may be

anything between 30-60 volts, depending on the type of valve used.

Operation

The operation of the set is very simple. The reaction should be loosely coupled, and the "super" coils gradually coupled, when the set will immediately oscillate. Continue tightening the coupling until the coils are as close as possible, when it will be noticed that the circuit has ceased to oscillate.

Tuning may now be carried out as if the set were an ordinary reaction receiver.

When a signal has been tuned-in, varying the .001-microfarad condenser will produce an increase or decrease in volume and cause the set to oscillate. As a rule one position will give the best results and it can be left at that.

If a power valve is used, the H.T. voltage may be anything up to 150 volts.

Results

At one mile from London the set picked up 2LO at strong loud-speaker strength on a 4-ft. frame aerial. On an indoor aerial signals were

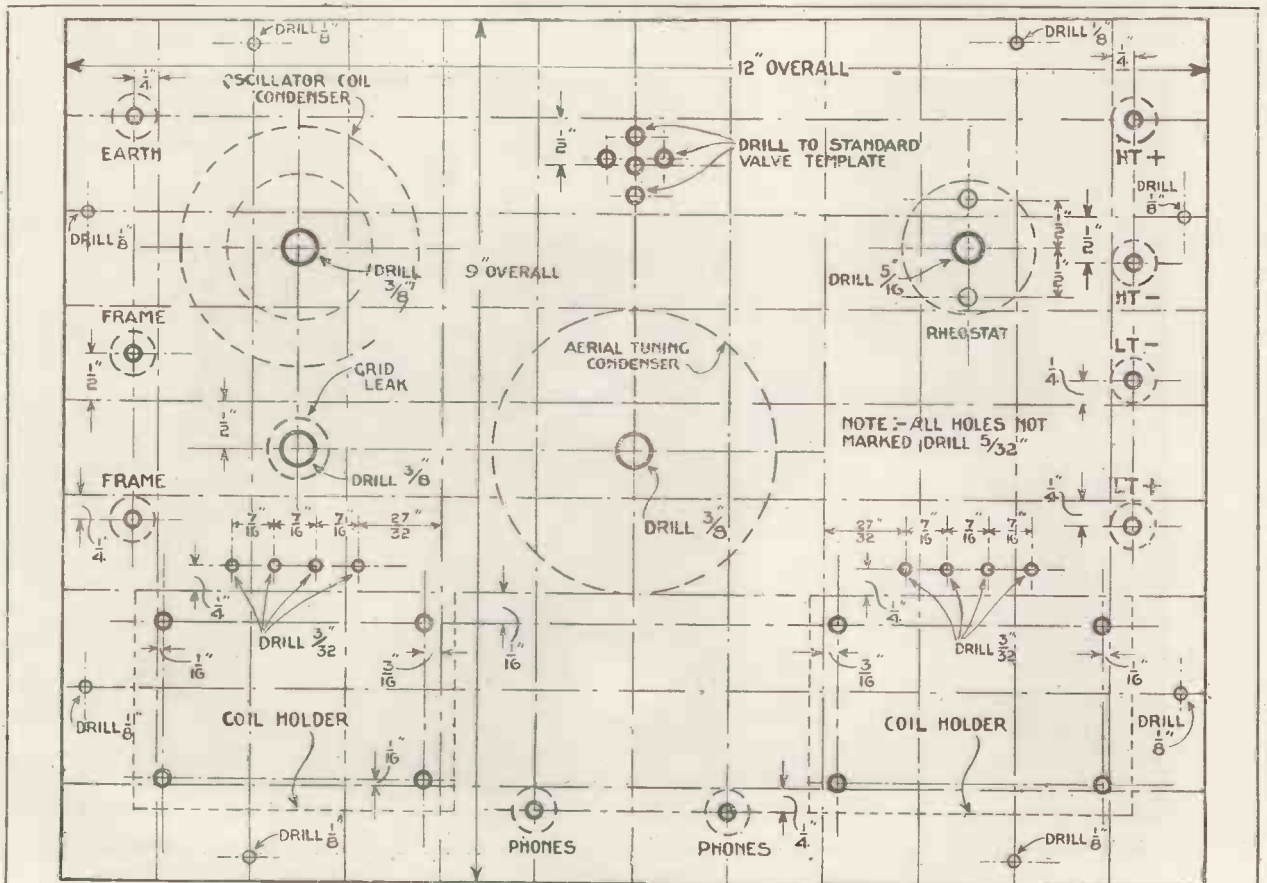

This is a reproduction of the Blueprint Panel-drilling Template Given Free with this issue.

All England on a Frame Aerial with One Valve !

deafening. Croydon's harmonic on 450 metres came in at good phone strength.

A word about the conditions under which the set was tested will not be out of place.

Interference

The tests were carried out in a room in close proximity to all kinds of interference. Despite these adverse conditions the set showed quietness of working, extreme sensitivity, selectivity, and ease of control.

The shorter the wavelength used the more efficient this super receiver will function.

An outside aerial should not be used with the receiver, as such an aerial causes a considerable amount of interference through oscillation.

During the tests best reception was obtained when using a C4 for reaction and a C3 in series with ordinary broadcast-wavelength frame.

The set has a normal range of about 50 to 100 miles, depending on numerous conditions.

Results

The receiver was next tested at a place five miles from London and used in conjunction with a frame aerial wound with No. 16 gauge enamelled copper wire on a framework 4 ft. across and a D.E 5 power valve with 150 volts on the anode. This necessitated only slightly coupling the super coils (as shown in photograph).

The first station to be brought in was, of course, 2 L.O. He was easily audible 20 ft. from the loud-speaker. Swinging the frame in a south-west direction, Bournemouth was just comfortable on phones. By turning the frame aerial in a northerly direction, Manchester was faintly audible (2 Z Y is very difficult to hear in the London district).

Newcastle was next heard, but this station seemed to fade, though at times he was very strong.

Numerous "carrier waves" were picked up on this waveband, but signals could not be tuned in. A particularly loud carrier wave proved to be the Glasgow station, which was successfully tuned in without much

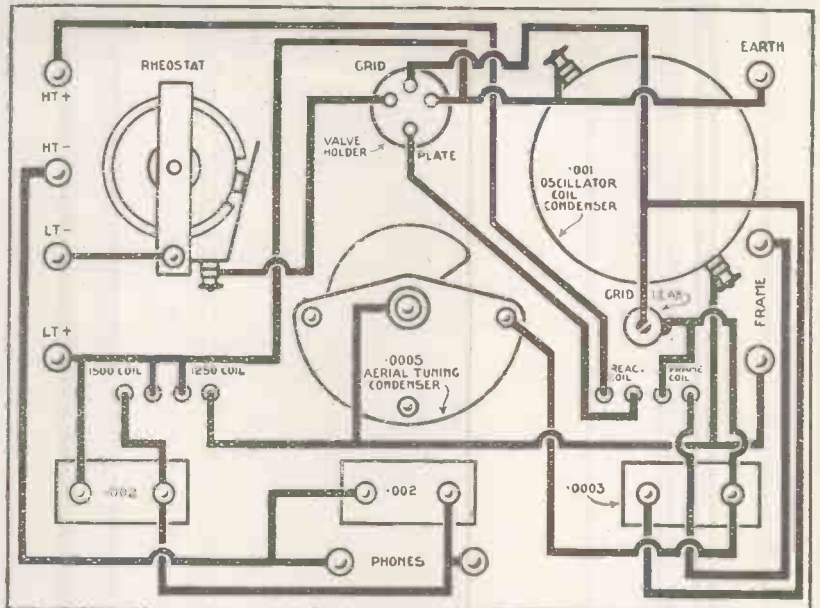

A reproduction of the Free Coloured Wiring Diagram presented with this issue.

difficulty, spoken items being clearly understood.

A 150 coil was afterwards plugged in the aerial circuit, and with a 75 coil for reaction Chelmsford was heard. Tuning on this wave was very flat and not at all satisfactory.

The receiver was next tried with a smaller frame-aerial, and amateurs on 200 metres were received at remarkable strength.

These results were enough to prove that the set is super efficient on the short waves.

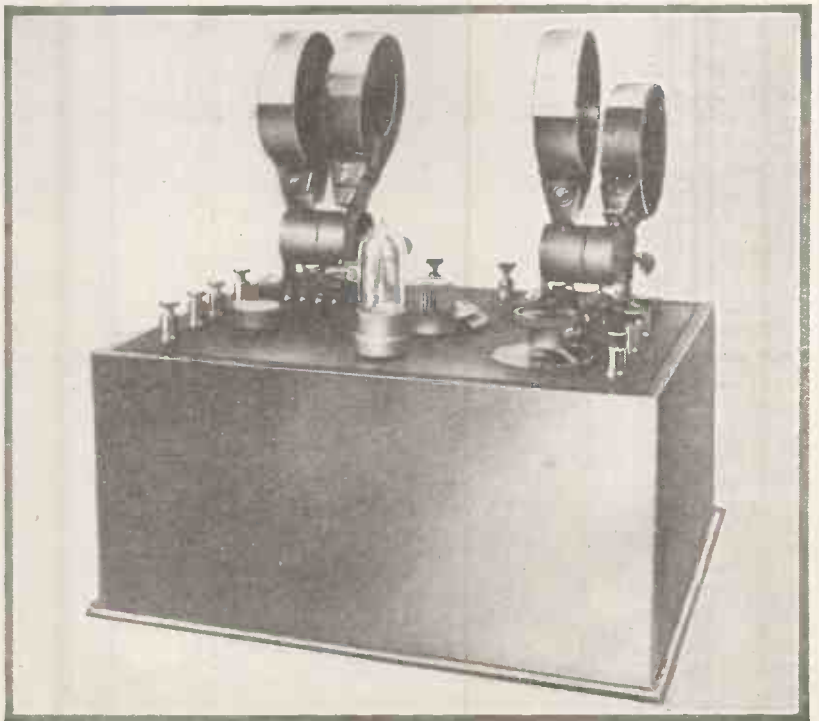

The neat appearance of the completed Receiver can be judged from this photograph.

I want to Broadcast

BBROADCASTING is going through a phase which resembles in many respects what has already occurred in the film industry. Just as the development of the cinema has led to the employment of thousands of people whose special talents were suited to that class of work and no other, so the popularity of listening-in has provided work in large quantities for entertainers who might have found it difficult to make headway in other directions.

One does not forget, of course, that many of the artistes associated with both broadcasting and the screen had previously attained fame on the concert platform and stage. But I am dealing at the moment with what may be called the unknown element—the

vast army of men and women who have certain talents—or imagine they have—and are struggling to make them known to the public. In the case of entertainers, it is to the possibilities of broadcasting that increasing attention is being turned.

The "Broadcasting Voice"

To achieve success, a singer must possess a "broadcasting voice,"—a voice of that peculiar timbre that tunes in well with the microphone,—and it may have that quality without necessarily being one that would bring its owner fame on the platform.

That is an important consideration to a vocalist, and it partly accounts for the rush to broadcast that has been made.



Drawing by A. M. Robbie.

The second reason is not without its pathetic side. The microphone may not inaptly be described as a thing of many ears but no eyes. It is a ruthless instrument, recording the faintest sounds, and refusing to do the barest justice to those it does not like.

But, whatever it may do in the future, at present it sees nothing, and many an artiste pouring his or her sweet tones into it has had reason to be grateful for that fact.

It is, unfortunately, only too true that there are thousands of gifted entertainers who can never hope to reap their reward in public because of deficiencies of personal appearance. Once in the British Broadcasting Company's studio, that drawback is completely wiped out.

Solid merit—that is the sole essential. It is probably no exaggeration to say that hundreds of artistes—both singers and instrumentalists—have found wireless telephony something of a godsend.

Broadcasting, in a word, has opened up possibilities that never existed before, and I was not surprised when told by an official of the company that a considerable number of artistes each week ask to be tested.

It is a rule that no one applies in vain, and at the London station alone there are a hundred auditions every week. Similar tests are always going on at other stations all over the country.

Talent Wanted

"We want talent," I was informed. "When we find a new singer or player

we are as pleased as an astronomer who discovers a new planet. But how scarce they are!

"Our percentage of successes is only about two: out of every hundred applicants we find two artistes whom we can employ. Once on our books, there is, of course, plenty of work for them. This, in fact, is really the largest concert agency in the world."

When an artiste in the London area applies for an engagement, he (or she) is asked to attend at a fixed time at the Savoy Hill studio, and there he finds himself in the company of scores of others on a similar errand.

There are all sorts and conditions of men and women, from the demure young lady, full of nervousness in view of the coming ordeal, to the

"old hand," who is all bounce and bustle, and apparently anxious to give the impression that he has only to be heard to secure an engagement for life.

Curiosity

It is quickly evident to the trained eyes of the officials that some are there merely from motives of curiosity. Their real object is to see the studio, which they have tried so much to visualise as they have listened-in.

Permission to see the studio being very rarely given to the public, this is one method of defeating the regulations—at least up to a point, for, of course, there is no broadcasting going on.

"Well, I've seen it," said one young woman on emerging from the room, with its heavily draped walls and padded floor, "and it's the nearest approach to a padded cell that I've ever set my eyes on."

One or two others of the crowd waiting patiently for their turn in the cosily-furnished corridor outside the studio are mainly anxious to obtain the opinion of experts regarding the quality of their voices.

They receive this for nothing, and it may be useful whether the ultimate aim be broadcasting or concert work.

Conducting an Audition

Presently, a door is opened, and one of the applicants is motioned to enter the room. Seated there are the accompanist and either Mr. Stanton Jefferies or Mr. Dan Godfrey, jun., who conduct most of the auditions.

Everything proceeds without fuss, but there is no time for pleasant formalities, and quickly the artiste, a soprano, is asked what she proposes to sing.

Frequently, she names some old stand-by which the musical director has been condemned to hear thousands of times, but his patience is infinite, and with a smile he settles back in his chair to listen.

She sings of the birds and the trees and the golden sunshine, and then she finishes and looks wistfully at the director. But he shakes his head; she has tried and lost. Struggling to smile, she folds up her music and walks out.

She is succeeded by a bulky, rotund person who states what a nice day it is, and he hopes the director is well, and he'll sing "Mate o' Mine."

It is obvious before he has sung

more than a few notes that he has not the faintest notion of the vocal art, but he is allowed to bring his song to its proper close. Then he is told briefly, but firmly, that he is not "quite suitable."

Many of the singers have no chance whatever of success. Some well-meaning friend has raised, without any sort of real foundation, golden hopes of wealth and fame, and here the victims are, ready to set the ball rolling. It is a quick disillusionment that awaits them.

The next to enter is a concertina performer, and he has not been long at work before it is evident that listeners-in have a good deal to thank the system of auditions for; the musical director quickly arranges with him to give up all hope of broadcasting.

Then comes an elderly woman, with greying hair, and clothes which tell their own sad story of struggles to keep up appearances. In her

At the London Station alone over 100 auditions are granted weekly.

In this article THE WIRELESS MAGAZINE Commissioner describes a typical scene on "audition day" at 2 L O and explains why "many are called but few are chosen."

younger days she sang on the platform, and dressed "with the best of them." But it is different now.

No doubt her mind goes back to old times as she begins her song and trusts that the impassive expert sitting there will not notice that just a little of the necessary vocal resonance is missing. But he does, and she leaves the room with the gloomy reflection that another possible source of income has failed to materialise.

A young man limps in on crutches. He is a victim of the war, and though he sang frequently for fees before he was crippled by a German bullet, public engagements are now practically impossible. But crutches are no drawback here, and as he has the right kind of voice as well as the technique of an accomplished artiste he is informed that he will be placed on the special list. His face lights up with pleasure as he realises that this means work, and a fairly large amount of it, within a month or two.

Drawing-room Entertainers

He is succeeded by two smart-looking young men who have announced themselves as drawing-room entertainers. One takes possession of the grand piano, and proceeds to make noises, while the other gets ready to sing something about girls and the dilemma of a man who wondered why he kissed one.

But these artistes have evidently disagreed about who is to have the solo part, for the piano drowns the singer completely. The director intervenes with the cruel verdict.

A shy girl obliges with "Somewhere a Voice is Calling." She has promise of being a singer some day, but her services would be of no value to the company at present because she is untrained. Regretfully she hears the decision and leaves the room.

Immediately, her place is taken by a young man with a violin. He has no pretensions to a prepossessing appearance, but he proves beyond all doubt that he has a musical soul, and he hears the glad words which indicate that he has come through the test successfully.

So the ordeal goes on. There is a fair chance for everybody, and the right kind of talent is bound to be recognised.

No one is happier than the musical director when he is able to add to the list of qualified artistes.

The Next Stage

The next stage is the actual broadcasting, and this, it may be said, imposes a much greater strain on the nerves than a mere audition. Men and women who have been accustomed to the limelight for many years frankly confess their nervousness when they find themselves standing before the microphone.

Mr. Baldwin, the Premier, who, it will be remembered, broadcast a speech during the last General Election, was a little overawed by his task, and had a preliminary rehearsal in private.

After all, it is no light thing to speak for fifteen or twenty minutes to a vast unseen audience, and have no indication of any kind of the effect of one's efforts upon the listeners.

When Mr. Bernard Shaw read one of his plays some time ago he asked, just before he began, how many people would be able to hear him. "Three or four millions," was the reply.

"I WANT TO BROADCAST"

(Continued from preceding page)

The Shavian eyebrows were lifted in mild surprise, as, without another word, he took up his position in front of the microphone.

It should be explained that except in very rare circumstances the manuscripts of all speeches, lectures, and so on, must be submitted for the approval of the company's officials before being broadcast. This precaution is taken to ensure that everything likely to be distasteful to listeners is cut out.

Even distinguished personalities must submit to this rule. It is on record that one of the most famous statesmen the country possesses actually had certain parts of his speech deleted before delivery. He was not a little indignant, but it was felt that no exception could be made.

Strict Censorship

It is seldom, indeed, that a speaker who is not accustomed to broadcasting work succeeds in getting his manuscript through at the first attempt. It may contain, perhaps unintentionally, a free advertisement for somebody or some firm, or it may be too short or too long.

When the suggested corrections have been made the manuscript must again be submitted, and if it is then in order it is stamped and signed. If the slightest deviation is made in the delivery of the speech, the announcer has authority to throw the microphone out of circuit.

"Was that all right?" is usually the first question of the new-comer as he leaves the studio after broadcasting. He has reached the climax of an ordeal that really begins, in the case of a singer, when he receives the notification of his engagement.

Will he be able to do himself justice in those strange surroundings, and how will the silent millions regard his efforts?

He arrives at Savoy Hill to find the premises a hive of activity. Making his way up to the studio in which he is to sing, he probably finds a red light glowing outside each of its doors.

This is a signal that broadcasting is going on at that very moment, and that entrance is rigidly barred.

It may be that an announcer, comfortably reclining in a chair,

with legs crossed, is reading the day's news, or the orchestra may be playing a selection.

Before the Microphone

When at last the singer's turn comes, there is little time to waste. He is ushered into the room, and he sees, perhaps for the first time, the mysterious microphone which has figured so largely in his thoughts.

It is a simple-looking instrument resting in a rubber sling, which is contained in a wooden framework. There is nothing about it to cause a moment's anxiety, and yet the mere sight of it must have struck terror into the hearts of thousands of people.

But time presses. Every listener in has heard the announcer's intimation: "There will now be an interval of one minute." In that short period he has to introduce the broadcaster into the studio, tell him the distance at which he must stand from the microphone, the volume of sound required, and also emphasise

the necessity of avoiding even the rustling of paper, so sensitive is the instrument.

Then the singer is announced, and the next moment he is left alone, so to speak, with his unseen audience of millions, each of whom he imagines to be merclessly criticising him.

To make matters worse, his voice, just when he needs it most, seems to have lost all its power, and he is about to break out in a cold perspiration when he realises that this is due to the heavy draperies of the room, and their action in neutralising the echo.

With a feeling of relief he brings his song to a close. Deathly silence! Not a sound to indicate whether he has pleased or disgusted. It is an eerie sensation.

But before he has time to ponder the situation over, he is out of the room again, and nestling down into a cosy settee.

It is over. He has broadcast, and incidentally laid the foundations of a new career. H. S. G.

NAUEN TIME SIGNALS

LISTENERS who have tuned in some of the German stations towards noon will, undoubtedly, have heard strong morse signals on the broadcasting wave-band. These are, in many cases, the time signals transmitted by the Nauen station and relayed by the German broadcasting centres. The signals from Nauen (P O Z), transmitted on 3,100 metres, are, in the case of Frankfurt-on-Main, picked up on a frame aerial in the vicinity of that city, amplified, conveyed by land-line to the station, again amplified, and broadcast on 470 metres for the benefit of the inhabitants. The original signals are automatic, inasmuch as the Nauen transmitter is set in operation by means of a special chronometer installed at the Berlin-Treptow Observatory. There is no need to be proficient in morse to understand them, as the following explanation will prove.

A "preliminary call" consisting of 20 V's (...—) is given, followed

at 11.56' 17" by —.—.— and the letters P (.—.—.), O (—.—), Z (—.—.), Nauen's call-sign. Then follow, M (—.—), G (—.—.), Z (—.—.), indicating that the time is "Mittel Greenwicher Zeit" (Greenwich Mean time).

The actual time signals are transmitted from 11.57' onwards by means of 7 X's (—.—.—), finishing up with the letter O (—.—), the last stroke indicating the exact minute (11.58'). By means of 5 N's (—.—), followed by the same O (—.—) and 5 G's (—.—) terminating in the same manner, the time for 11.58' and 11.59' is clearly indicated.

The "finish" signal (.—.—) ends the transmission. In Germany this is known as the ONOGO system of time transmission, the word comprising the various letters used. On the original wavelength of 3,100 metres the signals can easily be picked up in this country on a crystal receiver.

J. G. A.



Wireless and the Country Newspaper

THERE can be no doubt whatever that wireless is far more popular now than ever before. One result of this increased popularity has been that country newspapers in many districts have started the publication in their columns of a weekly article on wireless.

Some of these articles are of considerable merit, but in many cases the experienced wireless experimenter looks upon these local efforts with kindly good humour and does not take them too seriously.

The discerning man of wireless knows where to go for authoritative articles on his favourite hobby, and, moreover, he knows where to get expert technical advice at the price of a stamped addressed envelope.

A correspondent who is at present holidaying (lucky man) in the North of England has sent me one of these wireless articles cut from a local paper.

On reading this article I was rather taken aback by a statement to the effect that it is a feature of wireless that good and efficient reception is an elusive object. I have been wondering how much truth there is in this statement.



Low-loss Apparatus

WHEN I recently asked one of the leading members of a very well-known firm of wireless manufacturers what kind of a year his firm looked like having, he replied, "A low-loss year." For a while I was considerably mystified by this reply. I tried to reconcile it with the old notion of a man of business living on his losses.

However, the manufacturer made things clear by saying that the de-

mand of the wireless public seemed to be for "low-loss this, and low-loss that, and low-loss everything else" they wanted.

"What exactly is meant by the term 'low-loss'?" I asked the manufacturer.

"That's a question for the technical expert," was his reply, and try as I would, I could get no further enlightenment from him.

I am rather inclined to think that



"Low-loss apparatus."

those who have formed the opinion that there will be a great demand for so-called low-loss apparatus this year have been reading some of the American wireless magazines.

Judging from the advertisement pages of these periodicals, low-loss parts must be making a stronger appeal to the American wireless "fan" than anything else in the wireless line just now.

As far as low-loss tuning coils are concerned, I imagine that the ideal to aim at in the construction of



"Dope?" "Nope."

such coils is well expressed by the following typical description of an American low-loss tuning coil:

95 per cent. air dielectric and no dope on the windings.

I wonder if you like that word dope as much as I do. Can't you imagine an American wireless enthusiast purchasing a low-loss coil?

How is the following for a specimen

of the probable conversation over the purchase of a low-loss tuning coil on the other side?

Purchaser: "How much air dielectric is there in this coil?"

Salesman: "Ninety-five purr cent., as near a handred as parssible."

Purchaser: "Dope?"

Salesman: "Nope."

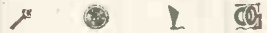

Touch

I HAD a very curious and disconcerting experience recently. A wireless neighbour who has just built a thoroughly good three-valve set came in to tell me he was ready to test it and to ask me to go along with him and help him to get an understanding of the working of the set. I had kept an eye on the set during its construction and I knew it was correct in every detail, so, thinking to myself this is easy, I went most willingly.

For a long time I have been using dull-emitter valves. My wireless neighbour had purchased bright-emitters since it was a very easy matter for him to get accumulators charged. I sat down in front of the set and, you would scarcely believe it, I was a good twenty minutes before I was the master of that set and could make it do what I wanted. And why, do you think? Simply because I had lost the "touch" for bright-emitter valves. There I sat not getting the results I knew I ought to be getting and blaming, in my own mind, condensers, coils, everything, whilst the whole trouble lay in the fact that that "touch" had forsaken me.

Constant use of dull-emitters had caused me to turn the carbon pellet filament resistances almost full on. I had mechanically set the resistances for the three valves just as if I were using my own dull-emitters. It was only by reducing the filament

current to the first low-frequency amplifying valve that I realised what I had been doing. When I adjusted the other two filament resistances to the best position the set went beautifully.



High-frequency Amplification

A VERY old friend of mine who has just taken to wireless was particularly anxious that I should see the two-valve set he had purchased. As I knew the type of set my friend had been persuaded into buying, I was not in the least anxious to see it, because I always find it most difficult to discuss and answer questions about a commercial set which I know to be rather below the average in the signal strength it gives. You see you cannot exactly explain to a broadcastcatcher that, in his set, signal strength has been sacrificed in the attempt to make a fool-proof and non-oscillating receiver. However, I had to do it on this occasion and I am very glad that it is over.



"A very old friend of mine."

The set in question was a two-valve receiver in which the first valve was a high-frequency amplifying valve, the second, of course, being the detector valve. After very careful observation lasting well over an hour, I came to the conclusion, in my own mind, that my friend's two-valve set gave a little less signal strength than the usual home-made single-valver with reaction. My friend, however, was perfectly satisfied with it since it gave audible results on three pairs of phones.

During the time I was listening-in with this set I found myself wondering whether high-frequency amplification will become a thing of the past as our broadcasting stations get more powerful and more efficient. High-frequency amplification has its uses if properly applied, but my experience is that many listeners who use a high-frequency amplifying valve would get on far better without it.

At its best, a high-frequency amplifying valve only increases signal strength some three or four times, whereas a low-frequency amplifying valve increases signal strength by

twice that amount at least. For one of the most modern types of low-frequency transformer, an amplification factor of 35 is claimed when a particular type of valve is used. It is very difficult to see how such



"After careful observation."

a large amount of amplification could be obtained by the use of one high-frequency amplifying valve.

I have recently been reading that one of the great merits of high-frequency amplification is that it gives increased selectivity. It does in some sets. A week ago I was listening to a three-valve set having one high-frequency valve, tuned-anode type. With this set the owner found it impossible to tune in Radio-Paris when Chelmsford was transmitting. Indeed, 5 X X came in equally well on any adjustment of the anode variable condenser.

There is not much selectivity about a set of that kind. With a three-valve set I am using just now, I can tune in Radio-Paris so that Chelmsford is only faintly audible in the background, and I am hoping to eliminate Chelmsford altogether when Radio-Paris is being received by a specially designed coil. The three-valve set I refer to has a detector valve followed by two low-frequency amplifying valves, and the transformers have been very carefully chosen after much experiment.

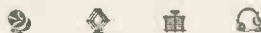

Light-adjustment Variable Condensers

HAS it ever struck you that our variable condensers with light-adjustment attachments are somewhat crude when looked at from a purely mechanical point of view? The



"5 X X came in."

majority of such variable condensers have a separate single plate working on a spindle which passes through a hollow main spindle. This is perhaps the obvious way of solving the mechanical problem involved in the

construction of such a variable condenser.

It is necessary, however, to pay a fairly high price for such a condenser if one is determined to be absolutely sure that it will cause no trouble when in use.

Another method which our manufacturers use is to mount the separate light-adjustment plate on one part of the main spindle and the condenser proper on the other part of the main spindle. One dial in these condensers works both the main condenser and the plate.

When it is desired to engage the main condenser, the dial is pressed down and turned round until the two parts of the spindle become interlocked. When it is desired to use the light-adjustment plate alone the dial is allowed to spring back, and in this position the dial turns the plate only. Although such a condenser is most ingeniously constructed, and reflects the greatest credit on the designer, it is one which does not always work out well in actual



"The dial and the plate."

practice. For instance, with certain types of dull-emitter valves which are somewhat microphonic, such a variable condenser makes for rather a lot of unwanted noise.

Personally, I have been pleased to see a revival of that type of variable condenser in which the light-adjustment plate is moved by a small handle which travels round the edge of the dial proper. I have also been greatly interested to see the introduction of the "geared" type of variable condenser which gives a delicate movement of the whole set of plates.

The "geared" type of variable condenser has been used for some time in America. One of the latest types to be introduced over there is one in which both sets of plates rotate, the movement being such that the two sets of plates move into each other as the capacity of the condenser is increased. Each set of plates is mounted on a spindle geared to the dial spindle. Perhaps the most interesting feature of this condenser is that it takes one complete turn of the dial to vary the condenser from minimum to maxi-

mum capacity and not half a turn as in the majority of our English condensers. We have by no means exhausted the ingenuity of the designers of variable condensers, and there is plenty of room for improve-



"Two sets of plates."

ment in these very necessary instruments.

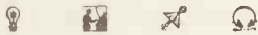

Thunderstorms

I HAVE just been reading an article on frame aerials in which the writer states that it is only in the summer that atmospheric are troublesome. In wireless circles it is not at all well known that we have thunderstorms throughout the year, even in the winter months. Of course, winter thunderstorms are neither as frequent nor as severe as summer thunderstorms, but it is a great mistake to assume that wireless reception will not be interfered with by those annoying atmospheric which come from thunderstorms, in the winter months.

Last year thunderstorms occurred somewhere in the British Isles on no less than twenty-one days in January. In February there were sixteen days with thunderstorms, and in March there were eleven such days. One of the January thunderstorms passed up the English Channel and the lightning from it was visible all over Southern England.

I do not remember this storm now, but I am sure that, if it occurred during the hours of broadcasting, it must have caused a good deal of noise in broadcast receivers in the south of England. I do remember being surprised more than once at the beginning of last year with unusually



"In wireless circles."

powerful atmospheric, and on one occasion I can remember that atmospheric persisted throughout the afternoon and evening.

One of the most interesting things about thunderstorms is that they

travel at a fair speed. Winter thunderstorms move at a rate somewhere round about 25 miles an hour. Since one single thunderstorm can cause atmospheric in wireless receivers within a few hundred miles of it, one can readily understand how it is that atmospheric are troublesome for hours when there is not a sign of thunder in the immediate neighbourhood.

Speaking of last year reminds me that May was a very bad month for thunderstorms. Not one day in that month was entirely free from thunder over the British Isles. The worst locality for thunderstorms last May was South-eastern England. On the average there are three days in May with thunderstorms in the London broadcasting area.

In May, 1924, there were no less than ten days with thunderstorms in the London district. If, therefore, you desire to cut down atmospheric by using a frame aerial, I should advise you to make that frame aerial pretty soon and not postpone the making of it until the arrival of summer.

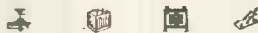

Low-loss Coils

LIKE most wireless enthusiasts who are interested in the experimental side of the subject, I have been trying my hand recently at making so-called low-loss coils for short-wave reception. I take it that a low-loss coil is one which has a very low value of what is called self-capacity and which, at the same time, presents a minimum of resistance to the high-frequency currents which traverse the coil.

A low value of high-frequency resistance is assured by using a thick wire for the winding of the coil. The self-capacity of a coil is a somewhat complex quantity depending not only on the way in which the coil is wound but also on the material and bulk of the former on which the coil is built.

My own attempts to build a low-loss coil have been made with No. 18 d.c.c. wire, and I have made a number of attempts to wind coils of this wire with the minimum amount of material holding the coil together. I have even been guilty of the foolish attempt to wind a coil of this wire using no former whatever. The type of coil I tried to wind was the flat spiral. If you fancy the idea you are perfectly welcome to do what you

like with it, but should you try to do as I did, you will find it rather a difficult matter to wind a formerless coil. Wire often refuses to stop where you want it to stop, and if you do happen to get a pleasing pattern of a formerless coil, it is a certainty that you will, sooner or later, catch the coil on something or other and pull it out of shape.

When you start to wind a formerless coil the thing seems ridiculously easy, and you wonder why you have never done it before. But when you have passed the twentieth turn say, you begin to find that your coil is assuming a springiness which is most troublesome, and which makes it very hard to go on with. Then, of course, a formerless coil is bound to be sadly lacking in rigidity.

After trying to wind formerless low-loss coils (high loss as regards temper), I was struck with another remarkably original idea. Why should there not be low-loss coils for the higher wavelengths? So taken was I with this idea that I unwound



"Struck with another idea."

a Chelmsford coil and reconstructed it. The coil must have had a pretty high value of self-capacity originally. I had an assistant to help me with the unwinding and the re-winding. How do you think we managed the job?

We unwound the original coil and placed the wire for the time being on an ordinary domestic clothes-horse, single-pole throw-over type. While the wire was on the clothes horse we made certain changes in the former, shape and bulk, with the idea of getting a much lower value of self-capacity in the new coil. No, we did *not* put the clothes-horse in front of the fire to dry the cotton covering.

It was an easy matter to take the wire off the clothes-horse when re-winding the coil on the altered former. We did it without getting a single kink. What do you think happened when we tried the new coil? We could not get Chelmsford on it. We had taken away so much self-capacity that the variable condenser across the coil would not take us up to Chelmsford's wavelength. So we had to put more wire on the

coil. This, of course, increased the resistance. What we gained in losing self-capacity we lost in gaining resistance most likely. I think I shall leave low-loss coils alone for a while.

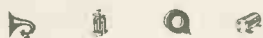

Long Ago

THE other evening I was having a look over some of my old wireless junk when I came across a home-assembled variable condenser. As I held that condenser in my hand I felt very thankful that it was not necessary to put together a variable condenser from a multitude of small parts if one wanted a cheap article these days.

Do you remember the awful job it was assembling one of those fearful condensers? Do you remember buying washers which were just a fraction too small for the condenser rods? Do you remember how you always seemed to find out that those washers were too small on a Sunday



"My old wireless junk."

when you could not buy any bigger ones? I wonder whether you have spent hours trying to file out the insides of those miserable little washers.

Wireless was a fiddling job in those early days, and there was no more fiddling job than putting together one of those condensers which we are now inclined to laugh at. When I look at one of my own home-assembled condensers I always have a vivid recollection of a prolonged and tedious hunt for that last washer all over the carpet and even under the hearth rug.

Once I found that last vital washer in the turn-up of a leg of my trousers. Funny place for a washer to turn up at the last moment, wasn't it? But such work was good for us, and it certainly has made me appreciative of the variable condensers which I can purchase at a reasonable price to-day.

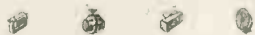

An Amateur's Broadcast Concert

PASSING through Derby on my way to the North of England one Saturday

night not long ago, I purchased a Derby evening paper to pick up the latest football news. On turning over the pages of the paper I was very interested to see, in a prominent position at the top of a column on an inside page, a letter announcing that a local wireless experimenter,



"That washer!"

6 W H, would broadcast a concert the following Sunday morning. The wavelength of the transmission was given, and it was stated that a small orchestra would provide popular music.

There are so many amateur wireless transmitters in the London area that one is perhaps inclined to overlook the fact that there are other transmitters in other parts of the country. Derby 6 W H is to be congratulated on his forethought in announcing his broadcast concert beforehand. If other of our amateur transmitters would find it possible to do this, we should be able to make our Sunday mornings much more interesting from a wireless point of view.

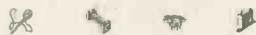

History Repeats Itself

I HAVE been deriving considerable enjoyment recently from certain of the wireless news items which have appeared in our newspapers. Very probably you, too, have been deriving enjoyment from the same source.

You know the kind of news item I mean. Wireless lends itself rather readily to the writer whose imagination and love for the sensational run away with him at times. Give such



"An amateur broadcast."

a writer a few wireless facts, and he will build an article around them in much the same way as a baker builds a penny bun round a few spicy currants.

An old friend of mine, who had evidently been reading one of these same light and airy—I very nearly

said ethereal—articles has just been in to see me.

"Look here, old man," he said, "you had better own up to it. You are a back number as far as wireless is concerned. Why! man alive, there's a fellow in one of the home counties who can pick up two or three of the B.B.C. stations on a bit of wire slung across his sitting-room and that on a one-valve set only."

"Really," I replied with a yawn. "Come on now. Own up to it. You're a wireless back number."

"Perhaps I am," I replied dolefully, "one has an awful job these days to keep up with wireless. Some folk keep up with it till two or three in the morning listening-in to America, you know. Speaking of back-numbers, though, reminds me that you have never looked over the back number shelf in my workshop. Come along with me now. There are a few back number receiving sets you might be interested in."

We adjourned to the workshop.



"Not enough 'currant.'"

After a casual glance at two or three crystal sets, I took down from the back number shelf a one-valve receiver to which was tied a label with the date June, 1923, written on it.

"Let us try this back number in the warmth of the sitting-room," I suggested. "It is over eighteen months old, but it was a pretty good thing in its day."

I carried the one-valve back number set to my sitting-room and placed it on a small table near the fire. My friend looked mystified as I slung fifteen feet of worn-out bell wire across the room from corner to corner and connected one end of it to the aerial terminal of the set. A valve was placed in the holder, and the batteries, earth wire, and two pairs of phones connected up. Placing one pair of phones on my own head, I passed the other pair to my friend. His astonishment was great when he heard the volume of sound from the nearest broadcasting station some forty odd miles away. His astonishment was far greater, though, when I picked up two more distant stations.

"Now, then, just to show you what was possible in June, nineteen

twenty-thr-r-ree," I said, "I will do away even with the small aerial I have erected across the room and rely on Mother Earth alone."

With the earth connected to the aerial terminal of the set and nothing connected to the earth terminal, my back number set brought in the local broadcasting station at good phone strength. My friend was astounded.

"Why ever didn't you write to the papers and tell them all about this set when you made it eighteen months ago?" he asked.

"When I made this particular set," I replied, "every wireless paper in the country knew all about it, and wireless enthusiasts all over the country did just what I did with it. Take my advice, my boy, read an up-to-date wireless paper. You will then be able to add the right number of grains of salt to anything you read outside the real wireless papers. Not only that, but you will save yourself from emulating the historical genius who discovered a few years ago that Queen Anne was dead."

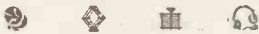

My Aerial

AFTER withstanding all the buffeting of the winter gales, my aerial wire broke in quite a light wind the other morning. I had not noticed that the wire was down, and I was very surprised when a wireless friend told me that my aerial had become an earth.

On examining the wire I found that the breakage had occurred just by one of the insulators, the seven strands having all snapped off at the same point.

This particular aerial wire had been up over two years, and it had been moved at least twice during that period, so I suppose I ought not to grumble at the service the wire has given me. On going over the whole wire carefully, it was noticed that everywhere the wire had hardened and become decidedly brittle.

The black enamel on the separate strands seemed to have "run" in places in such a way as to make the strands appear to form a solid wire.

It was a simple piece of work to replace the broken wire, and I am very glad that I have done so, for results are noticeably better since the new wire went up. I suppose there must have been a weak place in the old wire for a long time

before it broke, and this weak place would certainly have a bad effect



"Amusing the neighbours."

on the signal strength I was obtaining.

The new single-wire aerial was put up on a very wet afternoon. Much to the amusement of one of my neighbours, I carried a large umbrella round with me all the time I was working in the garden. Before finally hoisting the new wire, I had it suspended about five feet above the ground.

While in that position, I counted the number of raindrops per foot hanging from the wire at various points. The highest count I got was six per foot.

Since I have read somewhere or other that raindrops frequently carry a small electric charge, I shall not be so surprised in future at those curious little noises I sometimes



"Curious noises during rain."

get when receiving telephony during a heavy rainstorm.

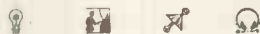

The Set that Wouldn't

A MOST annoying thing has happened to me. I dare say the same kind of thing has happened to you before this. A new acquaintance has been in to hear my latest three-valve set. It is a good set, and I have had excellent results from it. News of my success with this particular set has evidently travelled outside the inner circle of my immediate friends, for my new acquaintance had never called to see me before.

Ten minutes before my new acquaintance came in the set was working beautifully. From Radio-Paris I was getting the strongest and clearest signals I have had for months. But (would you believe it?) no sooner had my new acquaintance seated himself in one of my listening-in chairs and had got one of my

listening-in cigarettes well alight than that wretched three-valve set began to play me tricks. Reception became an uncertain quantity. There were times when only the faintest noise could be heard in the loud-speaker.

Has this sort of thing ever happened to you? Do you remember the state of nervous tension you got into when your own set last refused to behave nicely before a visitor? I am sure you fully sympathise with me over my doleful experience.

After half an hour of erratic reception signals went altogether. Do what I could, I was unable to improve matters. My new acquaintance took his departure thoughtfully. He was kind enough to express the wish that I should have more success with my new set on another occasion.

Two minutes after he had left me the set was going like ten men and a boy! Yes, I know what you are thinking about it all, but you are quite wrong. I had merely screwed the top of the aerial terminal hard down on to the tag at the end of the aerial lead. I had unscrewed this terminal when my new acquaintance first came in. You see, I didn't want him to ask me to help him to make a set like my new one. I am rather busy just now, and I am dead set against taking on any more wireless constructional work at the moment.

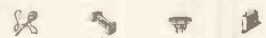

Know Your Valve

IF you happen to change from bright-emitters to dull-emitters or vice versa, take my advice, go easily at first. Even if you change from one make of valve to another, you might get inferior results from lack of "touch" for the new make of valve. You know what a pleasure it is to ride in a motor-car with a driver who has the right "hands" for that type of car. You remember, perhaps, how that good driver can slip from one gear to another almost noiselessly. Those of us who are constantly using wireless receiving sets should make a point of cultivating a similar characteristic.

I have heard that the constant playing of a large organ destroys a player's "touch" for the piano. I wonder if the constant use of dull-emitters will destroy a wireless man's "touch" for bright emitters? I hope not.

The "Cat-whisker Touch"

WHILE on this subject of "touch," I am reminded that, when I was last holidaying at a famous spa in the north of England, I built a crystal set there, and was delighted to be able to pick up 5 XX at good strength. I left that crystal set there and at least three wireless enthusiasts have tried to pick up 5 XX with it but have not succeeded. They have written to me to ask how I did it.

There is nothing wonderful in it at all. Those three enthusiasts are valve users. They were never brought up on a crystal set as I was. All the valves in the world would never make me lose the cat-whisker "touch" which I acquired before the present-day valve was on the market.

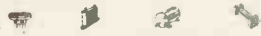

A Good Omen

FOR the greater part of last year the end of my aerial away from the house was attached to the top of a tree. The height of the aerial at that end must have been something like twenty feet, not much more. Now, the open end of my aerial is attached to the top of a mast and its height above the grass of my lawn must be forty feet. This aerial mast stands very near to a tree. In fact, the mast passes upwards between two of the lower branches of the tree.

Although I have obtained better reception from the distant stations since I erected the mast, nothing has pleased me more than to notice that a thrush has recently chosen the top



"A good omen!"

of my mast as its position from which to sing its glorious morning song. I suppose the thrush has chosen the top of the mast because it is the highest point in the vicinity.

Anyhow, for the last three mornings, my aerial thrush has sung its most beautiful song from the top of the aerial mast. I wish I could fix a microphone to the top of my mast and broadcast the notes of my thrush.

If I thought there were the slightest danger that my beautiful singer would fly into my aerial wire, I would

"What the Wireless Public Has Been Waiting For"

I AM still receiving hosts of congratulatory letters—indeed, I have been deluged with them. Let me thank sincerely all my correspondents and tell them frankly that I shall do my best to maintain the standard set in my already-published issues. Many of the letter writers tell me that I shall have difficulty in making future issues as good as Nos. 1, 2 and 3. In a sense I shall, inasmuch as the production of those issues and the outstanding success of their public reception could not be achieved without very hard work and the meeting and vanquishing of many troubles. But—here is No. 4! Is it as good? I can assure all my correspondents that nothing but the best will find its way into my pages. At all costs, both of energy and money, I shall maintain the standard.

I am glad to report that THE WIRELESS MAGAZINE is doing extraordinarily well, and knowing as I do that so much of its success is due to the kind recommendations of my readers, I wish to thank most warmly everybody who has "passed the word along."

The heading to this editorial message is taken from a letter just to hand from a Sheffield reader. "I watched the floating of THE WIRELESS MAGAZINE with interest," he tells me. "It is exactly what the wireless public has been waiting for and it fills a need. The contents of the first three issues intrigue me and make me believe that at last someone has had the courage to tackle the problem of giving wireless enthusiasts exactly what they require."

Well — here's No. 4! How do you like it?

B. E. J.

put dozens of corks on that wire, big corks, too, and I would light the wire up at night. But I am forgetting. The thrush does not fly or sing at night. It leaves night work to the nightingale.

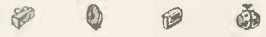

Give a Dog a Bad Name and—

It has always seemed to me most unfortunate that the loud-speaker has become so named. The original lengthy phrase, loud-speaking telephone receiver, was, of course, hopeless for general use, but it is a great pity that the phrase has become shortened to the familiar term "loud-speaker."

Loud is not an attractive word when used in connection with speech or music. A pleasant voice is never a loud one. Sweet music is as soothing to the nerves as loud music is trying. I am sure that, because of its name, many users of the loud-speaker expect a great volume of sound from the instrument, and that this expectation causes them to force the loud-speaker beyond its powers of good reproduction.

What a pity it is that some ingenious manufacturer did not invent a really attractive name for the loud-speaker when it first appeared on the market. Why should it be called a speaker at all? There would be just as much sense, or rather lack of sense, in calling an earphone a soft-speaker. Imagine what you would feel like if you went to borrow from your nearest wireless neighbour a pair of soft-speakers for an unexpected visitor.

The words earphone and headphone are so appropriate, why should



"The Song of the Thrush"

we not call our loud-speakers "room-phones"? The word roomphone is explanatory of the function of this most useful instrument.

If you glance through the advertisement pages of an American wireless periodical you will see how American manufacturers, at any rate, try to evade the use of the term loud-speaker. Timbre-tone, needle-phone, audiphone, super-speaker, and radio reproduction-speaker are a few current attempts to give the loud-speaker a better name. HALYARD.

THE NEW STATIONS

The story of the Daventry high-power Station and the new 2 LO specially told for "THE WIRELESS MAGAZINE" by The B.C.'s Chief Engineer.

By
Capt
P. P.
Eckersley

WE are on the eve of certain interesting developments on the technical side of British broadcasting. I refer to the opening of our new London station and the transfer of the Chelmsford equipment to Daventry. Readers of THE WIRELESS MAGAZINE may like to know some technical details of the two stations.

We did not necessarily want to move our station from Marconi House, but the Air Ministry receiving station is partially interfered with by our transmission, so that a move was forced upon us. Our problems in choosing a new site were manifold. The desiderata of a site are:

(a) Not too far from the present position, since receiving sets are adjusted for a certain distribution, and a great upset would result did we move our station far.

(b) To be placed upon a roof site so that local shielding can be avoided.

(c) The roof to be strong enough to support adequate masts.

(d) The building to be steel framed on account of earthing difficulties.

(e) The owners of the building to be willing to give access day and night, and to submit to the inconvenience of the necessary constructional operations.

(f) The building to be suitable from the point of view of the London County Council, who must ensure that the fire risks are the minimum, while the factor of safety, structurally, is high.

(g) That there is room for the considerable quantity of apparatus associated with a broadcast transmitter.

(h) That the roof is reasonably flat.

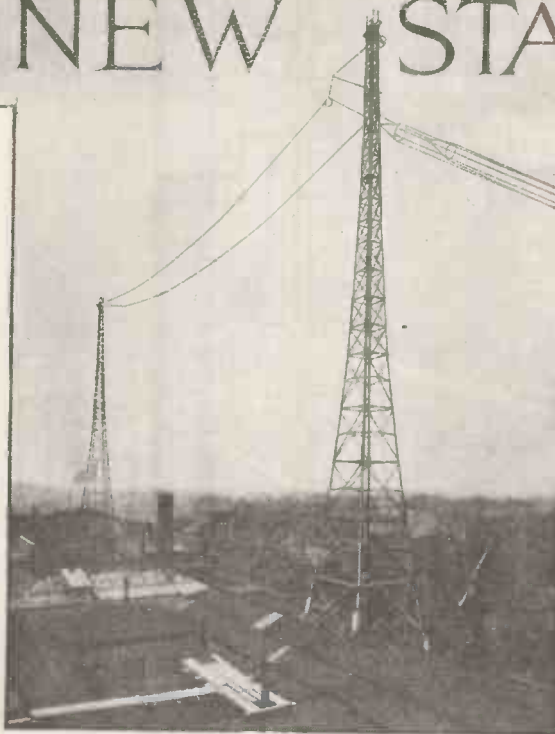

The Complete Aerial System of 2 LO's New Transmitter.

(i) That the building should be reasonably high and not shielded by other near-by buildings.

(j) That the site should be reasonably far away from the Admiralty and the Air Ministry—one mile was given as a minimum and two miles as desirable.

A Formidable List

This is a formidable list, and with the realisation of the many authorities who have to be consulted, the many factors that have to be taken into account, we shall, I hope, be forgiven for the long time that has elapsed between our decision to move and the change itself.

The new site on the roof of a West End shop fulfils nearly all, if indeed not quite all, the conditions outlined above.

Two steel towers, each 150 ft. high, their feet resting upon the main members of the structure, themselves embedded in the ground itself, have been erected. As an engineering feat these deserve special mention. They are, I am told, not more than half an inch out of the vertical.

Equipped with scaling ladders, painted grey, towering above the surrounding buildings, they are, we

hope, a permanent monument to British broadcasting and to the skill of mechanical engineers. They weigh 20 tons each and are designed to stand a pull of $1\frac{1}{2}$ tons, the factor of safety being 4.

The aerial is of the inverted L type, the down-lead, at an angle of 45° , coming to the roof of a little building which contains the transmitting set proper. The strain of the twin sausage members of the down-lead aerial is taken by chain

insulators, firmly secured to steel members attached to the building frame, while flexible connecting wires no longer under strain are brought to a porcelain insulator. Above, the aerial loses its sausage formation to taper into straight wires.

We cannot use the full span of the aerial, its natural period of electric oscillation being too great for the short wavelength in use, in spite of a series condenser.

One day we may use the other half for a second transmitter, so that two London programmes may be radiated simultaneously. So far no definite proposition of this sort is even mooted, but we built against the possibility.

Special machines are necessary to convert the mains power (2-phase, 4-wire, 240-volt) to D.C. high-current power to charge the valve-filament lighting batteries, and to high-frequency alternating current for supply, after rectification and smoothing, to the valve anodes. These machines are housed in a "lean-to" on another part of the roof of the building, and are remotely controlled from the transmitting hut itself, and may be started and stopped

(Continued on page 381)

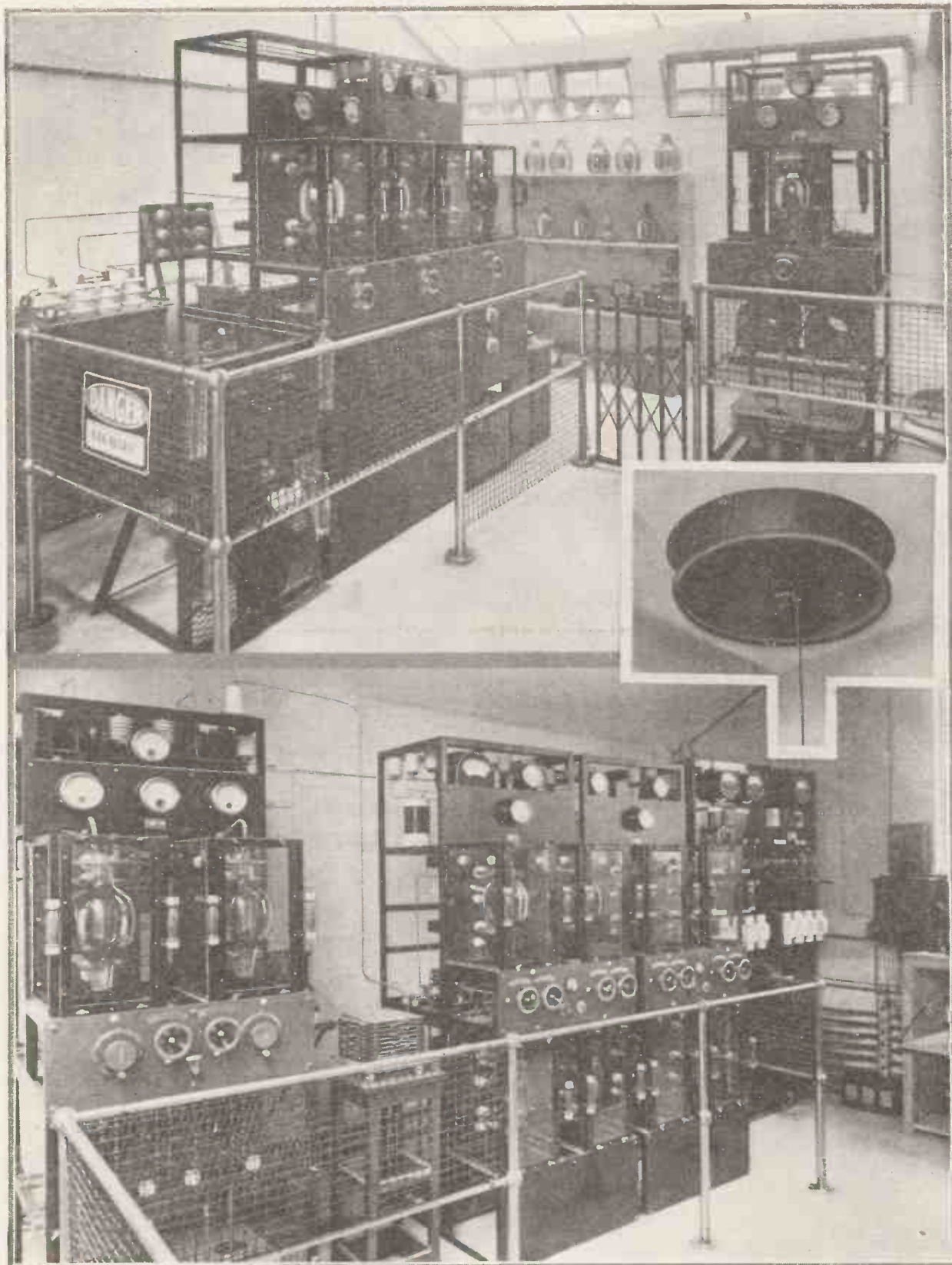

Top.—At left of photograph are shown the Rectifying Panels ; at right, the Master Oscillator and Modulator. Bottom.—Actual Transmitting and Final Modulator Panels. Inset.—Internal connection to Pot Insulator in Roof to which Lead-in is connected.

THE NEW STATIONS

(Continued from
page 379)

by the closing of an ordinary tumbler switch on the transmitter power panel. The transmitting hut is divided into two partitions, one to contain the 800 ampere-hour (5 hour rating) accumulators, weighing incidentally $4\frac{1}{2}$ tons, the other to house the transmitting gear proper.

This gear is designed to handle three kilowatts on the anodes of the oscillating valves, double the power of the standard stations. There are four panels arranged round three

broadcast, another for communication, and a last as spare.

Further, to ensure freedom from breakdown—a workman's pick has been known to sever a whole bunch of telephone cables—another emergency land-line takes a different route. These lines run underground, in conformity with modern telephone practice.

The higher towers, the site on higher ground, the increased power, the improvements in design gained as

defeat difficulties. One asks, however, for public sympathy if at first anticipations are not realised.

I shall be pleased if our double power results in our equal service. It must be remembered incidentally that double power theoretically only results in less than $1\frac{1}{2}$ times the range.

I must ask, too, those who have been, say, one mile from the old and are now two miles from the new 2 L O to realise that they are twice as far

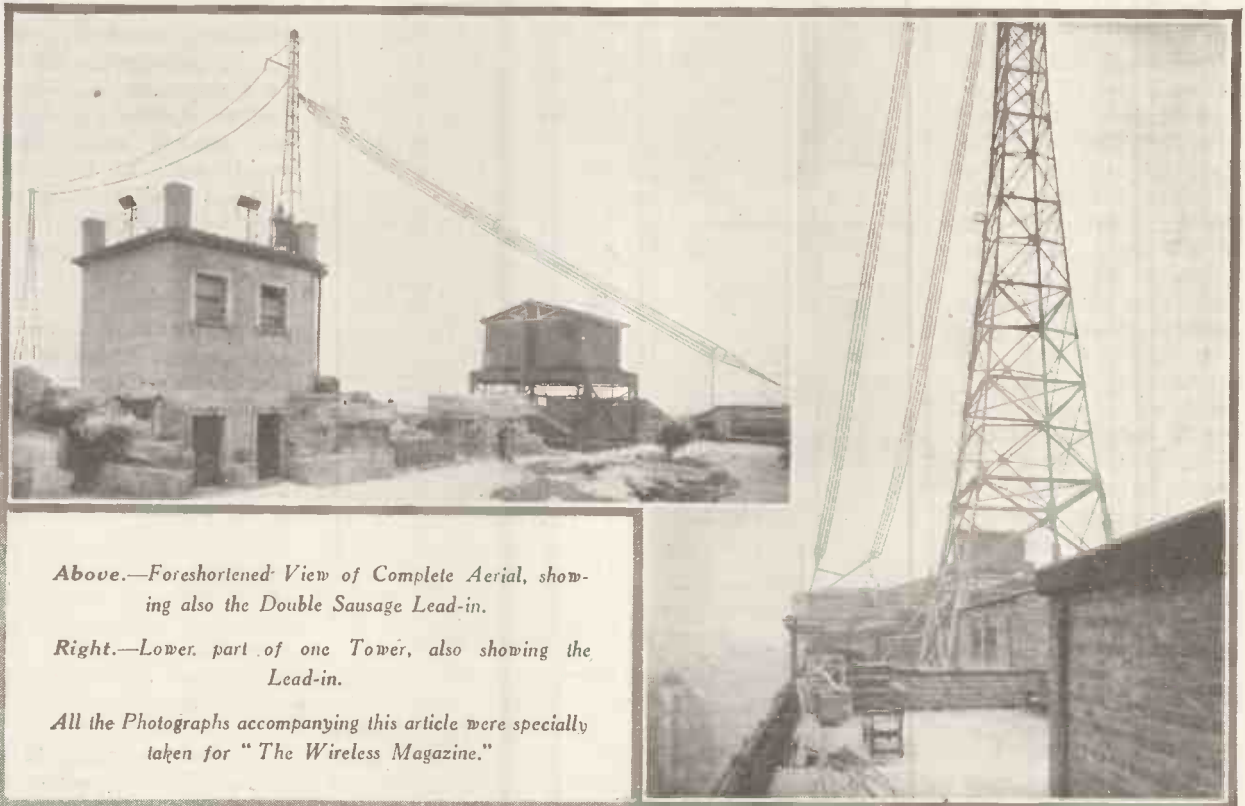

Above.—Foreshortened View of Complete Aerial, showing also the Double Sausage Lead-in.

Right.—Lower part of one Tower, also showing the Lead-in.

All the Photographs accompanying this article were specially taken for "The Wireless Magazine."

sides of the hut. One panel deals with the power switches and the rectifying valves, with their associated transformers; another panel contains the master-oscillator gear, a third contains the gear for producing the aerial current, and the last modulator panel controls the intensity of the oscillations in sympathy with the input from the control room at Savoy Hill.

It is erroneous to suppose that we are moving our studios; on the contrary, we are consolidating our position at Savoy Hill and building more. Three land-lines connect studio and transmitter, one for the

result of past experience, may lead many to expect greatly improved transmissions both as regards strength and quality of signal. Here I would sound a note of warning, however.

The building of wireless stations in the heart of big cities is a difficult task, and the designer has no reliable data on which to predict performance. Steel roofs, steel towers and new forms of aerial necessarily play the deuce with radiation. It is impossible to avoid trouble; one must have broad enough shoulders to face criticism, and enough technical knowledge and mother wit to

away. This may seem obvious, but it is on occasions not realised because they have been so close before. If a man were living ten miles from a station and then removed to twenty miles, he would expect a weaker signal. The same conditions apply in units as it does in tens of miles.

Turning now to Daventry, the site of our new high-power station, one must refer to projected plans and not to actualities. Midsummer, if our calculations are right and our sub-contractors are not let down by sub-sub-contractors (and they in turn by sub-sub-sub-contractors), should see the opening.

The New Stations

(Continued from page 381)

At the moment the top of Borough Hill, Daventry, is transformed from a wind-swept, lonely plateau to "a busy scene of feverish activity." There are men planning out the mast positions; builders at work with brick, mortar and wood; haulage men perched on petrol engines, puffing up the long light railway track from the roadside dump, and a host of technicians bringing together the material for our new station.

Two masts have to go up, each 500 ft. high or 1,200 ft. above the plains beneath. They are to be crowned by winking lights to warn aircraft from blundering into our precious T aerial. This, 600 ft. across its horizontal part, is to be of sausage formation; hoops of ash, 6 ft. in diameter, bound over with copper, will hold the six wires apart, lead-in and T part alike. The strain of the downward section is to be taken to three concrete anchors, while the wires are led through a lantern to the insulator below, and brought finally to join up with the inductance in the hut.

The "Earth"

The earth is a circle of plates 100 ft. in radius, buried 3 ft. in the ground. From the rim of the plates 36 wires, their strain taken by small stayed masts, concentrate upon the lantern. This is copper bound, and the junction of the radiating wires forms the earth.

Such an aerial and earth might well be envied by the man who would like to hear Radio-Paris on a crystal set!

A large earthing switch carefully isolating the set is to be used to avoid the effects of lightning and static changes when the aerial is not in use.

The building itself is divided into several rooms. The dimensions of the whole structure are 64 ft. by 116 ft. One room contains the machines, eight in all; the largest

to deliver 70 kilowatts and the smaller filament-lighting machines to deliver 10 kilowatts each. The power is brought up to a small sub-station at 11,000 volts, 3-phase, and is there converted to 375 volts

only naturally on a bigger scale. To avoid the necessity of building a speech choke with sufficient iron and copper to stand the necessary copper loss and iron saturation, a transformer will be used where the

feed to the oscillator on one supply will cancel the D.C. magnetising component of the control system fed from another supply. The choke is, in fact, a transformer with the D.C. components reversed upon one another to prevent iron saturation. This ingenious connection, due, I believe, to Capt. Round, of the Marconi Company, solves a potential difficulty in the design of high-power choke-control transmitters, since in our original conceptions we thought to have to build a special room to hold the choke alone!

The transmitter room is railed off from main gangways by iron stanchions giving access through safety gates, which when opened cut off the supply. Besides these rooms there is an instrument test room—a small room which also houses the land-line apparatus—where the impulses are magnified and corrected against distortion, and a small studio for test and announcement purposes.

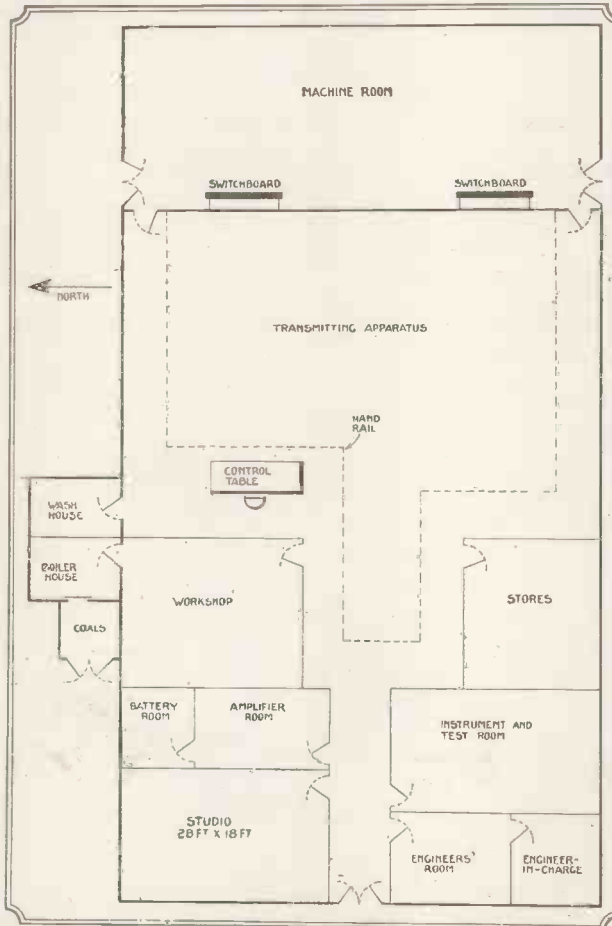

Proposed Layout of the Daventry Station.

for application to the prime motor movers.

We are to be connected to a ring main, so that if the cable or main generating plant should fail, we shall still obtain a supply on the other circuit of the ring.

The machine room will contain the necessary starters for the machines and a distribution switchboard for the output. The supply of the high-tension circuit will be rectified A.C., and the supply to the main transformers will be at 500 volts 300 cycles.

Water-cooled Valves

The valves themselves will be water cooled, and an elaborate water-circulating system with special insulating sprays will serve to dissipate the 30-35 kilowatts dead loss in the tubes. The set will be largely a replica of our standard arrangement,

We think that the station, when erected, will be unique and should satisfy a very large area of "crystal" population. Its radius of action to a crystal is practically wholly confined to land.

Although it was our hope to be able to erect the station nearer London, so as not to upset the many crystal users on the South Coast, and so as further to overcome the bugbear of ship jamming, one must admit that a more central spot for England could not have been chosen.

It is essential to realise, however, that the site was not of our choosing; we are a little apprehensive at having to use a long overhead land-line, but knowing the keenness and skill of the Post Office engineers and their ability to give us, and you, good service, we do not hesitate to shoulder a possible 5 per cent. factor of unreliability.

WAVELETS

It has been suggested that wireless sets should be installed in the parlours of Government houses. But is not this rather hard on those people who would prefer to have a sofa?

The short cut to dissatisfaction—accessories at cut prices.

The announcement that refrigeration can be broadcast as easily as music leaves us cold.

An inquirer asks—Do wireless waves bend? We are afraid we cannot give him a straight answer.

Welshmen have been protesting against a certain speech not being broadcast in Welsh. They ought to be grateful for the change.

The women want longer wireless talks on fashions. But unfortunately this does not mean that they will make the fashions last longer.

Gold is now being used for cat-whiskers. In Scotland, however, the new invention is naturally limited to pocket sets.

We must have truth in our wireless, says a prominent personage. Otherwise, of course, he might just as well stick to golf.

It having been proved that the sun interferes with wireless, we hear that the B.B.C. has arranged that it ain't gonna shine no mo'.

A band has recently broadcast from the bottom of a coal mine. We suspect that the performance must have been on a low level.

Now that dance music is so admirably magnified by wireless, perhaps somebody will try magnifying dance frocks, too.

ANSWER to correspondent: We have referred your query on interference to our mother-in-law. She seems about the most accomplished expert on the subject whom we know.

We are sorry that some of the wireless fans we know don't assist in clearing the atmosphere. On the contrary.

A NORTHERN amateur has been boasting in the press about his home-made portable loud-speaker. We shall be glad to see its birth certificate.

A NEW type of loud-speaker is said to be designed on the model of the human throat. We understand that its capacity is calculated in pints.

A FINSBURY Salvation Army officer says that men nowadays prefer wireless to whisky. An admirable spirit!

ANSWER to correspondent: No, the engines on the Southern Railway have not yet been fitted with wireless to enable the drivers to receive the time signal.

It is to be hoped that Our Dumb Friends' League has now overcome the outbreak of "howling" which has been interfering with its Committee meetings lately.

A LECTURE on golf has been broadcast. This is believed to be the first case on record where the rival crazes of wireless and cross-words have been combined.

WIRELESS has enabled a bazaar in Birmingham to be opened from 2 L.O. That's nothing; if the Prohibitionists get their way the pubs in Glasgow will be closed from Westminster.

A GYMNASIUM instructor in America is conducting a daily class in physical jerks over the wireless. With his words of command in the morse code, presumably.

PROFESSOR: And who discovered the crystal that is now in use in nearly every home?

ABSENT-MINDED STUDENT: Mr. Kruschen.

THE (LOUD-)SPEAKER CRYSTAL AT LAST



Prospective Customer (inspecting one of the latest "—ites"): "And is it really very sensitive?"

Shop Assistant: "Sensitive, sir! I should say so! Don't talk too loud or the bally stuff will answer you back!"

OVER half a million loud-speakers are said to be sold in America annually. It looks as though they use them to train the tourists they send over here!

AMERICA has a station with the call sign WOO. Evidently established for the benefit of those wireless widows of whom we hear so much.

LISTENERS are still writing letters to the Press about howling. Yet some of the papers in which the letters appear are the worst howlers that ever existed.

COPENHAGEN, we learn, has two wavelengths. Almost as good as the Southern Railway, which has two time-tables—one in print and the other in actuality.

THE Leeds-Bradford station is broadcasting lessons in the morse code on three days a week. We hope the matter will be brought before the N.S.P.C.C.

ITEMS from a London programme have been heard in Palestine. If we are not mistaken, the voice of Palestine is also occasionally heard in London.

AN American magazine has an article on the Radio Lyre. We have had experience of the same species in our local Wireless Society.

AT 2 SAVOY HILL, W.C.2.

THE informal international conference of European broadcasting authorities which took place recently in London was not of great importance in itself, but it undoubtedly marked the beginning of a transition period between what may be aptly called the national and international eras of broadcasting.

This is a case in which the progress of events has forced broadcasting authorities to move in advance of Governments. The next big international wireless conference will be held at Washington, probably early next year. Broadcasting is on the agenda, but wireless telegraphy occupies the place of honour.

The Official Mind

It is perhaps a symptom of the conservatism of the official mind that broadcasting is usually put in the background when wireless in general is being discussed. In point of fact, broadcasting is now of interest to many millions who think of wireless only in terms of their daily programmes. With the rapid development of new stations on the Continent and with a general tendency to increase power, all kinds of complications have supervened already.

In this country, in the Plymouth area, interference from Continental broadcasting is most pronounced and annoying. We (the B.B.C.) came to the conclusion that something would have to be done in advance of the Washington Conference. The Continental stations agreed, and delegates of most of the leading broadcasting authorities in Europe got together in London in March. They decided to set up a Broadcasting Bureau at Geneva.

This is to do much more than collect and distribute information. It is also to conduct negotiations aimed at getting round emergencies and the various "snags" that are constantly cropping up in what is still necessarily the early stages of the international organisation of broadcasting. The London conference did not get very far with the allotment and distribution of wavelengths and power, but they managed for the first time to pool all their difficulties and their requirements, and to make clear the state of their organisation and their plans.

A Page Specially Contributed by the B.B.C.

The Pirates' Claim

The second reading of the Wireless Bill has been deferred. The indications are that the Postmaster-General is quite prepared to meet the objections of those critics who take exception to the severity of the penalties. So far as broadcasting is concerned, the only really essential point of the Bill is that it should regularise the licence position and put a stop to a state of affairs in which about half of those who receive programmes pay for the programmes of the other half as well as for their own.

It is significant that already in some parts of the country where there has previously been organised abstention from licences there is now a rush on the Post Offices for new receiving licences.

More Alternative Programmes

If the Bill gets through in essentials, and there is every reason to believe it will, we should soon be receiving a great deal more money than at present. It is, of course, impossible to say quite how much, but various alternative schemes of expansion have already been completed, and there is no doubt that by the end of this year the British broadcasting services will be greatly improved and extended on both the programme and the technical sides.

The area of crystal reception now covers more than 80 per cent. of the total population of these islands, and 35 per cent. of the population can get some kind of alternative service also on a crystal. The soundest constructive criticism which is being made now is that more should be done to provide really alternative services.

For instance, there is substance in the argument that the best way to begin to deal effectively with the vexed controversy between high-brow and low-brow is to provide a new alternative service from London. This new service should be definitely and consistently of a high-brow character. It should be designed to

meet the needs of that influential minority which cannot tolerate popular programmes.

But no one should be forced to have this programme only; 2 L.O. should continue in its efforts to put out what might be described as a cosmopolitan programme of a definitely popular character.

It is true that the 5 X X programme is alternative for a certain number of people, but it should be remembered that 5 X X is also the only programme of perhaps an even greater number. What we shall try to do, therefore, will be to extend the principle of alternative programmes in order that more listeners may be satisfied all the time instead of, as at present, all listeners being satisfied only part of the time.

But there are many difficulties to be overcome before this policy can be made effective, and it is impossible as yet to indicate when new services may commence.

B.B.C. and Listeners

In all the Press discussion of wireless leagues and associations there has been no mention of the considerable organisations of listeners that are already in existence. As long ago as October, 1923, a listeners' club was formed in Aberdeen. It has proved very successful, both in stimulating interest in broadcasting and in providing suggestions to the B.B.C. Then, again, at Cardiff there is a "silent fellowship" of 8,000 registered members. This has now been transformed into a radio guild, with its own executive and independent organisation.

This sort of thing has been definitely encouraged by us all over the country. It should not be assumed, therefore, that up to the present the interests of listeners have had no sponsors. In point of fact, it is the interests of listeners that is the dominating consideration in our policy.

To prove this it is only necessary to remember that under our contract we were required to build only eight main stations; we have actually completed twenty-one—in pursuing a policy aimed at making our programmes available to the

(Continued on page 467)

THERE is such a decided superiority of women over men in this country (note the tactful way I avoid all mention of the hated word surplus) that there surely must be also far more women than men who listen-in.

I draw attention to this because it always strikes me as curious that the great army of feminine listeners-in is so little catered for. THE WIRELESS MAGAZINE is the first periodical to my knowledge which devotes space to the women's point of view, and as for manufacturers of sets—surely they're losing a golden opportunity in devoting all their energies to building equipment for men.

Sets that Run Themselves

Why won't the same kind of sets do for both men and women? Well, simply because of the wide difference in their attitudes towards broadcasting. To men, with their inherent love of what we women rather irreverently designate fiddling about, the more knobs and wires a set has the more delightful it must be.

But we women, despite a very occasional female engineer, not only don't understand wireless machinery, we don't want to. The necessary manipulation of our sets both confuses and bores us. We've always a sneaking conviction that something will blow up or catch fire or pinch our fingers.

What we want are sets (valve as well as crystal) which will run themselves. And I'm told, on good authority, that they can be got, only most women don't know about them and therefore don't ask for them. Sets, I mean, which are permanently tuned-in to one station, so that one has only to insert a single plug and listening-in becomes as simple as plugging in a reading lamp to its wall socket. There's never a knob to worry one. Phones, too, that allow one to walk about the room while they are on, so that a wandering cotton reel may be retrieved in the middle of a song or



one's nose be powdered at the glass without interrupting a symphony.

It seems to me that sets of this type, which practically run themselves, ought to be insisted on in every home where there is no man to do the adjusting, or where the womenfolk want to listen-in in the afternoon when paterfamilias is at the office.

Inventions that are Wanted

While I'm on the subject of ideal sets, may I drop a few hints to wireless inventors and enterprising manufacturers as to some improvements all women would like to have included in their listening-in apparatus. The first would certainly be phones which have no nuts or screws to catch in one's hair and break it.

Even shingled locks are not immune from this minor nuisance, and the long-haired suffer proportionately more. Phones which don't press too hard, and so avoid both sore ears and racking headaches after an hour of listening-in, would also be a boon. I've often given up in the middle of a fascinating programme because I really couldn't endure the pressure on my lobes any longer.

And would any kind inventor who sympathises with housewives please turn his attention to originating phones which drown all household noises save and except a knocking or ringing at the front door? It's a

The heading photograph shows Lady Muir Mackenzie listening-in with a self-contained portable set.

bit annoying, after a cosy evening given to the B.B.C. programme, to be met next day by one's best friend, who remarks very huffily:

"Your house seems to be a fortress nowadays. I knocked and knocked last night (it was raining hard, too), but you never came to the door, though I distinctly saw a light between the curtains."

No Shop, Please

I wonder what the average woman thinks about the

suggestion, made from time to time in various quarters, that the B.B.C. should adopt the American plan of broadcasting daily the current market prices of foodstuffs?

For myself—No, a thousand times NO. It's bad enough to have to endure (or skip) every evening those dull barometer readings and duller football results, without being given the superlative boredom of having our job thrust upon us out of working hours. Wireless is a relaxation; so let's not have to associate it with "shop," please.

Besides, what good would food prices be to us in the afternoon or evening, when our day's marketing is long done? To be of any use such an item would have to be broadcast at 9 a.m., when not one housewife in a hundred has time to listen.

Those Hoary Jokes

There's one blessing wireless has brought to women which I've never heard them comment on, though it's a very real one. I mean that it's given men a whole set of (comparatively) new jokes against their sisters and their cousins and their aunts; and given the said sisters and cousins and aunts the relief of reflecting that they've only heard *this* one (the "loud-speaker" gibe, for instance) a few dozen instead of a few thousand times.

To be fair, I suppose women have their hoary witticisms against their lords and masters, too, but don't notice how ancient they are. Perhaps some man will write and give me a list of them. A. M. M.

CRYSTAL SET CONSTRUCTION

*In Successive
Pictures*

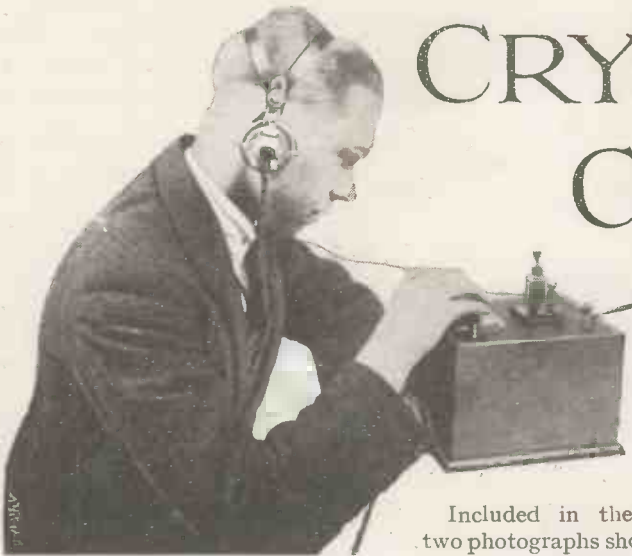

Included in the illustrations are two photographs showing the cabinet. This may easily be made by the amateur able to handle the usual

if these are followed the case should be the exact size for the set.

THE set illustrated in the accompanying photographs is variometer tuned, and embodies the usual crystal-set circuit. The variometer used in the original set was an Igranic giving a wavelength range of between 300 and 500 metres, but any other good make of variometer may, of course, be substituted.

It will be noticed that four fillet pieces are fitted into each corner of the cabinet. These are triangular-shaped pieces of wood, and are glued in position so that when the panel rests on them it is level with the top of the case. The panel may be fixed in position by being screwed to the fillet pieces with $\frac{3}{8}$ in. countersunk brass screws.

Used in conjunction with a good aerial and earth no difficulty should be experienced in operating three pairs of phones from this set providing the distance from the local station does not exceed 20 miles or so.

It should be noted that in making the case it is preferable to use brass screws throughout. The choice of wood for the cabinet will depend on the taste and pocket of the constructor, but if a neat, well-looking case is required, no wood will be more suitable than well-seasoned mahogany.

With the aid of the two photographs of the underside of the panel showing the wiring, it should be an easy matter to connect up the set once the components have been assembled, but in case there should be any difficulty in this direction we give a circuit diagram herewith.

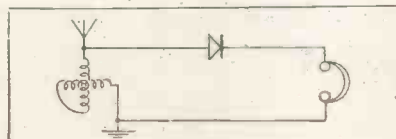

Circuit Diagram.

COMPONENTS REQUIRED

- 1 Ebonite Panel, 7 × 5 in.
- 1 Variometer (for broadcast wavelengths).
- 4 Terminals.
- 1 Crystal Detector.
- Tinned-copper Wire.

simple woodworking tools. The principal dimensions of the cabinet are given in the photographs, and

The parts required for constructing the receiver are given in the preceding column. If possible, only those parts specified should be used, but if any departure from the list has to be made the parts substituted should be of equal quality to those specified.

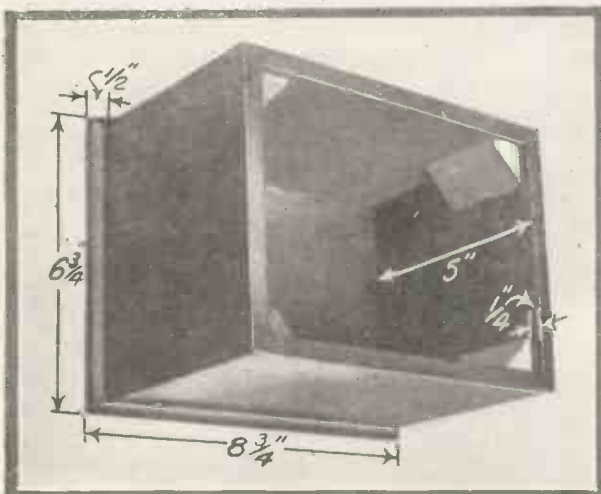

Fig. 1.—Cabinet Showing Positions of Fillets.

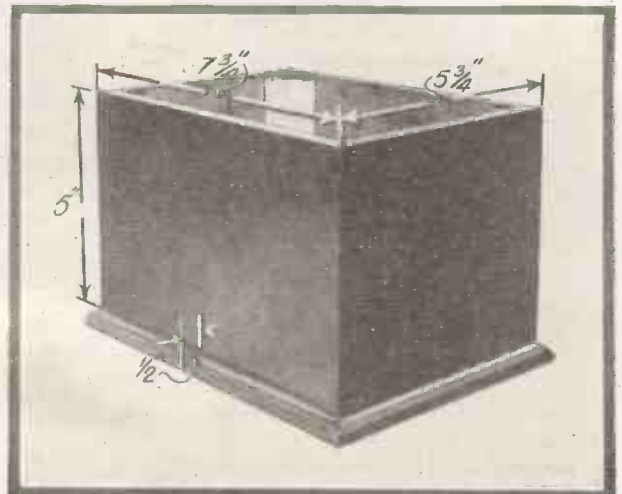

Fig. 2.—Cabinet with Principal Dimensions.



Fig. 4.—Disposition of Components.

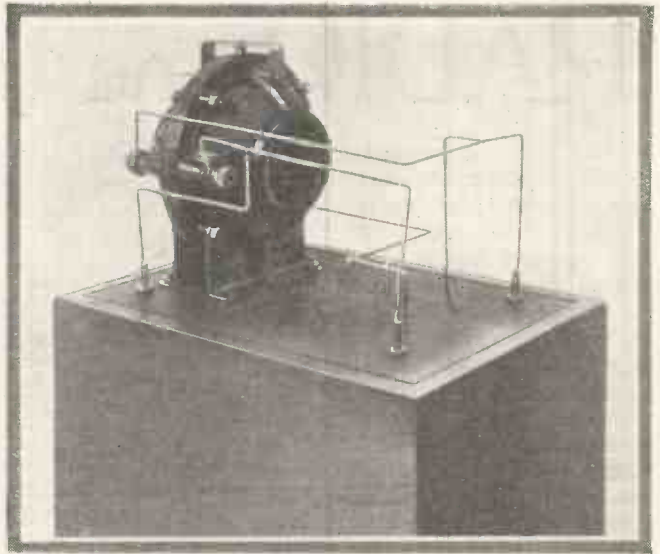

Fig. 5.—Underside of Panel, showing Wiring.

The first operation in constructing the set will be to drill the panel as shown in Fig. 3. After this has been done the components should be mounted as shown in Fig. 4. Commence wiring the set by referring to Figs. 5 and 6, which show views of the wiring on the underside of the panel from opposite sides. A cabinet for the receiver may be easily made by the aid of Figs. 1 and 2. In these two photographs are shown the dimensions of the

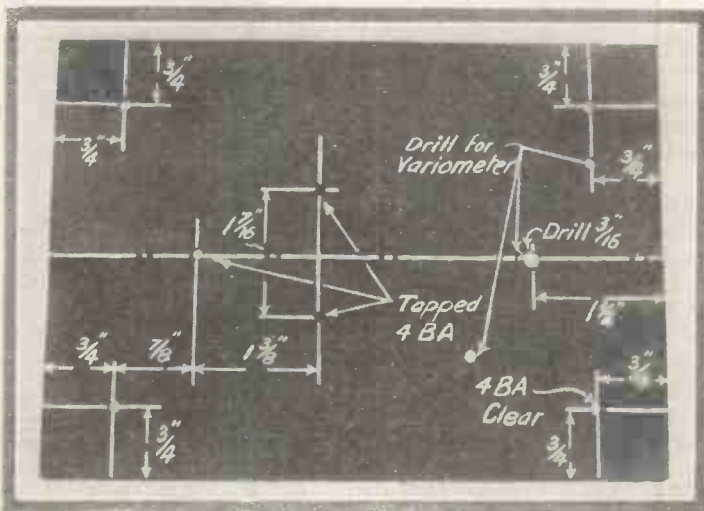

Fig. 3.—Panel, with sizes and positions of holes indicated.

cabinet and the positions of the fillets that support the panel.

In the cabinet illustrated no elaborate wood-working joints are used, as these are unnecessary in a case for such a set as this. When finished the case will be greatly improved if it is french-polished, though a good varnish will give a passable result.

Before either french-polishing or varnishing the case, it should be thoroughly sanded and all holes filled with beeswax.

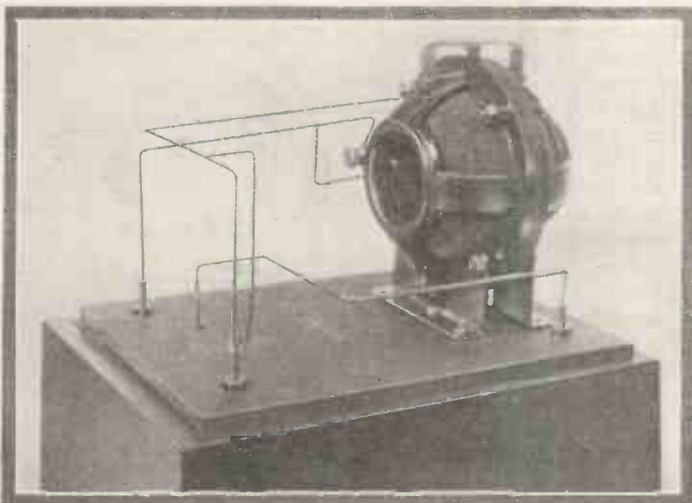

Fig. 6.—Another view of wiring.



Fig. 7.—The Set complete.

RADIO and the RUSTIC

IN the beginning I must beg of you not to run away with the idea that my liver is laid up for repairs. Nothing of the sort. Nor have I been missing my morning pinch; though I confess that last Tuesday, not having a sixpence in the house with which to measure my diurnal dose, I took enough to cover five pennies and two ha'pennies. After which, so full of the curdled milk of human kindness did I become, to say nothing of beans and pep and vim and verve and abandon, that I went out and leaped over seven five-barred gates, bent a couple of lamp-posts, and was rude to a police inspector.

Believe me, my friends, I am actuated in this matter by no other motive than a fervent desire to rouse the country to a sense of the danger, I might almost say the doom, which threatens this Empah on which the sun never shines. Very well, then!

For unless something is done, and that right soon, this great commonwealth of nations, this tight little island set in the silver what'sname, as W. Shakespeare, Esq., observes, this happy land will be in both the soup and the cart, even as our old friend Gibbon declined and fell during the Wars of the Romans.

However, we don't seem to be getting any further, so perhaps it would be as well if I told you what I'm talking about. That's if I can find out.

And what, I ask, what is the foundation of this aforesaid Empah?



THE YEOMAN OF ENGLAND.

Showing Gaffer Mumblegum, the jolly farmer, before the introduction of Wireless.

(From a gin-and-water colour.)

Being another "JOKING APART" article by F. W. THOMAS of "Star" fame

"Illustrated" by Himself

Is it the Stock Exchange? Nope! Man cannot live on bulls and bears alone. Is it the Army and Navy? Nope again; though I admit that not once nor twice in our rough old island story these institutions have come in rather handy.

No, gentlemen; it is the Yeomen of England who are the salt of our earth. The farmers. The gentlemen with the rural chin-whiskers and the muck on their boots. The Gaffers and Jarges who call the cattle home across the sands of Dee and other holiday resorts. It is on these that our hope is founded.

For Radio—Radio, my friends, Romans, and countrymen, is ruining the farmer. Our agriculture, our turmuts and carrots, and with these our very life blood, are threatened with extinction; and I repeat that unless something is done ere it be too late, it will be too late to do anything.

Let me expound.

Years ago, before George Stephenson had been invented, before the income tax became ambitious, in those far-off days when St. Paul's Cathedral was but a little tin church, and the G.P.O. merely a pillar-box, I used to spend my summer holidays on a farm in Sussex. A real honest-to-goodness farm it was, furnished with heaps of manure and stuff, and a gaffer with hair round his chin to keep his chest warm in winter, and a large and penetrating smell of pigs.

Happy days! I would get up in the morning, every morning, and with a song on my lips, I would sally forth to milk the kine and pick up the eggs, the new laid and the merely fresh; or go round to the pigs to gather a fresh rasher for breakfast.

My host was the aforesaid farmer with the face fringe, one Gaffer Mumblegum; a truly rural speci-

men, of the good red earthy earth. And it was my delight, when the day's work was done, to sit in the ingle nook and listen to the old gentleman talking of hops and crops and wopse and other horticultural gossip.

He was a fine specimen, was the Gaffer, and his low rumbling accents were so broad that he had to stretch his mouth from ear to there to let them come out.

"Ooooooy, laaaad," he'd say; "them be a main grumptions lot of yobbles, them be. Us'll get up early to-morrer and swish they clubbocks before they'm so as to be what you might call snitchled. And then there be they warmles. They'm all vetched to blazes, and the cloom's creeping up on 'em, and 'fore we knows where we are they'll be too murglesome to eat."

That was the sort of stuff. Maybe there are one or two words that I didn't hear correctly, but that was the spirit of it.

Somebody says somewhere that the greatest benefactor of the human race is the man who makes two brussels sprout where but one sprouted before; and if that be true, then you and I owe the Gaffer more than we shall ever pay. For he dug and delved, and ploughed and mowed, and reaped and sowed, and tickled the earth and made it laugh with plenty. He gave us corn for our bread, oats for our porridge, eggs for our elections, and mash for our sausages. He provided the



THE SAME GAFFER.

Listening to the Children's Hour when he ought to be curling his kail. He is now wearing his patent wireless whiskers.

(From the cast-iron engraving by Gosh.)

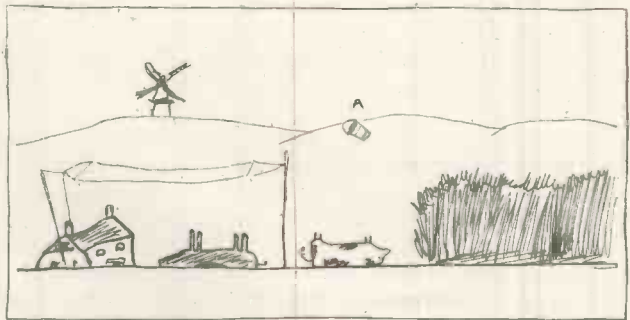
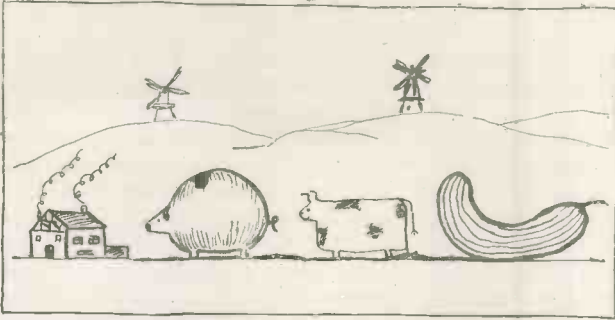

(Left) Mumblegum Farm in pre-radio days, showing Ethel the Prize Pig, Rudolph the Bouncing Bullock, and James the Gigantic Marrow. (From a firewood cut after Mr. Sidney Cooper—or was it Gladys?) (Right) Mumblegum Farm to-day. The homestead, you will observe, is tumbling to pieces. All the fires are out, the pig has become pork,

and Rudolph has kicked the bucket. (Bucket shown at A.) There is now only one windmill, as owing to the Gaffer's neglect there isn't enough wind for two. The beautiful crop on the right consists of thistles. The Gaffer is indoors trying to get Copenhagen on his super-regenerative-reflex four-valver.

ladies with flour with which to camouflage their noses; and produced the wool for their powder puffs. He gave us onions to go with our steak, pork for our chops, and horse-hair for our sofas. And always he had a song in his heart, a jolly ballad all about manure and bone-meal, that would have made the welkin ring had there been one in those parts; which there wasn't, owing to the Lord of the Manor having pinched and sold it to an American millionaire in order to clear the mortgage off the cow-shed.

Such was Gaffer Mumblegum. A real Briton, as honest as the day, providing you kept your weather eye on him; as upright as his trousers would permit him to be, which wasn't a lot; because when he stooped you could hear the things creaking in their more vulnerable parts.

But what of the Gaffer to-day? Ah, my friends, echo answers, "What?" (N.B.—A common or garden echo would, of course, answer "To-day," but this is a patent contraption, guaranteed to answer "what" on the slightest provocation.)

What, I repeat, of the Gaffer to-day?

Well, I went down not long since to stay the week-end. And as I trudged up the long white road from the station I thought of the jolly restful time I was going to have, far from the madding crowd's ignoble strife and all that sort of thing; of the healing peace, the lowing calves, the new-laid milk, and so forth.

And here, bless his old gums, here was the Gaffer himself, striding across the plough to meet me.

"Whoi," I said in the local patois. "Whoi, if it bent Mus'r Mumblegum sure-ly, so 'tis an' all. How be it with you, Gaffer? How

be the oold hoss, and the oold dun cow, and the gert old pink vat hog as did look so promising last year?"

"Oh, quite well, thank you," he said; and at his voice you could have knocked me down with a battle-axe. You could, honest! Gone was the soft and soothing speech, gone the open vowels and broad accents. Oh, what a fall was there, my countrymen! He reminded me of Mr. Palmer.

And then I saw close against the Tudor farm house, a thirty-foot pole and a single wire. At which, I wept full sore.

Later I was taken indoors and introduced to Mr. Mumblegum's four-valve super-heterodyne, with regenerative reflex, ditto detector, how-d'ye-do whatname, and little oil bath.

He had built it, he told me, in order to get the weather and market reports, to know when was the best time to sell his hogs and sow his wheat. But had he sown any? Not a stitch!

Night after night, when he should have been asleep, he sat by the fire twiddling the thing-me-jigs, fishing in the firmament for Paris and Aberdeen, raking the ether for Cardiff and Nijni-Novgorod.

Thus the morning sun, which should have found him up and doing, weeding the cabbages or encouraging the lal to curl, saw him still abed, his nose protruding over the top sheet and emitting porcine oscillations. Meanwhile his cows went un-milked, his pigs put on no superfluous flesh, his hens laid when the fit took them, and the only mangel in the place was the one in the wash-house which was rusty.

The whole farm was rapidly going to rack and ruin, while the Gaffer himself wandered about his land, knee deep in weeds, and singing, not

the "Farmer's Boy," but "In a Monastery Garden." The bit at the end where the orchestra lays aside its wind and percussion instruments, and makes vocal noises likely to cause a breach of the lead-in tube.

Time was when Master Mumblegum would show me with pride a monstrous marrow that he had reared by hand, or a runner bean that I mistook for a cucumber. To-day he no longer boasts of his prowess in this field, but tells me lies about Schenectady, and how he nearly got WOP and WOW and BYF the night before last.

And where was the peace and rest, the sweet seclusion that I had been led to expect, the healing balm for my jaded nerves? As I lay in my little bed, wropt in slumber and dreaming of lilacs, and sucking-pigs, and nightingales, and other rural amusements, there came to me one night the Gaffer, wildly excited, shaking me rudely by the shoulder, and driving away my dreams so that I sat up in bed, wide-eyed and wondering?

Was it a rick fire? Had the old dun cow died? Had Mistress Mumblegum contracted croup in the wee small hours? "Not a bit of it.

"Never mind about your trousers," he said. "Come down as you are. There's not a minute to lose. I've got WEAF as plain as a pikestaff."

Well, I am a kind-hearted sort of fool. I did not rise up in my wrath and my pyjamas and smite that old idiot with a bed knob. Because there weren't any knobs on the bed. I did not strangle him and throw his corpse to the sucking-pigs, because there weren't any sucking-pigs. He'd sold 'em to buy a new condenser. I got up, even as he bade me, and went down into his cold back room to hear this wonder; to see what America had to say.

And this, so far as I can remember, was what I heard:

Krrrrrk Weeeeeeeeeooooooo
iiiiiekrk! Wubblewubblewub-
blewubble! Kkkkkkrrrrrrrk!
Werkwerkwerkwerk! Weeeee-
iiiiiooooouuuuuu! Swish!
Bang! Wallop! Wallop!
Bang! Swish! Krrrrrrrkeeee-
iiiiiooooouuuuuu!

Which may or may not be true. I am not sufficiently acquainted with the niceties of the American tongue to say.

"Isn't that wonderful?" said the Gaffer. "Don't that thrill you to the marrow of your bones?"

"Yes, it does," I said. "It chills me to the marrow of my bones, and I'm going back to bed. It is 3 A.M., and nearly time you were getting up to milk your cow and clean her teeth, and plough and sow and reap and mow, and be a farmer's boy-o-y-o-y, and be a farmer's boy; and if you don't soon go to bed you'll meet yourself coming downstairs."

With which I departed in high dudgeon. Some of the highest dudgeon I have ever departed in.

Sure enough, when I arose next morning Mumblegum was still abed, waking the echoes with his nasal obbligato; and when I went out to look round—well, you never saw such a sight. Talk about neglect. There were his two old sows, looking as if they hadn't had a wash for months, simply wallowing in filth, and judging by the guttural noises they made, bung full of neglected adenoids and enlarged tonsils. There was the old dun cow, very dirty and disreputable, and saying "Mer-ooooo!" in a plaintive voice, which is cow language for "Nobody loves me, and where's my breakfast?" And on the big three-acre field, where once grew corn, was nothing but a bumper crop of crows.

As for Mrs. Mumblegum—well, she listens to the cookery stuff and copies out the recipes, and when something goes wrong with the set and the voice fades, she makes up the missing ingredients out of her own head.

Thus, you see, instead of the rural Roast Beef of Old England, with boiled pud'n and spuds, we get *tortue claire*, devilled rissoles à la Botticelli, and *pommes accumulatores*,

with the result that the Gaffer is losing flesh.

To sum up, wireless is having a dreadful effect on our agriculture, and a still worse effect on our agriculturists. Farmers may be getting WEAF all right, but they are losing their sleep. The land is being neglected, the stock is deteriorating, and men who once lived for nothing but sulphate of potash and stable refuse, now think only of reactions and condensers.

Starvation stares us in the face, and presently, when the food shortage gets acute, we shall ask for bread, and they will give us an ohm. Which is very sad and ought to be seen to.

BACK-ANSWERS TO CORRESPONDENTS

PERPLEXED:—Yes, George, all that mess of wire inside the box is part of the gadget. That's why it is called wireless. The fact that you

I didn't. He was before my time.

NEXT DOOR:—Yes, a really efficient loud-speaker is very useful for removing green fly from rose trees. It deafens the insects, and then they can't hear you approaching with the tobacco juice and soft soap.

SUPER-SET (Sydenham):—As you say, the Crystal Palace ought to make quite a good earth. Solder your wire on to the base of the North Tower when nobody is looking.

BARNEY GOOGLE:—You have won your bet. "It Ain't Going to Rain No Mo'" was not written by Beethoven.

CURIOS:—As you say, it does seem unnecessary to take Percy Scholes to Newcastle. In reply to your second query Wagner is pronounced Wagner, but some people pronounce him rotten.

ENQUIRER:—The tune of "In a Monastery Garden" is roughly as follows: "Deedle doo-dah, doo-dah, doo-dah; deedle doo-dah, doo-dah, doo-dah."

ESMERALDA:—Yes, I have noticed that Philemon always sounds as if he'd just run up seven flights of stairs. I expect his Window is on the ground floor.

GENEVIEVE:—Maybe the silk hose that you were drying on the aerial blew across to the next door wire, and thus caused a short circuit. Why not wear elastic stockings?

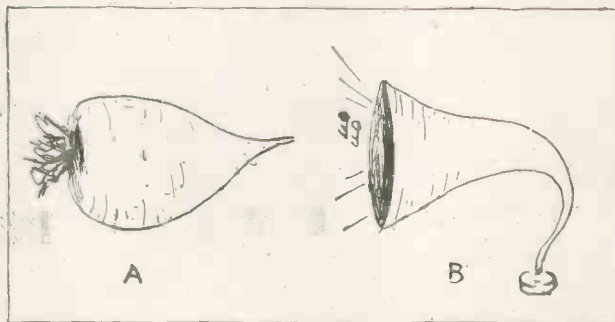

Showing at A, a beetroot grown by Mumblegum in 1919. At B, same beetroot as grown to-day. Taken from life.

have taken it out and used it for pipe-cleaners probably accounts for the fact that you can't get Halifax. If you don't put it back you'll get hell, I shouldn't wonder.

EXPERT:—Oh, yes. With a nine-valve set at Golders Green you ought to be able to bring in 2 L.O quite strongly. Perhaps you've forgotten to pay your licence.

GRANDAD:—If the children complain about your fox-trotting until midnight, get rid of them. The feeding at Dr. Barnardo's, I am told, is quite good.

PUZZLED:—Probably the oodlum-gadget has fouled the B.F. or the O.P. If it isn't that, it is very likely something else. No, a candle stuck in a beer bottle makes a poor substitute for a dull-emitter valve, and I cannot recommend it.

ANXIOUS:—Wireless was originally discovered by Hertz. He is now dead. I can't say who killed him.

The Use of Potentiometers

THE potentiometer is one of the most important components incorporated in a set employing radio-frequency amplification. By its use the radio-frequency amplifying valves are controlled so that the set is brought to its maximum point of sensitivity without danger of oscillation.

Apart from use with amplifying valves, however, potentiometers may also be used with beneficial effects for controlling the high-tension supply to the plate of the detecting valve. When so used it is to the high-tension battery what the fine tuning adjustment is to the condenser—a means whereby a finer degree of control is obtained.

"TERMINAL."

Novelties and New Apparatus of the Month

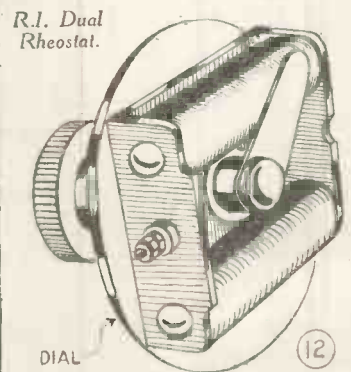
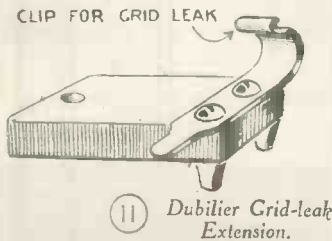
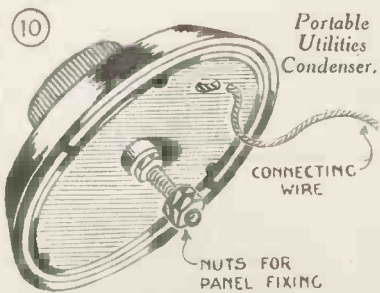
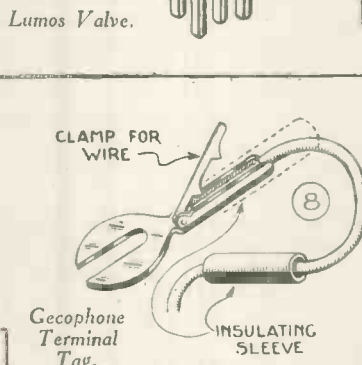
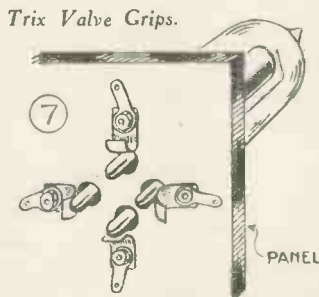
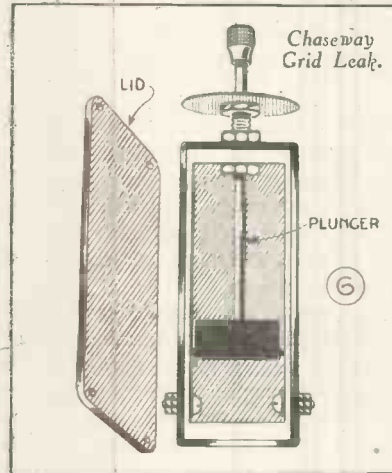
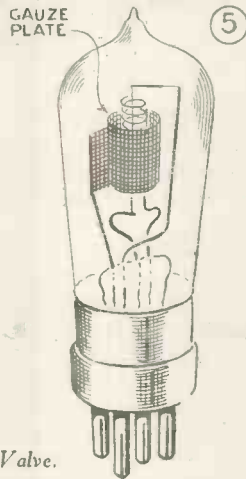
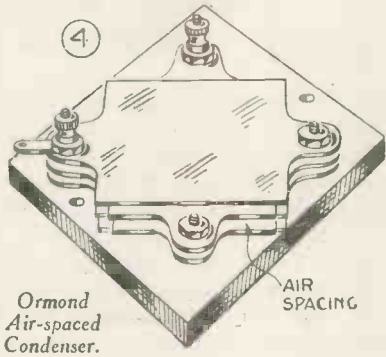
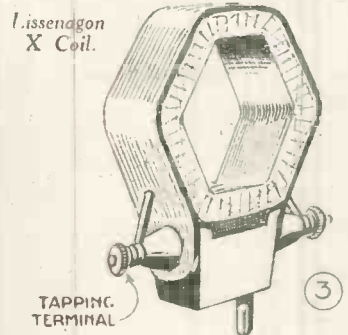
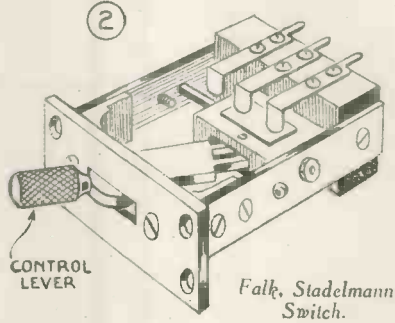
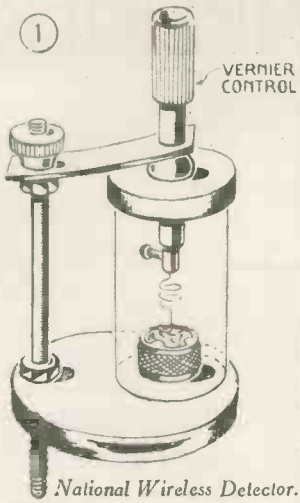

(For Description see page 456).

BUILDING A POWER AMPLIFIER

When is an amplifier a power amplifier?

When it has special-ratio transformers, when the valves used are individually suitable for these transformers, when a high value of high-tension is used & when grid bias is incorporated.



This article describes in detail how to build & operate a power amplifier specially suitable for working a big loud-speaker. This amplifier has been carefully designed, built & tested in "THE WIRELESS MAGAZINE" WORKSHOP.

THERE seems to be a large body of opinion to the effect that the loud-speaker is a very imperfect instrument, whereas if the truth were only known the fault probably lies in the actual receiving and amplifying apparatus.

Good loud-speaker results cannot be obtained by pushing reaction up to the limit and adding a stage of low-frequency amplification, using a cheap transformer and an ordinary valve. A good low-frequency amplifying valve should possess a characteristic curve having a long straight portion for a comparatively large part of its length.

The curve of an ordinary receiving valve possesses only a small straight portion, and if the power is pushed up too far that part of the characteristic on which the valve is working includes regions having an appreciable curvature. Furthermore, distortion is introduced by the valve if "grid current" is flowing.

The amplifier here described has been designed so as to give sufficient power to fill a large room without distortion when connected to an

existing valve detector. Provision has been made by means of two "push-pull" switches for cutting out one or both valves as required.

Circuit Diagram

Referring to the circuit diagram, Fig. 1, it will be seen that an extra negative grid potential is applied to both of the valves through the secondary windings of the two transformers. Unless a negative potential is applied to the grids during each cycle of current from the transformer there will be a period during which

Too much negative grid potential would move the operating point of the valve from the middle of the straight part of the characteristic curve. The most suitable voltage is best found by experiment.

In Fig. 1 a .001-microfarad condenser is shown across the primary of the first transformer; this may be omitted if there is already one across the output of the detector unit.

Returning to the circuit diagram, it will be noticed that the usual connection between the H.T. and L.T. batteries has been omitted.

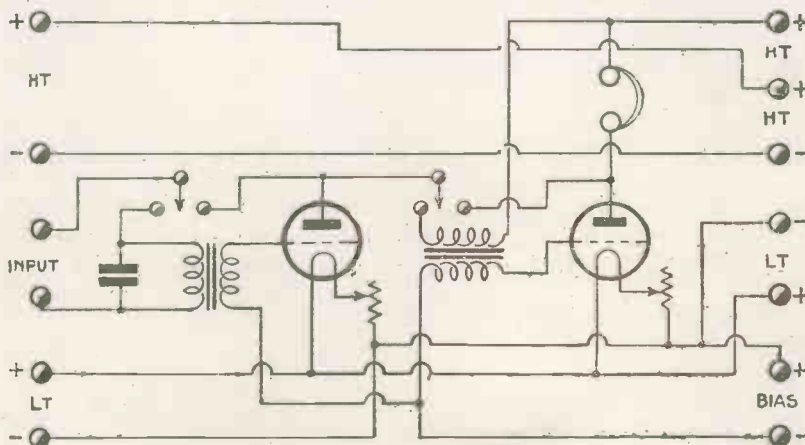

Fig. 1.—Circuit Diagram.

the grid is positively charged, with the result that grid current will flow, causing serious distortion.

This may be remedied by the insertion of a "grid-biasing" battery consisting of a few small dry cells.

This connection is, of course, made in the valve-detector unit.

Extra terminals are provided for cross-connection of the H.T. and L.T. batteries to the existing valve detector.

The components required for the amplifier are:

- 1 ebonite panel, 10 in. by 8 in. (St. Helens Cable Co.).
- 2 valve holders (Aermonic).
- 2 valve windows.
- 2 filament rheostats (Burndept "Dual").
- 2 L.F. transformers (Rauland).
- 15 terminals.

(Continued on page 394)

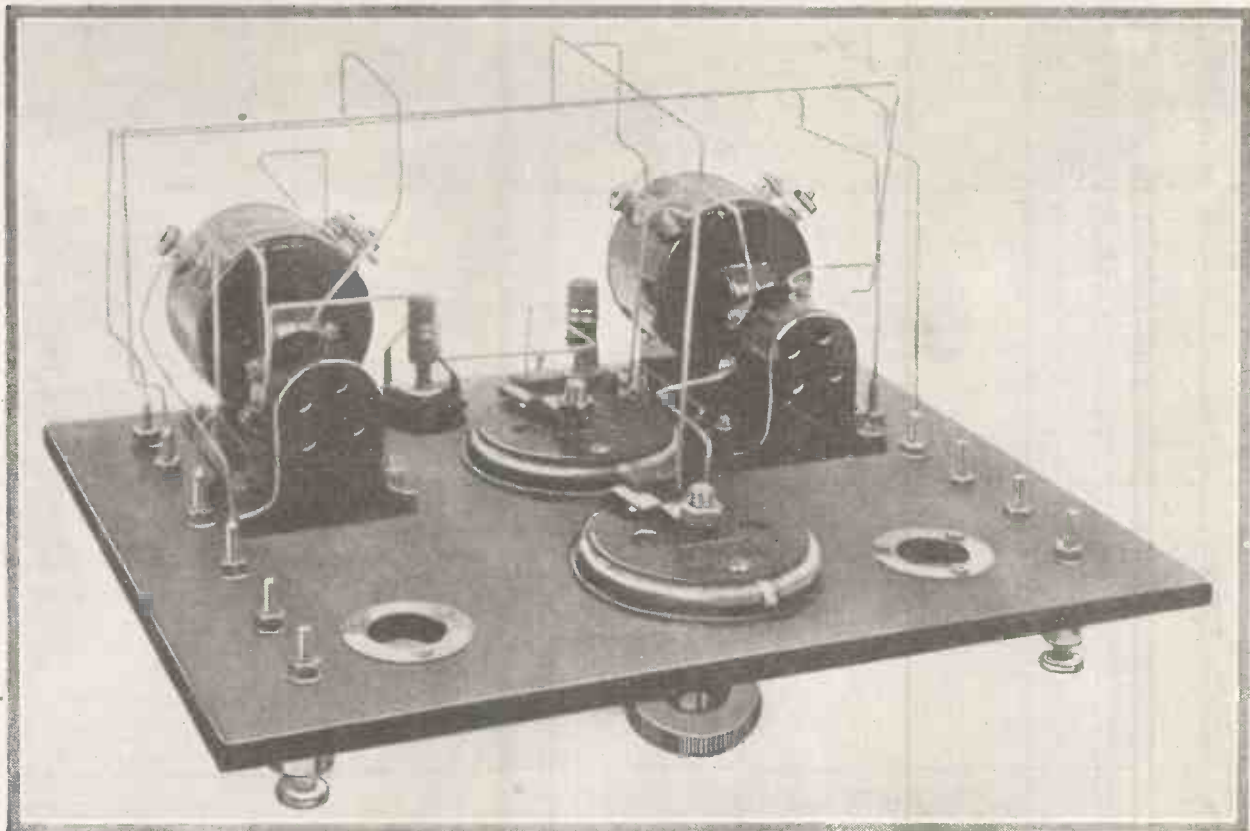

This view shows clearly the wiring and positions of the filament resistances.

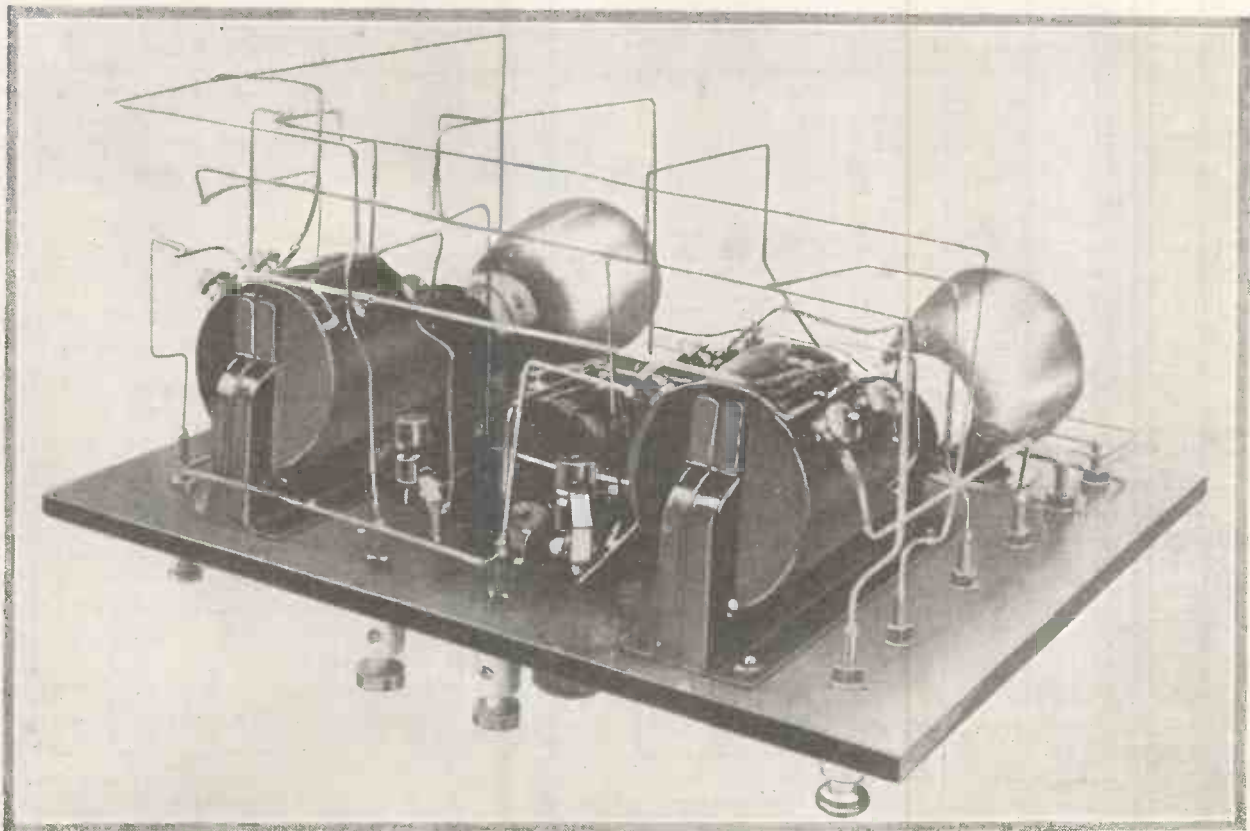

Another view showing the positions of the transformers and switches.

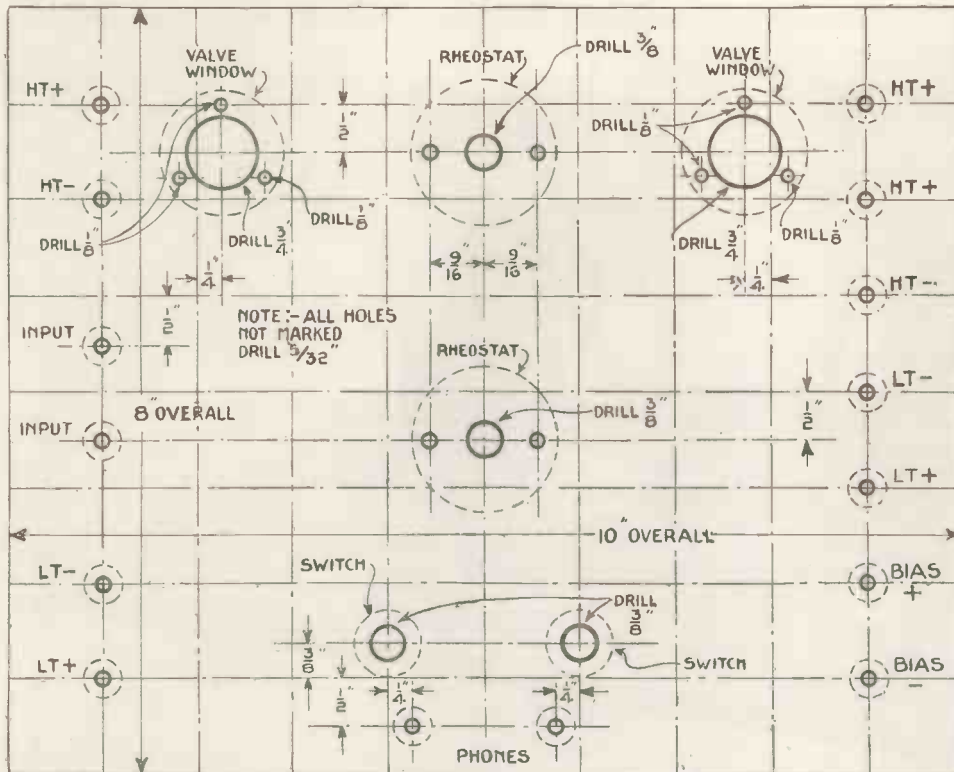

Fig. 3.—Half-scale Layout of the Panel.

1 .001-microfarad fixed condenser (Lissen).

2 "push-pull" switches (Lissen 3-point).

2 power valves (Mullard D.F.A.1).

1 100-volt H.T. battery (Ediswan).

1 sloping oak cabinet to suit panel.

A dimensioned sketch of the cabinet is given in Fig. 2. It may be obtained, however, ready made from Henry Joseph & Co., of Victoria Street, London, S.W.1

The panel may be obtained cut to size from the St. Helens Cable Co., of Slough. A drilling diagram of the panel is given in Fig. 3.

Mark out on a piece of paper, cut to the size of the panel, the centres of all the holes to be drilled. Lay the paper flat on the panel and mark the centres of the holes with a sharp steel point.

With the photographs and the wiring diagram

no difficulty should be experienced in mounting the various components. The .001-microfarad fixed condenser placed across the input terminals is

The connecting-up of the amplifier is simplicity itself. The two input terminals are connected to the
(Continued at bottom of next page)

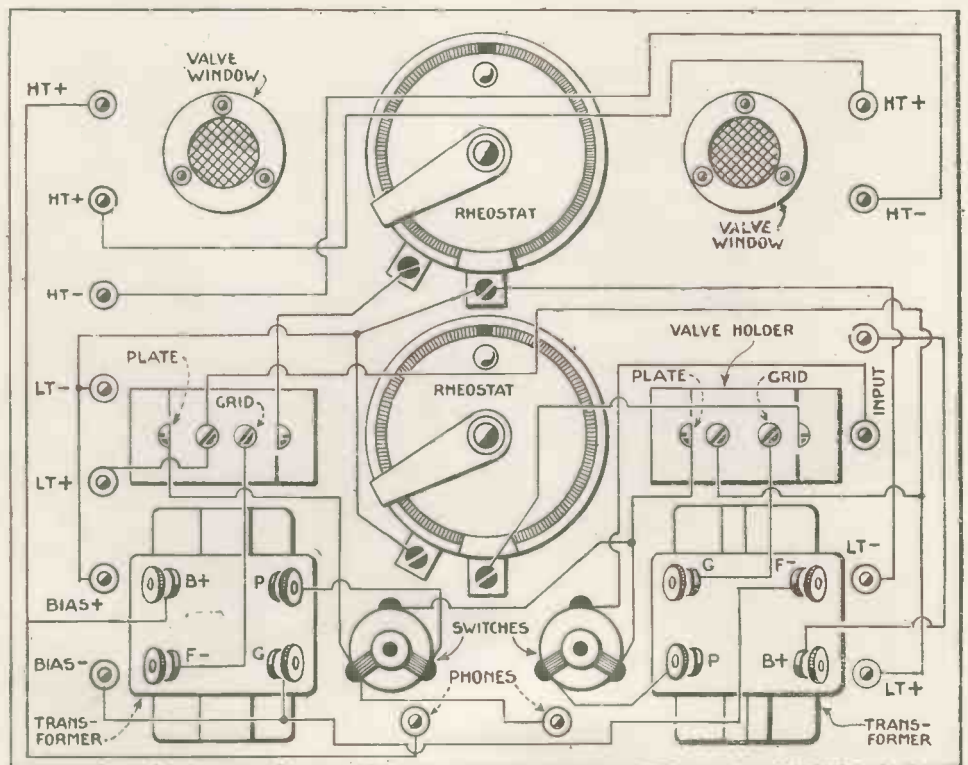

Fig. 4.—Wiring Diagram of the Power Amplifier.

held in position by the stiff wire connected to it.

Start wiring up the filament circuit and the switches first and see that no wire passes over the tops of the valve holders, otherwise it will be impossible to plug-in the valves. Wire up as shown in Fig. 4.

Burndt "Dual" filament rheostats make possible the use of dull- or bright-emitter power valves.

In the actual amplifier Mullard D.F.A.1 valves gave excellent results.

To eliminate a tendency to oscillate at low frequency it was necessary to reverse the secondary of the last transformer, that is to connect terminals F and G to grid and L.T. — respectively, as shown in Fig. 4. This may not be necessary in all cases.

Economy in High-tension Batteries

THE high-tension battery is often a constant source of annoyance and capital expenditure, mainly owing to the fact that the amateur does not appreciate that the small cells of which it is built have a very small storage capacity. Any prolonged drain on the average battery considerably shortens its useful life, and this often occurs when a set using three or more stages of valve amplification is used.

For this reason alone it is advisable to use grid-bias batteries on the audio-frequency amplifying valves, as by the use of a suitable negative potential valve on the grids of these valves the anode dissipation can be halved. An added advantage is that the signals will be strengthened and rendered clearer.

The higher the potential or value in volts of the high-tension battery the more current will the valves "draw" from it, so that particular attention should be paid to grid bias where potentials exceeding 60 volts are used on low-frequency amplifiers.

High-tension batteries should never be tested by a flash-lamp bulb or a moving iron voltmeter. Most pocket flash-lamp bulbs take about 2 to 3 ampere at $4\frac{1}{2}$ volts, and as

the maximum allowable current which should be drawn from the battery should be limited to about 12 milliamps., if a long life is hoped for, the withdrawal of 200 to 300 milliamperes by means of the bulb is a serious matter. Some amateurs make a practice of using this bulb about once a week, and there is no doubt but that the life of the battery is reduced by at least one-third of the possible life by so doing.

Valve Consumption

If it is imperative to test the high-tension battery this should be done by means of a moving coil voltmeter having a resistance of at least 40,000 ohms. Such instruments are now obtainable at a very low price. The best method of high-tension battery testing is, however, by means of a milliammeter inserted in the anode circuit of the last amplifier valve. The average current consumption of a hard amplifier when the filament voltage is at 4 volts and the anode voltage about 75 volts, is one and a half to two and a half milliamperes when a negative grid bias of $1\frac{1}{2}$ volts is used.

A still better method is to use the milliammeter when the battery is

new and note the anode current. After six months the battery is again tested in the same manner, and if any considerable drop is noted in the current, the battery may as well be discarded, but with a three-valve set a ninety-volt battery should last quite nine months with fair treatment. A. J. C.

A Wireless Proposal

DEAR Margot, listen in, I pray,
I love you more than I can say,
But though I long to know my fate
My heart begins to oscillate.
I know your other suitors are
Loud-speakers, bolder men by far;
I've not proposed to you, alas!
Because I am a tongue-tied ass.
But wireless makes me unafraid,
These words of mine have been re-
layed,

So put your earphones on, my dear,
And my impassioned pleading hear.
Ah, if you only will agree
To marry a poor chap like me
We will—starting with our relations—

Broadcast the wedding invitations!
L. M. O.

(Continued from previous page)

phone terminals of the valve detector unit, while the H.T. and L.T. terminals on the left-hand side of the panel are connected to the H.T. and L.T. terminals on the detector unit.

The H.T., L.T. and grid-bias batteries themselves are connected to the proper terminals on the right-hand side of the panel.

Next, connect a pair of phones to the phone terminals on the bottom of the panel. Push the two "push-pull" switches right in and tune in signals on the valve detector in the usual manner.

The loud-speaker is then connected up in place of the phones and one or both of the switches pulled out, thus bringing either one or both stages of L.F. amplification into action. The grid-bias battery should then be adjusted until distortionless signals are received.

It will be noticed that three H.T.

terminals are provided on the right-hand side of the panel. Reading downwards from the top these are extra + H.T., normal + H.T. and - H.T.

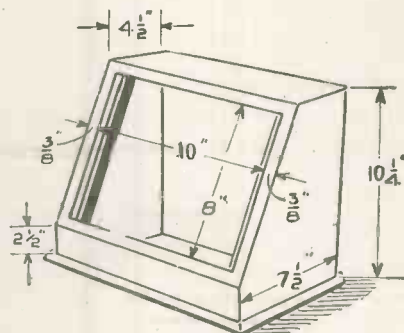

Fig. 2.—Details of Cabinet.

The normal + H.T. terminal is merely carried through the amplifier to the H.T. terminal on the detector unit, thus ensuring that the plate of the detector is not

supplied with the high voltage that is necessary for the power valves.

As a guide to the beginner, the following voltages are suggested: grid-bias battery, 3 to 6 volts (there should be means of varying this voltage, a tapped battery for this purpose being obtainable from Edison Swan, Ltd.); high-tension battery, 100 volts, tapped at 60 volts for normal H.T., and at the full 100 volts for the extra H.T.

A SCOTTISH inventor has designed a wireless instrument for broadcasting moving objects. This will be decidedly unpopular amongst most political speakers and dud music-hall artistes.

It is said that there are several ways of treating crystals that have lost their sensitivity. We are afraid, however, that the formula for treating would not be of much interest, especially to our Scottish readers.

The Wonders of the Electric Current

QUITE a number of beginners find it very difficult to understand wireless properly because they know so little about electricity. There are many, too, who, though by no means beginners, have but a very slight knowledge of the elementary principles of the great force which is behind it all.

Were a score of wireless experts asked to describe, for instance, the working of dry cells, such as those used in the high-tension battery, I very much doubt whether five of them would score full marks.

In this article it is hoped to be able to introduce the reader, if he is not already familiar with them, to some of the wonders of the electric current.

How Current Flows

It must be clearly understood that we cannot make electricity. Now I can see you rising up in arms and preparing to deny the truth of such a statement.

You have probably seen the huge dynamos driven by engines which produce the electric power required for running factories, for lighting and for heating in your own town, or you may have a magneto on your car or your motor-cycle, and it seems fairly obvious that these things do make electricity.

There are also the dry cells which work electric bells in your house. Do not these also make electricity?

The answer in every case is that these things no more make electricity than a pump manufactures water. They are in fact nothing more or less than pumps which set electricity in motion in a definite direction, and enable us to harness it so as to do useful work by giving it a head or pressure.

Look for a moment at Fig. 1. At the left-hand side of the drawing

AN EXPLANATION
OF THE
GREAT FORCE
THAT MAKES
WIRELESS
POSSIBLE.



AN ARTICLE
FOR
EVERY AMATEUR

we see a lake, which we may imagine to be at sea-level.

We cannot make the water in it do any useful work unless we somehow give it a head. This may be done by providing a pump and a tank raised on high supports.

The pump conveys the water up into the tank, whence, owing to its head, it flows at considerable pressure, striking the vanes of a water-wheel below and causing the wheel to turn.

Having done its work, the water falls into a drain and returns to the lake. So long as we keep the pump going the water-wheel will work, but if the pump is allowed to stop the water-wheel will come to rest as soon as the tank is empty.

Pressure and Work

The pump shown in the drawing is doing precisely the same work as the dynamo, the magneto or the battery. The pump does its work by lifting the water, which, when raised, is always trying to return to sea-level. Its endeavours produce pressure, and once we have pressure we can obtain work.

The electric pump creates pressure by massing electricity of opposite sorts—we shall see more of this in a moment—at its poles.

Electricity endeavours, just as water does, to find its normal level, thus enabling us to employ its pres-

sure for work. If you imagine your battery as a pump and its negative pole as a tank such as that shown in the drawing you will obtain a fairly clear conception of the way in which current is made to pass through a circuit.

Electricity is everywhere, and in everything. All matter so far as we know at present is in fact composed of electricity.

If you could see the page which you are now reading as it really is, it would not appear as a

solid white surface with black marks upon it. It would look rather like a dance of gnats such as is seen on a warm evening; for this apparently solid page consists really of millions upon millions of little bodies known as atoms, all of which are in motion, whilst between them are considerable spaces.

Electrical "Systems"

I have called the atoms "bodies"; actually they are systems not unlike that of the sun, upon a tiny scale. At the centre of each system is a body known as the nucleus or proton.

Round it revolve at terrific speed its very much smaller planets, the electrons. The difference in size between the electrons and the proton is similar to that between a single pigeon and St. Paul's Cathedral.

Upon the number and the arrangement of the electrons of an atom depends the nature of the atom itself. Thus atom systems of one kind give us iron, of another kind, hydrogen gas, and of a third sort, carbon. But in every case, whatever the number of its electrons, the atom is normally perfectly balanced.

The electrons are charges of negative electricity and do not carry, contain or create charges of electricity: they are electricity.

In electricity, like attracts unlike

and repels like. The proton is so arranged that its positive charge is exactly sufficient to counterbalance its negative electrons.

They do not fall in upon it any more than the earth falls in upon the sun, owing to the enormous speed at which they revolve. The atom, then, is normally a stable system in which the opposing forces, positive and negative, just cancel one another.

Positive-ion Attraction

If one of the electrons of an atom is removed all kinds of things begin to happen. The positive charge of the nucleus is now excessive and the atom exerts a strong attraction upon other electrons, striving to obtain a fresh one to replace that which it has lost.

The force exerted by an atom mutilated in this way, or a positive ion as it is called, upon electrons is something so enormous that it is almost beyond our comprehension.

When you try to lift a large stone from the ground you may be unable to do so on account of the force known as gravity which causes the stone to have weight. Gravity is the force which tries to pull everything down to the centre of the earth.

The fact that it is a strong force is brought home to us by our inability to lift the stone, or, again, if we trip over something as we are walking and fall.

Greater than Gravity

The attraction which exists between a positive ion and an electron is almost inconceivably greater than the force of gravity. If gravity were as great a pin would weigh hundreds of tons!

What the battery or any other kind of electric pump does is to wrench electrons away from atoms, and to pile up at one pole an excess of electrons, and at the other an excess of positive ions.

It is the attraction between the two, their endeavours to rush together, which gives us electrical pressure, causing current to flow round a circuit and making it possible for us to light lamps, work machinery, run railways or transmit messages from one end of the earth to the other.

We will think for a moment of a very simple electric circuit such as that which heats the filaments of your wireless set.

Here we have the accumulator acting as a pump and a circuit con-

sisting of the leads below the panel, the rheostats, the valve legs, the valve pins and the filaments themselves.

Electricity leaves the negative pole of the accumulator and rushes round the circuit, heating the filaments as it passes through them and causing them to glow.

Now just how does this flow of electricity from negative round the circuit and back to positive take place? To understand it we had better imagine that at the negative pole of the battery there is a single free electron.

This electron dashes into an atom at the end of the wire which is attached to the negative terminal. Such is the force of its impact that it drives out one of the atom's own electrons, which it replaces as a satellite.

Substitution

The ejected electron forces itself into the next atom, driving out an electron and taking its place. And so the process goes on in every part of the circuit the net result being that one electron enters from the negative pole and one (not the same one) issues at the positive.

If you have ever watched the process of shunting in a goods yard you will have seen something very much of the same kind. It is desired to send the last wagon of a long train into a particular siding.

The shunter throws off the coupling between it and the one before it. The driver now reverses his engine

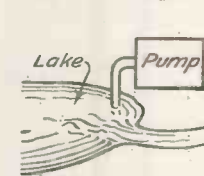

Fig. 1.—Water Analogy explaining Nature of Electric Current.

and opens the throttle. The locomotive crashes into the first wagon which bumps into the second; the second does the same to the third, and so on right down the train until the last wagon feels the force of the impulse.

As its coupling is no longer there to restrain it, it is flung off from the train and sent to its proper place in the siding.

Actually, even when so small a current as that required to heat the filament of a single dull-emitter valve is flowing, it is a question not of one electron entering and one leaving the circuit but of millions upon millions doing so every second.

The greater the number of excess electrons at the negative pole of the battery the higher will be the pressure or head of the electricity.

Electrical Pressure

Electrical pressure is measured in units called volts. A single dry cell has a pressure or E.M.F. of 1.5 volts and a single accumulator cell a pressure of about 2 volts.

The combined cells of an ordinary high-tension battery may have a voltage of from 60 to 120 volts.

Volts are always the units of electrical pressure.

If you look once more at the drawing in Fig. 1, a moment's thought will show you that the amount of water circulated will depend upon the size of the pipes.

Should they be very small a given pressure will be able to force only a little through them, whilst if they are large the same pressure will deliver a much greater quantity. It is just the same in the electrical circuit.

Effect of Resistance

If we insert a resistance and do not alter the voltage, the amount of current flowing will be reduced. We can increase the current flowing by lessening the resistance or by raising the pressure.

Electrical pressure, as we have seen, is measured in volts; the amount of current flowing is measured in amperes which correspond to gallons per second in the water circuit. The measure of resistance is the ohm, which obtained

its name from one of the great pioneers of electrical study who propounded the law that current (c) flowing in any circuit is directly proportional to the voltage (E) and to the resistance encountered.

Ohm's law can be expressed as $C = \frac{E}{R}$. Knowing any two of the three factors you can find the third.

(Continued on page 413)

PROOF CONCLUSIVE!

*A mystery story
by that well-
known author and
wireless amateur,
Capt Frank H.
Shaw. Incident-
ally, it contains a
prophecy*



*Illustrated
by
Charles
Crombie*

"This looks serious," he stated portentously.

POLICE-CONSTABLE JENKINS was admitted to be a good deal of a fool.

So far as the promise went, he was extremely likely to remain police-constable. His sergeant was consistently surly with him: Jenkins brought very few cases forward, not even speed-limit offences, and a sergeant more or less blossoms on the activities of his underlings, as all the legal world knows. And general admission was almost right. Jenkins was a fool.

For instance, on the night of January 10, 1925, he wilfully deserted his beat, entered his tiny cottage, laid his dripping helmet on the first step of the stairs, and advised his wife not to embrace him because of the water that streamed from his cape.

"Thought I'd just sneak a minute or two with that wireless," he said. "Nothing ever happens at Braxhill, and the White Lion's closed quiet and orderly. I'll be just in time for that special stunt."

"You and your wireless!" said his wife, who was secretly jealous of the policeman's enthusiasm; "where'll you be if the sergeant happens to nip around?"

"Catch him—a night like this!" retorted Jenkins.

He was entirely wrong, and he deserved nothing better than detection, dismissal and disgrace. He was every different sort of a fool to stray from his duty in mere sensual pursuit of his chief pleasure; but wireless was an everlasting mania with him, and had been ever since he'd tediously and inefficiently built up his first modest crystal set and thus opened a charmed gate to many bewildering marvels.

He knew little enough of the technicalities of his hobby. What he did know was that if you tuned in to certain wavelengths you got certain results, most of them pleasurable.

P.C. Jenkins, for example, was fond of music. Braxhill supported no public orchestra, Jenkins could not afford a piano, nor for the matter of that, could he or his wife play a single note. Gramophone discs were scratched—young Silas Jenkins liked to use them for quoits. But the wireless served admirably. And to-night, as was announced by the programmes, something quite out of the ordinary was due to take place at 10.30 p.m. It was now 10.27.

The excellent timekeeper on the mantelpiece of the snug living kitchen announced that fact, and that clock was set regularly by the broadcast time signal.

Jenkins removed his streaming cape, licked his lips happily, and applied himself to the earphones.

"Hello, everybody! 2 L O speaking," he presently heard in a familiar, pleasing voice. "Chevalier Lizto Wallasch, the eminent pianist and composer, is now about to perform an entirely new composition of his own for the first time by wireless. This marks a distinct advance in anything previously attempted in broadcasting. Chevalier Wallasch will compose the music as he proceeds. There is no written score extant. One moment, please. Chevalier Wallasch now."

Almost immediately P.C. Jenkins's face widened into a delighted grin. This was music he could appreciate and understand, none of that high-brow stuff they occasionally flung to the ether, music that gave him, as he expressed it, "A reg'lar wambling in his innards!"

This was the real thing, catchy, lilting, mocking: the sort of a rippling tune that took a man's brain by

storm. It made him want to get up and dance: it made him want to reach out an arm and snatch his buxom wife to his breast and pirouette with her all over the kitchen floor. It was a maddening tune, a truly unforgettable tune. He hummed it through pursed lips, a bar behind the eminent composer.

"Comic tune, that!" said his wife, busily knitting a jumper. "What is it? Never heard nothing like it afore."

"Ah, that's a good one," Jenkins said when the last rollicking chords had died away. "Umpty-tiddley-hi-ti, um-pum! Sorter tune to keep a man's feet warm, eh? First time it's ever been produced, the announcer says. Well, I don't suppose there's likely to be no sort of an ongcore—so I'll—umpty-tiddley-hi-ti, um-pum. Harf a minute, Ellen: let's try it."

He lifted his wife from her chair and, humming that intriguing tune, swept her about the kitchen floor. The tune was like magic: it forced itself into his somewhat bucolic mentality and insisted on remaining there. It fascinated, as certain infrequent tunes do. It was with him, causing his feet to beat a grotesque double-shuffle, as he donned his cape and adjusted his helmet. A fine tune, that.

"Uncommon glad I sneaked in and listened to it," Jenkins said, as he closed his garden gate behind him and stalked solemnly into the bleak rain- and wind-swept road. "First time ever played, too, eh? Lucky I chanced my arm and listened in to-night. Umpty-tiddley-hi-ti, um-pum! Umpty-tiddley-hi-ti, up-pum!"

He was still humming the unforgettable tune when a woman came wildly towards him, precipitated herself on his ample chest, and, linking her arms about his neck, gasped "Murder!"

P.C. Jenkins came suddenly to the realities of earth.

"Hold on, what're you doin'?" he demanded.

"Murder—Mrs. Lagollette's lying dead in her blood," panted the informant. "Down at La Maison—murdered, she is, sure's death. Oh, Gawd! the blood!"

"Steady on!" His training stood his friend. P.C. Jenkins flashed on the woman the ray of his electric torch, which torches had recently been issued to the county constabulary in replacement of the old-fashioned

and presence-disclosing bull's eye lanterns.

"Steady on!" he repeated. "Say that all over agen, and remember that what you say might be used in evidence agen you. Now."

"I didn't murder her!" the woman, whom he now recognised for Mrs. Lagollette's only maidservant, gasped indignantly. "They all say you're a fool, and it's proved. Oh, come on!" She tugged at his arm, interfering with his search for a little-used notebook. "She's dead, I tell you!"

Jenkins obeyed the urge and accompanied the woman along the road. A row of small bungalows, locally known as The Pillboxes, had been built on a stretch of ground overlooking the sea: La Maison was one of them, as Jenkins knew.

"I got off the bus at Playman's Corner, the 10.45, as anyone'll prove," said the servant, producing a latchkey and opening the front door; "and I walked down the road in comp'ny. Here's what I found." Dramatically she pushed open the door of a tiny drawing-room.

The first object therein to arouse Jenkins's interest was a wireless loud-speaker. Morse signals were now coming through—the switch was still turned on. And it was the simple fact of this wireless loud speaker that drew Jenkins's interest, drew it even more certainly than the tragic figure on the drawing-room floor.

Mrs. Lagollette was dead. She had been shot through the heart. Might be, it was after a quarrel or even a struggle that she had died. A clock had been swept from the mantelpiece; it lay on its face on the hearth-rug.

P.C. Jenkins felt quite bewildered. During his years of service capital crimes had not come his way. Braxhill was a trifling, ordinary place enough, where nothing out of the common ever happened. An occasional drunk and disorderly, maybe; a few cases against dashing motorists, that summed up the total of Jenkins's experiences. For the most part his day duty kept him doing point work at the cross-roads.

There hadn't been a burglary within living memory; Braxhill was too poor to attract the predatory. It was simply a village settlement that had become half-popular amongst a certain element, who fancied open country as a relief from town, and who believed, sometimes erroneously, that it was possible to make de-

pleted post-war incomes stretch further there than in livelier haunts of mankind.

"This looks serious," he stated portentously.

"It is serious: she's dead," said the maidservant, a harsh-featured woman with an instinctive hostility against the entire male sex, probably bred by her own unattractiveness.

"Well, you be careful what you say, Miss Smithers," Jenkins remarked severely. He wished he was better equipped for the task. His initial training in coping with problems of this nature, theoretical though it was, was almost forgotten. However, it was up to him to do his best.

"Where's the weapon?" he demanded.

"How do I know?" countered Miss Smithers, and raucously recited her previous story. She seemed more than eager to rush out and bring in witnesses to prove that she had been at Littlefold; that she had returned on the bus, arriving at 10.45 p.m.; that she had not been alone until the moment when she opened the front door of La Maison with the latch-key provided by her mistress on her nights out, and so made the tragic discovery.

"There must be a weapon—a pistol, if she shot herself," said Jenkins. "Umpty-tiddley-hi-ti: um-pum." He checked himself from muttering that intriguing brain-storming tune with blushing difficulty.

"She never shot herself, not her!" cried Miss Smithers indignantly. "She had her tantrums, and I'd be the last to say she hadn't her failings; but shoot herself—take her own life! Never!"

"Then who did?" Jenkins wanted to know.

"That's for you to find out," he was promptly told. He set to work to the best of his ability. He knelt beside the poor clay of a once startlingly beautiful woman, a woman he had known: who saluted him graciously as she passed the cross-roads: who had bestowed a comforting tip upon him last Christmas Eve. Yes, she was dead, but not long dead. She was still warm, for one thing: the blood had hardly ceased to flow from the ludicrously trifling hole in her breast.

Noisy wireless signals came from the loud-speaker as Jenkins made clumsy examination. All the busy Channel traffic seemed to be speaking at once, and there were a few atmospherics, too. The detached thought

in Jenkins's mind was that those atmospheric hadn't started crashing when that catchy tune was coming through: otherwise they might have spoilt it completely. As it was: "Umptey-tiddley-hi-ti, um-pum!" he breathed.

"You'd ought to know better than sing them low, music-hall songs in the presence of the holy dead!" Miss Smithers berated him.

Jenkins knew that he was a fool; he knew he ought to be concentrating on this, the most promising case that had ever intruded on his notice, but that queer tune wouldn't let him alone. It ran through his head like an electric current.

And—here a queer thought penetrated his mind—as like as not dead Mrs. Lagollette had heard that very tune at 10.30 when it was broadcast. Maybe it was the last thing she had ever heard, saving only the dull clap of the pistol shot that had rid her of life. Strange, that—whilst he was sneaking away off duty, listening to the tune—umpty-tiddley-hi-ti — um-pum — murder might actually have been consummating! He automatically reached and switched off the loud-speaker.

"The thing is to find out who's done it," he stated sagely. "Now, let's look around a bit."

It was truly a remarkable thing, but the sight of that slain woman aroused in the mind of P.C. Jenkins, known by all his superiors as a fool and nothing better, with a crazy-headed fondness for wireless gadgets, a rankling detestation of someone or something. Her Christmas box, for instance, had served to buy young Silas Jenkins, aged three, a satisfactory skin horse that he had long coveted. It had brought happiness to the Jenkins' home as a consequence.

"I'd like to find out who killed her," he thought. "Handsome woman, too—kindly."

"Had she any enemies?" he asked aloud.

"Not as I know of, she was very select, as you might have heard. Kept herself to herself, if you believe me. Barring Mr. Tranley, nobody never came about this place much."

"Mr. Tranley? Him at Uplea Holme? Friendly with her, was he?"

"Well, not to say friendly, but he did come here sometimes. Which you'll take it from me, officer, someone she knew done this."

"How's that?" Jenkins, mated

to a ready-thinking wife, a masterful woman, had a high opinion of the mentality of the weaker sex, so-called. He was quite willing to avail himself of the domestic's evident acumen.

"Well, look here. She opened her front door herself, didn't she? There's only one latch-key, and I'd got that with me. She opened her front door to let whoever murdered her in. Look here. He come in—didn't force his way in. He wiped his feet on the mat—see his muddy footprints on the lino between the door and the mat, and no footprints beyond."

Jenkins nodded: he made careful scrutiny of the evidence. Someone had certainly entered the house, and not so very long ago as all that, because the footprints in the narrow hall were still damp. He made sure of that, always humming the strange, fascinating tune that seemed to have indented itself on his brain.

"He might have forced entry by a window," he objected. But even he was able to ascertain that no window had been forced. The latches were all secure. Investigation disclosed no footprints in the narrow garden beds outside the windows. But there were certainly definite footprints in the hall, not his own, for he had carefully stepped from the threshold to the mat on entering. They might certainly have been Miss Smithers' and yet—no. These were the imprints of a man's boots—larger and broader than those made by the maid.

"It's a rum job," he said. "Well, you stop here, don't venture to touch nothing: nothing, d'you see? I'm going to inform the doctor and the sergeant."

Which he did as promptly as possible, speeding to his cottage to secure his bicycle first of all. As he pedalled, the catchy wireless tune drummed through his brain.

It was a queer mix up, looked at from any angle. If he hadn't sneaked into his own kitchen to listen-in he might have heard the fatal shot fired, might even have seen the murderer leave La Maison after perpetrating the crime. Not that that was particularly likely, because his customary beat was from the White Lion to the cross-roads and round by Holmby Lane, and so towards the farther end of the village. But he might have seen something suspicious. He had been guilty of dereliction of duty in any case. In

a dull way he felt somehow responsible for Mrs. Lagollette's death.

"I'd like to have the taking of that bloke!" was his thought.

But, of course, the county people would be called in—the people who admitted Jenkins to be a fool; and if they failed, Scotland Yard would be invited to lend a hand. It was the sort of crime that demanded the exertion of keen brains, brains infinitely superior to those of a country constable, who could only just control cross-road traffic.

Sergeant Brewster and Dr. Little wasted no time in reaching La Maison. To them, after the examination, Jenkins reported such discoveries as he had contrived to make. He mentioned that Mr. Tranley was on visiting terms with the deceased, and that in his opinion only an acquaintance could have committed the murder. Sergeant Brewster eyed him pityingly and cast about for clues. But there were surprisingly few. The inquiry promised to be a long process of sheer exhaustion.

"All the same, we'd best see Mr. Tranley, and satisfy ourselves he didn't do it," the sergeant said. "Not that he's a likely suspect—harmless gentleman, refined, gentle as a fly." Mr. Tranley, ignoring Jenkins, had treated the sergeant handsomely during the past Christmas. "You'd best slip up there along of me, Jenkins."

Country crimes, when first discovered, are seldom melodramatic affairs. It is only when the newspapers begin to busy themselves that the real sensations start. The policeman escorted Miss Smithers—by now growing a trifle hysterical, and anxiously entreating to be allowed to bring witnesses to prove her innocence—to Jenkins's own cottage, where she would be looked after by Mrs. Jenkins until morning.

Then the two men, leaving the house of death closed and sealed behind them, proceeded to the residence of Mr. Tranley.

They found the place in darkness: some knocking and ringing were required ere the household was aroused. It was a scared maid-servant who answered their summons. Mr. Tranley was in bed and asleep, she said. She would call him, however. Whilst she was doing so Brewster cast searching glances everywhere. There were no muddy footprints on the polished lino of the hall. The Burberry hanging on the stand was bone-dry.

"He knows nothing, I'll bet a hat," said the sergeant.

Mr. Tranley descended in dressing-gown and bedroom slippers, yawning, but composed.

He evidenced surprise at the policemen's presence, but no alarm. He was a quiet man, grey-haired, in-offensive.

"Come into my study," he invited, before the policeman could say anything. In the study he lit a gas-fire that promptly threw out a grateful heat. Over his shoulder he asked:

"What brings you here, sergeant?" The presence of Jenkins he totally ignored.

"Hearing that you're acquainted with Mrs. Lagollette, sir," Brewster began portentously, "we thought it right to acquaint you with the fact that she's been found dead, under circumstances pointing to murder."

"God bless my soul!" Mr. Tranley stood upright, turned, faced the policeman. Then he sat down in an arm-chair, resting one hand on the arm, tapping with his fingers.

"Maybe," said Brewster, still portentous, though softening a little, "maybe, seeing as how the lady's by way of being a friend of yours, you'd inform us of your movements lately. The doctor's evidence is that she was presumably alive at or

about ten-thirty. A clock lying on the floor, Constable Jenkins points out, had stopped at ten-twenty-five. It was pretty nearly fully wound up."

"God bless my soul!" repeated Mr. Tranley. "Do you mean to suggest that you are accusing me of being a party to Mrs. Lagollette's death—my friend's death?"

"Oh, no, sir, nothing so serious as that. But seeing as how you're her friend, in a manner of speaking——"

"Help yourselves to whisky, officers: you'll find it in the tantalus. Mrs. Lagollette dead! God bless my soul! Whilst I was soundly asleep in my bed—dear me! I saw Mrs. Lagollette this morning—we met in Friary Lane, I remember, and she was then in the best of health and spirits: I have not seen her since. I retired to bed at nine-thirty, as I am suffering from an embryo cold, as you may have noticed." Mr. Tranley sneezed; obviously he was sickening for influenza, then very prevalent. "I instructed my parlourmaid to bring me hot whisky and I was in bed when she brought it at about nine-forty, I should say. After drinking it I immediately went to sleep."

"We never suspected for one minute you was affected, sir," the sergeant said, applying himself to the tantalus. The first tumbler he passed to Jenkins, who lifted it to his lips, then set it down untasted.

"What sort of wireless set might you have, sir?" Jenkins suddenly and innocently asked.

"Wireless? Detestable

thing! I have no set. I can't bear it. This is one of the few houses unfitted with a receiving set," said Mr. Tranley crisply. Jenkins—it must have been his greatest moment—moved quickly to the seated figure.

"Then what're you hummin' that tune for?" he asked. "You've got no wireless; that tune was broadcast by wireless for the first time at ten-thirty to-night. Where did you hear it, eh?"

"What do you mean?"

"There was a wireless set in the dead lady's room. You've none here; you say you was in bed, asleep, at the time that tune was being played, for the first and only time, remember—no, you don't!" Jenkins seized the hand that was emerging from the dressing-gown pocket, and twitched the tiny automatic clear.

In some ways, and especially where wireless was concerned, Jenkins wasn't such a fool as he looked. You can't go counter to the incontrovertible evidence, try as you will. It was a catchy, unmistakable, abiding tune Chevalier Wallasch had broadcast that night, the kind of tune that runs persistently through a man's brain even when he is unconscious of the fact. It had been running through Jenkins's mind whilst Brewster filled the tumblers. Seemingly it had been running through Mr. Tranley's mind, too—and he had unconsciously hummed it, beating time with his fingers on his chair-arm. It was a tune you couldn't mistake; it was unlike any other tune ever composed.

It was a tune that sent a murderer to the scaffold, and P.C. Jenkins to a sergeant's job.

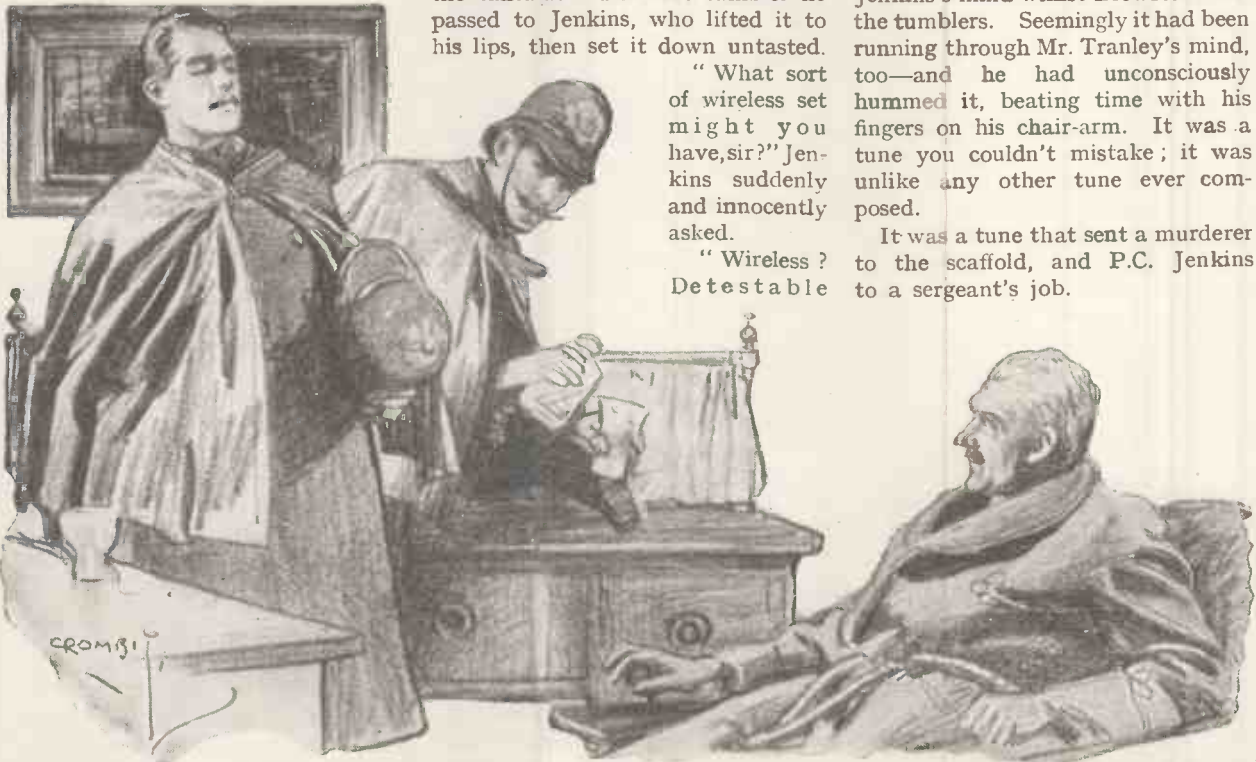

"What sort of wireless set might you have, sir?" Jenkins suddenly and innocently asked.

More Power to Your Crystal



Air-spaced Coil.

MY station is outside the range of ordinary decent reception from a broadcasting station. It is over thirty miles from the nearest one-and-a-half-kilowatt transmitter. Last winter it was just possible to

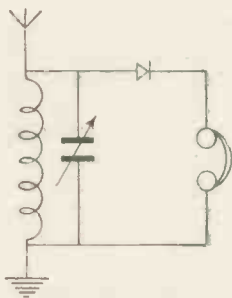

Fig. 1.—Ordinary Crystal Circuit.

hear the transmissions from that station when the house was very quiet, and when, at night time, reception conditions were normal to good. Sometimes a second station, twice the distance of the first, was just heard, and there were one or two freak receptions from very distant stations.

Series of Experiments

With the coming of the long nights a series of experiments were laid out, with the object of discovering whether it was possible, by a number of small improvements, to get better reception. Obviously it is only possible to judge of the combined results of such small improvements when signal strength is, normally, very small. Even then they have, separately, so tiny a result as to be practically unrecognisable. They will probably have little interest for

the crystal-user living within a few miles of a transmitting station; but they may be of very great interest to the man who lives on the edge of decent crystal range, say ten miles.

Early Experiments

The experiments were directed towards finding out how far losses in signal strength could be put down to phones, tuning coils and condensers and, possibly, to inefficient use of the crystal itself.

The crystal was first tested under best possible conditions, and two pieces were chosen for the series of experiments. One was a piece of Shaw's Hertzite and the other a piece of "Dayzite." The only difference that could be detected was that the "Dayzite" seemed to have more sensitive spots; it was, in fact, more or less sensitive all over, whereas the Hertzite, which

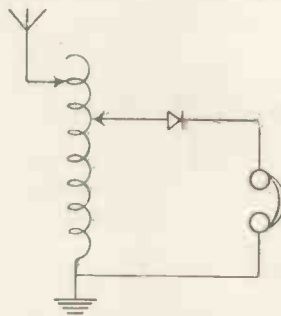

Fig. 2.—Modified Circuit.

had been in use, on and off, for over a year, had many "blind" portions on its surface.

The circuit used was the ordinary one shown in Figure 1. The inductances tried were four types of commercially made plug-in coils. Without specifying all the coils tried, it may be said that a "Lissen" coil was decided on as the best, with a "Gambrell" not far behind.

The next test was on the phones. Four pairs were available. One pair was the most expensive that could be obtained, two other pairs were very good phones of the ordinary

diaphragm type, costing 25s. a pair, and the fourth pair was of continental make. With the first-named pair, speech was intelligible when the house was quiet, and a second station could just be heard though not clearly. Music was recognisable from the nearest station. With the diaphragm-type phones speech could be heard but only with difficulty. Music was fairly recognisable. One pair, which specified "matched" earpieces, seemed very good on a soprano solo. The continental phones would hardly give a sound and were discarded as not worth further trouble.

The next series of experiments was with the tuning inductance. Various variometers were tried but seemed to give no advantage over the best plug-in coil and condenser. It should be said that the tuning condenser, of .001 microfarad maximum capacity, was a very good one, a "Marconiphone"—known to have very low losses. Probably with some of the cheaper makes of tuning condenser the losses would have been so great that the variometers would have shown an advantage.

The Inductance Coil

Then a special air-spaced inductance was wound. This is shown in the photograph. The diameter of the coil is about 11 inches and the turns are spaced a quarter of an

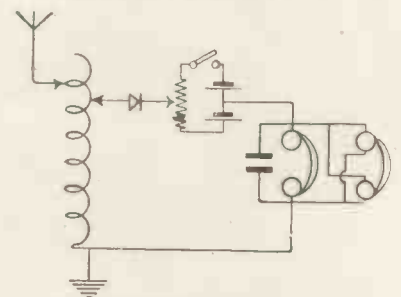

Fig. 3.—Improved Circuit.

inch apart. The circuit was made up as shown in Figure 2. By carefully arranging the aerial and earth
(Continued at bottom of next page)

WIRELESS TERM-INOLOGICAL INEXACTITUDES

TO help the numerous beginners among readers of THE WIRELESS MAGAZINE, I have prepared the following explanations of technical terms, which I trust may be found useful.

Wireless is a method of receiving messages without wires; hence the first operation is to put wires up all over the place.

Laying out the panel is to change your panel doctor after recovering from brain-fever induced by books on "Wireless Made Simple."

High frequency is the number of times you put your hand in your pocket buying wireless parts.

An *amplifier* is a fellow who narrates at length how he gets America.

A *detector* is an official of the Post

Office employed to verify receivers' licences.

Winding the coil is an Army expression equivalent to "swinging the lead."

An *accumulator* is a man who has no wireless, but buys National Savings Certificates.

A *potentiometer* is an instrument for discovering the potential ability of an amateur for making up wireless sets.

Ohms is the call-sign of the income tax collector.

Getting a bad reception is what he naturally expects.

High-tension positive is the state of mind of an amateur nearing the completion of a "simple two-valve set." See also *Lunacy*.

To *oscillate* is to be unable to make up your mind whether to have a crystal set or a Transatlantic transmitter.

To *get a good earth* is to lose your balance fixing the aerial to the chimney stack.

A *super loud-speaker*—an instrument of torture employed in the Star Chamber—also used by Smith next door.

Component parts are the parts you buy to make up a set, but which will not fit in.

Terminals are little things to stop you spending any more money on your set.

A *receiver* is what is appointed if you get beyond this stage.

H. D. WILLIAMS.

MORE POWER TO YOUR CRYSTAL

(Continued from previous page)

tappings, without the use of a tuning condenser, it was possible to get signals that appeared to be louder than any that had yet been received.

The circuit is, of course, a very old one. The only difference between it and some of the earliest crystal receiving circuits is in the use of an air-spaced coil. A good condenser, the one already mentioned, was put in parallel with the coil, between the crystal tapping and the earth, but did not seem to make any particular difference though tuning was easier. A cheap condenser, with metal end-plates and small ebonite bushes, was substituted, and there was no doubt at all that there was a serious reduction in signal strength. This was undoubtedly due to losses in the condenser.

The next experiment was with a condenser across the phones. This is usually shown in circuit diagrams, and generally left out by home constructors as word has gone round that it makes no difference. It certainly did seem to make no

difference, but a .002 microfarad condenser was left in shunt across the phones because it was not thought scientific to trust to the capacity of the leads and the magnet windings to act as a by-pass for radio-frequency energy.

Then from a brother experimenter came two hints of further possible improvements. The first was that it might be found that putting a little potential on the crystal, as we used to do in the old days with carborundum, would be a gain. This was tried, but the advantage, if any, was small, though the crystal certainly seemed more "lively." The necessary voltage to give this liveliness was quite small. Only two cells were used, and the potentiometer tapping arm could not be taken far from the centre without wiping out signals altogether. The total resistance of the potentiometer used was 300 ohms.

A Big Improvement

The other hint was concerned with the phones. It was suggested that the use of 2,000 ohms phones with a low-resistance crystal was bad practice, and that if the two earpieces

were connected in parallel instead of in series the resistance would be brought down to a figure more suited to the resistance of the crystal. This alteration was made by disconnecting the cords altogether from one earpiece and from the negative side of the other earpiece. Then the negative lead from the first earpiece was connected to the second earpiece and two long flex leads taken from that earpiece to the terminals of the empty one. Again improvement, if any, was not noticeable when tried on the plug-in coil circuit shown in Figure 1.

All the improvements were now lumped together in the circuit shown in Figure 3. At once it was obvious that they had added their effects together to make a really big improvement. With the crystal set to its best it was now possible to hear the nearest station, thirty miles away, very clearly indeed, and the second station, sixty miles away, could be heard as well as had the first with the circuit in its original condition. Which of the improvements gave the best result it was impossible to tell, but the combined effect was very gratifying. "VOLTA WATTS."

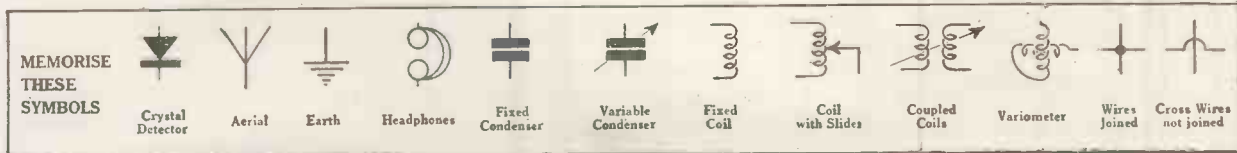

Youth Will Be Served!

THE salesman was busy making up a profit and loss account for the past week when the doorway was darkened by the passage of a stout, elderly lady with a good-humoured countenance. Putting down his pen, the salesman hastened to the counter and became aware of



"Accompanied by a small boy"

the fact that the lady was accompanied by a small, pale, bespectacled boy, apparently about ten years old.

"Good afternoon, madam," said the salesman, in his best manner. "A bright, manly little fellow, your son, madam, if you will permit me to say so, and a credit to his mother. The bent of his young mind is scientific, if I am any judge, madam. The interest which he betrays in the electrical apparatus in the showcases shows that very clearly. His father would be in one of the branches of the engineering profession, perhaps?"

The stout lady's expression was still one of great good humour.

Astonished and Bewildered

"Many's the time I've been mistaken for Cedric's mother," she confessed, "but truth to tell, he's my grandson. His father is a foreman baker," she added, as an after-thought.

The salesman looked astonished and bewildered. "If I might hazard a conjecture, madam," he said, respectfully, "I should say that both you and your daughter were married at a very early age?"

"My son is the boy's father," the lady replied, "and as good a son as ever—"

"Grandma!" muttered Cedric, pulling at the stout lady's hand. "We were going to buy some wireless."

Leaning over the counter, and speaking in a fatherly voice, the salesman inquired what the dear little fellow would like to be shown.

"A variable grid leak—calibrated, and a three o's three condenser with

one-hole fixing," said Cedric quickly, "and I don't want any rubbish, because I'm building a supersonic heterodyne receiver."

Starting back in his astonishment, the salesman stepped squarely into a box containing six gross of glass tubes, each tube sheltering a piece of specially selected "buzzite."

Trodden on Something

The sickening crash was followed by a guffaw from the delighted Cedric; and the stout lady, who appeared to have grasped the situation very rapidly, informed the unhappy tradesman that she believed he had trodden on something!

Begging to be excused for one moment the wretched man retired beneath the counter, and repeated rapidly as many words as he could remember in the brief space of time at his disposal.

Having relieved his feelings a little and brushed a fair amount of glass and fragments of buzzite from his



"Ten bob or nothing"

boots, he reappeared and, in comparatively gentle tones, requested the young gentleman to be good enough to indicate which of the articles in the showcases he would like to examine more closely.

"The case on your right," he declared, "contains the finest assortment of condensers in town, and the long case on your left is replete with all the latest ideas in grid leaks, variable and invariable; switches, both on and off; and valve legs—I should say limbs, madam," bowing gravely, "in wonderful variety. This shop, madam, is the Mecca of the intelligent schoolboy, and—"

A Sporting Offer

He was interrupted by a growl from Cedric: "Haven't you got any better stuff than this?" he was saying. "Most of it looks as if it ought to be in the museum. There's only one decent condenser in the lot. How

much is that one with the ebonite end-plates and integral vernier?"

The salesman gasped, and looked closely at the pale-faced lad, who was peering through his spectacles at the showcase with a very discontented look on his face.

"The price of that precision instrument, my boy," he said kindly, "is—er—is fifteen shillings."

The boy sniffed. "I'll toss you ten bob or nothing, for the sport of the thing!" and taking a coin from his pocket, he spun it in the air and caught it neatly on the back of his hand. "Call to me!" he cried.

"Heads!" called the salesman, involuntarily.

"Tails!" cried the boy triumphantly, and he seized the condenser. "Here, gran, put it in your basket. That's a bit of luck! Where are the calibrated grid leaks?"

"I'm sorry, my boy," said the stupefied salesman, "but I haven't had time to calibrate them. They are, however, guaranteed to leak with the best."

Characteristic

"Never mind," said the boy. "Now, that foreign valve over there—have you a graph showing its characteristics?"

"I have not, my lad," replied the salesman coldly. "Might I inquire, madam, the age of your grandson?"

"Just turned seventeen," said the stout lady, with a beaming smile. "In his golfing suit he looks very much younger, doesn't he? Now, none of my family look their age! Cedric has heard gentlemen and ladies singing in America many a time on the wireless cabinet he made himself. Say 'Good afternoon' to the kind gentleman who has given



"Stepped into a box of glass tubes"

you such a nice piece of wireless, Cedric; we must be getting on!"

When they had gone, the miserable man buried his head in his hands and moaned piteously. A. H.

Long-Distance Aerials

It does not follow from the title of this article that there is any material difference between the type of aerial which is best for long-distance work and the type which will give the best performance on local stations. But the point which does arise is the obvious one, that whereas one hundred per cent. efficiency is not absolutely necessary when an aerial is to be used chiefly for local

work, it becomes essential when long-distance work is tackled.

Now to consider what really is the best type of aerial for long-distance working. The type and size of aerial is governed, when no transmitting is done, mainly by the wavelengths the user wishes to receive. As a main rule it may be stated that it is inadvisable to make any very great changes in the wavelength of an aerial by either adding inductance or capacity in the receiver itself.

This, of course, is the normal method of tuning.

What I mean is, that if the natural wavelength of the aerial is a hundred metres and inductance is added within the

receiver to enable it to tune up to ten thousand metres, the results will not be so good as if an aerial were used which had a natural wavelength nearer to the one to be received, and a smaller proportion of added inductance.

But as few amateurs wish to receive anything on a wavelength higher than a couple of thousand metres, and all stations even as high as this are comparatively near, we can assume that our aerial is to work on wavelengths round about the broadcast band. We will discuss this type of aerial first.

A great deal has been both said and written about the comparative merits of the T and inverted L type of aerial. Possibly, under local conditions, one may be a little better than the other, but I personally doubt whether there is anything in the choice.

It is not a matter so much of type as of construction that is vital in aerials. Choose either the inverted L or the T and then make certain that it is properly erected. If broadcasting is the main item

wanted, then a single-wire aerial is better than a double or multi-wire one unless space is very confined.

The illustration, Fig. 1, will show how an aerial of the T type may be arranged.

Height Above Ground

The main point in aerial erection is to raise the wire above the ground level. This does not mean above the ground itself, but above the level of any surrounding objects which are earthed.

The "ground level" in this case may be taken as the level of the roof tops of surrounding houses unless there happen to be a number of trees about, when the tops of the trees will constitute the "ground level."

It must be remembered that anything touching the wire will convey the currents passing in it to earth if the other end of the interfering object is earthed.

As the currents flowing on the surface of an aerial wire are high-frequency currents, it follows that they are capable of jumping physical gaps of some extent.

An earthed object, therefore, such as a tree, will convey these currents if it is sufficiently near the aerial wire or lead-in; the space between it and the aerial being, in a way, a condenser.

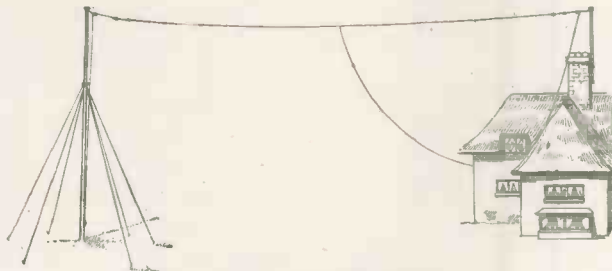

Fig. 1.—Typical T Aerial.

work, it becomes essential when long-distance work is tackled.

This point really needs no illustration, but every amateur must know that 2 LO can be brought in with a reasonably sensitive set without either aerial or earth at a distance of about fourteen miles from the transmitting aerial.

It is often disadvantageous to have a very good aerial under such conditions, the energy picked up by it being so great as to overload even a crystal used with a couple of stages of low-frequency amplification for loud-speaker work.

Alternative Methods

Those who desire a really efficient aerial for long-distance work can get over this difficulty in a number of ways, without the trouble of running two aerials. They can, of course, use a couple of stages of H.F. without either aerial or earth, and use the aerial for receiving another station on another set at the same time.

This is quite practicable. Some alteration in tuning is effected, of course, but this is a minor matter.

Perhaps the best method is to disconnect the earth wire altogether when using a super-efficient aerial. This should tone down reception from a local station to reasonable volume. A certain amount of detuning can also be employed.

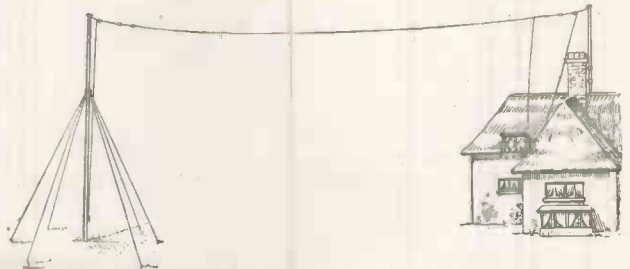

Fig. 2.—Typical Inverted L Aerial.

The First Rule

Therefore we arrive at our first rule. Erect the aerial in such a way that it clears the ground level, if only by a few inches, and so that the nearest earthed object is far enough away from it to be safe.

It will be found that even if the aerial has to be shortened to achieve this, the results will be better.

LONG-DISTANCE AERIALS (Continued)

We have now succeeded in ensuring that currents will flow in our aerial when they come into contact with it, in preference to flowing to earth via tree or some such adjacent conductor. Let us now ensure that we do not lose any of these currents while they are passing via the lead-in to our set.

Again we must remember that high-frequency currents will jump gaps, and will prefer to the actual aerial a directly-earthed conductor if they can reach one.

This means that every portion of our aerial system must be kept well clear of surrounding earthed objects.

A common fault is to arrange the lead-in so that it falls in close proximity to the walls of the house.

This is very bad practice, even when insulated wire is used. Insulation will not keep high-frequency currents in a wire.

In nearly all cases where the inverted L is used the lead-in will fall parallel with the house wall. In the case of a T the lead-in, brought from the aerial at a point some distance from the house, will not come into proximity to it until it actually enters the lead-in tube. Fig. 2 will illustrate this.

Precautions must not be relaxed even after the lead-in has entered the house. The tube should pass through the wall or window frame, and be long enough to project a considerable distance, say a foot at least, on either side, thus keeping the wire clear of walls.

It is suicidal to fasten the interior lead-in along the wainscoting or wall. It should be carried from the inside end of the tube in such a manner that it hangs absolutely clear of

ceiling, walls, and floor until it reaches the set.

Now, having considered the most important points, let us attend to some which, though less important, are still worthy of consideration.

Insulators

If an aerial mast carries no guy wires any higher than about half way up, it is not necessary to worry about insulators. If the guys are carried to the top, then every guy wire, whether reaching to the top or not, should carry insulators breaking it into unequal parts.

These insulators should be set in pairs; one is not sufficient.

The aerial itself should carry double insulators in series between the wire and the spreader. If this is done and the insulators spaced a fair distance apart, say one foot, no trouble should be experienced; and additional insulators between spreader and pole are rather a disadvantage than an advantage.

insulator is touching the pole itself is not efficient.

If the aerial is of the T type, measure the point where the lead-in is to connect so that it is absolutely the electrical centre; if an inverted L type, connect the lead-in so that it is at the exact end.

If attention is paid to these points in construction instead of to the fetish of erecting an aerial as high and as long as possible, the results will be surprising.

It is quite certain that the man with a small and, perhaps, not too high aerial which is really efficiently erected, will get results far better than the man with a great aerial reaching miles above his house and stretching for a full hundred feet from pole to pole if this latter is erected, as many aeriels are, without any considerations of electrical efficiency.

It is all very well to have an aerial which will catch the faintest tremors, but what is the use of it unless these are conveyed safely to the receiver?

For short-wave work on a hundred metres the length of the aerial does not matter. The insulation of it does. The aerial described above will work perfectly down to fifty metres. Below that no aerial is necessary.

Perhaps it is not quite fair to say that an aerial is unnecessary. "No aerial in the accepted sense of the term" would be more accurate, but since the radiation system

on very short wavelengths is practically nothing but a condenser, any consideration of this type of long-distance aerial would necessitate an article to itself.

Amateurs will find that in many cases an earth may be dispensed with below 150 metres. E. C. D.

FORCE OF HABIT



Father, crazed on wireless, is mending a clock and puts it to his ear.
Son, also crazed: "What's on?"

Distance from Pole

Again, even if it means sacrificing some of the length of the aerial, it is wise to erect it so that the wire itself finishes some distance from the pole.

A wire drawn so tight that the

Valve Circuits You Can Try

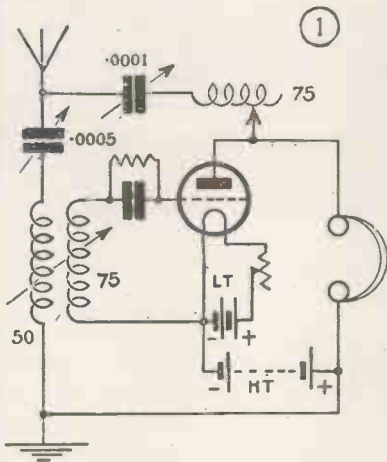

On this page are given five unusual one-valve circuits that every amateur should try. Where no special values of grid leak and condenser are indicated these should be of 2 megohms and .0003 microfarad respectively. The figures against coils indicate the approximate numbers of turns for British broadcast reception.

Circuit 1 (left).—A selective circuit of the capacity-reaction type. When the coil connected to the plate of the valve and the .001-microfarad variable condenser are tuned to the wavelength of interfering signals, these are eliminated.

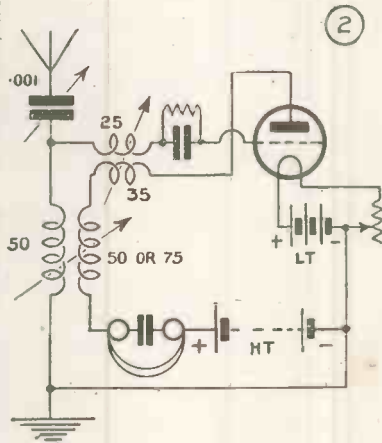

Circuit 2 (above).—A double-reaction circuit in which the reaction is coupled to both the aerial and grid circuits.

In using a set employing this circuit experiments should be made in reversing the coupling of the coils.

Very fine reaction control is obtainable by making final adjustments with the grid coils alone.

The brilliancy of the filament and the H.T. voltage should be so adjusted that no "overlap" occurs when adjusting the coupling.

Circuit 3 (centre).—A circuit allowing of very sharp and selective tuning.

The aerial itself is tuned to the desired wavelength by means of the variometer tuning arrangement and the grid circuit is also tunable.

Grid and anode reaction is employed, the circuit lending itself to very critical tuning for long-distance reception.

For the variometer arrangement and the other three coils a two-way and a three-way coil holder can be used.

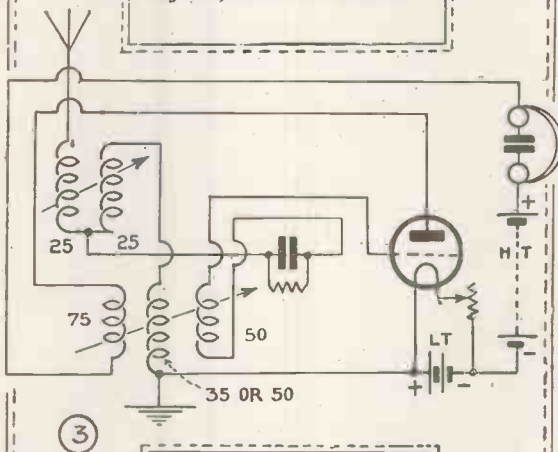

Circuit 4 (left).—The point of interest in this circuit is the control of the aerial tuning and reaction coils.

Coils Nos. 35 and 50 form a variometer, while the remaining coil, which may be the end coil in a three-coil holder, enables reaction effects to be obtained.

Circuit 5 (right).—An extremely selective circuit of the loose-coupled type working upon the principle of a transmitting circuit. In use, it is advisable to keep the coils well apart.

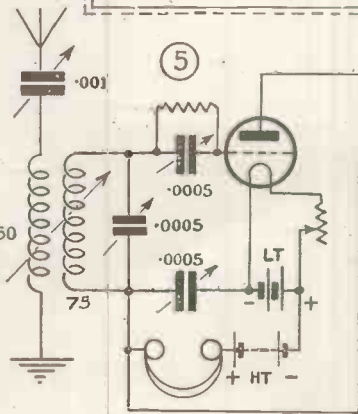
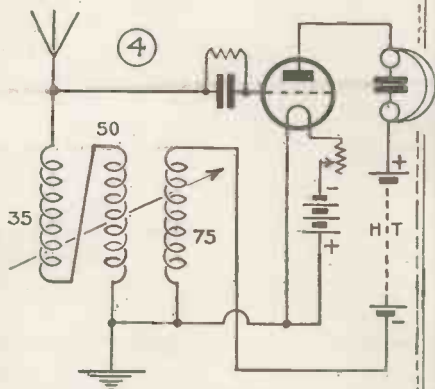



I WONDER how many of the critics of the B.B.C. programmes realise exactly what they are getting for their money! Of the annual licence fee of 10s. only half goes to the B.B.C. The remainder, I fear, must be classed in that category of expenditure for which no decent Britisher has ever yet had anything but abuse.

Taxes ?

It is frankly "taxes"! and I am far too timid to attempt to defend anything in the nature of "taxes" (that is, indeed, if they can be defended, which, being a Britisher myself, I doubt!).

From the broadcast listener's point of view, if not from that of the B.B.C., the price of the programmes is 10s. per household (not per head, please note) per annum.

True, in order to avail himself of this offer the prospective listener must provide himself with a receiving set. What this will cost him depends very largely on what he chooses

to spend. I am not considering the wireless amateur whose chief interest is in the technical side of the hobby. He spends his money to amuse himself with his experiments; the B.B.C. and their programme are a side issue to him. The household I have in view is the one which "goes in" for a wireless set as they would for a

gramophone—to be entertained, and sometimes (though rarely of their own volition!) instructed by the programmes provided by one of the B.B.C. stations. I say *one* of the stations advisedly, for if the listener provides himself with a set of sufficient range to pick and choose his programmes he becomes largely independent of the B.B.C. There are always Radio-Paris, Brussels, Madrid, even "The Eternal City" itself, offering their "wares" (yes, Mr. Printer, an "r" not a "v") to him, even when a symphony concert or the Savoy bands, being "S.B. from all stations," offend his fastidious taste according to whether or no his hair and eyebrows meet.

tion, where it will no longer "waste its sweetness on the desert"—sea! With this and "relays" being opened at the rate they are now it is not too much to say that within a few months a district where a crystal set is not amply sufficient for the "one-station" man's needs will be hard to find.

Cost of Crystal Set

For a five-pound note a prospective listener should be able to provide himself with all he could possibly desire in the matter of crystal sets, aerial and all included. This is an outside estimate. Many have done it for one pound. But let us allow a "fiver." Now, such a set will, in

fact, last for an almost indefinite time. In actual practice, once the "wireless microbe" has really got a grip it will almost certainly be scrapped for a more ambitious thing of valves and loud-speaker. But let us assume that it has to be reckoned as depreciating by "fair wear and tear." Shall I be accused of optimism if I put the life of the

Analysis of a Week's Programmes from 2 L O

	H.	M.
"High brow" music (symphony orchestras, etc.)	3	0
"Middle brow" musical items, such as may be "under-standed of the people" (military bands, light orchestras, etc. Much of it really high-class music)	12	45
Definitely "low brow" stuff (music-hall turns, "pierrrot" type concert parties, and jazz)	11	25
Children's Corner	5	0
School Instruction	2	30
"Instructive" talks (very miscellaneous, including art, science, travel, history, etc., and religious addresses)	3	25
Talks on sport	0	45
"Chats" (mostly in the 4-5 p.m. "Tea Table" transmission)	5	5
News, etc.	3	10

Now, the "one-station" listener will generally be a crystal-user. There are, of course, a few districts still outside crystal range of any station. But an immense area has been covered by the advent of H.P. broadcasting, and this will be extended by the removal of the station to its new permanent posi-

tion. Really, I do not think that I can. Well, then, five years' life for the set, depreciation 20 per cent. per annum = £1.

Maintenance Costs

New crystals will perhaps cost as much as 10s., though they need not. But the temptation to try the latest

"ite" must be reckoned with. Very good, allow 10s. a year for crystals.

We are now in a position to reckon the total annual cost of wireless entertainment.

	£	s.	d.
Licence		10	0
Depreciation of set	1	0	0
Crystals		10	0
Total	£2	0	0

Out of this the B.B.C. gets only 5s. Its members profit by the stimulation of their trade. But the listener we are considering is not of the type out of whom much can be got in that way. £7 10s. in five years isn't a very quick turnover!

For his £2 the listener gets a programme *every day in the year*. But suppose, to arrive at round figures, that he takes a fortnight's holiday, so that his "listening year" is one of 50 weeks only. Then the cost is just under 10d. a week. And the station is broadcasting on an average about 45 hours each week. So the entertainment is provided at under a ½d. an hour!

What the Listener Gets

I have analysed the programme for a typical week from 2 L. O. The result is shown on the opposite page.

The sportsman seems to come off worst in this analysis. But it must be remembered that a great part of the news bulletins deals with sport, and anyway there are few people so utterly devoid of other interests that they would install a wireless set merely to listen to talks on sport. Apart from the talks and instruction (which fittingly cost a little more), anyone too high-brow to listen to anything commoner than Bach, etc., gets his wants supplied at about ¾d. an hour.

An Appreciation

Yet there are grumblers! It has been well said that some people will be discontented with the cut of the haloes served out to them in Heaven! Perhaps I shall, for I have before now put down the phones with an exclamation of disgust when an item was announced which I thought too—(well, I will leave the reader to guess the height of my brow from the contents of this article). But, anyhow, I do appreciate the efforts of the B.B.C. in their task of trying to please everybody. H. W. S.

Crystal Considerations

TO a great extent the thermionic valve has replaced the crystal in wireless work, and owing to this fact research work in connection with crystals as rectifiers has not been as general as it might have been. There is still quite a lot to be learnt concerning the somewhat humble crystal, and to a serious experimenter there is a vast field of discovery waiting to be explored.

"—ites"

Many different types of crystals are on the market to-day, most of which seem to carry the suffix "ite" as a part of their designation, which is liable to cause confusion in identifying those crystals whose proper mineralogical name has such a suffix. The various sellers compete one against the other in praising the qualities of their products.

It will, no doubt, come as a surprise to many to learn that most of these "new" crystals are really nothing more than galena which has been subjected to various artificial processes. Galena, as a crystal, was known to experimenters long before the advent of broadcasting.

Besides galena there are several other types of crystals.

Types of Crystals

Crystals can be divided into two distinct classes. Firstly, there are those crystals which require another crystal to be in contact with them, well known as "perikon" combinations; and secondly, those crystals which require a metal contact, perhaps more familiarly known as the catwhisker type.

In the first class we can place such crystals as tellurium, copper pyrites, chalcocite (copper glance), zincite and bornite. In the second class there are silicon, iron pyrites, galena, carborundum, molybdenite, corundum, etc.

Of the "perikon" type I have found the best combination to be tellurium with zincite, and zincite with copper pyrites an alternative combination giving almost equal results. With the tellurium and zincite combination I have found reception extraordinarily clear, and in the old days I used to receive

Writtle in North London on such a crystal.

One cannot fully appreciate the advantages of a "perikon" combination until it has been tried, and, in my opinion, a perikon crystal is far superior to the more common catwhisker connection. In the first place, a perikon crystal will retain its sensitivity for a greater period of time, and is not so prone to be thrown out of adjustment by reason of being jarred or shaken. I have had a perikon crystal in use on one setting for upwards of six months, and during this period I have never had cause to disturb the setting. The crystal has been exposed to varying temperatures, and is without a dust cover. Against the above advantages may be placed the disadvantage that it is more difficult to find the sensitive point than is the case with crystals requiring a metal contact.

Popular Types

The second class of crystals is undoubtedly more popular, and the various crystals of this class require certain metal contacts for their successful working. Silicon requires a steel contact, as does carborundum. Galena, which can also be used as a perikon crystal, will work equally well with gold, brass, copper or silver contacts, and it is perhaps due to this fact that so many dealers favour galena as the basis of their products. Iron pyrites requires a gold and molybdenite a silver contact.

It is possible to spend an interesting evening experimenting with various crystals and crystal combinations. Unfortunately, some of the crystals enumerated above are rather expensive, tellurium especially so. But it is worth the extra money when one comes to compare the results achieved.

Other Types

There are several other types of crystals which can be experimented with, such as cerrusite, blende, domeykite, graphite, pyrrhotine, etc. However, before the experimenter proposes to use such crystals it would be advisable for him to gain experience with the various crystals mentioned in the earlier part of this article. S. W.

Gadgets, Hints and Tips

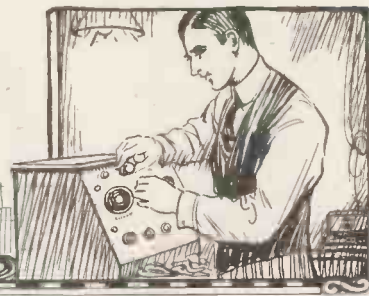

Protecting Valves

THE most vulnerable point in a valve, apart from the filament, is the little glass pip at the top, which is the place through which the air has been pumped to make a vacuum.

A comparatively light shock will very often break or crack this fragile tip, permitting air to enter the valve and render it useless.

To increase the strength at this point the pip should be covered with a fairly thick layer of sealing wax, which will absorb the shock of an accidental tap of any kind.

F.C.L.

Low-loss Coil Former

Low-loss coils without formers are becoming increasingly popular among amateurs, and the following hint may be useful to some constructors.

A simple former can be made by fixing a number of stout nails into a piece of wood round the periphery of an imaginary circle. Thick wire can then be wound round the nails, basket fashion.

The nails should be set at a slight outward angle as indicated in the

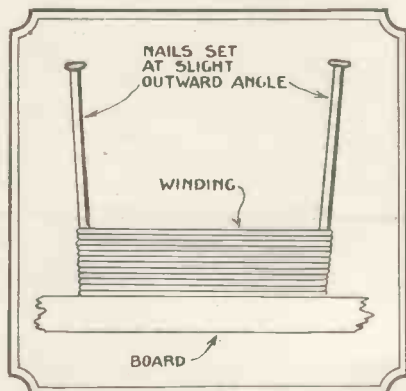

Low-loss Coil Former.

diagram. In this way the windings will be held taut and kept in position without slipping.

For winding such coils, No. 16- or 18-gauge double cotton-covered wire can be used.

A.P.

Insulating the Lead-in

It is sometimes inconvenient to drill a hole in a window frame just to accommodate a lead-in tube. In such cases the following arrangement can be used, especially when the window is only a small one.

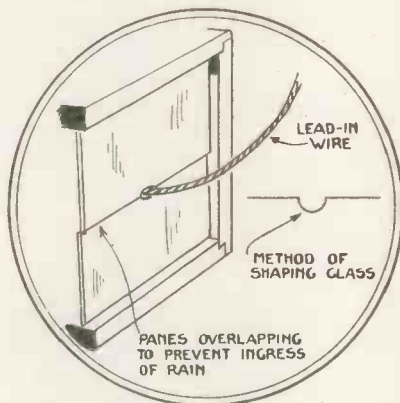

Insulating the Lead-in.

A pane of glass, slightly deeper than actually needed to fit the frame, is obtained and cut in half. In the middle of one edge of each half a semicircular cut is made with a file, as indicated in the diagram.

The lead-in wire can be conveniently taken into the room through this hole. There should, of course, be no strain on the lead-in or the glass will be broken.

M.G.A.

Valve-leg Contacts

WHEN fitting a new valve in a set it is always advisable to make sure that good contact is made between the legs and the sockets or clips on the set.

If the valve legs are of the ordinary split type it is a good plan to spread the legs out a little with the blade of a penknife before fitting.

This also applies to valves that have been lying idle for some time.

Fine emery-cloth should be used for removing any oxidation or lacquer from the legs.

H.R.S.

Marking-out Panels

MANY amateurs frequently mark out their panels with a pencil. This greatly decreases the efficiency of the set, however, as the pencil marks act as conducting paths and cause leakage from one component to another.

The best way of marking-out panels is to scratch the lines required with a sharply pointed steel tool.

R.M.R.

Fixing Crystals

To economise in Wood's metal when fixing a crystal a quantity of brass or iron filings may be placed in the cup with the metal before melting the latter.

A.R.

Fixing the Grid Leak

DIFFICULTY may be experienced in mounting a grid leak or anode resistance when a condenser with clips is not used in conjunction with it.

When thick wire is used for connecting up the set, however, the method illustrated can be used.

Two leads are kept apart by a small block of ebonite, and their

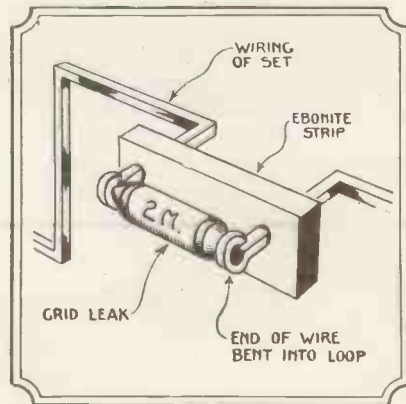

Grid-leak Mount.

ends shaped so as to form a mount for the resistance. The result is a quite rigid mount.

Other small components can often be conveniently fixed in the same way, thus saving trouble.

R.J.C.

Storing Your Crystals

How often are you unable to find those spare crystals you keep on hand just when they are wanted? Here is a simple gadget for storing crystals

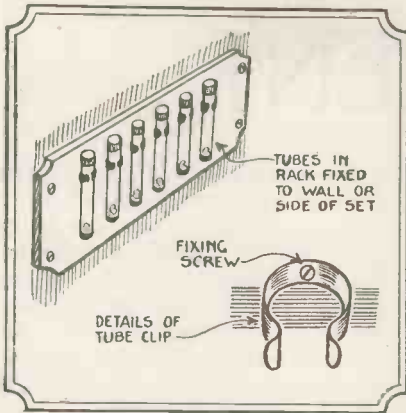

Simple Crystal Rack.

so that they can always be found directly you want them.

As can be seen from the diagram, a number of small glass tubes are fixed by means of metal clips to a piece of wood.

The clips may conveniently be of the type shown in the diagram, while for the sake of appearance the wood should be stained or varnished. Labels may be fixed to each tube to denote the make or composition of the contents.

H.A.K.

Improved Coil Former

When a number of low-loss Lorenz coils have to be made, the type of peg fixing shown in the diagram will be found worth while, as,

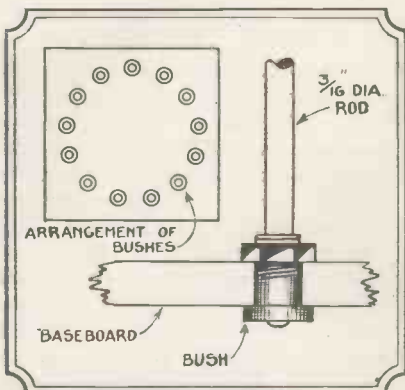

Improved Coil Former.

although the pegs are held firmly in position while winding, they can be instantly removed after completion of the coil without the use of tools.

When the next coil is to be wound,

it is only a moment's work to replace the pins.

Referring to the diagram, it will be seen that each hole in the former base is fitted with a brass bush of the type supplied for one-hole fixing components.

Although lengths of No. 2 B.A. screwed rod can be used for the pins, it is advisable to obtain $\frac{1}{8}$ -in. diameter mild steel rods for the purpose; these can be obtained quite cheaply from most metal dealers or engineers' stores.

R.J.T.

Condenser Mounting

When fixing condenser or variometer dials of the American type, in which a small grub screw is employed for clamping, it is often found that the dial—owing to the excessive projection of the spindle

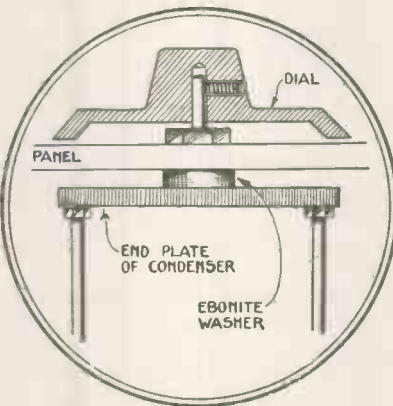

Condenser Mounting.

bush—cannot be mounted near the panel.

By placing an ebonite washer bored to suit the spindle bush between the instrument and the back of the panel, projection of the bush beyond the fixing nut is obviated, thus allowing the dial to be fixed in its correct position near the panel surface.

If a suitable ebonite bush is not available small blocks of wood can be glued to the top of the condenser.

K.D.M.

Screening the Loud-speaker

To many people the appearance of the usual type of loud-speaker is distasteful. A simple method of screening the instrument without detracting from the volume of sound emitted is shown in the diagram.

A piece of ordinary muslin, of a size depending on the flare of the loud-speaker, is stretched over a framework of wood or metal made in the form of a screen.

This is placed in front of the instrument, as shown, after making any necessary adjustments to the diaphragm, etc.

The lady-listener will no doubt

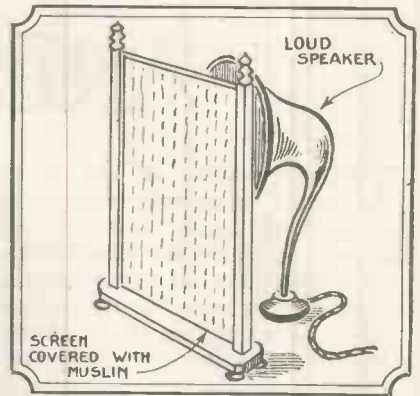

Screening the Loud-speaker.

be able to apply some decorative effect to the screen, thus making it really pleasing to the eye. J.R.S.

Under-panel Detector

PROTECTED from dust and possible breakage, the novel under-panel crystal detector shown in the diagram will be found to give quite good results, providing a good crystal—sensitive over all or most of its surface—is used.

Crystal cups are fitted into the ends of a piece of ebonite or fibre tubing (one cup contains the crystal, while the other has a brass bush of the one-hole fixing type soldered to it).

A $\frac{1}{8}$ -in. brass rod, to which is soldered a catwhisker, is pushed

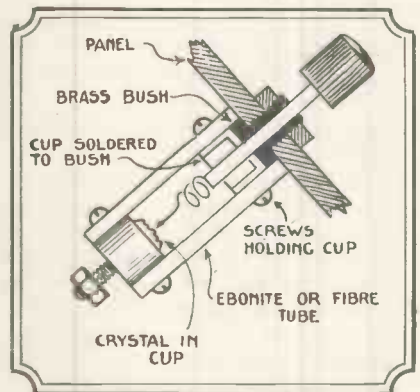

Under-panel Detector.]

through the centre hole of the bush in order to make contact with the crystal.

Attachment to the panel is made by means of the one-hole fixing bush.

D.K.W.

WHY SOME TRANSFORMERS ARE INEFFICIENT

THE importance of the transformer in wireless reception is too widely realised to-day to warrant further emphasis in this article. Anyone who has had any experience of wireless knows that this is the instrument on which results mainly depend. It is the instrument that makes or mars a receiver. A good transformer can, literally, "transform" a third-rate set into a first-rate set. In view of the progress that has been achieved in transformer design and construction during the past year, a brief account of the practical difficulties encountered in this sphere may be of interest.

Energy Wasted

The efficiency of any instrument depends upon the amount of energy that is wasted when the instrument is in operation. The efficiency is inversely proportional to the energy wasted. That is to say, the smaller the amount of energy wasted, the higher the efficiency of the instrument. (Inefficiency is also due to secondary effects, but these will be considered later.) The main factors responsible for energy losses in transformers are as follows:

- (1) Losses due to the resistance of the primary and secondary windings.
- (2) Losses due to the effect known as "hysteresis."
- (3) Losses due to "eddy currents" in the iron core.
- (4) Losses due to magnetic leakage.

The first of these losses will, of course, depend upon the length and thickness and quality of the wire used. Its reduction can only be effected within limits depending upon the purpose for which the transformer is required. The second source of loss (hysteresis) demands great care and experience in the choice of the iron out of which the core of the transformer is made. A few words on this subject will not be out of place here.

When an alternating current is passed through a coil of wire an alternating magnetic field rises and

falls round that coil. Although this magnetic field is, at any moment, composed of the individual rings of magnetic flux that surround the separate turns of the coil, the collective effect of these rings is to produce a definite magnetic field all round the coil. This magnetic field, of course, also occupies the core of the coil. Now iron has a much lower magnetic resistance than air, and anything that will help to reduce the magnetic resistance of a transformer will naturally help to increase the magnetic field—and, hence, the efficiency—of that transformer. As this effect is particularly desirable in the case of low-frequency transformers, the latter are usually fitted with iron frames which provide a complete low-resistance path to the magnetic field.

Theoretically, the magnetic field rises and falls with the current that produces it. Actually, however, there is always a tendency for the magnetic flux to lag behind the current. Experiment shows that there is always a certain amount of flux left in the iron frame after the current in the coil has died down to zero. On reaching zero the current begins to build up in the reverse direction, producing a new (reversed) magnetic field. This reversed flux, of course, "clashes with" the flux that has lagged behind in the iron since the previous half-cycle of current. A certain amount of the new flux is thus wasted in wiping out the remaining traces of the old flux.

Quality of Iron

All such wasted energy manifests itself as heat in the frame of the transformer. As the extent to which hysteresis occurs depends upon the quality of iron in the frame the greatest care should be taken in the matter of choosing suitable metal for transformer purposes.

Eddy currents represent another source of wastage against which careful provision has to be made.

The manner in which these wasteful little currents are produced in the frame of a transformer can be explained quite briefly. In the first place, we know that when a conductor is moved in a magnetic field there is a current induced in it. And the same effect is produced, of course, by causing a varying magnetic field to flow round a (stationary) conductor. This is the principle on which the transformer itself works: the varying magnetic field produced by the current in the primary coil induces a current in the secondary coil. But it must be remembered that the iron frame is also a conductor that comes within the influence of this same magnetic field. The latter, therefore, produces small currents in the iron frame, and since these currents serve no useful purpose they represent so much waste energy.

Preventing Wastage

It can be demonstrated that these eddy currents flow at right angles to the direction in which the magnetic field acts. The magnetic field acts round the frame, of course (i.e. along its length), and the eddy currents therefore from side to side (i.e. across its thickness). As a means of preventing this form of waste the method of lamination is now universally employed. In laminated frames the iron, instead of being composed of one piece, is made up of a number of thin sheets, each sheet being insulated from its neighbours. This effectively breaks up the path along which the eddy currents try to flow, and thus prevents undue loss from this source. The success of this measure depends largely upon the efficiency of the insulation between the iron sheets, and on the thickness and quality of the latter.

Finally, there are the losses arising from magnetic leakage. When a transformer is fitted with a suitable frame, all the magnetic lines of force crowd into this low-resistance path. If the frame is not of suitable shape

and dimensions, some of the lines of force will be compelled to "find their own way," as it were, through the air. This effect is known as "magnetic leakage." In the practical sphere, therefore, this problem resolves itself mainly into a problem of designing a frame that can accommodate *all* the lines of force.

Inductance

There is another very important factor to be observed in connection with the use of iron cores and frames. The presence of iron in a transformer, in strengthening the magnetic field round the latter, thereby *increases the inductance* of the transformer. But the inductance of a transformer also depends upon the frequency of

WIRELESS TERMS TRAVESTIED



the electrical impulses passing through it. (The greater the frequency the greater the inductance.) If, therefore, an iron-core transformer were used for the purpose of receiving signals of radio frequency, there would be two causes operating to increase its inductance. In actual fact, the inductance of such a transformer would be so excessive that it would act as a "choke coil" on the incoming signals and allow no oscillations to penetrate it. In dealing with high-frequency currents, therefore, the inductance factor is kept within reasonable limits by dispensing with iron cores.

M. E.

Those Accumulators

THE life of an accumulator depends to a large extent upon the amount of work which it does, therefore when purchasing this accessory it is always as well to see that it is large enough to deal with its allotted task and yet not so large that it will take many weeks to discharge.

It is safe to assume that the bright-emitter valve takes half an ampere, and if we have a three-valve set to feed, one and a half amperes per hour are consumed. If the set is run for four hours per night nightly the total current consumed is 42 actual ampere hours per week.

A 40 actual ampere hour accumulator is then sufficient for our requirements, and two such accumulators may be charged and discharged alternatively once a week. The actual capacity of an accumulator is half its stated intermittent capacity.

By carefully selecting the capacity of an accumulator we ensure that it is kept in good condition, for nothing damages an accumulator so readily as to leave it standing for long periods in a discharged or semi-discharged condition.

Level of the Acid

The level of the acid is another important matter. Many accumulators have a line marked upon the container, and it is intended that the acid should always reach this line. If the accumulator is not so marked it is a safe plan to keep the acid level slightly above the tops of the plates.

If the acid falls below this level the cells should be "topped up" with pure distilled water obtainable from the charging station or the chemist. Common tap water should not be used for this purpose, as it contains impurities dangerous to the chemical compound contained in the plates; neither should acid be used by the amateur.

Should the cells "froth" badly during charge, it is an indication that the acid requires changing, the frothing probably being due to an impurity in the electrolyte. Gassing and "frothing" must not be con-

fused. The former is a healthy sign and consists of small bubbles of released gas, whilst the latter takes the form of a scum on the surface of the acid.

The acid should not be changed by the amateur, but the cell should be taken to the charging station for the purpose, where it will be discharged, emptied and refilled with acid of proper specific gravity and afterwards recharged for a long period.

Condition

If, in the course of time, the paste of the positive plates falls away from the grid and touches the negative plates (grey in colour) a long thin stick may be inserted between the plates and the obstruction pushed to the bottom of the cell, otherwise the cell will "short" and become useless.

If the trouble persists, however, there is no remedy but to have a new set of positive plates inserted. A cell which is in good condition shows the positive plates to be of a good deep chocolate colour and the negatives a dark grey. Should a yellow or white sediment be apparent on either set of plates it is a sure sign that the accumulator is not getting sufficient work and requires thoroughly charging and discharging more often.

If this is not done the cells will rapidly become worse and in the end they will become completely ruined and refuse to take a charge.

A. J. C.

The Wonders of the Electric Current (Cont. from p. 397)

Here is a useful tip. Write down the formula in the heading photograph. Cover with your finger the factor which you wish to find and you will see exactly how you must proceed. For example, supposing that we know that the current is 2 amperes and the pressure 6 volts. What is the resistance? Place your finger over R and E is left.

C

Divide 6 by 2 and the answer is 3 ohms. R. W. H.

Wiring the House for Phones

IT is often desirable to have facilities for listening-in in several rooms of the house, and as it is often impossible to move the set about, the best way of getting over the difficulty is to wire the house with extension leads from the phone terminals of the set. If the wire used is well insulated and of low resistance, very little loss of signal strength will be noticed.

All tappings should be soldered, and the joint bound with insulating tape. It will be seen that the phones are in parallel, as then any

This should be neatly made, the brass fittings being polished and lacquered, so that it will not be out of place in any room. In the one shown, provision is made for four pairs of phones, but this number can, of course, be reduced or increased. "Rawlplugs" are very suitable for fixing a fitting of this kind to a plaster wall without damage.

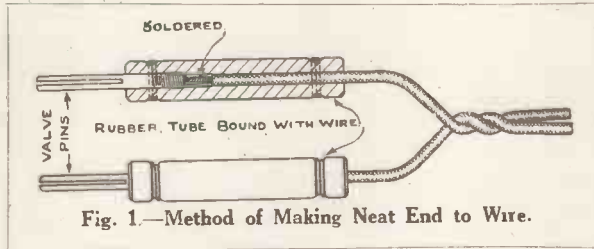

Fig. 1.—Method of Making Neat End to Wire.

No Loss in Strength

I have found that no loss at all can be detected providing that low-resistance phones are used, and the current is transformed to the lower voltage by means of the usual phone transformer, before entering the extension leads. With high-resistance phones and no transformer, a little loss is noticed, but not enough to be serious, except, perhaps, with weak signals on a crystal set.

Making the Plugs

A good wire to use is that known as "Electron" wire. Ex-army field telephone cable, if obtainable, may also be used with success. The extension is carried out as follows:

First, all the phones are fitted with special ends to their leads, made from valve pins. Fig. 1 shows the method of making a neat ending. The phone terminals of the set are replaced by two valve sockets.

Tuning In

Tuning-in is performed with a pair of phones plugged into these sockets, and then the phones are replaced by the ends of the extension leads, which are also fitted with valve pins.

The leads are taken through the house to the different rooms, using staples for fixing them as neatly and as unobtrusively to the walls as possible. Fig. 2 shows the method of making tappings to several rooms.

pair can be unplugged without breaking the main circuit, and so putting the others out of use. This method is only applicable to phones

A Warning!
Finally, a word of warning. When phones are in use in several rooms, do not forget that words spoken in one may often be heard in another! This fact may be used in order to carry on a conversation between two rooms if desired.

W. E. M.

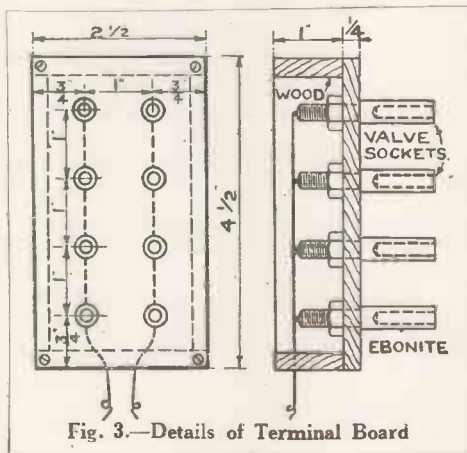

Fig. 3.—Details of Terminal Board

of the same resistance. If phones of different resistances are used, they must be in series, and then on removing one pair it will be necessary

of energy between the plate and grid circuits. If the aerial is very long it will absorb the energy transferred back from the plate to the grid and thus prevent the set attaining its maximum efficiency.

Up to a certain point the shorter the aerial the easier it will be for the set to oscillate. If, on the other hand, the aerial is too short, the set is apt to oscillate on the least provocation, bringing about a state of affairs equally as bad as if the set would not oscillate at all.

For all-round reception, the 100-ft. aerial is most suitable; nothing is gained by departing either one way or the other from that length at least as far as broad-cast reception is concerned.

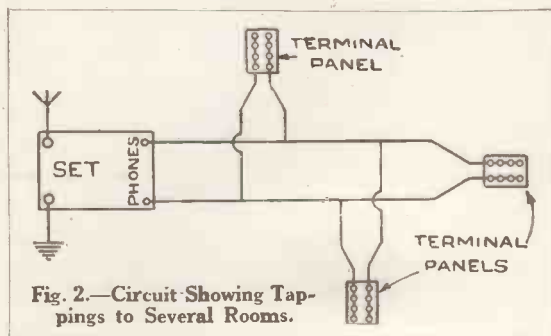

Fig. 2.—Circuit Showing Tappings to Several Rooms.

to short the sockets from which they were removed. In each room at the end of the extension leads is fixed a terminal board. Fig. 3 gives details of this:

"TERMINAL."

Stories of Early Broadcasts

SOME EXPERIENCES BY WILLIAM LE QUEUX

IN my research laboratory high up on the Hog's Back, just outside Guildford, were made some of the first attempts at broadcasting. They were fraught with much humour and considerable disappointment, both to my assistants—Mr. E. Brown and Mr. L. Love—and also to my listeners.

A good many old-time amateurs will recollect how, after continuous experiments lasting over eighteen months, they suddenly heard, one night about five years ago, 2 A Z calling by telephone.

First Wireless Telephone

It was the first time they had heard wireless telephony, therefore many could not believe their ears. The whole thing was weird and uncanny—a voice from the void!

Soon, however, people became interested, and for one hour each night—namely, from nine until ten—my big generator (the Marconi Company had lent me a roomful of apparatus) was humming; and I broadcast over the length and breadth of the Kingdom, as far north as Aberdeen, where I was heard distinctly.

From that room, packed with apparatus which included the latest type of Marconi seven-valve amplifier and note magnifier, German six-valve amplifiers, a Creed "recorder," and a transmitting set of our own design, the first broadcasting to amateurs took place.

The engineers of the Marconi Company at Chelmsford were highly interested in my attempts, while one of the first to see my apparatus was my old friend Mr. W. W. Burnham, mainly through whose efforts the B.B.C. later came into being. I suppose because I had been engaged in serious research work in wireless over many years, since the days of the "coherer," everyone was exceedingly kind to me—even the authorities who rule the ether.

Success, however, did not come to us until failure after failure and disaster after disaster had many times reduced us to anger and even to tears. For months, day in and day out, I spoke into the microphone, an ordinary post office "solid-back," to a friend who had a good receiving set only half a mile away; but hour by hour he told me over the land-line that there was a dead and depressing silence upon my wavelength, which was 1,010 metres. We raised it and we lowered it. We altered the circuit a dozen times; shocks and thrills we had many, but 2 A Z remained speechless, and every day, on entering the laboratory, I felt like reducing the whole box of tricks to dust with a sledge hammer.

One morning, however, we received the great thrill of our lives by the receipt of a letter from that well-known amateur, Mr. F. Townshend, at Ipswich, 80 miles distant, saying that he heard us quite plainly on the previous night and giving us a record of our transmission. Success! We were silent no longer!

In celebration of the event, we increased our power on that evening, with the dire result that we put our generator out of action!

This meant more tribulation and expense, for the makers would not undertake to re-wind it, and after a silence of a fortnight we re-started with another new generator.

Three Thousand Volts!

On the night when we tested it I was making some adjustments to the set and wearing a rubber glove, when I accidentally touched my wrist against a terminal and took a flying leap across the room, with about three thousand volts through me.

"Ah!" remarked my friend Brown quite casually. "All these things are sent to try us!"

I fear that my language was unprintable, for besides sustaining a very serious shock, which upset my



nerves for several weeks, I had been badly burnt on the wrist of one arm and in the palm of the other hand. An almost similar accident had occurred to my friend Love somewhat earlier.

With our new generator we decided to purchase a gramophone. We bought a secondhand one for nineteen and sixpence, including a dozen worn-out records and a box of needles, and with this wheezy instrument we inflicted tortures upon our listeners. "We parted on the shore," by Harry Lauder, was one of our favourites, and this we performed nightly.

No News

As the transmission of news was forbidden by our licence, we resorted to reading comic weather reports and forecasts, such as: "London, S.E., and Channel: Heavy south-westerly gales if it is not fine, with an earthquake at Tooting. N.E. district: Much rain, with a waterspout near Newcastle," and so on.

Our general news bulletin consisted in reading a few items from the evening paper embellished by our own caustic remarks concerning men and matters mentioned in the Press.

One day in a secondhand shop I picked up for sixpence a book on Etiquette for Men. This we made our stand-by, and in all seriousness, often addressing ourselves to amateurs whom we named personally, we read our nightly portions of "How to Behave in Company." Some of the instructions how to play the gentleman were excruciatingly funny, and our own laughter was

often transmitted as well as the stern directions given.

As soon as we had firmly established this burlesque programme we began to receive shoals of letters and postcards. The letters were mostly abusive, and to the writers of such we gave "back chat" through the medium of wireless telephony.

One night an amusing and unrehearsed scene occurred in our "studio." We had two aerials, one for transmission and one for reception. We started up a well-known fox-trot, on the old gramophone, whereupon the "recorder" suddenly began to tap to the rhythm of the tune. We were, much to our surprise, recording our own music!

A FALLING-OFF IN SIGNAL STRENGTH!



It was explained by the fact of two aerials, and that the switch of the one for reception had been left in.

Another amusing episode took place one very stormy night. On the previous evening I had promised my listeners to broadcast as usual, but at the last moment I was called to London.

My friend Mr. Love, who lived half a mile away, always listened for me at 8.45 p.m., when we made adjustments prior to broadcasting at 9. Knowing that he would be listening at that moment, I switched on my generator and called:

"Love! Love! Love! I can

do nothing to-night. I'm going out at once. Will you please come up here and carry on as usual?" And I repeated the message.

Then I switched over and listened to his reply, for he, too, had a smaller transmitting set, a most effective one, which he had constructed himself, for he is an expert radio engineer.

Far-off Reply

Instead of hearing his voice I heard a far-off reply in a distinctly foreign accent. This mysterious voice said: "Hulloa! 2 A Z! Hulloa! This is De Boek in Brussels calling. What was that about Love? Could not get you. What did you say about love? Please repeat. De Boek over for 2 A Z."

The request surprised me—for I had no idea that a telephony set existed in Brussels, or that I was being listened to there. At The Hague, however, telephony experiments were daily in progress, and we constantly exchanged conversations.

I switched on and repeated to Brussels my message to my friend Love, whereupon the answer came back: "Cannot understand. Only the word Love. O.K. We're all in love, 2 A Z, are we not?"

And he switched off.

Leg-pulling

Later on, when the Chelmsford and "Victorian" experiments had taken place, a certain amateur in Surrey boasted of his long-distance reception of telephony and claimed to hear all sorts of tests from various parts of Europe. Hence we decided one day to "pull his leg."

We raised our wavelength to 2,500 metres, and then, in my best Italian, I announced myself as the station at Coltano making telephony tests to Naples. I read extracts from an old copy of the Milan *Secolo* and chattered in Italian to my supposed fellow experimenter.

Next morning the amateur in question went about in a state of the highest satisfaction declaring to all and sundry that he had heard Coltano and expressed to me wonder that we had not heard it!

Such were some of the humours of the first broadcasting.

THE wireless hero of the day: The man who frankly asks the assistant behind the counter for a fool-proof set.

Another New Valve!

THAT'S the third one gone this year! Rather an expensive luxury burning out valves like this, eh? But there are one or two little points which, if attended to, will result in securing a much longer life for even the weakest of valves.

For instance, the filament temperature may be considerably reduced. Perhaps it is not generally known that increasing the filament temperature above the normal, even to a small extent, will reduce the life of the valve by half what it might have been if the low-tension voltage had not exceeded that stipulated by the makers.

Reduced Voltage

By reducing the filament voltage to 3.5 volts for a 4-volt valve the life may be increased by one-third to one-half as long again.

The voltage should be measured across the valve filament terminals and not across the accumulator, and for this reason a special pair of contacts should be embodied in this portion of the circuit for measuring purposes. The extent to which the filament brilliancy or temperature may be reduced is governed by what is known as the characteristic of the valve.

In the case of a detector valve the dimming of the valve may be accomplished by an alteration in the value of the grid leak and a step up in anode potential, or both, but in many cases it will be found that a detector valve will function quite well with 3 to 4 volts on the filament, the only difference noticeable being that the reaction effect is not so easy to obtain.

H.F. Amplifiers

High-frequency amplifiers are easily doctored in this way, and very little trouble will be experienced in getting them to run efficiently at a low temperature, provided that the anode voltage is correspondingly increased.

The markings on a valve by the manufacturer need only be adhered to when the full filament voltage is used, and if the amateur will ring the changes on the valve in the manner advocated and obtain for himself a filament voltmeter he will find that his valves will last considerably longer.

A. J. C.

Summer-time Aerials

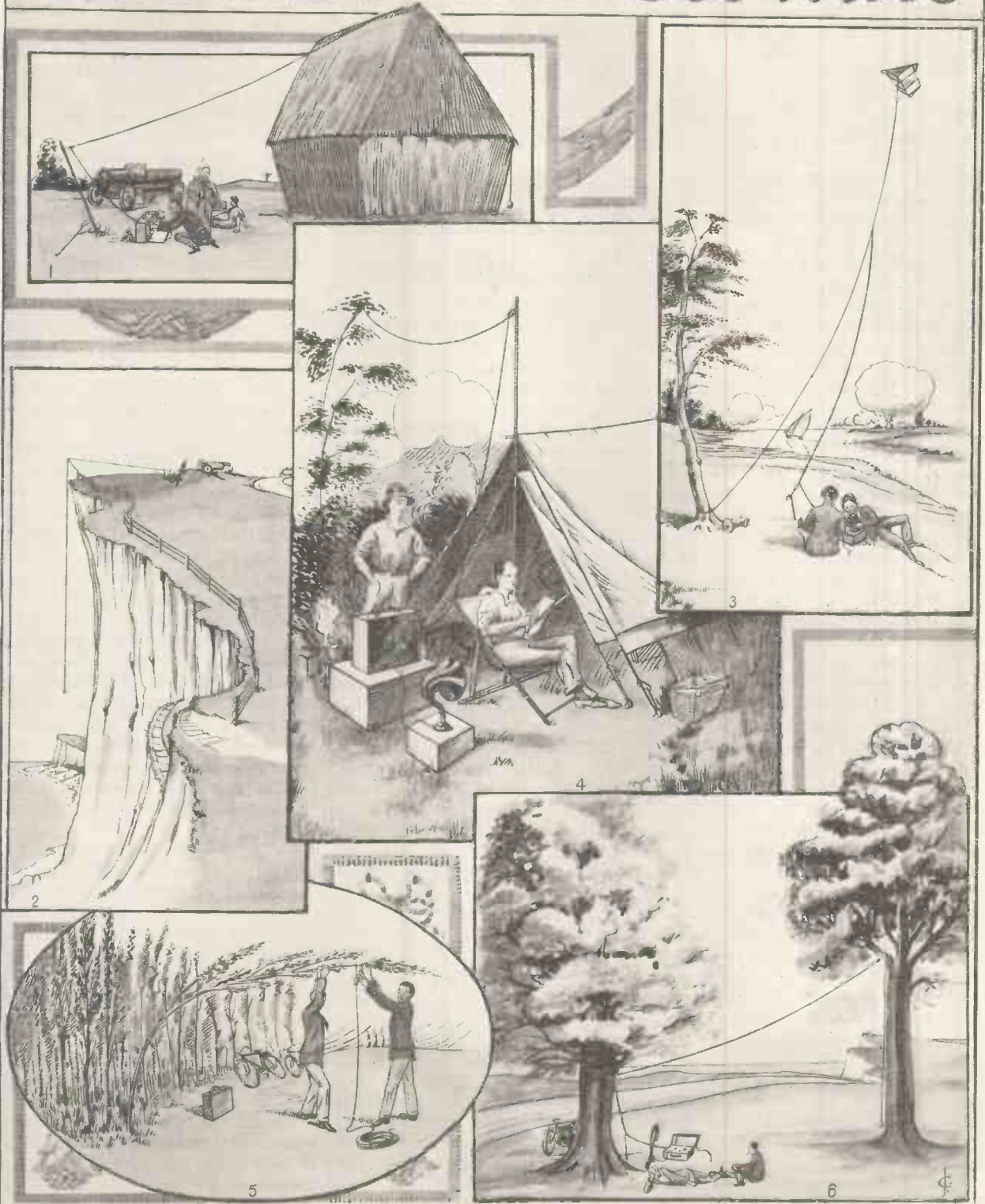

1.—Weighted wire slung over hay-stack. 2.—Cliff aerial. 3.—Kite aerial. 4.—Camp aerial. 5.—Country-side aerial. 6.—Wire slung over tree branch.

Choosing the Loud-Speaker

WHEN I first began to use a loud-speaker there was only one make on the market, and the demand for these was so great that they were difficult to obtain. One had, therefore, no choice in the matter at all. Nowadays things are very different. I do not know how many different makes of loud-speakers there are, but they must run into dozens. Essentially all are based on the same principles.

The loud-speaker, of whatever type it may be, consists of a big telephone receiver provided with a diaphragm of large diameter, and usually with a horn. In one type the horn is done away with and the diaphragm takes the form of a large disc of pleated paper.

Desirable Qualities

Before setting out to choose a loud-speaker it is just as well to have perfectly clearly in your mind the qualities which are desirable, and those that are not. Do not expect the loud-speaker to amplify. It will not do so, except to a very limited extent. Unless, therefore, your signals are uncomfortably strong in the phones you will not obtain a great volume of sound from any kind of loud-speaker. What we want such an instrument to do is to reproduce speech and music without noticeable distortion.

I say noticeable because actually there must always be a small amount of distortion in any sound reproducing instrument which operates by means of a metal diaphragm. You will find on hearing various kinds of loud-speakers tested that, like pianos, they vary considerably in their pitch. Some are high-pitched, some medium and some low.

Speaking generally, the high- or medium-pitched instrument gives the best and clearest reproduction of speech, whilst that with a low pitch introduces a kind of mellowness and fullness of tone into musical items. This kind of instrument, however, often makes speech sound rather throaty.

Most loud-speakers will do fairly well when they are dealing with a signal of only moderate strength; when, for example, the words of the

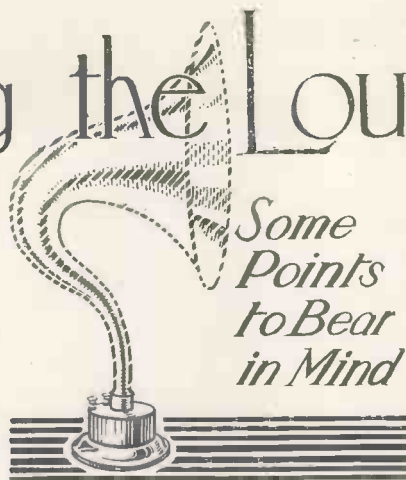

speakers that they have been able to suppress to a very great extent the effects of resonance. Still they are there, and if the instrument is used in certain surroundings their presence will make itself felt.

Again, the horn also has its own natural frequency and resonates whenever that frequency is produced by the diaphragm. It must not be forgotten that any room has a natural frequency, and there may also be resonance from small articles such as gas globes or vases and small parts of its furniture or fittings. All singers know how difficult it is to make the voice carry in certain rooms, and there are some halls in which even the most highly trained vocalists cannot avoid becoming a little sharp or flat.

It may happen, then, that the room itself, or something in it, will serve to accentuate the unwanted resonance of the loud-speaker on certain notes. Some time ago when I was trying a new instrument I found that it gave perfect working except that a certain note, whenever it was reproduced at big strength, always produced a distressing buzz. I thought at first that this was due to a defect in the loud-speaker itself, but when with the help of several yards of flex wire I took it into another room I found that the buzz no longer occurred. It was eventually tracked down to one of the piano candle holders.

In Different Rooms

Here is a curious illustration of the way in which certain rooms suit certain kinds of loud-speakers. The one which I generally use gives in its own room really excellent reproductions of both speech and music. If, however, I take it to a friend's wireless den it does not do half so well as his own instrument, whilst his, though its working approaches perfection at his house, does very badly if he brings it down to mine.

By far the best way of selecting a loud-speaker with a certainty that it will give satisfaction is this: Go to a wireless shop and hear various types tried out, noting the two or three of them whose reproduction seems most pleasing to you. Explain

announcer are audible up to about fifteen feet from the trumpet. When the volume of sound is of small dimensions any distortion that may be present is so little emphasised that it is difficult to detect it.

The real test for any loud-speaker is to get the salesman to attach it to a large set and then to tune in a strong signal very loudly. If the loud-speaker will pass this test with flying colours you may be pretty sure that there is nothing amiss with it.

But even so you may be disappointed with the results that it gives when you install it in your own home. You may find that it has not the same quality of tone as it had in the shop, and that certain notes are stressed with very unpleasant results. There are two possible causes of this effect: your set may not be all that it should be, or the room may not suit the loud-speaker. With the set itself we will deal in a moment. Let us see what we mean by saying that the room may not suit the loud-speaker.

In the receiver of the instrument we have wire-wound electromagnets and a thin metal diaphragm. Each

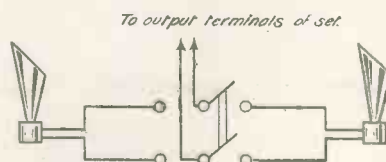

Fig. 1.—Switch for Comparison of Loud-speakers.

of these has its own natural frequency, and whenever a note corresponding to that frequency occurs in the sounds that it is reproducing, the loud-speaker will respond to it more strongly than it does to others. So skilled have manufacturers become nowadays in designing loud-

that you would like to try them on your own set before deciding, and have them sent round.

When trying one against another I make use of a double-pole change-over switch in the way shown in Fig. 1. By this means you can change over instantly from one to the other and can very rapidly form an opinion as to their respective merits. Choose the loud-speaker which does best in your own room, and you will be satisfied.

Concerning the Set

Now for the set itself. If there is any distortion present in its output this will be very much more noticeable with the loud-speaker than with the phones. Therefore, before you install a loud-speaker be quite sure that your reproduction is as nearly perfect as you can make it.

Distortion arises as a rule from one or more of the following causes:

(1) Working the set too close to the oscillating point. This can be rectified by making less use of reaction.

(2) The use of interval transformers of poor design which have a very strongly marked natural frequency. The remedy here is to place a resistance of from 50,000 to 100,000 ohms in shunt with the secondary windings of either or both. This will cut down signal strength to some extent, but will greatly improve the tone.

(3) Interaction between low-frequency transformers. If this cannot be cured by separating them, by earthing their cores or by placing their windings at right angles to one another, try the effect of substituting resistance-capacity coupling for the second transformer.

(4) Using an unsuitable valve as second note magnifier. A valve in this position has to deal with fairly big potential differences upon its grid, and unless the straight portion of its characteristic curve is very long, the working point may be taken down by oscillations of large amplitude to the lower bend, in which case partial re-rectification takes place with horrible results. The valve used as second note magnifier should always be one with a good straight portion of the characteristic to the left of the zero line. It should be worked at a high plate voltage in order to throw the curve over to the left.

(5) A flow of grid current in the second note magnifier. In most

valves there is an appreciable flow of grid current when the working point is at zero grid volts or slightly positive. The effect of grid current is to damp the flow in the anode circuit.

If, therefore, a positive half cycle takes the working point up to zero volts or beyond it, grid current will occur and the output will be distorted. The remedy is to use a suitable negative grid bias so as to keep the working point low down on the straight portion of the characteristic curve though still away from the bend in the curve.

There is one last consideration which is an important one. Is it best to use a high- or low-resistance loud-speaker? The high-resistance instrument has the advantage that it is connected directly to the output terminals of the set whilst that with low-resistance windings requires a transformer.

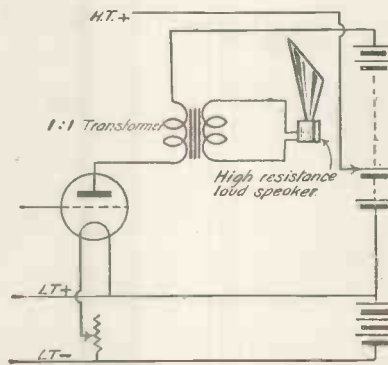

Fig. 2.—Method of Using High Voltage with H. R. Loud-speaker.

Every additional iron-cored transformer in the set enormously increases the chances of distortion through interaction as well as through resonance. The effects of interaction can be overcome entirely if the transformer is placed not in the set but with the loud-speaker at some distance from it, and provided that the transformer is of good make, very little distortion will occur through resonance.

The great advantage of using a low-resistance instrument is that its windings do not have to carry the steady current in the plate circuit of the last valve.

We can, therefore, use a very high anode voltage without the slightest risk of burning out the windings of the loud-speaker.

The high-resistance instrument is possibly a little better as regards

purity, but I do not think that there is much in it. If you want to use a big plate voltage with the high-resistance instrument you can easily do so by the method shown in Fig. 2. A 1 to 1 transformer is made by the Metropolitan Vickers Company, and is not an expensive fitting. If it is used the windings of the loud-speaker are relieved from the strain imposed by a high voltage. J. H. R.

The Reservoir Condenser

THE reservoir or smoothing condenser placed across the positive and negative terminals of the high-tension battery performs two functions—the smoothing-out of the noises of the battery and the providing of a path for the high-frequency oscillations in the set.

It is the first-named function with which we are more immediately concerned because the second is not so apparent.

With regard to the first function, however, most "dry" H.T. batteries make a greater or smaller number of parasitic sounds owing to the chemical action taking place inside them, and the noises become more apparent when the battery has been in use for some time. The reservoir condenser smooths these noises out, taking upon itself a duty analogous to the "gas bag" of a suction gas engine.

Its Action

The condenser may perhaps be better imagined as a rubber bag into which the current of the battery is being forced by the electromotive force (volts). The bag, being elastic, expands within certain limits, and becomes filled by the pressure exerted, consequently sufficient energy is stored up to supply the valve anode current for an infinitesimal fraction of a second; sufficiently long, however, for the pressure to the valve to be perfectly constant during that brief period.

Hence, if the voltage of the battery fluctuates ever so slightly during that period, the condenser has sufficient "elasticity" and current stored up to render such fluctuation harmless so far as the valve current supply is concerned.

The condenser should have a relatively high value, approximately half a microfarad to two microfarads. A. J. C.

CAN WE LEARN FROM THE AMERICAN AMATEUR?

American & British Ideas Compared

IT is most interesting to compare the opinions and ideas of wireless reception now ruling in America with those which obtain in our own country. Broadcasting in the United States began on a large scale, long before we knew it in this country. We may, in fact, say that our American cousins had a year's start of us, for I believe that I am right in saying that they passed their first million wireless enthusiasts whilst our holders of receiving licences were still low down in the ten thousands. But if we came late into the field we showed as a nation a remarkable aptitude for picking up both the theory and the practice of wireless, and though we cannot yet equal the American numbers there can be no doubt that we have, to say the least of it, drawn level in both transmission and reception.

Developed on Different Lines

Wireless reception has not developed on quite the same lines in the two countries. The average amateur-made receiving set in America differs considerably in its circuits, its arrangement, its design and its components from that made by our own constructors. This is at first sight a little surprising, for our wireless papers circulate in America, and theirs over here, so that there is a fairly free interchange of ideas. But there are fashions in wireless as in everything else, and though its main principles are international, each country seems to adopt its own distinct methods of working out the practical side of the matter.

The conditions in America are rather different from those which prevail in this country. Here we have nine main broadcasting stations with a power of 1.5 kilowatts, eleven relays rated at 200 watts, and one high-power station whose present power is in the neighbourhood of 16 kilowatts. That is, we have twenty-one broadcasting stations altogether, and

all of them are controlled by one authority, the B.B.C. In America the number of broadcasting stations runs to about seven hundred. Some of them, such as K D K A, W B Z, W G Y, W E A F and W G N, are rated at 1 kilowatt, but the majority have a power of a good deal less than 500 watts. They are run, not by

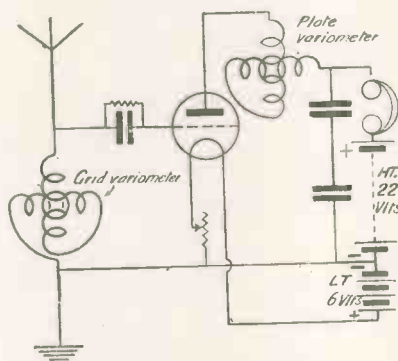

Popular American Circuit.

one company, but by a great number of individuals, institutions, societies and companies.

Selecting at random six consecutive stations from a complete list which is before me as I write, I find that the first is controlled by a garage, the second by a polytechnic institute, the third by an electrical company, the fourth by a company manufacturing farm implements, the fifth by a church and the sixth by a newspaper. Further, we find that single towns may contain a very large number of stations. There are, for example, fifteen in New York and ten in Philadelphia.

A certain amount of Government control is exercised to prevent undue jamming between neighbouring stations operating upon wavelengths that are close to one another.

One result of this condition of affairs is that there is practically no town of any size in the United States where broadcasting cannot be obtained by means of the crystal or the single-valve set. It was not

therefore surprising to find that for some time high-frequency amplification was not nearly so popular in America as it was in this country. The average valve set used for loud-speaker work a year ago consisted of a variometer or variocoupler tuner followed by a rectifier and two transformer-coupled note-magnifiers. The use of reaction, magnetic or by capacity, was, and is, practically universal.

The diagram which shows an American circuit which is still very popular with or without the addition of note-magnifying stages. It contains several interesting points.

Reaction Effect

The reaction effect is obtained by means of the plate variometer, for when both plate and grid circuits are sharply tuned the set will oscillate owing to the capacity coupling within the valve.

Notice the position of the grid leak. It is shown in shunt with the grid condenser and connected between the grid and—L.T. This last is a very common feature in American sets though theoretically it is quite wrong, since rectification when grid leak and condenser are used depends upon the flow of grid current in the valve. If the grid is set at zero volts by being attached to the negative end of the low-tension battery there is, or should be, very little grid current indeed.

The flow of grid current is, however, increased by the use of a very low plate voltage, twenty-two volts being almost universal for the anode of the rectifier. Of valves we shall see more in a moment.

The Armstrong and the Flewelling super regenerative (every new circuit over there is a super-something!) opened the eyes of wireless folk to the possibilities of long-distance reception. These circuits are used extensively, and large numbers of constructors also made up straight multi-valve sets containing one or

two stages of high-frequency amplification, transformer coupling, tuned or aperiodic, being very widely used.

Except where the variometer is employed to give reaction effects as in the diagram, it is very rarely that one comes across in American circuits the efficient tuned-plate coupling of which so much use is made by our own amateurs. American radio-frequency transformers of the ordinary type that I have tried out are not strikingly efficient, nor are they very well matched. However, a further development soon followed the super-regenerative circuit.

Neurodyne Circuit

This was the neurodyne, which, though it has not yet caught on to a very great extent in this country, is probably the easiest and most satisfactory form of high-frequency amplifier to operate. With it three sharply tuned stages of H.F. can be used and perfect stability retained. It was when the neurodyne came into prominence that the American manufacturer showed what he could do. Foreseeing the demand, he placed upon the market various neurodyne "kits." These consist of sets of well-made and perfectly-matched transformers with the necessary condensers. Hence the constructor who wished to make up a neurodyne set in the States can buy all the parts with the greatest ease and at moderate cost.

The "kit" idea has been developed considerably and excellent outfits containing all the essentials for the super-heterodyne receiver, which is now fast becoming a favourite over there, are obtainable.

To-day the American enthusiast desires long-distance reception, and he gets it as a rule with the help of the neurodyne or with the super-heterodyne. But he also seems to like a good deal of noise, for the majority of multi-valve designs that

one sees, whether "straight" or not, contain two or three stages of low-frequency amplification. Here transformer coupling is the type which is most popular, though one firm at any rate is turning out resistance-capacity units which can be connected up in place of transformers.

Small Use of Grid Bias

The most startling feature about the note-magnifying side of valve sets is the comparatively small use made of negative grid bias. In some designs the "C" battery, as the grid-biasing battery is called, appears, but as a rule there is no sign of it. Nor do we find much use made of quality-improving devices such as a fixed condenser across the primary of the second low-frequency transformer, or resistances shunted across the secondary of either transformer.

The telephone condenser now appears in few designs, and if a high-tension battery condenser is used it is often of a size that we should regard as altogether insufficient for the purpose. Plugs and jacks, which are not widely employed in this country, appear upon a very large proportion of American receiving sets.

Perhaps the most surprising point when one comes to review American conditions is the very small choice of receiving valves afforded the amateur. In an American wireless paper before me now there are only two advertisements of valves, and

each of these deals with a similar range. There is a six-volt pair, one of which is used for rectification and high-frequency amplification and the other for note magnification; there is a ".06" valve; and there are two valves of the "Weco" type which differ from one another only in the arrangement of their pins. This is roughly the selection available for the American amateur. And even when he goes out to purchase, say, a UV 199, which is the American equivalent of our ".06" types, he cannot be certain that he is getting what he pays for, for what is called piracy is rampant over there and there are any number of spurious "tubes" on offer.

No Specialised Valves

The specialised valve such as the small power amplifier or the anti-capacity valve is practically unknown. When one comes to try out American valves one is thankful that we have in this country a large number of manufacturing firms in keen competition, each of which turns out a large selection of well-made valves. I do not mean to say that American valves are not very fair performers; they are. But lack of specialisation is, I think, a very great drawback.

Amongst other components the American variable condenser is that which is the most striking. Speaking generally those on the market at moderate prices are in some re-

spects superior to those obtainable in this country. The American public demands now a precision variable condenser, usually with a "fine" tuning device. Fine tuning is done in a large number of cases by means of gears.

On the other hand the square-law condenser, which we have developed very rapidly, appears to find little or no favour in the States. Another curious point is that one seldom

(Continued on page 434)

AN AMERICAN BROADCASTING STUDIO



Large enough to accommodate a group of artists or a jazz band, this studio at the Crosley (W L W) broadcasting station is furnished with antique pieces from Italy and Spain. An ancient French tapestry adorns the wall.

PRACTICAL COIL WINDING

IN the last instalment it was explained how a basket coil could be improved by removing the pegs and substituting for them thin strips of insulating material. By using a large diameter of peg in the former the angle of the zig-zag

crank spindle. To effect the correct interlacing it is essential that the cam shall be geared down from the spindle carrying the former. As there is always an odd number of spokes it is not possible to use an equal gear and to divide the number of cams on the cam wheel by two, which would be necessary for a single basket-coil formation, or by four for the double-basket system of interweaving the wire. The cam wheel must therefore have exactly the same number of cams or buttons on it as there are spokes in the spider, and be geared down to two to one for a single-basket coil and four to one for a double-basket coil.

inclined projection on the guide lever to work on the buttons, but the roller idea proved much more satisfactory. The guide lever has numerous holes for the wire drilled in its uppermost extremity. By providing several holes the most convenient one can be chosen, without involving any other mechanical adjustments to the machine. A light spring is necessary to control the guide lever and maintain it in the normal position when it is not being deflected by the cams. An old lock spring was used, but quite as good results were obtained by holding the lever against the cam wheel by a short piece of narrow garter-elastic.

In examining the photographs it may be noticed that the cam wheel has eighteen holes in it. It was thought that by putting two cam buttons into the holes side by side the guide lever action could be

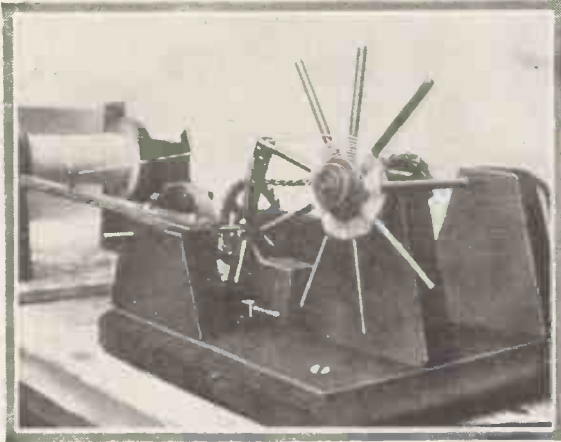

Fig. 28.—Automatic Winder.

formation of the coil is increased, and the crossing is less acute, as shown by diagrams *a* and *b* in Fig. 26. The coil is thereby strengthened mechanically, especially if it is finished by fitting the strips as shown at *c* in Fig. 26 all the way round. This is also shown in Fig. 27.

In covering a coil of this kind, i.e. one of large diameter with the three or five supports as illustrated in Fig. 21, it is not difficult to miss the few pegs in wrapping the tape round the coil. Such a coil could be left dry, and reliance made on the tape to keep out moisture.

Automatic Winder

The automatic winder illustrated in the photographs (Figs. 28 and 29) was made up entirely out of construction toy gear wheels and Bond's ladder chain and sprocket wheels. Where a permanently and constantly used device of this kind is considered, of course, more robust gears and shafts than those employed in the writer's experimental machine can be introduced. For an amateur, the winder as constructed is, however, quite a sound workable machine.

The spider type former is, in this mechanism, mounted directly on the

Interlacing

As illustrated in the sketches and photograph (Figs. 29, 30, and 31) the interlacing is effected by a vibrating guide, which is moved in perfect rhythm by the cams or buttons on the cam wheel. Normally the wire is arranged to feed in line with the front of the spider, the cams diverting it to the back of the spokes. The interlacing guide has a roller—a part of a terminal—fitted on its face, which engages the cam buttons. These buttons are actually No. 2 B.A. roundheaded screws.

At first the writer made an in-



Fig. 26A.—Small Pegs.



Fig. 26B.—Large Pegs.



Fig. 26C.—Fibre Strip in place of Pegs.

changed over by this simple means from a single-basket formation to the double-basket system of winding. The fallacy of this scheme was soon discovered and the principle laid down in the previous paragraph,

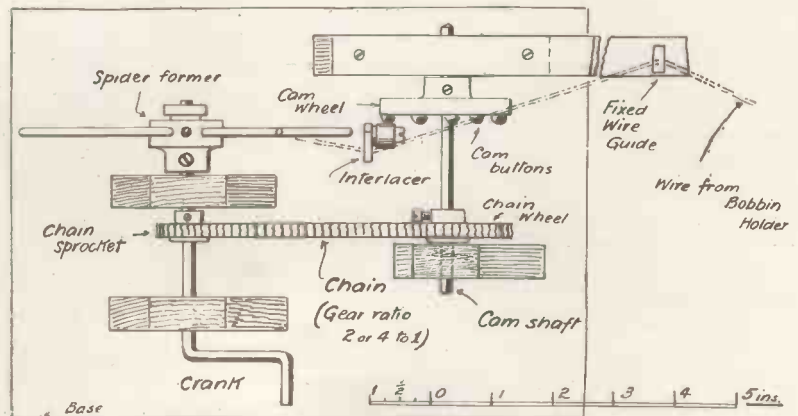

Fig. 30.—General Details of Automatic Winder.

viz. the necessity of affecting the change by gearing, recognised as the only possible one.

Binding the Coils

The instability of a basket coil which is wound on a pegged spider, the spokes of which are withdrawn after winding, makes it necessary to bind some of the adjacent coils to-

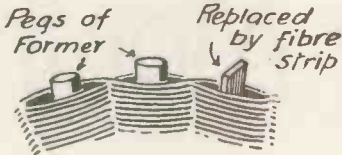

Fig. 27.—Peg Replaced by Fibre.

gether, with more particular reference to the beginning and end of the coil. This binding can be done with a needle and darning cotton (cotton, not darning wool).

The best method for finally binding an open, dry coil—i.e. a coil without any supporting wax or varnish and one which is not covered with tape—is to tie the cotton round

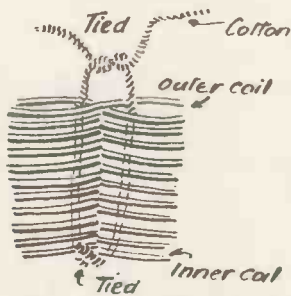

Fig. 32.—Method of Binding Coil.

two of the innermost coils and then bring one thread up each side of the crossing of the wires to the outer edge of the coil and to there tie it again. An attempt to illustrate this method is shown in Fig. 32.

Drying Out and Proofing

The coils should, after being bound or otherwise made stable, be dried out by being placed in a warm oven. If they are to be used unproofed the set should be in a dry room, as dampness increases the capacity of a coil as well as impairs the insulating value of the cotton covering. Of course the coils may be completely covered with varnished tape, but even then they cannot be considered immune from the adverse effects of a damp atmosphere.

Proofing may be accomplished by dipping the coils in paraffin wax while still on the former. The wax

should be made molten in a saucepan of boiling water.

In proofing the coils avoid the steam from the water, otherwise the coil may be made as damp as it was before the process of drying out. However, this point is perhaps not so very important, as if the wax is being heated by water which is at boiling point, the complete immersion of the coil will drive off the moisture which may be present in the coil. This can be observed, and the cessation of the bubbles of steam rising from the submerged coil will indicate in a greater or less degree that the moisture has been driven out of the insulation.

Superfluous Wax

While still within the confines of the pot holding the wax, all superfluous wax may be thrown off by spinning the coil. Shellac varnish of the very best quality, made extremely thin, may be used for proofing.

It is, indeed, considered by some to be a superior method to waxing.

The excess of varnish may be thrown off as described above and, after coating, the coil should be baked in a warm oven to harden or actually to dry out the spirit in the varnish.

H. GREENLY.

(To be continued.)

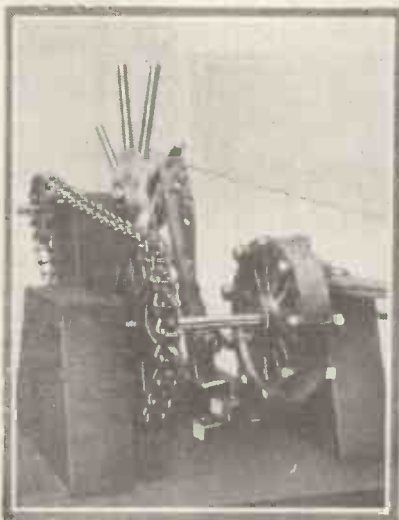

Fig. 29.—View of Interlacer.

RE-RADIATION

IT is a common experience for a crystal listener working in the near vicinity of a valve set to experience curious fluctuations in signal

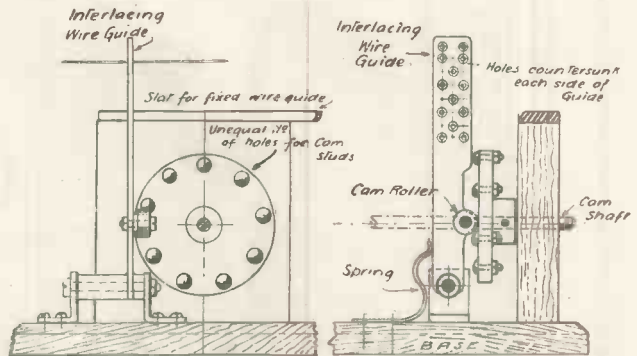

Fig. 31.—Details of Cam-operated Interlacer.

strength. Sometimes he will receive signals of unusual volume, whilst at other times they sink below par.

Energy Thrown Off

If he is quite satisfied that the fault does not lie inside his own circuits, he is probably experiencing the effects of re-radiation from the neighbouring valve set. The latter is not oscillating or radiating in the ordinary sense of the term. It is merely re-transmitting the actual signals received. Usually this occurs when the valve receiver is set just below the point of oscillation. In these circumstances the aerial has practically no zero damping, that is, no effective resistance, and the received signal currents build up to such an extent that some of the energy is thrown off into the surrounding ether.

Increased Strength

So long as both aërials are tuned to the same broadcast station the crystal operator is on velvet, because he gets increased signal strength. However, as soon as the valve operator switches over to some other wavelength, this benefit disappears. The re-radiation effect now "blankets" the neighbouring aerial, and causes the crystal signals to sink below their normal value.

A. J. C.

It is said that the cows in America give more milk than usual after listening to a wireless jazz programme. After reading this, we have decided to serenade our milkman with a saxophone each morning.

Broadcast Music of the Month



Miss Nellie Norway with her Silver Bells.

MOST wireless enthusiasts will admit that a marked improvement has been made in the general programmes of the month. True, we would still like to hear the Directors of the B.B.C. sing in unison with a super chorus of Station Directors, "We ain't gonna talk no more, no more," but it is only right to say that there has been a more popular atmosphere prevailing "all along the line."

Mr. George Grossmith

Possibly this is due to the influence of Mr. George Grossmith, who is now attached to the permanent Advisory Staff, and certainly few actor-managers know better how to attract and hold—the two not always being synonymous—an audience than this member of the famous family who have been famous actors from grandfather down to the present day. Son of the

popular George Grossmith, and nephew of Weedon, he and his brother Lawrence may be said to have covered every form of dramatic art, and his parts in light comedy and as Gaiety star are too numerous to mention. As part author, too, who will forget that best of modern burlesques, *Great Cæsar?* We may well hope that with his collaboration we shall speedily obtain a "Brighter 2 L.O."

Fourth International Concert

It is somewhat late in the day to discuss the pros and cons of the American Miracle Play *The Pilgrim's Progress*, written by Mr. Stilman Kelley, a Cincinnati University Professor. But the fact that it involved the singing of so many well-known English artists makes it still of wireless interest. There was nothing original to be expected as regards the plot, for practically the story of Bunyan's "Pilgrim's Progress" was adhered to quite faithfully, but the singing, especially the choral part, was excellent, as was only to be expected from the fact that we heard Miss Ursula Greville, Mr. Joseph Farrington, Mr. Dennis Noble, Harold Williams and John Coates, all, except Miss Greville, being familiar names to all good wireless audiences.

Miss Greville has been really the pioneer of the British modern art song, and has just returned from a highly successful American tour. She combines two arts for, besides her talents as singer, she has had a successful literary career, and is still editress of the musical review *The Sackbut*.

Mr. Farrington has made himself especially noted for his operatic

TWO OF THE WORLD'S—



M. Paderewski took his own piano and chair to 2 L.O.



Miss Phyllis Lett.



Mr. Stuart Morrison.



Miss Astra Desmond.



Mr. C. Whitaker-Wilson.



Miss Emilia Conti.



Mr. Harry East.

rôles, and his work with the British National Opera Company has placed him well to the fore recently.

Mr. Williams and Mr. Dennis Noble are also members of the same opera company, and their recent work in the studios in addition to their operatic work needs no detailed comment.

Conducted by Joseph Lewis

The work itself was carried out by the Birmingham Symphony Orchestra with a Festival Chorus of The Wolverhampton Musical Society, under the baton of Joseph Lewis, who has conducted this combination on other occasions prior to his appointment as Musical Director of the Birmingham Broadcasting Station. There were 320 voices in the chorus and 80 performers in the orchestra.

Mr. Lewis has been anxious to make it clear that he did not choose his chorus from the Midlands, because he thought that it would provide better results than a London Symphony Choir, but in order that he might have ample opportunity for rehearsal, and it is quite evident that this choice thoroughly justified itself in the performance. Everyone admitted the chorus played a very prominent part.

The fact of two such artists as Tetrzzini and Paderewski broadcasting almost within a week literally puts an appearance before the microphone as an honour, instead of a thing to be avoided, or done under a different name, as we have had instances. At the former concert the rest of the cast, which included some of the greatest names in the concert world, were necessarily dimmed, if ever so slightly, by the fact that popular imagination had seized upon the prima donna as the chief attraction and was prone, as usual, to forget its own people.

Yet it would be hard to find a greater artist than Lamond, who played the same work of Beethoven, by sheer coincidence, as Paderewski himself. A Scottish pianist, Frederic Lamond has made the study of Beethoven as

personal a one as Pachmann of Chopin, or Harold Samuel of Bach, and one might say that all the three players are these composers' modern prototypes.

Then again, consider the fame of Isolde Menges, our finest woman violinist. From the early days when she was "discovered" by Lyell Taylor, then head of the Brighton Municipal Orchestra, she has proved herself a woman genius on the G string alone, where her tone has all the power of a man without the masculine roughness.

For the rest, Miss Phyllis Lett, who has now gone on a long Australian tour, Mr. W. H. Squire, the 'cellist, and John Goss, the singer who has made sea chanteys peculiarly his own, are all great artists. On the foreign side I liked the four Russian singers, Messrs. Denissoff, Kasakoff, and N. N. and K. N. Kedroff, who have become widely known here in London as the Kedroff Quartet.

Mr. Dinh Gilly

Mr. Dinh Gilly, the operatic baritone and colleague of Caruso, was at his best. It was certainly a triumph in programmes and opens the way for every other

(Continued on next page)



Miss Gladys Merredew.



Mr. George Crossmith.



Miss Ursula Greville.

—GREATEST BROADCASTERS



Mme. Tetrzzini looks over 2 L O with Mr. Percy Pitt.



Mr. Harold Williams.



Miss Constance Izard.



Miss Margaret Glanville.



Mr. Joseph Lewis.

great artist of the world to appear before the microphone.

The entertainers of the past month, you may have noted, have been on a higher plane, more of the real actor, and less of the knockabout comedian, who, although in his place on the music-hall stage or restaurant platform, has decidedly not been the right medium for wireless humour. Amongst the best heard recently is, of course, Walter Todd; Wilson James; another wireless entertainer of long-standing popularity with his connection with the concert party, The Gaeties, as well as his solo turns; Louis Hertel, inimitable mimic, and Ernest Wellbeloved.

In the Fighting Zone

The last is particularly well known for his work throughout the war in the fighting zone where, in between actions, he still contrived to use his professional talents. Indeed, Mr. Wellbeloved will have it that his best tribute was paid him in France, when playing the part of a burglar. At first sight of him, a big bull-dog promptly left his master in the stalls and made a bee line for the stage, with a view to protecting the home from the midnight intruder.

Mr. Wellbeloved was rescued in time, and the matter explained, I presume to the dog. But it is not only in make-up that this actor excels, but in dramatic delivery and character study in voice and expression.

Mr. Hertel needs no introduction. From the outset of wireless he has created his own characters, best amongst



Mr. E. Wellbeloved.



Miss Isolde Menges.



Mr. Cyril Lidington.

them being "Mrs. Struggles," who vies well with any other Cockney character study yet created. During the last month Mr. Hertel, who has been one of the best-known ventriloquists on the stage, has revived his art of mimicry, and I know of one family where a "free fight" almost ensued, so certain were various members that John Henry, Willy Rouse, Jay Kaye and others were actually speaking in the flesh instead of in the spirit by the medium of their confrère Louis Hertel.

Mr. Cyril Lidington is another artist whose repertoire ranges from excerpts of Shakespeare to songs of Schumann, and one of the best of his interpretations is "The Cane-bottomed Chair" of Thackeray, not an easy work to deliver.

More Humour

While on the subject of humour, mention must be made, too, of Miss Gladys Merredew, the child impersonator, and the Novelty Trio, which consists of Mr. Ronald Gourley, the blind pianist whom we all like for his capacity to make classic symphonies from a mixture of jazz and Beethoven, Miss Margaret Glanville and Mr. Harry East. The last writes all his own material, and both he and his partner are known throughout the provincial theatres as well as at the B.B.C. stations.

For the art of character study, Miss Christine Crowe stands out prominently. In addition, she is firmly implanted in the hearts of Northern listeners, not only for her splendid rendering of their own

(Continued on page 451)



Mr. Frederick Lake.



Miss Christine Crowe.



Miss Constance Wentworth.



Mr. Louis Hertel.

Above and Below Stairs

By RENÉ BULL

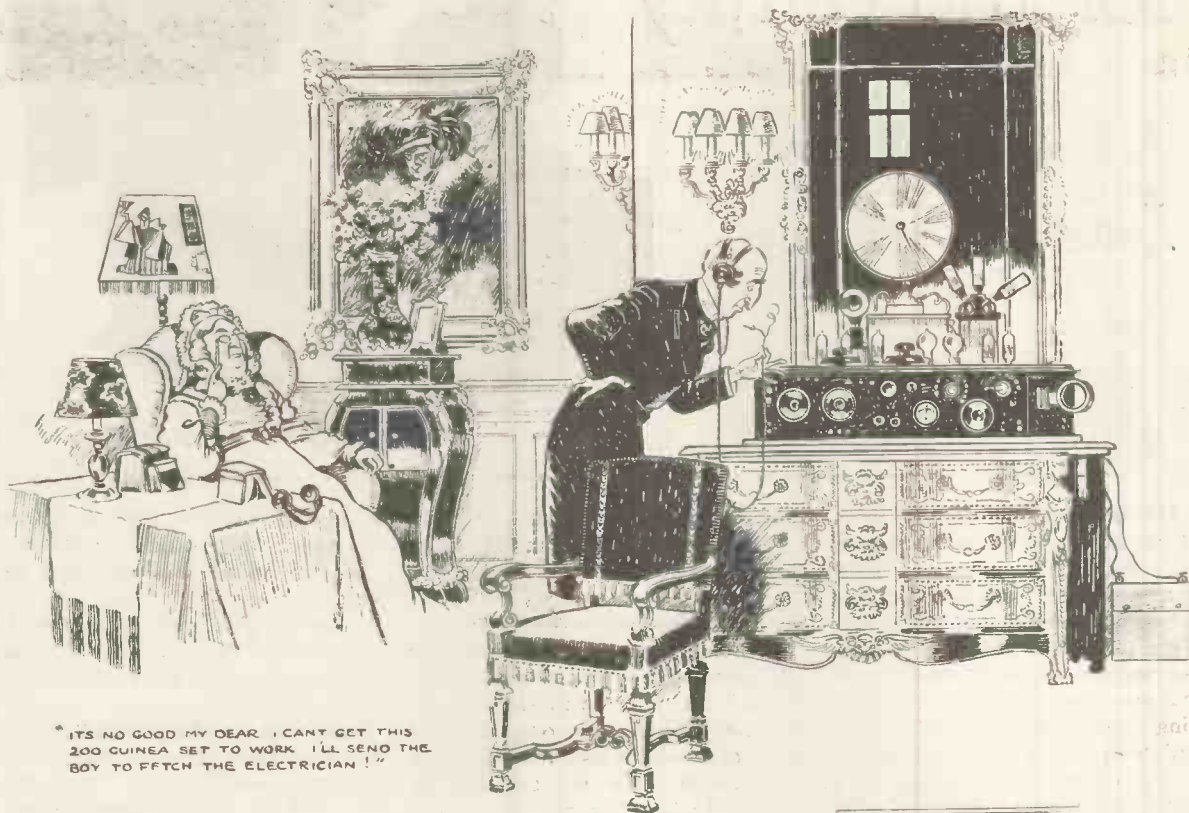

"IT'S NO GOOD MY DEAR, I CAN'T GET THIS 200 GUINEA SET TO WORK. I'LL SEND THE BOY TO FETCH THE ELECTRICIAN!"

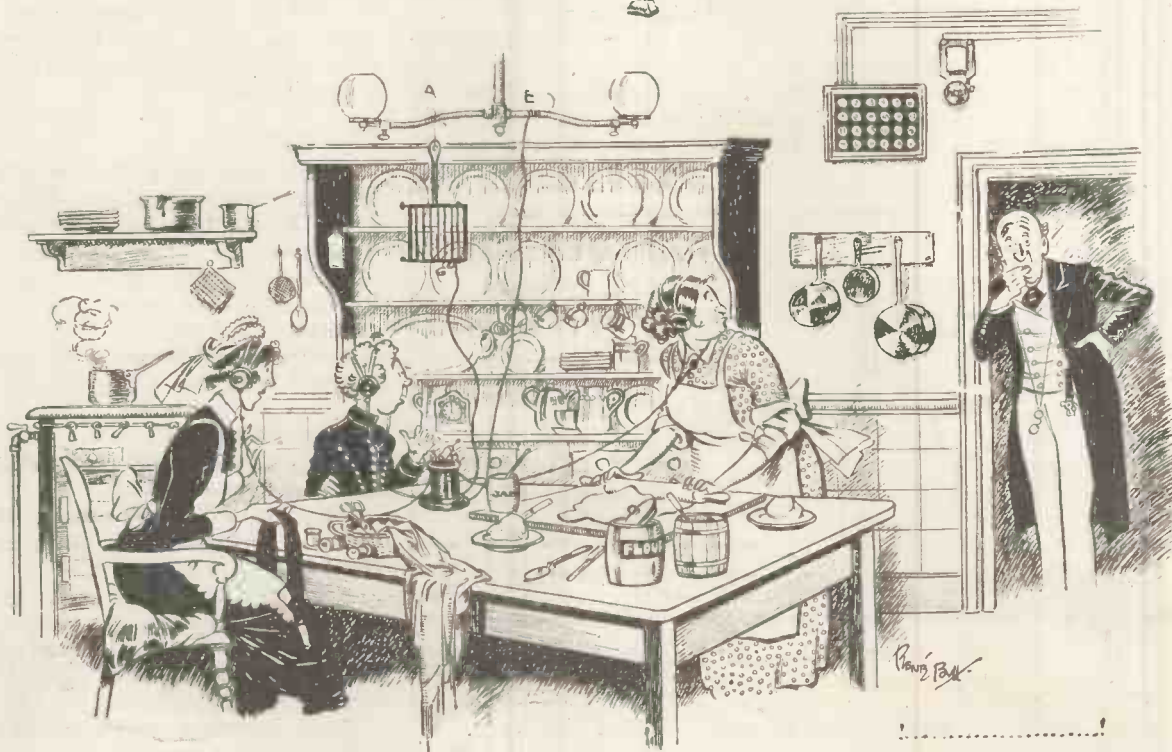

René Bull

A Loud-speaker Three-valver for the Family

A Simple & Efficient Set with a Volume-control Switch and with only Two Tuning Controls. Designed & Built by the Technical Staff of "THE WIRELESS MAGAZINE"



WE believe that, where it is possible, every home should possess a simple valve receiver capable of giving loud distortionless reception of one or two of the broadcasting stations on the loud-speaker.

The main feature of such a set must be its ease of operation, so that the inexperienced members of the family will find no difficulty in tuning-in during the absence of a more enlightened member.

This three-valve set has been designed for this purpose, the circuit used being of a straightforward type. There are only two tuning controls requiring care in manipula-

tion, namely the variable condenser on the right of the panel and the coupling of the reaction and aerial coils.

No Complicated Switching

Although complicated switching has been avoided, it has been thought advisable to include in the receiver a switch for cutting out the last stage of low-frequency amplification, thus making the set suitable for reception with phones.

Referring to the circuit diagram (Fig. 1), it will be seen that a variable resistance has been placed across the secondary of the last transformer. This was found necessary for the

elimination of an unpleasant low-frequency howl which started when the last valve was switched into operation.

The variable resistance is of the anode type (made by Lissen), and, by suitable adjustment the howl was corrected.

Grid bias on the grids of the two low-frequency valves is essential for distortionless reception. Using Mullard DFAR valves, a grid bias of approximately 3 volts (using 100 volts high tension) was found to be a suitable value.

The Cabinet

Quite a neat and suitable case for this set is made by Messrs. Pickett Bros. It will be seen that the lid closes down on the set, covering up the panel and the valves. Expensive accidents to valves are thus avoided.

A dimensioned sketch of the case is shown in Fig. 2.

Components Used

The parts used in the construction of the set were as follow :

- 1 Radion mahoganite panel 12 in. by 12 in. by $\frac{3}{16}$ in. thick (American Hard Rubber Co.).
- 2 L.F. transformers, first and second stages (Eureka).
- 2 filament rheostats (Enterprise Manuf. Co., Ltd.).
- 1 grid leak (Dubilier).
- 1 grid condenser, .0003 microfarad, with clips (Dubilier).

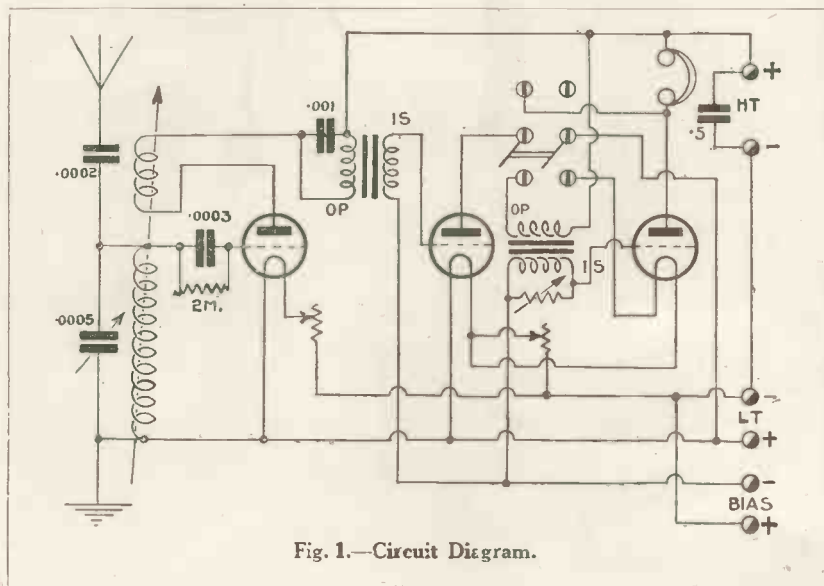
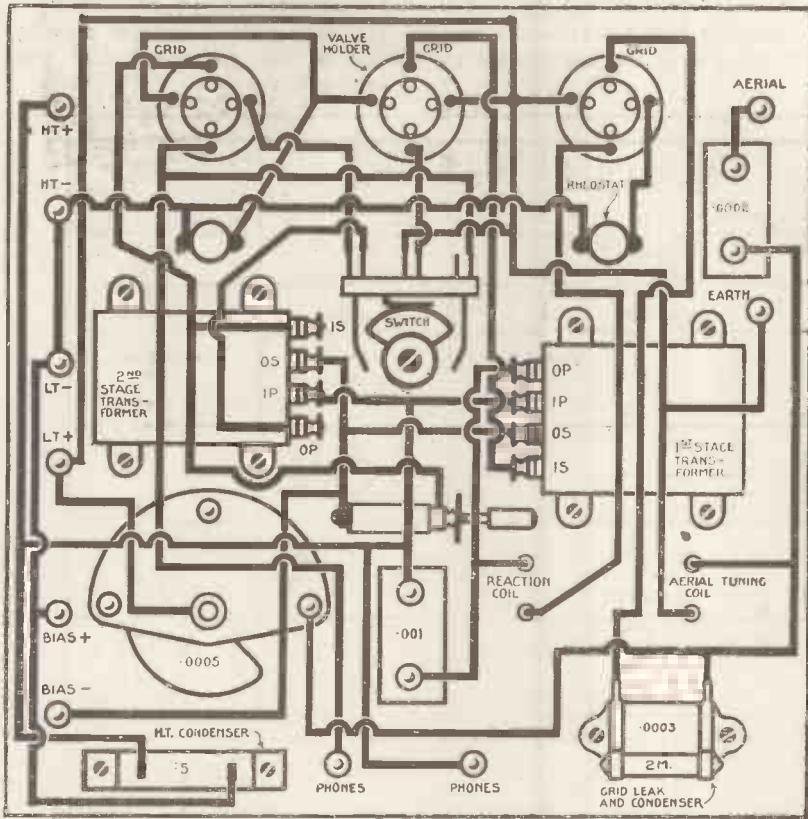

Fig. 1.—Circuit Diagram.

A Coloured Wiring Diagram is Given Free with this Issue



This is a reproduction of the Free Coloured Wiring Diagram.

point out that, if at all possible, guaranteed ebonite should be used. Should unguaranteed material be used, however, the shiny surface should be removed by rubbing both sides with emery cloth after the holes have been drilled. Restoration of the black appearance of the ebonite is obtained by rubbing with a clean rag on which has been sprinkled a little oil.

Wiring

The photographs of the under side of the panel will reveal the method of mounting the components, and the actual wiring is seen on the coloured wiring plate given with this issue.

No. 16-gauge tinned-copper wire of round section may be used for wiring up, many people preferring this to the square wire. This, however, is only a matter of opinion.

Follow the usual practice of spacing the wires as much as possible. Be especially careful that the grid and plate wires do not run close and parallel to one another.

In the coloured wiring diagram the filament-lighting circuit has been shown in red, the grid circuits in

(Continued on next page)

- 1 .5-microfarad fixed condenser.
- 1 .001-microfarad fixed condenser (Lissen).
- 1 .0002-microfarad fixed condenser (Lissen).
- 1 .0005-microfarad variable condenser.
- 1 two-way coil holder.
- 1 dial indicating arrow (A. F. Bulgin).
- 3 valve holders, anti-capacity type.
- 1 variable anode resistance (Lissen).
- 1 2-pole double-throw switch ("Utility").
- 11 terminals.

Marking the Panel

A half-scale layout of the panel, showing the position of all holes to be drilled, is given on page 430. Cut a piece of paper the full size of the panel, and from the dimensions given, mark on the paper the centres of the holes. Lay this piece of paper flat on the panel and mark through at the intersections.

While on this subject we would

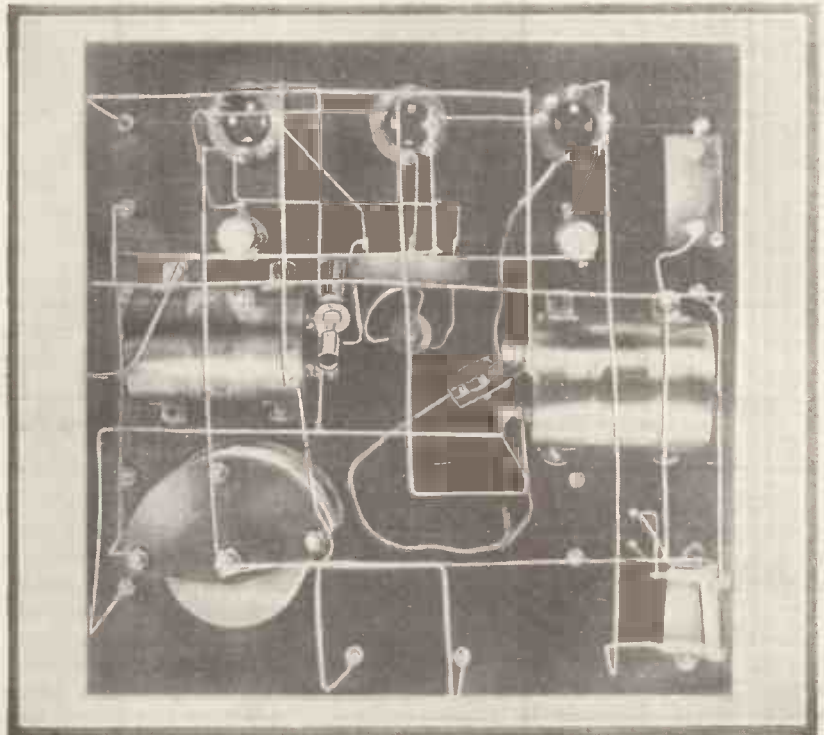

Photograph showing the Wiring Completed.

blue and white and the plate circuits in full blue lines.

In order, as far as possible, to avoid any mistake, it is advisable to complete the wiring of each circuit before starting on the next.

For the sake of convenience the low-frequency transformer terminals

mounted on the back of the panel only three soldering tags would be seen, the other three being directly behind.

In order to make the wiring of the switch obvious from the diagram, the six soldering tags have been shown in three pairs, the left-hand tags

rheostats to the "maximum" position.

If there is a mistake in the wiring which would cause valve "burn-outs," the fact will be indicated by the filaments lighting up.

For connections to the moving socket of the two-coil holder use

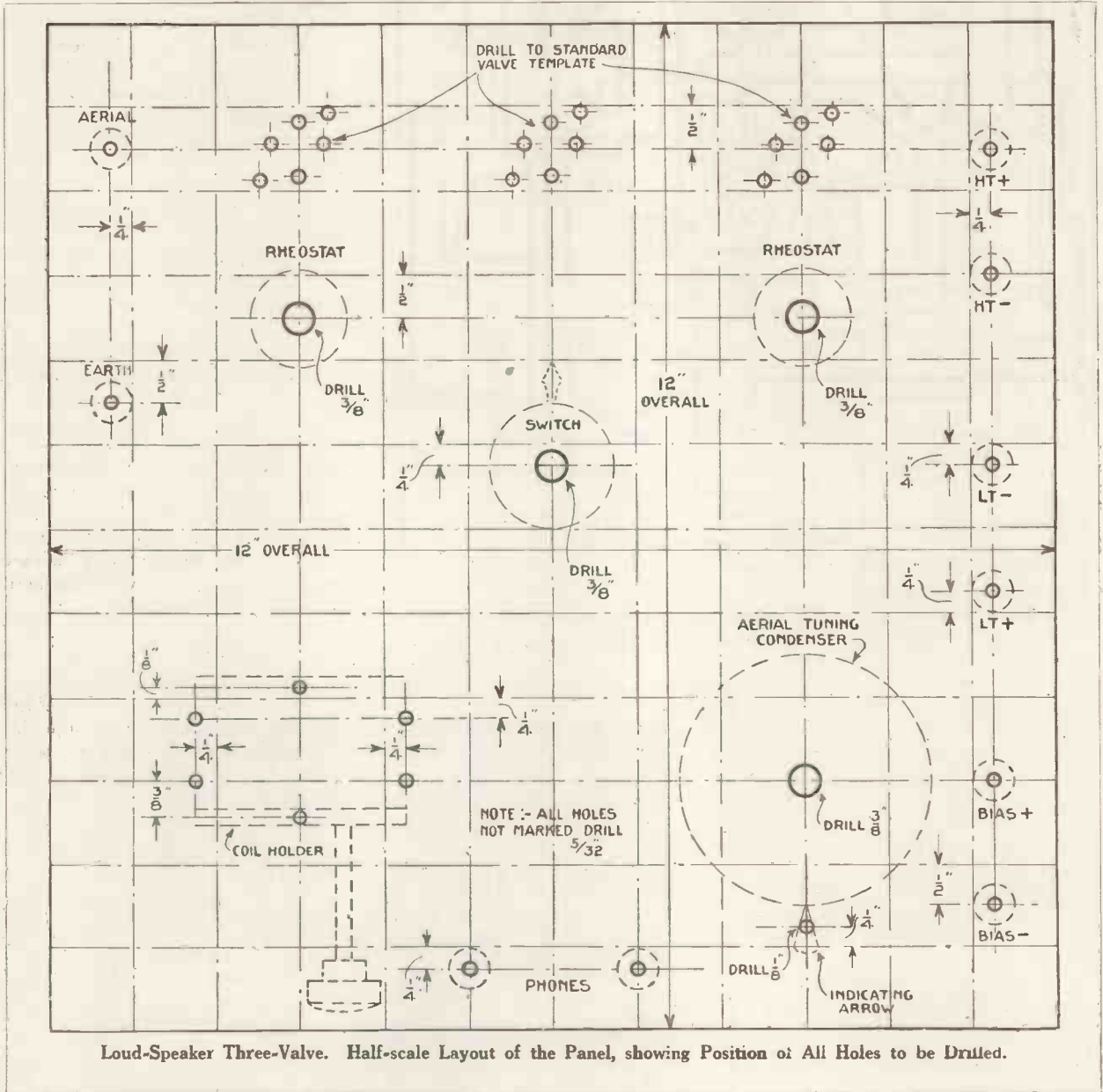

Loud-Speaker Three-Valve. Half-scale Layout of the Panel, showing Position of All Holes to be Drilled.

are shown drawn in the same plane. Actually, on the instrument itself, the terminals are arranged differently.

The only other difficulty that may arise is in connection with the switch. There are six soldering tags on the switch arranged in three pairs. Looking at the actual instru-

ment of the three pairs being those nearer to the panel.

Having completed the wiring, check it over thoroughly with the coloured diagram. As a precautionary test it is advisable to plug in three valves and connect the low-tension battery to the high-tension terminals, at the same time turning the filament

short pieces of flex. The small fixed condensers need not necessarily be screwed down to the panel, the stiff wire used for wiring up being sufficient to keep them in place.

Valves

The choice of suitable valves is a very important matter and has

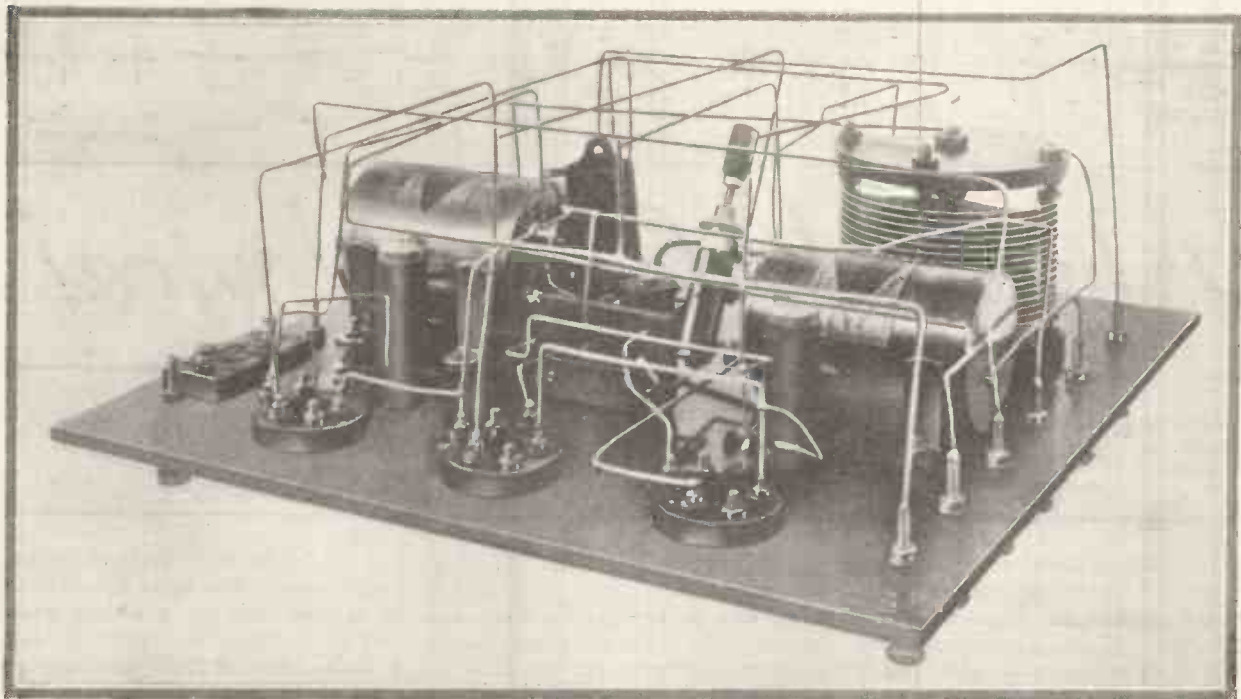

Loud-speaker Three-valve: Photograph showing Arrangement of Components on Panel.

a direct bearing on the results obtained. We found, on testing the receiver, that the following valves were very suitable.

For the detector valve a Cossor P1, and for the two low-frequency amplifiers two Mullard DFA1 valves were used.

Using the Set

Plug in a No. 50 and a No. 75 coil in the aerial and reaction sockets respectively of the two-coil holder and connect the aerial, earth, phones and batteries to the proper terminals.

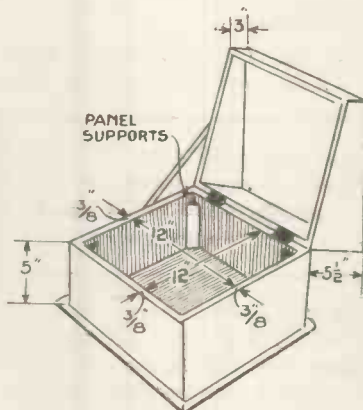

Fig. 2.—Details of Cabinet

Keep the reaction coil well away from the aerial coil and search round for signals by slowly turning the variable condenser. When signals are heard they may be greatly strengthened by gradually bringing the reaction coil close to the aerial coil.

Don't Oscillate

Care must be taken that the reaction and aerial coils are not so closely coupled that the set is brought into a state of oscillation, causing serious interference to other amateurs within a wide radius.

NEUTRODYNE POINTS

STATED briefly, the neutrodyne circuit allows the use of several stages of high-frequency amplification in series, with a consequent gain both in range and selectivity.

Amongst other things it promises the abolition of the outside aerial in favour of the indoor frame or loop. Although less initial energy is picked up by the latter, the deficiency can be more than made good by using additional stages of high-frequency amplification.

In the ordinary way a multi-valve set containing even two high-frequency stages is very difficult to handle and control, because of its tendency to "boil over" into self-

oscillation. This is due to the "back coupling" set up between the grid and plate circuits across the condenser path formed by the natural capacity between the plate, grid and filament inside the bulb.

Neutralising Condenser

In the neutrodyne circuit this "back coupling" is neutralised by a small coupling condenser which is deliberately inserted between the plate and grid circuits and is arranged to deliver impulses in opposition to those passing across the bulb electrodes. The two effects balance each other, so that the set as a whole remains quiet and stable, even when three or more high-frequency stages are in operation.

Not Difficult to Handle

Although an expensive luxury, the handling of the neutrodyne receiver is not difficult even for the beginner. Once the balancing condensers have been adjusted for each valve, the setting remains constant throughout a wide range of wavelengths. Finally, the neutrodyne method of preventing self-oscillation involves no loss of energy, so that the full gain in amplification is retained for each separate stage. A.J.C.

A MANCHESTER amateur, listening to Schenectady, recently picked up a very fine tenor. We would prefer to pick up quite an ordinary fiver, however, in the Strand.



Absolutely for the Novice!

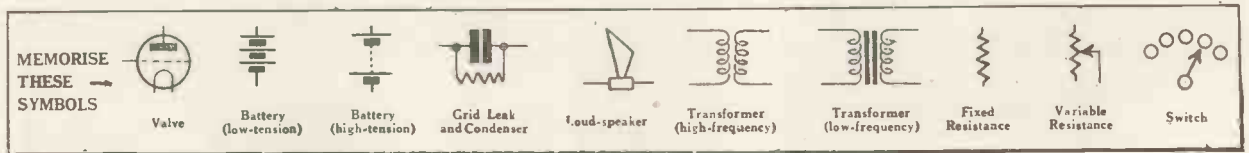

THE best-known form of loop aerial is the upright frame aerial. In its commercial form this is a stand upon which is mounted a two- or three-foot square wooden frame, having wound round and round upon its rim from five to ten turns of insulated wire, each turn of wire being spaced from $\frac{1}{4}$ in. to $\frac{1}{2}$ in. from the next turn (Fig. 6). The cage holding the wire is arranged so that it can swivel round upon a fixed central upright support. Each end of the continuous wire loop arrangement is brought to a terminal and the aerial and earth terminals of the set are connected to these (Fig. 7) by suitable rubber-covered flexible connecting wires. Good quality electric-light flex will do if the strands of the flex are untwisted and connected up separately.

A frame aerial is extremely interesting, not on account of the loudness of the signals obtained with it, for, as already stated, its efficiency is

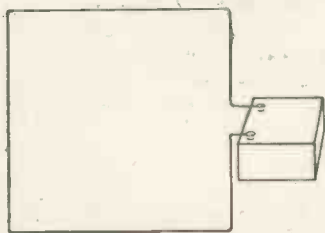

Fig. 7.—Connections of Loop Aerial.

comparatively poor, but because it is "directional."

It works at its best when pointing one way. Hence by its use you can find out almost exactly the direction of any broadcasting station from which you might be picking up signals, as these signals sound strongest when the frame and its

windings are in line with the direction whence they come. Signals fall away almost to nothing when the windings of a frame aerial are exactly at right angles to the direction of the broadcast station which has been tuned in.

Easy Tuning

For this reason a frame aerial has distinctive usefulness in some

This month the author discusses loop and frame aeri- als and the importance of a good earth connection.

localities. For instance, when receiving British broadcasting with a frame aerial in the neighbourhood of Oxford, by setting the frame to an easterly and westerly direction, London will tune in easily, but Birmingham hardly at all. If the frame is turned to point North and South, London is cut out and Birmingham easily tunes in.

An outdoor aerial will also be distinctly directional where its horizontal portion is at least eight times as long as its vertical or approximately vertical lead-in wire, while every aerial is faintly directional, in that it gives a slight preference to signals coming towards its nose (Fig. 8). The "nose" would be the lead-in junction.

Making a Frame Aerial

An easily home-made and very efficient frame aerial can be made by nailing (or better dovetailing) four wooden laths together at the corners so that they form a square frame rim, like the four sides of a very

shallow box with the top and bottom taken away. The laths should each be 3 feet long by 3 inches wide, and of a reasonable stoutness, say $\frac{3}{8}$ inch. Around this wooden rim wind seven turns of flexible rubber covered lead-in cable, or at a pinch well insulated " $\frac{3}{22}$ " electric-light cable will do.

Fasten the turns at each corner of the frame by binding them down with a turn or two of electricians' adhesive tape. At each end of the winding leave a 4- or 5-foot length of free cable, baring the wire for an inch or so. On attaching one of the free ends to the aerial terminal of the set, and the other free end to the earth terminal and suitably arranging the frame upright and pointing toward the wanted broadcasting station, quite respectable results will be obtained.

Earth Connections

The standard earth connection is made by attaching a length of

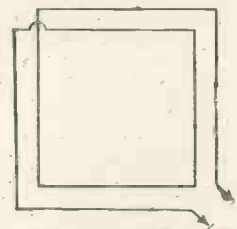

Fig. 6.—Arrangement of Wires.

copper wire to a soldered joint on a water pipe. A pipe leading from a cistern will not do, as this is only intermittently in good electrical contact with the water in the mains.

A good alternative "earth" may be obtained by attaching the lead to

(Continued on page 434)

LISSENIUM

MADE IN THREE TYPES.



LISSESTAT MINOR (patents pending)
—is replacing thousands of discarded and
inefficient rheostats. Provides LISSEN-
STAT control at a popular price. LISSEN
ONE-HOLE FIXING, OF COURSE ... **3/6**



LISSESTAT MAJOR (patents pending)
—gives the most acute tuning possible.
LISSEN ONE-HOLE FIXING ... **7/6**



LISSESTAT UNIVERSAL (patents pend-
ing)—with its protective device for dull
emitters. LISSEN ONE-HOLE FIXING,
OF COURSE ... **10/6**

*Receivers fitted with Lissenstat Control are
equipped for the finest detection possible.*

Give the valve a fair chance—

YOUR valve will detect with extra-
ordinary power with LISSESTAT
control. Only by accurate control
of critical electron emission can success in
distant telephony be achieved—and with
no other rheostat can the performance of
the LISSESTAT be duplicated. A
separate LISSESTAT for the detector
valve, one for each H.F. valve, and (de-
sirable, but not quite so important) one
for each L.F. valve, too, and you will get
sharper tuning than ever you have known
before. By its structure and its composi-
tion, *LISSESTAT control gives the
valve a capacity to detect as no other
rheostat can.*

The appropriate leak value—

Every different condition of recep-
tion may call for a different leak
value—you can get it with the
LISSEN Variable Grid Leak (patents
pending). Distant stations—near-by
transmissions — strong signals or
weak—reaction or not—hard valves
or soft—straight circuit or reflex—
if you are using the LISSEN Vari-
able Grid Leak you are certain of
getting the utmost sensitivity out of
your tuning. Every range of
resistance value required of a leak
is covered, with minute variation
throughout. LISSEN ONE-
HOLE FIXING, OF
COURSE ... **2/6**

LISSEN VARIABLE ANODE RESISTANCE

20,000 to 250,000 ohms, same out-
ward appearance as the LISSEN
Variable Grid Leak ... **2/6**

Parts that pull together—

When you know that every vital part in
your receiver is pulling strongly with
each other, you know that you have a
receiver which is the best you can ever
get.

Build with all LISSEN PARTS—there is one for every vital place



*SMOOTH OUT YOUR LOUD-SPEAKER DISTOR-
TION BY PUTTING A LISSEN VARIABLE GRID
LEAK ACROSS THE SECONDARY of the last
transformer or across the loud-speaker itself. First
position is better, last may be easier. The difference
will be very noticeable.*

LISSEN LIMITED

500-520 Woodger Road, Goldhawk Road,
Shepherd's Bush, London, W.12.

Telephones—Riverside 3380, 3381, 3382, 1072.
Telegrams—"Lissenium, London."

In writing to advertisers, please say you saw the advertisement in THE WIRELESS MAGAZINE.

a well-cleaned gas pipe, since gas mains, like water mains, run mostly under the ground.

A third earth can be made by soldering one end of a piece of stout copper wire, such as aerial wire, firmly and liberally to an old and worn-out metal bath, or can, of large size, and burying the metal as deeply as possible in the ground outdoors. Where this is done, it is essential that the hole be dug deep enough to get to a permanently moist stratum of soil or sub-soil, for if the soil dries, the efficiency of the earth lessens.

An earth that has deteriorated through drying up of the soil may be temporarily restored by giving the ground a heavy watering.

Capacity Earth

An entirely different sort of "earth," which does not depend for efficiency upon moisture, is the capacity earth. To make a capacity earth, take a good stout wire not less in length than the aerial wire, and lay it along the ground exactly under the aerial. The far end of the wire may optionally be soldered or screwed to a brass, cop-

per, or steel pointed pin or peg, of any length from 6 inches to 3 feet, though the longer the better, this pin being driven well down into the soil.

But even without such anchoring down, a capacity earth will work by its own surface earth connection, thereby being very suitable for temporary use, as for instance in summer time when rigging up wireless at a picnic.

A length of wire netting laid flat upon the ground underneath the aerial and having a copper wire twisted or soldered to one end of it also makes a good capacity or emergency earth where there is no pool of water handy in which to immerse a tin can or bucket with an earth wire attached.

Improvised Aerials

Improvised aerials for outdoor experiments in wireless reception,

and for indoor experiments also, are many and various, and of varying usefulness.

Where signals are strong enough, a wire attached to the frame of an iron or brass bedstead will give weak but passable reception.

At distances up to five or ten miles from a broadcasting station, when using a three-valve set with at least one stage of high-frequency amplification, the wiring inside the set itself will often act as a very small aerial, permitting broadcasting to be picked up faintly with no wire at all on the aerial terminal.

A 10- or 20-foot length of insulated electric-light wire connected to the aerial terminal at one end and having the rest of its length left lying anyhow, or preferably stretched up as high as possible, is another useful, though inefficient aerial for high-power sets only. Another dodge is

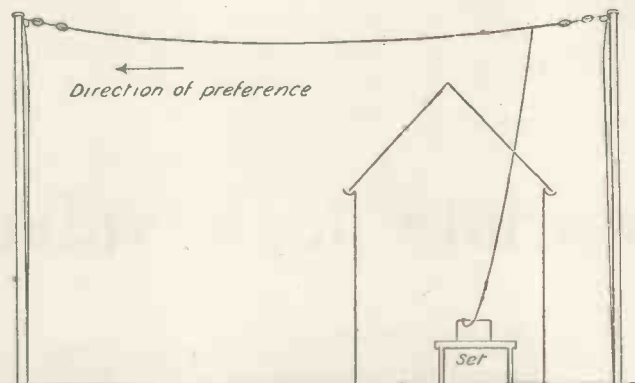

Fig. 8.—Directional Effect of Outdoor Aerial.

to use the electric-bell wiring of the house, or to make a branch tapping through a .0003-microfarad (popularly called three o's three) fixed condenser from the electric light wiring.

Vertical Loop

Again, a single vertical loop of wire of any size whatever, from a total length of 10 feet to that of a 100 feet, may be used either indoors or outdoors as aerial and capacity earth combined, being in effect a less compact form of frame aerial. In its largest size, and when made of well insulated wire, it is a good and efficient aerial for any set, though highly directional, and therefore only suitable for picking up transmissions from one chosen broadcasting station along the line of direction of which it must be set to point.

COLIN BENNETT.

To be continued

CAN WE LEARN FROM THE AMERICAN AMATEUR?

(Continued from page 421)

sees the minimum capacity of a variable condenser stated—its rating is by the number of its plates, which is of course never a very accurate guide. Metal end plates, too, appear to be in greater favour than ebonite.

Low-frequency Transformers

I do not think that the Americans can touch our own makers as regards low-frequency transformers of the finest type. Most of their well-known makes are distinctly good, but they have nothing to equal the completely distortionless qualities of one or two of our more highly-priced types. Small components such as grid leaks, fixed condensers, terminals and the like are well made, neatly designed and of high efficiency.

Make-up of American Sets

The general make-up of receiving sets in the two countries is different. The most popular type in this country is the set consisting of a horizontal panel, upon one side or the other of which all components are mounted, fixed to the top of a cabinet.

In American sets the main panel is vertical. It is long and narrow, and serves as a rule to carry nothing but the rheostats and tuning condensers. All the other components, valves, transformers, grid leaks, fixed condensers and so on, are mounted upon a horizontal sub-panel fixed to the bottom of the first. This is, I believe, a first rate idea, for it makes for neatness and compactness, and above all for shortness of leads. To some extent it has been adopted already in this country, and I believe that it will shortly become almost universal on this side of the Atlantic as well as upon the other.

J. H. R.

WOMEN can be classified in two categories, says the cynic. Those who are always nagging, and those whose husbands have been cute enough to buy them wireless sets.

CRITICS are suggesting that there ought to be more wireless dramas. There will be, when we catch the howlers who have been disturbing our programme for the last few nights.



Brandes Superior
Matched Tone
Headphones
PRICE NOW

20/-

All Brandes products carry our official money-back guarantee, enabling you to return them within 10 days if dissatisfied. This really means a free trial.

The unusual constructive theory of Brandes Matched Tone Headphones secures a tremendous improvement in accuracy, sensitivity and volume. A simple explanation is this: strike the same note at the same instant on any two musical instruments of the same kind. It's a hundred chances to one against both notes being of the same strength and pitch. Consequently, they jar, and you would much rather hear one alone. If both notes were exactly similar it would be pleasing, and you would have greater volume and clarity. Brandes, with both receivers matched to exactly the same degree, achieve the desired end. Ask your Dealer for Brandes.

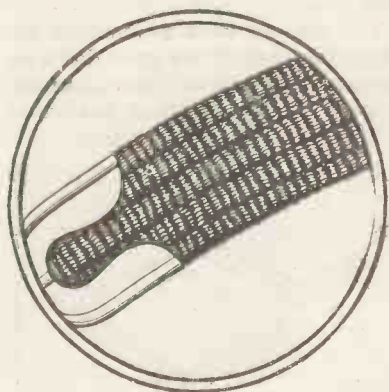

The headbands are made of piano wire covered in soft, corded webbing. At both ends the wire is firmly clamped together so that the original shape may be easily bent to fit the natural line of the head without fear of injuring the headband. They mean comfort without hard and irritable constriction.

British Manufacture
(B.B.C. Stamped).



Table-Talker

42/-

Brandes

The Name to know in Radio

Brandes Limited, 296, Regent Street, W.1.

WORKS: Slough, Bucks.

20/-



Superior "Matched Tone" Headphones

TRADE MARK

In writing to advertisers, please say you saw the advertisement in THE WIRELESS MAGAZINE.



Wireless Woodwork

*Using the Tools:
Making Accumulator Cases and Frame Aerials*

WOODWORK is an important branch of wireless constructional work, and considerable expense can often be saved by the amateur with some small knowledge of the best methods of construction. In the majority of cases it will be found that comparatively simple joints, such as those that can be made with the elementary tools possessed by practically every amateur, are all that are required.

One of the chief branches of woodwork is that of making small box-like cabinets to contain sets. The chief difficulty in the construction of these is that of joining the corners.

The simplest method is to butt and nail them, but this is seldom satisfactory and presents a very un-gainly appearance. A very good method is shown in Fig. 1, in which two of the sides are rebated at the ends, the remaining sides fitting into these rebates.

Preparing the Timber

It is advisable to use prepared timber for the work, as this is brought to an equal thickness and saves considerable labour. The four sides of the cabinet should be first cut off to length and carefully squared up, making allowance in the length of two

of the pieces for the space occupied by the small laps formed by the rebates on the remaining sides.

The thickness of the laps should be pre-determined so that the exact length can be obtained. A cutting gauge should be set to this thickness and the ends of the two sides marked with it. The gauge is then re-set to the exact thickness of the sides and the depth of the rebates marked out with this.

The surplus wood is removed by first sawing across the grain down to the required depth and then chopping it away with a chisel in the same

(Continued on page 438)

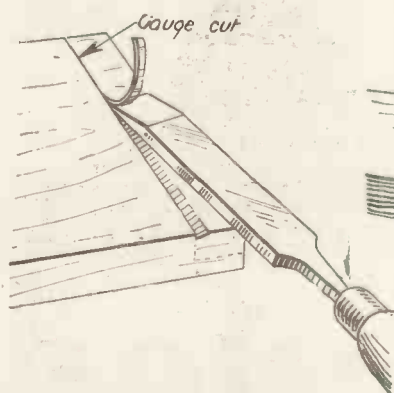

Fig. 2.—Cutting a Channel

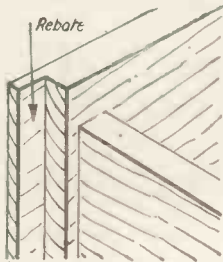

Fig. 1.—Rebated Joint.

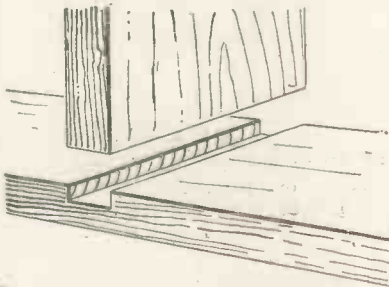

Fig. 3.—Grooved Joint.

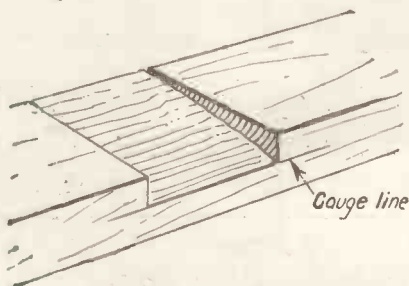

Fig. 5.—Half of Surplus Wood Cut Away.

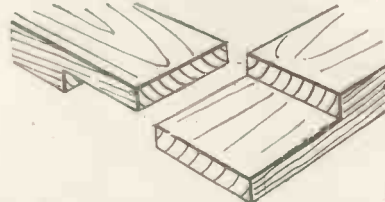

Fig. 6.—Halved Joint for Frame.

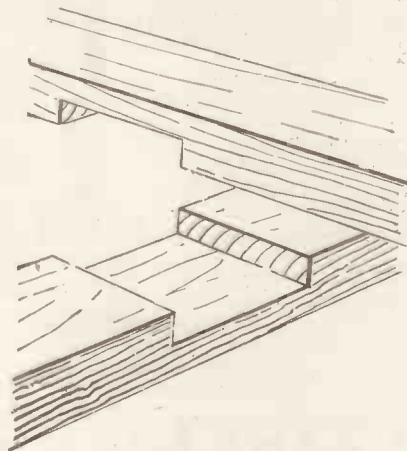

Fig. 4.—Halved Joint.

This remarkable reception of the U.S. Station at Springfield (Mass.) in Coventry is further proof of



super-efficiency.

Mr. S. Edward Bacon, Steward of the Coventry and County Club, received word by cable that his brother, a vocalist, would broadcast from the American Station W.B.Z. (Springfield, Mass.), on December 29. Mr. Bacon, using a 4-valve A.J.S. Receiver, promptly got in touch from Coventry, and "heard both songs perfectly at loud-speaker strength."

RADIO SECRET REVEALED.
 Story of an Impromptu Concert From U.S. VOCALIST'S DESIRE. To Sing to Brother at Coventry.
 From a Gazette Correspondent. COVENTRY, Thursday. To hear his brother's voice coming to him in song across the wide space of the Atlantic has been the unique experience of Mr. S. Edward Bacon, steward of the Coventry and County Club, Coventry. Listeners who were successful in getting into touch on Monday night with the American wireless station W.B.Z. at Springfield (Mass.), were interested to hear the announcement that a short concert could be given for the benefit of one of the artist's relatives who lives in Coventry, England.
THE EXPLANATION. The explanation is that one of the singers was Mr. Henry G. Bacon, a student of the Massachusetts Institute of Technology, and in his desire that his brother should hear him sing, he had cabled a hint at Coventry the time the concert would begin. Mr. Henry Bacon sang two songs, "John Peel" and "Love, I am lonely," both of which Mr. Edward Bacon heard perfectly.

THURSDAY, JANUARY
VOICE ACROSS THE SEA.
Coventry Man in America
SINGS TO RELATIVES.
 The statement by a correspondent in yesterday's issue of the "Midland Daily Telegraph" that he heard a concert broadcast from the American station W.B.Z. "for the benefit of one of their artist's relatives in Coventry, England," was read with interest, especially Mr. S. Edward Bacon, steward of the Coventry and County Club, who has since referred to "The Times" and "The Daily Mail" as follows: "I noticed in last issue of the 'Telegraph,' in the column of letters from the American station W.B.Z. on December 29, to 'one of the Coventry, England, by the Mass Institute of Technology, U.S.A., was the singing 'John Peel' an item of which I heard strength on my four-valve A.J.S. 'John Peel,' and received three or four others 'Binedev' a combined Bo between each for U.R. gave the singing down for own."

A. J. STEVENS & CO. (1914), LTD., WIRELESS BRANCH, WOLVERHAMPTON. Phone: 1550; Wireless Call Sign: 5 R I; Grams: "Reception, Wolverhampton."

...down for a receipt, and that they afterwards written through to a hockey match which was to be played at eight o'clock between the Hamilton players and a team selected from the Canadian National Hockey League. "I picked this up, too, and heard the ... afterwards that Mr. ..."

Although "conditions were not good" — He heard "perfectly at loud-speaker strength" on his A.J.S. 4-VALVE RECEIVER

THE A.J.S. "UNITOP" CABINET RECEIVER

forms top section of "Unit System" Cabinet and contains A.J.S. 4-valve Receiver. Complete in itself, it may be converted into a beautiful pedestal cabinet by subsequent purchase of first a centre section to contain both batteries and then base section containing special A.J.S. Loud Speaker. Used alone, the "Unitop" is a compact and attractive piece of furniture and a highly efficient Receiver, easily portable for outdoor functions. In Mahogany, or Light, Dark or Wax-polished Oak. Complete with all accessories, ready for use, 30 guineas. (Without accessories, £24 10 0.)

A.J.S. LOUD SPEAKERS.

Accurately proportioned non-resonant horn, giving correct acoustic properties. True reproduction and extreme sensitivity without distortion. With metal horn and plated fittings, £4 15 0. With Oak or Mahogany horn and plated fittings, £5 10 0.

Ask the nearest A.J.S. Dealer to show you these and other A.J.S. Wireless Instruments, including the "Unit System" 4-valve Cabinet, the "Desk type" 2, 3, and 4-valve Receivers, and the A.J.S. 4-valve Pedestal Cabinet.



Illustrated List free on request.

WIRELESS WOODWORK

(Continued from page 436)

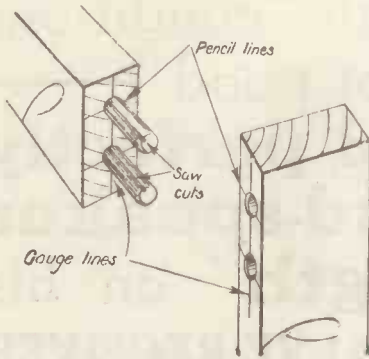

Fig. 7.—Dowelled Joint.

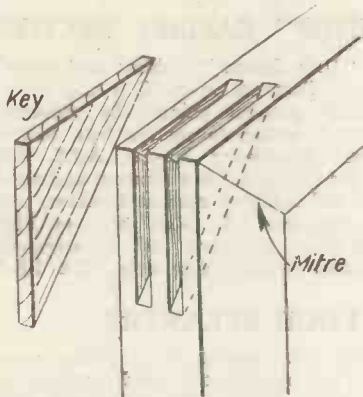

Fig. 8.—Keyed Mitre Joint.

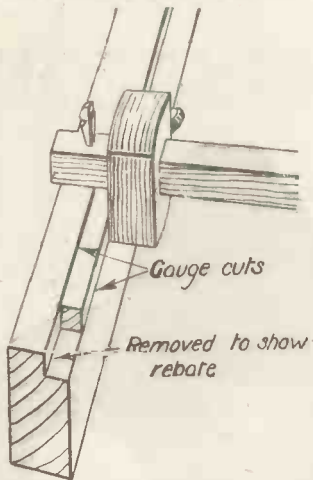

Fig. 9.—Cutting Small Rebate.

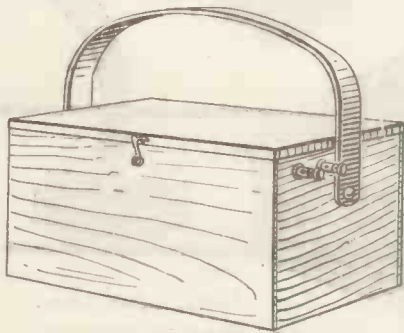

Fig. 10.—Accumulator Case.

direction as the grain. In order that the saw cut may be made in exactly the correct place it is advisable to cut a small channel at the gauge line as shown in Fig. 2. This not only forms a channel for the saw to run in, but also ensures a sharp and clean finish to the joint. This procedure will also be found useful when making other joints. The joints are secured together with glue and nails. It is a good plan to drive the nails slightly askew in alternate directions so that a dovetail grip is obtained.

Fixing Partitions

It is often necessary to fit a partition in a cabinet and a strong method of fixing this is shown in Fig. 3. Two chisel cuts should be first squared across the wood at the position to be occupied by the groove. Small channels are then cut to these lines in a similar way to that shown in Fig. 2. The depth of the groove is marked on both edges with a gauge. The sides of the groove are then cut with a saw down to the gauge line and the surplus wood removed with a chisel, working first from one edge and finishing off from the other.

Another joint constantly occurring is that shown in Fig. 4. It is very useful when making certain types of frame aerials. The exact width of the wood is first marked in the required position on the face side of one piece and on the reverse side of the other. They should be marked out with a chisel so that the channels

(Continued on page 440)

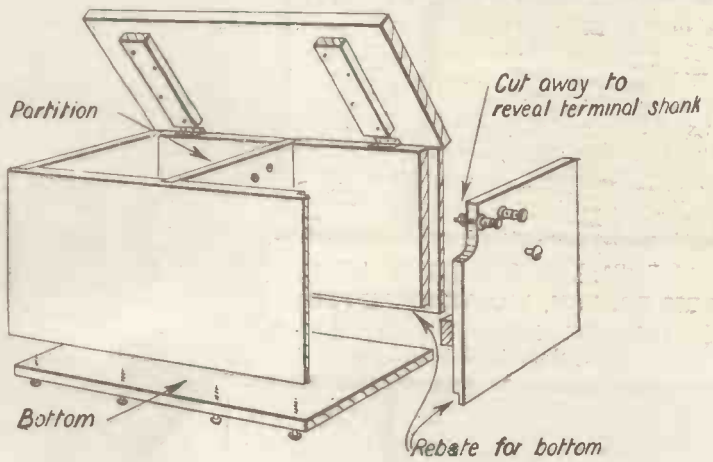

Fig. 11.—Details of Accumulator Case.

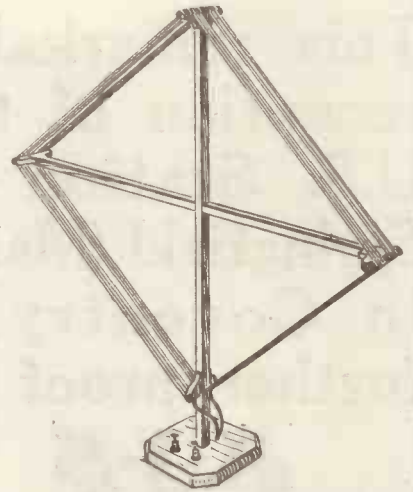

Fig. 12.—Simple Frame Aerial.

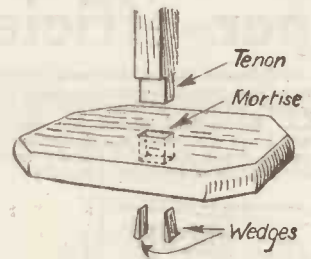

Fig. 13.—Frame Aerial Base.

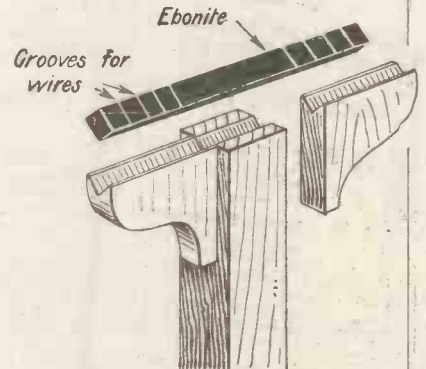

Fig. 14.—Details of Ends of Arms.

Radiola Receivers

Radiola I
(Valve-crystal)



BOTH these sets employ a special, easily tuned reflex circuit, which is equivalent, in effect, to an extra valve. Both are fitted with B.T.H. type B.5 (0.06 amps) valves, which consume so little current that standard dry cells can be quite successfully used for filament lighting.

Radiola I (Valve-Crystal) Receiver

This is the ideal set for head telephone reception over distances up to 100 miles, two c.ystals, with change-over switch are provided

	PRICE	£	s.	d.
with enclosed H.T. Battery and B.5 Valve	-	9	0	0
B.T.H. Headphones (4,000 ohms)	-	1	0	0

Radiola II (2-Valve) Receiver

The power of three valves is secured by the use of a dual amplification circuit. Under average conditions this set will receive all B.B.C. stations.

	PRICE	£	s.	d.
with enclosed H.T. and L.T. Dry Batteries and two B.5 Valves	-	18	0	0
B.T.H. Headphones (4,000 ohms)	-	1	0	0

Obtainable from all Electricians & Radio Dealers

We also make Crystal Sets, Loud speakers, Amplifiers and "Tungar" Battery Chargers

The British Thomson-Houston Co. Ltd

Works
Coventry

Offices: Crown House,
Aldwych, London, W.C.2.

Radiola II
(Two-valve)



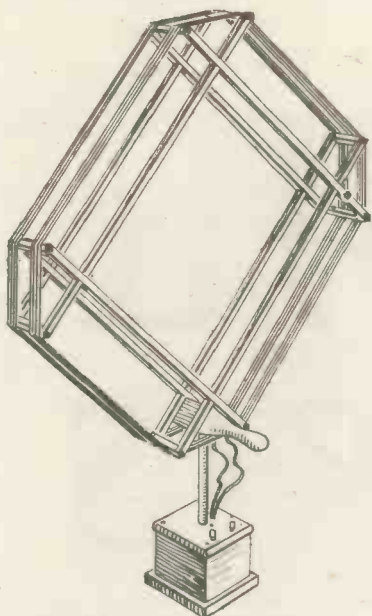

Fig. 15.—Revolving Frame Aerial.

(Continued from page 438)

can be cut as shown in Fig. 2. The edges of both pieces are next marked with a gauge set to exactly half the thickness of the wood, using the gauge from the face side of both members. The sides are then cut with a saw and the waste wood removed as in Fig. 5, cutting first from one side as shown, and finishing off from the other.

Three alternative methods of joining the corners of various types of frames, such as cabinet doors, etc., are shown in Figs. 6, 7 and 8. Fig. 6, known as a halved joint, is made in a similar way to that in Fig. 4. The two pieces are often screwed together.

In Fig. 7, dowels are used. The thickness of these depends upon the thickness of the wood to be joined; $\frac{3}{8}$ -in. dowels are suitable for 1-in. wood. To ensure the joint being level and true when finished, the position of the dowels should be marked with a gauge as shown in Fig. 7. The gauge should be used from the face side of both pieces. Pencil lines should be marked first on the end of the left-hand piece.

The latter is then held in the correct position on the other piece and the marks transferred. In all dowelling work it is advisable to saw slots along the length of each dowel, as shown. This is done to allow a certain amount of the glue to escape when the dowels are knocked into their respective holes. If this is not

done the glue in the holes will be compressed and will be liable to split the wood. It is also a good plan to slightly countersink the tops of the dowel holes.

When making the joint in Fig. 8, the mitre should be cut on a mitre block. The whole framework is then glued together and allowed to stand until the glue has set. This being done slots are cut at the corners with a saw and chisel. The keys shown in Fig. 8 should be preferably of hard wood and should be glued in position and cleaned off when the glue has thoroughly set. A simpler method of making a similar joint is to make a series of saw cuts across the mitre with a fairly thick saw. Pieces of saw-cut veneer are then glued in the saw cuts.

Cutting Rebates

It is often necessary to cut rebates in the woodwork of wireless apparatus and a simple method of doing this is shown in Fig. 9. A cutting gauge is first set to the depth of the rebate and a deep cut made along the edge of the work. The gauge is then re-set to the width of the rebate and another cut made as shown in Fig. 9. Rebates up to a depth of $\frac{3}{8}$ in. can be easily cut in soft wood in this way.

The examples of wireless apparatus shown in Figs. 10, 12, and 15, involve in their construction the majority of joints used in wireless work.

Fig. 10 is an accumulator case and is made in a similar way to small cabinets used for sets. Fig. 11 shows the construction. The corners are rebated together, as shown in Fig. 1, and the partition is fitted into the grooves, as in Fig. 3. The bottom

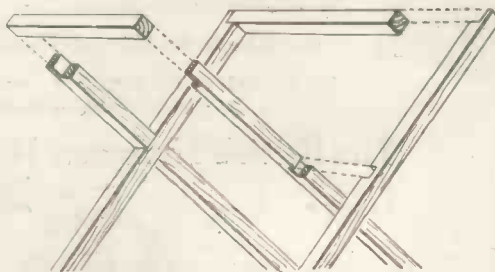

Fig. 17.—Details of Frame Construction.

edges of the sides are also rebated to take the bottom, which is screwed. It is important to note that all metal work, such as screws and hinges, should be of brass.

Terminals are fixed to one side of the case, as shown in Fig. 11, so that the necessary connections can be made without opening the lid. It

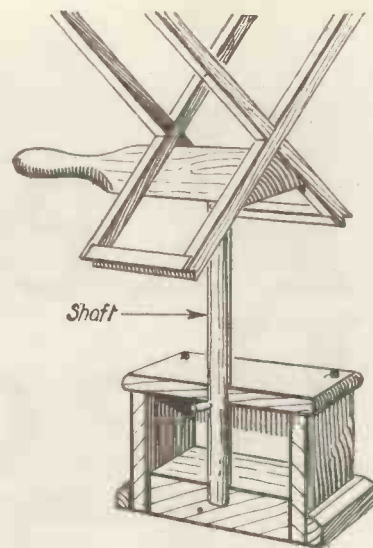

Fig. 16.—Section through Base showing how Shaft revolves.

will be noticed that a small block is fixed to the side below the terminals. This is to prevent the accumulator from becoming damaged by rubbing against the terminals.

A handle is provided by means of a leather strap fastened to round-headed brass screws. The strap should be sufficiently long so that it will pass to the back of the case when the lid is opened.

The frame aerial shown in Fig. 12 is made from $\frac{3}{4}$ -in. squares halved together at the centre in a similar manner to that shown in Fig. 4. It is mounted upon a base as in Fig. 13. A mortise is cut right through the base. The joint is strengthened by driving in wedges to the sides of the tenon. Terminals should be bushed with ebonite. The wires from the aerial are taken through a hole in the base and fastened to the terminals on the underside. Small grooves are cut under the base so that the wires do not project. Fig. 14 shows the arrangement at the ends of the arms. Small brackets are glued at each side and a "V" groove cut as shown to hold the ebonite.

A rather more elaborate frame aerial, made to revolve on its base, is shown in Fig. 15. Fig. 16 shows a section through the base. The shaft below the aerial is a piece of $\frac{3}{4}$ -in. dowel and fits through a hole in the top of the base and into another hole at the bottom. Another small dowel is fitted into the shaft

(Continued on page 453)

The Radio Mail

For sensitiveness
use
Wuncell
Valves

Published periodically in the interest of Valve Users

A new type of Dull Emitter

Experts declare new Wuncell Dull Emitter likely to revolutionise Valve design

TO produce a Dull Emitter Valve which operates with a glow that is almost invisible in daylight is a feat that has just been accomplished by the London firm of A. C. Cossor Ltd. This new Valve—called the Wuncell because it requires only one cell to operate it—is certainly the nearest approach to the ideal of a "cold valve" that we have yet seen. Viewed under working conditions the filament could just be seen glowing in daylight, while in a dark room it could readily be likened to the embers of a dying match.

Asked to give some approximate idea of the actual temperature, a representative of the firm stated that, according to pyrometer tests, the reading was 800 degrees as against the 2,000 degrees required by Bright Emitters and even some types of Dull Emitters. For our benefit actual tests were made between the amount of heat (or light) generated by a Wuncell and other types of Valves. The differences were most marked, and demonstrated to the lay mind in a very striking manner that such a low filament temperature must mean a vastly increased life for the Valve.

The British Valve still the best

But it was on actual Broadcasting tests that this new Wuncell showed that, so far as this country is concerned, we have nothing to fear from Continental Valve manufacturers. For the purposes of demonstration a good four-Valve set was used. For the first Valve—which acted as a high-frequency amplifier—a Wuncell type W.2 was used, while for the last stage one of the new Wuncell Loud Speaker Valves was used as a power amplifier. The other two Valves were the standard W.1 Wuncells.

Connected to a fairly good aerial in North London, 2LO had to be considerably de-tuned even for three Valves in order to prevent "blasting" from the Loud Speaker, while with the fourth valve in operation every B.B.C. main station, with the exception of Cardiff, was brought in with incredible volume and exceptional purity. Cardiff

—owing to our close proximity to 2LO—could not be tuned in. The following Continental stations were also received at good Loud Speaker strength: Hilversum (a Dutch broadcasting station with call sign HDO), Bremen on 330 metres, Zurich, Radio Iberica of Madrid, and a further Continental station which could not be identified owing to "fading" but which corresponded in wave-length to Vienna.

Wuncells just as sensitive as Bright Emitter Valves

The result of these tests certainly demonstrated that the new Wuncell Valves are not one whit less sensitive than standard Bright Emitter Valves. Another remarkable feature of these Wuncell Valves was their complete freedom from microphonic noises. It has hitherto always been an inherent disadvantage of other dull emitters that even footsteps in the room or other slight vibrations are communicated to the Valve to cause ringing noises in the headphones or Loud Speaker. All the usual tests, such as tapping the table on which the receiver was placed, adjustments of the rheostats, etc., failed to produce the slightest suggestion of a microphonic noise.

We understand that the reason for this improvement is to be found in the special Wuncell method of mounting the filament. Instead of being supported between two electrodes, sprung apart to counteract expansion and contraction, its filament is arched (following standard Cossor practice) and supported at the centre by a third electrode. No doubt, too, the grid—cleverly designed and very rigid—is a contributory factor to this result.

Use Wuncells along with Bright Emitters in the same Set

We were most impressed, not only by the very neat appearance of the Wuncell, but with the vast amount of forethought and research work that must obviously have been put into its construction. For instance, because it was realised by the designers that

many multi-valve users would like to try out one Wuncell in conjunction with their ordinary Valves, a special base was designed. This base carries a resistance in series with the filament to permit the valve being used with either a 4- or 6-volt accumulator. Normally, of course, the Wuncell functions at rather less than 2 volts. This excellent idea gives any amateur a chance of trying out one of these new Dull Emitters and comparing its behaviour with the Bright Emitters he may be using. At any later date—by the use of a small screw—the resistance can be short-circuited and the Wuncell used at its correct current of 2 volts. It is worth while noting, too, that all Wuncell Valves are being supplied with the new black low-capacity base in which air only is used at the dielectric between the leads to the four valve legs.

Experts that have witnessed demonstrations of Wuncell valves have expressed their satisfaction at the production of a Dull Emitter which can compare most favourably with the best Bright Emitters. It has always been felt that hitherto a sacrifice of at least 20 per cent. in volume has been the price that must be paid to obtain the conveniences offered by Dull Emitters.

Valves to be in sealed boxes

One well-known manufacturer definitely decides to issue all future Valves in sealed cartons only

A move of the utmost importance has been made by A. C. Cossor Ltd.—the well-known British Valve manufacturers. They have decided that in order to protect the public and to ensure their Valves being used in absolutely new condition, they are now sealing every Valve in its carton at the Works. Asked how it would be possible for the shopkeeper to be certain that he was selling a sound Cossor Valve, a member of the firm explained to a representative of the *Radio Mail* that this was a matter which had certainly presented some difficulties. Various methods had been carefully tried out, including sealing the legs of the Valves and other devices, but none had proved so satisfactory in practice as the method they were now adopting. This consists of wrapping the Valves in a very generous covering of cotton wool, after having first brought two copper wires from the filament legs to two studs on the end of the box. When a customer wants a Cossor Valve, these two brass contacts are placed in series with an electric flash-lamp battery and a bulb. If the filament should happen to be damaged, the circuit will not be complete and the lamp will not light. This test can be easily carried out without breaking the seal of the box by means of a very ingenious showcard, which we understand Cossor's are supplying free of charge to all Wireless dealers.

A prominent manufacturer of Broadcast Instruments emphatically endorsed this new idea. He agreed that it was a wise move that had been long awaited. The public, he declared, welcomed any method of purchasing usable accessories under a seal. In his opinion the Wireless dealer—while not shirking responsibility—considered that the manufacturer ought to take steps to see that his (the manufacturer's) responsibility ended only when the article reached the actual user.

How long should Valves last?

Many keen wireless amateurs get over twelve months' service

How long a Valve lasts depends very largely on how it is used. Some men can make their suits last very much longer than others—a little care and attention now and again will prevent crasses forming and the material from losing its freshness. The same applies to Valve. For instance, how many amateurs know that the use of filament switches in a Receiving Set—although a great convenience—shorten the lives of the Valves very considerably. Rheostats should be used for the purpose of turning current on and off; to throw the full load on at the turn of a switch is to cause a sudden expansion of the wire used in the filament, and to switch off suddenly is to cause a sudden contraction. No Valves built can withstand such strains indefinitely.

Treat your Valves properly and you'll find they'll last very much longer. For instance, Mr. G. H. Hasemer, of 9 Galliard Road, writes as follows:—

"I think it is only right to testify to the excellence of Cossor Valves, more particularly as far as I am concerned the P.1. On December 1, 1923, I purchased two of these Valves and they have been going strong ever since, and are functioning well now. They have been in use on an average of 24 hours per day from date of purchase, which brings present life up to nearly 1,000 hours. How long they will last I cannot say—perhaps you can estimate. However, I shall certainly repeat a selection of Cossor P.1."

While Mr. J. Harris, of 13 Stepney Bank, Newcastle-on-Tyne, thinks that sixteen months' regular service for one Cossor Valve is something of a record. Writing on January 27, 1925, he says:—

"In September of 1923 I purchased a P.1 Cossor Valve, and wish to state that it has given me excellent service until to-day. The Valve in question has never missed the Savoy Bands, nor Official News of the B.B.C. Total life of Valve, sixteen months.

Perhaps there are others who can beat this record, but I, as an old user of Cossors, am perfectly satisfied."

Even this record would seem to be eclipsed by a Cossor P.1 which has been doing yeoman service every day for a period of 1,700 working hours on a One-Valve Reflex Set. The owner, Mr. Harold Cooper, of 8 Cotherstone Road, London, S.W.2, expresses his satisfaction in these terms:—

"I should like to mention that I have used a Cossor No. V 9132" in use since last September, and averaging at four hours per day (very moderate average for afternoons and evenings) it has given over 1,700 working hours, and is still going strong, and therefore bears out conclusively all you claim in your advertisement; my circuit is One-Valve Crystal 'Reflex.'"

Have you got down to the short waves yet?

Get ready for the new Broadcasting Stations operating on 100 metres or less

There's lots of enjoyment to be obtained from short-wave reception. If you can read Morse, you should certainly alter your set so that you can get down to 80 metres and under. Any evening will find scores of British amateurs corresponding with their friends across the seas. The most extraordinary thing about these short waves is their tremendous power of penetration. Using but very little power, amateurs can send messages immense distances. Incidentally the tuning of short waves means

the use only of high-grade components and suitable Valves. How far American amateurs can send on short waves is a matter of conjecture—it is sufficient to say that signals have been received in this country without aerial or earth. In this connection, Mr. J. Gordon Richie, the well-known Glasgow experimenter, writes as follows:—

"10th December, 1924.
"Some time ago I wrote you concerning the excellent reception of American broadcasting obtained with two of your P.1 Valves. They have since demonstrated their capabilities in another way."

I am now using a Reinartz-type receiver on the very short waves of 80 metres and under, consisting of detector and one low-frequency, and during the past fortnight have logged 106 American amateurs, of which twenty were heard on one night without either aerial or earth. Either of my two 'Cossors,' now almost two years old, are the only Valves I have got to oscillate below about 60 metres.

Considering the constant use and incidental 'knocking about' to which these Valves have been subjected, I think this speaks highly for your products, and I am looking forward to a further period of their usefulness."

Cossor Valves

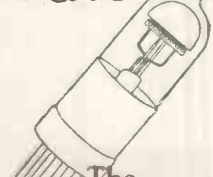

The Valves that give your Set that long distance feeling!

Gilbert Ad. 2046.

In writing to advertisers, please say you saw the advertisement in THE WIRELESS MAGAZINE.



THE pursuit of long-distance broadcasting and amateur stations is a very fascinating way of spending one's wireless time, and one which even old hands at the game often enjoy. It is also excellent for those who suffer from insomnia! A great many articles have been written telling precisely how to receive distant stations, more particularly America, describing everything in detail from the first nut and bolt to the announcer's twang, but to my mind the most important factor is the one least accented, probably, of all. This is the skill in operation.

Importance of Tuning

When one sees a simple two-valve (detector and note-magnifier) set having but two knobs—tuning condenser and reaction—the novice thinks that half an hour will make him an expert at tuning-in—and so it will as regards his local station 5 or 10 miles away. Nothing seems easier than to tune with the two knobs, which are only slightly interdependent. But to get all that is possible out of the set one must devote a considerable time to examining it and its ways. This does not sound encouraging at all, but it is far better to realise one's difficulties fully.

If you want to try your luck at DX work, go the round of all the European broadcasting stations on

a single-valve set and stick to it till you get them. This is far better than losing a night's sleep for nothing!

Having a set (types will be discussed later), make yourself familiar with it by careful practice, and you will be more than half-way towards your goal.

Now I expect many of you are saying "So-and-so got WGY on one valve, having had a set for half an hour," or something like that. Quite so, but he was lucky. You may try to emulate his example and have a poor night in consequence.

Now if you are an expert on your own set you will be able to get speech from far weaker carrier waves than you would otherwise. Carriers which one would deem irresolvable can often be persuaded to give speech under expert persuasion—and it is here that you get repaid for your trouble.

The first maxim of DX work is to know your set really well.

Naturally a set must be efficient to be of any use. In view of all that has been said in the wireless press on efficiency in receivers, only special points need be noted here.

Firstly, as regards the number of valves.

Personally I prefer one high-

Our heading photograph shows the London staff of the Canadian National Railway tuning-in to a concert from Monckton, New Brunswick.

frequency in a straight tuned-anode circuit. For those who have not been operating sets for very long, the use of one low-frequency only is advisable. A high-frequency valve that is fine on fairly near stations may be more trouble than it is worth on DX work unless it is one of the best and is operated very carefully indeed.

We will assume that the set comprises one detector and one L.F. amplifier. The valves should be selected with care and tested on varying H.T. and L.T. voltages carefully till the best signals are obtained and until overlap vanishes. This latter item is very important.

Oscillation

When the reaction coupling is increased oscillation should start very gradually and smoothly and must not make any click at all. The secret of this is correct H.T. or L.T. and/or a variable grid leak. The tuning condenser should not, under any circumstances, be greater than .0005-microfarad capacity and should have a long handle. It should preferably be a square-law condenser.

Ebonite end plates, if made of real ebonite, are far better than metal. The reaction control should be capable, too, of very accurate adjustment, or careful tuning is wasted.

The tuning coils may be of the plug-in type, but should not be of

(Continued on page 444)



Type 620.

Similar to type 610, but for vertical panel mounting. Fitted with screw terminals.

- 0.0001-0.009 mfd. 3/6
- 0.01 mfd. ... 4/-
- 0.011-0.015 mfd. 4/6



Type 610.

A new Mica Condenser suitable for all purposes. Fitted with screw terminals and detachable grid-leak clips.

- 0.0001-0.009 mfd. 3/6
- 0.01 mfd. ... 4/-
- 0.011-0.015 mfd. 4/6

Why Mica ?

These are two new and improved Dubilier Mica Condensers suitable for use in all circuits. They represent a considerable advance in convenience for general purposes over the Types 600 and 600a, and are known as Types 610 and 620 respectively.

* * * * *

And now, why Mica ? Why not paper, or treated rubber, or some other and cheaper composition ? The capacity of a condenser depends on three things : the size of the plates, their distance apart, and that property of the di-electric that is measured in terms of " Specific Inductive Capacity " (S.I.C.). The greater the S.I.C. of a di-electric the smaller quantity is required to produce a given capacity ; this also enables the whole condenser to be smaller, more compact, and less liable to inaccuracies and variations.

Now, Mica has a high S.I.C. It also has great " di-electric strength "—i.e., it will not break down electrically even under very high voltages. It is, therefore, easily the most reliable and constant di-electric there is, particularly for capacities of less than about 1 mfd.

Although they are a little dearer, it always pays to

Specify Dubilier.

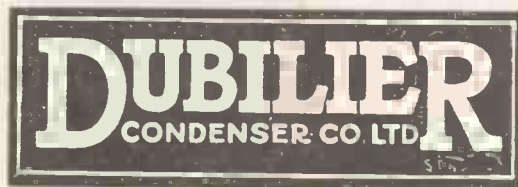

Advt of the Dubilier Condenser Co., Ltd., Ducon Works, Victoria Rd., North Acton, London, W.3.

Phone : Chiswick 2241-2-3.

E.P.S. 92

In writing to advertisers, please say you saw the advertisement in THE WIRELESS MAGAZINE.

HOW TO RECEIVE AMERICA

(Continued from page 442)

the honeycomb type, but single-layer solenoids or baskets, preferably of fairly thick wire, for best results.

As for circuits, I personally prefer a loosely coupled aerial circuit, because of the great interference on the broadcasting waves. The aerial coil may be untuned and should be a little smaller than that which is normally used in the aerial circuit on the direct-coupled set. The secondary must be a little larger.

Ready for Work

If these points are noted, together with the general principles of design so often outlined, the set is ready for work. One thing vitally necessary is a really good pair of phones.

The next thing is to lose some sleep! About 1 a.m. listen round about 2 L O's wave, and just above, for carriers, and tune carefully to avoid oscillating as far as possible. When a carrier is heard it should be tuned in carefully, when it will probably be found that it is the harmonic of a high-power station!

After a little persuasion W G Y should be heard on 380 metres, failing which K D K A on 326 should be searched for.

These are by far the easiest distant stations to get. The American stations work on all wavelengths from 230 to 580 metres, the more powerful ones being mostly above 320 metres.

American Call Signs

A word would not be out of place here as regards call signs in America. All broadcast stations there have three- or four-letter call signs, beginning with either K or W. Normally all calls beginning with W belong to stations on the eastern side of the States, and those with the prefix K to stations on the western half, but there are a few exceptions such as K D K A.

Canadian stations transmit on waves between 400 and 450 metres, and their calls begin with C and have three or four letters. C K A C is one of the loudest on 425 metres.

Having received a few stations, about 4 to 4.30 a.m. it will be noted that stations get few and far between and eventually go altogether, but that is no excuse for going to bed. This is the time to listen to hundreds

of amateurs on short wavelengths, between 75 and 85 metres.

Sets capable of this are quite normal, but the dimensions of the coils and condensers are reduced accordingly.

Here, also, the tuning experience acquired is of great value, particularly if K D K A on about 65 metres is listened for.

Most amateurs are working on morse, and the man who does not know morse loses half the benefit of his set. It is easy to get twenty or thirty stations all over the States in an hour on these wavelengths, signals being of very great strength.

The amateur call signs in the States are divided into nine sections, each under one numeral and having two or three letters. As a guide to those who have not call books, the sections are made thus: Calls beginning with the numeral 1 come from stations in the first district, which is New England—or the "top right-hand corner" of the States. These calls range from 1 A A to 1 W Z and 1 A A A to 1 C Z Z or maybe 1 D Z Z in a year or two's time. There are also stations with calls 1 X A to 1 X B Z, 1 Y A to 1 Y Z, and 1 Z A to 1 Z Z, which are specially privileged stations working on special wavelengths or power. This applies to all calls beginning with X, Y or Z.

The second district comprises New York City and New Jersey, the calls being 2 A A to 2 W Z and 2 A A A to 2 D Z Z approximately. Also 2 X A to 2 Z Z and 2 X A A to 2 Z B Z as above.

The third district consists of Pennsylvania and its environs, and calls go down to 3 C Z Z and as before.

Other Districts

The fourth district comprises Florida, Georgia and the N. and S. Carolinas. Call signs all comprise two letters 4 A A to 4 Z Z. The first four districts are down the coast in numerical order. The eighth district lies just behind the 2nd and 3rd (calls to 8 D Z Z and as above). The 5th and 9th districts cover most of the central States, the latter being the top half (calls to 9 E Z Z), and the former being the bottom half (calls to 5 A Z Z). The sixth and seventh cover the California and Washington regions respectively (calls to 6 C Z Z and 7 B Z Z, respectively).

Naturally signals are heard chiefly from the first district and most rarely from the sixth and seventh. The two latter need a real receiver and are a worthy ambition for a keen D X man.

Identification Prefixes

All U.S. stations call thus: "cq 'U' 1 A A A" instead of "de." This is so that countries cannot be confused, for 2, 5 and 6 are used in England and 8 in France. Therefore by common consent the various countries prefix identification letters to their calls, thus: England, G; U.S.A., U; Canada, C; Mexico, M; Australia, A; New Zealand, Z; France, F; Denmark, D; Holland, N; Cuba, Q; South Africa, O; Belgium, B; and so on.

These points should enable any stations heard to be recognised. Amateurs can mostly be heard from 10 or 10.30 p.m. to 8.30 a.m. next morning from the States just at present, so this will carry you through till breakfast, with, perhaps, a New Zealander on 100 metres to finish with.

I will then wish you joy with "the morning after the night before."

F. L. HOGG (G 2 S H).

IF YOU WANT TO BUY A SET

and know nothing of wireless, let us help you to choose it. With our special experience we are able to advise as to which are the best types of sets for use in any particular circumstances.

Tell us how much, roughly, you wish to spend, where you are situated, what stations you wish to receive (whether only the local station or others as well), whether you intend to use headphones or a loud-speaker, and we will advise you as to the general lines of sets that will answer your purpose.

Send your enquiry with coupon (p. 471) and stamped addressed envelope to

"Buyers' Advice Bureau,"

THE WIRELESS MAGAZINE,

La Belle Sauvage, E.C.A.

ONE of the items broadcast from Glasgow was entitled "Ma Ain Wee Hoose." That's that Wheatley at it again.

"Just listen-and-leave-it"

"Polar-Twin" marks further important stage in Wireless Development—ONE KNOB ONLY to tune-in all stations—no accumulators—and a reasonable price—

It depends whether you want knobs or music. If your desire is to listen, here is the Set with fewer knobs and more music. An epoch in Wireless is marked by it. Now you can buy a valve set that looks fine and handsome, but does not ask you to fool with it; it just gives you the music, calling for no attention—*permitting none*—for its seven highly-specialised, instrument-finished components are enclosed behind a panel that exposes just one control-dial—giving you all the range, the change and the power of an ordinary *three-valve* set.

Its Performance:—

"Polar-Twin" will operate a loud speaker, with an outside aerial, at a distance of 20 to 60 miles; or with an indoor aerial at a distance of 10 to 15 miles. With an outdoor aerial of average efficiency it will receive all British Stations and many Continental ones on the Headphones. It will also receive American stations, with a good aerial and careful tuning.

No Accumulators:—

"Polar-Twin" operates from Dry Batteries. It uses two Mullard Dull-Emitter Valves, with both high-frequency and low-frequency amplification. It embodies reaction, adjustable but requiring no attention. The rheostat is interchangeable for bright valves if required.

The "Polar-Twin" is made by Radio Engineers World-famous for Maritime and High Power Wireless Equipment. It carries a concise and definite guarantee of perfect operation, and Polar Service Agents exist in all British Towns and Cities, who will demonstrate, install, and instruct.

Sold by all good-class Radio Dealers, who will willingly demonstrate. We can supply, carriage paid, but your Dealer's name should be enclosed with your order.

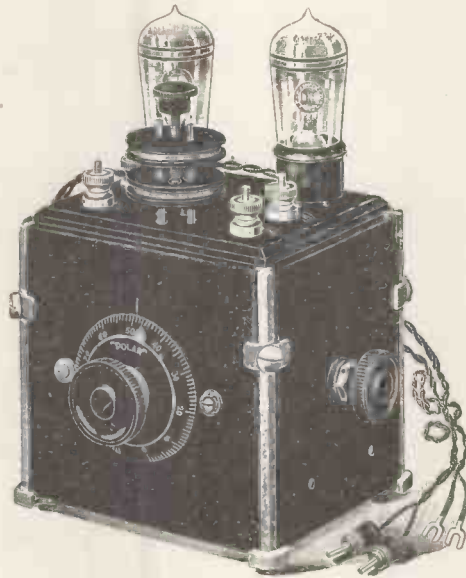

16-page Booklet fully descriptive, free from your Dealer, or from us (enclose 3d. stamps).

£6 = 15

(Without accessories, Royalty Paid.)

Price with all accessories, including 'phones: ... £12 0 0

Price with all accessories but with an Amplion Junior Loud Speaker instead of 'phones: £13 10 0

A Few Reports:—

BARRY—(12 miles from Cardiff). Good loud speaker results from Cardiff. Majority of B.B.C. Stations and KDKA and WGY on headphones.

NEWCASTLE—Aerial 12 ft. high and 30 ft. long, twin. 5 NO very loud on the loud speaker. French stations audible a few feet from loud speaker.

Aberdeen quite loud on headphones.

CULLERCOATS—Outside aerial 30 ft. high and 40 ft. long (including down lead). Interference from the Cullercoats Station which was using 5 k.w. at a distance of 100 yards, although not eliminated, has been considerably cut down.

Newcastle and London programmes were exceptionally loud and very good on the loud speaker.

The American Station at Springfield (Mass.) was picked up at good phone strength.



RADIO COMMUNICATION CO., LTD., 34-45 NORFOLK ST., STRAND, W.C.2.

In writing to advertisers, please say you saw the advertisement in THE WIRELESS MAGAZINE.

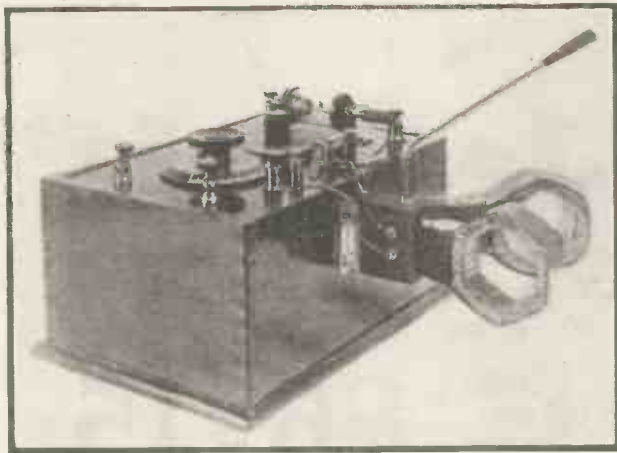

Completed Crystal Set.

The Long-distance Experimenters's Crystal Set

LONG-DISTANCE experimenting with a crystal set has a charm entirely its own. That such experiments are sometimes successful is amply proved by the reports which appear in these columns from time to time stating that some station far beyond the normal range of a set has been logged.

Selectivity Wanted

The ordinary type of crystal set is not very well adapted for such experimenting owing to its lack of selectivity. What is required is a set with which all unwanted signals can be easily tuned out.

The set here described has been designed especially for the amateur who desires to adopt this form of experimenting without going to any great expense.

The circuit is unique, though perhaps it is well known by the naval

operators who have worked crystal receivers. Loose coupling is used, but, in addition, a fine-adjusting condenser supplies capacity coupling between the coils. The operation of the circuit is easily followed.

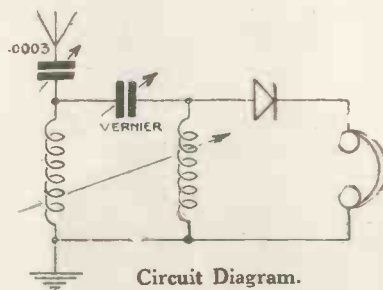

Circuit Diagram.

Briefly, the signals in the tuned primary circuit are applied by way of capacity and magnetic coupling, to the secondary coil of a large inductance, which gives a step-up effect.

The parts required for the set are :

1 ebonite panel, 9 in. by 6 in. (American Hard Rubber Co.).

1 .0003-microfarad square-law variable condenser.

1 fine-adjusting condenser (Lissen Ltd.).

1 crystal detector (National Wireless and Electric Co.)

8 terminals.

1 two-way coil holder.

Tinned copper wire.

Cabinet

The cabinet for this receiver is very simple to make, and if the builder is any good at wood-working it will present a very easy proposition. The cabinet should be made from $\frac{3}{4}$ -in. mahogany. Five pieces are required—two, 6 $\frac{3}{4}$ in. by 4 $\frac{1}{2}$ in. ; two, 9 in. by 4 $\frac{1}{2}$ in. ; and one 10 $\frac{1}{4}$ in. by 7 $\frac{1}{4}$ in.

When completed, small right
(Continued on page 448)

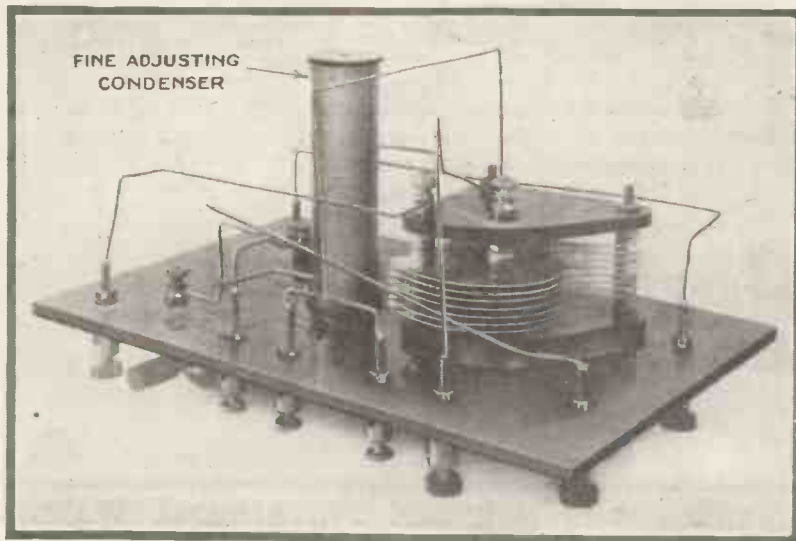

Back of Panel.

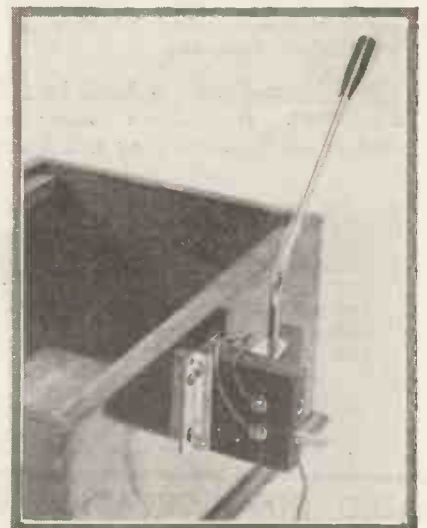

Coil Holder.

□ *A comprehensive series of practical and up-to-date manuals covering the whole field of the handyman's needs. Each work is written by an expert, is fully illustrated with photographs and diagrams, and contains just the information needed to secure satisfactory results.*

Amateur Mechanic & Work Handbooks

<i>Basket Making</i>	<i>Handyman's 1,000 Practical Receipts</i>
<i>Bookbinding</i>	<i>House Painting and Decorating</i>
<i>Boot Making and Mending</i>	<i>Household Repairs</i>
<i>Building Model Boats</i>	<i>Incubators and Chicken Rearers</i>
<i>Camera Making</i>	<i>Induction Coils</i>
<i>Clock Cleaning and Repairing</i>	<i>Magneto Repair & Adjustment</i>
<i>Conjuring Apparatus</i>	<i>Metal Turning Made Easy</i>
<i>Cycle Repairing and Adjusting</i>	<i>Miniature Electric Lighting</i>
<i>Domestic Jobbing</i>	<i>Motor Cycles and Side-cars</i>
<i>Dynamo & Electric-motor Building</i>	<i>Mounting and Framing Pictures</i>
<i>Dynamo and Motor Erection and Management</i>	<i>Photography Simplified</i>
<i>Electric Accumulators</i>	<i>Pianos</i>
<i>Electric Bells and Telephones</i>	<i>Poultry Houses and Appliances</i>
<i>Electric Clocks</i>	<i>Small Dynamos and How to Make Them (including Electric Motors)</i>
<i>Electric Lighting</i>	<i>Small Electric Apparatus</i>
<i>Electric Primary Batteries</i>	<i>Small Lathes—Making and Using</i>
<i>Electro-plating</i>	<i>Small Workshop Appliances</i>
<i>Fishing Rods and Tackle, Making and Mending</i>	<i>Stage Illusions & Entertainments</i>
<i>Furniture Repairing</i>	<i>Ticket-writing and Sign-painting</i>
<i>Gilding, Silvering and Bronzing</i>	<i>Tinplate Work</i>
<i>Gramophones and Phonographs</i>	<i>Toy Making</i>

The above are only a small selection of representative titles. A full, descriptive list of the 80 books in the series can be had post free by return from the Publishers.

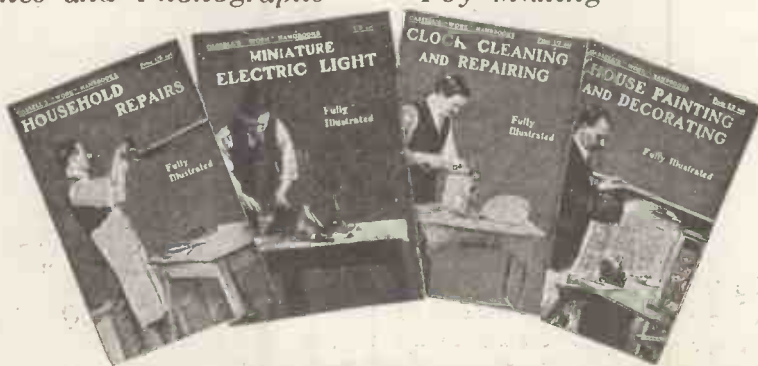

Obtainable from all Newsagents and Booksellers 1/6 net each, or post free by return 1/9 from "Amateur Mechanic," La Belle Sauvage, E.C.4.

These are the Books that show you how to make and save money

Cassell & Company, Ltd.



Publishers, London

In writing to advertisers, please say you saw the advertisement in THE WIRELESS MAGAZINE.

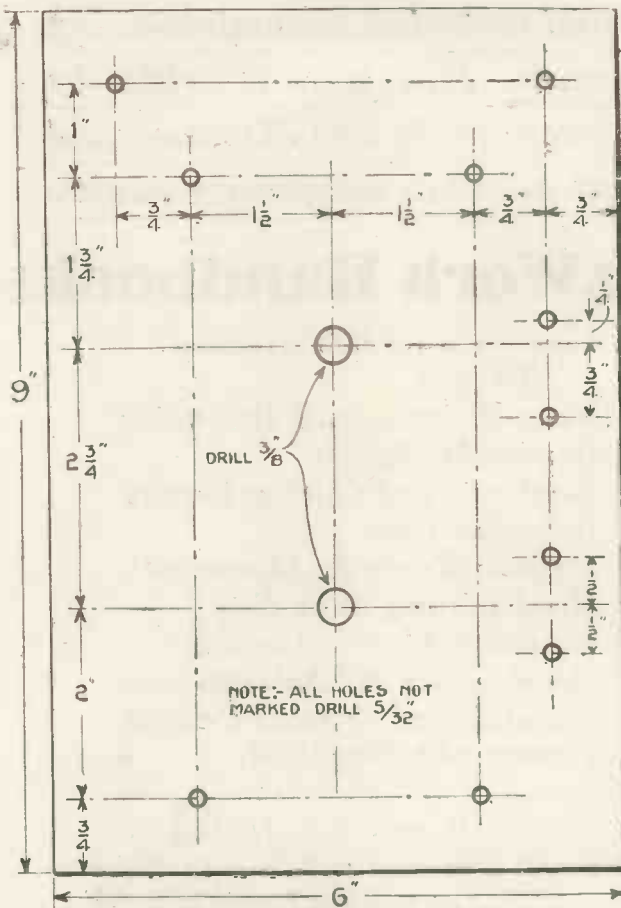

Half-scale Panel Layout.

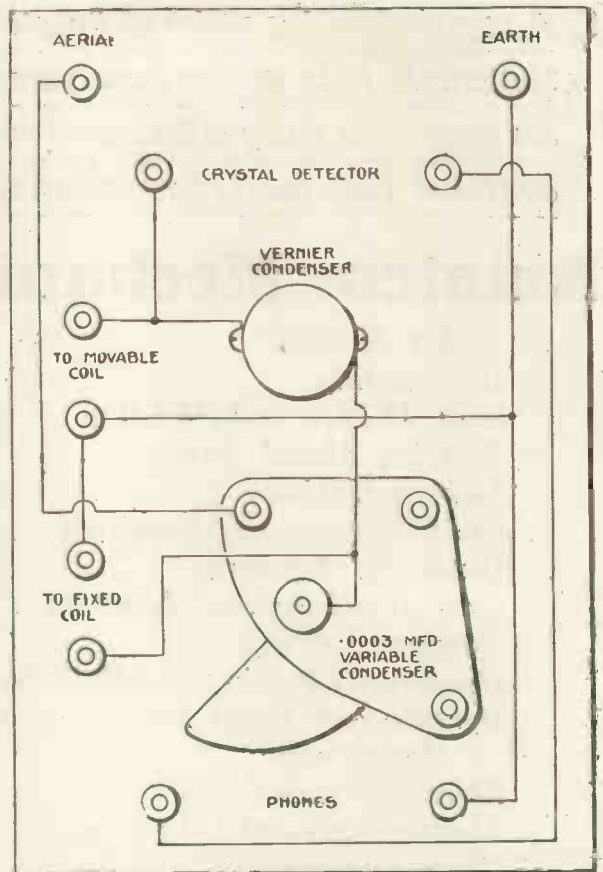

Wiring can be Easily Carried out by Reference to this Wiring Diagram.

(Continued from page 446)

angled pieces of wood are fitted in each corner of the cabinet $\frac{1}{8}$ in. from the top. When the panel is fitted in it should lie flush with the top of the box.

Those who do not wish to make their own cabinet may obtain a suitable one from Pickett Bros., of Bexley Heath.

Mark on the panel with a centre punch the centres of all holes to be drilled, and drill slowly to avoid heating. Mount components, and wire as shown in the diagrams and photographs.

The coil holder is mounted on the side of the box.

Operation and Results

To operate the set connect aerial and earth leads and phones, and plug in two No. 75 coils.

Couple the coils tightly and tune with the condenser. When a station is heard, vary the coupling condenser until the signals are at their loudest.

The connections from one of the coils should be reversed and any improvement noticed.

If the signals are being jammed,

loosen the coupling of the coils and re-tune. It will be noticed that a station can be completely cut out by simply turning the coupling condenser knob.

If a 75 coil is too big in the aerial circuit, try a 60 or 50. It is best to have a larger coil in the secondary than in the primary, so that there will be a step-up effect.

At less than one mile, 2 L O could be completely cut out by varying the coupling condenser! At two miles tuning was extremely sharp. For these results an outdoor aerial about 75 feet long and two 75 coils for aerial and secondary were used.

ONE of the earliest pioneers of wireless was named Shoemaker. According to his name, he is the sort of man who would have been able to give us a tip or two.

A SCIENTIST calculates that the diameter of an electron is 37 times the hundred millionth millionth of a centimetre. Or, to put it in plain language, about the size of the portion of ham found in refreshment-room sandwiches.

MODULATION

THE average current through the phones of a detector valve varies as the square of the voltages applied to the grid. When receiving telephony the grid voltage is a complex of the carrier-wave as modulated by the voice frequencies.

In the process of detection or demodulation the plate current is found to comprise undesired frequencies not present in the original voice, and therefore representing a source of distortion. The magnitude of these extraneous frequencies depends upon the degree to which the carrier-wave is modulated at the transmitting end.

Good Quality

With a low degree of modulation the quality of the voice or music is good, but the signals are weak in volume.

On the other hand, a high percentage of modulation produces strong signals, but the quality of reproduction is impaired by the presence of the undesired frequencies previously mentioned. B. A. R.



The Piano

The reproduction of the rich volume and subtle overtones produced by a fine piano represent one of the most critical tests for a loud speaker.

The agile touch of the musician — one moment hovering over the keyboard with elfin lightness, the next descending with tremendous energy — calls for the most exacting design and workmanship if it is to be faithfully reproduced.

GECOPHONE Loud Speakers will give a perfect reproduction of piano-forte music with a naturalness and quality that attract the most discriminating music lover.

This is why your ultimate choice will be **GECOPHONE** Loud Speakers

The experience and world-wide reputation of the G.E.C is behind all GECOPHONE Wireless products.

GECOPHONE Loud Speakers represent the highest standard of design and workmanship, and are as near perfection as specialised knowledge, experience and exceptional manufacturing facilities can make them.

SOLD BY GECOPHONE SERVICE DEPOTS, WIRELESS DEALERS, STORES, ETC.

(Manufacturers & Wholesale only.)
THE GENERAL ELECTRIC Co., LTD. Head Office, Magnet House, Kingsway, W.C.2.



In writing to advertisers, please say you saw the advertisement in THE WIRELESS MAGAZINE.

*A Section
for the
Boys and
Girls*



Cousin Crysta's Corner

DEAR BOYS AND GIRLS,

The competition which appeared on this page in the March issue of THE WIRELESS MAGAZINE (an essay containing several mistakes) proved very interesting, judging from the number of letters received from my readers in connection with it.

After much labour I have selected the two winning letters, the writers of which will be awarded crystal sets complete with phones, valued at not less than 50s. each.

Result of "Mistakes" Competition

The two successful competitors are ERNEST SHAW, Sheffield, and C. B. PULMAN, Allerton, Bradford.

The prize of 1cs. 6d. for the best contribution received during the month is awarded to N. V. Parker, of Southport, for the novel crystal detector described on this page.

Let me remind my readers once again that I am always pleased to hear from them, especially if they have anything of interest to other readers. Address all letters to:

COUSIN
CRYSTA,
THE WIRELESS
MAGAZINE, La
Belle Sauvage,
London, E.C.4.

A Revolvable Crystal Detector

TWO nails, two telephone pattern terminals, the arm of an ordinary crystal detector, and a small piece of wood or ebonite for the baseboard, are all that are required to make this novel detector.

The pointed ends of the nails are filed with a three-cornered file so that they assume the shape shown in Fig. 1.

When this has been done, screw the two terminals into the baseboard, and fix the nails and crystal as shown in Fig. 2. Fig. 3 is a side-view of one of the nails fixed.

With such a detector as this you can use all parts of the crystal by slackening the terminal screws and revolving the nails. A side-view of the completed gadget is given in Fig. 4.—(N. V. Parker, Southport.)

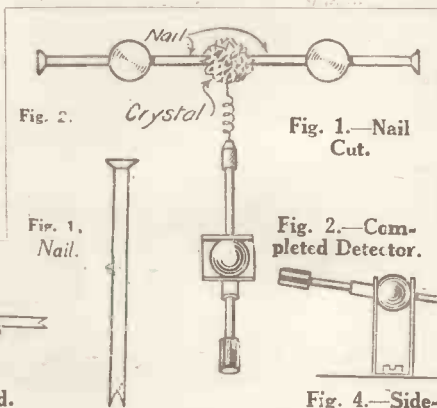

Wireless and Schools

THE making of wireless apparatus comprises the science lesson at many schools nowadays, and it is no uncommon sight to see quite efficient and neat sets which have been constructed by boys scarcely in their teens.

All interested in this branch of work were afforded an excellent opportunity of seeing what may be done by the average schoolboy, at the Schools' Radio Exhibition held in London in March. The sets on view comprised both long and short-range outfits, and the neatness in construction was much admired.

Catwhisker Hints

THE points of most catwhiskers are often blunt and thus prevent results being all that they should be. This may easily be overcome by nipping the end of the whisker off with a sharp pair of scissors held slantwise.

Will GORDON NIELL (Belfast), who wrote the short article "A Simple Aerial Earth Switch" that appeared in the April issue of THE WIRELESS MAGAZINE, please write to me again and enclose his address?

Music of the Month

(Continued from page 426)

"Doric," but for the fact that she was the first "Auntie" of Aberdeen Station,

Heard on the entertainment side may be mentioned Mr. Frederick Lake, in his solos as well as in duologues with another artist, Miss Constance Wentworth. Both in their dual turns and singly they have made a great hit in matters wireless.

Amongst the Singers

Amongst the vocalists have figured Miss Astra Desmond, who sang again recently with Sir Edward Elgar, Mme. Emilia Conti, one of the best-known English and continental singers, and Miss Felice Hyde, whose operatic performances have established her in both musical worlds.

The Instrumentalists

Mr. Angus Morrison, who gave another classical recital recently in London, as well as being heard subsequently "over the ether," is one of our best pianists.

Players of unique instruments have had their fair showing, amongst them being Miss Nellie Norway, with her silver bells. She has travelled with her bells all over the world, and reckons that in America and Canada alone she travelled over 40,000 miles to fulfil her contract of three hundred concerts.

The flute is another instrument which "radios" well, and some very fine results have been obtained when the Municipal Orchestra at Bournemouth is relayed, for here we have two famous Belgians, the Gennin brothers. Both have played from the age of prodigies, and both may be said to have accomplished prodigies in the sheer artistry of their work.

The Art of Talking

A talk on kindred subjects by a real musician is always a pleasant item, and Mr. C. Whitaker Wilson, the well-known organist and composer knows how to handle his subjects as well as his instruments. He has been heard at 2 LO and at Bournemouth, and his special items have aroused considerable discussion.

STUDIUS.

In writing to advertisers, please say you saw the advertisement in THE WIRELESS MAGAZINE.

451



The Living Artistes

THERE is no greater test for a Transformer than Loud Speaker reproduction of a Symphony Concert. Delicate arias and impressive crescendos mean a wide range in amplification valves that will readily discover any integral weakness of design.

For a transformer to be capable of amplifying all frequencies equally—from the shrill notes of the piccolo to the boom of the double bass—necessitates the application of scientific laws.

The Eureka Concert Grand, owing to its exclusive design, does amplify all audible frequencies equally—that is why in the reproduction of a Symphony Concert you will not hear the violins stressed to the exclusion of the flute or the oboe. In fact, when the Concert Grand is used in conjunction with a good Loud Speaker, each Instru-

ment can be readily picked out and identified. How very few L.F. Transformers will permit this being done!

Music lovers throughout the country have been quick to recognise that the Eureka has set an entirely new standard of tone perfection.

If your present Set is not giving you satisfaction, remove the L.F. Transformers and substitute a pair of Eurekas. You'll then know how well it really can perform, unhampered by unsuitable and inefficient components.

Concert Grand 30/- Portable Utilities Co., Ltd. Eureka No. 2 22/6
Fisher Street, London, W.C.1. (For Second Stage)

Supreme **EUREKA** for Tone

Gilbert Ad. 2428.



Every Crystal user will have one!

A really stable crystal detector that will remain permanently set from the moment you first put it in your receiver.

No adjustment whatever is necessary, as contact is unaffected in any way by vibration.

No catwhisker is used.

Rectification is by a selected piece of a rare mineral in combination with another mineral, and the critical adjustments required by catwhisker reception are entirely eliminated.

The use of a spring plunger fixed to one of the elements enables the point of contact between the crystals to be moved, if desired, although searching for sensitive spots is unnecessary, since the contact surfaces of both crystals are unvaryingly sensitive throughout their area.

The enormous demand for this beautiful component and the continued stream of congratulatory testimonials from members of the public have more than assured us that the R.I. Permanent Mineral Detector will find a place in nearly every crystal receiver in the country.

Price, complete with metal brackets and screws for mounting, 6/-. Write for leaflet "The Discovery of 1925," free on application.

Contractors to the Admiralty and all Government Departments.



12 HYDE ST
OXFORD ST
LONDON W.C.1

In writing to advertisers, please say you saw the advertisement in THE WIRELESS MAGAZINE.

For the WIRELESS BOOKSHELF

THE article by Mr. F. W. Thomas (the *Star* humorist) which appeared in the first issue of THE WIRELESS MAGAZINE was declared by so many of our readers to be the funniest thing yet in wireless literature that we shall, perhaps, be forgiven if we devote a little space this month to a review of a few of his books.

The books are all published by G. P. Putnam's Sons, London, price 2s. 6d.

In his book, "The Merry Go Round," which is a reprint of sketches woven around the four seasons of the year, Mr. Thomas treats the reader to some very wholesome humour. The ability to force humour out of the most common-

place subjects is one of "F. W. T.'s" characteristics, and is strongly in evidence here.

"Extra Turns" comprises something like fifty stories. When one appreciates the fact that every other sentence written by Mr. Thomas provokes a laugh, one gains some idea of the value of this book as a tonic for dull minds.

In "Saturday Nights" Mr. Thomas gives one the impression that he regards life as one huge comedy, with everybody playing the rôle of comedian. His ability to ridicule the most commonplace subject is so great that he has written quite a charming tale of woe (and humour) about the breaking of a shoe-lace!

The reader of "Rain and Shine" gets an insight into Mr. Thomas's ability as a humorous poetry-writer. Interspersed with the prose are several examples of him in this rôle, and as one reads them one wonders if there is any branch of humour in which Mr. Thomas would fail.

Abolishing the Filament Battery

THE latest phase in the struggle to simplify the valve consists in using a thermopile in place of the troublesome accumulator for heating the filament. The thermopile, it may be explained, is a form of battery in which electromotive force is generated simply by the application of heat to a junction of different metals. No acid or lead-oxide plates are required and no re-charging. All that is necessary is to maintain a constant supply of heat, which, theoretically, may be supplied from any available source, such as a spirit lamp or gas burner.

The main reasons why so convenient a source of electricity has not previously been utilised for this purpose are: (1) the ordinary type of thermopile will only generate a very feeble current, insufficient to feed even a dull-emitter, and (2) it is necessary to maintain the "pile" at an absolutely constant temperature, otherwise the generated current will fluctuate in value and so cause crackling and other noises in the phones or loud-speaker. In the Sabin filament thermopile recently placed on the market, special

"thermo" elements are used, the positive consisting of strips of tellurium and selenium alloy, and the negative of strips of nickel.

The strips are heated by alternating or direct current, which is taken from the ordinary electric supply mains and passed through a high-resistance heater, the temperature being maintained absolutely constant by means of a suitable control rheostat.

The same principle could obviously be applied to replace the ordinary H.T. battery of dry cells. The one drawback to the Sabin thermopile is that it requires an electric heater. The next step is for some enterprising inventor to develop a thermopile which will produce a steady current of sufficient strength when heated from some more convenient source, such as an ordinary gas-burner or spirit lamp.

B. A. R.

A NORTHERN angling society has fitted a wireless set in its headquarters. Now we may expect some fishy stories about getting Borneo on two valves.

Wireless Woodwork

(Continued from page 440)

immediately below the top of the base to prevent it from lifting right out. The holes should be rubbed with candle grease to ensure easy working. The bottom should be made of thick heavy wood to give stability to the whole. If necessary it should be weighted with lead. The construction of the framework is shown in Fig. 17. The arms are halved together and the cross-pieces at the tops fitted into notches or rebates.

These cross-pieces are afterwards cut away in the form of a "V" groove in a similar manner to that in Fig. 14, to hold the ebonite insulating pieces. The framework is fastened to the shaft as in Fig. 16, and a triangular piece of wood is screwed to the frame. This shaft fits into a hole bored in the underside of the triangular piece, the latter being continued at one side to form a handle. The terminals should be bushed with ebonite as in Fig. 12. The framework could be suitably made from $\frac{3}{8}$ -in. or $\frac{1}{2}$ -in. squares.

C. H. HAYWARD.

MORE STATIONS

FURTHER Continental broadcasting stations are either under construction or looming on the horizon, and should progress continue we shall require specially selective receivers to tune them in whilst discarding the neighbouring transmissions we do not require.

There should be by the summer an increased demand for announcers, but I pity the poor official—unless he be native-born—who undertakes such a job, say, in Poland, Russia, Hungary or Czecho-Slovakia. I have been puzzling out some articles in Warsaw and Budapest wireless journals, and have gathered that it is their intention to issue Esperanto editions in order to render their publications of international interest.

This is all to the good, as, when I glanced at these journals, I felt very much like the Irishman who, on seeing a Hebrew sign for the first time, declared that although he could not make out a single word he thought he could play it on the fute!

"JAY COOTE."

In writing to advertisers, please say you saw the advertisement in THE WIRELESS MAGAZINE.

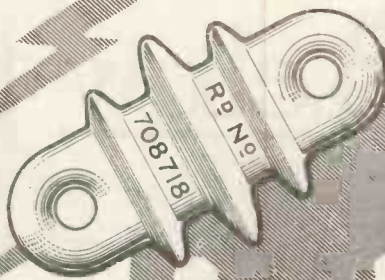

Feed the Brute

Try this ancient advice on your wireless set.
A half-starved set cannot give satisfactory reception.
Are you starving your set?
Consider these three points.

1. THE NEW CLIMAX AERIAL INSULATOR. (Registered Design No. 708718)

This will stand **FOUR TIMES** the flash over voltage of the ordinary cheap shell or egg insulator, while it has far less capacity to earth. It is made of the same High Tension vitreous porcelain as the 100,000 volt insulators on High Power Transmission lines. It will stand a direct pull of hundreds of pounds. It is entirely non-hygroscopic. It cannot absorb moisture even if fractured. It insulates perfectly during rainfall. It is self cleaning on all surfaces.

Price per pair, 1/-. Set of four insulators, with two shock absorbers, 2/6.

2. THE CLIMAX RADIO EARTH. The low-loss direct tubular earth. Far better than the old-fashioned water-pipe or gas-pipe earth. Ready for use. Easily fitted. Maximum efficiency. Length approx. 30ins. Price 5/-. Climax Insulated Low-loss Earth Lead, 20ft. 1/3.

3. THE CLIMAX LIGHTNING ARRESTER. Made on the multi-gap, quenched spark principle. Provides atmospheric space charges and lightning discharges with a straight path to earth of very low reluctance. Protects the set whether in use or not. No switches necessary. The mica insulating discs and series multiple gaps ensure complete absence of shunting effect, leaving your signals at maximum strength. Price 7/6 complete, ready to fix.

A very attractive crystal set in a small, beautifully finished mahogany case, carrying a brilliantly polished panel with silver finished fittings. The detector is the well-known Climax Sure-Set Plug-in detector, fitted with micrometer adjustment. This detector can be set quickly and easily, and is very stable when set. It has all the advantages of a permanent detector with the advantage that you can adjust it. The miniature switch enables the wave length to be changed over to Chelmsford without using any loading coils. Tuning is by variometer, and is very sharp and efficient. When not in use, the aerial can be switched direct to earth, thus giving complete protection against lightning.

Price 21/-

The highest possible grade of crystal set at the lowest possible price.

Insist on the name **CLIMAX**. If substitutes are offered send direct.

CLIMAX
RADIO

CLIMAX PATENTS Ltd.
182 Church Street, London, W.8.

Telephone: Park 2023.

When you want a new crystal—specify **CLIMAX super crystal**, 1/- per box.



TWO most interesting letters have been sent to me from readers who have recently become short-wave enthusiasts. As others will, without doubt, be asking the same questions I do not think I can do better than use them as the text for a paragraph or so.

The first letter suggests that it would be a good thing if I would prepare and publish a table of stations transmitting regular short-wave telephony as there are many now taking up short-wave work who cannot read morse signals and who want to know when they can be sure of getting telephony. My answer is that I only wish it were possible to prepare such a list. Unfortunately the only telephony on really short waves that we are certain of is KDKA's 63 metre transmission. That starts at 11.15 G.M.T. each evening and is a regular broadcast transmission.

There is, however, quite a large amount of telephony, some professional, but mostly amateur, on wavelengths below 200 metres. Some of it is very good. The short-wave enthusiast is, in fact, in precisely the same case as we old hands were in the days before there was any broadcasting. When we wanted to listen to telephony we went "fishing."

Fine-tuning Devices

The second letter concerns fine-tuning devices, my quariest finding very considerable difficulty in accurately tuning very high frequencies. I have given him the best advice I can by letter but because it is a subject in which we are all interested I will here repeat my remarks.

By the way, before I begin, will readers please note that all letters arising out of these notes should be addressed to me at the offices of this magazine and not to my private residence.

The provision of some means of fine tuning is absolutely necessary for short-wave work. To begin with

the condensers should be good ones with firm bearings. They should not be of much bigger maximum capacity than about .00025 microfarad and the so-called "square-law" type are useful because they give open scale wavelength readings at low capacities. Also good square-law condensers should have a lower minimum capacity than similarly good standard type.

Personally, I am not in favour of fine-adjustment devices for fine work on short waves because they make accurate calibration of the scale difficult and the fine-adjustment plate has a different capacity effect at various parts of the scale of the main condenser. I use a geared dial with a ratio of twelve to one. That is to say the knob turns fast whilst the actual condenser plates turn slowly. This enables the very finest tuning to be done without the complication of a fine-adjustment plate.

Simultaneous Morse Transmission.

Having written thus far I left my typewriter and tuned in on the short-wave set to see what was going on. To my delight I jumped in on a most interesting experiment being conducted by French YZ, who can be heard working almost every day. This experiment was a simultaneous transmission on 50 and 82 metres with the idea of comparing fading and efficiency. Presumably M. Lecroart was using the same power on both waves.

If he were, there was certainly a very marked difference in efficiency. The 50-metre signals came in at enormous strength. I called it R 9. The note was good and there was no fading. The 83-metre signals were not more than half the strength of the others and the note was hoarse and difficult to read. YZ is a fine fellow for those who are only just learning to read morse, for he sends at about five words per minute and repeats each word twice. He usually sends his messages in both French

and English as he is very anxious to have reports from English listeners.

There is, of course, nothing very wonderful about simultaneous transmission. Our own B.B.C. stations are always doing it, and we have other notable examples of the same thing in the United States. But I had not, previous to the experiments I have noted, come across any amateur simultaneous transmissions. It certainly is a useful way of comparing not only efficiency on two different wavelengths but the efficiency of two different types of transmitters.

Wireless "Fishing"

Wireless fishing is a most fascinating and exciting pastime. You slowly move the tuning controls of your set until you get a "bite." Having got the "bite" you play your "fish" until you have landed him—in other words until you have logged his callsign. The best hours for this sport are Sunday mornings and afternoons until 3 p.m. and the nights after broadcasting has stopped. Continental telephony can frequently be picked up early in the evening.

Distance Work

I have been away, lately, holiday making in a part of the world where aeriels are few and far between, and so I have not been doing much in the way of sitting up until the small hours listening to American "brass pounders." I have heard Canadian I A R on 50 metres, though. He was working at 1 o'clock G.M.T. (a.m.—of course) and coming through very strongly. One does not like to prophesy, even about the progress of so sturdy a youngster as wireless; but I feel it in my bones that it will not be long before we shall be able to communicate with the Americans without having to wait until cold night is upon us and the whole house sleeping save only the enthusiastic wireless man.

Mr. Reinartz, of circuit fame, has

(Continued on page 457)

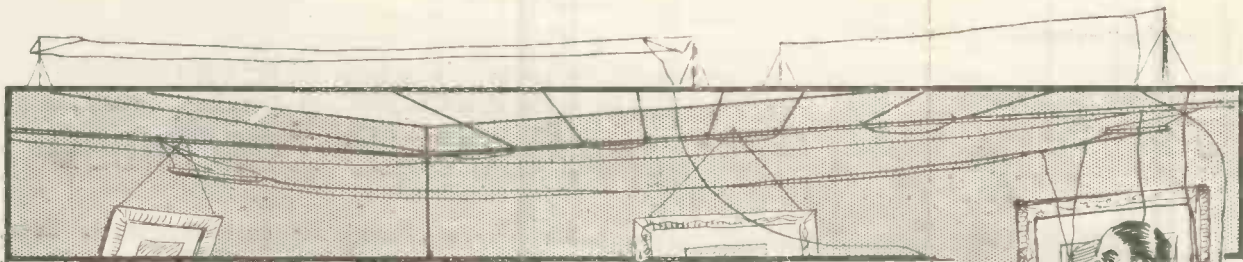

CONCLUSIVE PROOF THAT ELECTRON WIRE IS THE BEST OF ALL AERIALS

Read this and be convinced:—

AMATEUR WIRELESS, March 14, 1925.

"To test a sample of Electron aerial wire I adopted a rather unique method. I erected a number of aerials (of different wires) of exactly the same length, including a length of Electron wire.

"Then I tuned in a crystal set to London on what I thought would be one of the best aerials, and detuned until signals were only just audible.

"Next I 'borrowed' an independent observer, who sat with his back to the set. I then changed the aerials about, while the observer noted the difference in signal strength. **EVERY TIME HE VOTED FOR THE ELECTRON AERIAL.** This was quite a conclusive test, and I can recommend this wire to anyone who wants to fix up an aerial with the minimum of trouble."

AMATEUR WIRELESS, March 7, 1925.

"I have noted with some interest that many amateurs make a habit of religiously cleaning their aerial wires. I say religiously because the operation generally takes place on a Sunday morning. Now, whilst it is true that the surface oxidation on a copper wire increases the H.F. resistance of the aerial, it is doubtful whether any amount of cleaning will improve matters, because it is obviously not possible to clean between the strands, where the atmosphere attacks the copper just as thoroughly as it does the outer surface."

Testimonials like this from so eminent a paper as "Amateur Wireless" is authoritative, and furthermore it fully substantiates our claim that ELECTRON WIRE does all that we claim for it. It is the only aerial for the crystal user, as well as the more serious investigator. IT DOES BRING RESULTS—is non-corrosive, and has a heavy vulcanized insulation.



ON SALE EVERYWHERE.

The **CHEAPEST AERIAL** and the Best in the World. **1'8**

The Aerial you will eventually use.

LOUDSPEAKER
AND 'PHONE
EXTENSIONS

Two 150 feet
lengths laid double.
300ft.
5/-

Two 250 feet
lengths laid double.
500ft.
8/-

NOW IN
BOXES

Carriage Paid.

NEW LONDON ELECTRON WORKS, Ltd.
Dept. No. 67. (Members of the B.B.C.)
EAST HAM, LONDON, E.6.

Telephone: East Ham: 1408.
(Private Branch Exchange)

Telegrams: "Stannum, London."

(About 2 miles East of Blackwall Tunnel.)

'Buses: 40, 101, 23, 5, 15.



In writing to advertisers, please say you saw the advertisement in THE WIRELESS MAGAZINE.

TRADE **DECKO** MARK



THE BACK OF PANEL VALVE-HOLDER.

Points of Excellence

1. Pure Ebonite.
2. One Hole Fixing.
3. Low Capacity.
4. Split Grid.
5. Split Plate.
6. Safety Sockets.
7. Soldering Tags.
8. Central View.

PRICE **2/-** EACH

IN CARTONS

From all dealers or in case of difficulty write to the Manufacturers:

A.F. BULGIN & CO.
 514 CURSIOR STREET
 CHANCERY LANE E.C.6. LONDON
 TEL. HOLBORN 2077

"SPENCER" VALVES

ALL PURPOSE. ALL BRITISH.

Fil. Volts. 4.5. **8/6** each. .65 amps.

VALVE REPAIRS MOST TYPES **6/6**

DULL EMITTERS 9/- '06 TYPE 10/6
 KENITE PANELS 7 x 5 1/- and pro rata

SPENCER'S STORES, LTD.

4/5 Nasson's Av., Coleman St., London E.C.2
 Telephone: London Wall 2292.

DUTCH RADIO FIRM
 require Agency.

Apply to "R,"
 c/o **KIRBERGER & KESPER,**
 LTD., AMSTERDAM, HOLLAND.

That Book you want!

Foyles can supply it. Immense stock (second-hand and new), on Wireless, other Technical, Scientific and all other subjects. Write for Catalogue 567 (free), mentioning requirements. Books sent on approval.

That Book you do not want!

Foyles will buy it—a single volume up to a library.
 FOYLES, 121 Chancery Cross Road, London W.C.2.

In writing to advertisers, please say you saw the advertisement in THE WIRELESS MAGAZINE.

NOVELTIES AND NEW APPARATUS DESCRIBED

BELOW we give brief descriptions of the novelties and new apparatus illustrated on page 391.

1.—A neat crystal detector for upright panel mounting, made by the National Wireless and Electric Co., of 42, Gray's Inn Road, W.C.1. Very fine adjustment can be obtained by means of the screw motion controlling the movement of the cat-whisker.

2.—Of special use in high-frequency circuits is the new anti-capacity key-type switch shown. A metal block let into a piece of insulating material that is moved by the knob provides a conducting path between the switch contacts. It is made by Falk, Stadelmann & Co., Ltd., of Farringdon Road, E.C.1.

3.—For experimental circuits the Lissenagon X tapped coil is just the thing. This is a 60-turn coil, with one tapping taken 10 turns from one end and the other tapping taken 6 turns from the other end. The address of Lissen, Ltd., is Woodger Road, Goldhawk Road, Shepherd's Bush, W.

4.—Very small capacity fixed condensers are being made with air dielectrics. The example shown is made by the Ormond Engineering Co., of Pentonville Road, King's Cross, N.1.

5.—An interesting feature of the Lumos valve is that it has a wire gauze anode instead of the familiar solid metal plate. The makers are the Lumos Radio Valve Co., of 64, Mill Hill Road, Acton, W.3.

6.—In the Chaseway grid leak, made by the Chase Electrical Manufacturing Co., Ltd., of 184, Fleet Street, E.C.4, the resistance is varied by the movement of a plunger that makes variable contact with the resistance "lines" inside the case.

7.—A simple anti-capacity valve mount made for Trix Grips, a speciality manufactured by Eric J. Lever, of 33, Clerkenwell Green, E.C.1.

8.—A new form of connecting tag to which a wire can be easily and rigidly fixed without soldering. It is made by the General Electric Co., Ltd., of Magnet House, Kingsway, W.C.

9.—Made from rolled mica and copper foil the new K-type fixed

condenser made by Wates Bros., Ltd., takes up little room in a set. The firm's address is 12-14, Great Queen Street, Kingsway, W.C.2.

10.—This is not merely a knob; it is a variable condenser as well! It seems to be just the thing for use in portable sets. The manufacturers are Portable Utilities Co., Ltd., of Fisher Street, W.C.1. It is made in capacities of .0005 and .001 microfarad.

11.—For use when the grid leak is not required in parallel with the condenser, the Dubilier Condenser Co., Ltd., have produced this extension. The firm's address is Ducon Works, Victoria Road, North Acton, W.3.

12.—This dual rheostat, made by Radio Instruments, Ltd., of 12, Hyde Street, Oxford Street, W.C.1, can be used with either a bright- or dull-emitter.

Don'ts in Loud-speaker Reception

DON'T forget that quality is better than quantity, and that you have a loud-speaker and not a loud-squeaker.

Don't use reaction.

Don't overload your valves; if there is not sufficient volume, add another stage of amplification.

Don't forget to use plenty of grid bias.

Don't forget that resistance-capacity coupled amplifiers distort less than most transformer-coupled instruments.

Don't forget a 1.0-microfarad fixed by-pass condenser across the high-tension battery.

Don't forget that special valves are made for power amplification.

Don't forget that the position of the loud-speaker in the room greatly affects results in some cases.

Don't adjust your loud-speaker merely for the sake of turning a knob; put a dummy control on the set if you can't keep your fingers still.

Don't forget that your neighbours may not appreciate two hours of the Savoy bands as much as you do.

Don't forget that less "background" noise is heard if the loud-speaker is not directly in the high-tension leads.

Don't forget that ten milliamperes through the windings for hours at a time will not improve the magnets; if you have a high-resistance loud-speaker remember that there are such things as 1:1 phone transformers.

Don't forget that the positive loud-speaker terminal should go to positive high-tension.

Don't forget that quality means better articulation, and that better articulation means more enjoyment.

G. W.

Below the Broadcasting Belt

(Continued from page 454)

succeeded in getting across in broad daylight. It has been proved again and again that it is only necessary for one amateur to show the way for many to follow, and so it is a "safe bet" that we shall be picking up other Americans before long and they, also, will be reading us.

Ultra Short Waves

A couple of months ago I promised some notes on reception below 50 metres and as Mr. Reinartz's transmission, referred to above, was on 21 metres this promise comes to my mind. As a matter of fact I have little to tell you as yet, but I have been very busy experimenting. I have succeeded in getting down to about 15 metres on a set not designed for these very low wavelengths. The tuning coil consisted of five turns, four inches in diameter, spaced $\frac{1}{4}$ in. apart with glass beads.

The circuit is a Reinartz and one complete turn of this coil was in the aerial circuit. The oscillations were not very strong and I have not heard any signals; but the coil responded reasonably well to harmonics from a heterodyne wavemeter a few feet away.

I understand that British amateur transmitters may shortly be allowed to drop below the 150 metres which is now supposed to be their low limit.

E. H. R.

In most of the American stations, the number of watts used is being restricted. We understand that the restriction applies particularly to the type of watts known as "Watts yours?"



Bridging the Atlantic on a Brown

THE following extract from the issue of "Amateur Wireless" dated October 25th, 1924, may prove of encouragement to many Wireless enthusiasts who have not yet been able to receive KDKA on 68 metres at loud speaker strength.

"Even in these days of long-distance records it is something of an achievement to receive KDKA's short-wave transmission at loud speaker strength in the middle of the West End, but this has been accomplished."

"The aerial was above the showrooms of S. G. Brown, Ltd., at 19, Mortimer Street, W.1 (just behind Oxford Street), the set a single detector valve with two stages of note magnification, the loud speaker a Brown Q model and the operators the manager, Mr. R. M. Lucy, and one of his assistants, Mr. H. W. Pope."

"Between 12.30 and 2.0 a.m. on Saturday, October 11th, these two enthusiasts heard a musical programme transmitted from KDKA on about 68 metres."

It is a recognised fact that due to its exclusive tuned reed mechanism any type of Brown Loud Speaker requires considerably less power to enable it to reproduce at full volume. This means, in addition, that any Brown Loud Speaker is much more sensitive for long distance work.

The world-wide reputation for sensitiveness and purity of tone which has been won by the Brown A-type Headphone is shared equally by Brown Loud Speakers. Before you choose your Loud Speaker be sure to hear a Brown in one of its three sizes.



TYPE Q
£15 15 0
in all
resistances.



TYPE H.1.
21 in. high:
120 ohms
£5 5 0
2,000 ohms
£5 8 0
4,000 ohms
£5 10 0

S. G. BROWN, Ltd.,
Victoria Road,
N. Acton, W.3.

Showrooms:

19, Mortimer Street, W.1.
15, Moorfields, Liverpool.
67, High St., Southampton.



Gilbert Ad. 2417.

In writing to advertisers, please say you saw the advertisement in THE WIRELESS MAGAZINE.

Our Cross-Word Puzzles

THE cross-word puzzle which we give our readers this month was compiled by Mr. W. W. Denny, of Folkestone, who was awarded a prize for this puzzle in the cross-word competition announced in the February issue of THE WIRELESS MAGAZINE.

Readers should note that prizes are not offered for correct solutions of the puzzle given this month.

The correct solution of this month's puzzle, together with a further puzzle, will be given in our next issue.

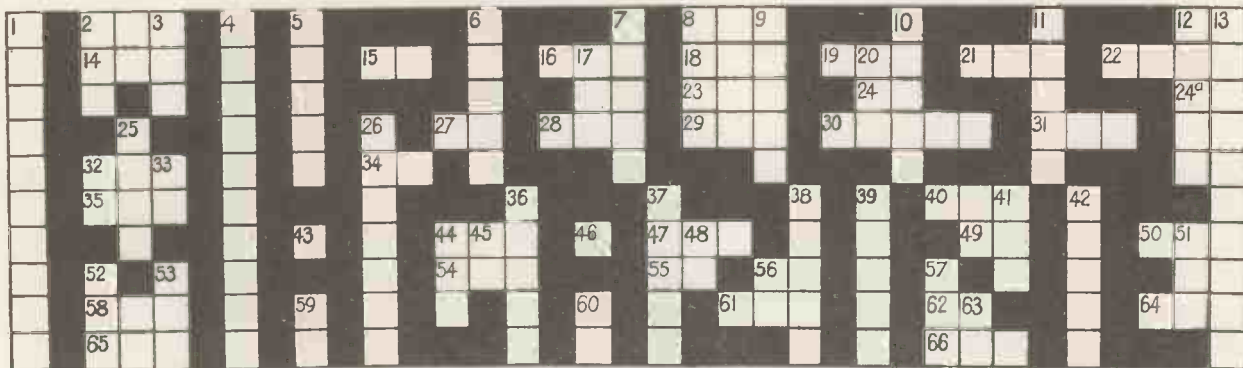

This is one of the prize-winning puzzles in our February competition.

RESULT OF MARCH COMPETITION

The prizes offered in connection with our March cross-word competition have been awarded as follows:

- 1st Prize—
S. T. HOCKADAY (Exmouth).
2nd Prize—
E. GRUNDY (Failsforth).

These competitors will be awarded goods chosen from the lists of advertisers in this magazine to the value of Five Guineas and Two Guineas respectively.

CLUES

DOWN.

- 1.—Instrument used for testing accumulators. 2.—Second half of name of a clock well known to listeners. 3.—Sticky fluid. 4.—They never satisfy everybody. 5.—What are *not* required on a panel. 6.—Some soft valves. 7.—The most prominent things on a panel. 9.—Part of a set. 10.—Wireless. 11.—Some sets are made up of these. 12.—Best material to put round an earth tube. 13.—A B.B.C. station. 17.—Coil put after an H.F. valve. 20.—What the cat did when a "whisker" was wanted. 25.—Some spots on a crystal. 26.—Electrical path. 32.—Direction of SBR from 2 L.O. 33.—First two letters of a dull-emitter. 36.—Necessary in every set. 37.—A rectifier. 38.—Valves. 39.—A valve electrode. 41.—We are all supposed to pay it. 42.—A frequency (low). 44.—Take a connection. 45.—Sent before automatic morse. 48.—Call of first regular broadcasting station in England (excluding numeral). 51.—Tuning coil (abbrev.). 52.—French unit used in calculating inductance. 53.—On the other end of the terminal. 57.—Unit of capacity (abbrev.). 59.—International amateur prefix for India. 60.—Ditto for New Zealand. 63.—A frequency (abbrev.).

ACROSS.

- 2.—First word of a well-known public clock. 8.—Where you will look to find solution to No. 32 down. 12.—

- 14.—A type of current. 14.—A species of Australian o trich. 15.—Initials of well-known and popular make of low-frequency transformer. 16.—A secondary tuning coil. 18.—General-purpose valve. 19.—A valve that is suitable for amplifying, rectifying, and oscillating. 21.—American wireless amateur. 22.—A type of interference. 23.—Christian name of a conductor well known to listeners. 24.—Call of Amsterdam on 1,500 C.W. 24A.—Call of a relay station reversed (excluding numeral). 27.—Type of current most useful for charging accumulators. 28.—An electrode (abb.). 29.—Call of last main station erected by the B.B.C. 30.—To solder. 31.—What you have to do before soldering. 32.—Waves travel over it easiest. 34.—A secondary connection in an amplifier. 35.—Word sometimes put before "phones." 40.—A valve function (abbrev.). 43.—Nationality call letter reserved for code abbreviations. 44.—It comes before L.O. 46.—Nationality call sign for Russia. 47.—Unit used when measuring filament consumption (abbrev.).

- 49.—Term used in distinguishing screws (metal). 50.—Military force making extensive use of wireless. 54.—A coil. 55.—"B" battery. 56.—What the first general news bulletin always is. 58.—Call of Carnarvon (14,000 metres C.W.). 61.—What we shall soon do by wireless. 62.—Call of first French station to start regular broadcasting. 64.—An almost perfect insulator. 65.—A collection of wireless instruments. 66.—A range of dull-filament amplifying valves.

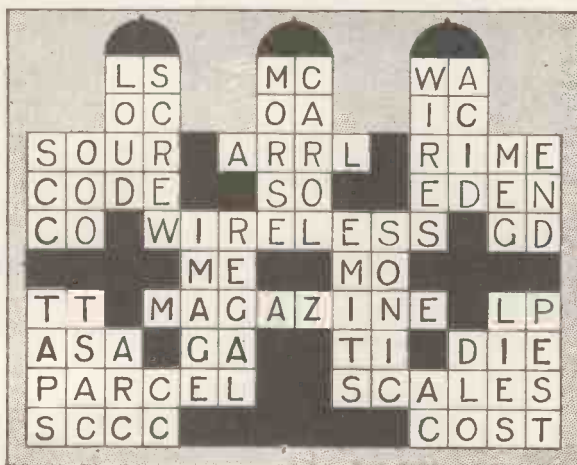

SOLUTION OF MARCH PUZZLE.



Another fine new "ORMOND" feature!

All the fine old "ORMOND" qualities
—AND SOMETHING MORE.

SQUARE LAW CONDENSER

No. 3

Best Quality EBONITE END PLATES, 1/4" thick.

Substitution of Special Take-up Springs, so eliminating the use of Thackray washers. Guaranteed spacing .073 in. thick.

ONE HOLE FIXING.

This apparatus is mechanically sound, and is supplied either with or without vernier.

PRICES :—

Without Vernier.	With Vernier.
.001 ... 9/-	.001 ... 10/6
.0005 ... 8/-	.0005 ... 9/6
.0003 ... 7/6	.0003 ... 9/-
.00025 ... 6/6	.00025 ... 8/-

DELIVERY FROM STOCK.

The "Square Law" Type Variable Condenser.

THE use of a "Square Law" Condenser renders the tuning of a Receiver a very simple matter indeed. A calibration chart may be made by the following simple means:—

Tune in a station of a known wave-length on the lower part of the condenser scale and plot it on the chart. Repeat this process with another station of known wave-length which is received on the upper part of the condenser scale. Draw a straight line through the two points and the chart is complete.

Owing to details of its design, this type of Variable Condenser possesses a negligible minimum capacity, and the specially shaped vanes give an ease of control which is entirely unknown to users of the ordinary type.

We specialise in turning Brass and Steel Screws and Machined Parts and Accessories of all descriptions.

All cheques and Postal Orders should be crossed and made payable to "The Ormond Engineering Company."

Look for the name "ORMOND" on all our products!

Write for our new (1925) Catalogue. Trade Terms on Request.

ORMOND ENGINEERING CO.,

199-205, Pentonville Rd.,
King's Cross, London, N.1.

Telegrams—"ORMONDENGL, KINGCROSS."
Telephone—CLERKENWELL 9344 (3 lines).
Factory—Whiskin St., CLERKENWELL, E.C.1.
25 Years' British Manufacturing Experience.

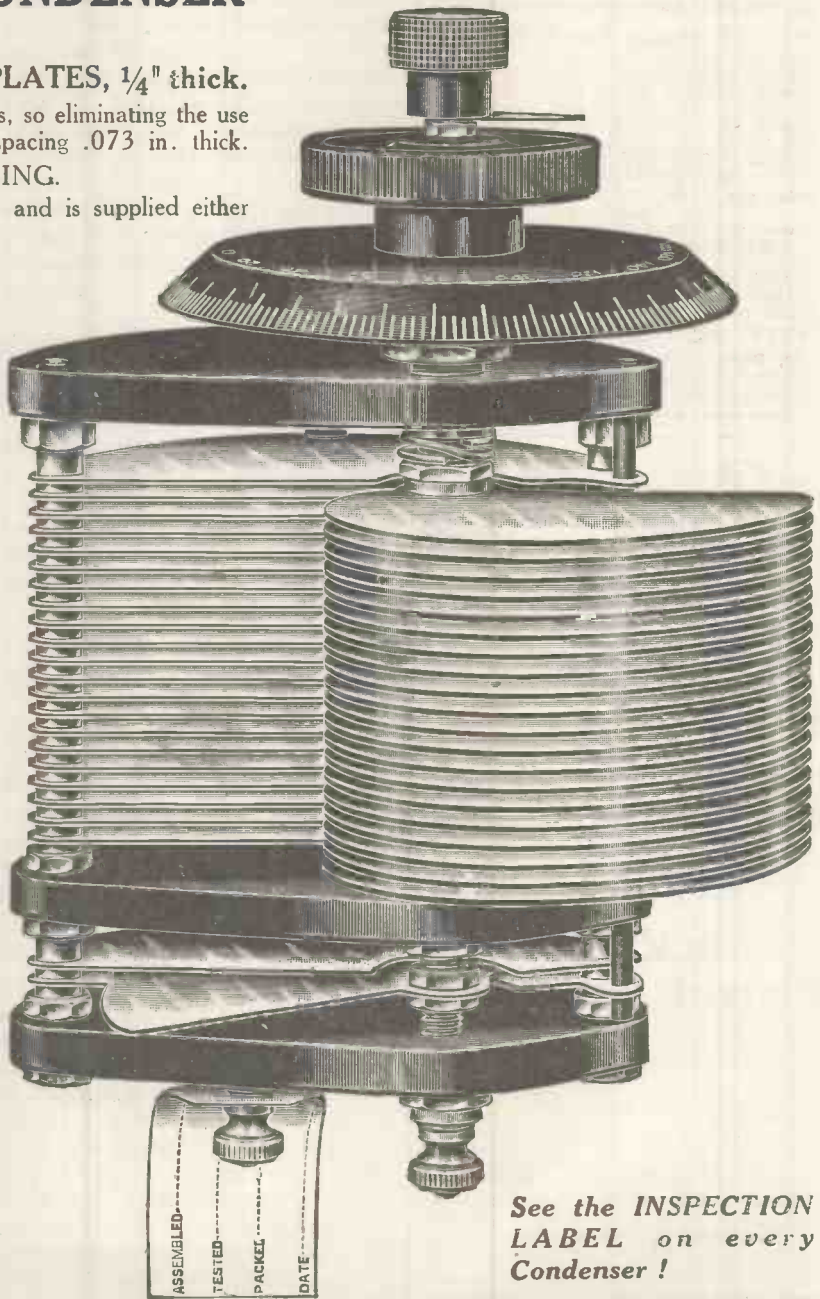
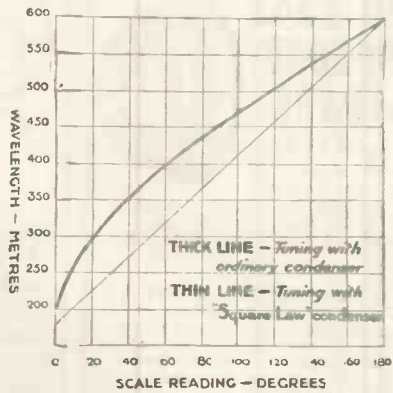

See the INSPECTION LABEL on every Condenser!

In writing to advertisers, please say you saw the advertisement in THE WIRELESS MAGAZINE.

H'EAR EASY HEADPHONE EARPADS



The Acme of Comfort
Recommended by the
Medical Profession.

Do your Headphones grip your head like a vice? If so, don't suffer torture one day longer. Fit a pair of "H'Ear Easy" Phone Pads. Although the phones lie close to the ear

THERE IS NO PRESSURE WHATSOEVER as they give a complete cushion effect. The acme of comfort is obtained, and the phones may be worn for hours on end without the slightest discomfort or fatigue. Moreover, the hearing is considerably enhanced, as all external noises are deadened.

Send P.O. for 2 - NOW—stating make of phones

"C.A.C." Simplex French Polish. This new Simplex Polish is a discovery indeed. It enables the novice to do real French Polishing without trouble or risk of failure. It provides just the thing wanted for completing cabinet work in best style.

A CHILD CAN USE IT WITH PROFESSIONAL RESULTS.

Price, per bottle, with full instructions, 2/-. Postage 6d.

Price, per Outfit, containing Polish, Rubber, and Three Stains, 4/-. Postage 6d.

A trial will convince the most sceptical of the results we claim for this wonderful polish.

CITY ACUMULATOR CO.,

10, Rangoon Street, London, E.C.3.
Branches—79, Old Christchurch Road, Bournemouth; Central Street, Leeds.

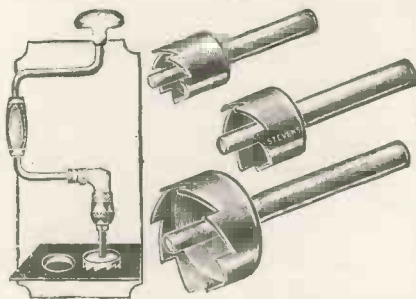

Don't spoil your panels with "amateurish" holes

Your panel sets the standard by which the face value of your craftsmanship is judged—and the look of your panel depends on the holes. Cut clean, true holes in your ebonite panels with

ROCKWOOD Panel Cutters

Made in three sizes: $\frac{3}{4}$ in., 1 in., and $1\frac{1}{2}$ in. Used for cutting peek holes, or fitting bezels, or cutting socket holes in transformer shelves.

No. T.563	Set of 3	Price 12/6
No. T.560	$\frac{3}{4}$ in. size	.. 3/9
No. T.561	1 in. size	.. 4/3
No. T.562	$1\frac{1}{2}$ in. size	.. 5/6

ROCKWOOD CO., LTD.,
147, Queen Victoria Street, London.

The famous SPINTITE WRENCH
can now be obtained for B.A. nuts.
Write for illustrated List W.M.

Continental Notes

SOME few weeks ago, an Austrian paper published a letter received from a local correspondent in which it was stated that the listener had picked up the new Moscow broadcasting station. An appeal was made by the announcer to amateurs who might have tuned him in with the request that reports be sent to—; the name of the street was not clearly heard, and the correspondent explained that it was "unverstaendlich" (not understandable). Curiously enough, this circumstance was reported by several French and English wireless journals who, in the innocence of their hearts, gave the address as "Unverstaendlichestrasse," or "Unintelligible Street."

It is really not surprising that such mistakes should occur, as even some of the foreign names of cities have been altered from time to time. St. Petersburg has twice changed its appellation since the war, once to Petrograd and later to Leningrad; Christiania has reverted to Oslo, and who, but a native, would recognize in Helsinki the town of Helsingfors, in Finland?

English Abroad!

And again: Ai uas ät dhe ssiätr. Uen du ju rais? Schi ssöh.

No, these words do not belong to a new tongue invented to compete with Esperanto or Ido, but are "English as she is spoke" abroad. The sentences form part of the lessons published in a Viennese paper to convey to its readers the correct sounds of OUR language, according to teutonic phonetics.

Poetical News

Every Monday I have made a point of listening to a novel item broadcast by the Eiffel Tower in the course of the 6 p.m. programme. It is simply a clever review, in verse, of all topical events which have taken place in Paris during the preceding week. Although the voice sounds masculine, I am not sure that "le poète inconnu" does not belong to the weaker—or should I say fairer?—sex.

The verses are undoubtedly witty, the rhymes clever, and the idea strikes me as offering great opportunities to an anonymous poet. The Eiffel Tower concerts have been particularly good of late, although there is always a tendency to incorporate certain musical items of a futurist or cubist style. Personally, I am neither high-brow nor low-brow, but I cannot believe that this class of music appeals to very many listeners.

As far as I can judge, FL broadcasts excerpts from new works in order to advertise these very up-to-date composers.

By the way, apart from the ordinary daily concert at 6 p.m., a new series of musical transmissions is now being given every Wednesday, Friday and Sunday evening at 8.30 p.m. B.S.T., on 1,500 metres. These entertainments have been organised by "Les Amis des Auditions Artistiques de la Tour Eiffel," a Paris wireless association. The French and the German nations have one characteristic in common: they both love long, high-sounding titles.

Wanted—A New Name

Commenting on concerts broadcast from Transatlantic liners, a French paper the other day referred to a well-known ocean greyhound as "le Levinathan." This may have been quite accidental—I feel sure it was—but the steamship company might consider the rechristening of its crack boat in view of the number of wealthy Orientals who have patronised it!

International Conference

I can quite understand why the B.B.C. recently held in London a miniature "International Conference" to discuss the question of mutual interference as between British and European broadcasting stations.

Such interference has been particularly prevalent during the past two months. I certainly believe that unless radical measures are adopted the trouble will not only persist, but will be strongly aggravated in the near future. It must be borne in mind that many new stations will shortly "take the ether," and that several of the existing ones will operate with considerably increased power.

Berlin, Hamburg, Frankfurt-on-Main, Leipzig, Stuttgart, Munich are

In writing to advertisers, please say you saw the advertisement in THE WIRELESS MAGAZINE.

all to become either 6- or 10-kilowatt stations, and further $1\frac{1}{2}$ -kilowatt relays are being erected.

Apart from Germany, we shall soon be hearing a "big noise" from Madrid, where the new 8-kilowatt transmitter is ready for tests. Poland, Lettland, Lithuania, Russia, Hungary, Italy, and Austria are also coming into line, and most of them will be working on the already crowded broadcasting wave-band. We shall all soon require specially selective receivers to tune-in any individual station and to discard the neighbouring transmissions we do not require.

The question of interference is a serious one in Europe, although we do not suffer so much from it here as is proved to be the case in other countries. The Parisian listener today, with his four stations, has a very thin time of it, from what my French friends tell me. Owing to lack of organisation and friendly co-operation, each station appears to have collared the wavelength which suited it best, and this with dire results.

PTT, according to my correspondent, interferes on all wavelengths between 300 and 3,000 metres, which should constitute a record. In its turn it suffers greatly from Leipzig. FL on 1,500 metres cuts out, in Paris, any decent reception of 5 XX, and Radio-Paris, already worried to death by PCH (Scheveningen), now complains of PTT.

French listeners state that, although there are from two to three Paris stations in the air every evening, between 8.30 and 10.30 p.m., it is difficult to hear either or any of them well.

When all is said and done, we do manage things better over here.

"JAY COOTE."

THE oscillator's pet proverb:—"It is more blessed to give than to receive."

ACID from your accumulator will eat holes in almost anything, says *Amateur Wireless*. Almost anything. The author must get his steak from the same butcher as we do.

A CORRESPONDENT says that he can't understand ohms, and they are a nuisance. The same remark applies to the OHMS envelopes that the Chancellor sends out about this time of the year.

In writing to advertisers, please say you saw the advertisement in THE WIRELESS MAGAZINE.

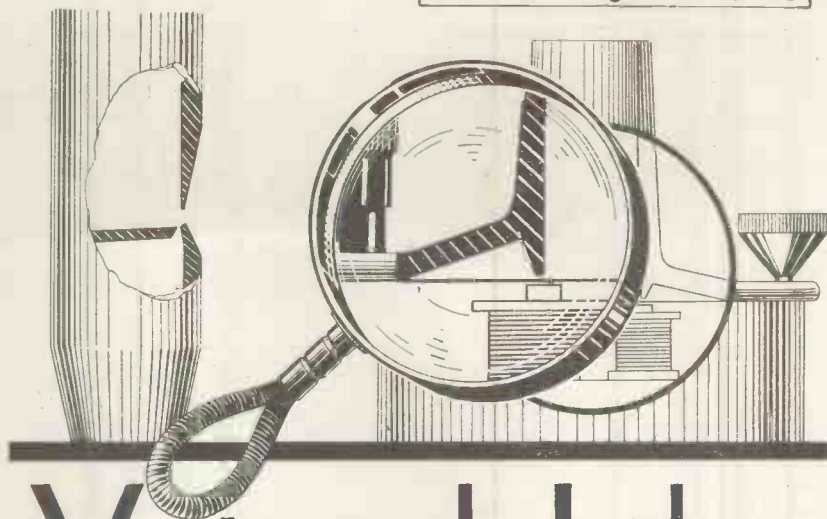

Voiced Like an Organ

The voice is in the mouth of the horn and not in the box.

FOR true reproduction a Loud Speaker should amplify the vibrations of the diaphragm. It should not add any Harmonics, or take any away.

In certain types of organ pipes, it is necessary to produce the *pure fundamental tones*. The lip of the pipe is the place where the voicer's art is applied to *obtain this result*. The lip of the Loud Speaker is the part which has to be considered for fine reproduction. You appreciate MUSIC. You will appreciate the RADIO-SUN. In sunlit mahogany finish.

Price £5

Write for leaflet describing the Wonderful Difference, and ask your dealer to arrange with us for a demonstration.



AUTO SUNDRIES LTD.,

10, LOWER GROSVENOR PLACE, LONDON, S.W.1.



What the Reader Thinks

Why "Wireless" ?

To the Editor of "The Wireless Magazine."

SIR,—There is one enterprise that might well be undertaken by a new magazine, even if it led to the alteration of its own name, and that is the finding of an appropriate word to replace the absurd misnomer "wireless."

From the aerial to the phone leads the whole concern is so obviously "wireful" rather than "wireless." My own set is not, I think, so very plainly full of wire, yet it is surprising how many people have commented on the ridiculousness of such a term as "wireless" in connection with it; and I have not had it very long.

It seems to me that the time is now ripe for a reform in this small matter, and I should think that, if a really suitable word could be found, the Press and the B.B.C. would surely co-operate to broadcast it, in which case it would soon replace the older word.

Perhaps a competition might prove interesting. Without hope of a prize I offer "radiophone," which, however, almost suggests itself. It does not seem such a bad word, as a word, and it has some meaning and not, like "wireless," an inverted meaning.

To save possible arguments I may add that I quite understand how the term "wireless" has arisen.—J. J. Fletcher (Kilgetty, Pem.).

Hand-capacity Effects

SIR,—I have found that with a series aerial condenser hand-capacity effects are much more pronounced with the moving vanes connected to the grid than vice versa. In the case of a parallel condenser the moving vanes should be connected to earth. The rule to follow is to connect the moving vanes to a point of fixed H.F. potential.

The difficulty of the series-parallel switch is overcome by connecting the fixed vanes permanently to the grid, so that in the series position the

moving vanes are connected to the aerial and in the parallel position to earth.—R. A. Irving (Carlisle).

Results with Single-valve

SIR,—For some time past I have been using a single-valve reaction set, and on it have picked up the following stations: all the main B.B.C. stations, Madrid, Radio-Paris, Hilversum, Eiffel Tower, and Königwusterhausen. Other stations have been tuned-in but not identified.

I am situated fifty-seven miles S.W. of London and have not a very good aerial.—H. G. King (Alresford, Hants).

Re-conditioning Dull-emitters

SIR,—A paragraph in the March issue of THE WIRELESS MAGAZINE on the re-conditioning of dull-emitters has saved me nearly £6, so I must needs say "Thank you." It is possible my experience may be of value to others.

I have a five-valve set with two stages H.F. I use four B 5 valves and a B 6. I recently fitted five new valves of this type, but my results were poor. The valves had never been over-heated. The set was O.K. because it functioned splendidly with bright-emitters.

I was contemplating the purchase of a new set of valves of another make when I read the paragraph mentioned. I had previously tried the "boiling" process without result, so tried the "baking" process. The valves had half an hour of a moderate oven, then half an hour's "boiling."

On switching on the H.T. current the result was seemingly a complete failure. There was not a whisper even. I tried all the B 5's in the detector position—nothing doing. The set refused to oscillate. I then tried the power valve as a detector and got results.

The rectification was rather woolly,

(To the writers of all the letters printed on this page we have awarded Cossor valves. Next month we shall award Mullard valves to the writers of the letters published.)

but the volume was fairly good and gradually improved. I was inclined to condemn the B 5 as a detector, and to prove the point I put the B 6 in its proper position and the B 5 in the detector position. I was surprised to find I got a result, though I needed much closer reaction coupling and had to retune the set.

Volume was not great at first but improved after a while and in the end equalled that of the bright-emitters or very nearly. Of course the whole point is this—at first the baking process seemed a failure but in the end proved a great success. The set had to be working some hours before results were appreciated.—T. W. Smart (Creeetown, N.B.).

TUNGSTALITE

THE Tungstalite crystal is the subject of a special announcement made in the April issue of THE WIRELESS MAGAZINE, but we are informed there was a rather unfortunate omission made.

Towards the lower part of the announcement the advice is given to "make a thousand different contacts on a thousand different points," and this very excellent advice should have been followed by the words, "and secure 100 per cent. reception," but owing to one of those mysteries well known in printing offices, the latter words were omitted.

Never mind, in correcting the mistake we are at any rate given an opportunity of saying that we have tried the Tungstalite crystal and have found it to meet the maker's claims in every respect.

THE main failure about many of the baby sets now on the market is that they are likely to suffer from howling just after the bedtime story.

WIRELESS pirates are doomed, according to one newspaper. At the present time, however, they seem to be getting boomed.

THE PANEL

DE LUXE



THE advantage that a Radion Panel confers on a Receiving Set is much more than merely adding a gold case to a watch. Rather, is it comparable to the addition of that delicate compensating balance wheel mechanism which ensures split-second accuracy. If you aim at 100 per cent. efficiency for your Set you'll naturally start with a Radion Panel. With dials to match.

R Radion is available in 21 different sizes in black and mahogany. Radion can also be supplied in any special size. Black 1d. per square inch, mahogany 1½d. per square inch.

RADION

American Hard Rubber Company (Britain) Ltd.

Head Office: 13a Fore Street. London, E.C. 2
Depots: 120 Wellington Street, Glasgow. 116 Snow Hill, Birmingham.
Irish Agents: 8 Corporation Street, Belfast.

Gilbert Ad. 2667.

SPECIAL FRAME AERIALS

for Hetrodyne Circuits and All-England Circuit

as in this issue.

AMERICAN AND ENGLISH PARTS FOR NEW CIRCUITS

RAULAND TRANSFORMERS

A. MUNDAY, Ltd.

Electrical and Wireless Engineers.

59, WATLING STREET, E.C.4.

(One door from Queen Victoria St., and Queen St.)

and at 45, EASTCHEAP, E.C.3.

WHOLESALE AND RETAIL.

Tele. : CITY 2972.

Tele. : ROYAL 4632.

The Weekly that solves your Wireless Problems

Amateur Wireless

3^D

Every Thursday

Take "Amateur Wireless" Each Week and Get the Best Results from Your Set

Cassell's, Publishers, London

Exclusively devoted to the interests of Wireless Amateurs and essentially a practical paper. It is lavishly illustrated with photo reproductions and many explanatory drawings and diagrams. A great feature is Expert Replies to Readers' Questions. Other regular features, all fully illustrated, are — On Your Wavelength! (Chatty paragraphs by "Thermion"), Components You Can Rely Upon, Around the Showrooms, Progress and Invention, Latest News in Brief, Times and Wavelengths of Home and Foreign Stations, etc. etc.



In writing to advertisers, please say you saw the advertisement in THE WIRELESS MAGAZINE

Wireless Gramophone Loud Speaker

THE **Dulce-Tone**

is the link between your Wireless Set and the Gramophone.



Leading radio and gramophone designing engineers who have subjected the Dulce-Tone to rigid tests and inspection agree that it sets an entirely new standard in tonal qualities of radio reproduction, both vocal and instrumental. Dulce-Tone is NOT AN ATTACHMENT. It is used simply by placing the needle of the gramophone on the vibrating reed of the Dulce-Tone. It does not require the removal or change of any part of the machine. Dulce-Tone can be used and then laid aside as easily as a record—in fact, the operation is virtually the same. Hence it does not reduce the use or availability of the gramophone for the playing of records.

Model V, for Victor-Victrola machine.
Model S, for use on all other gramophones.

Price - - £2 10s. 0d.

NOTICE.
To Wireless Constructors and Experimenters. All our products are tested and fully guaranteed by our principal, Mr. C. G. Vokes, A.M.I. Mech. E., etc.

C. G. VOKES & CO.,
38, CONDUIT ST., REGENT ST., W.1

Barclays 870

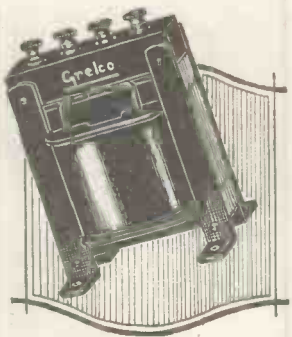

The Grelco "Giant" L.F. Transformer — The Transformer with a Punch!

ANOTHER
Grelco
TRIUMPH

Overall dimensions:
3 3/8" long, 5 1/2" high, 2 1/2" wide.
Weight: 3 lb. 3 oz.

ARE RESULTS YOUR FIRST CONSIDERATION?

OUR latest product is undoubtedly the most wonderful L.F. Transformer ever produced, and to ensure its absolute supremacy no expense has been spared. As a rough guide to its construction, it may be mentioned that there are 32,000 turns of comparatively heavy gauge wire (ensuring great mechanical strength) which approximates over 3 miles, and this, together with the very liberal inter-insulated iron core and highly scientific design, make an ideal combination. This instrument gives a delightfully mellow and full tone, utterly devoid of all distortion and its graph shows a straight line. So confident are we of its superlative merits that we are anxious for those interested to bring (during Broadcasting hours) any L.F. Transformer when Comparative Tests will be given without entailing any obligation whatsoever. The wonderful half-page report by Radio Press (*Wireless Weekly*, March 4) will tell you more about it.

Ratios 1-2 } **30/- Post 9d.**
 1-4 }
 1-6 } *Delivery by return.*

ELECTRIC GRAFTON COMPANY

54, GRAFTON ST., TOTTENHAM CT. RD., LONDON, W.C.
Phone: Museum 241 Works: Slough.



If it's 'Cha away' it's the Right Way Always

A TRIUMPH OF BRITISH ENGINEERING

THE **'CHASEWAY'** NEW

HOME BATTERY CHARGER for ALTERNATING CURRENT

Whilst others have been arguing about "safeguarding" British Radio Industry "CHASEWAY" engineers have been busy on the best "safeguard," namely giving a better article at a reasonable price. The "CHASEWAY" DIRECT CURRENT CHARGER was produced only last September and an infinitely better product at nearly half the price of its nearest competitor—thousands sold. Then the "CHASEWAY" GRIDLEAK caused a stir by establishing itself as the ONLY reliable gridleak on the market—a really scientific instrument, scientifically tested and guaranteed and commended by the Radio Journals. Now the "CHASEWAY" ALTERNATING CURRENT charger has come—a real feat of engineering. The only BRITISH product of its kind. Most A/C chargers are foreign and this BRITISH product is vastly superior—and at a lower price. Read the following points and then write for fuller details, naming the voltage and periodicity of your local supply.

1. Used by connection with lamp socket or wall plug, and consumes very little current.
2. ABSOLUTELY MECHANICAL (not a vibrator or a buzzer) has no liquids or messy chemicals, no expensive bulbs to be replaced at frequent intervals.
3. SILENT RUNNING, SELF-CONTAINED, absolutely complete.
4. Adjustable from 0 to 5 amps. charging rate.
5. Adjustable for recharging 2, 4, 6, 8, 10 and 12 volt accumulators for WIRELESS and MOTOR requirements.
6. A year's guarantee with every one—nothing on the market of same high "efficiency."

Before buying any A/C Charger ask the guaranteed "efficiency"—then you'll buy "CHASEWAY."



Send Stamp for illustrated Catalogue of "CHASEWAY" PRACTICAL PRODUCTS

CHASE ELECTRICAL MFG. CO., Ltd
184G, FLEET STREET, LONDON, E.C.1

'FAMA' DUTCH VALVES

	Retail Price
Dull-Emitters, Filament 1.6 to 2.0, Plate 20 to 100, Amps. 0.06	12/6 each
"R" Type (Amplifier), Filament 3.8 to 4.0, Plate 60 to 100, Amps. 0.5	4/9 each
Tubular (Detector), Filament 3.8 to 4.0, Plate 40 to 60, Amps. 0.5	4/9 each
High Tension Batteries (best quality), 60 volt, tapped every 3 volts	6/9 each
Headphones, best adjustable diaphragm, double leather headbands	10/6 pair
Headphones, best non-adjustable diaphragm, double leather headbands	9/6 pair

Please remit sufficient postage.

BISHOPSGATE ELECTRIC SUPPLY (1924) CO.
(Dept. W.), First Floor, 180, Bishopsgate, LONDON, E.C.2
Phone: Central, 7361.
All these goods sent at purchaser's risk. Trade enquiries invited.

GO TO SCHOOL

Don't play with Wireless—learn all about it!

For half a crown a year, we send you every month our "Brighter Wireless" circuit—always simply wonderful and wonderfully simple—our "Wireless School," and heaps of information such as will enable you to become a wireless expert without puzzling or worrying. As a start we show you how to read diagrams, make an indoor aerial to receive all B.B.C. programmes, how to eliminate your local station, and build the loudest two valve circuit yet designed, from just a few simple parts.

ALL THIS FOR 2½d. A MONTH

Send half a crown now and secure a year's entertainment, instruction and "schooling" in "BRIGHTER WIRELESS" WAY. Press Exclusives, 2, Wine Office Court, Fleet St., London, E.C.4

In writing to advertisers, please say you saw the advertisement in THE WIRELESS MAGAZINE.

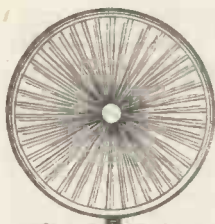

Questions Simply Answered

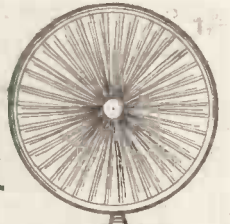

Using the Mains

Q.—Can I use the D.C. mains (200 v.) on my power-amplifier without any chokes?—T. K. (Oldham).

A.—No. A good way is to connect the secondary winding of an old intervalve-transformer in series with the positive lead of the mains and then shunt the mains with a 2-microfarad condenser.

One side of the mains is generally earthed, and this should be connected to the earth terminal of the set through a .25-microfarad condenser.—X.

Testing Coils

Q.—How can I test different coils on my crystal set so as to tell which is best?—W. P. (Leigh).

A.—Test each of the coils by connecting a galvanometer to the phone terminals of the set. The best coil will cause the greatest deflection of the galvanometer needle.—X. P.

Crystal Current

Q.—Is it worth while fitting a potentiometer and battery to my crystal set (using hertzite crystal)?—C. Y. (Plymouth).

A.—Some crystals work better with a small potential applied to them. Treated galenas certainly benefit by it.—R. P.

Connecting a Milliammeter

Q.—I have bought a milliammeter and wish to use it on my valve set so that I can see when distortion takes place in the loud-speaker. How shall I connect the instrument up?—T. C. M. (Bradford).

A.—Connect the milliammeter in the + H.T. lead. Tune in a nearby station, and if the set is distorting the needle will move. Adjust grid bias (or H.T. supply) until the needle is absolutely stationary. It is when the needle is not moving that the best results are obtained.—S.

Definition of S.I.C.

Q.—What do the letters S.I.C. mean?—T. P. C. (Twickenham).

A.—S.I.C. stands for specific inductive capacity.—Z.

Oscillation

Q.—I cannot get my set to oscillate. I have tried reversing the leads to the reaction coil, without effect. What other remedies should I try?—G. D. B. (Belfast).

A.—The coupling between the coils may not be tight enough. Try using a bigger reaction coil, and if this does

not alter matters, the trouble is probably due to the aerial leaking badly. Try putting a condenser of about .0002 microfarad in series with the aerial.—M. G.

Preventing Interference

Q.—How can I stop the interference from a small house-lighting plant which is working near my receiver?—M. S. (Hastings).

A.—You will probably have considerable difficulty in cutting out the disturbances set up by the lighting installation.

Interference from commutator sparking can sometimes be eliminated by using a counterpoise earth. Alternatively, large capacity condensers may be connected across the brushes of the machine.

The H.T. wiring of the ignition should be covered by metal braid which should be earthed.—Y.

Connections for Variable Condensers

Q.—Is there any special method of connecting the fixed and moving vanes in a variable condenser?—M. T. C. (Birkenhead).

YOUR QUESTIONS ANSWERED

At some time or other you are certain to come up against some difficulty in wireless that you cannot solve unaided.

Instead of worrying yourself with knotty problems, let the Technical Staff of THE WIRELESS MAGAZINE answer your questions for you.

Replies of general interest will be published each month, but a post reply will be sent without delay to every question if the following conditions are observed.

Ask one question at a time; write on one side of the paper only; attach to it the coupon on page 471; and send it with a stamped addressed reply envelope to: The Editor, THE WIRELESS MAGAZINE, La Belle Sauvage, London, E.C.A.

A.—In most of the condensers now in use the moving vanes should be connected to earth or the lowest potential part of the circuit.—M.

Value of High-tension

Q.—What value of H.T. battery shall I require for a 2-valve reflex set?—J. J. C. (Dundee).

A.—This will depend entirely on the valves used, but 60-100 volts should be suitable.—U. K.

Relationship of Coils

Q.—What should be the relationship between the aerial and the reaction coils?—J. T. (Cambridge).

A.—If the aerial has a large capacity and resistance the reaction coil will have to be large enough to overcome this. The reaction coil should be of just sufficient value to enable the regeneration to be easily controlled. There is no fixed rule.—S.

Failure to Oscillate

Q.—I am using a crystal-valve reflex set on an aerial approximately 130 feet in length. I find great difficulty in getting the set to oscillate. Would dispensing with the earth lead be beneficial?—M. L. (Wimbledon).

A.—Leave the earth connected, and try putting a .0002-microfarad fixed condenser in series with the aerial. This will result in the damping effect of the aerial, which seems to be the cause of the set not oscillating, being lessened.—Y.

Amplifying Signals

Q.—Would it be possible to amplify the speech from a P. O. phone so as to make it audible on the loud-speaker?—H. C. (Preston).

A.—As it is not permissible to make alterations to the phone installation the only method you could use would be to fasten a microphone button on the earpiece and amplify the current in the microphone by means of a 2- or 3-valve amplifier.—P.

Parallel or Series

Q.—I wish to use two pairs of phones in my valve receiver. Should I connect them in series or parallel?—P. M. C. (Chelmsford).

A.—This will depend on the resistance of the phones. If the impedance of the last valve is low and high-resistance phones are used it would be better to connect them in parallel.

The best method would be to change over from series to parallel and note which is the best way.—H. C.

At 2, Savoy Hill, W.C.2

(Continued from page 384)

maximum number of people at a minimum cost.

If we had been working in the interests of manufacturers or in any other interest other than that of the listeners themselves, this crystal policy would not have been followed. We shall continue to welcome all outside efforts that honestly endeavour to strengthen its public-service character, but recent developments do not introduce any striking novelty.

Studio Problems

There are signs that before very long, if funds are available, our main studios will have to be transformed into auditoriums, or else moved to auditoriums already in existence. The problem of studio acoustics, echo and resonance have been solved so far as is possible in the present comparatively small rooms, but there is still an artistic objection to the modified drapings of the new studio at 2 L.O.

The echo is too deadened for the

effective reproduction of some operatic music; moreover, no artificial expedients quite compensate for the lack of the atmosphere of a large hall, or the presence of at least a nucleus of an audience.

The Americans are having the same difficulties. At some of their big stations the most important programmes are to be put out from large halls and theatres. We are tackling this problem, and if the present plans mature important developments can be anticipated before long.

Watch George Crossmith

George Crossmith is not regarding his job at 2, Savoy Hill, W.C.2, as anything in the nature of a sinecure. Despite his other intense preoccupations, he has been very busy both at 2 L.O. and at other stations. He is, of course, concentrating on the light entertainment side, which is his métier.

His first appearance before the microphone at Glasgow the other day was a great success. The George Crossmith touch should soon be in evidence in all our programmes.

High Salaries Myth

Some newspapers have opened their columns to complaints against us on the score of extravagant salaries and swollen staff. Of course complaints of this kind make better "copy" than adequate replies, even if the latter have the virtue of being true. B.B.C. salaries are lower throughout than those applying in competitive business concerns. They are approximately the same as those for corresponding grades in the Civil Service. Members of the B.B.C. staff are frequently receiving offers of much higher salaries than they are now getting.

One firm recently offered a B.B.C. official a five years' contract at three times his present salary. As for the charge of over-staffing, even a slight knowledge of the company disposes of this. The average working day is more like twelve hours than eight.

In this present year salaries, wages, and miscellaneous charges are stabilising, and the proportion of expenditure devoted to programmes is steadily increasing and should be of the order of 70 per cent.

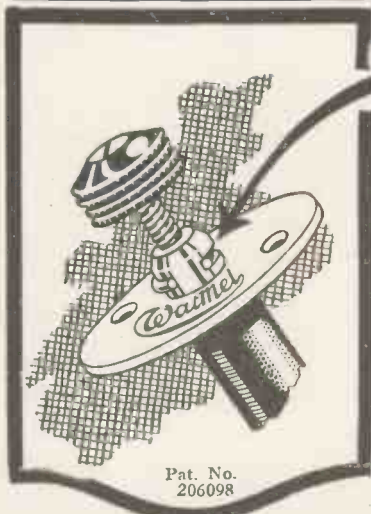

Pat. No. 206098

Recessed into the collar, a D shape spring presses firmly upon the controlling plunger. This device ensures after constant use that the essential contact is maintained electrically good.

Send P.C. for Descriptive Folder. SEE THE TRADE MARK

Watmel

ON EVERY GRID LEAK. BEWARE OF IMITATIONS.

The WATMEL WIRELESS Co. Ltd.

332a, Goswell Rd., London, E.C.1. Telephone - - CLERKENWELL 7990.

One trouble less

It is the little things that escape detection. A faulty connection here, and bad contact there—all play their damaging part in robbing your receiver of its fullest power and range.

Those experimenters who favour the use of the variable grid leak appreciate how it gives the final touch—clearing reception to make it rich, pure and round in tonal quality. The WATMEL is well known as the first variable grid leak which became available to the home constructor, and its consistent record for reliability to get the best out of the detector valve is without compeer.

If you are troubled with poor results pay particular attention to the working of the Detector Valve. Reduce the H.T. voltage consistent with good volume and incorporate THE WATMEL VARIABLE GRID LEAK.

5 to .5 Megohms ... 2/6
50,000 to 100,000 Ohms 3/6

Other resistances to suit any circuit.

From all Dealers.

LEAVE IT TO FLUXITE



An un-soldered wireless set is a breeding ground for those little devils of distortion and bad reception. They thrive on the delicate currents that pass through the circuit. Each un-soldered joint is a trap. One spot alone is sufficient to lower the receptive qualities of your set, so just think what

is missed if all the joints are left un-soldered. Fluxite chases away all soldering worries, and makes possible the perfect soldered joint, making your circuit one whole, solid piece of wiring instead of twenty or thirty odd patchy lengths. Make up your mind and solder your wiring now. It is so simple, Leave it to Fluxite.

Ask your Ironmonger or Hardware Dealer to show you the neat little

FLUXITE SOLDERING SET

It is perfectly simple to use, and will last for years in constant use. It contains a special "small-space" Soldering Iron with non-heating metal handle, a Pocket Blow-lamp, FLUXITE, solder, etc., and full instructions. Price 7/6. Write to us should you be unable to obtain it.

Price 7/6



FLUXITE SIMPLIFIES SOLDERING

All Hardware and Ironmongery Stores sell FLUXITE in tins, price 8d., 1/4, and 2/8

Buy a Tin To-day, FLUXITE, LTD., 332 Brington Street, London, S.E.18.

ANOTHER USE FOR FLUXITE. Hardening Tools & Case Hardening. ASK FOR LEAFLET on improved methods

Barc ays 935

In writing to advertisers, please say you saw the advertisement in THE WIRELESS MAGAZINE.



Why I Prefer the GRAMOPHONE

Continued Interest

THE attraction of wireless is not merely, as Mr. Weare Giffard mentions, due to its novelty, which naturally soon wears off, but to the great interest presented, first in constructing and gradually improving the set, secondly in the programmes themselves, and lastly in the "tapping" of distant stations, a thrill which only tends to increase as time goes on.

With regard to the programmes one might compare the wireless to the "table d'hôte" dinner and the gramophone to that ordered "à la carte." But in choosing our own programmes we may leave untasted many new and interesting things with which the varied wireless programmes would supply us.

Of all the points in favour of wireless, the greatest is the knowledge that whatever is broadcast is actually taking place as we hear it. It is this wonderful attribute and its great human interest, amply compensating for unsightly aerials or uncomfortable phones, that give wireless such a great advantage over the gramophone.—(Miss) H. M. Laurier (Wimbledon).

An Educational Factor

Wireless is no passing novelty, but an established institution, furthering the education and pleasure of the world. Its shortcomings are too few and inconsequent to influence its universal adoption.

People, to whom "nocturne" conveyed nothing, become acquainted with the works of all the great masters through the mighty medium of the ether, learning and enjoying better and more music than ever.

Mr. Giffard may hear a record reproduction of Tetrassini, but listeners-in hear her actual singing—which is vastly different.

All are catered for, and the variety of programmes lends a veritable spice to the evening hours of listeners-in.—H. Shapero (Dundee).

Purity of Tone

As the possessor of a gramophone, and having myself been inflicted on occasion with the raucous discordant noises emitted from a friend's loud-speaker, I was at one time in entire

is pure and sweet; in operation it is silent; it requires no attention; is infinitely cheaper to maintain; and one is sure of a varied programme each evening.—F. Leach (Stockport).

A "Convert's" Views

I am a wireless convert, after having been for many years an ardent devotee of the gramophone. There are several compelling reasons for my conversion, among them being those of comfort and expense.

The quantity of music available through wireless would be utterly beyond my means (which are of the smallest possible dimensions) in the shape of records.

The music transmitted is excellent, and there is no reason why the tone should be inferior to that of the gramophone. If it is, the fault is in the receiver.

I think wireless can meet the gramophone on its own ground and emerge triumphant.—(Miss) H. F. Atkinson (Redcar, Yorks).

An Unfortunate Impression

"Weare Giffard's" first experience of wireless reception seems to have been unfortunate, and surely it cannot fairly be used as an argument against broadcasting, since, as he himself admits, the receiving apparatus itself was not working properly.

If your contributor objects to the unsightly appearance of his neighbour's aerial, he must also remember that there are many aerials made which are much less offensive.

Lastly has there ever been a record made of a news bulletin or a time signal—those two most necessary of items?—(Miss) Rita L. Behm (S. Woodford, E.18).

WHY I PREFER THE GRAMOPHONE.

The letters published on this page are the winning letters received in connection with the competition arising out of "Weare Giffard's" article "Why I Prefer the Gramophone," which appeared in the March issue of "The Wireless Magazine."

The First Prize (goods to the value of Three Guineas chosen from the catalogues of advertisers in this issue) has been awarded to Miss H. M. Laurier, 24, Parkside Gardens, Wimbledon, S.W.19, whose reply to "Weare Giffard's" criticisms has been adjudged the best. To each of the writers of the other letters published we have awarded an Ediswan valve.

sympathy with "Weare Giffard's" preference for the former.

Recently, however, I had to decide whether to purchase further records or build a wireless set. I decided upon the latter, and my decision was more than justified.

Briefly, the gramophone is noisy, requires constant attention, and furthermore one is dependent upon the purchase of new records to provide a change of programme.

The Great "HOW-TO-DO-IT" Weekly

A paper devoted entirely to helping all who like to turn their hands to some useful domestic job or interesting practical hobby.



☞ MONEY-MAKING

It helps you to make profitable use of your spare time.

☞ MONEY-SAVING

It gives reliable help with in-and-out-door repairs and construction.

☞ PRACTICAL

It is written and illustrated throughout by people who know the amateur's difficulties and needs.

☞ INTERESTING

Its well-illustrated articles are always fresh, original and varied in scope.

Special Offer

To Readers of "The Wireless Magazine." A free copy of the current issue of "The Amateur Mechanic" will be sent post free to any reader who sends a postcard before April 18th to the Editor, "Amateur Mechanic," 24, La Belle Sauvage, E.C.4.

"The Amateur Mechanic" makes all the difference to you between failure and the supreme satisfaction that comes from "something attempted, something done." It is edited by Bernard E. Jones, editor of "The Wireless Magazine," Cassell's "Work" Handbooks, "Amateur Wireless," and other famous technical publications; and the contributors to it—each an expert in his own department—not only know the Amateur's difficulties, but know exactly how to direct the Handyman to achieve his purpose. The articles are simple, practical, clear and illuminating.

For 3d. a week "The Amateur Mechanic" will save you pounds a year

3^D

Every Thursday



In writing to advertisers, please say you saw the advertisement in THE WIRELESS MAGAZINE.

The power absorbed, however, is measured by the *square* of the induced current, so that the new current in the aerial will not be doubled (for that would correspond to a four-fold power at the transmitter), but will be increased in the ratio $\sqrt{2} : 1$ or approximately 1.4 to 1.

Other things being equal, one ought therefore to enjoy an increase of roughly fifty per cent. in signal strength, on any given crystal set, from the new station as compared with the old.

Wireless Power Transmission

It is significant that in the new Wireless Act the Postmaster General is given full control over all apparatus intended for the transmission of power (as distinct from signals) by ether waves. Up to the present the problem of distributing heavy power by wireless has not been solved, although many inventors have been hard at work on it for some time. The Postmaster General is, however, apparently of the opinion that this is bound to come in due course, and is preparing himself accordingly.

The new provision, if passed into

law, will also include all apparatus intended for the distant control by wireless of aeroplanes, submarines, and similar moving mechanism. Up to now such systems have not been held to fall within the P.M.G.'s monopoly, since they are not used for sending messages.

In future they will apparently have to be licensed on the same footing as apparatus used purely for signalling purposes.

Two-way Wireless

Ordinary telephone conversation, in which the speaker at one end can break in and interrupt the person at the far end, is now possible with the latest type of wireless installation. Clear two-way speech between the United States and this country has, in fact, been attained in the course of recent trials carried out at the Post Office station at Rugby.

The Post Office engineers are confident that within a year it will be possible for any telephone subscriber to ring up New York *via* Rugby and the other. From New York an extension to any other American town will, of course, be possible over the existing land lines. B. A. R.

DAMPING VALVE VIBRATIONS

POSSESSORS of loud-speakers may have noticed that in some instances there appears to arise a peculiar "musical coupling" between that instrument and the wireless receiver. In most cases when such a condition exists strong microphonic and other noises are present.

Although increasing the distance between the loud-speaker and the set may slightly remedy matters, experiments have proved to the writer that most of these extraneous noises can be considerably subdued, if not entirely removed, by connecting the tops of all the valves together by means of electrician's insulating tape. The tape is merely stuck to the valves and held in position by perforating a small hole to accommodate the pip.

The cure appears to lie in the fact that the valves being thus joined together are, consequently, steadied and not allowed to vibrate. Besides doing away with the noises, the tape prevents damage to the filaments by vibration. J. G. A.



If you're not getting me it's not my fault, it's your "Toob"!

GET A "DEXTRAUDION"

3-VOLT .06 AND CONFOUND THE SCEPTICS!

THE "DEXTRAUDION" 2½-3 volt .06 DULL EMITTER is the latest product of ECONOMIC ELECTRIC, LTD., and costs **18/-**

Gives greater power than a bright emitter, unequalled sensitivity—and it lasts!

On sale at most Radio dealers of repute or direct from ECONOMIC ELECTRIC, LTD., 10, Fitzroy Square, W.1, for 18/- post free, with guaranteed safe delivery.

HULLO! C.Q., WILL DAY CALLING

To-day go to DAY—it will pay

T'ANDCO BASKET COILS (100 to 4,500 metres.)
Duplex wound, 25 gauge D.C.C. wire, sewn supports unwaxed, very firm and strong, recognised as the finest type Coils yet made. Enamelled.

Size 1.	2 in., approximately	150 to 300 metres	5d. each.	No. 1.	4d. each
2.	2½ in.,	250 to 400	" 6d. "	2.	6d. "
3.	3 in.,	350 to 550	" 7d. "	3.	6d. "
4.	3 in.,	450 to 650	" 8½d. "	4.	7d. "
5.	3½ in.,	600 to 750	" 10d. "	5.	8d. "
6.	4 in.,	700 to 1,000	" 1/2 "	6.	9d. "
7.	4½ in.,	950 to 1,350	" 1/4½ "	7.	10d. "
8.	5 in.,	1,300 to 1,750	" 1/8 "	8.	1/- "
9.	5½ in.,	1,700 to 2,600	" 2/- "	9.	1/2 "
				10.	1/4 "
				11.	1/6 "
				12.	1/8 "

EBONITE COIL HOLDERS 1/6 each

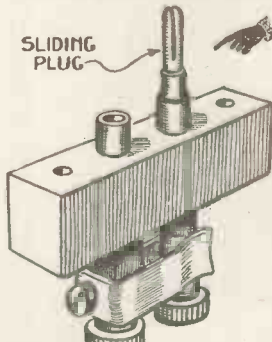

Will Day loading-coil plug that completes the circuit when the coil is removed.

PRICE 2/- EACH.

H.F. Transformer each
Formers — Turned Ebonite ... 1/6
The A.B.C. Wave Trap—Ebonite Former, cut ready for Winding ... 3/-
McMichael Valve Holders for Wood Panel Mounting 2/-
Wood Base Mounting, Coil Ends ... 1/3

MAKE NO MISTAKE IN YOUR SELECTION. Do not keep wasting money on crystals of unknown repute.

GET A CRYSTAL THAT HAS STOOD THE TEST OF TIME. DAYZITE REGD.
Sold only boxed with Silver Cat's-whisker, 2/6 each, post 3d. extra. Makes excellent contact with Zincite for a Perikon Detector.

Write at once for our new catalogue, post free* by mentioning "Wireless Magazine."

WILL DAY, LTD., 19, LISLE STREET, LEICESTER SQUARE, LONDON, W.C.2.
*Phone: Regent 4577. Telegrams: "Titles, Westrand, London."

"The Wireless Magazine" Buyers' Guide

The announcements of the firms below mentioned will be found in the February-May issues of THE WIRELESS MAGAZINE.

Aerial Equipment	PAGE	Crystals and Detectors (cont.)	PAGE	Sets (Crystal)	PAGE
Helix Ltd.	113	W. Molback	220, 227, 234, 344	Anderson's Wireless Sales Agency	115
A. Munday, Ltd.	403	Neutron, Ltd.	103	Ashcrofts Wireless Stores	120
New London Electron Works, Ltd.	455	Radio Instruments Ltd.		Belling & Lee, Ltd.	103
		Back page, Mar.,	452	British Thomson-Houston Co., Ltd.	439
Accumulators		Rose Bros. Electrical Co., Ltd.	104	Falk, Stadelmann & Co., Ltd.	126
Grafton Electric Co.	112	Russell & Shaw	113	General Electric Co., Ltd.	85, 199
Imperial Motor Industries, Ltd.	110, 325	Tungstallite, Ltd.	8, 128, 244, 364	J. W. B. Wireless Co.	5, 231, 343
		V. C. Crystal	362	Lissen, Ltd.	193
Battery Chargers		Ebonite		National Wireless & Electric Co.	91, 347
Chase Electrical Manufacturing Co., Ltd.	343, 405	American Hard Rubber Co., Ltd.	463	Radio Instruments, Ltd.	Page iv cover, May
Gran-Goldman Service	109, 229	Bowyer-Lowe Co., Ltd.		White & Co.	113
Lionel Robinson & Co.	232, 353	Page ii cover, Feb.-Mar.			
Books & Publications		Grid Leaks		Sets (Valve)	
American Technical Society	94	Dubilier Condenser Co., Ltd.	319	British Engineering Products Co.	112, 229, 341
Cassell & Co., Ltd.	362, 447, 463, 469, 470	Igranic Electric Co., Ltd.	83, 237	British Thomson-Houston Co., Ltd.	439
Foyles	220, 342, 456	Mullard Radio Valve Co.	332	Peter Curtis, Ltd.	115
Press Exclusives	96, 122, 336	E. Shipton & Co., Ltd.	105, 205	Falk, Stadelmann & Co., Ltd.	126
Chapman & Hall, Ltd.	120	Watmel Wireless Co.	205, 341, 467	General Electric Co., Ltd.	331
Coils and Coil Winders		Loud-speakers		Peto-Scott Co., Ltd.	237
A. W. Knight, Ltd.	101	A. J. Stevens & Co. (1914), Ltd.	77, 197, 437	Radio Communication Co., Ltd.	329, 445
Igranic Electric Co. Cover ii, No. 3	433	Auto Sundries, Ltd.	221, 325, 401	Page iv cover, Feb. and May	
Lissen, Ltd.	433	Brandes	75, 195, 435	Scientific Supply Stores	232
Components		S. G. Brown, Ltd.	212, 335, 457	Sterling Telephone & Electric Co., Ltd.	363
A. J. Stevens & Co. (1914) Ltd.	77	C. A. Vandervell & Co., Ltd.	7	A. J. Stevens & Co. (1914), Ltd.	437
S. E. Bland	115	General Electric Co., Ltd.	449		
Climax Patents, Ltd.	453	Alfred Graham & Co.	123, 241, 391	Soldering Flux	
Craik & Smith	238, 345	E. E. Rosen & Co.	105	Fluxite, Ltd.	109, 234, 341, 467
Will Day, Ltd.	471	Sterling Telephone & Electric Co., Ltd.	127, 363	Terminals	
Economic Electric, Ltd.	347	C. G. Vokes & Co.	405	Belling & Lee, Ltd.	239
Falk, Stadelmann & Co., Ltd.	242			Pettigrew & Merriman, Ltd.	242
A. W. Gamage, Ltd.	125	Miscellaneous		Tools	
Grafton Electric Co.	239, 341	A. F. Bulgin & Co.	229, 336, 456	Economic Electric Co.	1, 121
Igranic Electric Co., Ltd.	83, 237, ii cov., Nos. 3 and 4	Bennett College	81	Rockwood Co., Ltd.	96
J. Jarvis	107	City Accumulator Co., Ltd.	460	Transformers	
Henry Kennett	238	City Correspondence College	353	Anderson's Wireless Sales Agency	231
Lissen, Ltd.	73, 193, 313, 433	Dell & Co.	120, 353	Beard & Fitch, Ltd.	225
A. Munday, Ltd.	357	Dripped	111	Gaston E. Marbaix	122
Radiophones, Ltd.	106	Hobbies, Ltd.	235	Grafton Electric Co.	465
K. Raymond	118, 119, 223	E. J. Lever	128	J. Jarvis	120
Scientific Supply Stores	105, 232	The Linguaphone Institute	95, 211	Ormond Engineering Co.	209, 321
E. Shipton & Co., Ltd.	205, 344	London School of Cartooning	97	Portable Utilities Co., Ltd.	333, 451
Spencer's Stores.	94, 220, 342	Mackintosh's Toffee	117	Radio Instruments, Ltd.	325
Ward & Goldstone, Ltd.	2	Metropolitan College	5	M. Robin	101
Wates Bros., Ltd.	225	Players Tobacco, Cigarettes	215	Wholesale Wireless Co.	362
Wireless Supplies	220	Pomona Rubber Co.	120		
Condensers		Rockwood Co., Ltd.	460	Valves	
Bowyer-Lowe Co., Ltd.	Page ii cover, Feb.-Mar.	H. J. Searie & Son, Ltd.	108, 230	Bishopsgate Electric Supply (1924) Co.	120, 236, 465
Dubilier Condenser Co., Ltd.	443	M. Verstraeten	115, 236, 470	British Thomson-Houston Co., Ltd.	219, 323
Falk, Stadelmann & Co., Ltd.	5, 126	Phones		A. C. Cossor, Ltd.	201, 317, 441
Faillon Condenser Co., Ltd.	205	B. D. & Co.	110	Craik & Smith, Ltd.	470
Jackson Bros.	109	Bechstein Radio Co.	4	Economic Electric Ltd.	1, 121, 471
Gaston E. Marbaix	227	Bowerman's Phone	113	Electron Co., Ltd.	229
A. Munday, Ltd.	120, 239	Brandes	75, 195, 315, 435	Fellows Magneto Co., Ltd.	87
J. H. Naylor, Ltd.	362	British L. M. Ericsson Manufacturing Co., Ltd.	6	Mullard Radio Valve Co., Ltd.	Page iii cover, Feb.-May
Ormond Engineering Co., Ltd.	459	S. G. Brown Ltd.	92		
Radiovox Co.	117	Goodman's	220, 236, 357	Valve Repairers	
K. Raymond.	223	Imperial Motor Industries, Ltd.	110, 216	G.W.I., Ltd.	101, 231, 353
Crystals and Detectors		Pettigrew & Merriman, Ltd.	213	Spencer's Stores	456
Britain's Best Crystal, Ltd.	101	Simpson's (Brighton), Ltd.	345	Valve Renewal Co.	353, 357, 470
Will Day, Ltd.	106, 351	Sterling Telephone & Electric Co., Ltd.	79, 243		
A. Hinderlich	107, 239, 345	J. W. Miller	109, 238, 353		
Listron	115				
Merton Davis, Parnell & Co.	235				

*Do this for increased
Volume and Clarity*

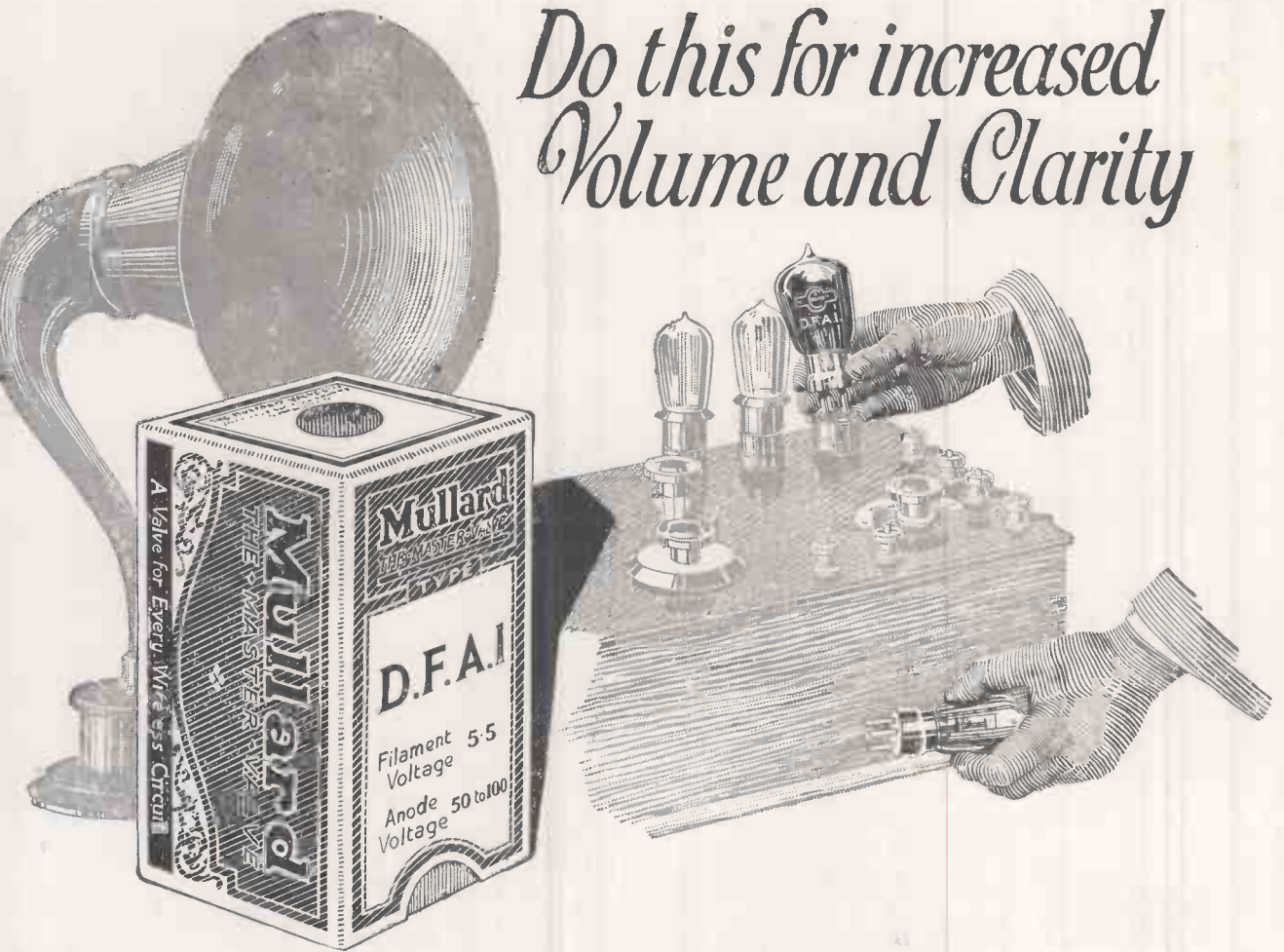

JUST take out your last L.F. stage valve and insert a Mullard D.F.A. MASTER VALVE. You will be delighted with the immediate increase in volume and clarity from your loud speaker. The special construction of these Master Valves gives powerful and pure amplification and yet requires *LESS* current than your present valves.

If you use a 4-volt accumulator,
ASK FOR A MULLARD D.F.A.0 (.35 amp.), Price 26/-

If you use a 6-volt accumulator,
ASK FOR A MULLARD D.F.A.1 (.2 amp.), Price 30/-

If you use dry cells (6 volts),
ASK FOR A MULLARD D.F.A.3 (.06 amp.), Price 32/-

Leaflet V.A.4 gives full technical information. Obtainable from all wireless stores, electricians, ironmongers, etc.

Mullard

THE • MASTER • VALVE

Advt.—The Mullard Radio Valve Co., Ltd. (W.M.), Nightingale Works, Balham, S.W.12.

In writing to advertisers, please say you saw the advertisement in THE WIRELESS MAGAZINE.



"SHE CAN MANAGE IT"

"THAT'S the best present we have ever bought
her, Edward. Just look! Only a turn of the
knob, and she tunes in a Fairyland of music."

"Isn't it delightful? Hours and hours of entertain-
ment and pleasant education, just by turning one dial.
You cannot call it a toy—it's a miracle. That R.I.
Permanent Detector is the wonderful key to more
than perfect detection. It makes the whole intricate
science of radio reception a question of the easiest
of easy adjustments."

"I think every mother in the world should get an
R.I. Permanent Detector Crystal Set for her children.
There's realms of happiness in that beautiful polished
cabinet."

"But why for children only? I have a good mind
to stay at home and listen-in myself, the reception is
so pure from the R.I. Permanent Detector Crystal
Set."

"No, no, Edward, let her enjoy it alone."

Write for leaflet W.M. free on application.

Crystal Set	£2 2 0
Chelmsford	£2 15 0
Two-Valve Amplifier and Crystal	£12 12 0
Permanent Mineral Detector complete with metal brackets and screws for mounting	6 0



12 HYDE STREET, OXFORD STREET, LONDON W.C.1

Contractors to the Admiralty and all Government Departments.

**Panel drilling template
and
Wiring diagram**

ARMSTRONG ONE-VALVE SET ("A")

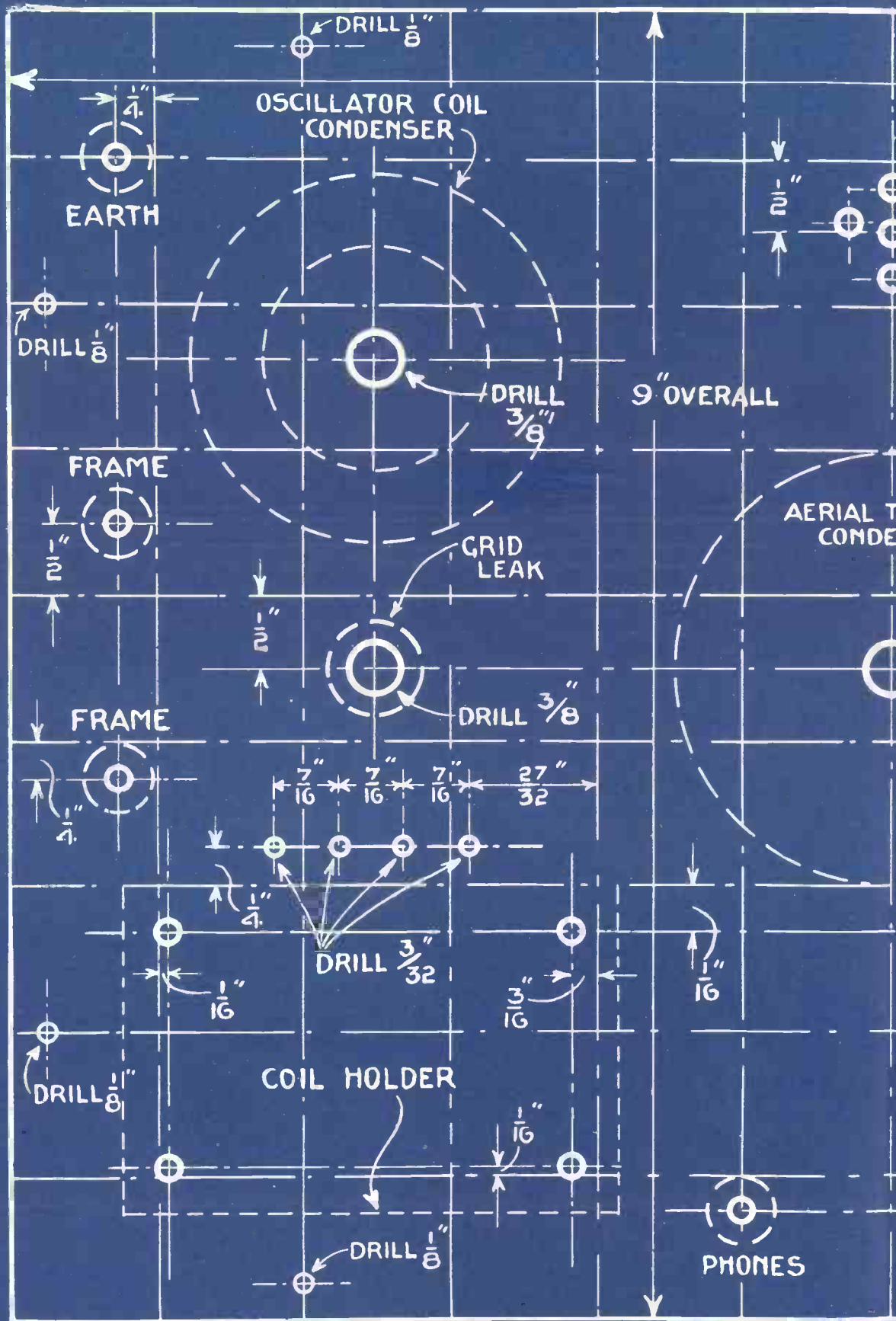

ll England on a Frame Aerial with One Valve"):

PANEL DRILLING TEMPLATE

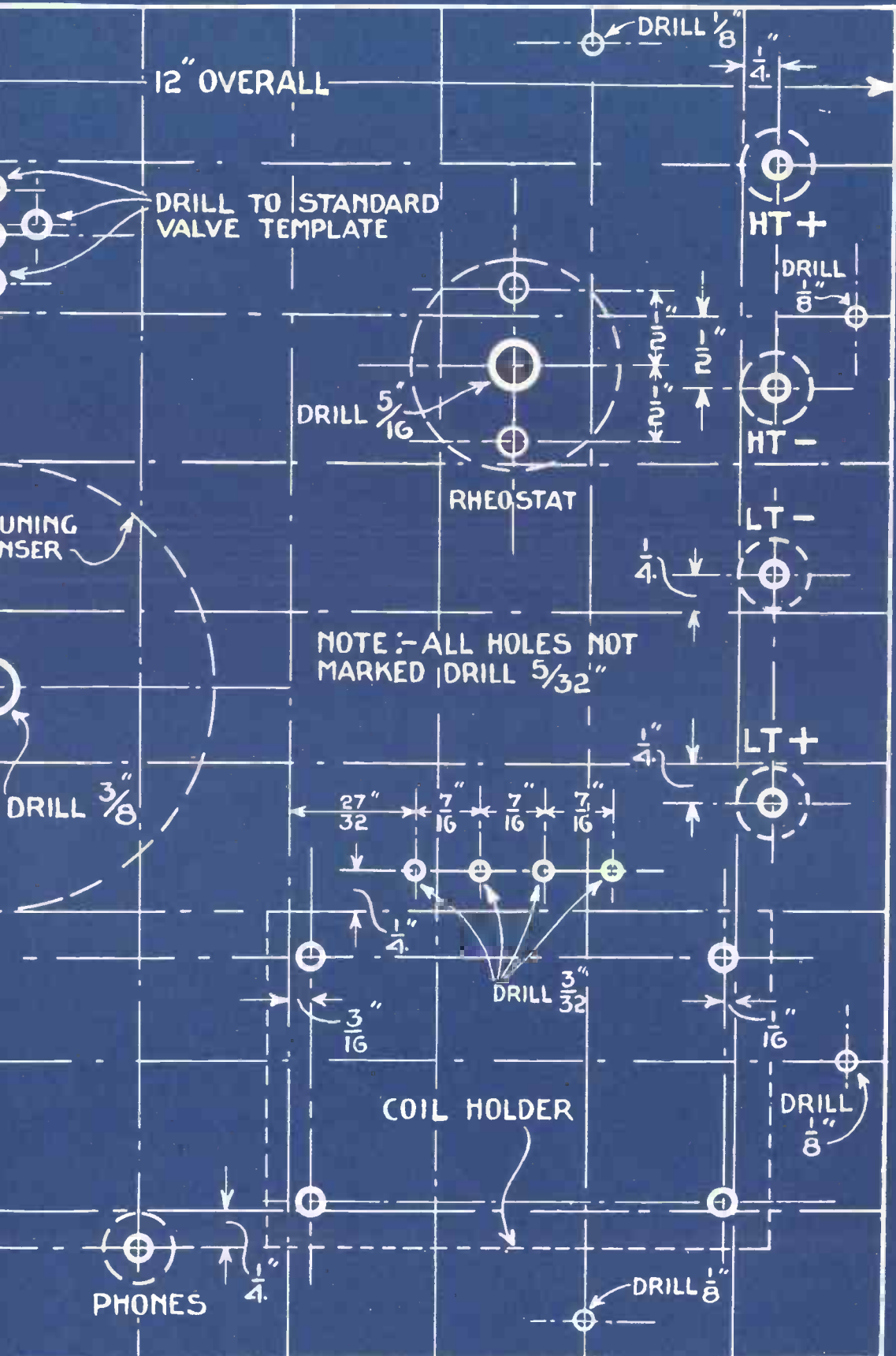

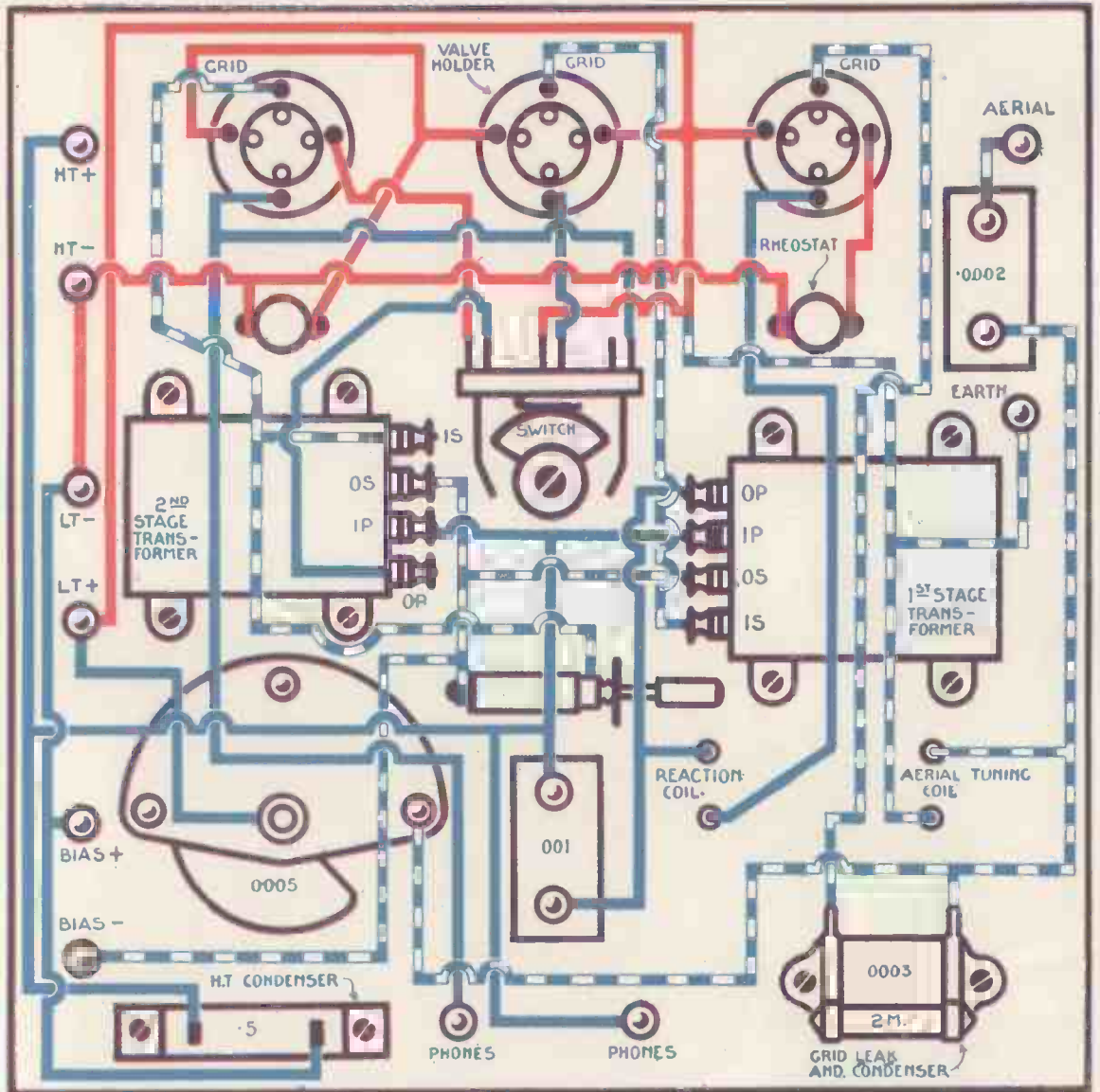

A LOUD-SPEAKER THREE-VALVER FOR THE FAMILY

TWO WIRING DIAGRAMS

Key to Wiring Diagram : Red Wiring, filament-lighting circuit ; Blue-and-white, aerial circuit ; Blue Wiring, other circuits.

For Full Constructional Particulars see "The Wireless Magazine" for May, 1925.

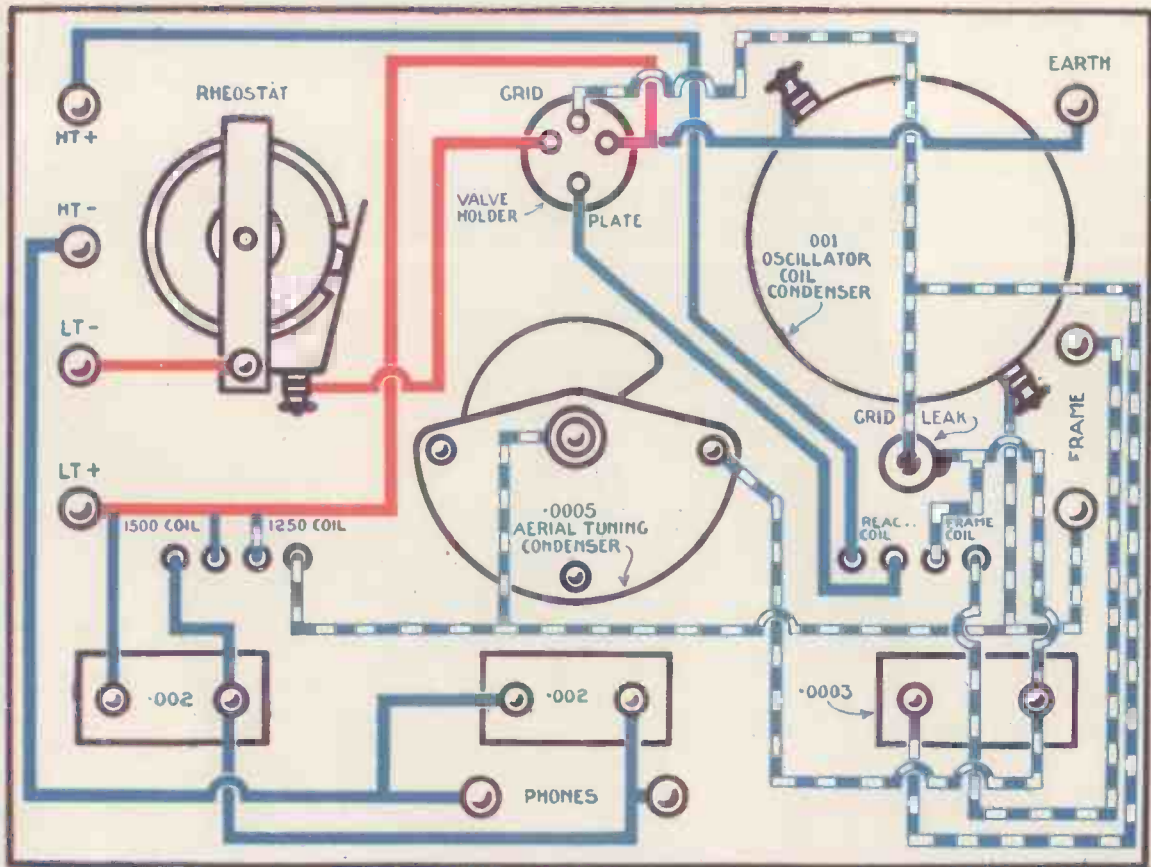

ARMSTRONG ONE-VALVE SET ("All England on a Frame Aerial with One Valve")