

DECEMBER 1963

TAPE

RECORDING MAGAZINE

2½



IN THIS ISSUE

- How we made the 'Tape of the Year'
- Drama productions on tape
- News of new products
- Microphones: their types and uses
- Test Bench report on microphones
- Short story
- Reviews of tape records
- Equipment tested

Spotlight on versatility...

MODEL STB1

A mono/stereo record/replay unit comprising a 4 speed tape deck twin recording and twin replay pre-amplifiers suitable for use with external Hi-Fidelity amplifiers.

| | | | |
|----------|--|-----------|--|
| 1 | Record and monitor - upper track | 8 | Transfer of upper track recording to lower track |
| 2 | Record and monitor - lower track | 9 | Transfer of lower track recording to upper track |
| 3 | Record stereo with monitoring | 10 | Transfer of upper track to lower track, adding a synchronised signal |
| 4 | Record on lower track with monitoring whilst playing back upper track | 11 | Transfer of lower track to upper track, adding a synchronised signal |
| 5 | Record on lower track <i>without</i> monitoring | 12 | Replay only upper track |
| 6 | Record on upper track with monitoring whilst playing back lower track | 13 | Replay only lower track |
| 7 | Record on upper track <i>without</i> monitoring whilst replaying lower track | 14 | Stereo playback |

The above table of functions gives some idea of the versatility of this brilliant new design from Brenell. The recorder is built as one unit and can be removed bodily from the carrying case for transfer to a Hi-Fi Console.

For details of this and other models, write to sole manufacturers:

Brenell

BRENELL ENGINEERING CO. LTD

1a DOUGHTY STREET, LONDON, W.C.1

Telephone: HOLborn 7356/8



THE RECORDER CO.

for best machines on advantageous terms

| | Deposit | 12 Monthly | Cash |
|---------------------------------|---------|------------|-------|
| | £ s. d. | Payments | Price |
| | | £ s. d. | Gns. |
| 4-TRACK STEREO/MONAUURAL | | | |
| Sony TC 500 ... | 11 6 0 | 8 6 8 | 106 |
| Ferrograph 424 ... | 11 12 0 | 8 13 2 | 110 |
| Grundig TK46 ... | 10 12 0 | 7 15 7 | 99 |
| Telefunken 97 ... | 10 0 0 | 7 9 7 | 95 |
| Sony 464 CS ... | 10 0 0 | 7 7 10 | 94 |
| Siemens Mod. 12 ... | 9 16 0 | 7 9 5 | 93 |
| Philips EL3534 ... | 9 16 0 | 7 4 8 | 92 |

| | Deposit | 12 Monthly | Cash |
|---------------------------------|---------|------------|-------|
| | £ s. d. | Payments | Price |
| | | £ s. d. | Gns. |
| 2-TRACK STEREO/MONAUURAL | | | |
| Brenell STB 1 ... | 12 0 0 | 9 0 0 | £120 |
| Ferrograph 422 ... | 11 12 0 | 8 13 2 | 110 |
| Telefunken 98 ... | 10 0 0 | 7 9 7 | 95 |

| | Deposit | 12 Monthly | Cash |
|-------------------------|---------|------------|-------|
| | £ s. d. | Payments | Price |
| | | £ s. d. | Gns. |
| MAINS TWIN-TRACK | | | |
| Brenell 5 Type "M" ... | 9 5 0 | 6 18 7 | 88 |
| Ferrograph 5A/N ... | 8 19 0 | 6 13 10 | 85 |
| Telefunken 85 ... | 8 15 0 | 6 10 8 | 83 |
| Grundig TK41 ... | 8 0 0 | 5 17 11 | 75 |
| Brenell 5/2 (Meter) ... | 7 15 6 | 5 16 7 | 74 |
| Brenell 5/2 ... | 7 5 0 | 5 8 8 | 69 |
| Reps R10 ... | 6 4 0 | 4 12 11 | 59 |
| Telefunken 95 ... | 6 4 0 | 4 12 11 | 59 |
| Truvox 92 ... | 7 5 0 | 5 8 8 | 69 |
| Grundig TK18 ... | 4 2 0 | 3 1 5 | 39 |
| Truvox R62 ... | 4 2 0 | 3 1 5 | 39 |
| Grundig TK14 ... | 3 13 6 | 2 15 2 | 35 |
| Wyndson Trident ... | 3 10 0 | 2 11 11 | 33 |
| Elizabethan LZ30 ... | 3 7 3 | 2 10 5 | 32 |
| Ferguson 3200 ... | 2 16 6 | 2 0 10 | 26 |

| | Deposit | 12 Monthly | Cash |
|----------------------------|---------|------------|-------|
| | £ s. d. | Payments | Price |
| | | £ s. d. | Gns. |
| 4-TRACK MONAUURAL | | | |
| Grundig TK40 ... | 8 0 0 | 5 17 11 | 75 |
| Truvox R92 ... | 7 5 0 | 5 8 8 | 69 |
| Reps R10 ... | 7 5 0 | 5 8 8 | 69 |
| Fidelity Major de Luxe ... | 3 13 6 | 2 15 2 | 35 |
| Philips EL3549 ... | 6 12 0 | 4 17 6 | 62 |
| Grundig TK23 ... | 4 15 0 | 3 10 10 | 45 |
| Philips EL3541/H ... | 4 12 0 | 3 5 10 | 42 |
| Truvox R64 ... | 4 2 0 | 3 1 5 | 39 |
| Elizabethan LZ29 ... | 4 0 0 | 2 19 10 | 38 |
| Philips EL3541 ... | 3 15 8 | 2 16 9 | 36 |
| Ferguson 3202 ... | 3 10 0 | 2 11 11 | 33 |
| Philips "Star Maker" ... | 2 16 9 | 2 2 7 | 27 |

| | Deposit | 12 Monthly | Cash |
|----------------------------|---------|------------|-------|
| | £ s. d. | Payments | Price |
| | | £ s. d. | Gns. |
| BATTERY | | | |
| Uher 4000S ... | 9 16 0 | 7 6 5 | 93 |
| Ficord 202 ... | 7 0 0 | 5 3 10 | 66 |
| Butoba MT5 ... | 7 0 0 | 5 3 10 | 66 |
| Stuzzi Magnette ... | 6 4 0 | 4 12 11 | 59 |
| Optacord 414Bat./Mains ... | 4 19 0 | 3 14 0 | 47 |
| Grundig TK6 ... | 6 17 0 | 5 2 4 | 65 |
| Philips EL3586 ... | 2 12 6 | 1 19 5 | 25 |

| | Deposit | 12 Monthly | Cash |
|--------------------------------|---------|------------|-------|
| | £ s. d. | Payments | Price |
| | | £ s. d. | Gns. |
| TRUVOX HI-FI TAPE UNITS | | | |
| TWIN-TRACK | | | |
| PD.82 Standard ... | 4 4 0 | 3 3 0 | 42 |
| PD.87 Stereo ... | 6 6 0 | 4 14 6 | 63 |
| FOUR-TRACK | | | |
| PD.84 Standard ... | 4 12 0 | 3 9 0 | 46 |
| PD.86 Stereo ... | 6 6 0 | 4 14 6 | 63 |

H.P. also over 18 and 24 months

Open Saturday 6 p.m.—Friday 6-30 p.m.

If unable to call, write for free brochure, or send deposit now for quick delivery

INTEREST FREE TERMS

FREE DELIVERY
PART EXCHANGE

THE RECORDER CO.

**SONY
TC-500**

Price
106 gns.

Deposit £11 6 0
12 Monthly Payments £8 6 8



Complete 4-track Stereophonic and Monophonic Tape Recording System ● 2 full-range, balanced satellite speaker systems ● Sound on sound recording ● Capable of operation in either vertical or horizontal positions ● Separate Mic/Aux level controls for mix recording ● 2 professionally calibrated VU meters ● Complete with 2 SONY F-87 cardioid dynamic microphones.

We will be pleased to Demonstrate this fine Model or send full details.

(Dept. T) 188, WEST END LANE,
WEST HAMPSTEAD, LONDON, N.W.6

Telephone: SW1 4977



TRU-CORD PORTABLE ALL-TRANSISTOR TAPE RECORDERS

Type 203 in a modern vacuum formed plastic carrying case.
Price 34 gns. complete.

Type R119K in a fashionable leatherette-covered wooden case.
Price 33 gns. complete.

1. Excellent reproduction, especially through an external speaker.
 2. No pressure pad on record head, "Contour method used."
 3. Separate erase and record heads by "Bogen" combined with a push pull osc. giving an excellent frequency response and sig/noise ratio.
 4. Special orders for facilities not fitted as standard, can be quoted for and carried out, amongst these facilities, are:— mixing, straight through amplifier, superimposing etc.
 5. SPARES AND SERVICE GUARANTEED.
 6. Wide range of accessories.
- Both machines are supplied complete with 600 ft. tape, empty spool, radio lead, battery, instruction book, circuit diagram and dual mike of 50 K or 200 ohms for use with line transformer.

TECHNICAL DATA:

Tape speed $3\frac{1}{2}$ i.p.s. · International double track · Frequency range 60—7,500 c/s ± 3 dB · Wow and flutter < 0.5% · Signal to noise > 50 dB · Rotary switch for START, STOP, FAST REWIND, OFF · 3 push buttons for RECORDING, PLAY-BACK, QUICK STOP · Tone control, Volume control · Pre-set recording level and monitoring · Recording control by magic line · Connections for dynamic microphone, radio, phone, earphone, external loudspeaker · Recording time 2 x 1 hour · Spool diameter max. $4\frac{1}{2}$ " · **Power supply:** Type 203 = 4 dry mono-cell batteries (4 x 1.5V) or 6V accumulator which can be recharged by means of the AC adapter or car battery (6V or 12V), or AC power adapter · Type R119K = 4 dry mono-cell batteries (4 x 1.5V) or car battery (6V and 12V), or AC power adapter · **Weight:** both types approx. 5 lbs. without batteries · **Measurements:** Type 203 = $10\frac{1}{2}$ " x 4" x $10\frac{1}{2}$ "

Enquiries to: C. BRADDOCK LTD., 266 WATERLOO ROAD,
BLACKPOOL, LANCs. Trade Enquiries Welcome





The outstanding
NEW RESLO
STUDIO
MICROPHONE
type SR1

The new Reslo "Studio" professional ribbon microphone has been specially developed for studio use by broadcasting authorities and professional recording companies throughout the world and is manufactured to the highest possible standards.

The overall frequency response which covers a range of 30 c/s-20,000 c/s is outstandingly smooth and straight giving a very clean and natural quality of reproduction.

The Reslo SRI is ideal for general studio musical use, due to excellent transient response and freedom from non-linear distortion. It is also ideal for orchestral recording.

Features of the design are the very low hum pick-up and the ability to alter the response characteristic for high quality speech announcing. Each microphone which is individually checked to within 2 dB of the publicised response curve, is supplied complete in a padded instrument case together with a set of mounting adaptors and 6yds. of screened cable.

Send for literature and price list of the complete range of Reslo microphones and loudspeakers.



GREAT NEW SONY SOUND!



SONY TC. 500

TO THE SERIOUS AMATEUR COME THE LATEST, THE FINEST TECHNICAL ADVANCEMENTS IN STEREOHONIC TAPE RECORDING AND PLAYBACK. THE SOUND IS SONY, THE VERSATILITY IS SONY, THE QUALITY IS SONY. THIS IS FOR THE CONNOISSEUR—THE **SONY TC. 500**

106 GNS with 2 Sony F87 Cardoid Dynamic microphones and all accessories.

SONY[®]
RESEARCH MAKES THE DIFFERENCE

Detailed specification of this tremendous Sony tape recorder freely available from the Sole U.K. distributors:



EXTRACTS FROM SPECIFICATION:

Full stereo facilities with independent recording and playback amplifiers, providing professional mixing facilities. Manual cueing, digital tape counter, instant stop, automatic tape lifter. Instantaneous selection of $7\frac{1}{2}/3\frac{3}{4}$ ips. Response—30-18000 cps at $7\frac{1}{2}$ ips. Harmonic distortion—less than 2% at 3 db below rated output. Detachable speakers for stereo separation.

TELLUX LIMITED
High Fidelity Division
GALLOWS CORNER, ROMFORD, ESSEX



Can't blame a man for trying. Who doesn't want more Philips Tape for his tape recorder? Wonderfully sensitive, long-lasting, packed in coloured-coded boxes for easy identification, Philips Tape makes every recorder sound better than ever. It's a great gift! What's more, the 3", 5", 5½" and 7" reels are each ready-packed in colourful Christmas wrappers. Just add your greeting and send the tape on its way to a warm welcome. Give Philips Tape to everyone you know with a tape recorder: buy it now and reduce your Christmas shopping problem.

** Note to Tape Recorder Owners*

If you don't want to leave recorded messages about, just put this page in a conspicuous place and wait for that happy December 25th!



PHILIPS TAPE
makes a wonderful gift
- it's ready packed in colourful Christmas wrappers

Another wonderful product from PHILIPS – the friend of the family

PHILIPS ELECTRICAL LIMITED · ELECTRO ACOUSTICS DIVISION · CENTURY HOUSE · SHAFTESBURY AVENUE · LONDON · W.C.2

FREE TRAVEL!!



AKAI M6

FREE TRAIN FARES. FREE BUS FARES. FREE PETROL, ETC.

Why not come to London, see the sights, do your Christmas shopping, visit relations, and if you purchase a tape recorder, value over £30 from us, have all your individual travelling expenses paid in respect of the distance travelled both ways at the extremely generous rate of 3d. per mile!! (max. £5.) This is no gimmick offer but a genuine endeavour to ensure that before you purchase a tape recorder you have the opportunity of seeing and hearing the largest and finest selection of tape recorders on display in the U.K., as well as the SPECIAL OFFERS we are able to make to personal callers only, two of which are detailed below. No matter how near or far you live, if it be Bonny Scotland, Merry Midlands or anywhere else in the British Isles why not take us up on this offer and see London and us at our expense. The Voucher below is valid for three months.

SPECIAL OFFERS

AKAI-M6 This superb 2/4 track Stereo/Mono professional type recorder is renowned the world over as being the finest in its class available. Freq. Response 30-20,000 c.p.s. Fantastic performance. Listed and sold everywhere at £136 10s. Few

89GNS
(Less Microphones)

SONY 464 CS The latest Sony 4-track Stereo/Mono model. Full Stereo record/replay, sound on sound facilities. Two inbuilt speakers and amplifiers, two magic eyes, etc. Listed and sold everywhere at £99 14s. Limited number for personal callers only.

69GNS
(Less Microphones)

| | | |
|----------------------------|--|--------------|
| FREE TRAVEL VOUCHER | THIS VOUCHER MUST BE HANDED IN WHEN CLAIMING EXPENSES | |
| NAME | OFFICE SALES REF. | |
| ADDRESS..... | DISTANCE(miles) | AMOUNT |
| | SIGNED | |

HOW TO GET TO US

CITY SHOWROOMS.

The most accessible Tape Recorder showrooms in Gt. Britain. Situated immediately opposite well known and easy to get to Liverpool Street main line station (see diagram.) On the Central, Metropolitan and Circle tube lines. Over 28 'bus routes stop outside or near our doors. NOTE: City shop open Mon.-Fri. 9 a.m.-6 p.m. Closed Saturdays. Open Sunday 9-30 a.m.-2 p.m.

STRATFORD. Ideally situated for East London, Essex and Hertfordshire. Immediately adjacent to Maryland Station on the Liverpool Street line and easily reached by road, rail or 'bus. Closed half-day Thurs. Open Mon.-Sat. 9 a.m. to 6 p.m.

EAST HAM. Within easy reach of Dagenham, Romford, Barking and close to Woolwich Ferry or Blackwall Tunnel for easy access for all of Kent. Situated immediately opposite East Ham Station. Closed half-day Thurs. Open Mon.-Sat. 9 a.m. to 6 p.m.

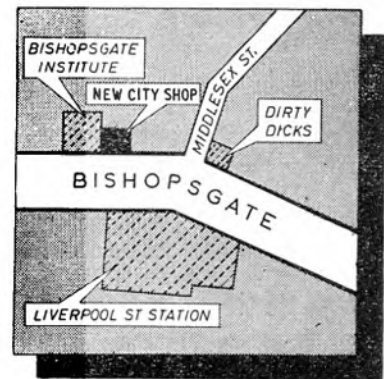

CITY & ESSEX

T A P E

RECORDER CENTRES

228 BISHOPSGATE, LONDON, E.C.2
2 MARYLAND STATION, STRATFORD, LONDON, E.15
205 HIGH STREET NORTH, EAST HAM, LONDON, E.6

BIS 2609
MAR 5879
GRA 6543



This beats everything !

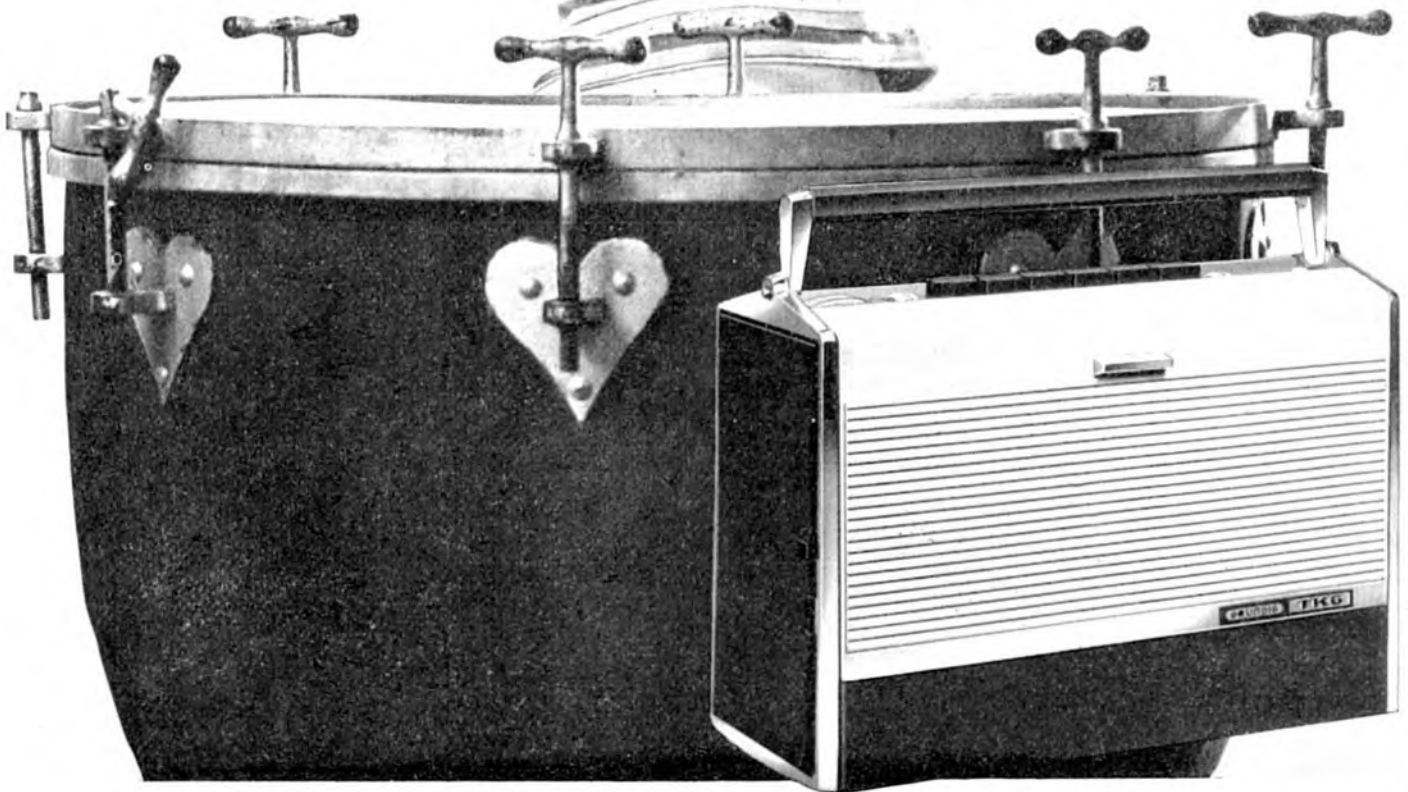

THE SUPERLATIVE **TK6**

A new-era Grundig. No machine like it anywhere. Mains-operated transistorised portable tape recorder. Own built-in battery or car battery operated. Next-century design. Concert hall quality. Two speeds. Four hours play-back. Ask your Grundig Dealer for a demonstration of this brilliant new model. 65 gns. including microphone and triple play tape.

SPECIFICATION

- Speeds 3 $\frac{3}{4}$ and 1 $\frac{7}{8}$ i.p.s. • Frequency Response up to 13,000 c/s • 13 Transistors and Diodes
- Revolutionary HF controlled and transistor stabilised motor • Recording Level Meter—Battery indicator
- Tape Canister • Fast forward, rewind, stop, start, temporary stop and recording by press buttons
- Highly sensitive dynamic moving coil microphone • 1,200 feet of triple play tape supplied
- Auto adaptor available • Extra large loudspeaker • Dimensions 12 $\frac{3}{4}$ " x 5 $\frac{1}{4}$ " x 9 $\frac{1}{2}$ " • Separate bass and treble controls.



GRUNDIG (Great Britain) LIMITED
 Newlands Park, Sydenham, London S.E.26 SYD 2211
Please send me the exciting TK6 leaflet

NAME

ADDRESS

.....

TRM/10

equal to top
studio quality

MICROKIT CONDENSER MICROPHONE



Unusually high
output (150mV)
Can be fed into
any amplifier
or tape recorder
Output impedance
600 ohms cathode
follower
ONE YEAR FREE
replacement
service guarantee

Delivery from stock
In kit form for assembly 20 gns
'Assembled and tested' 25 gns



World distribution
CHATEAU PRODUCTIONS LTD
25 DENMARK ST., LONDON, W.C.2
telephone COV 3026

You're guaranteed a better deal when you .

PART EXCHANGE

YOUR TAPE RECORDER

with **R·E·W**

Just a few of the machines in stock waiting your inspection—NOW!

| | |
|----------------------------|----------|
| FERROGRAPH 5AN... | 85 gns. |
| GRUNDIG TK46 ... | 99 gns. |
| BRENELL Mk. V Series 2 ... | 69 gns. |
| BRENELL Mk. V "M" ... | 88 gns. |
| REVOX Stereo ... | 110 gns. |
| REPS. R.10 2-Track ... | 59 gns. |
| SIMON S.P. 5 ... | 93 gns. |
| TANDBERG Stereo 6 ... | 110 gns. |
| TANDBERG Stereo 7 ... | 93 gns. |
| AKAI Stereo ... | 130 gns. |
| VORTEXION WVA ... | £93.13.0 |
| FERROGRAPH 522-524 ... | 110 gns. |
| SONY Stereo 521 ... | 124 gns. |
| AMPEX Stereo 1273 ... | 290 gns. |

A friendly welcome awaits you at our new, recently extended showrooms where you will find a large array of fine equipment at all price levels. With a comprehensive service geared to your personal satisfaction we can provide generous part exchange facilities, immediate delivery and—if you cannot visit us—a fast and friendly Mail Order Service. Remember, your guarantee of a better deal is in the name and reputation of R.E.W. (Earlsfield) Ltd.

MACHINE OF THE MONTH
PAMPHONIC REFLECTOGRAPH
Type A 105 gns.

A magnificent new machine with a re-designed amplifier giving improved frequency response at all speeds on both record and playback.
2 Speeds: 3 $\frac{1}{2}$ and 7 $\frac{1}{2}$ i.p.s.
Separate Play-back Amplifier. V.U.M. Meter. Semi-prof.

No Interest Terms £11. 5s. deposit, 12 monthly payments of £8. 5s. Also available on H.P. Terms, 18-24 months to pay.

CASH FOR YOUR TAPE RECORDER
or Hi-Fi. Highest cash offers for good equipment . . . get in touch today!

R·E·W

'PLUS FIVE' SERVICE!

- Generous Part Exchange Allowances
- No Interest Terms—Lowest Deposits
- Off-the-shelf delivery from the biggest range under one roof
- Optional Personal Insurance
- FREE Servicing—FREE Delivery

REMEMBER . . . you're guaranteed a better, faster deal

AT R·E·W (EARLSFIELD) LTD. *Personal callers always welcome*
(THE TAPE RECORDER & HI-FI CENTRE)

Write or 'phone Mail Order Dept. "TRM" 266-8 UPPER TOOTING RD., LONDON, S.W.17.
Telephone: BALham 9174-5



for the professional

IRISH

—the recording tape that gives the finest fidelity possible. How? Through the unique Ferrosheen process. Exclusive to Irish tape, this process produces a mirror-smooth surface to a magnetic tape with distinct technical advantages to satisfy even the most meticulous professional. The Ferrosheen process makes for exceptional high frequency response (due to precise perfection of tape/head contact) . . . head wear is minimal . . . external lubrication unnecessary—less oxide abrasion, no lubricant build-up on recorder head . . . minimum drop out . . . maximum reduction of background noise. Your Irish Tape stockist, and other details including technical data, from A. C. Farnell Ltd. Hereford House, Vicar Lane, Leeds 2 Tel: 35111.

'IRISH', 'FERROSHEEN' and 'Signature Binding' are registered trade marks of Orradio Industries Inc., Opelika, Alabama.



LOEWE OPTA

Hi-Fi Tape Recorders

FOR PERFECTION IN SOUND

THE LATEST ADDITION TO THE OPTACORD RANGE

OPTACORD 414

With the first-ever high frequency motor ensuring long life and constant speeds. Unsurpassed for a portable tape recorder. For use on mains, batteries and car batteries.

47 Gns.

Ask our Representative to call, or see the complete range at our Showrooms

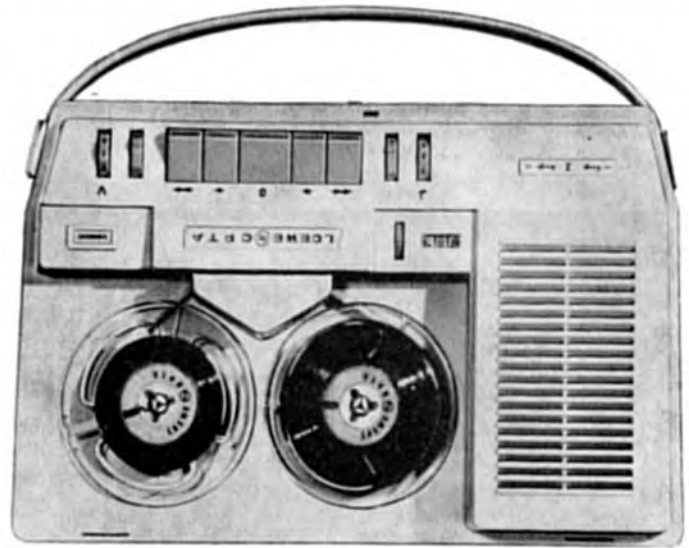

HIGHGATE ACOUSTICS

71/73, GT. PORTLAND STREET, LONDON, W.1 Telephone: MUSEUM 2901/6

TAPE RECORDING YEARBOOK 1964

The latest edition of the ever-popular TAPE RECORDING YEARBOOK is now on the bookstalls, or available direct from the publishers using the form below.

CONTENTS INCLUDE

- ★The only available up-to-date catalogue of every tape recorder on the market with full specifications, price, etc. plus photographs.
 - ★A review of tape developments during the past year
 - ★A chapter on the basic facts concerning tape recording
 - ★Technical, creative and organised activity
- ★Glossary of technical terms, "at-a-glance" tabulated catalogues of microphones, radio tuners, mixer units and associated equipment
 - ★Manufacturers, dealers and club secretary addresses

PRICE 7s. 6d.

POST NOW to: TAPE Recording "Magazine,"
7, Tudor Street, London, E.C.4.

Please send me.....copy(ies) of Tape Recording Yearbook 1964 at 7s. 6d. a copy(including postage) (\$1.25), I enclose remittance herewith.

Name Address.....



What gives this Christmas?

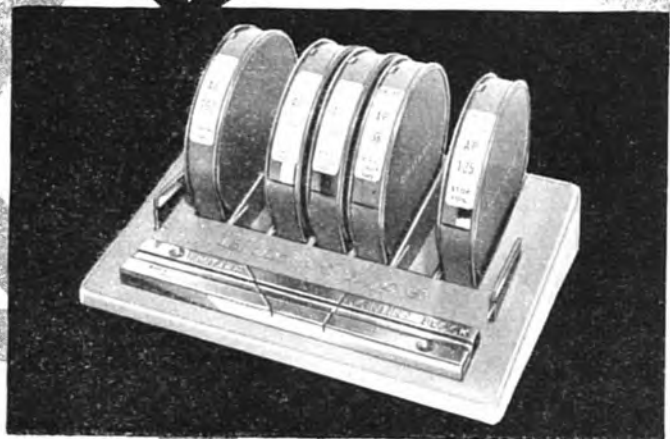
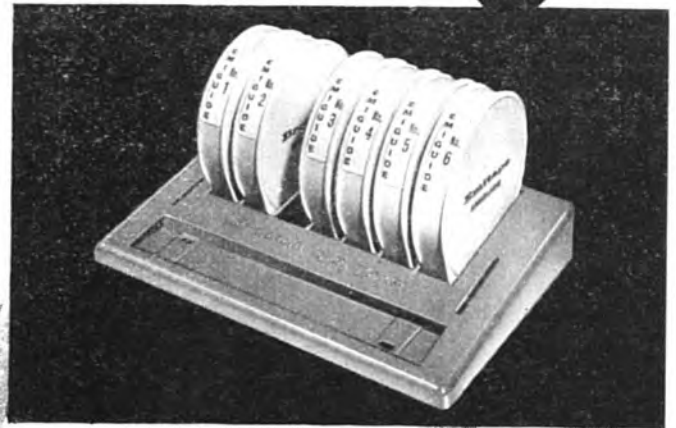

Emitape make merry with four seasonal suggestions

Give an Emi-present this Christmas. They're gift-wrapped, ready to give. Stacks to choose from—how about one of these? **Christmas Emitape** It's got a surprise up its sleeve—instructions for six tape and recorder games to get the party going. Just the right note for Christmas.

Emiguides All the tricks of the tape taught on a tape—from outdoor recording to sound effects. 8/6 each or 51/- the set.

Going by the book "The Emitape Guide to Better Recording" by John Borwick is really good practical value—56 pages for only 2/6.

Emitape Accessory Kit Complete set to deal with all the mechanics of tape editing and the like—37/6. Or separately. Either way it's a gift!

Emitape E.M.I. TAPE LTD., HAYES, MIDDLESEX.

TAPE

RECORDING
MAGAZINE

Vol. 7 No. 12 December 1963

IN THIS ISSUE

- Tape trends and tape talk** 14
By the Editor
- How we made the "Tape of the Year"** 15
Michael Avel
- Microphones; their types and uses** 18
James A. Moir
- Testing the current microphones** 20
H. Burrell-Hadden
- Dramatape Miscellany** 23
By Perspective
- Tape recorders and hire purchase** 25
John Gaselee
- Tape Talk** 29
Alan Edward Beeby
- A damsel in distress** 30
Short story
- Test Bench** 33
Cossor CR 1603
- Service Bureau** 34
Harry Mack
- Tape records reviewed** 36
Edward Greenfield
- Popular music on tape** 36
Don Wedge
- New Products** 38
- News from the clubs** 41
- Tape Exchanges** 41
- Advertisement Inquiry Service** 49

COVER PHOTOGRAPH: Denis Comper (left) marks the opening of his new Putney studios with what appears to be a "Tape v. Disc" discussion with Redvers Kyle of Associated Rediffusion. Photo by "Baker Visuals"

"TAPE Recording Magazine" is published on the third Wednesday in the month, by Print and Press Services Ltd., from 7, Tudor Street, London, E.C.4.

"TAPE Recording Magazine" is available by a postal subscription of 25s. per annum (U.S.A. \$3.75) including postage, or it can be obtained at newsagents, bookstalls and music dealers. In the event of difficulty, write to the Publishers at 7, Tudor Street, London, E.C.4.

Back numbers, if still in print, are available at 2s. 6d. per copy for issues up to November 1959, and 2s. per copy for later numbers.

Address all communications

7 TUDOR STREET, LONDON, E.C.4 FLE 1455

EDITORIAL

Editor,
R. DOUGLAS BROWN

Assistant Editor, FRED CHANDLER

ADVERTISING

Advertisement Manager,
MISS PAMELA DURHAM



The
classic
sound



of
The Incomparable
Ferrograph

Send this coupon for illustrated leaflet and prices

NAME

ADDRESS

THE FERROGRAPH CO. LTD.
84 BLACKFRIARS ROAD, LONDON S.E.1 Tel: WATERloo 1981

TR3

Tape trends and tape talk

By the Editor

CONTACT WITH REPRESENTATIVES of the tape recording industry on the Continent has left me in an optimistic mood about the future of the hobby. German manufacturers of recording equipment estimate that they will sell four million machines in the current year—half of them at home, the other half exported.

But what is more astonishing is that they have set a target for the end of 1965 which, if achieved, will mean that one home in every four in West Germany will have its tape recorder.

From what I have seen—and I have visited a number of European manufacturers—the target *will* be achieved.

A vast new tape recording public is being created and within a few years we should be on an equal basis with amateur photography.

Indeed, we may be swallowing up amateur photography—if the promise of the first domestic video-recorders is fulfilled.

It's an exciting and challenging prospect.

International Contest

THE TWELFTH INTERNATIONAL Recording Contest (CIMES), judged this year at Liege, was an enjoyable get-together of all those who are concerned with amateur recording. As well as the representatives of Continental manufacturers, there was the usual gathering of personalities from various broadcasting concerns and, of course, the leaders of the club movement—Chasseurs de Son, as they call themselves in Europe.

Eight European nations were directly represented at the meeting of the International Federation, and two international clubs, one of which sent its representative from the U.S.A.

Applications to join the Federation have been received from clubs in Australia and Japan, so that it looks like taking on a more genuinely international character in the year ahead.

Next year's meeting of the International looks like being a memorable one, for it will take place in Lausanne during a great Swiss Fair which is being staged there.

British successes

AS IS ANNOUNCED ON ANOTHER page, British tapes took two prizes at the CIMES this year. "Breakdown," which was "Tape of the Year" in the British Contest, was voted into top place in the Compositions section of the International event. Mike Avel and Mike Ray, of the Triumph Motor Cycle Owners' Club, were in Liege to receive congratulations. As their prize they collected a Butoba recorder.

"Meditation on the Crucifixion," which won the Schools Section of the British Contest, was placed third in the International event and was awarded a bronze trophy donated by the Swiss Association of Sound Hunters.

I hope I shall not be misunderstood if I state, without comment, that there was a substantial minority of judges who thought "Breakdown" should have been awarded the Grand Prix Mono.

In fact, this award went to an 18-year-old Lausanne student, Bernard Pichon. He had recorded a number of Swiss radio news and weather bulletins, had selected from them the phrases he required and had reassembled these to produce an amusing mock broadcast. This extract gives the flavour: "In Peru a volcano had erupted. The King and Queen of the Belgians were rescued at the last moment by firemen's ladders. . . ."

Stereo tapes are now judged separately in the International event and the Grand Prix Stereo also went to Switzerland this year—to a 36-year-old music professor who recorded a performance by a choir of 210 in the church at Winterthur. He conducted the performance himself.

A magic tape

ONE OF THE MOST remarkable tapes in the Contest, in my view, was submitted by a French schoolmaster, Paul le Bohec, of Tregastel—last year his entry won the Schools' section.

This time he told the story of an eight-year-old boy who stuttered, and of the cure. It is all on the tape: recordings of the original impediment, of interviews with the parents, of examination and analysis of the psychological problem involved.

And there is the moment when, the cure almost complete, comes a symbolic cutting up with scissors of the early tapes containing the stutter. There was something very like magic about this tape.

I hope, in a later issue, to print in full the script.

Script translations

ON THE SUBJECT OF SCRIPTS, I must tell those who want to see their tapes successful at CIMES that first-class translations into both French and German are essential. Under the rules of CIMES, it is the responsibility of entrants to provide scripts in the three languages (English, of course, is the third).

This year and last we were able to make special arrangements to secure translations. It is unlikely that we shall be able to do so next year. What we will try to do, however, is to compile a panel of tape enthusiasts who are also linguists and who would be ready to help in this way for a nominal fee. Will volunteers please write?

In addition to verbatim scripts, competitors would be well advised to provide a brief synopsis—not more than 150 words—of the task they are setting themselves on the tapes they submit.

It will soon be London's turn again to stage the CIMES Contest. Outstanding British tapes in next year's Contest would be a suitable preliminary exercise.

LAUGH WITH JEEVES

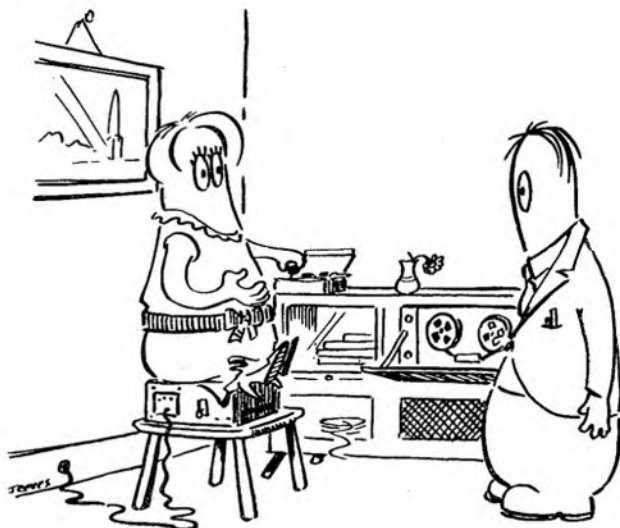

"I've been sitting on your bulk eraser all afternoon, and I haven't lost an ounce."

How we made the 'Tape of the Year'

By MIKE AVEL

PROFESSOR COBB, working at the Institute of Mental Research, Nutlake, had a theory that like the human brain, mechanical transport relies upon electrical control and is therefore equally liable under conditions of severe stress to suffer from a nervous breakdown.

These were the opening remarks of our ten-minute entry for the British Amateur Tape Recording Contest.

The idea develops. Taxis run amok; the talking lift gets its messages muddled and feels sick with vertigo; the underground train suffers from claustrophobia; a No. 36 bus makes a dash to paddle in the Kensington Round Pond; and helicopters start off in reverse and screw themselves into the ground. Eventually Professor Cobb is contacted. He decides to treat the taxis first, and herds them into the underground garage at Hyde Park to effect a recovery by hypnotising them. Unfortunately the Professor puts himself and his colleagues to sleep and we leave the taxis getting more and more out of control.

Just to get the script into this form took two valuable months, meeting weekly and sometimes twice weekly. We worked five weeks on an earlier idea, were not satisfied with the final script, and reluctantly threw it in the waste paper basket and started from scratch again.

In preparing the script not a thought was given to the difficult problems we were setting ourselves in producing the many unique sounds and effects.

I say we, because we worked as a committee of four, Mike Ray, Walter Buchanan, Eric Mayer and myself, planned the method. Many of the recordings were made on location, using a home-made portable recorder. Everyone we found was most co-operative. Let me illustrate:

One of the team was sent out to get a bus engine, for the paddling in the pond sequence. Mid-morning saw him waiting at a bus-stop in the Lower Richmond Road. When a bus eventually arrived, the driver was very pleased to drive along in first gear for our recording, and even suggested that he should rev. up a bit, in jerks. This he did, not giving a thought for his passengers who were being thrown about inside. Finally the recording was made and naturally the driver wanted to know "what all this was in aid of." When he learned that the recording was wanted for an entry into a

tape recording contest and was in fact of a bus paddling in a pond, he apparently gave a nervous laugh and quickly departed. Unfortunately when the rest of the committee heard the recording, they rejected it and felt it would have been much better if it had been made by a ribbon microphone instead of the cheap moving coil one originally employed. The next attempt to record a bus was made one evening, at a different bus-stop. As our member, armed now with a ribbon microphone, strode out to the approaching bus a head popped out and said "Blimey, not you again mate!" If this gentleman reads this account, we would like to express our thanks for his wonderful co-operation on both occasions.

As already explained, the script also called for a talking lift to be suffering from vertigo and talking to itself. The lift was to close its gates and go down to the bottom of its shaft where it was to meet an underground train suffering from claustrophobia.

To build up the sequence we made a list of the basic sound effects. These included lift gates closing, a lift descending, an underground train pumping; and another drawing out of the station. One member of our team went off with a battery portable recorder to get these sounds. He chose a station with a suitable lift and recorded its gates clanging shut and the sound of it going down while actually standing inside the lift. It was a "talking lift" but he only recorded its voice to guide us as to its sound, for the words had to be changed to our own.

Once on the platform he waited for a train to arrive and he had to let three or four go before he got one that was pumping. Running along the platform he held his dynamic type microphone close to the air pump to concentrate on this sound and avoid too much noise of people, tunnel echo, etc. After that he stood near the front of the train and recorded several trains starting up and fading away, paying close attention to get the level right and avoid overloading.

We met the following week and went

Readers are invited to describe their own experiences recording a particular effect. Two guineas will be paid for published articles, which should not exceed 500 words.

through his recordings to select the best edition of each of the required sounds. To create the voice of the lift one of us spoke into a microphone which was connected in a small home-made transistor amplifier to a loudspeaker in the cellar. This sound was picked up by a ribbon microphone and fed to our Ferrograph recorder. The volume of the transistor amplifier was adjusted to overload slightly to give the poor quality which we wanted and the amplifier was switched on and off for each sentence to produce the required "talking lift" effect. Eventually we had: "click, stand clear of the gates, click—pause, click, gland clear of the states, click—longer pause, click (fainter) I feel sick, click. . . ."

While this was being recorded the sound of the gates closing was held ready under pause control on a second tape recorder so that it could be released exactly when the lift said it would go down. The actor's voice and the lift recordings had already been adjusted for the correct balance of volume on our home-made mixer. Our member working the recorders listened on headphones and followed a copy of the script—no separate studio with glass window being available!

The sound of the train pumping was cut from the tape on the portable recorder and joined up to form a short closed loop. With this sort of editing it is necessary to listen to the rhythm of the pumping and to cut and joint the tape between pumps to preserve this rhythm. Several attempts had to be made with such a definite sound before the slightest trace of hiccup at the joint had been avoided. This loop was played on a home-made loop reproducing deck which, although simple and cheap, was adequate for such a sound effect. The mixer gain control serving this sound was advanced when the lift was nearing the end of its journey so that it seemed as if one was in the lift and approaching the platform at the foot of the shaft. The conversation between the lift and the train then took place.

The actor taking the part of the train did his piece live in front of the microphone while, because the other member was not available at that time, the voice of the lift was released from an edited and marked recording. This made it quite a tricky conversation to record and fourteen or more attempts were made before being satisfied with the result.

To get the timbre right, the train actor spoke while having his stomach pummelled by another member who worked in rhythm with the "pumping" loop which he heard on headphones. Quite twenty minutes elapsed before we could do this without being convulsed with laughter. The producer then shouted "cut" and the next sequence was set up.

In this, the sound of pumping from the loop was mixed with the train actor speaking and at just the correct moment the train departing sound was released from the other recorder and the pumping allowed to be drowned and faded out. Here again the mixer gain controls had to be set for the right balance of volumes and the main recorder was monitored for the correct overall level. The voice and sound of the train were slowly faded out together as the train departed, its actor saying "I've got to get out, I've got to get out, I've got to get out" in the rhythm of its wheels. This and the previous sequence were edited together to produce the whole sound picture of lift and train.

Thus in five evenings, working from 8 p.m. to 1 a.m., we had produced just 1 minute 25 seconds of our 10½-minute tape.

British successes in International Amateur Recording Contest 1963

BRITAIN TOOK ONLY ONE first prize in the 1963 CIMES at Liege. "Breakdown," the fantasy drama of London with its motor traffic out of the control of its citizens, was placed first in the Compositions section.

The Triumph Motor Cycle Owners' Club, who made the tape, were awarded a Butoba MT7 recorder.

A bronze award by the Swiss Sound Hunters' Association was won by H. J. Walding and the Stimpson Avenue School at Northampton for "Meditation on the Crucifixion." This tape was placed third in the Schools section.

Other British entries fared as follows: T. Kurkowski's "Ode to an Inca God" was placed fifth among six tapes in the Composition section.

Peter L. Bastin's "Worcester Jail" was placed fourth among nine tapes in the Documentary section.

Denis B. Affleck's "Double reverse" was placed third among five tapes in the Technical Experiment class.

Philip P. Towell's "Magnificat in F" was placed fourth among the seven stereo tapes in the Music section.

Judging was by a panel of representatives from Belgium, Denmark, France, Germany, Great Britain, Holland and Switzerland and from the Centre International Scolaire de Correspondance Sonore and the Union Mondiale des Voix Francaises.

The British jurors were Alan Stableford, Chairman of the Federation of British Tape Recording Clubs, and Douglas Brown, Editor of *TAPE Recording Magazine* and Compère of the B.B.C. programme "Sound."

The Challenge Shield awarded by *TAPE Recording Magazine* to the tape gaining the highest mark in the Contest goes to M. Bernard Pichon, of Switzerland. The Cup awarded by the Dutch Sound Hunters for the best national selection of tapes was won by Germany.



MEMBERS of the Committee of the Union Mondiale des Voix Francaises seen in a TV studio in Paris during their recent meeting there. Left to right: Mrs. Phyllis Copinger (GB), M. Jose Allays (Belgium), M. Emile Garin (USA) and M. Guy Serin (France). They were interviewed about their activities in a popular TV programme called "Paris-Club." Also seen in the photo; part of the contribution made to the programme by a French actress who sang between the interviews!

London tape club plays Santa for Dr. Barnado's

LAST Christmas I visited a famous London departmental store along with thousands of children. We were all after gifts: the children were arranging to have their stockings filled; and I wanted a reel of tape filled with seasonal material.

I first of all recorded the children making their requests, and followed this with an interview with Father Christmas himself. The tape had been made with children in mind, and so our bearded friend answered my questions in the way Santa himself would have done. He spoke about the preparations made before the seasonal rush for presents; of his activities in Toyland during the rest of the year; and closed with a message for children. The tape opened and closed with children from my local church singing carols.

A copy of the recording, made for one of our club's "Members Tape Time" sessions, was eventually sent to Dr. Barnado's. They were delighted to receive it, and we became good friends. Soon afterwards we received an appeal for a tape recorder for their family homes, and *TAPE* and other magazines kindly printed letters of appeal on their behalf. Unfortunately these brought no response so our club members decided to present the children with a recorder given to the club by our president Alan Stableford.

We went to the Head Office of Dr. Barnado's in London's East End where we met the General Secretary Mr. Peter Hunt. I recorded the presentation ceremony on a battery portable machine, and taped an interview with Mr. Hunt who told me a little about the history of the Homes started a hundred-odd years ago when the Doctor was studying to be a missionary. Today there are over a hundred homes in

England, Australia and Kenya; and these have passed through their hands some 163,000 children.

A few weeks after the presentation our club received a wonderful tape from the Home to which our recorder had gone, plus photographs showing the machine being put to good use by its young owners. Their ages ranged from three upwards; the very young contributed nursery rhymes and the older children recorded poems and songs. The tape ended with a "Thank You" from the House Mother, and a loud joint appreciation from all the children.

The outcome of my original "Member's Tape Time" tape is that our club has decided to adopt this small family of twenty children, visit them from time to time, and send some toys at Christmas.

RON TUCKER



A few of the children seen with their new recorder

MICROPHONES: THEIR TYPES AND USES

PART TWO

BY J. A. MOIR

THOUGH the cheap moving coil microphones may not be so good as an expensive piezo unit, it is generally true that the moving coil microphones have a more satisfactory performance than the piezo types.

All moving coil microphones are essentially similar in construction to a moving coil loudspeaker, a product with which the reader will generally be more familiar. In an emergency, a moving coil speaker may often be used as a microphone.

A section through one of the earlier M.C. types shown in Fig. 1 indicates the resemblance to a moving coil speaker. The actual diaphragm and moving coil assembly, were lighter than those used in a speaker and the suspension system was particularly soft, in order to secure a low low-frequency resonance. Though this type had a high output voltage, it was large and heavy and the polar diagram was unsatisfactory by current standards, being circular at low frequencies and very narrow at high frequencies. This and the rather well defined low-frequency resonance made speech rather boomy, particularly in a room with poor acoustic characteristics.

Standard Telephones and Cables have long marketed a range of moving coil microphones having a high reputation, so it is worth taking a look at some typical units.

The Type 4035 type is very similar in construction to a pressure unit type of loudspeaker, the diaphragm being a thin, aluminium spinning, supported by a very flexible corrugated metal surround. A light moving coil is attached to the periphery of the metal diaphragm, the coil moving in the field provided by a small permanent magnet and thus developing a signal voltage

across the coil terminals. Corrugated metal surrounds do not have the flexibility that is necessary to bring the resonance of the diaphragm mass and suspension stiffness sufficiently low in the frequency range. Without some form of compensation for the inevitable diaphragm resonance, the output voltage would fall away below the frequency of resonance. Correction is obtained by producing acoustic resonance between the volume of air enclosed behind the diaphragm and the mass of air contained in a small diameter tube that couples the rear and front faces of the diaphragm.

This device is in fact the forerunner of the ported loudspeaker cabinet, the idea being due to A. L. Thuras of Bell Telephone Laboratories who developed it for the original Western Electric moving coil microphone, the father of the present series of S.T. & C. units.

As Fig. 2 shows, the frequency response is extended and smooth and the amplitude distortion is low. The present 4035 and its predecessor the 4017, must be two of the most popular microphones in professional circles, though the cardioid types to be discussed later are displacing unidirectional microphones of all types.

S.T. & C. use an alternative method of indicating the variations in frequency response that occur when sounds approach the microphone from different directions. Fig. 2 shows the frequency response of 4035 microphone when the sound source is at various angles with respect to the microphone face. It will be seen that the output voltage in the low frequency range is substantially independent of the orientation of the microphone but that the output voltage at the high frequency end of the range (above 5,000 cps) falls away rapidly as the microphone is turned away from the sound source.

As explained in the last issue, this characteristic is typical of all simple microphones. It would appear at first sight, that the effect could be completely corrected by having the artists always face the front of the microphone, but in fact, this is only partly true.

The sound reflected from the room walls, approaches the microphone from all angles and this reverberant sound produces higher output at the low frequency end of the range than at the high frequency end. Thus the best sound quality is always secured when the artist is close to the microphone, for this reduces the relative amplitude of the reverberant sound. At the same time, the artist should not be too close or the puffs of air from his lips will produce undesirable noises. Six to twenty-four inches is a satisfactory spacing between microphone and artist, though this may be increased if the acoustic characteristics of the room are above average. Where an omni-directional characteristic is really required, a microphone can be mounted face upwards, as in the familiar S.T. & C. ball-and-biscuit version, the 4021.

It was noted in the first instalment on microphones that a cardioid type polar diagram was generally desirable for good sound quality, for this allows the microphone to ignore some of the room reverberation, just as the human hearing system can do. While there is no particular difficulty in achieving such a directional response at high frequencies, it requires considerable technical ingenuity to achieve the same result at frequencies below about 1,000 cps.

The basic microphone consisting of a small diaphragm mounted in any form of housing that prevents sound reaching the rear of the diaphragm, will respond equally

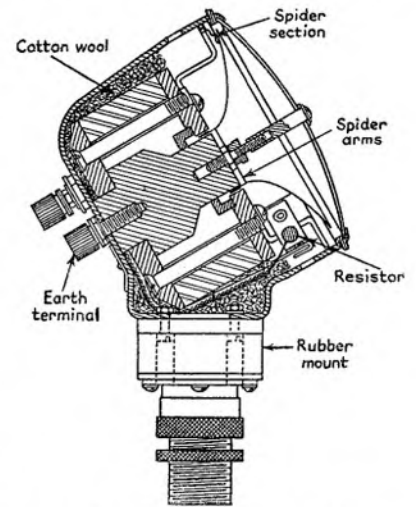

Fig. 1. Moving coil microphone.

to low frequency sounds arriving from any direction. Sounds arriving from the rear, merely bend round the housing (diffract is the technical term) and produce the same pressure on the diaphragm as they would have done if the diaphragm had faced the oncoming sound wave.

If the rear of the casing is opened up to permit the sound wave to have free access to both sides of the diaphragm, the microphone will develop the same output voltage from a sound source either in front or behind the unit. However, a sound source on either side of the microphone and in the same plane as the diaphragm, will now produce zero output voltage, for the sound wave will produce exactly the same pressure on both sides of the diaphragm and there will be no resultant movement and thus no signal voltage. The polar diagram so obtained, is known as a figure-of-eight and is illustrated by Fig. 3. It is the natural response of the ribbon type microphones to be discussed in the next instalment.

This sounds a delightfully simple way of obtaining a directional response, just take the microphone "works" out of the case

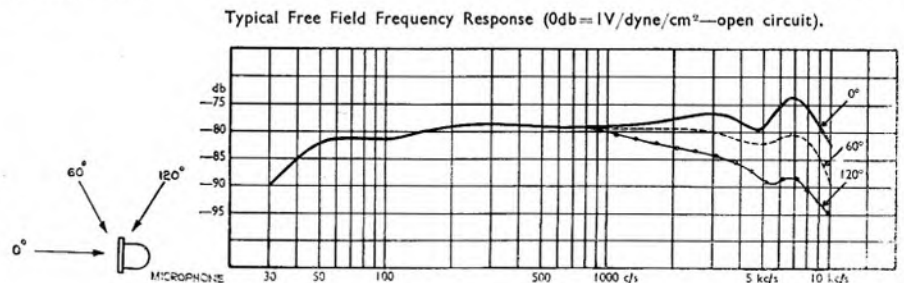

Fig. 2. Performance of an S.T. & C. type 4035 moving coil microphone.



H. Burrell Hadden discusses and tests eight of the current microphones

IT is perhaps not sufficiently realised that the choice of microphone can very materially affect the result obtained under any given recording conditions, irrespective of the type or quality of the recorder in use. I suppose that in most cases we tend to use the microphone supplied with our tape recorder, without even stopping to think whether a different type might give us better results. Of course a decision of this sort may well be influenced by considerations of available cash, but the serious recordist cannot really afford to be without a selection of several different types.

I have often wondered whether it would not be sensible to sell tape machines without a microphone, so forcing the purchaser to decide for himself the type of instrument best suited to his needs. I suppose this would be good for those of us who are experienced recordists, but anyone buying a recorder for the first time rightly expects a microphone to be included in the price. The trouble is that the microphone supplied is so often inferior in quality to the recorder with which it is sold. This is, I suppose, inevitable, since the price of the outfit must be kept within reasonable bounds, and good quality microphones are rather expensive. Some of the makers of higher priced recorders do leave the choice to the purchaser, content with recommending a number of different types, all of which will work satisfactorily with the equipment.

Microphones can be classified in several

different ways. The most often used classification in the amateur recording world is probably that of the mode of generation—the way that the electrical signal is produced. Such descriptions as “Dynamic,” “Electrostatic,” or “Piezo-Electric” come into this category. All dynamic microphones depend for their production of electrical energy on the movement of a conductor in a magnetic



A.K.G. D77A dual moving coil cardioid stereophonic microphone. £15 10s.

field. In the moving-coil microphone, the sound wave acts on a light diaphragm, to which is attached a small coil of wire, and as the diaphragm moves the coil moves in and out of a narrow gap in an iron yoke attached to a permanent magnet. In the ribbon microphone, the sound wave moves the conductor itself, a very light strip of metallic foil suspended between the poles of a magnet. The electrostatic microphone operates by the sound wave acting on a diaphragm which is one plate of a variable capacitor; this capacitor is polarised with a fixed DC voltage, and the capacity variations produce minute variations in this voltage

The frequency responses of the polar diagrams shown in these pages are as follows:—

MONO MICROPHONES

200 cps ————
1,000 cps ————
8,000 cps ······

STEREO MICROPHONES

200 cps ———— and ————
1,000 cps ———— and ······
8,000 cps ······ and ————

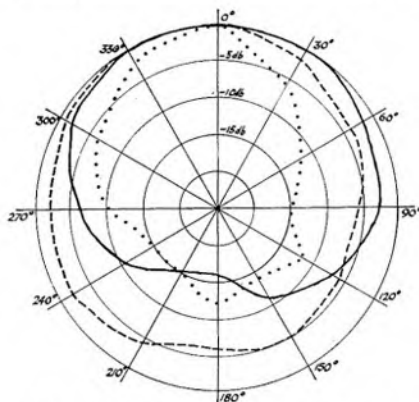

A.K.G. D19C moving coil cardioid microphone. £17 10s.

which can be amplified. In the case of the piezo-electric types, the sound wave causes the twisting of a crystal, usually, though not invariably, of Rochelle Salt, this material being such that it produces an electrical voltage across two faces when it is distorted in this way. The sound can either act directly on the crystal, or more often, on a diaphragm attached to one corner of it.

Whilst such a classification can tell us something about how a microphone works, it by no means tells us the whole story. The

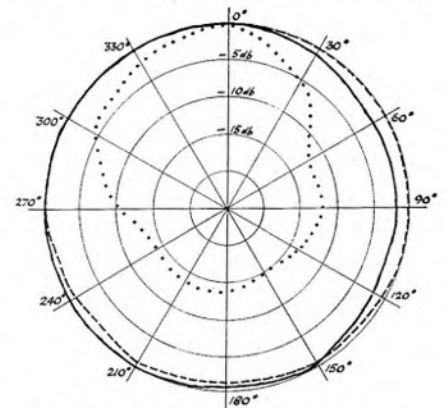

Beyer M119 dynamic moving coil omnidirectional microphone. £16 10s. 1d.

second type of classification tells us a little more. In this case we classify in terms of how the sound wave actually makes the diaphragm or moving element move. If the sound can only reach one side of the diaphragm, and is prevented from reaching the other side, then the diaphragm will respond to the pressure of the sound wave at a given instant, and the microphone is, naturally enough, said to be pressure operated. Most moving-coil and crystal microphones are of this type. If the sound is allowed free access to both sides of the diaphragm, as in the ribbon microphone, then a pressure difference, or gradient, exists between the front and back, and it is this which causes the diaphragm to move. It is also possible to utilise a combination of both types of working, termed pressure/pressure gradient operation.

From the point of view of the actual use of a microphone in recording, the polar diagram classification is probably of the greatest interest.

This shows how the sensitivity of the microphone varies according to the angle at which the sound reaches the diaphragm. If the microphone is placed in a fixed position and a sound source of constant

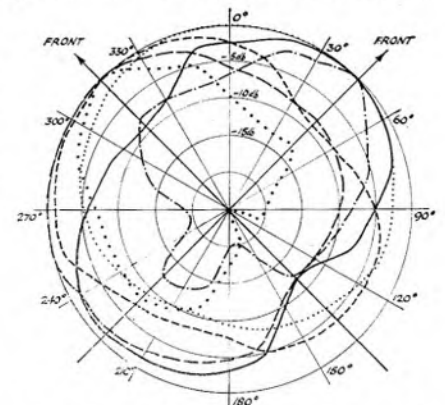

Grundig GDSM202 moving coil stereophonic microphone. £14 14s.

amplitude is moved around it, keeping the distance of the source from the microphone constant, then a graph can be plotted of the microphone output against the angle of incidence of the sound. This curve is called the "Polar Diagram" of the instrument for that particular sound. It must be noted that it does not necessarily follow that if the pitch of the sound is changed, the polar diagram will remain the same; it most certainly should do so, and the amount of variation of the polar curve as the frequency of the sound source is changed gives a measure of the quality of the microphone. The better the instrument, the less variation there will be.

Broadly speaking, there are three main types of microphone when they are classified in this way. These are first, omnidirectional, where the polar diagram is a circle, and the microphone is equally sensitive in all directions: These microphones are the pressure operated ones. Secondly, "figure of eight," equally sensitive on the front and back, but dead on the two sides: these are the pressure gradient ones. And thirdly, the "cardioid," sensitive on one side only: these are operated by a combination of both pressure and pressure gradient. Some professional instruments are made in such a way that the polar diagram can be varied at will by the user to suit any conditions, and some of these include polar

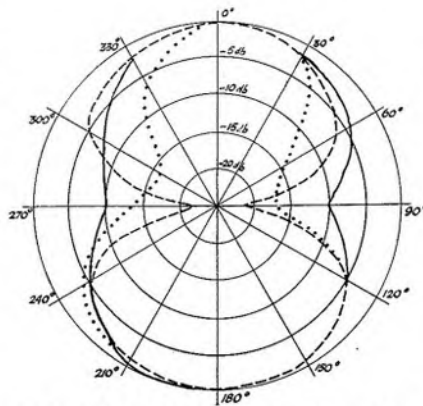

Reslo RBT/L ribbon "figure-of-eight" microphone. £10 2s.

teur use, but a good one can be purchased from about £10. This microphone, because of its bi-directional polar diagram, is very suitable for use under domestic conditions, since by careful placing the characteristics can be used to regulate the ratio of direct sound from the source to the reverberant sound from the room. It is this ratio that governs the apparent distance of the sound when the recording is reproduced. More reverberation produces a distant effect, less a nearer one.

The figure-of-eight microphone has two minor disadvantages. It is extremely sensitive to handling and wind noise, so that it must be used on a stand and can never be used in the open air; and it has a "built-in" bass rise which gets progressively worse when the sound source is closer than about three feet. Notwithstanding these slight difficulties, the quality of recordings produced by even a cheap ribbon microphone can be of a very high standard.

The cardioid microphone, with its "one-sided" polar characteristic, carries the ability to reject unwanted reverberation or nearby sounds one stage further. This type of microphone tends to be more expensive than either of the others, and a good quality cardioid microphone can cost a great deal of money. However some quite acceptable units can be purchased in the region of £20. These are mostly of the moving-coil type, specially designed to have this type of polar curve instead of the more common omnidirectional one. The more expensive cardioid microphones tend to be of the electrostatic or "condenser" type, but these may cost up to £100 or even more. The moving coil cardioids have one disadvantage: they are all rather sensitive to handling, and should where possible be used on a stand.

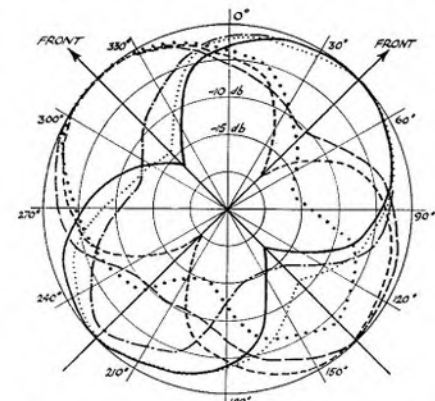

Lustraphone VR65/NS "Stereoilus" dual ribbon figure-of-eight stereophonic microphone. £15 15s.

curves that are between the three main divisions. However, for amateur use these will seldom be encountered, since they are extremely expensive.

The omnidirectional microphone is most likely to be supplied with a low or medium priced tape machine. At least, it is a nominally omnidirectional one, but most of the cheaper versions of this type of microphone tend to become more and more directional as the sound frequency is raised. They will pick up sounds all round them at low frequencies, but at the high end of the spectrum they become markedly directional. True omnidirectional types can of course be obtained, but the better they are in this respect the more expensive they become. This type of instrument, usually of the moving coil or crystal type, is exceedingly robust mechanically and responds least to being held in the hand. It is also less sensitive to wind than are the other types and so is more suitable than they are for use in the open air. Indoors however it can give us more room reverberation than perhaps is often desirable.

The figure-of-eight microphone, usually, though not invariably, of the ribbon type, is somewhat more expensive than the average omnidirectional type available for ama-

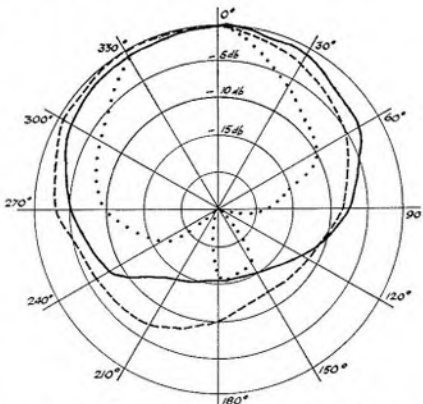

Shure 55S moving coil cardioid microphone. £27 13s. 4d.

I tested three types of stereophonic microphone intended for the coincident microphone type of stereophony, and five monophonic instruments. Two of the stereophonic microphones were of the twin moving coil cardioid type and one was a twin ribbon with figure-of-eight polar diagram. The monophonic instruments were one moving coil omnidirectional type, three moving coil cardioid types, and a figure-of-eight ribbon. The price range extended from £10 to £27. All the microphones performed well, and all except the Uher M511, which was intended as a reporting microphone for speech, were capable of making satisfactory recordings of music. The two ribbon types, the Lustraphone VR65/NS for stereo and the Reslo RBT/L for mono gave the smoothest frequency response, and therefore are to be recommended for more serious music work. The omnidirectional Beyer M119 had the usual increasing directivity at the higher frequencies, but its lack of handling noise and relative insensitivity to wind noise enabled it to make some very satisfactory recordings of music, interviews and effects in the open air.

Of the cardioid types, the Shure 555 maintained its polar characteristic very well over the frequency range tested, the A.K.G. D19/C reverting to omnidirectional at low frequencies. However, by judicious use of the bass cut provided the effect of this could

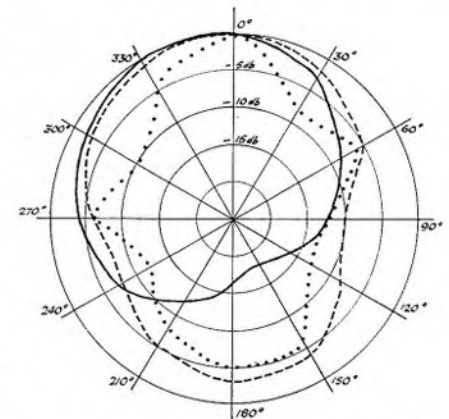

Uher M511 moving coil cardioid microphone. £10 7s. 3d.

be substantially reduced, at least under speech conditions. This microphone, and of course the Shure 55S would seem to be very suitable in public address applications where reduction of howlback is essential.

The performance of the three stereophonic types in so far as stereophonic effect was concerned was rather variable. The polar diagrams of the two halves of the Lustraphone VR65/NS were excellently matched figures-of-eight, and in consequence this instrument gave very clear images. Coupled with its excellent frequency response and the fact that it is the cheapest of the three instruments, this is undoubtedly a very good buy. Of the two cardioid types the polar diagrams of the Grundig GDSM202 was quite well maintained, and good stereophonic results were obtained, but the A.K.G. D77A seemed to me to give rather poorly defined stereophonic images. With this microphone too it was not possible to set the two capsules both facing forwards, a desirable requirement if the stereophonic system is to be properly balanced.

The polar responses of all the units tested are shown in the diagrams.

CHRISTMAS!



GIVE **Scotch** MAGNETIC TAPE IN THIS **GAY** WRAPPER

Scotch Magnetic Tape is the perfect present for anyone who owns a tape recorder. And all the 5", 5 $\frac{3}{4}$ " and 7" boxes are packed in colourful seasonal wrappings. **New lower prices, too!**

3M MINNESOTA MINING AND
 MANUFACTURING CO., LTD.
 3M HOUSE · WIGMORE STREET · LONDON W.1

SPOKEN CHRISTMAS "CARDS" FOR FARAWAY FRIENDS

Why not send truly personal greetings to faraway friends on a Scotch "One Five Special" Inexpensive, at only 5/3 per reel. Runs 15 mins. at 3 $\frac{3}{4}$ i.p.s. Packed in a box designed to be sent through the post.



Dramatape miscellany

By PERSPECTIVE

THIS month's sketch was originally written in 1948—when there were no domestic tape recorders. Despite reproduction from disc (on a clock-work gramophone), the author used the same elements now used for tape. But you will notice that the "victim" is an Englishman. The original characters were all "revolutionaries"—a skit on stories of the time. It's now been altered to provide a new interpretation.

You can do exactly the same with all sketches and plays—never think you're tied down to the literal script. The opportunity to try out new versions of the same material is one of the delights of dramatape. It can certainly form the basis of a society competition. (Don't forget that women can create male accents in comedy; so can men, vice versa).

But printed dialogue can never convey the exact nuances of everyday speech. You, the actor, must bring the script to life. Do this by inventing extra words here and there—especially when one character has to "interrupt" another. Improvise a few hesitations, grunts and so on—just as you do in real life. Amateur actors are incredibly shy in this respect: they read out word-by-word like little-Tommy-reciting. It's no use blaming the dialogue if results aren't life-like—the actors are simply not doing their job. You, as producer, should tell them so! Get them to listen to the BBC drama repertory company; its members are exemplars in "conversational acting."

Mention of the BBC always raises the question of regional accents. Do they matter when casting? *They don't.* You're lucky if you possess a rich accent—it can give quality to your elocution, (John Arlott and Michael Mac Liammoir are examples of beautifully accented voices). It's absurd to imagine that Shakespeare, for example, must be spoken in standard English.

The BBC use a "standard" accent so that everyone from idiot to débutante, can comprehend it. We are free of this duty. But a standard accent and a regional accent are equally undesirable if badly produced. You'll find many "accents" aren't true accents at all—they are merely slovenly pronunciation. We should all make a point of practising sight-reading on tape; our voice-production then improves. An actor should, of course, be able to imitate accents other than his own. But he shouldn't inhibit his own accent—he should exploit it.

I'd be glad to hear how you get on with the sketches and other drama material. The best tapes will be discussed in next month's Miscellany, together with matters arising from last month. But I do request that return-postage is included with all tapes sent to the magazine.

COPING WITH COPYRIGHT

I am asked: "We often need to record incidental music in our plays, but usually the disc is copyright. What then?"

The solution: play your disc during the

society presentation. This may surprise producers who record everything in advance, but a presentation is far from being a mechanical playback. To mix disc (or tape) "on the night" adds to the sense of occasion. Reproduction is certainly superior to the commonly-used "acoustic mixing" (i.e. re-recording via a microphone during the session).

There are various methods of replaying disc over the same speaker as the tape, but re-playing on an ordinary record-player isn't to be despised. Naturally, you have to rehearse groove-selections—plus fades and switching on/off. This "straight re-play" avoids copyright infringement, but two licences are needed if your presentation is made public. (Apply The Performing Rights Society Ltd., 29 Berners Street, London, W.1.; and Phonographic Performances Ltd., Evelyn House, 62 Oxford Street, London, W.1.) Licences aren't needed if the premises are already covered by a general licence.

Licences for copyright plays are a separate matter and are issued by the agent named on the play-set. This licence is granted for specific dates only, and should be obtained

before recording. As a rough guide, I suggest you offer half to one-third the stage-performance fee.

Most agents take a commonsense view and don't object to private drama recording: a restrictive attitude would hardly stimulate play-set sales. But you must be fair in return. Don't give extra presentations in public without sending up the fee—and don't issue the tape to third parties. A responsible society will always enjoy good relations with reputable play-publishers and agents.

HOW TO CUT A COCONUT IN HALF

"Why should anyone want to?" is a fair question. But a pair of coconut shells are traditional equipment for any self-respecting effects-operator. We had the entire committee supporting the nut on a chair—while the treasurer tried to saw it. Result: a broken shell and a quick visit to the casualty ward.

The easiest way is to scribe a line right round the nut—use a sharp knife. Then tap the nut sharply against the edge of a stone step; it will break into two neat halves. Eating the white is certainly good exercise for the teeth—all our jaws ached for days...

Two-minute tape sketch by David Haines

THIS is a new comedy series for drama-in-sound enthusiasts. Each monthly sketch will play for about two minutes, giving simple but progressive exercises in perspective, acoustic and sound-effects. You can then apply the techniques to recorded play-readings.

We shall also print sketches that don't include a word of dialogue. The story will be told entirely in sound-effects, an art referred to here as "aural mime." These are intended for the sound-effects enthusiast, always a valuable member in a dramatape society.

We start with a simple situation in one location. It can be performed on any tape recorder. You can enact the movement literally, or you can use studio perspective. Amateurs familiar with the Focal Press *Dramatape Guide* will recognise suitable methods.

HOW TO START

Always start by making a recording of the dialogue by itself. Ignore the studio notes in square brackets. Record the dialogue over and over until you're satisfied with the fluency. Then examine the studio notes and include the movements etc. in a final version.

NOTES FOR NEWCOMERS

1. A large empty room will suggest an open-air courtyard.
 2. Marching feet can be suggested by sliding dried peas to-and-fro in a cardboard box.
 3. A hand, slapped on a suitable book, will suggest a rifle. Add an oral whiplash sound.
- Two people are enough to suggest a squad. For echo, record the sound on a second tape recorder; then re-record in unison.

Cast: The captain (harsh accent). A soldier (typical). A polite prisoner (English).

Location: A military courtyard.

ANNOUNCER: We present a sketch entitled "The Firing Squad." The scene is somewhere in Latin America. . . .

We hear the gradual approach of marching feet on hard ground.

CAPTAIN: (approaching) [i.e., turning on-mike] Members of the firing squad . . . Halt! (Footsteps halt) Stand the prisoner against the wall!

SOLDIER: [close mike] This way, señor.

PRISONER: [turning off-mike] (politely) Yes, but there is something I'd just like to mention—

CAPTAIN: Silence, señor! Your trial is over; we do the rest. Stand to attention against the wall . . . that's right. And may God have mercy on your soul. Members of the firing squad, in the name of the revolution, release your safety-catches! (We hear a series of clicks.) Take aim . . . fire!

We hear the echoing crash of rifle fire, followed by a pause.

CAPTAIN: (incredulously) God in Heaven . . . missed!

PRISONER: (speaking from the distance) [i.e., at distant-mike] Excuse me, Capitano, all I want to say is—

CAPTAIN: (frantically) Be quiet, señor! The day is hot and my nerves are not in good condition. Members of the firing squad, in the name of the revolution, take aim . . . careful aim . . . fire!

We again hear the echoing crash of the rifles, followed by a silent pause.

PRISONER: Excuse me, Capitano, but I have a suggestion—

CAPTAIN: (furiously) I don't want your suggestions! I'm capable of handling your execution for myself. Members of the firing squad, in the name of the revolution, take aim . . . fire!

We hear another crash of rifle-fire.

CAPTAIN: (aghast) It's happened again . . . we've missed. . . .

PRISONER: Excuse me, but all I want to say is—

CAPTAIN: (shouting) Will you stop interrupting? Members of the firing squad, in the name of the revolution, take aim . . . fire!

We hear another crash of rifle-fire. The echoes roll away despairingly, into silence.

CAPTAIN: (irritably) Oh, very well; what is it?

PRISONER: (helpfully) All I meant to say was: oughtn't I to take off my bullet-proof vest?

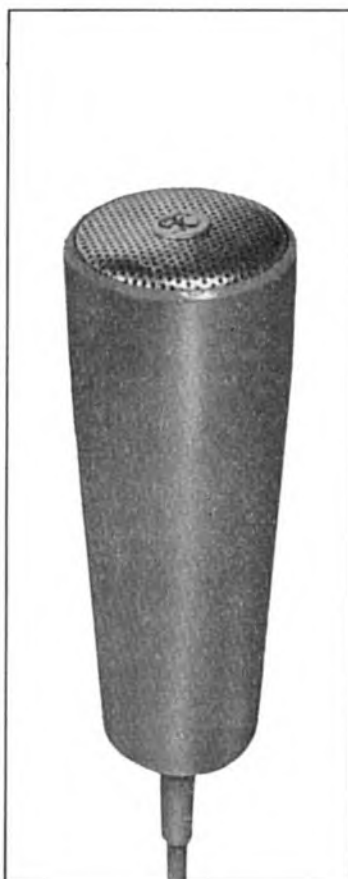

A PROFESSIONAL MICROPHONE AT A POPULAR PRICE

The STC 4118 is a light-weight, tubular, omni-directional, moving coil microphone offering high performance at a very moderate price. It is eminently suitable for use with loudspeaker amplifying equipment and for recording speech and music. The microphone is designed for amateur and professional use. The 4118 can be fitted to desk or table stands, held in the hand, or worn as a neck microphone, either with a neck halter or a clothing clip. A length of thin, flexible PVC insulated, screened cable is provided. Abbreviated Technical Data—Frequency range: 100c/s to 15kc/s. Impedance: 200 ohms (50,000 ohms to order). Sensitivity: -65dB ref. 1 volt/dyne/cm² (50,000 ohms type). -80dB volt/dyne/cm² (200 ohm type). Polar response: Omni-directional. STC are suppliers of microphones to the BBC, ITA contractors and overseas broadcasting administrations. At a cost of £4.19.6d. (plus 3/6d. p. & p.) this microphone is available only from: Standard Telephones and Cables Limited, Electro-Mechanical Division, West Road, Harlow, Essex. Telephone Harlow 21341. Telex 81184.

world-wide telecommunications and electronics **STC**

Tape recorders on hire purchase

By JOHN GASELEE

WHEN buying a tape recorder on credit terms, the first point to determine is which will be the cheapest method. Useful as hire purchase is, it is not the cheapest way to buy equipment.

The cheapest method is to borrow from a bank—but few banks are willing to lend money for such a purpose. Nevertheless, if it is possible to obtain a personal loan—perhaps to cover other costs as well—it is almost certain that this will be cheaper in the long run than a hire purchase contract. In this case one can claim relief of income tax on the interest paid to the bank. No relief is allowed on a normal hire purchase “service charge.”

The chances are that this will not be possible. Even so, a credit sale may be cheaper than hire purchase. In this case, one may pay a quarter of the price when buying the recorder, and a further tenth each month. This could mean you would not pay more than the cash price of the recorder, but it is a point to watch.

Unfortunately, it may not be possible to buy by this method, and you may have to resort to hire purchase. Even so, once having decided on hire purchase, remember that often there is a fairly wide variation in the rates of service charge quoted by different shops and stores. It would pay to “shop around” to see where one can obtain the lowest rate.

Although it may seem that the deposit required is not very high, remember that this is the *minimum* amount needed. Anyone able to pay more than the minimum deposit will find it very much cheaper to do so in the long run. Pay as much as you can reasonably afford, and not as little as you need.

The reason for this is quite simply that the service charge is calculated on the whole of the outstanding amount after you have paid the deposit. Another way to save money on the deposit is not to agree on too long a period for the contract. The longer the period over which repayment is made, the cheaper each monthly payment. However, the service charge is calculated not only on the amount of money outstanding, but also on the period during which the repayment will be made. As a result, if

one arranges for the repayment to be made over two years, the actual cost of borrowing the money (over and above the cash price of the recorder) will be twice as much as if one had settled to make the payments over only one year.

Incidentally, although the dealer from whom one obtains the recorder may produce all the forms which one will be required to sign, the actual agreement (signed over a sixpenny stamp and in the presence of a witness to make it a legal document) is with a finance house or hire purchase company. It is this firm which advances the money to the dealer.

All the time the hire purchase contract is in force, the tape recorder will in fact belong to the hire purchase company. Until the last penny has been paid off, you are only the hirer, it does not belong to you.

For this reason, usually there are a number of terms and conditions in a hire purchase contract. Even though the print may be rather small, it is important to read them carefully and to ask for any to be explained which are not quite clear.

Another important point is that you may not be allowed to take “the goods” (as the recorder will be described) out of the United Kingdom. Nevertheless, anybody wishing to take a recorder abroad on holiday for a particular purpose may not meet with any difficulties. It is essential, however, to obtain the agreement of the finance house (in writing) before actually taking it away.

Another condition is likely to stipulate that the recorder must be fully covered by insurance during the period of the hire purchase contract. Obviously this is a sensible step. For, if the recorder should be stolen or damaged beyond repair, clearly it would not be desirable to pay the outstanding balance to the finance house.

There are special policies for recorders on the market which provide cover on “all risks” terms. Probably it will be necessary for a policy to be endorsed showing the interest of the hire purchase company. The reason for this is simply that in the event of a heavy claim (say, for the total loss of the recorder), the finance house has first call on the insurance money to pay off the outstanding debt. Anything left over comes to the hirer. For depending on the age of the recorder, the insurance policy may not pay the full cost price—even though this is the amount for which the recorder is insured.

One of the main problems so far as hire purchase is concerned arises when, for one reason or another, it is not possible to maintain the payments. A way to avoid this is not only to think of the monthly payments on the recorder, but to bear in mind all the other regular outgoings. Remember to leave a margin in the budgeting to allow for the emergencies which are almost certain to occur at some stage during the period of one or two years. Quite often it is possible to insure the repayments during sick or unemployment periods. This may be a sensible step to take.

The usual position is that if one is more than about ten days overdue with a payment, the finance house has the right to come and take the tape recorder without any formality. It should be added, however, that usually (i.e., in cases where the hire price is less than £300), if one-third of the purchase price has been paid, the finance house will have to obtain a Court Order before taking possession.

Nevertheless, usually this is only a formality. Don't, therefore, let payments become overdue. If it is impossible to make them promptly, explain the whole position in good time to the financiers—who may be very reasonable.

Now, a $\frac{1}{8}$ -inch tape on a new battery recorder

AN important new development in battery-operated midget recorders will be announced early in the New Year by one of the biggest manufacturers.

It will be a machine using one-eighth of an inch wide tape in a plastic cartridge, recording half track at $1\frac{1}{2}$ ips.

The first of the new machines is already on sale overseas, but detailed information cannot be released in Britain until marketing plans have been completed.

A new book for tape enthusiasts

MANUAL OF SOUND RECORDING by John Aldred.

Published by Fountain Press 1963. 352 pages. Illustrated. Price 75s.

IT'S all here. This substantial new book by John Aldred—a professional sound recording engineer who is also well-known in amateur circles through his friendly talks and writings—has chapters on microphones, studios, stereo, motion picture recording and everything in between.

Today's fantastic spread of magnetic tape recording is naturally reflected in the book, but disc and optical film recording and reproduction are also described in detail. The author's involvement in photography, the field of sound recording for which he is most famous, also shows up in his final chapter on domestic recording equipment. Adding sound to home movies, using striped film or synchronising devices, is enthusiastically discussed and illustrated.

This question of illustration was clearly an important feature of planning the book. There are photographs all the way through—almost too many, since they presumably account for the high cost of the book. But their value to non-technical readers will be considerable. This is much more a book for the amateur than the professional—though the dust-jacket says it is written for both types of reader.

I have kept my only serious grouse about the book to the last. I am sorry to report that the opening sections on basic principles contain several examples of faulty theory and loose grammar. I can illustrate the type and flavour of these by two examples.

Quote (page 46): “A Moving Coil is omni-directional at all frequencies, even to sound approaching from the rear of the microphone.”

Comment: Some moving coil microphones are unidirectional. The second half of the sentence is redundant.

Quote (page 62): “The optimum design for such a reflector is a parabola, a curve where every point on the reflector is at the same distance from the point of focus.”

Comment: This defines a circle, not a parabola.

Whether these slips are important or not may depend on one's reasons for reading the book. For my part I think it is a pity they have been allowed to appear and spoil an otherwise interesting, though expensive, addition to the literature of sound recording.

JOHN BORWICK

WORLD RECORD CLUB OFFERS YOU THE CHOICE OF ANY 3 PRE-RECORDED TAPES



85 Beethoven's magnificent Emperor Concerto. A brilliant virtuoso performance by Yuri Boukoff with L'Orchestre des Concerts de Colonne under Pierre Dervaux. **Also in stereo.**



74 Superb Sarah Vaughan in ten great numbers. If I Loved You, Saturday, It's Delovely, You'll find me There, etc. Every one a hit.



83 Brilliant Devy Erlich gives dazzling performance of Mendelssohn's Violin Concerto, plus Kreider Memories. Ernest Bour conducts Sudwestfunk Orchestra.



58 The fabulous, dynamic Duke Ellington himself in eight great numbers, including Stomping at the Savoy, In the Mood and Honey-suckle Rose.



81 Some of Chopin's loveliest melodies magnificently played by world-famous pianist Fou Ts'ong—The Four Ballades, Nocturne in F Sharp Major, etc.



79 Patsy Cline sings 12 smash hit numbers including Walking after Midnight, Too many Secrets, I Can't Forget, Hungry for Love, etc.



12 Beethoven Eroica Symphony. Josef Krips conducts the London Symphony Orchestra in a masterly performance of this monumental work. **Also in stereo.**



84 Schubert's Rosamunde. Kurt Redel, conducting the Munich Symphony Orchestra, has just the lightness of touch needed for this enchanting and ever popular music.



76 Unforgettable Art Tatum in person plays Tenderly, Body & Soul, Without a Song, Begin the Beguine—12 superb numbers from the greatest-ever jazz pianist.



53 These two suites, containing some of Bizet's most thrilling music, are given magnificent performances by the Sinfonia of London under the immortal Glenn Miller and his band.



77 In the Mood, Bugle Call Rag, Chattanooga Choo-Choo, Serenade in Blue—9 original tracks by the immortal Glenn Miller and his band.



54 Tchaikovsky's last and greatest symphony, here given a splendidly moving rendering by the Sinfonia of London conducted by Muir Mathieson. **Also in stereo.**



80 Dynamic Billy Daniels sings his greatest hits including Summertime, Old Black Magic, On the Street Where You Live, Kiss of Love, and 11 more.



69 The exquisite playing of the Virtuoso Ensemble matches the beauty of Schubert's celebrated Trout Quintet, which contains some of his most famous melodies.



65 Our Love is Here to Stay, The Nearness of You, Guilty, and nine more great hits, all with America's top vocal group, the fabulous Four Freshmen.



72 The magnificent Platters bring you Sixteen Tons, My Dream, Mystery of You, You'll Never, Never Know, One in a Million—10 superb numbers.



32 Star cast and orchestra stage all the famous songs Getting to Know You, Hello Young Lovers, I Whistle a Happy Tune, Shall We Dance, etc. 12 superb tracks in all. **Also in stereo.**



89 The one and only Dakota Staton sings If I Love Again, On Green Dolphin Street, Pick Yourself Up, Meet Me at No Special Place, etc.



63 Cuban Carnival, Yesterdays, Blues in My Heart, and eight more great numbers played by George Shearing with vocals by Dakota Staton.



60 Chabrier's colourful Espana, with Suite Pastorale, Joyeuse Marche and Bourree Fantaisque. Paul Bonneau conducts Champs Elysees Theatre Orchestra.



30 Ian Carmichael, Joyce Blair, star cast orchestra. As Long as He Needs Me, Consider Yourself, all the hit numbers from Lionel Bart's great show. **Also in stereo.**



61 The world's 3 greatest sonatas—Beethoven's Moonlight, Pathetic and Appassionata—superbly played by famous T.V. pianist Joseph Cooper.



25 Ian Wallace, Joyce Blair and chorus. Some Enchanted Evening, I'm in Love With a Wonderful Guy, Bali Ha'i, and all the unforgettable songs from this great musical. **Also in stereo.**



48 Deep in My Heart, Drinking Song, Serenade—all the old favourites fresher than ever with Marion Grimaldi, Linden Singers and Orchestra. **Also in stereo.**



59 The silken voice of Nat King Cole in Walkin', Because You're Mine, You'll Never Grow Old, Baby Won't You Say You Love Me and 8 more.



39 Great ballet conductor John Hollingsworth and the Sinfonia of London in a sparklingly fresh interpretation of Tchaikovsky's famous Ballet. **Also in stereo.**



73 Born to be with You, Mad about the Boy, Tomorrow but not Today, That Old Feeling—and six more hits by the brilliant and beautiful Patti Page.



2 Grieg Piano Concerto, Alexander Jenner in an electrifying performance with the Bavarian State Radio Orchestra—conducted by Odd Gruner-Hegge.



91 Barbara Leigh with all-star cast and orchestra sings It's Never Too Late, I could be happy with You, We said We Wouldn't Look Back, 12 in all. **Also in stereo.**

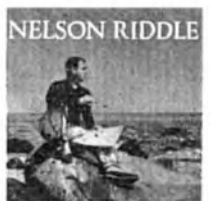

71 The smooth sound of the Nelson Riddle Orchestra in Touch of Your Lips, Body and Soul, The Tender Touch, As You Desire Me—11 favourites in all.

FOR ONLY 30/-

THE GREATEST BREAKTHROUGH SINCE TAPE RECORDING!

Here is the greatest World Record Club introductory offer ever made . . . a unique offer never before matched by any record club or company anywhere in the world!

EVERY ONE OF WORLD RECORD CLUB'S UNRIVALLED RELEASES AS 12" LPs IS NOW AVAILABLE ON 3½ ips TAPE!

Now you have the opportunity to play any WRC release on your tape recorder. Each of these 'tape records' runs on either 3½ ips, mono, on 5" spools and can be played on either 2 or 4 track recorders. New electronic techniques of tape-to-tape transfer give these 3½ ips WRC pre-recorded tapes a standard of reproduction unattainable previously at less than 7½ ips.

WORLD RECORD CLUB 7-POINT PLAN MEANS BETTER LISTENING FOR YOU!

1. AN UNPARALLELED INTRODUCTORY OFFER.

Choose now, any three of the superb 3½ ips pre-recorded tapes shown here, for only 10/- each and number them on the attached coupon. (if you wish, of course, you can choose 12" LPs instead. Introductory discs and tapes are both the same price.) Please send no money until after you have received, played and approved them. We want you to prove to yourself, before paying, that our tapes are equal to the world's best.

2. THE OPPORTUNITY TO BUILD A UNIQUE TAPE COLLECTION.

The WRC plan offers you an exciting and varied annual repertoire of more than 60 selected tape releases, covering classics, jazz, shows, ballet music, light music and 'pops'. Every one is a superlatively recorded 3½ ips mono tape (or 12" LP—mono and stereo). Tapes are offered to you at the

Don't miss this great opportunity. Send off the coupon today, for your 3 introductory selections for only 30/-

privilege club price of 29/- (plus a small charge for post and packing)—much less than you would pay elsewhere for recordings of anything like this quality.

Your only obligation, as a Club member, is to agree to buy four more tapes (or 12" LPs) during your year of membership. Beyond this, there is no subscription or membership fee.

3. A PLANNED PROGRAMME.

Every World Record Club release is hand-picked by an independent panel of Britain's top musical authorities. The Countess of Harewood, Lord Montagu of Beaulieu, Sir Arthur Bliss, Richard Attenborough, Cyril Ornadel, Ray Ellington, Leon Goossens, Malcolm Arnold, Steve Race, John Hollingsworth, Antony Hopkins—and, as special adviser on tape, Miles Henslow.

4. FREE MONTHLY MAGAZINE.

A monthly magazine, packed with fascinating musical articles, reviews, news and pictures, is issued free to all members.

5. SPECIAL CONCERT PRICE CONCESSIONS.

Many concert halls and theatres throughout the country (including the Royal Festival Hall) allow special concession rates to club members for many performances.

6. FREE BONUS TAPES.

The more you buy, the more you save! After fulfilling the minimum membership obligations, you earn another tape of your own choice free for every extra three you buy!

7. EXCLUSIVE EXTRA RELEASES.

In addition to the regular monthly selections, the club offers members exclusive extra tapes at the standard Club price.

World Record Club is unique—the first and greatest Record and Tape Club in Britain, with the largest show catalogue (on tape and mono/stereo disc) in the world. No other method of tape—or record-buying offers you so many additional benefits, so much freedom and variety of choice, with no 'high-pressure' selling. And, of course, there are no subscriptions or membership fees of any kind.



... AND IF YOU OWN A STEREO TAPE RECORDER hear the fantastic reproduction of

STEREO 21

THE NEWEST, TRUEST SOUND ON TAPE TODAY!

Revolutionary new STEREO 21 pre-recorded tapes (7½ ips twin-track) are issued exclusively by World Record Club. But they are offered *without membership commitments of any kind*. The first list of all new STEREO 21 releases is now available. It features 30 superb stereophonic tapes ranging from *Beethoven's Eroica* with Josef Krips conducting the LSO, to a lavish full-cast production of *Oklahoma*.

As always, WRC prices present unparalleled value—all STEREO 21 releases cost either 50/- or 60/- depending on playing time (up to 50 minutes). STEREO 21 tapes are now obtainable through leading retailers or direct by post from World Record Club. Send for full catalogue now—STEREO 21 must be heard to be believed!

7-DAY FREE TRIAL OFFER—POST TODAY!

STEREO 21 FREE BROCHURE

To WORLD RECORD CLUB (Dept TRG8) Box 11
PARKBRIDGE HOUSE, RICHMOND, SURREY.

SEND NO MONEY NOW

| | |
|---------------------------------|---------|
| 3½ ips pre-recorded tapes | 12" LPs |
|---------------------------------|---------|

Tick what you want

Please send me, without obligation, on 7-day free trial, the three selections indicated. (Your 3 selections must be either all tape or all disc.) If satisfied, I will pay you 30/- plus 3/- postage, packing and insurance. Only at that stage may you enrol me as a full member of World Record Club, entitled to all the benefits described. My only obligation as a member would be to agree to purchase 4 more top quality 3½ ips tapes (or 12" LPs) over the next year at the special club price of 29/- each. If I am not completely satisfied with my 3 selections, I will return them to you within 7 days, in good condition, and owe you nothing. **NOTE** I understand I will be asked to pay £1 deposit when I become a tape member (this does not apply to disc members). This deposit is refundable.

Signed _____
this offer applies in Gt. Britain and N. Ireland only.

MY 3-SELECTION 'PACKAGE' COMPRISES

Choice No. 1 Choice No. 2 Choice No. 3



(place tape/disc key numbers only in the circles)

Tick here if stereo 12" LPs are required where available

Mr/Mrs/Miss
(BLOCK CAPITALS PLEASE)

ADDRESS

To WORLD RECORD CLUB (Dept TRG8)
Box 11 PARKBRIDGE HOUSE, RICHMOND, SURREY.

Please send me your free colour brochure, showing the full range of your new STEREO 21 releases.

NAME
(BLOCK CAPITALS PLEASE)

ADDRESS

WHATEVER YOUR ASSIGNMENT—GET THE **FI-CORD 202** PORTABLE BATTERY/MAINS RECORDER— *so much in so little space*

Another assignment for Fi-Cord Fred, safely stowed under his belt, thanks to the compact versatility of the Fi-Cord 202. The Fi-Cord 202 caters for the most exacting professional and for the enthusiastic amateur. Whether you are in a sound-proof studio or perched on a rocky ledge, the Fi-Cord 202 gives you high-fidelity recording at your fingertips. And with this wonderful, lightweight machine you have all the practical advantages of a full-size recorder.

The Fi-Cord 202 offers all these features:

2 speeds— $7\frac{1}{2}$ and $3\frac{3}{4}$ · Standard 4" spools
Vu-meter · Fast forward wind · Fast rewind
Resettable counter · Manual volume control

Built-in loudspeaker · Sockets for microphone, extension speaker and remote control · Safety record switch · Easy-load battery cassettes · Battery warning lamp · Mains input optional.

ACCESSORIES INCLUDE: Carrying case, choice of microphones, power packs for mains and car.

There is a full range of Beyer microphones, from general purpose to ultra-studio quality, to cover every use of the Fi-Cord 202.

Price: 66 guineas, including long life mercury batteries and tape.

Write for fully illustrated brochure and address of nearest stockist to:



FI-CORD INTERNATIONAL 40A, DOVER STREET, LONDON, W.1. HYDe Park 3448



Alan Edward Beeby's TAPE TALK

THE current flood of "How To . . ." instruction tapes continues to flow unchecked, drenching gullible buyers with advice on everything from law-practice to rabbit-breeding. The constant dripping of one I was forced to sit and listen to recently would have worn away far more than a stone of anyone's tolerance.

At the risk of reducing myself to a laughing-stock, I'm repeating the following six cardinal points of etiquette which, according to the author (who also recorded the talk), should be faithfully observed by Budding Street-Interviewers. The bracketed comments, by the way, occurred to me while listening to the tape.

- (1) "Step forward, holding the microphone firmly in your hand." (*The British method, presumably, as opposed to the Spanish way of clenching it between one's teeth.*)
- (2) "Do not clutch at the subject's clothing or touch them in any way during the interview." (*Unless she grabs hold of you first.*)
- (3) "If your subject starts to walk away, do not run after him." (*Unless he's trying to swipe your microphone.*)
- (4) "Do not try to force your way into a building for the purpose of obtaining an interview." (*Smashing a window with the microphone is also out.*)
- (5) "Do not call your subject 'Mate,' 'Dear,' 'Chum,'

New firm presents sound effect discs

A RANGE of sound effect discs designed for tape, cine and slide enthusiasts, are announced by Recorded Tuition Limited.

The first of the new issues (MFX 1) includes lions roaring, aircraft landing, road drills, cell doors, storm at sea, police cars and trains. Others in the series include sounds of wild animals (AFX 1); a complete disc of the sounds of British railways



(TFX 1); horses and domestic animals (MFX 3); varied sounds (MFX 2); electronic music and sounds (EFX 1); and haunted house and mystery sounds (HMX 1).

All the 45 rpm discs are copyright free for amateur enthusiasts. They have been compiled by F. C. Judd, A.Inst.E., one-time contributor to *TAPE Recording Magazine*, who is widely known for his sound effect productions.

The discs will sell at 7s. 6d. each, plus 6d. postage and are available from Recorded Tuition Limited, 174/176, Maybank Road, South Woodford, London, E.18.

'Brother' or 'Cock.' (Exceptions to this rule, in same order: *Tarzan, Bambi, Andy Capp, George Brown, M.P., and the Duke of Edinburgh.*) (6) "Choose your subjects carefully. Do not, for example, stop a young couple hurrying out of a cinema late at night. They may be anxious to catch a bus." (*Or something . . .*)

This tape, at 15s. 6d., is good value for money. Erased, it can be used over and over again for recordings of your own.

A YOUNG MARRIED couple (friends of my wife and I) recently acquired their first tape recorder. They live in London, whilst we're up here in the Midlands; consequently, we don't get to see each other very often. "It'll be nice to be able to exchange tapes," observed my colleague. "Much better than writing letters," and added that we could expect to receive the first tape from them within the next few days.

We waited. A week went by, with still no sign of the promised tape. Eventually, we got an apologetic 'phone call from the husband, explaining the reason why we hadn't heard tape-wise:

"It's a most extraordinary thing," he said, "but, do you know, when we switched the machine on, we couldn't think of a blessed thing to say!" The fact that they'd compiled a list of talking-points hadn't made any difference either. "We just simply seem to dry up completely." Had I any remedies to offer as a cure for mike-fright, he wanted to know. For once, I was stumped. Is there, in fact, a cure? Perhaps some readers may have overcome this particular problem in their early days. If so, I'd be glad to know how they managed it.

I can recall being embarrassed only once during such a session. It was on a Saturday morning quite recently, and I was sitting upstairs at my desk in front of the study window, making a tape to another contact up North. Suddenly, there was a bumping sound, and the top of our window cleaner's ladder appeared, followed a few seconds later by his head and shoulders. He looked in, saw me sitting there quite alone in the room, apparently nattering away to myself nineteen-to-the-dozen. He couldn't, however, see the microphone (which was hidden behind the desk-top) or the recording unit tucked away in a far corner. All of which probably explains why he's been trying to avoid me in the street lately. . . .

A "Tape" reader who recently visited my home was kind enough to comment most favourably on the sound-quality of my hi-fi lash-up. "I reckon it's fabulous!" he enthused. "Why don't you write about it sometime?" The simple answer is because I know full well that there are amateur set-ups every bit as good, if not better, than my own. However, in case anyone's interested. . . .

I have a Vortexion WVA recorder, a Goldring-Lenco record deck and an Armstrong "Jubilee" Mk.II radio-tuner/amplifier, all built into a single unit. My study, where the unit is situated, is actually a converted bedroom, and the effectiveness of its reproduction, I think, owes much to a speaker-housing idea I had while building the unit earlier this year.

Ours is an eighty-years-old terraced house, which, in common with others of its kind, has a built-in wardrobe in the front bedroom, ending about two feet from the ceiling. Being in the fireplace recess, this naturally provides a space roughly 2 ft. x 4 ft. and this was lined through-



out with speaker-felt, the baffle carrying the speaker-assembly being clamped firmly across the front opening. I should, perhaps, add that the study itself is quite "heavily" furnished with velvet curtains, carpet, panelled walls and three-piece suite, etc.

An interesting point for anyone considering this "recess" idea—and a favourable one, too, it would seem, when there are neighbours to consider.

NEW Super quality Tape



Improved—at no increase in price

SUPERIOR callendered oxide to make "dropouts" even rarer than before

SUPERIOR new Triple Play, stronger and more stretch-free than most DP; all reel-sizes 3" to 7"

LEADER TAPE trailer and stopfool on 4" to 7" spools, all grades

ALL REELS factory-sealed in polythene

AT LEAST 40 PER CENT CHEAPER than any other tape of comparable quality

— POST THIS COUPON NOW! —

DE VILLIERS (ELECTRONIC WORLD) LTD.
18d STRUTTON GROUND · LONDON S.W.1

STANDARD PLAY (PVC) BASE

| | | | | |
|---------------|------------|--------------------------|------------|--------------------------|
| 3"/150ft. | 4 for 18/- | <input type="checkbox"/> | 48/- dozen | <input type="checkbox"/> |
| 4"/300ft. | 4 for 26/- | <input type="checkbox"/> | | |
| 5"/600ft. | 2 for 26/- | <input type="checkbox"/> | | |
| 5 1/2"/900ft. | 16/- | <input type="checkbox"/> | | |
| 7"/1,200ft. | 19/- | <input type="checkbox"/> | | |

LONG PLAY (Prestressed Polyester Base)

| | | | | |
|-----------------|------------|--------------------------|------------|--------------------------|
| 3"/225ft. | 4 for 22/- | <input type="checkbox"/> | 60/- dozen | <input type="checkbox"/> |
| 4"/450ft. | 2 for 21/- | <input type="checkbox"/> | | |
| 5"/900ft. | 2 for 35/- | <input type="checkbox"/> | | |
| 5 1/2"/1,200ft. | 24/- | <input type="checkbox"/> | | |
| 7"/1,800ft. | 31/- | <input type="checkbox"/> | | |

DOUBLE PLAY (Prestressed Polyester Base)

| | | | | |
|-----------------|------------|--------------------------|-------------|--------------------------|
| 3"/375ft. | 2 for 20/- | <input type="checkbox"/> | 108/- dozen | <input type="checkbox"/> |
| 4"/600ft. | 2 for 30/- | <input type="checkbox"/> | | |
| 5"/1,200ft. | 27/- | <input type="checkbox"/> | | |
| 5 1/2"/1,800ft. | 35/- | <input type="checkbox"/> | | |
| 7"/2,400ft. | 45/- | <input type="checkbox"/> | | |

TRIPLE PLAY (Prestressed Polyester Base)

| | | | | |
|-----------------|------------|--------------------------|-------------|--------------------------|
| 3"/475ft. | 2 for 26/6 | <input type="checkbox"/> | 150/- dozen | <input type="checkbox"/> |
| 3 1/2"/650ft. | 17/- | <input type="checkbox"/> | | |
| 4"/900ft. | 23/6 | <input type="checkbox"/> | | |
| 5"/1,700ft. | 40/- | <input type="checkbox"/> | | |
| 5 1/2"/2,300ft. | 52/6 | <input type="checkbox"/> | | |
| 7"/3,300ft. | 80/- | <input type="checkbox"/> | | |

I enclose £ s. d. Post Free

NAME

ADDRESS

BLOCK CAPITALS PLEASE Cash with Order

I BEGAN to worry about Bill. He had been gone a long time. There was absolutely no sign of him, nor of our labrador, Napoleon.

The sun disappeared behind a huge, black cloud and I shivered as the rumble of thunder came from far off. A stiff breeze sprang up from the sea.

I decided to make my way back to where our new Mini Minor was parked. As I walked, I kept looking round for Bill. It seemed stupid to admit that he could disappear before my very eyes, but he had.

About fifteen minutes earlier we had stopped to stretch our legs and give the dog a run along the beach, but Napoleon, sniffing about and exploring, picked up the scent of a rabbit and in a flash had wriggled through a fence and had streaked off in pursuit.

Bill whistled and called out, but Napoleon wasn't having any. Finally, Bill had made off after him. Almost immediately, he and the dog were out of sight.

It was only when I was nearing the car again did I notice the warning sign on a pole, reading, TRESPASSERS WILL BE PROSECUTED.

Obviously, Bill hadn't seen this, and I became more worried about him, hoping that both he and the dog would return before any trouble developed.

But trouble was only a few feet away. . . .

An approaching car slowed as it neared our Mini, then braked to a stop. My heart fell when I saw two burly uniformed policemen emerge, and walk purposefully towards me.

I reached our car, at the same time as they did.

"Is this your car, miss?"

I gulped. "Well — er, no. It's my husband's." I explained to two unsympathetic faces. "I'm his wife," I added stupidly.

"Really?" one of them replied, with the merest flicker of an eyelid, as the other began to circle the Mini-Minor slowly, his note-book at the ready.

"Where is your husband?" I was asked. What could I say? He's breaking the law over there? I groaned inwardly. "He's — taken the dog for a walk," I told them.

A peal of thunder sounded nearer, adding more misery to the grim scene.

The two policemen looked around. "Has he gone far?" asked one.

"I don't—really know!" I stammered.

The one with the notebook tapped on the roof of the car, and said, "Have you reported the accident which caused this damage?"

I looked dejectedly at the dents and bashes on the roof and shook my head slowly. "It really wasn't what you would call an accident." I hedged.

"What happened, then?"

I looked from one to the other and wished that Bill were with me. I took a deep breath, and said, "An elephant stood on it."

The policemen exchanged glances. One of them pushed his cap back and scratched his head with his pencil. "An elephant?"

I nodded, feeling my cheeks flush. "Susie, I think her name is."

With a snap, the notebook closed. It was wagged in front of my nose as the policeman spoke. "Look, miss, I'm in no mood for jokes. This is a serious matter. Just where has your husband gone to?"

A damsel in distress

"I told you! He took the dog for a walk!" I exclaimed, imagining that by now, Napoleon would be lying dead somewhere and Bill thrown into some rat-infested dungeon.

"This is hardly the weather for walking," one of them said, as drops of rain began to fall. "When did he leave? Where did he go?"

I swung my arm about, and pointed generally in the direction I had just come from.

"And you say this is your car?"

"Yes."

"What's the registration number, then?"

"Mm — it's — er, YSU — um, 20 something."

"You don't know the number of your own car?" the taller of the two men said. "Can I see the papers for it?"

"Papers?" I echoed.

"Yes. Registration book. Insurance certificate."

I shook my head again. "I didn't know you needed papers for it."

"I'm afraid I'll have to ask you to come along with me, miss. I'm not satisfied with your story at all. Please get in the police car," I was instructed in the best Z-cars tradition.

I goggled at him. "Are you arresting me?"

"No. I just want to make some inquiries, that's all. There'll be some more questions the sergeant'll want to ask you."

I was too stunned to move. "But what about my husband? I can't walk away and leave him! He won't know where I am!"

"Don't you worry about that, miss. Now, please get in."

I looked about frantically hoping for a miracle, but Bill was nowhere to be seen. One of the men took me by the elbow and gently led me to the car, as the other brought my handbag and portable tape-recorder from the Mini-Minor.

Only one of the men got in beside me, the other standing by the Mini awaiting Bill's arrival.

I was taken into the nearest big town and driven into the police station yard. Inside, I was asked to sit on an uncomfortable wooden chair. The uniformed policeman who had driven me, laid my belongings on the counter and talked in a low voice to the station sergeant.

"Any report of an accident involving a red Mini-Minor?" I heard him ask, slip-

ping his notebook across to the sergeant. "Here are the details."

The grey-haired sergeant muttered something under his breath as his finger ran down the entries in his ledger. "Nothing here, Fred," he said finally.

Fred nodded and turned to me. "All right, miss. Let's start at the beginning. What's your name?"

"Rogers. Mrs. Jean Rogers."

"You're husband's first name?"

"Bill."

"Are you aware, Mrs. Rogers, that you were unable to tell me the registration number of the car you say belongs to your husband?"

"It's not surprising, considering —"

"Well, that, plus the fact," he rattled on, "that you were behaving in a suspicious manner in a restricted parking area makes things look serious for you."

"What do you mean?" I asked, bewildered.

"What were you doing parking at that particular point on the road?"

"I've told you already!"

"Who were you waiting for, Mrs. Rogers?" the sergeant asked.

"My husband!"

"Who was he supposed to meet? What was he doing there?"

"He wasn't meeting anyone! He was simply taking the dog for a walk!" By now, I doubted whether I'd ever see Bill again, alive or dead.

The sergeant leaned over the counter and spoke softly and clearly. "Do you know where your car was parked?"

"Of course! On the main road, overlooking a sandy bay. We —"

"I didn't mean that. Let me explain. At that point, the main coast road skirts the boundary of a War Department Research Station. You were parked there. Yet, at the approach to the Station, from both north and south, there is a warning notice which clearly states that parking is prohibited within that stretch of road."

I swallowed hard. "We — didn't know!" This news conjured up a picture of Bill having been arrested, tried, found guilty of spying and shot.

The sergeant continued to watch me, as Fred took over again. "Of course, if you can explain your presence there. . . ." Then, quick as a flash, he shot at me. "What did you use your tape recorder for? Recording secret information from whoever you arranged to meet? Someone from the Station, perhaps?"

"What?" I stared at him in wide-eyed astonishment.

"Very clever method," he continued. "After you've passed the message on to a secret foreign power, you erase the tape, leaving no trace. Yes, very clever, Mrs. Rogers. I know a bit about these machines, you know."

"Maybe you do, but I can assure you there's nothing very secret in any of my tapes!"

"Ah! So you hadn't effected a meeting at the time we apprehended you?"

"Now, look —"

"Mrs. Rogers," the sergeant interrupted. "Tell me about the damage to your car. I understand the roof has been severely bashed and dented?"

"Yes. That's right."

"How did it happen?"

"An elephant stood on it."

For a moment there was silence, then the sergeant smiled and said, "Couldn't have been that. We've had no elephants around here for years. Shot the last one myself, as a matter of fact."

Fred grinned and the sergeant shut the ledger with a flourish.

"Listen to me, both of you!" I told them angrily. I don't see anything to laugh at! I'm telling you the truth!"

"Have you been drinking?"

"Of course not!"

"We can put you to the test, you know."

"I don't care what you do! I'm quite sober, and I repeat, an elephant stood on our car!"

"Oh, come now, Mrs. Rogers," Fred said, wearily, "how do you expect anyone to believe a story like that?"

Before I could think of something biting sarcastic to reply, the sergeant asked me, "Well now, just where did you meet this elephant?"

I looked at him evenly. "On the beach. About ten miles south of here."

"On the beach," he repeated tonelessly. "How stupid of me to ask. I mean, where else would you expect to find an elephant?" he continued heavily. "And what was it doing there? Picnicking?"

I glared at him. "It was being led along by a young Indian boy," I told him, holding my temper as long as I could.

"Then it was an Indian elephant?" asked Fred, grinning.

"I don't know!" I answered. "All I can tell you is that the elephant's name is Susie."

The sergeant slapped the open palm of his hand on the counter. "Mrs. Rogers. I think this has gone far enough."

I turned on him. "Really? What do you want me to say? That we ran into a ditch, rolled over, righted the car and drove merrily on our way?"

"It does have a greater ring of truth to it."

Outside, a screech of brakes took our attention. Car doors were slammed and a loud barking could be heard. The station door opened and Bill entered, followed by Napoleon and the other uniformed constable.

Bill smiled warmly when he saw me, and the dog bounded over to where I sat. It was then that I saw he held a dead rabbit in his mouth. With frantic tail-wagging, he presented the offering to me and lay down at my feet, contented.

"Oh, no, Napoleon!" I groaned.

"Found him and the dog within the grounds of the War Department. I've alerted the security, although it looks like a straightforward case of poaching to me."

"I wasn't poaching!" Bill exclaimed loudly. "The dog ran into the grounds and I followed with only one purpose in mind. To bring him back!"

"You're Mr. Rogers, then?" the sergeant inquired. Bill nodded.

"Is this your wife?"

"Yes."

"Tell me, Mr. Rogers, are you the owner of the red Mini-Minor outside?"

"Yes."

"What's the registration number?"

"YUS 920."

"May I see the papers?"

"They're on the shelf beside the steering column."

The sergeant nodded to Fred, who walked over to the door, then turned to Bill again, "We seem to be getting somewhere at last. Now about the damage to the roof of your car. Can you explain that?"

Bill looked surprised. "Didn't my wife tell you?"

"I'd rather hear it from you, if you don't mind."

"Well, it was a stupid thing really, but I don't suppose I could have done anything to avoid it."

"Come to the point, Mr. Rogers."

"An elephant stood on it."

The sergeant stared at him, closed his eyes and shook his head slowly from side to side.

"But that's what your wife said!" he gasped.

"Naturally. That's what happened."

"Was there —," the sergeant began cautiously, with a glance at me, "A little Indian boy there, too?"

JEAN ROGERS relates another of her short stories

"Yes! That's right!" Bill agreed eagerly. "I'm afraid I don't understand. Please explain the details."

Fred returned and laid the car papers on the counter. As Bill talked, the sergeant examined them.

"At the beginning of the week, I traded in my old sports car and bought this new Mini. Today has been the first half-decent day this week, so I thought I'd take Jean for a spin. We were about ten miles from here when I slowed down and tried to work out where the best place would be to have lunch. When I stopped to consult the map, we saw the circus trucks parked by the roadside, ahead of us."

I looked round the faces of the policemen. They were all blank.

"We got out and walked among them for a bit. Then Jean noticed the elephant. . . . It was being led along the beach, so we walked over to it. In charge was a little Indian boy who seemed to know next to no English. There was a whole menagerie—all in mobile cages, of course. The elephant cage had been giving trouble, so while they tried to carry out repairs, the elephant was taken for a walk along the beach."

"That doesn't explain the damage to your car," the sergeant pointed out.

"I'm coming to that. We went back to the road and chatted to the circus folk for a while. When we returned to our car again, we saw, to our horror, Susie—that's the elephant's name, by the way, had both her front feet on the roof of the Mini-Minor. The little Indian boy was trying to pull her off, but Susie would not budge. One of the circus people explained that our car was almost the same shape and exactly the same colour as each of the tubs Susie uses in her act."

The sergeant scratched his head, but said nothing.

"The circus owners were very kind. They said they'd accept full responsibility."

"Where is this menagerie now?" the sergeant asked, a trifle harshly.

"I don't know," Bill admitted. "When we left, I heard them say something about having to abandon the elephant cage and make her walk. But I don't know where they were heading for."

The sergeant let out his breath slowly. "It's an incredible story. I don't know whether to believe it or not!"

"It sounds crazy to me," Fred told him. "Whoever heard of an elephant going for a walk along the beach?"

Something in my mind went 'click.' I — I can prove it!" I told them suddenly

"How?"

"My portable tape-recorder," I explained, walking over to the counter. "I recorded the elephant when she was trumpeting loudly."

The sergeant looked at me as if I was crazy, and I tried to look back at him as if I wasn't.

"Yes," Bill said. "My wife and I are very keen on tape-recording. We like to acquire unusual sounds, and we felt that Susie would prove to be quite an asset to our library."

We all gathered round the counter, as I set up the recorder. I pressed the 'play' button, and waited.

The first sounds were the swishing of the sea, the whine of the wind and the crashing of the breakers. Then in the distance, a chattering and squealing of many animals.

"That doesn't sound like an elephant to me!" Fred scoffed.

"Naturally," I said, drily. "It's a cageful of monkeys," I added with a quick meaning look at the policeman and the barred windows of the police station.

The sound faded, then the trumpeting of Susie began, majestically strong and clear. It was a beautiful recording. In between the bellowing, a young voice babbled away in a foreign tongue followed by Bill's unanswered questions.

The noise became deafening until the sergeant shouted. "That's enough! That's enough! Turn it off!"

I switched it off and the room became silent again.

"Well —," the sergeant began, but words failed him.

"It's the wildest story I've ever heard. Bar none," Fred said, unkindly.

"I suppose we could try to trace the circus," the sergeant suggested, and asked Bill. "Do you remember the name of the owner?"

"I took a note of it," Bill said. He hunted through his pockets and brought out a piece of paper. "Here we are. Lester's."

"I can't say I've heard of it," the sergeant told us. "Must be strangers to this part of the country."

Bill was about to speak, when the sergeant grimaced and held his hands over his ears. "I thought I told you to turn that thing off?" he shouted at me.

"It is off!" I yelled back. The cause of his discomfort was obvious. The room was once again filled with the loud trumpeting of Susie.

I was the first to move. I dashed over to the window and stood rooted to the floor. Outside, Susie, once again having spotted our red Mini-Minor, forgot herself and began to go through her act. The little Indian boy tugged, pulled and pleaded, but he was obviously wasting his time. Susie was giving the performance of her life. The other circus people were running towards her, as the metal roof of the car creaked and strained under her weight.

Inside the police station, the policemen stood and gaped. With saddened heart, I turned to the sergeant, and asked, "May we go now?"

COSSOR

4 TRACK

TAPE RECORDER

FOR ONLY **28** GUINEAS

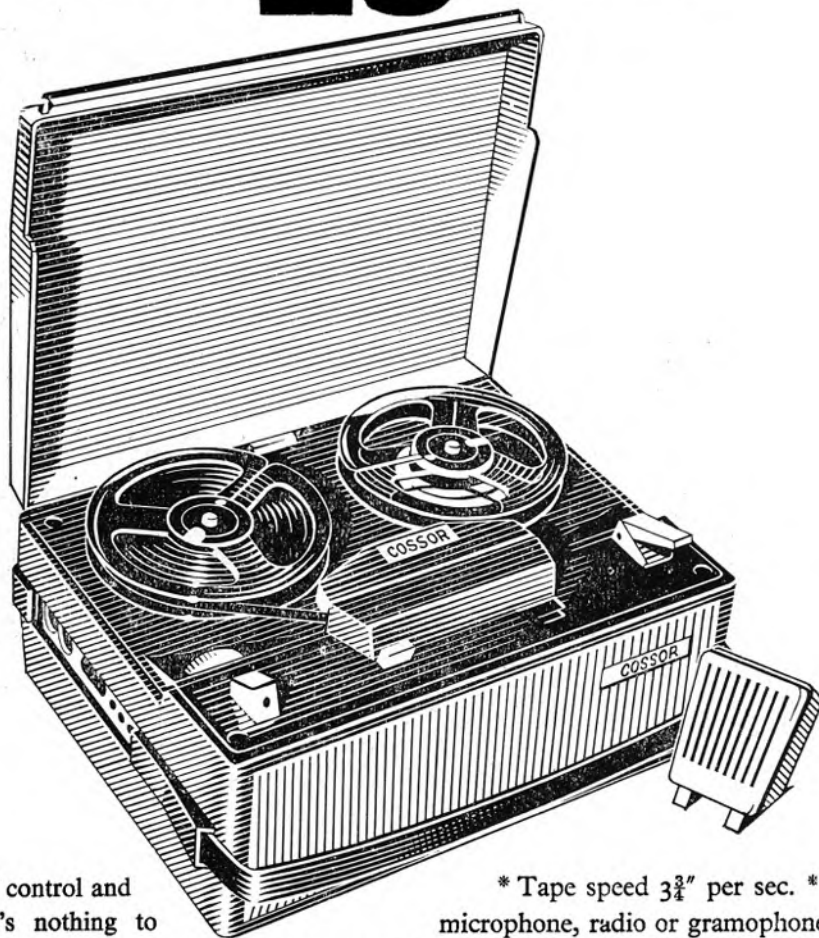

For sheer simplicity, ease of control and functional efficiency, there's nothing to better the CR 1603. It has excellent 4-track recording and playback with minimum controls—at a price within every family budget, and the all-transistor amplifier means instant operation—no warm-up time. A 5 $\frac{3}{4}$ " reel Double Play tape gives 6 hours playing. 5" reel L.P. tape and moving coil microphone supplied. Polystyrene cabinet in two-tone green.

* Tape speed 3 $\frac{3}{4}$ " per sec. * Records from microphone, radio or gramophone pick-up * All transistor amplifier * Will play back through radio, hi-fi or external loudspeaker * Moving coil meter indicates recording level * Takes reel sizes up to 5 $\frac{3}{4}$ " diameter * Recording level can be adjusted with tape stationary.

Life's livelier with **COSSOR** *of course !!*
 COSSOR RADIO & TELEVISION LTD., 233 TOTTENHAM COURT ROAD, LONDON, W.1.

TELEVISIONS · RADIOS · RADIOGRAMS · TAPE RECORDERS

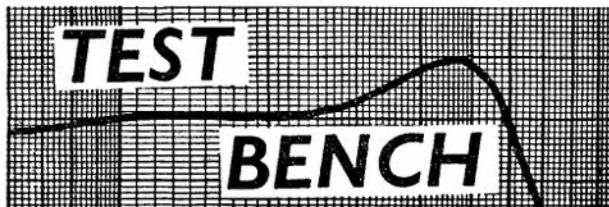

COSSOR 1603

Alan Beaument

SOMEWHAT to my surprise, I found that this recorder is made in Holland, presumably by the Philips' side of the organisation. Certainly, the components and style of assembly look very Continental and "Philipsish." Be that as it may, whoever produced it did a commendable job.

It is a transistorised, AC mains (only) operated, single-speed, four-track machine of simple, uncluttered design and pleasing appearance, tropicalised for world-wide use. The case is made of tough, moulded plastic, in two shades of green, with a strong carrying handle (not detachable) across the front. The removable lid has no hinges, or other fittings fastened to it, all fancy trimmings and catches having been eliminated in favour of a plain moulding, with catches integral. This results in a very neat and unobtrusive job, with nothing to tarnish or rust.

The recorder operates on mains voltages of 110, 127 and 200/250 at 50 or 60 cycles, the consumption being approximately 25 watts. Mains voltage is selected by means of an adjuster mounted underneath the case in a recess which also provides storage for the three-core mains lead. Accessories supplied consist of a five-inch reel of LP tape, an empty spool, a moving-coil (dynamic) microphone in a hand/desk case with lead and plug, and a fully-illustrated operating handbook. The latter is quite good, but suffers from the common fault of not detailing the pin numbers for connections to the various plugs which results in a tedious process of elimination when wishing to use one's own accessories.

DECK AND CONTROLS

The recorder is switched on by means of an edgewise-mounted knob, in front of the feed spool, which operates both the "on/off" switch and the combined "record/playback" level control. A single motor, which with extra fused windings, doubles as a mains transformer, drives the spools and capstan through idler pulleys and a belt, respectively, giving a fixed tape speed of 3½ ips. The belt is kept clean by running it through the bristles of a small brush, and 50 or 60 cps operation is obtained by placing the belt in the appropriate slot of a double pulley on the motor spindle.

Any of the four tracks can be used by operating a selector switch to the left front of the head covers and the usual reel-inversion procedure. A total playing time of six hours is available when a maximum-sized (5½-inch) reel of DP tape is used. The

rear head cover is part of the top moulding, but the front cover is detachable, for head cleaning, etc., the "record/playback" head being fully screened during operation.

To record, a red push-button on the left of the deck is depressed. With the tape stationary the recording level can be set by means of a moving-coil meter to the right of the track switch. The tape is then started by holding down the red button and depressing a lever switch on the right of the deck. This switch is depressed for playback



only, and rotated to left or right, with its mounting bracket, for fast winding. Although not particularly fast, rewind does give a smooth, firm reel. Braking is positive and there is no tape spillage or looping.

* * *

CONNECTIONS AND AMPLIFIER

The following connections are made to four sockets on a panel on the left-hand side of the recorder:—

(a) Microphone input: sensitivity 400 microvolts at 1,500 ohms impedance.

(b) Radio input: sensitivity 2.0 mV at 20 Kilohms impedance and on the same socket, output to external amplifier; 1.5 v max. at the same impedance.

(c) Pick-up input: sensitivity 100 mV at 680 Kilohms impedance.

(d) External loudspeaker: impedance 3 to 7 ohms.

The amplifier is transistorised and has a claimed frequency response of 80 to 13,000 cps \pm 3 dB, at an output power of 700 mW. This is fed to a four-inch round p.m. loudspeaker on the front of the case. A printed-circuit panel, mounted immediately behind the sockets, carries the amplifier components, giving the interior a clean—and (and half-empty!)—appearance and improving the accessibility for maintenance. The compact assembly is adequately screened, resulting in a very low level of hum and noise, in spite of the high sensitivity on the microphone channel.

OPERATION AND PERFORMANCE

There is little to be said about the operation of the recorder. There are so few controls that operation is simplicity itself! Every possible aspect is covered by the handbook so that it would seem to be the ideal machine for anyone who requires only to make an acceptable recording with the absolute minimum of fuss.

Performance figures for the microphone alone are not given, but it is very sensitive and produces a pleasant, natural sound, free from any objectionable peaks or resonances. Even music recorded through it had a surprisingly lifelike quality. Recording on other input signals, too, results in a playback signal free from wow, noise and hum—provided that leads are properly screened—and the quality of reproduction when external amplifiers and/or loudspeakers are used is truly enjoyable.

There is no doubt that the long struggle made by the conscientious manufacturers to achieve the best possible reproduction, is now really paying dividends and some of the smaller modern recorders are as good as one would have expected semi-professional models to be, only a few years ago. This one is a little beauty and I would recommend it unhesitatingly as a good domestic machine.

Access to the works is easy, top or bottom, when routine maintenance is required. Only the lever switch need be removed—and that just pulls off. One small snag, however (all these things seem to have "one small snag"!) when removing the top half of the case, the record-level meter does not remain behind on the chassis, as in some of the larger machines. It comes up with the cover. The leads are solid, not stranded flexible, and they break when the cover is turned over. I know. I broke 'em! Please, manufacturers, *don't* use solid wire for movable fittings—or, better still, don't move the bits. Fix them to the chassis where they'll stay put when doing the odd cleaning and oiling job, etc. Nothing is more annoying than having lumps hanging.

Since the above is just a plea to make the serviceman's life a happier one, and most of you will probably not want to see inside your recorder for years on end (modern lubrication being almost permanent), the comment is not intended as a deterrent. The recorder will, I'm sure, give lots of reliable fun to all future purchasers and is, in my opinion at its selling price of 28 guineas, one of the best bargains on the market today.

Manufacturer's Specifications

Supply: Mains only, at 110, 127, 200-250 volts, 50 or 60 cps.

Consumption: 25 watts (approx.).

Speed: 3½ ips.

Recording sense: Four tracks, left to right.

Amplifier: Transistorised.

Output: 700 mW.

Loudspeaker: Four-inch diameter, 3 to 7 ohms impedance, p.m.

Frequency response: 80-13,000 cps \pm 3 dB.

Inputs: Microphone 1,500 ohms, 0.4 mV; Radio 20 Kilohms, 2.0 mV; and Pick-up 680 Kilohms, 100.0 mV.

Outputs: Loudspeaker 3-7 ohms; Radio (or extension amplifier) 20 Kilohms, 1.5 v. Reel size: 5½ inch maximum.

Manufacturers: Cossor Radio and Television Co. Ltd., 233 Tottenham Court Road, London, W.1.

ARMCHAIR TRAVEL



with **Worldwide Tapetalk**

BRITAIN'S LARGEST & FRIENDLIEST
TAPE EXCHANGE.

S.A.E. for details to:— **WORLDWIDE TAPETALK (T.R.M.)**
35, THE GARDENS, HARROW, MIDDLESEX.

TUTOR-TAPES AVAILABLE AT REDUCED PRICES



Elementary Courses—£2 10s.
(3½ i.p.s.)

Comprehensive Courses—£5
(3½ i.p.s.)

Prices include one copy of
handbook

Full details sent on request. Free demon-
stration at our premises.

TUTOR-TAPE CO. LTD.

2 REPLINGHAM ROAD, LONDON, S.W.18
(Opposite Southfields Station) Tel: VAN 8787

Tape-to-Disc Services

RAPID Recording Service

78s and L.Ps. from your own tapes. (48 hour
service). Master Discs and pressings. Record-
ing Studio. Mobile Recording Van.

Associated Company—

EDUCATIONAL RECORDINGS LTD.

Specialists in Sleep-learning and Audio Learn-
ing. Tapes on Mind Management; Positive
Personality; Memory Training; How to Pass
Examinations. Manufacturers of the "Sleep-o-
matic Unit" to be used with our Sleep-learning
tape. Foreign language courses available for
sleep-learning.

Brochures on request from:—

RAPID RECORDING SERVICE (Dept., TRG)
21 Bishops Close, Walthamstow, E.17 COP 3889

IF QUALITY AND DURABILITY MATTER

(especially with LPs from your precious tape
recordings) consult Britain's oldest transfer
service.

If minimum 20 identical copies are required,
we can manufacture hard-wearing commercial
pressings with your own labels. (Excellent
fund-raiser.)

... also consult Audio Supply Association for
unbiased information on reliable recording and
reproduction equipment to suit your specific
requirements. Members receive information on
latest products and also benefit from special
bulk purchases of tapes, equipment, acces-
sories. (Membership 7s. 6d. p.a.). Please specify
requirements. Sixty-page Hi-Fi catalogue 4s. 6d.

SOUND NEWS PRODUCTIONS

10, Clifford Street, New Bond Street, London,
W.1. REG 2745.

SERVICE BUREAU

Hooking it up

By HARRY MACK

NINE-TENTHS of the fun of being a tape recording enthusiast comes from stringing together odd pieces of equipment, and kidding one's self that the lash-up so produced is in the nature of a serious scientific experiment.

The trouble is that very often we forget to be properly scientific—to take notes and measurements and compare results. Consequently, when the neighbour we so want to impress calls around, much face-losing time is spent in searching for what might—in more senses than one—be called "the lost c(h)ord."

The professionals get over this problem by linking up the disparate pieces of gear with 600 ohm line, at a small drive voltage and a fairly heavy peak current handling ability. Many domestic tape recorders have this "Line" output socket, with perhaps a couple of volts of signal available on playback, at 600 ohms impedance. Apart from its use as a monitoring output, it is seldom employed.

Standardisation reaches its limit in those demonstration consoles with which the more ambitious dealers attempt to seduce our cheque books. A bewildering array of equipment, forbiddingly new, is connected by hidden means to a control panel so that, at the flick of a switch, almost anything can be hooked up to anything else. All the fun

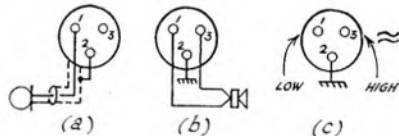

Fig. 1

is behind the scenes, in fact—and speaking as one who has enjoyed the task of linking the bits and pieces, I can vouch for the complexity, and the challenge, of some of the possible combinations.

At home, we are limited by the purse strings. Hence the letters we sometimes receive, asking whether we think such-and-such a hook-up will work. The reader is testing the water with our elbow before taking the plunge. We are always happy to hear of these problems, and do our best to advise.

Typical of the queries that regularly arrive was a letter from B.H. of Gloucester, who had acquired a Telefunken machine. He had no instruction booklet, and wanted

to know the correct connections to the sockets for pick-up and extension loud-speaker. Fortunately, the use of the D.I.N. plug and socket has become pretty well standardised on Continental equipment, and the connections shown in Fig. 1 provide a general guide. These are views from the rear of the socket (or, alternatively, looking at the actual pins of the plug).

Note that in each case the central pin (2) is taken to chassis, or system earth. Fig. 1a is a typical input socket, with microphone or pick-up input taken from pins 1 and 2. Fig. 1b shows one type of output socket, where the extension loudspeaker is loaded across pins 1 and 3, and Fig. 1c is the usual type of output socket which has a "Line" output facility for feeding an external amplifier, with the low impedance output between pins 1 and 2, and the 600 ohm output from pins 3 and 2.

Many domestic tape recorders employ the single-pole plus outer shield connection for the microphone input, as illustrated in Fig. 2. There are two difficulties here, as F. T. M. of Leeds discovered. The microphone cable may be single, or twin-screened. In either case, the screening goes to the outer shield of the plug. When used for this type of input, one of the inner pair of a twin-screened cable is also taken to the shield, and the other goes straight through the plug to the central pin. Care must be taken when soldering, not to allow the heat to "run back" along the wire and melt the rather thin insulation,

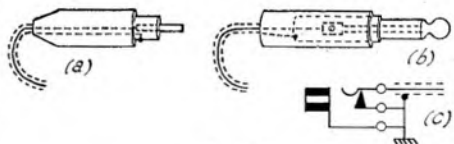

Fig. 2

causing an intermittent short-circuit. The best method is to measure carefully the amount of wire that needs to be bared, clean out the hollow pin thoroughly with a suitable piece of stiff wire as the iron is applied, tin the end of the microphone cable while using a heat shunt (holding the wire between soldering iron and insulation with a pair of pliers that will serve to dissipate the heat), then assemble and solder briefly to secure, finally cleaning any surplus solder from the outside of the plug by scraping gently with a knife blade, or by filing.

The standard jack plug, as shown in Fig. 2b, is pretty well self-explanatory. The inner cable goes to the fixing screw or solder point of the central part, which terminates in a threaded rod on which the end knob is screwed. An insulating collar divides this knob from the barrel, to which the outer screening is connected, and an outer grip-shield holds the whole together.

More confusing to some folks is the microphone socket, intended for the former type of "phono" plug. The theoretical method of depicting this is shown in Fig. 2c. It will be noted that the outer collar is taken to chassis, but the inner part, with which the central pin of the plug connects, has a kind of switch connection shorting it to chassis. The physical form this "switch" takes may be a spring blade, a tipped contact, or simply a bent piece of wire. The principle is merely that the end of the microphone plug pin pushes the contact at the top clear of the shorting contact, thus placing the microphone effectively between the upper contact and chassis.

There are two possible faults here, as J. T. Colne, discovered. The contacts can be insufficiently sprung together when the plug is removed, leaving an open-circuit across

the microphone input and possibly hum during playback (a fault which J.T. found strangely enhanced when he put his hand near the socket to operate the gain control). Alternatively, the short-circuit contact may be bent too close and the insertion of the microphone plug may not totally remove it, resulting in intermittent recording.

But we have digressed. Our main theme was the connection of equipment, with especial regard to matching. The great bugbear is a lack of standardisation on output and input levels.

Some tape recorders have a high impedance output up to two volts (2,000mV), others no more than a tenth of this. Some amplifiers will fully load with an input of 20mV; others require some 500 mV to give of their best. Connecting the two pieces of equipment needs more than a mere impedance match. It is necessary to know both output and input levels, and to allow for discrepancies. If the tape recorder output is too large, the input stage of the

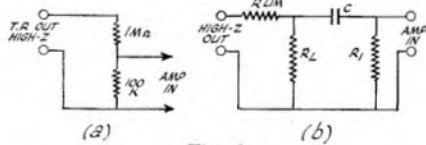

Fig. 3

amplifier will overload, with consequent distortion, unless precautions are taken. This is the more common case. The only time when the output of a tape recorder would be too low normally is when an attempt to drive a single output stage of, for instance, a radiogram, is made.

Overloading may not be immediately apparent. Turning down the tape recorder gain control is not necessarily the answer, for this decreases the signal-to-noise ratio, and gives rise to hum problems. If the gain has to be turned up on the amplifier, and down on the tape recorder, try the effect of attenuating the signal.

Easier said than done, commented A.C.I.G., Plymouth. How does one calculate the values of resistors to be used? If we merely place a potential divider across the output, tapping off an appropriate amount of signal, the value of resistor to do this may well be too small, and will shunt the input of the amplifier, as in Fig. 3a. Here, the problem of reducing by nine-tenths has been tackled, incorrectly, by putting a total resistance of ten units (one megohm) across the output, and tapping off one unit (100k) to feed the amplifier. Unfortunately, the amplifier input may need a higher impedance for correct matching. One megohm may be more realistic. But if we put ten megohms across the line output, the voltage transfer will be affected by the shunting of the output circuit. Remembering that this could well be the anode circuit of a valve amplifying stage, it is best to retain the correct loading at this point and attenuate externally.

This can be done by blocking the DC load from the output, by inserting a capacitor, then loading the amplifier correctly, with the high impedance (resistance) having less effect on the tape recorder output. Fig. 3b gives a plain attenuator circuit, with a reduction of nine-tenths. The danger here is the temptation to use the wrong value of capacitor—because it is handy. Note that C and R₁ form a time constant, which, if sufficiently low, can attenuate the bass too much. If RL is 10K, with the limited resistor R_{lim} 100K, and the amplifier requires one megohm loading, provided by R₁, then C needs to be at least 0.1 mfd.

Connecting an extension loudspeaker is less of a problem. But there are still one

or two pitfalls. First is the need for correct matching. Some tape recorders require a 15-ohm extension speaker; most use 3-ohms loading. This must be checked before the loudspeaker is connected, as the effect of connecting a 3-ohm speaker to a 15-ohm output terminal is to shunt the internal speaker, cutting down the output, and, more important, to risk blowing the external speaker inside output by the application of too much power.

The type of shorting socket shown in Fig. 2c., for microphone input connection, is used also for extension loudspeaker connection, with the difference that, instead of short-circuiting, the connections open-circuit the internal loudspeaker circuit when the extension plug is inserted. It is most important that the output valve is not operated without correct loading, and for this purpose, the extension loudspeaker should be connected correctly to its plug before this is inserted, where such a muting socket is employed.

Where several loudspeakers are to be used, various impedance combinations can be usefully joined up, always remembering that the power output is limited by that available from the amplifier (or tape recorder output). A popular method is to connect two or three extension loudspeakers in parallel, perhaps wired to different rooms, or corners of a hall.

In this case, the pitfall, as J.D., Solihull, found, is incorrect phasing. To put it briefly, all the cones must go inwards and come outwards together, or the sound waves tend to cancel. To check the phasing, simply place a flashlamp battery across the extension speaker leads before connecting up, mark positive and negative, noting whether the cone jumps inward or outward, and polarise the other loudspeaker leads in the same manner.

On the subject of polarisation, we come to the question of using a condenser microphone in place of a crystal type, or vice versa. Reader F.K.H., Bournemouth, met this problem, when he acquired a Grundig tape recorder minus the microphone.

The condenser microphone, as widely employed by Grundig, requires a polarising voltage. This is usually a DC voltage of about 100V, supplied from a well-smoothed, high impedance source. If a crystal microphone is connected directly to the input socket, damage could possibly occur to the crystal, and the polarising voltage must be disconnected. The connections to the

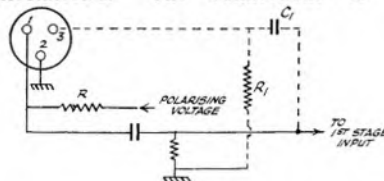

Fig. 4

D.I.N. socket are as shown in Fig. 4, where the pin 2 again goes to chassis and pin 1 to the first stage, but where a voltage is added, via limiting resistor R. This can be disconnected; but a better idea is to employ the unused pin 3, connecting the crystal microphone between 2 and 3, with the added matching components R₁ and C₁, so that both types of microphone could be used as required.

It is worth noting, in conclusion, that where a ribbon or moving coil microphone with matching transformer is connected to the input designed for a condenser microphone, the low DC resistance of the transformer winding effectively shunts the high impedance polarising source, and no further modification is needed. But matching must be preserved for optimum results.

WALLACE HEATON

Christmas presents

No problem!

Send for our 200 page catalogue of photo, radio, and tape recorders 2/6

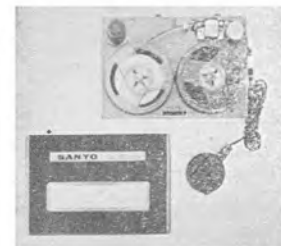

EVER POPULAR SANYO
POCKET TAPE RECORDER
NEW POPULAR PRICE

£11 - 11 - 0

Complete with tape, microphone and case. Recommended for speech recording.

NEW a quality pocket transistor radio by HITACHI £6 6 0

6 TRANSISTOR, MEDIUM WAVE, with case and earphone.

TRIONIC BABY ALARM £5. 19. 6

TRIONIC INTERCOM £4. 19. 6

(Batteries extra 3/9)

8mm SOUND STRIPE

● Continuous demonstrations Oct. 10th to Dec. 31st

● Write for full details on how to add SOUND TO YOUR OWN FILMS

93-4 FLEET ST., LONDON, E.C.4.

FLE 9391



YOUR LOCAL DEALER

In this feature you can check your nearest dealer who is a hi-fi specialist giving expert attention to tape equipment.

LONDON

HI-FI CENTRE

Branch of KINGS ELECTRONICS

178, HIGH STREET, E.17

Walthamstow's Leading
Stockist of all makes of.

**TAPE RECORDERS
AMPLIFIERS, TUNERS, etc.**

Free Demonstration in the
comfort of your own home

PHONE AMH 6242 or COP 4488

Lee Electronics

THE TAPE RECORDER & HI-FI AUDIO SPECIALISTS
400, EDGWARE ROAD, LONDON, W.2
London's leading Stockists of High-
Fidelity and Audio Equipment. Many
Bargains in new and reconditioned
Equipment

SEND FOR FREE LISTS OF RECORDING
TAPES, RECORDERS, AMPLIFIERS, ETC.

All Machines demonstrated for performance on Record
and Playback. All leading makes of Hi-Fi equipment
from stock

PADDINGTON 5521

- ★ TAPE RECORDER HIRE
- ★ TAPE TO DISC 78 & LP
- ★ RECORDING STUDIO
- ★ TAPE RECORDER
REPAIRS
- ★ SALES—EXCHANGES

MAGNEGRAPH

1, Hanway Place, London, W.1.
Tel.: LANgham 2156

Tape records reviewed

**A newcomer
and
an
old
favourite**

CLASSICS



By Edward
Greenfield

LALO—Symphonie Espagnole. **SARASATE**—Romanza Andaluza. Salvatore Accardo (violin) with the Padeloup Orchestra conducted by Herbert Albert. Saga (STG 8085), 3 $\frac{3}{4}$ ips, mono. 32s. 6d.

Salvatore Accardo is a young Italian in his early twenties. I had never heard of him before, but on this showing his rich centre-of-the-note playing promises very well indeed. He has plenty of youthful fire, too, for this colourful showpiece, and, incidentally, all five movements are included when often the Allegretto third movement is left out. The Sarasate piece, too, is an attractive fill-up.

Such playing deserves better recording. The soloist himself comes off well enough as he apparently was close to the microphone, but the orchestra is very backward indeed in a sort of low-fidelity fog. Admittedly, the solo playing is what matters more than anything, but it would have been nice to have a proper balance.

IVOR NOVELLO—"His Greatest Songs." Vanessa Lee, Marion Grimaldi, Julie Bryan, Ivor Emmanuel, the Williams Singers. Michael Collins and his Orchestra and the voice of Ivor Novello. HMV (TA-CLP 1258), 3 $\frac{3}{4}$ ips, mono. 35s.

The names of the singers are enough to commend the tape to Ivor Novello devotees, with Vanessa Lee in particular lending the right authenticity (as important to devotees of operetta as to archivists). The orchestrations by Brian Fahey and Ray Terry follow the traditional lush pattern which was exactly right for the deliberately sweet confection Novello favoured with his memorable tinkling tunes set to Christopher Hassall's expertly sentimental words.

I am sorry a heavier voice was not used for *We'll gather lilacs* (a picture of lilacs on the box by the way), but Marion Grimaldi sings very sweetly. The voice of Ivor Novello—featured prominently in the credits—comes in for a very brief moment in the last item, reciting first an unidentifiable phrase (I tried a dozen times) and then the words of *My dearest dear*, while in the background Julie Bryan croons the melody. The recording, made several years ago, is still very good.

MUSIC FROM PALM COURT. Palm Court Orchestra led by Alfred Sverdlöv. Saga (STG 8104), 3 $\frac{3}{4}$ ips, mono. 32s. 6d.

Introduced by the few inevitable bars of Strauss's *Waltzes from the South*, this is a characteristic Palm Court programme with a selection of Gilbert and Sullivan favourites, the Blue Danube, Poet and

Peasant and Liszt's Second Hungarian Rhapsody all reduced to tea-shop proportions. The selection is leavened with soprano solos by Enid Hartle—Cherry Ripe and Santa Lucia. It is very much background music, and I have no doubt many will find it both useful and attractive. I wish the recording was brighter.

"PRAISE MY SOUL"—Hymns Ancient and Modern. The Cantata Choir of St. Martin-in-the-Fields conducted by John Churchill. Saga (STG 8099), 3 $\frac{3}{4}$ ips, mono. 32s. 6d.

It was an excellent idea to collect favourite congregational hymns on a single tape. The presentation is straightforward with choir and organ conveying a simple church atmosphere. Naturally, the setting of stanzas is varied and—most welcome and exciting effect in any hymn-singing—we have some excellent descants in last verses—*Holy! Holy! Holy!*, *Praise to the Holiest*, *Thou whose Almighty Word*, and so on. Above all, the right tunes are used—or what I regard as the right tunes. There is nothing so annoying after looking forward to a favourite to find its effect emasculated in some unfamiliar new setting perversely preferred by the organist.

The one snag is the recording—rather distant and muffled under a low frequency range.

**Ella does
it
again
with this
record**

POPULAR



By Don
Wedge

ELLA SWINGS BRIGHTLY WITH NELSON. Ella Fitzgerald with Nelson Riddle. Verve (TA-VLP 9001), 3 $\frac{3}{4}$ ips, mono. 35s.

Ella Fitzgerald is back in the mood of the George Gershwin-Jerome Kern Song Book albums which brought her greatest success. They spanned both the jazz and pop fields, being accepted in both at the same time. She does it again with this record.

Nelson Riddle's arrangements are of his highest standard and worth listening to in themselves. This is a long record and there are substantial orchestral pieces on each of the twelve numbers.

The standard is so fantastically high it is hard to pick highlights. Certainly one of them is the rarely heard Duke Ellington number, *What am I here for*, which continued running around my brain long after I had finished playing the record.

THE SHADOWS' GREATEST HITS. Columbia (TA-33SX 1522), 3 $\frac{3}{4}$ ips, mono. 35s.

Though the Beatles are now the biggest attraction in pop music, the appeal of Cliff Richard and the Shadows has dimmed little. Here is a record for many older teenagers' Christmas list.

All the group's big successes are included. The exciting *Apache*, adventurous *Wonderful Land*, the novel *Guitar Tango* and the intriguing *Man of Mystery*, among the more notable.

The fifteen numbers include five written by various members of the Shadows, the

pretty *Midnight*, the wittily titled *36-24-36* and the cute *Stars fell on Stockton* which some day ought to have a book written about it!

In the public eye, the Shadows are often in the background compared with their resident singer, but this collection of their most successful recordings shows just how wide-ranging their work has been.

As well as *Frightened City*, there is *The Boys* film title song and *The Savage* from the first really successful British musical picture, *The Young Ones*.

GENE KRUPA MEETS BUDDY RICH. WRC (TT 248), 3½ ips, mono. 29s.

Gene Krupa and Buddy Rich have spanned the decades as the leading jazz drummers with the big swing bands and now the small jazz groups. They were members of many of Norman Granz's "Jazz at the Philharmonic" package shows, a feature of which was their drum duets.

Granz took them into a New York recording studio together for the first time. The result, this album, was first issued on his Clef label (on Columbia here) in the 50's and is now available on a tape through World Record Club.

The drummers are joined by a group of leading instrumentalists of the day. Oscar Peterson is the pianist and the trumpet section is made up of Dizzy Gillespie and Roy Eldridge!

The opening numbers on the two tracks, *Buddy's Blues* and *Gene's Blues*, are the compositions and major features for Rich and Krupa respectively. Though old, the record has an infectious quality that makes it a notable addition to jazz tapes.

CALL ME MISTER. Mr. Acker Bilk and his Paramount Jazz Band. Columbia (TA-33SX 1525), 3½ ips, mono. 35s.

Acker Bilk's fruity vocal chords set this record off to a warm start with *Manana Pasado Manana*, but afterwards the emphasis is on the band.

In the eleven numbers, Bilk only sings again once on *Home*, and there is one vocal from drummer Ron McKay, *Baby Brown*.

Bilk has his quiet clarinet solo on *When you Smile* which he wrote himself, but the majority of the tracks feature the lightly swinging trad band.

BORN FREE. Frank Ifield. Columbia (TA-33SX 1534), 3½ ips, mono. 35s.

The country-tinged voice of Frank Ifield gets a free rein on this album, mostly consisting of other peoples' hits, Hank Williams' *Cold Cold Heart*, Matt Monro's *My Kind of Girl* and Claude King's *Wolverton Mountain* among them.

Ifield's refreshing new version of the old Bing Crosby success *Please* would grace any hit parade. He gives it a completely new life.

I think he has great command over this type of song. He comes out best with *Riders in the sky*, though his most effective of the fourteen songs is the restrained *Scarlet Ribbons*.

DREAM A LITTLE. Nat King Cole. WRC (TT 315), 3½ ips, mono. 29s.

This is Cole living up to his reputation. Old records admittedly, but some superb performances.

The tapes reviewed this month are issued by the following companies:
 "HMV," "Columbia," "Verve": E.M.I. Records Ltd., 20, Manchester Square, London, W.1.
 "Recotape," Eastern Productions Ltd., 22, Coastal Chambers, Buckingham Palace Road, London, S.W.1.
 "Saga": Saga Records Ltd., 127, Kensal Road, London, W.10.
 "WRC": World Record Club, Box 11, Park-bridge House, The Little Green, Richmond, Surrey.

The whole of the first track, including the title song and other not-too-often-heard pieces, is by the King Cole Trio the original piano-bass-guitar group with which he laid the basis of his fame and success. One of the numbers, *Peaches*, is completely instrumental.

There is an abrupt change after the turn-over. Track two's opener, *Too soon*, has Nelson Riddle's strings enveloping Cole's satin voice. The next number, *Rough riding*, is even more mood shattering with conductor Dave Cavanaugh's powerful brass introduction.

As the record develops, Cole is also teamed with Les Baxter and Pete Rugolo in such rarely heard pieces *The Story of my Wife*, *Sleeping Beauty* and *Where Were you?* as well as an exceptionally good *Mother Nature and Father Time*.

Though the numbers were probably recorded many years ago, this King Cole record reigns happily among 1963's best releases.

BILLY AND SARAH. Billy Eckstein and Sarah Vaughan. WRC (TT 249), 3½ ips, mono. 29s.

Two of the finest singers of the day are teamed in four duets and four solo numbers each. When two artists are coupled on a record it is their joint contributions which should hold most interest.

Eckstein and Miss Vaughan start very well with *Dedicated to you* but it is really with their individual performances of *No Orchids for my Lady* and *What a Difference a day makes* respectively—that makes this record really worth having.

HOW TO SUCCEED IN BUSINESS WITHOUT REALLY TRYING. WRC (TT 322), 3½ ips, mono. 29s.

The World Record Club loses no time in up-dating its repertoire of London's stage musical successes.

"How to Succeed" does not have a strong score. None of the songs are really memorable, though many are cute (*Paris Original*), sensitive (*Happy to Keep his Dinner Warm*), clever (*A Secretary is not a toy*) or very funny (*The Company way*).

The show succeeds because it has so many laughs. Its satire is often sharp, is never cruel. It will run for a long time. If you have not seen it, this tape will be a suitable aperitif.

CONCERTO FOR MY LOVE. George Shearing with orchestra and choir. Capitol (TA-T 1755), 3½ ips, mono. 35s.

The magical combination of pianist Shearing, a large string orchestra and quiet ladies' voices, is back again with twelve more well-known songs.

It is a kind of dreamy music perfect for a dentist's surgery and could quieten the most harrassed nerves.

At least one dose ought to be in every record collection.

ORGAN FORGERIES. Jackie Brown.

Recotape (RML 108), 3½ ips, mono. 21s.

"The Mighty Wurlitzer," the great attraction at so many movie palaces of the '30's, produces an enormous amount of noise. Recotape marked a sizeable packet of it in this collection of signature tunes of Britain's best known organists, reproduced by Jackie Brown.

There is a wealth of nostalgia as the themes of such noted organists as Sandy Macpherson, Reginald Dixon, Joseph Seal, Reginald Foort and seven others are reproduced with considerable sympathy.

YOUR LOCAL DEALER

LONDON

Masseys Centre of Sound

West London's Hi-Fi Tape Recorder Specialist
 —Demonstration Room with Comparator
 APPOINTED FERROGRAPH DEALER

AT

CHISWICK, W.4

Accessories, All Kinds—Servicing—Pre-Recorded
 Tapes Mono/Stereo
 121-123 High Road—10 a.m.—7 p.m.

◀ TEL: CHI 2082 ▶

(not closed for lunch)

Leonard G. Francis presents—

SHEEN

TAPE RECORDER CENTRE LTD.

Specialists in Tape Recorders
 and Accessories etc.

—THE CENTRE FOR—

FRIENDLY HELP — SALES — SERVICE
 HOME DEMONSTRATIONS ANYTIME
 —MODELS FROM 19 GNS.—
 PRE-RECORDED TAPE: LANGUAGES
 DANCE CLASSICS JAZZ

CALL—WRITE—PHONE

8 Station Parade, Sheen Lane, Sheen,
 London, S.W.14 (next to Mortlake Station, S.R.)

Showrooms: PROSPECT 0985 10 a.m.—7 p.m.

THE SOUTH

HAMILTON

ELECTRONICS

HIGH FIDELITY
 TAPE RECORDERS

35 LONDON ROAD
SOUTHAMPTON

TELEPHONE 28622

PORTSMOUTH and SOUTHAMPTON

Tape Recorder Specialists

APPROVED AGENTS FOR:—
 PHILIPS - GRUNDIG - FERROGRAPH
 VORTEXION, ETC.

- ALL MAKES OF TAPE RECORDERS SUPPLIED
- ACCESSORIES AND HI-FI EQUIPMENT
- PART EXCHANGES AND SECOND-HAND MACHINES
- PROMPT AND SKILLED SERVICING

RECORDING MACHINES LTD.

299 Commercial Road, Portsmouth
 Telephone: 23097
 4 New Road, Southampton
 Telephone: 27092



**YOUR LOCAL
DEALER**

*In this feature you
can check your nearest
dealer who is a hi-fi
specialist giving expert
attention to tape equip-
ment.*

THE SOUTH

TAPE RECORDERS
(Bournemouth) LTD (Exeter)
Southern England's
Biggest Centres for
**PHILIPS . FERROGRAPH
GRUNDIG . TELEFUNKEN**
BRENNEL . AND ALL LEADING MAKES

Accessories by return Call, write or phone

THE TAPE RECORDER PEOPLE

874 Christchurch Rd., BOURNEMOUTH Tel. 45096
3 Seamoor Road, WESTBOURNE Tel. 64292
1 Sidwell Street, EXETER Tel. 75779

**WORTHING TAPE
RECORDER CENTRE**
22 New Broadway, West Worthing, Sussex
TAPE AND HI-FI SPECIALISTS
Agents for Vortexion, Ferrograph,
Fi-Cord, Truvox, Philips, Revox,
Butoba, Wyndors, Elizabethan,
Brenell, Loewe-Opta, Grundig,
Leak, Quad, Armstrong, Shirley,
S.T.C., Reslo.

REPAIRS. TERMS. EXCHANGES.
Telephone: WORTHING 9260

SCOTLAND

GLASGOW
Tape Recorder Specialists

APPROVED AGENTS FOR:—
PHILIPS - GRUNDIG - FERROGRAPH
VORTEXION, ETC.

- ALL MAKES OF TAPE RECORDERS SUPPLIED
- ACCESSORIES AND HI-FI EQUIPMENT
- PART EXCHANGES AND SECOND-HAND MACHINES
- PROMPT AND SKILLED SERVICING

RECORDING MACHINES LTD.
60 ST. VINCENT STREET, GLASGOW, C.2
Telephone: City 3847/8

NEW PRODUCTS

NEW 3-SPEED TAPE DECK ANNOUNCED

A COMPLETELY new design tape deck has been introduced by Lorlin Electronic, a company associated with the early Verdik tape deck. The new unit, the SB.26, is a three-speed, two- or four-track unit with mono or stereo versions.

Provision is made for fitting up to three heads. The tape speeds are $7\frac{1}{2}$, $3\frac{1}{2}$ and $1\frac{1}{2}$ ips, and it will accommodate up to seven-inch spools allowing a playing time of 64 minutes per track using standard-play tape (12,000 ft.) at the middle speed. Rewind for 1,200 ft. is achieved within 45 seconds. Three motors are employed for rewind, take-up and capstan drive. Press-button controls are for stop, record, fast wind and rewind. A slide button operates the solenoid-held mechanism to start the tape movement.

Other features include a four-digit rev. counter with rapid zero return, safety erase lock to prevent accidental erasure, pause control, solenoid-operated Ferrodo-lined brakes and mounting from horizontal to 45 degrees. Wow and flutter is rated at better than 0.1 per cent at $7\frac{1}{2}$ ips.

The Model SB.26 measures $13\frac{1}{4}$ x $12\frac{1}{4}$ with $1\frac{1}{2}$ inches clearance above top of cabinet board and five inches below. It weighs $18\frac{1}{2}$ lb. The finish is in dark grey and chrome or black and copper.

The four-track stereo version with three heads costs 39 guineas. Two-track mono, with three heads costs 31 guineas.

Lorlin Electronic Co. Limited, 23, Wardour Street, London, W.1.

SONY ANNOUNCE FOUR-TRACK STEREO MODEL

LATEST recorder to be introduced by Tellux Ltd. is the Sony TC 500 four-track stereophonic machine.

A wide range of facilities is available on this two-speed model (illustrated above), including the ability to operate the two channels independently. With this feature it is possible to record on track one, return to the start of the tape, record another programme on track three, and then play both programmes simultaneously.

The TC 500 will accommodate up to seven-inch spools, providing a playing time of 96 minutes per track using long-play tape at the slower speed of $3\frac{1}{2}$ ips. The quoted frequency response is 30-18,000 cps at $7\frac{1}{2}$ ips ($50-14,000 \pm 2$ dB), and 30-13,000 cps at $3\frac{1}{2}$ ips. Signal-to-noise ratio is rated at 50 dB, and wow and flutter at better than 0.15 per cent and 0.20 per cent respectively.

Among the features are facilities for mixing, monitoring and separate bass and treble controls, pause control, two meter-recording level indicators, digital rev. counter with automatic reset to zero, and

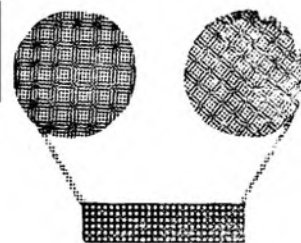

Sony TC 500

two detachable loudspeakers providing an output of three watts per channel.

Inputs are provided for microphone (high impedance) and auxiliary (high impedance). Outputs are provided for a monitor speaker (low impedance), line output (600 ohms) and stereo monitoring (low impedance).

Power requirements are 100, 110, 117, 125, 220 or 240 volts, 50/60 cycles, with consumption rated at 110 watts. Tube complement includes two 12AD7 (or 12AX7), two 6AU6, two 6AQ5, a 12BH7A and a 6CA4.

The recorder, including lid loudspeakers, measures $18\frac{1}{2}$ x $16\frac{1}{4}$ x $12\frac{1}{4}$ inches, and weighs 55 lb. The price is 106 guineas, complete with two cardioid dynamic microphones.

Tellux Limited, Avenue Works, Gallows Corner, Colchester Road, Romford, Essex.

ELECTRONIC WORLD INTRODUCE TRIPLE-PLAY TAPE

THE introduction of triple-play tape into the Electronic World range is announced.

Available in all reel sizes from three to seven inches, the new tape is described as stronger and more stretch-free than most DP tapes. Other changes in the Electronic World improved range includes PVC instead of acetate base for standard play tapes; the introduction of leader tape, trailer, and stop foil on four- to seven-inch reels; and polythene wrapping bags on all reels.

The new prices for their current range is as follows:—

Standard (PVC base): Three-inch (150 ft.), four for 18s.; 4-inch (300 ft.), four for 26s.; 5-inch (600 ft.), two for 26s.; $5\frac{1}{2}$ -inch (900 ft.), 16s. each; and 7-inch (1,200 ft.), 19s. each.

Long-play (Pre-stressed polyester base): Three-inch (225 ft.), four for 22s.; 4-inch (450 ft.), two for 21s.; 5-inch (900 ft.), two for 35s.; $5\frac{1}{2}$ -inch (1,200 ft.), 24s. each; 7-inch (1,800 ft.), 31s. each.

Double-play (Pre-stressed Polyester base): Three-inch (375 ft.), two for 20s.; 4-inch (600 ft.), two for 30s.; 5-inch (1,200 ft.), 27s. each; $5\frac{1}{2}$ -inch (1,800 ft.), 35s. each; and 7-inch (2,400 ft.), 45s. each.

Triple-play (Pre-stressed polyester base): Three-inch (475 ft.); two for 26s. 6d.; $3\frac{1}{2}$ -inch (650 ft.), 17s. each; 4-inch (900 ft.), 23s. 6d. each; 5-inch (1,700 ft.), 40s. each;

5½-inch (2,300 ft.), 52s. 6d. each; and 7-inch (3,300 ft.), 80s. each.

De Villiers (Electronic World) Limited, 16-20, Strutton Ground, London, S.W.1.

BULK ERASER FOR ANY SIZE REEL

A NEW bulk eraser has been introduced by Amos of Exeter. The new unit, illustrated below, is the Weircliffe Bulk Eraser, designed to provide a very fast, complete and foolproof method of erasing complete spools of tape, in a single operation, which can take as little as five seconds to perform.

Tapes are cleaned by inserting the reel of cassette into the receiving slot of the eraser. Spring-loaded guides and reject mechanism enable tapes to be cleaned at the rate of ten seconds per tape. A combined switch gate ensures that the instrument is only operational during the cleaning of each tape, so that there is no limit to the number of tapes that may be consecutively cleaned. Completely saturated tapes are cleaned equally effectively, and the unit can accommodate any size reel.

Two standard models are available. Model 6 is suitable for five-inch to 8½-inch reels, and model 7 accepts commercial



6½-inch and 8-inch continuous tape cassettes. Both models are housed in attractive rugged mahogany cases impregnated with clear Melamine to withstand hard wear. Normal operating voltage range is 200 v, 220-240 v, 50 cycles, but erasers can be supplied to order for any voltage.

The Weircliffe Bulk Eraser measures 11½ x 12½ x 7½ inches, weighs 33 lb. Intermittent current consumption is 14 amps. The price is £29.

Amos of Exeter Limited, Weircliffe Court, Exwick, Exeter, Devon.

BATTERY/MAINS RECORDER FROM JAPAN

LATEST of the Japanese-manufactured recorders to appear is the Sanyo battery and mains-operated S-61TMR (illustrated above).

This is a two-speed, 3½ and 1½ ips, two-track recorder selling at £37 16s. Accommodation for 3½-inch reels is given providing a playing time of up to an hour per track using triple-play tape at the slower speed. Rewind is accomplished within two minutes.

The quoted frequency response is 150-7,000 cps at 3½ ips, and 150-4,000 cps at 1½ ips. Output power is rated at one watt (800 mW undistorted) through the built-in 4 x 2½-inch elliptical 8 ohm loudspeaker.

Among the features of the TMR is a com-



bined meter recording level and battery life indicator; remote control facilities via the dynamic microphone; and mains power through the AC adaptor available for an extra three guineas.

Push-button controls are incorporated for start, stop and rewind in either direction. Other features include inputs for microphone and radio/pick-up, extension loudspeaker socket.

The power supply nine-volt DC (six flash-light batteries).

The TMR measures 10 x 8½ x 3 inches and weighs 5½ lb. excluding batteries. Including mains battery adaptor, leather carrying case, microphones and accessories case, full reel of tape and spare reel, microphone, magnetic earphone, recording lead and splicing tape, the TMR sells at 39 guineas. Other optional accessories include remote control footswitch and telephone pick-up.

Russell Richards Limited, 1, Dyers Buildings, Holborn, E.C.1.

NEW LONG-LIFE BATTERIES BY EVER-READY

FOUR or five times the life of standard batteries at present on the market is claimed for the new high power HP2 battery introduced by Ever-Ready. With dimensions similar to the U2, the HP2 will increase the long-term efficiency of battery-operated tape recorders giving more power for longer periods.

They will sell at 2s. 0d. each.

Ever-Ready Co. (Great Britain) Limited, Hercules Place, London, N.7.

PRICE REDUCTIONS

DENHAM & MORLEY LTD., U.K. agents for the Butoba battery portable tape recorders have announced a price-reduction for the MT7.

As from September 7 this unit is selling at 38 guineas instead of 44 guineas.

Denham & Morley Limited, Denmore House, 173-175, Cleveland Street, London, W.1.

AGFA LIMITED announce that the retail price of their PE 65 triple-play tape (3,600 ft. on a seven-inch spool) has been reduced in price from £6 13s. 9d. to £5 15s.

Agfa Limited, 27, Regent Street, London, S.W.1.

CORRECTION

IN the "New Products" section of our last issue we omitted to state that the Shaftesbury TR804 tape recorder is a four-track machine.

YOUR LOCAL DEALER

MIDLANDS

Audio Electronics (Midlands) Ltd.

Specialists in Dictation Mcs., Tape Recorders, Inter-Com., Tapes and Accessories

Full After Sales Service on all Equipment

PHILIPS, GRUNDIG, TRUVOX, ELIZABETHAN, ETC.

203 STAFFORD STREET, WALSALL.

Tel.: 21086

SOUND BUSINESS

Specialists in Sound Reproducing Equipment Stockists of Butoba, Grundig, Sony, Tandberg, Vortexion, etc.

Backed by a First-Class Service Department

TYSONIC

W. M. Tyson, M.Brit.I.R.E.
41 Russell St., Leamington Spa
phone 24935

THE NORTH

CUSSINS & LIGHT LTD.

YORK'S LEADING RADIO TV & ELECTRICAL STORE

Visit our First Floor TAPE RECORDER CENTRE

LARGEST RANGE OF RECORDERS & ACCESSORIES IN THE NORTH
KING'S SQ. YORK



TAPE RECORDER CENTRE (Halifax)

stock all the best tape recorders and hi-fi equipment. Agents for Revox, Tandberg, Ferrograph, etc. Demonstrations by expert staff. Two years' free service on recorders over £35.

30 King Cross St., Halifax. Phone 66832

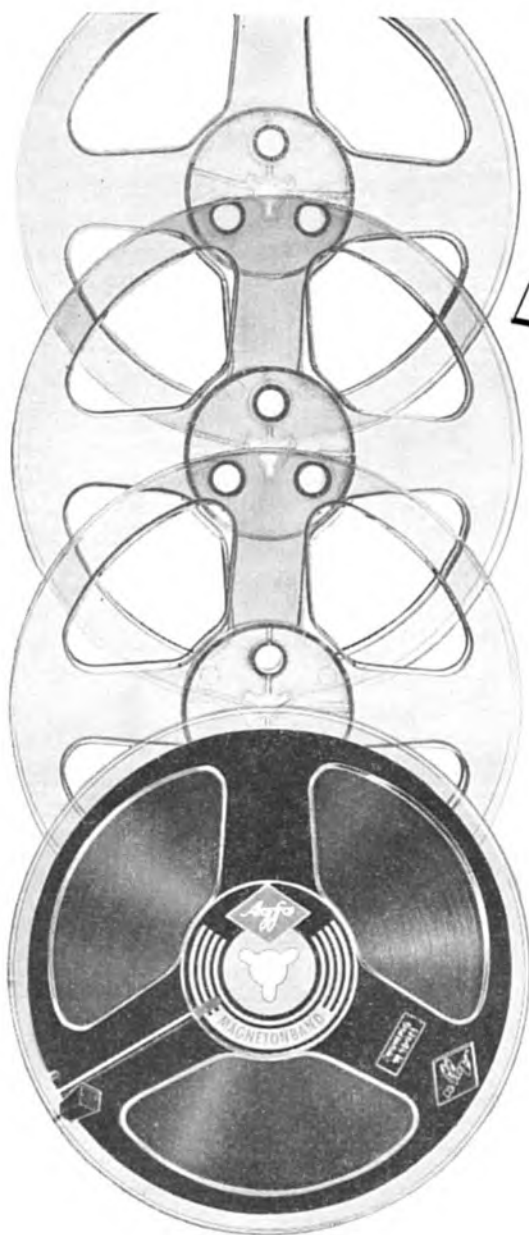

**three
into
one**

TRIPLE PLAY PE 65 TAPE

- * Lengthy operas can be recorded on a single spool without change of track.
- * Your battery recorder will play for three times as long.
- * Agfa triple play tape will not stretch, or break because it is pre-stressed during manufacture.



PE65 tape available on 3 · 4 · 4½ · 5 · 5½ & 7 inch spools
DEER PARK RD. LONDON SW17. CHERRYWOOD 1121



BIRMINGHAM

A four-channel mixer unit kit purchased by members was demonstrated at the October 21 meeting of the Birmingham club. The unit was built under the direction of club technical officer Brian Skinner who demonstrated it using Ferrograph and Stella recorders, two microphones and a disc record player.

Following initial help, including an advisory tape, to the pupils of a local Grammar school, members were invited to give a demonstration of their recording techniques. Mrs. Dawn Knee and Trevor Gilbert visited the school, and gave a sound and cine demonstration using a Revox recorder.

Another of the club's recent activities included a talk and demonstration on editing given by Mr. E. Walford. Whilst demonstrating the importance of preserving the natural rhythm of words and especially the length of gaps between words when one had been removed, he inadvertently cut off the final "m" sound on "some" when removing it from the sentence "some main road." Amends were made when he adroitly replaced the "m" with no audible difference.

For the remainder of the evening he demonstrated music editing, removing phrases and even single notes with a deceptive ease.

Secretary: J. T. Gilbert, "Woodcote," Box Trees Road, Dorridge, Solihull, Birmingham, Warwickshire.

BATH

The Bath society recently held its fourth AGM and elected a new secretary. They also announced a change of venue. Meetings are now held fortnightly as from October 30, at 24, Green Park, Bath.

A successful year was reported by the retiring committee; and plans were straightaway made for a series of location recordings to be made in the near future.

Secretary: R. J. Empson, 17, Lucklands Road, Weston Park, Weston, Bath, Somerset.

CATHOLIC TAPE RECORDERS

Since Catholic Tape Recorders of America developed itself into an international body, there has been a steady increase in British membership.

Mrs. Maura Warren, widow of George Warren, the original U.K. Representative, is now taking over the reins. In a recent letter she describes some of the activities of the club which includes the issue of a quarterly bulletin, and annual roster, and points out that there is no restriction for membership of the club on religious grounds. It helps, she writes, if you are interested, have a tape recorder, and are human.

U.K. Representative: Mrs. Maura Warren, 16a, Hendon Lane, Finchley, London, N.3.

COVENTRY

At the latest meeting of the Coventry club, members were hosts to members of the Warwick and Leamington society who shared their programme. Fourteen visitors attended to see Stan Day give a demonstration of his Ferrograph and Cyril Stanley demonstrate his home-built parabolic reflector. Among the examples shown by Cyril were a blackbird recorded close to a very busy main road, and a locomotive recorded from a distance of 400 yards. The Coventry part of the programme concluded with a look at Len Lucas' loudspeaker which was used to play some organ recordings.

The guests then took over with a tape/slide show of Scotland presented by Mr. Wilkinson who used a Philips

EL3585 battery portable recorder. The Warwick guest had made his recordings during the actual filming and he was congratulated on some high quality location recordings. He used a Sony recorder for his show.

For an earlier meeting sound effects were the order of the evening. Armed with such items as dinner forks, emery cloth, tea towel, tumbler, sugar and flour—to name just a couple—the members were able to attempt the creation of creaking doors, gates, thunder, and footsteps. Among the interesting and informative effects recorded, outstanding were said to be the wind and thunder by Mr. Atkins, and Rupert Gillard's footsteps, barefoot and otherwise.

The members are now in the midst of compiling a tape for the current production of the Brooklands Little Theatre Group.

Secretary: L. S. Day, 41, Moseley Avenue, Coventry, Warwickshire.

EAST GREENWICH

News of a new club formed in East Greenwich is announced by Charles "Rusty" Waghorn, of 98, Colomb Street, East Greenwich, London, S.E.10. Interested readers are invited to contact the secretary regarding the meeting times and dates.

ERITH

Another new club is announced, for Erith, where the South Reach Youth Centre has started a tape section. The group meets on alternate Tuesdays at the Youth Centre.

One of its first ventures was to establish a hospital service scheme. This began with the co-operation of an enthusiast in Natal, South Africa, who passed the group a message for a fourteen-year-old patient in Erith hospital from her sister and other relatives who she had not seen for a number of years.

First success of the club came with the award made to member Terence Brett whose recording of a local Grammar School choir received a First Class Star in the National Association of Boys' Club Arts and Crafts Festival.

Secretary: T. C. Butler, South Reach County Youth Centre, Manor Road, Erith, Kent.

GLASGOW

Members of the West of Scotland tape club in Glasgow have been busy recently, especially when they took over the programme arrangements from the committee members. A demonstration of tape loop production; a location recording made in Ireland; and a talk on frequency responses were among the programmes arranged. The latter talk was given by script-writers John and Peter Douglas. Lester Leighton also presented a disc-jockey show, and followed this with an explanation of his techniques.

The last meeting of the month was given over to a demonstration by a local dealer who exhibited recorders, loudspeakers and radio tuners.

Secretary: A. McCullum, 9, Glen Devon Square, Glasgow, E.3.

GLASGOW 2

A new club starting in Glasgow and affiliated to the Scottish Catholic Film Institute, is announced. Meetings are held in the Diocesan Centre at 14, Newton Place, Glasgow C.3, on the first Tuesday of every month.

Already the club compiles a monthly tape magazine which is distributed to hospital and homes throughout Glasgow and the West of Scotland. Members are also building up a tape library.

Secretary: Brian P. Geary, 12, Ascaig Crescent, Glasgow, S.W.2.

LEICESTER

A live recording session with a trio of piano, violin and cello was held in the Museum Art Gallery during a recent meeting of the Leicester club. Member J. Buckler recorded in mono and stereo on his Ferrographs 422 and Series 5, while members T. Billsdon

and J. Moule used their Philips EL3541 and Brenell Mk 5M recorders.

During September, the members were expecting to have a demonstration of the Truvox PD86 tape deck by J. Atkins, and a demonstration of equipment by the Leicester Radio Society. Members of the Hinkley club were invited to attend this latter show.

Secretary: Peter J. Starie, 43, Western Park Road, Leicester, Leicestershire.

LONDON

Another recent AGM, this time for the London club, Ken Blake vacated the chair in favour of Ron Tucker. During the evening a talk on Break-down, the "Tape of the Year" in the BATRC was given by one of its producers, Mike Avel (he writes about the tape on page 15 of this issue), and he also played it through for members.

For the club's next meeting, members welcome once again Mr. Richard Keen, producer of the "Sound" programme, who will be talking about and demonstrating "Editing—the tricks of the trade." A later meeting will include the first of a series of talks by members on how they use their recorders. This will be followed a month later by a visit from B.A.S.F. Chemicals Ltd.

Secretary: Douglas J. Morris, 80, Tangier Road, Richmond, Surrey.

MIDLANDS ASSOCIATION

The Association of Midland Tape Recording Clubs held its first outing during September. Members from two clubs in Birmingham and another in Kidderminster travelled to the Wild Fowl Trust at Slimbridge where they met the Rugby club members. Before returning home after a brilliantly sunny afternoon's filming and recording, the party visited an historic castle at Berkeley.

Since its formation, the Association has enrolled all but three of the Midland clubs as members. Their bi-monthly bulletin has proved very successful, and plans are now afoot to organise their first tape competition. Secretary: J. T. Gilbert, "Woodcote," Box Trees Road, Dorridge, Solihull, Warwickshire.

SHEERNESS

The Sheerness club members announce that they now meet on the first Thursday of each month at 9, St. George's Avenue, Sheerness.

Secretary: C. D. Bushnell, 19, Harps Avenue, Minster, Sheerness, Kent.

THORNTON HEATH

Members of the Thornton Heath club are now able to relax a little after the pressure of the full summer schedule of fêtes and carnivals in which it has taken part. Two of their mobile units have been in constant demand, and the club has received many complimentary letters from the organisers they have assisted.

By arrangement with the manufacturers two Global Speed erasers have been tried and tested by members who were well pleased with the new product. A report with constructive criticism has been sent to the manufacturers. Kodak Ltd. have also made available samples of their new standard and triple-play-tapes, and these are undergoing practical tests on mains and battery-operated machines.

The November club contest took the form of an appreciation and criticism of the Network Three programme "Sound" on the British Amateur Tape Recording Contest. G. M. Webb gained most points. The competition was followed by a playthrough of the winning entries received from Roger Aslin, secretary of the Federation of British Tape Recording Clubs. The extract version with judges comments had been played on a previous club night.

Recent demonstrations have been given to the members by Messrs. Grundig (G.B.) Ltd., Planet Projects, and Clyne Stern Radio. The latter two companies combined to give a demonstration of matched pre-amplifiers,

amplifiers and Goodman speakers operating with the Planet decks. Their winter programme is filling up, and the next expected visitor will be Mr. Wilson of B.A.S.F. Chemicals Ltd.

The club's latest contest on "How to advertise the club" was won, surprisingly, by the publicity officer, Mr. J. Bradley.

Secretary: E. J. Bashford, 4, Dunheved Road North, Thornton Heath, Surrey.

WOOLWICH

The Woolwich tape club announces that meetings are now being held every Thursday in the New Eltham Public Library, starting at 7.30 p.m.

Secretary: Stan Byfield, 62, West Park, Mottingham, London, S.E.9.

TAPE EXCHANGES

Tape recorder owners who wish to contact others with similar interests, to exchange news and views by tape are invited to fill in and return the form shown on page 38, giving their name, age, address, special hobby or interest for this section.

Details given here also include speeds and spool size to be used, name of recorder, and special area to be contacted.

Benfield, Michael G. (24). 34, Campbell Road, Southsea, Hampshire. Dramatics, recording, music. 7½, 3½, 1½. 7-inch spool. Grundig TK20, Robuk RK3. **Overseas.**

Black, Derek (26). 3, Viewforth Square, Edinburgh 10, Scotland. 3½ ips. 5½-inch spool. Elizabethan. **Overseas.**

Bradford, F. H. (38). Hillview, Trellissick Road, Hayle, Cornwall. Psychic research, literature, classical music. 7½, 3½ ips. 8½-inch spool. Ferrograph 5. Female contacts preferred.

Brain, Reverend D. (42). 40, The Crescent, Lancing, Sussex. Bible study, church activities. 3½ ips. 7-inch spool. Philips. **USA, Canada.**

Carr, Christopher J. (32). 28, Eastry Road, Erith, Kent. Philately, railroad folk songs. 3½ ips. 7-inch spool. Stella 454, four-track. **USA, Fiji, Mauritius.**

Clayton, Jack (23). 406, Middleton Road, Oldham, Lancashire. Photography, cinema. 15, 7½, 3½, 1½ ips. 8½-inch spool. Brenell Mark 5M, Grundig TK24, Stella. **England.**

Cox, Stanley H. (34). 67, Elford Grove, Harehills, Leeds 8, Yorkshire. Recording films, books, records. 7½, 3½, 1½ ips. 7-inch spool. Philips EL3585, Grundig TK20, Sony 521, stereo.

Crossfield, Joseph L. (21). Hellingly Hospital, Hailsham, Sussex. 35mm. Photography, dancing, jazz. 3½ ips. 5½-inch spool. Kolster-Brande, four-track. **Jamaica, UK, France.**

Dando, D. J. (42). 11, Whitepost Hill, Redhill, Surrey. Radio construction. 3½ ips. 7-inch spool. Philips EL3541/H. **South-East England.**

Devlin, Gary (23). 8, Roushdown Villas, Boxmoor, Hertfordshire. Films, music. 7½, 3½, 1½ ips. 5½-inch spool. Civic, two-track. **USA, USSR.**

Dyke, Alec P. (35). 164, Gill Avenue, Fishponds, Bristol. Brass and military bands. 3½ ips. 5½-inch spool. Grundig TK20, Grundig Cub, Walter 303. **Australia, New Zealand.**

Fletcher, Edward (26). 16, Guan Soon Avenue, Singapore, Malaya (RAF). 8mm cine, electronics, karting, guitar, music. 7½, 3½, 1½ ips. 7-inch spool. Tandberg "7". Letters not required.

Gammot, Thomas (47). 16, Chestnut Court, Curzon Crescent, Willesden, London, N.W.10. 35mm photography, hi-fi, music. 7½, 3½ ips. 7-inch spool. Simon SP4. **USA, UK.**

Hardingham, James (27). 396, Norwich Road, Ipswich, Suffolk. Sound effects, humour, jazz, pop music. 7½, 3½, 1½, 15/16 ips. 7-inch spool. Philips EL3549, four-track.

(Continued on page 42)

CLASSIFIED ADVERTISEMENTS

Rate—Sixpence per word (minimum 5s.); Trade, ninepence per word (minimum 10s.); box numbers, one shilling extra. Payment with copy. Copy should be sent to Advertising Department, "Tape Recording Magazine," 7, Tudor Street, London, E.C.4.

TAPE RECORDS

FOREIGN LANGUAGES ON TAPE from 38s. 6d. French, Italian, Spanish, German, Russian. Full money-back guarantee.—S.A.E., Visaphone Co. Ltd., 28, Brookland Hill, London, N.W.11.

PRE-RECORDED TAPES. Unique complete catalogue listing all makes, Mono, Stereo, 7½ and 3½ ips, including World Record Club tapes. Call for FREE copy or send 1s. mailing fee.—Dept. T.R.I., Teletape Ltd., 33, Edgware Road, W.2. PAD 1942.

TAPE RECORDINGS. World-famous Hypnotist and Harley Street Psychoanalyst, W. J. Ousby (Instructional recordings). For increasing confidence and Overcoming Inferiorities, Lessening Nervous Tension, also instruction courses on Self-Hypnosis and Auto-Suggestion. Send name and address for list of Mr. Ousby's tape recordings. Details sent in plain envelope without obligation. W. J. Ousby, Home Farm Estate, Northchurch, Berkhamsted, Hertfordshire.

Taped "Sound Effects" No. 1, 35 Sounds, 1 Hour. "Light Switch" to "Thunder Storm." 3½ ips 32s. 8d. 7½ ips 42s. 2 Track Monaural. Global Products, 13, Stanley Street, Rothwell, Northants.

TAPE EXCHANGES

(Continued from page 41)

Harper, Arthur W. (35). D3, Renown House, Lake Chad, Gibraltar. English and Spanish languages, all music, general interests. 3½ ips. 5½-inch spool. Grundig TK23, four-track.

Harrison, J. (28). 16, Holmwood Drive, Leicester. Films, recording, reading, all music. 15, 7½, 3½, 1½ ips. 8½-inch spool. Brenell Mk 5M. Male contacts only.

Hooke, David (27). 11, Arundel Square, Barnsbury, London, N.7. Photography, films, all music. 3½ ips. 5-inch spool. Grundig recorder. Male contacts only. Letters first please.

Hoyle, Ted (54). 37, Highbury Road, Meanwood, Leeds 6, Yorkshire. Photography, mechanics, building, cars. 3½ ips. 3-inch spool. Clarion recorder.

Holland.

Hurst, Nicholas (28). 123a, Fencible Road, Hainault, Ilford, Essex. 8mm photography, politics, music. 7½ ips. 7-inch spool. Grundig recorder.

Sweden, USA.

Jones, Miss Doris (32). 20, Main Bay Road, Pukerua Bay, Wellington, New Zealand. Travel, cinema, theatre. 7½, 3½, 1½ ips. 7-inch spool. Collaro Studio. North London.

NEW EQUIPMENT

Ferrograph 5 A/N, 422 and 424, Revox E36, etc., always in stock, City and Essex Tape Recorder Centres. (See page 8).

TAPE RECORDERS. SAVE FROM 30 per cent to 60 per cent on the original price. Large stocks of second-hand, new, shop soiled machines. All guaranteed. Obtainable on our **NO INTEREST TERMS.** Best part exchange allowances on your existing equipment. CALL, WRITE, PHONE today for free list. Quotation and details. Our Mail Order covers the whole Country.—R. E. W. Earlsfield Ltd., 266, Upper Tooting Road, London, S.W.17. Balham 7710.

TAPE SPLICING, easy with Easy-splice Splicer, guaranteed, 5s. Scotch Boy Splicing Tape, 3s. P. & P., 6d. Easysplice Manufacturers, 30, Lawrence Road, Ealing.

£10,000 worth of Hi-Fi equipment and Tape Recorder accessories. Due to purchase of wholesaler's entire stock we can offer hundreds of bargains in pickups, cartridges, diamond styli, microphones, tape accessories at greatly reduced prices. Send 3d. stamp for comprehensive lists. Lee Electronics, 400, Edgware Road, London, W.2. PAD-dington 5521.

SITUATIONS VACANT

ELECTRONIC ENGINEERS required for the maintenance of professional tape recording equipment and all associated test gear. Applicants must have a sound basic electronic knowledge. Experience on audio equipment an advantage. Please write giving details of age and experience quoting ref. 1/T/2 to: Group Personnel Manager, 04213/F, E.M.I. Limited, Hayes, Middlesex.

Lock, N. R. (30). 115, Standard Road, Hounslow, Middlesex. Driving, swimming, reading. 3½, 1½ ips. 3-inch spool. Santo portable recorder.

MacKenzie, Miss N. M. (40). 25, Higher Compton Road, Hartley, Plymouth, Devon. Travel, sailing, fashion, novels. 7½, 3½, 1½ ips. 7-inch spool. Grundig TK41. France.

Nash, Pete (22). 6, Devon Square, Newton Abbot, Devon. Photography, swimming, jazz music. 7½, 3½, 1½ ips. 7-inch spool. Philips, four-track.

Orritt, John. 28, Park Avenue, Rushton, Northamptonshire. Stereo, still and cine photography, camping, music. 7½, 1½ ips. 7-inch spool. Telefunken 97.

Oxley, Geoff (42). 13, Cromarty Avenue, Crosland Hill, Huddersfield, Yorkshire. 35mm photography, Italian language, classical music. 7½, 3½ ips. 8½-inch spool. Ferrograph 422. **UK and Italy.**

Page, Miss Molly (41). 41, Bushway, Dagenham, Essex. Gardening, conversation, music. 3½ ips. 5½-inch spool. Elpico.

Rennie, John (28). 12m, Ronald Street, Coatbridge, Scotland. Photography, travel, books, music. 3½ ips. 5½-inch spool. Grundig TK20.

Seward, Mr. D. L. J. (22). 663, Harrow Road, Wembley, Middlesex. Sound effects, films, humour, classical and pop music. 7½, 3½ ips. 7-inch spool. Simon SP5, stereo, Philips EL3542. America, New Zealand.

TAPE TO DISC

TAPE-TO-DISC RECORDING SERVICE. All speeds. 50-minute LPs. Photographic sleeves with all recordings.—E.R.S., 162, Shirland Road, London, W.9.

J. & B. RECORDINGS, Tape/disc. Mobile unit. Quality recording. 14, Willows Avenue, Morden, Surrey. Mitcham 9952.

JOHN HASSELL RECORDINGS. Tape to Disc. Studio and mobile services.—21, Nassau Road, London, S.W.13. Riverside 7150.

TAPE TO DISC RECORDING Reduced prices. Finest professional quality. 10-inch LP—35s. (32 mins.), 12-inch LP—40s. (45 mins.), 7-inch EP—17s. 6d.

48-HOUR POSTAL SERVICE S.a.e. for leaflet to Deroy Sound Service, 52, Hest Bank Lane, Hest Bank, Lancaster. Tel.: H.B. 2444.

MAGNETIC TAPE

A UNIQUE BUY! Recording tape top brand, 5½ in., 1,200 ft., 19s. 6d.; 7 in., 2,400 ft., D.P., 28s. 6d. P. & F., 1s. 6d. per spool. Bargains in all sizes. S.A.E. for list. E. C. Kingsley & Co., 132, Tottenham Court Road, London, W.1. EUSton 6500.

TAPE, 7 in., 2,400 ft. Mylar, 27s. 6d. David Cavalier, 17, Leigh Park Road, Leigh-on-Sea.

TAPES POST FREE. High quality low price. Long play PVC 4 in. 450 ft. 8s. 6d.; 5 in. 900 ft. 12s. 6d.; 5½ in. 1,200 ft. 16s.; 7 in. 1,800 ft. 22s. 6d.; Double play polyester 3 in. 400 ft. 9s.; 4 in. 600 ft. 12s.; 5 in. 1,200 ft. 20s.; 5½ in. 1,800 ft. 28s.; 7 in. 2,400 ft. 36s.; Discount on four or more. Refund guarantee. M.S. Recording Tapes (Dept. T.M.) 21, Hoyle Street, Radcliffe, Manchester. Also at Tottington, Lancs.

Try Japanese Tape, costs nearly half normal, same quality. Details: A. Nathan, 1, Crick Road, Oxford.

What is Jay Williams doing now?—see advertisement on page 43.

MISCELLANEOUS

8 mm. Home Movies. Send 1s. for fully illustrated catalogue. (Dept. 31), Mountain Films Ltd., 1, New Burlington Street, London, W.1.

Good cash prices for tape recorders —Tel: Maryland 5879. (See page 8).

HIGHEST CASH PRICES offered for good quality Tape Recorders and Hi-Fi. See our advert page 43 this issue. R.E.W., 266-8, Upper Tooting Road, London, S.W.17.

Recorder need repairing? Then let City and Essex Tape Recorder Centres do it for you expertly and economically. (See page 8).

SOUND EFFECTS. 45 r.p.m. EP CASTLE & CONTRAST records, 7s. 6d. plus 6d. stamp each. Mixed effects, Animals, Trains, Electronic Sounds and Music, etc. 3d. stamp for list to Recorded Tuition Limited, 174, Maybank Road, South Woodford, London, E.18.

The book with everything. **MODERN TAPE RECORDING**—fun, games, stunts, effects, creative techniques, club organising, interviewing... perfect Christmas present, 31s. S.a.e. details. World Audio, 136, Brockley Grove, London, S.E.4.

Underpillow Speakers. Listen without disturbing others. 3 in. x 5 in., 15 ohms, £2 11s. 6d. Timer Unit, designed especially for whisper teaching. Famous make. Three on/off periods in 24 hours. 13 amp. 200/240 v., comp., plugs, etc., £5 13s. 3d. "Sleep Learning"—the book essential for all go-ahead people. Send 6s. 6d. to York House, Dept. B., Huddersfield.

We specialise in Tape Recorder and Hi-Fi repairs and offer a speedy service. Telesonic Limited, 92, Tottenham Court Road, London, W.1. MUS 8177. Leading Hi-Fi Dealers.

TAPE EXCHANGES

Calling WWTT172, Edmonton; WWTT381, Singapore; WWTT429, Takamatsu; WWTT80, Sidney; WWTT706, Durban; WWTT666, Kuwait; WWTT393, Cape Town; and WORLDWIDE TAPETALK Stations everywhere; Festive Greetings and A Happy Tapetalking 1964. WWTT:HQ, 35, The Gardens, Harrow.

FRIENDLY FOLK ASSOCIATION, Torquay (Est. 1943). Social introductions, Pen-friends, Book-lovers, Stamps, Photography. Tapesponding. Members 100 countries.

Make friends anywhere, by taping and by correspondence. Age 17 upwards. Send now for interesting free details: The Friendly Bureau (Registered), 43, Clifford Road, Walsley, Cheshire.

Make interesting new friends UK and overseas, all ages. Join Victory Club, 34, Honeywell Road, London, S.W.11. Details free. Established 20 years.

WANTED

WANTED FOR CASH. Good quality tape recorders and audio equipment—Part exchanges—Sales—Recording Services. Magnograph, 1, Hanway Place, Oxford Street, London, W.1. Tel: LANzham 2156.

WANTED—Elizabethan Auxiliary amplifier for model FMT 3. Details: 18, Highclere Street, Sydenham, London, S.E.26.

INDEX TO ADVERTISERS

| | |
|---|-----------|
| A. Brown & Sons | 46 |
| A. C. Farnell Ltd. | 10 |
| Agfa Ltd. | 40 |
| Audio Electronics (Midlands) Ltd. | 39 |
| Armstrong Audio Ltd. | 43 |
| B.A.S.F. Chemicals Ltd. Back Cover | |
| Berean Forward Movement | 51 |
| Brenell Engineering Co. Ltd. | 3 |
| C. Braddock Ltd. | 4 |
| Chateau Productions Ltd. | 10 |
| City & Essex Tape Recorder Centres | 8 and 19 |
| Cossor Radio & Television Ltd. | 32 |
| Cussins & Light Ltd. | 39 |
| Daystrom Ltd. | 44 |
| De Villiers (Electronic World) Ltd. | 29 |
| Educational Recordings Ltd. | 50 |
| E.M.I. Records Ltd. | 45 |
| E.M.I. Tape Ltd. | 12 |
| Fleord International | 28 |
| Francis of Streatham | 44 |
| Freedmans Musical Instruments | 46 |
| Global Products | 50 |
| Grampan Reproducers Ltd. | 46 |
| Grundig (Great Britain) Ltd. | 9 |
| Hamilton Electronics | 37 |
| Hi-Fi Centre Ltd. | 36 |
| Highgate Acoustics Ltd. | 11 |
| Howards Tape Recorders | 2 |
| J. J. Francis (Wood Green) Ltd. | 51 |
| J. Williams & Co. | 43 |
| Lee Electronics | 36 |
| Lustraphone Ltd. | 43 |
| Magnograph | 36 |
| Massey's Centre of Sound | 37 |
| Minitape | 51 |
| Minnesota Mining & Manufacturing Co. Ltd. | 22 |
| Philips Electrical Ltd. | 7 |
| Rapid Recording Service | 34 |
| Recording Machines Ltd. (Glasgow) | 38 |
| Recording Machines Ltd. (Portsmouth) | 37 |
| Rent A Tape (Recordings) Ltd. | 51 |
| Resolound Ltd. | 5 |
| R.E.W. (Earlsfield) Ltd. | 10 |
| Shen Tape Recorder Centre Ltd. | 37 |
| Soundcraft Magnetics Ltd. | 16 |
| Sound News Productions | 34 |
| Standard Telephones & Cables Ltd. Stereolectrics Ltd. | 24 |
| Tape Recorders (Bournemouth) Ltd. | 50 |
| Tape Recorder Centre (Halifax) | 39 |
| Tellux Ltd. | 6 |
| The Ferrograph Co. Ltd. | 13 |
| The Recorder Co. | 4 |
| Tutor Tape Co. Ltd. | 34 |
| Tysonic | 39 |
| Ultra Radio & Television Ltd. | 48 |
| Wallace Heaton | 35 |
| Welmeec Corporation Ltd. | 47 |
| World Record Club | 26 and 27 |
| Worldwide Tapetalk | 34 |
| Worthing Tape Recorder Centre Ltd. | 38 |

Tape recorder owners wishing to make contact with others of similar interests are invited to complete and return this form. (BLOCK LETTERS PLEASE)

Name Age

Address

Special interests

Speeds to be used Maximum spool size

Recorder owned

Special areas to be contacted

(Unless otherwise stated, I am prepared to accept tapes from any part of the world)

**INEXPENSIVE
BASIS OF
A COMPLETE
HI-FI SYSTEM**

**WITH FACILITIES FOR
TAPE RECORDING
AND PLAY-BACK**

Armstrong

**STEREO 55
TUNER AMPLIFIER
CHASSIS**

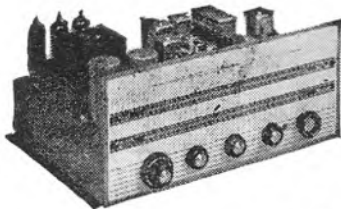

One compact chassis combines AM and FM tuners, Stereo Control Unit and two Power Amplifiers used together so that up to 10 watts output is available. Provision for tape recording and play-back is made with a choice of inputs for crystal or ceramic pick-ups including the Decca Deram. The facilities are also available for use with a tape deck and its associated pre-amplifier.

Price..... £29 18 0

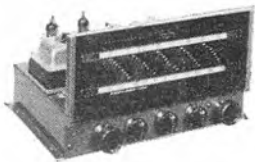

**AF 208 AM/FM
CHASSIS**

A high quality tuner amplifier chassis which can be used for the conversion of an existing radiogram or as the basis for building a new radiogram or reproducing system. A system which can include tape recording and play-back as well as the normal AM and FM radio and record reproduction.

Price..... £21 4 0

Write for descriptive literature to

ARMSTRONG AUDIO LTD.

(Dept. TDC) Warlters Road, London, N.7. Tel: NORTH 3213

LUSTRAPHONE

— the foremost name in microphones



**RIBBONETTE
MICROPHONE**

A pencil ribbon microphone giving the highest standard of monaural or stereophonic reproduction, the Ribbonette by Lustraphone is a really high-quality product.



**LAVALIER
MICROPHONE**

With an adjustable halter neck to leave the hands free, the Lavalier by Lustraphone is a most efficient dynamic microphone, equally effective indoors or outdoors.

Send for fully illustrated literature



LUSTRAPHONE LIMITED

(Dept TM1) St George's Works, Regent's Park Road, London, NW1. PR1mrose 8844/516

NOW JAY WILLIAMS OFFERS

TAPES BY RETURN

MAIL ORDER SERVICE

- Jay Williams full guarantee and until 1st January, 1964:—
- Free—Tape Index with every order
- Free—Recording Manual with orders over 40s.

FOR A "TAPE BY RETURN" POST YOUR COUPON TODAY

BASF NORMAL RETAIL PRICES magnetophonband

STANDARD PLAY

3in. 150ft. 7/6
4in. 300ft. 13/6
5in. 600ft. 21/-
5½in. 900ft. 28/-
7in. 1200ft. 35/-

LONG PLAY

3in. 210ft. 9/-
4in. 450ft. 14/6
5in. 900ft. 28/-
5½in. 1200ft. 35/-
7in. 1800ft. 50/-

DOUBLE PLAY

3in. 300ft. 14/-
4in. 600ft. 25/-
5in. 1200ft. 42/-
5½in. 1800ft. 55/-
7in. 2400ft. 77/6

TRIPLE PLAY

3in. 450ft. 22/-
4in. 900ft. 39/-
5in. 1800ft. 66/-
5½in. 2400ft. 90/-
7in. 3600ft. 115/-

J. WILLIAMS & COMPANY
208 Hagley Road, Birmingham 16

I enclose remittance for £ : s. d. Post Free

NAME.....

ADDRESS.....

BLOCK LETTERS. Cash with Order. C.O.D. 2/6 extra

FRANCIS OF STREATHAM

| | |
|---------------------------------------|---|
| *Brenell STB/I Stereo... £120 | *Telefunken 97 Stereo... 95 gns. |
| *Akai M6 Stereo ... 89 gns. | *Telefunken 98 Stereo... 95 gns. |
| *Brenell Mk. V. Model M 88 gns. | Truvox Series 60, 1/2 & 1/4 Tr. 39 gns. |
| *Brenell Mk. V. Series 2 69 gns. | Truvox Series 80/2 Tr. 55 gns. |
| Cossor 4 Tr. 1604 2Sp ... 39 gns. | Truvox Series 80/4 Tr. 59 gns. |
| Cossor 4 Tr. 1605 ... 62 gns. | *Vortexion WVA ... £93.13.0 |
| Cossor 4 Tr. 1603 ... 28 gns. | *Vortexion WVB ... £110.3.0 |
| Elizabethan Popular ... 22 gns. | *Vortexion C Stereo ... £148.10.0 |
| Elizabethan LZ. 30 ... 32 gns. | *Vortexion CBL ... £160 |
| Elizabethan LZ. 29 ... 36 gns. | Wyndorsor Trident ... 33 gns. |
| Ferguson 3200 ... 26 gns. | |
| Ferguson 3202 2Sp 4 Tr. 33 gns. | |
| *Ferrograph Series V ... 85 gns. | |
| *Ferrograph 422 or 424 110 gns. | |
| Fidelity Argyll Minor ... 22 gns. | |
| Grundig TK14 ... 35 gns. | |
| Grundig TK18 Magic Ear ... 39 gns. | |
| Grundig TK23 ... 45 gns. | |
| Grundig TK40 ... 75 gns. | |
| Grundig TK41 ... 75 gns. | |
| *Grundig TK46 Stereo... 99 gns. | |
| Loewe Opta 403 2Sp ... 45 gns. | |
| Philips 4 Tr. "Starmaker" 27 gns. | |
| Philips 4 Tr. 3541/H ... 42 gns. | |
| Philips 4 Tr. 3549 ... 62 gns. | |
| Philips 4 Tr. Stereo 3534 92 gns. | |
| *Rectograph 'A' 1/2 Tr. 105 gns. | |
| Robuk ... 36 gns. | |
| *Simon SP5 ... 93 gns. | |
| Sony Stereo 464 ... 75 gns. | |
| Sony 1/2 and 1/4 Track 521... 89 gns. | |
| Stella 4 Tr. 454 ... 38 gns. | |
| Stella 4 Tr. 459 ... 62 gns. | |
| Stella 458 2Sp 4 Tr. ... 39 gns. | |
| *Tandberg Series 6 ... 110 gns. | |
| *Tandberg Series 7 ... 93 gns. | |
| *Telefunken 85 de-luxe 83 gns. | |
| *Telefunken 95 ... 59 gns. | |
| *Telefunken 96 4 Tr. ... 69 gns. | |

BATTERY PORTABLES

| |
|---------------------------------|
| Philips Portable ... 24 gns. |
| *Butoba ... 66 gns. |
| Clarion Phonotrix ... 19 gns. |
| *Fi-Cord 202 ... 66 gns. |
| Stella ... 25 gns. |
| Stuzzi Memo-Cord ... 25 gns. |
| Loewe Opta 414 Bt./Mns. 47 gns. |
| Uher 4000/s ... 93 gns. |
| Cossor ... 25 gns. |

*Microphone extra

TRUVOX DECKS with Pre-Amps

| |
|-----------------------------------|
| PD 82—Standard Twin Tr. £42.0.0 |
| PD 84—Standard 4 Tr. £46.0.0 |
| PD 83—Professional 2 Tr. £48.10.0 |
| PD 85—Professional 4 Tr. £52.10.0 |
| PD 86—Pro. 4 Tr. St. ... £63.0.0 |
| PD 87—Pro. 2 Tr. St. ... £63.0.0 |

Also by Brenell and Wright and Weaire

MAINS POWER PACKS

| |
|-----------------------------------|
| Philips, Cossor, Stella... £5.0.0 |
| Grundig... 8 gns. |
| Butoba... 11 gns. |
| Fi-Cord ... £7.10.0 |

LEADING STOCKISTS OF EQUIPMENT FOR TAPE and HI-FI

... and NO EXTRA FOR CREDIT TERMS

- ★ Minimum Deposit
- ★ No Interest or Service Charges on H.P. up to 18 months
- ★ Free Service during Guarantee Period

Prices subject to alteration as announced by manufacturers

- MICROPHONES, MIXERS etc.
 - Gramplan Reflector ... £6.0.0
 - Gramplan Ribbon ... £11.10.0
 - Gramplan DP/4 Dynamic £8.0.0
 - Lustraphone Ribbon ... £7.17.6
 - Lustraphone LFV/59 ... £8.18.6
 - Simon 'Cadenza' Ribbon £10.10.0
 - Reslo Dynamic Cardioid £10.15.6
 - Reslo Ribbon ... £10.2.0
 - Reslo Pencil Ribbon ... £8.0.0
 - A.K.G. D.19c. Mic. ... £17.10.0
 - A.K.G. Stereo D.77a Low Z £15.10.0
 - A.K.G. K.50 Headphones £7.10.0
 - Grundig Stereo Mixer 18 gns.
 - TSL 3 Channel Mixer £27.6
- Microphones by ACOS, and TELEFUNKEN All Walgain Products. Brenell and Philips mixers.

- TAPES & ACCESSORIES
 - Standard, Double Play, Long Play and Triple Play in all sizes by all leading makers.

- Deflexers by Walgain, Wearite.
 - Pre-recorded Tapes by Columbia, H.M.V., Saga, Music on Tape, etc.
 - Bib, Bond and E.M.I. splicers.
 - Matching transformers. Plugs, sockets, etc.

Hi-Fi Dept.

- STEREO AND MONO AMPLIFIERS
 - Quad Scott Chapman
 - Tripletone Aveyley Leak
 - Rogers Armstrong B. & O. H.M.V. Pye Eagle
- TUNERS by
 - Quad Rogers B. & O. Chapman
 - Leak Armstrong Pye H.M.V. Tripletone Aveyley
- LOUDSPEAKERS
 - Quad Pye Philips W.B. Colrad Wharfedale Goodmans Tannoy Leak Lockwood Lowther Kef Rogers Mordaunt
- MOTORS, PICKUPS,
 - Garrard Tannoy
 - Goldring-Lenco Connoisseur Shure Decca Stereo A.D.C. Decca'Deram' Philips Acos Ronette B. & O. E.M.I. SME Mk. II Ortofon Thorens Pickering Eagle BSR

All types of Diamond and Sapphire styli, stereo and mono. Microlifts, Garrard, Goldring, Acos Pressure Gauges; Disc Preener, Acos Dust Bag

● CABINETS Record Housing and GKD

169-173 STREATHAM HIGH ROAD, LONDON, S.W.16

Between St. Leonard's Church and Streatham Station

STReatham 0466/0192

FOR ALL MUSIC LOVERS AND HI-FI ENTHUSIASTS

We offer a wide range of different models including Radios, Speakers, Amplifiers and Test Instruments



Hear our Hi-Fi demonstrations at the D.I.Y. EXHIBITION, OLYMPIA, Aug. 30-Sept. 14

Save Money Building Your own Equipment!



TA-IS

TAPE AMPLIFIER UNITS: Models TA-1M and TA-IS. The mono version, TA-1M, can be modified to the stereo version, TA-IS, by the modification kit TA-1C. Special features include bias level control, recording level indicators. Printe circuit boards.

TA-1C £6.15.0. TA-1M £19.2.6. TA-IS £24.10.0.



S-33

HI-FI STEREO 6 W AMPLIFIER Model S-33
Only 0.3% distortion at 2 1/2 w/chl. £13.7.6.

DE-LUXE STEREO AMPLIFIER Model S-33H

De-Luxe version of the S-33 with two tone grey perspex panel. With higher sensitivity necessary to accept the Decca Deram pick up. £15.17.6.

HI-FI FM TUNER Model FM-4U

Available in two units. Tuning unit (FMT-4U £2.15.0 incl. P.T.). I.F. amplifier (FMA-4U £12.6.0). Printed circuit for I.F. Amplifier and Ratio detector own built-in power supply, 7 valves. Tuning range, 88-108 Mc/s. Total price £15.1.0.

HI-FI AM/FM TUNER. Model AFM-1.
Also available in two units as above: Tuning heart (AFM-T1 £4.13.6 inc. P.T.) and I.F. amplifier (AFM-A1 £20.13.0). Total £25.6.6.

HI-FI STEREO 18W AMPLIFIER Model S-99
Within its power rating, this handsome looking amplifier is the finest available. U/L push-pull output. Printed circuit board construction. £27.19.6.



AM FM TUNER



S-99

We guarantee that without any previous experience—you can build any of our models.

All orders delivered free U.K. ● ALL MODELS AVAILABLE ASSEMBLED—PRICES ON REQUEST ● Deferred terms available U.K. over £10

EQUIPMENT CABINETS

A range of equipment cabinets is available including kits, ready assembled cabinets or assembled and fully finished cabinets. Why not send for full details free of any obligation?

Prices from £6.19.6. to £29.8.0.

TRUVOX TAPE DECKS.

Models D83-2 D83-4

High quality stereo Tape Decks.

D83-2 2 track for higher fidelity £31.10.0.

D83-4 (identical presentation) 4 track. £29.8.0.



TRUVOX D83



MALVERN



COTSWOLD



STUDIO

COTSWOLD & MFS SPEAKER SYSTEMS
The "Cotswold" is an acoustically designed enclosure 26" x 23" x 14 1/2" with 3 speakers covering the full frequency range 30-20,000 c/s. The "Cotswold" MFS. A minimum floor space model size 36" high x 16 1/2" x 14" deep. Price either model £23.4.0.

COLLARO "STUDIO" TAPE DECK

This stylish tape transcriber is by far the best "buy" in its price range, with 3 speeds 1 1/2, 3 1/2, 7 1/2 i.p.s. £17.10.0.

Without obligation please send me

FREE BRITISH HEATHKIT CATALOGUE

Full details of Model(s)

Name

Address

(Block capitals please)



AMERICAN HEATHKIT CATALOGUE SHOWING RANGE of over 250 models and full details of direct mail order scheme for only 1/- post paid, write to:

DAYSTROM LTD.

Dept. T9
Gloucester, England.



THE MIKADO
H.M.V. TA-CLP1592/3



NEW WORLD SYMPHONY
COLUMBIA TA-33SX1025



MADAM BUTTERFLY
H.M.V. TA-CLP1334



RACHMANINOV PIANO CON. No 2
H.M.V. TA-CLP1478



SWAN LAKE
H.M.V. TA-CLP1018

THE BIGGEST CHOICE IS ON E.M.I. 3 3/4 I.P.S. MONO TWIN TRACK TAPE RECORDS



BLITZ!
H.M.V. TA-CLP1569



THE MERRY WIDOW
H.M.V. TA-CLP1226



SEMPRINI
H.M.V. TA-CLP1137



THE SOUND OF MUSIC
H.M.V. TA-CLP1453



BOBBY DARIN
CAPITOL TA-T1791



THE KING AND I
CAPITOL TA-W740



PEGGY LEE/SHEARING
CAPITOL TA-T1219



FRANK SINATRA
CAPITOL TA-W1491



SHIRLEY BASSEY
COLUMBIA TA-33SX1178



MR. ACKER BILK
COLUMBIA TA-33SX1493



RUSS CONWAY
COLUMBIA TA-33SX1464



CLIFF RICHARD
and THE SHADOWS
COLUMBIA TA-33SX1472



BEYOND THE FRINGE
PARLOPHONE TA-PMC1145



CONNIE FRANCIS
M-G-M TA-MGM-C870



GIGI
M-G-M TA-MGM-C770



EARTHA KITT
M-G-M TA-MGM-C878



BOBBY VEE
LIBERTY TA-LBY1112



FERRANTE AND TEICHER
UNITED ARTISTS TA-ULP1010

Ask your dealer for
FREE leaflet giving
full details of the
many other tape
records available, or
write to the address
below



THE GREATEST RECORDING
ORGANISATION IN THE WORLD

E.M.I. RECORDS LTD., DEPT. T, E.M.I. HOUSE, 20 MANCHESTER SQUARE LONDON W.1.

TAPE RECORDER COVERS



Smart, waterproof cover to give complete protection to your tape recorder. Made from rubberised canvas in navy, wine, tan, grey and bottle green with white contrasting pipings, reinforced base, handy zip microphone pocket and name panel.

| | |
|--------------------------------------|-------|
| Cossor 1602 | 57/6 |
| " 1601 | 63/- |
| Stella ST455 | 63/- |
| " ST454 | 57/6 |
| Saja MK.5 | 57/6 |
| Stuzzi Tricorder | 58/- |
| Saba | 63/- |
| Wyndson Viscount | 55/* |
| " Victor | 60/* |
| Elizabethan Princess | 60/- |
| " Avon | 60/- |
| " Escort | 57/6* |
| " Major | 63/- |
| " FT.1 | 66/- |
| " FT.3 | † |
| Fi-Cord | 52/6 |
| Korting (4 track stereo) | 63/- |
| Harting Stereo | 66/- |
| Fidelity Argyle | 55/* |
| Walter 101 | 55/- |
| Simon SP4 | 63/* |
| Clarion (complete with strap) | 52/6 |
| Brenell Mk.5 | 77/- |
| " 3 star | 69/- |
| Minivox | † |

| | |
|----------------------|------|
| Grundig TK.5 | 55/- |
| " TK.8 | 63/- |
| " TK.20 | 52/6 |
| " TK.24 | 55/- |
| " TK.25 | 55/- |
| " TK.30 | 60/- |
| " TK.35 | 63/- |
| " TK.50 | 60/- |
| " TK.55 | 63/- |
| " TK.60 | 75/* |
| " TK.830/3D | 63/- |
| " Cub | 35/- |
| Telefunken 85 | 60/* |
| " 85 | 65/- |
| " 75/15 | 55/- |
| " 76K | 55/- |
| " 77K | † |
| Philips 8108 | 57/6 |
| " 8109 | 63/- |
| " EL3538 | 63/- |
| " EL3542 | 63/- |
| " EL3536 | 70/* |
| " EL3515 | 57/6 |
| " EL3541/15 | 57/6 |

A. BROWN & SONS LTD.

24-28, GEORGE STREET, HULL Tel: 25413, 25412

HOW GOOD?

Does your microphone match your recorder? Remember — it's impossible to get out better than you put in! We can offer an unrivalled selection of the very best microphones and accessories on **VERY EASY TERMS.**

SEND NOW for free brochures on Shure, A.K.G., Reslo, Gramplan and many others.

AUDIO DEPARTMENT



534 HIGH ROAD, LEYTONSTONE, E.II.
Telephone: LEYtonstone 4789.

Alive to every sound



Like the ears of this wary fox, the Gramplan DP4 microphone is sensitive to an extremely wide range of sounds. With its uniform frequency response from 50 to 15,000 c/s, the reliable, medium-priced DP4 will greatly improve the standard of your recordings.

Gramplan DP4

—also for broadcasting, public address and call systems.

Low impedance microphone, complete with connector and 18 ft. screened lead **£8.0.0.**
Medium and high impedance models . . . **£9.0.0.**

A complete range of stands, swivel holders, reflectors and other accessories is available.

GRAMPIAN— sounds like the real thing!

Write or phone for illustrated leaflets:

GRAMPIAN REPRODUCERS LTD

Hanworth Trading Estate, Feltham, Middlesex. Feltham 2657





It's tense in the studio before the tapes begin to roll
(and Telefunken stands by to capture every sound in thrilling high-fidelity)

THERE IS A LOT of work to be done, and after the musicians and artists have left, Telefunken's work still continues. No wonder that top studio engineers like Telefunken, it's the machine the professionals trust. Precision-made, capturing every sound and nuance, they are the perfect instruments for the job. And you can't achieve *that* overnight. Telefunken made the world's first

tape-recorders, and their long experience is built into every machine. Telefunken were first, and they still are, manufacturing tape-recorders with studio features for you to have at home.

Telefunken manufacture a wide range of tape-recorders and accessories for amateur and professional use.

Call in at your dealer and hear them

demonstrated. Examine their ease of operation. See how easily they will integrate into your present sound system. Telefunken will amaze you with its sheer breadth of range, the fidelity of its reproduction. There is a Telefunken tape-recorder for you, equal in quality to your favourite music.

Telefunken has sound quality taped.

There is a range of 6 models from 43 gns to 95 gns. Write for free descriptive brochure and price-list to:—

WELMEC CORPORATION LIMITED
 27 CHANCERY LANE · LONDON WC2
 Telephone: CHAncery 9944



TELEFUNKEN



**YOU NEVER THOUGHT YOU'D BE
ABLE TO BUY A 2 SPEED/4 TRACK
TAPE RECORDER LIKE THIS FOR
ONLY 33 GNS!!!!!!!!!!!!!!!!!!!!**

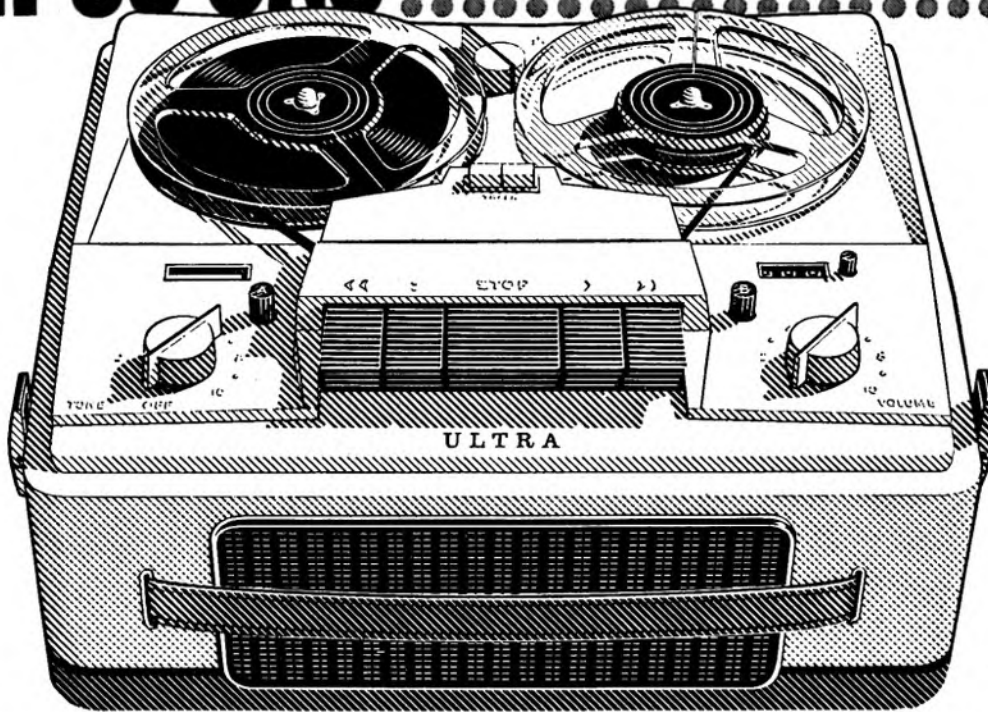

Only Ultra could have given you all these fabulous features for 33 gns: the tape economy of 4 tracks and 2 speeds, fascinating 2-track replay, mixing and superimposing effects, instant start/stop button on microphone, programme indicator, radio/pick-up recording and many other facilities. All these in a fabulously styled tape recorder with a choice of cream and coffee or scarlet and grey two-tone leather-cloth finish with exciting satin-silver trim!

Get your dealer to
demonstrate it or
write for
colour folder to

ULTRA

Ultra Radio and
Television Ltd
Television House
Eastcote Ruislip Middlesex

How would you get on to tape the sound of a storm at sea? . . . or a ghost in a haunted house? . . . or a man splashing through a sea of mud?

Answers, in simple language, to these and many other sound effects problems are given by Alan Edward Beeby in

SOUND EFFECTS ON TAPE

the latest in our series of handbooks for the tape recording enthusiast.

PRICE 3s 6d (post free)
(USA \$0.75)

AVAILABLE FROM 7, TUDOR STREET, LONDON, E.C.4

Others in the series

ADVICE ON BUYING A TAPE RECORDER

J. F. Ling
2/6 (post free) (U.S.A. \$0.65)

INTRODUCTION TO THE TAPE RECORDER

Charles Langton
3/6 (post free) (U.S.A. \$0.75)

HI-FI FOR THE MUSIC LOVER

Edward Greenfield
3/- (post free) (U.S.A. \$0.70)

TAPE AND CINE

John Aldred
3/- (post free) (U.S.A. \$0.70)

HOW TO RECORD WEDDINGS

Paul Addinsell
3/- (post free) (U.S.A. \$0.70)

ADVERTISMENT INQUIRIES SERVICE

I should like further information about the

.....
.....
(product) mentioned on page.....of the
..... issue of TAPE
Recording Magazine.

NAME
ADDRESS

December 1963

This is a special service for readers of TAPE Recording Magazine. It enables you—without cost—to get fuller information about those products in which you are particularly interested. Fill in one coupon below for each inquiry, with your name and address in block capitals in each case. Then cut out the whole of this section, following the dotted line, fold as indicated overleaf and post to us.

I should like further information about the

.....
.....
(product) mentioned on page.....of the
..... issue of TAPE
Recording Magazine.

NAME
ADDRESS

December 1963

I should like further information about the

.....
.....
(product) mentioned on page.....of the
..... issue of TAPE
Recording Magazine.

NAME
ADDRESS

December 1963

I should like further information about the

.....
.....
(product) mentioned on page.....of the
..... issue of TAPE
Recording Magazine.

NAME
ADDRESS

December 1963

GLOBAL PRODUCTS

A stamped addressed envelope will bring you details of the following equipment:—

“Bulk Tape Eraser and Head Demagnetizer.” “Tape Splicer (All Metal).” (Trade inquiries welcomed.)
 Canadian “Bel Clear” Recording Tape.
 Standard. 5” 600’ 12/6. 7” 1200’ 18/6.
 Long Play. 5” 900’ 15/-. 5½” 1200’ 18/6. 7” 1800’ 25/-.
 Also Double Play Tape. 7” 2400’ 34/-.
 Postage 1/- per spool. Three or more post free
 13, STANLEY STREET, ROTHWELL, NORTHANTS

TAPE RECORDING AND HI-FI

By the Editor of TAPE Recording Magazine

The best available introductory guide
 160 pages, 40 illustrations. 13s. 3d. (including postage)
 from Tape, 7, Tudor Street, London, E.C.4

COMPLETE “SLEEPOMATIC” UNIT FOR ONLY £20

Comprising transistorised tape machine, auto time-switch, microphone, batteries, and under-pillow speaker.

INTERESTING FREE BOOKLET

and details of our range of tapes, discs, and equipment gladly sent on receipt of postcard.

(We are the pioneers of Automated Sleep-learning in Gt. Britain)

EDUCATIONAL RECORDINGS LTD., (Dept. T.G.)

21 Bishops Close, Church Lane, London, E.17

Invitation to Sound Reality

High Fidelity Equipment should bring to you the closest possible approach to the original sound . . . but in choosing we have to bear in mind your own individual requirements.

Let us assist you with a well chosen selection of equipment which can give you quick and accurate comparisons under the right conditions.

Specialist in High Fidelity Sound.

H. D. KIRK *Stereolectrics* **LIMITED**

Phone: 23093

150 HIGHER BRIDGE STREET

BOLTON

CUT ALONG DOTTED LINE

POSTAGE
WILL BE
PAID BY
PRINT AND
PRESS
SERVICES
LIMITED

THIRD FOLD HERE

**TAPE RECORDING MAGAZINE,
7, TUDOR STREET,
LONDON, E.C.4**

BUSINESS REPLY FOLDER
Licence No. ND 922

SECOND FOLD HERE

NO POSTAGE
STAMP
NECESSARY
IF POSTED
IN GREAT
BRITAIN OR
NORTHERN
IRELAND

FLAP A

FLAP B

FIRST FOLD ALONG THIS LINE

Fold along lines as indicated and then tuck Flap A into Flap B

J. J. FRANCIS (WOOD GREEN) LTD.

☆
☆
☆
S
E
R
V
I
C
E

A
F
T
E
R

S
A
L
E
S

☆
☆
☆

WHAT A RECORDER!

YOU COULD NOT BUY BETTER!

NOW WE ARE GIVING

DEMONSTRATIONS ON THIS

SUPERB MACHINE OF

OUTSTANDING QUALITY AND

REGARDING THE PRICE, ITS ONLY **33** GNS FOR 2 TRACK

35 GNS FOR 4 TRACK



Send for a descriptive leaflet on this remarkable machine

J. J. FRANCIS (WOOD GREEN) LTD. BOWes Pk.
123 Alexandra Road, Hornsey, N.8. 1662

£10

ALLOWANCE ON
YOUR OLD RECORDER
REGARDLESS OF
CONDITION IN PART
EXCHANGE

The Berean Forward Movement

(NON-SECTARIAN
NON-DENOMINATIONAL)

Loan of over 850 reliable expositions of the Bible available on tape (3½ ips) for cost of postage only (free to the blind and infirm). Invaluable to all Christians, from teachers to tyros; for Bible Study groups or private meditation. Supporting literature also available. Send for free, complete list of tapes and literature to *B.F.M., "Eastgrove," Marsham Way, Gerrards Cross, Bucks.*

"LISTEN AND LEARN"

*Pre-Recorded Study Tapes for Accountancy,
Secretarial and Commercial Students*

The ideal way to Study and Revise. Saves hours of Study. Our Tape Library covers all the examination subjects. Prepared by Qualified Accountants and Secretaries. The Tapes can be rented or purchased at very low cost.

Write now for free brochure "Listen and Learn" to

RENT-A-TAPE (Recordings) Limited
Northfield Lane, Brixham, S. Devon

THE MINITAPE

Has the pleasure to offer Top Quality
Magnetic Recording tape—in attractive boxes
in the following sizes:

On 3in. Spools

225ft. long play P.V.C. with leader **3s. 6d.** each.

300ft. long play P.V.C. with leader **4s. 9d.** each.

450 ft. extra long play fully tensitised **6s. 11d.** each.

On 4 in. Spools

450ft. extended play with leader **6s. 6d.** each.

600ft. double play with leader **9s. 6d.** each.

850ft. extra double play with leader **19s. 6d.** each.

Postage 1s. 6d. extra unless more than 3 tapes ordered.

Delivery is immediate upon receiving the remittance
and money is refunded if not satisfactory.

MINITAPE

18, LANDSDOWN PLACE, LEWES, SUSSEX

**BASF HAS YOUR
CHRISTMAS PRESENT
PROBLEM TAPED**



BASF LETTER TAPES

Your friends will be delighted to actually hear from you this Christmas. Use a BASF Letter Tape specially made for mailing. Only 5/6d.



**BASF LIBRARY BOXES WITH
1 OR 3 TAPES**

Holds three tapes in swivel open cassettes to provide a quick reference library, and to protect tapes from dust or damage. From 31/-.



BASF TAPES

The Connoisseur's specification for quality recordings. There is in the range a tape for any type of recorder.

TAPE CUTTER BOX

A complete kit containing everything needed for editing tape. 52/6.



TAPE MANUAL

A complete guide to tape recording. Clear diagrams and illustrations make it an invaluable aid. 1/6d.



**-SYMBOL OF
AUTHENTIC SOUND**

FOR FURTHER DETAILS WRITE TO:

BASF CHEMICALS LIMITED, 5a GILLESPIE ROAD, LONDON, N.5. TEL: CANONBURY 2011