

TAPE

RECORDING
AND HI-FI MAGAZINE

Elizabethan

Some people want a superb recorder
and buy the Essex. Some want an exquisite console
and select the Mayfair. Many buy the
Escort, because it's versatile and simple. A whole
lot are buying the sensational new
Bandbox—neat, small, 2 speeds, 29 gns.
*Everybody who wants the best in tape recorders
is bound to buy Elizabethan*

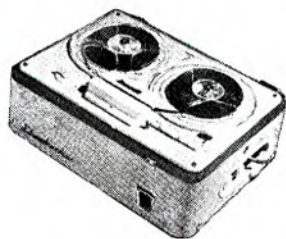

The Elizabethan Escort, 45 gns. complete

ⓔⓐⓅ SEE US AT THE AUDIO FAIR · DEMONSTRATION ROOM 219 · BOOTH 52 ⓔⓐⓅ

Elizabethan

BRITAIN'S LEADING PUBLICATION IN THIS FIELD



HI-FI

**BTH EXPERIENCE
BRINGS OUT THE BEST
IN SOUND REPRODUCTION**

CONTROL PANEL

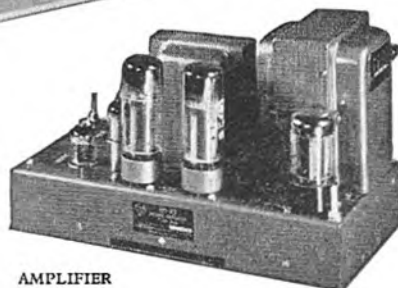

AMPLIFIER



The most brilliant disc or tape recording is wasted unless it can be brilliantly reproduced. The thousands of Hi-Fi enthusiasts who visited the 1958 Radio Show were most impressed by the results achieved with the new BTH equipment. Designed by Mr. James Moir, M.I.E.E., the control unit and amplifier give entirely new standards of stereophonic or single-channel reproduction. Behind this achievement is 30 years' BTH experience in building the highest quality sound reproduction equipment for cinemas and public buildings. At the Festival of Britain in 1951, it was BTH who first introduced the public to stereophonic sound.

THESE FEATURES ARE UNIQUE

Infinitely-variable cut-off constant-slope filter provides the best adjustment for individual records or radio programmes. High sensitivity inputs available for direct connection to tape head or pick-up without the need for additional pre-amplifiers. Separate low sensitivity inputs for disc or tape also provided. Printed circuits ensure reliability and negligible background noise. Output is 20 watts with very low harmonic and intermodulation distortion at full power. Built-in compensation for disc and tape recording characteristics is automatically selected by the input switch. The amplifier covers the entire audio frequency range and has separate bass and treble controls.

A range of matching loudspeakers is also available.



SEND FOR DESCRIPTIVE LITERATURE

Control Panel and Amplifier £42 AVAILABLE DIRECT FROM STOCK

HEAR IT—AND YOU'LL CHOOSE BTH

BTH SOUND EQUIPMENT LTD

CROWN HOUSE, ALDWYCH, LONDON, W.C.2.



Journey through music

One of the blessings of owning a Grundig is the extent to which it widens your knowledge of music. With a Grundig you can look beyond the obvious and explore—and there is much to explore even with a composer whom you know well.

Delius is a case in point. To most of us the music of Delius is unmistakably English in character. Tranquil, evocative, beautiful, as in the scenes by the river in “The Walk to the Paradise Gardens”. But what about “Sea Drift”? Still Delius but a different Delius. How do you know you will like it? It needs more than a single hearing.

With a Grundig you can record it, live with it and then judge. If you decide against including it in your collection the decision costs you nothing. You simply record another work over it *on the same tape* and continue to explore.

Get the best out of Music....get a

GRUNDIG

GRUNDIG (Great Britain) LTD.

*Advertising & Showrooms : 39/41 NEW OXFORD STREET, LONDON, W.C.1.
Trade enquiries to: NEWLANDS PARK, SYDENHAM, LONDON, S.E.26.
(Electronics Division, Gas Purification & Chemical Co. Limited)*

GS 153



C. Q.
Junior

Most Hi-Fi Dealers can now demonstrate and supply C.Q. equipment. In case of difficulty contact our sole distributors

TECHNICAL SUPPLIERS, LTD.
63 GOLDHAWK ROAD,
LONDON, W.12.
Telephone: Shepherds Bush 2581/4794

C. Q. JUNIOR

REPRODUCER

Now after two years further experience and development an even smaller speaker has emerged. The frequency range is 45 to 12,000 c/s and the power handling 4 watts continuously or 8-10 watts speech or music. Dimensions are 17" x 9½" x 10". A genuine "bookcase" speaker. Four sides are veneered and polished so that it can be mounted either vertically or horizontally.

Weight 10 lbs. (4.5 kilos) packed. Impedance 15 ohms. Matching Transformer available for 3, 5, 8 or 15 ohms. The JUNIOR will enhance the quality of any tape recorder.

"Twin Four" Stereo Amplifier 21 gns.
10 watt Amplifier 21 gns.
"Junior" Reproducer 13 gns.
"Senior" Reproducer 17½ gns.
"Tetraq" High-Frequency Reproducer £6 15 0

13 GNS.

TAX PAID

Finish: Medium Walnut or Sapele Mahogany.

"THE Q-FLEX LOUD-SPEAKER" by A. R. Neve. An outline of the flexing wall principle with performance graphs and constructional details. From your dealer or bookseller 3s.

Post free 3s.6d.

ADVANCE INFORMATION is now available on the new CQ "Tapeheart" Stereo Record/Replay and oscillator unit. High performance equalized to C.C.I.R. for direct connection to any good tape deck. Write for details **C.Q. Audio Ltd., 2, Sarnesfield Road, Enfield, Middlesex. ENF. 8262.**

KALEIDASOUND

To be held in the Ballroom of the Imperial Hotel, Russell Square, W.C.1.

on 2nd, 3rd, 4th and 5th April, 1959.

Stereo and Single channel disc and tape equipment by

C.Q. AUDIO LTD. REPS (TAPE RECORDERS) LTD.

TICKETS from C.Q. REPS or T.S.L.



All machines are complete with tape and microphone, except those marked *, which are less microphone.

•••• PAYMENTS REDUCED! the FINEST TAPE RECORDERS on NEW INTEREST FREE TERMS ••••

Write, Phone or Call to-day. You can buy by post with perfect confidence

Yes, no interest, and that is not all—for my personal attention, advice and help, are freely given. Full demonstrations at any time (evening and weekends by arrangement) and in addition to the superb Harting you can see and hear a selection of the most interesting recorders available. Remember, I am here to help you. Leaflets gladly sent if you are unable to call.

DAILY DEMONSTRATIONS OF



- The Dulci Harting deck with pre-amp.
- The Tandberg Stereo.
- The New Telefunken Models.
- C.Q. Speakers.
- Full demonstrations of all popular models.

MODEL	Cash Price Gns.	Deposit £ s. d.	12 Monthly Payments. £ s. d.
Philips 8109	39	4 19 0	3 0 0
Elizabethan Escort	45	6 5 0	3 8 4
Saja Standard	45	6 5 0	3 8 4
Verdik S1	45	6 5 0	3 8 4
Magnafon	45	6 5 0	3 8 4
Wyndor Viscount	49	6 19 0	3 14 2
Grundig TK20	50	6 15 0	3 16 3
Dulci Harting Deck* with pre-amp	55	7 5 0	4 3 4
Telefunken 75 with mike	55	7 5 0	4 3 4
Saja Export	56	7 6 0	4 5 10
Brenell 3 Star	58	7 10 0	4 9 0
Truvox R2	59	7 19 0	4 10 0
Elizabethan Essex*	65	8 5 0	5 0 0
Veritone Venus*	66	8 9 0	5 2 6
Baird	67	8 11 0	5 3 0
Brenell MKV with mike	69	8 11 0	5 5 6
Stuzzi Magnette	69	8 11 0	5 5 6
Telefunken 85*	75	9 15 0	5 15 0
Harting HMS*	82	10 12 0	6 5 8
Grundig TK35*	82	10 12 0	6 5 8
Grundig TK830/30*	100	15 0 0	7 10 0
Tandberg Stereo*	114	19 14 0	8 6 8

Dickinsons of Pall Mall Ltd.

11 Royal Opera Arcade, Pall Mall, S.W.1. TRA. 2881

The Royal Opera Arcade lies behind Her Majesty's Theatre in the Haymarket (one minute from Piccadilly Circus or Trafalgar Square)

The



of a good Tape Recorder
is its **DECK!**

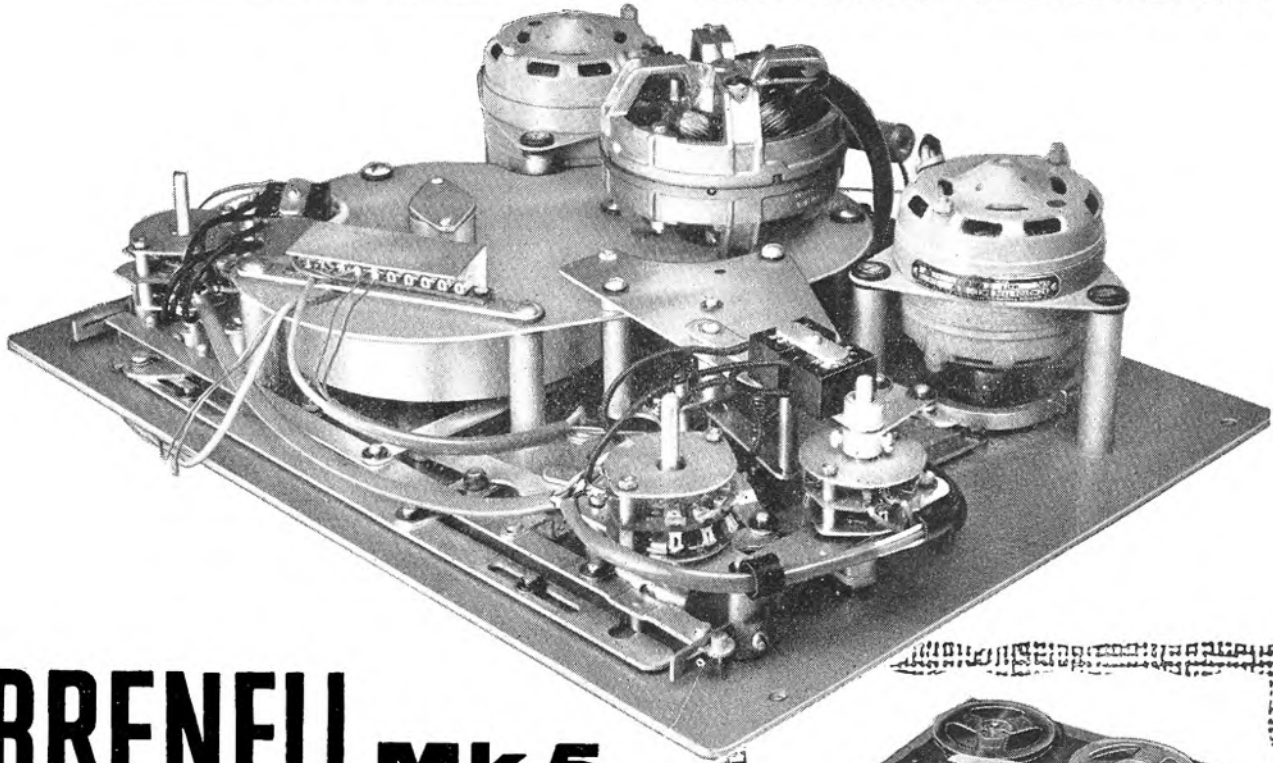

BRENELL Mk 5

One of the most versatile general purpose decks on the market—precision engineering at its best!

The Mk 5 deck is the outcome of 10 years' exhaustive research and manufacturing experience. Its remarkable features include four operating speeds, four heads can be fitted and 8 1/4 in. professional spools accommodated. For ease of operation only two switches (interlocked for safety) are employed. These control record, playback, wind and rewind and have extended shafts for fitting extra wafers if necessary. This feature makes the deck quickly adaptable for use with a variety of Hi-Fi equipment. Speed stability is ensured by a large statically and dynamically balanced flywheel. Brakes are mechanically operated. Safety device to prevent accidental erasure is incorporated. Instant stop without spillage, fast rewind in either direction (45 secs. for 1,200ft.) and azimuth adjustment are among its well proved features. For stereo, conversion can be carried out at little extra cost.

Tape Deck with provision for extra heads..... 28 gns.
Complete record/playback amplifier with power unit £24
Stereo/Rec. Playback (including mounting rack)..... £93 16s.

See these models at the Audio Fair—Stand 37, Room No. 111

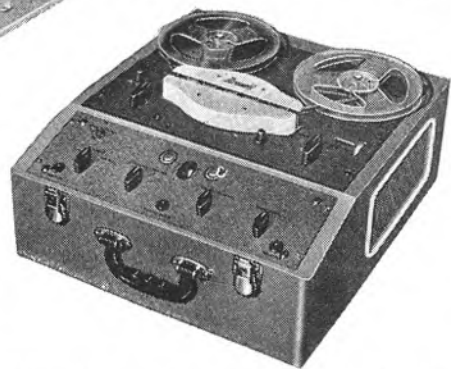

MK.5 TAPE RECORDER

Incorporating the Mk. 5 deck with all its outstanding features, its unit construction makes internal inspection, lubrication and adjustment a matter of minutes. 64 gns. including 1,200ft. of tape.

3 STAR PORTABLE

Smart appearance, brilliant performance, fine engineering at a price within the reach of almost everyone. Recently approved by the Council of Industrial Design. 58 gns. including 1,200ft. of tape, spool and microphone.



Full details from sole manufacturers—

BRENELL ENGINEERING CO. LTD.

1a, DOUGHTY STREET, LONDON, W.C.1

Telephone: CHA 5809 · HOL 7358

**IT'S SPECTACULAR!
THE STUZZI 'MAGNETTE'**



A fully transistorised battery operated recorder with all the features expected from a mains operated recorder of advanced design.

NEW waterproof covers to protect your valuable recorders. Choice of colours: navy blue, tan and wine with white piping. Specials made to order. Full range to suit.

Popular models in preparation:
TK5 Cover complete with microphone pocket. Price now only 36s.
TK8 Cover complete with microphone pocket. Price now only 39s.
TK 830/3D Cover. Price now only 40s. 6d.
TRADE ENQUIRIES INVITED

- * Size 11" x 4 1/4" x 8" Weight 8lbs.
- * Twin Speed 1 1/2 and 3 1/2.
- * Twin Track.
- * Frequency 80-9000 cycles.
- * Up to two hours per reel playtime.
- * Magic Eye.
- * Position Indicator.
- * Amplifier Facilities.
- * Id. an hour to run—approx.

69gns. complete with microphone and radio connecting leads.



also the

minifon

One of the world's smallest wire recorders

TAPE RECORDERS BY

Grundig, Geloso, Telefunken, Truvox, Elizabethan, Wyndson, Simon, Phonotrix, Tutor and last but not least the **STUZZI MAGNETTE and MAMBO**

TAPE DECKS.

MICROPHONES AND STANDS. Grundig, Cadenza, Geloso, Cosmocord, Lustraphone, Reslo, etc.

CRYSTAL PEN STAND MICROPHONE complete with ball point pen—suit Geloso TR 175. Price £6 18s. 0d.

TAPES. Grundig, B.A.S.F., Emitape, Scotch Boy and Telefunken Double Play.

JOINTING AND EDITING ACCESSORIES. Mixers, Tuners, Amplifiers, Converters, Speakers, Record Transcription Units, Spares.

★ No Interest Terms ★ Free Delivery

A. BROWN & SONS LTD. TAPE RECORDING DEPT.
24-28 George Street, Hull, E. YORKS
Telephone: 15412, 15413

ANY £50 TAPE RECORDER FOR 50/-

★ NO INTEREST CHARGES ★

★ 18 MONTHS TO PAY ★

We have the Biggest Sales in the U.K. Why? Because we give you the Best Terms!

SPECIAL CASH TERMS ★ FREE DELIVERY ANYWHERE IN U.K. ★ FREE SERVICING FOR 12 MONTHS ★ NO PURCHASE TAX ★ PART-EXCHANGES AND SECOND-HAND MACHINES ★ 150 machines, 35 models in stock ★ Mail Order Department covers the whole country ★ Open all day Saturday ★ Main Agents for all the best makes ★



**HOWARD
PHOTOGRAPHIC**

Write, phone or call for free brochures and details of our terms to the Tape Recorder & Camera Centre:
218, HIGH ST. • BROMLEY • KENT • RAV 4477



★ **GO STEREO**
with **TRUVOX**

Truvox Tape Recorders can now be supplied fitted with a stereophonic head at extra cost—add a second loudspeaker and amplifier and you can enjoy all the thrills of stereophony in your own home.

Available from all leading radio dealers or full details from:—

... till you've heard

a **TRUVOX**

R2 TAPE RECORDER

From the very first replay—pre-recorded or your own home-recorded programme—you'll be thrilled with its sureness of tonal quality and ease of control. Just as you recognise the voice of a friend on the 'phone or your favourite songster on radio or record, you'll know that this is the instrument you've always wanted. Designed and built by pioneers in the development and manufacture of Tape Decks and Tape Recording Amplifiers—TRUVOX are justly proud of an instrument that lives up to "all that the name implies." Increased production at our new, modern factory now enables us to offer this famous **56 GNS.** instrument at reduced prices—Models now available from

<p>TRUVOX Stereophonic Head for replay of pre-recorded stereophonic tapes.</p>	<p>TRUVOX Radio Jacks for direct radio reception and recording.</p>	<p>TRUVOX Telephone Adaptor for 2-way telephone conversation recording.</p>
---	--	--

TRUVOX LIMITED, NEASDEN LANE, LONDON, N.W. 10 (Tel.: GLAdstone 6455)

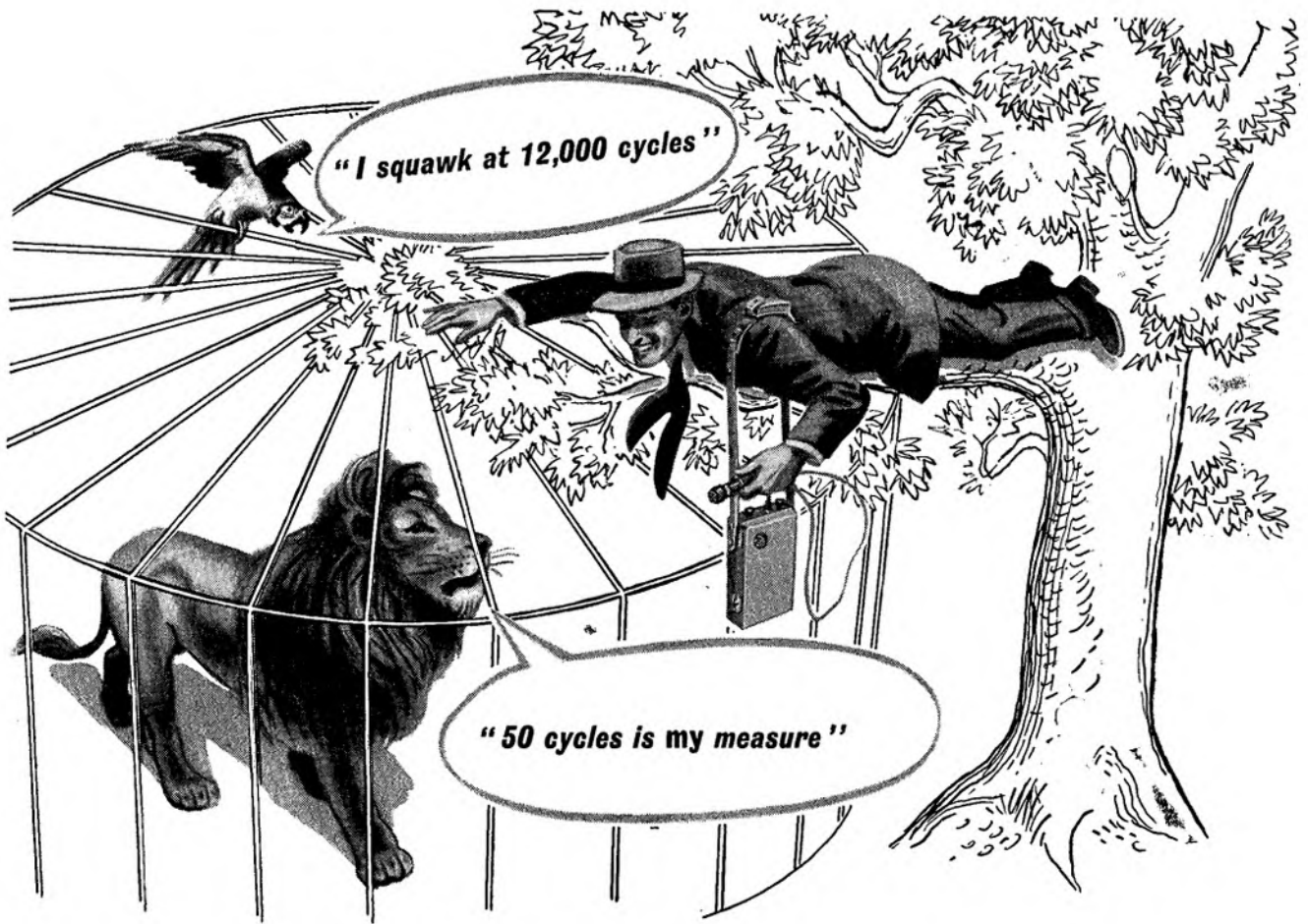

They both record perfectly on the new

FI-CORD hi-fi **Portable Tape Recorder**

THE NEW high fidelity portable tape recorder (weighs only $4\frac{1}{2}$ lb) which records with standard tapes at standard speeds— $7\frac{1}{2}$ and $1\frac{1}{8}$ i.p.s.—and adds living sound to cine. Frequency response: 50—12,000 c.p.s. ± 3 db. Measures $9\frac{5}{8}$ " x 5" x $2\frac{3}{4}$ ". Rechargeable batteries, separate automatic charger included. Integral monitoring speaker. Fully transistorised.



59 gns. complete with microphone, tape, batteries and charger

Full details from

FI-CORD LTD · 40A Dover Street · London · W1

Telephone: HYDe Park 3448

See **FI-CORD** in action at the **AUDIO FAIR**
Russell Hotel, London, W.C.1
April 2nd—5th. STAND No. 22
... and visit the **FI-CORD**
Demonstration Room No. 361



TAPE RECORDS

S U P P L E M E N T

THE CLASSICS



by **Edward Greenfield**

(recorded music critic of the *Manchester Guardian*)

IT is one of the marks of a great piece of music that it can be interpreted in a variety of ways. Almost more than any other music the piano works of Chopin have been subjected to the most startling array of different interpretations from the most wilfully mannered to the most rigidly drilled. The waltzes in particular have over the years come in for amazingly different treatment, and I was interested to find that Saga was issuing a tape of them played by Sergio Fiorentino.

Fiorentino, I feel, is one of Saga's greatest assets. I confess I had not heard of him before Saga started issuing tapes last year, but what I have heard is certainly impressive if not always sympathetic. Fiorentino is very much a young super-efficient virtuoso of the hammer-and-tongs school. Not a very promising recommendation, one might say, for playing Chopin. Chopin above all needs sympathy, and too often in recent years we have heard muscular young men from across the Atlantic batter the living daylights out of him. That—with two exceptions among the waltzes—is not, I am glad to say, what Fiorentino does.

Take the two exceptions first. Fiorentino is quite merciless to the **E minor waltz** usually played last in the sequence but here in the pianist's rearranged order played earlier. It is taken at a fantastic speed, which with its repeated notes among other difficulties is breathtakingly exciting, but really very unlike Chopin. Then too in one of my favourite waltzes the **A flat major Opus 64 No. 3**, Fiorentino completely fails to capture the whimsicality of the piece, trying instead to force the pace. (STE 3002.)

As a whole this performance will not suit those who like their Chopin played in half-tones with delicacy predominating. Fiorentino (as one heard in his previous recordings) has strong fingers and does not hesitate to use them to the full. He certainly does not indulge in half-tones, and anyone demanding them will be disappointed here. But as I said Chopin can stand a great many different interpretations. Fiorentino's comparatively heavy touch is dramatic and he has an easy fluent rubato which sounds spontaneous. Rubato can so often seem mannered, but even where he indulges in fairly extreme rhythmic fluctuations Fiorentino

(Continued on page 12)

high
performance
dual
impedance
the

Cadenza REGD.

ribbon microphone

designed and manufactured in England



A worthy link in the chain between live sound and perfect recording, the Cadenza ribbon microphone has been designed to give performance of the level of studio equipment, while remaining in the medium price range.

It can be used as either a low or high impedance microphone to suit any type of equipment and to give almost unlimited cable length without line transformers.

The entirely new arrangement of ribbon and magnet gives an output which is flat to within close limits over the wide range from 50 c.p.s. to 12,000 c.p.s. This enables the user to record the full gamut of symphony orchestra, cathedral organ, or the strong rhythmic bass and percussive highlights which add so much to the drive of jazz—even the solo piano, normally the most difficult instrument, is faithfully reproduced.

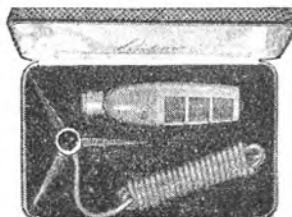

Microphone with dual impedance head in presentation case, 8½ gns.

Microphone (dual impedance head) and tripod desk stand, with 11 ft. of cable, 10 gns.

See it at the Audio Fair, Booth 61, Dem. Room 347

Send now for illustrated folder (EC4) or ask your radio dealer

Simon Sound Service Ltd
46-50 George Street, London W1
WELbeck 2371

DIXONS

OF MANCHESTER
offer you

TAPE RECORDERS ONLY

In addition to supplying all good makes and stocking almost every accessory, we are the main service and Sales agents for the famous **Telefunken**.

Our service department cannot be equalled in the North and is up to Telefunken and Grundig standard so that we are able to implement maker's guarantee on most makes without returning to manufacturers.



Tapes, microphones and all spares by return of post and reasonable H.P. terms available.

DIXON'S TAPE RECORDERS

227, Oxford Road, Manchester

ARDwick 4269

To
keep
your
tapes

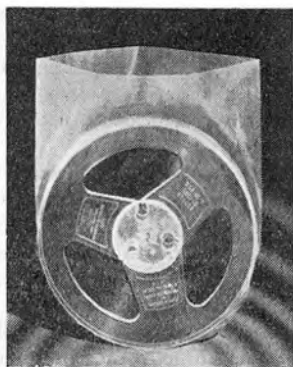

in
perfect
order

use TAPE PROTECTORS!

Made from top-quality polythene, and having a generous 'turn-over' closure, they protect your tapes from dust and atmospheric changes.

Equally necessary for both pre-recorded and virgin tapes, they are the answer to "sticking."

In packets of 12: 3"—1/6d.; 4"—1/8d.; 5"—1/9d.
5½"—2/- 7"—2/4d.; 8½"—2/8d.

FROM YOUR DEALER; OR WRITE TO US, ADDING 6d. POSTAGE

Swains
Papercraft Ltd.

Dept. 6,
Buckhurst Hill,
Essex.

**TRADE
ENQUIRIES
INVITED**

never gives that impression. He has much of the "presence" of a really great pianist, and that is basically why though one may disagree with quite a number of points of interpretation one will still find this playing most interesting.

Fiorentino plays fifteen waltzes, the fourteen usual ones plus the early **E major** of 1829. His order of playing them is strange, but then Dinu Lipatti had the habit of rearranging them too. There is a fill-up of **three Ecosseises Opus 72 C**—in spite of their late opus number early works, light and charming.

I wish I could welcome my other Saga tape this month—a selection from Strauss's operetta **Die Fledermaus** (STA 7010). This contains a half-hour pot-pourri covering most of the numbers and sung by a cast in German. Perhaps with such fine recordings in the catalogue by some of the greatest opera singers of the day one's standards in this work have become excessively high, but really this performance is just not good enough.

You might hear such a performance (and be very pleased to do so) if you happened to miss your connection in some dim town on the Westphalian plain. But what is very acceptable in such circumstances does not sound the same in a recording. The soloists appear strained and the Roselinda (with a ripe wobble) on the verge of retirement. The best soloist is the Adele who manages her coloratura in "Mein Herr Marquis" with no suspicion of Florence Foster Jenkins noises. The vigorous chorus and orchestra make some amends but why was the chorus put so far away? I have not been able to discover the names of any of the performers—perhaps just as well.

BEAT AND OFF-BEAT



by **Don Wedge**

(of "New Musical Express")

PUTTING Tommy Steele, Yana and Jimmy Edwards in a Rodgers and Hammerstein musical sounded like a mad idea. Harold Fielding persevered and turned it into a cross with a traditional British pantomime and a huge success at the London Coliseum.

It is based on a version of "Cinderella" the composer and lyricist wrote for American television. It was not a great success, although it starred Julie Andrews during her Broadway "My Fair Lady" days.

More than usual courage was needed to stage it in these circumstances. Fielding backed it to the extent of at least £70,000 before the curtain first went up.

To expand it from a 75-minute TV show to a three-hour spectacular stage production required extra numbers. They were chosen from "Me and Juliet" and "Pipe Dreams," Rodgers and Hammerstein shows never likely to be staged here. Steele also wrote a point number for Edwards and himself.

In their version (STB 8022, monaural; STE 3006, stereo;

also LP disc), Saga have kept mainly to the TV "Cinderella," adding only the well-known "No Other Love" and "Marriage Type Love," the best number on the record, from "Me and Juliet."

B.B.C. conductor Gilbert Vintner, making a commercial record for the first time, is musical director. An impressive array of singers is headed by Dennis Quilley and Elizabeth Lerner, with Helen Clare and Dudley Rolph making important contributions.

Vintner has mastered his score and provides an excellent backing to the singers, whose record it really is. The two principals are admirably cast. The big surprise is Dennis Quilley, who was not known to me on record previously.

Helen Clare joins Liz Lerner for "Impossible," which has one of Oscar Hammerstein's wittiest lyrics. Dudley Rolf and an unnamed gentleman give a very funny performance of "The Step-Sisters' Lament."

But it is Quilley and the chorus who haunt me still with "Do I Love You," a beautiful ballad.

There is no effort made to turn the performances into a replica of the stage show. Decca have done that with the London cast. Saga have done well to concentrate on the music and have been well served.

* * *

BRUCE TRENT plays the Prince in the London production. It is rather co-incidental, therefore, that he should figure prominently on the other tape I heard this month—"West Side Story," also from Saga (STB 8021, monaural; STE 3005, stereo; it is also available on LP and EP discs).

The company is rather proud that this is the only full-length record on the market apart from Philips' LP of the original American cast. Their pride should not end there. They have produced a fine concert version of the show.

It features the orchestra and musical director (Lawrence Leonard) from Her Majesty's, incidentally playing from the only copies of composer Leonard Bernstein's scores in Britain.

"West Side Story" is an important theatrical event. Virtually the whole of the London cast are Americans. This was arranged with the British stage unions because of the nature of the show. Its scope goes beyond what we have known previously.

In the theatre, it was Jerome Robbins' dances that created the most startling impression. On record, we concentrate on Leonard Bernstein's music.

The scope of this is amazing. It is well illustrated in the overture which taxes the orchestra. It is difficult to play near-jazz and a few bars later to switch to something near-symphonic. That is what Bernstein, through Leonard, asks.

There is no trouble with the vocal numbers. They retain the same mood throughout, on the whole. Bruce Trent sings Tony's songs, partnered by Lucille Graham as the girl-friend Maria. Mary Thomas and Joyce Berry are also featured in "A Boy Like That."

Trent normally is heard as a "big" tenor. Here he has to change his style to something more subdued. Lucille Graham has no such problems, singing in her usual manner. They combine for the particularly beautiful "One Hand, One Heart." It is most moving.

All have combined to make a fine, interesting and valuable record. Balance was adequately controlled by Saga's James Lock, both for "West Side Story" and "Cinderella."

* * *

JUST ONE DISC. If you have any doubts left about Frank Sinatra, spare 1 min. 59 sec. to hear him make something of the barren-sounding "French Foreign Legion," his latest single release.

AT AUDIO HOUSE

More outstanding values in
tape recorders!

Low price - top performance

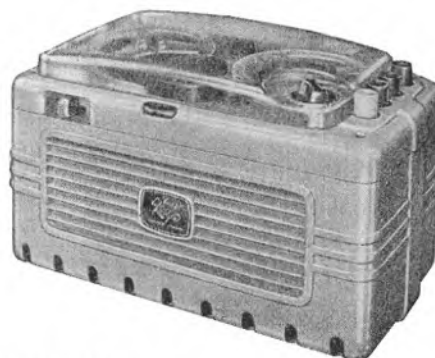

GELOSO

Inexpensive yet a machine giving good quality reproduction. Its versatility in use makes it a tape recorder you can take with you anywhere. 2 speeds: 3½ i.p.s. and 1½ i.p.s. Fingertip control. Supplied complete with microphone. Attractive continental compact design. Made in Italy. Price complete **38 GNS.**

CONVERTER For operation of recorder from 12v. D.C. battery input. Ideal for use in car, caravan or boat 9½ gns.

Although this recorder has many advantages as a domestic model it can be used as an office dictation machine with the following accessories:

FOOT CONTROL Providing stop, Forward and back spacer 6 gns.

DESK FINGER-TIP CONTROL Providing remote control for stop, Forward and back spacer 5 gns.

STETHOPHONE HEADSET Auto cut-out of internal speaker 3 gns.

VERDIK

A fully monitored **QUALITY** tape recorder with a feature hitherto obtainable only in de-luxe recorders. Separate Record and Playback amplifiers and heads allow playback as you record. Speeds: 3½ i.p.s., 7½ i.p.s. Five valves plus magic eye level indicator. Frequency range 40c/s to 12kcs. Playback through high flux internal speaker (or 15 ohm external speaker) alternatively through your hi-fi amplifier. Complete with 1,200ft. tape and microphone.



45 GNS.

RECORDER CHECK SERVICE

Are you taking advantage of this service recently introduced by Audio House? It is proving a boon to many users of tape recorders as it gives a new lease of life to their equipment resulting in better performance. Send your recorder to Audio House for a complete clean and check. All for 2 gns. A thorough inspection is given and advice if any repairs are necessary. Ask for full details NOW.



AUDIO HOUSE
8 DARTMOUTH PARK
AVENUE, LONDON, N.W.5
Telephone: GULliver 1131

Our showroom is open for demonstrations daily 9-30-6. Friday 1-30-9. Closed Monday. Only 16 minutes from Charing Cross by Northern Underground (or Bus 27, 134, 137) to Tufnell Park Station, thence 4 minutes' walk.

ON SALE APRIL 2nd

*the first
independent
issue of*

STEREO SOUND
AND MUSIC MAGAZINE

THE JOURNAL FOR ALL WHO
WISH TO KEEP UP-TO-DATE
WITH EVERY ASPECT OF
STEREOPHONIC SOUND.
MONTHLY 2s. 6d.

*Here are some of the contents
of the first issue:—*

Stereo at the Audio Fair

Reviews of stereo recordings

**Test report of the 4-track Tandberg
and other items of equipment**

**IEE Convention on Stereophonic
Sound Recording, Reproduction
and Broadcasting**

**Stereo explained to the layman, by
Charles Langton**

Behind the B B C stereo scenes

Stereo in the home

The orchestra and its composition

**Stereo recording, by
Angus McKenzie**

*Place an order with your news-
agent now, or send 36s. for one
year's subscription to Rolls House
Publishing Co., Breams Buildings,
London, E.C.4.*

NEW FIRM ISSUES BURNS' TAPES

ANOTHER firm is now issuing tape records—Music on Tape Ltd., 6, Laurence Pountney Hill, London, E.C.4. Two interesting records among the first issues will appeal to Scotsmen and lovers of poetry.

One is titled "A Nicht wi' Burns," and the Keltic Group are heard performing a wide selection of excerpts in song, music and verse.

The other provides excerpts from Burns' poems, spoken by George Cunningham, including "Address to a Haggis," "A Man's a Man for A' that," and the whole of the tale, "Tam O'Shanter."

Each of these tapes cost 30s., and provides 30 minutes' playing time. Both are available for either 3½ or 7½ ips recorders.

Music on Tape also announce seven titles in their catalogue of classical music. Each can be obtained for playing at 3½ ips (price 13s.) or 7½ ips (price 15s.). Playing time in either case is 16 minutes.

The titles include some of the best-known music of Strauss, Offenbach, Grieg, Bizet, Beethoven and Chopin.

DID YOU SEE?

**LEARNING LANGUAGES
WITH YOUR TAPE RECORDER**

June, 1958

RECORDING RADIO PROGRAMMES

January, 1959

THE A.B.C. OF AMPLIFIERS

July, 1958

**COPYING TAPES WITH
A SINGLE MACHINE**

August, 1958

**TAPE RECORDERS
OF THE FUTURE**

By James Moir

February, 1959

**HOW TO CATCH THE
SONGS OF BIRDS**

September, 1958

**A SOUND PORTRAIT OF
YOUR TOWN OR VILLAGE**

October, 1958

**BASIC RULES WHEN YOU
RECORD LIVE MUSIC**

November, 1958

*If you missed them, you can still read
them in back numbers of Tape Recording
and Hi-Fi Magazine, available at 2s. 6d. a
copy, including postage, from Rolls House
Publishing Co., 2 Breams Buildings, Fetter
Lane, London, E.C.4*

New! A TRULY REMARKABLE BRITISH INVENTION!

Gramdeck

GRAMOPHONE TAPE RECORDER

- Instantly turns your gramophone into a first-class Tape-Recorder.
- As easy as putting on a record. Slip it on—it's a tape-recorder! Lift it off—it's a record-player!
- Records direct from radio or microphone.
- Plays back at the flick of a switch through gramophone or radio.

ALL THE ADVANTAGES OF A TAPE-RECORDER FROM YOUR RECORD-PLAYER OR RADIOGRAM—AT LITTLE EXTRA COST

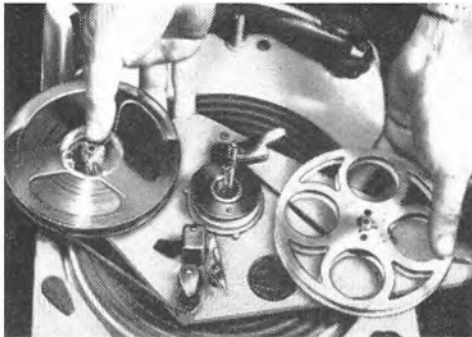

Gramdeck is completely new . . . a revolutionary and ingenious invention that instantly turns your gramophone into a tape-recorder and back into a gramophone at will! Slip the Gramdeck on to your turntable and you have the finest tape-recorder you've ever heard. Lift it off . . . your gramophone is ready to play records again. There are no motors or valves to go wrong—and you get a quality of reproduction that has to be heard to be believed! Everyone is praising the Gramdeck. "The quality is at least equal to that obtained from a good micro-groove disc," says a leading professional journal.

WORKS FROM ANY RECORD-PLAYER OR RADIOGRAM

Hear music, speech . . . your favourite radio programme . . . the voices of your family—Gramdeck can record and reproduce them all with a wonderful depth and breadth of tone. And because Gramdeck uses the equipment you already possess in your own gramophone, it costs a mere fraction of the high quality tape-recorder normally

required to obtain such excellent results. Full details, technical specifications, photographs, Easy Terms . . . everything you want to know about the amazing Gramdeck, are given in the fully-illustrated Gramdeck Book. Find out how you, too, can so easily have full tape-recording facilities! Send for the Gramdeck Book today. It's FREE!

COMPLETE—READY TO RECORD OR PLAY BACK!
£13.12s **EASY TERMS AVAILABLE**
CASH

- ★ Plays at 7½ in. per sec. Other speeds if desired.
- ★ Uses standard single or double-track tape
- ★ Erase head. Fast motor re-wind or hand re-wind.
- ★ Instantly plays back through gramophone or radio.
- ★ Enables you to record outdoors, too!
- ★ Tone as good as you get from your radio or gramophone!

"Ingenious — simple . . . why on earth did no one think of it before!"—*THE TAPE RECORDER.*

"Ingenious and robust."—*BRITISH SOUND RECORDING ASSOCIATION JOURNAL.*

"Quality of reproduction excellent . . . real hi-fi results . . . potential is tremendous . . . both designer and manufacturer should be congratulated."—*BRITISH RADIO AND TV RETAILERS' REVIEW.*

MADE BY THE FIRM THAT MAKES MICRO-WAVE WAVE-GUIDES FOR VISCOUNTS AND BRITANNIAS

Gramdeck

GRAMOPHONE TAPE RECORDER



FREE BOOK—POST NOW!

I would like to know how to turn my gramophone into a first-class tape-recorder . . . please send me the Gramdeck Book—FREE and without obligation.

(Write, if you prefer not to cut coupon)

NAME

ADDRESS

GRAMDECK (Dept. TP/801), 29 Wright's Lane, Kensington, London, W.8

ONLY OBTAINABLE FROM AND GUARANTEED BY ANDREW MERRYFIELD OF KENSINGTON

UNIQUE TAPE RECORDER EXCHANGE SCHEME

HI-FI
"ESSEX"

65 gns.
Mike
extra



NOW YOU CAN HAVE THE LATEST TAPE RECORDER YOU HAVE ALWAYS WANTED. WE WILL GIVE YOU A GENEROUS ALLOWANCE ON YOUR MACHINE WHICH WE WILL TAKE AS A DEPOSIT.

- ★ NO INTEREST TERMS
- ★ FREE MAINTENANCE
- ★ FREE DELIVERY
- ★ 40 MODELS ON DISPLAY
- ★ BEST CASH OFFERS FOR GOOD QUALITY RECORDERS

TANDBERG STEREOPHONIC ...	114gns.	KURLAND HI-FI	56gns.
ELIZABETHAN ESCORT	45gns.	HARTING HI-FI	82gns.
STUZZI MAGNETTE	69gns.	WALTER 101	29gns.
ELIZABETHAN MAYFAIR	72gns.	WALTER 303 DE-LUXE	42gns.
SOUND 444	45gns.	WALTER 505	57gns.
SOUND A20	55gns.	PERTH-SAJA Standard	45gns.
SOUND 555	65gns.	PERTH-SAJA De-luxe	56gns.
PHILIPS 8109	39gns.	TELEFUNKEN KL75	50gns.
PHILIPS 8108	62gns.	TELEFUNKEN KL85	75gns.
TRUVOX	59gns.	ELECTRON EMG 9/1	43gns.
WYNDSOR VISCOUNT	49gns.	GRUNDIG T.K.20	52gns.
BRENELL 3-STAR	58gns.	GRUNDIG T.K.25	62gns.
GELOSO	38gns.	GRUNDIG T.K.30	72gns.
PHONOTRIX (Batt.)	26gns.	GRUNDIG T.K.35	82gns.
G.B.C.	40gns.	SONOMAG	54gns.
VERDIK	45gns.	REGENTONE	55gns.
FERROGRAPH	89gns.	BRENELL 5 STAR	64gns.

Large selection of Tapes and Accessories. 2/- in the £ Deposit.
All machines available on No-Interest Terms. Call or write in confidence

REW EARLSFIELD LTD., 545, GARRATT LANE, S.W. 18. WIM 0709

5 MINUTES TOOTING BROADWAY

BUS STOP OUTSIDE, 100 YARDS FROM EARLSFIELD STATION

YOU DON'T MISS A SOUND

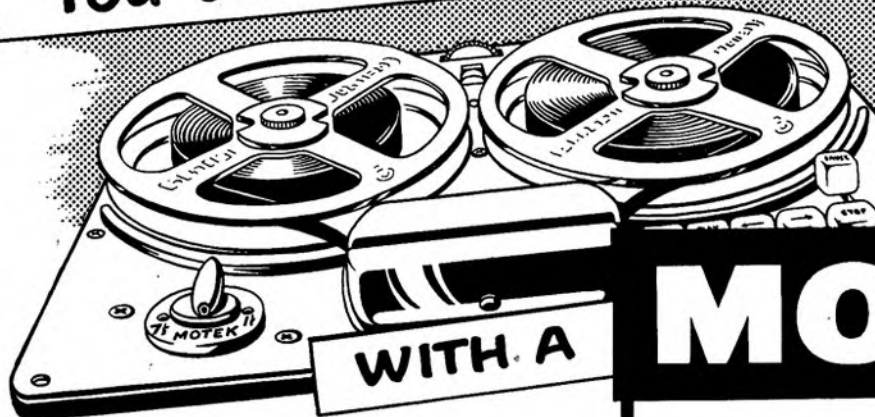

MOTEK

GIVES THE MOST
FOR LESS

No doubt about it, the Motek Tape Deck does its job more than perfectly. No wonder it's built into the finest recording machines.

Manufacturers and happy users alike feel confident with Motek—the confidence fine electrical engineering can give. Not just that, but Motek is decked with five shining star features which find many followers: Push Button Operation, Counter, Safety Erase Button, Pause Control, Three Speeds.

Patents Pending. Details on request.

LIST 21 GNS.

MODERN TECHNIQUES

Wedmore Street, London, N.19 Telephone: ARChway 3114

MY LOOK! MY BANDBOX



My new Elizabethan Bandbox. It's the smallest, finest, neatest recorder in the world. Just look at my Bandbox: it's as small and as neat as my model bag, and even I can lift it with a finger. Just listen to my Bandbox: sounds nice! My boy friend says the specification is wonderful for the price. It's got two speeds, 3 $\frac{1}{2}$ " and 1 $\frac{1}{2}$ " (the only two-speed recorder at this price). The loudspeaker is oval, 7" x 4". There are clever push-buttons (and even I can work them). There's an external monitoring sprocket, or something, and a dial position clock and you can turn knobs to change the sound. You can record two things at once. And there's a full-size 6-valve circus and four magnifier stages and I just love my Bandbox.

**You'll love it, too, and your
boyfriend can jolly well
buy you one.
He'll find it at all
the better dealers.**

29 GNS
including
Microphone, Tape
and Accessories

EAP For full details of the Elizabethan Bandbox, post this coupon to-day. E.A.P. (Tape Recorders) Ltd., Bridge Close, Oldchurch Road, Romford, Essex.

Name

Address

.....

BLOCK LETTERS PLEASE

Elizabethan

NOW

HEAR

The
Winston

**NEW
PERFECTION
IN
RECORDING
&
REPRODUCTION**

THOROUGHbred TAPE RECORDER

6 Salient Features

- **3 speed Tape Deck—3 hours 12 minutes playing time**
- **Twin Track Recording**
- **3 Loudspeakers. Superb tonal quality perfectly distributed**
- **1,800 ft. Spool Tape**
- **Built-in Mixing Unit**
- **Built-in Public Address System**

In these days a reliable Tape Recorder is a "must." Think how you could use a Winston Thoroughbred . . . Recording Speeches . . . Radio Items . . . Telephone Conversations. Can also be used as a separate amplifier for Public Address systems. In the home, the school, for business and recreation a Winston Thoroughbred is essential. The Free Winston Booklet that gives the many uses of a Tape Recorder, and includes a chapter for the technically-minded on recording, is available on request.

**69
GNS**



**PRICE
INCLUDES
MICROPHONE
—NO EXTRAS**

WINSTON ELECTRONICS LIMITED

GOVETT AVENUE, SHEPPERTON, MIDDLESEX

Telephone: WALTON-ON-THAMES 6321, P.B.X.

Cables: "WINSTON, SHEPPERTON"

Introducing the new

Reflectograph **STEREACORDER** model 570

The unique self-contained, transportable recorder incorporating separate record and playback stacked (in line) heads, separate record and playback amplifiers and Goodmans monitor loudspeakers. It records and plays back tapes...

STEREOPHONICALLY MONOPHONICALLY TWO-CHANNEL

Permitting superimposition on one track and reproduces stereo records from a stereo pick-up through the high quality amplifiers.

BRIEF SPECIFICATION:

Case in pigskin and luxan hide colours with loudspeakers fitted in dual-section lid. Reflectograph exclusive variable speed deck 8-3½ i.p.s. Neon-lit stroboscope showing precise speeds of 7½ and 3½ i.p.s. Three Garrard motors. Push button and lever controls, including "inching" facility. Provision for 8½" reels. Clock-type tape position indicator. Bib tape splicer. Double-track erase head (switchable). 45 db separation between each track of playback head, allowing interference free reproduction of one track of a two-track tape. Two pairs of separate record and playback amplifiers. Each pair having 3 watts undistorted output to CCIR res-

ponse. Tape/Input switch providing instant comparison between input signal and signal recorded on tape. Treble and bass tone cut controls. Two input and two output sockets. Peak level record meter. Complete with two 10 ft. speaker leads, two screened plugs, splicing tape, demonstration stereo tape and tape reel. Price 149 gns.

FOR THE TECHNICAL MAN —
Dimensions: 31" long x 14½" wide x 11½" high: Weight 70 lbs. Frequency Response: ±2 dB. 50—10,000 c/s: ±3 dB. 45—12,000 c/s. Overall Response: Strictly to C.C.I.R. recommended specifications. Signal to Noise Ratio: Better than—45 dB. (unweighted, including hum). Output from Playback Preamplifier: 200mV. R.M.S. Inputs to Record Amplifier (High Impedance): Microphone 1mV.: Radio or

pick-up 50-200mV.—for maximum record level. "Wow" and "Flutter": Better than 0.2% R.M.S. as measured on the G.B.-Kalee-Flutter Meter.

ONE YEAR'S FREE MAINTENANCE:
All Reflectographs are guaranteed for one year (including valves) . . . available throughout U.K. Service undertaken immediately by Engineers of the E.M.I. Company, Home Maintenance Ltd. Annual Service Contract available for 20 years subsequent for small annual fee.



Model 570 Price: 149 gns

Including 1 year's Free Service (including valves)

MULTIMUSIC LTD, MAYLANDS AVENUE,
HEMEL HEMPSTEAD, HERTS. TEL: BOXMOOR 3636

Hear the 570
in our studio on the 1st floor
at the
AUDIO FAIR
live stereo recording
sessions every 20 minutes

Now! it's easy to edit tapes — economically

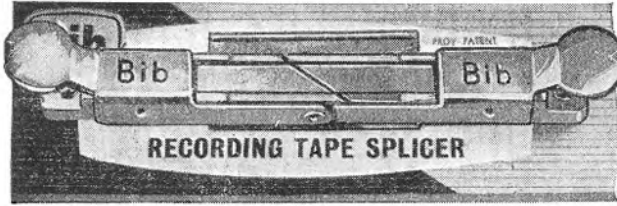

USE A PROFESSIONAL TYPE RECORDING TAPE SPLICER FOR EDITING AND MENDING RECORDING TAPE

On the new Mark II Bib Recording Tape Splicer both clamps are now of the easy lift type and are fitted on the same side to facilitate rapid removal of the jointed tapes. These improvements ensure even easier and quicker precise jointing of tapes. Because you can use all odd lengths of tape, you soon save the cost of the Splicer. If desired the Splicer can be attached directly to a tape recorder deck.

The technical experts say . . . "Everyone who uses a tape recorder will need this little tool. It is indispensable." P. WILSON, Gramophone.

"As a test I asked a non-technical person to splice some tapes and, after a couple of practice joints, perfect splices were made. A really useful gadget." D. W. ALDOUS, M.INST.E., M.B.K.S., Gramophone Record Review.

"The Bib Tape Splicer . . . produces a perfect joint with the minimum of effort." WIRELESS WORLD.

18/6
each (subject)



RECORDING TAPE SPLICER

Get one from your local stockist today. In case of difficulty write to us giving his name and address. Send stamped addressed envelope for helpful leaflet on tape editing.

Multicore Solders Ltd., Dept. T.R.3, Multicore Works, Hemel Hempstead, Herts.



MOVING-COIL MICROPHONE LD/61 "LUSTRETTE" IN ALL IMPEDANCES

Enables better "live" recordings to be taken on tape. The "Lustrette" embodies excellent features, including modern appearance, great compactness, robust construction and remarkable sensitivity over a very wide range. It is the ideal replacement microphone for crystal and condenser types and its price brings better recording within reach of all.

67/6

- Suitable for tape recorders of all types.
- For use as a desk or hand-held microphone.
- Plastic ivory-colour case, 2 1/4" high. With 9' cable.
- British-made by LUSTRAPHONE LTD., Britain's foremost microphone manufacturers.

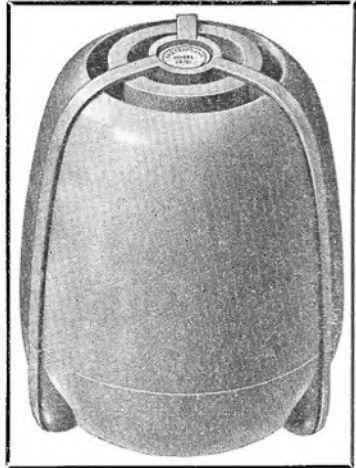

AT THE AUDIO FAIR

Full descriptive leaflet on request from:
LUSTRAPHONE LTD.,

**ST. GEORGE'S WORKS
REGENTS PARK ROAD
LONDON, N.W.1. PR1mrose 8844**

EST. 1889 THE SERVICE Co. (LONDON) LTD. 1792-2193 HOL.

14, HIGH HOLBORN, W.C. 1

(25 YARDS FROM CHANCERY LANE TUBE STATION)

CENTRAL LONDON'S TAPE RECORDER & PHOTOGRAPHIC DEALERS

**NO INTEREST CHARGES — DEMONSTRATIONS — SMALL DEPOSIT
THE BEST SERVICE FOR ALL YOUR REQUIREMENTS**

GRUNDIG TK20



YOUR SATISFACTION IS OUR INTENTION

	Cash Price	Deposit	12 Monthly Payments
	£ s. d.	£ s. d.	£ s. d.
Grundig TK20	54 12 0	4 4 0	4 4 0
Philips EL 3527	40 19 0	3 3 0	3 3 0
Brenell Three Star	60 18 0	4 13 0	4 13 8
Breneil Mk. 5.....	67 4 0	5 4 0	5 3 4
Wyndsoor Viscount	51 9 0	4 1 0	3 19 0
Walter 303.....	44 2 0	3 8 0	3 7 10
Elizabethan Essex	68 5 0	5 5 0	5 5 0
Elizabethan Mayfair	75 12 0	5 17 0	5 16 3
Elizabethan Escort.....	47 5 0	3 15 0	3 12 6
Philips AG 8108	65 2 0	5 2 0	5 0 0
*Telefunken KL75K	52 10 0	4 1 0	4 0 9
*Telefunken KL85K	78 15 0	6 3 0	6 1 0
*Grundig TK30	75 12 0	5 17 0	5 16 3
*Grundig TK25	65 2 0	5 2 0	5 0 0
Elizabethan F.M. Tuner	17 6 0	1 7 0	1 6 7

*Microphone Extra

ALL MAKES OF TAPES & ACCESSORIES SUPPLIED

A Tape-Recorder offers a complete new interest to the movie camera enthusiast—sound with your films is a possible exciting addition to your hobby, music commentary, dialogue! All yours on the "SERVICE" plan. Or if you have a Recorder think what a difference colour home movies will make to your life. Write or call for full details.

Made by Germany's leading
sound equipment manufacturers

SABA

high fidelity
twin track

fully automatic **TAPE RECORDER**

INCORPORATING ALL
THE FEATURES OF EVERY
GOOD QUALITY TAPE
RECORDER PLUS EX-
CLUSIVE REFINEMENTS

- Unlimited playback time
- 4 hours recording time
- Automatic tape reversal without change of reels or attendance
- Twin 7" × 4½" speakers in stereo arrangement
- Frequency range from 30 to 20,000 cycles
- A.C. operation, 70 watts can be set for 110, 130, 220, 240 v.

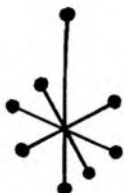
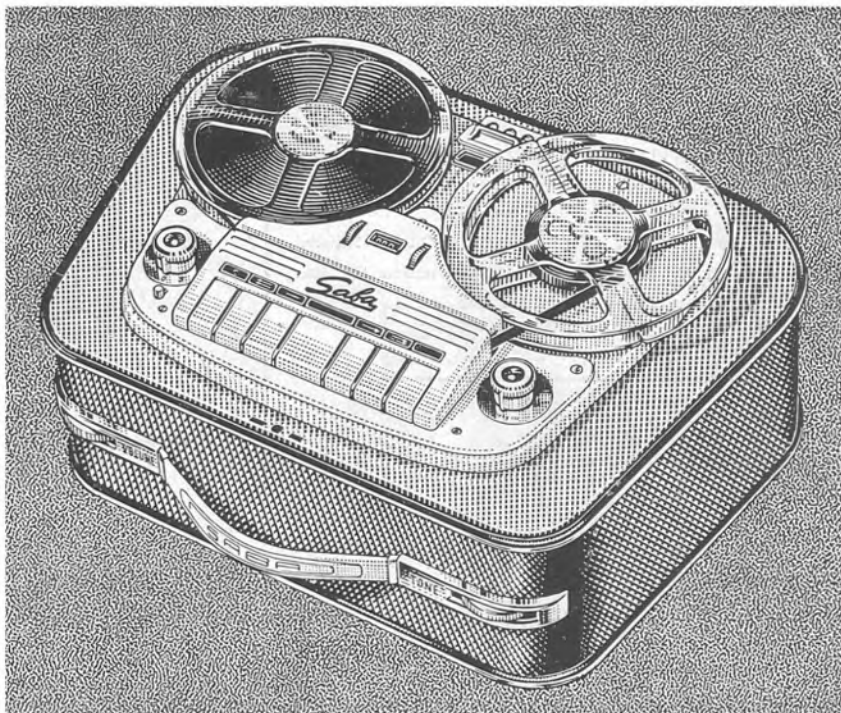

**ELECTRONICALLY OPERATED ILLUMINATED KEYS RESPOND
TO FINGER-TIP TOUCH**

Speech and music can be blended into previously recorded tapes by operation of the "Trick" key provided. Sockets for headphones or extension loudspeaker are fitted, also magic eye recording level indicator and tape meter.

A recording selector switch is arranged on the right of the control panel to set the machine to the type of recording required, "microphone," "radio" or "disc record." All three recording channels can be kept connected to the machine without changing cables.

PRICE **89** GUINEAS

M I C R O P H O N E
SABA D/II Microphone, directional type, fitted with speech/music switch.

PRICE **9** GUINEAS

Selmer

From all good dealers or send us your postcard marked "SABA 4"

114 CHARING CROSS ROAD LONDON W.C.2

+ ADD IT UP FOR YOURSELF



COMPLETE WITH
CRYSTAL MICROPHONE
AND 1,200ft OF EMITAPE

49 guineas

= The WyndSOR "Viscount"

WYNDSOR RECORDING COMPANY LTD., WyndSOR Works, Bellevue Road, Friern Barnet, London, N.11
Telephone: ENTerprise 2226/7

Telegrams: Wyndreco

- + first class electronic design giving brilliant reproduction
- + attractive styling in coffee and cream with gold-coloured fittings
- + detachable 10" × 6" elliptical speaker
- + three speeds—15", 7½" and 3¾" per second
- + frequency response of 50 to 12,000 cps ± 3 db at 7½ ips
- + push button track change
- + 7" spools
- + high and low sensitivity input sockets
- + independent high-impedance output socket (to C.C.I.R. Standards)
- + tone control
- + independent gain control for monitoring
- + luminous target recording level indicator
- + digital tape-position locator
- + facility for using solely as an amplifier
- + pause control
- + strong carrying case covered in P.V.C. leathercloth
- + twelve months' guarantee



Tape Recording and Hi-Fi Magazine is published on the 20th of each month by Print and Press Services Ltd., from 7 Tudor Street, London, E.C.4.

GENERAL EDITORS: IAN ARNISON and R. BROWN

TECHNICAL ADVISORY EDITOR: CHARLES LANGTON, A.M.Brit.I.R.E., A.M.Inst.E.

TECHNICAL ADVISERS: ANGUS MCKENZIE

F. C. JUDD, A.M.Inst.E.

CECIL ANDREW,

A.M.Brit.I.R.E., A.M.Inst.E.

STEREO: DOUGLAS GARDNER

Editor of Stereo Sound and Music Magazine

MUSIC: EDWARD GREENFIELD

Manchester Guardian recorded music critic

DON WEDGE

News Editor, New Musical Express

MOVIE-MAKING: JOHN ALDRED

NEWS AND CLUB ACTIVITIES: FRED CHANDLER

The Editors are always glad to receive articles, news items, illustrations, etc., intended for publication and payment is made on publication. When not accepted, material will be returned if a stamped, addressed envelope is enclosed, but the Editors cannot accept responsibility for the safety of such material.

"Tape Recording and Hi-Fi Magazine" is available by postal subscription at 28s. per annum, post free, or can be obtained at newsagents, bookstalls and radio and music dealers. In the event of difficulty, write to the distributors, Ralls House Publishing Co. Breams Buildings, London, E.C.4.

Back numbers are available at 2s. 6d. per copy, if still in print.

EDITORIAL

Address all communications

7 TUDOR STREET, LONDON, E.C.4

FLE 1455/6

ADVERTISING

1 CRANE COURT

FLEET STREET, LONDON, E.C.4

FLE 0197

IN THIS ISSUE

Tape Records reviewed 11

Edward Greenfield and Don Wedge

We take the view . . . 24

Editorial comment and information

Capturing those holiday sounds 27

Brian Vaughton

The International Recording Contest 30

THE LONDON AUDIO FAIR 32

Special illustrated review

Fitting a time-switch 44

Charles Langton

Tested in the lab. 45

A simple mixer unit 50

Patrick Copinger

New products review 55

News from the clubs 59

Announcing
TAPE RECORDING
HI-FI HANDBOOKS

To be published on April 2nd

**AN INTRODUCTION TO
THE TAPE RECORDER**

Charles Langton
3/6d. (4/- including postage)



**RECORDING
WEDDINGS**

Paul Addinsell
3/- (3/6d. including postage)

For early publication

STEREO Angus McKenzie

TAPE AND CINE John Aldred

ADVICE ON BUYING A
TAPE RECORDER J. F. Ling

Further details from
TAPE RECORDING HI-FI MAGAZINE
7 TUDOR STREET · LONDON · E.C.4

A DIGEST OF

NEWS, COMMENT AND

EDITORIAL OPINION

THIS is the time of the year when manufacturers and sales managers work overtime, and tape and hi-fi enthusiasts grow excitedly expectant. The Audio Fair has become the great gateway to the year: once inside one sees the prospect for all the months ahead, the new products already available, and the significant design trends that may prove portentous for the future.

This is the fourth Audio Fair just coming up and so popular has the event proved that it is being moved a mile or two northward into Bloomsbury, to the Russell Hotel.

In this issue, readers will find news of a selection of interesting new equipment which will appear for the first time on the stands at the Fair. There are other innovations which manufacturers prefer to keep secret at this stage, so that they will make the biggest possible impact "on the day." We respect their wishes, and we shall deal with these in our next issue.

Attendance at this year's Fair is likely to establish another record. In fact, the number of visitors is expected to be just as many as can be packed into the space in the time.

Tickets can be obtained from radio and hi-fi dealers, or we shall be happy to supply them if readers write to *Tape Recording and Hi-Fi Magazine*, marking the outside of their envelopes "Audio tickets" and enclosing a stamped, addressed envelope for reply.

"Mr. ORGANISER"

ONE of the most vigorous personalities behind the scenes of the Audio Fair is Mr. C. Rex-Hassan, the organiser. When we shared a noggin with him the other day, he was already keyed up for the great event.

He explained that he moves into the hotel a couple of days before the opening and stays put until everything is cleared away afterwards. We gather that he books a room for himself, but doesn't expect to have much chance to get his head to the pillow.

Mr. Rex-Hassan told me that he feels the time fast approaching when tape recording will justify its own exclusive annual fair.

He is a man with great experience of organising these things. Later this year, he is pioneering two new events—a Festival of Wine in July and a Gift Trades Fair in December. Last year he was busy on British stands at the Brussels International Fair.

He is, in fact, a designer as well as exhibitions organiser and public relations expert. At the Audio Fair, control of exhibitors rests with a Council of Management; Rex-Hassan is responsible for design and conception.

The originator of the idea of the Fair, he told me, was Mr. V. G. P. Weake, of Pamphonic. As a hi-fi enthusiast

We take the view .

himself, Rex-Hassan jumped at the chance to organise the first Fair in 1956.

This year he celebrates his 25th year of arranging exhibitions. But he had 12 years in the Army where, he declares, he learned a great deal about administration. He has travelled the world and turned his hand to many varied activities. As the foundation for this career, he had a Cambridge education at Trinity Hall.

Eighty per cent of those who attend the Audio Fair, he reported, are men. There is a surprisingly high proportion of stage people among them.

That reminded me of something. What about those gorgeous girls Rex-Hassan recruits to the Fair staff each year?

"Ah, the starlets," he said. "Yes, they like the chance to meet people. Two of those we had last year have had film parts since." He assures me that the starlets will be twinkling again this year.

A NEW SERVICE

THERE is a certain class of magazine in which the advertisements are read as avidly as the editorial content, and we have evidence that *Tape Recording Magazine* is one such.

In this issue, it will be more than ever true, with so many announcements of new products. It is appropriate, therefore, that we should introduce this month a new service which we believe will be of great assistance to readers and advertisers.

On page 65 will be found a special form which can be used to obtain all the manufacturers' literature you want. Instead of writing separately to a number of firms, you can indicate your interests on our form, cut it out and fold it as indicated, and send it to us. We pay the postage.

So it will cost you nothing, and it will save a lot of letter writing. We will see that advertisers get your request for quick attention.

DESIGN IDEAS

THE Council of Industrial Design did a good job with their exhibition "Hi-fi—a guide to good-looking listening" in London



This Council of Industrial Design photograph shows one of the handsome units which has just been produced as a prototype in the rapid development of contemporary style for hi-fi equipment

recently. I thought as I wandered around the strikingly handsome exhibits that contact was being made with a well-informed and discerning section of the public which was probably poorly informed about our field, particularly about tape recording.

At the Design Centre the basic facts explaining the different hi-fi and stereo components were well set out. Two room schemes were demonstrated and altogether the products of about thirty manufacturers were on display.

I noticed a number of prototypes that are not yet generally available, but should prove popular, provided the price turns out not to be too stratospheric. I illustrate one example on this page. This is a cabinet for housing stereo equipment, with two speakers tucked in neatly underneath. When in use, the speakers are lifted out and positioned to taste. These units are the work of Robert Heritage. Des.R.C.A., M.S.I.A.

CLUB DEVELOPMENTS

THE development of the local clubs continues apace in a most encouraging way. Colleague Fred Chandler continually plies me with news of lively meetings and of enthusiasts anxious to start up new groups where none yet exist.

Tape Recording Magazine continues to give its full backing to this natural, democratic growth of the clubs. A fresh supply of our special display poster has recently been printed and

copies are now available free. This poster announces the intention to form a new club in a particular locality and provides space to fill in the address to which enquiries should be made. Local hi-fi dealers are usually only too willing to co-operate by giving the bill a good showing.

We can also supply a draft constitution and set of rules if they are required.

The Federation of British Tape Recording Clubs will soon be celebrating its first birthday and is steadily gaining strength. It seems now to have fully established its claim to be the natural sort of national co-ordinating organisation for the clubs. If it is given the support it deserves, it will have a big part to play in the future development of tape activity.

Whatever the future holds, it seems to us vitally important that the club movement shall be entirely controlled by enthusiastic volunteers with no other interest than the furtherance of their hobby.

Owing to the full coverage of the Audio Fair exhibits, a number of regular features have had to be held over to our next issue.



recapture
it with a
WALTER 505

High Fidelity tape recorder

The Walter 505 gives you an orchestra in your hand—all the extra features you've been hoping for, and it's light enough to be *really* portable into the bargain. You'll be as thrilled with its superb quality as with its handsome modern styling. It has the new Walter Mark II Deck;

2 speeds, 2 speakers, 2 inputs, 2 outputs. **57 gns.**

Write now for free folders describing the 505 and the other Walter models.

WALTER 303 DE LUXE, with the 2 speed Walter Mark II Deck and many other attractive features. **42 gns.**

WALTER 101—a full-size tape recorder with a first class performance. **29 gns.**

All models complete with microphone, tape, radio/gram recording lead, instruction manual and 12 months guarantee.

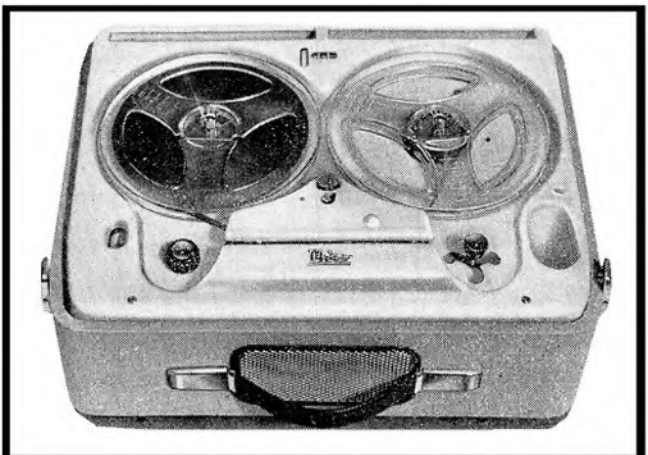

WALTER INSTRUMENTS LIMITED · MORDEN · SURREY · TELEPHONE: DERwent 4421

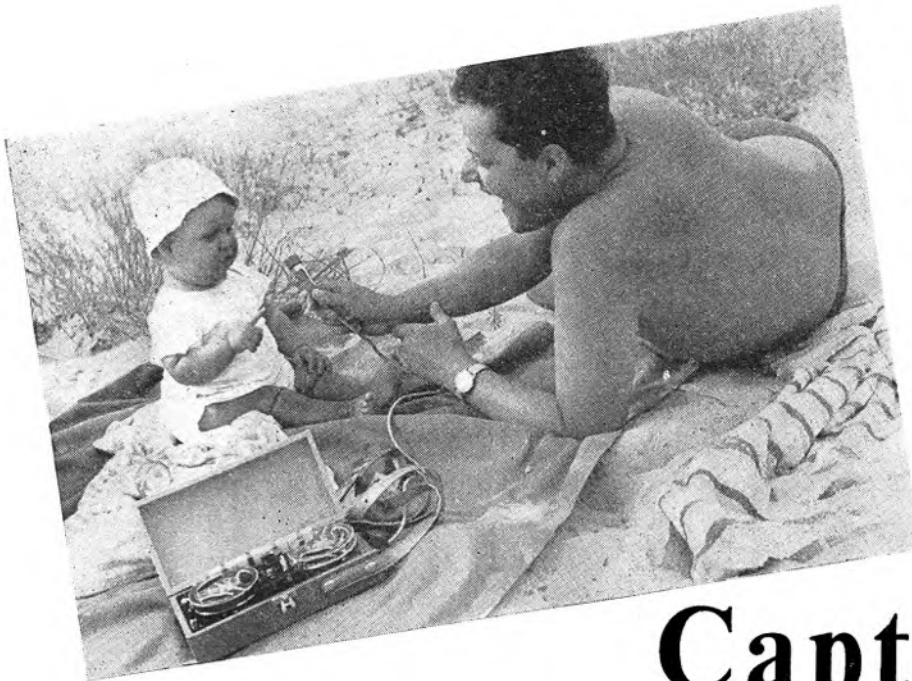

The popular B.B.C. "Holiday Hour" programme provides tape amateurs with good examples of the brief but evocative sound programmes that can easily be collected on holiday. Brian Vaughton describes here how he set about...

Capturing those holiday sounds

LAST year I was invited by B.B.C. producer Arthur Phillips to undertake an assignment for the "Holiday Hour" programme. It involved accompanying a party of boys from Hereson School, Ramsgate, on a sea cruise, recording during the voyage, and then preparing a programme item.

The equipment I took with me aboard the converted Brixham trawler *Terminist* included an E.M.I. L2 recorder, an S.T.C. 4032 hand microphone with windshield, and 20 boxes of tapes.

It was impossible to do any advance planning. I decided to record as many varied actuality sounds as possible, together with enough interviews to provide several alternative links between narration. Before sailing there was a short service on deck, and fond farewells between ship and shore as we chugged out into the Channel swell.

Our first steps on the Continent were taken at Terneuzen, where I found a café with one of those fascinating mechanical organs which provided good "actuality sound."

I felt I could safely leave interviews until later in the holiday, for two reasons. Firstly, the main requirement about interview work is to gain the confidence of your subject. You want him to do the talking—not you. Secondly, since I had time on my side, I could not only get to know the intended subjects well, but also decide what each one should talk about.

The broadcast length of each interview in this type of programme approximates 30-50 seconds, so there is no time to be wasted on irrelevant matter. You must make sure you get FACTS only.

Subjects for interviews can normally be placed in one of the following categories:—

Those who when requested to talk briefly about a few pre-discussed points, can go ahead "off the cuff."

Those who, if you write down relevant headings, can talk about each in turn.

Those who just shrivel up at the sight of a microphone. The best advice here is to find someone else! Failing this, you have to script the interview in its entirety, and hope it *sounds* spontaneous.

There are several different forms of interviewing and the requirements for a Holiday Hour type programme are far removed from those of, say, a Radio Newsreel item. In Holiday Hour the main points to be mentioned are discussed beforehand and often the interviewer's questions are not heard, so that a pure statement of fact is the result.

As the days passed, and I recorded ships' hooters, musical boxes, a brass band festival, night club dance music, and the constant chug-chug of our auxiliary engine, the programme began to take shape. I could now start to record the interviews which I needed to answer the questions most likely to be in the mind of listeners.

Some of these were: What was the aim of the voyage? What route was planned? How were the boys chosen? How did the boy who ran the ship's canteen organise things? What part did the boys play in the running of the *Terminist*? What mariners' tales could be told about *Terminist*?

(Continued on page 29)



Outstanding! More and more enthusiasts
are finding out the TEN great advantages
of BASF Magnetic Recording Tape.

the original — and still the best

F. A. HUGHES & CO. LTD

4 STANHOPE GATE LONDON W1 HYDE PARK 6080

The Enthusiast



The Fanatic

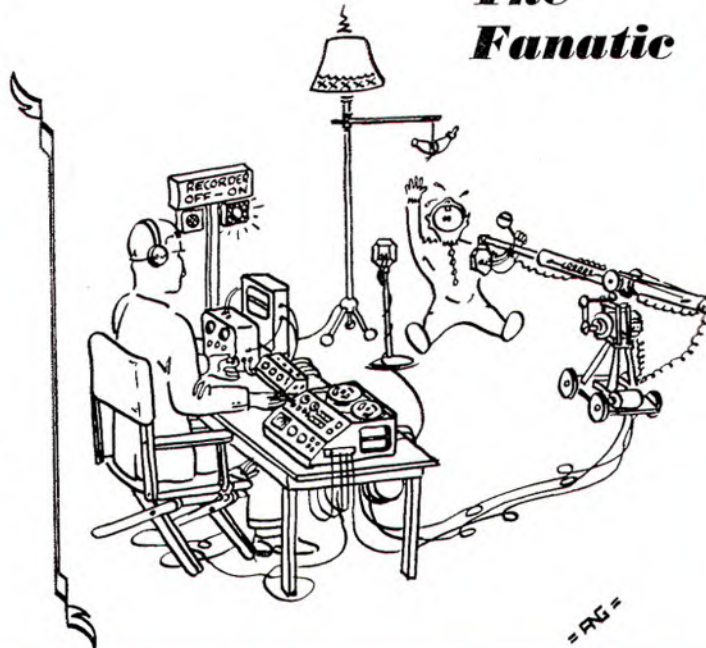

CAPTURING THOSE HOLIDAY SOUNDS

(Continued from page 27)

These questions could have been answered by narration, but how much better to allow the men and boys concerned to speak for themselves. Thus one could give "character" to the programme, and enable narration to be kept short.

On my return home, the problems of scripting began. Firstly, I listened non-stop to the four hours of material I had collected, and remembered that the whole item had to be condensed into 20 minutes! A rough script linking the most likely recordings was then drafted, with the proposed insets of tape marked "Take 1 . . . Take 2," etc., on small pieces of paper slipped into the appropriate places on the 5-inch reels. Then a discussion with the B.B.C. producer and a final script and the tapes were delivered to London for editing. Initially, the chosen inserts on the 5-inch reels, recorded at $7\frac{1}{2}$ ips on the midget recorder, were dubbed on to tape running at 15 ips. This is done to facilitate accurate cutting.

Gradually a reel of "actuality" tape was built up, each insert divided by a length of leader tape. This enabled the recording engineer to stop his machine during narration and prepare it to run in the next actuality insert on the producer's cue. The timing of the whole item now became of prime importance. Every second had to justify its inclusion, and before long lengths of discarded tape littered the floor.

At the final recording, narration and actuality were mixed together, using two acoustically-separated rooms, one containing tape recorders, the other a normal talks studio. Outside both rooms, behind a glass window, the producer sat at a control panel, supervising fade-in of narrator or tape sound at will, either separately or mixed.

Some sound sequences were built up from two or three sound sources. For example, moving up the Scheldt we hoisted the ship's mainsail. The boys hauled on ropes to yells of "heave, heave," while Captain Rae bawled friendly abuse at them from his post at the wheel. This was good actuality but, due to the distances and direction of sound making a satisfactory microphone balance impossible, the only answer was to record the event in three parts. Firstly, I recorded the boys "heaving," then the skipper shouting, and finally the waves swirling past the side of the ship. When all this was mixed together it produced exactly the effect required.

After several hours' work the recording was completed to the producer's satisfaction, and, at a later date, was joined to other items to make up another "Holiday Hour."

In next month's issue

BUILD YOURSELF A SECOND DECK

By Cecil Andrew, A.M. Brit. I.R.E., A.M. Inst. E.

THE FIRST COLLEGE COURSE ON
TAPE RECORDING—SPECIAL FEATURE

Be sure of your copy

—order it now

BRITISH

International

AMATEUR

Amateur

TAPE

Recording

RECORDING

Contest

CONTEST



TAPE RECORDING AND HI-FI MAGAZINE IS PROUD TO ANNOUNCE THAT IT HAS BEEN INVITED TO ORGANISE THE EIGHTH ANNUAL INTERNATIONAL TAPE RECORDING CONTEST IN LONDON NEXT AUTUMN. WE SHALL BE HOSTS TO MANY OF EUROPE'S TOP RECORDING EXPERTS, WHO WILL TRAVEL TO LONDON FOR THE EVENT.

Arrangements are being made in close consultation with the Federation of British Tape Recording Clubs.

They will attend the annual Congress of their organisation, the International Federation of Chasseurs de Son (F.I.C.S.), which can claim to be the most important organisation of its sort in the world, and to which *Tape Recording and Hi-Fi Magazine* is affiliated as the British representatives.

Then judges from eight countries will go into session for two or three days to hear the tapes submitted for the International Contest. Among them will be the best entries in the Third British Amateur Tape Recording Contest, sponsored by this magazine with the support of the British industry.

In each section of this Contest we shall award a first prize of ten guineas, and appropriate certificates.



The B.B.C. will be taking the closest interest in both Contests and we hope that the Network Three programme "Sound" will give them due attention.

The panel of judges of both Contests will now include an expert nominated by the B.B.C.



The provisional programme, in outline, is as follows:

Thursday, 29th October: Delegates arrive in London.

Friday, 30th October: Official reception and opening session of the Congress of the International Federation of Chasseurs de Son.

Saturday, 31st October: F.I.C.S. Congress continues. Official luncheon. Consideration of entries in the International Contest.

Sunday and Monday, 1st and 2nd November: Consideration of entries, and some other social functions, still to be arranged.

Tuesday, 3rd November: Conducted tour of London for overseas visitors.

On the Continent amateur recording has for many years received active support from broadcasting stations and many of the leading figures who have developed this

TOP EUROPEAN RECORDISTS DUE

association are expected in London. British enthusiasts will gain much from the opportunity to exchange ideas.

The work of the most talented amateur recordists in the world will also be heard for the first time by a British audience, so that there will be a unique chance to compare standards achieved.

We hope the British Contest will provide a worthy introduction to the later International event. Readers will know that only successful entries in the British Contest are eligible for the International Contest.

The closing date for all entries in the British Contest (except the special Schools' Section, concerning which a special announcement appears below) will be Friday, 31st July.

Those who wish to enter are therefore urged to apply for entry forms without delay. We can report that several hundred forms have already been sent out, so that this year's Contest is certain to be a bigger and more exciting event than the two previous events.

Individuals may enter for one or more of four main sections in the Contest. These are titled:—

1. *Compositions—radio plays, drama, sketches, etc. (not exceeding 15 minutes);*

2. *Documentaries and "reportage" (not exceeding 10 minutes);*

3. *Music or speech (not exceeding 4 minutes);*

4. *Actuality—unusual voices, historic moments (not exceeding 4 minutes).*

There is also a special section for Clubs, in which tapes may be submitted on the theme of "Discovering our Town." They must not exceed 15 minutes.

In addition to the £10 10s. prizes, the outstanding tape in all sections is chosen as the "Tape of the Year." The entrant responsible for it wins the handsome Emi-tape Challenge Cup, which he or she holds for one year. A smaller replica is awarded, to be retained.

We hope to organise again this year a special gathering at the Radio Show at Earls Court at which some of the best tapes will be played, the judges will offer comments, and the prizes will be awarded.

THE SCHOOLS CONTEST

The class gets down to it

Classes in many schools are now busy preparing tapes for the Schools section of the British Contest. How engrossed they can become is shown in the picture below.



Photo by courtesy of Messrs. Clarke & Smith

THIS year, for the first time, the Schools' Section of the British Amateur Tape Recording Contest is being organised separately from the other sections.

The intention is to build it up, in its own right, into a major event in the calendar, encouraging the developing use of tape recording as an educational medium. We know that more and more schools are becoming enthusi-

astic users of tape; we believe the Schools' Contest can play an important part in encouraging the trend.

Schools which enter for this year's event are invited to submit a feature-type tape, not exceeding 20 minutes' playing time, on the subject "How we see other countries."

This is a theme that lends itself to a wide variety of approaches and there is scope for imaginative conception, as well as for skill in planning and recording.

The winning school

The winning school in the British Contest will, of course, be awarded the Grundig Challenge Cup, awarded by Messrs. Grundig (Great Britain) Ltd.

The organisers will be adding their own prize, and the best tape will automatically be entered in the International Contest, where it will have the chance of winning other prizes in competition against schools in eight European countries.

Last year the Meeching Junior School at Newhaven not only won first place in the British Contest, but went on to take a second prize in the International event.

Schools which have not yet applied for their entry form for the Contest are urged to do so immediately. The closing date for receipt of tapes is Friday, 29th May. That leaves just over two months: time enough to start from scratch and do a good job, if you have not already decided to compete.

TAPE

RECORDING
AND HI-FI MAGAZINE

Special review of the

LONDON AUDIO FAIR 1959

Many interesting new products will be shown for the first time at this year's Fair. Many of them are described in the following pages.

The Fair will be staged at the Russell Hotel, London, WC 1, from April 2nd to 5th.

FRANCIS OF STREATHAM

The Complete Recorder
Specialists

THE LARGEST SELECTION OF LATEST-TYPE RECORDERS IN LONDON

	Price
*Brenell Mk. V	64gns.
Brenell 3 Star	58gns.
Elizabethan Bandbox	29gns.
Elizabethan Escort	45gns.
*Elizabethan Essex	65gns.
*Ferrograph 4AN	81gns.
*Ferrograph 4AN/S (Stereo).....	86gns.
Ferrograph Stereo-Ad	89gns.
Grundig TK20	30gns.
*Grundig TK25	52gns.
*Grundig TK30	62gns.
*Grundig TK35	72gns.
Geloso	82gns.
*Harting	38gns.
	82gns.

	Price
Magnafon Courier	49gns.
Magnafon Diplomat	51gns.
Perth-Saja Standard	45gns.
Perth-Saja De Luxe	56gns.
Philips EL 3527	39gns.
Philips 8108 G	62gns.
Phonotrix	26gns.
*Reflectograph	94gns.
Saba	89gns.
*Simon SP4	95gns.
Sound 444	45gns.
Sound A20	55gns.
Sound 555	65gns.
Sound Belle	26gns.

*Microphones extra

	Price
Spectone	76gns.
Stuzzi Maganette	69gns.
*Telefunken KL85	75gns.
*Telefunken KL85K	79gns.
Telefunken KL75	50gns.
Truvox R.2	59gns.
Verdik	45gns.
*Vortexion WVA	£93 13 0
*Vortexion WVB	£110 3 0
Walter 101	29gns.
Walter 303 De Luxe	42gns.
Walter 505	57gns.
Wyndors Dauphin	89gns.
Wyndors Viscount	49gns.

No Interest Credit Facilities

on terms to suit customers' convenience, with FREE SERVICE whilst under guarantee.

Hire Service

Tape Recorders may be hired from 45/- per week.

Hi-Fi and Associated Equipment

TAPES factory fresh by leading makers. Tape accessories. Microphone stands. AMPLIFIERS by Leak, Pamphonic, Dulci, Jason, Pye, etc. TRANSCRIPTION UNITS by Garrard, Collaro, Lenco. TUNERS by Dulci, T.S.L., Stirling, Elizabethan, Pamphonic, Jason, etc. PRE-RECORDED TAPES by Columbia & H.M.V., Saga, Elizabethan, etc. LOUD-SPEAKERS by Wharfedale, Goodman, W.B., Pye, etc. TAPE TO DISC SERVICE.

Tuners

	£	s.	d.
Dulci H42T AM/FM.....	24	19	0
Jason FMT/3 FM.....	23	19	6
Jason JTV, FM & TV Sound	26	13	10
Jason FMS/2 Switched FM.	23	19	6
Rogers FM.....	25	19	0
C.Q. FM Tuner	26	19	0
Pye FM Tuner	23	2	0
Pye AM/FM	30	9	0
Philco FM	19	19	0

Microphones

	£	s.	d.
Lustraphone "Lustrette" M/C	3	7	6
Lustraphone VR/64 Ribbon	7	17	6
Lustraphone VR/53 Studio			
Ribbon.....	9	19	6
Lustraphone LFV/59 Dynamic	8	18	6
Simon "Cadenza" complete	10	10	0

Also by Ronette, Acos, Reslo, etc. We will gladly advise on the type best suited to your requirements.

169-171, STREATHAM HIGH RD., LONDON, S.W. 16

Between St. Leonard's Church
and Streatham Station

STReatham 0466-0192

HEAVY ACCENT ON STEREO

A new Quad control unit

The Acoustical Manufacturing Co. Ltd., Huntingdon. Stand 15. Demonstration room 117.

A new Quad 22 control unit, incorporating design refinements, greater flexibility of input, and facilities for stereo, will make its first appearance at the Fair. At £25, complete with coupling cables and adaptor units, this will take a proud place in the splendid range from Huntingdon.

It will, of course, handle any input, match it correctly, amplify it, and apply such corrections as are desirable before passing the resultant signals to the power amplifiers and hence to the speakers.

Five control knobs and six push-buttons give the front panel a very workmanlike appearance and provide an impressive choice of performances—everything, in fact, the hi-fi and stereo enthusiast can want.

Visitors will also be able to see and hear the electrostatic speaker with which this firm are blazing a trail, as well as the Quad II power amplifier and FM tuner.

AMPEX ARRIVES

Ampex Corporation, Rank Cintel Ltd., Worsley Bridge Road, London, S.E.26. Stand 63. Demonstration room 259.

As forecast exclusively in last month's *Tape Recording Magazine*, Ampex machines are becoming available for the first time on the British market. Rank Cintel Ltd., who have been handling Ampex Videotape equipment here, now introduce the professional audio tape recorders.

Two recorders will be available. The first, Type 351, is a two-speed model—either 7½ and 15 ips, or 3½ and 7½ ips. At 15 ips, frequency response is quoted at 30 to 15,000 cps and signal-to-noise ratio at 70 dB full track and 65 dB half-track and two-channel stereo. The machine has separate record and playback heads and amplifiers.

The second model, Type 601-2, is described as a two-channel portable recorder (it weighs 42 lbs.). Speed is 7½ ips, at which quoted frequency response is 40 to 10,000 cps, plus or minus 2 dB. It has separate erase, record and playback heads, and separate record, playback, microphone and line amplifiers, all with 0.1 per cent maximum distortion. Input levels are measured by meter.

Continuous demonstrations of both monaural and stereo tape recordings specially made for the occasion will be given. Tickets will not be required.

We hope to publish fuller details of these machines in a later issue.

“Most complete radiogram”

Armstrong Wireless and Television Co. Ltd., Warlters Road, London, N.7. Stand 5. Demonstration room 222.

There is a heavy accent on stereo in the display of this well-known firm, and a new stereo pre-amplifier, the PCU 26, will be seen at the Fair for the first time. This model is designed for use with two Armstrong A. 10-type power amplifiers.

Certain to attract wide interest will be the Stereo-Twelve chassis, which Armstrong claim to be the most complete radiogram chassis ever produced. It is illustrated on this page.

This unit provides for every kind of stereo and monaural sound source and the output on each channel will match virtually any speaker available. The two channels are used

(Continued on page 36)



NEW DECK—The new Truvox deck which will be seen for the first time at the Fair and is bound to attract wide admiration

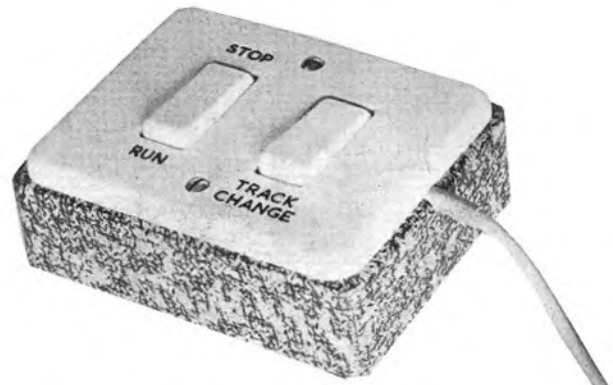

REMOTE CONTROL—Attention will also be given to this remote control switch which is being introduced by Simon Sound

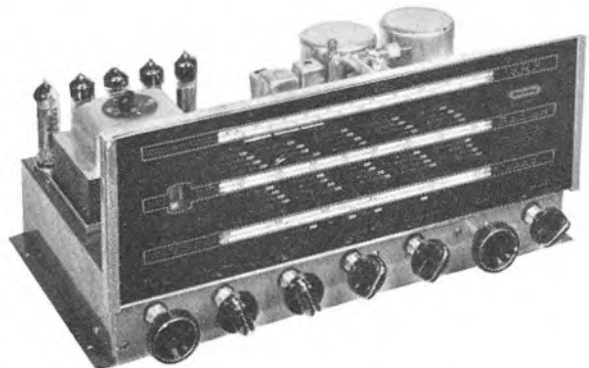

IT HAS EVERYTHING—The Armstrong Stereo-Twelve chassis, which provides for every kind of stereo and monaural sound source

The 'Masters' of your are made favourite LP records on

Emitape

Behind those brilliant, flawless performances on your favourite records lies a major technical triumph—EMITAPE! For some years now the 'masters' of most LP records have been made on the same standard .0015 in. base Emitape that you can buy . . . Proved technical superiority and durability of the PVC recorded tape—make Emitape the choice of world-famous companies like 'H.M.V.', Columbia, Parlophone—for recording all the greatest artistes of our day . . . For the same reason, the B.B.C., Independent Television and broadcasting authorities all over the world use hundreds of millions of feet of Emitape every year; it is equally in demand in the fields of industry and science. Backed by E.M.I.'s unique experience—going back over 60 years—and manufactured in the largest and most modern magnetic tape factory in Europe, Emitape is the basis for perfection in recording.

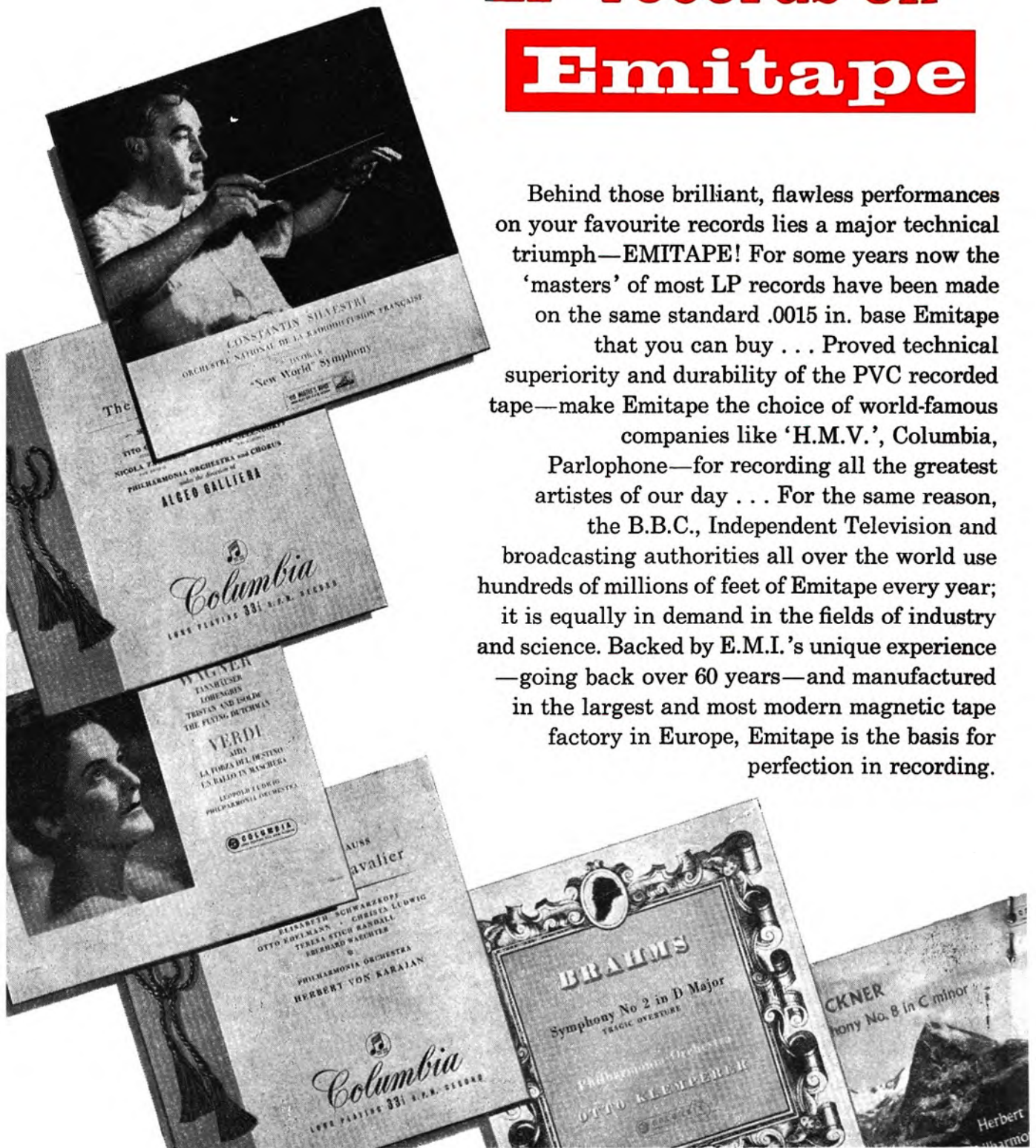

E.M.I. SALES & SERVICE LTD
(RECORDING MATERIALS DIVISION)
HAYES · MIDDLESEX

The 'Masters' of your are
made favourite
LP records on

Emitape

*—that's why leading tape recorder makers
recommend it . . .*

PERTH-SAJA

STANDARD Model

Tape Speeds—Single Tape Speed, 3½ ips giving a playing time of 2×1 hour on 1200 feet. *Speaker*—Large Elliptical. *Frequency Range*—50 c/s—16 kc/s. This wide range has been made possible by using Supertone—Heads with Ultra-Fine slots. *Valves*—EF86, ECC81, EL95, EC92, EM84. *Microphone*—Acos MIC 39—1 crystal stick microphone with 8 ft screened lead. Supplied free with instrument. *Input Sensitivity*—3 mV. *Output Voltage*—800 mV at 8 kilo-ohms. *Power Output*—2½ W. *Dimensions*—14" × 10½" × 6". *Weight*—17 lb.

TWIN DE LUXE Model

Tape Speeds—Giving two hours recording at 3½ ips on 1200 feet. Tape speed variations below 0.5 per cent. International Standard Double Track Recording. *Twin Speakers*—7" Elliptical with a 3" Tweeter. *Frequency Range*—50 c/s—12 kc/s at 3½ ips 50 c/s—16 kc/s cycles at 7½ ips *Valves*—EF86, ECC81, EL84, EL95, EM85. *Microphone*—Acos MIC 39—1 crystal stick microphone with 8 ft screened lead. Supplied free with instrument. *Input Sensitivity*—3 mV. *Output Voltage*—800 mV at 10 kilo-ohms. *Power Output*—3W. *Dimensions*—15½" × 12½" × 7". *Weight*—21 lb.



56 gns. complete with Microphone and Tape

PERTH RADIOS LIMITED

Marten House, 39-47 East Road, London N.1. Clerkenwell 2413-4

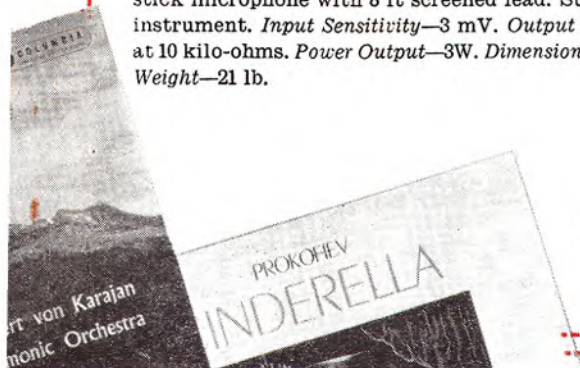

E.M.I. SALES & SERVICE LTD

(RECORDING MATERIALS DIVISION)

HAYES · MIDDLESEX

THE AUDIO FAIR

(Continued from page 33)

together for monaural reproduction, so that up to 12 watts output is available for both stereo and monaural.

Three alternative pick-up inputs are designed to accommodate almost any crystal pick-up and the tape input and output are suitable for use with a complete tape recorder or with a tape deck and its associated tape pre-amp.

Tape recording and play-back may be either stereo or monaural and, for recording, the output is independent of the volume control to allow monitoring at any volume level.

This very versatile unit is priced at 37 guineas.

This firm will show, in addition, a comprehensive range of amplifiers and tuners.

“Astronic” full range

Associated Electronic Engineers Ltd., Dalston Gardens, Stanmore, Middlesex. Stand 41. Demonstration room 120.

The full range of notable “Astronic” amplifiers, pre-amps and control units will be shown, including the attractively-styled units produced for the stereo enthusiasts.

A good example, worth looking for on the stand, is the “Stereo Onetwoeight,” a two-channel, eight watt amplifier. This has been designed to work direct with the latest crystal stereo cartridges. A selector switch gives a choice of inputs from either stereo LP, or 78 pick-up, or from radio or tape.

The price is £24 3s.

Brenell introduce mixer unit

Brenell Engineering Co. Ltd., 1a, Doughty Street, London, W.C.1. Stand 37. Demonstration room 111.

A new small mixer unit, designed primarily for high impedance sound sources, will be shown by Brenell.

But pride of place will be given to the two extremely successful recorders, the Mark V and the Three-Star, which are making a big impression in America, as well as on the home market.

The Three-Star portable has the approval of the Council of Industrial Design and, as the photograph on this page shows, has most attractive lines.

This firm makes the point that it exercises complete control over the production of all essential parts, and do not simply buy units to assemble.

All Brenell models are easily convertible for stereo use.

The Mark V is, of course, notable among British machines for its four speeds, provision for four sound heads, and ability to take 8½ in. spools. Yet there are only two switches, interlocked for safety.

This model costs 64 guineas, and the Three-Star 58 guineas.



COLLARO'S NEW DECK PLAYS 1 7/8 IPS

Collaro Ltd., Ripple Way, Barking, Essex. Stand 55. Demonstration room 237.

A most important development will be demonstrated by Collaro—a new “Studio” tape deck. This is a single-track, single direction unit, with one pair of magnetic heads. Space is provided for the fitting of a third head for stereo playing or for monitoring.

The deck operates at three speeds: 1½, 3¼ and 7½ ips. It accommodates up to 5½ in. spools within the area of the deck plate, but it is possible to handle 7 in. spools.

Other features listed are automatic self-compensating mechanical brakes, three separate motors, digital rev. counter, and controls of the piano key type, including a pause control.

The popular Collaro Mark IV tape transcriber will, of course, be on view, as well as a wide range of monaural and stereo disc-playing equipment.

Cosmocord may surprise

Cosmocord Ltd., Waltham Cross, Herts. Stand 48. Demonstration room 315.

There may be an important surprise on the Cosmocord stand this year. The firm is hoping to have ready a new pick-up arm designed specifically to reduce record and stylus wear and which they believe will set altogether new standards.

The ACOStereo 71 and 73 stereo cartridges will, of course, be prominently featured.

DULCI STEREO

The Dulci Co. Ltd., Villiers Road, London, N.W.2. Stand 27. Demonstration room 204.

Tape enthusiasts will be interested in the Dulci tape unit, which incorporates the Harting deck and combines most attractive styling with high-standard performance.

The Dulci unit incorporates a pre-amp and is ready to be used in conjunction with any hi-fi system. The two speeds are 7½ and 3¼ ips.

This firm, of course, has given great attention to stereo developments and will have an interesting range of amplifiers and pre-amps on display.

The Dulci H3S stereo-gram chasis at £29 3s. 10d. will doubtless attract much attention. This is designed to handle VHF broadcasts. LP and stereo discs, and tape. The tuner includes medium and long wave-bands, the gram pick-up is suitable for any type of single-channel or stereo pick-up or for stereo tapes, and tape recordings may be made direct from the radio section.

“Most comprehensive range”

Dynatron Radio Ltd., Maidenhead, Berks. Stand 43. Demonstration room 248.

DYNATRON CLAIM that they will be showing “the most comprehensive range of high fidelity equipment ever to be made available by a single manufacturer.”

It includes AM/FM tuners, pre-tuned VHF tuners, single channel and stereo tone-control units, single channel and stereo power amplifiers, power units, speaker enclosures, and a new three-way console designed to house hi-fi equipment.

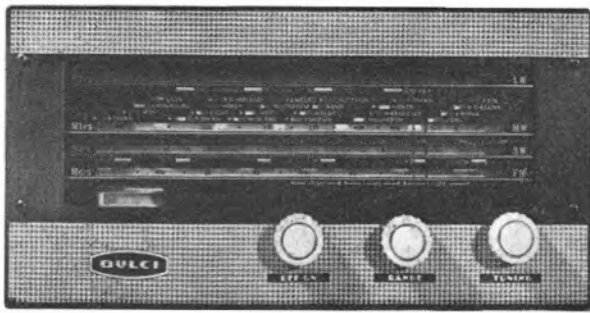

The Dulci H4T/2 tuner

E.A.P. WILL SHOW THEIR "BANDBOX"

EAP (Tape Recorders) Ltd., Bridge Close, Oldchurch Road, Romford, Essex. Stand 52. Demonstration room 219.

The famous Elizabethan range has been extended and improved since the last Audio Fair and one unit which is bound to attract much attention this year is the new 29-guineas "Bandbox," a simple machine with appeal to the teenagers' market.

This is the cheapest two-speed machine (3½ and 1½ ips) on the market, is small, light and neat (12 lbs. weight), but offers good recording and reproduction facilities.

For the more exacting, there will be the well-established "Escort," "Essex" and "Mayfair" machines.

The "Mayfair," an elegant console model, is one of the most eye-catching and ear-catching recorders in production. Its contemporary cabinet of bubinga and sycamore is capable of accommodating the Elizabethan FM tuner, so that it can be made a complete hi-fi radio-tape installation. The total cost of recorder and radio would be 88 guineas.

The full range of Elizabethan accessories, including microphones, telephone adaptors and connecting leads, will also be displayed.



The Elizabethan "Bandbox"—latest addition to the range of under-thirty guineas machines

FI-CORD'S PRICE PULL

Fi-Cord Ltd., 40a, Dover Street, London, W.1. Stand 22. Demonstration room 361.

Fi-Cord have a really powerful pull this year—a proved quality product at a greatly reduced price. The pocket-size transistorised recorder is now available at 59 guineas, including microphone, tape, batteries and charger. Even to those who already have tape equipment, it represents a most attractive proposition as an auxiliary unit. There is a hi-fi output socket provided.

At the Audio Fair, the manufacturers will be showing a special model housed in a transparent plastic case, giving a full view of the mechanism.

With a weight of 4½ lbs. and a quoted frequency response of 50 to 12,000 cps, plus or minus 3 dB, this is a recorder that everyone will be anxious to examine.

Grundig range will be there in full

Grundig (Great Britain) Ltd., 39/41 New Oxford Street, London, W.1. Stand 23. Demonstration room 202.

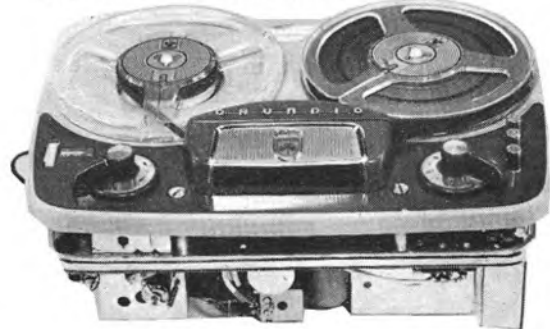

The Grundig TM 20 deck

Enthusiasts will find on the Grundig stand the familiar full range of machines—the single-speed (3½ ips) TK 20 and TM 20 models at 52 and 44 guineas respectively; the TK 25 model (1½ and 3½ ips) at 62 guineas; the TK 30 model (3½ and 7½ ips) at 72 guineas; and the TK 35 three-speed model (1½, 3½ and 7½ ips) at 82 guineas.

JASON'S NEW STEREO KIT

Jason Motor and Electronic Co., 3/4, Great Chapel Street, London, W.1. Stand 62. Demonstration room 313.

Jason are introducing a new 6-watt per channel stereo amplifier kit, featuring push-pull output and 5 mv pick-up sensitivity.

Many other kits will be displayed, as well as the well-known range of matching shelf-mounting tuners and amplifiers.

For many people, this will be the first opportunity to inspect the Jason TV sound and FM tuner JTV, which was introduced a few months ago as the first hi-fi TV sound unit in this country. It costs £26 11s. 10d.

It is, of course, invaluable to those who wish to record the B.B.C.'s experimental stereo broadcasts, for recording from most TV sets is hazardous because of their "live" chassis.



The Jason JTV unit

If you write to manufacturers direct for information, please mention that you saw it in Tape Recording and Hi-fi Magazine.

THE AUDIO FAIR

THE FIRST BRITISH STEREO MICROPHONE

Lustraphone Ltd., St. George's Works, Regent's Park Road, London, N.W.1. Stand 20.

Lustraphone will be proudly showing the first British-made stereo-microphone. This can be used for stereo and single-channel recording and appeals to every type of user, from the tape amateur to the recording studio. It is a very high-quality ribbon velocity microphone at an attractive price.

This firm will also show the special brackets designed to ensure correct placement for stereo when separate microphones are being used.

Further improvements in sensitivity and response have been achieved with the ribbon velocity microphones in the established range. And various new accessories, including microphone plug and socket releases, are being introduced.

A new fully-transistorised audio amplifier, model TPA/557, makes its appearance. This is a 15-watt output, 12-volt unit of completely new design. It is extremely compact and can be installed in the glove pocket under the dashboard of a car, connected to the car battery, and used with either an indoor-type speaker or an outdoor re-entrant horn speaker.

NOW IT'S DOUBLE PLAY TAPE

M.S.S. Recording Co. Ltd., 21, Bloomsbury St., London, W.C.1. Stand 17. Demonstration room 354.

The M.S.S. stand will provide evidence of two new developments—the introduction of double play tape and the manufac-

ture in bulk of magnetic recording heads of very high-quality design and performance.

The new Double Play tape uses a Melinex base, a British polyester film manufactured by I.C.I. and also used for the M.S.S. Long Play tape. This material is stated to have a special value in that it "clings" to the recording head, thereby ensuring maximum response on playback.

Double Play tape will be available in three sizes—300 feet on a 3 in. spool, 1,200 feet on a 5 in. spool, or 2,400 feet on a 7 in. spool.

This firm will also, of course, be demonstrating its standard "Mastertape," which claims high top response and low background noise and a smooth surface that reduces head wear.

Tape Storage Books, another line pioneered by M.S.S., will be displayed, as well as the CMR/DE tape recorder, a machine which touches professional standards.

Philips produce tape dictation machine

Philips Electrical Ltd., Century House, Shaftesbury Avenue, London, W.C.2. Stand 33. Demonstration room 252.

Philips will be introducing their new transcription pick-up arm NG 5400/S, fitted with pick-up head AG 3060, designed to reproduce stereo as well as monaural l.p.'s. Arm and head together sell at 15½ guineas.

This precision-engineered arm is professional in appearance, with a durable satin chrome finish. It is equipped with a micrometer playing-weight adjustment, and the arm pedestal and rest are adjustable in height so that the pick-up can be used with any separate turntable.

The crystal pick-up head has a diamond stylus and a frequency response of 30 to 12,000 cps is quoted. The recommended load resistance for each channel is ½ megohm, and the output is approximately ½ volt for each channel. Suggested playing weight is 4-6 grams.

Philips will also show their latest "Disc Jockey Junior," a portable table gramophone to play all standard sizes and speeds, selling at 15½ guineas.

The Philips range of tape recording accessories and speakers will also be shown.

Philips Electrical are introducing a new tape dictation machine, using the cassette principle, identified as Model EL 3581. Among its novel features is a snap-in type cassette containing 3 in. reels and proving 20 minutes' recording on each of two tracks.

It is a mains-operated machine, measures 10 x 7½ x 4 in. and weighs only 8 lbs.

Basic price is 35 guineas, but a range of accessories is supplied separately, including a microphone at six guineas, a carrying case at four guineas, and a loudspeaker at £5.

THREE PILOT SYSTEMS

Pilot Radio Ltd., Park Royal Road, London, N.W.10. Stand 59. Demonstration room 242.

PILOT WILL BE exhibiting their three amplifier systems, including the recent SHF 15—a combined stereo amplifier/control unit. This produces 7.5 watts output on each stereo channel, or 15 watts monaural. The high sensitivity of 3/5 mV allows the use of all new stereo pick-ups and radio, tape or auxiliary inputs. It costs 32 guineas.

Pilot have achieved an enviable reputation for modern styling, and their products have received the blessing of the Council of Industrial Design.

THE RECORDER Co. (dept. T)

188 West End Lane, West Hampstead
London, N.W.6. Telephone: SW1 4977

INTEREST FREE TAPE RECORDER TERMS OVER 12 MONTHS

Model	Deposit		12 Monthly Payments		Cash Price Gns.
	£	s. d.	£	s. d.	
Sound 333.....	2	16 0	2	0 10	26
EAP Bandbox	3	1 0	2	5 8	29
Philips EL3527	4	2 0	3	1 5	39
Escort	4	15 0	3	10 10	45
Sound 444.....	4	15 0	3	10 10	45
Viscount	5	3 0	3	17 2	49
Grundig TK20.....	5	12 0	4	1 8	52
Telefunken KL75	5	15 0	4	6 8	55
Brenell 3-Star.....	6	4 0	4	11 2	58
Fi-Cord	6	4 0	4	12 11	59
Philips AG8108	6	11 0	4	17 7	62
Sound 555.....	6	17 0	5	2 4	65
Grundig TK25.....	7	3 0	5	7 1	68
Stuzzi Magnette	7	5 0	5	8 8	69
Brenell Mark V.....	7	5 0	5	8 8	69
Essex	7	18 0	5	18 1	75
Grundig TK30.....	8	4 0	6	2 10	78
Telefunken KL85	8	8 0	6	6 0	80
Harting HM5	9	3 0	6	17 0	87
Grundig TK35.....	9	5 0	6	18 7	88
Simon SP/4.....	10	10 0	7	17 6	100
Reflectograph 500.....	10	18 0	8	3 10	104
Tandberg 4-Track Stereo	13	4 0	10	3 9	129

INCLUSIVE OF MICROPHONE, TAPE, MAKER'S GUARANTEE

- ★ We are mail-order specialists—free catalogues and full information on request.
- ★ Free Insurance Policy covering your payments in the event of sickness, accident or unemployment, etc.
- ★ Open all day Saturday. Fridays until 6-30 p.m.



The new Philips NG 5400/S pick-up arm

NEW SPECTO 161 MAKES ITS BOW

LOOK US UP!

Print and Press Services Ltd., 7, Tudor Street, London, E.C.4.
Stand 28.

Two journals which are pioneering their fields will share this stand: *Tape Recording and Hi-Fi Magazine* and *Stereo Sound and Music Magazine*. Copies of both will be on sale—it will be the first issue of the new Stereo publication.

Also available will be the first two publications in the new series of Tape Recording Handbooks, and some interesting new accessories for the tape enthusiast.

Another Stuzzi model

Recording Devices Ltd., 95, Villiers Road, London, N.W.2.

This firm will be showing for the first time a new Stuzzi recorder, to be known as the "Tricorder."

The outstanding feature is an operating speed new to the British market—fifteen-sixteenths of an inch per second. But it is a three-speed machine—with 3½ and 1½ ips as well.

At the slow speed frequency response is quoted at 40 to 4,000 cps.

It is a mains-operated machine, measuring 13 x 10 x 10½ in. Inputs are provided for mic., radio, pick-up connections, and telephone adaptor, and there are separate volume controls to permit mixing.

There are two built-in speakers, push-button operation, magic-eye, digital counter, and superimposition device.

The machine can also be controlled remotely from the microphone, and a slide projector can be controlled from the machine.

The two Stuzzi recorders already sold in Britain have attracted wide attention, especially the portable transistorised and battery-operated "Magnette."

The newcomer to the range is a three-speed recorder with all the latest facilities. At the time of writing the price has not been fixed, but the forecast is a "keen" figure.

Those who are not yet acquainted with the 45-guinea "Mambo," a 3½ ips mains machine with a quoted frequency response of 50 to 12,500 cps plus or minus 3 dB, will be able to inspect it.

The portable "Magnette" will also be displayed.

Simon remote control

Simon Sound Service Ltd., 46-50, George Street, Portman Square, London, W.1. Stand 61. Demonstration room 347.

The Simon SP/4 automatic recorder, introduced at last year's Fair, will have pride of place on this stand, with the equally well-known Cadenza dual-impedance ribbon microphone.

Tape enthusiasts will find another, extremely interesting, product appearing for the first time—a remote control unit for the SP/4. This controls the recorder in start, stop and track-change functions and can be used during record or replay.

It is attractively finished in matching rexine and measures 1½ x 2½ x 3½ in. Complete with 25 ft. cable and input plug, it is priced at three guineas.

The Simon FM tuner and stethoscope head-set are other items on show.

Specto Ltd., Vale Road, Windsor, Berks. Stand 49. Demonstration room 215.

One of the most interesting new products scheduled for introduction at the Audio Fair is the Spectone Model 161 recorder.

This machine is more compact than the well-known Spectone recorder, but it claims very high performance standards. It has a three-speed deck (15, 7½ and 3½ ips), and an interesting feature is that the deck can be operated without switching on the amplifier.

This allows tapes to be re-wound without unnecessary use of the valves. Rewind time, incidentally, is about three minutes.

The quoted frequency response is from 50 to 16,000 cps plus or minus 3dB at 15 ips, with an upper limit of 12, cps at 7½ ips and of 6,000 cps at 3½ ips, the other figures remaining as at 15 ips.

Hum and noise is stated at better than 40 dB below peak output, and wow and flutter at better than 0.15 per cent.

There are two inputs, one for high impedance microphone and one for radio or gramophone. Full mixing facilities are available on recording. Outputs are provided for an extension amplifier and an extension speaker.

The built-in speaker is a 6 x 4 ins. elliptical 15-ohm P.M. Weight of this new recorder is about 36 lbs. and overall dimensions 15½ x 15½ x 8½ ins.

The cabinet is designed to accommodate the microphone and mains cable and there is room in the lid to store three 7 in. reels, in addition to the two that may be kept on the deck.



**... FOR ALL
YOUR TAPE
REQUIREMENTS**

**EVERY LEADING MAKE OF RECORDER
ON INSTANT DEMONSTRATION**

GRUNDIG, ELIZABETHAN, BRENELL, TRUVOX, FERROGRAPH
SOUND, VORTEXION, HARTING, ELON, REFLECTOGRAPH,
SIMON, STUZZI, TANDBERG, TELEFUNKEN, STELLA, WALTER

Visit our Hi-Fi and Stereo Demonstration Studio at
42, TOTTENHAM COURT ROAD. Easy Terms available.

SPECIAL OFFER OF HIGH FIDELITY RECORDER HEADS

A further large purchase enables us to again reduce our price

Leading make, new and unused. Upper or lower track RECORD/PLAYBACK, high impedance, double wound and will reproduce up to 12,000 c.p.s. at 7½ i.p.s. Azimuth adjustments. Output 5 millivolts at 1 Kc at 7½ i.p.s. Low impedance ERASE Heads to match. List £4. Lasky's Price

PER PAIR **39/6** Post 1/3

Please specify upper or lower track.

SPECIAL TAPE OFFER

Brand new, perfect, boxed and guaranteed.

Famous make, P.V.C. base.

Standard:—

1,200ft. (7" spool) 21/-

850ft. (5½" spool) 16/6.

Gevaert Long Play Plastic:—

1,700ft. (7" spool) 35/-

850ft. (5" spool) 18/6.

210ft. (3" spool) 6/6.

ALL MAKES OF TAPE POST FREE

SCOTCH, E.M.I., GRUNDIG, B.A.S.F., FERROTAPE, M.S.S., TELEFUNKEN, etc. Standard, Long Play and the new Double Play, in all lengths.

LASKY'S (HARROW RD.) LTD. Dept. TR
42, TOTTENHAM COURT ROAD, W.1 MUSEum 2605
Open all day SATURDAY. Half-day Thursday.
MAIL ORDERS: 370, HARROW ROAD, PADDINGTON, W.9.

THE AUDIO FAIR

New Truvox deck available as stereo

Truvox Ltd., Neasden Lane, London, N.W.10. Stand 16. Demonstration room 342.

The new Mark VI Truvox deck, a beautifully-styled unit illustrated elsewhere in this issue, will be a highlight of this Fair.

This deck can be supplied with monaural or stereo heads for recording and reproduction. It is available only to manufacturers, but it is a reasonable supposition that it will become a widely familiar deck in the future.

It accommodates 7 in. spools.

An improved version of the type K tape recording amplifier, to be known as Mark II, will be shown. It has improved circuitry and is suitable for use with Mark III, IV and VI tape decks—one only for monaural record/replay or two together for stereo.

The Truvox R 2 recorder will be shown as a standard instrument, and also in conjunction with Unit B, which completes the Stereo Twin-set. This equipment supplies facilities for stereo and monaural recording and playback. It includes two built-in 10 x 6 in. speakers, but other extension speakers can be used if desired.

The full range of Truvox tape recording components and accessories will be shown.

VERITONE SHOW VENUS

Veritone Ltd., Avenue Parade, Ridge Avenue, London, N.21.

The new Veritone Venus portable recorder will be shown on this stand, with the handsome Venus Console of which it is a

progeny. These two machines are likely to cater for most needs. The Console made a big impression when it was seen at the last Radio Show and the new portable version is expected to attract considerable attention at this Fair. Full details were published in our last issue.

NEW VITAVOX SPEAKER

Vitavox Ltd., Westmoreland Road, London, N.W.9. Stand 7. Demonstration room 322.

IN THE DEM. ROOM this firm will be using its Hallmark loudspeaker systems to reproduce stereo disc and tape recordings, in conjunction with standard amplifying equipment.

A new item on the stand will be Type TR 30 high frequency unit, a direct-radiator moving coil speaker fitted with a polyester film diaphragm. It is intended for use with 12 in. and 15 in. bass units and is housed in a tubular body sealed at the rear, so that it can be mounted in the same enclosure as the bass unit.

A capacitor is incorporated to attenuate the input at low frequencies and no external dividing network is necessary. The price is £6 10s. (purchase tax extra).

The best-selling DU 120 duplex-coaxial speaker introduced at the last Audio Fair, and ideally suitable for stereo, will be displayed again.

Tape recordists will also be interested in the range of hand microphones.

30 years' W.B. experience

Whiteley Electrical Radio Co. Ltd., Victoria Street, Mansfield, Notts. Stand 3. Demonstration room 302.

The range of W.B. Stentorian hi-fi products displayed and demonstrated are the outcome of over 30 years' specialisation and complete manufacture within the organisation. The full range of speakers includes units varying in size from 1½ in. to 18 in. in diameter, and these units are available with a variety of cone constructions, speech coil impedance, and magnet strength to suit all requirements.

A new 12 in. unit has been designed, fitted with a specially designed cone and suspension, and this is intended as a full range reproducer.

The firm has carefully studied the needs of stereo enthusiasts and a range of special cabinets will be seen.

To enable those with W.B. 12 amplifiers to convert to stereo a control unit is introduced which can be used with two main amps or with the W.B.8S stereo amps.

THE AVANTIC RANGE

Beam-Echo Ltd., 13, South Molton Street, London, W.1. Stand 6. Demonstration room 115.

This firm will be showing a full range of their well-known Avantic units, practically all of them designed for use with stereo systems.

There is, of course, the handsome Junior "Glyndebourne" for those who want to get their hi-fi systems quickly and conveniently housed. This is supplied with one or other of a choice of amplifiers; any of the commercially available record player units or a tape deck can be fitted, and there is space for a tuner.

Among the loudspeaker units none is more superbly designed than the SL 12-21, an enclosure intended for use with medium-power stereo amplifiers, and containing a 12 in. speaker and a high-frequency pressure unit.

Sound Sales Ltd., West Street, Farnham, Surrey. Stand 36. Demonstrations at the Imperial Hotel (next door to the Russell).

The full range of Sound Sales' tri-channel and "A-Z" products will be shown on the stand. They will be demonstrated in a special room at the Imperial Hotel in order to ensure good listening conditions. Admission will be by ticket.

OUR BUSINESS—NO COMPROMISE

QUALITY ONLY

● WALLACE HEATON'S
LARGEST CITY STOCKISTS
of the
FINEST
TAPE
RECORDERS



Send today for FREE
RECORDER FOLDER

● We are specialists in the
latest HI-FI and Stereo
developments. Also 8 mm.
SOUND HOME MOVIES.

LISTS from Dept. MO/TR

CITY SALE & EXCHANGE LTD.

RADIO & PHOTOGRAPHIC SPECIALISTS

**93-94 FLEET STREET,
LONDON, E.C.4 Telephone: FLEet St. 9391/2**



One of the most handsome consoles now available is the Walter 1,000, with a walnut veneer finish. In addition to the tape-deck and amplifiers, there are five built-in speakers and provision to build in an FM tuner. The price is 130 guineas

STOP PRESS

Two new firms go to tape RGD MARK 107

R.G.D. have now joined the ranks of recorder manufacturers with a Mark 107 model selling at 69 guineas. It is a two-speed machine, for which the quoted frequency response is 30 to 18,000 cps at 7½ ips and 40 to 13,000 cps at 3½ ips.

There are electro-magnetic push-button controls, including an erase button. An extension cable permits remote control at any distance.

The overall dimensions are 16½ in. x 13 in. x 8 in. and the cabinet is covered in green and gold leatherette. The weight is 29 lbs.

The Mark 107 is supplied complete with a dynamic microphone, and a remote control foot switch and magnetic earphone are available for general office use.

Radio Gramophone Development Co., Ltd. Eastern Avenue West, Romford, Essex.

NORMENDE TITAN

ANOTHER CONTINENTAL machine reaches the British market. It is the Normende Titan. It has dual track operation (CCIR standards); speeds 3½ and 7½ ips.

Among its principal features are automatic stoppage on reaching the end of the tape, a three motor drive without belts or clutches, ten push-button controls including two editing keys, a three channel electronic mixer, monitoring through in-built speakers or separate earphones, three programme sources (microphone, gram, second tape recorder), film synchronisation without modification of the recorder, woofer in combination with two tweeters, recording control avoiding accidental erasure of tape.

The power supply is 50 or 60 cycles for 110/130/150/22/240 volts. Dimensions 16½ in. x 8 in. x 15 in. Weight 33 lbs. Price 89 guineas.

The deck is available separately. Price 66 guineas. (Sole U.K. distributors: Tak Continental Importers, Stone, Staffs.)

CQ & REPS AT IMPERIAL

As last year, there are a few firms who are not exhibiting at the Audio Fair, but who will be showing new products simultaneously elsewhere. We report on them below.

CQ Audio Ltd., 2, Sarnesfield Road, Enfield, Middlesex.
Exhibiting at Imperial Hotel, Russell Square, 2-5th April.

This firm will be showing its Senior CQ Reproducer, the "Q" Flex, and the new Junior reproducer described in this magazine last month, plus a full range of stereo amplifiers, pre-amps and tuners.

It plans also to introduce a new three-speaker system, on which development work has been going on for some time and which the manufacturers think will compare most favourably with any other speaker on the market. The price has not yet been fixed, but may be about 36 guineas.

Reps (Tape Recorders) Ltd., 118, Park Road, North Acton, London, W.3. Exhibiting in the Imperial Hotel Ballroom.

THIS COMPANY will be exhibiting its complete range of products, including an export model with record and replay characteristics corrected to either CCIR or NARTB.

The Collaro tape transcriber will be shown modified with a stereq in-line head, plus a second channel recording unit which can be added to models R20, R30 and R40. This unit will convert these models to dual-channel record/replay on 3½, 7½ and 15 ips.

Demonstrations will be made with an Aldis slide projector automatically controlled by a Reps recorder.

The Imperial Hotel exhibition will be open from 6 to 10 p.m. on Thursday, 2nd April, and from 10 a.m. to 9.30 p.m. on the following Friday, Saturday and Sunday. Tickets are available free, from dealers.

The Finest Selection in the West End! INTEREST FREE TERMS

MAKE	DEPOSIT		12 monthly payments of		CASH
	£	s. d.	£	s. d.	
Walter 101	3	0 0	2	5 9	29 gns.
Geloso	4	0 0	3	0 0	38 gns.
Philips EL 3527	4	0 0	3	1 7	39 gns.
Verdik	4	15 0	3	10 10	45 gns.
Elizabethan Escort	4	15 0	3	10 10	45 gns.
Wyndor Visco-unt.	5	9 0	3	15 5	49 gns.
Magnafon Courier	5	9 0	3	15 5	49 gns.
Telefunken KL75	5	5 0	3	18 9	50 gns.*
Grundig TK20	5	12 0	4	1 8	52 gns.
Dulci-Harting deck and pre amp.	6	0 0	4	6 3	55 gns.*
Brenell 3-star	6	8 0	4	13 0	58 gns.
Philips AG8108G	6	12 0	4	17 6	62 gns.
Grundig TK25	6	12 0	4	17 6	62 gns.*
Brenell Mark 5	7	4 0	5	0 0	64 gns.*
Stuzzi	7	9 0	5	8 4	69 gns.
Grundig TK30	7	12 0	5	13 4	72 gns.*
Telefunken KL85KL	8	9 0	6	4 2	79 gns.*
Grundig TK35	8	12 0	6	9 2	82 gns.*
Vortexion W.V.A.	9	8 0	6	18 4	88 gns.*
Saba	9	9 0	7	0 0	89 gns.*
Reflectograph 500	9	14 0	7	8 4	94 gns.*
Simon SP.4	10	0 0	7	9 5	95 gns.*

Leaflets available! *Microphone extra.

SPECIAL OFFER! The "DIAWA" 2-speed Recorder with moving coil mike. £1 Deposit and 30 weekly payments of £1. Cash 29 gns. Tuners, Amplifiers, Stereo Equipment, Mikes, etc., etc. on similar terms.

E. C. KINGSLEY & Co.

132, Tottenham Court Road (Corner of Warren St.)
London, W.1. Telephone: EUSton 6500.

AMERICAN DEVICE ERASES PRINT-THROUGH

THE new American device to erase print-through, referred to in an article in our last issue, is illustrated below. It is Audio Devices' simple and inexpensive "Echoraser" which removes print-through from valuable "echo-ridden" tape recordings, and it has just been shown for the first time in New York.

Needing no power to operate, the simple device consists of an upright chromium-plated brass bar, $1\frac{1}{2} \times \frac{3}{8} \times \frac{1}{4}$ ins. with a small energised area. The bar fits snugly over a $\frac{1}{4}$ in. base plate with two pins permanently installed on the tape deck.

The "Echoraser" package consists of two erasers, each with a different power of energised area: a red Echoraser for removing up to 9dB print-through, and a black Echoraser to remove as much as 18dB from more seriously-affected tapes. For instance, the print-through on a recording three years old can be reduced down to its value only one hour after recording.

Whichever Echoraser is required is slipped on to the deck.

Success in the amount of print-through reduction, however, is dependent on several factors: the storage conditions of the recorded tape, the age of the recording, the printing frequency or wavelength, and the magnetic properties of the tape.

But the Echoraser can be an invaluable tool for the recordist, in restoring priceless old recordings made useless by "background" noise. In the future, by employing good magnetic tape and echorasers it will be possible to store recordings with the assurance that they will remain unmarred by print-through.

There is no news at present of the new device becoming available in Britain.



RECORDER PICKED UP "INAUDIBLE" WORDS

Deprived of his power of speech, a polio sufferer was able to speak again to relatives and friends by means of a Saja tape recorder.

This machine, specially adapted, received his word sounds—sounds which, without the machine, would be inaudible—through a mechanism placed inside his mouth, and then recorded on the tape for audible playback.

Another example of how tape recorders can aid the afflicted, this story comes from South Africa.

Toy factory helps make new German models

From HANS KOEBNER, our
German correspondent

A COMBINATION of ideas by an electronics firm and a toy factory has led to the introduction on the German market of two very cheap new recorders.

The first of the new models is transistorised, and sells at about 10 guineas including microphone, tape, and permanently-attached leather case. It has a built-in loudspeaker.

The second of the recorders is a deluxe model. Selling price is around the fifteen guineas mark, microphone, tape and leather case included.

The reproduction of this deluxe model seemed to me, when I heard a playback through a radio-set, to be excellent.

Both recorders work with a set of batteries allowing an estimated fifty hours' running time.

Tape to Disc Services

TAPE TO DISC RECORDING

Microgroove LP from 27/6d.

78 rpm from 11/-

Also 45 rpm

48 HOUR SERVICE

S.A.E. for comprehensive leaflet to:—
Marsh, "Deroy" Sound Service, Little
Place, Moss Delph Lane, Aughton, Orms-
kirk, Lancashire. Tel.: AUG 3102

TAPE TO DISC SERVICE

78's or L.P.

QUEENSWAY RECORDING STUDIOS

123, Queensway, London, W.2.

Tel.: BAYwater 4992

TAPE RECORDER HIRE

TAPE TO DISC 78-LP
RECORDING STUDIO
SALES—EXCHANGES

MAGNEGRAPH

1 Hanway Place, London, W.1.

s.a.e. for leaflet or
telephone LAN 2156

RAPID RECORDING SERVICE

21, Bishops Close, Walthamstow, E.17. LAR 3889

Recording Studio equipped with new Steinway
Grand. Mobile Recording Van. 78s. and L.P.s
from your own tapes. Commentaries and music
on Synchronised L.P.s for cine enthusiasts.
Master Discs and Pressings

RENDEZVOUS RECORDS

(T. H. ADKINS)

TAPE TO DISC SERVICE

33 — 45 — 78 R.P.M.

S.A.E. to:

19 Blackfriars Street, Manchester 3

Tape to Disc Service

78s-45s and LPs made from your
own private recordings. From 6 mins.
to 40 mins. per disc (double sided).
Prices from 10s. 6d. Send S.A.E. to
Sunderland Sound Services, 28, View-
forth Terrace, Sunderland. Tel.: 57032.

YOUR EYE

says "That's a new gay box. Ah, 'scotch' Brand Magnetic Tape. Eye can tell there's quality inside, just as everybody says."

YOUR EAR

says "This 'scotch' Brand Tape certainly lives up to its reputation. It sounds perfect to me, and I'm an ear for music."

YOUR COMMON-SENSE

says "The quality suits the sound engineer—the exclusive silicone "dry lubrication" minimises wear on magnetic heads—the price suits the pocket—well, it's 'scotch' Brand for me every time!"

200 DOUBLE-PLAY

Tensitized Polyester is the wonderful new 'scotch' Brand Magnetic Tape. It's extra strong, and gives you double the playing time! Resists stretching. Keeps its high quality of reproduction year after year!

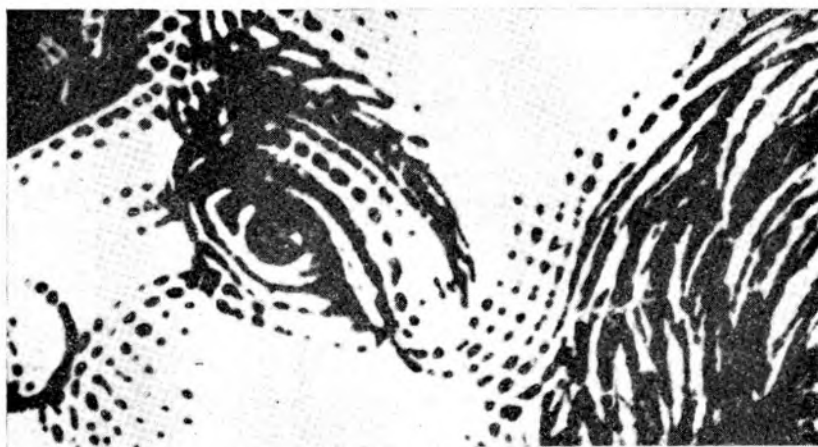
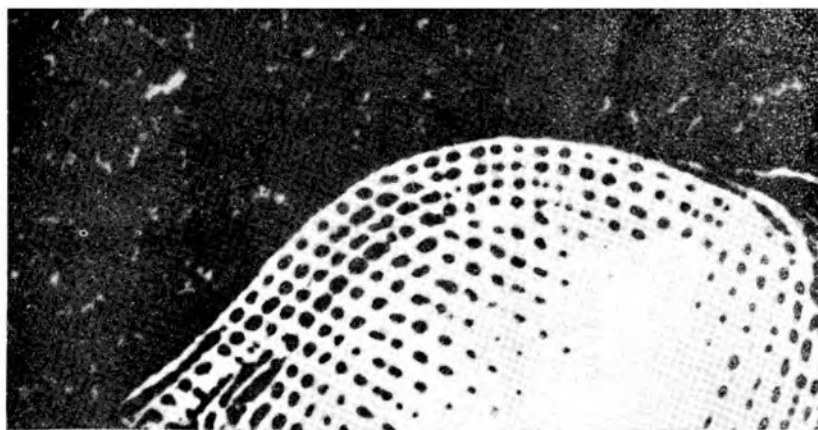

Ask your supplier for the ingenious PLAYING-TIME CALCULATOR—it's free!

Or write to our Head Office.

THE BBC USE **SCOTCH** BRAND MAGNETIC TAPE



MINNESOTA MINING AND MANUFACTURING CO. LTD.

Tape and Electrical Products Division. Head Office: 3M House, Wigmore Street, London W.1.
And at Birmingham · Manchester · Glasgow

FITTING A TIME-SWITCH

Charles Langton adds a
postscript to his article
in last month's issue

To complete the article which appeared in last month's issue of *Tape Recording Hi-Fi Magazine*, the following notes are to assist those who have purchased, or intend to purchase, a time-switch for the purpose of recording radio programmes during absence.

A time-switch operates on a similar principle to an alarm clock, and may be powered by a clockwork or electric motor. The clockwork models normally run for six hours or more on each winding, whilst the electrically operated run continuously.

The electrical connections are shown in Fig. 1. A neat job can be made by mounting the switch and outlet sockets on a wooden batten about 6 in. x 4 in., the mains lead terminating in the correct wall plug as used in the house. This is shown in Fig. 2. There are two types of time-switch available, the simplest being the kind which switch on at a predetermined time, and remain on until reset. Therefore, if using this type, the power will remain connected to the radio and recorder after the desired programme has ended.

This may not be serious if the owner returns within a reasonable period, and if the recorder is fitted with an automatic cut-off switch operated when the spool becomes unwound. Otherwise, the second type of time-switch should be considered. This is an improved type which switches off after a definite interval of time, previously decided upon. Various methods to adapt the simpler switch to cut off at the end of the tape will occur to the experimentally minded, and this may be carried out successfully using relays.

Care should be taken that the relays used will stand up to the mains voltage, however, and in general, modifications to the wiring of the recorder should only be carried out by competent technicians.

In operation the receiver must be tuned to the desired station and connected to the recorder. The volume control or modulation control will have to be correctly set, and the best way of doing this is to have a practice run earlier on and noting the control positions. Before leaving, ensure that the receiver and recorder switches are "on," and that the "record" button is pressed home.

On certain machines, this button will not stay down with the power off, and it will be necessary to devise a suitable clip for this purpose. Next, wind the time-switch (or connect the battery, if electrically operated. Two cycle lamp batteries are usually adequate) and set to about three minutes before the programme commences. Finally plug into the mains. As the programme will probably last longer than half an hour, a tape speed of $3\frac{1}{2}$ i.p.s. is most likely to be called for.

A word of warning. A number of recorders tend to continue unwinding freely when switched off before pressing the tape deck "stop" button and this will at least result in a tangle of tape. Therefore, if intending to use the self-resetting type of time-switch (for switching itself off), it is best to make the following test before going to any expense. Switch the recorder on to record or replay, and when running normally withdraw the mains plug. If the spool runs on as if it may damage the tape, it is best not to use this type of time-switch.

The same construction may also be used in conjunction with the home built time-switch described last month. Attention must be drawn to the fact that the clock switch in Fig. 1 now becomes the mains contact on the relay, and not the actual contacts within the clock itself.

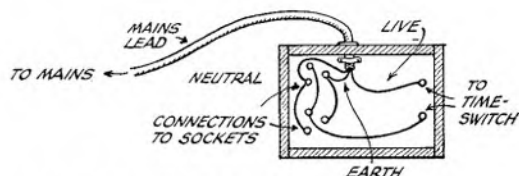
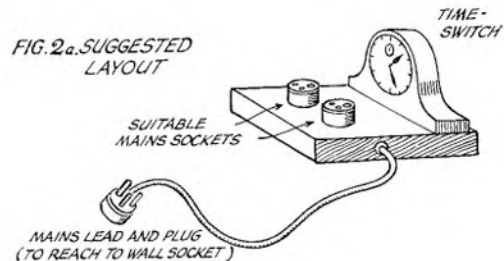
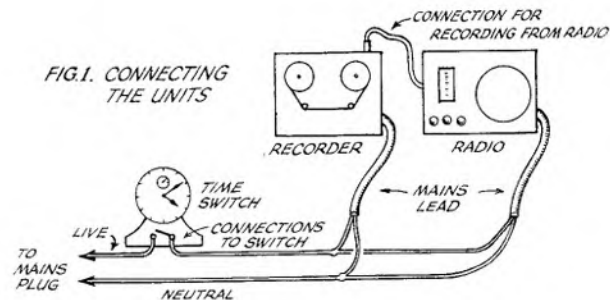

FIG. 2b. WIRING DIAGRAM. UNDERNEATH VIEW.

... AND A READER SUGGESTS A CONTEST

FURTHER to the article on Make Your Own Time-Switch. During the war I trained an elderly alarm clock to spool a wire round its alarm-wind handle thus pulling over an ordinary tumbler switch and starting up the radio.

That is to say that it could only do half what is wanted. After all, the reason for equipping a tape-recorder with a time-switch is that you are not there to switch it on yourself—so the odds are that you won't be there to switch it off, either. So unless you are willing to let your tape-recorder go on running possibly for hours, this thing is virtually useless.

What is wanted is this: A clock that will switch ON and OFF. That can be set for anything up to twelve hours ahead, and is accurate in operation to, say at most, two minutes of its setting.

(If you look at the products of the firms mentioned at the end of the article you will find that they do not adequately fulfil these requirements. Most of them are intended for serial operation and set for a long run so that the means of setting is by no means handy, or they cannot be set to close enough tolerance, or they give sixty minutes to "on" and there is no "off." And if you can show me one that is simply, handily set to give me half an hour's recording a couple of hours ahead [apart from Smith's oven clock which is not generally available] I'll get it tomorrow.)

Or, may I suggest a competition? It ought to arouse interest and inventiveness among your readers, and a small prize to the producer of the neatest and handiest design ought to benefit all of us.

JOHN WYNDHAM.

London, W.C.1.

Editor's note: Certainly. A three guinea prize for the best idea submitted before the end of April.



TESTED IN THE LAB

Telefunken model 85 demonstrates mechanical ingenuity

Typical of the thoroughness of German manufacture, the Telefunken type 85 Tape Recorder is an example of mechanical ingenuity. It is a domestic recorder incorporating several unique features which are not normally found on British made machines, and in this respect is probably one of the most flexible of its kind. For example, no less than fourteen different combinations of interconnection are possible and the instrument has special facilities for use as an office dictating machine.

For this latter purpose a special microphone can be supplied which incorporates a switch enabling the user to stop and start the recorder. Even special telephone adaptors can be supplied although these may not be useable with British G.P.O. telephones.

A "trick control" enables speech to be superimposed on music for example, or the mixing of various combinations of sounds. The same control also provides an interlock system to prevent complete erasure of a previous recording.

Another mechanical feature is the "pause button" so that the tape can be stopped instantly during recording or playback, but with an immediate re-start when the button is released. This is a very useful facility for cutting out unwanted speech when recording programmes from the radio.

Controls

All the main controls are conveniently situated on the deck panel and include "piano-key" buttons for stopping and starting the tape on record and playback. A fast wind and rewind control is provided, together with a tape position indicator reading directly through a window on the deck panel. A magic-eye recording level indicator is fitted and again ingenious use is made of controls in that the three input circuits may be selected individually by means of a switch which is integrated with the recording amplifier gain control.

The playback gain control is separate but is in fact a combination arrangement which enables the playback main amplifier to be switched off or brought into circuit for direct monitoring during recording.

Separate bass and treble controls are fitted, both of which are "thumb-wheel" operated from the front of the deck.

Tape accommodation is for a standard $7\frac{1}{2}$ in. spool, or smaller sizes, and if long playing tape is used, a total playing time of four hours six minutes is available at $3\frac{1}{2}$ in. per second, or three hours three minutes at $7\frac{1}{2}$ in. per second, which is quite sufficient for even long symphonies.

Circuitry

Conventional and readily available valves are used, such as the EF.86, ECC.83, ECL82, etc., and the heaters of the first stages of the pre-amplifier are supplied from a D.C. source. This achieves complete elimination of hum from the high gain stages, but it was felt, however, that HT smoothing could be improved as some 50 cycle hum was noticeable from the output

stage. This was born out by measurement of ripple voltage at the anode of the output valve.

The pre-amplifier is built into the main deck assembly whilst the output stages occupy a small chassis of their own.

A push-pull bias oscillator with a good clean waveform ensures noiseless recording and a test on virgin tape showed no residual noise after being passed through in the recording state.

Erasure is complete even on the heaviest of recordings.

Input Circuits

Provision is made for microphone, radio or pick-up inputs on a small panel at the rear of the recorder. Special screened plugs are required and although these were not supplied with the instrument, they are, in fact, readily available from the distributors. A panel for the adjustment of the mains input voltages is provided and covers the range of 110/240 volts, at 50 cps. with conversion to a mains frequency of 60 cps. if required.

Output Circuits

The type 85 has a single ended output stage providing 3 watts of audio power but since the loudspeakers are of good sensitivity more than sufficient volume is available for normal domestic purposes (the Telefunken 85 KL recorder is fitted with a push-pull output stage providing 6 watts of audio power). Extension loudspeaker sockets are provided as well as an outlet for connection to an external high fidelity amplifier system and provision is made for headphone monitoring during recording.

Servicing

Most radio and electronic equipment requires servicing at some time or other, and many do not realise that the greater part of servicing costs are often those for labour and time taken, such as the removal of the chassis, from the cabinet. Some designers take fiendish delight in making things difficult in this respect for the service engineer.

The Telefunken recorder can be removed from its case in a very few minutes. After taking off the control knobs, four screws release the entire deck panel and four more permit removal of the whole deck. This leaves only the main amplifier, which is released by four more screws.

(Continued on page 47)



With every Telefunken KL85K

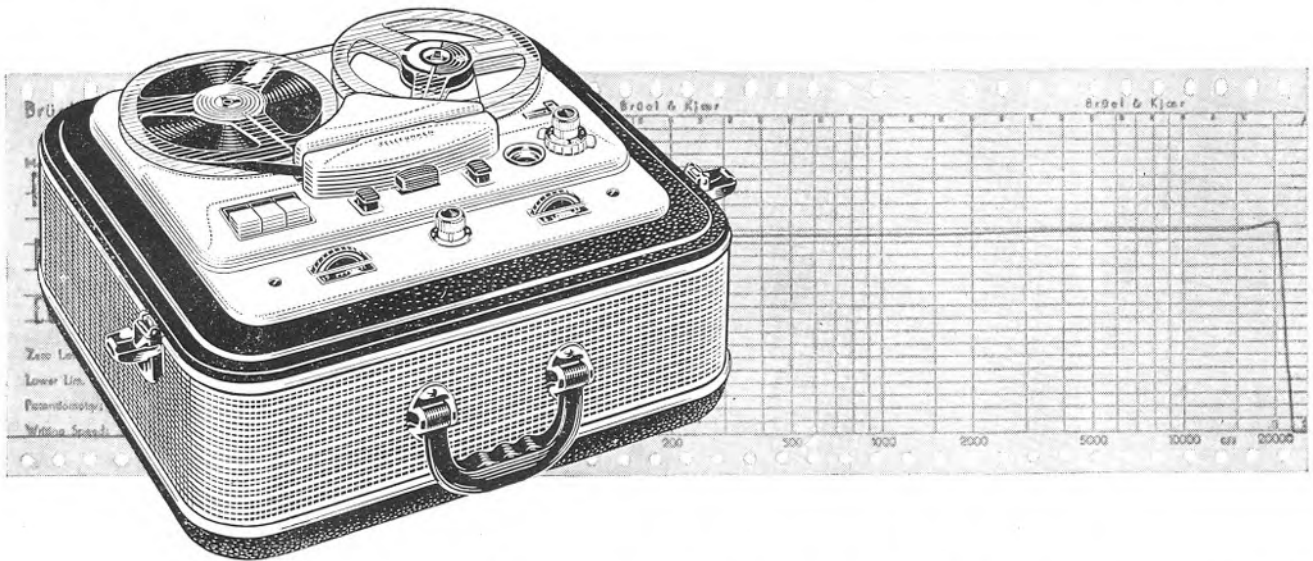

Frequency Response is Guaranteed by Certificate!

HERE is proof of Telefunken's confidence in the magnificent KL85K, a certificate showing the actual falling off in dB at the limits of frequency response. The frequency range from 30-20,000 cps at 7½ i.p.s. is guaranteed with ±3dB, and each model proudly carries the result of its individual test before leaving the factory.

DC heated, pre-amplified valves cut out hum and ground noise. Matched speakers give a tonal quality well exceeding Hi-Fi standards. LF amplifier with treble and bass controls operates separately for straight-through and monitoring work.

Patent automatic tape tension and superfine magnetic heads ensure fullest tape protection. Push-button controls for recording, stop, play back, quick stop, recording-interlock and trick button, etc.

MODEL KL85K
75 GNS. (Excl. Mike)

Testing the KL85K and producing the individual frequency response certificate.



You are cordially invited to visit

TELEFUNKEN

at the 1959

AUDIO FAIR

Demonstration Room

No. 337

★

The latest models and developments will be on show including exciting stereo machines

TELEFUNKEN

The originators of tape recording

Send Coupon for details of the complete range etc.
To WELMEC CORPORATION Ltd., 147 Strand, London, W.C.2

Name

Address.....

T.G.A.

TELEFUNKEN 85

Test report continued
from page 45

The deck is connected to the main amplifier by means of a cableform which can be unplugged thus allowing the deck to be lifted clear for inspection.

Minor adjustments to the mechanism can be made by taking off the deck panel only and azimuth alignment requires the removal of only the inspection cover to the tape head.

General

The recorder is attractively finished in green leatherette, with a cream deck panel, controls to match and gold lettering.

It is of a comparatively light weight and the lid may be removed completely when the recorder is in use.

A comprehensive instruction booklet together with the special Telefunken frequency response certificate is issued with all the 85 type instruments. The makers claim to be the only concern providing such a certificate and although the idea is not a completely new one, it is at least a further guarantee of performance of every individual recorder leaving the factory.

Functional Testing

The sample instrument was subjected to close testing of frequency response, wow and flutter content, hum and noise level, tape spooling, and the general reaction of the various controls.

Although the frequency range compared closely with the response certificate issued with the instrument, the output level at 40 cps. was in fact, below that specified by about 4 dB. There was, however, still ample reserve on the bass lift control to compensate for this.

It may be mentioned here that this recorder was tested with the EMI standard frequency test tape and with a standard laboratory signal generator and sensitive automatic frequency response plotting equipment, capable of showing deviations ± 0.25 dB. It was with this equipment that the effect of some tape flutter was measured. Deviation in steady output at frequencies above 6 K/c. by 0.5 to 1 dB were recorded and were probably due to rapid lateral movement of the tape with respect to the head gap. This may have been caused by lack of tape tension.

Wow was negligible, being practically undetectable when listening to a steady tone. However, some beat note effects were noticeable at a frequency of 200 cycles, presumably due to the presence of 50 cps. ripple from the HT line. Beat notes of approximately 0.5 dB in amplitude, when referred to the level of the main response, were measured at the anode of the output valve.

Noise level was negligible and did not exceed that normally given by an EF.86 head amplifier valve, but as already mentioned there was slight hum from the output stage due to AC ripple.

Tape spooling on both slow and fast winding is accurate and no tape spilling or jumping was experienced on stopping the tape from fast rewind.

Although the drive motor runs continuously, it remained quite cool after running non-stop for over eight hours. Other mechanisms such as the trip mechanism operated from the silver contact strip at the start and finish of a tape functioned efficiently by braking instantly from fast or slow winding. Normal braking with the stop button from fast wind or rewind is almost instantaneous.

All other controls responded efficiently, although the input selector switch appeared to be intermittent at times, probably due to a faulty contact.

Recordings were made at $7\frac{1}{2}$ in. per second of B.B.C. programmes from an F.M. tuner as well as music directly from gramophone records.

The music recordings were practically indistinguishable from those played directly from the original source while recorded

speech from a Telefunken type DB/11 microphone was crisp, clear and remarkably lifelike.

Similar tests were made at $3\frac{1}{2}$ in. per second, and whilst the higher frequencies are limited, music recordings were nevertheless still within acceptable domestic standards.

Specification

The following is the maker's specification of performance:—

Tape speeds $7\frac{1}{2}$ and $3\frac{1}{2}$ ips.

Frequency range ... 30 to 20,000 cps. at $7\frac{1}{2}$ ips.

30 to 15,000 cps. at $3\frac{1}{2}$ ips.

Recording inputs ... Two milli-volts at two megohms (microphone).

Two milli-volts at 100 K.ohms (radio).

150 milli-volts at one megohm (gram.).

Playback outputs ... Approx. 2 volts at 18 K.ohm (audio lead).

Approx. 10 volts at 100 K.ohms (crystal headphones).

Approx. 5 volts into 2,000 ohm headphones.

Approx. 3 watts output loaded with 4.5 ohms (output stage).

Fully automatic press button control with effects button.

Automatic tape-end stop by contacting foil.

Tape length indicator, counting backwards and forwards with zero adjustment.

F. C. JUDD.

USING TURNTABLE TO DRIVE AN EXTRA TAPE DECK

Equipment under review: "Gramdeck" tape recorder.

Distributors: Pullin Optical Co. Ltd., 93-97, New Cavendish Street, London, W.1.

Prices: Gramdeck £7 10s.; Control unit £5 12s. 6d.

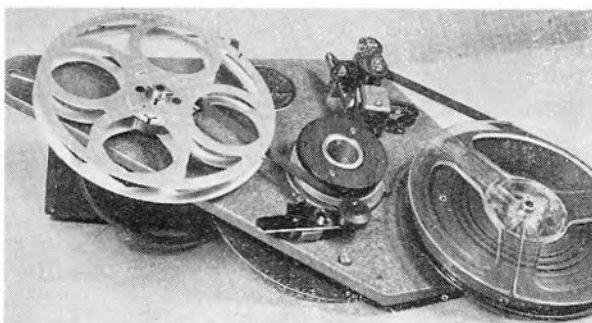

The Gramdeck is a simple tape transport mechanism which, as the name implies, obtains its drive from an ordinary gramophone turntable. With the Gramdeck it is possible to record and playback tapes using only a normal radio or record player in conjunction with the Gramdeck Control unit. The tape speed is arranged for $7\frac{1}{2}$ inches at a turntable speed of 78 r.p.m.

The wow and flutter content varies slightly from model to model and is generally higher than is expected from the average domestic tape recorder. A transcription table naturally provides the best form of drive, although any modern record playing unit is suitable. By using a clockwork turntable a very economical portable recorder is made, which is ideal for use out of doors.

(Continued on page 48)

THE "GRAMDECK"

Test report continued
from Page 47.

Setting up procedure is explained in detail in the eight-page leaflet supplied. To arrest the rotation of the deck itself there is an anchoring pillar which is screwed to the baseplate or motorboard. The deck must not bind on this anchoring pillar so that free movement of the deck plate is possible; otherwise a variation in pitch will occur once per revolution of the turntable. Spools of up to 7 inches in diameter can be used according to the amount of room available inside the cabinet. The single record/playback head can be rotated in its mount for azimuth adjustment. Since it has been accurately set on a pre-recorded tape it should only require adjusting when fitting a new head, and then with a test tape of 6k or 7k/cycles. Permanent magnet erasure is used, and the magnet has a guard which holds the tape clear to prevent accidents when playing back. One has to remember that there are no brakes on the spools, so that layers of tape are inclined to spill when lacing up. The take-up was inclined to be slack on the test model, and a full reel of tape needed watching when approaching the end of a run.

The Control unit can be mounted flush with the outside of the cabinet or left as a free-standing unit. It is transistorised, and self-contained with its own dry cell. The current drain is only 2mA and the 9 volt battery will last about 600 hours. Connections have to be made to the amplifier pick-up and loud-speaker sockets, and the loudspeaker can remain connected to provide a monitor.

There are two co-axial sockets on the front panel for the microphone input and the record head on the Gramdeck. When switched to RECORD one transistor operates as a bias oscil-

lator, and the other as a microphone pre-amp, with an input impedance of about 500 ohms. Suitable microphones of the moving coil type can be supplied by Reslo, Grampian, Lustraphone and Vitavox. The Acos range of crystal microphones can be used but a 100k resistor must be wired in series, inside the co-axial plug.

When recording the control unit output is passed into the pick-up sockets of the amplifier. If the Gramdeck is required for portable use the output can be taken directly into the record head. There is a switch on the front panel which is set on MONITOR for the first condition and DIRECT for the second condition. A playback can be obtained from the unit by using a pair of high resistance phones. There is no form of volume indicator provided, and one can hardly be surprised in a unit of this price. After a little practice it should be possible to arrive at a convenient recording level merely by listening to the loud-speaker monitor.

When the unit is set for playing back, both transistors are connected in tandem as a voltage amplifier incorporating a tone control. The output is approximately .25 volt and follows the standard CCIR characteristic when the tape speed is 7½ inches. The gap width is .00025 in. and a fairly level response is obtained from the control unit output over a range of 80 to 10,000 cycles ± 3 dB. If hum is encountered on playing back it may be caused by the turntable motor field picking up in the record head. In this case the deck should be rotated about its capstan until the hum is at its minimum. Then the fixing pillar can be finally screwed down. There is a rewind handle included in the kit, although the turntable can be used for rewinding by changing over the spools.

For the home constructor who wishes to build his own control unit and pre-amp. there is a circuit diagram and all other necessary information in the leaflet provided with the deck. The circuit makes use of a double triode valve (type ECC 83).

There is much to commend this Tape deck as an extra unit to supplement one's equipment. As already explained it can be used out of doors as a self-contained recorder, or to record from the radio or any other source.

JOHN ALDRED.

TAPE
RECORDING
AND HI-FI MAGAZINE

TAPE ACCESSORIES

(to be issued on April 2nd)

TEST TAPE

A test tape, particularly suitable for the keen amateur, wishing to test the efficiency of tape recorders and to check the balancing of stereo.

£ 2 2 0

TAPE TIME CALCULATOR

A simple, read-at-a-glance device which gives you the playing times for any size reel or length of tape from any speed, ½ to 15 ips. **3/6d.**

(4d. postage included)

All enquiries to:

TAPE RECORDING AND HI-FI MAGAZINE
7, TUDOR STREET - LONDON - E.C. 4

Doors, golf, fire —and an elephant walking

Opening and closing doors may be one of the human activities, but for sound effects purposes it is the most difficult of all to perform properly.

An opening door may be used to heighten dramatic tension. If the main action of a play is with a character the other side of the room the microphone must also be in that position; if the person is entering the room then the microphone must be close to the door on his side. In this case the door is opened by turning the handle slowly, letting all the mechanical action of the lock register, making a pause, and slowly closing the door.

The quick entry of a comic character is entirely different to this mannered approach; here the door handle is hit hard, rattled and turned very quickly to burst open. Most house doors will provide the sound needed but for amateur dramatic societies who may need a property car door the following description may prove useful to them.

Construct a frame of 2 in. x 2 in. unplanned deal timber, two feet high, one foot deep, eighteen inches wide. Make the door fit snugly into the frame. Screw onto the base of the frame a piece of half-inch thick plywood, the sides may be covered with ordinary 3-plywood, and the top and back with metal sheet.

Fit a car-type lock and handle and construct the door frame of sheet metal with a wood front. The apparatus may be held steady by placing a couple of stage weights inside.

Now here's a good rare sound effect for your collection—an elephant walking! Two coconut shells operated on top of a piece of felt that covers a resonator, such as a big drum, with the rhythm of a horse walking, but slower, easily achieves this sound.

The crackling of fire is produced by manipulating, squeezing, and separating a small ball of cellophane held close to the microphone.

The rustle of a person walking through long grass is made by moving a mass of old loose tape near to the microphone in rhythm with the footsteps, and if the sporadic breaking of twigs accompanies these noises it will sound the same as somebody walking through light undergrowth.

And if the same person happens to be playing golf, then the swish of foil or cane will, followed by the bounce noise of a golf ball on a floor board, complete the picture.

Book Review

FOR TV TECHNICIANS

THE *Television Servicing Handbook*, written by Mr. Gordon J. King, Assoc. Brit. I.R.E., and published by Odhams Press Ltd., at 30s., is a down-to-earth, clearly-written book mainly for the television service technician. The author presents the essential practical information required for the recognition, diagnosis, and repair of common and obscure faults.

The text is written from a general standpoint and can be applied to almost all receivers in present use, whilst a descriptive explanation is given about many circuits in common use. A small printer's error appears in Fig. 83 on page 133.

The book is well illustrated and up-to-date, and will prove ideal for the radio-service technician desiring a non-mathematical introduction to television practice, whilst valuable information is provided for all who are engaged upon the servicing of television receivers.

C. H. L.

NO TROUBLE WITH CUSTOMS

IN your January issue you publish a letter from Stanley White on the correct declaration for customs for tapes. I have been exchanging tapes all over the world for the past four years and have never had any trouble with customs authorities in this country nor reports from abroad of similar troubles.

I use the standard phrase suggested by the various international tape exchange clubs which is "Magnetic Tape Recorder Message" or "Personal Tape Recorded Letter. Return to sender" written on the green customs label (C1) obtainable from most Post Offices. These phrases or similar are used in foreign countries for tapes entering this country. I received such a tape only last week.

The phrase suggested by Customs and Excise which you publish could not possibly be written on their customs label, which is only 2½ x 1¼ in size, and has to include the weight and the value of the goods, with instructions printed on it in English and French. Presumably the phrase suggested is for use without a customs label, if it is possible to send a tape abroad without a green label.

W. P. COPINGER.

Kilmarnock, Scotland.

Tape exchanges with Russia

IREAD with interest Mr. Stanley White's attempt to exchange tapes with the Soviet Union.

In 1956 I had similar ambitions. I was successful in making one tape exchange with the Soviet Union.

The tapes were of folk music and a message of good will and without any political implications. My tape was made as an individual, exercising his American heritage and curiosity.

The Soviet Union's reply was "official" and approved. The studio facilities of "Radio Moscow" were used to satisfy my curiosity about their folk music. Why the exchange was approved I will never know, but for twenty minutes (at 30 ips tape speed) I listened, through the miracle of tape, to Moscow at its best.

I doubt if an event like this will ever occur again. Since 1956 the Soviet Union has liberalised its exchanges in other fields and, possibly, this was the beginning.

But the lesson is: the tape recorder can be more powerful than the bomb and may, if used with respect, get us talking to each other on a people to people basis—the only step towards tolerance.

ED. BUSH.

Box 101, Edinburg, Indiana, U.S.A.

Playing times

INOTE with great interest the list of playing times of various pieces of music in the January issue.

Perhaps readers will add the following four playing times to their list, which were omitted from the original.

Tchaikovsky, No. 1 Piano Concerto, 35 mins.; Beethoven, No. 3 Piano Concerto, 39 mins.; Mozart, Symphony No. 33, 17 mins.; Ibert, "Divertissement," 15 mins.

I am sure readers find these times very useful, and I for one will welcome any more additions to the list.

C. J. HUMPHREYS.

Carshulton, Surrey.

TAPE RECORDING AND HI-FI
MAGAZINE ADVICE BUREAU
APRIL, 1959

Patrick Copinger describes in this article how to build a simple accessory which can add immensely to the fun of recording. It is a straightforward do-it-yourself exercise which, with the aid of the illustrations, is within the ability of any reader anxious to start in this field.

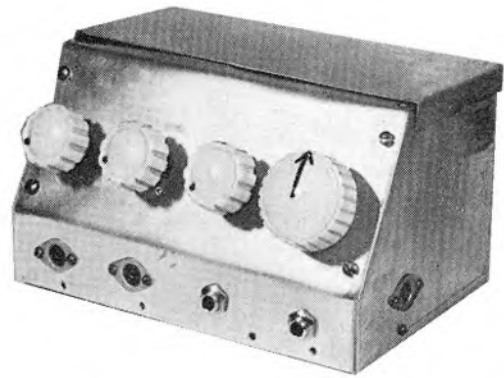

BUILD YOURSELF A SIMPLE MIXER UNIT

THIS mixer unit has been designed to enable users of tape recorders and amplifiers to mix various sources of input signal to the high impedance (microphone) input of most domestic tape recorders. With it, it is possible to use two microphones and two other signal sources (such as radio or gramophone and another tape recorder or radio tuner unit) mixing all four inputs if required by means of independent volume controls for each, feeding one signal out to the single microphone input to the tape recorder or other amplifier. Thus it would be possible, for instance, to recite a poem with background music supplied from radio or gramophone or another tape recorder. Using two tape recorders, it is possible to sing a duet or trio with yourself!

If you wish to record a play or a concert from a stage and put in commentaries during the performance, use two microphones, one on stage or near the performers as required, using a separate microphone yourself, with the mixer unit to hand in a concealed position where you may make comments, fading in and out as necessary.

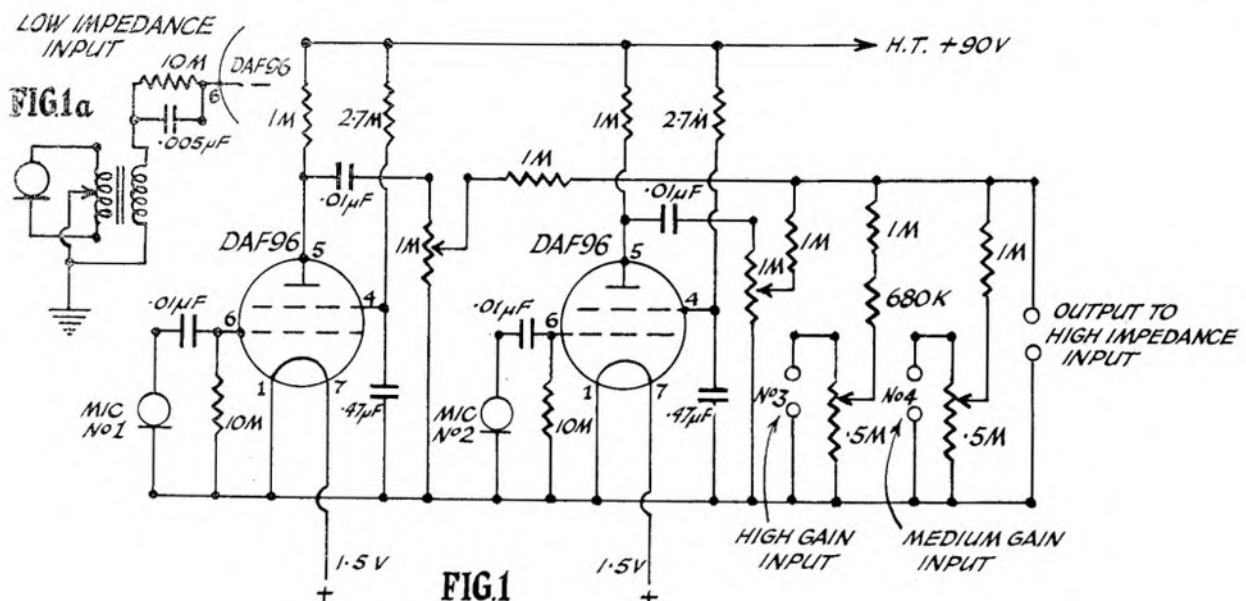

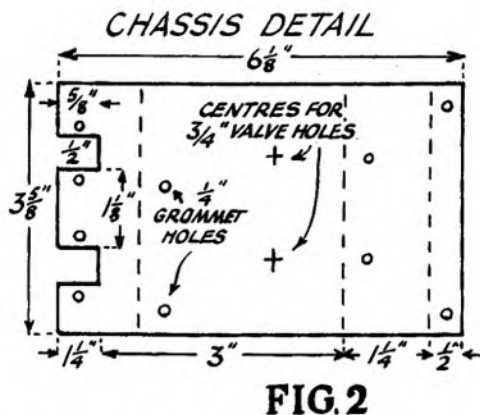

FIG. 2

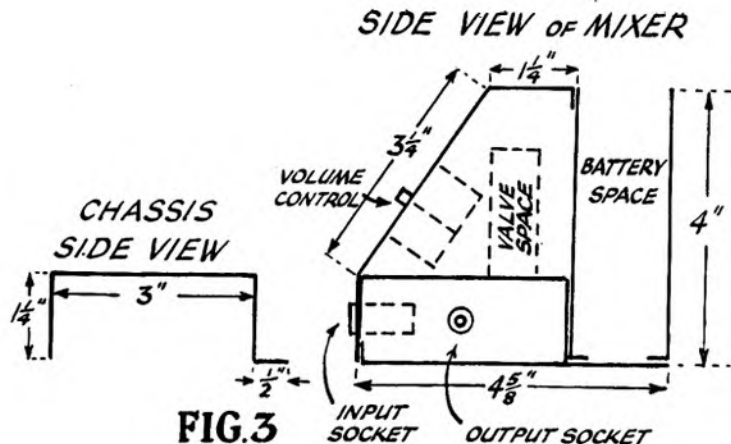

FIG. 3

DESCRIPTION OF CIRCUIT

The use of batteries for the power supply reduces the cost, eliminates risk of mains hum, and simplifies construction. For owners of battery portable tape recorders it enables mixing to be done "out in the field."

Two Mullard DAF 96 valves are recommended for this circuit for the amplification of the microphone inputs. These valves require the grid to be by-passed to earth by .47 mf capacitors. If unable to obtain this particular valve, .5 mf is quite suitable.

As shown in Fig. 1. the circuit gives two high impedance microphone inputs, one high gain input at No. 3 for radio, tape recorder or record player, and a lower gain input at No. 4 for use with radio tuner unit or tape pre-amp.

If a low impedance microphone input be required the circuit should be modified as in Fig. 1a. The type of transformer for low impedance input will depend on the design and type of microphone being used, but is not very critical so long as a good quality screened component is used. If in doubt, consult the manufacturers of the microphone.

All four potentiometers should be of the linear type and one may be switched, preferably No. 4 for the L.T. switch. If preferred a separate switch for L.T. may be used.

The batteries most suitable for this mixer are the Ever-Ready All Dry AD 35 for low tension, and the Batrymax B126 for 90 volt H.T.

CONSTRUCTION

The wiring and construction of this unit is fairly straightforward. First make the chassis on which the valve holders and components are to be mounted. 20 gauge sheet aluminium may be used for the chassis and the rest of the case. The chassis, Fig. 2, is 6 1/8" x 3 5/8" before bending to shape as in Fig. 3.

Mount valve holders and start wiring the chassis components to the valve holders. The layout of the components is shown in the sketch at Fig. 5. It is important that a single earth point be used, one exception being the 10 Meg resistor on V1 which is taken to the L.T. negative on that valve. The tag strip has one tag (the one used for mounting the strip) earthed to the chassis. Use rubber grommets in all holes where wires pass through the chassis or side panels.

The front panel should be cut to shape as in Fig. 4 and

(Continued on page 52)

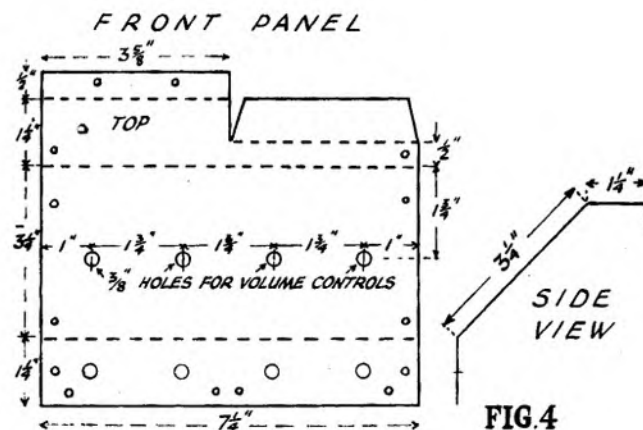

FIG. 4

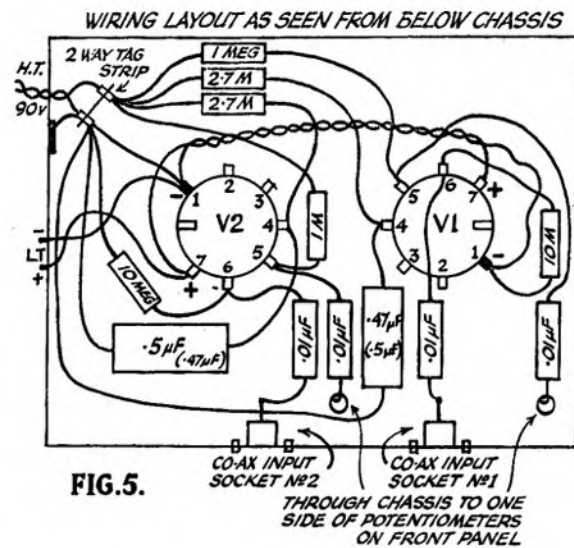

FIG. 5.

TSL UNIVERSAL SOUND MIXER

for use with

all Tape Recorders and Audio Amplifiers

Everyone concerned with audio, whether from a professional standpoint or in an amateur capacity, appreciates that in order to obtain a balanced and intelligible programme when a number of different signal sources are being used, adequate mixing facilities are essential.

All good tape recorders have a variety of signal input sockets but this facility alone is not sufficient. A mixing unit such as the TSL UNIVERSAL SOUND MIXER which will permit controlled fading in and out of one, two or three separate signal sources is a vital necessity if the completed recording is to compare with a high grade professional product. The TSL UNIVERSAL SOUND MIXER will accept three high impedance signals, e.g. microphone, pick-up and radio. Overall level in each case is controlled by a logarithmic potentiometer and fed to a common output socket which in turn is fed to an appropriate input on the recorder. Input and output connections are terminated on standard jack sockets to permit neat and electrically sound connections to be made instantaneously. Because the unit operates at high impedance, screened cable must be used for all inter-connecting leads.

Audio amplifiers are often used for P.A. work and social activities, their usefulness can also be widely extended by provision of a TSL UNIVERSAL SOUND MIXER. Method of operation for Audio amplifiers, etc., is the same as for recorders.

The TSL UNIVERSAL SOUND MIXER is laboratory designed and robustly built for long life. The numbers of the different input channels and the output sockets are clearly marked on the front.

INSTRUCTIONS FOR USE OF THE TSL MIXER UNIT

When recording from a large area source such as a choir, orchestra, or family group, it is possible to pick-up the whole group with a single uni-directional microphone. This will, however, result in a badly balanced recording, one section of the group perhaps being too predominant in the record. To correct for this two or three microphones should be used, each microphone being fed to a separate input on the mixer unit. The output is then monitored and the controls on the front adjusted until each section is heard at the required level.

Another case which is normally impossible to record satisfactorily is the vocalist singing to a piano, or in fact any instrument or group of instruments. The problem here is that if a single microphone is used the piano will drown the singer if the microphone is any distance from the voice source. Furthermore, if the microphone is closer to the piano than to the singer the sources must reach the microphone at different times resulting in a disjointed performance. This problem is solved by using two of the three available channels on the mixer, the third channel being ignored. One microphone is placed as near as possible to the vocalist and the other is placed near the piano. Then, by monitoring the output, the unit may be adjusted until just the right ratio is obtained.

In conferences, where contributions from many people are to be recorded, three omni-directional microphones should be used, positioned so as to cover the entire area. The mixer may then be adjusted so that wherever a person speaks the signal fed to the recorder will be constant. A similar method should be employed for recording a play.

Thus, whenever more than one microphone is used, or when a microphone is to be used in conjunction with a radio tuner or record player, the TSL UNIVERSAL MIXER UNIT is a necessity, especially when a spoken commentary is required to be superimposed between musical or other items.

Finish.—Gold hammer finished steel case with contemporary controls.

Weight.—1 lb. 6 oz.

Dimensions.—4½ in. x 3½ in. x 4½ in.

Guarantee.—Three years.

Price.—£2 2s.

Obtainable from all high class radio dealers or in case of difficulty write to:

TECHNICAL SUPPLIERS LIMITED
HUDSON HOUSE, 63 GOLDHAWK RD., LONDON, W.12

Telephone No.:
SHEpherds Bush 2581/4794

Telegrams:
Home: TEKNIKA LONDON Overseas: TEKNIKA

A SIMPLE MIXER UNIT

(Continued from page 51)

drilled as marked. Bend at dotted lines to shape of Fig. 5. The angle is such that the backs of the potentiometers will not foul the valves. Mount the input sockets, two co-axial sockets for the microphone inputs and two phone jacks for the radio inputs. Ensure that the co-axial sockets on front panel are securely screwed to the chassis. If preferred, co-axial sockets or phone jacks may be used throughout, although with the latter there may be insufficient space available in the electronic section.

Mount the four volume controls and arrange their fixing in such a way that all are at zero volume in the same position, normally about 7 o'clock. With self-tapping screws fasten the front panel to the chassis. Wire up the potentiometers and related resistors and connections from the amplifying circuits. Use red and black insulated flexible wires for H.T. and L.T. leads and take through grommet holes in back to battery box. Cut, drill and bend the valve screen as shown in Fig. 6.

The microphone input (electronic) section should be well screened, and small PVC insulated screened leads should be used from the two volume controls of this section to the output section through grommet holes in the valve screen.

It is a good plan to use white knobs on volume controls and mark each one with a spot of black paint near the edge to give an indication of the setting, as shown in the photograph. If a switched volume control is used for the L.T. switch, paint a good black line on it preferably vertically to indicate the "switch off" position. It might help if this switched control had a larger knob than the others for clarity. No indicator light is included in order to conserve battery life.

The wiring of the two radio inputs is straightforward. Use a three-way tag strip for the final connections as a joining point to take the output leads to the output socket.

Cut, drill and bend the side panels as shown in Fig. 8 and make certain that the hole for the output socket is positioned such that it is clear of the partition between radio input and battery box. This socket must also be kept clear of the final input socket, No. 4, on the front panel.

Thoroughly check all wiring and connections before connecting up batteries. A good way of doing this is to

BACK AND SIDE OF ELECTRONIC SECTION

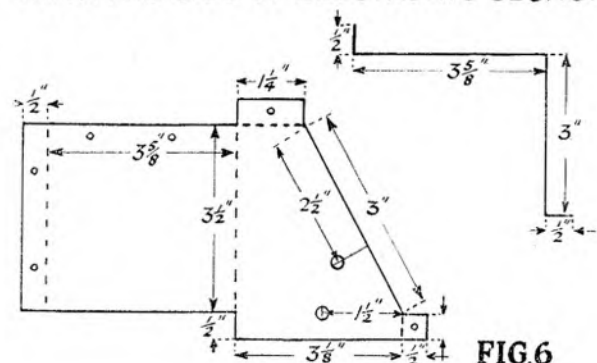
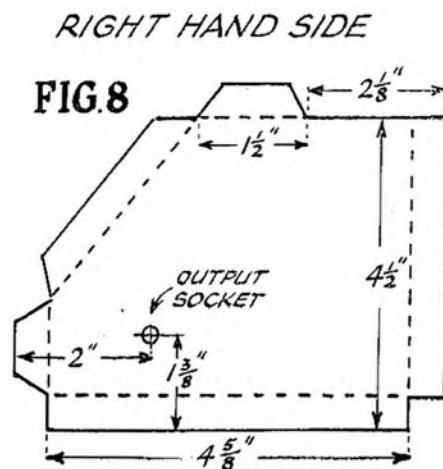
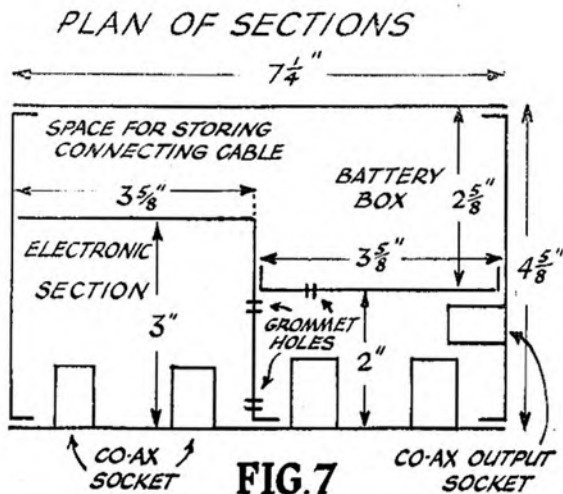

FIG. 6



trace the circuit diagram with a red pencil as each wire is traced out in the mixer as wired up. Any wire which has not been marked on the drawing may have been overlooked in the construction. Likewise check each component. Don't forget to insert the valves.

Finally, cut and drill the bottom, two back pieces and top cover as required and screw together, either with self-tapping screws or with 2 BA nuts and bolts. The sections go together as shown in Fig. 7. Connect up batteries and insert in battery box, making sure that the valve screen does not short the L.T. plug. Insert a piece of cardboard or paper packing, if necessary, besides the battery to keep the plug clear. A piece of cardboard should also be placed on top of the H.T. battery to prevent this plug possibly shorting on the lid.

TESTING

Connect the output of the mixer by co-axial lead to the microphone input of the tape recorder and switch on the tape recorder. If the tape recorder has a separate amplifier, switch over to that and listen for hum or other noises. There should be none.

If there is no separate amplifier, monitor on "record" position or record to check noise or hum. While checking this, plug in a microphone to No. 1 or 2 input and switch on the mixer. No warming up time is necessary.

Turn up gain to the appropriate input, with the tape recorder gain about half-way up, and start talking. There should be quite an appreciable increase in gain at the tape recorder, this being indicated by the use of a lower setting than usual on the tape recorder gain control. Check the other microphone input and the two radio inputs. There should be no interference between channels and with all controls turned down no signal should get through to the tape recorder.

If any hum is noticeable it may be caused by a leak to earth on one of the co-axial plugs or sockets, or by a badly soldered joint. Hum may occur only when a radio or gram is plugged in. This will almost certainly be due to an earth loop between radio and tape recorder, and might be cured by making sure that only one earth connection is used for both radio and tape recorder.

The author would like to acknowledge the assistance received from the Technical Services Department of Messrs. Mullard Ltd., in the design of this circuit.

- LIST OF COMPONENTS**
- | | | |
|---------------------------------|--|--|
| RESISTORS | | 2 Valve holders for above |
| 2 10 Meg. 1/4 watt | | 3 Co-axial flush input sockets |
| 2 2.7 Meg. " | | 2 Phone jack sockets. |
| 6 1 Meg. " | | 1 Batrymax B126 H.T. Battery |
| 2 1 Meg. Linear Potentiometers | | 1 All Dry AD35 L.T. Battery |
| 2 .5 Meg. Linear Potentiometers | | |
| CAPACITORS | | 2 Plugs for batteries |
| 4 .01 uF | | 1 L.T. 2-pin |
| 2 .47 uF | | 1 H.T. 3-pin |
| 2 Mullard DAF 96 valves | | Sundry wires, screws and 20 gauge aluminium. |

TeleTape



HOME OF TAPE RECORDING

What's new in the tape recording world? Find out at the Teletape headquarters at Marble Arch. Where you'll find all the latest T/R developments. Where you can see, hear and inspect every type of tape recorder made. Where you can get expert advice on your problems. And where you can buy on H.P. terms at cash prices. This is the place for enthusiasts!

Open till 8 p.m. Fridays. 6 p.m. Saturdays. Closed Thursdays p.m. Seven days free trial for cash customers.

Marble Arch too far away? Write for address of your nearest branch. Or send for free details of the tape recorder that interests you.

EVERY MAKE OF TAPE RECORDER IN STOCK Including:-

BRENELL 3-STAR . BRENELL Mk.5
 ELIZABETHAN ESCORT . ELIZABETHAN ESSEX . GRUNDIG T.K.20
 GRUNDIG T.K.25 . GRUNDIG T.K.30
 GRUNDIG T.K.35 . HARTING
 PERTH SAJA . PHILIPS E.L.3527
 PHILIPS A.G.8108 . REFLECTOGRAPH . REPS . SIMON S.P.4
 STUZZI MAGNETTE . TELEFUNKEN KL85 . TELEFUNKEN KL 75KX . TRUVOX R.2 . VERDIK
 VERITONE VENUS PORTABLE & CONSOLE . WYNDSOR VISCOUNT

Teletape Britain's Largest Tape Recorder Specialists

59a, EDGWARE RD. (2 mins. Marble Arch), W.2. Tel.: PADDINGTON 1942
 230, HERTFORD RD., Enfield Highway, Enfield, Middx. Tel.: HOWARD 1799

for those who want something more

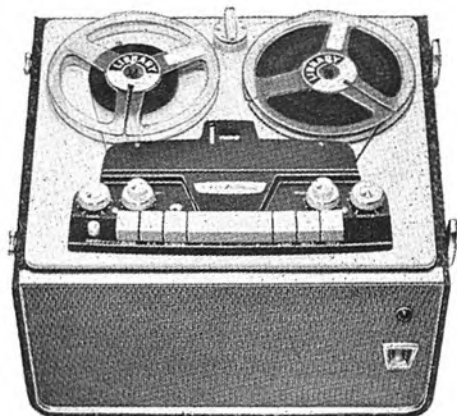
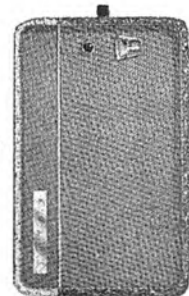

these figures

Frequency response
 at 3 $\frac{1}{2}$ i.p.s. 30-7000 c.p.s. \pm 3dB
 at 7 $\frac{1}{2}$ i.p.s., 30-15,000 c.p.s. \pm 3dB. ref. to 1 Kc
 Wow and flutter content—better than 0.2% peak to peak
 Output 10 watts push-pull

... and these features

Something really worthwhile has been achieved in the design of this fine new tape recorder. Performance of a high order has been married to a range of features, many of them exclusive to Simon, enormously increasing its value to the connoisseur of recorded sound.

Never before have all these been brought together in a portable tape recorder—3-way mixing, lift and cut on bass and treble, a monitor with separate bass and treble units giving you high quality sound without a separate loudspeaker and, to match the superb 10-watt ultra-linear amplifier, the Simon all push-button, automatic tape deck.

Automatic, in the Simon sense, is meant to be taken literally: it means continuous replay—the machine stops, reverses and changes to the other track with only a two-second pause, and with no necessity to touch any control. Similarly, up to three hours continuous recording can be made without attention, the machine automatically stopping at the end of the second track.

Look at its elegant styling, listen to it at your local dealer—you'll decide that this is the recorder for you.

SIMON AUTOMATIC DECK fully 'push-button-controlled'
 AUTOMATIC TAPE REVERSAL *without touching controls*
 3-WAY MIXING FACILITIES on both record and playback
 BASS AND TREBLE *LIFT AND CUT* with independent controls
 REMOTE CONTROL FACILITIES on both record and playback
 HIGH QUALITY MONITORING Paired bass and treble loudspeaker units
 10 WATTS OUTPUT from ultra-linear push-pull amplifier
 PUSH-PULL OSCILLATOR for noise and hum suppression
 ACCIDENTAL ERASURE PREVENTION by special record 'safety button'
 ACCURATE TAPE POSITION INDICATOR based on linear tape scale
 'PIN-POINT' MODULATION with cathode ray magic eye

simon SP. 4

combined in the new

incorporating the new Simon fully automatic tape deck



Two accessories to do justice to the SP4

THE CADENZA Ribbon microphone

Dual impedance head for flexibility in use:
 output sensibly flat between 50-12000 cps.
 In handsome presentation case: head only
 8! gns. With tripod desk stand 10 gns.

THE SIMON REMOTE CONTROL UNIT

Electrically operated, gives push-button control at any practical distance. (Stop/Start and track change on either Record or Playback.)
 Size 11" x 21" x 31"
 With 25 ft. of flex 3 gns.

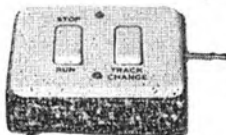

95 GNS

Your Simon Dealer would be pleased to arrange H.P. terms

Choose Simon for Sound

See it at the Audio Fair, Booth 61, Demonstration Room 347

Write now for brochure (E 4) to :

SIMON SOUND SERVICE LTD

46-50 George Street, Portman Square, London W.1

E 4

PRODUCTS REVIEW

B.S.R. ENTER TAPE FIELD WITH DECK



A LEADING FIRM in the hi-fi field, Birmingham Sound Reproducers Ltd., now enter the tape field with a new deck, to be known as the BSR Monardeck T.D.1. It uses a new type of recording head, patented in the United States, is a single-speed machine, and is designed to sell at a price that will appeal to a mass market.

The accompanying photograph is of an artist's impression of the original design, and some slight modifications have been made since it was prepared.

The deck operates at $3\frac{1}{2}$ ips and takes reels up to $5\frac{1}{2}$ in. diameter. Frequency response is quoted at 30 to 8,000 cps plus or minus 3 dB, but a note is added: "With careful attention to the equalisation in the amplifier, this can be extended upwards to 10,000 cps."

The first complete recorder incorporating the deck also comes from a firm new to the tape field, Messrs. J. & A. Margolin Ltd. First deliveries to the shops are expected to be in the "late Spring."

The price of the recorder has not been finally settled, but it may turn out to be near the 26 guineas mark.

The Margolin firm was founded in the latter part of the last century, manufacturing musical instruments. In the late 'twenties they introduced the Plus-a-gram record players and in 1948 this firm showed the first long-playing instrument in the world at the Radio Show.

Now it enters the radio, as well as the recorder field, with a portable transistor set selling at 20 guineas.

Messrs. J. & A. Margolin Ltd., 112/116, Old Street, London, E.C.1.

NEW "BALMORAL" MODELS

THE firm of Messrs. Taplin-Hirst & Co. Ltd. make their bow with two tape recorders carrying the name "Balmoral." The de luxe model illustrated overleaf is priced at 63 guineas.

Both models use the Collaro deck, giving speeds of 15, $7\frac{1}{2}$ and $3\frac{1}{2}$ ips. Both have separate record and playback amplifiers and are corrected to CCIR standards on record and playback.

(Continued on page 56)



In this feature every month you can check

YOUR LOCAL DEALER

who gives special attention to tape

**FREE HOME DEMONSTRATIONS
FREE SERVICE UNDER GUARANTEE
ELECTRONIC RECORDING EQUIPMENT**

186, WESTBOURNE GROVE, W.11

'Phone: BAYswater 6622

GRUNDIG SPECIALISTS

AGENTS FOR
TELEFUNKEN — PHILIPS — WALTER

Showroom open 9 a.m.—6 p.m. Mon. to Sat.
Closed Thurs. 1 p.m.

★★★★ **LEE ELECTRONICS** ★★★★★
(The Tape and Hi-Fi Specialists)

400, EDGWARE ROAD, LONDON, W.2

present their - ★ Five-Star Special ★
available on all Tape Recorders :-

- ★ Free Technical Advice.
- ★ Free Insurance and Delivery.
- ★ Free Home Demonstrations.
- ★ Free Maintenance whilst under guarantee.
- ★ Free of Interest Charges.

All Machines demonstrated for performance on
Record and Playback

All leading makes of Hi-Fi equipment from stock

★★★★ **PADDINGTON 5521** ★★★★★

Hi-Fi Consultants and Dealers

STUDIO RECORDING & DUBBING FACILITIES

Studio A, 40 ft. x 40 ft.

TAPE to DISC

professional standards

OLYMPIC SOUND STUDIOS

Carton Hall, Carton Street, London, W.1.

Tel. HUN. 1635

Agents for SAGA Records and Tapes

LONDON

CABINETS & EQUIPMENT by A. L. STAMFORD

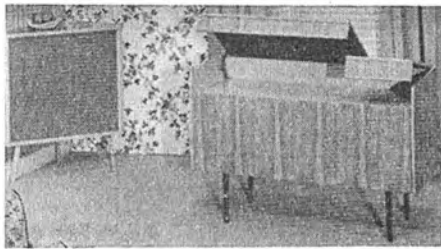

GP.60 EQUIPMENT CABINET to house the larger tape recorders and portables. Size: 47" x 20½" x 29" high. Price £19/19/0 or 60/- deposit and 9 monthly payments of 40/7. S.37 LOUD-SPEAKER ENCLOSURE to Goodmans specification for Axiette, also suitable for any 8" unit. Price £11/19/6, or 36/- deposit and 9

monthly payments of 24/4. CHOICE OF VENEERS. Delivery 12/6. WRITE for our new catalogues to our SHOWROOMS at 84/86 & 98 Weymouth Terrace, London, E.2. Tel.: SHO 5003
A. L. STAMFORD LTD. (DEPT. D3)

LONDON AREA

MUSICRAFT

20/22 HIGH ST., SOUTHALL, MIDDX. SOU 3828
13 KING ST., RICHMOND, SURREY RIC 6798
80-82 UXBRIDGE ROAD, EALING, W.13 EAL 6995

Hours of business: 9.00 a.m.-6 p.m. Mon.-Sat. (Wed. early closing)

THE SOUTH

HAMPSHIRE—HIGHCLIFFE-ON-SEA

J. H. WOOD

TAPE RECORDER STUDIO

Leading makes of Tape Recorders stocked.
Authorised Walter Service Centre.

ROGERS HIGH FIDELITY SOUND EQUIPMENT

Demonstrations of Sound with Home Cine

117, Ringwood Road, Highcliffe-on-Sea Telephone: 2040

TAPE RECORDERS (Bournemouth) LTD.

specialists in

ALL TAPE RECORDERS

main area dealers for

Grundig • Philips • Stuzzi

Authorised Telefunken Service Agents

Tapes and Accessories by return

Terms available on New or Reconditioned Sets
(Largest stockists in Southern Counties)

Write or phone: Seamoor Road, Westbourne 64292



Other features which the two models have in common are an output socket for a high-quality amplifier; loudspeaker monitoring through a separate amp; facilities for use as a straight-through amp; claimed frequency response of 40 to 12,000 cps plus or minus 3 db at 7½ ips.

Each is supplied with 1,200 feet of tape and an extension lead.

Additional facilities on the de luxe model include frequency correction for all speeds and facilities for super-imposition. It is also housed in a superior cabinet, and is supplied with a pencil microphone.

The "Standard plus" model, which costs 52 guineas, is supplied with a crystal mic.

Messrs. Taplin-Hirst & Co. Ltd., 22-23 Coram Street, London, W.C.1.

Grampian

announce

dynamic

microphone

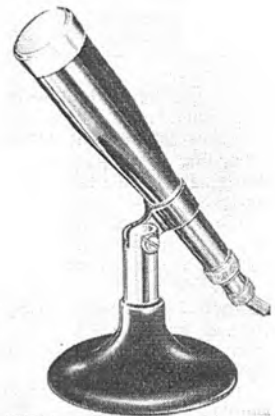

GRAMPIAN REPRODUCERS LTD. have recently marketed a high-output pressure-type dynamic microphone, DP4, which is suitable for all recording and public address activity.

It is a slender, well-proportioned unit, 8½ ins. long and just over 1¼ in. in diameter. It weighs only 7¼ ozs. and is finished in black and chrome.

It is stated to have a uniform, wide range frequency response from 50 to 15,000 cps.

Low, medium and high impedance models are available and they can be used as hand microphones (18 feet of lead is supplied) or with a variety of stands which are available.

Messrs. Grampian Reproducers Ltd., The Hanworth Trading Estate, Feltham, Middx.

B-J's new designs

A WHOLE RANGE of new B-J products is announced this month, to coincide with the London Audio Fair. Two new treble units using completely new design principles are of great interest.

The B-J Treble Twin illustrated opposite gives omni-directional spread of sound in one plane and a comparatively directional radiation in the other.

Depending upon the desired effect, the unit is positioned either horizontally or vertically. It can stand on an existing

speaker cabinet, or be hung on a wall between two stereo speakers.

It is priced at £9 19s. 11d.

The B-J Treble 20 is a development of the now well-known B-J Top C tweeter unit. It is described as a more refined unit in appearance and performance.

The speaker, in a 5-in. diameter cylinder, is mounted above two polished metal diffusers which are also designed to act as acoustic horns.

The aim is to achieve omni-directional spread of sound and to use the surface of the furniture on which the unit stands as a sounding board to increase the sound. The diffusers bend the sound waves into a horizontal plane, and the horn is, in effect, extended by the face on which the unit stands.

The price is 7 guineas.

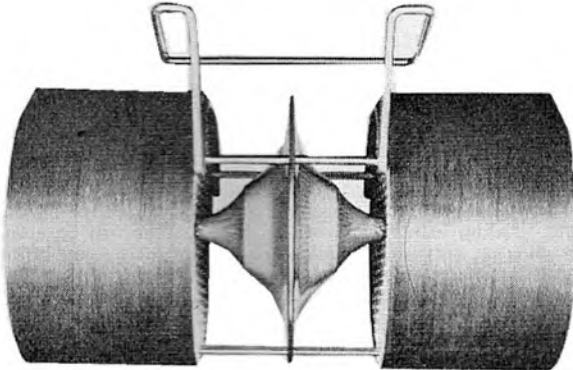

This firm also announces two new stereo cartridges, which can be obtained ready-mounted in plug-in shells.

One is the B-J-Elac 300, which costs £24 3s., and the other the B-J-Elac 200, at £20 9s. 6d.

Messrs. Burne-Jones & Co., Ltd., 18, Brunswick Road, Sutton, Surrey.

The Tannoy "Monitor"

A FEATURE that is claimed to be "the first radical improvement in permanent magnet design for nearly twenty years" is incorporated in the "Monitor" Dual Concentric loudspeaker recently introduced by Tannoy. The new feature is a magnetic shunt circuit which, it is stated, very considerably increases the useful magnetic flux with no increase in the magnet material used, so that the low frequency performance is greatly improved.

The original design of this unit has remained unchanged for twelve years, and the Monitor is a result of the decision by Tannoy to include in their standard production the improvements which have been incorporated in professional models.

A further refinement is an acoustic balance cavity associated with the high frequency diaphragm, designed to reduce even further the very low distortion products of the dual concentric and provide smoother frequency response. In addition, the unit is now completely dust-proof.

The frequency response of the twelve-inch model is given as 25 to 20,000 cps, and that of the fifteen-inch model as 23 to 20,000 cps. The power handling capacity is 30 watts and 50 watts respectively, depending on the type of enclosure.

Tannoy Products Ltd., Norwood Road, West Norwood, London, S.E.27.

* * *

E.M.I. HAVE just announced a major reorganisation in the development of Emitape, Emifilm and Emidisc. The Recording Materials Division of E.M.I. Sales and Service now becomes responsible for the development—as well as the production and sales—of its products.

General Manager of the Recording Materials Division is Mr. J. Wooler; Sales Manager, Mr. P. H. Wetherill; Development Manager, Mr. W. Soby; and Production Manager, Mr. D. Harris.



In this feature every month you can check

YOUR LOCAL DEALER

who gives special attention to tape

THE SOUTH

We supply all makes of

Tape Recorders

WE SERVICE ALL MAKES OF TAPE RECORDERS. OUR TERMS ARE THE BEST, OUR SERVICE THE BEST. 10% DEPOSIT, INTEREST FREE.

If you want a RECORDER, If you have a RECORDER, You need SERVICE

Telephone: RAV 4498.

WRITE FOR FREE DETAILS & BROCHURES TO:

The Tape Recorder Service Co.

43, NAPIER ROAD, BROMLEY, KENT.

THE MIDLANDS

R-E-S OF COVENTRY

SPECIALISTS IN HIGH FIDELITY and all makes of Tape Recorders

- ★ Stocks of Stereophonic and Pre-Recorded Tapes.
- ★ Demonstrations always available by fully qualified staff
- ★ The Best Selection—Terms or After Sales Service in the MIDLANDS

R-E-S (COVENTRY) LTD.

128 FAR GOSFORD ST. Coventry 60913

TAPE RECORDERS

on "NO-INTEREST" Terms!

Buy your new Tape Recorder without touching CAPITAL! NO EXTRA CHARGES FOR EXTENDED CREDIT. You pay the Retail Price only. All leading makes stocked—Grundig, British Ferrograph, Philips, Vortexion, Telefunken, Baird, Walters, etc.

JEWKES & CO. LTD.

The Midlands Hi-Fi and Tape Recorder Specialists

285, BROAD STREET, BIRMINGHAM 1. MID 4829/20.

THE NORTH-WEST

MANCHESTER

High Fidelity Developments Ltd.
The Sound Reproduction Specialists for
TAPE RECORDERS

Ferrograph, Brenell, Philips, Simon, Harting, Tandberg Stereo, Sonomag, Magnafon Stereo, Grundig etc. ALSO

ALL MAKES OF HI-FI EQUIPMENT

8, DEANS GATE
MANCHESTER
(Near Grosvenor Hotel)



TAPE PALS

Is this the way
to a better world?

It could be. Organisations such as World Tape Pals and Voicerecording Club (both in America), and the numerous Tape Recording Clubs springing up all over Britain, have got something. We shall endeavour to make our own contribution by supplying quality equipment, tapes and accessories. Our many years' experience enables us to give helpful advice and useful service. Call or write for our brochure and lists.



HOLDINGS
OF BLACKBURN LTD
Mincing Lane/Darwen St.
BLACKBURN

JOHN SHINN & SONS LTD.

Electronic Engineers

TOWN CENTRE, LEIGH, LANCS.
Also at MELODY HOUSE, 109 HIGH STREET,
BANGOR, N. WALES.
and MELODY HOUSE, 43, HALLGATE,
TOWN CENTRE, WIGAN, LANCS.

Pioneers in Tape Recorders since 1946

ALL MAKES STOCKED - TERMS AVAILABLE
All customers are made honorary members of the John Shinn Recording Club, with its attendant benefits

SCOTLAND

for SOUND
value SEE US

Hear and test the latest Philips, Simon, Vortexion, Elizabethan, Grundig, etc. You're safer with the specialists (fully equipped service department). Terms arranged.

M^cCORMACK'S

7 COWCADDENS ST.
(Opp. Buchanan St. Railway Stn.)

GLASGOW C.2 Phone: DOUGlas 2846

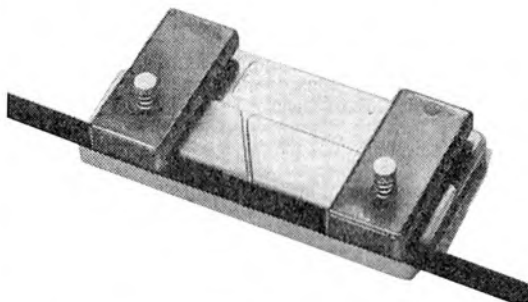

A NEW, SIMPLE SPLICER has been produced with the name "Easysplice." Two spring clamps hold the tape firmly, while a razor blade cut is made with the guidance of a stepped slot. The retail price is 6s. 3d.

Messrs. Easysplice, 30, Lawrence Road, Ealing, London, W.5.

* * *

INCREASED DEMAND for "Sound" tape recorders has caused the manufacturers to take over a third factory on the Wingate Trading Estate in North London. This will be going into production very shortly and, apart from increased output, will speed servicing and other facilities.

This firm also announces that the "Sound" screened jack plug, designed to reduce pick-up from external sources, has been increased in price to 5s.

Messrs. Tape Recorders (Electronics) Ltd., 784-788, High Road, Tottenham, London, N.17.

* * *

THE MSS COMPANY has secured a contract to supply magnetic recording tape of 1/4-in. width to the U.S. Air Force for use on their British Communications Corporation Mars Recorders.

* * *

Mr. A. R. Neve, Director of CQ Audio Ltd., recently lectured to the British Sound Recording Association at the Royal Society of Arts on the design features of the small speaker systems for which his company has become known.

At the end of the lecture he provided a demonstration of organ music played through the new CQ Junior reproducer, which was concealed under a framework.

Mr. Neve reports that it was something of a sensation when he removed the drapes and revealed that he was using so small a cabinet; the audience expected to see a very much larger speaker system.

* * *

FULL information about the Q-Flex loudspeaker is provided in a well-produced 16-page booklet by Mr. A. R. Neve entitled "The Q-Flex Loudspeaker." It is obtainable through booksellers and High Fidelity Specialists at 3s., or from C.Q. Audio Ltd. at 3s. 6d. post free.

C.Q. Audio Ltd., 2, Sarnesfield Road, Enfield, Middlesex

* * *

AMATEUR TECHNICIANS will appreciate the opportunity to build their own oscilloscope provided by the Heathkit High-definition 5-inch screen general purpose oscilloscope kit, Model I-12U, priced at £34 15s.

Special features of the specification include gold-plated printed circuit boards and preformed cable harness to simplify assembly and ensure high circuit stability and consistency, electronically stabilised power supply, the Heathkit patented sweep circuit giving extra sweep range, vertical bandwidth of 3 cps to 5 Mc/s, and a flat screen.

Daystrom Ltd., Gloucester.

Times to tune in . . .

ONE of the greatest works ever produced on the radio can be heard on 20th March, when the B.B.C. broadcasts the **Symphony of a Thousand**, by Gustav Mahler. Jascha Hoorenstein has been invited to conduct the work, which can rarely be performed because of the enormous forces involved.

The Symphony, Mahler's eighth, requires eight solo singers, two huge mixed choirs, a choir of boys' voices, an orchestra of 150 and an off-stage brass ensemble.

This will be only the sixth performance since that of 1910, eight months before the death of the composer. The last broadcast performance of the **Symphony of a Thousand** was in 1948, conducted by Sir Adrian Boult.

The whole of the concert is to be broadcast in the Third Programme direct from the Royal Albert Hall.

At the Royal Albert Hall the following night the Light Programme presents its

Our special feature giving details of radio programmes you may like to record

first Festival of Dance Music concert. Such bands as the Oscar Rabin Orchestra, the B.B.C. Northern Dance Orchestra, Bob Miller and the Millermen, the Jazz Couriers, and the Fraser Hayes Four are included in the programme, plus a number of outstanding instrumentalists and vocalists.

We would like to remind readers that the second of the jazz concerts can be heard on Saturday, 28th March, in the

Light Programme. Johnny Dankworth and Humphrey Lyttleton are two of the personalities in this programme, entitled "Dixieland and After."

Villem Tausky is to conduct the B.B.C. Concert Orchestra during a tour of Holland at the end of April. Five concerts will be given featuring special arrangements of the British and American musicals in the orchestrations of Sidney Torch. From each of the concerts a popular musical programme in the regular B.B.C. series will be broadcast.

The first of these concerts can be heard in the Friday Night is Music Night on 24th April, the second on 25th April in the Saturday Popular Concert. The remaining three can be heard in Melody Hour on 26th April, in Music to Remember on 27th April, and in Tuesday Tune-time on 28th April. Doreen Hulme and John Lawrenson are the soloists.

Edric Connor introduces Negro Spirituals on gramophone records on 27th March in the Light Programme.

In the Third Programme on 26th March Flora Robson will read Charles Peguy's **A Meditation on the Passion of our Lord**, from "Le Mystère de la Charité de Jeanne d'Arc."

NEWS FROM THE CLUBS

The Federation

THE Secretary has received a request from a tapespondent in Germany who wishes to exchange tapes with an English woman with children, to enable her to improve her knowledge of the English language.

The lady in question is a young married person with a daughter of four months. She once spent a year in England, and has a 3½ ips recorder.

Any reader wishing to exchange tapes should contact the Secretary who will pass on details.

(Secretary: Roy Penfold, 48, Holbrook Lane, Coventry.)

Australian-British Cobber Club

THIS club still maintains a constant stream of tapes to and from down-under. Latest of the tapes has been received from new settlers in Melbourne who sent a tape to their relatives left at home in Birmingham.

A very keen group in Melbourne, Australian and British, have organised a club to help new arrivals to settle in. The growing use of a recorder to send their greetings, impressions and advice is proving valuable for those in England who plan to join them later on.

The *Ambassadors Club* in Melbourne have sent tapes giving details of Australian education prospects. Also included in the tapes was an item on their social services and a feature on aborigine folk law.

(Secretary: Robert Thorpe, 63, Harbury Road, Cannon Hill, Birmingham 12.)

Bournemouth

A "GUESS the sound" competition has been won by the Club's only lady member, Mrs. W. Lawson. At the same meeting Mr. Townsend edited a commentary he has recorded to accompany coloured slides of a recent tour made by him.

At another meeting, Mr. Findlayson took along his Ferrograph Stereo Set to enable members to put views on the new developments.

A demonstration of a Stuzzi battery recorder and a Telefunken set was also heard.

The membership fee has been reduced to fifteen shillings, or twenty shillings for family membership.

Club meetings are to be held in future on alternate Tuesdays, the next meeting will be on March 24, anyone interested will be welcome.

(Secretary: Hedley R. Jones, 442, Poole Road, Branksome, Poole, Dorset.)

Braintree

A CLUB is to be formed in the Braintree area. Anyone interested is invited to write to Mr. Murray Hale, Bellows Cottage, Water Lane, Shalford, Braintree, Essex.

Cambridgeshire

A SMALL circle of enthusiasts have formed a club in Cambridgeshire. It is believed to be the first of its kind, for every member is a serviceman serving at the R.A.F. Station, Waterbeach.

The group is growing fast; already there are a dozen members owning a fair selection of recorders.

Their aim is to tapespond with other enthusiasts in all branches of H.M. Forces and indeed with all servicemen everywhere, and to encourage the formation of similar societies in other units.

They have sent tapes to servicemen throughout the world, who have been asked to pass on the Society's news and views.

(Secretary: R. L. Restace, Tape Recording Society, R.A.F. Waterbeach, Cambridgeshire.)

Birmingham

ONE of the new clubs recently formed in Birmingham has held its inaugural meeting. Located in the California district, eleven members attended the first gathering.

They had a helping hand from Messrs. Mitchells and Butlers, brewers, who redecorated the club room for them.

Monday night at eight is the time and day for future meetings, and they are to be held weekly.

(Secretary: Dennis Osborne, 75, Millmead Road, California, Birmingham 32.)

(Continued on page 61)



Jack Layne

says **"THE 'BELLE' OF THEM ALL!"**

The sensational new Sound 'Belle' brings tape recording within the reach of everyone! At only **26 gns.** the 'Belle' is the lowest cost quality tape recorder in the world and gives top class musical reproduction.

The 'Belle' has simple push button operation, well over 1 hour's playing time, twin track recording, very fast rewind, magic eye recording level indicator, and 3 watts output.

Smart and compact, the Sound 'Belle' is complete with long play tape, take-up spool, crystal microphone, extension lead for recording from radio or gramophone, detachable mains lead, built-in full-size elliptical speaker and facilities for use as a public address amplifier, record player and radio set.

Weight only 12 lb.

a.c. mains 110-250 volts 50-60 CPS

Size 10" x 7" x 4½"

12 months' guarantee



Hear it now at your local dealer or send for leaflet

THE SENSATIONAL NEW



Belle

26 GNS.

COMPLETE
with microphone and L.P. tape

Tape Recorders (Electronics) Ltd · 784-788 High Road, Tottenham, N.17 · Telephone: TOTtenham 0811-3

(Continued from page 59)

Coventry

FEBRUARY was a busy month for members, with a visit to the International Club at the Quakers Hall as a highlight. A programme arranged for the members included tapes from a number of overseas tapespondents including North America and Sweden.

At a later meeting Roy Penfold demonstrated his Boosey-Hawkes portable battery recorder, modified to 3½ ips, with a double-track head. A tape he had made at the Morris Motor Works was played back on the secretary's machine, a Philips AG 8108.

Other tapes played included one Roy Reynolds had received from America comparing present-day recording techniques with the ones used in the '20s. Mr. Thompson's auto suggestion tape was also heard. In this he endeavours to get members' hands clasped over their heads and to lock their fingers together.

Howard Freer and Allan Marston tied in the tape competition and each received a three inch tape. The next in the series of quizzes will focus on TV.

The Chairman announced that the club now has an official mechanic. He is Gordon Marsh who offers a twelve-hour return service. Roy Penfold has already had his Philips AG 8108 modified similar to the new model which is now on the market.

(Secretary: Roy V. Reynolds, 1, Thurlestone Road, Radford, Coventry.)

Edinburgh

A TAPE recording of the Hindenburg airship disaster was played by Sir Mark Dalrymple Bart at a recent meeting. Sir Mark was demonstrating his own special equipment which is designed to meet all his requirements.

Later, the future programme of the club was discussed and suggestions received are now being considered.

At an earlier meeting members heard a demonstration of an early model Ferrograph.

(Secretary: John Penman, 22, Lauriston Place, Edinburgh 3.)

Glasgow

THE club recently toured the projection room of Glasgow's Gaumont cinema. It has the new Todd AO projection system. An interview with the house manager, Mr. Wilks, and a lecture by the First Engineer in the projection room were recorded. The tape is being placed in the club library.

At a recent meeting, members discussed future programmes. Subjects and talks suggested include recorded samples of various microphones, and demonstrations on sound and ciné, to be given by Mr. P. H. Hunter. Two titled talks will be "Life on an Australian sheep farm" by chairman Harry Saunders and "Hoteliers Course" by Mr. P. J. Dupre Le Roux.

To mark the first birthday of the Society, members are arranging a dinner-dance. Anyone interested should contact the Secretary.

(Secretary: D. Craig, 55, Ledaig Street, Glasgow, E.1.)

Kettering

AT a recent meeting Mr. A. M. Andrews told how he recorded a commentary in English and Italian for a series of photographic slides used in a lecture to college groups in Europe and Italy.

Afterwards he demonstrated his activities recording Church Services for which he used his Ferrograph recorder, a mixer and two ribbon microphones.

Mr. White rounded off the evening with fifteen minutes of music, recorded in Chicago, on a large Wurlitzer Theatre Organ.

(Secretary: A. M. Webb, 93, Regent Street, Kettering, Northants.)

Leicester

THE second meeting of this club has been held and there are now thirteen members. A demonstration of the Tandberg Stereo Tape Recorder was given by the Secretary, on the machine loaned by Messrs. E. A. Wood, local retailers.

John Buckler gave an off-the-cuff talk on de-fluxing when the original speaker was unable to be present.

(Secretary: Peter J. Storie, 56, Minehead Street, Leicester.)

(Continued on page 63)

FREE!

40 page catalogue

See all that is latest and best at the Audio Fair, in person at the Tape Recorder Centre, or in their unique new Catalogue. Forty illustrated pages, giving details of all makes of Tape Recorders, Accessories and Hi-Fi equipment. The most comprehensive catalogue of its kind, listing 150 items. All orders over £30 on No-Interest Terms. For Tape Recorders and Hi-Fi YOU MUST SEE what the Tape Recorder Centre has to offer!



TAPE RECORDERS
GRUNDIG
ELIZABETHAN
FERROGRAPH
VORTEXION
WALTER
BRENELL
REFLECTOGRAPH
SIMON
TANDBERG
HARTING
TELEFUNKEN
PHILIPS
SPECTONE
VERDIK
VERITONE
STUZZI-MAGNETTE
FI-CORD
TRUVOX
BAIRD
MAGNAPON
KURLAND
REPS
REVOX
WYNDSOR

HI-FI EQUIPMENT,
MICROPHONES,
SPEAKERS, ETC.

LEAK
QUAD
ROGERS
ARMSTRONG
DULCI
JASON
PAMPHONIC
AVANTIC
W. B. STENTORIAN

GOODMANS
C.Q.
WHARF:DALE
ELAC
B.J.
GARRARD
CONNOISSEUR
GOLDRING
T.S.L.

STIRLING TUNERS
ACOS
LUSTRAPHONE
ELPICO-GELOSIO
SIMON-CADENZA
RESLO
RECORD HOUSING
LINEAR
TANNOY
ORTOFON
R.C.A.
LOWTHER

TAPE
EMITAPE
SCOTCH BOY
BASF
GRUNDIG
TELEFUNKEN
AGFA
ELPICO
SOUNDRITE

All Accessories,
tapes, etc. by
return of post.

All makes in
stock.

Choose with confidence from
the leading Specialists in the country:

THE TAPE RECORDER CENTRE

SYPHA SOUND SALES LTD. (DEPT. T
75, GRAND PARADE, HARRINGAY, LONDON, N.4 STAmford Hill 1146

KALEIDASOUND . . .

Reps Tape Recorder Ltd. and C. Q. Audio Ltd. invite you to visit Kaleidasound at the Imperial Hotel Ballroom Russell Square, W.C. 1, on—

MODEL R30; R40

Thursday, April 2nd
(6 p.m.—10 p.m.)

Friday, April 3rd
Saturday, April 4th
Sunday, April 5th
10 a.m.—9.30 p.m.

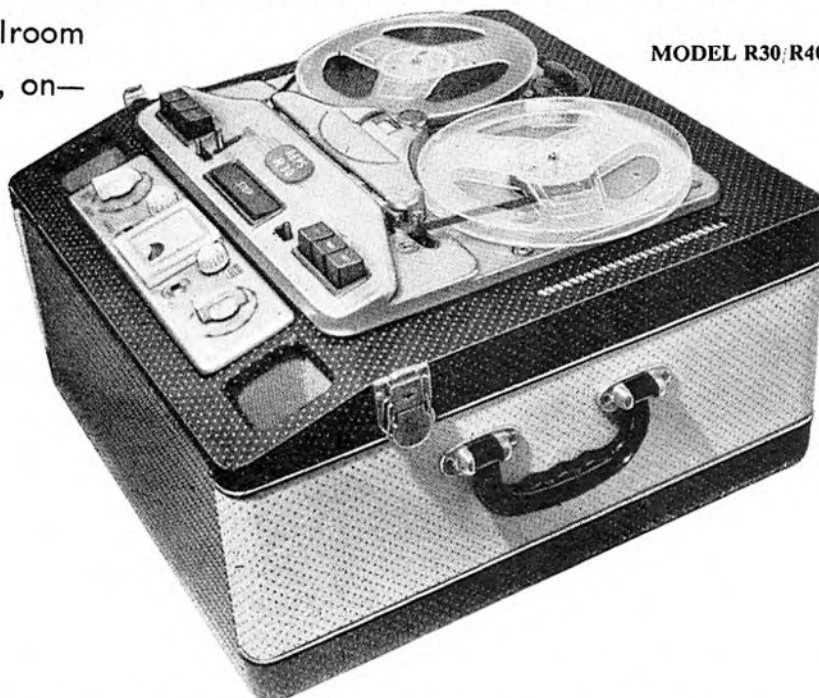

Free tickets available through your local dealer, or in case of difficulty apply direct

This company will be exhibiting a complete range of products including an export model with record and replay characteristics corrected to either C.C.I.R. or N.A.R.T.B. The Collaro Tape Transcriber will be shown modified with a Stereo in-line head, plus a second channel recording unit which can be added to models R20, R30 and R40. This unit will convert these models to dual channel record/reproduce on $3\frac{3}{4}$, $7\frac{1}{2}$, 15 i.p.s.

Demonstrations in leisurely and uncrowded conditions. Meals and refreshments available in the imperial Restaurant at moderate prices.

Demonstrations in the main part of the ballroom will be split between this Company and Messrs. C. Q. Audio Ltd. Our demonstrations will be made in conjunction with an Aldis Slide Projector which will be automatically controlled by the Reps Tape Recorder, indicating, visually, in colour, actual extracts being reproduced at any time throughout the demonstration.

Please send me without obligation full details of your range of Tape Recorders. I am particularly interested in Model R.....

Mr.

Fully illustrated literature available on request to—
REPS (TAPE RECORDERS) LTD
118 Park Road North, Acton, London, W.3
Phone : ACOrn 4141

(Continued from page 61)

London

FIFTEEN visitors were present and heard demonstrations of the Brenell Mk. V and stereo models, given by Mr. J. W. Raine, of Brenell Engineering Co., at a recent meeting.

Mr. Raine had brought along a variety of tapes. On the monaural machine he played part of a tape recorded from the U.K. end of the transatlantic cable. Excerpts from "Peter and the Wolf," the B.B.C. Sound programme, and a recording made at the Royal Albert Hall of Boys' Brigade bugle and pipe bands helped to give members an entertaining evening.

At a previous meeting Alan Stableford demonstrated the tiny Fi-Cord portable and the Secretary produced a tape quiz.

Ken Blake's Vortexion was used for the evening's recording together with a ten-inch Wharfedale speaker provided by the Chairman.

Mr. and Mrs. Pat Copinger and their son Paul recently sent a tape to the club from Scotland, thanking members for giving them Honorary Membership. A tape has been received from the Edinburgh Club and a letter from the club in Chesterfield requesting a tape.

(Secretary: Roger Aslin, Fairlea, Boar's Head, Crowborough, Sussex.)

Midlands

THE Midlands Tape Society has changed its name to The Tape Recording Society of Great Britain. This decision was taken at the annual meeting because the club believes the former name implied that its activities were restricted to the Midlands, when in fact anyone anywhere can join.

Archibald Cox becomes Chairman and Roger Arnold continues as Treasurer. Michael Nyman is elected co-Secretary to John Walters who retains his position.

An anonymous cash gift has been received for the new sound-effects library which is being formed under the guiding hand of Peter Eames of Watford.

(Secretary: John Walters, 29, Pitt Street, Broadwaters, Kidderminster, Worcs.)

Rugby

THIS Society is interested in receiving tapes from other clubs or enthusiasts with material suitable for playing or dubbing, to be used for future club programmes. In return they will try to fulfil the same duty.

They have made personal contact with the clubs at Coventry, Leicester, Nottingham and Warwick, and they tapespond with Norwich Society.

Anyone wishing for a Rugby partner in a round robin, tape, or single tapespondence should communicate with the secretary.

(Secretary: Mike Brown, 219, Clifton Road, Rugby.)

South Africa

ITEMS in recent meetings include a talk and demonstration by Denoon Sieg on tape editing, splicing, dubbing, and cataloguing; and a competition for tapes of simulated sound effects. Tapes were awarded to the winners.

Eric Ridgeway has had to give up his post as club librarian due to pressure of work in other directions. Any queries in connection with the library should be addressed to the Secretary.

The club has offered free membership to blind members of Tape Aids for the Blind. This group now possesses its own offices in Durban where it has three sound-proof reading booths for recording its talking books. It is now a registered welfare organisation affiliated to the S.A. National Council for the Blind.

Suggestions have been made that the club should include a technical advisory service in its newsletter. A competition, with prizes, for musical compositions, entries to be tape recorded, has also been suggested and a decision awaited.

(Secretary: Denoon R. Sieg, P.O. Box 3392, Cape Town, South Africa.)

South-West Essex

READERS in this area may be interested to hear of the formation of a local tape club.

Write in the first instance to Mr. W. J. Tomlinson at 62, Beacontree Ave., Walthamstow, E.17, or phone Larkwood 3792.

(Continued on page 65)

HEATHKIT HI-FI DEMONSTRATION

During the LONDON AUDIO FAIR WEEK, April 2nd-5th, you are warmly invited to come and hear our Hi-Fi equipment and to see our range of British Heathkits at the

ROYAL HOTEL, RUSSELL SQUARE

(100 yds. from Hotel Russell)

In the meantime, should you like to have details of our models, please write to

DAYSTROM LTD., Dept. T., Gloucester.

Dealers! You may not always have the time to—

MIND YOUR OWN BUSINESS!

—but if you make a point of dealing with the WHOLESALERS WHO REALLY HELP, it won't matter so much! Every month we issue a friendly little booklet which introduces, and offers help and advice on all the new and more profitable lines, as well as the current best sellers. It's absolutely free to all bona-fide dealers, and all you need do is telephone, call or write to: V.E.S. WHOLESALERS LTD., 11, Gunnersbury Lane, ACTON, W. 3. Telephone: Acorn 5027. We specialise in TAPE RECORDERS, and are approved Wholesalers for all the best makes, including REPS, ELIZABETHAN, SOUND, TRUVOX, HARTING, G.B.C., GELOSO, PERTH-SAJA, STUZZI, TANBERG, BRENELL, COLLARO and the GRAMDECK attachment. We are also stockist of the SAGA-ELIZABETHAN and TSL-PHONOBAND pre-recorded tapes, also SCOTCH BOY, GEVASONER, MASTERTAPE and BASF tapes. We keep stock of different cabinets suitable for Tape-Decks, Hi-Fi and STEREO amplifiers, Transcribers and LOUDSPEAKERS, etc., including Leak, Dulci, Cq Britamer, Goodman, G.E.C., W. B. Lorenz, etc. Apart from this we keep an enormous selection of RADIO, TELEVISION and ELECTRICAL lines, ranging from Scratch Removers to Spin Dryers, Control Knobs to Convector, Fire-bars to Fluorescent Fittings, and Toasters to Test Gear! We have, in fact, more lines than Clapham Junction, but you will be on the right track if you Open An Account With Us Now! THE SIGNAL'S SET FOR SALES!

WAL GAIN TRANSISTOR PRE-AMP

HIGH GAIN LOW NOISE TRANSISTOR PRE-AMPLIFIER

"After trying this little device I would never again dream of using an input transformer... the WAL Gain Improved the crispness to a notable degree... So far I have only tried it out with Ortofon, Expert, and Garrard... Moreover there is no hum pick-up, magnetic or otherwise and the background noise is negligible... I can imagine, that it will prove useful for the input to the playback amplifier of some tape recorders."

Percy Wilson, M.A.,
The Gramophone,
June, 1958, issue.

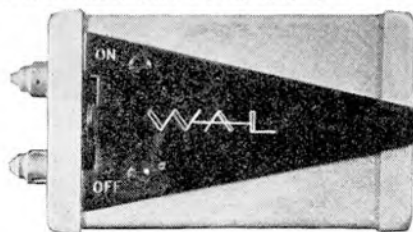

"A WAL professional tape eraser which wipes both tracks perfectly clean in a space of half a minute... it is a real godsend."

Percy Wilson, M.A.
The Gramophone,
August, 1958 issue.
Price £7 18s. 6d.
Size 6½" x 4½" x 3½"

THE WAL TAPE ERASER



Ask your dealer for a WAL

Wellington Acoustic Laboratories Ltd., Farnham, Surrey, England
Phones 6461 and 4961

Classified advertisements

Rate—Sixpence per word (minimum 5s.); Trade, ninepence per word (minimum 10s.); box numbers, one shilling extra. Payment with copy. Copy should be sent to Advertisement Department, "Tape Recording Magazine," 1 Crane Court, Fleet Street, London, E.C.4.

GRUNDIG TK 25 and microphone. Unused gift. Can register guarantee. £52 10s. Box No. 281.

RECORDING TAPES—BEST VALUE EVER!!!

1,200 ft. Plastic Recording Tape on 7 in. reels, list price 35s., our price 22s. Also 850 ft. on 5½ in. reels, list price 28s., our price 19s.; sealed cartons; p. & p. 1s. 6d. extra.

SAVE & SAFE BUY "DIRECT" D.P.S. Co., 2, Harrow Road, corner Edgware Road, London, W.2. Tel.: PAD 7581.

JOHN HASSELL RECORDINGS Tape/Disc. All Speeds. C.C.I.R. Studio, 21, Nassau Road, London, S.W.13. Riverside 7150.

FRIENDLY FOLK ASSOCIATION, 87, Terrace, Torquay.—Leading International Correspondence Hobby Club since 1943. Now included, facilities for Tapesponding. Details free.

Special purchase of Tape Recorders at third saving! The famous 2-speed "Daiwa" with moving coil mike and monitoring earphone. As widely advertised. Brand new but without maker's guarantee. Limited number. Cash ONLY. £22 10s., p. & p. 10s. Stop Press! Limited quantity of the famous "Philco" self-powered FM Tuner in contemporary walnut cabinet at only 16 gns. or on 10 per cent deposit terms. Telesonic Ltd., 153, Tottenham Court Road, London, W.1. EUSTON 2221.

Have you anything you wish to sell or buy?

Remember classified advertising in the columns of TAPE RECORDING MAGAZINE brings results.

EARN MONEY FROM TAPE. Readers in Manchester and district who would like to participate part-time in interesting preliminary work prior to undertaking sound-recording engagements, please write Box 280.

WANT to hire a Fi-Cord for last week in July. Box 285.

"EROICA" RECORDING STUDIOS (Established 1949). When you buy from this studio you are safe in the knowledge that you have a recorder which comes up to professional standards. Your guarantee is our long experience of using, as well as supplying, first-class recording equipment properly suited to the purpose. Whether you require a recorder for general use at home, for music, teaching, speech therapy or the exacting requirements of research, we met all such needs for years and you will find us glad to help you in your choice. Your Tape Recordings transferred to high quality microgroove LPs and 45s. Agents for the incomparable Ferrograph Recorders, Brenell, etc. "EROICA" RECORDING STUDIOS (1949), 31, Peel St., Eccles, Manchester. ECCLES 1624. Musical Director, Thurlow Smith, A.R.M.C.M.

TAPE RECORDERS, players, radios, etc. (modern), wanted for cash or exchange. Callers or particulars. Cooks, 159 and 187 Praed Street, W.2 (opp. Paddington Station). PAD 6464.

TELEFUNKEN Tape Recorder, KL35. Two tape speeds, 3½ & 7½. Built in mixer and effects button. Separate heads. Monitoring on record or playback. Complete with D.11 microphone. Tape and radio lead. £70 o.n.o. Box 286.

GRUNDIG TK 12 Tape Recorder as new, complete with microphone, foot control telescope earphone, 5,850 ft. tape reels, £58. Phone FLE 9666 office hours.

Representatives with established connection with best class Hi-Fi and Tape Recorder retailers to carry world's finest Tape Recorder on generous commission terms. Details of existing lines carried, territory covered, etc. Box 283.

SPECTONE (current model) purchased 20th November, 1958, virtually as new, for sale. 1½ wanted. Box 282.

ONLY FROM US! Famous make stick mike listed 5 gns. only £2 14s. Save 15s. on 7 in. LP Geveart tape 35s.; 5 in. LP Geveart listed 28s. only 19s. 6d.; 7 in. 1,200 ft. Ferrotape ex-M.O.S. listed 42s. only 25s.; 5½ in 250 ft. for Grundig, etc., 19s. 6d. Many other tape bargains—our list will save you ££s! Outstanding secondhand Tape Recorder bargains from Ferrograph to Walter. All new recorders supplied with Free Xtra tapes. We buy for cash or exchange Recorders, Hi-Fi equipment, Radios, Cameras, etc. Specialist Repair Service, E. C. Kingsley & Co., 132, Tottenham Court Road, London, W.1. EUS. 6500.

FERROGRAPH, 4A/N, £50. McGugan, 83, Warwick Rd., S.W.5. FRO. 2870 any time.

FOR SALE.—E.M.I. TR.50 Professional Tape Recorder. Cost £225 in new condition. Sell £100. Apply Christian Broadcasting Commission, Hawkley Studios, Liss, Hampshire.

WANTED. — Radio manufacturing firm require a good service engineer, able to deal independently with all types of repairs to their Tape Recorders. Good wages—good prospects. Apply Box 284.

MEDIUM coercivity tape (approximately 1,200 ft.). Used professionally—bulk erased. As new 21s. Joined tape 16s. Cash with order. Postage 1s. 6d. per reel. Studio 7 Agfa tape 30s.—1,200 ft. As used in all Olympic Studio master recordings. E.M.I. Stereo tape reproducer, plus tone controls, to drive stereo output amplifier. Perfect—only £50. Coilaro 4.T/200 turntable and pick-up—£15. Pair of G.E.C. ribbon microphones, stereo, 30 ohms, perfect. Original boxes, £16 per pair. Apply OLYMPIC SOUND STUDIOS, Carton Hall, Carton St., W.1.

TAPE RECORDERS.—Large selection of used models, most as new. Three months guarantee. Part exchanges with other machines, cameras, binoculars, etc. Ferrograph Tape, 7 in. spool, 1,200 ft., 25s. Cooks Miscellaneous Store, 159 and 187, Praed Street, W.2 (opp. Paddington Station). PAD 6464 or 5931.

GRUNDIG TK/25. Purchased 16th January, 1959 (Wallace Heaton bill shown). With GDM/111 microphone and tape. Total cost was £73 10s. Offered at £52 o.n.o. for quick sale, John Goodman. Phone: MEADway 2525 (London).

Educational Tapesponding—Languages, Shorthand, Morse Code, etc. Mitchell, 150, Station Avenue, West Ewell, Surrey.

EASYSPLICE SPLICER MAKES TAPE SPLICING EASY

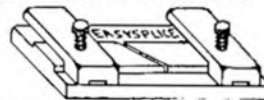

PROV. PAT. PRICE 6/9 P. & P. 6d.
EASYSPLICE, 30, LAWRENCE RD.,
EALING, LONDON

TAPE RECORDER SERVICE ENGINEERS THE BRUCE-MILLER COMPANY

65 Fortress Road, London, N.W.5 GUL 2468
from minor repairs to complete overhauls

Tape Organ Club

TAPE recordists who are interested in organ music are invited to write to Carl Williams for details of the club. Membership is free to persons outside the U.S.A.

Mr. Williams also invites anyone who can contribute privately-made recordings of organ music to contact him.

A library of newspaper cuttings about the activities of members is being collected.

(Secretary: Carl Williams, 19, Van Derveer Street, Amsterdam, New York, U.S.A.)

Tape Respondents International

ROBERT ELLIS, a Scottish schoolmaster, has been chosen as official representative in Great Britain to Tape Respondents International.

T.R.I. have their headquarters in St. Louis, Missouri, U.S.A. During a tornado which hit the town in February, their rooms were lucky enough to escape with only slight damage, although property at the other end of the building was levelled to the ground.

(U.K. Rep.: Robert Ellis, Schoolhouse, Whitsom, By Duns, Berwickshire, Scotland.)

Ulster

MEMBERS have produced a tape magazine called *The Evergreens*. It is for distribution to old people's homes and includes musical requests from the old people themselves. *The Evergreens* is produced by Mr. R. McComb and Mr. R. G. Wisoner.

At a recent meeting members entertained Mr. P. Thompson, a B.B.C. studio manager, who gave a talk on recording tech-

nique. This was followed by question time with Mr. Thompson in the chair.

(Secretary: W. J. Scott, 41, Haypark Avenue, Belfast. Belfast 48950.)

Warwick

THIS Society was recently entertained with a tape/slide show received from Lloyd Alford, of London, Ontario. Apart from many shots of the town, the film, lasting over thirty minutes, showed an unusual park in London called "Storybook Garden." The same show has already circulated in Canada and America. The producer was complimented on its originality and continuity.

A tape quiz contest has been started. It will be judged monthly, with a prize for the winner each month.

Members are looking forward to exchange visits with other tape clubs. Tape exchanges are welcomed from fellow clubs.

(Secretary: D. V. Randle, 4, Edmonscote Road, Leamington Spa, Warwickshire.)

World Tape Pals

JOHAN J. ALBERTSE succeeds Max Nicholls as South African Representative for W.T.P. All inquiries about W.T.P. for this area should now be addressed to him at P.O. Box 48, Beaconsfield, Cape Province.

Mr. Nicholls will continue to represent Tape Respondents International in the Union.

Member Jack Murdoch is organising a novel audio-visual round-robin using tape with 8mm. film of 35mm. slides. Each participant is asked to compile either fifty feet of film or twenty slides of his own locality, including a shot of himself, with a commentary on tape. Each package is then sent on to a tape pal, eventually returning to its originator. Any member interested should write direct to Mr. Murdoch at 17, Hartley Avenue, West Footscray, Melbourne W.12, Australia.

-----CUT ALONG DOTTED LINE-----

ADVERTISEMENT ENQUIRIES SERVICE

Tick against entries in the index below advertisement(s) of product(s) about which you would like to receive further information. Fill in your name and address, fold form as directed overleaf, and post.

	Page		Page
<input type="checkbox"/> Brenell Engineering Co. Ltd.	7	<input type="checkbox"/> Perth Radios Ltd.	67
<input type="checkbox"/> British Thompson-Houston Co. Ltd.	4	<input type="checkbox"/> Pullin Optical Co. Ltd.	15
<input type="checkbox"/> Brown A. & Sons Ltd.	8	<input type="checkbox"/> Quality Mart	13
<input type="checkbox"/> City Sale & Exchange	40	<input type="checkbox"/> Queensway Recording Studios	42
<input type="checkbox"/> Cosmocord Ltd.	68	<input type="checkbox"/> Radio Centre	66
<input type="checkbox"/> C.Q. Audio Ltd.	6	<input type="checkbox"/> Rapid Recording Service	42
<input type="checkbox"/> Daystrom Ltd.	63	<input type="checkbox"/> Rendezvous Records	62
<input type="checkbox"/> Deroy Sound Service	42	<input type="checkbox"/> Repts (Tape Recorders) Ltd.	57
<input type="checkbox"/> Dickinson of Pall Mall	6	<input type="checkbox"/> R.E.S. (Coventry) Ltd.	16
<input type="checkbox"/> Dixons Electronics	12	<input type="checkbox"/> R.E.W. Earlsfield Ltd.	21
<input type="checkbox"/> E.A.P. (Tape Recorders) Ltd.	Front cover and 17	<input type="checkbox"/> Selmer, Henri & Co. Ltd.	58
<input type="checkbox"/> Easysplice	64	<input type="checkbox"/> Shinn, John & Sons Ltd.	11 & 54
<input type="checkbox"/> Electronic Recording Equipment	55	<input type="checkbox"/> Simon Sound Service Ltd.	66
<input type="checkbox"/> E.M.I. Sales and Service Ltd.	34 & 35	<input type="checkbox"/> Stamford, A. L.	56
<input type="checkbox"/> Fi-Cord Ltd.	10	<input type="checkbox"/> Sunderland Sound Service	42
<input type="checkbox"/> Francis of Streatham	32	<input type="checkbox"/> Swains Papercraft	12
<input type="checkbox"/> Grundig (Great Britain) Ltd.	5	<input type="checkbox"/> Sypha Sound Sales Ltd.	61
<input type="checkbox"/> Hi-Fi Developments Ltd.	58	<input type="checkbox"/> Tape Recorders (Bournemouth) Ltd.	56
<input type="checkbox"/> Holdings of Blackburn	8	<input type="checkbox"/> Tape Recorders (Electronics) Ltd.	60
<input type="checkbox"/> Howard Photographic	8	<input type="checkbox"/> Tape Recorder Service Co.	52
<input type="checkbox"/> Hughes, F.A. & Co. Ltd.	28	<input type="checkbox"/> Technical Suppliers Ltd.	8
<input type="checkbox"/> Imhof's (Retail) Ltd.	2	<input type="checkbox"/> Telesonic	41
<input type="checkbox"/> Jewkes & Co. Ltd.	57	<input type="checkbox"/> Teletape	53
<input type="checkbox"/> Lasky's Radio	39	<input type="checkbox"/> The Bruce-Miller Co.	64
<input type="checkbox"/> Lee Electronics	55	<input type="checkbox"/> The Recorder Co.	38
<input type="checkbox"/> Lustraphone Ltd.	20	<input type="checkbox"/> The Service Co.	20
<input type="checkbox"/> Magnograph	42	<input type="checkbox"/> Truvox Ltd.	9
<input type="checkbox"/> McCormack's	58	<input type="checkbox"/> Veritone Ltd.	3
<input type="checkbox"/> Minnesota Mining & Manufacturing Co. Ltd.	43	<input type="checkbox"/> V.E.S. Wholesale Ltd.	63
<input type="checkbox"/> Modern Techniques	16	<input type="checkbox"/> Walter Instruments Ltd.	26
<input type="checkbox"/> Multicore Solders Ltd.	20	<input type="checkbox"/> Watts Radio (Mail Order) Ltd.	67
<input type="checkbox"/> Mullhausie Ltd.	19	<input type="checkbox"/> Wellington Acoustic Laboratories Ltd.	63
<input type="checkbox"/> Musicraft	56	<input type="checkbox"/> Welmec Corporation Ltd.	46
<input type="checkbox"/> Olympic Sound Studios	55	<input type="checkbox"/> Winston Electronics Ltd.	18
		<input type="checkbox"/> Wood, J. H.	56
		<input type="checkbox"/> Wyndsor Recording Co. Ltd.	22

I am also interested in the edit-

orial reference on page.....

to.....

NAME

ADDRESS.....

April, 1959

TAPE LECTURES

A series of monthly lectures organised by "Tape Recording and Hi-Fi Magazine," in association with Olympic Sound Studios.

May 2nd at 3 p.m. **RUPERT NEVE**

will give a lecture-demonstration on

LOUDSPEAKERS

Olympic Sound Studios, Carton Street,
London, W.1

Admission Free

For a **TIP TOP**
PART EXCHANGE ALLOWANCE
on your old recorder

- ★ ALL MAKES STOCKED
- ★ BALANCE BY EASY TERMS

CONSULT

Paul Simmon

35, Northgate, Halifax. Phone 2240

YOURS FOR 10% DEPOSIT

Detailed below is a selection
of equipment available on
easy repayment terms

Whatever your requirements—we stock it

	Cash	Deposit	12 Monthly Payments of	18 Monthly Payments of
AMPLIFIERS & CONTROL UNITS				
Acoustical Quad M. II...	£42 0 0	£4 4 0	£3 12 6	£2 10 6
Leak TL12+ and Point One				
C/U ...	£31 10 0	£3 3 0	£2 14 4	£1 17 10
Rogers Junior Mk. II ...	£28 0 0	£2 16 0	£2 8 4	£1 13 7
LOUDSPEAKER ENCLOSURES COMPLETE & SPEAKER UNITS				
Wharfedale S.F.B.3 ...	£39 10 0	£4 0 0	£3 8 1	£2 7 4
Goodmans Sherwood I	£32 11 0	£3 6 0	£2 16 1	£1 19 0
Acoustical Electrostatic	£52 0 0	£5 4 0	£4 7 5	£2 19 10
Wharfedale Super 12				
FS/AL ...	£17 10 0	£1 15 3	£1 10 2	£1 1 0
Goodmans Stereophonic				
Bowl Unit ...	£8 8 0			
Goodmans Axiom 300	£11 5 9	£1 4 0	19 4	13 6
TAPE RECORDERS				
Ferroglyph JAN ...	£82 19 0	£8 9 0	£6 19 8	£4 15 3
Veritone Venus ...	£69 6 0	£6 19 0	£5 16 5	£3 19 7
*Grundig TK35 ...	£86 2 0	£8 13 6	£7 8 5	£5 3 3
*Sound 555 ...	£68 5 0	£6 17 3	£5 17 8	£4 1 10
Brenell 3 Star ...	£60 18 0	£6 8 0	£5 1 9	£3 7 5
*Grundig TK20 ...	£54 12 0	£5 12 0	£4 11 6	£3 2 8
Telefunken KL75K ...	£52 10 0	£5 5 0	£4 8 3	£3 0 5
*Sound 444 ...	£47 5 0	£4 14 6	£4 1 6	£2 16 9
Verdik ...	£47 5 0	£4 14 6	£4 1 6	£2 16 9
*Sound Belle ...	£27 6 0	£2 16 0	£2 5 9	£1 11 4
<i>*Plus Microphone</i>				
TURNTABLE UNITS & PICKUPS				
Garrard 301 Stroboscopic	£28 0 11	£2 17 6	£2 8 3	£1 13 7
Connoisseur Type B ...	£29 5 3	£3 0 0	£2 10 4	£1 15 0
Lenco GL 58/RD (with Stereo Pickup) ...	£29 3 10	£2 19 6	£2 10 1	£1 14 11
Decca Stereo Pickup ...	£22 0 0	£2 4 0	£1 18 0	£1 6 5

THE RADIO CENTRE E & G THE RADIO CENTRE LTD.
33 Tottenham Court Road, London, W.1.

Tel.: MUSEum 6667

LONDON'S TAPE RECORDER CENTRE

CUT ALONG DOTTED LINE

POSTAGE
WILL BE
PAID BY
PRINT AND
PRESS
SERVICES
LIMITED

TAPE RECORDING & HI-FI MAGAZINE,
ADVERTISEMENT ENQUIRIES,
7, TUDOR STREET,
LONDON, E.C.4.

BUSINESS REPLY FOLDER
Licence No. ND 922

THIRD FOLD HERE

SECOND FOLD HERE

FLAP A

FLAP B

FIRST FOLD ALONG THIS LINE

NO POSTAGE
NECESSARY
IF POSTED
IN GREAT
BRITAIN OR
NORTHERN
IRELAND

TO OBTAIN DETAILS
OF ADVERTISERS



Make sure your name and
address etc., is clearly shown
on the form overleaf.

Cut along the dotted
lines.

Fold along lines as indicated
and then tuck Flap A into
Flap B.

RECORDING TAPE

RETURN OF POST SERVICE

All the following items are normally kept in stock for delivery by return of post. In the event of supplies being held up from the makers we advise delivery position by return.

BASF

Standard PVC Base. 150ft. (3") 8/-. 300ft. (4") 13/6. 600ft. (5") 21/-. 850ft. (5½") 28/-. 1,200ft. (7") 35/-.
 LONG PLAY. PVC Base. 210ft. (3") 9/-. 850ft. (5") 28/-. 1,200ft. (5½") 35/-. 1,700ft. (7") 50/-.
 DOUBLE PLAY. Reels contain twice the length of standard tape. 300ft. (3") 14/-. 600ft. (4") 25/-. 1,200ft. (5") 42/-. 1,600ft. (5½") 52/6. 2,400ft. (7") 77/6.
 EDITING TAPE. This tape has a special matt surface which enables marks to be made upon it. One size only, 395ft. on 4" spool 25/-.
BRITISH FERROGRAPH
 On Hublock Reels. 200ft. (3½") 12/6. 600ft. (5") 26/9. 1,200ft. (7") 45/-. 1,750ft. (8½") 63/-.
EMITAPE
 "88" PVC Base. Message 175ft. (3") 7/6. Junior 600ft. (5") 21/-. Continental 850ft. (5½") 28/-. Standard 1,200ft. (7") 35/-. Professional 1,800ft. (8½") 57/6.
 "99" LONG PLAY. PVC Base. Message 250ft. (3") 9/6. Junior 850ft. (5") 28/-. Continental 1,200ft. (5½") 35/-. Standard 1,800ft. (7") 50/-. Professional 2,400ft. (8½") 72/6.
EMITAPE IN EMICASES
 Emitape packed in the new plastic containers.
 "88" Junior 600ft. (5") 23/6. Continental 850ft. (5½") 30/6. Standard 1,200ft. (7") 37/6.
 "99" LONG PLAY. Junior 850ft. (5") 30/6. Continental 1,200ft. (5½") 37/6. Standard 1,800ft. (7") 52/6.

SPECIAL TAPE OFFERS! Send for list.

GELOSO

3" Spools. Standard 12/-. Long Play 16/-.
GRUNDIG
 T4. 120ft. (3") 7/9. T2. 850ft. (5½") 27/6. T3. 1,200ft. (7") 35/-.
 LONG PLAY. TLP1. 1,200ft. (5½") 35/-. TLP2. 1,700ft. (7") 50/-.
MSS MASTERTAPE
 PM/15. 150ft. (3") 5/6. 300ft. (4") 10/6. 600ft. (5") 20/-. 850ft. (5½") 27/6. 1,200ft. (7") 35/-. 1,750ft. (8½") 50/-.
 LONG PLAY. 225ft. (3") 8/6. 450ft. (4") 14/6. 850ft. (5") 28/-. 1,200ft. (5½") 35/-. 1,800ft. (7") 50/-. 2,400ft. (8½") 70/-.
PHILIPS
 300ft. (4") 13/6. 600ft. (5") 21/-. 1,200ft. (7") 35/-.
 LONG PLAY. 850ft. (5") 28/-. 1,800ft. (7") 50/-.
SCOTCH BOY
 No. 111A. Acetate Base. 200ft. (3") 6/3. 600ft. (5") 16/-. 850ft. (5½") 22/-. 1,200ft. (7") 27/-.
 No. 150. LONG PLAY. Polyester Base. 300ft. (3") 9/6. 900ft. (5") 28/-. 1,275ft. (5½") 35/-. 1,800ft. (7") 50/-.
 No. 120 High Output. Acetate Base. 600ft. (5") 23/-. 850ft. (5½") 31/-. 1,200ft. (7") 39/-.
 No. 111V. Super Base. PVC Base. 200ft. (3") 7/6. 600ft. (5") 21/-. 850ft. (5½") 28/-. 1,200ft. (7") 35/-.
TELEFUNKEN
 EXTRA PLAY TAPE. These contain TWICE the length of standard tape. 1,200ft. on 5" spool 35/-. 2,400ft. on 7" spool 72/6.
 NOTE.—All Tapes are Standard Play except where shown as Long Play.
 Wide range of Tapes Accessories in stock. See our advertisement in November issue. Detailed list free on request
TERMS OF BUSINESS.—Cash with order or C.O.D. All tape is post free, but postage is extra on orders under £3 for accessories. C.O.D. fees are charged on C.O.D. orders under £5.
H.P. TERMS are available on orders for Tape and Accessories over £5 in value. Send for details.

WATTS RADIO (MAIL ORDER) LTD.

54, Church Street, Weybridge, Surrey

Telephone WEYBRIDGE 4556

PLEASE NOTE—Post orders only to the above address

more features in PERTH-SAJA

Made in Germany to exacting specifications

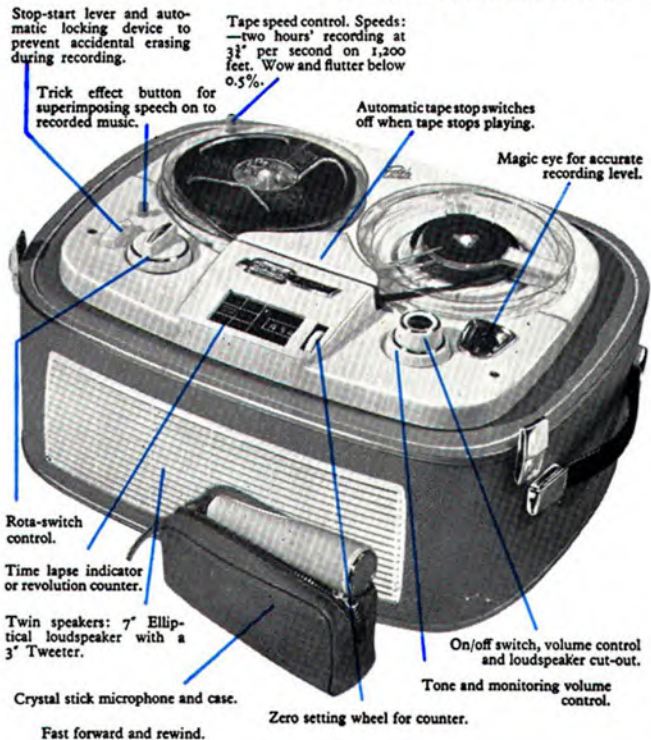

Lovelier styling plus extra features make the Perth-Saja Tape Recorder the finest value money can buy. Send coupon for illustrated literature and name of nearest stockist



Beautifully styled two-tone carrying case. Easy to carry.

TWIN DE LUXE MODEL 56 GNS
Complete with Microphone and Tape.

STANDARD MODEL - 45 GNS
Complete with Microphone and Tape.

**EASY TERMS
AT YOUR DEALERS**

To **PERTH RADIOS LTD.**, Marten House, 39-47 East Road, London, N.1

Please send me literature on the Perth-Saja Tape Recorder

Name.....

Address

.....

acos

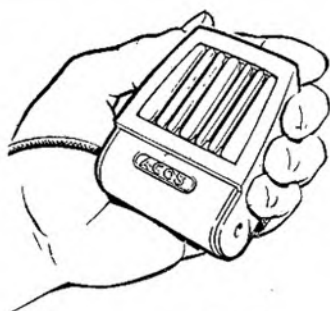

FOR MIKES

MIC 40

The Acos MIC 40, for instance, is a neat, fold-away microphone, that either fits snugly into the hand, or stands on its own. One of the smallest microphones in the country, in attractive dual colours, the MIC 40 is standard equipment with many well-known tape recorders. It is also available separately from most good dealers. The price is moderate, and the sensitivity and sound reproduction are remarkably good. Acos also make several other, equally successful microphones in different price ranges.

SEE YOU AT THE AUDIO FAIR, ROOM 315, BOOTH 48—RECMF EXHIBITION, STAND 43
COSMOCORD LTD WALTHAM CROSS HERTS • TEL: WALTHAM CROSS 5206 (London subscribers please dial WA4 5206)