

*RA Poole*

# THE POST OFFICE ELECTRICAL ENGINEERS' JOURNAL



Vol. 52 Part 2

JULY 1959

## CONTENTS

	Page
INTRODUCTION OF SEMI-AUTOMATIC OPERATION OF CONTINENTAL TELEPHONE SERVICES—M. G. Turnbull .....	89
THE LONDON INTERNATIONAL MAINTENANCE CENTRE K. E. Stotesbury, B.Sc.(Eng.), A.M.I.E.E., and S. H. L. Byrne .....	96
THE IXth PLENARY ASSEMBLY OF THE C.C.I.R., LOS ANGELES, APRIL 1959 .....	101
TELEGRAPH DISTORTION IN THE TRUNK NETWORK OF THE TELEGRAPH AUTOMATIC SWITCHING SYSTEM—L. K. Wheeler, B.Sc.(Eng.), A.M.I.E.E., and A. C. Frost, A.M.I.E.E. ....	103
WAVEFORM DISTORTION IN TELEVISION LINKS, Part 1—Introduction to Waveform Distortion I. F. Macdiarmid, A.M.I.E.E. ....	108
CABLE CREEPAGE R. H. Harris .....	115
A MEDIUM-DISTANCE, BUILT-IN OUT-BAND SIGNALLING, CARRIER TERMINAL EQUIPMENT, Part 1—General Performance Requirements—E. T. C. Harris, B.Sc.(Eng.), A.M.I.E.E., and K. C. A. King, Associate I.E.E. ....	122
THE GENERATION OF STABLE CARRIER FREQUENCIES IN THE RANGE 3,800–4,200 Mc/s R. J. D. Scarbrough, B.Sc.(Eng.), A.M.I.E.E., K. H. Ferguson, and A. W. Searls .....	125
FREQUENCY-METER OPERATING IN THE H <sub>011</sub> MODE IN THE RANGE 3,975–4,275 Mc/s R. L. O. Tattersall, A.M.I.E.E. ....	129
PROSPECTS FOR TRANSATLANTIC TELEVISION BY CABLE R. J. Halsey, C.M.G., B.Sc.(Eng.), F.C.G.I., D.I.C., M.I.E.E., and A. R. A. Rendall, O.B.E., Ph.D., M.I.E.E. ....	136
HER MAJESTY THE QUEEN'S VISIT TO CANADA—News Films over the Transatlantic Telephone Cable .....	140
INCREASING THE TRAFFIC CAPACITY OF TRANSATLANTIC AND OTHER SUBMARINE TELEPHONE CABLES .....	140
THE LONDON PAYROLL COMPUTERS H. T. McGrath, B.Sc. ....	142
THE FIRST MONTHS OF SUBSCRIBER TRUNK DIALLING .....	144
NOTES AND COMMENTS .....	146
INSTITUTION OF POST OFFICE ELECTRICAL ENGINEERS .....	146
REGIONAL NOTES .....	148
ASSOCIATE SECTION NOTES .....	155
STAFF CHANGES .....	159
BOOK REVIEWS .....	100, 107, 121, 128, 135, 145, 158

Price 2/6 net



# THE POST OFFICE

## ELECTRICAL ENGINEERS' JOURNAL

Vol. 52 Part 2

JULY 1959

### Introduction of Semi-Automatic Operation of Continental Telephone Services

M. G. TURNBULL†

U.D.C. 621.395.35:621.395.5

Following field trials of two different voice-frequency signalling systems for use between any two national telephone systems, agreement was reached through the C.C.I.T.T. on the use of these two systems. This article describes briefly the results of the field trials and the agreed signals to be used over international circuits. This is followed by an outline of the equipment and trunking arrangements provided at London for semi-automatic working of the European international circuits.

that the specification for international signalling systems should take into account any additional requirements that might arise with fully automatic operation, as far as they could be foreseen. Several problems remain to be resolved before fully automatic operation can be introduced generally and these are receiving urgent consideration.

#### INTRODUCTION

THE growth in the international telephone service over the past few years, and the extension of automatic working within national networks, has made it desirable to introduce facilities to enable operators to complete calls to subscribers in other countries without the assistance of operators in those countries. This method of working is known as semi-automatic operation.

The basic technical problem involved in providing a semi-automatic international telephone service is the provision of a means of interworking between national telephone systems that may differ widely in respect of facilities provided and type of equipment employed. To avoid the necessity for a multiplicity of different types of equipment to cater for the differences which may exist between different countries, agreement has been reached through the International Telegraph and Telephone Consultative Committee (C.C.I.T.T.) on the use of two types of signalling systems, either one of which will serve as a connecting link between two national telephone systems. Previously the two systems had been subjected to extensive tests between 1952 and 1954 by a number of countries and proved to be satisfactory. Complete specifications for these systems were, therefore, drawn up and issued in Volume V of the C.C.I.F.\* Green Book.

At the time these specifications were drawn up a number of countries were considering the introduction of national subscriber trunk dialling, and it was felt logical to assume that international subscriber dialling would be introduced during the life of the equipment provided for operator dialling. It was, therefore, decided

#### CONDUCT AND RESULTS OF THE FIELD TRIALS

The main object of the field trials was to test the relative merits of the two proposed signalling systems under service conditions, but the trials also provided an opportunity for the operating services to obtain experience of international semi-automatic operation. In particular, the opportunity was taken to examine the extent to which calls could be completely established and controlled by an operator at the outgoing international exchange without the assistance of an operator in the distant country.

The scope of the field-trial network, which was set up on a route-by-route basis between July 1952 and May 1954, has been described elsewhere.<sup>1</sup> After preliminary engineering tests, the circuits were used for carrying public traffic, all types of call—ordinary, personal and those requiring an incoming operator—being handled without discrimination. Although several series of engineering tests were made of calls established over more than one international circuit and, therefore, switched at an intermediate international exchange, such transit routings were not used for public traffic due to the comparatively small number of field-trial circuits available.

The results of the field trials from an operational point of view have already been discussed elsewhere,<sup>2</sup> but the overall results obtained with public traffic, from observations on the outgoing equipment, are of particular interest. These results are summarized in Table 1.

It was not possible to discriminate between faults occurring in the national network of the distant country and faults due to the international signalling system. The total failures due to faults, therefore, included all faults between the manual board at the outgoing terminal exchange and the foreign subscriber.

The fault records were analysed in several different ways in an endeavour to extract the maximum possible information, particularly in so far as a comparison of

† Assistant Engineer, Telephone Exchange Systems Development Branch, E.-in-C.'s Office.

\* The C.C.I.F. (International Telephone Consultative Committee) and the C.C.I.T. (International Telegraph Consultative Committee) were combined in 1955 to form the C.C.I.T.T. (International Telegraph and Telephone Consultative Committee).

TABLE 1  
Results Obtained from Field Trial Equipment

System	Result of Attempt to Establish a Connexion	Number of Calls	Percentage of Total Calls
1 v.f.	Effective	12,860	77.1
	Ineffective for reasons other than faults	2,403	14.4
	Ineffective due to faults	1,426	8.5
2 v.f.	Effective	22,897	77.8
	Ineffective for reasons other than faults	4,438	15.0
	Ineffective due to faults	2,126	7.2

TABLE 2  
Analysis of Faults Traced and Cleared with Respect to the Location of the Fault

Location of Fault	1 v.f. System		2 v.f. System	
	Number	Percentage	Number	Percentage
Outgoing end	23	12.4	56	11.0
Line	81	43.8	223	43.8
Incoming end	46	24.9	106	20.8
National network	35	18.9	121	23.8
Not indicated	—	—	3	0.6
TOTAL	185	100	509	100

Note: The number of faults for the 1v.f. system was smaller than that for the 2v.f. system because the latter was installed first and was, therefore, in operation for a longer period.

the performance of the two systems was concerned. Table 2 gives an analysis of the faults traced and cleared with respect to the location of the fault. It can be seen that the division, in percentage, of faults among the four categories was sensibly the same for the two systems, and that the total faults attributed to the equipment at the outgoing and incoming ends was between 30 and 40 per cent of the total faults cleared.

The conclusion drawn from the results of the field trials was that, in the conditions under which the trials were made, the semi-automatic circuits with either signalling system had given complete satisfaction to the operating services. The fault statistics gave no evidence of any superiority of one signalling system over the other, and had established no evidence of any systematic faults arising from the principles embodied in either system. Therefore, the field trials, although proving the practicability of semi-automatic working on international circuits, were inconclusive in determining the choice of a standard signalling system.

The Final Report, issued by the Field Trials Commission (C.E.A.) of the C.C.I.F., was considered at a special meeting of the 6th and 8th Study Groups held in Geneva in September 1954. At this meeting it was

found that, although there was unanimity of views regarding the operational facilities for semi-automatic working, it was not possible to arrive at a unanimous recommendation regarding the exclusive use of a single signalling system. The use of a single standard system is not so essential for terminal service, but in the case of transit-switched traffic the coexistence of more than one signalling system would give rise to very great difficulties. Agreement was finally reached on the following compromise solution, which gives national administrations maximum freedom in the choice of a signalling system while still achieving a certain degree of standardization for transit operation.

(a) On international routes carrying only terminal traffic, one or other of the two international signalling systems should be used, the choice being determined by mutual agreement. Where agreement cannot be reached, the system to be used will be that in use, or preferred, at the outgoing centre.

(b) The 2 v.f. signalling system should normally be used for transit operation except where special agreement is reached between three or more countries to use the 1 v.f. signalling system for transit operation between themselves.

It was also agreed that, to enable the equipment to be as simple as possible and to avoid double connexions and "lock-ups," the international semi-automatic telephone circuits should be operated in one direction only.

#### DEFINITIONS AND FUNCTIONS OF THE SIGNALS USED OVER INTERNATIONAL CIRCUITS

As a result of the experience gained during the field trials it was agreed that the following signals should be used.

*Seizing Signal* (transmitted in the forward direction)—This signal is transmitted at the beginning of a call to initiate circuit operation at the incoming end of an international circuit. The seizing signal can also perform certain switching functions and for this purpose two different types of seizing signal are provided:

(a) The "terminal-seizing" signal, which can be used for bringing into circuit, at the incoming international exchange, equipment used exclusively for switching the call within the national network of the incoming country.

(b) The "transit-seizing" signal, which can be used for giving access, at the incoming international exchange, to equipment provided for switching the call to another international exchange.

*Proceed-to-Send Signal* (transmitted in the backward direction)—This signal is transmitted from the incoming end of an international circuit following the receipt of a seizing signal, to indicate that conditions have been established for the reception of the numerical routing information. In the 2 v.f. signalling system two different proceed-to-send signals are provided:

(a) The "terminal proceed-to-send" signal is used to invite the transmission of the necessary numerical information for routing the call within the national network of the destination country.

(b) The "transit proceed-to-send" signal is used to invite the transmission of only those numerical signals necessary for routing the call through the international transit exchange.

*Pulsing Signal* (transmitted in the forward direction)—This signal consists of a number of elements, and a



succession of pulsing signals is transmitted corresponding to the information required to switch the call in the desired direction.

**Acknowledgement Signal** (transmitted in the backward direction)—This signal is provided in the 2 v.f. signalling system only and is transmitted from the incoming end of an international circuit to indicate that a complete numerical signal has been correctly received.

**End-of-Pulsing Signal** (transmitted in the forward direction)—This signal is transmitted from the outgoing international exchange to indicate that no further pulsing signals will be transmitted over the line.

**Number - Received Signal** (transmitted in the backward direction)—This signal is sent from the incoming international terminal exchange when the incoming register at this exchange has recognized that it has received a complete national number.

**Busy-Flash Signal** (transmitted in the backward direction)—This signal is sent to the outgoing international exchange to indicate that either the route or the called subscriber is busy. The transmission of this signal is optional since the national networks of certain countries do not cater for this facility.

**Answer Signal** (transmitted in the backward direction)—This signal is sent to the outgoing international exchange to indicate that the called subscriber has answered the call.

**Clear-Back Signal** (transmitted in the backward direction)—This signal is sent to the outgoing international exchange to indicate that the called party has cleared.

**Forward - Transfer Signal** (transmitted in the forward direction)—This signal is sent to the incoming international exchange when the outgoing operator wishes to seek the assistance of an operator at the incoming terminal exchange. This signal will, normally, serve to bring an assistance operator into circuit in the case of a call completed automatically at this exchange. When a call has been completed by an operator at the incoming international exchange this signal will cause the incoming operator to be recalled.

**Clear-Forward Signal** (transmitted in the forward direction)—This signal is sent in the forward direction on the termination of a call when the operator at the outgoing international exchange withdraws her cord-circuit plug from the switchboard jack, or when an equivalent operation is performed.

**Release-Guard Signal** (transmitted in the backward direction)—This signal is transmitted in the backward direction in response to the clear-forward signal to indicate that the latter signal has been fully effective in bringing about the release of the switching apparatus at the incoming end of an international circuit.

TABLE 3  
Codes of V.F. Signals for 2 V.F. Signalling System

Forward Direction			Backward Direction		
Signal	Field Trial Code	Revised Code	Signal	Field Trial Code	Revised Code
Terminal seizure	CX	PX	Terminal proceed-to-send	X	X
Transit seizure	CY	PY	Transit proceed-to-send	Y	Y
Digital signals	Binary Code 1-(10) (see Table 4)		Terminal acknowledgement	x	x
			Transit acknowledgement	y	y
			Number received	C	P
End-of-pulsing	Binary Code (15)		Busy flash	CX	PX
Access to operator	Binary Code (11)		Ring tone	CY	Not provided
Access to particular operator	Binary Code (12)		Answer	PY	PY
Forward transfer	PXX	PYY	Clear back	PX	PX
Clear forward	PYY	PXX	Re-answer	PY	PY
			Release guard	PYY	PYY
			Blocking	PX	PX

NOMINAL SIGNALLING FREQUENCIES:  
X or x = 2,040 c/s  
Y or y = 2,400 c/s  
C and P (Compound elements) = 2,040 + 2,400 c/s

REVISED SIGNAL TIMINGS:  
Signal Element

P	Signal Duration (ms)	Recognition Time (ms)
x or y	120-180	60-100
X or Y	28-42	5-15
XX or YY	100-170	30-50
	280-420	160-240

TABLE 4  
2 V.F. Binary Code

Pulsing Signal	Numerical Equivalent of Signal Elements	2 <sup>3</sup> = 8	2 <sup>2</sup> = 4	2 <sup>1</sup> = 2	2 <sup>0</sup> = 1	Pulsing Signal	Numerical Equivalent of Signal Elements	2 <sup>3</sup> = 8	2 <sup>2</sup> = 4	2 <sup>1</sup> = 2	2 <sup>0</sup> = 1
		Binary Code						Binary Code			
	Number						Number				
1	1	Y	Y	Y	X	Access to operator	(11)	X	Y	X	X
2	2	Y	Y	X	Y						
3	3	Y	Y	X	X	Access to particular operator	(12)	X	X	Y	Y
4	4	Y	X	Y	Y						
5	5	Y	X	Y	X	Spare	(13)	X	X	Y	X
6	6	Y	X	X	Y	Spare	(14)	X	X	X	Y
7	7	Y	X	X	X	End-of-pulsing	(15)	X	X	X	X
8	8	X	Y	Y	Y		Spare	(16)	Y	Y	Y
9	9	X	Y	Y	X						
0	(10)	X	Y	X	Y						

NOMINAL SIGNALLING FREQUENCIES:  
X = 2,040 c/s      Y = 2,400 c/s

SIGNAL DURATION:  
X or Y Elements = 27-42 ms tone with 27-42 ms silent interval between the elements. There should be at least 27-42 ms between successive pulsing signals.

TABLE 5  
Code of V.F. Signals for 1V.F. Signalling System

Forward Direction			Backward Direction		
Signal	Field Trial Code	Revised Code	Signal	Field Trial Code	Revised Code
Terminal seizure	X	X	Proceed to send	X	X
Transit seizure	XX	XX	Number received	Not provided	X
Digital signals	Arythmic Code 1-(10) (see Table 6)		Busy flash	X	XX
			Ring tone	XSX	Not provided
End-of-pulsing	Arythmic Code (15)		Answer	X	XSX
Access to operator	Arythmic Code (11)		Clear back	Train of pulses XSSXSSX...	XX
Access to particular operator	Arythmic Code (12)		Re-answer	No signal	XSX
Forward transfer	X	XSX	Release guard	XSSXX	XSSXX
Clear forward	XSSXX	XSSXX	Blocking	Continuous signal	

NOMINAL SIGNALLING FREQUENCY: 2,280 c/s

REVISED SIGNAL TIMINGS:

Signal Element	Signal Duration (ms)	Recognition Time (m)
X	120-180	60-100
XX	480-720	300-450
S	80-120	30-50

TABLE 6  
1V.F. Arythmic Code

Pulsing Signal	Numerical Equivalent of Signal Elements	2 <sup>3</sup> = 8	2 <sup>2</sup> = 4	2 <sup>1</sup> = 2	2 <sup>0</sup> = 1	Stop
		Signal elements				
		Start	1	2	3	
Digit 1	(1)					
Digit 2	(2)					
Digit 3	(3)					
Digit 4	(4)					
Digit 5	(5)					
Digit 6	(6)					
Digit 7	(7)					
Digit 8	(8)					
Digit 9	(9)					
Digit 0	(10)					
Access to operator	(11)					
Access to particular operator	(12)					
Spare	(13)					
Spare	(14)					
End of pulsing	(15)					
Spare	(16)					

NOMINAL SIGNALLING FREQUENCY: 2,280 c/s

SIGNAL DURATIONS:

The start, stop and signal elements each have a nominal duration of 50 ms, corresponding to a speed of sending of 20 bauds.

**Blocking Signal** (transmitted in the backward direction)  
—This signal is sent to the outgoing end of the circuit to cause the international circuit to test "busy" when it is necessary to perform certain maintenance operations at the incoming international exchange.

SIGNAL CODES OF THE TWO STANDARD  
SIGNALLING SYSTEMS

In the revision of the specifications of the equipment used for the field trial, certain changes were made to the basic signal codes of the 1v.f. and 2v.f. systems, these changes being made primarily to improve the margins of security of circuit operation and, where possible, to simplify the timing requirements. It was also necessary to modify the signal code of the 1v.f. system so that it gave the same operating facilities as the 2v.f. system; this resulted in a major modification to the 1v.f. code of signals. The signal codes are given in Tables 3 and 4 for the 2v.f.

system, and in Tables 5 and 6 for the 1v.f. system; in these tables a comparison is made between the signals codes adopted for the field trials and the revised signal codes. In the case of the pulsing signals transmitted with the 1v.f. system, the digital information has been rearranged to conform with the mathematical arrangement of the binary code.

FACILITIES AND TRUNKING  
ARRANGEMENTS OF THE LONDON  
INTERNATIONAL AUTOMATIC  
EXCHANGE

The equipment provided at London for the field trials remained in service after the conclusion of the trials and was augmented in 1954 to enable the whole of the Amsterdam route to be converted to semi-automatic operation. The field-trial equipment was, however, primarily designed to test the relative merits of the two signalling systems and was not intended for large-scale expansion.

After the issue of the revised C.C.I.F. specification for international signalling equipment in 1955 the design was started of equipment for a new exchange capable of providing 1,000 incoming and 1,000 outgoing circuits. The outgoing circuits cater for 2v.f. working only, this being in accordance with the C.C.I.F. recommendation, mentioned previously, that the choice of the signalling used on any route may be determined by the outgoing centre, but both 1v.f. and 2v.f. incoming equipment will be provided at the London centre.

The trunking arrangements of the London equipment are shown in Fig. 1 and Fig. 2, which refer to the outgoing

and incoming equipment, respectively.

*Outgoing-Route Selection*

The equipment provided at London on the initial installation caters primarily for direct routings, and access to each outgoing semi-automatic circuit is provided from the Continental manual board. It is envisaged, however, that a limited number of routings will require to be switched through an international centre in another country, so that the facility has been provided for all outgoing circuits to be used, if required, for either terminal or transit connexions. Because of the common access from the multiple, and because the establishment of a transit call proceeds in a different manner from that of a terminal call, information must be passed to the outgoing equipment indicating what type of call, terminal or transit, is being made. This information is given by the depression of either a terminal start key or a transit start key during the setting up of the call.



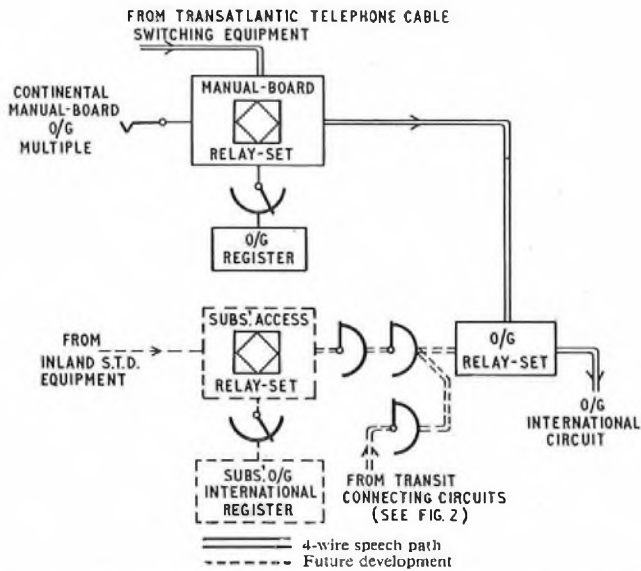

The manual-board relay-set and subscriber's access relay-set include 4-wire/2-wire terminating sets

FIG. 1—TRUNKING ARRANGEMENT OF OUTGOING EQUIPMENT

### Signals Keyed by the Operator

Each manual-board position in the Continental exchange is provided with a signal key-strip for setting up the connexions. The order in which the signals are keyed for a call to a distant subscriber is as follows:

- (i) Terminal-start signal or transit-start signal.
- (ii) Two-digit international code—on transit calls only.
- (iii) National number of required subscriber (may be up to 10 digits).

### (iv) End-of-keying signal.

This information is received and stored by the outgoing register.

### Assistance Facility

If the outgoing operator requires the assistance of an operator in a distant country, due, for example, to language difficulty with the called subscriber, it is possible to call an operator in the incoming country into circuit. The signal used to provide this facility is the forward-transfer signal which is initiated by the operation of the position ring-key.

On calls set up automatically within the incoming terminal country, the reception of a forward-transfer signal will cause an assistance operator who can speak the required language to be associated with the connexion already established.

On a call routed via an operator at the distant incoming international centre, the reception of the forward-transfer signal will cause the incoming operator to be recalled.

### Language Discrimination

The service language to be used between operators in the European service is agreed, for each route, by the administrations concerned. With semi-automatic operation it is convenient to permit access to common manual-board positions at the incoming terminal exchange and, hence, it is necessary to indicate to the operators answering calls to these positions the service language to be used. To cater for this requirement, a language digit is transmitted preceding the normal digital information. The language digit may be keyed by the operator or inserted automatically; the second

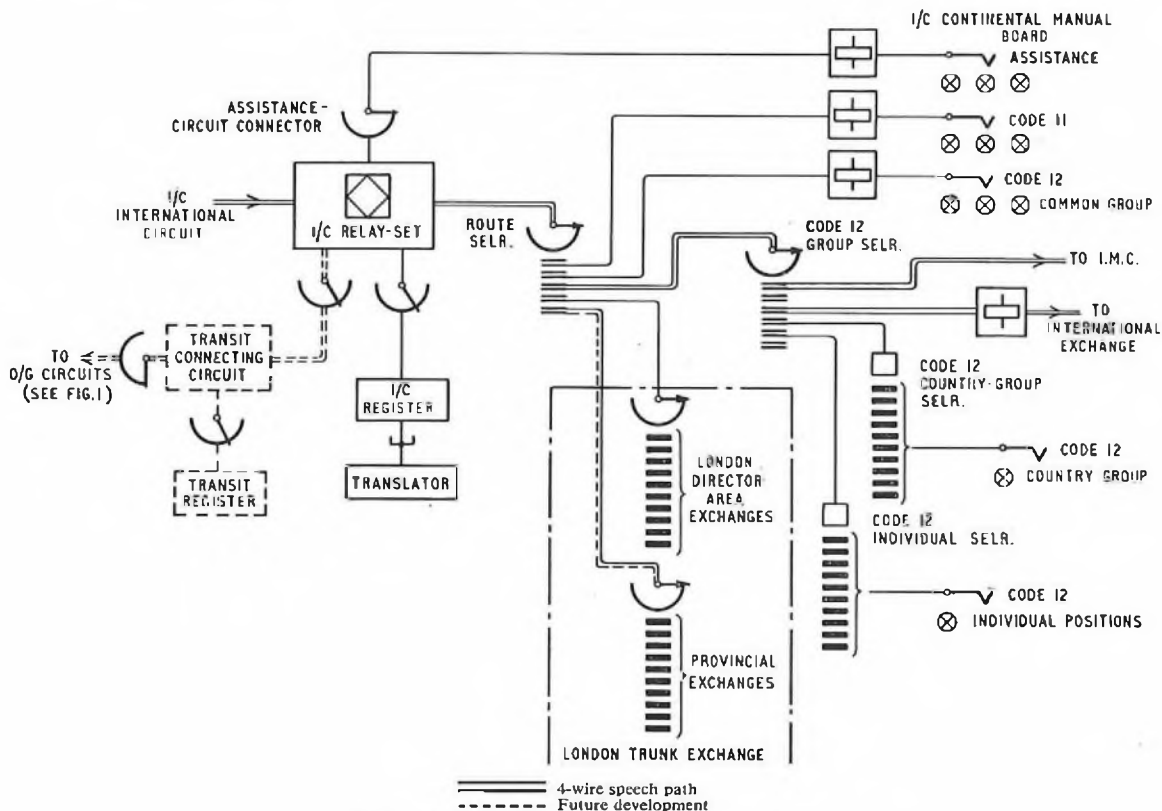

The incoming relay-set includes a 4-wire/2-wire terminating set

FIG. 2—TRUNKING ARRANGEMENT OF INCOMING EQUIPMENT

method has been adopted in the design of the outgoing equipment at London. For a terminal call, for which the outgoing register receives a terminal-start signal, the language digit required is determined by a discriminating signal received from the associated manual-board relay-sets. For transit calls, the language digit is determined within the outgoing register, by an examination of the country code keyed by the calling operator.

At the incoming terminal exchange the language digit is detected by the incoming register, being the first digit received, and an appropriate signal is extended from the incoming register to the incoming relay-set, where it is stored for future use should the call be to the manual-board position, or should assistance be required later. The method used to indicate the language to be spoken on calls incoming to London is by the provision of three calling lamps per incoming manual-board circuit, each calling lamp being used to indicate a particular language.

#### *Outgoing Equipment*

Provision is made in the outgoing relay-set for joint access from the manual board and selector level to permit, at a later stage, access for international subscriber-dialled calls and for international transit calls. No provision has been made in the initial installation for international subscriber dialling or for automatic international transit operation other than ensuring that these facilities can be added at a later stage.

The voice-frequency receiver, which converts the incoming v.f. signals into d.c. signals, is associated with the outgoing relay-set and includes a buffer amplifier to protect the receiver from near-end interference. All voice-frequency signals are sent under the control of static relays located in the outgoing relay-set, the control for pulsing signals being on a d.c. basis from the outgoing register. The duration of the line signals is accurately timed by three capacitor-controlled relays and these relays, operating in sequence, generate any of the required line signals.

A limited number of manual-board relay-sets have been provided with access from the transatlantic telephone-cable switching equipment, and these circuits cater for the extension of transatlantic calls to the continent, on a 4-wire basis, via the International and Continental manual boards.

#### *Signalling-Failure Alarm Conditions*

Due to the high cost of international circuits it is most desirable to keep the out-of-service time to a minimum and special arrangements have been made for the detection and indication of signalling failures. Wherever possible in the international signalling systems each signal is acknowledged; the acknowledgement of the seizing signal is the proceed-to-send or busy signal, whilst the clear-forward signal is acknowledged by the release-guard signal. In the 2 v.f. system each numerical signal is also acknowledged by an acknowledgement signal.

If, during the setting up of a connexion, the outgoing register fails to receive a proceed-to-send or acknowledgement signal the register is forcibly released after a short period, and the operator will receive number-unobtainable tone. When the operator clears the clear-forward signal will be sent, which should result in the reception of a release-guard signal, this latter signal restoring the circuit to normal. Should a release-guard signal not

be received, the outgoing circuit remains busied and the clear-forward signal is repeated at intervals of about 1 minute. If a release-guard signal is not received within 3-6 minutes an indication is given on a circuit alarm at the International Maintenance Centre (I.M.C.),<sup>3</sup> thus bringing the fault to the notice of the engineering staff.

The above conditions are the normal working conditions, but keys are provided on the test positions in the I.M.C. to enable any circuit to be kept under observation if intermittent faults that could be masked by the repeat-clear facility are suspected. Thus, a key, when operated, disconnects the repeat-clear facility and provides for an alarm to be given, as soon as the operator clears down the associated circuit, should there have been a failure to receive a proceed-to-send or an acknowledgement signal. The operation of this key also provides for an alarm to be given in the event of a release-guard signal not being received within 5-10 seconds of sending a clear-forward signal.

#### *Incoming Equipment*

Each incoming international line is connected to an incoming relay-set which is associated with a voice-frequency receiver and buffer amplifier. Provision is made for each incoming relay-set to have access to one of two types of register depending on the type of seizing signal received, one being a terminal register which will control the routing of calls within the national network and the other a transit register whose function is to direct the call to another country. There is at present no demand for automatic transit routings and the transit switching equipment has not, therefore, been provided, but it can be added at any time should the facility be required.

On terminal calls the selection of the required service is provided by a route selector (a motor uniselector), which is positioned under the control of the incoming register. This selector caters for five groups of circuits, each group having an availability of 10-40, the total availability being limited to 100.

The incoming register-translators differ from those provided for subscriber trunk dialling,<sup>4</sup> in as much as they combine the functions of an incoming register-translator for calls incoming to London and a controlling register-translator for calls incoming to the provinces. Each translator provides for the translation of 300 3-digit London codes and 300 3-digit provincial codes. The incoming register discriminates, from the second digit received (the first digit being the language digit), between calls to be routed to the London director area and those which are to be routed to the provinces and applies an appropriate marking condition to the translator. The operational sequences are similar to those used in the national incoming register-translator for director areas.<sup>5</sup>

Access is provided from the route selector to the London (Faraday) trunk-exchange incoming-unit for calls to London subscribers, and via the London (Faraday) trunk-exchange outgoing-unit for calls to provincial subscribers. The incoming relay-set and the route selector cater for 4-wire switching but, initially, 2-wire switching will be provided on calls to the inland network until such time as 4-wire selector switching becomes available.

#### *Access to the Incoming Manual Board*

To obtain uniformity in operating procedures the dialling codes for access to the manual boards at each



distant incoming international centre have been standardized. Since the use of 4-element codes for the transmission of the digital information provides discrete codes for the numerical digits 1-0 and also for the codes 11-16, it has been agreed to utilize codes 11 and 12 for this purpose.

The code-11 operator performs the functions of an incoming "B" operator for the completion of calls which cannot be established automatically by the controlling operators in distant countries.

The code-12 operator deals with calls which cannot be completed by the outgoing controlling operator in the prescribed number of attempts and with certain classes of call requiring special treatment, or she may serve as a booking operator.

Provision is made at London for access via the route selector to the code-11 and code-12 common group of manual-board circuits, and to the code-12 country group selectors which have particular levels allocated to the larger foreign countries for the booking of calls. Direct access is also provided via a code-12 group selector to the International exchange to permit calls from the continent of Europe to be routed automatically, on a 4-wire basis, to the International exchange by the keying of code 12, followed by the digit 8. In addition, code-12 individual-position final selectors cater for access to particular positions of the Continental manual board. The code-12 individual-position service is used for the extension of calls which have been booked in a distant country, the position number being given to the booking operator in the distant country at the time of booking the call. A novel feature of the code-12 selectors is that no manual-board relay-sets are provided, the normal sleeve-control termination being included in the selector circuit, thus providing a considerable economy in equipment.

#### *Incoming Subscriber-Dialled Calls*

Provision has been made in the design of the incoming register to cater for the requirements of incoming calls from subscribers in distant countries. It has been agreed internationally that the digit "0" should be sent in place of the language digit on subscriber-dialled calls, as an indication to the incoming equipment that the call is from a subscriber and not from an operator. On a subscriber-dialled call no end-of-pulsing signal will be received, and the incoming register has to determine when sufficient digits have been received. For a call to a London subscriber this is readily determined by counting the digits received, since all calls will consist of eight digits. With calls to subscribers in the provinces the number of digits may vary between seven and nine and

it is not possible to determine the correct number of digits in every case except by an analysis of the first five digits of the national number. It is not considered practical to analyse up to five digits on all calls and use is made of time-pulse discrimination to determine when the complete number has been received. A 5-second time-pulse circuit is connected after the receipt of the seventh and eighth digits and if no further digit is received within this period it is assumed that a complete number of digits has been received.

#### CONCLUSIONS

Equipment to cater for semi-automatic operation on 300 outgoing and 300 incoming circuits using the international 2 v.f. system was installed at the London Faraday International Exchange during 1958. Part of the equipment was brought into service in November 1958, with circuits to Amsterdam and Rotterdam, and has proved satisfactory in service. Several other routes were converted to semi-automatic operation in the early part of 1959, when the equipment became fully operational. Work is now proceeding on the installation of a quantity of incoming 1 v.f. equipment for use on the Paris route. When this equipment has been installed, semi-automatic operation will be possible to any European centre suitably equipped with international signalling and switching systems.

The future developments that are now being considered involve the extension of this installation to cater for international subscriber dialling, automatic transit-switching for European circuits, and the integration of the continental and international telephone services with 4-wire switching.

#### ACKNOWLEDGEMENTS

The author gratefully acknowledges the help and advice given by colleagues in the Telephone Exchange Systems Development Branch, E.-in-C.'s Office, and in particular that of Mr. C. J. Maurer, during the preparation of this article.

#### References

- <sup>1</sup> MILES, J. V. C.C.I.F. Field Trials of International Semi-Automatic Telephone Operation. *P.O.E.E.J.*, Vol. 45, pp. 120 and 160, Oct. 1952 and Jan. 1953.
- <sup>2</sup> PETCHE, E. A. International Trunk Mechanization. *Post Office Telecommunications Journal*, Vol. 8, p. 29, Autumn 1955.
- <sup>3</sup> STOTESBURY, K. E., and BYRNE, S. H. L. The London International Maintenance Centre. (In this issue of the *P.O.E.E.J.*)
- <sup>4</sup> *P.O.E.E.J.*, Vol. 51, pp. 268-309, Jan. 1959.
- <sup>5</sup> WATERS, H. S. and SHEPPARD, S. H. Incoming Register-Translator for Director Areas. *P.O.E.E.J.*, Vol. 51, p. 303, Jan. 1959.

# The London International Maintenance Centre

K. E. STOTESBURY, B.Sc.(Eng.), A.M.I.E.E., and S. H. L. BYRNE†

U.D.C. 621.395.5.004.5(421)

With the introduction of the semi-automatic operation of continental telephone services it was necessary to define and agree, internationally, the organization required for testing and clearing faults on international circuits. The organization in each telephone administration established to perform these duties is known as the International Maintenance Centre. This article describes the organization of the London International Maintenance Centre and the testing equipment provided to maintain continental circuits.

## INTRODUCTION

THE introduction of the semi-automatic operation of international circuits<sup>1</sup> has necessitated a complete revision of the organization for the maintenance of international circuits. Voice-frequency signalling equipment is considerably more complex than the manual signalling equipment which it supersedes, and, from a maintenance point of view, requires special fault-localizing procedures involving the use of test equipment designed to indicate quickly and precisely the type of fault which may exist.

The work of the International Maintenance Centre (I.M.C.) can be divided roughly into two parts; one is concerned with the prevention of faults and requires the carrying out of periodical tests of international circuits to ensure that they conform to certain accepted standards of maintenance, and the other is the localization of faults as they arise. By combining the functions of carrier-group control and circuit control, the I.M.C. is able to keep the out-of-service time to a minimum.

The voice-frequency signalling and associated equipment has been designed to provide a large measure of automatic indication of faults, which are immediately brought to the attention of the maintenance personnel. It is a function of the I.M.C. to ensure that these faults are dealt with expeditiously.

The following describes the organization which has been set up at the London international centre and the test equipment which has been provided to maintain continental circuits. This section is known as the London I.M.C./C. Later, another section will be provided dealing specifically with Commonwealth and transatlantic telephone cable circuits and will be known as the London I.M.C./A.

## RESPONSIBILITIES OF AN INTERNATIONAL MAINTENANCE CENTRE

The duties of an International Maintenance Centre are clearly defined. The XVIIth Plenary Assembly of the International Telephone Consultative Committee (C.C.I.F.\*), 1954<sup>2</sup>, agreed that each Administration would be responsible for the testing and clearance of faults on its outgoing semi-automatic circuits, i.e. circuits with manual access at the outgoing end and with dialling facilities into the distant automatic equipment. The body within each Administration which would carry out

† The authors are, respectively, Area Engineer and Executive Engineer, Long Distance Area, London Telecommunications Region.

\* The International Telegraph Consultative Committee (C.C.I.T.) and the International Telephone Consultative Committee (C.C.I.F.) were combined in 1955 to form the International Telegraph and Telephone Consultative Committee (C.C.I.T.T.).

these duties should be the I.M.C., whose responsibilities are as follows:

(a) To receive all reports of faults on its outgoing international circuits and conduct tests with a view to the broad localization of faults, limiting this to ascertaining the division of technical responsibility for their clearance.

(b) To entrust the clearance of faults to the appropriate technical division as determined by the broad localization.

(c) To ensure that the out-of-service times on its outgoing international circuits (due to faults or other causes) are kept to a minimum compatible with the needs of the service.

(d) To return a circuit to the operating services after having verified its correct functioning.

(e) To keep detailed records of the faults, localizations and clearances with which it has been concerned.

(f) To co-operate with the I.M.C.s of other countries in respect to the broad localization of faults on its incoming international circuits, and accept responsibility for the clearance of faults found to exist in or beyond the centre concerned.

(g) To advise the I.M.C. of an outgoing circuit of the need to put any of its incoming international circuits out of use.

(h) To ensure that routine tests on its outgoing international circuits are carried out at specified times, and that any faults revealed by such tests are dealt with expeditiously.

(i) To ensure that new outgoing international circuits are satisfactory in operation before being brought into service, and co-operate with the I.M.C.s of other countries in any tests which may be necessary on new incoming circuits.

The control, for transmission purposes, of the line is not included in these responsibilities and it was agreed that the repeater station attached to each I.M.C. should be the control station for the semi-automatic circuits outgoing from that centre. At London, however, the transmission control of the line is exercised from the same test-desk position as that used by the testing officer carrying out the duties of the I.M.C. These test-desk positions are, therefore, provided with facilities for testing the operation of semi-automatic circuits and also for testing the transmission quality of the international line.

## GENERAL LAYOUT OF THE LONDON INTERNATIONAL MAINTENANCE CENTRE

In the test-room at the London I.M.C. (Fig. 1), two separate suites of normal test positions are provided, one to accommodate the controlled circuits, and the other to accommodate the non-controlled circuits. This allows the testing equipment and replacement equipment peculiar to either outgoing circuits or incoming circuits to be segregated. This division also allows advantage to be taken of the lower degree of responsibility of the I.M.C. for incoming circuits, thus permitting increased loading, with circuits, of the non-controlled-circuit positions compared with the controlled-circuit positions. For the



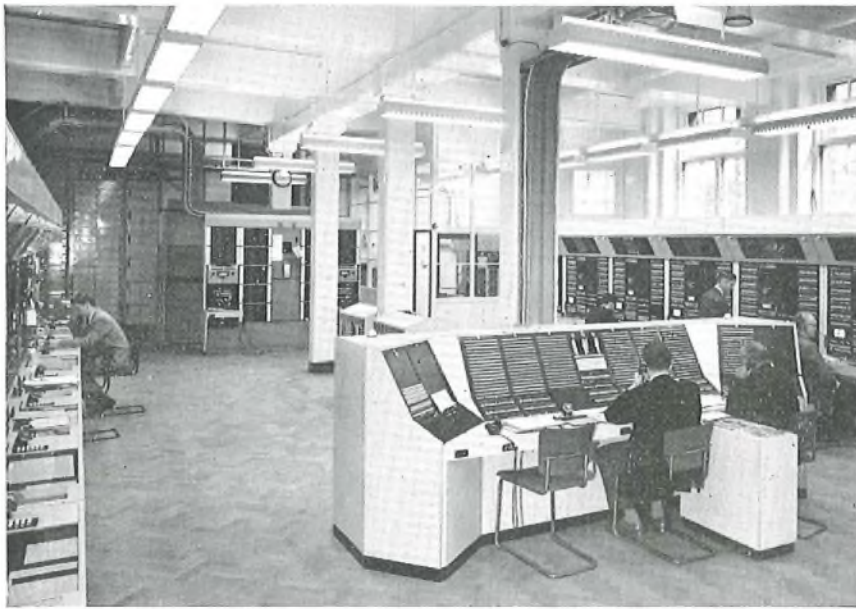

FIG. 1—GENERAL LAYOUT OF THE LONDON I.M.C.

lining-up and initial testing of new and rearranged circuits, "circuit-provision" test positions have been installed so that the appropriate testing facilities may be provided economically and, also, to ensure that a normal test position will not be occupied with such work for a long period, leading to delay in the localization of faults. For similar reasons, a "transmission-overhaul" position and a "special-testing" position are provided.

In addition to their I.M.C. and transmission-control duties, the test-room staff have other responsibilities affecting the layout and equipment of the centre, some of which are as follows:

(a) The number of manual-signalling circuits over which access to distant-centre operators is obtained will exceed, for some years, the number of semi-automatic circuits, and a small number of the former will always exist and require to be tested. The International Telegraph and Telephone Consultative Committee (C.C.I.T.T.) recognizes only both-way manual-manual circuits and since, by agreement, London is the controlling end for such circuits, these circuits will be dealt with on the controlled-circuit suite. The circuit break jacks and busying arrangements have been wired identically to those used for semi-automatic circuits so that modification, as routes are converted to semi-automatic working, is avoided. Testing equipment for these circuits and replacement sleeve-control relay-sets are, therefore, necessary on the controlled-circuit positions.

(b) Picture calls are connected by the test-room staff on a 4-wire basis to avoid terminal reflection, and all terminal equipment that has relay contacts in the transmission path is bypassed, thus avoiding any risk of small changes of transmission loss. The number of these calls (over 10,000 were completed in 1958) justifies the provision of a special position equipped to give the required facilities.

(c) Music-type (high-grade) program circuits are provided to continental centres. These are tested and connected by engineering staff over specially provided 2-wire local circuit ends to the B.B.C., the Independent Television Programme Contractors or other London

renters, or via inland and overseas high-grade circuits to more-distant renters. About 7,000 such connexions were made in 1958. The testing equipment and patching field for the music-type circuits have been separated from the remainder of the test-room by a glazed partition, allowing connexions to be monitored aurally without interference with other duties, and preventing patching connexions being disturbed accidentally during general test-room operations.

(d) Until h.f. equipment can be installed in the continental repeater station, the terminal carrier equipment for many continental 12-circuit carrier groups is situated in the various London (Faraday) repeater stations and the London (Kingsway) repeater station, depending on the location of the carrier-cable termination. To limit the foreign-language-speaking engineering staff required, and to prevent the difficulties which would arise if distant terminals had dealings with many London terminal

stations, the carrier-group control of these groups is vested in the test-room. All circuits and spare channels are taken through U-links on 4-wire U-link panels, with the circuits arranged in carrier-group order. Although h.f. measurements are made by the staff at the group-terminal repeater station, all contact with the distant end, and the overseas intermediate stations, is made by test-room staff. The test-room staff also carry out most maintenance measurements, on the extended channel ends, at audio frequencies.

Thus, to meet the requirements and responsibilities of the London I.M.C. the following equipment has been provided initially:

Controlled-circuit test positions	8
Non-controlled-circuit test positions	4
Circuit-provision test positions	2
Special-test position	1
Picture-call position	1
Program-circuit positions	3
Circuit-overhaul position	1
4-wire carrier-group control racks	4
Fault-report and control positions	3

This installation, together with the other section of the I.M.C. dealing with the Commonwealth and trans-atlantic circuits that will be installed next year, caters for the anticipated circuit growth up to 1979. Space has been left for the additional testing equipment that may be necessary in the next 20 years. During this time continental and international subscriber dialling are probable developments.

#### THE TEST POSITIONS

##### *General Layout*

Because standard test-rack positions did not provide the facilities required for this installation, the test positions for the I.M.C. were constructed locally to meet the requirements. For the test positions giving access to the controlled and non-controlled circuits it was necessary to use four vertical-face panels for each position, and for the other positions, with their

special requirements, this basic type was suitably modified. Each test-position writing shelf has a glass-panel inset, under which notices giving general information and instructions can be placed. Behind this glass-panel inset, and at the base of the vertical-face panels, hang the testing cords and patching cords, while on the right-hand side of the writing shelf is fitted the numerical signal keysender used for setting up test calls through the equipment. A standard dial is also provided for making service calls through the national network. The test positions are covered in plastic sheeting, which gives an easily cleaned, durable surface.

The four vertical-face panels contain the testing equipment, with its controlling keys, and the circuit-access break jacks together with their associated circuit busy keys, busy lamps, alarm lamps and alarm change-

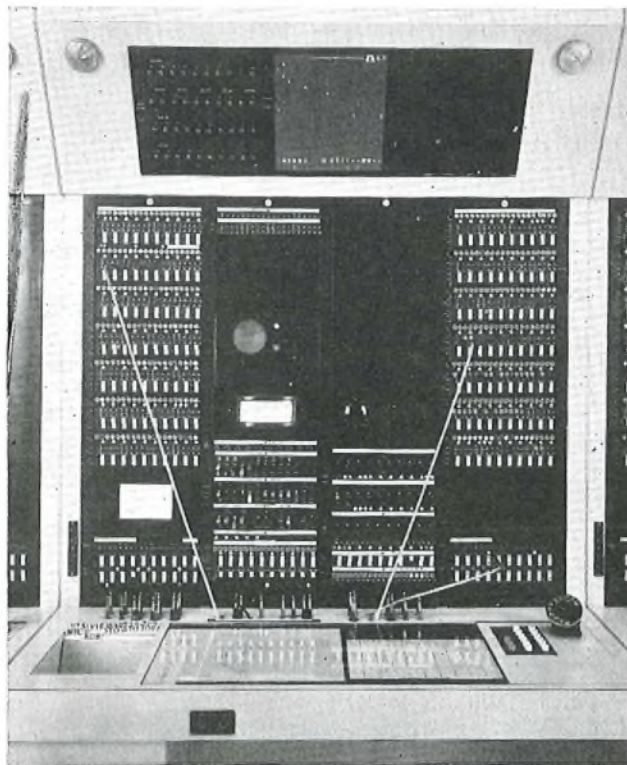

FIG. 2—A CONTROLLED-CIRCUIT TEST POSITION

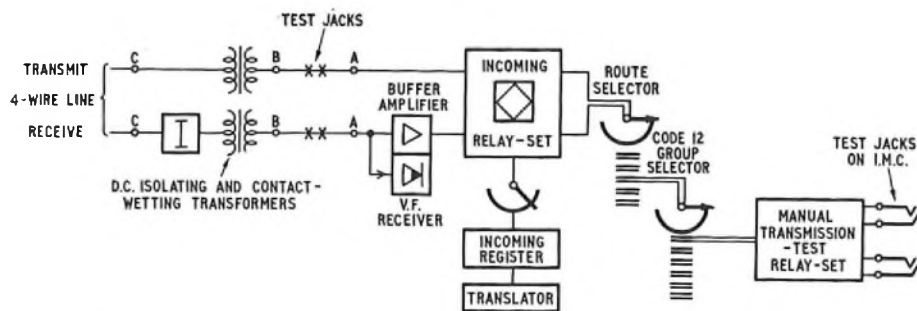

FIG. 4—ARRANGEMENT OF THE TESTING ACCESS-POINTS ON INCOMING SEMI-AUTOMATIC CIRCUITS

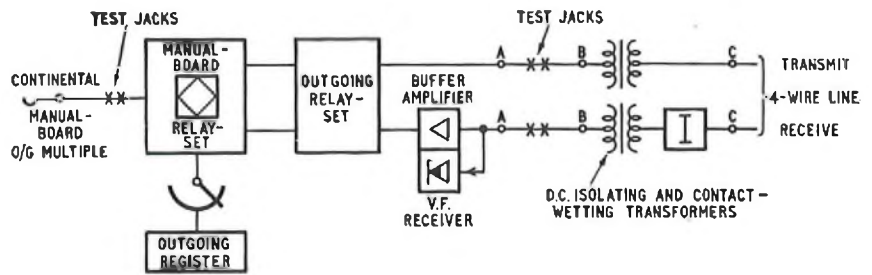

FIG. 3—ARRANGEMENT OF THE TESTING ACCESS-POINTS ON OUTGOING SEMI-AUTOMATIC CIRCUITS

over keys. At the top of the vertical panels there is a forward-sloping section where the call-progress indicator, described below, and the carrier-group busy keys are fitted. This section is hinged to allow access for maintenance purposes. A detailed view of one of the controlled-circuit test positions is shown in Fig. 2.

All the cabling associated with the test positions is run inside the top of the positions, and all cable racking in the I.M.C. will be enclosed to avoid accumulation of dust.

The fault-control positions are situated in the centre of the I.M.C. (Fig. 1) and consist of a specially designed console, with seating for three fault-control officers.

#### Testing Facilities

Access for testing purposes is provided on the 2-wire side of the manual-board relay-set and on the 4-wire line of each outgoing semi-automatic circuit, and, also, on the 4-wire line of each incoming semi-automatic circuit, by connecting the circuit through break jacks on the appropriate test positions. These arrangements for access to the circuits are shown in Fig. 3 and 4, respectively. This access, together with the testing facilities provided, permits the rapid localization of faults on to the line, to the automatic-apparatus room or to the manual switchroom. With reference to Fig. 3 and 4 it should be noted that circuit-switching jacks may be inserted at points A, access jacks for the connexion of picture calls may be inserted at points B in nominated circuits, and change-over links may be inserted at points C in multi-channel voice-frequency telegraph reserve circuits.

To reduce the risk of break-jack contact failure, and at the same time give an additional facility, the break jacks on the exchange side of the 4-wire-line break jacks have been wired so that they may be used as a monitoring point.

#### Circuit-Alarm Arrangements

When the alarm change-over key associated with the break jacks of any circuit is in its normal position the alarm lamp flashes if a release-guard signal is not received from the distant end of the international circuit within 3-6 minutes after the outgoing equipment has been released. During this period the clear-forward signal is sent every minute, so that the alarm condition indicates a failure of from three to six attempts to clear down.



When testing a circuit for fault-localization purposes, or when all circuits to a distant centre are under special observation because, for example, of a rise in the failure rate on that route, the alarm change-over keys associated with the appropriate alarm lamps may be operated. With an alarm change-over key operated the alarm lamp is caused to flash if

(a) a proceed-to-send or busy-flash signal is not received within 15–30 seconds of the sending of a seizing signal, or

(b) an acknowledgement signal is not received within 5–10 seconds of the transmission of a numerical signal, or

(c) a release-guard signal is not received within 5–10 seconds of the transmission of a clear-forward signal.

Should any of these conditions arise the circuit is held busied, awaiting maintenance attention.

In general terms, these alternative alarm arrangements have the effect that, in the first case, with the alarm change-over key in its normal position, only a definite failure likely to result in the circuit being unworkable will operate the circuit alarm, while in the second case, with the alarm change-over key operated, any slight trouble that is likely from time to time to result in a call being set up incorrectly will operate the circuit alarm. However, in the second case it may be considerably more difficult to locate the cause of the alarm.

#### *Busying a Circuit from the Incoming End*

Facilities are provided at the incoming end of an international circuit for the circuit to be automatically busied at the outgoing end should maintenance attention be required for a short period only. This busying is effected by the operation of a key on the test position, or seizure of the incoming equipment by a tester or routiner, which causes a "blocking" signal to be returned to the outgoing-end equipment to busy the circuit. At the outgoing end the circuit-alarm lamp will glow if the circuit is busied in this manner for a period exceeding 6–12 minutes.

#### *Call-Progress Indicator*

Facilities are provided for the testing officer to be able to follow the progress of a call using equipment known as the Call-Progress Indicator (C.P.I.); with this equipment the signals exchanged over an international circuit are indicated on a display panel as the call progresses. When the C.P.I. is used for monitoring a circuit using the international 2 v.f. signalling system, the signals are detected by two signal receivers, one of which is connected to the transmit pair and the other to the receive pair of the circuit. Provided the v.f. signals on the circuit are at a suitable level and not seriously distorted they are decoded and indicated on the lamp-display panel. The receipt of a line signal in either direction causes the display lamp for any previous signal in that direction to be extinguished, and the new signal is decoded and displayed. The circuit arrangements allow for signals in both directions to be decoded simultaneously, if required. Numerical signals and their acknowledgement signals are also decoded and displayed, but the whole of the numerical display is retained until the equipment is automatically reset on the receipt of a release-guard signal.

A similar arrangement is provided for monitoring calls on circuits using the international 1 v.f. signalling system. The selection of the appropriate section of the C.P.I. equipment to deal with signals from either a

1 v.f. or a 2 v.f. international signalling system is made by the operation of a key, but the same display panel is used in both cases.

The display panel is arranged to display up to 16 pulsing signals comprised of two destination-code digits, which may be repeated twice to cater for a routing via two transit centres, the language digit, 10 digits of the called subscriber's national number, and the end-of-pulsing signal. In addition, the display panel can indicate the receipt of any of the standard line signals for both the 1 v.f. and the 2 v.f. international signalling systems.<sup>1</sup>

The C.P.I. does not carry out precise measurements of the duration of the signals; when these measurements are required they are obtained by the use of a calibrated signal generator and measuring apparatus which is fitted on one of the test positions, and which has been described elsewhere.<sup>3</sup>

#### *Picture-Call Position*

Briefly, the present system of setting up calls for the transmission of pictures by facsimile telegraphy over the continental telephone network is a modification of the normal demand procedure for completing a telephone call. Thus, when the called subscriber has agreed to accept a facsimile call, both ends of the telephone circuit being used are intercepted at 4-wire points, and these 4-wire points are extended to the renters' premises at both ends over specially provided 4-wire circuits. By this method all terminal equipment containing relay and key contacts which are normally in the transmission path is removed from the circuit. The renters then have the use of the circuit until the originator of the call notifies the operator that the call has been completed. The 4-wire interception is then cleared down and the circuit is restored for normal telephone use.

This procedure provides a satisfactory means of meeting the conditions required by these calls, which, to be successful, demand negligible reflection of signals (this condition is best met by providing a 4-wire circuit from subscriber to subscriber) and negligible change of transmission loss of the circuit throughout the time a picture is being transmitted. The most convenient point to establish such a 4-wire connexion is in the test-room, where a 4-wire point is available and where the staff are fully aware of the technical requirements of such calls and the means of minimizing disturbances to the calls. Since the number of such calls is high, and is rising, a specially equipped position has been provided. This position has, terminated on jacks on the vertical-face panels, the 4-wire local circuits direct to the London newspapers and news agencies who use this service, and 4-wire-line break jacks in the continental telephone circuits nominated as suitable and normally used for setting up these calls. Short stranded-conductor patching cords are used to interconnect these circuits as required. Speaker circuits from, and to, the London operators and continental picture-call controls are provided to ensure speedy and co-ordinated setting up and taking down of these connexions. Also, arrangements have been made so that up to three officers may function simultaneously on the one position during peak periods, which are liable to occur when an event of international importance occurs in any country.

The picture-call position is equipped with 4-wire speaker cord-circuits to allow speaking to both ends of the circuit to ensure the connexion is established and both parties are ready to proceed. Also, high-impedance



peak-program meters are provided to check the transmission level of the picture signal. A normal 4-wire-line test-cord is fitted to allow immediate checks to be made on the circuit should trouble be reported.

Occasionally additional circuits to those nominated for picture traffic are required for a picture connexion. A circuit is chosen that is likely to give good performance, and it is patched through, via break jacks on the picture-call position, from its normal line-side 4-wire break jacks on either a controlled-circuit position or non-controlled-circuit position, and back to its normal exchange-side 4-wire break jack. Although patched through the picture-call position, the circuit is available for normal traffic use until such time as the picture call is ready, when the circuit is intercepted and the 4-wire end-to-end connexion is completed.

#### CONCLUSIONS

The task of designing and installing the London I.M.C. was made difficult by the short time available and the peculiarities of the accommodation. The main difficulties created by the accommodation were due to the existence of centrally placed pillars and strengthening ceiling beams, and the low floor-loading permitted. Team work was essential, and co-operation between members of the Engineering Department, External

Telecommunications Executive, London Telecommunications Region, Long Distance Area and London Power Section, and the Ministry of Works (to name the organizations most concerned) was close throughout the project. The burden of the installation work fell on the London Power Section and the Long Distance Area, for the short time available made it quite impossible to produce detailed specifications to enable the work to be done under contract, and the appearance of the room is a credit to their standard of workmanship.

#### ACKNOWLEDGEMENTS

The authors' thanks are due to all who helped in the writing of this article, especially those members of the Telephone Exchange Systems Development Branch, Engineering Department, who, having been associated with the design of the testing equipment, have been most helpful with suggestions and criticisms.

#### References

- <sup>1</sup> TURNBULL, M. G. Introduction of Semi-Automatic Operation of Continental Telephone Services. (In this issue of the *P.O.E.E.J.*)
- <sup>2</sup> C.C.I.F. XVIIITH PLENARY ASSEMBLY. Signalling and Switching. *Green Book*, Vol. V, Part 3, Geneva, Oct. 1954.
- <sup>3</sup> MAURER, C. J., and NOTMAN, R. A. A Calibrated Signal Generator and Measuring Apparatus for International Signalling Systems. *P.O.E.E.J.*, Vol. 51, p. 180, Oct. 1958.

## Book Reviews

"Extrusion of Plastics." E. G. Fisher, Ph.C., F.P.I. Published for the Plastics Institute by Jliffe & Sons. 114 pp. 37 diagrams and 4 pages of art plates. 21s.

This volume is the first of a series of monographs on plastics which is to be published under the auspices of the Plastics Institute, and which will deal with the more important processes and plastic materials.

The dust cover states that "They have been planned primarily to cover the syllabus in the technology, chemistry, engineering, and physics of plastics leading to the Diploma, Graduateship and Associateship of the Plastics Institute; but they will also be found invaluable by anyone who wishes to obtain specialized information on a particular subject connected with plastics."

The extrusion of plastics is dealt with under the following chapter headings:

Introduction; Basic Principles of Extrusion; Theoretical Considerations of the Modern Single Screw Extrusion Machine; Multiscrew Extrusion Machines; Constructional Features of Extrusion Machines; Materials for Extrusion and General Applications; The Extrusion of Thermosets.

On an average about 7-10 references, mostly to literature in the 1945-55 period, are given after each chapter.

Looking for specific information on points that might interest engineers concerned with extrusion the following are adequately covered for a book of 114 pages:—ram extrusion, wet extrusion, pump extrusion and screw extrusion, dry extrusion, single and multi-screw machines, single and multi-start screws, zoning of screws, types of screws for different purposes and materials, heat and power requirements, cooling, barrel design, die adaptor design, die design, wire covering and take-off systems. There does not appear to be any reference to continuous vulcanizing machines but it may be argued that these are more appropriate to a book on rubber extrusion.

The book is well written and logically arranged and would appear to serve its declared purpose very well. A. A. N.

An Introduction to the Theory and Practice of Semiconductors. A. A. Shepherd, M.Sc., Ph.D., A.Inst.P. Constable & Co., Ltd. 206 pp. 99 ill. 18s. 6d.

Semiconductors and transistors continue to attract increasing attention from scientists, technologists and engineers. The subjects are so full of new ideas, facts, processes and analyses that it is difficult to say which parts are the most fascinating; but they have become so extensive that books about them have to be selective, if not highly selective, in the choice of fields covered. Dr. Shepherd opens his small book with brief accounts of the physicist's model of solids and of the measurement of the electrical properties of semiconductors and their interpretation; he then turns to the technology of germanium and silicon, semiconductor diodes, transistors and photocells, largely in descriptive terms, though that part of the chapter which deals with the physical processes of rectification might well have come a little earlier. A final chapter deals with the compounds of elements of Group III of the periodic table with elements of Group V, which are semiconductors and have some properties comparable with or superior to those of germanium and silicon. No attempt is made at elaboration and, but for some loose use of the pronoun "this," the writing is easily followed. In condensing many hundreds of papers into so few pages the author can rarely be accused of oversimplification; there is little more serious than the derivation of the capacitance of a space charge double layer (more often called a depletion layer) from the equation for a parallel-plate capacitor rather than directly from  $dQ/dV$ . But the author's skill must not lead the reader to believe that following up the references given will always be as easy a task as reading the book.

The diagrams are simple, but generally sufficient, even if a little inelegant here and there. In all, the book should fulfil its purpose of introducing advanced students and young graduates to the subject, "without tears."

J. R. T.

# The IXth Plenary Assembly of the C.C.I.R., Los Angeles, April 1959

U.D.C. 061.3:621.396

## INTRODUCTION

THE IXth Plenary Assembly of the C.C.I.R. (Comité Consultatif International des Radiocommunications) was held, at the invitation of the United States Government, in Los Angeles during the period 2–29 April 1959. Plenary Assemblies of this body, an organ of the International Telecommunication Union, (itself a specialized agency of the United Nations) are held at intervals of about three years, previous post-war conferences being held in Stockholm (1948),<sup>1</sup> Geneva (1951),<sup>2</sup> London (1953)<sup>3</sup> and Warsaw (1956).

The organization of the Assembly was no mean task, for some 40 countries, together with about 30 private operating agencies, international organizations and scientific or industrial bodies, were represented by upwards of 300 delegates. Secretarial, translation, interpretation and office staffs accounted for another 115 persons, so that the total strength of the conference exceeded 400. The United Kingdom delegation of 27, under the leadership of the Assistant Engineer-in-Chief, Radio, included Col. A. H. Read, Telecommunications Attaché from the British Embassy in Washington, nine delegates from the Post Office, the Department of Scientific and Industrial Research and the British Joint Communications and Electronics Board, together with ten representatives of the B.B.C., I.T.A. and other British operating agencies, four advisers from the Radio Industry Council, a Conference Officer and a Secretary.

The scope of the conference was wide, covering the whole technical field of radio communication from the simplest transmission of Morse telegraphy to the complex systems required for the transmission of multi-channel telephony and television. The work was split up among 14 Study Groups, each dealing with a particular field of study. To give in detail the results of the Conference would be impossible in a short review, for more than 700 papers were studied, some 200 of them being adopted by the Plenary Assembly, most of them unanimously, for inclusion in the official volume of documents of the C.C.I.R. Space permits only the mention of a few of the more important matters dealt with by the various Study Groups.

## WORK OF CONFERENCE

### *Study Group I—Transmitters*

This Study Group, which is concerned with all aspects of radio transmitters has, amongst other things, recommended closer frequency tolerances and tighter limits for spurious emissions for new transmitters in the various classes of radio services throughout the spectrum. It has also agreed on standard signalling conditions for frequency-shift and duplex radio-telegraph transmissions.

### *Study Group II—Receivers*

The work of Study Group II consists mainly of collecting information on the performance of receivers for various classes of service. This work, which is primarily concerned with future planning, was continued and revised tables giving the latest information on sensitivity, selectivity and stability were approved. The influence of atmospheric noise on receiver performance is also being studied.

### *Study Group III—Fixed Service Systems*

Of the many matters dealt with by Study Group III, which is concerned with the telegraph, telephone and facsimile systems used by fixed radio services (operating generally below 30 Mc/s), were the prediction of the performance of radio-telegraph systems, in terms of the band-width and the signal-to-noise ratio of the system, and the preferred characteristics of 7-unit ARQ (error detection and correction) radio-telegraph systems.

### *Study Groups IV, V and VI—Propagation*

These three Study Groups deal respectively with ground-wave, tropospheric and ionospheric radio propagation. Among many other matters, of particular interest are (a) the revision of the long-distance tropospheric propagation curves essential for the planning of sound broadcasting and television services in the v.h.f. and u.h.f. bands, (b) the study of propagation by scattering from the lower ionosphere using frequencies in the lower part of the v.h.f. band over distances of some 1,000–2,000 km, (c) the revision of atmospheric-noise data, (d) the study of sporadic-E reflections on a global basis with a view to improving frequency predictions and enabling the degree of interference caused by such reflections to be calculated, and (e) the study of the technical factors affecting the selection of frequencies for communication to and between artificial earth satellites and other space vehicles.

### *Study Group VII—Standard Frequencies*

Standard frequency and time signals are transmitted in the h.f. band from a number of stations. The C.C.I.R. recommendations for the preferred characteristics for such transmissions were reviewed and brought up-to-date in the light of the increasing accuracy required by some specialized users. It may be noted that the British service from MSF (Rugby) is operated fully in accordance with the latest recommendations.

### *Study Group VIII—International Monitoring*

This Study Group has reported on the preferred equipments and methods for the measurement at monitoring stations of frequency, field strength, band-width, etc. of various types of radio emissions, and of the necessary and attainable accuracies of measurement. It has also reported on the automatic monitoring of spectrum occupancy and on the facilities to be provided by mobile monitoring stations.

The Study Group is also concerned with the identification of radio emissions and has recommended methods of inserting identifying signals in various types of radio emissions without interrupting traffic.

### *Study Group IX—Radio-Relay Systems*

Study Group IX has revised or prepared recommendations relating to radio-relay systems for television and telephony. Perhaps the most important are those concerning radio-frequency channel arrangements. The arrangements formerly applying to six go and six return r.f. channels, each for 600 telephone channels, in the 2,000 and 4,000 Mc/s frequency bands have been extended to cover broadband channels for 1,800 telephone

channels, or systems with one television and 600 telephone channels on each radio carrier.

For the 6,000 Mc/s band a new radio-frequency arrangement for eight go and eight return channels has been adopted as the preferred standard for world-wide use. This new standard can be applied to systems with 600, 960 or 1,800 telephone channels in each radio-frequency channel and provides for interconnexion with similar systems operating in the 2,000 and 4,000 Mc/s bands.

Among other recommendations adopted are those dealing with the pre-emphasis characteristics to be used on radio-relay systems for multi-channel telephony and television; noise limits for such systems; and preferred frequencies and levels for pilot signals on such systems.

#### *Study Group X—Broadcasting*

Study Group X is concerned with all forms of sound broadcasting (except tropical broadcasting) and recording. It has made recommendations on the necessary protection ratios in v.h.f. frequency-modulation sound broadcasting. Previous standards of recording for program-exchange purposes have been brought up to date. New studies have been made of stereophonic sound broadcasting and compatible single-sideband broadcasting.

#### *Study Group XI—Television*

The most important work of this Study Group concerns the question of television standards for Bands IV and V, and progress has been made towards the goal of common standards for monochrome and colour television in these bands in Europe.

All European countries (including the United Kingdom) have stated that they are prepared to adopt a channel spacing of 8 Mc/s in Bands IV and V to achieve a uniform channelling arrangement and, in consequence, a more efficient use of the spectrum. Of the countries now using other than 625-line standards in Bands I and III, Belgium will use 625-lines in Bands IV and V, the United Kingdom has said the standard to be used with an 8 Mc/s channel width is still under consideration and France, while considering 625-line standards with an 8 Mc/s channel width for colour television, at present wishes to make some use of Bands IV and V for a second 819-line monochrome service (but using a 16 Mc/s channel).

In addition, many countries now using 625-line standards with a 7 Mc/s channel width in Bands I and III have stated they would be prepared to use an 8 Mc/s channel width in Bands IV and V if this would enable a common standard to be achieved. Some countries have said they would be ready to adopt a value of

4.43 Mc/s for the colour sub-carrier frequency of a standard colour television system.

#### *Study Group XII—Tropical Broadcasting*

This Study Group has reported on improved methods for calculating the sky-wave field-strength of tropical broadcasting transmitters and on the necessary protection ratios and fading allowances in the planning of tropical broadcasting services. It has agreed that further studies are needed before final recommendations are made.

#### *Study Group XIII—Mobile Services*

This Study Group is concerned with land, maritime and aeronautical mobile radio communications. One of its more important recommendations lays down technical standards for the introduction of single-sideband systems for maritime and aeronautical radio services. Other recommendations concern the international distress signal "MAYDAY" and the accuracy of bearings of radio direction finders, both vitally important matters when ships or aircraft are in distress. A study has also been made of "selective calling" systems and agreement was reached on the lines of further investigation.

#### *Study Group XIV—Vocabulary*

This Study Group is concerned with terms, definitions, symbols, etc. One aspect of its work of general interest is a recommendation that the term Hertz (Hz) is acceptable as an alternative to cycles per second (c/s).

#### CONCLUSION

Recommendations made by the C.C.I.R. are not in themselves mandatory but form a guide for good design of radio equipment of all kinds. Consequently they are put into practice to a large extent. In addition, where necessary, they are used as the basis for the recommendations of an Administrative Radio Conference to which the majority of countries bind themselves. The imminence of such an Administrative Radio Conference, to be held later this year in Geneva, makes the results of the Los Angeles conference of particular importance.

As a result of an invitation issued by the Government of India and unanimously accepted by the Conference, the next C.C.I.R. Plenary Assembly will be held in New Delhi in 1962.

C. F. B.

#### *References*

- <sup>1</sup> Fifth Plenary Meeting of the C.C.I.R., Stockholm, July 1948. *P.O.E.E.J.*, Vol. 41, p. 155, Oct. 1948.
- <sup>2</sup> The VIth Plenary Meeting of the C.C.I.R., Geneva, June 1951. *P.O.E.E.J.*, Vol. 44, p. 132, Oct. 1951.
- <sup>3</sup> VIIth Plenary Assembly of the C.C.I.R., London, 1953. *P.O.E.E.J.*, Vol. 46, p. 202, Jan. 1954.



# Telegraph Distortion in the Trunk Network of the Telegraph Automatic Switching System

L. K. WHEELER, B.Sc.(Eng.), A.M.I.E.E., and A. C. FROST, A.M.I.E.E.†

U.D.C. 621.317.34:621.3.018.782.4:621.394.74

The Telegraph Distortion Analyser described in a previous article has been used to collect data on the service performance of the v.f. channels in the automatic telegraph switching system and a statistical analysis has been made to obtain an estimate of the quality of connexions involving various numbers of channels.

## INTRODUCTION

THE provision of v.f. channels in the telegraph automatic switching system was founded on the general principle that it should be possible to connect any two switching centres through the medium of not more than three channels in tandem. This was based on distortion measurements made on channels operating under known adverse conditions. The system gives a very satisfactory telegraph service but quantitative data to provide an overall estimate of the quality of performance in terms of telegraph distortion under normal working conditions has hitherto not been available. An investigation has now been made of the distribution of telegraph distortion in a considerable sample of circuits comprising various numbers of channels in tandem and statistical techniques have been employed to predict the numbers of connexions that may be expected to meet a given criterion of performance. The field of investigation was extended beyond the consideration of only three links in tandem to discover the grade of service which might be expected with more links. This is of importance when considering the

† The authors are, respectively, Assistant Staff Engineer and Senior Executive Engineer, Post Office Research Station.

economics of providing channels to meet the demands of international telex operation.

The results of the investigation show that in general a high-grade performance is obtained from the network as originally planned and that although a lower security of performance results from permitting an increase in the number of links in tandem, the risk is calculable. It is also shown that, if steps could be taken to reduce the incidence of bias distortion, a considerable improvement in overall performance would ensue.

## SCOPE OF TESTS

The total number of telegraph circuits examined was 728, each being composed of a number of tandem-connected channels ranging from two to six. The circuits were set up by dialling to provide a route through various switching centres to the centre at which the measurements were made. Two series of tests were conducted, one, termed "London tests," with the connexions originating and terminating at a London switching centre and the other, termed "Birmingham tests," with connexions from London to Birmingham. In general, the v.f. telegraph apparatus in service is Type 3, but one London centre has Type 4 apparatus, which is of a superior performance. In the first series of tests all connexions included one link of Type 4 apparatus, whereas in the second series a very small proportion of the connexions included this apparatus. The effect of this is clearly shown in the measurements. Table 1 shows the number of tests of each size of circuit and the proportion of the tests that

TABLE 1  
Percentage Use of Intermediate Switching Centres

Intermediate Switching Centre	Number of links in tandem, <i>N</i> Number of observations, <i>n</i>									
	London Tests					Birmingham Tests				
	<i>N</i> = 2 <i>n</i> = 20	<i>N</i> = 3 <i>n</i> = 100	<i>N</i> = 4 <i>n</i> = 40	<i>N</i> = 5 <i>n</i> = 100	<i>N</i> = 6 <i>n</i> = 60	<i>N</i> = 2 <i>n</i> = 11	<i>N</i> = 3 <i>n</i> = 49	<i>N</i> = 4 <i>n</i> = 100	<i>N</i> = 5 <i>n</i> = 200	<i>N</i> = 6 <i>n</i> = 98
Aberdeen (JAB)							2.0	1.3	1.3	1.8
Belfast (JBE)							2.0	0.7	1.5	1.2
Birmingham (JBM)	20.0	19.0	16.7	17.5	14.3				0.2	
Bournemouth (JBH)							3.1	2.0	1.8	2.2
Brighton (JBR)									0.7	0.2
Bristol (JBS)					11.0	9.1	16.3	12.0	11.1	13.0
Cardiff (JCF)						9.1	4.1	4.7	4.3	4.3
Edinburgh (JEH)					6.0	9.1	4.1	4.7	4.5	4.5
Exeter (JEX)	10.0		8.3	3.0	5.0		1.0	0.3	1.1	1.2
Glasgow (JGW)	10.0	19.0	15.8	16.5	10.7		14.3	11.7	9.8	11.7
Grimsby (JGY)							2.0	1.7	2.0	1.4
Hull (JHU)						9.1	1.0	1.7	0.8	0.4
Leeds (JLS)	20.0	20.0	15.0	16.0	13.0	9.1	22.5	17.6	16.7	16.2
Liverpool (JLV)	10.0	16.0	12.5	12.5	9.3	9.1	8.2	8.0	6.4	8.2
London (Centre) (JTS)								5.7	7.5	6.5
London (North) (JXN)			10.8	11.0	9.7					
London (West) (JXW)								9.6	11.3	11.2
Manchester (JMR)	20.0	15.0	11.7	13.5	9.0	9.1	7.2	7.0	6.5	6.3
Newcastle (JNT)	10.0	11.0	9.2	10.0	7.3	9.1	6.2	6.0	5.2	4.9
Nottingham (JNG)						9.1	2.0	2.3	2.3	1.4
Sheffield (JSH)						9.1	2.0	1.7	2.3	1.4
Southampton (JSO)					4.7	9.0	2.0	1.3	2.7	2.0

involved the various intermediate switching centres. An attempt was made to plan the routes for the tests according to random choice, but this was possible only in part, as some switching centres have a very limited number of routes available. Because the channels to be tested were selected automatically, they functioned as they would in ordinary service, without any possibility of being specially adjusted.

#### MEASUREMENTS

The measuring apparatus employed was the Telegraph Distortion Analyser.\* The modulation rate of the test signal was 50 bauds, the character length was 7.5 units and the distortion of the test transmitter was less than 0.25 per cent. The text of the test-message was: THE QUICK BROWN FOX JUMPS OVER THE LAZY DOG 12345 67890 LINE X C/R L/F L/S (X = 1, 2, 3, 4, 5, 6 or 7).

The measurement made on each circuit was the distribution of individual start-stop distortion of 1,000 space-to-mark transitions. This restriction to one kind of transition must be borne in mind when reading the subsequent discussion, particularly where "distortion" or "distribution of distortion" is used without specific qualification. Space-to-mark transitions were chosen because, being of opposite polarity to that of the commencement of the start element, they are directly affected by bias, which is found to make a dominant contribution to the limiting of circuit performance. The size of sample, 1,000 transitions, has been found to be adequate for this particular type of study; comparison of the statistics derived from measurements of 1,000 and 10,000 transitions indicated that very little precision was gained for the additional cost in testing time.

The results of the distortion measurement on a typical circuit are shown as a distribution curve in Fig. 1. This curve can be used as a source of information

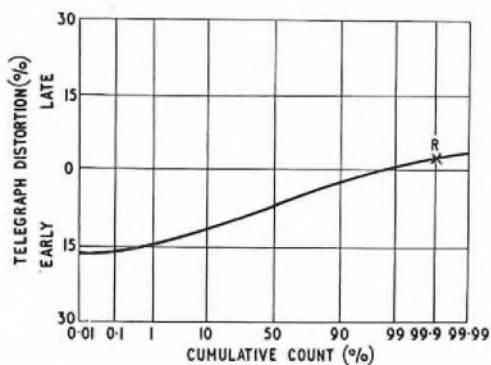

FIG. 1—DISTORTION MEASURED ON A TYPICAL CIRCUIT

about the performance of the particular circuit; for example, the point R shows that on the average one transition in 1,000 has more than 3 per cent late distortion, or + 3 per cent distortion has a probability of  $P = 0.001$ .

#### ANALYSIS OF DATA

It was found that the individual-circuit distortion curves were of a similar shape and that they could be individually represented by two parameters— $m$ , the

\* WHEELER, L. K., and FROST, A. C. A Telegraph Distortion Analyser. *P.O.E.E.J.*, Vol. 47, p. 5, Apr. 1954.

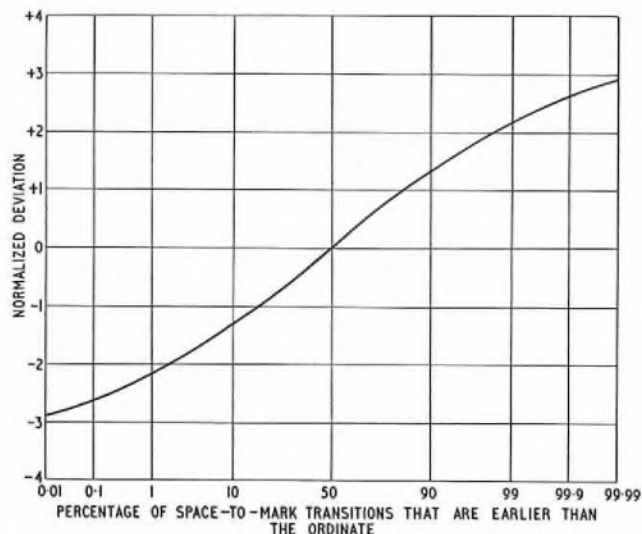

FIG. 2—THE FUNDAMENTAL DISTRIBUTION CURVE

mean distortion (i.e. the mid-point value of the curve) and  $s$ , the standard deviation of distortion (which determines the slope)—applied to a fundamental curve ( $s$  is a scaling factor and  $m$  determines the vertical displacement). The fundamental curve (Fig. 2) the values for which are shown in Table 2, was derived empirically from the analysis of observations on 60 circuits.

TABLE 2  
The Fundamental Distribution Curve (see Fig. 2)

$x_0$	$F$	$x_0$	$F$
- 3.10	0.001	0.0	50.0
- 2.90	0.01	0.5	68.4
- 2.62	0.1	1.0	83.7
- 2.5	0.2	1.27	90.0
- 2.12	1.0	1.5	93.9
- 2.0	1.6	2.0	98.4
- 1.5	6.1	2.12	99.0
- 1.27	10.0	2.5	99.8
- 1.0	16.3	2.62	99.9
- 0.5	31.6	2.90	99.99
0.0	50.0	3.10	99.999

$x_0$  = normalized deviation of  $x$   
 $F$  = percentage of space-to-mark transitions that are earlier than  $x$

$$x_0 = \frac{x - m}{s}, \text{ where}$$

$x$  = given value of distortion  
 $m$  = mean value of distortion  
 $s$  = standard deviation of distortion

For circuits comprising a given number of links, it was also found that the distributions of these parameters ( $m$  and  $s$ ) could be closely represented by the normal error-curve and that there was negligible correlation between them. Hence it is possible to characterize fairly accurately the performance of a whole group of circuits in terms of the statistics of these distributions:

$\bar{m}$  the mean of the mean values ( $m$ ) of distortion,  
 $\sigma_1$  the standard deviation of  $m$ ,  
 $\bar{s}$  the mean of the standard deviations ( $s$ ) of distortion,  
 $\sigma_2$  the standard deviation of  $s$ .

Using these statistics and the fundamental curve, it is possible to calculate for each size group of circuits the proportion of circuits expected to meet a given criterion, e.g. producing an inherent start-stop distortion of less

than 30 per cent ( $P = 0.0001$ ),\* but, due to the limited size of the sample of circuits, comparison of these proportions for the various size groups revealed an apparently anomalous progression. To bring some consistency to the final predictions of the quality of the telegraph network, an attempt is made in the following to relate the values of the statistics to the number of links in the circuits on the foundation of the generally accepted theories of the addition of distortion in tandem-connected links, i.e. that bias is algebraically additive, characteristic distortion is directly additive and fortuitous distortion is quadratically additive, but these are strictly applicable to only small values of distortion.

DERIVATION OF RELATIONSHIP BETWEEN DISTORTION STATISTICS AND NUMBER OF LINKS

The distortion measured is the inherent distortion (of space-to-mark transitions) and therefore contains contributions of bias, characteristic and fortuitous distortion. For simplicity it will be assumed generally that there is no interdependence of these contributions.

The mean distortion on a group of circuits each consisting of a given number of links will be largely decided by the average value of bias distortion for single links, but it is possible for the mean value of characteristic distortion to be other than zero and this will also affect the observed mean distortion. The standard deviation of the mean distortions will be controlled by that of bias distortion. The mean of the standard deviations of distortion will naturally depend upon the fortuitous distortion, but it will also contain a component due to the dispersion of characteristic distortion. The standard deviation of the standard deviations of distortion will depend upon the distribution of the mean noise power in the circuits and probably on the interaction of the various types of distortion, but it is not readily predicted.

Let

- $a$  = mean bias distortion of single links
- $b$  = standard deviation of bias distortion of single links
- $c$  = fortuitous component of the standard deviation of the distortion of single links
- $d$  = characteristic component of the standard deviation of the distortion of single links
- $e$  = characteristic component of the mean distortion of single links
- $N$  = number of links in tandem

Then

$$\bar{m} = (a + e) N \dots\dots\dots(1)$$

$$\sigma_1 = b\sqrt{N} \dots\dots\dots(2)$$

$$\bar{s}^2 = c^2N + d^2N^2 \dots\dots\dots(3)$$

These expressions have been used to fit curves to the values derived from the observations, as shown in Fig. 3, 4, 5 and 6. When applied to the London tests equation (3) has been modified to the form

$$\bar{s}^2 = c^2N + [d(N - 1) + d_1]^2$$

to take into account the difference in the characteristic distortion produced by the final link from that in the other links.

Whilst, in general, the fitted curves pass within the 95 per cent confidence limits of the statistics derived from the observations, there are several instances where

\* "Inherent" distortion is the total distortion produced by the circuit when the input to the circuit is an undistorted signal;  $P = 0.0001$  signifies that the probability of the distortion exceeding the quoted value is 1 in 10,000.

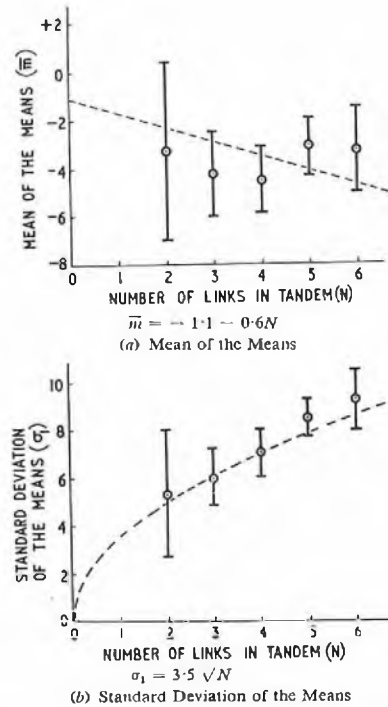

Note: A circle indicates an observed value, its 95 per cent confidence limits being indicated by the extremities of the bars

FIG. 3—BIRMINGHAM TESTS (MEANS)

they do not. This is because they have been selected to give a representation of the results of both series of tests, and the tests terminating in London comprise the smaller number of observations.

Considering the mean of the means ( $\bar{m}$ ), (Fig. 3 (a))

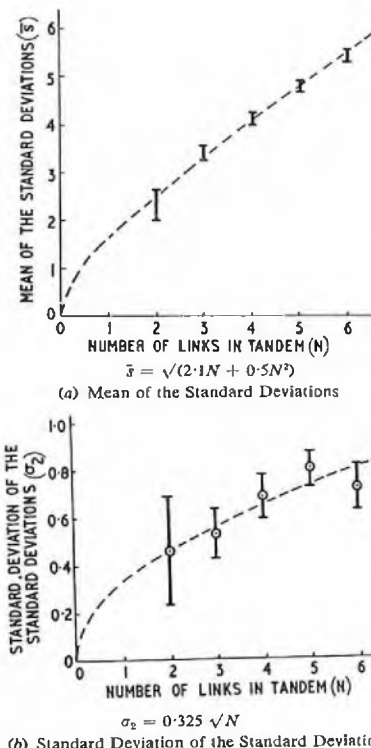

Note: A circle indicates an observed value, its 95 per cent confidence limits being indicated by the extremities of the bars

FIG. 4—BIRMINGHAM TESTS (STANDARD DEVIATIONS)



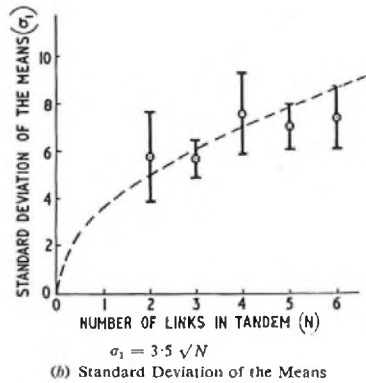
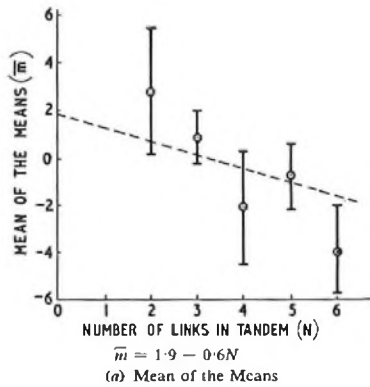

Note: A circle indicates an observed value, its 95 per cent confidence limits being indicated by the extremities of the bars

FIG. 5—LONDON TESTS (MEANS)

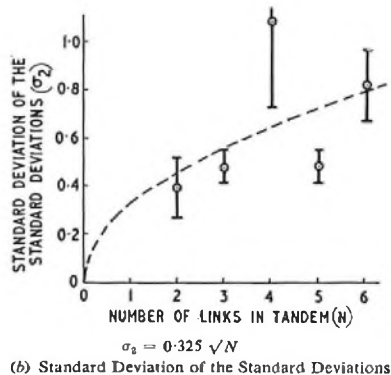
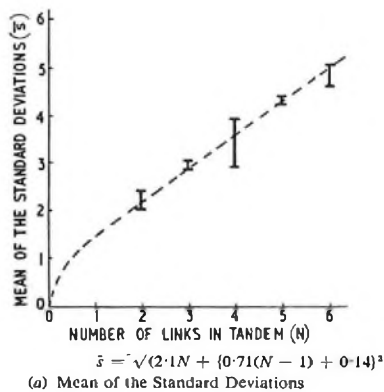

Note: A circle indicates an observed value, its 95 per cent confidence limits being indicated by the extremities of the bars

FIG. 6—LONDON TESTS (STANDARD DEVIATIONS)

and 5 (a) a value of  $(a + e) = -0.6$  gives a representation of the general trend, but a possible fit can be obtained only by the introduction of a constant term, different for the two tests. A possible explanation for this is that, since the measurements were made at two stations, there was some circumstance individual to the station at the time of the test which influenced the bias on the channels terminated there.

The standard deviation of the means ( $\sigma_1$ ), Fig. 3 (b) and 5 (b), in both tests is fitted to a similar degree by a value of  $b = 3.5$ . This high value indicates the considerable variation of bias over the whole system and its serious effect upon the inherent distortion.

The relatively good representation which is achieved for the mean of the standard deviations ( $\bar{s}$ ), Fig. 4 (a) and 6 (a), may be regarded as justifying the notions of characteristic distortion being directly additive and fortuitous distortion being quadratically additive.

No attempt was made to substantiate from theory an expression relating the standard deviation of the standard deviations ( $\sigma_2$ ) to the number of links, but  $\sigma_2 = 0.325\sqrt{N}$  provides a possible fit, although agreement with the London test results is not very satisfactory. The relatively low value of the constant indicates a fair degree of uniformity of circuits comprising a given number of links from the aspect of fortuitous and characteristic distortion and may be largely due to the variations in noise level.

#### ESTIMATION OF QUALITY OF TRANSMISSION

By the use of the derived statistics and the fundamental distribution curve, an estimate has been made of the proportion of circuits which will have a better performance than that signified by a degree of inherent distortion of 30 per cent ( $P = 0.0001$ ), assuming them to be composed entirely of Type 3 or Type 4 channel links. This is shown in Fig. 7. It should not be assumed,

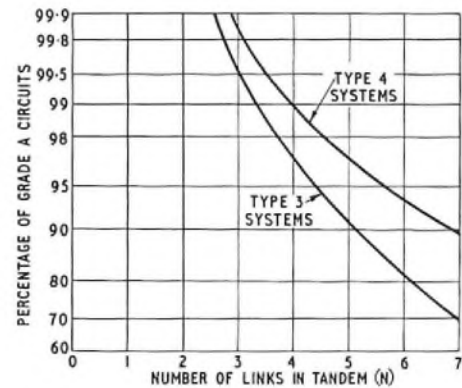

Grade A Circuits—those of performance better than that signified by a degree of inherent distortion of 30 per cent ( $P = 0.0001$ )

FIG. 7—COMPARISON OF TYPE 3 AND TYPE 4 V.F. TELEGRAPH SYSTEMS

however, that all circuits failing to achieve this criterion are unserviceable. For this estimation it is assumed that the additional constant term in  $\bar{m}$  is  $-2$ , i.e. that the influence of a particular terminal station will not be more adverse than this. The forecast is therefore slightly pessimistic as the majority of stations are probably better.

This stage might have been achieved more directly from the original observations and a comparison is

TABLE 3  
Comparison of Number (A) of Circuits having a Distortion of 30 per cent ( $P = 0.0001$ )

Number of links	Number of tests	A(i)	A(ii)
London (Centre) to London (Centre)	2	20	20
	3	100	100
	4	40	39
London (Centre) to Birmingham	5	100	96
	6	60	55
London (North) to Birmingham	2	11	11
	3	49	49
	4	100	98
	5	200	187
	6	98	84

Note: The number of circuits (A) was deduced from:  
(i) the measured distributions directly,  
(ii) the final curves produced by statistical inference.

shown in Table 3, but from the mathematical models derived it is possible to study the influence upon the overall performance of the network of variation in the parameters. This is illustrated in Fig. 8. One particular result shown is that if, in general, the bias distortion could be halved, one more link could be added for the same grade of performance.

#### CONCLUSION

Although the effort involved in conducting these tests and collating the results was considerable, it must be admitted that, in the statistical sense, the sample considered is very limited and that the conclusions must be applied with due caution. Nevertheless, it is felt that, as an example of an attempt to measure the performance of a fairly large switching network, this work should prove a good basis for further investigations. The

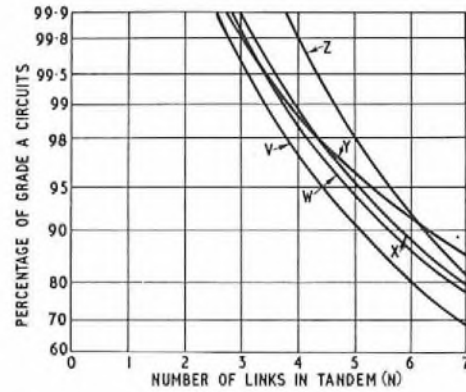

Curve V—Circuits as found during the transmission tests  
Curve W—Hypothetical circuits in which the average value of bias distortion per link has been reduced from 0.6 per cent marking to zero  
Curve X—Hypothetical circuits in which the mean value of the fortuitous distortion component of the standard deviation of distortion has been reduced to half its present value  
Curve Y—Hypothetical circuits in which the mean value of the characteristic distortion component of the standard deviation of distortion has been reduced to half its present value  
Curve Z—Hypothetical circuits in which the standard deviation of bias distortion has been reduced to half its present value.  
Grade A Circuits—Those of performance better than that signified by a degree of inherent distortion of 30 per cent ( $P = 0.0001$ )

FIG. 8—EFFECT OF REDUCING THE VARIOUS FORMS OF DISTORTION (TYPE 3 V.F. TELEGRAPH SYSTEMS)

procedure, to a large degree, circumvents the difficulties arising if one attempts to predict overall quality from consideration of the behaviour of single links alone.

#### ACKNOWLEDGEMENTS

The authors are grateful for the assistance of Mr. R. A. Hastie, who suggested the possibility of deriving the empirical fundamental distribution curve to facilitate the summary of these tests.

## Book Review

"Pulse and Time-Base Generators." D. A. Levell, M.Sc., A.M.I.E.E. Sir Isaac Pitman & Sons, Ltd. x + 175 pp. 145 ill. 25s.

Its scope is reasonably defined by the title of this book, which, although evidently written from the aspect of the radar specialist, is directed both to the student and the electronics engineer. Slightly less than half the volume is devoted to a consideration of both passive and active basic circuit elements and the remainder deals with more complex specialist circuits and their application to triggers, pulse modulators and time bases. Short sections are included outlining the principles of the electronic valve, in which, strangely enough, triodes and more complex valves, are introduced before diodes which follow later in a chapter on non-linear circuits. These sections no doubt made for completeness in the university dissertation upon which the book was based. They are rather sketchy and are probably redundant as far as the average engineer is concerned; he will have assimilated the information during his basic training, and will have reference books already available to make good any lapses of memory. Transistors are dealt with in a separate, final, chapter. The fact that the exploitation of transistors is comparatively recent and is still being intensively continued is presumably the cause of this arrangement, but there seems little to commend it. Transistors are evidently here to stay and they and their applications should surely have been included at the appropriate points in the main body of this new book.

The section on passive networks includes useful design

data on the response of simple circuits to step and ramp-functions. In contrast the descriptions of the large number of practical circuits that have been evolved over the years are almost entirely qualitative. The engineer wishing to employ, say, a suppressor-grid-controlled sanaphant (p. 140) or even a Schmitt trigger (p. 68) for a given job is left unguided in his choice of component values. To give a detailed analysis of all the circuits catalogued would doubtless be an immense task but an introduction to an elegant design technique for a few typical cases would have been welcomed by many. The section on distributed delay lines makes no mention of magnetic-core delay lines which have now been available for several years.

The author employs the terms "selector," and occasionally "clipper," to describe circuits that would commonly be called "limiters." An Eccles-Jordan trigger is defined (p. 69) as one which is switched alternately from one state to the other by the repeated application of identical pulses. It is interesting to note, however, that the original article referred to mentions the application of pulses to the grid of one valve only, so that only the first of a series of unipolar pulses will cause triggering. The symmetrical arrangement in which pulses are applied simultaneously to both valves was evidently a later development.

The diagrams are clear but do not follow British Standard recommendations. A decimal numbering scheme is employed in the text and for diagrams and bibliography, but not in the index; the inclusion of section numbers at the head of each page would have been helpful. Even by current standards the book seems a little expensive in proportion to its size and quality of production.

I.P.O.E.E. Library No. 2506

J. W. A.

# Waveform Distortion in Television Links

## Part 1—Introduction to Waveform Distortion

I. F. MACDIARMID, A.M.I.E.E.†

U.D.C. 621.3.018.782:621.397.2

The linear transmission performance of television links is now measured and specified in terms of their responses to certain standardized test waveforms. The aim of this article is to provide a simple non-mathematical introduction to the basic ideas connected with the measurement of waveform distortion. In Part 1 of the article, the reasons for the use of waveforms and the choice of test signals are discussed. A number of examples of simple waveform distortions are then given to illustrate the advantages of waveform measurements and their connexion with the more familiar steady-state responses. In Part 2 the application of tolerance limits to waveform responses will be considered and methods of correction of waveform distortion will be described.

### INTRODUCTION

THE concepts of sine-wave transmission and the methods of sine-wave circuit analysis are so firmly fixed in the minds of some engineers that they find the greatest difficulty in thinking in any other terms. In speech or music transmission the exact reproduction of the original waveform is not important (subject to certain rather wide restrictions) provided that the magnitudes of its spectral components are reproduced accurately. The sine-wave concepts then yield enormous advantages in respect of simplicity of thinking and analysis. In television transmission, however, the exact reproduction of waveform is essential for distortionless transmission and, in what may be termed "sine-wave thinking," this means that the phases of the spectral components of the waveform must be considered in addition to their magnitudes. This requirement, together with another difficulty concerning tolerances which will be mentioned later, adds so much complication to the methods of sine-wave thinking that, for many purposes concerned with television transmission, it is worthwhile to abandon the familiar sine-wave ideas and think directly in terms of some more relevant waveform.

The purpose of this article is to give in simple terms some methods of thinking of waveform distortions which have proved useful in studying and designing links for the transmission of television signals, and, as examples of these methods of thinking, to describe means of measuring and correcting waveform distortions in practical systems.

The following remarks apply to all that follows and are given now to avoid making the article difficult to follow by virtue of frequent restrictions and provisos.

(a) The distortions referred to are all linear distortions, i.e. the distortion is independent of the magnitude of the applied signal.

(b) Examples and comments with respect to television systems all apply directly to the British 405-line 3 Mc/s system but with appropriate modifications would also apply to systems working to other standards.

(c) It is the author's aim to present an introduction to, and way of thinking of, the problems of waveform distortion in as simple and non-mathematical a manner as possible; consequently a number of statements will be made which are only approximately true or are subject to certain restrictions. These restrictions will be pointed

out only if they are likely to be important in practice. Various text-books and specialized papers are available to those who wish to study the subject more fully.

### WAVEFORM DISTORTION

#### *The Basis of Sine-Wave Thinking*

The concept of the Fourier series is one that is very firmly established in the minds of communications engineers and is one of the fundamental ideas of sine-wave thinking. It shows that any recurrent waveform can be represented by a series of sine- and cosine-waves harmonically related to the fundamental frequency of recurrence. The idea is extended to non-recurrent waveforms in the Fourier integral by making the fundamental frequency tend to zero. It follows from this that a network or transmission system which will pass sine-waves of all frequencies in the band of interest without change in relative amplitude and phase will also pass without distortion any other waveform whose spectrum is confined to the band of interest. The sine-wave is not unique in possessing this Fourier property. It is possible to represent an arbitrary waveform by a series of waveforms other than sine-waves but none of the alternatives find common practical use.

Another fundamental concept of sine-wave thinking is that the derivative and the integral of a sine-wave with respect to time have the same waveform as the original sine-wave and are merely altered in magnitude and displaced in time. This property is invaluable in circuit analysis as can be seen from a simple example; if one mesh of a circuit contains  $R$ ,  $L$  and  $C$  and an e.m.f.,  $e$ , the basic circuit equation is

$$L \frac{di}{dt} + Ri + \frac{1}{C} \int i dt = e$$

If the e.m.f. has the form  $e = E \sin \omega t$ , i.e. a sine-wave existing for all time, the equation, as is well known, becomes

$$[j\omega L + R + 1/j\omega C]i = E \sin \omega t$$

which immediately gives the solution for the current and the voltage across any of the components.

If, on the other hand, the e.m.f. has the form of a step function  $H(t)$ , i.e. the voltage amplitude is zero until  $t = 0$  when it jumps instantaneously to  $E$  volts and remains at this value indefinitely, then the differential equation must be solved as such and three different types of solution for the current can be obtained according to the value of  $L/CR^2$ . These are sketched in Fig. 1. Furthermore, the voltage across the inductor and the capacitor are now of a different waveform from the current and must be calculated separately if they are required.

This example illustrates the great simplification of circuit analysis which results from the property that the integral and derivative of a sine-wave have the same shape as the sine-wave. A much more complete but very readable discussion of the philosophy of circuit theory is given in a text-book by Guillemin.<sup>1</sup>

† Senior Executive Engineer, Post Office Research Station.



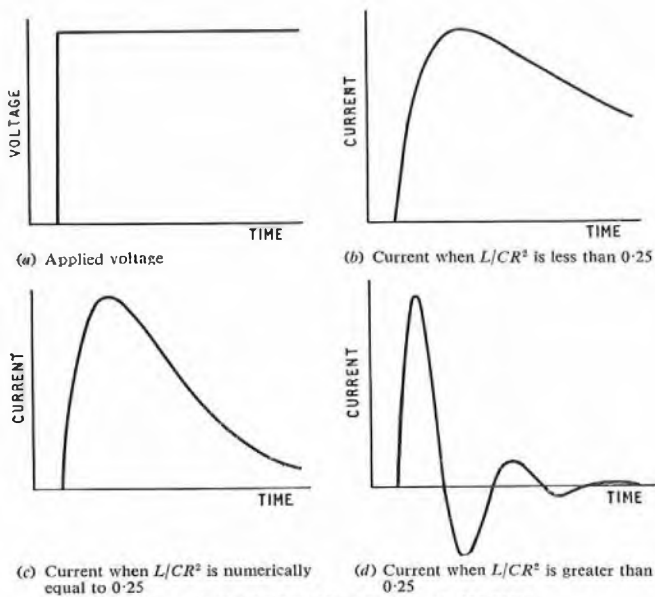

FIG. 1—STEP RESPONSE OF R, L, C CIRCUIT

### The Disadvantages of Sine-Wave Thinking

In considering some of the practical problems of specifying, designing, testing and maintaining television links and equipment some of the disadvantages of the sine-wave become evident. Firstly, the sine-wave is in no way typical of a television picture; rarely does any part of a picture waveform look like a single sine-wave. If any simple waveform can be regarded as typical of a television picture it is either the step function, corresponding to a sudden change from one shade of grey to another, or the narrow pulse (or impulse) corresponding to a small spot of light in a dark background, or vice versa. A picture waveform could be built up from either of these signals by taking a succession of them occurring at appropriate times with suitable signs and amplitudes.

Secondly, when specifying or measuring the performance of television equipment in sine-wave terms, the phase/frequency characteristic is as important as the gain/frequency characteristic but is very much more difficult to measure over the required frequency range.

Thirdly, having measured the gain/frequency and phase/frequency characteristics, no immediate idea can be obtained of the effect on a picture of any distortion in the characteristics. To obtain this it is necessary to go through the mathematical operations of calculating, from the measured characteristics, the waveform response to a step function or other suitable waveform. This is a lengthy process which is not usually undertaken lightly.

Finally, what is perhaps the most important objection to the use of sine-waves arises in considering the question of tolerances. In any practical transmission system some distortion must exist and the engineer's job is to keep this as small as is economically practicable. In a television system the distortion is finally judged subjectively by eye but the results of this assessment can, in principle at least, be translated directly into distortion limits on the picture waveform. It is therefore possible to specify tolerances in the response of a transmission system to a specified waveform or waveforms which will correspond to any desired amount of picture impairment. While it is possible, using Fourier transforms, to transform a particular waveform response into the corresponding

steady-state characteristics and vice versa there is no method known which will transform waveform tolerances into steady-state tolerances.

In practice the greatest difficulties arise when dealing with modest amounts of distortion. If the distortion is very large it will cause serious picture impairment and it does not matter much whether it is expressed in terms of waveform response or steady-state response. Similarly in the case of equipment which is virtually distortionless, such as a single video amplifier, it may not matter greatly in which form the distortion is expressed. However, in the most common practical case where the amount of distortion to be tolerated is modest, the only economical method is to specify and measure the waveform response and to abandon the sine-wave ideas.

### Choice of Test Waveform

Before one can start thinking in terms of waveform response it is necessary to have in mind a suitable test waveform or waveforms. Although in principle any waveform having a more or less continuous spectrum over the frequency band of interest can be used for measuring waveform distortion, in practice it is desirable that the waveform or waveforms used should meet as many as possible of the following conditions.

(a) It should be representative of commonly occurring parts of a television picture.

(b) The shape should be simple so that the presence or absence of distortion can readily be observed when the waveform is displayed on an oscilloscope.

(c) The shape should be simple mathematically (not necessarily the same thing as in (b)) so that it can conveniently be used in calculations.

(d) The spectrum should be confined to the frequency band of interest so that irrelevant information is not obtained from distortions occurring outside this band.

(e) It should provide the most sensitive indication of any distortion likely to be met in practice so that small amounts of distortion can be detected. In theory this condition cannot be met by any single waveform and it is possible to devise a special waveform which will give the most sensitive indication of any particular distortion.

(f) The waveform, or an adequate approximation to it, should be capable of being generated in an economical and reproducible manner so that test-signal generators can be made which will not differ significantly in performance.

The waveforms which come nearest to meeting the above requirements are the unit step function and the unit impulse. The unit step function has a voltage amplitude of zero until a time when it jumps instantaneously to unity and remains there indefinitely. In practice this waveform can be approximated by a long rectangular pulse or by a repetitive square-wave. These are equivalent to two steps, or a succession of steps, of opposite sign occurring one after the other. In practice, for distortions which occur at frequencies above the repetition frequency, the response to the repetitive waveform differs little from the response to the single step but is much more convenient to display on an oscilloscope.

The amplitude of the unit impulse is zero until a time when it jumps instantaneously to infinity and back to zero where it remains for all later time; the area under this infinitely high and infinitesimally narrow pulse is unity. The unit impulse is the derivative with respect

to time of the unit step. The unit impulse in its ideal form, and even in a practical approximation to it, is clearly of little use as a test signal because the large amplitude would tend to overload any amplifiers present and the considerable loss of amplitude which would result from any band-width restriction would lead to an impairment of signal/noise ratio. However, when the testing of television links and equipment is being considered there is no point in using a pulse which is narrower than the smallest picture detail that the television system is capable of transmitting without serious change in amplitude. In fact, to meet condition (d) above it is essential that the pulse should not be too narrow.

Consideration of the conditions given above has led to the choice of a sine-squared shape, i.e. the square of one half-cycle of a sine-wave, for the narrow-pulse test signal.<sup>2,3</sup> A choice of two alternative pulse-widths is desirable in practice, the narrower one having a half-amplitude duration  $T$ , where  $T$  is the reciprocal of twice the nominal upper frequency limit of the television system ( $T = 1/6 \mu\text{s}$  for the British 3 Mc/s system), and the wider one a half-amplitude duration  $2T$ . It is perhaps worth remarking that the sine-squared pulse of duration  $T$  is equivalent to one whole cycle of a 3 Mc/s cosine-wave, starting and finishing at its negative peaks, with an added d.c. component of such a value as to raise the negative peaks to the zero line.

A good and reproducible approximation to the sine-squared pulse can be obtained by passing an approximation to an ideal impulse through a special type of low-pass filter network.<sup>2</sup> The reproducibility of the output waveform then depends almost entirely on the tolerances of the inductors and capacitors in the network. These components can be measured accurately by normal means.

Conditions (a), (b), (d) and (f) above suggest that the shape of the transitions of the square-wave approximation to the step function should also be controlled. This can conveniently be done by means of the network used for shaping the sine-squared pulse and, because the step is the integral of the impulse, the square-wave transition will be of "integrated sine-squared" shape.

When the sine-squared pulse and the square-wave type of signal, both repetitive at about the television line-repetition frequency (10 kc/s), are combined and synchronizing pulses added for convenience in testing those links that require them, the "pulse-and-bar" test waveform is obtained.<sup>4</sup> This waveform, illustrated in Fig. 2, is used for the measurement of distortions in the frequency band from 10 kc/s to 3 Mc/s and it goes most of the way to meeting all the conditions outlined earlier. Fig. 2 (a) shows the complete waveform and Fig. 2 (b) shows the detail of both the pulse and one edge of the bar on an expanded time scale, this display

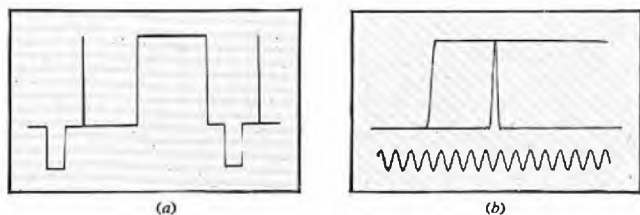

(a) Complete waveform ( $2T$ )  
(b)  $2T$  sine-squared pulse and bar edge on expanded time scale. The timing wave has a frequency of 1 Mc/s.

FIG. 2—PULSE-AND-BAR TEST WAVEFORM

being obtained by arranging the oscilloscope time-base to trigger twice in the  $100 \mu\text{s}$  repetition period.

The envelopes of the spectra of the  $T$  and  $2T$  sine-squared pulses and a bar having  $2T$  integrated sine-squared edges are plotted against frequency in Fig. 3.

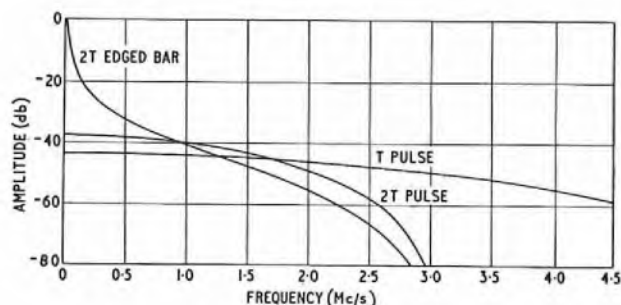

The ordinates are the peak-to-peak amplitudes of the spectral components in decibels relative to the peak-to-peak amplitude of the waveform.

FIG. 3—ENVELOPES OF SPECTRA OF  $T$  AND  $2T$  SINE-SQUARED PULSES AND  $50 \mu\text{s}$  BAR HAVING INTEGRATED SINE-SQUARED TRANSITIONS ( $2T$ )

The spectra are, of course, line spectra consisting of harmonics of the repetition frequency (10 kc/s) and the curves show the peak-to-peak amplitudes of the harmonics in decibels relative to the peak-to-peak waveform amplitude. For ease of calculation and drawing a  $50 \mu\text{s}$  bar has been used instead of the  $40 \mu\text{s}$  width used in the actual waveform. The curve represents, to within 0.5 db, the amplitudes of the largest harmonics in the actual waveform; some of the harmonics will have amplitudes smaller than indicated by the curve. The curves in Fig. 3 give some indication of the frequency ranges over which the test signals are most useful. Because of the large amplitude of its spectral components the bar will provide the most sensitive test for distortions in the frequency range 10 kc/s to about 0.5 Mc/s. Similarly, for distortions above about 2.2 Mc/s the  $T$  pulse will provide the most sensitive test, while in the intervening region from about 0.5 to 2.2 Mc/s the  $2T$  pulse is the most suitable test signal. This division is not hard and fast; the sensitivity of any one of the test signals depends not only on its spectrum, but also on the nature of the distortion and the method of interpreting the measurement.

#### EXAMPLES OF WAVEFORM DISTORTION

As an introduction to thinking in terms of waveform responses it is instructive to consider some simple examples of waveform distortion. The examples considered first will all relate to minimum-phase-shift networks.<sup>5</sup> In this class of network, which includes most commonly used networks other than phase equalizers, the phase/frequency characteristic is uniquely related to the amplitude/frequency characteristic over the whole frequency range from zero to infinity; in most cases it is only necessary to consider the amplitude/frequency characteristic.

#### Exponential Overshoots and Undershoots

A simple class of waveform distortion which can be produced by various combinations of resistance and capacitance, or resistance and inductance, is illustrated in Fig. 4 and 5. Fig. 4 shows the gain/frequency characteristics of the distortions, normalized to zero gain at low frequencies. The corresponding waveform distortions are shown in Fig. 5, which shows the response

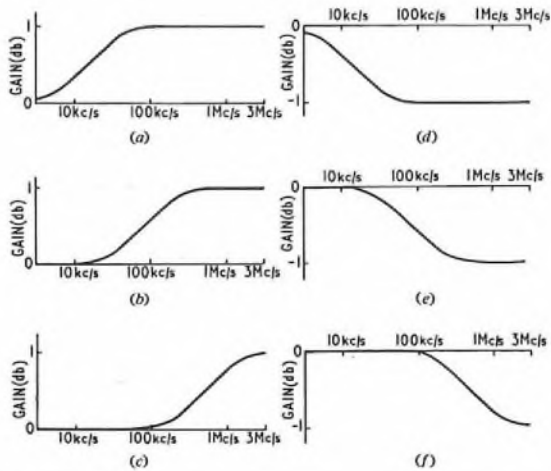

(a), (b) and (c) are overshoot distortions having time constants of 12, 2 and  $\frac{1}{2}$   $\mu$ s respectively  
 (d), (e) and (f) are undershoot distortions having time constants of 12, 2 and  $\frac{1}{2}$   $\mu$ s respectively

FIG. 4—GAIN/FREQUENCY RESPONSES OF EXPONENTIAL OVERSHOOT AND UNDERSHOOT DISTORTIONS

to the  $2T$  pulse-and-bar waveform. Where the high-frequency gain exceeds that at low frequencies the step response overshoots its final amplitude and returns to it on an exponential whose time-constant is related inversely to the frequency at which the distortion occurs. Similarly, where the high-frequency gain is less than the gain at low frequencies the step response undershoots its final value and rises more slowly on an exponential similarly related to the frequency of the distortion. The magnitude of the overshoot or undershoot is related to the magnitude of the gain change. For small values of distortion where the time-constant of the exponential is

long compared with the rise time of the step, the overshoot or undershoot expressed as a percentage of the final value of the step response is numerically equal to the percentage change in gain expressed as a voltage ratio. Fig. 4 and 5 show also that distortions at low frequencies produce a waveform distortion with a long time-constant while distortions at higher frequencies produce waveform distortions with shorter time-constants. In addition they show that the bar is much more sensitive to low-frequency distortion than the pulse, but with the highest frequency illustrated the effect on the  $2T$  pulse is more easily identified than that on the bar.

#### Resonant Networks

A greater variety of responses is possible with resonant networks than with the non-resonant ones considered above. However, only two have been selected for illustration. The gain/frequency characteristics are shown in Fig. 6 and the  $2T$  pulse-and-bar waveform responses in Fig. 7. The first network, Fig. 6 (a) and 7 (a), is very flatly tuned to 44 kc/s causing a dip of less than 2 db at this frequency. The effect on the bar response is very large. The network in Fig. 6 (b) and 7 (b) is sharply tuned to 710 kc/s causing the gain to dip by 6 db at this frequency. The effect on the waveform is to produce a lightly-damped oscillation following the pulse and bar edge. The frequency of the oscillation, or "ringing" as it is often called, is the same as the frequency at which the gain dip occurs, and the initial amplitude and the damping factor are determined mainly by the width of the dip and only to a minor extent by its magnitude provided this is large.

These distortions illustrate the difficulty of setting limits on the steady-state response when limits on the waveform response are really required. The response having the larger departure from a flat gain/frequency response gives a comparatively trivial waveform distortion

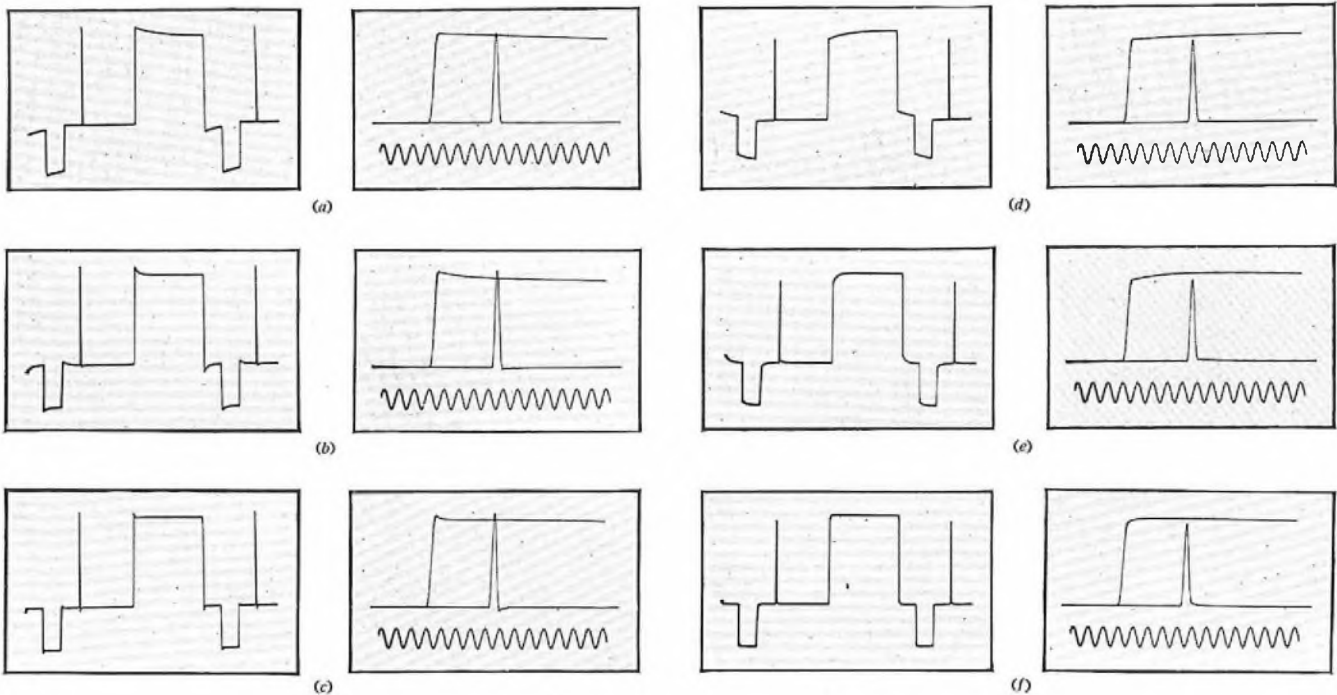

(a), (b) and (c) are overshoot distortions having time constants of 12, 2 and  $\frac{1}{2}$   $\mu$ s respectively  
 (d), (e) and (f) are undershoot distortions of time constant 12, 2 and  $\frac{1}{2}$   $\mu$ s respectively

FIG. 5—WAVEFORM RESPONSES OF EXPONENTIAL OVERSHOOT AND UNDERSHOOT DISTORTIONS



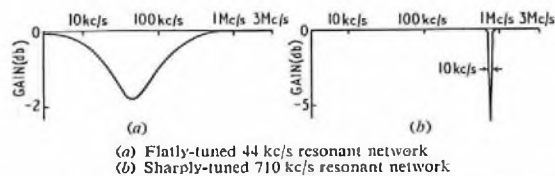

FIG. 6—GAIN/FREQUENCY RESPONSES OF RESONANT NETWORKS

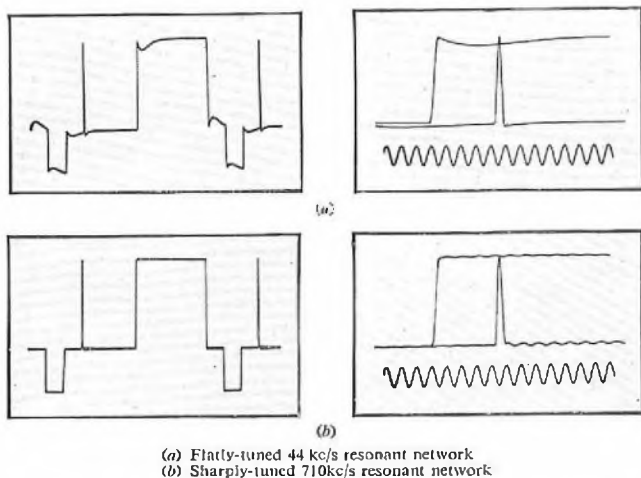

FIG. 7—WAVEFORM RESPONSES OF RESONANT NETWORKS

while that with the small departure from flatness gives a large waveform distortion. The latter (Fig. 6 (a)) is interesting because the gain-frequency and phase/frequency responses just meet an early (now superseded) specification for television links. The resulting serious waveform distortion produces streaking on a television picture of a magnitude which would be regarded as intolerable by most viewers.

### Echoes

Echoes are produced by a signal arriving at its destination over two different paths having different time delays. In the case of radiated signals the receiver may pick up a direct signal plus an indirect one reflected from some large building. When the signals are confined to cables, echoes can be produced by reflections from impedance mismatches.

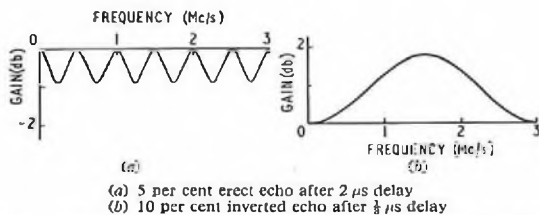

FIG. 8—GAIN/FREQUENCY RESPONSES OF ECHO DISTORTIONS

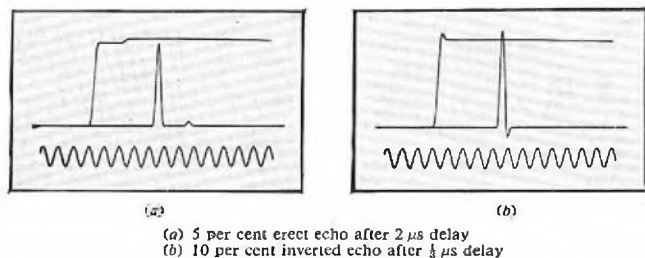

FIG. 9—WAVEFORM RESPONSES OF ECHO DISTORTIONS

Fig. 8 and 9 show the gain/frequency and waveform responses corresponding to two echoes with different time delays. The echo with the longer delay can be seen in Fig. 9 (a) to be a small replica of the pulse, but arriving  $2 \mu\text{s}$  later, while a replica of the bar edge also follows the bar edge  $2 \mu\text{s}$  later. In the cases illustrated the echoes are undistorted but in practice an echo signal, having travelled a greater distance, may itself have suffered waveform distortion.

The echo shown in Fig. 9 (b) is inverted and delayed by  $1/3 \mu\text{s}$ . With this short delay the echo is not separated from the  $2T$  pulse and looks rather similar to the exponential overshoot shown in Fig. 5 (c). The similarity is not so surprising when the gain/frequency responses are compared, when they will be seen to have the same general character within the range explored by the  $2T$  pulse.

A result which can be inferred from Fig. 8 and 9 is that a distortion spread over a large part of the frequency spectrum tends to produce a waveform distortion which is localized in time. The converse is also true as is illustrated in Fig. 6 (b) and 7 (b).

The sinusoidal ripple in Fig. 8 (a) is not unlike the result which may be obtained in equalizing a long cable link by conventional means. In fact quasi-echoes are often produced by equalization tolerances. It can be seen that if the effect of more enthusiastic equalization is merely to reduce the pitch of the ripple without changing its amplitude the effect on the waveform response is to produce an echo of the same size but with a greater delay, making it more difficult to deal with.

In addition to being a form of distortion met in practice, the echo is also of theoretical importance. By extending the concept of the echo to include echoes arriving before the main signal as well as after it, Wheeler<sup>6</sup> has shown that in a finite band-width any distortion of the gain/frequency and/or phase/frequency characteristics can be represented by a pattern of echoes. This can be done by making a Fourier analysis of, say, the gain/frequency characteristic to express it as a series of sinusoidal terms each of different pitch (Fig. 8 could represent two such terms) each of which terms is then identified with a pair of symmetrically placed echoes. A similar process is then used on the phase/frequency characteristic. It is not proposed to go further into Wheeler's method here, but the idea of expressing distortions in terms of echoes is important and will be referred to later.

### Band-width Restriction

Band-width restriction is not strictly speaking a waveform distortion but it is a fundamental feature of any practical television system. Band-width costs money and no more band-width can usually be allocated to a television circuit than is absolutely essential. It is therefore important to see what happens to the waveform response when the band-width is restricted.

Fig. 10 and 11 show the gain/frequency characteristics and waveform responses corresponding to two different methods of band-width restriction, the upper frequency limit being  $3 \text{ Mc/s}$ . A slow cut-off, produced in this example by a  $2T$  sine-squared shaping-network, is shown in Fig. 10 (a). The shapes of the  $T$  and  $2T$  pulses in Fig. 11 (a) are not greatly altered except that they are widened and their amplitudes are reduced.

It is appropriate to point out at this stage that in a

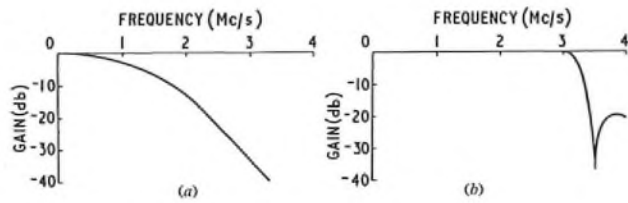

(a) Slow cut-off produced by a  $\frac{1}{2}$   $\mu$ s sine-squared pulse-shaping network  
 (b) Rapid cut-off produced by 3.2 Mc/s low-pass filter

FIG. 10—GAIN/FREQUENCY RESPONSES OF BAND-WIDTH-RESTRICTING NETWORKS

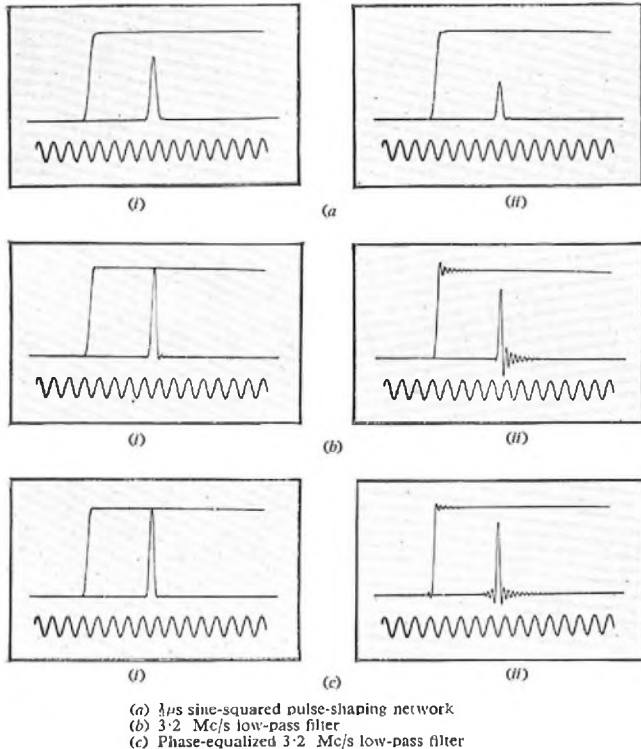

(a)  $\frac{1}{2}$   $\mu$ s sine-squared pulse-shaping network  
 (b) 3.2 Mc/s low-pass filter  
 (c) Phase-equalized 3.2 Mc/s low-pass filter

Note.—*a(i)*, *b(i)* and *c(i)* are the responses with a  $2T$  pulse applied.  
*a(ii)*, *b(ii)* and *c(ii)* are the responses with a  $T$  pulse applied.

FIG. 11—WAVEFORM RESPONSES OF BAND-WIDTH-RESTRICTING NETWORKS

low-pass system the area under a pulse is a constant, because the area represents the d.c. component of the pulse. This means that any distortion which widens a pulse, or adds positive "skirts" to it, must reduce its height relative to the bar, while any distortion causing overshoot adds negative area and thus causes the height of the pulse to increase.

The other type of band-width restriction, shown in Fig. 10 (b) and 11 (b), is the sharp cut-off, produced in this example by a filter which has virtually no attenuation distortion below 3 Mc/s but which cuts off sharply above this frequency. It will be seen that the filter has little effect on the  $2T$  response but reduces the height of the  $T$  pulse and causes a damped oscillation or ringing to follow both the pulse and the bar edge. The reduction in  $T$  pulse height is however not nearly as great as that produced by the slow cut-off. These two examples represent extremes of cut-off characteristic. Intermediate shapes of cut-off characteristic are possible and will have intermediate waveform responses; for example, an intermediate shape, still developing a large loss at frequencies above 3 Mc/s, will give  $2T$  and  $T$

pulse heights greater than in Fig. 11 (a) but less than in Fig. 11 (b) and the ringing which follows the  $T$  pulse will also be less than in Fig. 11 (b). The heights of the  $2T$  and  $T$  pulses are important in a television picture because they represent the brightness with which fine details are reproduced, and therefore the cut-off characteristic of Fig. 10 (b) seems to be the most desirable provided that the ringing is not a limiting factor.

The filter whose response is shown in Fig. 11 (b) has a negligible variation of gain up to 3 Mc/s but has a substantial phase distortion in the pass band. If this phase distortion is reduced by adding a suitable phase-equalizer the waveform response becomes as shown in Fig. 11 (c). It can be seen that the principal effect of phase equalization is to reduce the amplitude of the ring on the right-hand side of the  $T$  pulse response and to introduce a ring of almost equal size on the left-hand side. Less noticeable effects are the slight improvement of the  $2T$  response and a slight increase in the height of the  $T$  pulse. These latter effects are more important when the phase distortion is greater than that of the filter used for the illustrations.

The phase-equalized sharp-cut-off filter is therefore the type of network which gives the largest heights to the  $T$  and  $2T$  pulse responses consistent with negligible distortion of the  $2T$  pulse shape and minimum ringing on the  $T$  pulse. The filter used is a practical approximation to the physically unrealizable "ideal low-pass filter." This has zero attenuation distortion and zero phase distortion in its pass band and an infinitely steep cut-off and infinite attenuation in the stop band. The waveform response of the ideal filter can be calculated, e.g. the response of a 3 Mc/s filter to the  $T$  pulse has a pulse height of 82 per cent of the bar height, a half-amplitude duration of 0.223  $\mu$ s, a first overshoot of 13 per cent of the pulse height and completely symmetrical ringing on the two sides of the pulse, the ringing frequency being 3 Mc/s. The ideal low-pass filter represents the performance target for long television links on cable where the transmission band must be terminated sharply for economic reasons. If individual links can be made to approximate sufficiently closely to the ideal filter characteristics, the waveform response at the end of a number of links in tandem will be the same as that of one link.

#### Attenuation and Phase Distortions

It is of interest to consider next how attenuation and phase distortions taken separately affect the waveform response. To avoid discussion of the difficulties of measuring phase distortion and of expressing the results in a useful manner, an example is given entirely in terms of waveform response. The example selected is of a distortion which is confined to the frequency band explored by a  $2T$  pulse and is not complicated by effects caused by a cut-off.

Fig. 12 (a) shows a waveform distortion of the minimum-phase-shift type which is not unlike the exponential undershoot shown in Fig. 5. The waveform response of the attenuation distortion only is shown in Fig. 12 (b) while that of the phase distortion only is shown in Fig. 12 (c). It can be seen that the attenuation distortion gives a sine-squared pulse response which is completely symmetrical about the centre line through the pulse. This is the feature of a sine-squared pulse response which enables the absence of phase distortion to be verified. Referring back to Fig. 11 (b) and 11 (c)



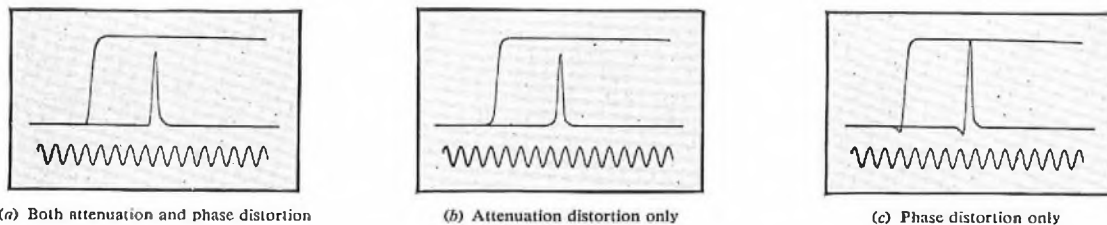

FIG. 12—WAVEFORM RESPONSES OF ATTENUATION AND PHASE DISTORTIONS

it can be seen that the addition of the phase equalizer to the filter makes the ringing, caused by the filter cut-off (attenuation distortion), very nearly symmetrical and the lack of complete symmetry is a measure of the imperfection of the correction of the phase distortion.

The effect of phase distortion only is to produce a pulse response which is skew-symmetrical about the centre line in the manner shown in Fig. 12 (c). The height of the pulse is not materially affected in this case as equal positive and negative areas are added to it. This is an approximation which applies only when the amount of phase distortion is modest, as in the example chosen.

Comparison of Fig. 12 (b) and (c) with Fig. 12 (a) shows that on the right-hand side of the pulse the distortion is of the same size and shape in (b) and (c) and each is about one-half the size of the distortion in (a). On the left-hand side of the pulse the distortions in (b) and (c) are also of about the same size and shape but of opposite sign while in (a) there is no distortion on the left-hand side. It can be seen from this that when the attenuation and phase distortions are combined to give the minimum-phase-shift case, the distortions on the left-hand side of the pulse cancel while those on the right-hand side add. The attenuation and phase distortions in a minimum-phase-shift network of the type used in the example therefore contribute equally to the waveform distortion, which normally always appears on the right-hand side of the pulse. The appearance of distortions on the left-hand side as in Fig. 11 (c), 12 (b) and 12 (c) is at first sight rather mysterious as it suggests that the network being tested is giving an output signal in anticipation of the input signal being applied. This is clearly not possible and any network having a distortion on the left-hand side of the pulse response must contain a delay, equal at least to the time between the beginning of the distortion and the beginning of the pulse.

The statement made above that the attenuation and phase distortions contribute equally to the waveform distortion is an approximation which applies only to distortions of the type considered. Another case of practical importance is where the attenuation distortion occurs outside the frequency band of interest. Consider, for example, a low-pass filter with no attenuation distortion in its pass band up to say 3 Mc/s, and then a rapid cut-off to a stop-band attenuation of say 40 db, which is constant at all frequencies up to infinity. The waveform response of such a filter would be not unlike that shown in Fig. 11 (b). If now the stop-band attenuation were increased to, say, 120 db, for example by connecting three similar filters in cascade, the effect of the increased attenuation on the waveform would be negligible because one 40 db filter will already reduce all the spectral components of the pulse above 3 Mc/s to negligible proportions. However, in a minimum-phase-shift network, the phase-shift at any frequency depends on the attenuation over the whole frequency range from

zero to infinity.<sup>5</sup> The increase in attenuation above 3 Mc/s will therefore cause increased phase distortion below 3 Mc/s and this can have a considerable effect on the waveform response. In transmission systems having a sharp cut-off, the phase distortion in the pass-band can have a very much greater effect on the waveform response than any small attenuation distortion which exists in the pass-band. This case is of practical importance when considering long cable links where enormous attenuations exist outside the pass-band. The waveform distortion in such cases may be caused entirely by the phase distortion and will take the form of a reduction in *T*-pulse height, an increase in half-amplitude duration and a ring of very large amplitude on the right-hand side of the pulse. The benefits of phase equalization in such a case are much more striking than in the example shown in Fig. 11 (b) and (c).

#### CONCLUSION TO PART I

A selection of waveform distortions has been shown, which, with the exception of Fig. 12 (b) and (c), are typical of distortions which may occur in television links and equipment, although in practice they do not often occur singly and may therefore be more difficult to identify. The examples illustrate some of the advantages of the pulse-and-bar waveform as a sensitive test signal for showing distortions, and indicate how different types of distortion occurring in different parts of the frequency spectrum are shown up by the pulse-and-bar waveform. The examples also illustrate some of the difficulties in putting limits on steady-state characteristics when limits on waveform distortion are the primary requirement. In most of the examples, phase distortion contributes equally with attenuation distortion to produce the total waveform distortion, but in some practical cases the effect of the phase distortion may predominate. Attenuation distortion without phase distortion is rare in television links but in picture generating and reproducing equipment, aperture distortion, caused by the finite size of a scanning spot, is of this type.

(To be continued)

#### References

- <sup>1</sup> GUILLEMIN, E. A. *Communication Networks* (John Wiley 1931), Vol. 1.
- <sup>2</sup> MACDIARMID, I. F. A Testing Pulse for Television Links. *Proceedings I.E.E.*, Paper No. 1267R, Apr. 1952 (Vol. 99, Part IIIA, p. 436).
- <sup>3</sup> HUNT, G. J., and ELLIOT, E. W. An Introduction to the Sine-Squared Pulse. *Journal of the Television Society*, Vol. 7, p. 49, Apr. 1953.
- <sup>4</sup> MACDIARMID, I. F., and PHILLIPS, B. A Pulse-and-Bar Waveform Generator for Testing Television Links. *Proceedings I.E.E.*, Paper No. 2687R, Sept. 1958 (Vol. 105, Part B, p. 440).
- <sup>5</sup> BODE, H. W. *Network Analysis and Feedback Amplifier Design*. (Van Nostrand, 1945).
- <sup>6</sup> WHEELER, H. A. The Interpretation of Amplitude and Phase Distortion in Terms of Paired Echoes. *Proceedings of the Institute of Radio Engineers*, Vol. 27, p. 359, June 1939.



# Cable Creepage

R. H. HARRIS†

U.D.C. 621.315.232:621.315.221.5

Since the first reported case in 1921, the incidence of cable-creepage faults has steadily increased in spite of the extensive and expensive anti-creepage measures that have been carried out.

This article surveys the whole problem of cable creepage and describes the investigations that have been carried out by the Post Office and other administrations into the causes of cable creepage and the conditions under which it occurs.

A description is given of the various anti-creepage devices that have been developed and assessments are made of their performance. Details are also given of some unusual cases of cable creepage.

## INTRODUCTION

THE first reported case of cable creepage occurred in 1921 when cables in a duct route under the Liverpool-Warrington road were affected. No details are available of the circumstances, or of any remedial action, but it is, no doubt, fairly safe to assume that at the time the occurrence was regarded as little more than an interesting phenomenon and the possibility that this was the beginning of quite a serious national problem for external telecommunication engineers was probably not realized. However, cases of creepage occurred later in increasing numbers and the cable faults that ensued showed that cable creepage was much more than an interesting phenomenon; it was in fact a problem requiring serious attention. Consequently, in 1927, an investigation into the causes of cable creepage was carried out. This investigation and other research into the problem will be referred to in later paragraphs.

## INCIDENCE OF FAULTS AND CABLE CREEPAGE

In the one-year period 1957-58, 4,148 faults occurred in main trunk cables and, of this number, 167 faults, or approximately 4 per cent of the total, were attributed to cable creepage; since the cable-sheath mileage was 42,511 the number of creepage faults per 100 sheath miles was 0.39. Statistics for junction and local cables are not available but a national percentage of creepage faults for junction cables would probably be similar to that for main trunk cables, whereas the percentage for local cables is likely to be less than that for main trunk cables because many of the duct routes subject to creepage are not near towns and therefore carry few local cables. The trend of the incidence of cable-creepage faults over the last ten years, whether it be assessed as a percentage of the total number of faults or as the number of faults per 100 sheath miles, is unfortunately a rising one, as the following figures show:

	1946-47	1957-58
Creepage faults as a percentage of total faults .. .. .	2.4%	4.0%
Creepage faults per 100 sheath miles .. .. .	0.14	0.39

This rising trend is a disturbing feature because extensive and expensive anti-creepage measures have already been carried out.

## RESEARCH INTO THE CAUSES OF CABLE CREEPAGE

### *Experiments carried out by F. E. Bentley*

As far as is known the first serious investigation into the causes of cable creepage was carried out in 1927 by

F. E. Bentley and was described in a paper read before the Liverpool Section of the Institution of Electrical Engineers.

In these experiments a length of duct-track on the Manchester-Oldham road near Failsworth was exposed and covered with a "saddle" of concrete. A length of cable was drawn in and a similar length of cable was drawn in a spare way in an adjacent section of track which was not treated with cement. Both cables were marked and observations were taken at intervals over a period of 15 months. It was found that whereas the cable crept in the untreated section of track the cable in the treated section remained stationary.

The author concluded that "this experiment offers conclusive proof that most creeping is directly due to vibrations set up by the passing of heavy vehicles."

### *Investigations by Other Administrations*

Very little is known of the cable-creepage experiences of other administrations and absence of such information would suggest that cable creepage is not a serious problem to them, possibly because of cable installations which differ from those of the Post Office, e.g. a greater use of directly buried cable. However, instances of electricity-supply cables moving in ducts have been reported. British Electrical and Allied Research Association reports have referred to the movement of supply cables in duct caused by alternate heating and cooling of the cable under varying conditions. Heating and cooling of the cable causes, respectively, expansion and contraction which, under certain circumstances, e.g. on gradients, results in movement of the cable along the duct (on a gradient the movement is downhill). It is felt that the effects of heating and cooling, which may be important for supply cables, can safely be neglected for telecommunication cables in the considerations of the cable creepage problem.

### *Investigations carried out by the Post Office Research Branch*

In 1937 the Post Office Research Branch carried out very extensive investigations in localities that had become notorious for cable creepage, e.g. Ilchester, Watford, Brighton, Taunton and Selmeaton. In addition to the field investigations, laboratory experiments were carried out at the Research Station. At about the same time an article on cable creepage appeared in this Journal.\*

The basis of the investigations was the measurement of vertical and horizontal vibrations generated by road vehicles on the road surface and in the earth beneath the road. Other factors investigated were:

- (a) Actual depression of the road surface caused by the passage of vehicles over it.
- (b) Effect of stiffness of a cable.
- (c) Effect of different types of road surface, e.g. uneven or smooth.

† Assistant Engineer, External Plant and Protection Branch, E.-in-C.'s Office.

\* TIMMIS, A. C. "The Creepage of Underground Cables." *P.O.E.E.J.*, Vol. 30, p. 180, Oct. 1937.

- (d) Tension developed in a cable due to cable creepage.
- (e) Effect of speed and weight of vehicles.

It was concluded that as the horizontal vibrations detected in the road surfaces during the experiments were sinusoidal in nature, an earlier suggestion that the creepage was similar to the movement of coal on a conveyor belt (a slow forward movement of the belt and a quick backward jerk producing a forward movement of the coal) was disproved since this requires a saw-toothed vibration; the creepage is more likely to be due to the depression caused by a vehicle with the road vibrations playing only a secondary part. A theory developed on this line of thought was given by Timmis in his article and is known as the "Surf-riding Theory" (see Fig. 1).

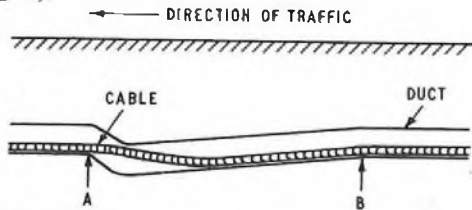

- (a) The weight of a vehicle compresses the earth beneath the road and the duct line is depressed as shown between A and B
- (b) The depression moves along the duct line as the vehicle proceeds along the road
- (c) The cable moves forward (in the direction of the vehicle) as the duct restores, in the same way as a surf-rider advances by sliding down the face of a wave

FIG. 1—"SURF-RIDING" THEORY OF CABLE CREEPAGE

#### Another Possible Theory

The surf-riding theory is generally accepted but another possible theory relies on the conveyor-belt principle described earlier, the slow forward and quick backward movement of the ducts being caused by the travelling depression in the earth mass when a heavily laden vehicle passes along the road surface. At the front of the depression the ducts are acted upon by a force along a line which is assumed to be roughly  $45^\circ$  forward from a perpendicular line drawn through the axis of the front wheels of the vehicle. This force has a horizontal, as well as a vertical component, i.e. the ducts are forced forward as well as downward. At the rear of the depression there is a similar force, the horizontal component of which, however, forces the ducts backward. After the depression has passed the earth-mass recovers slowly and the ducts assume approximately their original positions. Thus a cable in a duct so affected is caused to creep by the following sequence of events as the front and rear wheels pass in turn over an arbitrary reference.

(i) The duct is forced rapidly forward, breaking the static friction between the duct and cable.

(ii) The duct is forced rapidly backward, moving in this direction relative to the cable.

(iii) The earth-mass recovers slowly and the duct moves forward to approximately its original position carrying the cable with it, the movement being too slow to overcome friction.

Fig. 2 illustrates this theory, and for simplicity only the effect of the rear portion of the travelling depression (events ii and iii) is shown. Also, the downward effects are neglected.

#### CONDITIONS ASSOCIATED WITH CABLE CREEPAGE

The 1937 investigation by the Research Branch enabled the conditions associated with cable creepage to be identified. These conditions are summarized as follows:

(a) The cable creeps in the direction of the traffic directly above it.

(b) Creepage is greater under roads with poor sub-soil, such as clay, shingle, peat, etc., than under those having more-solid sub-soil. Creepage is also pronounced if the road is badly drained.

(c) Creepage is more marked under embanked roads than under roads passing through a cutting.

(d) If the sub-soil is bad the condition of the road surface (excluding concreted roads) has no effect on the extent of creepage, but measurements have shown that if the sub-soil is fairly good the condition of the road surface may have an effect on creepage. These measurements were not conclusive but the indications were that creepage tends to be more severe with a "bumpy" surface than with a level one.

(e) Creepage occurs mainly on cable routes under carriageways and rarely occurs when the cable runs under a footway unless the track is within about 4 ft of the nearside traffic wheels.

(f) There is a tendency for cables to creep more on a long straight section of road than on a winding one.

(g) Creepage under concreted roads is not likely.

(h) Creepage is more pronounced on downhill sections than on uphill, but has occurred uphill in a number of cases.

(i) Creepage occurs mostly in earthenware self-aligning ducts.

#### Effect of Modern Traffic

Present-day road traffic is considerably greater than it was pre-war and by any cable-creepage theory an increase in the volume of traffic must produce an increase in creepage tendency. Within limits it is reasonable to assume that an increase in the load carried by traffic will also produce a corresponding increase in creepage tendency; it is questionable however, whether the load per vehicle has increased very much since before the war and any increase there might be is unlikely to affect appreciably the overall creepage tendency. The effect

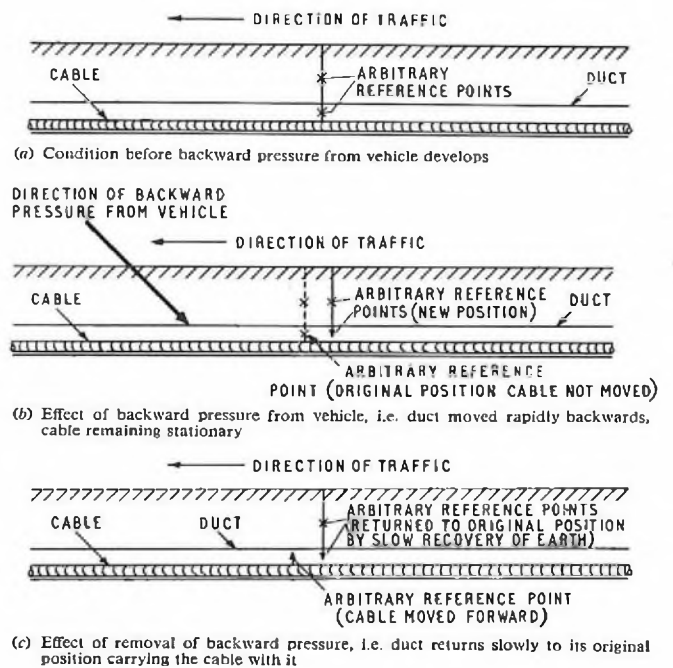

FIG. 2—"CONVEYOR-BELT" THEORY OF CABLE CREEPAGE



of increased speed of vehicles on creepage tendency is problematic but with all other factors equal it would be reasonable to assume that an increase in speed would not alter the amount of creepage in a given period of time. During the Research Branch's investigation, however, it was found that for a pneumatic-tyred lorry earth vibrations increased in amplitude with increase in speed of the lorry until a "critical" speed was reached and above this the amplitude decreased. The critical speed was about 16 m.p.h. The depression in the road surface caused by the lorry appeared to be more marked with slower speeds. From these findings, therefore, there would be some expectation that creepage tendency would decrease with an increase in road traffic speed in the range above "critical" speed. It should be remembered, however, that the type of traffic likely to cause cable creepage is that of heavily laden goods vehicles and these are required by law not to exceed certain speed limits (until recently, 20 m.p.h. for the heavier vehicles and 30 m.p.h. for others) and these restrictions have been in force for many years; the general speed of "creepage-causing" traffic should therefore be very much the same now as it was before the war.

#### DEVELOPMENT OF ANTI-CREEPAGE MEASURES

##### Damping

The damping of ducts by placing a saddle of concrete over them is probably the earliest anti-creepage measure adopted. Comparatively little damping has apparently been done, which is surprising because damping would seem to be the method with the best chance of success, without the encumbrances necessary (cable anchors, etc.) with other methods. Damping is a costly method for existing duct-tracks and it is probably on grounds of prohibitive cost that so little has been done. There is, however, the aspect that frequently, when ducts have been laid, the possibility of cable creepage occurring in them has not been considered so that no damping has been carried out—at a time when the additional cost would be least and no doubt well justified.

There have been a few instances of damping failing to prevent cable creepage. In an investigation of one of these cases, which occurred on the Hereford-Shrewsbury road (A49), where creepage at the rate of about 1 ft per year was reported, it was found that a "cushion" of mud and clay lay between the concrete saddle and the ducts. No doubt the "cushion" allowed the continued movement of the ducts under traffic influence. The investigation brought a realization that the standard method of damping has an inherent weakness in that under unstable conditions the unreliability of the adhesion between concrete and duct may result in the duct "dropping out" of its damping and then becoming prone to traffic influence. The standard method of damping is shown in Fig. 3.

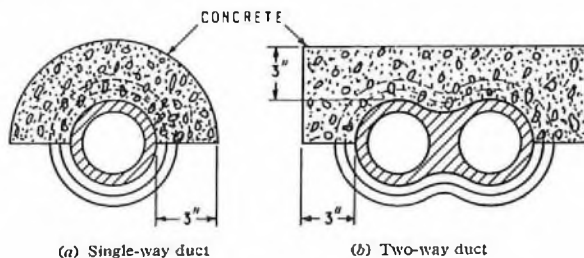

FIG. 3—METHOD OF DAMPING DUCTS

##### Wooden-Block-Type Anti-Creepage Devices (A.C.D.)

An early form of cable anchor or A.C.D. consisted of a lead collar, plumbed to the lead cable sheath near the duct-mouth, and wooden blocks interposed between the jointing-chamber wall and lead collar. The standard A.C.D. that was developed on this principle is known as the "A.C.D. No. 1." A weakness in this type of A.C.D. is the necessity for plumbing, which is liable to weaken the lead sheath of the cable. Consequently, failures have occurred due to sheath fracture near the plumbed portion of the A.C.D. Another disadvantage is the necessity to completely dismantle the device, because of the obstruction it presents, when additional cables are required in the duct-way. Many A.C.D.s No. 1 have been in satisfactory use for many years and will no doubt continue to give good service but nevertheless they must always be regarded as suspect because of their inherent weakness in design.

##### Cable-Grip-Type A.C.D.

A type of A.C.D. that utilizes a double-eyed cable grip and is known as the "A.C.D. No. 2" was developed primarily for anchoring coaxial cables, but it has also been used as an alternative to the wooden-block type for anchoring audio cables. The A.C.D. No. 2 is costly to install because it has to be constructed to suit the dimensions of the particular jointing chamber.

##### "Sugar Shovel" Type A.C.D.

The "Sugar Shovel" type of A.C.D., known as the No. 4 Cable Anchor, is illustrated in Fig. 4. This device,

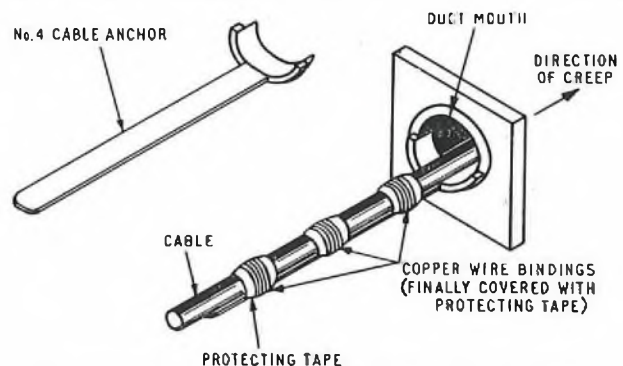

FIG. 4—"SUGAR SHOVEL" TYPE OF ANTI-CREEPAGE DEVICE

which came into use in 1950, had the advantage that the duct-way was not obstructed, installation was comparatively simple and the anchor was cheap to manufacture. There were, however, weaknesses in the original design of the anchor, coupled with weaknesses in the method of installation. These weaknesses were the use of a "plain" tail on the anchor and the reliance placed on the protection tape over which the copper-wire bindings were applied. Despite the fact that this method appeared quite satisfactory from laboratory tests it was found in practice that (a) the cable, under creepage, passed through the wire bindings or (b) the cable carried the bindings along the tail, or a combination of (a) and (b) was experienced. As a result of these failures the design of the anchor and the method of installation were modified in 1953.

##### Modified "Sugar Shovel" Type A.C.D.

The modification to the anchor-tail was simple—it was merely provided with recesses in which to locate the



wire bindings. The wire bindings are now applied directly over the lead sheath, and where they pass over the top of the sheath they are soldered to it. The amount of soldering required is quite small and merely serves as initial "keying" until the bindings take up the strain and grip the cable by virtue of their own canting action. Galvanized-iron wire is now used instead of copper to limit any possible corrosion damage to the lead sheath arising from the bi-metallic arrangement. This is the current method of anchoring and appears reasonably satisfactory. A disadvantage is that the cable, under creepage influence, is still permitted to move until the wire bindings take up the strain. This movement, referred to as settlement, can amount to an inch or more and is a potential cause of faults.

#### Core Constriction

The constriction of a cable core by swaging or dressing-down the cable sheath is a measure for preventing the core from moving independently of the sheath. Such movement has been known to take place even when the sheath appears to have been adequately anchored. Core creepage seems to obey the same rules as normal cable creepage, e.g. the movement is in the direction of the traffic. Core constriction is not fully effective in all cases and it is a difficult operation to carry out in many jointing chambers because of the cramped conditions. A further limitation is that it cannot be done on coaxial cables having only a small number of audio pairs surrounding the coaxial pairs. Whilst core constriction is still a current method to apply in persistent cases of core creepage it is hoped that a more effective method will be found.

#### EXPERIMENTAL TYPES OF A.C.D.

##### Anti-"Creep-in" Device

This device, which is likely to be made a standard Post Office item shortly, is illustrated in Fig. 5. It will

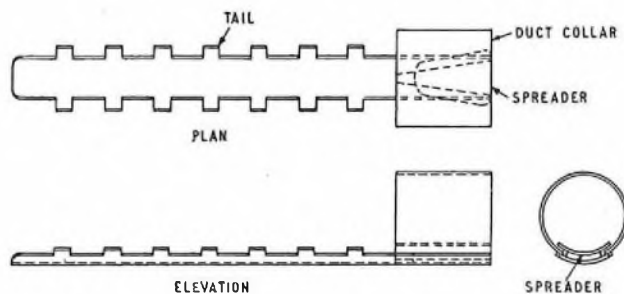

FIG. 5—ANTI-CREEPAGE DEVICE TO PREVENT "CREEP-IN"

be seen that the device is provided with a serrated tail to which the cable is attached by means of wire bindings in a manner similar to that used with the No. 4 Cable Anchor. The tail is held fast in the "creep-in" duct-mouth by the collar, which is expanded to develop a friction grip on the internal surface of the duct. Expansion of the collar is achieved by means of the wedge-shaped spreader attachment fitted to the end of the tail; the spreader, which is located in a corresponding tapered slot in the collar, expands the collar when the tail is pulled towards the duct-mouth.

The need for an anti-"creep-in" device has been apparent by the number of cases which have occurred where, despite the quite satisfactory anchoring of a cable at its "creep-out" end, "straightening-out" and

stretching of the cable along the duct takes place, giving rise to an appreciable length of cable (over 2 in. has been noted) passing into the jointing chamber at the "creep-in" end and causing sheath fractures.

##### Self-Clamping-Type A.C.D.

A self-clamping type of A.C.D. which is under development is illustrated in Fig. 6. The principle of

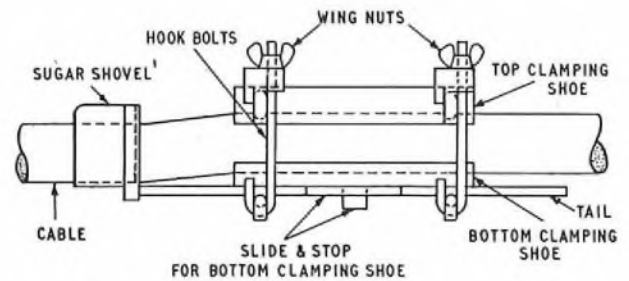
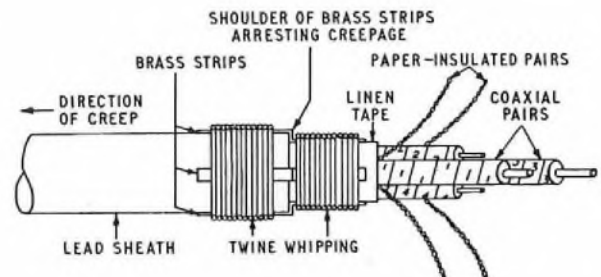

FIG. 6—EXPERIMENTAL SELF-CLAMPING ANTI-CREEPAGE DEVICE

the device is quite simple; as the cable tends to move forward it is clamped more tightly between the clamping shoes because of the pivoting action of the hook-bolts. Initial grip on the cable is obtained by screwing down the winged-nuts. The device shows some promise, being simple to install and positive in action, but some precautions will need to be taken to prevent rapid deterioration of the device under jointing-chamber conditions. Also, the problem of catering for more than one cable in any one duct-way has still to be overcome.

##### A.C.D.s for Coaxial Pairs

As was stated earlier, core constriction cannot be carried out on coaxial cables which have only a small number of layer pairs surrounding the coaxial pairs. Even if constriction could be done it would have no effect on the centre conductors of coaxial pairs, which tend to move in relation to their tubes. Methods of anchoring a coaxial cable core and centre conductors are illustrated in Fig. 7.



(a) Anti-creepage device for coaxial cables having few paper-insulated pairs

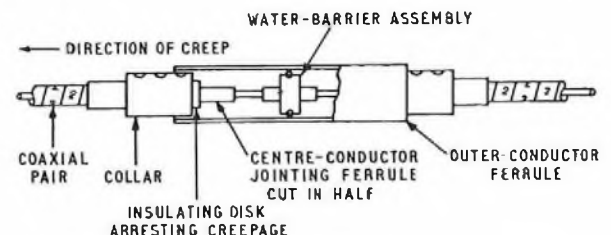

(b) Anti-centre-conductor-creepage device for coaxial cables

FIG. 7—ANTI-CREEPAGE DEVICES FOR COAXIAL CABLES



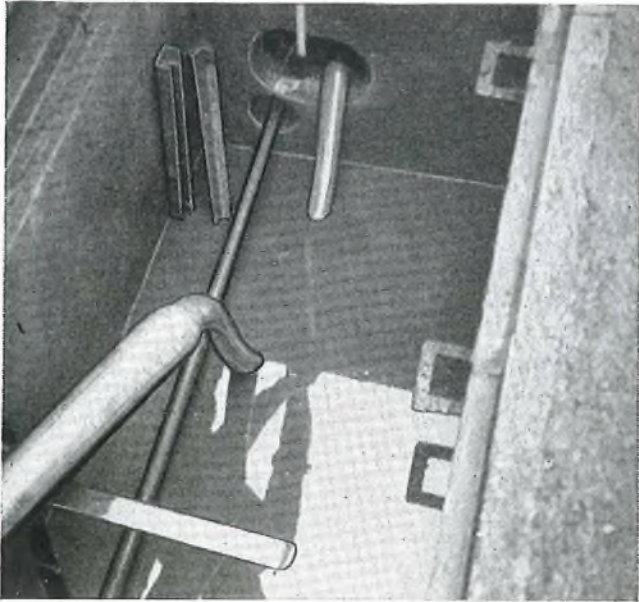

FIG. 8—EFFECT OF CABLE CREEPAGE; SLACK CABLE ACCUMULATED IN JOINTING CHAMBER

#### DIFFICULTIES IN ANCHORING MORE THAN ONE CABLE IN A DUCT-WAY

If a duct-way contains more than one cable it is usually quite difficult to anchor each of the cables effectively without a complicated form of device. If, for example, a wooden-block type of A.C.D. is used, it is necessary to cut the blocks and lead sheet fairly accurately to suit the size and formation of the cables concerned and, at the same time, allow sufficient room for the plumbing operation. Also, with an A.C.D. which employs the No. 4 Cable Anchor the attaching of more than one cable to the anchor-tail cannot be done really efficiently although it is sometimes practicable, when only two cables are contained in a duct-way, for two No. 4 Cable Anchors to be fitted in the duct-way, side-by-side, with one cable attached to each. There is

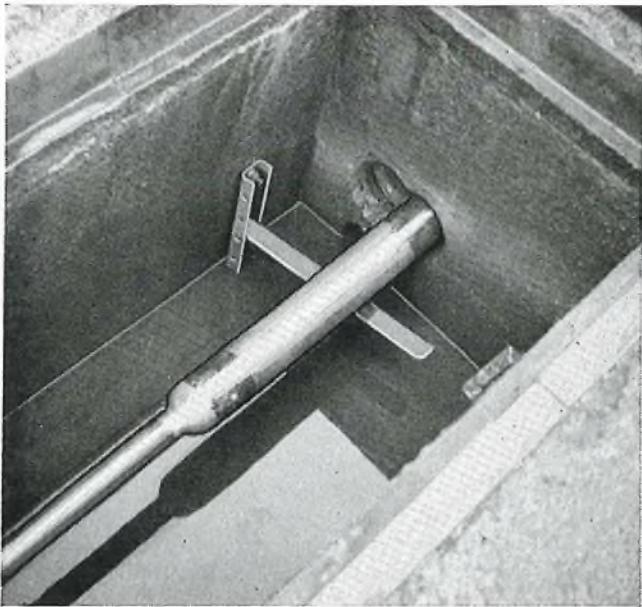

FIG. 9—EFFECT OF CABLE CREEPAGE; JOINT JAMMED IN DUCT-MOUTH

clearly a need for a "multiple-anchor" and the possibilities of producing one are under consideration, but the design of a device adaptable without undue complication to the many different conditions that are encountered in jointing chambers presents a problem not easily overcome.

#### SIGNS AND SYMPTOMS OF CABLE CREEPAGE

Fig. 8 and 9 indicate examples of obvious creepage and Fig. 10 indicates an example of cable creepage which, at first sight perhaps, is not obvious. The joint shown has moved from the conventional position between the supporting brackets to its present position—a distance of approximately 18 in. The signs and symptoms of cable creepage are as follows:

- (a) Cable joints out-of-centre in supporting bay and moving towards duct entries.
- (b) Cable joints askew.
- (c) Cable joints lifted off supporting brackets.
- (d) Cables bent or straightened out.

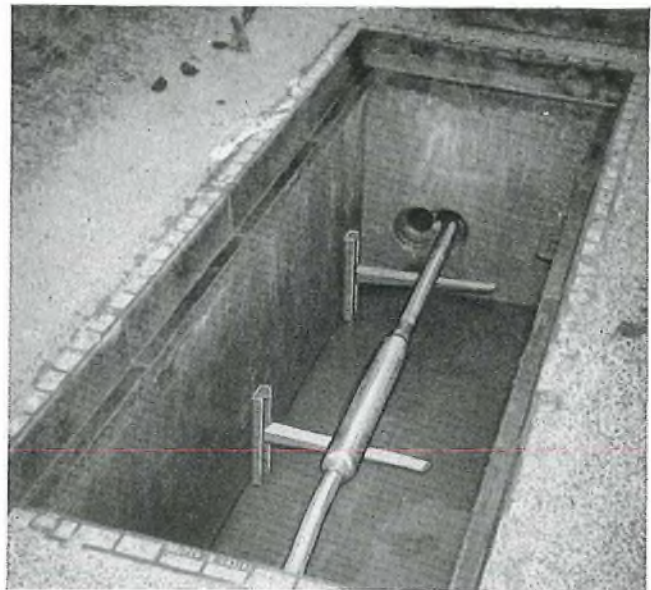

FIG. 10—EFFECT OF CABLE CREEPAGE; JOINT MOVED OUT OF POSITION

- (e) Cables wrinkled.
- (f) Supporting brackets pushed out of line (by joint wipes usually).
- (g) Lead protection collars pushed out of duct entries.

The above signs and symptoms result from appreciable creepage. As suggested earlier it is possible for creepage conditions to exist which are so little pronounced that the signs and symptoms listed are not of sufficient magnitude to be noticeable unless a careful examination is made. Thus it follows that creepage conditions can exist without being suspected. Nevertheless, failures of cables are liable to arise from creepage even though it is very slight and unsuspected. Two of the most positive indications of cable creepage are:

- (a) The existence of "flats" on the underside of the cable (or joint-sleeve) which result when the cable (or sleeve) passes over a fixed surface such as a supporting bracket or duct-mouth. (These "flats" can usually be felt by the fingers or seen with the aid of a mirror; a movement of  $\frac{1}{8}$  in. or less can be detected in this way.



(b) The change in distance between a "creepage marker" placed on a cable and a reference point in the jointing chamber.

#### EXTENT OF CABLE-CREEPAGE MOVEMENT

The extent of cable creepage in any particular case is usually classed as slight, moderate or severe. The degree of severity in the three classes is quite arbitrary but is roughly of the following order:

Degree of Creepage Severity	Cable Movement
slight	up to 1 in.
moderate	over 1 in. up to 3 in.
severe	over 3 in.

It is interesting to study the relationship between extent of cable-creepage movement and traffic. From an actual case, 260,000 goods vehicles pass per year over a duct-track in which, within a year, a cable creeps 12 in. (classed as severe creepage). Thus, each vehicle causes the cable to move  $\frac{12}{260,000}$  in. = 0.00005 in. approximately.

It is possible that this value of 0.00005 in./vehicle could be used as a "constant" for forecasting, with some degree of accuracy, the amount of cable creepage to be expected in many other localities with similar road, sub-soil and duct conditions.

#### MAGNITUDE OF CABLE-CREEPAGE STRESS

During the Research Branch investigation a creepage pull of about 250 lb was recorded on an isolated length of cable. Whilst the figure of 250 lb may possibly be taken as a fair indication of the general order of creepage stresses it is thought that the actual values vary considerably from cable length to cable length because of the many differing conditions of duct, sub-soil, traffic, etc. It is also possible that creepage stress is related to the size, i.e. weight, of the cable involved. Many instances that suggest that creepage forces vary can be given, e.g. in one jointing chamber the bindings of a No. 4 anchor installation were found to be very tight and canted to an angle of nearly 45°, whereas in another jointing chamber the bindings of an identical A.C.D. of similar age were tight but only canted a few degrees from the vertical.

#### SOME UNUSUAL CASES OF CABLE CREEPAGE AND POINTS OF INTEREST

##### *Reversed Direction of Creepage Movement*

A case of a cable tending to reverse its direction of creep has occurred on a cable route under the A229 road near Hastings. The duct-track is near the centre of the road. No. 4 Cable Anchors had been fitted to the cable on the "correct" side of the jointing chamber to arrest creepage towards Hastings. An examination of the jointing chamber some time after the anchor had been installed revealed that the device was leaving the duct entry, indicating a reversal in the direction of creep. A possible explanation of this is that holiday traffic returning from Hastings, particularly at week-ends is very heavy and many of the vehicles may encroach on the "wrong" side of the road so that their wheels are over the duct-track. Thus there is a tendency to creepage in the direction of the returning traffic.

#### *Cable Creepage in Metallic Conduits*

A few cases of cable creepage occurring in metallic ducts have occurred. One particular case involved a coaxial cable route under the A74 road near Ecclefechan in Scotland, the cable being laid in iron pipe which was once used for the old Northern Underground route. The coaxial cable has been affected by both core creepage and sheath creepage, which has not responded fully, so far, to remedial action. This action has included the providing of both "creep-out" and "creep-in" cable anchors, the building of intermediate jointing chambers to provide additional anchor points and the drastic course of swaging down the cable sheath (to arrest the core creepage). Presumably the cable creepage occurs because of the defective joints in the metallic conduit permitting independent movement of the pipe sections under traffic influence.

#### *Creepage of Directly Buried Armoured Cables*

Creepage of the core of armoured cables that are directly buried in the ground sometimes occurs when the cables are laid in the grass verge near a road surface. The usual treatment is to swage down the lead sheath. The explanation is not easily determined but it is thought to be that the cable sheath behaves like a duct under "creepage-causing" influence and as a result the core moves as a cable does in a duct.

#### *Effect of Earth Subsidence*

When a section of duct-track is affected by earth subsidence the usual effect on the cables is that they are drawn in from both ends of the section. It is conceivable, however, that cable movement due to subsidence may be confused with "normal" cable creepage, but it is clearly dangerous to apply anti-creepage anchors to the cables in these circumstances as cable fracture is liable to occur because of the possibly considerable weight of earth pressing down on the duct-track. Fortunately, subsidence usually produces quite definite effects on the surface such as hollows in road surfaces and cracks in nearby buildings, and frequently localities which are prone to subsidence, e.g. those near mine-workings, are well-known locally. In the main, therefore, sufficient information should be available to avoid any confusion between subsidence and "normal" cable creepage.

#### *Effect of Temperature Change on Coaxial Cables*

A number of cases have occurred where the centre conductors of coaxial pairs in cables have broken away from their jointing ferrules. The cause of some of these failures has been attributed, incorrectly, to core creepage; the real cause has been the considerable tension developed in the centre conductors by contraction following a reduction of ambient temperature in cold weather. In some instances a contributory factor to the failures has been defective soldering of the jointing ferrules. The "pulling" of centre conductors due to the reduction of temperature is very prevalent in long routes of single-coaxial-pair cables, in which no "lay" is given to the coaxial pair. In multi-coaxial-pair cables, where the coaxial pairs rotate in a "lay," failures of the centre conductors due to reduction of temperature do not occur very frequently. It is probable that a coaxial cable laid and jointed in hot weather will be more liable to "temperature" failures of the centre conductor than one laid and jointed in cold weather.



## CONCLUSIONS

Because of the increasing road traffic and increasing sheath mileage the trend in cable-creepage fault incidence will be a rising one. The counter measures to off-set this trend fall into two categories, namely:

(a) Counter measures for existing cable routes.

(b) Counter measures for new cable routes or those that are at the planning stage.

In (a), the counter measures are the greater use of A.C.D.s and in some difficult cases the use of damping. With regard to the extent that A.C.D.s should be used, it seems better to anticipate cable creepage rather than to wait for it to occur. This means that most duct-tracks of self-aligning ducts under main roads (apart from concrete roads) are suspect for cable creepage and therefore all the cables in every jointing chamber should be provided with A.C.D.s. Furthermore, for adequate protection it appears that "creep-in" as well as "creep-out" type A.C.D.s are necessary. Damping appears to be justified only when, in established cases of severe

cable creepage, A.C.D.s prove inadequate or have a very limited life.

In (b), the counter measures are largely the avoiding of the conditions that produce cable creepage, and in this respect the following are points for consideration:

(i) Avoid laying ducts under main road surfaces (apart from concrete roads) wherever possible.

(ii) (Supplementary to (i)). When dual-carriageways are involved the possibility of laying ducts under the centre "strip" should be investigated.

(iii) If the laying of ducts under main road surfaces cannot be avoided, provide damping or even surround the ducts with concrete as they are laid.

(iv) If, under a main road, a new duct-track is laid near an existing one, the disturbance of the sub-soil may result in the existing track becoming one in which cable creepage will occur. Therefore the possibility of, say, damping the existing track as a combined operation with the provision and damping of the new track should be investigated.

## Book Review

"Mathematics Applied to Electrical Engineering." A. G. Warren, M.Sc., M.I.E.E., F.Inst.P. Chapman & Hall, Ltd., London, 464 pp. 150 ill. 70s.

This is the second (and revised) edition of a book that first appeared in the autumn of 1939. The original first edition was reviewed in this Journal in the spring of 1940 (Vol. 33, p. 49, April 1940). Here it was stated—"The author has turned out a book that will be useful to engineers. There is much to praise and little to blame. But, as space is limited here, we shall leave out the praising: a few critical remarks are likely to be more useful in the long run."

The author was criticized because in his discussion of differentiation under the integral sign he had omitted the case of variable limits. It was pointed out that the practical application of a fundamental theorem of electric circuit theory, namely,

$$I(t) = \frac{d}{dt} \int_n^t A(t-\psi) E(\psi) d\psi$$

involves the differentiation of a definite integral with variable limits; and that the omission of a discussion of this case from a text designed for electrical engineers was remarkable. This omission, however, has now been dealt with; for this revised edition contains a complete and satisfactory discussion of differentiation under the integral sign when parametric limits are involved. Moreover, this second edition shows how the above expression can be applied to electric circuit problems. The treatment is clear and accurate and forms a valuable feature of the new edition.

In the review of the first edition the author was also criticized for an inadequate treatment of the Heaviside operational calculus. It was claimed that his discussion was too brief to be of any real value to an engineer. This criticism is certainly not valid for this second edition, for the author has completely rewritten and extended his former treatment. In addition, he has introduced a completely new chapter on the theory of functions of a complex variable in order to discuss the Bromwich inversion of the Heaviside transform. Also, he has deleted the section on harmonic analysis that appeared in the chapter on Fourier methods in the first edition. This has made room in the second edition for a discussion of Fourier integrals and their connexion with Heaviside functions.

The author does not make the fashionable mistake of

rejecting the basic principles of Heaviside's operational methods in favour of symbolic calculus or transform techniques. Unlike the modern advocates of symbolic calculus he does not talk about "p—premultiplied Laplace transforms" and thereby introduce difficulties (and even errors) that can easily be avoided by following the direct Heaviside lead. This trouble started after Bromwich had used the theory of functions of a complex variable to explain how Heaviside's methods worked. For then Carson noticed that a method given by Heaviside (and reinterpreted by Bromwich) for finding an operator associated with a given function looked like a method used by Laplace (1812). The result was that a large number of books have been written for engineers based upon what is called the "Laplace transform" and completely ignoring the improvements embodied in the Heaviside-Bromwich treatment (1916). Heaviside's direct operational calculus as used in this book has many advantages over Laplace transform techniques; the author shows the remarkable ease with which Heaviside's methods can be applied to the calculation of transient responses and emphasizes the fact that only simple mathematics is involved.

A monograph such as this must be largely a personal document reflecting the particular interests of its author. Here he has dealt with those parts of mathematics he considers of most value to electrical engineers. Thus there are chapters dealing with the mathematical manipulation of scalar and vector quantities, symmetrical components, the solution of differential equations, etc. These chapters contain worked examples on the operation of transformers and alternating current generators, valve oscillators, moving coil speakers, high-frequency resistance, inductive heating, flux waves, transmission of energy, etc.

An interesting chapter on Bessel functions is followed by one showing how they can be applied to the solution of problems connected with coaxial cables, strip conductors, energy losses in solenoids and modulation of carrier waves. The last chapter, dealing with conjugate functions, is most interesting for it takes the reader, in easy stages, up to problems calling for Schwarz-Christoffel transformations.

This book is well written, accurate, and commendably free from any straining after rigour. It is also very well produced; the type is easy to read and the diagrams are clearly constructed. It is a book that can be warmly recommended to all those interested in the application of mathematics to electrical engineering.

H. J. J.

# A Medium-Distance, Built-in Out-band Signalling, Carrier Terminal Equipment

## Part 1—General Performance Requirements

E. T. C. HARRIS, B.Sc.(Eng.), A.M.I.E.E., and K. C. A. KING, Associate I.E.E.†

U.D.C. 621.395.44:621.395.63

Some of the factors considered in the overall specification for a medium-distance carrier terminal equipment with built-in signalling facilities are discussed in Part 1 of this article. In Part 2, to be published later, a detailed description will be given of an equipment which has successfully completed its field trials.

### INTRODUCTION

IT has been the practice in the Post Office for many years now to separate the equipment required for the transmission of speech over carrier and coaxial systems from that necessary for signalling. Signalling tones were within the speech band of 300–3,400 c/s and were transmitted from and detected at the exchange terminations of the circuits. The transmission engineer was therefore able to design his equipment with no special regard for the problems of the signalling engineer.

“Built-in” signalling systems where the signalling is an integral part of the transmission equipment have, nevertheless, been recognized to be useful in some fields for many years and the general principles have been described.<sup>1</sup> It is, however, only fairly recently that the detailed requirements of such a system have been set out.

An earlier article<sup>2</sup> included a brief description of a built-in signalling system and a later article<sup>3</sup> has covered the signalling aspects in detail. In this article some of the factors considered in drawing up the overall specification for the transmission equipment are discussed and a description is given of a system that has been found to meet the required performance limits after extensive trials, including the carrying of traffic, on a Middlesborough–Newcastle route.

It had been decided that the built-in signalling equipment should be capable of working over standard line-systems. The most convenient point of inter-connection was at the Group Distribution Frame where channels are assembled in the basic carrier-group frequency range of 60–108 kc/s. When in this band a group of channels should be capable of being handled by any carrier or coaxial system, although certain long-distance groups have been found to include spurious 4 kc/s multiple tones that would cause interference. The built-in out-band signalling carrier terminal equipment, therefore, consists of only that equipment necessary to modulate a group of channels, each with its signalling tone, into the group frequency band.

### OVERALL SPECIFICATION

One of the prime aims in drawing up the specification was to enable the Post Office to obtain channel translating equipment that would be less expensive than the standard 4 kc/s channel equipment. Moreover, where the signalling requirements permitted the use of a continuous signalling code further economies should be

realized as compared with a speech-path system giving the same facilities.

A particularly useful field of application is for distances of, say, 20 to 60 miles where line costs are usually a fairly small proportion of the total circuit costs and line bandwidth may therefore profitably be exchanged for cheapness in terminal equipment. The specification did not lay down the number of channels to be assembled in the carrier-group frequency band although it was assumed that it would be either 8 or 12, when the channel spacing would be either 6 or 4 kc/s respectively.

Further relaxations from standard practice were considered where these could have resulted in significant economies although the general performance standards laid down were those applying to the normal equipment for the main trunk network.

### CONSTRUCTION AND LAYOUT

There are at present two standard forms of construction for transmission equipment; pre-51-type consisting of panel-mounted equipment bolted to both sides of a U-section iron framework—the form of construction familiar to engineers for many years—and 51-type<sup>4</sup>, where panels are jacked into a sheet-steel box-framework, two rack-sides being bolted back to back to form the equivalent of a pre-51-type rack.

The 51-type construction was preferred for the built-in signalling carrier equipment but alternative forms that offered comparable facilities, and which could be assembled in repeater stations together with either of the standard forms, were to be considered. The equipment submitted and described later was in a form known as “Unit Construction Practice” (U.C.P.) developed by the Automatic Telephone & Electric Co., Ltd., and Telephone

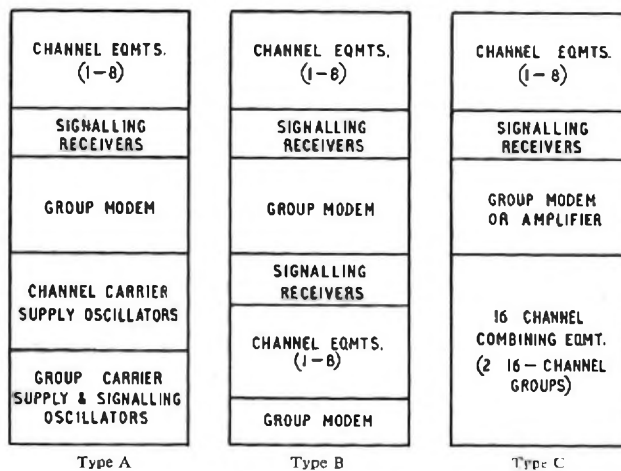

Each equipment has two forms, one suitable for operation from a.c. mains supplies and one suitable for operation from station battery supplies

FIG. 1—PRINCIPAL RACK-SIDE ASSEMBLIES OF MEDIUM-DISTANCE CARRIER TERMINAL EQUIPMENT

† Mr. Harris is a Senior Executive Engineer, Main Lines Development and Maintenance Branch, E.-in-C.'s Office. Mr. King is with the Telephone Manufacturing Co., Ltd.



Manufacturing Co., Ltd. This is a form of construction similar to 51-type and although certain facilities were lacking it was accepted as an alternative for this carrier equipment.

In U.C.P., components are mounted in can-assemblies which are carried on a panel frame. The frame width is about 19 in. and the depth is a convenient multiple of  $1\frac{3}{4}$  in.; on this equipment most panels are  $3\frac{1}{2}$  in. deep. The panel frames then jack into the rack-side framework, which is constructed of sheet steel in the standard width and, in this application, has a height of 9 ft.

Equipment for the medium-distance carrier system is mounted on a rack-side to form one of several forms of assembly, the various forms being necessary to meet the circuit routing conditions that may be required.

#### CIRCUIT FACILITIES

The basic equipment (Type A—See Fig. 1) mounts the apparatus for translating eight speech channels to and from the frequency band 60–108 kc/s together with signalling oscillators. In the transmit direction of transmission the channels are assembled initially in the frequency band 12–60 kc/s so that a 12–60 kc/s to 60–108 kc/s carrier group modems provided together with all necessary carriers. Similar translation processes are used in the receive direction of transmission.

When further 60–108 kc/s carrier groups are needed, the Type B rack-side, mounting equipment sufficient for two 8-channel carrier groups, can be added and operated from the carrier and signalling oscillators on the Type A rack-side. Finally, the third rack-side (Type C) mounts equipment for a fourth 8-channel carrier group together with two sets of 16-channel combining panels. Again these channel equipments can work from the carrier supplies and signalling tones provided by the Type A rack-side. The three rack-sides can therefore mount all the modulating, carrier and signalling equipment required for the transmission and reception of two 16-channel carrier groups assembled at line frequencies in the band 12–108 kc/s.

Carrier power from one Type A rack-side is sufficient to feed two Type B rack-sides and these three rack-sides can together provide five 8-channel carrier groups each operating in either the 12–60 kc/s or 60–108 kc/s frequency band as required.

#### SPECIFIED ELECTRICAL PERFORMANCE AND SPECIAL FEATURES

##### *Frequency Response*

The performance of the channel modulators was to be such that the relevant C.C.I.T.T.\* performance limits should be met. Initially, in drafting the specification, it was envisaged that most of the circuits to be provided using the equipment would be point-to-point circuits and performance limits were set fairly wide. Subsequently, it was thought that circuits might be formed by connecting several medium-distance carrier links in tandem and the limits were therefore narrowed to the small proportion of the C.C.I.T.T. overall circuit figures that may be apportioned to one individual equipment.

The reference circuit of the C.C.I.T.T. includes three pairs (transmit and receive) of channel modulation stages.

\* International Telegraph and Telephone Consultative Committee (formerly the C.C.I.T. and C.C.I.F.).

† dbm0—decibels relative to 1 mW when measured at, or referred to, a point of zero relative level (usually the 2-wire point of the circuit).

To ensure that the overall circuit distortion does not exceed that permitted, and assuming no distortion over each channel frequency-band due to other group-frequency equipment, the spread in the gain/frequency characteristic of the transmit and receive equipments should each not exceed one-sixth of the overall figures. There is, however, some scatter in the results obtained from different equipments and the response specified is therefore close to one-quarter of the C.C.I.T.T. figures for the maximum permissible variations in gain/frequency characteristic of a standard 300–3,400 c/s channel. These figures may have to be reviewed in the light of the results obtained because the present trend is to tighten audio-to-audio response limits so as to cater for the larger number of audio translations that may be desirable for economic reasons with subscriber trunk dialling.

##### *Channel Overload-Limiting*

The channel overload-limiting characteristic required was in accordance with that specified for the channel equipment normally used on coaxial and carrier lines. At the channel modulator input when an 800 c/s signal is increased in level from  $-13$  to  $+4$  dbm0† the departure from linearity should not exceed  $\pm 0.3$  db, and as the input level is further increased, the required output level should at no time exceed a level of 9.5 db above the output level obtained with a  $+4$  dbm0 level.

Considerable variations in the limiting characteristic are therefore permissible at input levels beyond the "linear" range. In this medium-distance equipment a biased limiter is used that restricts output levels to a maximum of 2 db above that obtained with a  $+4$  dbm0 input level.

It has been the usual practice to feed channel modulators with a low-level carrier so that the modulators themselves provide the desirable limiting characteristic. The energy of high-level audio input signals is then diverted into unwanted modulation products some of which appear, within the nominal speech band, as second and third harmonics of the input signal. To prevent these harmonics from falsely operating the signalling receiver, which is tuned to 4.3 kc/s, a limiter with a sharp "turn-over" above a level of  $+4$  dbm0 is included in the modulator input. This is followed by a 3.4 kc/s low-pass filter connected before the modulator. Both modulator and demodulator are operated as devices linear with respect to input and output signals so that no significant spurious 4.3 kc/s signalling tones are produced by harmonics of 2.15 and 1.43 kc/s input signals.

##### *Carrier Generation*

One of the desirable features of the medium-distance equipment was that carrier generators should be an integral part of the equipment, thus facilitating ready installation of carrier terminals in small stations. A convenient way of doing this is to use individual crystal oscillators but associated difficulties are the limitation of the number of channels that can be fed from one oscillator without standby facilities, and the relatively large frequency-drift that can occur when using simple oscillators.

The United Kingdom carrier and coaxial network is designed to enable circuits to conform to the C.C.I.T.T. recommendation of a maximum frequency-error of 2 c/s, a limit suitable from consideration of speech and program transmissions, v.f. telegraphy and signalling.



Medium-distance circuits are intended primarily to be suitable for speech transmission. Here frequency errors up to 20 c/s would cause few difficulties while the built-in signalling equipment is, of course, designed to cater for the variations in frequency that could occur in use. On the basis of a monthly maintenance adjustment of oscillator frequency the maximum variation that should occur is 3 c/s so that the greatest frequency error occurring over a point-to-point link should be 6 c/s. In the exceptional case of two or more links being used in tandem together with certain external, in-band, signalling equipment, signalling failure could occur under adverse conditions.

Although medium-distance equipment was intended for operation with the integral carrier generators the use of an alternative higher-power carrier source controlled by a master oscillator was not ruled out. This would yield the advantages of cheapness when supplying many carrier terminal equipments and greater frequency stability. The stability of the present integral carrier oscillators would have to be improved if there were any considerable scale of provision of this carrier equipment in the main trunk network as, in the normal way, channel translations are not expected to make any material contribution to the overall 2 c/s permissible error. Another version of the equipment, shortly to be made available by the manufacturer, will provide all carriers synchronized with a master oscillator; the maximum error with this equipment will be approximately 0.1 c/s.

### Signalling

The basic requirements and the design of signalling equipment for use over carrier channels that include a built-in out-band signalling path have been described in detail elsewhere.<sup>3</sup> In this carrier equipment the signalling frequency was made 4.3 kc/s so as to lie conveniently in the gap between the top audio frequency of 3.4 kc/s and the adjacent virtual carrier frequency, corresponding to 6 kc/s in the channel.

The normal signalling level is at -20 dbm0 but the equipment will continue to work, though not with the same distortion limits, over the range of levels +3 db to -10 db relative to normal. This large range of possible working levels is required to take into account the permissible change of 2 db in transmission equivalent of a working circuit as well as the variations from setting-up level due to changes in the gain/frequency characteristic of the interconnecting 60-108 kc/s line link.

Large changes in the response over the group frequency band would only occur under adverse conditions and with several links in tandem. It is, however, a principle that channels that would be adequate for a speech transmission should, if possible, not fail because of a signalling failure.

The maximum permissible overall distortion of a 10 p.p.s. signal, applied at the end of a specified tie circuit connected to the modulator static relay, when measured between the output of the initial pulsing relay and the contacts of the distant signalling relay, is  $\pm 2.5$  ms. This distortion limit applies with a variation in the transmission equivalent of the circuit of +3 to -7 db from nominal.

Various other signalling requirements were specified, such as the facility of being able to work with signalling

tone either "on" or "off" during non-signalling periods to enable common designs of exchange relay-sets to be used where possible.

The distortion limit of  $\pm 2.5$  ms allows for the connexion of two of these links in tandem with d.c. repetition at the interconnexion point. Where more than two links are needed in tandem, consideration would have to be given to the use of in-band a.c. signalling.

### Power Supplies

Power supplies in repeater stations are normally either fully-guarded a.c. supplies at 240 volt  $\pm 1.5$  per cent, or 21-volt regulated, 24-volt unregulated and 130-volt battery supplies; in some stations a 50-volt battery supply for the operation of relays is also available.

It had been hoped that it would have been possible to have common forms of rack-side for the two types of power supplies, and indeed for the panels also to be equally suitable after only minor changes in the strapping of heater-circuit wiring. The battery h.t. voltage could be made 154 volts by using the unregulated 24-volt supply in series with the 130-volt supply, and this was suitable for either a.c. or d.c. type panels but the difficulties in accommodating 6.3-volt a.c. or 21-volt d.c. heater-supplies were such that two series of equipment were necessary.

### Standby Equipment and Alarms

The provision of standby equipment for working channels depends on the number of channels that would be affected by an equipment failure, the likelihood of such a failure and the importance of the circuits carried. It was thought to be a useful compromise to have automatic-change-over standby oscillators for the 120 kc/s group modem carrier supply where eight or more channels may be affected by a failure, but to use simple individual oscillators for the channel supplies, where a maximum of only five channels could fail with failure of one oscillator. In the later version of the equipment automatic change-over to a standby equipment is provided on the failure of any channel, group or pilot supply.

There is a further 60 kc/s supply, derived by division from the 120 kc/s group modem carrier frequency, that is provided when required for supplying a continuous line pilot in those installations where no other 60 kc/s source is provided. Full standby facilities are always needed when this supply is provided.

The alarm system was left as simple as possible, the only faults that would give rise to a station alarm under normal working conditions being a power-supply or fuse failure and a change-over of a 120 kc/s or a 60 kc/s oscillator.

*(To be continued)*

### References

<sup>1</sup> HORSFIELD, B. R., and SMITH, D. C. A.C. Signalling—A Review of Current Problems. *I.P.O.E.E. Printed Paper No. 204*, 1952.

<sup>2</sup> CHILVER, L. W. J., and WATKINS, A. H. New Line Transmission Equipment. *P.O.E.E.J.*, Vol. 49, p. 12, Apr. 1956.

<sup>3</sup> HORSFIELD, B. R., GIBSON, R. W., and MILLER, C. B. Signalling Over Carrier Channels that Provide a Built-in Out-of-Speech-Band Signalling Path. *P.O.E.E.J.*, Vol. 50, pp. 76 and 165, July and Oct. 1957.

<sup>4</sup> HARRIS, E. T. C., and SPRATT, C. J. An Improved Form of Mechanical Construction for Transmission Equipment—51-Type Construction. *P.O.E.E.J.*, Vol. 51, p. 197, Oct. 1958.

# The Generation of Stable Carrier Frequencies in the Range 3,800–4,200 Mc/s

R. J. D. SCARBROUGH, B.Sc.(Eng.), A.M.I.E.E., K. H. FERGUSON, and A. W. SEARLS†

U.D.C. 621.373.421.14.029.64

The performance requirements of carrier generators for use with microwave communication systems are briefly considered and a microwave precision-cavity-controlled triode oscillator and a quartz-controlled carrier source are described. Both generators have been designed for operation in the frequency band 3,800–4,200 Mc/s and their suitability for incorporation in microwave communication systems is discussed.

## INTRODUCTION

A MICROWAVE communication system operating in the region of 4,000 Mc/s and carrying four multi-channel telephone supergroups has been described in this Journal.<sup>1</sup> The microwave carrier source used is a reflex-klystron oscillator which is electromechanically servo-controlled to the frequency of a reference cavity-resonator. S.H.F. oscillators of this type are in current use and have given satisfactory service. However, this particular form of automatic frequency-control is rather complicated and has a higher fault incidence than is considered desirable. It is for this reason, and also because it is probable that future requirements will demand an improved frequency stability, that consideration has been given to alternative carrier sources in which the frequency is directly controlled by a cavity or quartz-crystal resonator. The commercial availability of microwave triode valves has provided new scope in the application of frequency multiplication and controlled oscillators to microwave carrier generation.

Before proceeding with a description of the techniques employed, it is appropriate to mention the importance of carrier-frequency stability in relation to the performance of microwave communication systems. It will be evident that a drift in the microwave carrier frequency or in the local oscillator frequency will displace the baseband signal so that it becomes asymmetrically placed in the pass-band of i.f. and s.h.f. filters. If the system has to accommodate wide frequency variations the uniformity of the pass-band group-delay/frequency characteristics of these filters must be extended beyond limits which are considered reasonable. It is equally important that the microwave carrier sources should have a good short-term frequency stability\* since any residual phase modulation will be transferred to the baseband and can seriously degrade the signal/noise ratio of the baseband channels. A careful examination of these factors has fixed the acceptable limits of the long-term and short-term carrier stability as  $\pm 25$  parts and 0.1 part in a million, respectively. A carrier generator should meet this specification and be able to supply a 50 mW carrier level at any frequency within the communication band 3,800–4,200 Mc/s.

## A TRIODE AMPLIFIER AND CIRCUIT AT MICROWAVE FREQUENCIES

Microwave triodes are usually of the "disc-seal" type<sup>2,3</sup> where each electrode is built into a radial copper fin fused to the glass envelope. This form of construction enables the capacitance and lead inductance associated with the valve electrodes to be usefully integrated with

the external tuned circuit. The effects of finite electron transit time, which can seriously curtail the high-frequency amplification of a valve, are reduced by keeping the grid-cathode spacing to a minimum. The VX3061 is a typical microwave triode<sup>3</sup> which has been used with the grounded-grid amplifier shown in the lower part of Fig. 1.

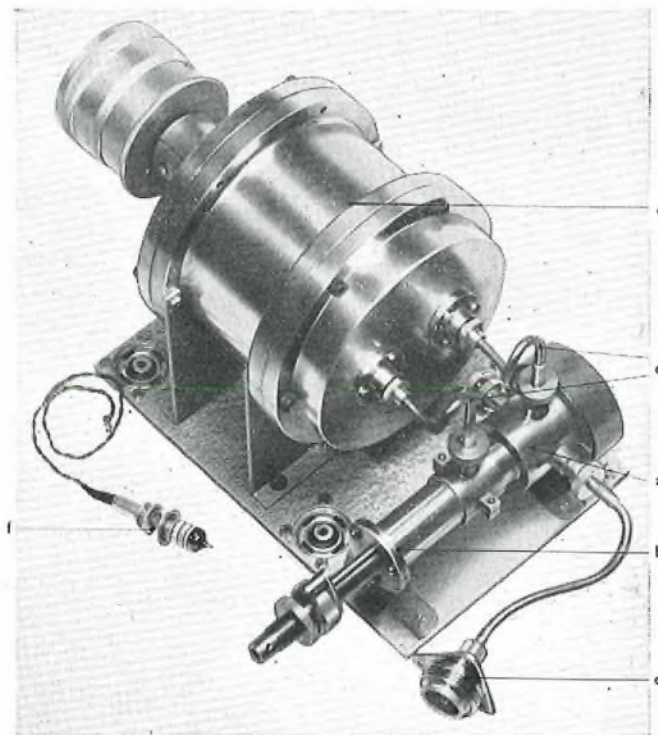

(a) Anode line of amplifier  
(c) Control cavity  
(e) Oscillator output  
(b) Cathode line of amplifier  
(d) Coaxial coupling leads  
(f) Microwave triode valve

FIG. 1—CAVITY-CONTROLLED OSCILLATOR

The principal dimensions and performance of this valve are summarized as follows:

Grid-cathode spacing	0.035 mm
Grid wire diameter	0.010 mm
Grid pitch	546 turns per inch
Planar cathode diameter	4 mm.

Amplification in the circuit shown in Fig. 1 operating at 4,000 Mc/s with a band-width of about 30 Mc/s:

- (a) 12 db with an output of 100 mW
  - (b) 9 db with an output of 1 watt
- Maximum anode dissipation of 10 watts

Often the most suitable choice of inductive circuit-element at microwave frequencies is a short-circuited length of coaxial transmission line.<sup>4</sup> If the line length  $l$

† The authors are, respectively, Executive Engineer and Assistant Engineers, Post Office Research Station.

\* The short-term frequency-stability of a microwave carrier is most suitably expressed in terms of the peak carrier-frequency deviation arising from noise and hum-derived phase modulation.



is less than a quarter wavelength,  $\lambda/4$ , the input reactance,  $X$ , will be inductive and is given by  $X = jZ_0 \tan(2\pi l/\lambda)$  where  $Z_0$  is the characteristic impedance of the line. This reactance will be repeated as the line is increased by half wavelengths ( $n\lambda/2$ ) and thus permits a choice of multiple line-lengths. When such a line is connected between the anode and grid electrodes of a valve it will become resonant with the inter-electrode capacitance  $C$ , such that  $1/\omega_0 C - Z_0 \tan(2\pi l/\lambda) = 0$ , where  $\omega_0$  is the angular frequency of resonance. It will be evident that this arrangement behaves as a parallel-tuned resonant circuit at frequencies close to the frequency ( $\omega_0/2\pi$ ) of operation. The main advantage of such an arrangement is that the circuit is completely shielded and prevents both power loss and interference by radiation. The values of Q-factor for such a line will vary between 200 and 1,000 depending on the circuit losses and the external damping.

The lower part of Fig. 2 gives a diagrammatic representation of the amplifier circuit associated with the VX3061 triode. The input and output resonant lines have

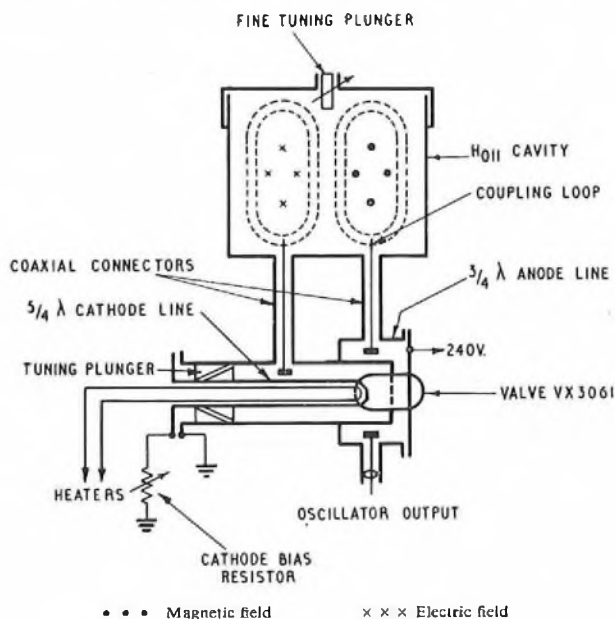

FIG. 2—DIAGRAMMATIC REPRESENTATION OF THE CAVITY-CONTROLLED OSCILLATOR

lengths approaching  $5\lambda/4$  and  $3\lambda/4$  respectively. For convenience of construction the output line has been folded back and surrounds the input line. The cathode line is tuned by displacing a short-circuiting plunger which varies the effective length of the line. The anode line is tuned by a small screw which presents an effective capacitance across the resonant line. It will be seen that both lines are arranged to include a low-impedance gap which provides d.c. isolation of the anode and cathode without noticeably affecting its high-frequency operation. A similar amplifier circuit with an extended cathode line has been used for operation at longer wavelengths so that the valve can be employed as a frequency multiplier.

#### A CAVITY-CONTROLLED OSCILLATOR

In general, an oscillator can be considered as an amplifier with a feedback path so phased that the voltage returned to the amplifier input will sustain a circulation of energy. If the feedback path includes

a tuned circuit with a Q-factor very much greater than the Q-factor associated with other circuits in the path it will exercise predominant control of the frequency of oscillation. This frequency will correspond closely to the resonant frequency and have the stability of the high-Q circuit. In the design of stable oscillators operating at lower frequencies a quartz-crystal resonator is generally the most suitable choice of control element.

At microwave frequencies the counterpart of a high-Q tuned circuit is found in the cavity resonator. Fig. 2 shows how the microwave triode amplifier previously described has been associated with a cylindrical-cavity resonator to provide a stable microwave oscillator. This control cavity operates in the  $H_{011}$  mode<sup>5</sup> and was machined from an ingot of special steel (e.g. Invar, Nilo 36, or Permant steel) chosen for its low temperature-coefficient of expansion. Its construction is rigid in form with a wall thickness of  $\frac{3}{8}$  in. to provide good mechanical and thermal stability. The cavity has been sealed and filled with dry air to ensure that its resonant frequency is independent of permittivity changes arising from variations in atmospheric humidity and temperature.<sup>5</sup> The interior surfaces are plated with silver and are polished to give a good optical reflecting surface. The resulting high surface conductivity is necessary to achieve the highest Q-factor. An unloaded Q-factor of 44,000 was realized, which represents about 90 per cent of the theoretical maximum. The loaded Q-factor is 22,000 and is at least 44 times the Q-factors associated with the anode and cathode tuned lines of the amplifier circuit.

The cavity is provided with two small loops coupling with the electromagnetic field, and is connected to the anode and cathode tuned lines by the short coaxial lines shown in Fig. 1. The lengths of these connecting lines are adjusted, in conjunction with the anode-line and cathode-line tuning, to ensure the correct phasing of the feedback circuit. A second probe outlet coupled to the tuned anode-line is connected to the oscillator load by another coaxial line. The control cavity and amplifier form the basic unit of the microwave carrier source shown in Fig. 3. The power supplies for the oscillator are stabilized to reduce changes in the frequency of oscillation produced by variations in the value of valve parameters. The spurious phase modulation has been further reduced by the use of d.c. heater supplies.

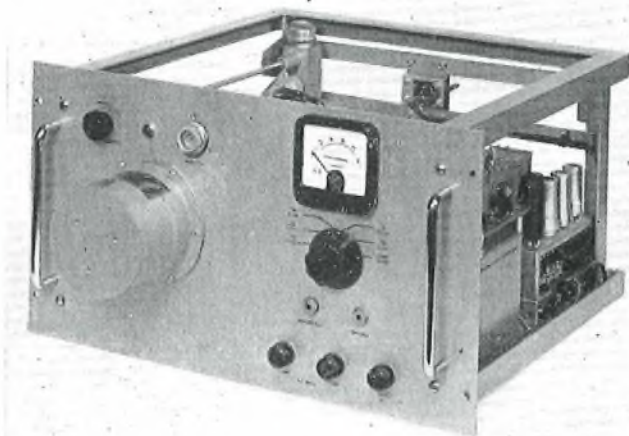

FIG. 3—CAVITY-CONTROLLED MICROWAVE CARRIER SOURCE



### Performance

In general, the noise band-width\* of an oscillator decreases as the effective Q-factor (usually called the loaded Q-factor of the circuit) is increased. The loaded Q-factor in this instance is about 22,000 and a noise band-width less than one part in ten thousand million of the carrier frequency is expected. The most convenient technique for estimating the phase modulation of an oscillator is to use a frequency changer and low-frequency spectrum analyser. This presents a problem in that the observed spectrum will include a contribution from the "beating" oscillator. A series of comparisons with crystal-controlled carriers indicates that the effective noise band-width of the oscillator is less than 25 c/s. This high degree of spectral purity is considerably better than is required for microwave systems and is particularly useful when the oscillator is employed as a "noise-free" reference. The long-term frequency stability is largely dependent on the changes with temperature of the resonant frequency of the cavity. In the temperature range 20-40°C the change in frequency of this oscillator is 2.5 parts in a million per degree centigrade. This low value of coefficient is obtained only after the cavity has had a cyclic heat treatment, but is still equivalent to about twice the value expected from the temperature-coefficient of expansion of the material used for the cavity walls.

### A QUARTZ-CONTROLLED MULTIPLIER CHAIN

Techniques of frequency multiplication are well established in the field of short-wave communication. When a triode valve amplifier is biased well beyond cut-off and driven with a large sinusoidal input voltage, the anode current will flow in pulses of short duration. These pulses are rich in harmonics, which can be individually selected by tuning the anode circuit to the appropriate resonant frequency. This technique can be extended to microwave frequencies by the use of suitable valves and resonant circuits. It will be seen that the last stage of the multiplier chain shown in Fig. 4 uses a triode VX3061 as a frequency tripler with the input driven at 1,350 Mc/s and with the output circuit tuned to select the third harmonic at 4,050 Mc/s. In the equipment shown in Fig. 5 a quartz crystal, oscillating at 50 Mc/s in an oven, provides the basic frequency control. This oscillator drives four successive frequency triplers and provides a carrier source at 4,050 Mc/s. It

\* The noise band-width of an oscillator is defined as the frequency interval between the half-power points of the power output/frequency spectrum.<sup>6</sup>

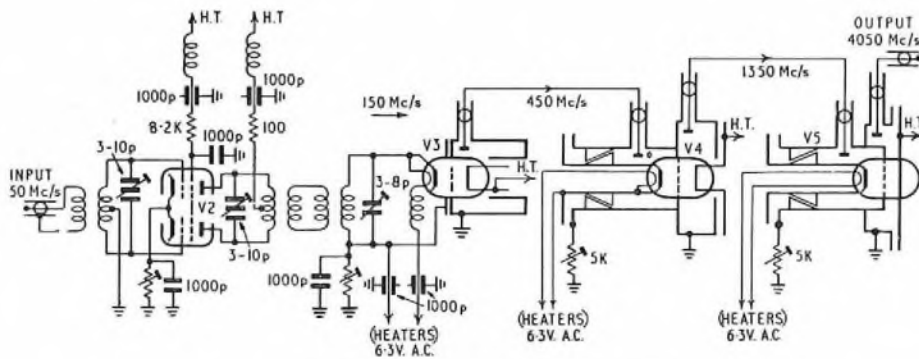

V2—QQV02-6; V3 and V4—CV354; V5—VX3061  
FIG. 4—BASIC CIRCUIT OF 50/4,050 Mc/s MULTIPLIER

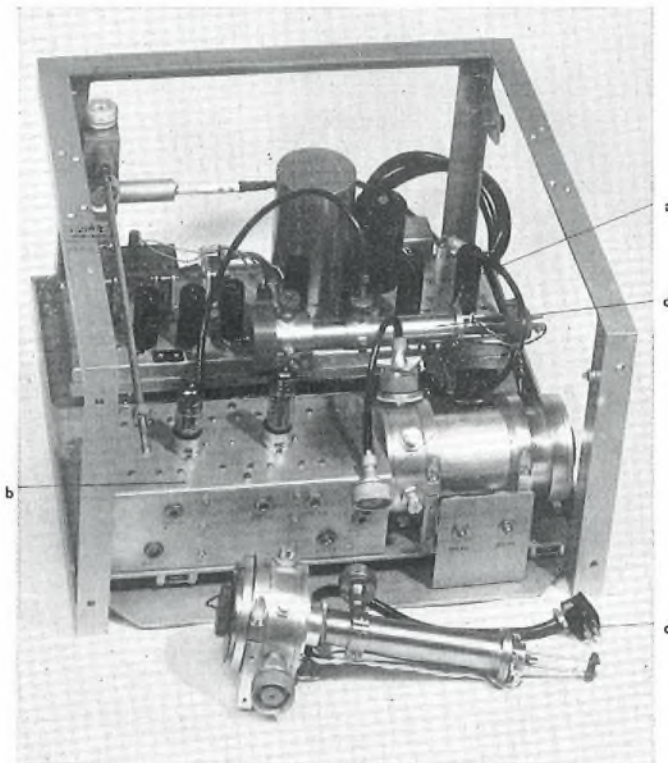

(a) 50 Mc/s quartz crystal in oven (sub unit)  
(b) 50-450 Mc/s frequency multiplier  
(c) 450-1,350 Mc/s frequency multiplier  
(d) 1,350-4,050 Mc/s frequency multiplier

FIG. 5—QUARTZ-CRYSTAL-CONTROLLED MICROWAVE CARRIER SOURCE (INTERIOR VIEW)

will be seen from Fig. 4 that the change from lumped circuit-elements to coaxial lines for the tuned circuits occurs at the 150/450 Mc/s stage. At and below the frequency of 150 Mc/s the physical length of a resonant line would exceed 15 in. and it is more convenient to use lumped-element resonant circuits. At and above the frequency of 450 Mc/s the stray capacitance and lead inductance form an appreciable part of the composite tuned circuit. Without the use of line techniques it then becomes difficult to realize the small additional inductance and capacitance required to obtain a parallel tuned circuit with reasonable Q-factor.

### Performance

Extended frequency measurements have shown that the long-term stability of the quartz-crystal-controlled carrier source is identical with that of the quartz-crystal driving oscillator and is better than one part in a million. In considering the short-term stability of a frequency-multiplier chain it will be realized that each valve is a potential phase modulator and that the early stages will make the largest contribution to the final phase modulation. In this equipment particular care has been taken to stabilize the h.t. supply and the stages up to 150 Mc/s are operated with d.c. heater supplies to reduce the

phase modulation and thus to improve the output spectral purity. These measures have improved the short-term stability to one part in a hundred million, which is more than adequate for the present microwave communication systems. However, it is anticipated that a further overall improvement could be realized by reducing the operating frequency of the crystal oscillator and incorporating a further stage of frequency multiplication. It would be necessary, however, to compromise between the improved short-term stability of the crystal oscillator operating at the lower frequency and the phase modulation introduced by the additional multiplier stages.

#### CONCLUSION

The triode oscillator offers an improved stability over the electromechanically servo-controlled reflex-klystron oscillator but it would require additional temperature compensation to equal the long-term stability of the quartz-crystal-controlled carrier frequency source. The main merit of the triode oscillator is its basic simplicity, which will reduce maintenance problems. At present, however, it is, basically, a fixed-frequency source which requires painstaking phasing during the initial alignment period. For these reasons it seems likely that the application of this type of oscillator will be restricted to laboratory use as a reference source of high spectral purity. With the quartz-crystal controlled carrier source the present performance appears to be superior to the requirements of the multi-channel systems envisaged at the moment. It is almost certain, then, that the carrier frequencies of future systems will be quartz-crystal-controlled and in the case of carrier sources for present microwave communication systems the performance can

be relaxed. This will result in a worthwhile reduction in the size and cost of the quartz-crystal-controlled carrier generation equipment described.

#### ACKNOWLEDGEMENTS

The authors wish to express their appreciation of the help given by Mr. F. G. Clifford in the preparation of this article and to acknowledge the work of Mr. R. L. O. Tattersall in the early development of the triode oscillator. They also acknowledge the assistance of Messrs. K. Groves and P. Hefford who developed the crystal oscillator. The triode valve VX3061 and its amplifier circuit were developed at the G.E.C. Research Laboratories, Wembley, under the auspices of the Co-ordination of Valve Development Committee (Admiralty) to meet a Post Office specification.

#### References

- <sup>1</sup> CORKE, R. L., and others. A 4,000 Mc/s Radio System for the Transmission of Four Telephony Supergroups (240 Circuits). *P.O.E.E.J.*, Vol. 50, p. 106 and 150, July and Oct. 1957.
- <sup>2</sup> WHITE, R. W. A Survey of Modern Valves: Part 5.—Valves for Use in the Range 30–3,000 Mc/s (Bands 8 and 9). *P.O.E.E.J.*, Vol. 43, p. 78. July 1950.
- <sup>3</sup> BRAY, W. J. A Survey of Modern Valves: Part 6 (a).—Valves for Use at Frequencies above 3,000 Mc/s. *P.O.E.E.J.*, Vol. 43 p. 148. Oct. 1950.
- <sup>4</sup> REICH, H. J., ORDUNG, P. F., KRAUSS, H. L., and SKALNIK, J. G. Microwave Theory and Techniques (Van Nostrand Series, 1953), Chap. 9.
- <sup>5</sup> TATTERSALL, R. L. O. Frequency Meter Operating in the  $H_{011}$  Mode in the Range 3,975–4,275 Mc/s. (In this issue of the *P.O.E.E.J.*).
- <sup>6</sup> EDSON, W. A. Vacuum Tube Oscillators (Wiley, 1953). Chap. 15.

---

## Book Review

“Basic Electrical Engineering.” J. Shepherd, B.Sc., A.M.I.E.E., A. H. Morton, B.Sc., A.M.I.E.E., A.M.Brit.I.R.E., and L. F. Spence, B.Sc., A.M.I.E.E. Sir Isaac Pitman & Sons, Ltd. 310 pp. 220 ill. 27s. 6d.

This book has been prepared mainly to suit the needs of students studying for the Ordinary National Certificate in Electrical Engineering. The work follows the main lines of the new London University Part 1 syllabus in Electrical Engineering and the Intermediate Standard in the City and Guilds of London Institute Electrical Engineering Practice examination.

Nine chapters deal with units and simple circuits, elements of electromagnetism, elementary instruments and measurements, capacitance and electrostatics, single-phase a.c. circuits, simple three-phase circuits, the d.c. machine, transformers and elementary electronics. The text of the book adopts the rationalized M.K.S. units, there being no reference to the C.G.S. system.

Any addition to the present range of text books in this field must be judged on new material, scope and presentation. No new material is included in the present book except perhaps the adoption of the M.K.S. system of units throughout. From a student's point of view, however, the book has merit in presentation as numerous excellently solved and illustrated examples are set throughout the book. These examples are carefully selected to stress basic principles to students. Each chapter ends with a set of

examples (with answers) taken from Ordinary National Certificate and London University examination papers.

Due perhaps to the limitation in size of book, or possibly due to the participation of three authors, the book is a little unbalanced. The chapters on units and simple circuits, elements of electromagnetism, and single-phase a.c. circuits, are excellent. The chapters on d.c. machines, transformers and elementary electronics, however, are not of the same high standard. That on d.c. machines is not sufficiently lucid for student purposes. It contains a number of errors (a particularly unfortunate one being Fig. 7.17 which shows poles of unequal width and brushes unequally spaced). The chapter on transformers is too brief, being limited to a very basic treatment in four pages. There is no mention of no-load condition, losses, or regulation. The chapter on elementary electronics is limited to an elementary treatment of a few aspects (i.e. simple valve theory, diode rectification, simple triode valve and triode valve amplifier treatment, simple cathode-ray tube treatment). This scope hardly justifies the title “elementary electronics.” It is admittedly difficult to give an elementary treatment of the vast field of modern electronics. Selection must be made. If, however, material on electronics is to be included in a book of this nature, it deserves a fuller scope, and a general introductory treatment of a wider field than that given is, perhaps, called for.

The book is well produced, the diagrams are clear and well drawn and fit excellently with the text.

S. W.



# Frequency-Meter Operating in the $H_{011}$ Mode in the Range 3,975–4,275 Mc/s

R. L. O. TATTERSALL, A.M.I.E.E.†

U.D.C. 621.317.761:621.372.413

A description is given of the design and construction of a cavity frequency-meter covering the range 3,975–4,275 Mc/s and having an accuracy of 1 part in  $10^6$ . It is hermetically sealed and has an average Q-factor of 16,000. The model described is the prototype for a series of three frequency-meters covering the range 3,625–4,250 Mc/s in overlapping ranges of 225 Mc/s each.

## INTRODUCTION

CAVITY frequency-meters are used in microwave communication systems to check the accuracy of the frequencies of the local oscillators associated with the transmitting and receiving equipments. They are also used during the adjustment, prior to installation, of waveguide filters and other microwave components. Consider, for example, a multi-channel frequency-modulated system. An error in the frequency of one of the microwave oscillators will shift the mean frequency of the signal away from the centre frequency of the filters, and the phase characteristic will no longer be symmetrical about the mean signal frequency. This will increase the distortion, and the increased intermodulation between channels will degrade the signal/noise ratio. A maximum frequency difference of  $\pm 1$  Mc/s between the transmitter and receiver is accepted as satisfying the signal/noise ratio requirements. The frequency of each oscillator must, therefore, be correct to  $\pm 0.5$  Mc/s, or approximately 1 part in  $10^4$  at 4,000 Mc/s. The

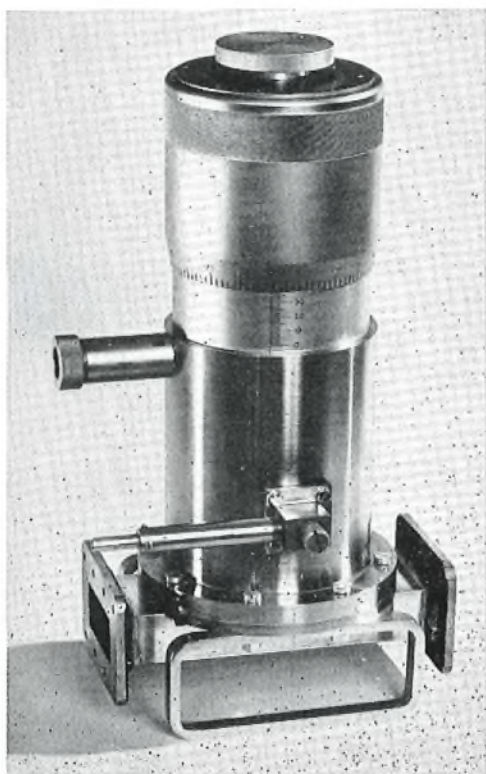

FIG. 1— $H_{011}$  CAVITY FREQUENCY-METER, 3,975–4,275 MC/S

frequency-meters used to measure these signals should, for preference, be accurate to one order better than the tolerance of the oscillator frequency. The meter described is shown in Fig. 1, and covers the range 3,975–4,275 Mc/s with a reading accuracy of 1 part in  $10^6$ . It is the prototype for a series of three frequency-meters covering the range 3,625–4,250 Mc/s.

## GENERAL DESIGN CONSIDERATIONS

A cavity frequency-meter consists essentially of a tunable cavity resonator which is loosely coupled to the source of frequency to be measured and to a detector circuit (see Fig. 2). The resonator is tuned by adjusting

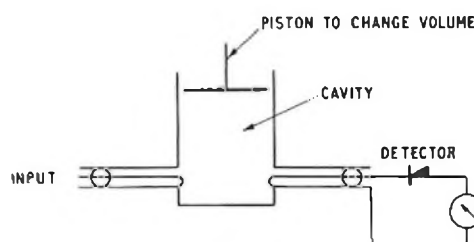

FIG. 2—PRINCIPLE OF CAVITY FREQUENCY-METER

the volume of the cavity and the accuracy depends upon various electrical and mechanical design factors which will be considered briefly.

Electrically the resonator is rather similar to a tuned LC circuit and the sharpness of its resonance may be expressed using the Q-factor, given by:

$$Q = 2\pi f_r \frac{W}{P}$$

where  $f_r$  = frequency of resonance, in cycles per second,  
 $W$  = mean energy stored in the resonator, in joules,  
 $P$  = energy dissipation per second, in watts.

The sharpness of resonance may also be defined in terms of the band-width between the points on either side of resonance at which the voltage or current response is 0.707 of the maximum response. The band-width between these "3 db points" is given by:

$$Q = \frac{f_r}{\Delta f}$$

where  $\Delta f$  = band-width.

The resolution is determined by the reduction in response at the detector as the frequency meter is tuned away from resonance. The response using a square-law detector will fall by 4 per cent when the cavity is detuned by  $1/10Q$  of the resonant frequency. A Q-factor of 10,000 should therefore be adequate to obtain the required reading accuracy of 1 part in  $10^6$ .

Changes of ambient temperature and of atmospheric pressure and humidity will affect the precise frequency of resonance unless precautions are taken. The resonant frequency will be reduced by thermal expansion of the cavity. For example, if the walls are made of brass with

† Senior Executive Engineer, Post Office Research Station.



a coefficient of linear expansion of  $19 \times 10^{-6}$  per degree Celsius, a temperature change of  $5^\circ\text{C}$  will alter the resonant frequency by 1 part in  $10^4$ . The anticipated working temperature range is  $10^\circ\text{C}$  to  $32^\circ\text{C}$  so that temperature correction curves or tables would be necessary for a brass cavity. The need for correction can be avoided by using a low-coefficient material such as Invar steel, which has a coefficient of expansion of only  $1 \times 10^{-6}$  per degree Celsius. The first experimental model was in fact constructed of brass, but a special steel with a low coefficient of expansion is used for the final design.

If the cavity is open to the atmosphere the resonant frequency will vary slightly with changes of barometric pressure, temperature and humidity, since these all affect the permittivity of the dielectric contained in the cavity. The permittivity depends upon the density and proportions of dry air and water vapour present in the cavity. Dry air has a permittivity of 1.0006 at N.T.P. and water vapour one of 1.008 (corrected to N.T.P.); the permittivity of a mixture varies linearly between the two values, so the value at a given temperature and relative humidity may be found with the aid of a table of saturated vapour pressures. The variations in resonant frequency due to humidity changes are given in Table 1.

TABLE 1  
Effect of Relative Humidity on Resonant Frequency

Temperature	$10^\circ\text{C}$	$20^\circ\text{C}$	$30^\circ\text{C}$	$40^\circ\text{C}$
Frequency change (parts in $10^6$ ) for relative humidity change from 0% to 100%	- 4.4	- 8.3	- 15	- 26

Thus an increase in relative humidity from 40 to 90 per cent at  $20^\circ\text{C}$  would reduce the frequency by over four parts in  $10^6$ . The density of the air, and hence the permittivity, vary with atmospheric pressure and temperature. An increase in frequency of 1 part in  $10^6$  would be caused by a rise in temperature of 20 degrees or by a reduction in pressure of 1 in. of mercury.

The need for corrections for the effects of atmospheric changes can be avoided by hermetically sealing the resonator. However, the density of the air inside the cavity will vary with the piston setting since the air will be compressed as the piston and the sealing bellows move inwards. (See Fig. 9 for construction.) This produced a frequency error of 2.5 parts in  $10^6$  for the experimental cavity over the range of piston movement, but, provided no leaks occur, the error is absorbed in the calibration.

The mechanical design of the frequency meter must be adequate to give the required reading accuracy of 1 part in  $10^6$ , and a long term accuracy of 2.5 parts in  $10^6$ . It must be possible to adjust the position of the piston smoothly and without appreciable backlash, so that, in terms of frequency change, it can be set readily to 1 part in  $10^6$ . Considerable forces have to be overcome in a hermetically sealed cavity and the micrometer threads have to be carefully designed and well finished to reduce wear to acceptable limits. Cyclic errors may be caused by eccentric movements in the mechanical drive, or by cyclic errors in the pitch of the screw threads. They will be absorbed in the calibration, but the work of calibrating the frequency meter is much simplified if such errors are made negligible.

#### MODE OF OSCILLATION IN CAVITY

Any closed volume with continuous conducting walls will behave as a resonator at certain frequencies. The major source of imperfection leading to a finite Q-factor is the loss in the conducting walls. Generally speaking, the best Q-factor for a cavity of given volume and given material will be obtained when the ratio of the volume to the superficial area of the walls is a maximum, i.e. with a spherical cavity. However, a cylinder with closed ends of length approximately equal to the diameter is the best practical approximation when an adjustable high-Q resonator is required, and it is much favoured for cavity resonators.

The cylindrical cavity can be considered to be a section of waveguide half a wavelength long, terminated at each end by reflecting walls. Electromagnetic waves are reflected to and fro, and the wave motion in the cavity is the result of adding together the instantaneous fields of two similar waves travelling in opposite directions. The phase relations, neglecting losses, are such that at one instant the magnetic fields of the two waves will add together while the electric fields cancel out. A quarter of a cycle later the electric fields add while the magnetic fields cancel out. The stored energy is alternately stored in a magnetic field and then in an electric field, as in a resonant LC circuit.

A cavity is capable of supporting a large number of modes of oscillation, each having a different wave pattern and frequency. If an unwanted mode falls within the frequency range of the frequency meter, ambiguity may result from tuning the cavity to this response instead of to the main response for which it is calibrated. Generally, the frequency/dial-reading curves of the main and unwanted responses have different slopes, and occasionally cross each other. A "crossover" within the tuning range can cause serious ambiguity and

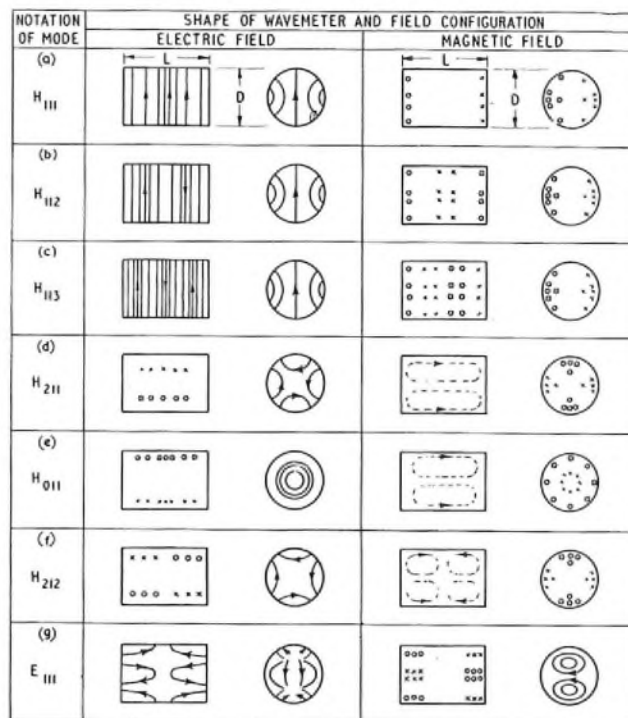

Electric and magnetic fields are in time quadrature if the effects of losses be neglected  
FIG. 3—SOME MODES OF OSCILLATION IN A PERFECT CYLINDRICAL CAVITY

changes in sensitivity, and indeed the suppression of unwanted modes and the avoidance of "crossovers" are major problems in the design of a high-precision cavity frequency-meter.

The configurations of some of the modes possible in a cylindrical cavity are shown in Fig. 3. At (a) the mode of oscillation is such that at one instant (neglecting losses) the whole of the energy is stored in the electric field. A quarter of a cycle later the energy has been transferred into the circular magnetic field ringing the position previously occupied by the electric field. This process is repeated over the next half-cycle with the polarities reversed, and so on. At (b) the same pattern is repeated twice along the length of the cavity, and at (c) three times. The notation shown in the left-hand column of Fig. 3 is a convenient method of describing modes of oscillation in both cylindrical and rectangular cavities. Some points are common to the two cases, but, to avoid confusion, cylindrical cavities only are considered here. The following descriptions are not rigid definitions<sup>1</sup> but they will give a useful picture of the system.

The letter H means that there is a component of magnetic field along the length of the cavity, while the electric field is purely transverse; E refers to the converse conditions. In general the E modes do not cause much interference in a cavity designed to use an H mode. The first figure refers to half the number of times the field changes polarity along a radius sweeping once round the circular section of the cavity. For example in the H<sub>111</sub> mode the polarity changes twice, in the H<sub>211</sub> mode four times, while in the H<sub>011</sub> mode there is no change. The second figure indicates the number of times the pattern is repeated from the centre to the sides of the cavity. Higher-order modes of this type have frequencies well above the range of the frequency meter and only the order 1 need be considered here. It will be seen from (a), (b) and (c) of Fig. 3 that the last figure refers to the number of times the pattern is repeated along the length of the cavity.

It has been shown<sup>2</sup> that the H<sub>01n</sub> modes require the least volume for a given frequency and Q-factor. At 4,000 Mc/s, the H<sub>011</sub> mode gives a sufficiently high Q-factor for the present design and although it requires a fairly large cavity the size is not unmanageable. The optimum Q-factor for the H<sub>011</sub> mode occurs when the diameter and length are equal. Knowing the mode of oscillation, the dimensions of the cavity, and the depth of penetration of current in the walls, the maximum attainable Q-factor can be calculated. The depth of penetration depends upon the resistivity of the material and the frequency of oscillation and, for a silver-plated cavity, is  $1.01 \times 10^{-4}$  mm at 4,000 Mc/s. The theoretical Q-factor is 49,000, but in practice it is reduced to about 16,000 probably due to losses in the E<sub>111</sub> mode which theoretically has the same frequency as the H<sub>011</sub> mode at all settings of the frequency meter. The loading of the input and output circuits also reduces the Q-factor.

An inherent advantage of the H<sub>011</sub> mode is that the wall currents circulate round the axis of the cylinder. No currents flow across the joint between the end plate and the cylinder, because there is no e.m.f. from the field in this direction, and additional dissipation is not caused by the joint. Indeed, a gap can be deliberately introduced between the piston or plunger used to tune the cavity and the cylinder, without interfering with the wanted mode for, besides avoiding troubles associated

with moving contacts, this tends to suppress unwanted modes which require conduction across the gap. The piston used to tune the cavity has a sliding action to minimize the possibility of cyclic errors which would be difficult to avoid if the piston were rotated as it moved in and out.

#### CHOICE OF DIMENSIONS

The relationship between frequency, diameter and length for the cylindrical modes can be shown con-

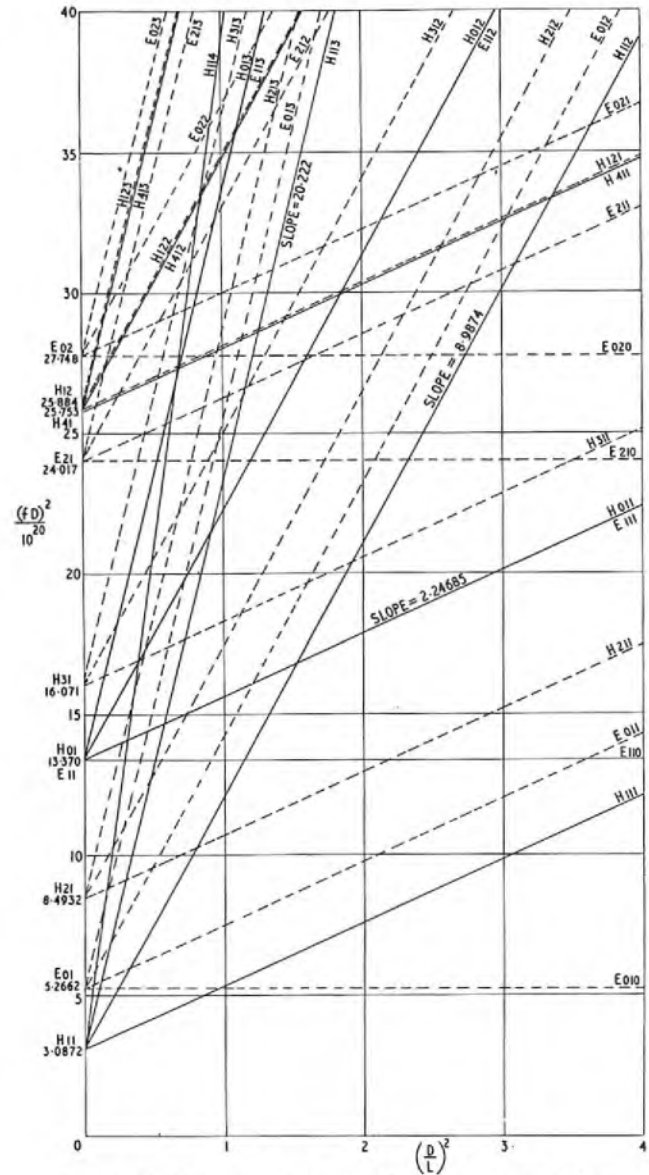

FIG. 4.—PERFECT CYLINDER RESONANCES (MODE CHART)

veniently in the form of a mode chart (Fig. 4). Each curve is a straight line of the form:<sup>3</sup>

$$(fD)^2 = A + B \left(\frac{D}{L}\right)^2$$

where  $f$  = frequency (c/s)

$D$  = diameter (cm)

$L$  = length (cm)

and  $A$  and  $B$  are constants.

For the  $H_{011}$  mode

$$A = \left( \frac{3.832c}{\pi} \right)^2$$

and  $B = \left( \frac{c}{2} \right)^2,$

where  $c =$  velocity of light  $= 2.9979 \times 10^{10}$  cm/s *in vacuo*. (The velocity is approximately 0.03 per cent less in dry air.)

The figure 3.832 is a root of a Bessel function, and can be calculated to any required degree of accuracy. This type of equation forms the basis of a method of measuring the speed of light in terms of the dimensions and resonant frequency of a cylindrical cavity.<sup>4</sup>

The optimum ratio of diameter to length is influenced by three factors:

(a) Dependence of the Q-factor of the cavity upon the ratio  $D/L$ ,

(b) Interference from other modes of resonance, and

(c) The rate of change of frequency with length.

The Q-factor is not greatly affected by the ratio  $D/L$  over the practical range. The maximum value of  $Q$  for the  $H_{011}$  mode occurs when  $D/L = 1$ , and falls by only 8 per cent when the length tends to infinity, i.e.  $D/L \rightarrow 0$ . The ratio  $D/L$  has to be increased to 2.8 to reduce  $Q$  by 30 per cent. The range  $0 < D/L < 2.8$  is ample for most frequency meters.

The mode chart (Fig. 4) gives an indication of the interference likely to be caused by other modes. Interference can occur where the piston position is such that the main mode and another mode resonate at the same frequency, at points such as the intersections of the  $H_{112}$  and  $H_{113}$  modes with the  $H_{011}$  mode. It is desirable that the working range of a frequency-meter should not include a crossover of the principal mode with another mode. Experiment has shown that the intersection of the  $E_{012}$  mode and the principal mode may be ignored, and that the effects of the  $H_{212}$  crossover can be reduced to acceptable proportions by careful positioning of the coupling loops. An  $H_{011}$  mode frequency-meter can therefore be designed to operate between the intersections of the  $H_{113}$  and  $H_{112}$  modes with the  $H_{011}$  mode, or to the right of the  $H_{112}$  mode on the mode chart. The space to the left of the  $H_{114}$  mode is unsuitable, one reason being that as the ratio  $D/L$  becomes small an unduly long cavity is required.

The overall frequency range to be covered is from 3,625–4,250 Mc/s and is 17.2 per cent of the lower frequency. The space available between the intersections of the  $H_{114}$  and  $H_{113}$  modes with the  $H_{011}$  mode is only 2.1 per cent and a set of at least nine frequency-meters would be required to give complete coverage. A range of 7.0 per cent is available between the  $H_{113}$  and  $H_{112}$  modes and three frequency-meters would be required, while to the right of the  $H_{112}$  mode space is unlimited and only one would be required.

The frequency-meters are tuned by micrometer adjustment of the length, so the choice of the working position on the mode chart is also influenced by the rate of frequency change with length. At the right-hand side of the mode chart, the higher values of  $(D/L)^2$  represent lower values of  $L$ , and the rate of change of frequency with length is greatly increased. The micrometer must be sufficiently accurate to enable the frequency to be read to 1 part in  $10^5$ . If the region to the right of the  $H_{112}$  mode were used the complete range of 17.2 per cent

would be covered by a 0.69 in. movement of the piston. This is equivalent to a frequency change of 25,000 parts in  $10^5$  per inch and would require a delicate and expensive micrometer accurate to better than 1/25,000 in. The space on the  $H_{011}$  curve between its intersections with the  $H_{113}$  and  $H_{112}$  modes gives a travel of 2.0 in. for a 7.0 per cent frequency change, equivalent to 3,500 parts in  $10^5$  per inch, and requires a reasonably accurate micrometer. The  $H_{114}$ – $H_{113}$  space would give a 1.9 in. movement for 2.2 per cent; the fine adjustment of 1,100 parts in  $10^5$  per in. is attractive, but the number of frequency-meters necessary to cover the overall range would be prohibitive. The  $H_{113}$ – $H_{112}$  space has therefore been chosen, requiring three frequency-meters to cover the overall range. The  $H_{212}$  mode crosses the wanted mode but, by using appropriate coupling loops, as described below, its effect on the wanted mode has been minimized.

#### COUPLING TO CAVITY

The frequency-meter coupling is arranged to draw a small proportion of power from a waveguide, which may either form part of a through circuit or may have one end connected to a matched termination. Resonance is detected by a silicon rectifier coupled into the cavity and connected to a sensitive galvanometer.

In the cavity either a coupling loop or an iris, consisting of a small window in the wall of the cavity, can be used to couple with the magnetic field of the  $H_{011}$  mode (see Fig. 3 for field configuration). Loop coupling was chosen to simplify hermetic sealing. Coupling into the waveguide may then be either by loop on the wide or narrow side of the guide linked by the magnetic field. Alternatively a probe may be used on the wide side to couple with the electric field along the length of the probe (Fig. 5). It was found impossible to obtain the

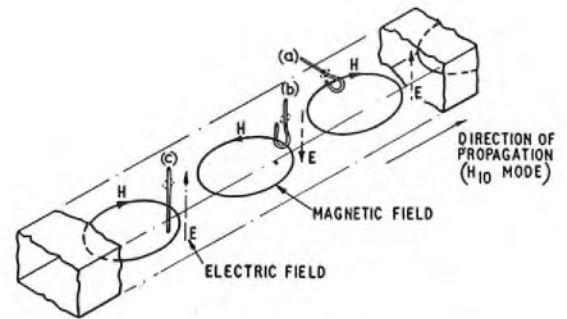

(a) Loop in the narrow side of guide, coupling with the magnetic field.  
(b) Loop in the wide side of guide, coupling with the magnetic field.  
(c) Probe in the wide side of guide, coupling with the electric field.

FIG. 5.—USE OF LOOPS AND PROBES TO EXTRACT POWER FROM A RECTANGULAR WAVEGUIDE

specified sensitivity of  $1.5 \mu\text{A}$  per 1 mW of waveguide power with loop coupling in the narrow side of the guide, so probe coupling in the wide side was tried and found to be satisfactory.

#### Suppression of Unwanted Modes

Reference has already been made to the presence of interfering modes of resonance. In particular, ambiguity may be expected within the working range of the frequency-meter due to responses from the  $H_{113}$ ,  $H_{212}$ ,  $H_{112}$  and  $E_{111}$  modes; outside the normal frequency range responses may also be obtained from such modes



as  $H_{211}$  and  $H_{311}$  (see Fig. 4). The response at the more serious of the interfering modes may be reduced by any or all of the following methods:

(a) Arrangement of the input coupling to avoid excitation of the unwanted mode.

(b) Arrangement of the detector coupling to avoid detection of unwanted resonances.

(c) Damping of unwanted modes by placing wires or resistive cards in line with the electric field, or by introducing choke gaps to interrupt the wall currents.

Method (a) has been used to suppress the  $H_{112}$  and  $H_{113}$  modes. Two probes are used in the waveguide and are placed half a guide-wavelength apart so that the induced voltages are in antiphase. The associated loops in the cavity are positioned to excite diametrically opposite magnetic fields. The  $H_{011}$  mode, and unfortunately the  $H_{212}$  mode also, are excited rather than the  $H_{112}$  and  $H_{113}$  modes (see Fig. 3 for field configuration). Interference from the  $H_{112}$  mode occurs over a larger portion of the tuning range than in the case of the  $H_{113}$  mode. The probe spacing has therefore been chosen to be an exact half-wavelength at the frequency of intersection of the  $H_{112}$  and  $H_{011}$  modes. Interference from the  $E_{012}$  mode is negligible since the planes of the loops are at  $90^\circ$  to the direction required to excite this mode.

Method (b) is useful for dealing with the  $H_{212}$  mode. The detector loop is placed in the cavity wall with its axis parallel to the axis of the cavity at a height corresponding to half the length of the cavity when tuned to the intersection point of the  $H_{212}$  and  $H_{011}$  modes. The Z component of the magnetic field of the  $H_{212}$  mode is parallel to the axis of the cavity, and is zero at this height. Detection of the  $H_{11n}$  series of modes is suppressed by placing the detector loop on the diameter of the cavity which is at  $90^\circ$  to the axis of the waveguide. Power will be dissipated by these modes at their intersections with the  $H_{011}$  mode, and will cause a local reduction in sensitivity, even though detection of the unwanted mode is suppressed. This is illustrated in Fig. 6 and 7, which show the performance at the  $E_{212}$

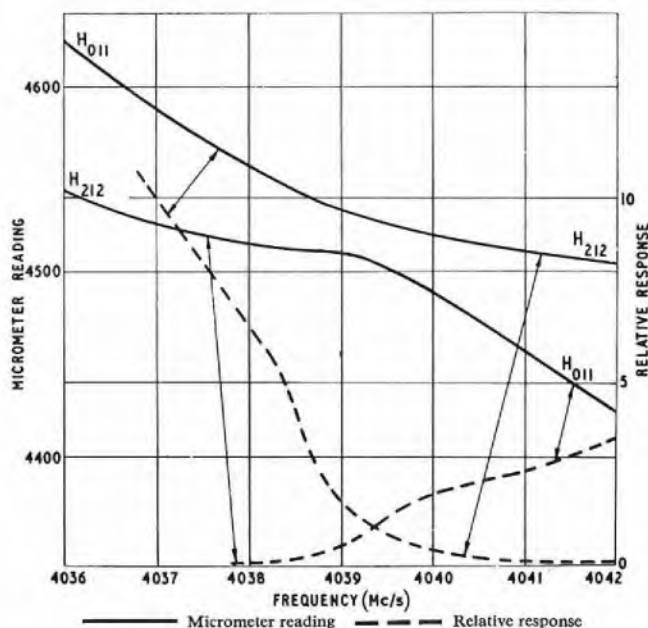

FIG. 6—BEHAVIOUR AT  $H_{011}$ - $E_{212}$  CROSSOVER WITH DETECTOR LOOP IN LINE WITH AXIS OF GUIDE

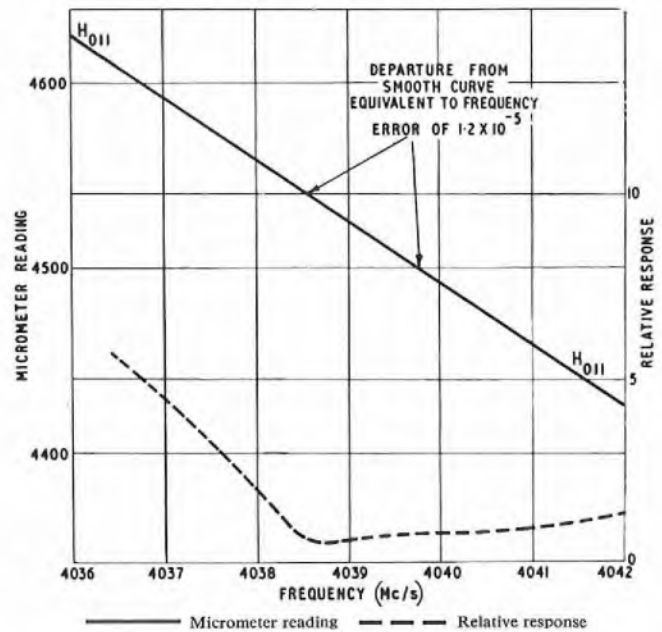

FIG. 7—BEHAVIOUR AT  $H_{011}$ - $E_{212}$  CROSSOVER WITH DETECTOR LOOP AT RIGHT-ANGLES TO AXIS OF GUIDE

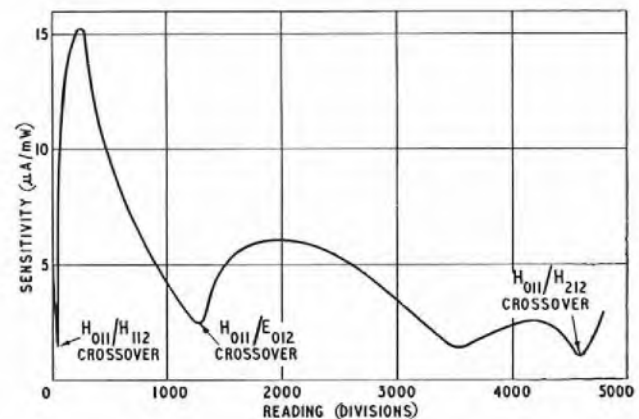

FIG. 8—SENSITIVITY

crossover, first with the detector loop in line with the guide and then at  $90^\circ$  to the guide. In the first case the readings would be ambiguous and incorrect in this region. In the second case the frequency response merely suffers two slight inflexions, though the sensitivity falls severely in the region of the crossover. The sensitivity over the whole range of the frequency meter is shown in Fig. 8.

Method (c) is used to suppress a second response which occurs about 10 Mc/s above the main response and is of similar amplitude. It is probably due to the  $E_{111}$  mode which theoretically has the same frequency as the  $H_{011}$  mode for the same dimensions, and is therefore known as a "companion mode." Gaps of about 0.01 in. are introduced between the piston and the cavity walls, as described earlier, and in the final design at the bottom of the cavity also, to interrupt the wall currents of this unwanted mode.

#### Size of Coupling Loops

The resistance looking into each coupling loop depends upon its area. Experiment has shown that the cavity is seriously loaded by an excessive loop area, even with loose coupling between the probe and the waveguide,

and consequently the Q-factor is degraded. The best loop area was found by exciting the cavity through weak coupling and observing the change in the Q-factor as the area was varied. A detector coupling which reduces the Q-factor by about 10 per cent is satisfactory, gives sufficient sensitivity, and yet retains a high Q-factor. Finally, the length of the waveguide probes was adjusted to give the required sensitivity, and the Q-factor checked to ensure that it had not been appreciably reduced by the input loading.

#### MECHANICAL DESIGN

A photograph of the frequency-meter is shown in Fig. 1, and details of the mechanical construction are given in Fig. 9. The resonant part of the cavity is enclosed

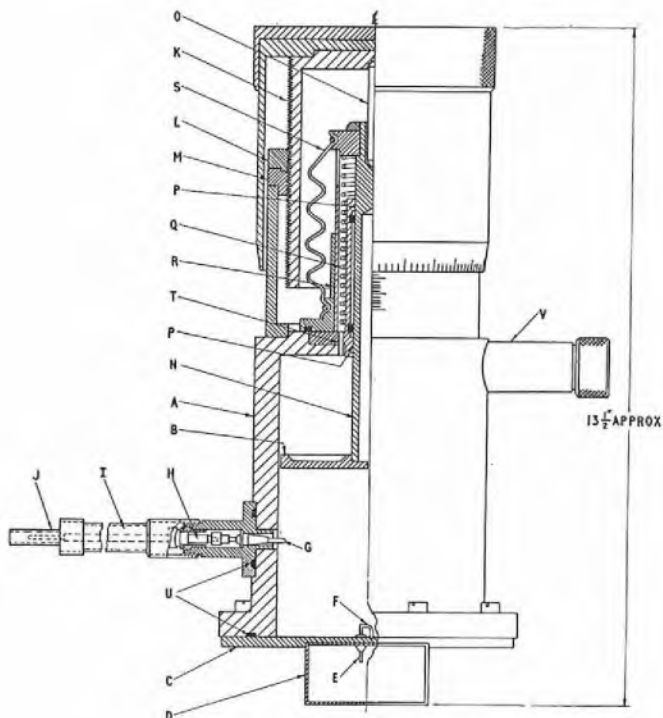

FIG. 9—CONSTRUCTION OF EXPERIMENTAL  $H_{011}$  CAVITY FREQUENCY-METER

by the cavity body A, the piston B, and the baseplate C. The edge and back of the piston are coated with graphite to reduce interference from spurious resonances in the back cavity. The cavity is excited by power from the waveguide D, size WG-11,  $2\frac{1}{2}$  in. by  $1\frac{1}{4}$  in., via two probes E and loops F of which only one set is shown. The detector loop G energizes a silicon crystal H, and the rectified current is passed through a coaxial line having a dielectric composed of dust cores I to the output socket J, and so to a galvanometer. The purpose of the dust cores is to provide a high attenuation (greater than 40 db per inch) in this lead at the frequency being measured. The cavity, base-plate and piston are silver plated to increase the conductivity of the cavity walls, and in the final design the plating is protected by a layer of polystyrene lacquer. Allan and Curling<sup>5</sup> have shown that the contribution to losses by the lacquer is negligible. The cavity surfaces have a smooth finish to ensure that their area, and therefore the dissipation, is as small as possible. Localized changes in the diameter

of the cavity do not greatly affect the calibration curve and are not important in an individually calibrated frequency-meter.

The movement of the piston is controlled by a screw micrometer and the simplest method would be to allow the piston to rotate with the screw. A non-rotating piston rod is, however, preferable as it facilitates the hermetic sealing of the entry to the cavity, and cyclic errors due to misalignment of the piston are minimized. The screw K is guided by two nuts L and M; nut L can be rotated and clamped by screws in slotted holes to reduce backlash to a minimum. The pitch of the thread is  $\frac{1}{32}$  in. and the total piston movement is 2.2 in. Since there are 100 divisions on the thimble, the range of the experimental frequency-meter is covered by about 7,000 divisions. The longitudinal motion is transmitted to the piston rod N via a push rod O, which greatly reduces errors due to eccentric motion of the screw. The piston rod slides in bearings P and is forced against the push rod by a spring Q, which is kept in position by a pair of spring guides R. The guides also prevent rotation of the piston. The spring has a free length of 18 in. and is compressed to about 4 in.; consequently the force is fairly constant over the working range of movement. Since the bearings are hermetically sealed by means of a p.v.c. gaiter S the spring must be sufficiently strong to overcome the excess external pressure due to an increase in barometric pressure or a reduction in ambient temperature. The pressure difference acts upon the mean area of the gaiter, and the resultant forces amount to 1.5 lb for a change in barometric pressure of 1 in. of mercury, and 3.5 lb over the specified working temperature range of 22 degrees Celsius. The spring is effectively stiffened by the compression of air inside the gaiter and cavity as the piston is depressed, and produces a maximum variation in force of 4 lb. A breather tube T links the two spaces.

A lubricating grease containing molybdenum disulphide has been found effective in preventing a sticky action at the micrometer threads due to the load of these forces. Hardened and ground steel threads of truncated V-section are used to avoid contact trouble at the tips of the thread, and to leave space for excess lubricant and dirt. End stops are arranged to arrest the rotary motion of the micrometer screw and incorporate a simple shock-absorbing device.

The hermetic seal is completed by the use of glass-to-metal seals at the coupling-loop connexions, and by "O" Rings U where the base-plate and detector mount are joined to the body of the cavity. A desiccator V, containing silica gel, ensures that the calibration will not be affected in the event of moisture penetrating into the cavity. The frequency/temperature coefficient has been minimized in the final design by using special low-temperature-coefficient steel for the cavity walls and end plates, and mild steel for the nut mounting, piston rod, and push rod so that the piston moves inwards as the cavity walls expand.

#### PERFORMANCE

##### Frequency Range

An experimental frequency-meter, to which all test results refer, has a range from 3,975 to 4,275 Mc/s. In the final model the frequency range is limited to 225 Mc/s, and is covered by approximately 5,000 divisions of the micrometer scale. There will be three

types of meter covering the ranges 3,625–3,850, 3,825–4,050 and 4,025–4,250 Mc/s.

#### *Q-Factor and Resolution*

The Q-factor lies between 12,000 and 20,000, depending upon the setting of the micrometer. No pronounced dip is apparent at the crossover points of the unwanted modes with the main mode. The resetting accuracy taken over ten successive readings in the centre of the range has been found to be better than  $\pm 0.2$  of a division, equivalent to  $\pm 2$  parts in  $10^6$  in terms of frequency.

#### *Mechanical Stability and Cyclic Errors*

The error due to resetting in either a clockwise or anticlockwise direction while applying an upward or a downward force of 6 lb on the thimble does not exceed 6 parts in  $10^6$ . The cyclic error has been checked by calibrating the frequency-meter over two turns of the micrometer head at 1 Mc/s intervals, requiring 13 measurements in all. The error is less than 4 parts in  $10^6$ .

#### *Unwanted Resonances*

The response of the frequency-meter to unwanted resonances is usually at least 15 db below the main response. The  $E_{111}$  mode has the same frequency as the  $H_{011}$  mode for a perfect cylinder, but disturbances such as the coupling loops and the gaps at each end of the cylinder displace the  $E_{111}$  mode about 10 Mc/s higher than the  $H_{011}$  mode. The response to this mode is at least 23 db below the main response. There is a tendency for modes which cross the main mode to become more prominent as the crossover point is approached. The most serious instance would be the  $H_{113}$  mode but, in the final design, this cross-over is excluded from the ranges of the frequency meters.

#### *Coupling*

The effect on the resonant frequency of standing waves in the waveguide to which the frequency-meter

is coupled has been checked by terminating the waveguide in a short-circuiting piston and making frequency measurements as the piston was moved through a quarter of a guide-wavelength. The apparent frequency change was less than 3 parts in  $10^6$ . The effect of changes in the detector has been observed by using five different samples of type CV103 detector crystals. The resultant frequency change was less than  $\pm 3$  parts in  $10^6$ .

#### CONCLUSIONS

The results obtained with the experimental model show that an accuracy of 1 part in  $10^6$  can be obtained over a 300 Mc/s range in the region of 4,100 Mc/s. The response of the experimental model to unwanted modes within the range of the frequency-meter is usually more than 15 db below the main response. For work where the frequency and strength of the signal are unknown it is desirable to augment the precision cavity with a non-ambiguous frequency-meter of simple design.

#### ACKNOWLEDGEMENTS

The writer wishes to thank colleagues in the E.-in-C.'s Office for their help in the experimental and development work and for constructing the experimental models to close dimensional tolerances.

#### References

- <sup>1</sup> B.S. 204:1943, Supplement No. 1 (1948). Glossary of Terms used in Waveguide Technique (British Standards Institution).
- <sup>2</sup> KINZER, J. P. Cylinder Resonator of Minimum Volume for given Q. Bell Telephone Laboratories, MM-43-3500-32, Apr. 6, 1943.
- <sup>3</sup> MONTGOMERY, C. G. Technique of Microwave Measurements. McGraw-Hill Book Co. Inc. (Radiation Laboratory Series, 1947), Vol. 11, pp. 297-303.
- <sup>4</sup> ESSEN, L. The Velocity of Propagation of Electromagnetic Waves Derived from the Resonant Frequencies of a Cylindrical Cavity Resonator. *Proceedings of the Royal Society, Series A*, Vol. 204, p. 260.
- <sup>5</sup> ALLAN, H. R. and CURLING, C. D. The Design and Use of Resonant Cavity Wavemeters for Spectrum Measurements of Pulsed Transmitters at Wavelengths near 10 cm. *Journal I.E.E.*, Vol. 95, Part III, No. 38, p. 31, Nov. 1948.

---

## Book Review

“Problems in Radio Engineering. E. T. A. Rapson. Seventh edition. Pitman & Sons, Ltd. 177 pp. 21 ill. 15s.

This book, which has become well known to radio engineering students through previous editions, is unique in that it is mainly composed of a large number and variety of questions in telecommunication examinations set in the past 20 or 30 years by the City and Guilds of London Institute, the Institution of Electrical Engineers, the University of London and, in recent years, by the British Institution of Radio Engineers. That the book is now produced in its seventh edition is proof of its popularity.

The questions are largely of the numerical-problem type and are classified under 48 separate groups, each generally being preceded by a short summary of the basic laws or formula concerned with the particular subject. It is this feature which has no doubt made a strong appeal to radio engineering students.

In the preface to this edition the author says that a number of early descriptive questions have been deleted. Surely it would have been wise also to discard many of the early

numerical problems, some of which date back to the 1920s. For example, one such problem, in which line attenuation is quoted in the long out-dated transmission units, can only confuse the modern student who has to grapple with decibels.

It is not difficult to suggest ways in which this book might be still further improved. There are no descriptive questions or problems quoted on v.h.f. amplifiers (earthed-grid amplifiers, transit time and lead inductance effects, etc.), nor is any help given on problems concerned with frequency modulation, receiver noise and signal/noise ratios. It would have been very helpful to include standard formulae for voltage-standing-wave ratio and reflection coefficients in feeders, and also formulae on propagation and the sensitivity of a half-wave dipole and more-complex aeriels. In addition, it would have been of value to include short definitions of such commonly used terms as aerial gain and noise factor.

Other “gaps” might be found by readers; nevertheless there is no doubt that such shortcomings of the book will be overlooked by the student who wishes to obtain ready information and practice in numerical exercise, together with the added comfort that he can compare his answers with those printed at the end of the book.

J. K. S. J.



# Prospects for Transatlantic Television by Cable

R. J. HALSEY, C.M.G., B.Sc.(Eng.), F.C.G.I., D.I.C., M.I.E.E.,  
and A. R. A. RENDALL, O.B.E., Ph.D., M.I.E.E.†

U.D.C. 621.397.24:621.315.28

The possibilities are considered of transmitting television signals across the Atlantic by existing and future submerged-repeater coaxial-cable systems. It is concluded that, by eliminating redundancies in television signals and thus reducing the band-width required to, perhaps, 0.5–1 Mc/s, it should be possible to build a suitable coaxial-cable system within a few years. It is unlikely that a more conventional system of the standard used on land could be provided for some seven or eight years, by which time a system using transistors might be fully developed. On existing cables, it should be possible to transmit short television news items on a delay basis by exchanging band-width for time, a recorded item being transmitted at a lower speed, re-recorded at the distant end and finally reproduced at normal speed.

## INTRODUCTION

THE possibilities of transmitting television signals across the Atlantic have exercised both program companies and transmission engineers for a number of years, hopes being mainly centred on a radio-relay system using tropospheric scatter on the northern route, via Iceland and Greenland. Despite optimistic pronouncements regarding such a system it has not yet proved practicable, partly because the useful range of tropospheric scatter systems seems to be less than has sometimes been claimed and partly because of the intrinsic difficulties of the terrain. Other proposals have included radio-relay via aircraft and, more recently, via earth satellites.<sup>1</sup> The latter could either be simple reflectors or, later perhaps, be equipped as active relay stations; with the tremendous effort now being expended in this direction, at least a limited service via passive satellites might well prove practicable in the not-too-distant future.

Since the opening of the first transatlantic telephone cable system<sup>2</sup> in 1956, there has been a good deal of speculation on the prospects of television transmission over this or future cables and it is the purpose of this article to consider the technical problems involved and assess the possibilities of success by this means in the foreseeable future.

Television standards differ in various countries, and nowhere in Europe is the American 525-line, 60-fields/sec system employed. A reasonably satisfactory conversion in respect of the number of lines can be effected by re-scanning; this is common in Europe where several different line standards are in use. Conversion in respect of field frequency is more difficult but there is no reason to assume that this aspect of the problem cannot be solved satisfactorily. The video band-widths appropriate to the various systems range from 3 Mc/s to 10 Mc/s; the lowest applies to the British 405-line, 50-fields/sec system. On long coaxial cables video-frequency transmission is impracticable and the C.C.I.T.T.\* recommends<sup>3</sup> that television signals shall be transmitted as the upper side-band of a 1.056 Mc/s carrier, with a vestigial lower side-band extending down to approximately 0.5 Mc/s, i.e. 3.5 Mc/s in all for the British system, as in Fig. 1.

†Mr. Halsey is Director of Research, Post Office Research Station. Dr. Rendall is with the British Broadcasting Corporation.

\*C.C.I.T.T.—International Telegraph and Telephone Consultative Committee (formerly the C.C.I.T. and C.C.I.F.).

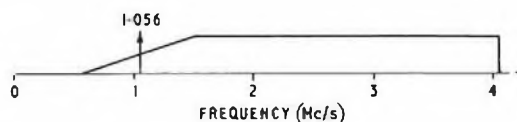

FIG. 1—C.C.I.T.T. FREQUENCY BAND FOR 405-LINE TELEVISION ON LAND CABLES

In studying the present problem, therefore, it is necessary to consider, firstly, the possibility of transmitting a frequency band of 3.5 Mc/s, or something approaching this, over a transatlantic cable some 2,000 nautical miles (n.m.) in length and, secondly, the possibilities of transmitting television signals using a much reduced band-width and, particularly, the band-width available or likely to be available on transatlantic cable systems.

## CHARACTERISTICS OF EXISTING AND PROJECTED CABLE SYSTEMS

Both the Scotland–Newfoundland section of the 1956 transatlantic telephone cable (TAT-1) and the France–Newfoundland section of the 1959 cable (TAT-2) utilize two unidirectional cables and, with about 51 repeaters in each, spaced at 37 n.m., provide for transmission bands approximately 16–164 kc/s, i.e. 148 kc/s wide. The repeaters are energized by power units, each with outputs of about 2 kV, located at the terminal stations and driving a constant direct current round the system, the power circuits of all the repeaters being in series (Fig. 2). This arrangement requires power-separating filters in each repeater, the high-pass filters being in the transmission circuit.

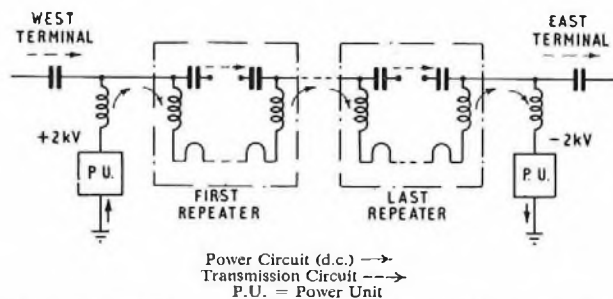

FIG. 2—SUBMARINE-CABLE POWER-FEEDING ARRANGEMENTS (TAT-1)

For telephony, it is cheaper to transmit in both directions over a single cable when this is possible within the terminal voltage limitation, and the development of the United Kingdom–Canada (CANTAT) system, due for completion in 1961, has been along these lines. In this system, a band-width of 240 kc/s is provided in each direction using directional filters (as well as power-separating filters) in each repeater and, with the 90 repeaters involved on the Scotland–Newfoundland section, the d.c. power-feeding voltage at each terminal will be as high as 4.5 kV.

Thus, a gross band-width of about 148 kc/s exists now

and some 240 kc/s will be available in 1961; it will be seen later, however, that in neither case is the full bandwidth likely to be suitable for television transmission because of delay distortion in the essential filters.

#### POSSIBILITY OF CABLE SYSTEMS OF GREATER BAND-WIDTH

For a cable of given size the maximum transmitted frequency is determined by the number of repeaters which can be energized with the maximum-permissible terminal-supply voltage; this in turn is settled mainly by the design of the capacitors in the power-separating filters in the repeaters. Thus, if the line current is 0.4 amp and the maximum terminal voltage is 5 kV, as at present, then the voltage drop in a 2,000 n.m. cable might be 2.3 kV, leaving 7.7 kV to energize 110 repeaters at 70 volts each—a typical requirement for the usual 3-stage amplifier.

Whereas the TAT-1 system uses conventional armoured cable<sup>4</sup> having a core diameter of 0.62 in., the CANTAT system will employ, over three-quarters of its length, a new design of light-weight (armourless) cable<sup>5</sup> with a 1.0 in. diameter core. The high-frequency attenuation of each of the two types of cable is roughly  $0.0027\sqrt{f/d}$  db/n.m.,  $f$  being the frequency in cycles per second and  $d$  the core diameter in inches. For a 1.0 in. core the attenuations are about 2.7 and 5.4 db/n.m. at 1 and 4 Mc/s respectively.

Light-weight cable of somewhat greater core diameter would no doubt be practicable but, the capacity of the cable ship being inversely proportional to the square of the cable diameter, greater diameter would involve splices in very deep water as well as other laying complications.

The maximum gain which can be provided by each repeater, assuming adequate negative feedback for the desired linearity, will depend upon:

(a) the minimum permissible level at the amplifier input, as determined by circuit noise,

(b) the maximum permissible level at the amplifier output, as determined by overload characteristics in relation to the peak signal power,

(c) the loss due to extraneous networks such as filters and equalizers, and

(d) the margins which must be allowed for changes in cable attenuation—anomalous changes on laying, temperature variations and ageing—and whether these can be wholly or partly absorbed by automatic level control in the repeaters.

The C.C.I.T.T. standard for a 2,500 km (1,350 n.m.) television channel requires that the r.m.s. weighted noise shall be at least 50 db below the peak-to-peak picture signal; the noise will arise mainly from thermal agitation at the input of each amplifier and, in a 3.5 Mc/s band, will be about -105 dbm;\* each repeater will make this contribution. The minimum permissible signal level can thus be determined when the approximate repeater spacing is known.

The maximum permissible level at the output of each amplifier will depend on the power-handling capacity of the output stage at the highest frequency transmitted and, with the class of long-life valve now available, this is

\*dbm—decibels relative to 1 mW.

†The American L3 land coaxial system,<sup>6</sup> which incorporates automatic gain control, requires 150 watts per repeater—five times that assumed for a submerged repeater.

§More can be accommodated by using companders on the telephone circuits.

about +22 dbm for top frequencies less than about 0.5 Mc/s, decreasing above this by about 3 db per octave. The outcome of these considerations is that, after allowing for equalizer losses, but without making any allowances at all for misalignment and subsequent cable changes, a system to transmit up to 4 Mc/s over a 1.0 in. core could employ repeaters having about 50 db maximum gain, spaced at 9.3 n.m. (216 for the 2,000 n.m. crossing to overcome a total attenuation of 10,800 db).

Even with this idealized arrangement, the power-feeding voltage would need to be increased to 9 kV—twice the present limit. A further increase is required because, to obtain adequate negative feedback at 4 Mc/s, it is necessary to use more than three valve stages. To obtain adequate gain stability and freedom from non-linear distortion some 30–35 db gain reduction must be provided by negative feedback. With the present valve this becomes impracticable, with only three stages, at about 1.5 Mc/s; at 4 Mc/s the number of valves would probably need to be doubled.

To take account of anomalous changes of cable attenuation on laying and other factors leading to initial misalignment of the system, together with temperature and ageing changes after laying, would require either substantially lower gain, so that changes of signal level could be accommodated without overload or excessive noise, or means for automatic gain control in each repeater. The latter requires a degree of complication never, so far, attempted in such a system, as well as a substantial increase in the power required in each repeater.‡

In the TAT-1 system the attenuation at 150 kc/s has decreased by some 10 db (0.3%) in three years and the decrease appears to be asymptotic to about 15 db (0.5%). On a 1.0 in. conventional cable the latter would be equivalent to some 27 db at 1 Mc/s and 55 db at 4 Mc/s, and automatic level control would clearly be essential. It is likely that light-weight cable is much more stable both in this respect and as regards anomalous laying changes; for the CANTAT system, a gain allowance of only 10 db (0.2%) has been made for misalignment and all cable changes.§ On this basis, the gain allowances in the 2,000 n.m. system being considered would have to be 10 and 20 db at 1 and 4 Mc/s respectively. The need for automatic level control must remain uncertain until more experience with light-weight cable has been obtained.

It has been shown that, with 5 kV terminal voltage, 110 repeaters could be energized; allowing 10 db for misalignment and cable changes, it is then possible to operate at frequencies up to a little over 1 Mc/s. To extend this to 1.5 Mc/s, the maximum at which three stages will suffice, 140 repeaters would be required, each of 48 db gain. To energize these it would be necessary either to raise the terminal voltage to 6 kV, or provide a separate power-feeding cable to an intermediate point, or reduce the voltage available in each repeater to about 55 volts. It seems likely therefore that, one way or another, it should be possible to provide a 1.5 Mc/s system; this, however, is likely to be the practicable limit with valves of the present type.

While better and more efficient valves are possible, the problem of ensuring that they are long-lived is a severe one and it seems likely that transistors offer the best prospect for further improvements. There is no doubt that transistor amplifiers of adequate bandwidth and reliability will become available, possibly in time for a

transistorized system to be laid within seven or eight years; they are certainly not available yet. Both the voltage and current requirements of transistor repeaters will be lower than for the present valve units, and this will enable many more to be operated in tandem with reasonable terminal voltages.

The effect on the out-of-service time of the system of a substantial increase in the number of repeaters is vitally important. On the basis of 10 per cent repeater failures in 20 years, on which TAT-1 was postulated, the average number of faults per annum on a system of 300 repeaters would be 1.5; this might well involve six weeks out-of-service time and cost £200,000. To reduce the number of faults the reliability of all the components must be correspondingly increased and this must always be an overriding design requirement.

Even with transistor repeaters it is unlikely that transmission of a full conventional television band-width will be achieved. Though this might eventually be technically possible, the economics of the problem are bound to lead to some measure of band-width conservation; this will now be considered.

#### POSSIBILITIES OF TELEVISION TRANSMISSION OVER A SYSTEM OF REDUCED BAND-WIDTH

Band-width compression of television signals generally can be effected in three ways:

- (a) by reduction of redundancies in the picture information,
- (b) by sacrifice of picture quality, and
- (c) by exchange of frequency band-width for time by a slowed-down scanning mechanism.

##### *Reduction of Redundancies*

There are three distinct types of redundancy in a television picture.<sup>7</sup> Firstly, the brightness variations along the scanning line are not random; secondly, a number of adjacent scanning lines contain identical or nearly identical information; and, thirdly, successive pictures are identical except in those parts where movement has occurred. Removal of redundancies does not, in itself, achieve band-width compression; it is also essential to store and redistribute the non-redundant information so that it is transmitted at a constant rate. Information theory indicates<sup>8</sup> that a 7 to 1 reduction in band-width might be achieved by quantizing and coding the brightness information, but the means of achieving such economy involve formidable problems which will require much effort before a solution is available. Work is proceeding in this field at a number of laboratories.

##### *Sacrifice of Picture Quality*

If the video band-width of a television transmission system is reduced below that normal for the system concerned, the rate of transmission of information will be restricted and picture quality will suffer. To take optimum advantage of reduced band-width it is necessary to effect economies in all three of the directions corresponding to the types of redundancy outlined earlier.

Along each scanning line the transition rate from one degree of brightness to another can be reduced; edges then become more blurred but the more gradual tonal transitions are unaffected. The subjective satisfaction of a picture depends very largely on the sharpness of edges and the permissible deterioration can only be determined

\*Moiré patterns—interference patterns such as are seen in moiré silk.

subjectively. Such tests using normal British 405-line signals indicate that, if the transmission system is free from delay distortion, the picture quality remains reasonably tolerable for topical events when the video band-width is reduced to about 1 Mc/s, i.e. a 3 to 1 reduction.

In like manner, vertical detail can be sacrificed by reducing the number of effective lines. In the final presentation, the full number of lines of the appropriate television standard would have to be restored and the overall result would be that successive lines would contain less change of information than in the original. If the original contains an edge slightly inclined to the horizontal, then all line scanning systems must reproduce this edge as an irregular curve: if the number of lines is large, the eye fails to distinguish any irregularity, but the coarseness of the structure of the picture becomes more apparent as the number of lines is reduced. A further harmful effect introduced by reducing the number of lines is aggravated moiré patterns;\* such patterns are generated by interference between the frequency of a pattern in the original scene and the scanning frequency. With fewer scanning lines this interference occurs with larger detail in the picture and is more obtrusive.

Finally, the number of pictures transmitted per second can be reduced. The presentation to a viewer must have a sufficient picture-repetition rate to avoid flicker, but a reduction might be made on an intermediate link and jerkiness of movement would be the price paid. If the original scene is slow moving then little information is lost by reducing the picture-repetition rate but if it were a fast-moving game, such as tennis, then the players and ball would proceed from place to place in a number of jerks, or the movement would be blurred.

For any particular reduced band-width which may be available there will be an optimum distribution of the above economies, which can only be assessed subjectively; many tests and observations would have to be made before optima could be determined. Once so determined, substantial effort would be required to design and produce terminal equipment to effect the necessary conversions; the overall system must accept the standard television signals of the country of origin and deliver the standard signals of the country of presentation. In the end, the loss in quality must be weighed against the interest aroused by televising a particular occasion. The choice may well be of accepting a sub-standard picture or none at all, a decision which will depend on the balance between the degree of deterioration which must be accepted and the satisfaction of being an immediate viewer of a particular event.

##### *Exchange of Band-width for Time*

If a video program is recorded on tape, it can be transmitted at a lower speed, be re-recorded at that lower speed at the distant end and finally be reproduced at normal speed. This constitutes a direct exchange of band-width for time and, within reason, the band-width could be reduced by any factor if the transmission time were similarly expanded; it is very probable that special magnetic recording equipment would have to be developed for the purpose. This process takes no account of different television standards on the two ends and would not be admissible alone.

A more attractive solution might be to record the event on film, scan the pictures at a slow speed for



transmission over the cable, re-record a film at the receiving end from a cathode-ray-tube display and then re-scan the film; the different television standards at the two ends would then present no obstacle. A proportional delay would be introduced by the slow-speed scanning and there would be fixed delays for film processing. This method appears promising for short news items. If a normal music channel is used for transmission the total band-width-reduction factor would be about 500; the time-expansion factor would probably be a good deal less than this since the video band-width would probably be reduced at the expense of picture quality. Since the cost of a long-distance circuit will be roughly proportional to both band-width and time, the cost of a transmission would be virtually unaffected by the degree of compression.

#### PROBLEMS INVOLVED IN THE TRANSMITTING OF REDUCED BAND-WIDTH SIGNALS BY CABLE

In the methods of band-width restriction discussed above the resultant picture signal will contain components of frequencies from that represented by the picture-repetition rate to the highest frequency required for the detail transmitted. In the last method, the exchange of band-width and time, components at very low frequencies, even fractions of a cycle per second, might exist in the signal. Transmission over a cable will necessarily involve a vestigial sideband and, as indicated earlier, this amounts in a normal transmission to 0.5 Mc/s or about 14 per cent of the total band-width. When time and band-width are interchanged, this proportion will remain fixed but with either of the other methods means must be found to reduce the vestigial sideband very substantially; this requires special attention to filtering and shaping techniques.

On repeated submarine-cable systems, the inherent delay distortion is so great as to be outside the experience of television circuit engineers. The reduction of this distortion to the requisite limits over the greatest possible part of the available frequency band is one of the major problems which would have to be faced if an attempt were made to use telephone cables for television transmission; even with the best possible correction, the full band-width will not be suitable.

In a unidirectional system such as TAT-1, the lower frequency is determined by the power-separating filters, which contribute considerable delay distortion of a nature which is exceedingly difficult to compensate. On TAT-1 it is unlikely that a band-width of much more than 100 kc/s, out of the total of 148 kc/s, could be made suitable and some of this would be needed to accommodate the vestigial sideband.

A single-cable system such as CANTAT also requires directional filters in each repeater and these, even more than the power-separating filters, cause substantial delay distortion towards the cut-off frequency; again the high-pass filter will be particularly difficult to compensate. With CANTAT it is unlikely that the band-width available for television could be as much as 200 kc/s—perhaps 170 kc/s—and, again, the vestigial sideband must be accommodated. It is clear that with the same gross band-width restriction, single-cable systems will always be substantially inferior to two-cable systems for television transmission, because of the inherent delay distortion in the directional filters.

#### CONCLUSIONS

On the existing TAT-1 cable a gross band-width of about 148 kc/s is available but the delay distortion is very severe and it is unlikely that much more than 100 kc/s could be made suitable for television; TAT-2, to be completed this year, is a similar system. On the CANTAT cable, due for completion in 1961, the gross band-width available will be 240 kc/s but here again delay distortion is likely to restrict the usable band to, perhaps, 170 kc/s. If it is practicable to restrict telephone service so that optimum use could be made of these cables for television—a matter outside the scope of the present article—it will probably prove possible, in due course, to transmit comparatively low-grade television on a non-delay basis. This might well suffice for special events in the absence of anything better but is unlikely to be adequate for general application. By exchanging band-width for time, either with or without other forms of compression, it should be possible to transmit pictures of good quality. The extended time scale makes this form of transmission unsuitable for anything but short items. However, it is the most readily applicable method.

It seems unlikely that a conventional television circuit of the standard used on land, or even something approaching this, could be provided for some seven or eight years, by which time a transistorized system might be fully developed.

The economics of system design show that it would be worthwhile to spend a good deal of money on terminal equipment to eliminate redundancies and thereby reduce the band-width required. This, it seems, is the way events should go, in which case a band-width of, perhaps, 0.5–1.0 Mc/s should suffice for a good picture. A 0.6 Mc/s system could clearly be built any time after 1961; it would merely be a two-cable version of CANTAT. It has been shown that a 1.0–1.5 Mc/s system should also be practicable, using valves of the type now available, if present hopes of the attenuation stability of light-weight cable are realized.

Whether a transatlantic television cable can be justified economically—the capital cost might well be as much as £20 million for the ocean crossing alone—is not a matter for consideration here. It would, however, be helpful, as in any communication system, to integrate requirements, and a television channel of restricted band-width might well be provided, ultimately, as part of a more comprehensive system. It could then be accommodated in that part of the transmission band which is least subject to delay distortion.

#### References

- <sup>1</sup>PIERCE, J. R. and KOMPNER, R. Transoceanic Communication by Means of Satellites. *Proceedings I.R.E.*, Vol. 47, p. 372, 1959.
- <sup>2</sup>The Transatlantic Telephone Cable. *P.O.E.E.J.*, Vol. 49, Part 4, Jan. 1957.
- <sup>3</sup>C.C.I.F. 18th Plenary Assembly (Geneva 1956) Vol. III bis, Sect. 8.2.
- <sup>4</sup>LEBERT, A. W., FISCHER, H. B., and BISKEBORN, M. C. Cable Design and Manufacture for the Transatlantic Submarine Cable System. *P.O.E.E.J.*, Vol. 49, p. 295, Jan. 1957.
- <sup>5</sup>BROCKBANK, R. A., and MEYERS, A. L. A New Deep-Sea Coaxial Cable. *P.O.E.E.J.*, Vol. 50, p. 7, Apr. 1957.
- <sup>6</sup>ELMENDORF, C. H., and others. The L3 Coaxial System: System Design. *Bell System Technical Journal*, Vol. 32, p. 781, 1953.
- <sup>7</sup>KRETZMER, E. R. Statistics of Television Signals. *Bell System Technical Journal*, Vol. 31, p. 751, 1952.
- <sup>8</sup>GOURIET, G. G. Band-width Compression of a Television Signal. *Proceedings I.E.E.*, Paper No. 2357R, May 1957 (Vol. 104, Part B, p. 265).

# Her Majesty the Queen's Visit to Canada

## Television News Films over the Transatlantic Telephone Cable

SHORT television news items relating to the visit of Her Majesty the Queen to Canada have been transmitted over the transatlantic telephone cable between Montreal and London by the British Broadcasting Corporation in collaboration with the Canadian Broadcasting Corporation. The first transmission was to Canada and covered Her Majesty's departure from London on 18 June; transmissions from Canada included her arrival and the official opening of the St. Lawrence Seaway.

The system used exchanges band-width for time, as outlined in the previous article. From a 16 mm tele-recording, alternate film frames are scanned at 200 lines/picture and at 25 lines/second; thus, two film frames are disposed of every 8 seconds, a time expansion of 100 to 1.

The horizontal definition is 360 picture-elements/line. The final video-frequency band, extending from a fraction of a cycle per second to 4,500 c/s, is amplitude modulated on a carrier of 5,000 c/s and transmitted as a vestigial sideband signal in the band 500-5,500c/s. To improve the signal/noise ratio, 160 per cent modulation and synchronous detection are employed.

The cable link consisted of a normal program channel (50-6,500 c/s) with special delay equalization.

The transmissions have been generally very successful and have evoked a good deal of technical and topical interest. For short items the method is very much quicker than aeroplane.

R. J. H.

A. R. A. R.

---

## Increasing the Traffic Capacity of Transatlantic and Other Submarine Telephone Cables

U.D.C.621.395.51:621.315.28

WHEN the first transatlantic telephone cable<sup>1</sup> (TAT-1) was planned, opinions concerning the likely traffic over the system differed considerably. In the event, the optimists were thoroughly justified and the pessimists confounded; means for increasing the traffic capacity soon had to be sought. Possibilities in this connexion have already been discussed in the Journal<sup>2</sup> and include:

(a) closer spacing of conventional telephone channels by reducing the guard bands between channels and/or by restricting band-width,

(b) frequency compression or coding systems, and

(c) time assignment speech interpolation (T.A.S.I.), a high-speed switching system in which unidirectional channels are seized electronically by the speech signals and occupied only while speech is present.

In respect of (a), developments at the Post Office Research Station, Dollis Hill, have led to 2 kc/s-spaced and 3 kc/s-spaced systems transmitting speech frequencies 300-2,170 c/s and 300-3,150 c/s, respectively. These are capable of increasing the number of circuits on the main Atlantic crossing from 36 to 72 and 48, respectively. In fact, complications exist because of the allocation of the original circuits as 29½ London-New York and 6½ London-Montreal circuits. In regard to (b) no developments leading to promise of early application have taken place.

The American Telephone & Telegraph Company (A. T. & T. Co.) approach to the problem was to press forward with the development of T.A.S.I., which had already been demonstrated experimentally. The Bell Telephone Laboratories evolved a system to operate over 36 circuits, such as were provided by the A. T. & T. Co. submarine-cable systems—already installed on TAT-1, Port Angeles-Anchorage (Alaska) and San Francisco-Hawaii, and planned for TAT-2 (European terminal at

Penmarch, Brittany), Miami-Puerto Rico and elsewhere.

In 1958 the A. T. & T. Co. Long Lines Department opened formal discussions with the Post Office with the object of installing this equipment on TAT-1. The system proposed<sup>3</sup> was planned for use on up to thirty-six 4 kc/s-spaced channels. For up to 34 calls, the connexions would be "solid" and switching would commence only with the 35th call; the 36th circuit would be used for control purposes and a total of some 72 connexions was provided for. When the question of operation of T.A.S.I. over 3 kc/s-spaced channels was raised, the two were found to be incompatible because of the requirements of the T.A.S.I. supervisory signals on both the control and traffic circuits. It was, however, subsequently considered worthwhile to modify the T.A.S.I. design to operate within the frequency band of the 3 kc/s-spaced channels, the number of circuits employed being increased to 36 + 1, providing at least 72 connexions and possibly more. A redesign for the full 48 circuits was not undertaken.

Consequent upon the decision that T.A.S.I. and 3 kc/s spacing would be made compatible, the following points were agreed with A. T. & T. Co.:

(i) That this arrangement would, where possible, be standard for submarine cable systems.

(ii) That the A. T. & T. Co. would be responsible for the development of T.A.S.I. in consultation with the Post Office, and would supply Post Office needs until and unless the Post Office wished to have the equipment manufactured in the United Kingdom.

(iii) That the Post Office, on similar terms, would be responsible for the development and supply of 3 kc/s-spaced channel equipment.

(iv) That the Miami-Puerto Rico system, due for service early in 1960, would be planned for and fully equipped initially with 3 kc/s channel equipment, with



a (36 + 1)/72-circuit T.A.S.I. system to follow as required.

(v) That the London–New York carrier groups in the TAT-1 system would be modified to provide thirty-nine 3 kc/s channels early in 1960—16 channels on each full group and 7 channels on the half group, leaving a 1 kc/s band for telegraphy if required; a (36 + 1)/72-circuit T.A.S.I. system would be added immediately, this being the first T.A.S.I. installation.

In subsequent discussions with the Canadian Overseas Telecommunication Corporation it was decided not to install T.A.S.I. on the London–Montreal circuits. On this route 2 kc/s-spaced channel equipment has been in operation since December 1957 as a temporary measure, with great success and without attracting any adverse criticism; this equipment is not compatible with T.A.S.I. and will give the maximum circuit provision on this route until the CANTAT system<sup>1</sup> is completed in 1961.

Modification of TAT-1 for 3 kc/s channels is a task of some magnitude, there being five basic difficulties:

(a) The inland carrier groups on both sides of the Atlantic are not “clean”; they carry tones at the 4 kc/s-spaced virtual carrier frequencies and these appear as approximately 1 kc/s and 2 kc/s tones on certain 3 kc/s-spaced channels.

(b) The A. T. & T. Co. are unwilling to install special equipment on the inland sections of transatlantic carrier groups from considerations of flexibility; in consequence the groups have narrow stop filters at 92 kc/s and section pilots at this frequency, which is not a virtual carrier frequency in the 3 kc/s system.

(c) 92 kc/s is not admissible as a pilot frequency in the 3 kc/s system.

(d) Through-group filters on both sides of the Atlantic are restrictive in respect of the end channels of 3 kc/s groups—at each end the “cut” is at high audio frequencies; the filtration is also inadequate at the 108 kc/s end when the adjacent group is also 3 kc/s-spaced.

(e) The overall group pilots on TAT-1 are at 84.08 kc/s, which appears as 3,170 c/s on one of the 3 kc/s channels; the speech frequencies also interfere with the pilots.

To overcome (a), it has been decided that the circuits will be operated, initially at least, on a 4 kc/s basis in the inland networks. This involves back-to-back channel equipments at the ends of the submarine section, i.e. at Oban and Sydney Mines, and “cleaning up” of the groups between these two points only. This decision was reached with reluctance because through-group working has been a cardinal feature of T.A.T.-system design. However, it automatically disposes of (b) above, permits the use of a different pilot frequency (96 kc/s) on the 3 kc/s section, thus overcoming (c), and goes a long way to dispose of (d) since the severe through-group-filter requirements are restricted to Clarenville, the junction of the two submarine cable systems. The filters already fitted at this point, while not properly meeting the full pass-band requirements of the 3 kc/s system, are much better than many in the inland networks. The shortcomings in respect of filtration at 108 kc/s are minimized by the arrangement of interconnexion of the groups at Clarenville and by the fact that high-efficiency channel equipment will not be used on the local groups between Clarenville and Sydney Mines.

To overcome (e) it has been necessary to redesign the

group-pilot equipment for the 3 kc/s-spaced section (i.e. the submarine cables) to operate at 84.00 kc/s instead of 84.08 kc/s; fortunately, the carrier leak in the channel equipment is already very low.

With channel equipment at Oban and Sydney Mines the group pilots will be interrupted at these points and the overall supervisory facilities will be lost. It is not practicable to bypass the channel equipment as there will be four carrier groups on the land sections and three on the submarine sections. The following arrangements will therefore be made:

(i) There will be 84.08 kc/s pilots on each land section and 84.00 kc/s pilots on the submarine section, i.e. three sections in all.

(ii) On each section the pilot will operate a group automatic-gain-control device.

(iii) Each section will have non-urgent ( $\pm 1$  db) and urgent ( $\pm 3$  db) alarms at the receiving end, the alarms being extended over an omnibus telegraph circuit to both London and White Plains (U.S.A.).

These arrangements should adequately replace the lost overall group-pilot facilities. On receipt of an urgent alarm, the groups concerned will be disconnected from the T.A.S.I. equipment.

Provision of program circuits is at present on a through basis using “music-in-band” equipment and displacing two or three speech channels (68–76 or 64–76 kc/s). With the new arrangements it becomes necessary to translate to audio frequencies at Oban and Sydney Mines but, to avoid special development, similar music-in-band equipments will be used in the 3 kc/s and 4 kc/s terminals.

Facilities for through-group working at Oban and Sydney Mines will be retained and this will permit the use of 2 kc/s-spaced channel equipments at London and White Plains in an emergency, e.g. failure of T.A.S.I.

For satisfactory operation of T.A.S.I. it is necessary that the delay distortion in the range of the T.A.S.I. supervisory signals (600–2,500 c/s) shall be less than 1.5 ms and this requires delay equalizers, which will be fitted at the receiving terminals. It is also planned to fit attenuation equalizers to bring each channel response within one-half of the normal C.C.I.T.T. limits up to about 3,100 c/s.

The T.A.T. London terminal and T.A.T. Test are now at Kingsway but will be transferred to the new International Terminal and International Maintenance Centre in Faraday Building during 1960. The T.A.S.I. terminal, comprising fifteen 11 ft 6 in. racks, will be installed at Faraday Building and for some months it will be necessary to connect it to Kingsway by some 500 cable pairs carrying talker trunks, channels and control circuits.

It is planned to bring the 3 kc/s-spaced channels into service in January 1960; T.A.S.I. should be partly operational during March 1960 and fully so by June 1960.

R. J. H.

#### References

- <sup>1</sup> The Transatlantic Telephone Cable. *P.O.E.E.J.*, Vol. 49, Part 4, Jan. 1957.
- <sup>2</sup> HALSEY, R. J. The Economic Usage of Broadband Transmission Systems. *P.O.E.E.J.*, Vol. 51, p. 212, Oct. 1958.
- <sup>3</sup> BULLINGTON, K., and FRASER, J. M. Engineering Aspects of TASI. *Bell System Technical Journal*, Vol. 38, p. 353, Mar. 1959.
- <sup>4</sup> A Proposed New Telephone Cable between the United Kingdom and Canada. *P.O.E.E.J.*, Vol. 50, p. 104, July 1957.



# The London Payroll Computers

H. T. McGRATH, B.Sc.†

U.D.C. 681.142.383/4

Electronic computers are to be used to calculate the pay of 112,000 Post Office employees in the London area, and associated equipment will prepare pay advices, postal drafts and other documents. The complete installation will consist of two National-Elliott 405 Computers, two Independent Samastronic Printers, paper-tape and other ancillary equipment.

## INTRODUCTION

A CENTRAL computing agency is being set up to calculate the pay and prepare payroll documents for 112,000 Post Office employees in the London area. It is known as the London Electronic Agency for Pay and Statistics (LEAPS) and is situated in Armour House adjacent to Post Office Headquarters. In addition to payroll work, LEAPS will undertake other data processing, statistical and computing jobs. The Agency is a branch of the Accountant General's Department and will employ about 90 people.

The Agency comprises two identical installations, LEAPS 1 and LEAPS 2, with common clerical and punch rooms. There are offices for the controlling officers, and programmers' and maintenance engineers' rooms.

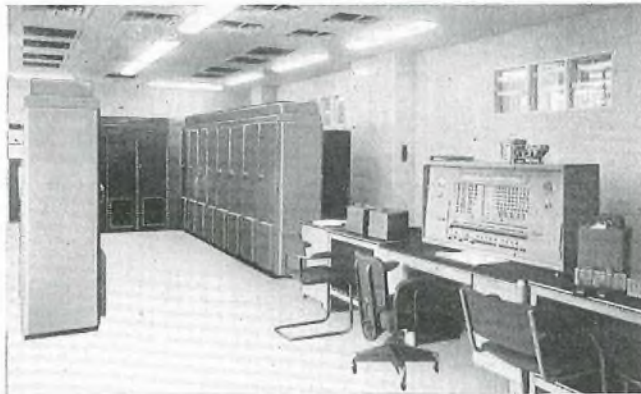

FIG. 1—GENERAL VIEW OF THE FIRST COMPUTER ROOM

In each computer room (Fig. 1) a National-Elliott 405 Computer has been installed with its control console and input and output equipment. The two print rooms each contain an Independent Samastronic Printer with associated electronic equipment for its magnetic-film drive. There are separate power and ventilation rooms for the two installations.

The punch room (Fig. 2) is used for the preparation of the paper tape in 5-unit code for the input of information to the computer.

## THE PAYROLL CYCLE

Every week, forms giving the names and pay numbers of each employee are printed in LEAPS and sent to the appropriate local pay offices. There, details of all factors affecting the employee's pay either permanently

† Senior Executive Engineer, Engineering Organization and Efficiency Branch, E.-in-C.'s Office.

\* LAVER, F. J. M. An Introduction to Electronic Computer Systems for Office Use. *P.O.E.E.J.*, Vol. 52, p. 13, Apr. 1959.



FIG. 2—PART OF THE PUNCH ROOM

(increments, promotions, etc.) or temporarily (overtime, Sunday duty, etc.) are entered on the forms, which are then returned to LEAPS in time for the next week's pay calculations. The information from the local pay offices is punched on paper tape and verified in the punch room, and the resulting verified tape is fed into the computer.

Stored in the computer on magnetic film are details of each employee's standard pay conditions; the computer uses this information and the amendment data fed in on paper tape to calculate the pay, income tax, voluntary deductions, etc., of each employee. As part of this process, the magnetic film records of each employee are brought up to date in readiness for the following week and all the details necessary for the printing of pay advices, postal drafts and local office forms are written on magnetic film. Using this film, the Samastronic printer prints these documents, which are despatched to the local offices for payment and for the preparation of amendment data.

## PAPER-TAPE EQUIPMENT

It is essential that any input to the computer be as accurate as possible and, therefore, paper-tape preparation takes place in two stages, using two types of machine. A prime tape is produced on a keyboard perforator and is then fed into a verifier where it is compared character by character with a second (verified) tape as this is produced by a second operator. The prime tape is then discarded and the verified tape used.

Initially, eight Creed machines of each type have been installed and when the Agency is fully loaded about 20 of each type will be in use.

## COMPUTERS

The National-Elliott 405 Computer is built-up from a number of cabinet assemblies, connected together to provide the facilities required by the customer. Standard plug-in units are used throughout in the construction of these assemblies.

The general principles of operation of such a computer have been described in a recent article\* in this Journal.

### Storage

Data and instructions are stored in the computer on (a) nickel delay lines, (b) a magnetic disk, and (c) 35 mm magnetic film.

The nickel delay lines are of two types, short lines storing a single computer "word" (i.e. a group of 32 binary digits) and long lines storing 16 words (512 bits). There are 31 long and 19 short lines used for storage, and these are located in the various assemblies; together they constitute the "working store" of the machine. The magnetic disk (three cabinets) stores 16,384 words ( $0.5 \times 10^6$  bits) on 64 tracks each of 256 words. For reading and writing, each track is divided into four sectors each holding a block of 64 words and data is transferred to and from the working store in 64-word blocks. The average time to read or write a 64-word block is 32.5 ms and the "packing" density on the magnetic surface is 166 bits/inch.

Apart from storage, the disk has three other functions: it provides the basic machine pulse supply of 333 kc/s, generated from a "clock" track; it controls the timing of the gating of data to and from the delay lines by signals generated from an "address track"; and the initial instructions which are necessary to enable any information to be read into the machine are permanently stored on one sector of the disk.

The magnetic films are 1,000 ft in length and each can store approximately 300,000 words ( $10^7$  bits). The film is run with a 1-mil gap between it and the read/write heads at a speed of 30 in./second and its "packing" density is 140 bits/inch.

Data is transferred to and from the working store in 64-word blocks, the time to read or write a block being 290 ms approximately for intermittent working, i.e. start, read/write, stop, and 170 ms approximately for continuous working. There are two master film units controlling the five film machines provided and the whole film store occupies seven cabinets.

### Input and Output

The two paper-tape input channels use Ferranti photoelectric tape readers which can read 5-bit characters at speeds up to 180 characters/second. At a later stage an Elliott card reader will be added which will read punched cards at 400 cards per minute (533 characters/second for 80-column cards).

The direct output from the computer is to a Creed perforator working at 25 5-bit characters/second and to a Creed Teleprinter No. 75 at 10 characters/second. These two output channels are normally used only when small amounts of output are required; for payroll work, however, large quantities of printing will be required and a fast output to one or more of the five magnetic-film units is used. The output films are then taken away and used to drive the Samastronic printer.

For the same reason, an "input/output compiler" is provided to simplify the task of programming input and output and the assembly and conversion of data from decimal or sterling quantities to the binary numbers used within the computer. For example, by using a single instruction it is possible, on input, to provide automatic decimal-binary conversion of several 5-bit characters representing a decimal integer.

### System Centre

Two cabinets of equipment contain the control and arithmetic units of the computer. In the control unit

are the instruction register and the sequence-control register; the former holds and decodes the instruction being obeyed while the latter arranges that orders are normally obeyed in sequence.

Examples of the time taken for the arithmetic unit to execute certain instructions are: addition and subtraction, 100  $\mu$ s; multiplication and division, 3.3 ms.

### Control Console

Facilities for monitoring the contents of the accumulator in the arithmetic unit, the instruction register, the working store, etc., and for manually inserting data and instructions are provided on the console.

### PRINTERS

The Samastronic printers are line-at-a-time printers and can produce five lines of print per second. There are 140 character positions per line and letters or numerals can be printed in all positions.

The printed characters are formed by a "dot-pattern" produced by a stylus wire and carbon ribbon; each character position has its own stylus. One end of the styli wires is oscillated across the paper by a bar, and the paper moves forward continuously. Each character position is, therefore, "scanned" by its own stylus wire. Pulse patterns corresponding to the various characters are connected, as required, to 140 moving-coil transducers associated with the other ends of the styli wires. Each pulse results in the printing of one dot in the character pattern.

Two webs of continuous stationery may be used and the movement of the webs is independently controlled by signals derived from the magnetic-film drive equipment. Paper-feed facilities include the selection of various spacings between lines of print and a "long throw" facility to ensure correct print registration when pre-printed forms are used.

The print film, prepared on the computer, contains alpha-numeric data<sup>‡</sup> in 6-bit code (five characters per word) and the control signals that select paper feeding and layout alternatives. The data is read from the film in 64-word blocks and is decoded in 16-word blocks (i.e. 80 characters). The 80 characters in each 16-word block make up one line of print and the positions in which the characters are printed are determined by alternative cross-connections on the printer, the alternatives being selected by programmed control signals on the film. There are also facilities for selecting the blocks from which printing is required and for suppressing printing from part of the selected blocks.

### POWER AND VENTILATION PLANT

Each of the two power rooms contains three motor-alternators which may be switched to either computer or printer installation as required. The supply to the alternators is by a 60 kVA 3-phase feeder to each power room direct from the building sub-station in the basement, and each power room can be switched to the alternative feeder if necessary. The feeders also provide the essential lighting supply for the installation and power for the punch-room machines.

Each computer dissipates about 25 kW as heat, which is extracted from the equipment by individual fans mounted at the top of each cabinet and from the computer room by extract grilles in the false ceiling above the

<sup>‡</sup> Alpha-numeric data—data consisting of alphabetical and/or numerical characters.



computer. The extracted air is replaced by filtered air blown in through diffusers in the false ceiling above the console. The temperature of the inlet air is controlled by a thermostat in the computer room, the warm extracted air being mixed with fresh air in the necessary proportions. The mixing takes place in the ventilation room, which contains the intake and extract fans, filters and the motor which controls the amount of air recirculated under thermostatic control.

#### MAINTENANCE

The whole of the installation is maintained by the City Telephone Area, London Telecommunications Region. Approximately two hours per day, before the start of operations, is reserved for computer maintenance, which consists of the running of a number of test programs under normal and marginal conditions, e.g. low voltage, and the changing of 4 per cent of the plug-in units daily according to a fixed schedule. The plug-in units removed from the computer are checked on special testers in the engineers' room and the characteristics of all valves and crystals are measured. The same procedure is followed for the printers.

#### PROGRESS TO DATE

The LEAPS 1 installation is now complete; the computer has passed its engineering acceptance tests and

final proving tests of the whole system are being made. The second computer is now being installed and delivery of the second printer is expected in the autumn.

By the end of the year, installation and testing of the whole installation should be complete.

#### ACKNOWLEDGEMENTS

The building and structural work have been the responsibility of the Ministry of Works while the installation of power, lighting and ventilation is being dealt with by the London Telecommunications Region to plans prepared by the Engineering Department, Power Branch. Preparation of the payroll programs and the systems analysis is being carried out by the Mechanization and Buildings Department (Central Organization and Methods Branch) and the Accountant General's Department. The Engineering Department (Engineering Organization and Efficiency Branch) is responsible for the overall planning and co-ordination of the engineering work.

The computers and electronic equipment for the printers were supplied by the National Cash Register Co., Ltd., and installed by Elliott Brothers, Ltd. The Independent Samastronic Printers are being supplied by International Computers & Tabulators, Ltd., and the paper-tape equipment by Creed & Co., Ltd.

---

## The First Months of Subscriber Trunk Dialling

U.D.C. 621.395.38:621.395.374

#### INTRODUCTION

THE 18,000 telephone subscribers connected to Bristol Central exchange were given dialling access to most of the major cities in the country on 5 December 1958. These subscribers are using the S.T.D. system\* to obtain some 5,000 trunk calls per day, which represents approximately 97 per cent of the trunk calls they can obtain by dialling. Assistance operators receive only about 70 requests per day from S.T.D. subscribers for assistance in making trunk calls; about half the requests are from S.T.D. subscribers who prefer an operator to establish their calls. In addition, there are about 120 requests per day for special-facility calls such as personal and transfer-charge calls. Since the opening of the service the number of trunk calls from subscribers with S.T.D. facilities has increased by over one-third while the average conversation time has reduced by about half a minute. These two factors together probably represent an increase in total trunk-occupation time, but no firm figures on this can yet be given. The time taken to set up calls has also been reduced by approximately half a minute.

The load on the auto-manual board, which serves the whole of the Bristol trunk group, has been reduced by approximately 20 per cent, some of which has already been made up by normal growth of other traffic. It is of interest to note that approximately one-third of the S.T.D. traffic is routed to London.

\* Subscriber Trunk Dialling. *P.O.E.E.J.*, Vol. 51, Part 4, Jan. 1959.

#### SUCCESS IN ESTABLISHING CALLS

Service observation of S.T.D. traffic reveals that at Bristol calls unsuccessful at first attempt due to plant conditions have decreased by something over 4 per cent compared with the figure prevailing under the previous semi-automatic system. This improvement has been obtained even though additional S.T.D. and trunk mechanization equipment have been introduced. The lower percentage of calls which have failed since the S.T.D. service started reflects the reliability of the new S.T.D. equipment and the value of the work done before the opening of the new service to improve trunk signalling equipment and the equipment in objective trunk exchanges.

#### MAINTENANCE EXPERIENCE UNDER S.T.D. CONDITIONS

The pre-opening examination of the plant was of assistance in bringing to light matters requiring attention to ensure a good service under S.T.D. conditions where the assistance of an operator to complete the calls is no longer available. The main matters requiring attention were as follows.

#### *Need for a Route Performance Indicator*

To control the performance of trunk routes an immediate indication is required of how many calls are failing due to plant so that service deterioration can be quickly recognized. Observations of live traffic have traditionally been used for this purpose but because of



the sample size, the period over which observations are taken and the random way in which calls are selected for observation, the results are not easy to interpret for maintenance purposes. Service measurements were therefore made using artificial traffic originated by operators. Twenty test calls per trunk route per day were made to final-selector test numbers in the objective exchange network, the calls being distributed over the day approximately in accordance with normal traffic trends. The number of failures was summarized after each series of 200 calls had been completed. Route performance changes throughout the day because during busy hours there is, of course, more frequent use of late-choice outlets which are difficult to maintain to the same standard as earlier choices. These changes in performance emphasize the need for measuring, and improving, service during busy hours.

#### *Effect on Service of Trunk-Circuit Faults*

Faults on early-choice trunk circuits cause sudden and serious deterioration in service if not detected very quickly. Line failures in carrier and coaxial systems can cause the loss of a number of trunk circuits at the same time, and, if all the circuits in a route are in one cable, may cause the failure of the whole route. To supplement the normal fault-reporting procedure it was arranged for any indication of carrier failure received by the Bristol repeater station to be passed immediately to the trunk-test positions so that circuits could be busied promptly at selector levels. Additionally, the automatic trunk and junction routiner was arranged to make a short test of selected early-choice circuits in non-busy periods. The circuits included one circuit in each main carrier group, so that, effectively, the trunk and junction routiner ensured the serviceability of the main carrier groups before each busy period.

All first-choice and second-choice circuits on outgoing selector levels were "crossed", on a shelf basis, so that a subscriber who has experienced a failure in a non-busy period due to a faulty early-choice circuit will have a reasonable chance of obtaining a satisfactory circuit on a repeat attempt. The effect on service of circuit failures will be still further reduced when a new national v.f. signalling system incorporating an automatic busying feature under call-failure conditions becomes available. Carrier-group pilot signals which will indicate line failure to a carrier-group control station are also envisaged.

#### *Failing Circuits*

When service on a route gradually deteriorated it was usually attributable to a number of circuits which whilst

not completely out of order had an abnormal call-failure rate. Special co-operative testing as part of an intensive test-call program, and the use of pulse-distortion measurements by means of an oscilloscope, proved valuable in tracing troubles on these circuits.

The excellent co-operation between the maintenance officers at distant exchanges and the Bristol staff resulted in expeditious clearance of faults and helped considerably in the provision of a satisfactory service.

#### RELIABILITY OF THE ELECTRONIC REGISTER-TRANSLATORS

Despite the considerable difference between the electronic and the normal electromechanical equipment, the staff have dealt adequately with the problems of fault clearance. In 4 months over 750,000 calls have been handled by the registers, and of these only about 150, i.e. 0.02 per cent, failed to mature due to defects in the register-translator and associated equipments. The table gives details of the component failures in the 6 months to 23 March 1959.

Failures of Components of Electronic Register-Translators in the 6 months to 23 March 1959.

Component	Number of Components	
	Fitted	Faulty
Metal Rectifiers	83,000	5
Resistors	75,000	Nil
Cold-Cathode Tubes	12,000	7
Capacitors	12,000	Nil
Chokes	1,000	Nil
Plugs (36-point)	600	6
Valves	100	1

#### PLAN FOR THE FUTURE

It is the objective that S.T.D. should provide a service which is not noticeably different in quality from that given on local calls. Experience at Bristol has shown that such a service is possible, with the measures outlined and with full co-operation between exchanges, Telephone Areas and Regions. An organization has been set up to assist in maintaining this co-operation and with team-working throughout the country under the general guidance of a specialized headquarters group there is no doubt that an extremely satisfactory S.T.D. service will be given.

A.E.C.  
J.M.

## Book Review

"The Ultra High Frequency Performance of Receiving Valves." W. E. Benham, B.Sc.(Lond.), F.Inst.P., and I. A. Harris, A.M.I.E.E., A.M.Brit.I.R.E. Macdonald & Co., Ltd., London. 169 pp. 52 ill. 28s.

The authors state that their aims in writing the book are (1) to present the theory of the conventional valve as a circuit element, enabling linear circuit analysis to be applied to the problem of valve amplifiers for small signals at ultra-high frequencies, and (2) to give a simple detailed account of the electronic processes in a valve. It is a modern approach to valve theory written by engineers with research experience in this field.

The presentation is new in that the currents in the valve electrode circuits are represented by mesh currents rather than by the conventional currents in the grids, anode and cathode. This treatment enables the effects of stray inductances and capacitances in the electrode system to be taken into account more completely than in some other approaches, especially as the effects are considered in the presence of transit-time effects. The valve as a whole is then regarded as a non-reciprocal quadripole whose behaviour in gain, admittance, etc., is analysed according to the mode of connexion of the electrodes. The theory is applicable to most types of valve, providing the operation is linear, i.e. within the small-signal range, and providing the electrode

(Continued on p. 158)

## Notes and Comments

### Birthday Honours

The Board of Editors offers congratulations to the following engineers honoured by Her Majesty the Queen in the Birthday Honours List.

Bristol Telephone Area .. ..	C. H. Lewis .. ..	Area Engineer .. ..	Member of the Most Excellent Order of the British Empire
Cambridge Telephone Area .. ..	A. E. Smith .. ..	Technical Officer .. ..	British Empire Medal
City Telephone Area, London .. ..	F. G. Walton .. ..	Leading Technical Officer .. ..	British Empire Medal
Engineering Department .. ..	E. Hunt .. ..	Technical Officer .. ..	British Empire Medal
Engineering Department .. ..	N. Walker .. ..	Senior Executive Engineer .. ..	Member of the Most Excellent Order of the British Empire
Liverpool Telephone Area .. ..	W. H. Ward .. ..	Technical Officer .. ..	British Empire Medal
London Telecommunications Region .. ..	W. S. Procter .. ..	Chief Regional Engineer .. ..	Officer of the Most Excellent Order of the British Empire
Newcastle-upon-Tyne Area .. ..	R. F. News .. ..	Mechanic-in-Charge .. ..	British Empire Medal
North Telephone Area, London .. ..	A. C. Butcher .. ..	Inspector .. ..	British Empire Medal
Telecommunications Region			

### G. H. Metson, M.C., D.Sc., Ph.D., M.Sc., B.Sc.(Eng.), M.I.E.E.

Dr. G. H. Metson, Deputy Chief Scientific Officer in the Thermionic Division at the Post Office Research Station, Dollis Hill, has been awarded the degree of Doctor of Science at Queen's University of Belfast for his work on the thermionic valve, and particularly on the oxide-coated cathode. Sincere congratulations are offered to Dr. Metson on obtaining this high academic distinction.

### Board of Editors

The Council of the Institution has appointed Mr. G. J. Millen a member of the Board of Editors in place of Mr. R. F. Waldegrave, who has recently completed his term of office as a member of Council. The Board would like to record its appreciation of the services rendered to the Journal by Mr. Waldegrave, and particularly to thank him for his help with illustrations for the Journal and Supplement.

Mr. J. H. Broadhurst has resigned from the post of Editor (Supplement) and Mr. A. G. Leighton, formerly an Assistant Editor, has been appointed to take his place. The new Assistant Editor is Mr. J. Martin. The Board of Editors takes this opportunity of thanking Mr. Broadhurst for his services, and in particular for his work on the Supplement to the Journal and the books of

model answers to City and Guilds of London Institute examinations in telecommunications subjects.

### 12-Year Index

An index to Volumes 39-50 (1946-1958) is being prepared and it is planned to publish it towards the end of the year. The price of the index will be 2s. (2s. 6d. post free) but one copy will be supplied without charge to each reader who places an advance order. Any reader wanting a free copy of the index should complete the address label enclosed with this Journal and return it to the Managing Editor forthwith.

### Subscriptions

Some subscriptions for the Journal have in the past been dealt with by Messrs. Birch & Whittington (Prop. Dorling & Co. (Epsom), Ltd.), but in future all correspondence about subscriptions, including renewals, should be sent to the following address:

The Post Office Electrical Engineers' Journal,  
G.P.O., 2-12 Gresham Street,  
London, E.C.2.

### Publication Delay

Because of the recent dispute in the printing industry the publication of this issue of the Journal has been very much delayed. The Board of Editors regrets any inconvenience to readers which this delay may have caused.

---

## Institution of Post Office Electrical Engineers

### Essay Competition 1958-59—Results

A prize of £6 6s. and an Institution Certificate have been awarded to the following competitor in respect of the essay named:

S. J. Spicer, Technical Officer, Engineering Department (Inland Radio Planning and Provision Branch). "The Design of a High Frequency Interference Tracing Receiver."

Prizes of £3 3s. each and Institution Certificates have been awarded to the following four competitors:

W. M. Milne, Technical Officer, Aberdeen (Scotland). "Visual Training Aids."

A. K. Hill, Technician, Class IIA, East Area (London Telecommunications Region). "Public Relations."

B. D. Lock, Technical Officer, London Postal Region. "Automatic Boiler Control Systems."

V. D. Ede, Technical Officer, Stoke-on-Trent (Midland Region). "Tracing Noise on Program Circuits."

Institution Certificates of Merit have been awarded to:

J. Williams, Technical Officer, Rotherham (North Eastern Region). "Basic Routines by Comparison."

J. G. A. Wallace, Technical Officer, Southport (North Western Region). "An Infra-Red Electrical Heating System in Practice."



G. R. Southall, Technician, Class IIA, Birmingham (Midland Region). "The First Two Years."

A. Forte, Technician, Class I, Gateshead (North Eastern Region). "Creepage in Underground Cables."

W. Morrison, Technical Officer, Edinburgh (Scotland). "Printed Circuits and their Potentialities."

The Council of the Institution is indebted to Mr. J. Stratton, Chairman of the Judging Panel, for the following review of the five prize-winning essays.

The first prize was awarded to Mr. S. J. Spicer, Technical Officer, Engineering Department. His essay is about "The Design of a High Frequency Interference Receiver." The author introduces the subject by briefly stating why an officer investigating interference complaints must have testing equipment, and after criticizing the receivers in current use he goes on to give an account of the consideration that was given to the design of a receiver that would overcome most of the shortcomings. For instance, transistors were considered, but since the receiver was to be used in the frequency range 30–250 Mc/s, transistors could only be used for intermediate-frequency stages. The author describes other factors which were taken into account and used to produce a satisfactory laboratory model.

The second prize was awarded to Mr. W. M. Milne, Technical Officer, Aberdeen, for his essay on "Visual Training Aids." He discusses the use of visual aids in training a telecommunications student and their advantages in helping to get a quick, practical understanding of what is taking place in various pieces of apparatus. He describes existing aids from photographs, sketches of parts of apparatus, charts, cut-away views and films. He deals at some length with two models, one to show the changes taking place in the signal frequencies in carrier working, and the other a scaled-down model of a manual exchange and associated external plant. He finishes with the thought that closed-circuit television could find its place in aids to Post Office engineering training.

The third prize was awarded to Mr. A. K. Hill, Technician, Class IIA, East Area, London Telecommunications Region. Mr. Hill, an Indian, or as he describes himself, a coloured man, has written an essay on "Public Relations." The title is used in its broadest sense and the essay is an interesting study of the views of a member of the Commonwealth on the relations between different races working together, the relationship between the Post Office and the unions, and the relationship between the Post Office and the subscribers.

The fourth prize was awarded to Mr. B. D. Lock, Technical Officer, London Postal Region, for his essay on "Automatic Boiler Control Systems." Mr. Lock, after stating the requirement of a heating system, describes broadly three methods of control: (i) mechanical, (ii) using room thermostats and time switches, and (iii) using an electronic variator with thermostats. He goes on to describe in more detail control systems fitted at one or two installations.

The fifth prize was awarded to Mr. V. D. Ede, Technical Officer, Stoke-on-Trent, for his essay on "Tracing Noise on Program Circuits." This is an account of the efforts made by the engineering staff of the Stoke-on-Trent Area to trace and remove noise on music circuits passing through the Area. These music circuits, although on screened pairs, developed trouble through noise after a fault had been cleared on the Stoke-on-Trent–Warrington No. 2 cable.

The Council of the Institution records its appreciation to Messrs. J. Stratton, G. Spears and A. J. Leckenby, who kindly undertook to adjudicate upon the essays entered for the competition.

*N.B.—Particulars of the next competition, entry for which closes on 31 December 1959, will be published later.*

#### **Institution Field Medal Awards, 1957–58 Session**

In addition to the Institution Senior and Junior silver and bronze medals, up to three bronze medals, the Field Medals, are awarded annually for the best papers read at

meetings of the Institution on field subjects primarily of Regional interest.

Field Medals were awarded to the following authors for papers read during the 1957–58 session:

E. J. Harris and K. E. Wilkinson, Bristol (South Western Region). "Subscriber Trunk Dialling at Bristol."

R. C. Such and H. F. Gibbs, Oxford (Home Counties Region). "The Oxford Cable Tunnel."

J. A. Lee, Sheffield (North Eastern Region). "Accidents on Duty."

The Council of the Institution is indebted to Mr. J. J. Edwards, Chairman of the Paper Selection Committee of Council, for the following précis of the medal-winning papers.

#### *Subscriber Trunk Dialling at Bristol*

The paper gives a brief description of the main features of the S.T.D. scheme for the British telephone system. In the course of this description reference is made to the national numbering scheme, the routing principles based on the use of register-translators, the new charging arrangements, and miscellaneous features, including the 50 c/s signalling scheme for operating meters at subscribers' premises; a brief reference is also made to the new pay-on-answer coin-box system. The application of the scheme to the Bristol area is described in some detail, and a simplified account of the electronic register-translator is included. The paper then reviews the arrangements which will obtain when S.T.D. is introduced at other centres in the South Western Region, with particular reference to Gloucester and Bournemouth, and concludes with a resumé of various extensions to the S.T.D. scheme which are currently under development in the Engineering Department.

#### *The Oxford Cable Tunnel*

This paper describes the planning, construction and cabling of 400 yards of 7 ft diameter tunnel, decided upon to avoid difficulties arising from the presence of sub-soil water, a culvert and other undertakers' plant, the foundations of the historic Tom Tower of Christchurch College, and traffic congestion in the narrow streets. The choice of method, soil consolidation and progress of construction, and the effects on the latter of various traffic restrictions, plant diversions and other points, are adequately covered. Gas precautions, temporary lighting and incidental flooding troubles during the cabling stages are dealt with, and descriptions of the various difficulties, which may not be apparent initially, make this a paper that should prove useful to any other Area facing a similar problem for the first time.

#### *Accidents on Duty*

This paper ventures far from the general technical field of I.P.O.E.E. papers, though, as the author points out, accidents cause a considerable drop in efficiency and thus can reduce the gains of technical advancement. The author makes a special plea for more development of mechanical aids to cover operations on ladders and poles, which are the sources of the largest percentage of lost time due to accidents: in one Area 45 per cent of the accident-sickness absence was due to accidents on ladders, which compares badly with the 33 per cent figure quoted by Mr. A. S. Stubbs in 1919. The author concludes with a number of suggestions for reducing the accident rate, and also suggests that there should be a "First Aider" in each working party.

S. Welch,  
General Secretary.

#### **Supplement to the Library Catalogue**

A Supplement to the Library Catalogue, listing the books added to and withdrawn from the library during 1958, is now available free on request from Honorary Local Secretaries and Associate Section Centre Secretaries.

*(Continued on page 154)*



# Regional Notes

## North Eastern Region

### LINCOLN AUTOMATIC TELEPHONE EXCHANGE

At 1.30 p.m. on Saturday, 18 April 1959, the new automatic telephone exchange in Lincoln was opened and the two manual exchanges, Lincoln Main and Lincoln Relief, opened in 1912 and 1950, respectively, were closed.

The site for the new exchange building, in Broadgate, was acquired before the 1939-45 war, and a considerable amount of ductwork and manhole rebuilding had been carried out. It was, however, necessary to lay a 48-way duct track from the exchange manhole to the cable chamber. Thirteen MU cables were diverted to the cable test racks in the repeater station and during the installation period two new cables, from Lincoln to Boston and to Retford were laid.

The installation was started in May 1957, and the exchange has been equipped with 8,400 calling equipments and a 9,100-line multiple. Forty-four manual positions, in two suites, have been installed as well as six monitorial positions. The repeater equipment installed consists of 1,536 Amplifiers, No. 32, and line termination and signalling equipments, together with three 12-channel m.c.v.f. systems.

With the opening of the exchange, the 6,362 subscribers can now dial 41 directly and indirectly connected U.A.X.s, and a further 12 U.A.X.s are available via Newark and Retford manual exchanges, to which junctions are available by code dialling. In anticipation of S.T.D. facilities in late 1960, subscribers' telephone dials are fitted with director-type number rings and level 100 is used for assistance traffic.

Lincoln, as the centre of a rural district, has 36 U.A.X.s parented on it, 28 of which are directly connected. The restrapping of the relay-sets at the U.A.X.s for 50-volt working, and pre-transfer testing to the new auto-manual exchange, presented a problem because of the limited time available between the call-through test and the main-exchange transfer. A number of proposals were studied and it was finally decided to adopt a novel scheme which involved a simple modification to the old manual-exchange (40-volt) incoming relay-sets.

The modification consisted of the connexion of a 40-volt battery in place of earth at relevant points in the negative line and reversal of the rectifier to give conditions similar to those on a 50-volt relay-set. Adoption of this idea permitted the 50-volt straps to be inserted at the U.A.X. end of the circuits at the same time as the auxiliary-route discriminating relay-sets were strapped for automatic working. Unidirectional incoming circuits to the U.A.X.s were strapped for 50-volt working without requiring any changes to the old manual exchange outgoing relay-sets.

After completion of the new exchange call-through test, joint engineering and traffic tests were made to the auto-manual exchange, and upon completion of these tests the circuits were left working to the old manual exchanges.

Two weeks before the main transfer the new auto-manual exchange was opened to cater for the pre-transfer of the Lincoln coin-box lines in accordance with the standard scheme for non-director-exchange conversions. During the same week-end that the manual switchboard was opened, all the U.A.X.s were diverted to the new exchange at the change-over strips. Approximately 370 U.A.X. junctions were transferred leaving only 10 to be switched at the time of the main transfer. Co-operation was not needed at the U.A.X.s since traffic tests by "dialling back" over the U.A.X. junctions verified correct transfer. To cater for the traffic originated by the Lincoln coin-box lines and U.A.X.s a skeleton network of outgoing junctions and trunks was pre-transferred.

In an endeavour to give the public an idea of how telephone design has progressed since the turn of the century, an exhibition of telephone equipment was held in the vacated relief-exchange switchroom after the transfer. The telephones on view ranged from the Telephone No. 1 to the

new 700-type telephone, and working demonstrations were given in automatic telephony, automatic telex and television-interference suppression.

J. E. S. and T. A. B.

### AN EXPERIMENT IN PUBLIC RELATIONS AT SHEFFIELD

This story of a successful effort, inaugurated in January last by the Engineering Division in the Sheffield Telephone Area, to improve relationships with the customer is particularly interesting in view of the P.M.G.'s message of 11 March about satisfactory and courteous service.

Sheffield has the doubtful honour of maintaining an automatic exchange working in what is probably the dirtiest area in the Region; the smoke-abatement committee's records indicate that in this exchange area the dust-fall averages over 40 tons per square mile per month, and reaches 70 tons per month at certain periods. The exchange in question is Attercliffe, and it serves some world-renowned steelworks which employ large P.B.X. staffs.

The idea of the experiment arose from a discussion between the Area Engineer and the two Technical Officers, who maintain the exchange, on how to improve still further the quality of service to these important and busy subscribers. The idea was to give an "At Home" for the P.B.X. operators, when they could be shown what was being done to give them a good service, and to help enlist their closer co-operation, for example, in the holding and tracing of faults. The Traffic Division was invited to assist in this venture, and they co-operated in writing to the firms and collating the replies. As the "At Home" would be during working hours it was expected that only a dozen or so operators would be released, and they could all be entertained in one afternoon. It was hoped that through these few the efforts being made to help them would be more widely known, and that greater satisfaction with the telephone service would follow in due course. But the response from the firms was quick and enthusiastic; it was almost a 100 per cent acceptance. It was, therefore, necessary to arrange seven afternoon visits, and when the last one had been completed a total of 54 operators from 23 firms had been entertained and shown the exchange.

It is too early to analyse statistics which may be affected by the venture, but the following is not without interest. During 1958, nine written and approximately 12 verbal complaints regarding the quality of service were received from the Attercliffe firms which sent operators to these visits. In the two months since the last visit, no written and no verbal complaints have been made to date. In addition, the P.B.X. faultsman reports considerably improved relationships and co-operation at all the P.B.X.s concerned.

Invitations have now been sent out to the larger P.B.X.s served by Owlerton satellite exchange with the intention of repeating the operation there. The possibility of making this an annual event is under consideration.

J. W. S.

### A METHOD OF ELECTRIC-LIGHT INSTALLATION IN A LARGE BUILDING

With much telecommunications plant difficulties arise due to the smallness of the pieces of equipment, but a problem of the opposite type has recently been dealt with in the Leeds Area. For the installation of a Sovex parcel-sorting machine, a large industrial-type building has been taken over and is being partially reconstructed. The building is over 100 yd long by 90 yd wide and the height to the roof trusses is 40 ft.

While the building work and some of the installation work was in progress it was necessary for the local electric-light and power staff to install a completely new lighting

system, and the problem was how to get the men to the job, i.e. up to the roof trusses. Scaffolding was hired for the purpose, but a tower nearly 40 ft high needs to be fairly rigid and, thus, is heavy and difficult to move about quickly. It was soon evident that the men were spending far more time handling the scaffolding than they were in fixing conduit, fittings and wiring. Also, the job was made difficult by the quantity of builder's materials and Sovex machine parts lying on the floor in the place where the men wished to erect the scaffolding. The solution to the problem was the use of a Simon hydraulic platform. This device, which is described in the Engineering Department's mechanical-aids brochure, E.-in-C. 2290, consists of a double-boom arrangement carried on a 5-ton long-wheel-base chassis. The lower boom is mounted on a turn-table and the upper boom carries a working platform. All movements of the platform are controlled from the platform itself. The device is often used for tree-cutting or the running of aerial cable, but its versatility also proved very useful in this case. The large floor area enabled the vehicle to be used freely, and the presence of builder's materials did not cause any difficulty, the booms allowing free range of movement to the exact point required.

The men working on the platform were well pleased with the arrangement; the platform is quite stable and well guarded and it can be manoeuvred to its required position with ease. All their energies could be directed to the actual work of the electric-light installation and there was no frustration caused by the inability to reach parts of the work due to building material being in the way, as occurred with the conventional tubular-scaffolding platform. Where it was necessary to pass from one bay of the building to another under relatively low cross beams, it was only a matter of a few minutes' work to lower the boom and drive the truck to its new position. The use of the Simon platform certainly effected a most considerable saving and allowed the job to proceed with speed.

W. E.

#### North Western Region BUILDING A CABLE CHAMBER AROUND AN EXISTING LEAD-IN

The partial transfer of the Birkenhead C.B.1 exchange area to automatic working took place on 9 April 1959, when Cloughton automatic telephone exchange was opened for service.

The automatic equipment is housed in a new building erected as a wing to the existing manual exchange-building. Due to site limitations the new wing could only be located in a position immediately over the existing lead-in to the manual exchange, which meant that the new cable chamber would have to be constructed around the lead-in, as shown in the

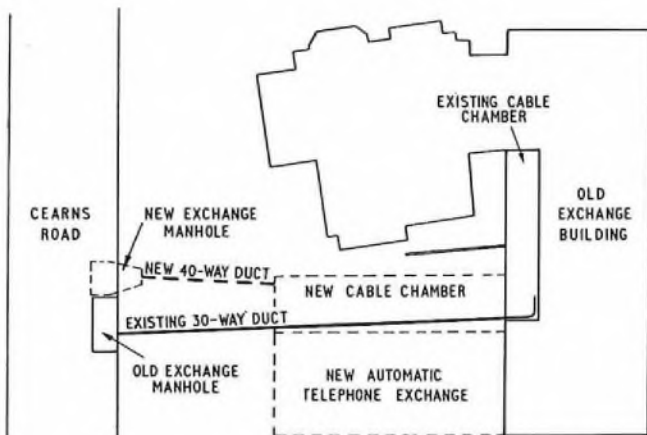

PLAN SHOWING POSITIONS OF EXISTING LEAD-IN AND NEW CABLE CHAMBER

sketch. To ensure that there would be no interruption to service and that building operations would proceed smoothly, building sequences had to be carefully planned and an unusual degree of liaison was necessary between the architects, building contractors and works supervisors.

Included in the design of the basement steelwork were subsidiary girders to be used as supports for slings to suspend the existing lead-in ducts until such time as the cable-chamber floor could be completed and cable racking erected.

The sequence of the building operations was as follows:

Firstly, the ground was excavated until the top surface of the existing lead-in, which consisted of two 9-way and two 6-way duct blocks, was exposed. Two trenches were excavated down to the required level of the cable chamber, one on each side of the lead-in, leaving the lead-in duct blocks fully exposed and perched precariously on an embankment along the full length of the excavation. Although the ground was reasonably stable, consisting of soft sandstone, clay, and strata of crumbling sandstone, a period of very heavy rain caused crumbling of the embankment. To counter any collapse of the duct, holes were excavated under the duct blocks at 2 ft intervals, heavy planks were forced through the holes, and by means of wooden staging and wedges the weight of the lead-in was eased off the embankment.

Excavation of the holes for the concrete footings for the main vertical steel supports of the building steelwork was then carried out, and the concrete foundation blocks were cast in position. Erection of the main steelwork followed and, when completed to ground-floor level, subsidiary girders were bolted in place in such a position that they were below the finished cable-chamber ceiling level and running parallel, and above, each side of the lead-in duct. The duct blocks were then supported at 2 ft intervals by means of slings made up from 7/14 suspension wire and stay tighteners. Each sling was passed under the duct blocks and over the subsidiary girders on either side. By adjustment of the stay tighteners the full weight of the lead-in duct and cable was eased from the wooden staging and held suspended from the steelwork.

The building contractor was now able to clear away the embankment, level the excavation, lay the concrete floor of the cable chamber, and proceed with brickwork and normal building operations.

A new lead-in of 48 ways from a new exchange manhole positioned adjacent to the existing exchange manhole was constructed, the new lead-in being roughly parallel to, and about 6 ft from, the remainder of the old lead-in which was not enclosed by the new cable chamber.

As soon as the cable chamber was completed the cable racking for the new Cloughton exchange cables was erected. This racking was made with additional cantilever-type support bolts on the far (back) side of the vertical H-sections. Cable bearers were bolted to the cable-chamber wall opposite to each cable-rack vertical H-section and a number of flat bars provided, cut to such a length that they could be supported between the wall cable-bearers and the additional bolts in the cable rack.

Now came the most difficult part of the operation when it was necessary to break the duct blocks from around the cables, moving the cables from the slings on to the support bars. This was done by first of all breaking away all spare bores, then breaking away the duct a block at a time, inserting the flat bars between each layer of cable as it was exposed, releasing the slings one by one and casing each end of the bars on to its support bolts. By slewing the suspended formation as near to the back wall of the cable chamber as possible, making use of a little slack obtained by flattening the bend where the cables turned in the old cable chamber, and by breaking open the duct from the top, the job was completed very successfully. Not only was there no interruption to any working lines but the cables were quite undamaged.



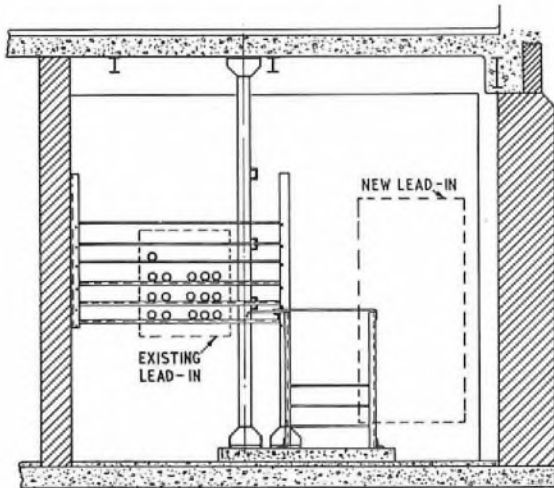

EXISTING CABLES SUPPORTED ON ADDITIONAL BEARERS IN NEW CABLE CHAMBER

That part of Birkenhead exchange which was not transferred to Claughton automatic telephone exchange will continue to operate as a manual exchange until the opening of a new automatic telephone exchange which has been planned for another site. It will then be possible to recover the cables and ancillary racking and, thus, complete a job which it is believed is unique.

J. F. C.

#### South Western Region

##### BOURNEMOUTH AUTOMATIC EXCHANGE

The new exchange and repeater station have been installed in a 4-floored building of strikingly modern design, situated in most pleasant surroundings on Bath Road, close to Bournemouth's East Cliff. A brick panel on the frontage is decorated with a bas-relief of Hermes, or Mercury as he is better known, and this, together with other architectural features of the building, has created considerable interest in the town. The view from the canteen on the upper floor embraces the whole of Bournemouth Bay, with the Isle of Wight to the east, and Poole Bay with Old Harry Rocks to the west, and there is no doubt that the staff are justly proud of their new environment.

The new auto-manual exchange replaces three others:

(i) Boscombe auto-manual group centre and tandem, which has been in service in the Telephone Manager's office since 1949. This functioned as a temporary auto-manual parent for Southbourne, Boscombe and Canford Cliffs discriminator-type satellites, and a tandem-switching centre for through traffic.

(ii) Bournemouth trunk group centre, which dealt with trunk traffic originated by Bournemouth manual-exchange subscribers, and was opened in 1950 by using the old Boscombe C.B. No. 1 switchboard sections converted to meet trunk requirements. The exchange was housed on the upper floor of what is now the Boscombe satellite-exchange building.

(iii) Bournemouth C.B. No. 1 installed in 1912, which in latter years has functioned simply as a toll and local exchange for Bournemouth subscribers.

Equipment installed in the new exchange includes 89 auto-manual positions in two suites, and a 16-position inquiry suite, all finished in medium oak and housed in a most imposing switchroom, as shown in the photograph. The switchroom is on the second floor of the new building, and in other rooms on the same floor are a 14-position directory-inquiry suite, which incorporates call-queuing facilities, and a 2-position centralized-service-observation desk. One of these observation positions is of the latest design with a 16-digit display panel for observation of

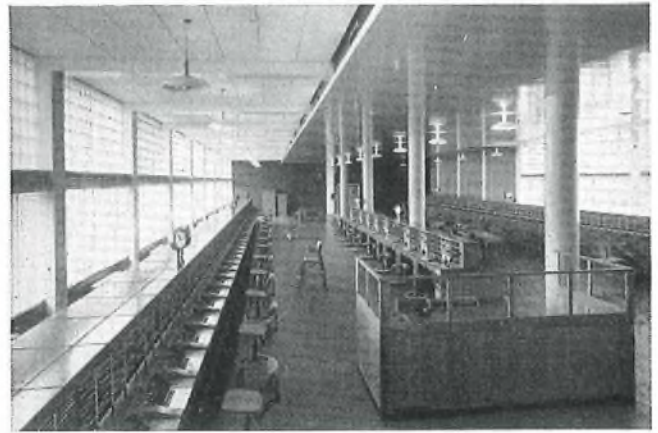

SWITCHROOM OF THE NEW BOURNEMOUTH AUTOMATIC EXCHANGE

automatic exchanges, while the other is for observation of manual exchanges still remaining in the area.

The new exchange has a capacity for 8,600 lines in its multiple, and the switching equipment occupies, with the repeater station, the whole of the first floor and comprises 7,775 subscribers' uniselectors, 4,450 first, second and third selectors, 699 final selectors, 4,711 relay-sets of various types, including A.C.1 and D.C.2 signalling relay-sets, and 480 motor uniselectors in the trunk unit. A 16-position test-desk suite, with filtered ENG facilities, provides accommodation for the maintenance control and trunk test which, until opening of the auto-manual switchboard, was housed in temporary accommodation at Telephone House. The repeater-station equipment, which replaces that previously in service at BH/A (in the Old Bournemouth manual-exchange building) and BH/B (on the northern outskirts of the town) includes channel equipment for 60 12-circuit carrier groups. In addition, terminations for 28 audio cables have been provided, together with the usual audio and music amplifiers, and signalling equipments. The exchange power plant consists of a divided float system, with three 600 amp generators and two batteries each with a nominal capacity of 5,590 Ah. Power is derived from 240-volt a.c. busbars energized by a 3-machine "no-break" power plant. A 160 kW diesel-driven stand-by machine is at present being installed, and in the event of mains failure this will provide power for both the repeater station and the telephone exchange. Fluorescent rack and frame lighting has been used throughout, and the telephone exchange has been wired with cream plastic-sheathed cable on grey runways and frames.

Due to the complexity of the project as a whole it was decided to carry out transfer operations in two stages. Prior to stage 1, all the MU and CJ cables were routed in and out of the new building, and the 2-wire ends of trunk and junction circuits were wired through change-over equipment to allow for instantaneous transfer from the old to the new manual boards.

At 1.15 p.m. on 8 April 1959, the first stage of the transfer, which involved bringing into service the new manual board and tandem-switching equipment, was successfully accomplished. Boscombe and Bournemouth trunk centres were closed, together with the tandem-switching equipment at Telephone House. A group of U.A.X.s, previously parented on Wareham, a C.B.S. No. 2 exchange 14 miles west of Bournemouth, were re-parented on the new exchange at the transfer. This involved switching the junctions at the U.A.X.s concerned, and at the same time opening new, non-parent, routes to Wareham. The second stage was carried out on 27 May 1959, when 5,650 Bournemouth subscribers were transferred from the old manual exchange to the new automatic equipment and became, together with subscribers connected to the satellites at Boscombe, South-



bourne and Canford Cliffs, part of the 5-digit linked-numbering scheme. Opportunity was also taken to introduce the code "100" for dialling access to the manual board for assistance, in preparation for S.T.D., which is due to be introduced in Bournemouth during 1961. However, coin-box subscribers and kiosk users will dial "0" for assistance for the present. A C.B. No. 9 3-position P.B.X. previously in service at the Telephone Manager's office has been closed down, all extensions having been converted to work as exchange lines on the new automatic equipment. Thus, a major step towards complete automation of the Bournemouth Telephone Area will have been achieved.

R. E. B.

#### ICING OF OVERHEAD WIRES IN THE GLOUCESTER AREA

On the morning of 7 February 1959, as a result of reported faults, it was found that overhead wires on the high ground of the Cotswold were, together with ice, approximately 1½ in. in diameter, and were sagging badly where they had not broken down under the weight of ice. That the damage was so great was most unexpected in view of the freedom from frost in the nearby towns and villages on the lower ground.



By courtesy of Cheltenham Newspaper Company, Ltd.

ICING OF OVERHEAD WIRES ON THE COTSWOLD HILLS

Whilst a maximum of 4°F of frost was recorded during the period from Friday, 6 February until Monday, 9 February, the phenomenon was due to the high moisture content in the air and a general south-westerly wind blowing the mist against objects to which it froze. The riming rate was of the order of ½ in. per hour, measured on an aerial wire 600 ft long, at a radio station in the district. The conditions were peculiar in as much that the so-called ice deposit was, in fact, frozen fog of a dirty grey nature.

Altogether 200 circuits spread over eight rural exchange areas were out of service. The continuing heavy fog and mist made restoration work difficult, but roads were cleared of fallen wires, and nine working parties were employed in preliminary clearing and restoration of service. Where routes were down and poles leaning interruption cable was provided and, where possible, wires were replaced. All circuits were restored by Friday, 13 February, the majority being back in service by Wednesday, 11 February.

#### London Telecommunications Region AN UNUSUAL OUTSIDE-BROADCAST TELEVISION CIRCUIT

A temporary outside-broadcast television circuit was set up for the B.B.C. between the Hippodrome, Brighton, and Broadcasting House, London, on 30 December, 1958. The circuit was 57½ miles long and was provided on one of the two spare tubes in the London-Brighton No. 4 cable. The circuit required 14 repeaters and, as the B.B.C. do not rent this quantity of video repeaters, it was necessary to use the rented 3-7 Mc/s outside-broadcast carrier equipment for the last 17½ miles and nine video repeaters for the remaining 40 miles.

The usual difficulties of "hum" and low-frequency slope, which are frequently met when transmitting video signals on coaxial cable using outside-broadcasting type of equipment, were overcome by an improved type of output amplifier. This amplifier was designed to give:

- (i) A maximum output level of +12 db relative to 1 volt peak-to-peak.
- (ii) A variable low-frequency "lift," i.e. below 15 kc/s.
- (iii) A selection of various "frame corrections."
- (iv) A variable output impedance of 50-90 ohms.

That part of the circuit between Brighton stations C and A on a telephone-cable pair proved the most difficult portion of the whole circuit and reduced the general quality, but even so the B.B.C. expressed satisfaction and the circuit had a 2 per cent K-rating.

B. H. M.

#### 1,700-LINE P.A.B.X. NO. 3 FOR THE UNILEVER GROUP OF COMPANIES

In January 1959 a 1,700-line P.A.B.X. No. 3\* (ultimate capacity 2,000 lines) was brought into service in the City Telephone Area, replacing a 21-position C.B. No. 10 switchboard and a 200-line P.A.B.X. No. 3 with two auto-manual positions. This represented Stage II of a 3-stage conversion for the Unilever group of companies.

Stage I was the provision in 1957 of the 200-line P.A.B.X. No. 3 to serve a newly constructed building, and Stage III will be the installation of a 600-line P.A.B.X. No. 3 making use of the equipment provided for Stage I and recovered under Stage II. The 600-line P.A.B.X. will serve another new building at present in course of construction.

Stage II involved some 24,000 hours of work in rewiring the extensions; replacing 2-wire circuits by 3-wire circuits in order to provide the inquiry facility; fitting approximately 2,000 telephones (some 300 extension plan numbers were involved); and testing the automatic equipment on completion of installation by the equipment contractor. The block wiring of the main building, Unilever House, and two of four other buildings was completely renewed, involving the fitting of 60 new distribution cases and completely re-cabling from a new M.D.F. situated in the new automatic-equipment room. This took a further 10,000 hours. In addition, a major rearrangement of the street cables was necessary to provide the exchange feed to the new M.D.F. and the cables to the other buildings.

The auto-manual switchboard consists of 13 switchboard positions of sleeve-control-type construction. A cable-turning section is followed by three suites of three positions each and one suite of four positions, each suite being separated by an angle section. Also in the switchroom are a supervisor's desk and an information desk, both office type, the latter being fitted with a key console to which callers dialling 7 are routed.

The numbering scheme is as follows:

Automatic extensions (1st subsidiary company)	2000-2049
Automatic extensions (2nd subsidiary company)	2050-2099
Automatic extensions (3rd subsidiary company)	2100-2149
Automatic extensions (Main group)	2200-3749

\* ROCHE, J. J. Post Office Standard P.A.B.X.s: Part 3.—The P.A.B.X. No. 3. *P.O.E.E.J.*, Vol. 47, p. 133, Oct. 1954.



Manual switchboard (General positions)	Digit 0
Manual switchboard (Long-distance positions)	Digit 8
Information desk	Digit 7
Outgoing public exchange lines	Digit 9
Hesketh House (existing 500-line P. A. B. X. No. 3)	Digit 6
United Africa House (proposed 600-line P. A. B. X. No. 3—Stage III)	Digit 5
Inter-switchboard circuits	Digits 41–40

The first selectors are segregated into four groups, i.e. a large main group and a small group for each of the three subsidiary companies. This enables the assistance (level 0) and exchange-line traffic (level 9) of the subsidiary companies to be kept entirely separate from that of Unilevers. Each subsidiary company has a single-position switchboard (SA 7560 type) with eight of 10 exchange lines working and the full 50 extension-jacks fitted. Besides the 0-level circuits each switchboard has two transfer circuits to the main switchboard, these being used for gaining access to the private wires via the main-switchboard operator. Extensions connected to the subsidiary switchboards obtain long-distance calls by dialling 0; they would not be connected by the main operator should they dial 8. Separate identity is thus achieved for the subsidiary companies while at the same time all the extensions have full access in dialling each other and the various private wires.

Operating time on the main switchboard is reduced by each position having a keysender (P.O. Type Key No. 254B) for use on outgoing exchange calls. The control circuit is of relay design, the equipment occupying one and a half 4 ft 6 in. wide racks. Free-line signalling is used on both the main and subsidiary switchboards as well as ancillary working on the main switchboard.

In all there are 200 exchange lines (176 on the main and 24 on the subsidiary switchboards). At the public exchange an additional rack of P.A.B.X. disconnect-clear equipment had to be provided and the level-9 direct-access exchange lines were connected to the barred-trunk group of 1st code selectors. The total number of private wires, auto–auto and auto–manual circuits was 73. Teed night service was provided on the first exchange line of Unilevers and each of the three subsidiary companies, as well as on selected other lines of the main Unilever number.

P. F. W.  
A. H. E.

### Midland Region

#### OLD-TYPE TELEGRAPH CABLE

Whilst excavating for a multi-duct route in Tamworth, Staffordshire, an old 2 in. cast-iron pipe was found to be

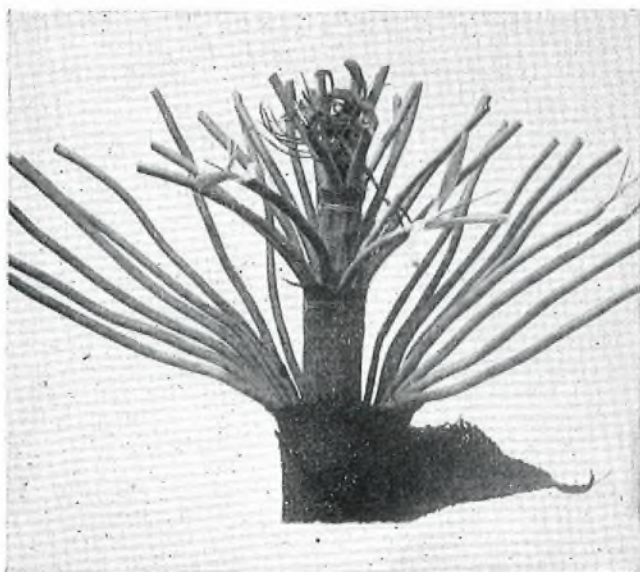

SECTION OF OLD TELEGRAPH CABLE RECOVERED AT TAMWORTH

obstructing the line of the duct. All undertakers were approached but no one claimed ownership, and it was decided to break open the pipe. This was done and a cable was exposed, which was found to consist of a centre galvanized-wire strand around which were lapped 36 40 lb/mile copper conductors, each conductor having a pink-paper lapping and enclosed in a lead sheath. The entire cable was wrapped with a bitumen-treated hessian tape. The pipe was completely dry and the bitumen was still fluid, retaining its characteristic smell. It is thought that the cable is an old type of Post Office telegraph cable laid about 1890.

H. S. C. and G. A. R. M.

### THRUST BORING AT ELMDON AIRPORT

In order to provide telecommunication service for the Ministry of Transport and Civil Aviation at Elmdon Airport, it was necessary to cross a 150 ft runway with two single 4 in. ducts. It was not considered desirable to break up the reinforced concrete of the runway, which was 4½ ft thick, and the alternative of thrust boring was decided upon. The Engineering Department recommended that, as the length was much beyond that normally undertaken by Post Office staff, a contract for the thrust boring should be placed with a well-known contractor who specializes in this particular type of work, and these arrangements were made.

To the surprise of the Area staff the contractor arrived equipped with a normal Post Office mechanical thrust-boring machine used with a hydraulic pump. The first crossing was achieved without great difficulty, although a drain at the edge of the runway had to be broken out and diverted. Then followed three unsuccessful attempts to provide the second crossing. A heavier boring machine with a larger size head was then used, the Post Office supplying the compressor and the airport authorities the water supply. A track locator was also used to follow the line of the boring head, but the runway reinforcement ruled out any success with this aid. In all, seven attempts were made to complete the second crossing. The airport authorities requested all work should cease for the holiday traffic, and it was decided that the contractor should abandon the attempt and the Area staff would try after the holiday period.

The Area staff undertook the work, and pilot holes 6 ft × 6 ft × 6 ft were excavated each side of the runway. Railway sleepers were used to take the thrust, and boring commenced with a pressure of between 1½–2 tons/in.<sup>2</sup>; this pressure was maintained throughout the operation. The head of the boring rod, which was at a depth of 5 ft in the pilot hole, emerged on the opposite side at a depth of 5 ft 9 in. Enlarged heads were used during the boring, and a 5 in. head preceded the duct No. 67 as it was drawn in. The pipes became uncoupled three times and the operation had to be repeated until finally a length of 4 yd remained which could not be drawn through. Completion of the ducting was carried out by forcing the pipes into position from the opposite pilot hole. The pipe was cleaned, a mandrel drawn through and the duct line was found to be quite satisfactory. The whole of the operation, which took 15 days, was carried out in inclement weather and continual pumping was necessary to keep the holes free from water. Further difficulty was encountered as the pilot holes had to be vacated each time the runway was in use by aircraft. The length of the thrust bore was 162 ft compared with the recommended maximum of 60 ft. It would, thus, seem that the length of bores could be greatly extended in suitable circumstances.

G. H. P.

### UNEXPECTED RESULT OF A THRUST-BORING OPERATION

On 20 January 1959 a complete breakdown developed on the Gloucester–Stratford and Evesham–Gloucester MU cables, both of which are 4 pr. 40 lb/mile screened plus



384 pr. 20 lb/mile P.C.Q.T. cables. Tests showed that both cables were faulty at the same point; the calculated fault location was approximately 5 miles from Evesham towards Gloucester.

When the maintenance staff arrived at this point a party of men was observed operating a thrust-boring machine. They were interrogated, but denied that their operations were anything to do with the cable breakdowns. However, it was decided to open up the ground at the point where they had last bored across the carriageway. When the duct was exposed, a  $1\frac{1}{8}$  in. diameter plastic water pipe was found threaded neatly through the duct and the two cables. The photograph shows the actual cables and water pipe at the

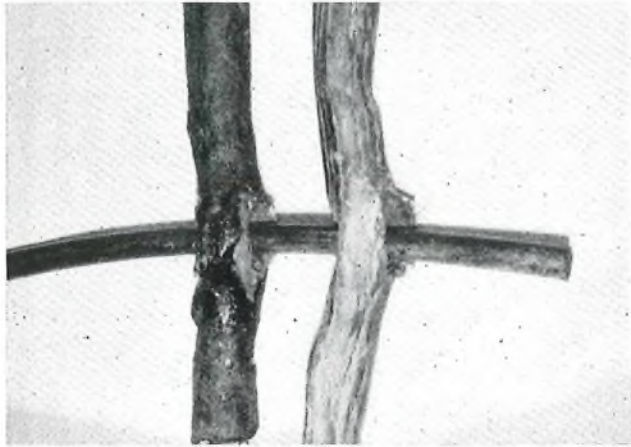

WATER PIPE THREADED THROUGH THE TWO MU CABLES

point of penetration, but it was not possible to take a picture in position owing to flood water, and the assembly shown is a reconstruction at ground level. All operations in temporarily restoring service were severely hampered by flood water.

F. A. A. P.

#### UNUSUAL ICING CONDITIONS

During a spell of continuous foggy weather early in February, the air temperature was slightly above freezing point, and there was no sign of frost in Birmingham. However, on high ground outside the city, a slight reduction in temperature resulted in severe icing of open wires, poles and fittings. This was particularly so at Frankley (840 ft above sea level) where the ice build-up on wires was from  $1-1\frac{1}{2}$  in. in diameter. On the windward side of stays and fittings the ice was 6-8 in. thick, in a flat sheet. The ice consisted of frozen smog, being grey in colour and of a fibrous texture. The 70 lb/mile wires sagged to hedge level, and although some poles were displaced, the route generally withstood the considerable loading well.

Similar icing conditions existed elsewhere in the Midland Region, particularly on high ground in Staffordshire where there were reports of 2 in. of ice on conductors.

R. G. T.

#### Wales and Border Counties

##### A NEW BRIDGE OVER CONWAY RIVER

Telford's suspension bridge carrying the A55 Chester to Bangor trunk road over the Conway river at the historic walled town of Conway, Caernarvonshire, has for many years disrupted the flow of traffic along the North Wales coast. The bridge was opened in 1826, and, although suitable for the road traffic of those days, it has of recent years caused considerable traffic delays.

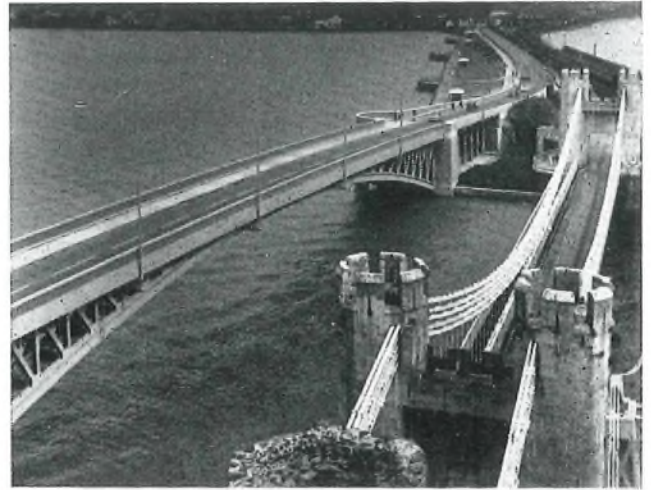

OLD AND NEW BRIDGES AT CONWAY

A new bridge was long overdue, and in 1955 the Ministry of Transport approved its construction at a cost of £534,000; building began in February 1955, and the bridge was opened to traffic in December 1958. The new bridge has been built parallel and close to the old one, and is a flat arch, two-pin type, with a span of 310 ft.

The old bridge carries the Colwyn Bay-Holyhead  $2 \times 0.375$  in. coaxial tubes + 136 pr. 20 lb/mile P.C.Q.T. the Colwyn Bay-Caernarvon No. 1, 74 pr. 40 lb/mile P.C.Q.T., the Colwyn Bay-Caernarvon No. 2, 4 screened-pairs 40 lb/mile + 156 pr. 20 lb/mile P.C.Q.T., and the Bangor-Colwyn Bay 434 pr. 20 lb/mile P.C.Q.T., MU cables. The first three are contained in two steel pipes secured to the underside of the bridge carriageway but, because of an objection to the extra weight imposed by an additional conduit, the last cable was provided with a lead-antimony alloy sheath, hessian protected, and was secured to the two steel pipes. The four cables are led from under the bridge and around the curving buttresses, supported on brackets and without conduit protection. Access for maintenance is from a travelling gantry slung from the bridge and the descent to the gantry, over the bridge handrail, was a harrowing experience.

The new bridge incorporates a services gallery under the footway on the north side. The gallery has a mesh floor, and it is possible to walk through without difficulty except at the crown of the arch, where the head-room is reduced to 3 ft. The gallery terminates at each end in large semi-circular services chambers which have been built into the abutments. Access to a services chamber from the surface is by a normal footway-manhole entrance and ladder.

It was considered desirable to lay nine duct ways across the bridge to cater for existing cables and future development, and because there is no continuous support in the services gallery steel pipes of the usual pattern were provided. In order to facilitate bridge maintenance in the centre one-third of the span, where every inch counts for accessibility, the nine ways were grouped in a compact triangular formation of four, three and two, instead of the more usual three by three arrangement. For the same reason the pipes could not be laid on the floor of the gallery, which already carried a 12 in. gas main, but had to be suspended from 7 in.  $\times$  4 in. rolled steel joists, occurring at 10 ft intervals and supporting the footway.

The consulting engineers would not allow the contractor to drill the joists to attach hangers for supporting the pipes, and it was necessary to use "Lindapter" double-pipe staples, bolted to the bottom flange, together with  $\frac{5}{8}$  in. mild-steel straps, suitably shaped to accommodate the triangular formation.



A cable rack was installed in each services chamber and provided with normal cable-bearers and brackets. From the services chambers 9-way multiple ducts were led out to join into the existing duct line. On the East side the ducts were laid on the bridge approaches in a sand-filled services trough under the footway, then through formal gardens and a rockery to an existing manhole on the embankment built by Telford. On the West side the ducts were laid under the new footway and the existing track was intercepted at a new manhole. In all, 280 yd of 9-way multiple ducts and 109 yd of steel pipe in 9-way formation were laid, and two manholes constructed. The work was done as building progressed by the bridge contractor, with Post Office supervision, and with the exception of one or two minor matters the work went smoothly and as planned. The cables have now to be changed over from the old to the new bridge.

To overcome the difficulty of a single-way entrance arch in the town wall on the West side of the old bridge, road improvements to provide a single-way traffic scheme through Conway are already in progress, and in connexion with this the Post Office is laying 130 yd of 4-way and 350 yd of 2-way multiple ducts. A "fly-over" arrangement at the level crossing on the East side is planned, and this should complete the elimination of the notorious Conway bottle-neck.

The future of Telford's beautiful bridge has yet to be decided. The frustrations and irritations it caused have already been forgotten and it is possible that it will remain as a work of art and a memorial to a great engineer.

R. E.

#### REMOVAL OF COMPLETE U.A.X. NO. 12

A fully equipped U.A.X. No. 12 was displaced by a U.A.X. No. 13 at Llanarth, in Cardiganshire, and it was decided to use this as the main portion of an extended-multiple U.A.X. No. 12 at Crosswell, some 30 miles away in Pembrokeshire. Service had been given at the latter exchange by a U.A.X. No. 5 in an A-type building, and all the equipment was in use. Since this A-type building was fit to house an extended U.A.X. No. 12, which will suffice for several years, it was arranged to carry out a transfer to a mobile U.A.X. No. 12 in the adjacent field as the first stage of the conversion. This having been done, and the Crosswell building cleared, all was ready for the Llanarth equipment to be removed there *en bloc*.

Such a removal has been done elsewhere, as described in the Regional Notes for the North Western Region in the

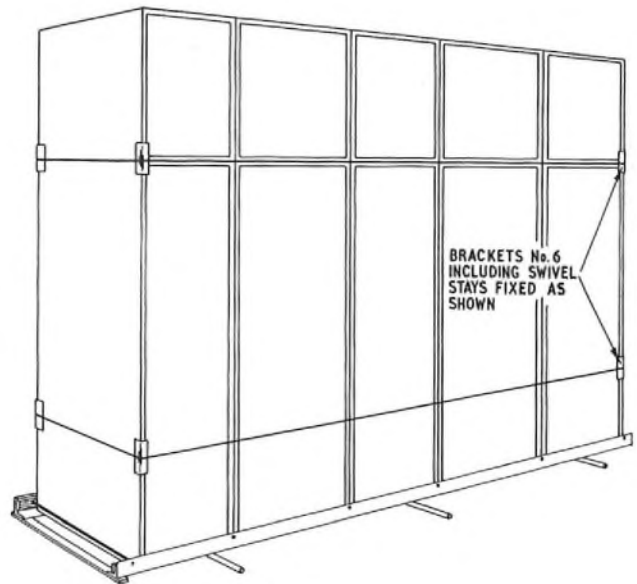

COMPLETE U.A.X. NO. 12 READY FOR REMOVAL TO ANOTHER BUILDING

*P.O.E.E.J.*, Vol. 44, p. 88, July 1951. The main feature of this present operation was a simple and convenient method of trussing the equipment for manoeuvring and carriage, as shown in the drawing. It consisted of fitting two angle sections, squared up inside by a batten, to clamp the base of the units together, and to provide a solid base for the assembly. Used in conjunction with two sets of chimney brackets, this proved very effective.

Selectors and relay-sets were removed, and the bolts fixing the feet to the units were loosened to insert the channels. The feet were then taken off and the units lowered so that they could be wheeled out without altering the door aperture. For moving the suite within the building 2 in. rollers were found convenient, and a 2-wheeled bogie was used to carry the load down the path to the road. A hired low loader transported the suite to Crosswell where the ground levels made unloading reasonably straightforward. The removal was commenced at 9.30 a.m. and by 1.30 p.m. the units were in position at Crosswell.

R. P.

I.P.O.E.E.—continued from p. 147

#### Additions to the Library

Library requisition forms are available from Honorary Local Secretaries, from Associate Section Centre Secretaries and representatives, and from the Librarian, I.P.O.E.E., G.P.O., 2-12 Gresham Street, London, E.C.2.

2528 *Switchgear Principles*. P. H. G. Crane (Brit. 1957).

A survey of the problems of circuit breaking, of the methods available and of the apparatus for putting them into practice.

2529 *Applied Mechanics*. J. A. Cormack (Brit. 1958).

Written for students reading applied mechanics for Ordinary National Certificate, and for those preparing for one of the professional examinations in the subject.

2530 *How to Get the Best out of Your Tape Recorder*. P. J. Guy (Brit. 1958).

Sets out the basic theory for those without scientific training.

2531 *Theory of Machines*. B. B. Low (Brit. 1958).

Deals with the subject to about the standard required in most universities and engineering institutions.

2532 *Interference Between Power Systems and Telecommunication Lines*. H. R. J. Klewe. (Brit. 1958).

A report of the Electrical Research Association. Contains all the basic information required by engineers concerned with the construction of power and communication lines.

2533 *Radio and Television Servicing*. Ed. E. Molloy and W. F. Poole (Brit. 1955).

Contains the circuit diagrams and servicing data of 1958/59 models.

2534 *Magnetic Recording Techniques*. W. E. Stewart (Amer. 1958).

A reference text for engineers and others working in the technical areas of the magnetic recording field—the physics and mathematics background is held to a minimum.

W. D. FLORENCE,  
Librarian.

# Associate Section Notes

## Leeds Centre

On Monday, 16 March 1959, members of the Leeds Centre attended the Institution of Electrical Engineers' Faraday Lecture on "Automation," given by Dr. H. Thomas in the Leeds Town Hall. Dr. Thomas is head of the department of Unilever, Ltd., which deals with electronics and computers. The widespread interest in this subject was reflected in the large attendance, and Dr. Thomas skilfully conducted his audience through the various stages of industrial and scientific development up to the present time. The lecture was well illustrated by the expert use of electromechanical and visual aids. It was generally agreed that great credit was due to Dr. Thomas and his assistants for the splendid presentation of his lecture on a science which may revolutionize our mode of life during the next decade.

On Thursday, 19 March 1959, the Leeds Centre were favoured with a visit by the President of the Associate Section, Mr. A. H. C. Knox, whose talk on "Appraisements and Promotions" was most interesting and instructive. This non-technical subject appealed to all, and it stimulated much discussion; questions were freely forthcoming and were ably answered. A very good attendance, which included visitors from the Bradford Centre, was recorded. The meeting closed at 9.30 p.m., the Chairman paying a sincere vote of thanks to Mr. Knox and coupling it with the Centre's best wishes to him for a successful term as President.

Finally, on Tuesday, 14 April 1959, the Leeds Centre was given a very interesting talk entitled "Recent Developments in Aerial Cable Construction" by Mr. J. Bluring of the Engineering Department, External Plant and Protection Branch. With the free use of films and slides Mr. Bluring described the various types of self-supporting aerial cable, the methods of suspension and the advantages and disadvantages of each type. After describing various common faults the speaker referred to the phenomenon known as "cable dancing" and the theory of mechanical vibrations, which is the subject of a treatise by Mr. Den Hertog, the American physicist. The Chairman thanked Mr. Bluring for his most interesting treatment of this subject and, as this was the last talk of the session, the Chairman thanked the members for the support and interest they had shown. He promised them a very interesting and varied program for the coming year.

C. B.

## Middlesbrough Centre

During the 1958-59 session, the first since the Centre re-formed, talks on varying subjects, from "Colour Photography" to "Police Organization", have been given. A talk by Mr. M. J. Rubin, Research Branch, Engineering Department, on "Electronic Switching" ended the session. Although it is evident that there is an interest in the Associate Section at this Centre, the committee look forward to increased support in the future.

J. L. B.

## Sheffield Centre

Our November meeting attracted a record attendance of over 120 members and visitors at a lecture on "Subscriber Trunk Dialling." It was given by Mr. T. A. Barker of the North Eastern Regional Headquarters, and we are indebted to him for lecture notes and diagrams supplied for perusal in advance of the meeting.

Mr. K. O. Verity of the London Centre was our speaker at the December meeting; his subject was "Some Peaceful Uses of Atomic Energy." The applications of radioactivity in medicine, agriculture and industry were discussed after we had been given some simple basic atomic theory and

some of the properties of radioactivity. Mr. Verity illustrated his talks with slides and a film "Atoms for Peace." This meeting was novel in that it was a joint meeting with the North Eastern Centre of the Senior Section; the chair was shared by Col. J. Baines, Chief Regional Engineer, North Eastern Region, and our own chairman, Mr. J. McInnes. The success of the meeting led to the hope that it will become an annual event.

As usual, the January meeting took the form of a social evening. A supper followed a film show, which was arranged and presented by members of the committee.

"Automatic Protection of High-Voltage Power Networks" was the subject of our February lecture by Mr. K. Bolton of the Yorkshire Electricity Board (Y.E.B.). He made particular reference to protection systems employing Post Office pilot lines.

During March a visit was made to the Brinsworth Mill of the Steel Peach and Tozer branch of the United Steel Companies. This mill was opened last year for the production of steel strip up to 18 in. wide in mild, carbon or special steel. The motor room was of particular interest; here we saw the electrical control gear and driving motors, and were struck by the variety of power supplies, all derived from the main 11 kV feed. Some motors were driven direct from this high-voltage feed, while at the other end of the scale there were machines powered by 230-volt d.c. supplies obtained from banks of 1,000-amp mercury-arc rectifiers. It was interesting to note that this power room was pressurized by a supply of filtered air to prevent the ingress of dust from the adjacent mill.

During the course of the winter session a series of talks on "Practical Aspects of Amplifier Design" has been given to the Radio Section by Mr. F. S. Brasher; they have been most interesting and enlightening.

J. E. S.

On Saturday, 4 April 1959, we learnt with great regret that our ex-secretary, John McCall, had passed away in his thirty-ninth year. John was a very keen and active supporter of this section, and during his term of office was largely responsible for the revival of the Sheffield group. His charming manner and enthusiasm made it a pleasure for me to work with him as Area Liaison Officer.

A floral tribute was sent from the Associate Section, and about 40 of his workmates attended the cremation on 8 April 1959.

John leaves a widow and an 11-year-old son, to whom our sincere sympathy is extended.

J. C. R. H.

## Sunderland Centre

At the Sunderland Centre, following the splendid start of the 1958-59 session, the program continued in October when the Sunderland safety officer, Mr. Johnson, presented some very instructive films on road safety.

The November meeting found us welcoming a visitor from Dollis Hill Research Station, Mr. M. J. Rubin, who explained the elements of that involved subject, "Electronic Switching." This was a follow-on from a previous lecture on the magnetic drum, and once again we had good support from the members of the Newcastle Centre.

In December Mr. J. Trotter of the Gateshead Technical College enlightened us on the ignition system of motor vehicles.

A very interesting evening was spent in January when Mr. G. Rennison, chief photographer of the *Sunderland Echo*, gave us an informal talk, and displayed photographs showing the work of the Army Cinematograph Unit, and press photographs in general.

On 2 February 1959, 16 of our members travelled to King's College, Newcastle, to hear Mr. Barron, Assistant



Engineer-in-Chief speak about S.T.D. This lecture was arranged by the Newcastle members of the I.E.E., and we are grateful to them for the invitation. Then, on the 26 February, a party visited the Sunderland power station of the Central Electricity Generating Board. The two guides spared no pains to make our tour both interesting and instructive, and all members thoroughly enjoyed the visit.

In March we had our first film show of the session; the films, of our own choice, covered subjects ranging from the British grid system to the manufacture of electric lamps. Unfortunately, several of our keen members could not attend some of the meetings because of the obligations of evening classes but, with planning for the coming session well in hand, we look forward to continued support.

W. C.

#### Chichester Centre

The Chichester Centre has completed a very successful 1958-59 session with regular lectures each month, except in March when the lecturer was unable to attend owing to illness.

The program commenced on 13 September 1959 with a visit to the Port of London. This was in the nature of a river cruise organized by the Port of London Authority. The cruise took about four hours and was thoroughly enjoyed by the members. The remainder of the program for the session was as follows:

- 1 October 1958: The opening meeting; a show of films supplied by the Gas Council.
- 15 October 1958: Visit to the new trunk mechanization exchange at Cosham; it was very well organized by the staff concerned.
- 5 November 1958: Mr. H. H. Cosh of the Central Electricity Board gave a lecture on "Electricity Supply"—a lecture on generation, well illustrated with slides made by the lecturer.
- 3 December 1958: The arranged lecture was postponed but the Centre secretary deputized with a film strip describing a visit to a photographic factory.
- January 1959: Film show with films supplied by the Irish linen manufacturers and the Trinidad Asphalt Company.
- 4 February 1959: "Past, Present and Future," by Mr. F. W. Greenway.
- 8 April 1959: The final meeting of the session was an open night for members' guests, with the subject "Touring in the British Isles" by courtesy of South-down Motor Services.

Considering the remoteness of the homes of some of our members the attendances at the meeting throughout the session have been very satisfactory. The 1959-60 program is now being prepared.

H. S. P.

#### Hitchin and Luton Centre

To start the new year an interesting meeting was held at Luton on 1 January 1959, when Mr. W. A. J. Paul, of the Dollis Hill Research Station, gave a talk, illustrated by films, on the use of cinematography in the Post Office. On 26 February 1959, Mr. A. E. Mayne, Telephone Manager, Guildford, gave a talk on "Telecommunications in the U.S.A.," illustrated with slides. Both of these meetings were well supported by members from all parts of the Area, and were much appreciated by them.

A visit to New Scotland Yard took place early in April and a visit to the B.B.C. television studios at Lime Grove has been arranged. A full program is being prepared for the new session, which will start in the autumn and be preceded by our annual general meeting.

E. T. N.

#### Slough Centre

The Slough Centre reports a very successful session for the past year, and wishes to thank all those who have

contributed in making the talks, demonstrations and visits so enjoyable.

At the annual general meeting the following officers were elected for the 1959-60 session: *President*: Mr. E. W. Weaver (Telephone Manager of Reading Area); *Chairman*: Mr. N. Cloke; *Treasurer*: Mr. R. Lambert; *Secretary*: Mr. F. Rigby; *Committee*: Messrs. J. O'Neill, F. Gemmel and J. Nutt.

F. R.

#### London Centre

At the time of writing, as May and the annual general meeting approach, reports are received from Area chairmen. A highlight among these reports, on a wide variety of activities, is one covering the making of a very entertaining amateur film by Messrs. Martin & Ham, of Thornton Heath exchange, in the South-West Area. This film, which parodies life at the exchange, was shown at the Centre technical film show last December, and has been shown at several Area meetings, too. It is a most praiseworthy effort. Another report is concerned with a visit, by the North-West Area, to Amsterdam and the Dutch bulbfields. A veritable air fleet of four Viking aircraft took the party from Blackbushe Aerodrome.

Attendance at Centre meetings has improved during the session and we look forward to still larger audiences in the future. The opening lecture of the 1959-60 session will again be a public lecture, which will be open to members' wives and friends. Dr. Tom Margerison, the well-known television scientist broadcaster and scientific editor of the magazine *New Scientist*, will be talking on "Exploring Space." The session will also include lectures on telex, the continental semi-automatic switching unit (installed at Faraday Building), synthetic speech, the Cable and Wireless organization, and the pay-on-answer call-office system, and it is planned to have lectures on S.T.D. and automatic aids in telephone maintenance. Tentative arrangements have been made for the Associate Section member giving the paper on the continental semi-automatic switching unit to lecture to other Centres.

Two lectures given before the Centre in the spring deserve mention. The first, an exceptional talk on "Radio Astronomy," was given by Dr. F. C. Smith of the Cavendish Laboratory, Cambridge, and our only regret was that he had to dash off back to Cambridge so soon afterwards. The second by Mr. D. M. Gambier, of the Main Lines Development and Maintenance Branch, on the "Transatlantic Telephone Cables" was so interesting that discussion continued well after the end of the lecture.

The inter-Area quiz has now reached the semi-final. Of the four teams surviving the first round, the West Area beat the City Area by one point, the closest match yet, and now the South-West Area have to meet the East Area before the finalists are decided. The last match was the best attended yet and we look forward to bigger audiences in the next two matches. The trophy has been brought out of retirement, polished up, and will be presented by the President of the Associate Section, Mr. A. H. C. Knox, at the annual general meeting.

Following the interest shown in the possibility of an Associate Section neck-tie, the Area chairmen are at present assessing the demand within their areas.

D. W. W.

#### Ayr Centre

Although notes from the Ayr Centre have not appeared for some time the Centre has been quite active. The membership stands at 88. The average attendance at meetings was 20; this low figure is largely due to members having to attend night-school classes. The list below shows the variety of subjects covered during the 1958-59 session.

September 1958: A quiz, by members of Ayr Centre.

October 1958: Lecture and demonstration on "Tape Recording," by Mr. D. Laurie.

November 1958: Lecture and demonstration on "Tran-

sisters and Valves," by Mr. Marsh, of Mullard, Ltd.  
December 1958: The Centre dinner and social evening,  
held in Carrick Lodge Hotel.

January 1959: Visit to Rolls-Royce factory at Hillington.  
February 1959: Lecture and demonstration on "Trunk  
Mechanization and Subscriber Trunk Dialling," by  
Mr. G. Campbell, from Post Office Headquarters,  
Scotland.

April 1959: Visit to Saxone shoe factory, Kilmarnock.

The excellent program and quality of the lectures justified  
a better attendance. However, the committee look forward  
to the next session with the hope that members will give their  
support, ideas and suggestions.

J. H.

#### Hamilton and Coatbridge Centre

The annual general meeting, held in April, concluded an  
interesting and instructive session. The policy tried out so  
successfully in the preceding year was continued, namely,  
that of developing the individual member's ability to  
express himself clearly from the rostrum or the body of the  
hall, and also to listen sympathetically yet critically, accepting,  
questioning or rejecting as need be.

The opening meeting, addressed by our only visiting  
speaker, was on "Public Speaking," and aptly set off a series  
of talks, debates and discussions covering a variety of  
subjects, e.g. "Foremanship," "Electric Motors," "Dis-  
cipline," "Staff Relationships." Though not over-ambitious,  
they did fulfill the two-fold purpose of creating a real  
healthy interest in "Our Job" and talking about its problems.

For our next program, now under consideration, we  
will be able to invite speakers to talk on subjects of general  
appeal with some assurance that they will be speaking to  
an appreciative and responsive audience.

A. M. L.

#### Edinburgh Centre

The February meeting consisted of the presentation of  
two papers which had previously been read to the Senior  
Section in Edinburgh. "Maintenance Control" was the  
title of the first paper, which was given by Mr. D. R. Leask,  
who, until quite recently, was Assistant Engineer at the  
Edinburgh maintenance control. Commencing with a  
detailed survey of the functions of a maintenance control,  
Mr. Leask then outlined the working of the "filtered  
ENG" service, which is under trial in Edinburgh, this being  
the first director area in which it has been introduced.

The second paper presented was entitled "Special Investi-  
gations" and was read by Mr. W. Ovens, in the absence of  
the author, Mr. W. McStravick, who was unfortunately on  
sick leave. The working of the special investigations team  
in Edinburgh was explained and illustrations were given of  
some of the unusual fault conditions encountered. During  
the evening many questions were asked and a most  
interesting discussion followed.

At the meeting of the Centre on 16 April 1959 we were  
honoured by a visit from the President of the Associate  
Section, Mr. A. H. C. Knox, who gave a talk entitled  
"Appraisements and Promotions." Mr. Knox had, during  
the two previous days, given this talk to the Aberdeen and  
Dundee Centres. Having been a member of many promo-  
tion boards, he had a large number of interesting points to  
make on the subject. Opportunity was later provided for  
members to ask questions relating to the promotion  
procedure. Our many guests at this meeting included  
Mr. A. G. Robins and Mr. F. N. Lucas, Regional Engineers  
from the Post Office Headquarters, Scotland, and also, from  
the Edinburgh Telephone Area, Mr. I. Matheson, Telephone  
Manager, and Mr. H. C. Stevenson, Area Engineer, Planning.

D. M. P.

#### Aberdeen Centre

Mr. A. H. C. Knox, President of the Associate Section,  
gave a very illuminating talk on "Appraisements and Pro-  
motions" to the Aberdeen Centre on Tuesday, 14 April 1959.  
This meeting was additional to our 1958-59 program,  
giving us a total of eight meetings for the session. The talk  
was successfully broadcast over land lines to Peterhead and  
Wick, with a total of 36 members attending.

For our future program we have arranged, tentatively, a  
visit to a local industry, and a bus outing to Dundee to see  
the S.T.D. equipment and meet our Dundee colleagues.

We also have talks on the following subjects provisionally  
scheduled for the forthcoming session: S.T.D., West Indies'  
Telephones, Major Works Control, Works Study, and  
Cable Corrosion.

J. G. P.

#### Dundee Centre

The annual general meeting was held on 7 April 1959,  
when the following officers were elected for the 1959-60  
session: *Chairman:* Mr. R. L. Topping; *Vice-Chairman:*  
Mr. W. G. L. Bennett; *Secretary:* Mr. D. L. Miller;  
*Treasurer:* Mr. J. S. Brown; *Committee:* Messrs. J.  
Matthew, D. Livingstone, R. Burns, R. C. Smith, E.  
Taunton and G. Sherwin; *Auditors:* Messrs. J. A. Lamb  
and E. MacLaggan.

The session just finished has been one of the most  
successful, with attendances at meetings around the 60 to 70  
mark, showing an increase of about 50 per cent on previous  
years.

The session opened on 14 October 1958 with a film show  
presented by "Esso," when three films were shown, namely,  
"Refinery at Work," "Lubrication," and "Farnborough Air  
Show."

On 4 November 1958, Mr. J. Lawson, a member of this  
centre, gave his paper on "Model Aircraft," which proved  
to be a very interesting and informative talk.

On 18 November 1958, Mr. A. Robertson gave us a talk  
on "Optical Lenses." This talk proved to be quite an eye-  
opener.

On 2 December 1958 we delved into the realms of high  
finance when Mr. A. Cameron, Chief Clerk, gave a talk on  
"Post Office Finance."

On 7 January 1959, Messrs. Forster, Barton and Ellis of  
the Telegraph Branch, Engineering Department, gave us their  
paper on "Automatic Telex Exchanges." This proved to be  
one of the worst evenings of the winter for weather, when  
transport throughout the city was at a standstill, but despite  
this over 40 members heard a most enlightening talk.

At present a new telephone exchange and repeater station  
are being constructed in Dundee, and our next two meetings  
dealt with the underground-plant transfer arrangement and  
the automatic-equipment design of these stations. On  
20 January 1959, Mr. J. S. Knight, Executive Engineer, dealt  
with the underground-plant transfer and on 10 February  
1959, two associate members, Messrs. W. L. G. Bennett  
and A. S. Reid, dealt with the design of the automatic  
exchange. This talk was relayed to our colleagues in  
Aberdeen, drawings and diagrams having been sent before-  
hand so that they were able to follow the talk.

On 11 March 1959, a quiz was held between the Dundee  
and Aberdeen Centres. The quiz masters were Mr. K. F.  
Jalland, Dundee, and Mr. J. B. Duff, Aberdeen. Dundee's  
team were Messrs. R. Burns, G. Baird, C. Coull and J.  
Mathew. This proved to be a most entertaining evening,  
with victory coming to Dundee.

The annual general meeting was held on 7 April 1959,  
and the session ended on 15 April 1959, when Mr. A. H. C.  
Knox, President of the Associate Section, gave us a talk on  
"Appraisements and Promotions."

In conclusion, I would like to thank the committee and  
members of this centre for the support and assistance given  
during the session.

D. L. M.



### Canterbury Centre

The 1958-59 session has been particularly successful in the variety of subjects we have had from visiting speakers, and also in the very encouraging increase in attendances by our members.

Mr. H. W. Harrison opened the session with a talk on engineering training and technical education. This evoked a very lively discussion. In November 1958 a talk on map reading by Mr. W. D. Bowden, Ordnance Survey Officer, proved to be extremely interesting. Our one film show, in December 1958, included "120,000 Kilowatts Under the Sea."

In January 1959, Mr. F. L. N. Samuels, Telephone Exchange Systems Development Branch, Engineering Department, gave a lecture and demonstration of magnetic-drum techniques. This meeting, which dealt with a subject all our members wish to know much more about, was very popular and was attended by nearly 100 members. Our February 1959 meeting dealt with "High-Speed Photography," a talk given by Messrs. E. W. C. Hubbard and G. L. Mack of the Telephone Exchange Standards and Maintenance Branch, Engineering Department; this was well received. The final formal meeting of the session was a talk on "Subscriber Trunk Dialling," by Mr. F. Wraight of the Home Counties Regional Headquarters. This was a most popular talk and was very well attended.

The committee are extremely grateful to the Telephone Manager, Mr. W. H. Scarborough, for his great support of this Centre and to his frequent attendance at the meetings. In recognition of this unfailing support to the Centre he was presented with an illuminated appreciation and a gold pen-

and-pencil set, subscribed for by the members. This presentation was made at a dinner, following the annual general meeting of the Canterbury Centre, held on Friday,



MR. GREEN MAKING THE PRESENTATION TO MR. SCARBOROUGH

8 May 1959. The photograph shows the presentation being made to Mr. Scarborough by Mr. Green, secretary of the Centre.

M. S. J. G.

## Book Reviews

### "The Ultra High Frequency Performance of Receiving Valves"— *continued from p. 145*

separation is much smaller than the shortest free-space operating wavelength. The latter restriction excludes travelling-wave valves from the theory. The limitations of the theory for large-signal behaviour are pointed out and a graphical method of solution of this problem is referred to so that oscillators and high-power amplifiers are not totally excluded from the book. An interesting analysis of valve noise is also added, refined by the theory of elastic reflection of electrons from the anode. The same refinement is applied also to the signal theory developed in the earlier chapters.

With the exception of a very few references to experimental justification the book is entirely theoretical and analytical. It is written by and for research engineers and physicists engaged in high-frequency valve and circuit design, whose attention it should claim with interest and profit, but to be fully convincing it should have more experimental evidence to support the theory. This is essential in a subject so recalcitrant to theory as electronic valve analysis.

W. A. R.

"Electronic Engineers Reference Book," General Editor L. E. C. Hughes, A.C.G.I., D.I.C., B.Sc.(Eng.), Ph.D., M.I.E.E. Heywood & Co., Ltd, 1,312 pp. 800 ill. 84s.

This book is not at all what its title implies. In the first place it is quite interesting to read, which can surely be said of very few reference books. In the second place it is not so much a source of information on electronics, as on techniques that owe something to electronics but which are rather outside the range of the normal electronic engineer's activities. The book might be called a general educator for telecommunications engineers, to bring them up to date in allied branches of electrical technology. The editor says in his preface that he "endeavours to put before engineers in industry and in development laboratories some of the latest knowledge and techniques which might not be easily available to them. . . . to provide suggestions and possibilities

to be taken into consideration when the problems are examined from various points of view; physical, chemical, production, safety, reliability, maintenance."

With terms of reference as wide as this, Dr. Hughes must have had a difficult task to decide which subjects to select and which to reject. As it is, he has included a fascinating range, from the physics of the ionosphere to the standardization of musical scales and scientific education. He has avoided subjects that are already well written up, e.g. radar, radio and television circuitry, wave filters, because most electrical engineering libraries are able to meet requests for such information already.

The subjects included are divided into nine large chapters with the following headings: (1) Fundamentals, (2) Radiations, (3) Electrics, (4) Valves, (5) Materials, (6) Vibrations, (7) Computers, (8) Automatics, (9) Miscellaneous. Each chapter has up to nine sections on different subjects, related, sometimes only remotely, to the main chapter heading. Each section is again subdivided into a number of articles contributed by over 50 specialists. It is clear that these writers have been allowed a good deal of freedom in framing their contributions, as the articles differ widely in their degree of detail and specialization. There is also inevitably a wide variety in the styles of writing. However, these are not necessarily adverse criticisms because the success of an engineer's reference book is not likely to be judged on the book's literary merits: after all, the engineering writer whose technical article is likely to live as a classic in the English language has probably yet to appear. Recognizing this, the Editor has wisely left each specialist to write as he thinks fit, and the result is a fascinating miscellany of technical information. Provided that the engineer thirsting after knowledge can remember the subjects that the book contains, so that he knows when it is profitable to refer to it, there is little doubt that he would find the book a valuable possession.

The publishers have produced the book very well. It is beautifully printed and bound and would prove a real acquisition to the more broad-minded among engineers.

C. F. F.

# Staff Changes

## Promotions

Name	Region	Date	Name	Region	Date
<i>Senior Executive Engineer to Assistant Staff Engineer</i>			<i>Inspector to Assistant Engineer</i>		
Lee, W. H.	E.T.E.	9.2.59	Friend, A. G.	L.T. Reg.	14.1.59
<i>Area Engineer to Telephone Manager</i>			Fletcher, E. A.	H.C. Reg.	4.12.58
Todkill, H.	Mid. Reg.	1.4.59	Brady, T.	Mid. Reg.	15.4.57
<i>Area Engineer to Deputy Telephone Manager</i>			Greenwood, F. A.	N.W. Reg.	21.1.59
Collins, J. E.	N.E. Reg. to N.W. Reg.	27.4.59	Maguire, S. P.	L.P. Reg.	12.10.56
<i>Executive Engineer to Area Engineer</i>			Gray, A.	L.P. Reg.	12.10.56
Facer, J. H.	Mid. Reg. to H.C. Reg.	13.4.59	Martin, S. W.	L.P. Reg.	12.10.56
<i>Executive Engineer to Senior Executive Engineer</i>			Alexander, H. L.	L.P. Reg.	12.10.56
Rance, J. W.	Scot.	2.3.59	Stevens, C.	L.P. Reg.	12.10.56
Simpson, W. G.	E.-in-C.O.	5.3.59	Kelly, J.	L.T. Reg.	30.1.59
Chamberlain, A. E.	E.T.E.	16.3.59	Brown, E. J.	W.B.C.	12.3.59
Thompson, C. D.	E.-in-C.O.	23.3.59	Webb, F. H.	N.E. Reg.	22.4.59
<i>Executive Engineer (Open Competition)</i>			Bowles, L. C.	Mid. Reg.	24.3.59
Knox, K. A. T.	E.-in-C.O.	1.1.59	Miles, E.	Mid. Reg.	13.4.59
<i>Executive Engineer (Limited Competition)</i>			Whiteside, J. L.	W.B.C.	20.4.59
Burling, K. G.	H.C. Reg. to E.-in-C.O.	1.4.59	Morris, E. K.	S.W. Reg.	15.4.59
Howarth, J. E.	E.-in-C.O.	23.3.59	<i>Technical Officer to Assistant Engineer</i>		
Cross, B.	E.-in-C.O.	16.3.59	Vogel, E. C.	E.-in-C.O.	20.1.59
Kennard, D. E.	E.-in-C.O.	16.3.59	Scott, E.	E.-in-C.O.	20.1.59
Ithell, A. H.	E.-in-C.O.	3.3.59	Little, J. A.	E.-in-C.O.	20.1.59
Wherry, A. B.	E.-in-C.O.	3.3.59	Tippler, J.	E.-in-C.O.	2.2.59
Wickens, R. F.	E.-in-C.O.	16.3.59	Baxter, M. S. J.	L.T. Reg. to E.-in-C.O.	20.1.59
Chandler, K.	E.-in-C.O.	16.3.59	Stanton, S. C.	L.T. Reg. to E.-in-C.O.	20.1.59
Haigh, B.	E.-in-C.O. to Scot.	16.3.59	Gilroy, J. S.	L.T. Reg. to E.-in-C.O.	20.1.59
Hann, F. A.	Mid. Reg.	1.4.59	Hogg, A. M.	L.T. Reg. to E.-in-C.O.	26.1.59
Smith, G. T. C.	L.T. Reg. to E.-in-C.O.	23.3.59	Coleman, W. T.	L.T. Reg. to E.-in-C.O.	26.1.59
<i>Assistant Engineer to Executive Engineer</i>			Ridge, R. A.	E.-in-C.O.	20.1.59
Norris, J. W.	L.T. Reg.	31.10.58	Franklin, A. K.	L.T. Reg. to E.-in-C.O.	20.1.59
Vidler, W. C.	N.I.	15.10.58	Frame, P.B.	E.-in-C.O.	20.1.59
Phillips, G. J. A.	E.-in-C.O.	22.12.58	Slater, F.	N.E. Reg.	1.1.59
Best, F. L.	H.C. Reg. to E.-in-C.O.	19.1.59	Wilson, G.	N.E. Reg.	24.11.58
Cosier, J. E. H.	E.-in-C.O.	22.12.58	Frost, P. J.	H.C. Reg.	4.12.58
Babidge, R. E.	S.W. Reg.	14.1.59	Leggett, R. F.	L.T. Reg.	6.1.59
Perry, E. T.	E.-in-C.O.	12.1.59	Phillips, J. E.	L.T. Reg.	9.1.59
Blick, N. E.	Mid. Reg.	22.1.59	Corne, B. F.	L.T. Reg.	6.1.59
Horrocks, P.	E.-in-C.O.	26.1.59	Jones, J. R.	L.T. Reg.	6.1.59
Whittaker, E. N.	Mid. Reg.	5.1.59	Amos, R. M.	Mid. Reg.	23.9.57
Jackson, J.	E.-in-C.O.	5.2.59	Merrill, F. G.	Mid. Reg.	19.8.58
Friend, N. L. W.	L.T. Reg.	22.1.59	Clark, E. E.	L.P. Reg.	1.7.57
Kennedy, B.	Mid. Reg.	22.1.59	Creigh, J. W.	L.P. Reg.	1.2.57
Curle, F. J.	L.T. Reg.	2.2.59	Argyle, L. F.	W.B.C.	19.1.59
Menday, F. G.	E.-in-C.O.	12.2.59	Harris, J. G.	L.P. Reg.	9.11.58
Meade, J. ( <i>In absentia</i> )	S.W. Reg.	5.2.59	Stubbs, S.	N.E. Reg.	23.2.59
Long, W. J.	S.W. Reg.	4.5.59	Birbeck, J. T.	Mid. Reg.	15.12.58
Philip, A.	Scot.	6.4.59	Spears, R. G.	L.T. Reg.	30.1.59
Watson, D. N.	N.W. Reg.	20.3.59	Hawkins, R. J.	L.T. Reg.	4.2.59
Welburn, R.	H.C. Reg.	13.4.59	Wisdom, F. A. W.	L.T. Reg.	30.1.59
Gibbon, R. D.	E.-in-C.O. to L.P. Reg.	6.5.59	Bradshaw, J. E.	L.T. Reg.	30.1.59
<i>Assistant Engineer (Open Competition)</i>			Phillips, D. A.	L.T. Reg.	30.1.59
Bates, E. J.	E.-in-C.O.	8.1.59	Bell, J. J. R. H.	E.-in-C.O.	31.3.59
Bircumshaw, D.	E.-in-C.O.	21.1.59	Mitchell, R. A.	E.-in-C.O.	31.3.59
Clarke, K. E.	E.-in-C.O.	5.1.59	Ledwith, D. A.	E.-in-C.O.	31.3.59
Copping, B.	E.-in-C.O.	5.1.59	Turner, T. M.	Scot.	10.3.59
Derbyshire, R. H.	E.-in-C.O.	5.1.59	Reid, R. S.	Scot.	10.3.59
Feltham, D. R.	E.-in-C.O.	5.1.59	Murphy, G. J.	L.T. Reg.	16.3.59
Fincham, P. C.	E.-in-C.O.	12.1.59	Reilly, W. J.	L.T. Reg.	16.3.59
Garside, R.	H.C. Reg.	5.1.59	Meggison, K.	N.E. Reg.	5.3.59
Hartog, W. B.	E.-in-C.O.	9.1.59	Shaw, E.	N.E. Reg.	5.3.59
Hempseed, P. H.	E.-in-C.O.	5.1.59	Gunn, L. J.	E.-in-C.O.	7.4.59
Hunt, R. J.	E.-in-C.O.	5.1.59	Kirkwood, T.	E.-in-C.O.	7.4.59
Jeffery, F.	N.E. Reg.	5.1.59	Bryant, I.	E.-in-C.O.	7.4.59
Martin-Royle, R. D.	E.-in-C.O.	5.1.59	Stubbs, D. L.	N.W. Reg. to E.-in-C.O.	7.4.59
Mitchell, P. A.	E.-in-C.O.	14.1.59	Francis, W. W.	E.-in-C.O.	7.4.59
Myers, H. B.	E.-in-C.O.	21.1.59	Hadkiss, L. R.	L.T. Reg. to E.-in-C.O.	7.4.59
Sweetman, B. E.	E.-in-C.O.	5.1.59	Rickarby, C. S.	L.T. Reg. to E.-in-C.O.	7.4.59
			Baker, S. H.	E.-in-C.O.	7.4.59
			Wildblood, W. J.	Mid. Reg. to E.-in-C.O.	7.4.59
			Hewstone, H. D.	L.T. Reg. to E.-in-C.O.	7.4.59
			Yates, T. C.	L.T. Reg. to E.-in-C.O.	7.4.59
			Davey, L. R.	L.T. Reg. to E.-in-C.O.	7.4.59
			Little, F. W.	L.T. Reg. to E.-in-C.O.	7.4.59
			Munday, E. A.	L.T. Reg. to E.-in-C.O.	7.4.59
			Baynham, C. A.	L.T. Reg. to E.-in-C.O.	7.4.59
			Leake, N. A.	N.I.	13.3.59



Promotions—continued.

Name	Region	Date	Name	Region	Date
<i>Technical Officer to Assistant Engineer—continued</i>			<i>Technician I to Inspector—continued</i>		
Wark, A. K.	Scot.	25.3.59	Binks, H. V.	N.E. Reg.	5.3.59
Haggart, J. R.	Scot.	25.3.59	Moroney, T. K.	N.W. Reg.	11.3.59
Walker, F.	N.I.	3.4.59	Mack, H. J.	L.T. Reg.	17.4.59
Barnett, L.	N.W. Reg.	11.3.59	Preece, W. G.	L.T. Reg.	17.4.59
Hinchley, R. B.	N.E. Reg.	11.3.59	Wyndham, G.	L.T. Reg.	20.4.59
Peek, D. T. C.	L.T. Reg.	3.4.59	Reynolds, D. G.	L.T. Reg.	11.3.59
Eddleston, E.	N.W. Reg.	14.4.59	Hough, G.	N.W. Reg.	18.3.59
<i>Draughtsman to Assistant Engineer</i>			<i>Experimental Officer (Open Competition)</i>		
Smith, T. R.	Mid. Reg.	1.1.59	Bell, D.	E.-in-C.O.	21.1.59
<i>Technical Officer to Inspector</i>			<i>Assistant Experimental Officer (Open Competition)</i>		
Maskell, G. C.	L.T. Reg.	4.2.59	Bryan, I. E.	E.-in-C.O.	9.1.59
Barry, B. G. V.	L.T. Reg.	12.2.59	Yule, S. K. (Miss)	E.-in-C.O.	1.1.59
Morris, L. A.	L.T. Reg.	4.2.59	Rohrer, B. R.	E.-in-C.O.	29.1.59
Venn, H. E.	L.T. Reg.	4.2.59	French, M. J. G. (Miss)	E.-in-C.O.	18.2.59
Neale, W. H. T.	L.T. Reg.	4.3.59	Phippen, J. H.	E.-in-C.O.	27.2.59
<i>Technician I to Inspector</i>			<i>Assistant (Scientific) (Open Competition)</i>		
Hill, S.	N.E. Reg.	25.11.58	Sargent, J. W.	E.-in-C.O.	7.1.59
Browell, J.	N.E. Reg.	1.9.57	Fishwick, B. J.	E.-in-C.O.	26.2.59
Sugden, D.	N.E. Reg.	18.1.59	<i>Technical Assistant II to Technical Assistant I</i>		
Sutcliffe, H. C.	N.E. Reg.	3.7.58	Shiells, E. D.	Scot. to E.-in-C.O.	1.4.59
Bentley, B.	N.E. Reg.	18.1.59	<i>Leading Draughtsman to Senior Draughtsman</i>		
Hayes, M.	H.C. Reg.	4.12.58	Clement, N. C.	W.B.C.	8.1.59
Stevenson, F. W.	H.C. Reg.	2.2.59	<i>Draughtsman to Leading Draughtsman</i>		
Bradley, C. J.	H.C. Reg.	4.12.58	McConnachie, J. M.	L.T. Reg. to L.P. Reg.	1.12.58
Rozier, J.	H.C. Reg.	4.12.58	Watters, G. H. S.	N.I.	6.2.59
Eames, R. W.	L.T. Reg.	7.1.59	Youde, A. L.	W.B.C.	1.4.59
Saggers, G. E.	L.T. Reg.	6.1.59	Mountford, E. D.	Mid. Reg. to Factories Dept.	20.4.59
Fergusson, W. A.	L.T. Reg.	7.1.59	<i>Clerical Officer to Executive Officer</i>		
Waldon, D. E.	S.W. Reg.	26.1.59	Lowry, M. J. (Miss)	E.-in-C.O.	27.11.58
Lawrence, S.	S.W. Reg.	9.1.59			
Burrough, C. F.	L.T. Reg.	30.1.59			
Wannan, J.	Scot.	13.3.59			
Gould, J.	Scot.	9.3.59			
Failes, J. W. M.	Scot.	3.3.59			
Craven, M.	Mid. Reg.	3.2.59			
Gill, D. G.	S.W. Reg.	19.3.59			
McMullen, J. A.	N.I.	27.1.59			

Retirements and Resignations

Name	Region	Date	Name	Region	Date
<i>Regional Engineer</i>			<i>Assistant Engineer</i>		
Wallcroft, F. E.	W.B.C.	31.3.59	Doubrowsky, J. L.	L.T. Reg.	31.1.59
<i>Area Engineer</i>			Keast, R. E.	S.W. Reg.	23.1.59
Griffiths, G. J.	Mid. Reg.	31.12.58	Major, A. S.	N.E. Reg.	25.1.59
Wright, C. H.	L.T. Reg.	31.12.58	McCubbin, W. J. K.	Scot.	26.1.59
Parsons, R. A. E.	L.T. Reg.	31.3.59	Jones, F. J.	L.T. Reg.	16.1.59
<i>Senior Executive Engineer</i>			McIntosh, A.	Scot.	20.1.59
Rhodes, W.	E.-in-C.O.	31.3.59	Kelley, D. B.	Scot.	4.1.59
<i>Executive Engineer</i>			Richards, B.	N.W. Reg.	24.1.59
Frost, J.	N.W. Reg.	3.12.58	Adair, J. C.	E.-in-C.O.	15.1.59
Anderson, J.	N.E. Reg.	5.12.58	<i>(Resigned)</i>		
Craig, W. A.	E.T.E.	5.1.59	Tinsley, W. F.	L.T. Reg.	3.2.59
McBurnie, R. S.	N.W. Reg.	23.1.59	Townsend, F. T. G.	H.C. Reg.	6.3.59
Peach, R. S.*	E.-in-C.O.	6.2.59	Perks, H.	Mid. Reg.	28.2.59
Ryan, R. L.	E.-in-C.O.	20.2.59	Hodson, G. H.	N.W. Reg.	19.2.59
Wilson, F.	S.W. Reg.	31.1.59	Davies, F. J.	E.T.E.	1.1.59
Luscombe, E. W.	E.-in-C.O.	28.2.59	Metcalf, F.	N.E. Reg.	20.2.59
<i>(Resigned)</i>			Brooker, H. J.	E.-in-C.O.	28.2.59
Wearn, R. G. O.	N.W. Reg.	11.3.59	<i>(Resigned)</i>		
Young, A.	Scot.	29.3.59	Martin, C. W. J.	E.T.E.	28.2.59
McKendrick, W.	Scot.	31.3.59	Hinton, G. B.	Mid. Reg.	12.3.59
Selby, G. R.	E.-in-C.O.	27.3.59	Snook, R. A.	H.C. Reg.	31.3.59
<i>(Resigned)</i>			Kempsell, C.	L.T. Reg.	14.3.59
			Bellion, W. E.	N.W. Reg.	4.3.59
			Parker, H.	N.W. Reg.	19.3.59
			Lynes, F. A.	E.T.E.	8.4.59

\*Mr. R. S. Peach is continuing as a disestablished officer with the E.-in-C.O.

### Transfers

Name	Region	Date	Name	Region	Date
<i>Senior Executive Engineer</i>			<i>Executive Engineer—continued</i>		
Froom, R. P. . . . .	E.-in-C.O. to I.T.U., Geneva	18.3.59	Bluring, J. . . . .	E.-in-C.O. to H.C. Reg.	13.4.59
<i>Executive Engineer</i>			<i>Assistant Engineer</i>		
Cunninghame, J. W. N. S.	E.-in-C.O. to W.B.C.	5.1.59	Dawkins, J. . . . .	E.-in-C.O. to M.T.C.A.	22.12.58
Jennings, J. C. . . . .	Nigeria to S.W. Reg.	11.1.59	Street, M. J. . . . .	H.C.R. to Min. of Supply	12.1.59
Rolls, A. . . . .	Nigeria to S.W. Reg.	9.2.59	Tolliday, E. . . . .	E.-in-C.O. to H.C. Reg.	26.1.59
Tarbet, A. G. . . . .	L.P. Reg. to Scot.	23.2.59	Stevens, H. E. . . . .	E.-in-C.O. to L.T. Reg.	6.2.59
Baxter, E. C. . . . .	India to L.T. Reg.	24.2.59	Dawson, G. H. . . . .	E.-in-C.O. to L.T. Reg.	18.2.59
			Hoare, H. V. . . . .	E.-in-C.O. to L.T. Reg.	9.2.59

### Deaths

Name	Region	Date	Name	Region	Date
<i>Executive Engineer</i>			<i>Assistant Engineer—continued</i>		
Blake, E. C. . . . .	H.C. Reg.	26.1.59	Alcock, G. E. . . . .	N.W. Reg.	20.1.59
Raffles, H. . . . .	S.W. Reg.	16.4.59	Kerslake, R. J. . . . .	S.W. Reg.	11.1.59
Wood, T. . . . .	N.E. Reg.	19.4.59	Bullen, W. L. . . . .	E.-in-C.O.	10.1.59
<i>Assistant Engineer</i>			Packham, E. C. . . . .	E.-in-C.O.	21.2.59
Smith, A. H. . . . .	Mid. Reg.	6.9.58	Buchanan, A. . . . .	Scot.	2.3.59
Taylor, A. E. . . . .	Mid. Reg.	30.9.58	Baron, J. C. . . . .	N.W. Reg.	4.2.59
Spooner, J. A. . . . .	E.-in-C.O.	11.10.58	Pratchett, C. . . . .	H.C. Reg.	10.3.59
Chany, C. H. . . . .	N.W. Reg.	12.10.58	Harvey, C. T. . . . .	L.T. Reg.	1.3.59
Beattie, F. . . . .	E.-in-C.O.	6.11.58	Mahoney, J. W. . . . .	L.T. Reg.	27.4.59
Heppinstall, R. V. . . . .	N.E. Reg.	12.11.58	<i>Inspector</i>		
Wenban, K. . . . .	L.T. Reg.	3.12.58	Gleave, J. T. . . . .	N.E. Reg.	22.10.58
Shaw, J. . . . .	S.W. Reg.	5.12.58	Sykes, R. P. . . . .	H.C. Reg.	1.11.58
Saunders, J. D. . . . .	H.C. Reg.	10.12.58	Hirst, K. H. . . . .	N.W. Reg.	27.11.58
Cooper, E. R. . . . .	E.-in-C.O.	1.1.59	Kearnes, F. J. . . . .	L.T. Reg.	28.11.58
Scott, D. W. R. . . . .	S.W. Reg.	29.1.59	Edmonds, A. T. . . . .	L.P. Reg.	1.12.58
Budgen, A. H. . . . .	H.C. Reg.	17.1.59	McAlister, C. . . . .	N.I.	2.12.58
Williams, E. S. . . . .	Mid. Reg.	7.1.59	Dunne, A. B. S. . . . .	L.T. Reg.	23.2.59
Bird, F. G. T. . . . .	H.C. Reg.	16.1.59	Campbell, M. . . . .	Scot.	9.2.59
Oswald, C. L. . . . .	L.T. Reg.	27.1.59	Turpin, F. W. . . . .	L.T. Reg.	19.3.59
Tribbeck, D. A. . . . .	S.W. Reg.	29.1.59			

### BOARD OF EDITORS

D. A. BARRON, M.Sc., M.I.E.E., Chairman.  
 L. F. SCANTLEBURY, Whit.Sch., A.C.G.I., D.I.C., M.I.E.E.  
 T. H. FLOWERS, M.B.E., B.Sc.(Eng.), M.I.E.E.  
 W. J. E. TOBIN, B.Sc.(Eng.), A.C.G.I., D.I.C., M.I.E.E.  
 A. J. LECKENBY, M.B.E.  
 G. J. MILLEN, A.M.I.E.E.  
 E. DAVIS, A.M.I.E.E., Managing Editor.  
 A. G. LEIGHTON, B.Sc.(Eng.), A.M.I.E.E., Editor (Supplement).  
 D. M. GAMBIER, A.M.I.E.E.  
 J. MARTIN, B.Sc.(Eng.), A.M.I.E.E. } Assistant Editors.  
 B. FARR, Secretary-Treasurer.

#### Copyright

The entire contents of this Journal are covered by general copyright, and special permission is necessary for reprinting long extracts, but editors are welcome to use not more than one-third of any article, provided credit is given at the beginning or end thus: "From *The Post Office Electrical Engineers' Journal*."

The Board of Editors is not responsible for the statements made or the opinions expressed in any of the articles in this Journal, unless such statement is made specifically by the Board.

#### Subscriptions and Back Numbers

The Journal is published quarterly, in April, July, October and January, price 2s. 6d. (3s. 3d. post free) per copy or 13s. per annum post free. Back numbers will be supplied, if available, price 2s. 6d. (3s. 3d. post free) per copy. All orders should be sent to *The Post Office Electrical Engineers' Journal*, G.P.O., 2-12 Gresham Street, London, E.C.2.

Employees of the British Post Office can obtain the Journal through local agents at the reduced price of 2s. per copy.

#### Binding Cases

Readers can have their copies of volumes bound at a cost of 10s. 6d. by sending the complete set of parts to the local Post Office distribution agent or to *The Post Office Electrical Engineers' Journal*, G.P.O., 2-12 Gresham Street, London, E.C.2. Alternatively, binding cases are available, price 3s.

#### Remittances

Remittances should be made payable to "*The P.O.E.E. Journal*" and should be crossed "& Co."

#### Advertisements

All correspondence relating to advertisement space reservations, copy, proofs, etc., should be addressed to the Advertisement Manager, *The Post Office Electrical Engineers' Journal*, G.P.O., 2-12 Gresham Street, London, E.C.2.

#### Communications

With the exceptions indicated above, all communications should be addressed to the Managing Editor, *The Post Office Electrical Engineers' Journal*, G.P.O., 2-12 Gresham Street, London, E.C.2. Telephone: HEAdquarters 1234.

#### Model Answer Books

Books of model answers to certain of the City and Guilds of London Institute examinations in telecommunications are published by the Board of Editors. Details of the books available are given at the end of the Supplement to the Journal.





Electronic  
stop  
watch . . .



. . . with Formica Copper Clad Laminates. This Transistorised Microsecond Chronometer designed by Rank Cintel for precise measurement of time intervals in the range of  $1 \mu$  second to 1 second employs printed circuit techniques. The circuits used throughout are produced from FORMICA copper-clad, the finest quality laminate made! ALL FORMICA laminates are tested for quality, performance and reliability.

**FORMICA LTD**

*for electrical insulation*

*Copper-clad, paper, fabric, and glass laminates. Engraving and printed material.*



A SUBSIDIARY COMPANY OF THE DE LA RUE COMPANY LTD.  
DE LA RUE HOUSE, 84/86 REGENT STREET, LONDON W.1

FORMICA is a registered trademark

# A new service for equipment designers and engineers

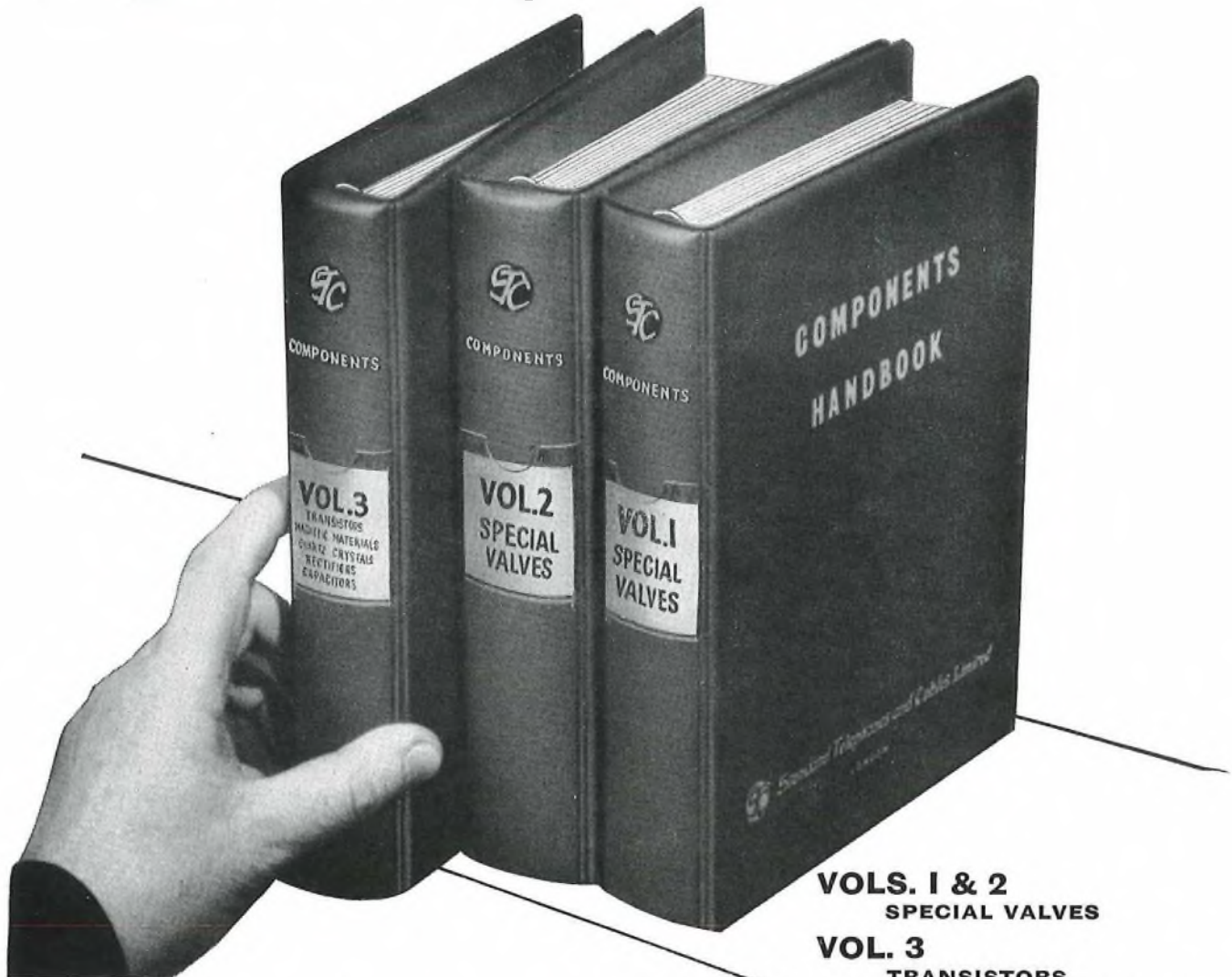

## S.T.C. Components Handbook

Equipment designers and engineers will find extensive use for this new service by S.T.C. Data Sheets on the full range of S.T.C. Components are included in these three loose-leaf volumes and amendments and additions will be made at quarterly intervals. The cost to subscribers of £1 per annum will include the binders, data sheets and all subsequent amendments.

*\* This applies in U.K. and N. Ireland only. Overseas Subscribers are requested not to send fee with application.*

**VOLS. 1 & 2**  
SPECIAL VALVES

**VOL. 3**  
TRANSISTORS  
MAGNETIC MATERIALS  
QUARTZ CRYSTALS  
RECTIFIERS · CAPACITORS

**VOL. 4** (to be issued in June)  
BRIMAR VALVES

Please register me as a subscriber for the  
S.T.C. Components Handbook. A Cheque/  
P.O. for £1 is enclosed.\*

Name.....

Company.....

Address.....

.....P.O.E.E. 7



*Standard Telephones and Cables Limited*

CONNAUGHT HOUSE · ALDWYCH · LONDON WC2



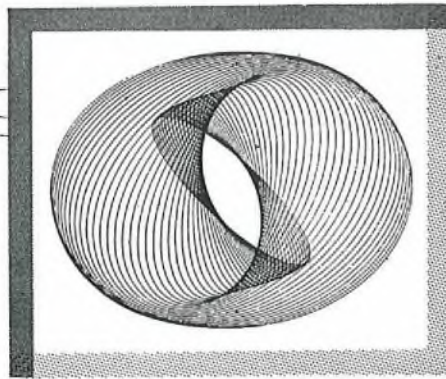

## Extreme toughness, flexibility and resistance

to abrasion, solvents and heat—all these qualities unite in Henley Enamelled Wires to give Industry a consistently high performance product. The superior physical properties of these wires provide exceptional dielectric strength and resistance to elevated temperatures and solvents, regardless of rigorous use. All Henley Enamelled Wires comply with the appropriate British Standards.

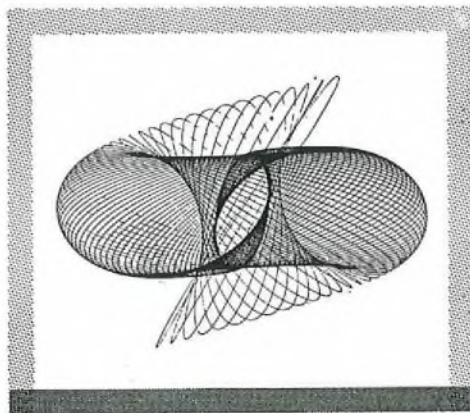
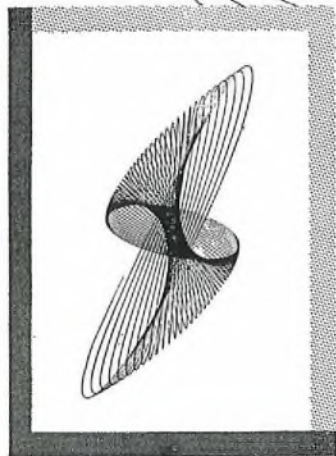
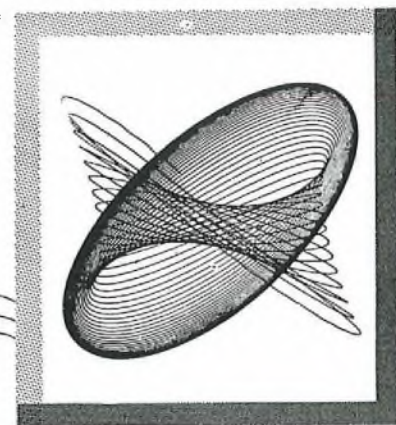

*The following types are available:*

Oleo-Resinous  
 Vinyl Acetal Base—Supermex  
 Polyurethane Base,  
 self-fluxing—Superthane  
 Polyester Base—Superester  
*Samples gladly sent on request.*

# HENLEY

## ENAMELLED COPPER WINDING WIRES

*An A.B.I. Company*

W. T. HENLEY'S TELEGRAPH WORKS CO. LTD  
 51-53 Hatton Garden, London, E.C.1. CHAncery 6822



BY APPOINTMENT TO  
 HER MAJESTY THE QUEEN  
 ELECTRIC CABLE  
 MANUFACTURERS

# S.T.C. small diameter Coaxial Cable System

The new *Standard* Small Diameter Coaxial Cable System is ideal for the economic provision of telephone circuits over trunk routes of comparative low traffic density.

It is designed to provide 300 speech circuits over a pair of coaxial tubes using the frequency band of 60 to 1,300 kc/s. Each speech circuit has an effective bandwidth of 300 to 3,400 c/s and meets the full C.C.I.T.T. performance for "circuit fictif" over a route distance of 1,600 miles (2,500 km).

## ALL-TRANSISTOR REPEATER



*The repeater unit may be quickly removed from the buried repeater housing for inspection and maintenance.*

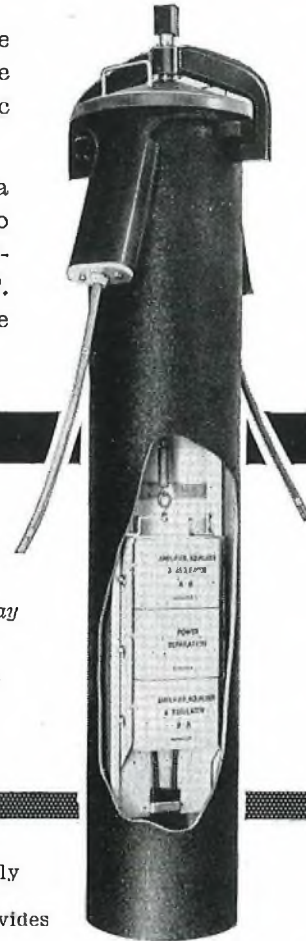

The system is fully flexible and among other facilities provides the following:—

- (a) Each telephone circuit may be passed directly to the local trunk switchboard as a two- or four-wire circuit.
- (b) Individual 12-circuit groups or 60-circuit super-groups may be interconnected at the appropriate stage, between systems radiating from the station.
- (c) On any of the telephone circuits it is possible to employ up to 24 voice frequency telegraph circuits in the range 420c/s to 3,180c/s.

## 4 mm COAXIAL TUBES

Two, four or more of the small diameter coaxial cores which are used with this system, can be laid up together with paper or polythene pairs or quads. The laid-up cable may then be sheathed with lead or plastic. The use of an expanded polythene dielectric makes the coaxial cores mechanically robust. The construction of the cable makes it very suitable for aerial installation particularly where size and weight are important factors.



*Standard Telephones and Cables Limited*

Registered Office: Connaught House · Aldwych · London W.C.2

TRANSMISSION DIVISION: NORTH WOOLWICH · LONDON · E.16



Whatever happens to the mains supply...

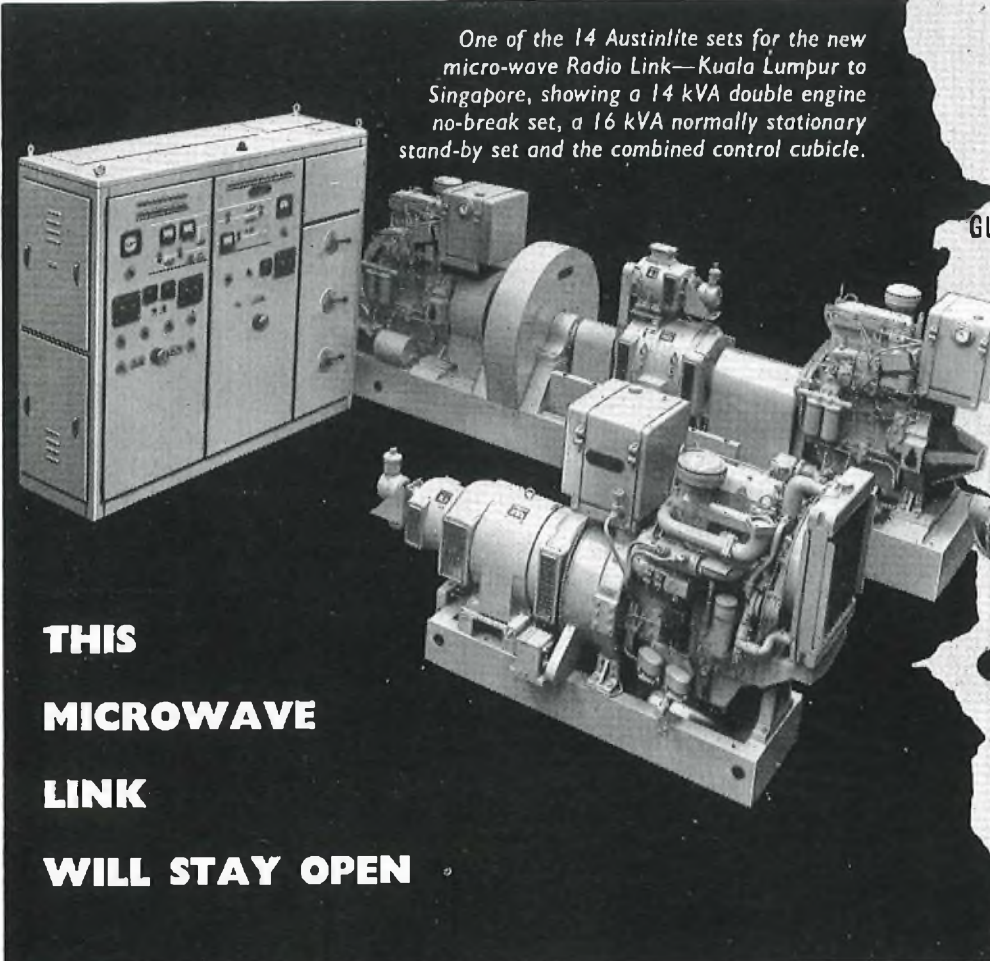

One of the 14 Austinlite sets for the new micro-wave Radio Link—Kuala Lumpur to Singapore, showing a 14 kVA double engine no-break set, a 16 kVA normally stationary stand-by set and the combined control cubicle.

**THIS  
MICROWAVE  
LINK  
WILL STAY OPEN**

The new microwave Radio Link between Kuala Lumpur and Singapore, some 350 miles of jungle, humidity and pests, is assured of an uninterrupted power supply. At each of the 14 stations along the route, Austinlite "No-Break" Generating power plant will perform a vital role. At three of them there is no mains supply and power will come from twin-engine Austinlite power plant, running night and day. At others, Austinlite equipment will act as stand-by to the mains supply and at certain selected stations Austinlite provide both the primary power and an alternative source for use during maintenance periods. Austinlite plant, designed for exacting conditions, is supplying stand-by power in many parts of the world.

**AUSTINLITE AUTOMATIC POWER PLANT**  
CUSTOM BUILT BY  
**STONE-CHANCE LIMITED, CRAWLEY, SUSSEX, ENGLAND**



B'NANAS  
KUALA LUMPUR  
S' PANG  
SEREMBAN  
GUN HILL  
TAMPIN  
JEMENTAH  
MALACCA  
JINSIR  
KLUANG  
G' LAMBAK  
G' PULAI  
JOHORE BAHRU  
FORT CANNING  
SINGAPORE



## RADIO CHANNELLING EQUIPMENT R60B

- For 60 carrier channels
- Fully transistorised and compact
- C.C.I.T.T. Performance
- Advanced components, methods and design
- Inbuilt signalling equipment

This equipment combines up to 60 speech circuits, in 5 groups of twelve, into a composite signal for v.h.f. or u.h.f. radio transmission.

The design is new throughout and the advantages of modern components and circuitry have been fully exploited. For details request leaflet. Jel. 3302



**TRANSMISSION EQUIPMENT TYPE CM.**

**AUTOMATIC TELEPHONE & ELECTRIC CO. LTD**

STROWGER HOUSE, ARUNDEL STREET, LONDON, W.C.2.

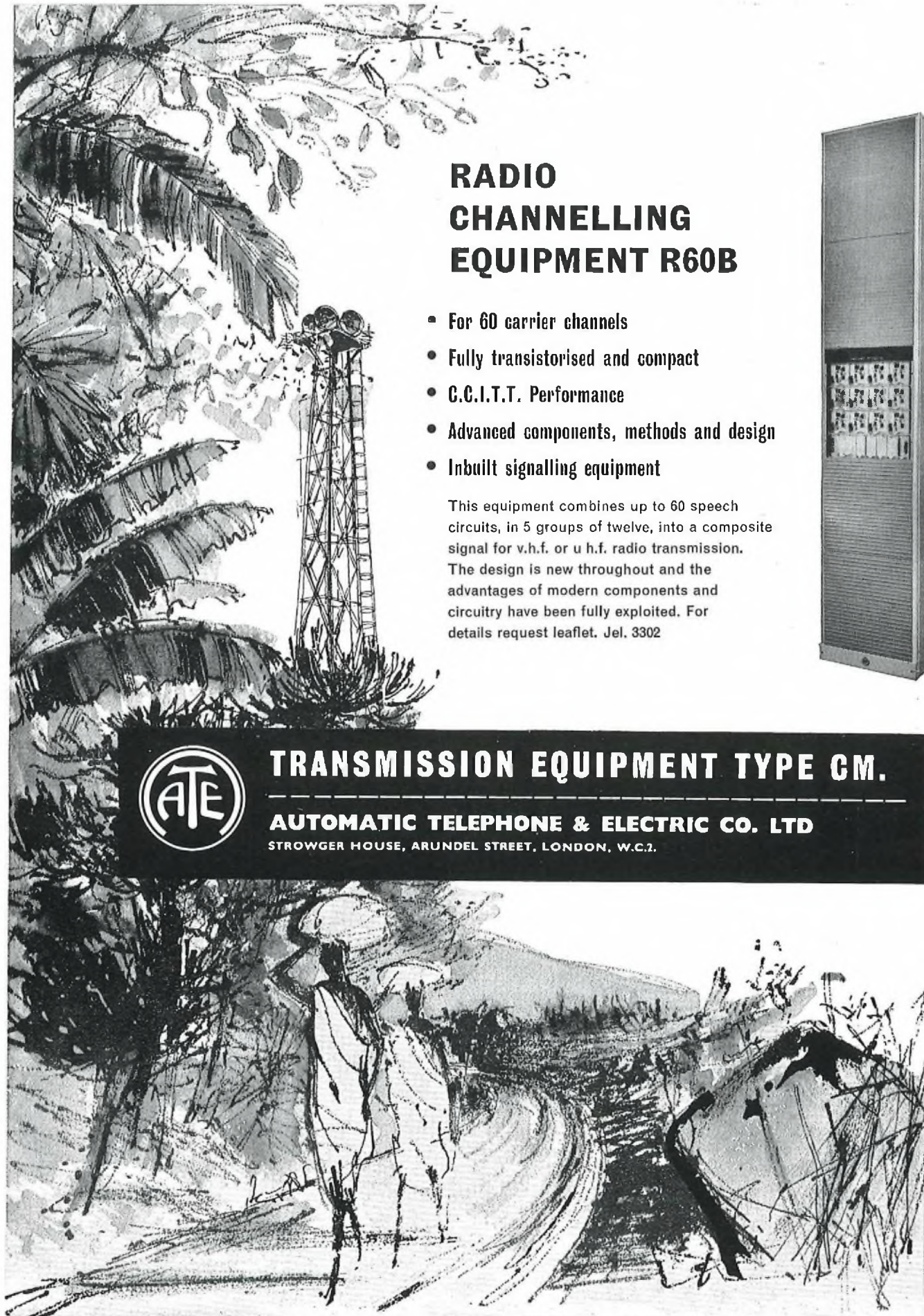



# Conventional F.S.K. receivers outmoded by new

## Standard

# RX5C

- The Standard RX5C represents probably the most notable advance in F.S.K. receiver design in the last decade.
- The whole concept centres round greatly increased "good-printing" time when compared to conventional limiter/discriminator techniques.
- Intensive study of field conditions has enabled some welcome technical features to be incorporated of particular interest to the discerning operator.
- The equipment is fully tropicalised to current governing user-specifications.
- A range of passband filters from 0.5 kc/s to 6 kc/s, variable frequency oscillator and Four-Frequency Duplex operation (F.6) are optionally available.

- Special attention has been paid to the use of "common valve" types and full self-checking circuit arrangements are incorporated to enable the operator to align and set up the receiver without external test apparatus.

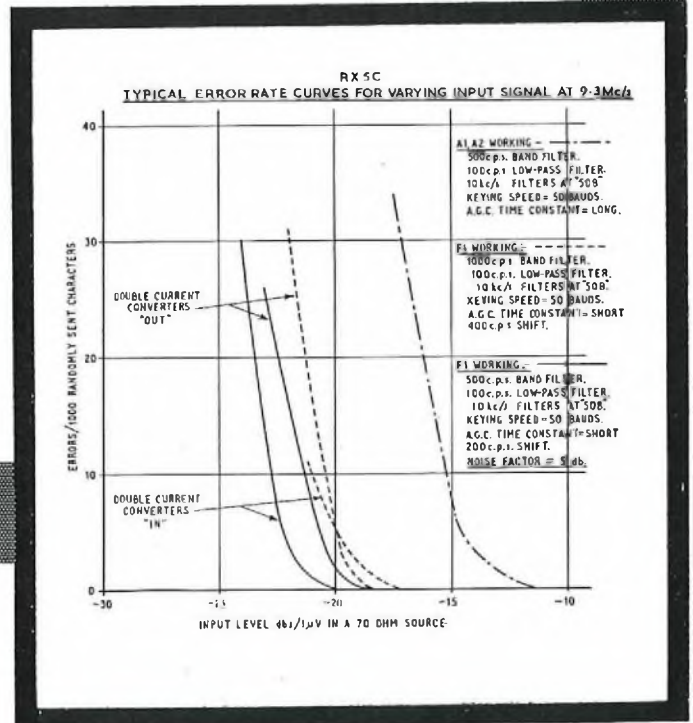

## Standard Telephones and Cables Limited

Registered Office: Connaught House, Aldwych, London, W.C.2

RADIO DIVISION: OAKLEIGH ROAD · NEW SOUTHGATE · LONDON N.11



*Corrosion protection...*

SIEMENS  
EDISWAN

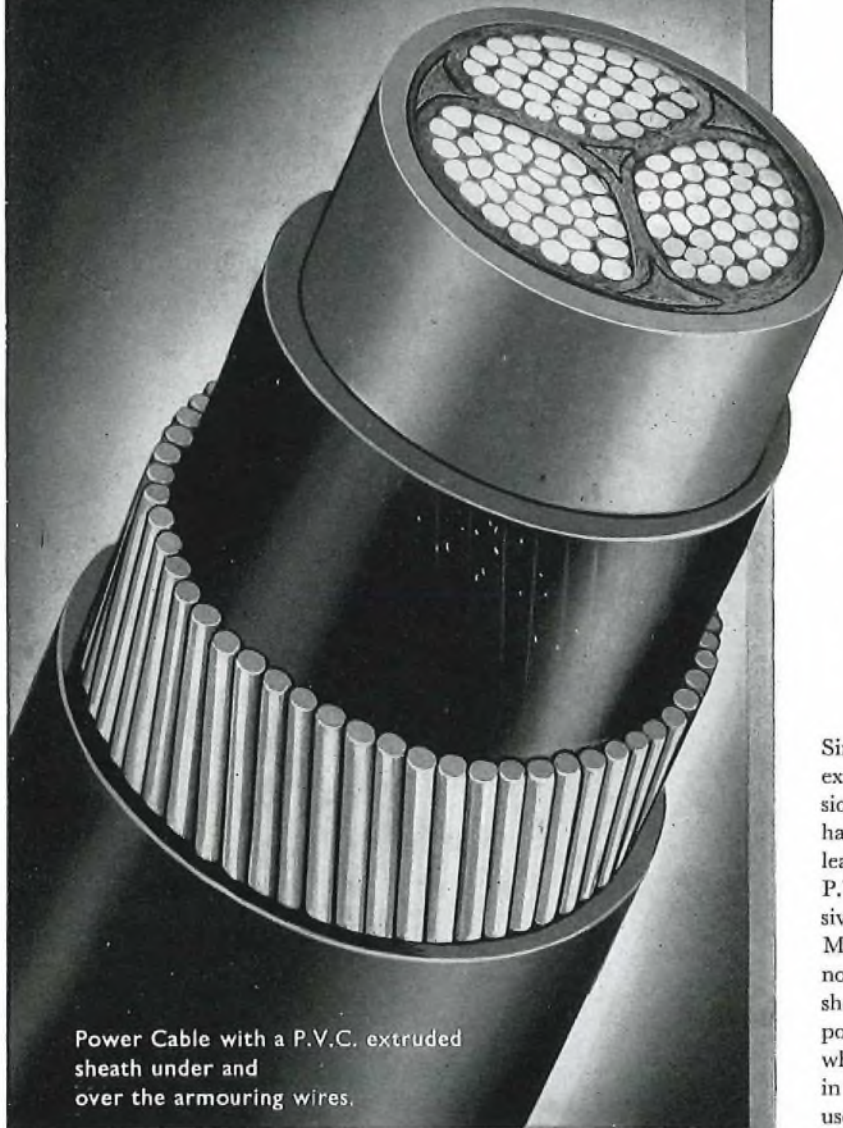

Power Cable with a P.V.C. extruded sheath under and over the armouring wires.

## P.V.C. EXTRUDED SHEATH CABLES

Since we pioneered the use of P.V.C. extruded sheath as a means of corrosion protection several years ago, we have laid and jointed many miles of lead covered cable sheathed with P.V.C. in situations of a highly corrosive nature.

Mechanically strong, flexible and non-inflammable, P.V.C. extruded sheath is suitable for all types of power and communication cables, whether underground, underwater or in air. Bituminous compound can be used under the P.V.C. if required as a safeguard against corrosion by differential aeration.

Suitable for all cable diameters, *armoured or unarmoured*, and for all working voltages.

All enquiries to:

**SIEMENS EDISON SWAN LTD.** An A.E.I. Company  
Power Cables Division, 155 Charing Cross Road, London, W.C.2

SIEMENS  
EDISWAN

**a power in cables**



# MAKE LIGHT WORK OF HEAVY FIXING

Every kind of bolt-fixing—in floors, walls, ceilings—completed in an hour or two and ready to take its full load! Even if there's no hurry, it's still sound business sense to get the job done efficiently and quickly with Rawlbolts. No virtue in work for work's sake!

## RAWLBOLTS



### PROVIDE ENORMOUS STRENGTH IN FRACTIONAL TIME

Rawlbolts are a *dry* fixing—they grip by expansion. No cold chiselling, no three-day wait for cement to harden! You *drill* the holes with one of the Rawlplug high-efficiency boring tools, hand or power. The machine is positioned, bolts tightened, and it's ready to go into operation *at once*—a rock-firm fixing that will never fail.

## 6 HEADS MEET EVERY NEED

For bolting to floors, use one of the 28 different sizes of LOOSE BOLT Rawlbolts (Fig. 1). These allow the machine to be slid into position without lifting. For wall fixings, use the Bolt projecting type (Fig. 2). These support the job while nuts are being tightened. For overhead and ceiling work, either type can be used. Other types are:—



1



2



3



4



5



6

Fig. 3. Pipehanger Rawlbolts (with adaptors for use with Pipehangers and other gas fittings).

Fig. 4. Rawlbolts fitted Pipeclips (7 sizes for  $\frac{1}{2}$ " up to  $2\frac{3}{4}$ " O/D pipe diameter).

Figs. 5 & 6. Hook Rawlbolts and Eye Rawlbolts for providing anchorage for guy ropes and cables, supporting suspended ceilings etc. (5 bolt diameters,  $\frac{3}{16}$ " up to  $\frac{1}{2}$ ".)

Write now for illustrated literature giving full details of Rawlbolts and the many high performance Rawlplug tools (hand, electric and pneumatic).



**THE RAWLPLUG COMPANY LTD.**

*The world's largest manufacturers of fixing devices*

**CROMWELL ROAD, LONDON, S.W.7**

Telephone: FREMANTLE 8111 (10 LINES)

Telegrams: RAWLPLUG SOUTHKENS LONDON

## THESE BORING TOOLS SAVE TIME



### RAWLDRILLS

for hand boring for Rawlbolt sizes A to G.

Rawlplug tools and drills are the toughest and most efficient in the world. There are sizes and types for every need—for drilling any hard material from concrete to glass, and for use by hand, electric and air power.

### DURIUM DRILLS

—the world's fastest masonry drill. (Big range for hand and power also Long series drilling lengths 12" and 16".)



### VIBROTO DRILLS

for vibration drilling in Vibroto machine



**STAR DRILLS**  
for hand boring all Rawlbolt sizes.



**RAWLCRETE Tungsten Carbide Drills**  
for rotary drilling in concrete etc.



### DURIUM HAMMER DRILLS

for use in electric hammers (for Rawlbolt sizes G to K).





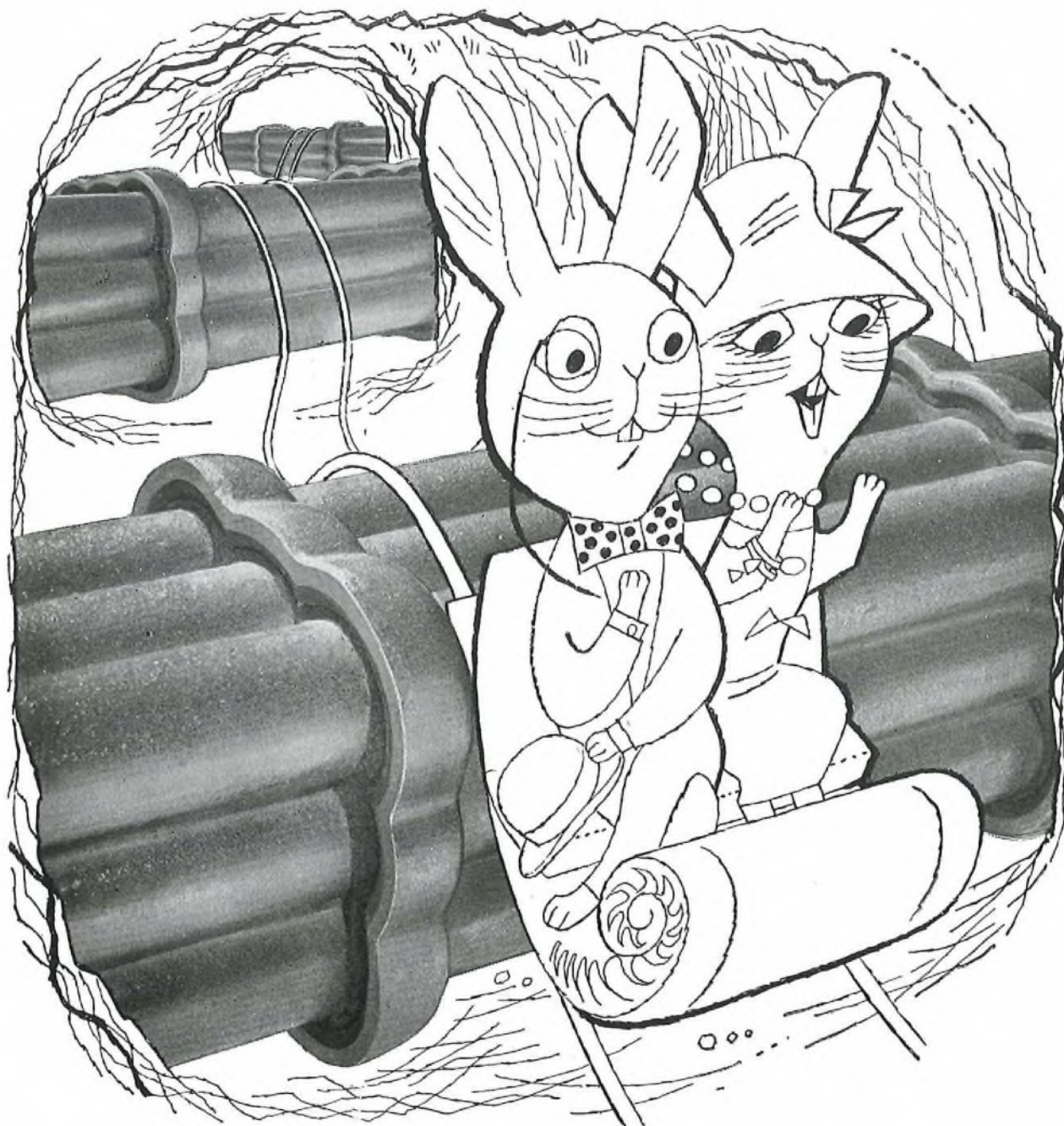

**'Yoops!' cried the young lady rabbit.** 'I'm *fwightened!*'

'Nonsense!' said the Baron. 'There's nothing to worry about. It's perfectly safe. This switch-back is built on salt glazed conduits, and they stand up to anything. No possible harm can—oo! that *was* a drop, wasn't it?

'As I was about to say, clay conduits are strong, durable, resistant to soil acids, im-

permeable, glassy smooth inside to prevent abrasion of the cables they carry—don't you think perhaps we're going a little bit fast? Oh yes, conduits! Yes, you can get them in singles, two-way, three-way, four-way, six-way, nine-way... nine-way... nnn... nn.'

'Yeth, Baron? Oh, Baron, you've gone all *gween*—and just when you were being so interesting, too!'

**Salt Glazed Clay Conduits — for cables, for ever**

NATIONAL SALT GLAZED PIPE MANUFACTURERS' ASSOCIATION



# S.T.C. WORLD-WIDE

S.T.C. are supplying main line microwave telephone systems to 16 countries and have already supplied systems with a capacity of over one million telephone circuit miles, 2000 television channel miles and an equal capacity of standby equipment.

*70-mile over-water path employing the latest automatic diversity system in which the SHF signals are combined in the correct phase before entry into the receiver.*

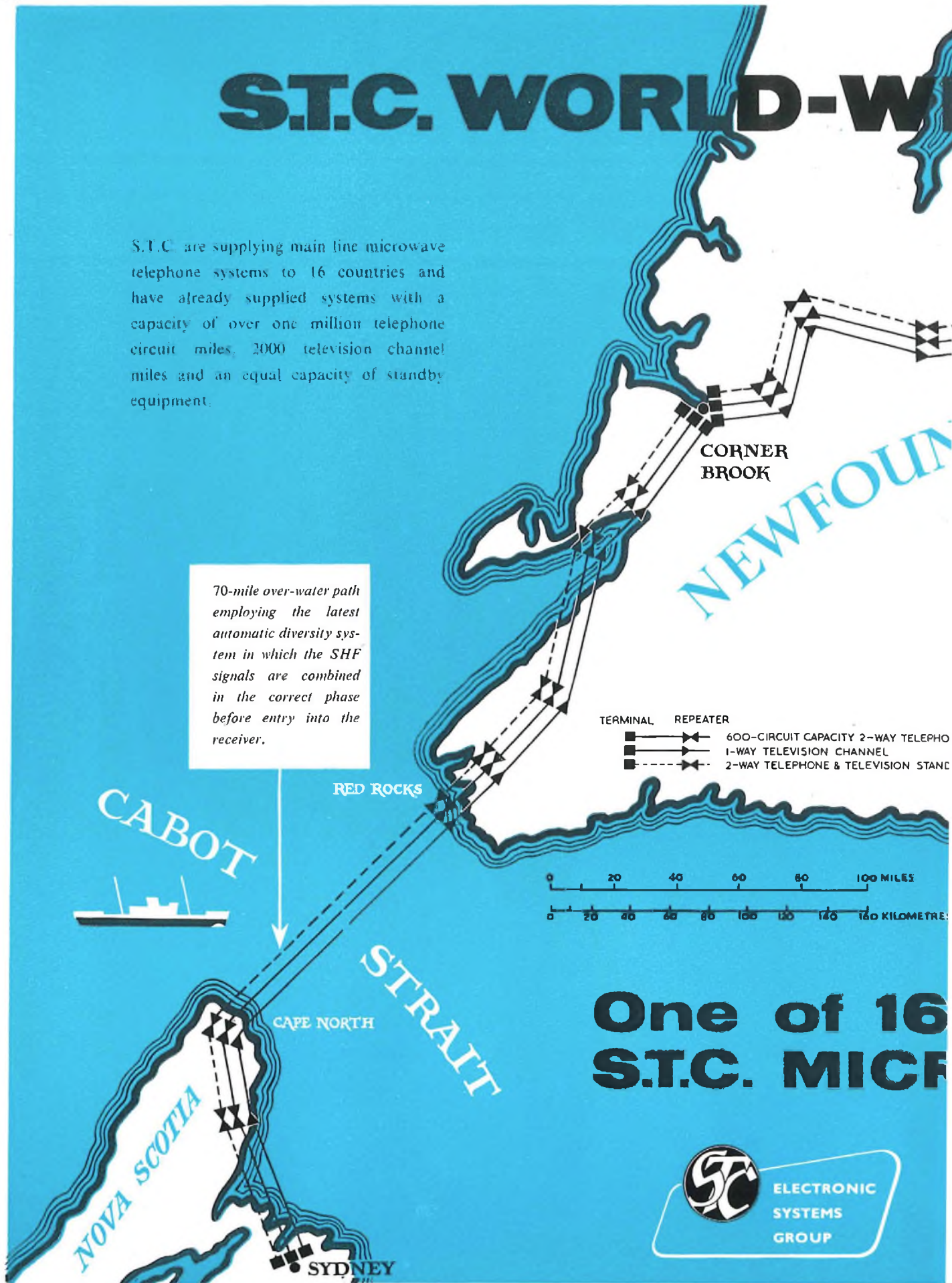

**One of 16  
S.T.C. MICR**



**ELECTRONIC  
SYSTEMS  
GROUP**



# DE EXPERIENCE

## DLAND

S.T.C. are supplying a 4000 Mc/s multi-channel microwave telephone and television system to the Canadian National Railways. It will form the final link in the trans-Canadian television network. The 536-mile route between St. John's and Sydney, Nova Scotia, includes a 70-mile over-water path, employing dual diversity reception, across the Cabot Strait.

Standard Telecommunications Laboratories, England, in conjunction with S.T.C. (Canada) carried out the propagation tests on the route and S.T.C. (London) in collaboration with their Canadian associates will provide technical assistance during installation.

S.T.C. are also supplying:

- 7000 Mc/s Microwave Links to Television Studios
- Supervisory and Remote Control Equipment
- Antennae
- Test Equipment
- Entrance Cables

CHANNEL

CHANNEL

## countries having OWAVE SYSTEMS

*Standard Telephones and Cables Limited*

Registered Office: Connaught House, Aldwych, London, W.C.2

TRANSMISSION DIVISION: NORTH WOOLWICH · LONDON E.16





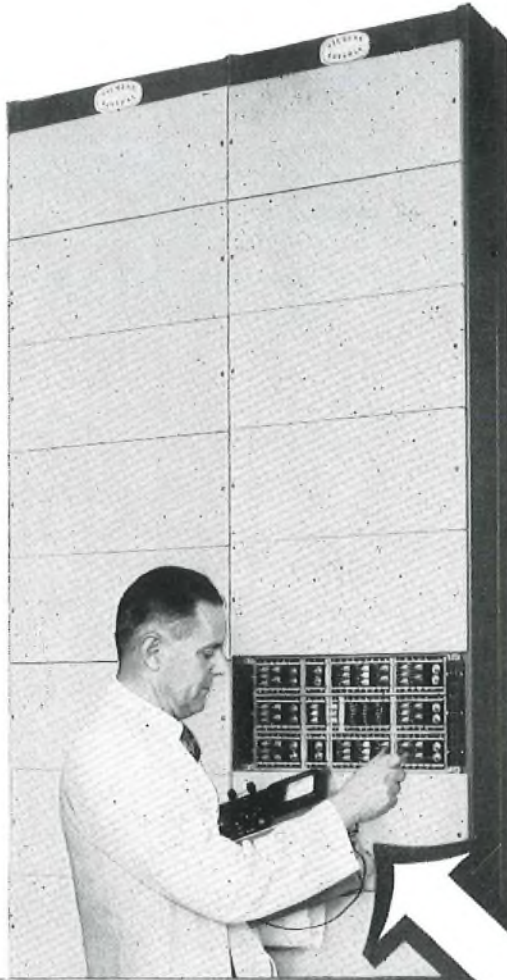

# 60 channels per bayside . . .

**complete with carrier and  
power supplies**

SIEMENS EDISWAN new equipment construction (E.C.3) offers this space saving advantage as well as these other features:

- 120 channel bay from 2 independently mountable baysides bolted back-to-back
- Complete with carrier and power supplies and inbuilt outband signalling
- Plug-in units
- Fully transistorised: designed and built to C.C.I.T.T. standards
- Complete and easy access to all components
- Uses standard 9 ft. by 20½ in. bays, allowing immediate incorporation into existing station arrangements
- Station cabling terminates at each 6-channel block

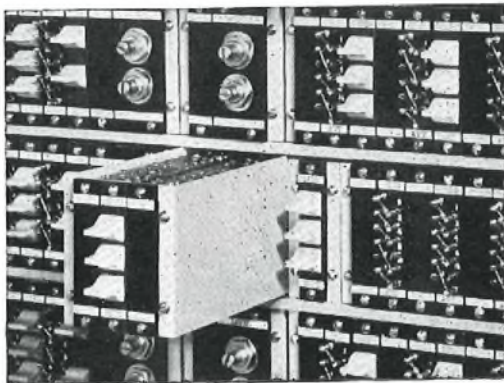

*6-channel block  
(prewired and pretested)*

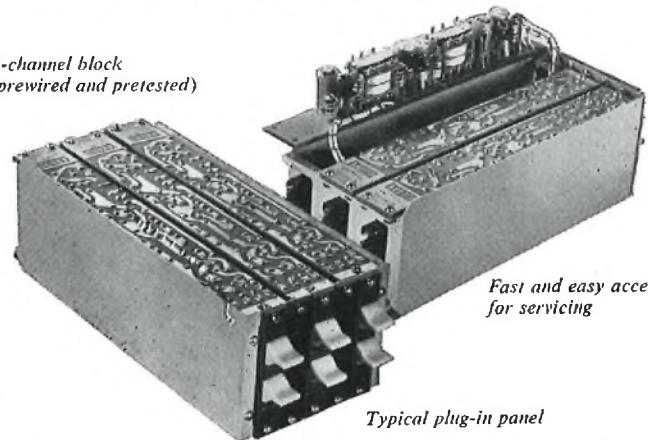

*Fast and easy access  
for servicing*

*Typical plug-in panel*

extending

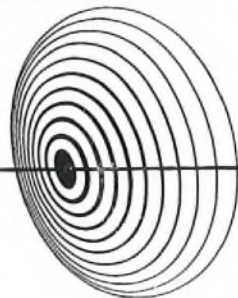

the frontiers of telecommunications



**SIEMENS EDISON SWAN LTD** An A.E.J. Company

Telecommunications Division P.D.8 Woolwich, London, S.E.18. Telephone: Woolwich 2020  
Telegrams: Sieswan Souphone London

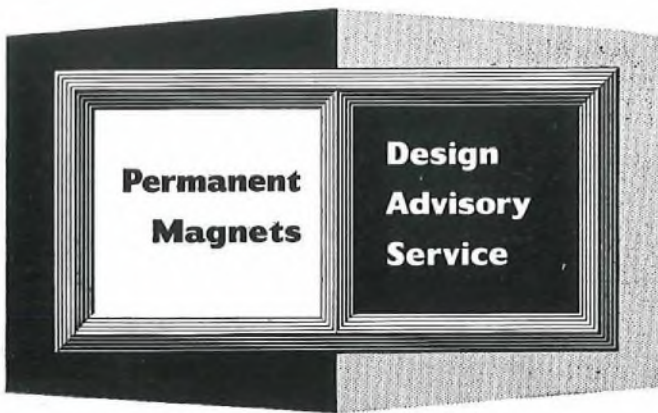

## Microwave Applications-1

*Advertisements in this series deal with general design considerations. If you require more specific information on the use of permanent magnets, please send your enquiry to the address below, mentioning the Design Advisory Service.*

It is well known that the efficiency and performance of many modern U.H.F. tubes depend on the reliability and stability of the permanent magnets associated with them.

To meet the magnetic requirements of some of these tubes, powerful electro-magnets consuming several kilowatts would be required. It is therefore not surprising that permanent magnets are in everyday use supplying these fields without the consumption of power, or the generation of heat.

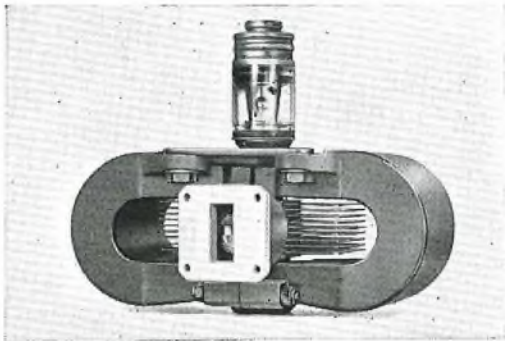

As a typical example, the above illustration shows a 'packaged' magnetron fitted with 'Ticonal' permanent magnets weighing approximately 3½ lb. each. They are protected to some degree, from disturbance due to the close proximity of ferro-magnetic objects, by an aluminium covering. These magnets supply the required magnetic field with extreme accuracy and stability, and take the place of an electromagnet which would weigh approximately 30 lb. and consume about ½ kW. The provision and stabilisation of a suitable power supply for such an electro-magnet would present additional problems of size, weight and cost.



Another example, illustrated above, shows a fully protected 'horn' shaped magnet which gives a magnetic field in the gap of 5500 oersteds and weighs only 14 lb. A particular feature of this magnet is that it is specially designed to give an accurate and stable performance under the worst possible condition of usage. It can be brought into contact with iron and steel and other magnets and still remain within the manufacturer's specification and retain its magnetic calibration.

Many types similar to the one illustrated are in current use, each magnet being specially designed to meet the individual requirements of a particular tube.

Among the many problems in connection with the generation of power at microwave frequencies, the requirements of stable magnetic fields can best be solved by the use of 'Ticonal' permanent magnets. Mullard engineers will be pleased to give details of available types and advice on the design of the magnetic circuits for new tube developments.

*If you wish to receive reprints of this advertisement and others in this series write to the address below.*

# Mullard



'TICONAL' PERMANENT MAGNETS  
'MAGNADUR' CERAMIC MAGNETS  
FERROXCUBE MAGNETIC CORES



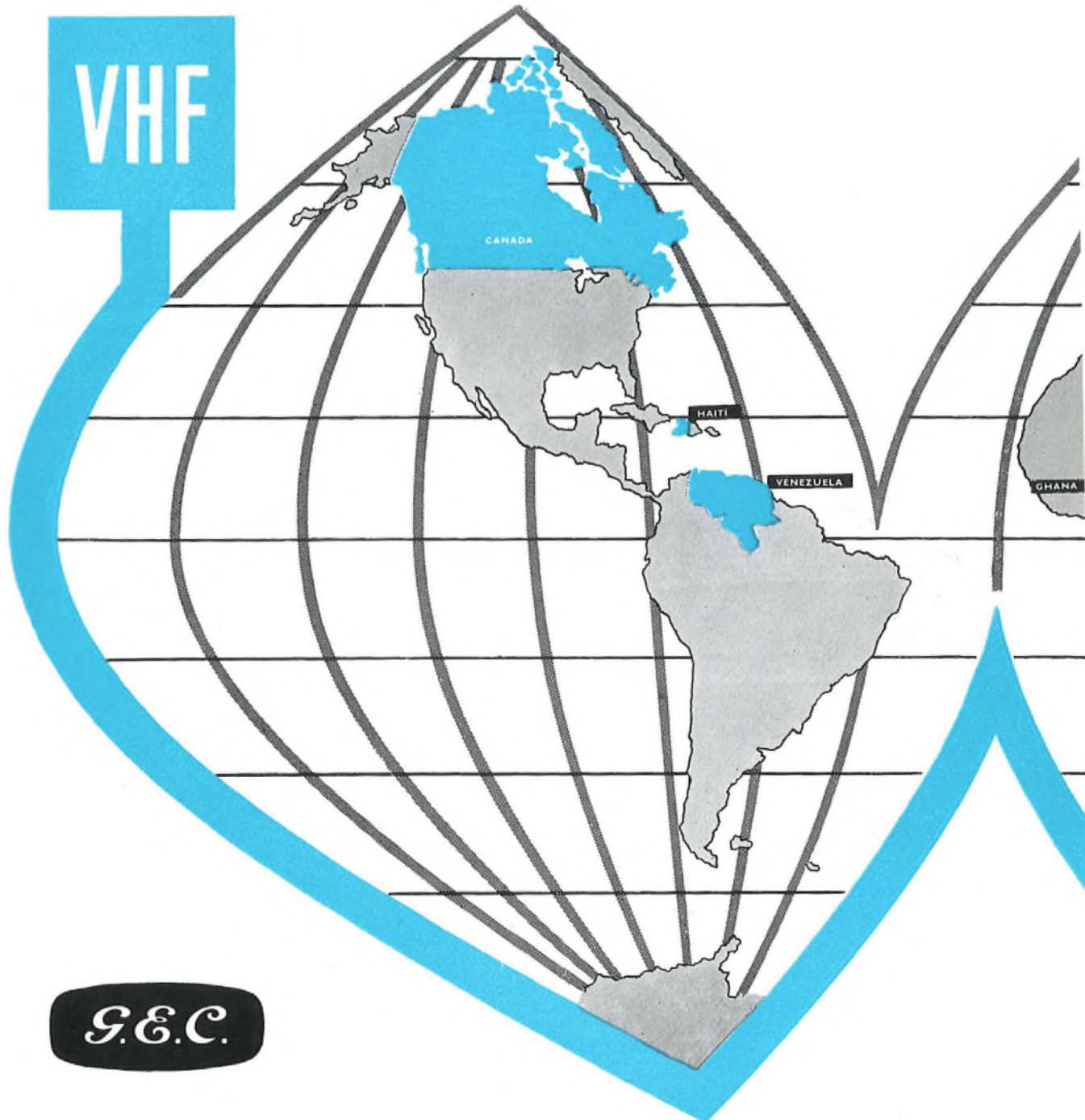

## Over 1,000 multi-circuit junction radio equipments throughout the world

G.E.C.'s outstanding contribution towards meeting the demand for new and better telecommunications is clearly illustrated by the large and increasing number of V.H.F. radio equipments supplied throughout the world.

*EVERYTHING FOR TELECOMMUNICATIONS*

THE GENERAL ELECTRIC COMPANY LIMITED OF ENGLAND · TELEPHONE, RADIO AND TELEVISION EQUIPMENT

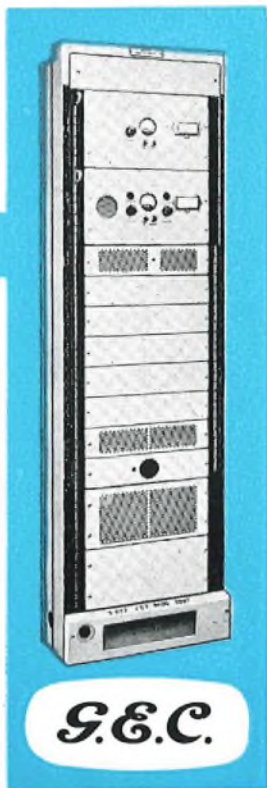
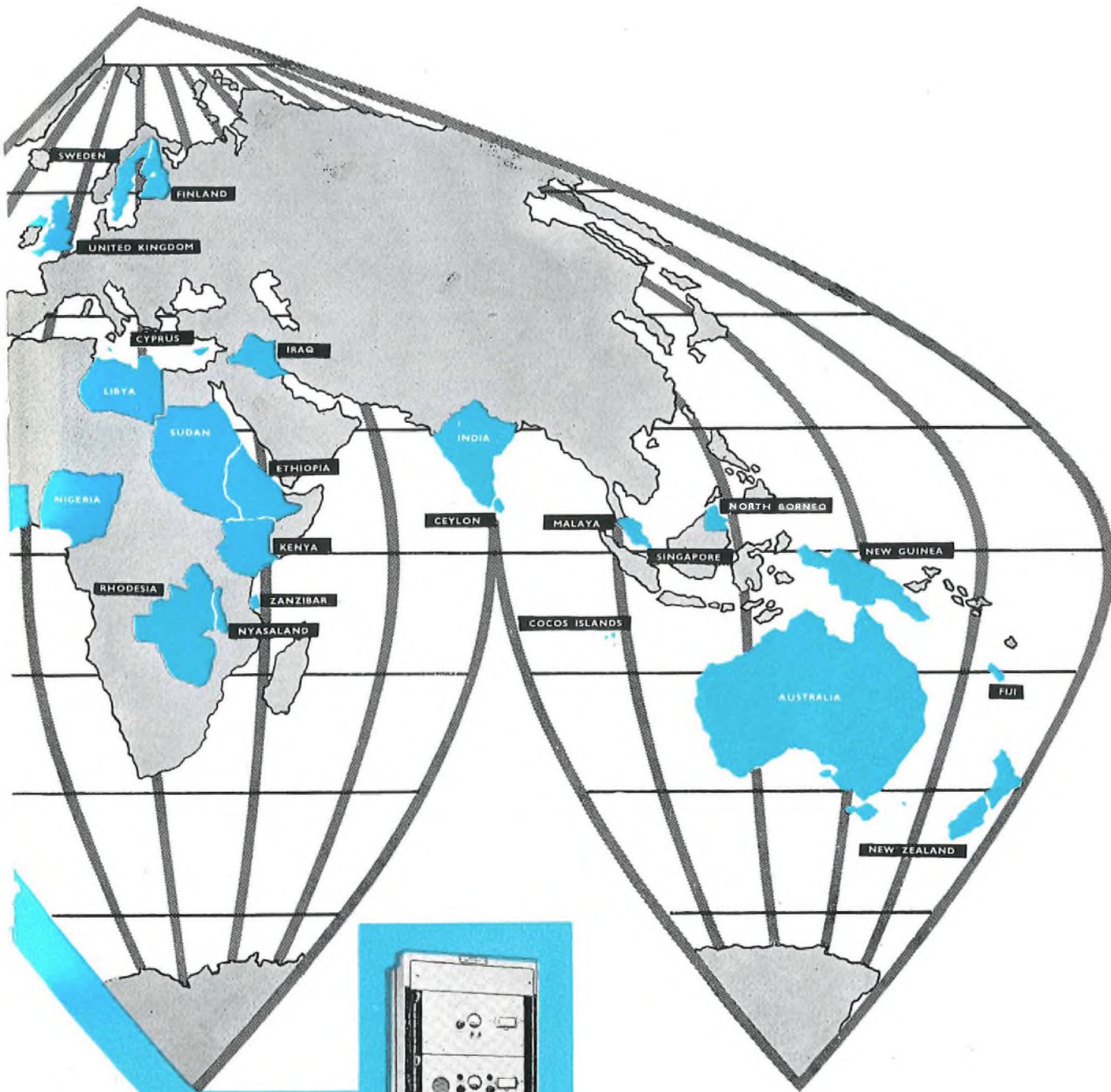

*V.H.F. radio equipments now in production include:*

**5-CIRCUIT RADIO EQUIPMENT.**

Provides five speech circuits, each transmitting the band 300c/s to 3400c/s over distances of up to about 40 miles.

**9-CIRCUIT RADIO EQUIPMENT.**

Provides nine speech circuits, each transmitting the band 300c/s to 3400c/s with out-of-band signalling, over distances of up to about 40 miles.

**TRANSPORTABLE 5-CIRCUIT RADIO EQUIPMENT.**

Ideal for temporary or emergency links.

*For further details regarding these equipments, please write for standard specifications SPO.5051, SPO.5060 and SPO.5070 respectively.*

**ipments**

**UNICATIONS**

**ORKS, COVENTRY, ENGLAND**



# TRANSISTORISED

## I + I CARRIER SYSTEM E.T.L.14

This single channel carrier system is used over an existing two-wire line to provide an extra speech circuit between 3.3 kc/s and 8.7 kc/s. The equipment will operate satisfactorily without repeaters over some 400 miles of open wire line. Signalling over the carrier circuit is at 500 c/s equivalent, standard 17 c/s ringing is used between the carrier terminal and the switchboard line.

Each terminal can be supplied in a metal cabinet or in rack mounting form. Power consumption is less than 0.25 watts and the system can be energised from mains, trickle charged accumulator or dry batteries.

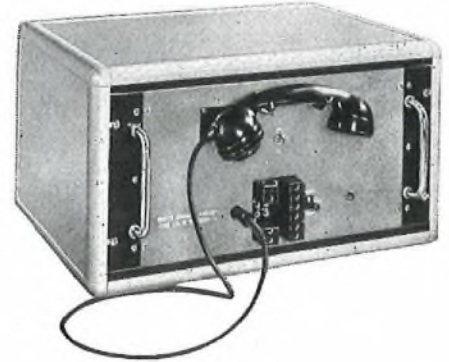

## F.M.T.17

The F.M.T.17 is intended for use over existing audio circuits. It enables frequency modulated duplex telegraph signals to be transmitted simultaneously with normal speech, without mutual interference and without any increase in bandwidth. Telegraph speeds are sufficiently high for good teleprinter operation and facilities are provided for single and double current working. The equipment is of unit construction and can be supplied for rack mounting or in a metal cabinet. Power requirements are very modest and operation can be from 12 or 24 volts D.C. or direct from mains.



## COMPANDORS

The compandor offers an economical means of improving performance on circuits which suffer from induced noise or crosstalk. It consists of two units, the compressor which operates in the transmit path, compressing the dynamic range in the ratio 2 : 1, low level signals being raised with respect to high levels and the expander which is

fitted in the receive path to restore the relative levels. Overall insertion loss is 0 db. Power is obtained from 12 volt batteries or suitable mains units; only 0.12 watts is required per compandor. The equipment is suitable for panel mounting and a standard 3½" deep panel will accommodate eight units, i.e. four compressors and four expanders.

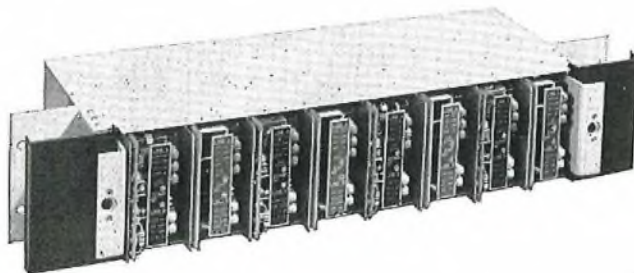

# transmission equipment

Ericsson Transmission Equipment is being developed continuously to meet the requirements of all administrations. Recent developments include the following fully transistorised items—

Multi-channel Carrier Termination equipment for use over radio and cable circuits.

A frequency modulated telegraph system enabling telegraph signals to be transmitted simultaneously with speech over existing telephone networks without increased bandwidth requirements. A single channel carrier system providing an extra two-way speech circuit over an existing open wire line.

Compact low-priced companders to give improved performance on radio and carrier circuits suffering from excessive induced noise and crosstalk.

A compact 7-channel stackable rural carrier system suitable for both-way junction circuits and at a price which makes it economical to use for individual subscriber services.

## FREQUENCY DIVISION MULTIPLEX

TCS.12 equipment provides groups of 12 channels of C.C.I.T.T. performance in the 60—108 kc/s spectrum and assembled into groups and supergroups for frequency division multiplex systems.

Sub-groups of 3-channels are used and a feature of the equipment is the ease with which a programme circuit can be substituted for one of the sub-groups. Speech-immune signalling paths at 3825 c/s equivalent are employed and the signalling circuits will handle 17 c/s ringing or automatic dialling. Current requirements are approximately 1.5 amps at 24-50 volts D.C. per nine foot rack of 36 channels.

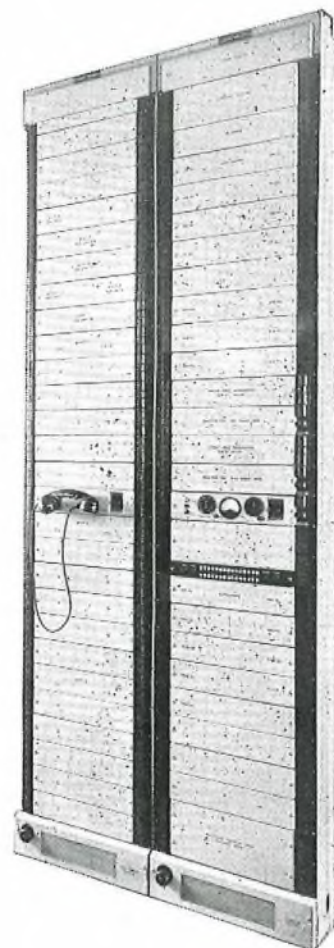

**cuts cost space and maintenance**

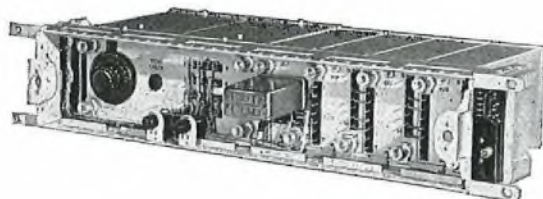

The associated frequency generating apparatus is controlled by a master oscillator (shown left) of high stability. Duplicate equipment is supplied and this together with automatic changeover provides a service of extreme reliability. Frequency checking, monitoring and alarm facilities are incorporated in the equipment and the whole carrier supply apparatus can be readily extended to meet all carrier supply requirements from 12 channels upwards.



E 115

**ERICSSON TELEPHONES LIMITED — ETELCO LIMITED**

HEAD OFFICE: 22 LINCOLNS INN FIELDS, LONDON, W.C.2. TEL. HOL. 6936.

WORKS:— BEESTON, NOTTINGHAM AND SUNDERLAND.



# Introducing the MC10

## a NEW 5-Channel Transistorised

# VHF Radio-Telephone Terminal

*Compact design which at low cost provides five high-grade telephone circuits*

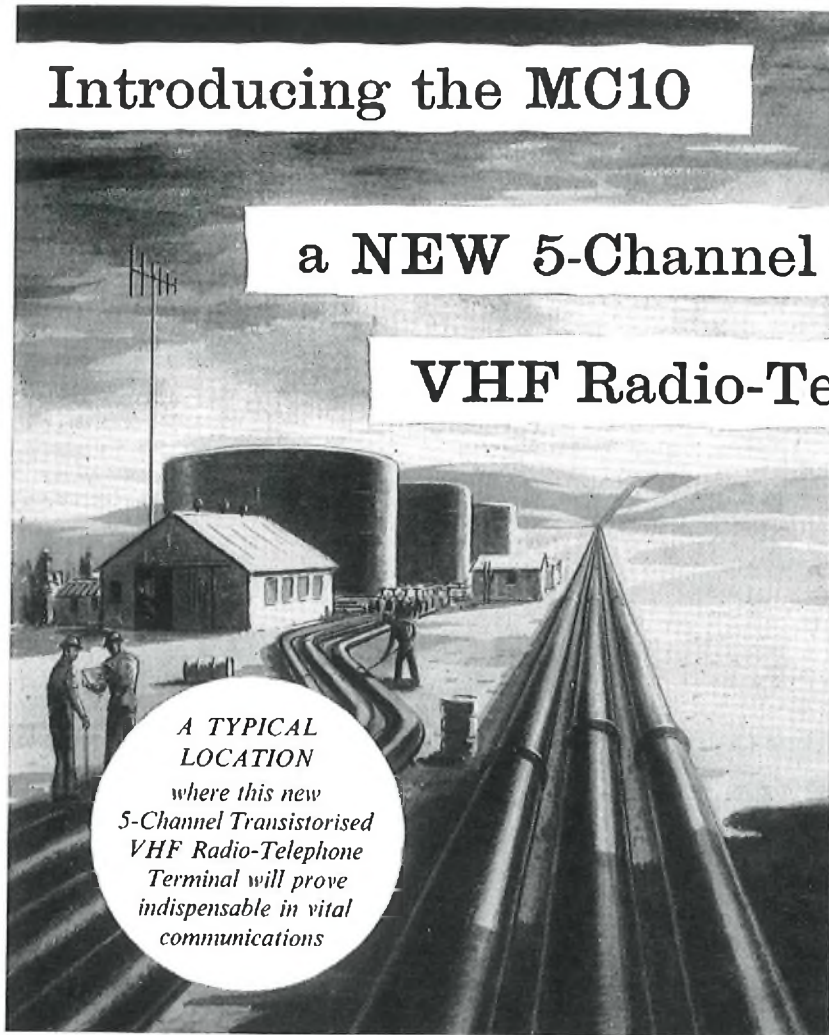

*A TYPICAL LOCATION where this new 5-Channel Transistorised VHF Radio-Telephone Terminal will prove indispensable in vital communications*



### Radio

Frequency range 156-184 Mc/s  
(other frequency ranges are available)

Transmitter power output 30 watts

Deviation 75 kc/s

Receiver Noise Factor 8db

*All characteristics of the transmitter and receiver conform to CCIR specifications*

### Carrier Telephone Equipment

5 Telephone channels · 4 kc/s spaced  
Equipped with Out of Band Signalling  
Facilities for dialling, Ringdown or  
junction working

Printed Wiring · Plug-in Units

Crystal frequency control

Resin cast components

*The result of co-operative enterprise between two great organizations*

**Redifon**

**SIEMENS  
EDISWAN**

#### REDIFON LIMITED

Communications Division, Wandsworth, London, S.W.18  
Telephone: VANdyke 7281  
*A Manufacturing Company In the Rediffusion Group*

#### SIEMENS EDISON SWAN LIMITED

Transmission Division, Woolwich, London, S.E.18  
Telephone: Woolwich 2020  
*An A.E.I. Company*

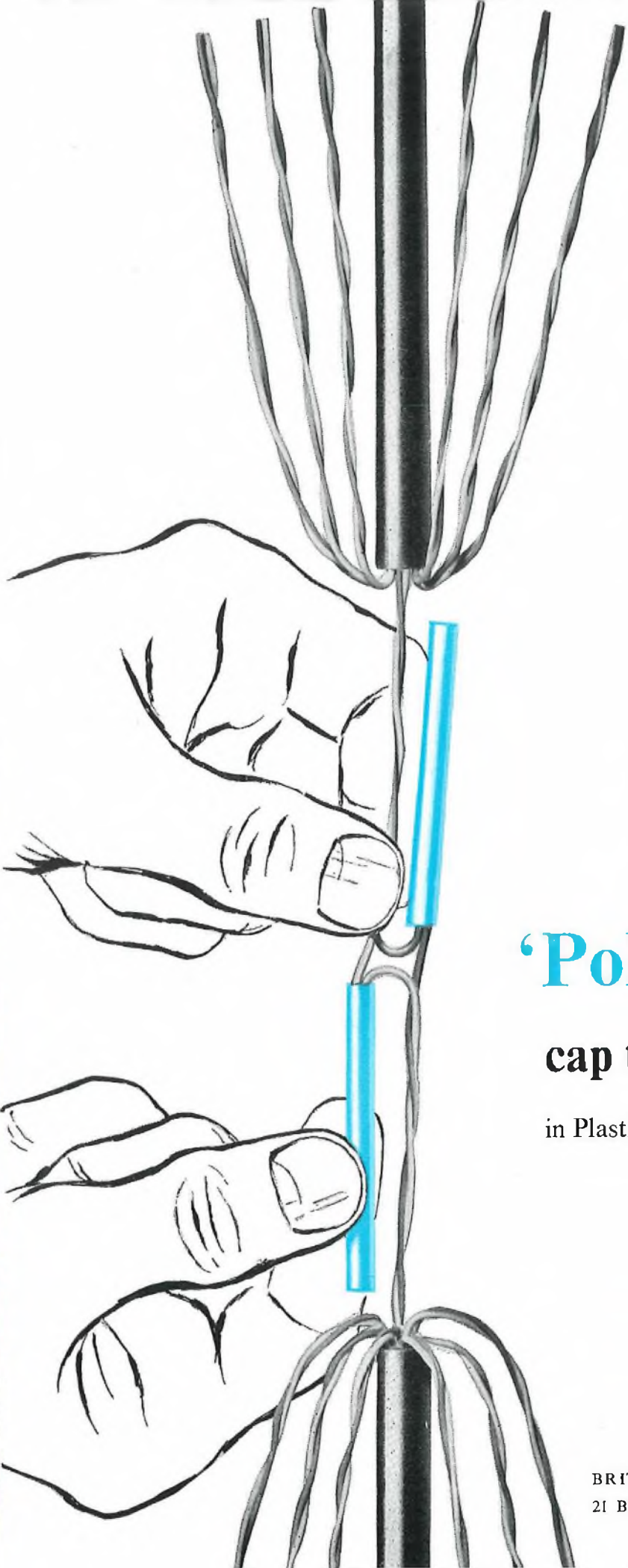

BICC Polytel sleeves insulate and seal the individual conductor joints in plastic insulated communication cables, against ingress of moisture.

They are made from polythene tubing, sealed at one end and filled with non-melting, non-hardening silicone grease which has good dielectric properties, a high degree of water repellence, oxidation resistance and a working temperature range suitable for home and overseas service.

Fitting is simple, the joint being folded back alongside the core and the Polytel sleeve pushed over the joint.

**BICC**

## 'Polytel' sleeves cap the conductor joints

in Plastic Insulated Communication Cables

*Publication GS25*

*gives further information.*

*May we send you a copy?*



# THE GENERAL ELECTRIC COMPANY

*have*

*pleasure*

*in*

*announcing*

*The New*



The original Gecophone has given yeoman service to subscribers in all parts of the world for the past 30 years.

The new Gecophone incorporates new ideas, new material and new components to produce a high performance telephone for service in all climates. In keeping with modern decorative schemes the new telephone is offered in a range of seven attractive colours:—

<b>Two-tone green</b>	<b>Two-tone grey</b>
<b>Concord blue</b>	<b>Topaz yellow</b>
<b>Lacquer red</b>	<b>Light ivory</b>
	<b>Black</b>

This outstanding instrument completes a comprehensive range to meet the normal demands of all Administrations and Subscribers.

*everything for telecommunications*

**THE GENERAL ELECTRIC COMPANY LIMITED of ENGLAND**  
TELEPHONE, RADIO and TELEVISION WORKS, COVENTRY ENGLAND



# Gecophone

for Overseas Administrations





# TELEGRAPH SIGNAL DISPLAY UNIT

## TYPE TDU2

The T.D.U.2 is designed for use, either as an independent unit for telegraph signal monitoring positions, or as an adjunct to the T.D.M.S.6B to enable a comprehensive analysis of telegraph wave form to be made.

**Principal features are:**

- \* *Easy to use.*
- \* *Provision for Z modulation.*
- \* *A time base having good short term stability and long term accuracy permits either start/stop or synchronous signals to be examined.*
- \* *X shift control calibrated in code element transition numbers.*
- \* *X expansion up to 5 screen diameters.*



# PORTABLE TELEGRAPH RELAY TESTING ADAPTOR RTAI



**Square and sine wave testing.** This adaptor is designed to check all types of polarised relays for bias and transit time, using the test signals generated by the T.D.M.S.5 series at signalling speeds within the range of the T.D.M.S., a visual indication of the condition and results of adjustment being indicated on the T.D.M.S.5.

**Principal features are:**

- \* *Caters for any type of polarised relay.*
- \* *Rapid determination of operating conditions.*
- \* *Rapid adjustment aided by visual indication.*
- \* *Simple to use.*
- \* *Square or sine wave test conditions.*

**AUTOMATIC TELEPHONE & ELECTRIC CO., LTD.**

Strowger House, Arundel Street, London, W.C.2

AT14951



# Economic trunk dialling

with **1VF**

For many years Siemens Edison Swan has been one of the main world suppliers of Voice Frequency Signalling Equipment for large trunk networks. To meet the needs of local junction and minor trunk networks not requiring the more complex signalling facilities of two-tone systems; an advanced single voice frequency signalling and dialling equipment is also available at low cost.

The design of the system incorporates C.C.I.T.T. performance recommendations. All circuits in a network capable of transmitting speech may be adapted economically for through signalling and dialling. The following are some of the salient features of the equipment:—

- Can be applied to any speech channel.
- Basically simple—does not complicate the line terminal or channelling equipment.
- Can be arranged for unidirectional or bothway signalling and dialling.
- Relay Set mounting in accordance with latest telephone exchange practice; can be installed with the telephone equipment and served from exchange power supplies.
- Uses standard components of latest design throughout.
- Requires negligible maintenance attention.
- Suitable for the introduction of economic subscriber trunk dialling.

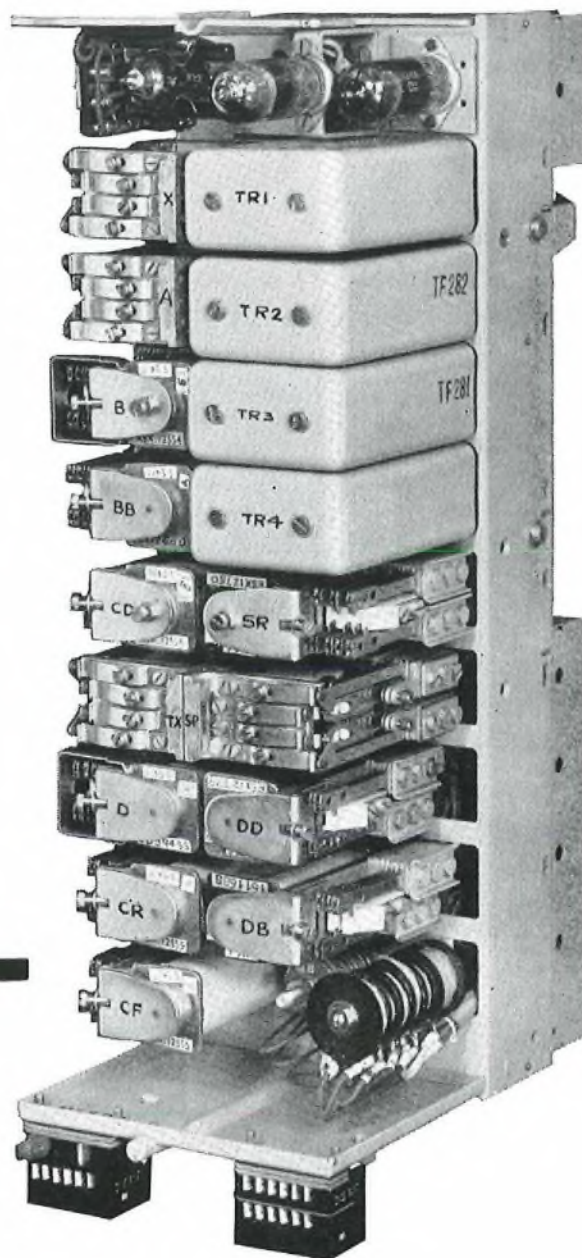

*1VF Terminal Relay Set*



**SIEMENS EDISON SWAN LTD.**

*Telecommunications Division P.D.5,  
Woolwich, London, S.E.18.  
Telephone: Woolwich 2020*





## CONSTANT POTENTIAL RECTIFIERS

*are associated with the d.c. power supplies to*

### THE SUBSCRIBER TRUNK DIALLING SYSTEM

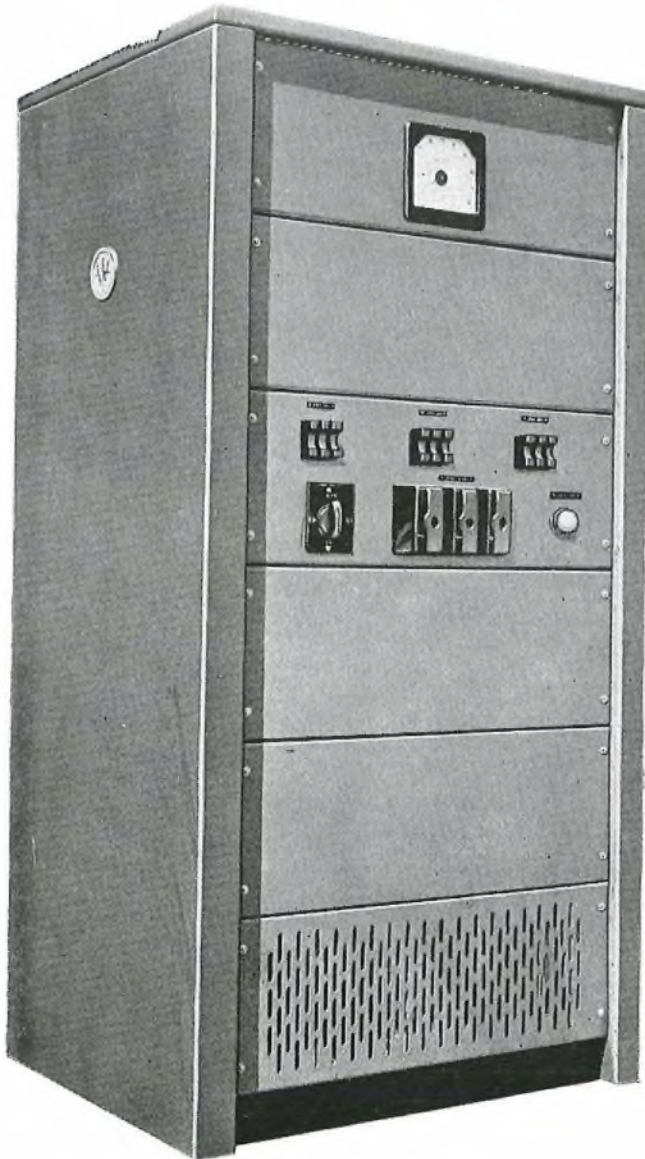

A Westinghouse transducer controlled rectifier set forms the basis of the power supply to the register translator in the new subscriber trunk dialling system. Equipments of this type are designed to stabilise the d.c. output voltage to less than  $\pm 1\%$  over a load range of 10% full load to full load despite simultaneous mains input voltage variations of  $\pm 6\%$  and frequency changes of  $+1\%$  to  $-2\%$ .

**WESTINGHOUSE BRAKE AND SIGNAL CO. LTD., 82 York Way, King's Cross, London, N.1**  
Tel.: TERminus 6432



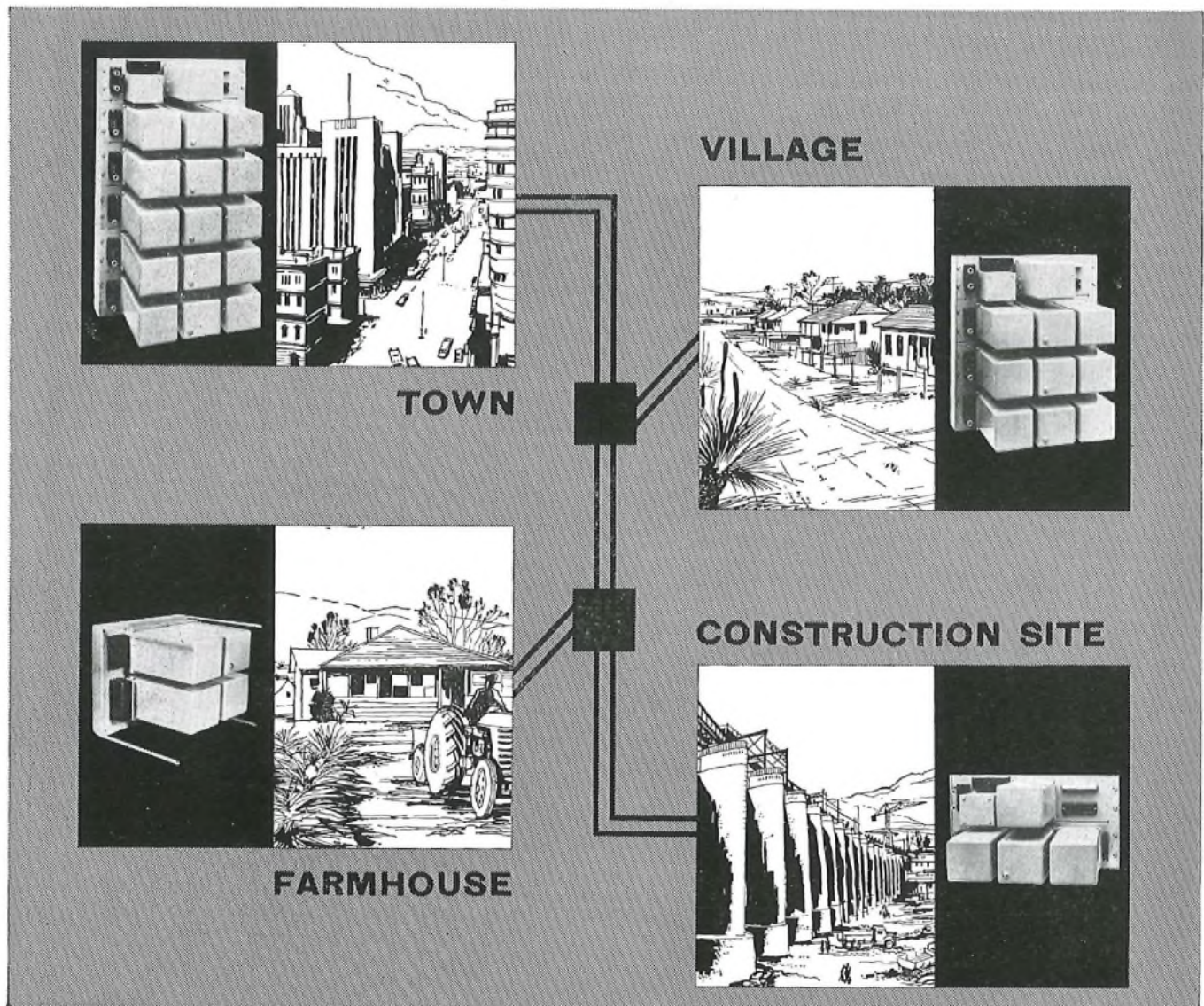

# Transistorised rural carrier telephone system-TRC7

*in service in many parts of the world*

A PRODUCT OF

**MULLARD EQUIPMENT LIMITED**

A COMPANY OF THE MULLARD GROUP

- Fully transistorised
- Simple installation
- Low power consumption
- Up to seven extra speech channels
- Ideal for temporary extra lines
- Fully tropicalised
- Pole mounted drop-off filters for greater flexibility

*Write for descriptive literature*

Mullard House · Torrington Place  
London · W.C.1 · Tel: LANGHAM 6633



## TUNGSTONE BATTERIES

are playing their part in the latest development in the Telephone System of this country, viz :-

## TRUNK DIALLING SYSTEM

Tungstone Products Ltd. are privileged to have installed their Batteries in the majority of "Satellite" Exchanges in the first area selected by H.M. Postmaster General for this great step forward in the history of the Telephone Service.

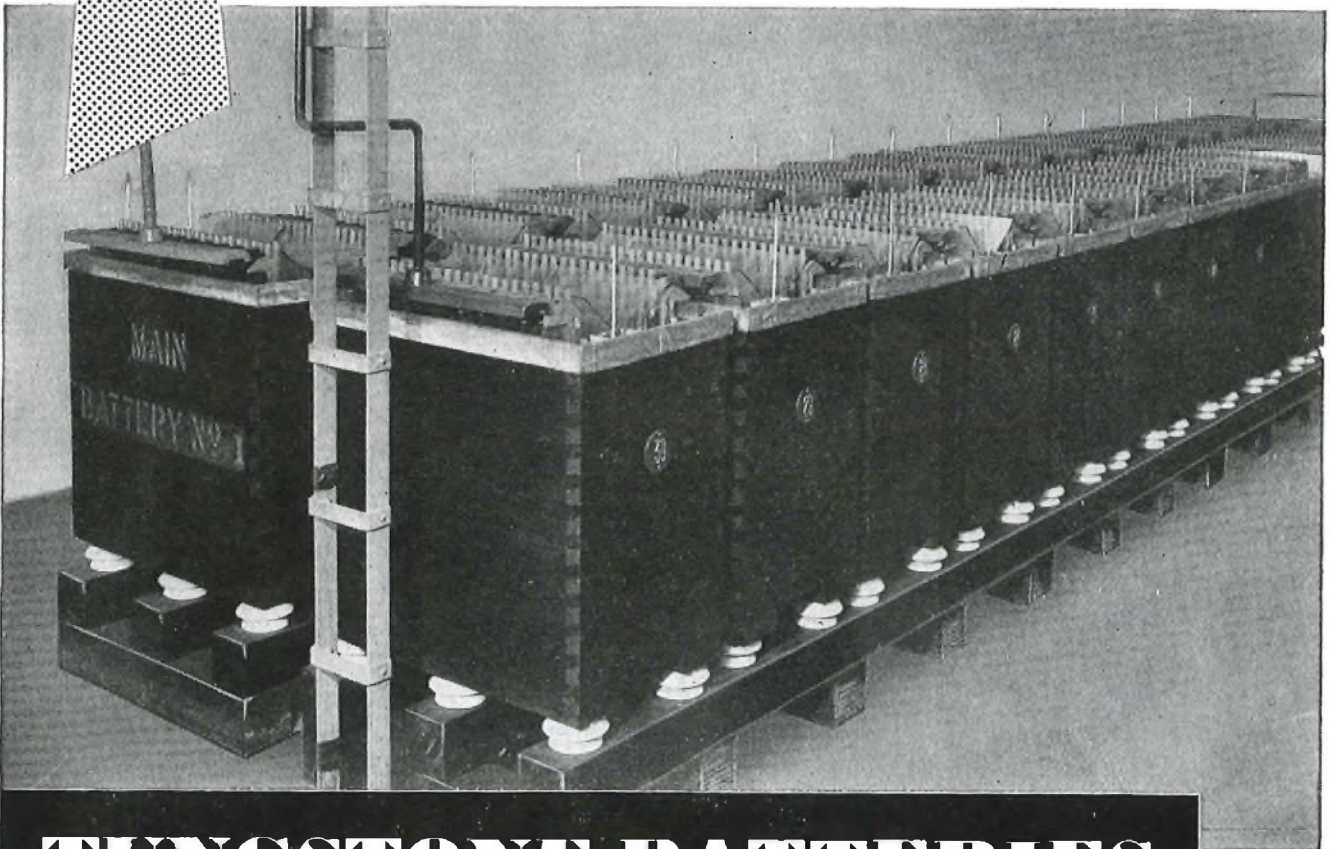

## TUNGSTONE BATTERIES

TUNGSTONE PRODUCTS LIMITED, 10 SALISBURY SQUARE, LONDON, E.C.4.

Works : MARKET HARBOROUGH, LEICS.

## *Marconi in Telecommunications*

The post and  
telegraph  
authorities  
of more than  
80 countries  
use Marconi  
equipment

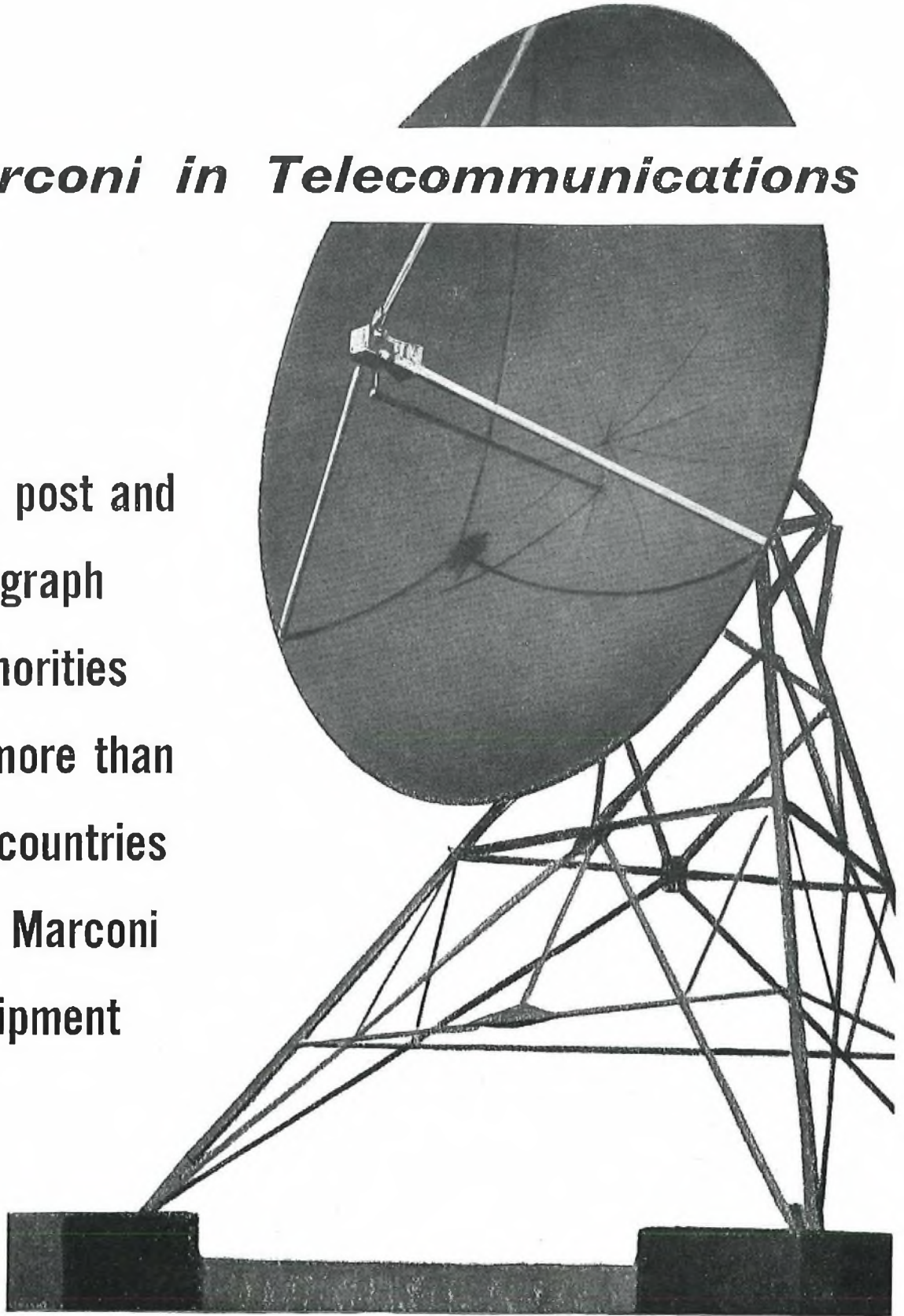

# MARCONI

**COMPLETE COMMUNICATION SYSTEMS**  
SURVEYED • PLANNED • INSTALLED • MAINTAINED



# Introducing **DENSAL**

—A GENERAL PURPOSE  
ELECTRICAL JOINTING COMPOUND

Suitable for most bolted and compression joints, busbar mating surfaces, etc., DENSAL ensures continuity of current flow, freedom of movement and prevention of corrosion.

*Write for Leaflet 033.*



**WINN & COALES LTD., DENSO HOUSE, CHAPEL RD., LONDON, S.E.27**

Telephone: GIPsy Hill 4247

Telegrams: Denselte, Westnor, London

Northern Area Headquarters, Denso House, Glebelands Road, Sale, Cheshire.

Telephone: Sale 8271

Telegrams: Denselte, Sale, Cheshire

Over 5,000,000  Permanent Magnets are manufactured each year in this Modern & Efficient Factory



**LOUD SPEAKER  
MAGNETS**

**in Alcomax**

**& Semi-Columnar Alcomax**

\* Write for literature

PM 108/56—Loud Speaker Magnets.

PM 169/57—Semi-Columnar  
Alcomax Magnets.

Bulletin M 10/57—Eclipse Shell-Moulded  
Permanent Magnets.



Made by the designers & manufacturers of Eclipse permanent magnets & chucks  
**JAMES NEILL & CO. (SHEFFIELD) LTD · SHEFFIELD · ENGLAND**



# THE NEW POTENTIOMETER

## Type PV2

This new miniature Wirewound Potentiometer is fully type-approved to R.C.S.C. styles RVW 13/14.

Available with normal shaft for knob operation, slotted shaft for preset adjustment by screwdriver, and longer slotted shaft with split collet locking device. All styles can be supplied with or without panel seals.

A wide air gap at the back of the component prevents condensation in humid conditions.

The resistance element is of copper-nickel wire for the lower values and nickel-chrome wire for the higher values; both are wound in strip form on a bakelite laminate of high electrical quality.

The resistance wire is welded at each end to an interwire, which is soldered to the connecting tag. The three tags are of plated brass and project through slots in the shell.

Contact ring and wiper arms, the tips of which are rhodium plated, are nickel silver. Shaft bush and nut are nickel-plated brass.

The lockable shaft model has a long bush with split conical extension at the end. The shaft is locked by a milled sleeve screwed over the bush compressing the split cone.

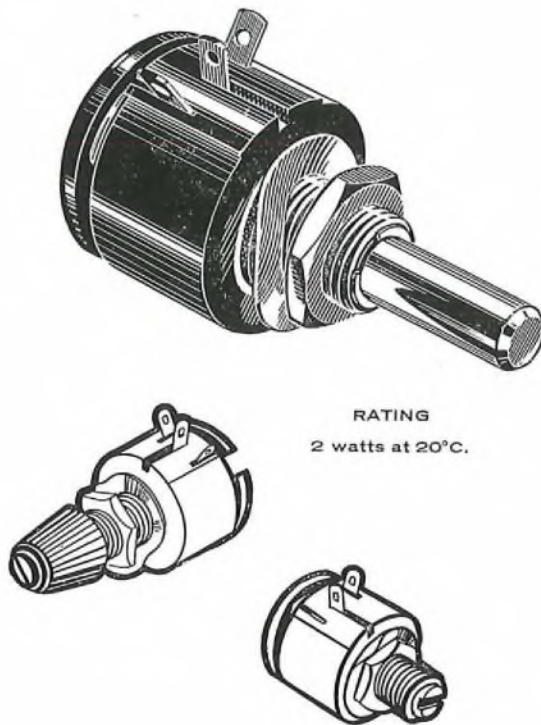

RATING  
2 watts at 20°C.

Illustrated are some of the styles available

Write for technical leaflet

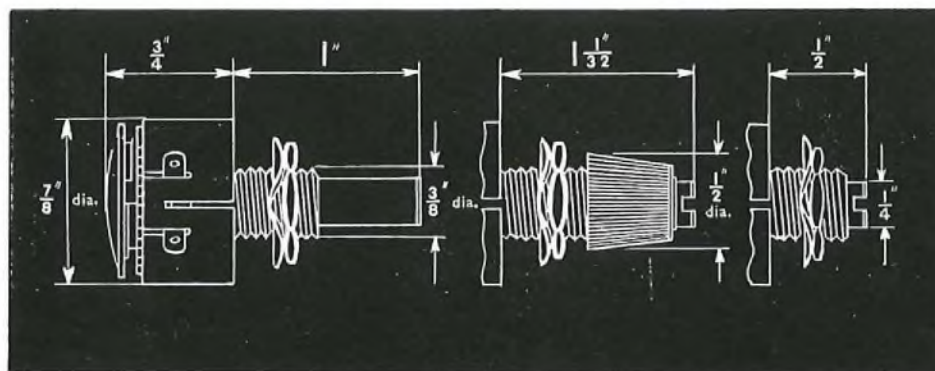

**Painton & Co. Ltd.**  
KINGSTHORPE NORTHAMPTON  
Tel: 32354/7 Telegrams: 'Ceil, Northampton'



# HIGH SPEED AUTOMATIC MORSE EQUIPMENT



**Keyboard Perforator  
Model 50**

Provided with locking device which prevents the simultaneous depression of two keys. Max. operating speed 750 characters per minute.

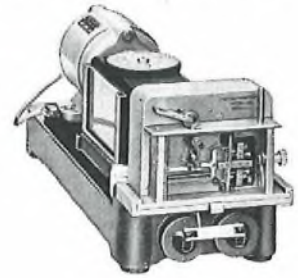

**Transmitter Model 112**

Speed range 13-250 words per minute. For training schools model 113 having a speed range of 5-35 words per minute is recommended.

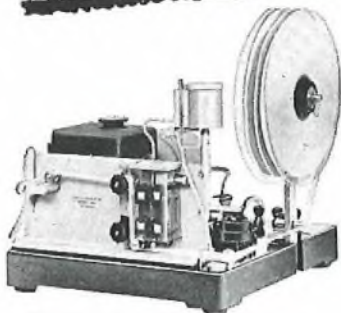

**Undulator Model 309**

Max. operating speed 300 words per minute. Other models available with double recording part and with amplifier/rectifier for tone frequency signals.

## G.N.T.

**Reperforator Model 451**

A truly synchronous receiver which produces a perforated tape similar to the one used for transmission. Normal speed range 40-200 words per minute.

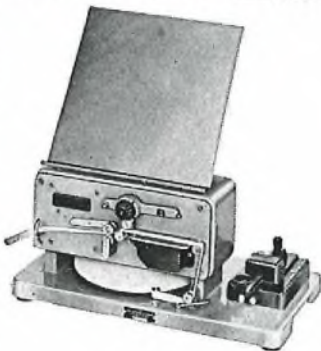
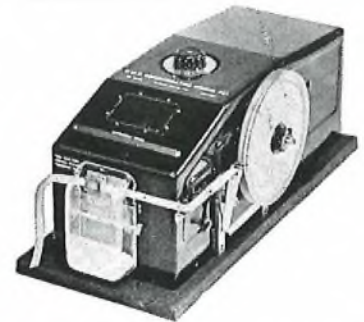

**Morseinker Model 1515**

Used for training purposes. Motor-driven. Also available with built-in amplifier/rectifier for tone frequency signals. Spring-driven models also available.

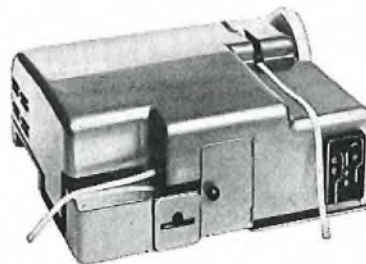

**Converter Model 2201**

For the conversion of a perforated Morse Code, or Cable Code, tape into a perforated 5-unit Code tape or into 5-unit signals at standard teleprinter speed.

**Converter Model 2206**

For the conversion of a perforated 5-unit Code tape into a perforated Morse Code, or Cable Code, tape.



# GREAT NORTHERN TELEGRAPH WORKS

DIVISION OF THE GREAT NORTHERN TELEGRAPH CO. LTD.

4, SYDHAVNS PLADS  
COPENHAGEN SV, DENMARK

LONDON OFFICE: 6, ST. HELEN'S PLACE  
LONDON E. C. 3.





**TMC make it more  
economical to connect  
isolated groups  
by telephone**

... by a very simple system too. Very aptly we call it the **SUBSCRIBERS' LINE CONCENTRATOR** because it actually concentrates into 2 junctions from the exchange the full telephone service normally given to 10 subscribers using direct exchange lines.

**SUBSCRIBERS' LINE CONCENTRATORS** provide economical communications for remote groups. For instance, four units using 8 junctions would service 40 subscribers and the initial outlay could be recouped in a comparatively short time because the installation and maintenance costs are so much lower.

**PRINCIPAL FEATURES OF THE SYSTEM**

- \* MANUAL OR AUTOMATIC WORKING WITHOUT MODIFICATION
- \* INCOMING AND OUTGOING CALLS ARE THE SAME AS FOR DIRECTLY CONNECTED SUBSCRIBERS
- \* REVERTIVE CALLS AS FOR ANY OTHER CLASS OF CALL
- \* NO POWER REQUIREMENTS AT THE REMOTE STATIONS
- \* CAN BE USED IN EXTREME TROPICAL CLIMATES
- \* FAULTS AUTOMATICALLY INDICATED IN THE MAIN EXCHANGE

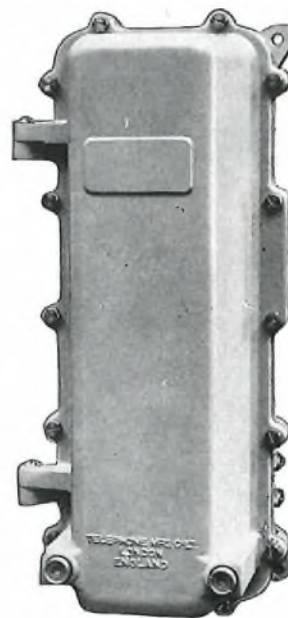

**TMC**

**SUBSCRIBERS' LINE CONCENTRATOR**

TELEPHONE MANUFACTURING COMPANY LIMITED  
Telephone and Switching Division • Hollingsworth Works • London SE21  
Telephone: GIPsy Hill 2211



Two new  
**TMC** carrier  
telephone  
equipments

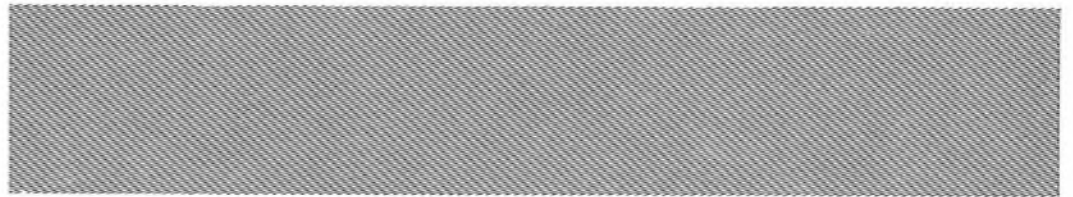

for S.T.D. and T.A.T.

**TELEPHONE MANUFACTURING COMPANY LIMITED**

Transmission Division, Cray Works, Sevenoaks Way, Orpington, Kent

**FOR LOW-COST BEARERS—  
8 CIRCUITS IN 60-108 KC/S BAND  
WITH OUT-BAND SIGNALLING**

- 6 kc/s channel spacing
- Channel bandwidth 300 c/s—3,400 c/s
- Dialling (E & M) or ring-down facilities
- Low-level signalling (-20dbm0) tone-on or tone-off idle
- Five 8-circuit groups on one double-sided 9 foot rack including carrier, signalling and power supplies
- Alternative version for 4-wire balanced-pair cables with complete equipment for two 16-circuit terminals on one double-sided 9 foot rack

Similar to equipment used by  
**THE BRITISH POST OFFICE**  
to provide **SHORT TRUNK CIRCUITS**  
with **OUT-BAND DIALLING**

**FOR HIGH-COST BEARERS—  
16 CIRCUITS IN 60-108 KC/S BAND  
WITH HIGH GRADE CHANNELS**

- 3 kc/s channel spacing
- Channel bandwidth 300 c/s—3,100 c/s
- Two 16-circuit groups on one double-sided 9 foot rack

Developed by  
**THE BRITISH POST OFFICE**  
for use on the  
**TRANS-ATLANTIC TELEPHONE CABLE**

THESE NEW CARRIER TELEPHONE EQUIPMENTS ARE  
THE LATEST ADDITIONS TO THE T.M.C. RANGE OF  
TRANSMISSION EQUIPMENT WHICH INCLUDES

Carrier Telephone and Telegraph Equipment  
for Cable, Open-Wire and Radio  
Transistorised 120 c/s and 170 c/s F.M.  
Telegraph Equipment  
Transistorised V.F. Repeater Equipment  
Transistorised Privacy Equipment

**SELLING AGENTS**

AUSTRALIA AND NEW ZEALAND

**Telephone Manufacturing Co.  
(A'sia) Pty. Ltd., Sydney, N.S.W.**

CANADA AND U.S.A.

**Telephone Manufacturing Co. Ltd.,  
Toronto, Ont.**

ALL OTHER COUNTRIES  
(for Transmission Equipment only)

**Automatic Telephone and Electric  
Co. Ltd., London**





You can count on

## Hivac Cold Cathode Tubes

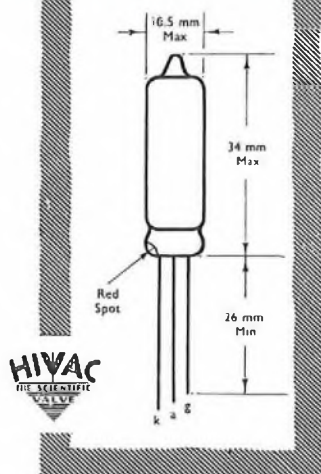

### Cold Cathode Triode XC18 (CV2486)

The XC18 is a wire-ended subminiature cold cathode triode. It is an electrically reliable and mechanically robust tube of superior quality.

- Minimum main gap breakdown voltage ... 210V
- Maintaining voltage ... 73V  $\pm$  5
- Trigger strike voltage ... 68V  $\pm$  6
- Maximum continuous cathode current ... 1mA
- Maximum pulsed cathode current ... 5mA

(Assuming a maximum duty cycle of 1 : 5)

Our Technical Service Department will be pleased to supply further information and assist in any problems arising from the use of Hivac tubes.

## Hivac Limited

A member of the Automatic Telephone & Electric Group

Stonefield Way · South Ruislip · Middlesex · Ruislip 3366

C11

# FERRANTI 7-Range CLIP-ON INSTRUMENTS



TYPE 'A' AMMETER  
0-10-25-50-100-250-500-  
1000 Amps. Write for  
List IN.17A.



TYPE 'V' VOLT-AMMETER  
0-10-25-100-250-1000 Amps.  
and 0-150-600 Volts.  
Write for List IN.17V.

7 ranges  
-1 switch



TYPE 'L' AMMETER  
0-10-25-50-100-250-500-  
1000 Amps. Specially  
designed for use on  
porcelain-clad fuses  
and heavy-duty con-  
ductors up to 4"  
dia. Write for  
List. IN.17L.

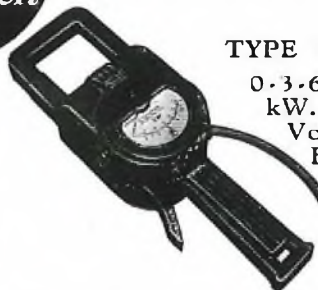

TYPE 'W' WATTMETER  
0-3-6-12-30-60-120-300  
kW. With High Quality  
Voltage Leads, HRC  
Fused Clips and Test  
Prods. Write for  
List IN.17W.



A leather case with shoulder strap is available for all models at an extra charge

FERRANTI LTD · MOSTON · MANCHESTER 10. London Office: Kern House, 36 Kingsway, W.C.2

# The MULTIMINOR

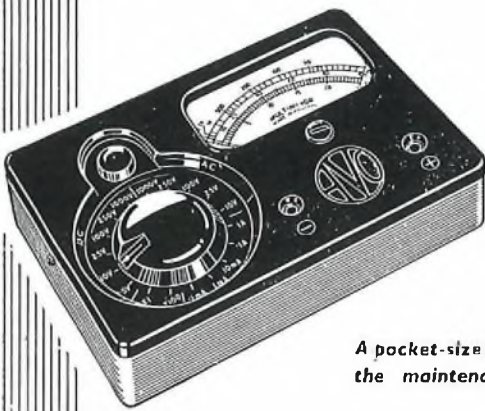

A pocket-size instrument for  
the maintenance engineer

## 19 RANGES

<b>D.C. Voltage</b>	<b>A.C. Voltage</b>
0—100 mV.	0—10 V.
0—2.5 V.	0—25 V.
0—10 V.	0—100 V.
0—25 V.	0—250 V.
0—100 V.	0—1000 V.
0—250 V.	
0—1000 V.	
	<b>D.C. Current</b>
	0—100 $\mu$ A
	0—1 mA
	0—10 mA
	0—100 mA
	0—1 A
<b>Resistance</b>	
0—20,000 $\Omega$	
0—2 M $\Omega$	

**Sensitivity:**  
10,000 ohms per volt on D.C.  
voltage ranges.  
1,000 ohms per volt on A.C.  
voltage ranges.

**Accuracy:**  
On D.C. 3% of full scale value.  
On A.C. 4% of full scale value.

Pocket Size: 5 $\frac{1}{8}$  x 3 $\frac{1}{4}$  x 1 $\frac{1}{2}$  inches.  
Weight: 1 lb. approx.

List Price:

# £9:10s.

complete with Test Leads and Clips  
Leather Case if required 32/6

Write for illustrated leaflet.

Designed and Manufactured by

# AVO Ltd.

AVOCET HOUSE · 92-96 VAUXHALL BRIDGE ROAD · LONDON · S.W.1

Telephone: VICTORIA 3404 (12 lines)

MM2

## TELEGRAPHY

By J. W. Freebody, Whit.Schol., B.Sc.(Eng.), etc. This new book is the successor to T. E. Herbert's *Telegraphy*—that indispensable work of reference used by engineers and telegraphists throughout the world since early in the century. For students, engineers, and all engaged on the operational and traffic aspects of the subject. The book fully covers the syllabuses of the C. and G. examinations in Telegraphy. 80/- net.

## MODERN ELECTRONIC COMPONENTS

By G. W. A. Dunner, M.B.E., M.I.E.E., etc. The first comprehensive book of its kind to be published in the world. It presents a comprehensive survey of the characteristics of the more common components, together with information on their behaviour under the arduous environmental conditions to which they are now frequently subjected. 55/- net.

FROM ALL BOOKSELLERS

## PITMAN TECHNICAL BOOKS

Parker Street, Kingsway, London, W.C.2

## for the right connection

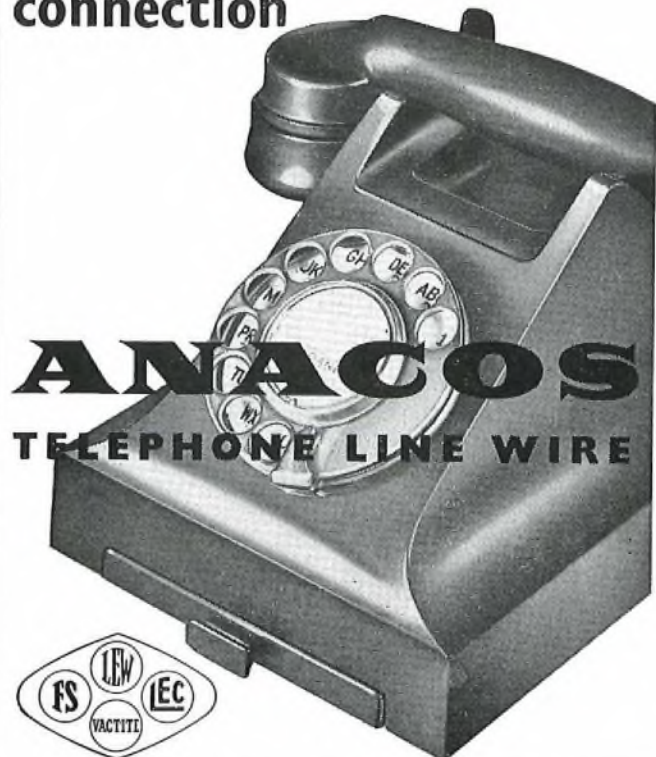

# ANACOS

## TELEPHONE LINE WIRE



**FREDERICK SMITH AND COMPANY**  
ANACONDA WORKS · SALFORD 3 · LANCs



## VALUABLE FREE BOOK

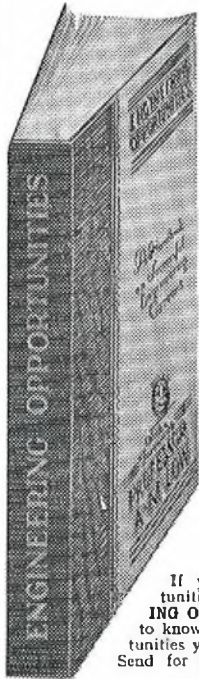

Tells You How to Pass Your C. & G. or Promotion Exam. at *First Attempt!*

All Post Office Engineering personnel who are anxious to obtain early promotion should at once send for a copy of our handbook "ENGINEERING OPPORTUNITIES," which among other intensely interesting matter describes our unique methods of preparation for TECHNICAL APPOINTMENTS IN THE POST OFFICE (Assistant Engineer—New Style and Assistant Traffic Superintendent), CITY AND GUILDS EXAMINATIONS in Principles of Telecommunications (1-5), Radio (1-4), Telephone Exchange Systems (1-3), Telegraphy (1), Line Transmission (1 and 2), Lines Plant Practice (1 and 2), Mathematics for Telecommunications (1-5), Electrical Engineering Practice (Prelim. Inter. and Final), and outlines a wide range of non-examination courses in all branches of Electrical, Mechanical, Civil, Automobile, Aeronautical and Radio Engineering.

Assistant Engineer and Assistant Traffic Superintendent. Open competitions now resumed. Age extensions for established Civil Servants. Ask us for full details.

We definitely guarantee  
"NO PASS—NO FEE"

If you intend to make the most of today's opportunities, you cannot afford to miss reading "ENGINEERING OPPORTUNITIES." It tells you everything you want to know to secure advancement, and describes many opportunities you may now be missing through lack of information. Send for your copy to-day—FREE and without obligation.

BRITISH INSTITUTE  
OF ENGINEERING TECHNOLOGY  
369 COLLEGE HOUSE,  
29-31 WRIGHT'S LANE, LONDON, W.8

# BIET



## GENERATING EQUIPMENT

from 500w to 100 kw

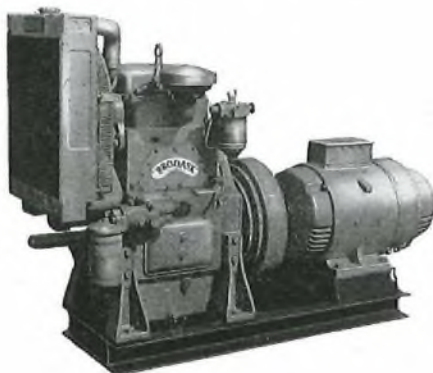

A Typical 12 kVA Set

FULLY AUTO—NON AUTO

**BRODIE & ASKHAM LTD.,**  
57/61 ST. ALBANS ROAD,  
WATFORD, HERTS.

PHONE:  
WATFORD 5175

GRAMS:  
BRODASK, WATFORD

# ADCOLA

PRODUCTS LIMITED  
(Regd Trade Mark)

FOR  
**SOLDERING INSTRUMENTS**  
and **EQUIPMENT**  
SUPPLIED FOR ALL VOLTAGES

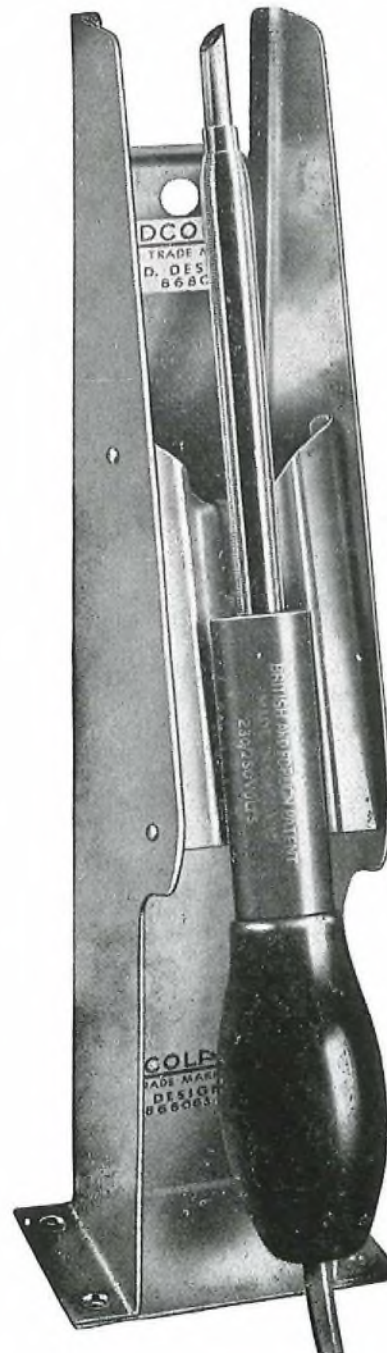

illustrated

DETACHABLE  
BIT  
MODEL  $\frac{3}{16}$ "  
List 64

PROTECTIVE  
SHIELD  
List 68

Write for Catalogues  
HEAD OFFICE, SERVICE AND SALES  
**ADCOLA PRODUCTS LTD.**  
GAUDEN ROAD, CLAPHAM HIGH STREET, LONDON, S.W.4  
Phone: MACaulay 3101, 4272

# “Britain calling America ... via the moon”

*MAY 14th, 1959.*

A new chapter in communications history was opened when scientists from Manchester University at Jodrell Bank transmitted the first messages in morse code and speech to America via the moon.

The transmitting and receiving equipment which successfully sent the messages a distance of half a million miles was designed and manufactured by Pye telecommunications engineers.

Foremost in design and manufacture Pye Telecommunications equipment is today solving communications problems in more than 90 countries throughout the world . . . *tomorrow in space.*

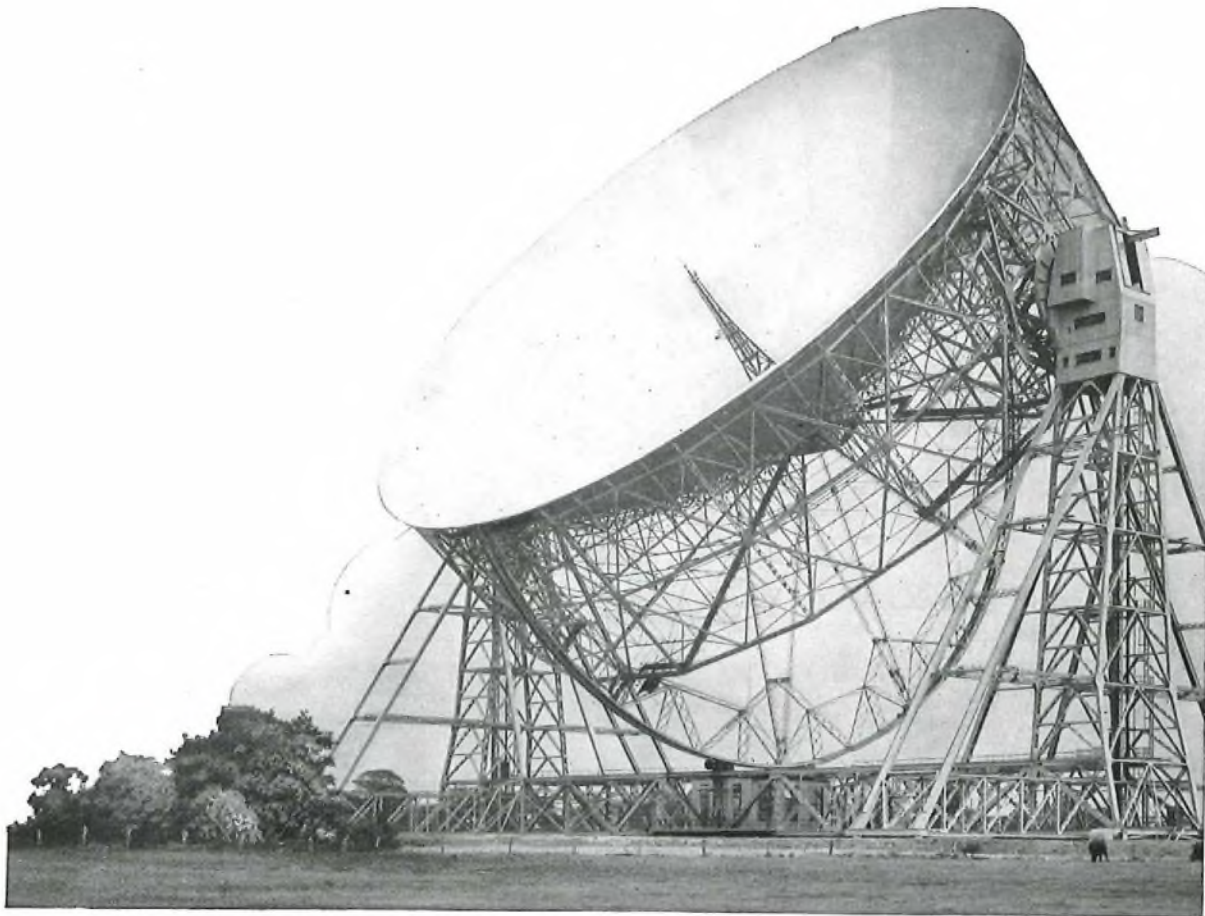

*Photograph by courtesy of the Director of the Jodrell Bank Experimental Station*

PYE TELECOMMUNICATIONS LIMITED · CAMBRIDGE · ENGLAND



*first in*

# PORTUGAL

An important project and another "first" for Standard Telephones and Cables Limited is the installation of a comprehensive coaxial cable telecommunications network between Lisbon and Oporto. This is a joint undertaking by S.T.C. and their associates, Standard Electrica, S.A. (Lisbon) for the Portuguese Telegraph & Telephones Administration (C.T.T.)

Two cables are provided over a route of some 250 miles (400 Km) consisting of a six tube coaxial cable of the latest type, with a parallel cable for short distance audio and carrier frequency circuits.

Manufacture and installation covering a period of approximately two years, presents an undertaking well within the capabilities of S.T.C. who are leaders in research and the development and manufacture of all types of telecommunication systems.

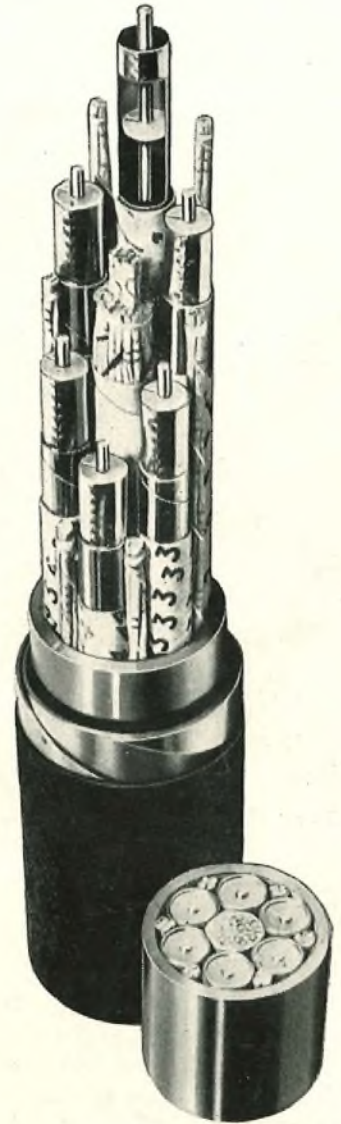
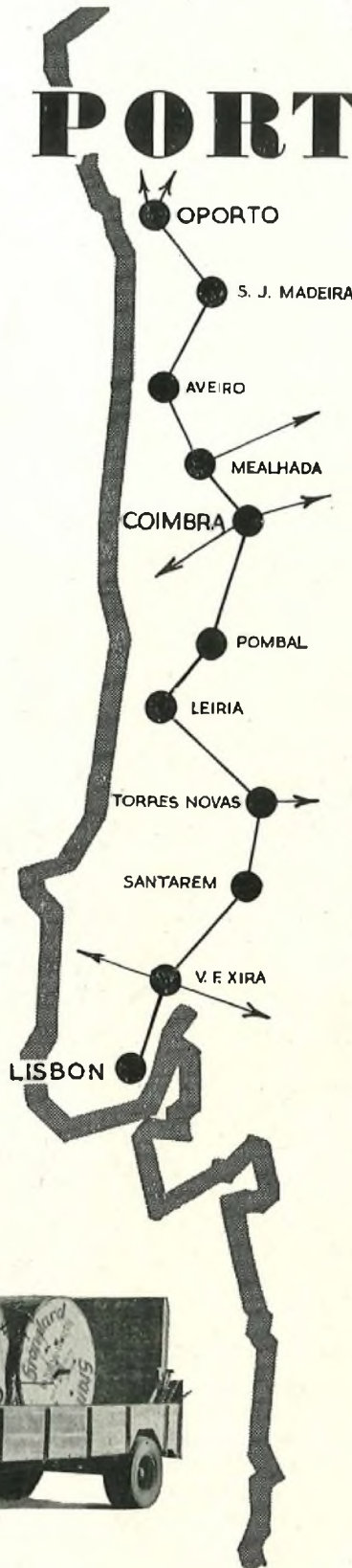

*Telescoped and cross-section samples of 6-core coaxial cable.*

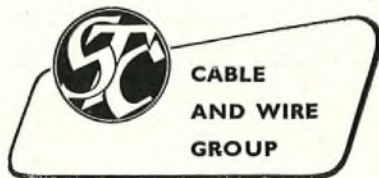

**Standard Telephones and Cables Limited**

Registered Office: Connaught House, Aldwych, London, W.C.2

TELEPHONE CABLE DIVISION: NORTH WOOLWICH · LONDON · E.16