

RA Roe

THE POST OFFICE ELECTRICAL ENGINEERS' JOURNAL

Vol. 50

JULY 1957

Part 2

CONTENTS

	PAGE
A FREQUENCY-MODULATED VOICE-FREQUENCY TELEGRAPH SYSTEM—W. F. S. Chittleburgh, B.Sc.(Eng.), A.C.G.I., D. Green, B.Sc.(Eng.), Graduate I.E.E., and A. W. Heywood, A.M.I.E.E.	69
SIGNALLING OVER CARRIER CHANNELS THAT PROVIDE A BUILT-IN OUT-OF-SPEECH-BAND SIGNALLING PATH, Part 1—General Principles—B. R. Horsfield, A.M.I.E.E., and R. W. Gibson, A.M.I.E.E.	76
OPERATIONAL RESEARCH IN THE POST OFFICE, Part 2—Probability Models—H. J. Josephs, M.I.E.E., and R. A. Hastie, M.A.	81
MEASURING WHEELS—S. Lifford, Graduate I.Mech.E.	86
AN EXPERIMENTAL GAS PLUMBING OUTFIT FOR CABLE JOINTERS—J. G. Donovan, A.M.I.E.E., and R. Tharby	88
A 4-Mc/s COAXIAL LINE EQUIPMENT—C. E. L. No. 4A—E. Davis, A.M.I.E.E.	92
THE USE OF THERMISTORS TO SUPPRESS BELL TINKLING ON SHARED-SERVICE LINES—F. A. Wilson, C.G.I.A., A.M.I.E.E., A.M.Brit.I.R.E.	98
PROVISION OF NUMBER UNOBTAINABLE TONE FROM FINAL SELECTORS—J. L. K. Ashwell and B. D. Gorton	102
A PROPOSED NEW TELEPHONE CABLE BETWEEN THE UNITED KINGDOM AND CANADA	104
A 4,000-Mc/s RADIO SYSTEM FOR THE TRANSMISSION OF FOUR TELEPHONY SUPERGROUPS (240 CIRCUITS)—R. L. Corke, A.M.I.E.E., E. V. Ephgrave, A.M.I.E.E., J. Hooper, A.M.I.E.E., and D. Wray, B.Sc.(Eng.), A.M.I.E.E.	106
A BROAD-BAND VARIABLE GROUP-DELAY EQUALIZER—R. Hamer, B.Sc., A.M.I.E.E., and R. G. Wilkinson	120
A BROAD-BAND INTERMEDIATE-FREQUENCY AMPLIFIER FOR USE IN FREQUENCY-MODULATION MICROWAVE RADIO RELAY-SYSTEMS—R. Hamer, B.Sc., A.M.I.E.E., and C. H. Gibbs, Associate I.E.E.	124
NOTES AND COMMENTS	127
INSTITUTION OF POST OFFICE ELECTRICAL ENGINEERS	127
ASSOCIATE SECTION NOTES	130
REGIONAL NOTES	133
STAFF CHANGES	138
BOOK REVIEWS	91, 97, 101, 123, 126, 129

Price 2/6 net

THE INSTITUTION OF POST OFFICE ELECTRICAL ENGINEERS



Unique in its field

Redifon R.151 **RECEIVER**

FOR PERFORMANCE — FOR VALUE

Radio teleprinter, teletype and telegraph receiver terminal. Dual space diversity. Six crystal controlled pre-tuned frequencies within the range of 2 to 27.5 M/cs. High stability for unattended operation on point to point links. A first class receiver, very reasonably priced.

6
SPOT

**HIGH STABILITY
CRYSTAL CONTROLLED
FREQUENCIES**

Radio Communications Division

REDIFON LIMITED, BROOMHILL ROAD, LONDON, S.W.18. VANdyke 7281

A Manufacturing Company in the Redifusion Group

radio and electronic components

By G. W. A. Dummer, M.B.E., etc. Here is a brand-new and unique series of books that gives a detailed picture of the range and limitations of the various fundamental electronic components and assistance in selecting the best component for a particular requirement. Illustrated.

- Vol. 1. Fixed Resistors. 28/- net.
- Vol. 2. Variable Resistors. 30/- net.
- Vol. 3. Fixed Capacitors. 45/- net.
- Vol. 4. Variable Capacitors. 32/6 net.

PITMAN Parker St., Kingsway, London, W.C.2

PASS YOUR CITY & GUILDS CERTIFICATES AND P.M.G. CERTIFICATE

We offer comprehensive home training in a wide range of subjects, including P.M.G. Certificates, City and Guilds Grouped Certificates in Telecommunications, A.M.Brit.I.R.E. Examination, Radio Amateur's Licence, Radio and Television Servicing Certificates, General Radio and Television Courses, Radar, Sound Recording, etc. Also Courses in all other branches of Engineering.

With the following Courses, Practical Kits are available.

Radio, Television, Mechanics, Electricity, Chemistry, Photography, Carpentry; also Draughtsmanship, Commercial Art, Amateur S.W. Radio, Languages, etc.

Write now

for FREE BROCHURE stating subjects of interest to:

E.M.I. INSTITUTES

Dept. 97, GROVE PARK ROAD, LONDON, W.4
An Educational Organization serving the E.M.I. Group of Companies, including "HIS MASTER'S VOICE", MARCONIPHONE, COLUMBIA, etc.

to.64

JUL/57

THE POST OFFICE ELECTRICAL ENGINEERS' JOURNAL

Vol. 50

July 1957

Part 2

A Frequency-Modulated Voice-Frequency Telegraph System

U.D.C. 621.394.441:621.376.3

The first narrow-band frequency-modulated voice-frequency telegraph system to be put into service by the Post Office was used to provide 11 circuits between the United Kingdom and Canada over the transatlantic telephone cable. This article describes the 24-circuit frequency-modulated voice-frequency telegraph system that was adapted to provide the transatlantic telegraph circuits and discusses the possible future use of frequency-modulated systems in the inland telegraph network.

INTRODUCTION

FREQUENCY-MODULATED voice-frequency (f.m.v.f.) telegraph systems offer a number of advantages over the older and more established amplitude-modulated (a.m.) systems. These advantages include improved performance with a given signal-to-noise ratio, wide received-signal level range, rapid response to changes of signal level and improved performance at higher speeds of operation for a given frequency spacing between channels. These factors make f.m.v.f. telegraph systems especially suitable for use where the transmission channels tend to be noisy, e.g. radio links and open-wire lines, and for circuits that exhibit frequent changes of signal level of short duration.

The whole of the inland v.f. telegraph network in this country at the present time is provided by means of a.m. systems. The majority of these are 6-, 12- or 18-circuit systems in which the channels are spaced 120 c/s apart. There are also a few systems installed which are capable of accommodating 24 circuits. The remainder are 4- or 8-circuit systems in which the channels are spaced 240 c/s apart but which employ the same types of channel filters as are used in the larger systems. The telegraph circuits provided by these systems are normally operated at a signalling speed of 50 bauds and, for the most part, cannot transmit signals at a speed greatly in excess of this figure without an intolerable degree of distortion being introduced. In deciding the type of system to be used to provide the telegraph circuits between London and Montreal over the transatlantic telephone (T.A.T.) cable, the paramount requirement was that the available band-width should be utilized in the most efficient manner possible; this was the most cogent reason for the eventual decision to use a f.m. system.

In its application to the T.A.T. cable, only part of a complete system has been provided, and certain modifications have been incorporated to permit maximum exploitation of the band-width available within the half telephone circuit allocated for telegraph purposes; the facility is available of extending the installation to accommodate the full complement of 24 circuits if required. This is the first narrow-band f.m.v.f. telegraph system to be put into service by the British Post Office.

The following description of the equipment is in terms of a standard 24-circuit system, details being given, where

† Mr. Chittleburgh and Mr. Green are with Standard Telephones & Cables, Ltd., Woolwich, and Mr. Heywood is an Executive Engineer in the Telegraph Branch, E.-in-C.'s Office.

W. F. S. CHITTLEBURGH, B.Sc.(Eng.), A.C.G.I.,
D. GREEN, B.Sc.(Eng.), Graduate I.E.E.,
and A. W. HEYWOOD, A.M.I.E.E.†

appropriate, of the modifications applied to the system for use over the T.A.T. cable.

GENERAL FEATURES OF THE SYSTEM

The equipment described provides up to 24 telegraph channels with mid-frequencies that are the odd harmonics of 60 c/s between 420 c/s and 3,180 c/s inclusive. The lower 12 channels, with mid-frequencies 420 c/s, 540 c/s, . . . 1,740 c/s, are provided by a single stage of modulation; the upper 12 channels, with mid-frequencies 1,860 c/s, . . . 3,180 c/s, are obtained by group-modulation, with a carrier frequency of 3,600 c/s, of a further group of 12 lower-frequency channels and by selection of the lower side-

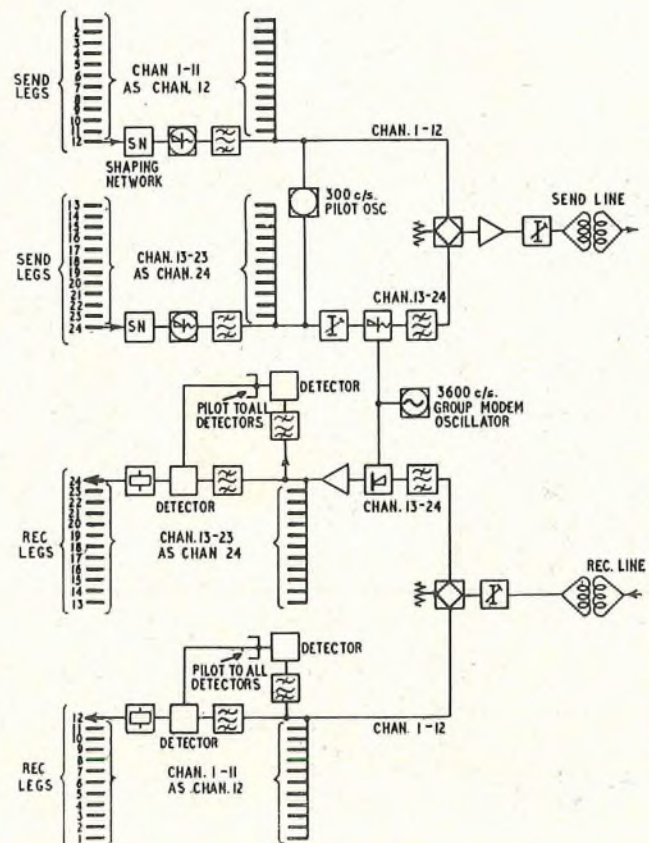

FIG. 1.—SIMPLIFIED BLOCK SCHEMATIC DIAGRAM OF ONE TERMINAL OF A 24-CIRCUIT SYSTEM.

band from the products of modulation. Fig. 1 is a simplified block schematic diagram of the equipment.

The panels are mounted on single-sided racks, 9 ft high, constructed in accordance with the 51-type equipment practice. Components that may be affected by high humidity are enclosed in hermetically sealed units, but apparatus requiring adjustment during initial setting-up or for maintenance is arranged for easy access.

Each v.f. telegraph circuit-end consists of an oscillator-modulator (occupying $3\frac{1}{2}$ in. of rack-side mounting space) and a detector ($5\frac{1}{4}$ in.). Each 9-ft rack-side mounts up to six circuit-ends, together with panels which contain apparatus common to six or more circuits. These panels are the group-modem, amplifier, pilot oscillator, pilot detector, alarm panel, jack panel and power units. The power units may provide 6.3V a.c. and 220V d.c. from 90–130V or 180–260V a.c. mains; or 6.3V a.c. only, the 220V d.c. supply being obtained from a centralized battery installation. The $\pm 80V$ d.c. telegraph signalling supply is normally obtained from a central source.

Owing to the sensitivity of f.m. systems to changes in the received frequencies, the individual carrier oscillators must be of high stability, and the effect of frequency drift occurring within the transmission channel must be reduced. Since this latter effect is the same on all the channels within a v.f. telegraph system, namely to introduce bias distortion on the received signal, it can be compensated for by the use of a pilot frequency, which undergoes the same change in frequency as the telegraph channel frequencies, and which enables a compensating bias to be introduced proportional to the change in frequency. This assumes that the changes in frequency are of a relatively slow nature and not such as may occur on radio links during selective fades. The pilot frequency used is 300 c/s, and a further pilot frequency of 3,300 c/s is derived by group-modulation.

The frequency band available for the telegraph system between London and Montreal is restricted to approximately 2,050–3,450 c/s. Eleven v.f. telegraph channels with mid-frequencies 2,100 c/s, . . . 3,300 c/s are accommodated

within this band, together with a pilot frequency of 3,420 c/s. These are derived from the lowest 11 channels of the standard 12-channel group (420 c/s, . . . 1,620 c/s), together with a 300-c/s pilot channel, and a group-modulating carrier frequency of 3,720 c/s.

Fig. 2 shows one of the 11-circuit terminals of the T.A.T. installation together with a third rack-side which carries a telegraph distortion measuring set and a separate 3-circuit f.m.v.f. telegraph system for the use of staff maintaining the T.A.T. cable system.¹

CHANNEL EQUIPMENT

Fig. 3 shows the panels which form one telegraph circuit-end. The upper panel is the oscillator-modulator for the sending channel and the lower is the detector for the receiving channel.

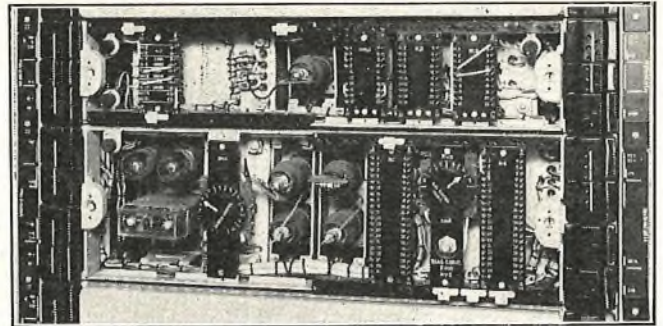

FIG. 3.—OSCILLATOR-MODULATOR AND DETECTOR.

The Oscillator-Modulator.

The oscillator-modulator used for each channel in the system has a stable and, over a limited range, a linear frequency-deviation characteristic against the input current from the d.c. send leg; the mean frequency of the oscillator is stabilized against variation of power supplies and ambient temperature. In addition, the design of the circuit avoids the use of valves in the modulating path and prevents the injection of modulating frequencies into the carrier-frequency portions of the circuit; this is particularly important from the point of view of carrier telegraph transmission, where the signalling speed is an appreciable fraction of the carrier frequency, since, by this means, the phenomenon commonly known as "carrier beat" is largely avoided.

The operating principle is similar to that of the reactance-valve, in that a reactive current, of such magnitude as to produce a change of frequency substantially proportional to the modulating voltage, is applied to the tuned circuit of the oscillator. In this case, the modulating voltage is derived from the d.c. signals on the telegraph send leg.

Fig. 4 is a block schematic diagram of the oscillator-

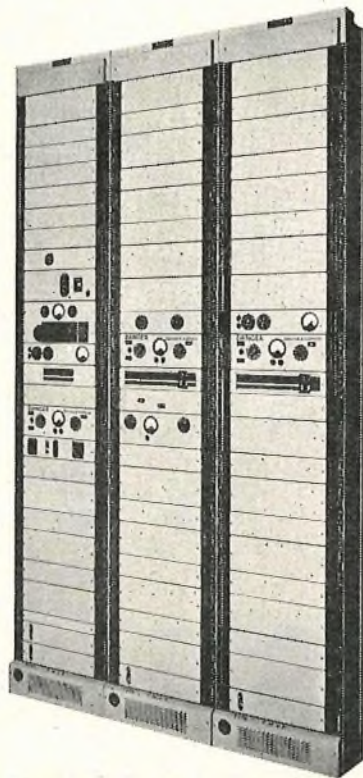

FIG. 2.—ONE OF THE 11-CIRCUIT TERMINALS FOR THE T.A.T. CABLE.

CONNECTION STRIPS		
LINE COIL	LINE COIL	DUMMY
	CHANNEL 25	CHANNEL 19
	3500 c/s	2580 c/s
DUMMIES	CHANNEL 24	CHANNEL 18
	3180 c/s	2460 c/s
T.D.T.S.	CHANNEL 23	CHANNEL 17
TRANSMITTER	3060 c/s	2340 c/s
T.O.M.S.	GROUP MODEM	DUMMY
OSCILLATOR		
T.O.M.S.	AMPLIFIER	T.M.S. REC. UNIT
OSCILLOGRAPH		
T.M.S. REC. UNIT	ALARM	ALARM
JACKS	JACKS	JACKS
DUMMY	PILOT DEVN.	JACKS
ALARM	RELAY TEST	DUMMIES
CONTROL	CHANNEL 22	CHANNEL 16
	2940 c/s	2220 c/s
OSC. MODS.	CHANNEL 21	CHANNEL 15
AND	2820 c/s	2100 c/s
DETS. FOR	CHANNEL 20	
THREE MICE	2700 c/s	
TPTR. CCTS.	PILOT OSC.	DUMMIES
DUMMY	PILOT DET.	
POWER UNIT	POWER UNIT	POWER UNIT
POWER UNIT	POWER UNIT	POWER UNIT
POWER DISTRIBUTION UNITS		

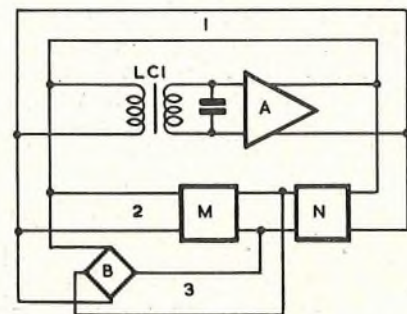

FIG. 4.—BLOCK SCHEMATIC DIAGRAM OF OSCILLATOR-MODULATOR.

modulator. Amplifier A maintains oscillations in the tuned circuit LC1 due to the action of the feedback via path 1, and, if the amplifier and feedback path have zero phase-shift, the frequency of oscillation will be the resonant frequency of LC1. If a phase-shift is inserted in the feedback path, then the frequency will change to that at which the tuned circuit LC1 produces an equal and opposite phase-shift.

Instead of introducing a phase-shift into the main feedback path 1, a quadrature feedback component is introduced via path 2. The network N introduces a fixed 90° phase-shift and the modulator M controls the magnitude and polarity of phase of the quadrature feedback. Up to the overload point of the modulator, the magnitude of the feedback via path 2 is proportional to the modulating voltage; in practice, however, it is only at the actual signal instants, when the control voltage passes through zero in changing its polarity, that this overload point is not exceeded. At these instants, the instantaneous magnitude of the quadrature feedback is proportional to the instantaneous control voltage; at all other times the magnitude of the quadrature component remains constant.

The ratio of the main feedback to the quadrature phase component is proportioned such that, when the modulator is overdriven, the frequency of oscillation is deviated by ± 30 c/s from the mid-frequency. Thus, as shown in the modulator characteristic (Fig. 5), when a marking condition

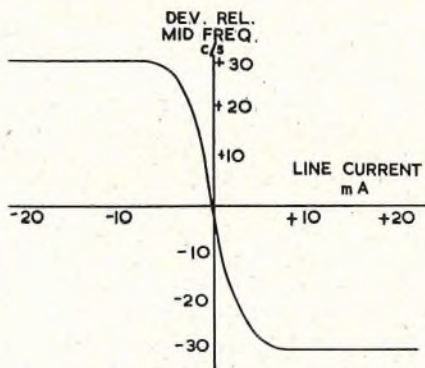

FIG. 5.—MODULATOR CHARACTERISTIC.

is applied to the send leg, the frequency is increased to 30 c/s above the mid-frequency; when a spacing condition is applied, the frequency is decreased to 30 c/s below the mid-frequency. Thus the total frequency shift between the marking and spacing frequencies is 60 c/s.

To compensate for changes in the resonant frequency of the tuned circuit LC1 due to variation in the ambient temperature, a third feedback via path 3 is introduced into the circuit. A voltage is taken from the output of the phase-shift network N via a bridge network B, one arm of which has a high positive coefficient of resistance with temperature. As the ambient temperature varies, so the balance of the bridge is upset to a greater or lesser extent, and a quadrature phase component of magnitude proportional to the change in ambient temperature appears at the output from the bridge network. This component is fed into the resonant circuit LC1, the magnitude being pre-adjusted for each individual oscillator, to compensate for the drift in resonant frequency of LC1.

A simplified circuit of the oscillator-modulator is shown in Fig. 6. The main feedback, which is controlled by potentiometer P1, is provided by the coupling between the inductor in the anode circuit of the oscillator valve and the resonant circuit LC1 in the grid circuit. The 90° phase-shift network comprises the resistor R1 and the capacitor C1. These two components form an unbalanced version of the more normal resistance-capacitance lattice type of

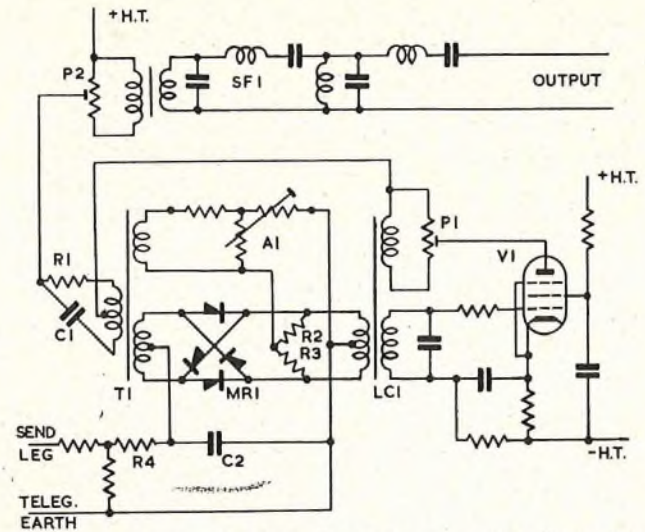

FIG. 6.—SIMPLIFIED CIRCUIT DIAGRAM OF THE OSCILLATOR-MODULATOR.

phase-shift network. The phase-reversing modulator is made up of one winding of the transformer T1, the ring of rectifiers MR1 and a second inductor coupled to LC1. The modulator is controlled by the d.c. signals on the telegraph send leg. Capacitor C2 together with resistor R4 provide some low-pass filtering of the d.c. telegraph signals before they are applied to the modulator. Temperature compensation is provided by the quadrature phase component taken from the third winding of transformer T1 and fed, via the preset attenuator A1, into the bridge circuit consisting of the resistors R2, R3 and the input winding of the resonant circuit LC1. R2 is a non-inductive resistor wound with pure nickel wire, which has a high positive coefficient of resistance with temperature. The loss of the attenuator A1 is adjusted on each oscillator panel to compensate for the particular temperature coefficient of the resonant circuit LC1. The adjustment of P1, which is also preset, controls the ratio of main feedback to quadrature component and hence controls the frequency deviation. It is adjusted to produce deviated frequencies 30 c/s above and below the nominal mid-frequency.

The output from the panel is taken via the level adjustment potentiometer P2 and the band-pass send filter SF1. This is a $1\frac{1}{2}$ -section filter of unbalanced-prototype design, and its output impedance is suitable for parallel connexion with other filters of similar design, to feed into a 600-ohm circuit.

A bias circuit, consisting of a rectifier bridge and a miniature relay, is connected in the send leg of each channel. Part of the current in the send leg is rectified and caused to operate the relay. Provided that the normal send-leg current is present, whether marking or spacing, the relay is held operated and the signals on the send leg pass to the channel oscillator-modulator. Should the send leg become disconnected or the current fall below a predetermined value, the relay releases and a steady positive potential is applied to the channel modulator so that a continuous spacing signal is transmitted. The purpose of this bias circuit is to prevent the transmission of spurious signals which might result from a disconnection in the send leg. The components of the bias circuit are mounted elsewhere on the rack-side than on the oscillator-modulator circuit.

The Detector Panel.

The detector panel is designed to amplify the incoming f.m.v.f. signals and to convert them into double-current d.c. telegraph signals.

The basic circuit that carries out the conversion is the

discriminator, which is of conventional design with two tuned circuits, one resonant above and the other below the mid-band frequency. The a.c. output from each circuit is rectified and the two outputs are combined in series-opposition. The resultant output-voltage characteristic is of the form shown in Fig. 7; it passes through zero

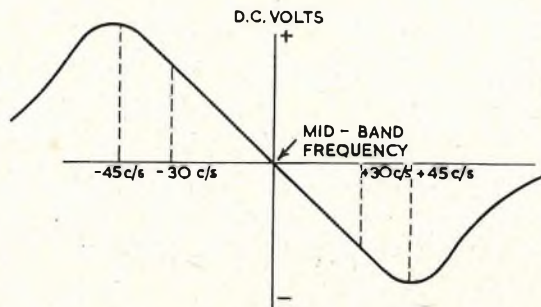

FIG. 7.—OUTPUT-VOLTAGE CHARACTERISTIC OF DISCRIMINATOR.

voltage at the mid-band frequency, and is approximately linear for 40 c/s on each side of the mid-band frequency.

In this type of discriminator, as in most others, the d.c. output depends on the level of the input signal as well as its frequency. Because any amplitude variation would cause distortion of the resultant d.c. output, the incoming voice-frequency signal is passed through a symmetrical voltage limiter before being applied to the discriminator. The positive and negative peak voltages of the a.c. waveform are limited equally to a predetermined value for all input levels within the operating range of the detector.

To achieve the high standard of performance of the system, the filtering in the detector is separated into two sections,

- (i) a band-pass receive filter, which selects from the received frequency spectrum the band of frequencies of the required channel, and
- (ii) a low-pass filter following the discriminator. This filters out the carrier ripple from the d.c. waveform and also improves the channel filtering by rejecting interference from the adjacent channels.

The double-current d.c. signals from the low-pass filter are fed to the telegraph output relay via a d.c. amplifier. This amplifier is of the flip-flop type, which facilitates the introduction of several bias controls. One of these is a manual control for overall line-up and adjustment of the channel; the others are preset controls to compensate for certain frequency and tuning errors.

It is not so convenient in the detector as in the oscillator-modulator to control the effective resonance of the tuned circuits in the discriminator. The effect of any difference between the frequency of the incoming signals and the resonant frequencies of the tuned circuits is to produce a d.c. bias in the double-current output of the discriminator and hence in the telegraph signals passed to the d.c. receive leg. The frequency difference may be caused by:—

- (a) drift in the oscillator frequency (which is catered for in the design of the oscillator and should not be a significant factor), or
- (b) drift in the resonant frequency of the tuned circuits in the discriminator as a result of ambient temperature changes, or
- (c) a shift in frequency of the voice-frequency signals during transmission over the transmission channel, where this channel undergoes one or more stages

of frequency translation. For example, in a carrier telephone channel, the modulator and demodulator carrier frequencies may not be accurately synchronized and may shift relative to one another, thus producing a discrepancy of possibly several cycles per second between the transmitted and received v.f. telegraph signals.

Since the causes of these frequency differences cannot easily be controlled, compensation is provided for the signal bias which they introduce. The bias effect due to cause (b) is individual to each telegraph channel and is counteracted by introducing into the output amplifier an equal and opposite bias which varies proportionately with temperature. This compensation is of preset value and is individually adjusted during the testing of each detector panel.

Provision is made on the system for the compensation of the bias effect due to cause (c). The pilot frequency previously mentioned is detected at the receiving terminal, the detector being arranged so that any drift in the received frequency produces a change in a d.c. voltage. Each channel detector is adjusted to produce equal bias as a result of a given frequency error. The voltage produced by the pilot detector is fed to the output amplifier of each channel detector and is such as to produce a bias to nullify that produced in each channel due to the frequency shift of its own voice-frequency signals.

A simplified circuit diagram of the channel detector is shown in Fig. 8. The band-pass receive filter in the input circuit is composed of a half-section of prototype and one section of m-derived type. The input to the filter is unbalanced and is suitable for parallel connexion with the other filters of the system across a 600-ohm circuit. Rectifiers MR1 and MR2 limit the a.c. signals. During the positive half-cycles of the a.c. waveform and when the signal voltage exceeds a predetermined value, rectifier MR1 shunts the transformer T1 with a low impedance; similarly, during the negative half-cycles of the a.c. waveform, rectifier MR2 shunts the transformer. The discriminator is formed by the two resonant circuits LC1 and LC2. One is tuned to 45 c/s above, and the other to 45 c/s below, the channel mid-band frequency. The low-pass filter, which follows the discriminator, comprising inductor L1 and capacitors C1 and C2, is of open-circuit design.

The temperature-compensating bias is introduced by connecting the low-potential side of the low-pass filter to a d.c. potential, the magnitude of which varies with change of temperature. This potential is derived from the bridge circuit formed by R1, R2, R3 and R4 across the 220V d.c. supply. Resistor R4 is wound with pure nickel wire and thus has a high positive coefficient of resistance with temperature. The compensating potential is taken from the slider of the potentiometer to enable the change of potential with temperature to be adjusted to suit each individual detector panel.

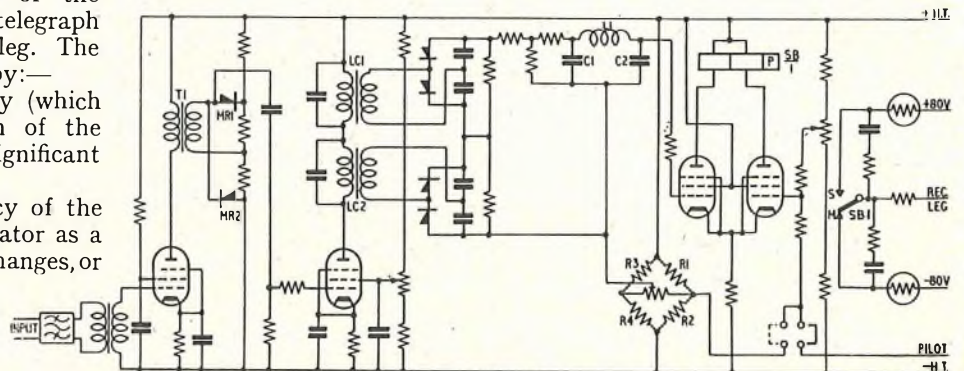

FIG. 8.—SIMPLIFIED CIRCUIT DIAGRAM OF DETECTOR.

The manual bias adjustment and the pilot compensation for frequency shift in the transmission channel are both introduced in the grid circuit of the second valve of the flip-flop output stage. The pilot control potential is derived from the pilot detector panel; if the pilot control facility is not required, a U-link change-over is provided to apply a fixed d.c. potential to the grid of the second output valve from the junction of resistors R1 and R2.

When a marking signal is received by the detector panel, the negative voltage from the discriminator is of sufficient value to cut off the first valve of the output stage. This reduces the current through the common cathode resistor and raises the grid potential of the second valve with respect to its cathode, thus causing it to pass more current. On receipt of a spacing signal, however, positive voltage from the discriminator is applied to the grid of the first valve, making this valve pass more current, the additional current through the cathode resistor producing sufficient bias to cut off the second valve.

The telegraph output relay, which is of the polarized type, is connected in the anode circuits of the two output valves, so that the tongue of the relay is held on the mark contact when the first valve is in the non-conducting state and on the space contact when the second valve is in the non-conducting state. The mark and space contacts are connected, via resistance lamps, to the negative and positive sides of the telegraph signalling supply, so that the tongue of the relay transmits the appropriate potential to the receive leg in response to incoming marking and spacing signals. A conventional spark-quench circuit is connected between the tongue and each relay contact.

PILOT-CHANNEL EQUIPMENT

The Pilot Oscillator.

The pilot-oscillator circuit is similar to that of the channel oscillator-modulators except that, since it is required to transmit only a fixed reference frequency, a modulator is not required and so is omitted from the circuit. It is, however, necessary to provide compensation for frequency drift with change of ambient temperature, and the method used is the same as for the channel oscillators. The pilot-oscillator panel provides two outputs, each via a separate band-pass filter. The filters are of similar design to, and are suitable for connexion in parallel with, the channel band-pass send filters. The two separate outputs are provided so that one may be transmitted direct to line with the lower-frequency group of channels while the second output may be group-modulated and transmitted with the upper-frequency group.

The Pilot Detector.

The pilot tone, after transmission over the transmission channel together with the v.f. telegraph signals, is filtered off in the pilot detector panel and is amplified, limited and detected in a discriminator circuit. The circuit of the filter, amplifier, limiter and discriminator is similar to that of a channel detector. Since, however, the purpose of the pilot detector panel is to provide a control voltage, the flip-flop output stage is replaced by one of the cathode-follower type, a simplified circuit diagram of which is shown in Fig. 9. As the pilot control potential is applied to the channel detectors at points of high impedance, the low impedance source for this potential from the cathode-follower stage provides adequate decoupling, and prevents any inter-modulation between channels.

The low-pass filter following the discriminator is a simple resistance-capacitance network with a long time-constant; this is permissible because the changes of frequency to be expected occur slowly. The nominal frequency of the input

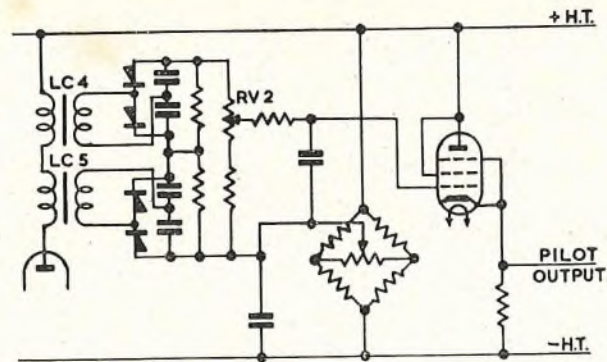

FIG. 9.—SIMPLIFIED CIRCUIT DIAGRAM OF DISCRIMINATOR AND OUTPUT STAGE OF PILOT RECEIVER.

signal and the mid-band frequency of the discriminator are each 300 c/s; therefore no voltage output is obtained from the discriminator unless a shift of the received frequency has occurred. Any output from the discriminator may be positive or negative depending upon the direction of the frequency shift. As in the channel detectors, the low-potential side of the low-pass filter is taken to a temperature compensating bridge, the output of which is adjusted to compensate for the effect of change in resonant frequency, with temperature, of the discriminator tuned circuits.

Two pilot detectors are provided in a 24-circuit system, one of which detects the pilot signal transmitted with the lower-frequency group of channels and is used to control these channels. The other detects the pilot signal transmitted with the higher-frequency group of channels, which it controls; this group of channels, together with its pilot control channel, undergoes group-modulation before transmission and group-demodulation before detection, and the pilot control therefore compensates not only for frequency errors within the transmission channel, but also for any error introduced by frequency difference between the group-modulator and the group-demodulator carrier oscillators. The pilot control is operative for a total frequency error of up to 10 c/s.

GROUP-MODULATION

Because the variation with temperature of the resonant frequency of the resonant circuits used in the oscillators and detectors is, by the nature of the components, proportional to their resonant frequency, the error in cycles per second, resulting from a given change in ambient temperature, of a circuit resonating at 3,180 c/s is approximately 7.5 times greater than that of a similar circuit resonating at 420 c/s. At the same time, each channel, regardless of its actual mid-band frequency, is modulated so that its frequency is deviated ± 30 c/s about its mid-band frequency and a frequency error of 1 c/s will produce the same degree of distortion on all channels. Hence, to maintain the same standard of performance, the frequency/temperature stability of the higher frequency channels must be made considerably greater than that of the lower frequency channels.

This difficulty is partly overcome by splitting the 24 channels of the system into two groups of 12 channels each, so that the highest mid-frequency generated by a channel oscillator-modulator is 1,740 c/s. The upper group of 12 channels is then produced by group-modulation, as has been described previously. Similarly, by a process of group-demodulation at the receiving terminal, the upper 12 channels are translated to the lower frequency band before detection. As it is necessary to maintain a high degree of stability in the carrier oscillator of the group modulator and demodulator, extra care is taken in the design and testing of this oscillator. A simplified circuit diagram of the group-modem is shown in Fig. 10.

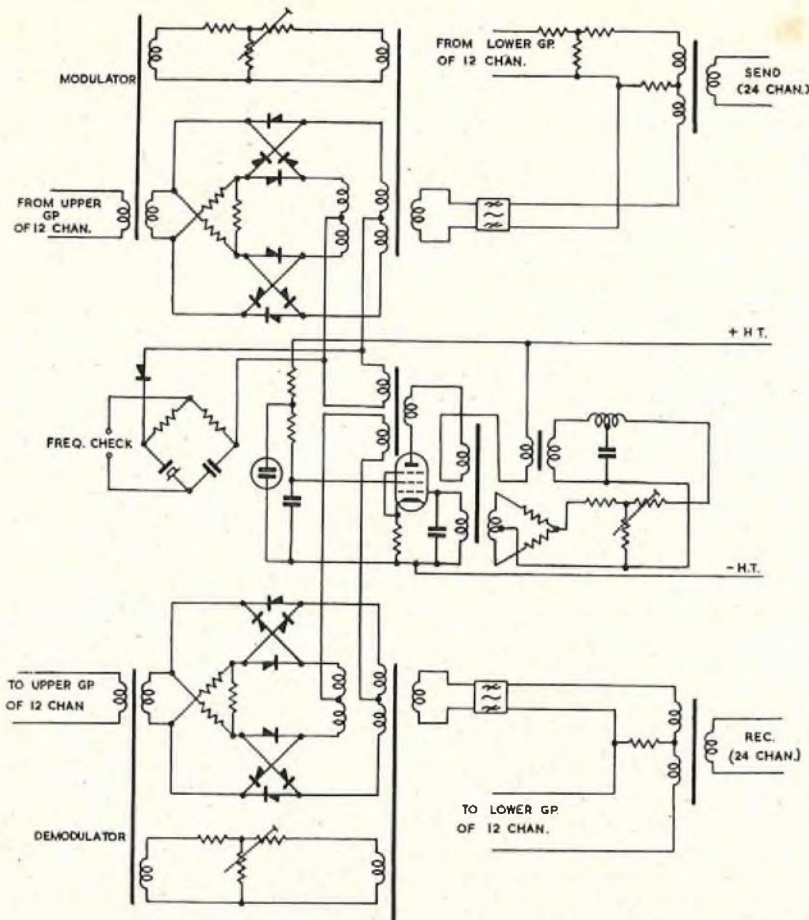

FIG. 10.—SIMPLIFIED CIRCUIT DIAGRAM OF GROUP-MODEM.

The oscillator employed is similar to the pilot oscillator, the 90° phase-shift network in this case being of the more conventional design using an inductor and a capacitor in a T-network. Increased stability against h.t. supply variation is achieved by the use of a neon lamp to stabilize the screen grid potential of the valve. As the frequency of the oscillator (3.6 kc/s) is not convenient for direct crystal-control, a crystal frequency-checking circuit is included. This consists of a metal rectifier, which acts as a harmonic generator, and a bridge circuit formed by a crystal, of which the resonant frequency is the fourth harmonic of the nominal oscillator frequency, a capacitor and two resistors. The input to the bridge, by virtue of the rectifier, contains the fourth harmonic of the oscillator frequency; when this coincides with the resonant frequency of the crystal, the output from the bridge is a maximum. The transmission-measuring-set (t.m.s.) receive-unit, mounted elsewhere on the equipment, is used to detect the output from the bridge.

Both the modulator and demodulator circuits are of the double-balanced type, each employing two bridges of metal rectifiers. These rectifier bridges are connected between two double-balanced hybrid networks, one being a transformer and the other being composed of resistors. The modulator is carefully designed and adjusted to reduce to a minimum the straight-through leakage of the input signals; the band-pass filter which follows the modulator assists in this respect and also rejects the upper-sideband frequencies produced in the modulation process.

To compensate for the loss in level which the signals suffer in undergoing group-modulation, the output from the band-pass filter is amplified before being transmitted to line. Before passing to the amplifier, the group-modulated signals are combined in a hybrid transformer with the signals from the lower-frequency directly-modulated chan-

nels, these being attenuated to a level comparable to that of the group-modulated signals. The common amplifier is of the normal audio-frequency line-amplifier type and is mounted on a separate panel on the rack-side.

On the receive side, the two groups of channels are separated by means of a hybrid transformer and filters; the lower-frequency group passes direct to the paralleled receive filters of the detector panels, while the higher-frequency group passes via a band-pass filter, similar in design to that in the send side, to the group-demodulator and thence to an amplifier before feeding into the paralleled receive filters of the second group of detector panels.

ALARM AND TEST FACILITIES

The alarm panel, one of which is provided on each rack-side, gives the following facilities:—

- Operation of the station alarms in the event of power supply failure on the rack-side. The panel caters for l.t., h.t. and telegraph-signalling supply failure.
- Operation of the station alarms in the event of the cathode current of any normally conducting valve on the various panels falling by more than a predetermined amount from its normal value.
- Facilities for checking the values of the various supply voltages employed on the rack-side.
- Facilities for checking a voltage proportional to the cathode current of each of the normally conducting valves on the rack-side.
- A general-purpose voltmeter for testing on the rack-side.

The normal test facilities provided on the equipment, other than those on the alarm panel, are a relay test panel and a t.m.s. receive unit.

The relay test panel is designed to enable the polarized relays used in the channel detectors to be adjusted, to check the d.c. sensitivity and to measure the transit-time and bias of these relays. The panel can also be used to transmit bias-free square-wave reversals at a nominal telegraph speed of 34 bauds, and to check and measure the bias of similar reversals received from a telegraph channel. For these two latter facilities a correctly-adjusted relay is required.

The t.m.s. receive unit is designed to make through-level and terminated-level measurements on 600-ohm balanced or unbalanced circuits and has a range of +25 to -45 dbm.*

For the use of this equipment on the T.A.T. system, a special pilot-level alarm was fitted. This accepts a signal from the pilot-detector panel after it has been filtered and amplified but before it has passed through the limiter. When this signal drops in level by more than approximately 10 db from its normal value and this condition persists for longer than 500 milliseconds, a relay is arranged to operate the station alarm.

A synchronous telegraph-distortion-measuring set (t.d.m.s.) was also incorporated in the installation for the T.A.T. system. In this country, this was equipped, together with the t.m.s. receive unit, on the rack-side mounting the panels for the three maintenance teleprinter circuits; in Canada, as these panels were not required, the t.d.m.s. and the t.m.s. receive unit were mounted on a test trolley. The t.d.m.s. comprises a separate transmitter and receiver. The transmitter provides the double-current square-wave telegraph signals, 1:1, 2:2, 6:1, 1:6, Q9S and Q9S

* dbm—decibels relative to 1 mW.

reversed, for testing the v.f. telegraph circuits in accordance with C.C.I.T.T. recommendations. The receiver affords the following facilities:—

- (a) It enables accurate measurements to be made of the synchronous distortion of a continuous train of double-current telegraph signals.
- (b) It enables the waveform of a continuously repeated d.c. telegraph signal to be observed, and thus allows relay contact bounce to be examined.
- (c) It enables the accuracy of channel oscillator frequencies to be measured, provision being made to check the time-base of the t.d.m.s. receiver against the frequency of a self-contained crystal.

Operation of the transmitter and receiver at either 60 or 80 bauds may be selected by the operation of a switch.

PERFORMANCE AND TEST RESULTS

Prior to the decision being taken to use this type of system to provide the London-Montreal telegraph circuits, extensive laboratory tests of a model 6-channel system were carried out. These tests comprised measurements of distortion at various signalling speeds and with changes of input level; measurements of the effects on distortion of inter-channel interference, frequency shift occurring within the v.f. system line, and variation of supply voltage and frequency; analysis of the distortion of the system in the presence of various levels of random noise interference using a telegraph distortion analyser²; and assessment of the performance of the system when operated over a circuit in a coaxial cable system and over a long physical line. The results of distortion tests indicated that, at 50 bauds, slightly better performance was likely to be given by this system over an input level range of -10 to -40 dbm than would be expected from an a.m. system over a more limited range of -20 to -35 dbm; at 80 bauds, considerably better performance was to be expected from the f.m. system, the average distortion of a single channel being only 4 per cent compared with 9 per cent for an a.m. system. On no channel did inter-channel interference cause the distortion to be increased by more than 2 per cent. The effects of changes of frequency up to 10 c/s occurring within the v.f. system line were adequately compensated for by the operation of the pilot channel control. Variation of the mains input frequency between 45 and 66 c/s, and of the voltage over a range of ± 10 per cent, caused no measurable deterioration in performance. Tests in the presence of random noise interference showed that the system would tolerate 8-10 db worse signal/noise ratio than would an a.m. system for the same increase in distortion, thus confirming the advantage expected from theoretical considerations.

After the system had been installed in London and Montreal, comprehensive tests were carried out on the London-Montreal telegraph circuits, with completely satisfactory results, before the T.A.T. cable was opened for public service. The overall distortion of mixed signals on all channels except the lowest v.f. channel was less than 4 per cent at 60 bauds and less than 8 per cent at all signalling speeds up to 80 bauds. The performance of the lowest

frequency channel was adversely affected to a slight extent by the proximity of its operating frequencies to the cut-off frequency of the telephone group-splitting filter; nevertheless, the distortion of this channel was no worse than 5 per cent at 60 bauds and 13 per cent at 80 bauds, which is satisfactory for 50-baud teleprinter signals or to carry a 2-channel, 6-unit, time-division multiplex system.¹

CONCLUSION

A number of telecommunications authorities, notably the Western Union Telegraph Co. and the American Telephone & Telegraph Co. in the U.S.A., and the French P.T.T., have adopted the principle of frequency-modulation for new multi-channel v.f. telegraph equipment. Consideration is also being given by the British Post Office to the introduction of f.m. systems into the inland network. The improved performance of a f.m. system, particularly in respect of low distortion and insensitivity to level variations, is of especial value in a switched network in which a connexion between two teleprinters may comprise a number of v.f. links in tandem. Owing to the extent of the existing a.m. network, it is likely that early development in this direction will be achieved only in conjunction with the growth and with the automatization of the telex service; for example, it may be advantageous to route circuits between London and other zone centres over f.m. systems.

The accommodation required for the equipment described is double that required by the existing standard type of a.m. equipment and four or more times what would be needed using the latest available techniques. However, in view of the comparatively short time which was available for testing and engineering equipment for the T.A.T. system and of the desire to use, so far as possible, only equipment which had undergone thorough performance tests and field trials, it was thought undesirable to consider the adoption of a more recently developed and relatively untried system for that important project. Whereas the requirements of the inland network would not justify the extra expense involved in providing the type of equipment described, its use was amply justified in the case of the T.A.T. scheme in view of its superior performance and of the possibility of doubling the traffic-carrying capacity by the use of time-division multiplex.

In view of current developments in the use of transistors, it is expected that f.m. systems will become available which will occupy considerably less space than existing equipment.

ACKNOWLEDGMENTS

The authors wish to acknowledge the co-operation and assistance of their colleagues in Standard Telephones & Cables, Ltd. and in the Telegraph Branch, E.-in-C.'s Office, who participated in the development and testing of the system.

References.

¹ CROISDALE, A. C., and HARRIS, E. T. C. The Transatlantic Telephone Cable. Special Equipment Designed and Manufactured in the United Kingdom: Part 3.—Telegraph Channels. *P.O.E.E.J.*, Vol. 49, p. 443, Jan. 1957.

² WHEELER, L. K. and FROST, A. C. A Telegraph Distortion Analyser. *P.O.E.E.J.*, Vol. 47, p. 5, Apr. 1954.

Signalling Over Carrier Channels that Provide a Built-in Out-of-Speech-Band Signalling Path

B. R. HORSFIELD, A.M.I.E.E.,
and R. W. GIBSON, A.M.I.E.E.†

Part 1.—General Principles

U.D.C. 621.395.63:621.395.44

A previous article¹ in the Journal described recent developments of multi-channel carrier systems that provide for signalling within the channel frequency band at frequencies outside the transmitted speech band. This article, which will be published in two parts, discusses the signalling facilities for these new carrier systems; Part 1 reviews the general principles of "out-band" signalling and Part 2 will describe the application of these principles to the design of specific signalling equipment.

INTRODUCTION

IN recent years considerable effort has been directed towards reducing the cost of providing signalling and dialling facilities over telephone circuits routed in multi-channel transmission systems. This effort has been principally directed into two lines of approach: first, an attempt to reduce the cost and complexity of voice frequency systems in which the signalling information is transmitted within the speech bandwidth ("in-band" systems), and secondly, the development of multi-channel systems that incorporate, as an integral feature of the design, signalling equipment using frequencies outside the speech bandwidth but within the channel bandwidth ("out-band" systems). The multi-channel systems with built-in out-band signalling, which are being developed by and for the Post Office, employ suppressed-carrier working, and this article relates primarily to such systems.

GENERAL CONSIDERATIONS

Independence of Speech and Signalling.

In transmission systems incorporating out-band signalling equipment, filters are used to separate the speech and signalling paths, typical arrangements being shown in Fig. 1. The separation of the speech and signalling paths

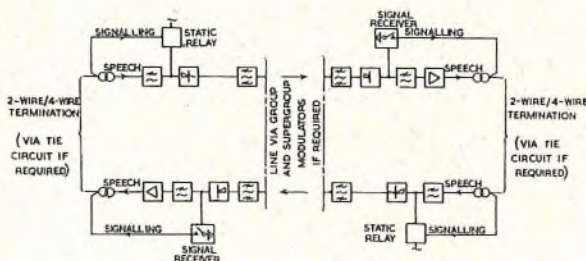

FIG. 1.—BASIC PRINCIPLES OF OUT-BAND SIGNALLING.

enables speech and signalling currents to be transmitted simultaneously and independently with little or no mutual interference, and where the number of facilities required is small it is possible to use continuous signalling codes in which the presence of signalling tone corresponds to one d.c. condition and the absence of signalling tone to another d.c. condition. Such codes enable d.c. signalling techniques to be closely simulated and permit the use of simple and inexpensive exchange relay sets. The use of continuous signalling codes necessitates the adoption of low signalling tone levels to avoid overloading common amplifiers in the transmission paths, and this in turn necessitates the use of sensitive signal receivers which may respond to low level interference and produce false signals. In a system designed to permit the use of continuous

† The authors are, respectively, Senior Executive Engineer and Executive Engineer, Telephone Development and Maintenance Branch, E.-in-C.'s Office.

¹ CHILVERS, L. W. J., and WATKINS, A. H. New Line Transmission Equipment. *P.O.E.E.J.*, Vol. 49, Part 1, p. 12. Apr. 1956.

signalling codes it is therefore necessary to ensure that the risk of false signals is reduced to a minimum, and this requirement may have repercussions on the design of the modulators, filters, etc., thus adding to the cost of the system. While the use of a pulse signalling code would ease this design problem it would necessitate the provision of more complicated exchange relay sets, and when account is taken of other factors, such as the difficulties which arise on non-homogeneous routings (referred to later), it is unlikely that out-band signalling would then be as attractive overall as v.f. speech-path signalling for a number of applications. One application, however, for which out-band signalling, even with a pulse signalling code, is particularly suitable arises on circuits over which it is required to transmit metering signals during the conversation period, since the independence of the speech and signalling paths enables such signals to be transmitted inaudibly. A further advantage which arises from the separation of the speech and signalling paths lies in the absence of problems due to "spill over" of signalling tones from one link to another in multi-link connexions; the need to ensure that such spill-over is ineffective leads to some complications in v.f. speech-path systems.

Flexibility of Application.

The facilities provided by circuits using out-band signalling and continuous signal codes may be changed by replacing the relatively inexpensive exchange relay sets, and in this respect such signalling systems tend to be more flexible than v.f. speech-path systems. This is of advantage, for example, where a h.f. route is required to operate on an automatic (C.B.) signalling basis initially, but to operate on a dialling basis later.

Interconnexion of the Exchange and Carrier Terminal Equipment.

When the exchange and carrier terminal are in the same building, the provision of d.c. signalling connexions between the two presents no particular problem, but when, as is not infrequently the case, they are in different buildings linked by tie circuits in external cables, several additional considerations arise. In particular it is necessary to cater for the maximum length of tie circuit that will be used in practice, and in the interests of economy it is desirable to use the same cable pairs for speech and signal transmission. Further, it is necessary to employ signalling arrangements which will not give rise to excessive noise interference in circuits routed in other pairs in the same cable, and it is desirable to ensure as far as possible that the arrangements adopted do not increase the susceptibility of the circuits to noise interference induced from other circuits in the same cable or from external sources. It is also desirable to employ signalling methods that will keep dial pulse distortion to a minimum.

Some difficulty arises in defining the maximum length of tie circuit that will occur in practice, since cases arise where circuits are routed partly in carrier systems and

partly in audio cables, and no clear distinction exists between a tie circuit and an audio-cable extension. It has been decided that a system which could cater for tie circuits consisting of up to five miles of 10-lb cable, or ten miles of 20-lb cable, at each terminal, would have a wide field of application, and this has been adopted as an initial design target; if tests show that the equipment is capable of giving the required performance over longer tie circuits advantage will, of course, be taken of this feature.

Modern practice is to locate the 2-wire/4-wire terminations in the exchanges rather than in the carrier terminals, since this offers transmission advantages, and two pairs in every tie cable will therefore normally be provided for each circuit. Signalling over these pairs may be effected by using loop currents or earth-return phantom currents, the basic principles being illustrated in Fig. 2. Earth phantom

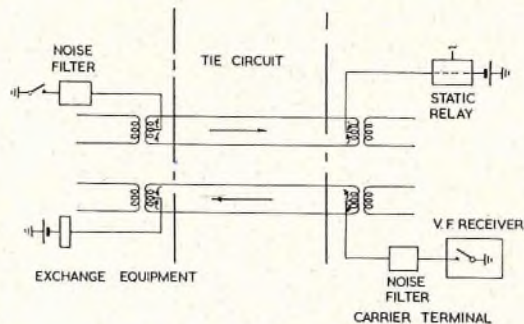

(a) Earth Phantom Signalling over Tie Circuits.

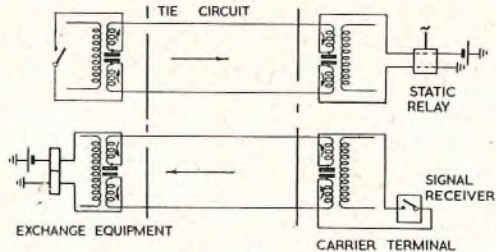

(b) Loop Signalling over Tie Circuits.

FIG. 2.—BASIC SIGNALLING PRINCIPLES.

signalling has a number of advantages over loop signalling in this application and has therefore been adopted. The principal advantages are:—

- (i) Longer tie circuits may be used, since the signalling-path resistance is less.
- (ii) The arrangement lends itself more readily to direct control of the static relay, since the connexion of the signalling equipment to the centre points of the line transformers avoids the need for balanced impedances.
- (iii) Dial pulse distortion is less, due to the absence of lumped capacitance in the pulsing path. As may be seen from Fig. 2 (b), loop signalling requires the provision of capacitors at the centre points of the line transformers.
- (iv) The magnetic effects of the signal currents in the line transformers are astatic, and standard line transformers may be used without impairment of transmission.
- (v) The signalling principles may readily be applied to earth-return leg signalling over 2-wire tie circuits, if required, without requiring any change to the signalling equipment in the carrier terminal and without necessitating special switching arrangements at the carrier terminal for both-way working.

The foregoing advantages are obtained at the expense of providing noise-suppression filters to prevent the generation of inductive disturbance in other circuits and at the possible risk that special measures may be necessary in some cases to protect the circuits from disturbances induced by external sources (e.g. rejection filters to minimize the effect of 50 c/s interference). Examination has shown that earth potential difference effects due to magnetic storms should not be troublesome over the tie circuit lengths permitted.

Composite Circuit Routings.

Cases may arise where circuits are routed partly in multi-channel systems equipped with out-band signalling and partly in other transmission media not so equipped (e.g. existing carrier and coaxial systems and amplified audio cables). While it is possible to envisage the provision of signal convertors in these cases to convert from out-band signalling to v.f. speech-path signalling (including elements to convert from a continuous to a pulse signal code and vice versa), the cost of the convertors plus the cost of the terminal relay sets would be at least as great, and probably greater, than that of providing speech-path signalling overall, and the latter is the preferred arrangement in such cases. It follows that in any multi-channel system designed to provide out-band signalling there are likely to be some channels in which the out-band signalling equipment is not required and it is desirable, therefore, that the connexion of the out-band signalling equipment should be optional—preferably on a channel basis. It also follows that some of the channels in a multi-channel system provided with out-band signalling may be required to carry v.f. speech-path signals. This requirement will also arise in the future if channels which utilize the out-band signalling equipment for line signalling are required to carry coded v.f. speech-path signals for the rapid transference of information between registers. Thus it is desirable that the channels in systems incorporating out-band signalling should be capable of transmitting simple and compound voice frequency signals (including short pulse signals) with negligible time distortion and without the production of any spurious frequency components. This requirement may give rise to special problems in the design of certain items of transmission equipment, e.g. compandors in systems for use on de-loaded audio cable pairs.

Cases are also likely to arise where circuits are routed in two or more multi-channel systems, all of which are provided with out-band signalling equipment. In such cases, where permitted by the system designs, the signals could be transmitted straight through as a.c. signals, or, alternatively, they may be repeated from system to system on a d.c. basis.

To permit the direct transmission of a.c. signals from system to system it would be necessary to ensure that all systems employed out-band signals of the same nominal frequency and amplitude and that the terminal equipments at the intermediate stations were capable of transmitting the speech and signalling currents on a "through" basis without impairment of the shape of the signal envelope. Where systems were interconnected on a "group" basis the latter requirement should not give rise to any difficulty, but where individual channels were interconnected on an audio-frequency basis it would be necessary to alter the filtration arrangements in the carrier equipment and to ensure that any tie circuits interposed between the systems were capable of transmitting the signalling frequency without excessive attenuation.

To permit the repetition of signals between systems on a d.c. basis, it is necessary only to ensure that the output

conditions from the signal receivers are suitable to permit direct keying of the static relays in succeeding systems over tie circuits within the specified limits and with acceptable pulse distortion.

The difficulties arising from the provision of alternative filtration arrangements, the existence of loaded tie circuits and the use of different signalling frequencies in systems designed for different applications, would frequently prevent the use of through a.c. signalling and it is anticipated that when channels are interconnected on an audio-frequency basis d.c. signal repetition will be the standard arrangement. The use of d.c. repetition has a cost disadvantage, however, since the number of static relays and signal receivers in each circuit increases as the number of systems through which the circuit is routed increases, whereas with through a.c. signalling (and v.f. speech-path signalling) only one static relay and receiver are required for each direction of signal transmission. Where similar systems are interconnected on a h.f. group basis, therefore, it is to be expected that through a.c. signalling will be employed wherever possible.

CHOICE OF SIGNAL CODE

The out-band systems will be required to function in the operator-dialling non-register trunk mechanization network, which will also be used to carry register-controlled subscriber-dialled trunk calls when subscriber trunk dialling is introduced in the near future. For this application, and for similar applications on certain types of junction circuit, the following signals are regarded as essential:—

From the Outgoing End—Seizure, pulsing and release (forward clear).

From the Incoming End—Answer and clear (backward clear).

In addition, the following signals are desirable:—

From the Incoming End—Release-guard and blocking.

The release-guard signal, by maintaining an engaged condition at the outgoing end of a circuit until the incoming equipment is ready to receive a further call, avoids the need for an arbitrarily timed guard in the outgoing equipment and eliminates the risk of a follow-on call being received by the incoming equipment while in the seized, or partly seized, condition if the time taken to release is exceptionally long. The release-guard signal also provides an automatic busy feature in the event of a line fault developing on the circuit, since a failure to receive this signal after an unsuccessful attempt to set up a call causes busy conditions to be set up at the outgoing end. The blocking signal, by applying an engaged condition to the outgoing equipment if the incoming equipment is taken into use, permits routine testing and similar maintenance operations to be carried out with minimum interference to traffic.

All the signals referred to above can be obtained from a continuous signal code of the type illustrated in Fig. 3 (a). With this code, signal tone is transmitted at the outgoing end immediately the circuit is seized. Dial pulses are transmitted as interruptions of tone, corresponding to the open periods of the dial contacts, and on completion of dialling the tone is maintained to hold the connexion. When the called party answers, signal tone is transmitted from the incoming end. Thus, during the conversation period, tone is normally transmitted in both directions. The backward clear condition is indicated by the disconnection of tone from the incoming end and the forward clear by the disconnection of tone from the outgoing end. During the release sequence of the incoming equipment, tone is returned from the incoming end to provide the

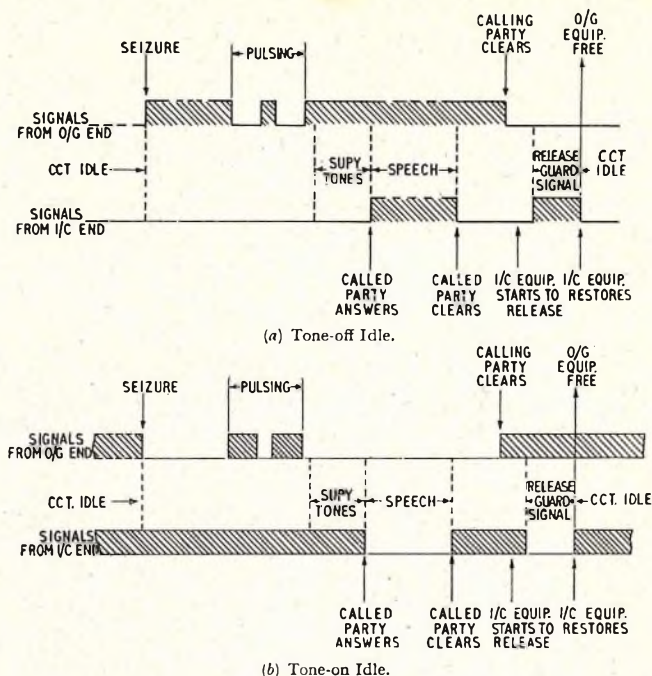

FIG. 3.—BASIC SIGNAL CODES.

release-guard signal and is disconnected when the equipment has restored to normal.

The foregoing description relates to a signal code in which tone is not transmitted during the idle condition. The same facilities may be obtained from a code in which tone is transmitted in the idle condition and in which the conditions are at all times the opposite of those just described; such a code is shown in Fig. 3 (b).

"Tone-off Idle" Versus "Tone-on Idle."

A "Tone-off Idle" code has the following advantages, by comparison with a "Tone-on Idle" code:—

1. Transient bursts of interference in the transmission path do not give rise to false dial pulses or to the premature release of established connexions.
2. Short-duration interruptions of the transmission path do not result in the seizure of idle incoming circuits. (With a "Tone-on Idle" code such interruptions could cause the simultaneous seizure and release of large numbers of incoming equipments with consequential repercussions on their distribution and/or fusing arrangements, and, in the case of circuits having direct access to registers, serious register congestion.)
3. Tone is connected to the receivers immediately after seizure and is maintained during the inter-train pauses. Thus, any a.g.c. features in the signal receivers function effectively for all the dial pulses in a train. (With a "Tone-on Idle" code, tone is disconnected on seizure and during the intertrain pauses for periods of indefinite duration; during these periods, with some designs of receiver, the sensitivity would drift to its maximum value and cause excessive distortion of the first pulse in each train.)
4. The presence of signal tone during conversation tends to make the system less prone to signal imitation by harmonics of speech currents. The presence of signal tone cannot be guaranteed, however, during all conversations, since on calls to non-metered services (e.g. service interception) an answer signal is not transmitted, and accordingly it is a basic requirement that the voice immunity performance should be satisfactory whether tone is present or not.

The foregoing advantages are obtained at the cost of the following disadvantages:—

1. Short duration interruptions of the transmission path may cause false dial pulses or premature release of connexions.
2. Transient bursts of interference may result in the seizure of idle incoming circuits. (The probability of bursts of interference occurring simultaneously on many channels in a system is much less than that of transient disconnexions occurring simultaneously, and the possible effect on distribution and/or fusing arrangements may be disregarded. For the same reason, and since bursts of interference are by their nature of very short duration, the risk of register congestion when the incoming circuits have direct access to registers does not arise.)
3. The loading of common amplifiers in the transmission system is increased during the busy hour, since the engaged channels are required to transmit speech and signalling currents simultaneously. (With a "Tone-on Idle" code the maximum signal energy is transmitted when the fewest circuits are in use.)
4. It is necessary to provide elements in the outgoing relay sets to apply an automatic re-test to restore to service circuits that are "busied-out" due to loss of the release-guard signal, e.g. as a result of a fault in the transmission path. (Such elements are not essential on uni-directional circuits employing a "Tone-on Idle" code, but are required with either code on both-way circuits.)

With either code it might be possible to minimize the effects of transient disconnexions by using a group pilot tone and arranging that in the event of a failure of this tone the instantaneous signalling conditions on each channel in the group were maintained while the fault persisted. The elements provided to obtain this protection would need to have extremely fast response times and would add appreciably to the cost of the signalling arrangements; while electronic circuits capable of achieving the required performance can be envisaged, so far as is known no practical designs of systems incorporating such elements have yet been produced.

From a detailed study of the relative merits of the two codes it appears that, for general application, "Tone-off Idle" offers a slight overall advantage. There may, however, be specific applications where "Tone-on Idle" is the more attractive and it is desirable that systems providing built-in out-band signalling should be capable of functioning satisfactorily with either code.

Provision of Additional Signals.

A continuous signal code of the type discussed in the previous paragraphs will satisfy the signalling requirements of trunk circuits and certain types of junction circuits, e.g. junctions between two non-director automatic exchanges. For other applications the circuit conditions to be indicated may require the provision of more signals than can be provided using a continuous signal code. One way of providing additional signals, while retaining a continuous signal code, would be to modulate the normal signal frequency, for example, at 50 c/s. This would require additional circuit elements in the exchange signalling relay sets, both to effect the modulation and to recognize the modulated signal. Alternatively, it would be possible to provide an additional signal, such as trunk offer, by adding a single-pulse signal to the continuous code. In other cases the signalling facilities required may necessitate the provision of several additional signals. For example, in U.A.X. circuits, the additional signals normally required are:—

From the U.A.X.—Seizure, level 9; seizure, level 0, ordinary subscriber; and seizure, level 0, coin box user.

To the U.A.X.—Trunk offer and manual hold.

To provide these additional signals with a single-frequency out-band system would necessitate the use of a pulse signal code with discrimination between the various signals given by varying the duration and/or number of pulses comprising a signal and by taking account of the sequence in which the pulses were received. Alternatively, the basic signals could be provided by an out-band system using a continuous signal code, supplemented by v.f. speech-path signalling equipment to provide the additional signals, or v.f. speech-path signalling equipment could be used to provide all signals. While the final choice between wholly out-band signalling, or out-band supplemented by v.f. speech-path, on the one hand, and wholly v.f. speech-path on the other, will depend on the circumstances, particular to individual cases, the use of an out-band system would be attractive should it be required to transmit metering signals over circuits during conversation, since, as stated earlier, these signals would be inaudible. It is thought unlikely that it would be necessary to provide on the same circuit, both repeat-metering signals and supervisory signals, in which case the metering signals could be transmitted, for example, by using pulses corresponding to the answered or unanswered supervisory condition at appropriate intervals. Should, however, both supervisory indications and repeat metering signals be required on the same circuit, some form of time discrimination between the two would be necessary.

PULSE DISTORTION PERFORMANCE REQUIREMENTS FOR POST OFFICE APPLICATIONS

The traffic carried by circuits equipped with out-band signalling will, in general, consist of either operator-dialled calls or subscriber-dialled calls routed via register/translator equipment at the originating exchange. Certain junction circuits, however, may also carry subscriber-dialled calls that are not routed via register/translator equipment.

Requirements for Junction and Auxiliary Trunk Circuits.

In these applications where the pulsing source is an operator's dial or a register/translator it is required that the performance of the system should permit access to be given beyond the terminal centre to exchanges within the local network without the need for pulse regeneration or correction at any intermediate point. The routing arrangements under these conditions are illustrated in Fig. 4.

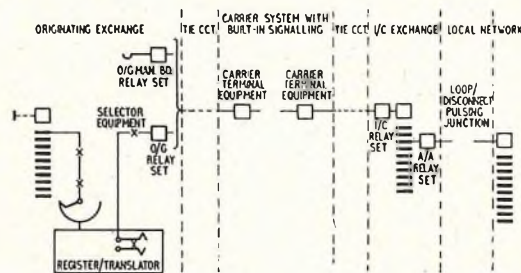

FIG. 4.—ROUTING ARRANGEMENTS.

When account is taken of the distortion introduced by the local junction network, with loop/disconnect pulsing over unamplified circuits of 0–1,500 ohms, the overall distortion margin available is -2 to $+14$ ms, i.e. $+6 \pm 8$ ms, for that part of the connexion between the pulse source (operator's dial or register pulsing-out contact) and the d.c. pulse repetition contact of the distant incoming exchange signalling relay set. In this sense, negative refers to an increase of the dial break pulse. The total pulse distortion introduced will be made up of (a) the distortion introduced by the d.c. pulse repetition stages in the outgoing and incoming exchange signalling relay sets, and (b)

the distortion introduced by the carrier system built-in signalling channel. The exchange signalling relay sets have been allocated ± 3 ms of the available variation of ± 8 , and the remainder, ± 5 ms, has been allocated to the carrier system signalling channel. These allowances include the distortion due to the effects of the tie circuits interconnecting the exchange relay sets and the carrier terminal equipment; that due to the tie circuit between the outgoing relay set and static relay is included in the ± 5 ms allowance for the carrier signalling channel, and that due to the tie circuit between the signal receiver and incoming relay set in the ± 3 ms allocated to the exchange relay sets.

(a) *Built-in signalling channel performance requirements*:—The distortion margin allocated to the carrier system signalling channel refers to the distortion introduced between the pulsing contact of the outgoing exchange relay set that controls the static relay of the carrier terminal equipment (either directly or over a tie circuit) and the output of the signal receiver relay contacts that repeat the pulses to the incoming exchange equipment. When considering the pulse-performance requirements for the carrier system signalling channel, allowance must be made for the fact that in many cases a connexion between two exchanges may be made up of more than one carrier system, with d.c. pulse repetition over audio tie circuits between the systems. At these intermediate points the pulse repetition arrangements between the signal receiver relay contacts of one system and the static relay of another, may be made identical to the conditions at an outgoing terminal between the outgoing relay set and static relay. The allowance of ± 5 ms may then be equally distributed over the number of carrier systems involved in a connexion. It is to be expected that connexions between two exchanges will not normally involve more than two carrier systems. Hence, the design requirements for the carrier system signalling channel are that the sum of the pulse distortion introduced by the static relay and signal receiver should not exceed ± 2.5 ms. This performance should be attained when the factors affecting pulse distortion are simultaneously adverse, e.g. relay adjustments, supply voltages and transmitted level of signalling tone. In particular the performance should be obtained when the static relay is pulsed directly or over a tie circuit of up to five miles of 10-lb cable or ten miles of 20-lb cable and over the range of received level of signal tone to be expected in practice due to variations of the overall transmission loss of the line.

As a guide to design, the system should give the required performance with an overall loss variation of at least $+3$, -7 db with respect to nominal.

(b) *Exchange signalling relay sets, performance requirements*:—The allowance of ± 3 ms allocated to the exchange signalling relay sets has to be shared between the outgoing and incoming relay sets. For the incoming relay set, the margin allocated should not be exceeded when the relay set is pulsed from a signal receiver, either directly or over a tie circuit of up to five miles of 10-lb cable, or ten miles of 20-lb cable.

The overall requirements for pulse distortion, namely,

$+6$, ± 8 ms, necessitate the provision of $+6$ ms bias. This will be introduced at the pulse repetition stages of the incoming and outgoing exchange relay sets, each contributing equally.

Requirements to Permit Subscriber Access to Junction Circuits.

It is unlikely that junction circuits carrying subscriber-dialled calls which are not routed via register equipment will have composite routings. Thus, only one carrier system will be involved, giving a pulse-distortion performance of ± 2.5 ms. To permit access beyond the terminal centre to exchanges in the local network, the overall distortion margin available between a subscriber's dial and the d.c. pulse repetition contacts of an incoming exchange relay set, is 0 to $+11.5$ ms. This will be satisfied provided that the sum of the distortion introduced by the exchange relay sets does not exceed ± 3 ms, and provided that these relay sets give a total positive bias of $+6$ ms.

Requirements for Circuits Within the Basic Trunk Network.

The present Post Office basic trunk network employs non-director switching principles. It has been designed to permit the use of loop/disconnect pulsing on group-to-zone and zone-to-group circuits, and unless pulsing aids are introduced at intermediate points, the distortion margin available for zone-to-zone circuits is ± 3 ms. It has not been found practicable to achieve an overall performance of ± 3 ms with the new carrier systems, especially when account is taken of the increased likelihood of composite routings on the longer trunk circuits. It has been decided, therefore, that on zone-to-zone circuits routed over the new carrier systems, a pulsing aid will be incorporated in the incoming exchange signalling relay sets. This aid will be a pulse corrector of the "constant-break output pulse" type; it will be described in a later issue of the Journal.

CONCLUSIONS

At the present stage of development it is not possible to reach a final conclusion on the relative fields of application of out-band and v.f. speech-path signalling since comparative costs have not yet been fully established.

The conditions most likely to prove favourable to the use of out-band signalling arise in applications where the majority of circuits are routed in not more than two—and preferably in only one—carrier systems, each of which is equipped with out-band signalling; where the carrier terminals and exchange equipments are located in the same building, or in buildings separated by tie circuits within the design limits of the system; and where the signalling facilities required will permit the use of a continuous signal code. Out-band signalling is particularly suitable for use on circuits over which it is required to transmit metering signals during conversation, and for circuits which are required to operate on a manual signalling basis initially, but to be capable of fairly simple and inexpensive conversion to dialling operation later. If the inclusion of out-band signalling in a carrier system necessitates a widening of the channel bandwidth beyond the standard 4 kc/s, this method of signalling would be more likely to prove economic on short routes than on long routes.

(To be continued.)

Part 2.—Probability Models

U.D.C. 31:383/384:519.2

The authors of this article have been consulted on a number of problems to which operational research methods are applicable, and this article is a result of suggestions to them that some "thinking aloud" on broad lines may be of interest to readers of the Journal. In operational research reliance must be placed only on those measurements or observations to which the mathematical theory of probabilities can be applied. Thus, it is apparent that the two mainstays of operational research are scientific sampling and the use of probability models to describe observations. Part I of this article discussed sampling, and Part 2, the concluding part, discusses some probability models of Post Office operations that have been the subject of recent work by the Research Branch of the Engineering Department.

INTRODUCTION

IN Part I of this article scientific sampling was discussed, and it was shown how static and dynamic populations can be sampled by using random numbers. This is one of the two mainstays of operational research in the Post Office, the aim of which is to provide "executive departments with a quantitative basis for decisions regarding the operations under their control."

The other mainstay of operational research is the use of probability models. These models, describing sets of possible observations, can often be used with advantage to deduce the characteristics of other related sets of observations when it is inconvenient or costly to observe the latter directly. As an easy example, suppose it is desired to find the number of junctions which will give a certain grade of service on a simple system. An experiment on the actual system by varying the number of junctions until they give the desired grade of service would be expensive and inconvenient; instead it is much easier to find a probability model for the offered traffic and to deduce the optimum number of junctions by analytical methods. In addition to this use, however, probability models are convenient for presenting the findings of operational research in a condensed form.

It is apparent that there are a great many Post Office problems which can be solved by using probability models. The nature of the model will vary from case to case and consequently no general rules can be given. It is the object of this article to discuss the attitude to be adopted when setting up models and to describe the possible use of some recent models of Post Office operations.

APPROACH TO PROBABILITY MODELS

Sometimes a probability model is criticized adversely on the grounds that there appears to be no physical reason for its validity. Such criticism is not valid. A probability model does not need a physical basis, since it is intended only as a description of a set of observations and not as an explanation.

Moreover, the model is intended to be an adequate description rather than an exact description; the standard of adequacy being measured in practical terms and depending on the use that will be made of the model. Thus, it is valid to use a model which is quite impossible on physical grounds provided it gives a good enough description in the range of interest. This is frequently done when variates which are essentially positive are assumed to be normally distributed; for example, in the determination of the best length of handle¹ for the subscriber's telephone it was assumed that the distance between ear and mouth for the telephone-using population was a normal variate.

For a given standard of adequacy, there are many models that can represent a set of observations. In practice, however, the one chosen is that which is most convenient for the purpose. If the model is to be used in

some analytical process, the one chosen would naturally be that with the most tractable mathematical form. By the same argument, therefore, it is permissible to use two different models to solve two different problems which depend upon the same data, each model suiting the mathematical convenience of the problem considered. This is done later where two different models for a local line network are used; it is interesting to note that another model describing such a network has already been published in the Journal.²

The fact that a model need only be an adequate description means that caution must be exercised in using it over a range for which it has not been tested. For example, suppose that it is concluded that a variate is normally distributed on the basis of 200 observations. It can be dangerous to suppose that the normal form continues at the extreme tails of the distribution; and there would be no justification for using this model to find, say, the variate value which is exceeded only once in 100,000 times.

TESTS OF SIGNIFICANCE

Sometimes a model can be set up *a priori* on physical grounds and with confidence that it will give a sufficiently accurate description of the observations. In most cases, however, it is necessary to postulate a model and test whether it is adequate. This is done by using tests of significance, which measure whether the actual observations differ from those predicted by the model by an amount greater than that which could be reasonably attributed to chance. There are many tests of significance (for instance, the t-test, the z-test, the F-test, the χ^2 -test) and the ideas behind some of them, together with their arithmetical details, have already been discussed in the Journal.¹ The choice of tests, sample size and level of significance used when testing a model depend largely on how accurate a description is needed and these factors can be adjudged only by practical experience.

The form of conclusion reached after making a test of significance shows that models can be no better than adequate descriptions of the observations. The conclusion will be either

- (a) the observations differ significantly from those predicted by the model and hence the model is rejected, or
- (b) the observations do not provide any evidence for rejecting the model as unsuitable.

Conclusion (b) does not directly accept models, but tests can be made so sensitive that any model which is not rejected will describe the observations accurately enough for practical purposes.

In addition to the arithmetical tests mentioned above, there are a number of graphical tests that play an important part in providing quick answers to operational research problems. These tests are made on arithmetic, logarithmic, Poissonian and binomial probability paper; and the fundamental ideas behind some of them have been discussed in the Journal.¹

† The authors are, respectively, Principal Scientific Officer and Senior Scientific Officer, Post Office Research Station.

THE POISSONIAN STREAM MODEL

Before the war in 1939, it was usually possible to satisfy the public demand for exchange lines and give an applicant service "on demand." After the war, however, it was not possible to maintain this very high grade of service, and the problem of forecasting the future demand for exchange lines in cable distribution areas became urgent.

Taking some arbitrary zero of time, the increase in the demand for lines in a distribution area up to some time t can be represented by the random variable $R(t)$. What we want to find is the probability $\text{Pr}(r)$ that $R(t) = r$. Unfortunately, this cannot be done conveniently by direct observation. Instead we write

$$R(t) = A(t) - C(t) \dots \dots \dots (1)$$

where $A(t)$ and $C(t)$ are random variables representing, respectively, the numbers of applications and cessations up to some time t . The next step is to obtain data from cable distribution areas and find models for $A(t)$ and $C(t)$ by the application of tests of significance. By virtue of such an examination it was found that both $A(t)$ and $C(t)$ could be represented adequately by independent Poissonian streams. Using these models, it was found analytically that

$$\text{Pr}(r) = \left(\frac{a}{c}\right)^{r/2} I_r(2\sqrt{ac}) \exp(-a - c) \dots \dots \dots (2)$$

where $I_r(2\sqrt{ac})$ denotes the modified Bessel function of the first kind of order r and argument $2\sqrt{ac}$ while a and c represent, respectively, the expected numbers of applications and cessations in the distribution area over the time period considered.

Transforming (2) into a Schäfli integral and developing this by the method of steepest descents, gives the convenient result,

$$\text{Pr}(r_0 \leq r \leq r_1) \simeq \Phi(X_{r_1+1/2}) - \Phi(X_{r_0-1/2}) \dots \dots (3)$$

where

$$\begin{aligned} X_r &= (r - \bar{r})/\sigma \\ \bar{r} &= a - c \\ \sigma^2 &= a + c \end{aligned}$$

and

$$\Phi(X) = \frac{1}{\sqrt{2\pi}} \int_{-\infty}^X \exp\left(-\frac{X^2}{2}\right) dX.$$

From (3), the probability that the difference r between the two Poissonian streams will lie between preassigned limits r_0 and r_1 may be calculated. In this expression, σ^2 represents the variance of r while \bar{r} denotes the expected increase in the demand for lines in the distribution area. X_r represents the normalized r -variable and the probability function $\Phi(X)$ is extensively tabulated.

It is a simple matter therefore to calculate the probabilities associated with different demands once the values of a and c are known. There are many ways of determining a and c from data readily available at the Telephone Manager's Office, but they cannot be discussed in detail here. A simple method is to assume that the values of these parameters during the forecast period are the same as those during a period preceding the forecast; this should give results which are accurate enough for many areas. More precise determinations can be made, however, by using time-series techniques. The numbers of applications in successive time periods are treated as a time-series which is split into a trend, a periodic component and a random component. The random component is ignored since it is already accounted for in (3) and the value of a during the forecast period is taken as the mean value of the trend and periodic components during that time. If the periodic component has a short period, the trend only is used to calculate a . The value of the parameter c is determined in a similar manner.

It may be argued that the occurrence of A to B transfers* in practice makes the Poissonian streams dependent. This

does not, however, really invalidate the model, for the A to B transfers can be removed from both the application and cessation streams giving streams with parameters $(a - \lambda)$ and $(c - \lambda)$ instead of a and c , where λ is the expected number of A to B transfers. The formula (3) may then be used with

$$\begin{aligned} \bar{r} &= a - c \\ \sigma^2 &= a + c - 2\lambda \end{aligned}$$

In practice the removal of A to B transfers makes little difference to the results and may be ignored. It will be noted that the two streams cannot in fact be perfectly independent since this would allow a negative demand for lines. The degree of dependence is small however and the model is adequate.

The probability expression (3) can be used without difficulty in answering preliminary questions about distribution areas. As a simple example, suppose it is required to determine the economic minimum number of spare pairs required to give a predetermined grade of service in a full-availability cabinet area by some time t . For time t , define the grade of service to be given to the public in this area by

$$L(\bar{r}) = \text{Workers}/(\text{Workers} + \text{Waiters}) \dots \dots \dots (4)$$

If at zero reference time there are W_0 workers, N_0 spares and no waiters, while at time t there are $(W_0 + N_0)$ workers and $(\bar{r} - N_0)$ waiters, it follows from (4) that

$$L = (W_0 + N_0)/(W_0 + \bar{r}).$$

This result shows that N_0 , the number of spares at zero time, may be calculated from

$$N_0 = \bar{r}L - W_0(1 - L) \dots \dots \dots (5)$$

where the grade of service index (4) can be fixed arbitrarily by the executive department concerned. From (5) it can be seen that N_0 is the expected value since it depends on the average value \bar{r} . For the upper limit of N_0 we may write

$$\hat{N}_0 = kL - W_0(1 - L) \dots \dots \dots (6)$$

where k is some number. From (5) and (6) it can be seen that the spare pair margin may be written

$$\hat{N}_0 - N_0 = (k - \bar{r})L \dots \dots \dots (7)$$

At this point it is apparent that the calculation of the probabilities associated with deviations from average values will call for the formulation of the probability distribution $\text{Pr}\{L(r)\}$ from which the number k required for (7) can be determined. The upper limit \hat{N}_0 (beyond which it is not economic to proceed) can be found from the fact that the pre-war grade of service to the public in the national local line network corresponded to a service index $L(r)$ of at least 95 per cent with 99 per cent confidence. This can be written

$$\text{Pr}[L(r) \leq 95\%] = 0.01$$

Thus \hat{N}_0 must satisfy the condition

$$\sum_{r=k}^{\infty} \text{Pr}(r) = 0.01 \dots \dots \dots (8)$$

where k is the minimum value of r in

$$0.95 \geq (W_0 + \hat{N}_0)/(W_0 + r)$$

It follows immediately from (3), the expression describing the Poissonian stream model, that (8) can be written

$$\Phi\left(\frac{k - \bar{r} - 1/2}{\sigma}\right) = 0.99 \dots \dots \dots (9)$$

from which the required value of k can be determined by reference to a table of the $\Phi(X)$ function. Thus, it can be seen that the calculation of the economic minimum number of spare pairs required to give a predetermined grade of service to the public in a cable distribution area can readily be made from (7) and (9).

* A transfer of service from an outgoing subscriber to an incoming tenant of the same premises—with or without alteration of apparatus.

THE EXPONENTIAL LIFE MODEL

Although the probability expression (3) describing the Poissonian stream model of a local line network can be used to answer questions concerning subscribers' cables, it is not so convenient for answering questions concerning penetration-factors in small distribution areas. For these questions it is necessary to take into account the type of property, the number of tenancies and the lines in use at the beginning of the forecast period, etc. To answer these questions it is advisable to construct a new model capable of taking these factors into account directly.

For the new model a tenancy in a distribution area is first regarded as a single source that can be in one of the complementary states S or \bar{S} . A source is in S if it has service or is waiting for service in a queue; while it is in \bar{S} if it does not want service. Suppose at reference time $t = 0$ the source under consideration is in \bar{S} and it has been in this state for some arbitrary time τ . Then let $f(t; \tau) dt$ denote the probability that this source will revert to S (for the first time after $t = 0$) in the time interval $(t, t + dt)$. By virtue of statistical evidence, the assumption is made that $f(t; \tau)$ can be equated to $a \exp(-at)$, where a is a parameter independent of t and τ . Similarly, there is a 'cessation distribution' $c \exp(-ct)$, such that if a source is in S at any arbitrary time $t = 0$, then the probability that it changes to \bar{S} (for the first time after $t = 0$) in the time interval $(t, t + dt)$ is given by $c \exp(-ct) dt$, where c is a parameter.

Initially, this exponential model is concerned with a single distribution area in which any source has access to any line. Furthermore, this area is assumed to be homogeneous with regard to the grade of property it covers so that a and c do not vary from source to source. It is also assumed that the area contains n sources, l lines, and that x_0 represents the number of sources in S at $t = 0$. In general, x_t will denote the number of sources in S at time t . From x_t the size of the queue or the number of spares may be found easily, for if $x_t > l$ there is a queue of size $x_t - l$, but if $x_t < l$ there will be $l - x_t$ spares, and if $x_t = l$ there are no spares and no queue.

From the stochastic differential equations describing the distribution area it was found that $\Pr(x_t|x_0)$, the probability of having x_t sources in S at time t , given that there are x_0 sources in S at $t = 0$, is

$$\Pr(x_t|x_0) = \frac{a^x c^{n-x}}{(a+c)^n} k_1^n \left(\frac{k_3}{k_1}\right)^{x_0+x_t} \sum_{\lambda=0}^{x_t} \left(\frac{k_1 k_2}{k_3^2}\right)^\lambda \binom{x_t}{\lambda} \binom{n-x_t}{x_t-\lambda} \dots \dots \dots (10)$$

where $k_1 = 1 + \frac{a}{c} \exp(-a-c)t$

$k_2 = 1 + \frac{c}{a} \exp(-a-c)t$

and $k_3 = 1 - \exp(-a-c)t$.

This expression describing the exponential model of a local line network is not as inconvenient as it may seem. A numerical study of (10) showed that it can be approximated to by a straight line on arithmetic probability paper for most practical values of n , x_0 , a and c . This is illustrated in Fig. 4 which shows the straight-line approximations for $n = 50$, $a = 0.4$, $c = 0.2$ and $x_0 = 15$ (5) 35. These straight lines can be drawn from a knowledge of the mean and variance of (10); the mean is given by

$$\bar{x}_t = \frac{a}{a+c} \{n k_3 + x_0 (k_2 - k_3)\}$$

while the variance is

$$\sigma_{x_t}^2 = \frac{ac k_3}{(a+c)^2} \{n k_1 + x_0 (k_2 - k_1)\}.$$

Before (10) can be used in practice, it is necessary to forecast values of a and c for each property grade separately;

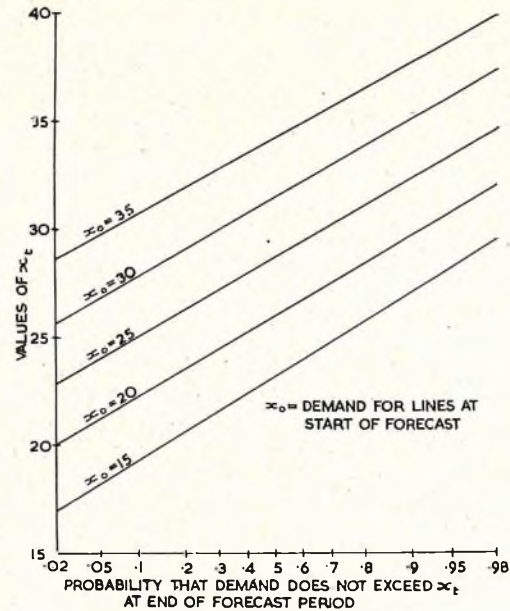

FIG. 4.—FORECASTING CHART FOR DISTRIBUTION AREA.

these forecasts can be made from a knowledge of the applications and cessations arriving at the Telephone Manager's Office. Details of the use of this model (which involves a method of combining the demands for different property grades) cannot be given here; but it is apparent from the above that the exponential life model has uses side-by-side with the Poissonian stream model in answering questions concerning local line networks.

THE BLACK ENVELOPE TECHNIQUE

Detailed information concerning the number, nature and treatment of the letter correspondence that passes through a sorting office, is required for staff and accommodation planning and for the efficient routing of traffic. For each main office it is desirable to have data such as:

- (i) the numbers of posted, delivered and forward items passing through the office in a year,
- (ii) the average number of sorting handlings for posted, delivered and forward items,
- (iii) the numbers of items despatched to travelling post offices,
- (iv) the proportions of items sorted to each selection at each sorting stage,
- (v) the average number of deferred items handled per day,
- (vi) the ratio of long to short letters, etc.

Some of these are obtained at present by assuming the existence of 'representative periods' in the year and by examining all the relevant items passing through the office during these periods. Although the resulting data are useful, it is desirable to devise a method of determining them on a basis of continuous sampling throughout the year instead of total-counting during selected periods.

The information required from the sample items can be obtained only if the items are sampled before their initial sortations. For posted items, at any rate, the stamp-cancelling machine is the most natural sampling position since it has a numbering device. Accordingly experiments were made to see whether suitable samples could be generated by purposive sampling of the items passing through a stamp-cancelling machine. The samples which were to be considered suitable were quasi-random and quasi-representative samples, i.e., samples giving results statistically indistinguishable from those given by unstratified random and representative sampling. This standard of

sampling was chosen so that the model of unstratified random sampling could be used when interpreting sample results; the degree of confidence in the statements made from sample observations would then be at least as great as that indicated by the model. The problem in this case therefore, was the inverse of the normal problem of finding a probability model to describe observations; here the model was known and it was desired to find how to take observations which would agree with it. The experiments showed that the samples formed by every k th item were suitable for a range of k from 10 to 1,000, and there was no indication that greater values of k would be unsuitable.

The suitability was tested in a number of ways of which the most sensitive was as follows. A group of 100,000 items passing through a stamp-cancelling machine under normal working conditions was sorted at the outward primary and the selections were recorded in order. Having brought the population to a standstill on paper, all the k possible 1 in k samples were selected and the numbers of items sorted to each selection were arranged in a table as shown in Table 3.

TABLE 3

Sample No.	1	2	...	k	Totals
Selection No. 1	48	53	49	
2	25	25	28	
3	147	133	152	
.....	
48	14	12	11	
Totals	$10^5/k$	$10^5/k$	$10^5/k$	100,000

The model of quasi-random sampling was then tested by calculating the value of χ^2 for this contingency table on the hypothesis that the k samples did not differ significantly, and non-significant values were obtained for a wide range of k (significantly low values would have indicated quasi-representative sampling).

To utilize this model, sorting offices may be divided into the two classes of 'sampling' and 'non-sampling' offices. The sampling offices include all offices for which detailed information, such as (i)-(vi) above, is wanted and all offices which have recording stamp-cancelling machines. In addition, some offices satisfying neither of these conditions are classed as sampling offices; these offices are chosen in such a way that an item which has been despatched from a sampling to a non-sampling office cannot pass through another sampling office later except by mistreatment. Assuming the model is correct for each stamp-cancelling machine, the following sampling principle* is arrived at:

Suppose that each item is put through a stamp-cancelling machine at the first sampling office through which it passes and that every k th item from each machine is distinguished as a sample item. Then the sample items in any group of items at a sampling office form a suitable sample of the items in that group.

For example, the delivered items at a sampling office will have passed through a machine either at that office or at some other sampling office, so that each of them has been given a 1 in k chance of selection as a sample item.

Once an item has been selected as a sample item, it remains a sample item wherever it travels in the postal system. The sample items must be easily recognized; this can be arranged by putting each sample item in an unsealed

* In 1955, the Post Office's Chief Statistician utilized this sampling principle in an experimental letter sampling scheme covering a restricted range of traffic. The practical details of this scheme differ from the original proposals described here.

unaddressed black sampling envelope before it leaves the vicinity of the stamp-cancelling machine, and by keeping the item in this black envelope until it reaches its final delivery stage.

All the information wanted can be obtained from an examination of the items in the black envelopes. This may be arranged in the manner shown in Fig. 5. It is shown

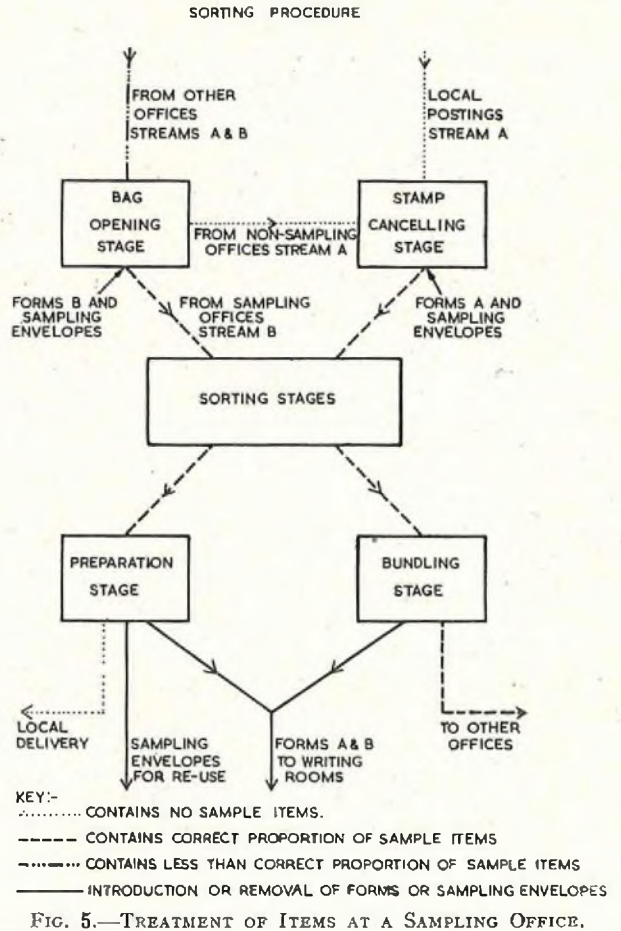

Sampling office.....		Date.....	Item No.....
(1)	Item received from { local postings, collection..... non-sampling office.....		
	as a { normal abnormal } item addressed to.....		
(2)	Nature of item: (i) short or long		
	(ii) postage paid by..... (iii) class of item..... etc.		
(3)	Sortation	Sorting Stage	Sorted to
	First		
	Second		
	Last		
(4)	Item { delivered locally, delivery..... despatched to.....		

FIG. 6.—FORM A.

that the items entering a sampling office are divided into (i) stream A, consisting of local postings and items received from non-sampling offices, and (ii) stream B, consisting of items received from other sampling offices. This separation may be facilitated by the use of differently designed despatching labels for sampling and non-sampling offices. All the items in stream A are put through the stamp-cancelling machines and every k th item is extracted. Each sample item is put in a black envelope together with Form A (Fig. 6) on which entries (1) and (2) have been made. After inserting Form A the black envelope passes the sorting stages appropriate to the sample item and entries are made in (3) at each stage. Eventually the envelope arrives either at a bundling stage or at a preparation stage for local delivery. In the former case, the sample item is despatched in its black envelope, but in the latter case the black envelope is withdrawn; in either case Form A is completed and sent to the writing-room. The procedure for stream B is similar. Since this stream comes from other sampling offices, then on the average 1 in k of its items are in black sampling envelopes. These are extracted at the bag-opening stage and Forms B (similar to Form A illustrated in Fig. 6) are associated with them. These black envelopes and their forms are then dealt with as before.

Forms A and B in the writing-room can be used to make measurements in a simple manner without delaying the traffic. For example, if the proportion of items receiving more than one sortation as a posted item is required, the number of forms relating to posted items and the number of these which show more than one posted sortation are counted; the proportion is then the ratio of the latter number to the former, and its precision (expressed as a confidence statement) can be found readily by referring to a table. Similarly, suppose the number of forward items handled during a year is required. If this is 1,816, then on the average $1,816/k$ forward items were handled during the year and the precision of this measurement may be found without difficulty.

MEASUREMENT OF POSTAL CHARACTERISTICS

Postal measurements may be classed as local or national. The former are measurements at individual offices or small groups of offices and are required mainly for staffing and accommodation problems, circulation and routing studies and the design of postal machinery. The national measurements refer to the postal system as a whole and are used by the Administration in economic studies and in assessing the quality of service given to the public.

The local measurements (in so far as they refer to letter correspondence) can be made by using the black envelope technique. If used continuously for this purpose, a value of $k = 10,000$ would suffice. Its adoption would involve passing more items through the stamp-cancelling machines but the present annual counts could be eliminated.

For the national measurements the double-register technique described in Part I can be used. In describing this technique it was shown that it is possible to select an unstratified random sample of the items delivered during the year. By specifying the samples necessary for the various national characteristics, it can be shown that all the measurements can be obtained from one sample of about 8,000 items so that only one-millionth of the population need be sampled.

Thus the black envelope and double-register techniques are complementary; each can be used separately but the two together cover virtually the whole field of postal traffic measurement. Local measurements relating to parcels and packets, however, are not covered by these techniques and remain a subject for further operational research.

The techniques described should not be considered solely as a means of obtaining routine information. Although they have been described as examples of operational research, they are themselves tools which will facilitate further operational research into the postal system. For any operational problem that arises, a suitable sample can be selected and examined at short notice (by one or other of the techniques), thereby giving the executive department a quantitative basis on which they can make their decision.

OTHER EXAMPLES OF OPERATIONAL RESEARCH

There are many other examples of the application of operational research methods to Post Office problems, but only a few can be mentioned in the space available for this article.

A problem which arose in 1952 in connexion with national savings policy was that of finding the mean life of national savings stamps, i.e., the mean time between purchase and surrender. In addition, it was required to find the proportions of stamps encashed and converted into other forms of national savings together with the life distribution of each. Under normal operating conditions, the life of the stamps can be found only when some form of marking, numbering or dating is introduced. Consequently the change in the design of the stamps which occurred in 1953, provided a unique opportunity for solving the problem. This change was utilized by collecting the following data from offices in a selected area during a period of five months:

- (a) stamps sold (in units of 6d.),
- (b) old-issue stamps encashed,
- (c) old-issue stamps converted into other savings,
- (d) new-issue stamps encashed, and
- (e) new-issue stamps converted into other savings.

An estimate of the mean life was found from the rate at which old-issue stamps were surrendered; the model used was that the surrender distribution is approximately negative exponential for most of the life-distributions encountered in practice. The life-distributions were found from (a), (d) and (e), by taking various distributions as models and testing these models by a comparison of actual and theoretical surrender rates. A comparison of the mean life obtained from the life-distributions and the mean life obtained by the first method provided a check on the validity of the analysis.

Another problem was concerned with the most efficient means of maintenance for call-offices in city areas. Questions were asked about the probability distribution of call-office faults and the degree of correlation between faults and receipts. By testing various models against observational data, answers to these questions were obtained. In the course of this work it was found that the fault distribution could be fitted with a two-parameter Pólya type of "contagious law" devised for the analysis of phenomena associated with contagious diseases. This led to the assumption that the call-office fault distribution indicated "contagion" (in the sense that each fault increases the probability of succeeding faults). It was found, however, that the Pólya type of fault distribution can be derived from the hypothesis that there is no contagion whatsoever, each fault being completely independent of the others and of the past history of the call-office. Consequently, the assumption that call-office faults are necessarily "contagious" was abandoned.

Operational research can be used in framing replacement policies when large numbers of identical units are employed in continuously operating systems. For instance, consider the replacement of valves in some network or the replacement of electric light bulbs in call-offices. In general there are two methods of replacement: in the first method, the

valves (or bulbs) are replaced as they fail; in the second method, the valves that fail are replaced up to some time T , and then all the valves in the system are replaced. Under some conditions the latter method is more economical than the former, and operational research methods can be used to find these conditions and the optimum value of T in any particular case.

CONCLUSION

Other examples could be given showing how operational research methods may be applied to the provision of standby equipment, the specification of acceptable circuit performance, the efficiency of inspection procedures, etc.; but the examples which have been given already are sufficient to illustrate the nature, aims and methods of the

operational research approach. It is apparent then that the field for operational research in the Post Office is very wide; nevertheless, it is quite distinct from the field of ordinary scientific research which is mainly concerned with new or improved materials, equipment, processes, etc. The quantitative commonsense methods of operational research should appeal to the executive, for they can be used alongside his methods of accountancy and thereby help him to make a rational decision.

References.

- ¹ DOUST, J. F., and JOSEPHS, H. J. A Simple Introduction to the Use of Statistics in Telecommunications Engineering. *P.O.E.E.J.*, Vol. 34, pp. 36, 79, 139, 173. Apr., July, Oct., 1941 and Jan. 1942.
² MELLOR, S. D. A Method of Assessing the Effect of Flexibility in Distribution Networks. *P.O.E.E.J.*, Vol. 45, p. 125, Oct., 1952.

Measuring Wheels

U.D.C. 531.716

S. LIFFORD, Graduate I. Mech. E.†

After a brief account of the history of measuring wheels, the accuracy of measurements using wheels, chains and tapes are compared and some indications are given of the field of use for measuring wheels.

INTRODUCTION

MEASURING wheels, known variously as Odometers, Waywisers or Perambulators, have been employed in differing forms since Roman times, for measuring linear distances by counting and recording the revolutions of a wheel of known circumference. The earliest reference to a measuring wheel being used by the Post Office was in an Act in 1710, in which it was stated that "the Post Master General shall appoint a person or persons to measure all roads by Wheel, except such roads where stages are already settled," and in a later paragraph of the same Act, "such person or persons shall swear on oath to perform the same to the best of their skill and judgment." The measuring wheel was widely used in this country by land surveyors during the 18th century, but gradually fell into disuse during the 19th century due to land surveying instruments of greater accuracy becoming available. It has recently been brought back into use by various civil engineering and public works contractors for certain classes of surveying work and is employed in the Post Office Engineering Department for general survey purposes where a high degree of accuracy is not essential.

DEVELOPMENT AND CONSTRUCTION

A Waywiser made in 1739 by a James Knights of Ipswich had an all-iron wheel of $\frac{1}{4}$ pole ($1\frac{3}{8}$ yd) circumference, geared to three dials recording poles, furlongs and miles up to a total of eight miles. Another model, of wooden construction, made by a John Smeaton in about 1750, had a wheel 1 yd in circumference and was capable of measuring distances up to nearly 31 miles with one traverse of the three dials, i.e. yards up to 60 yd on the first dial; 60-yd units up to 30, totalling 1,800 yd, on the second dial; and 1,800-yd units up to 30, totalling 54,000 yd, on the third dial. A smaller Waywiser made by a G. Adams in the late 18th century, had a brass wheel 18 in. in circumference and recorded up to four miles. An improved form of Waywiser, called a Perambulator, was made by W. & S. Jones at the beginning of the 19th century. It was of wooden construction and had a wheel of $\frac{1}{2}$ pole ($2\frac{3}{4}$ yd) circumference. Unlike the Waywiser, where the axle of the wheel was geared directly to the recording mechanism, the rotating motion of the wheel axle of this Perambulator was trans-

mitted by a pair of bevel wheels to a perpendicular shaft, running along one bearing fork, and from the shaft to the recording mechanism by a worm and pinion wheel. The recording device had an outer scale 7 in. in diameter, graduated in yards and poles, and its pointer made one revolution every furlong. An inner scale of 5 in. diameter, graduated in furlongs and miles up to 10 miles, was read by a second pointer. This Perambulator is similar to a measuring wheel dated 1895 (Fig. 1) used by the Post Office Engineering Department in about 1910, except that the measuring wheel has an iron wheel of 2 yd circumference.

The modern wheel (Fig. 2) used by the Engineering Department has a cast aluminium wheel with a solid

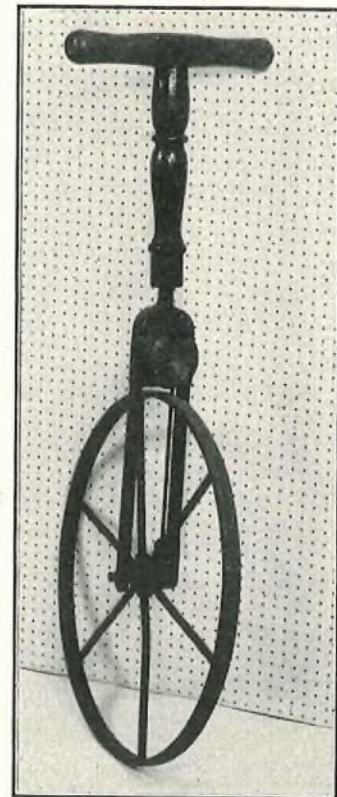

FIG. 1.—MEASURING WHEEL, 1895.

† The author is an Assistant Engineer, External Plant and Protection Branch, E.-in-C.'s Office.



FIG. 2.—MODERN MEASURING WHEEL.

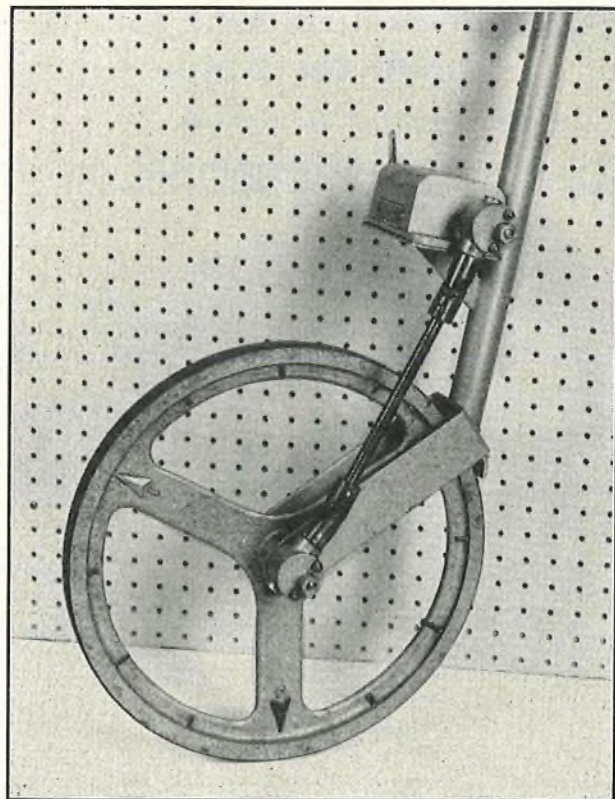

FIG. 3.—VIEW SHOWING GRADUATIONS ON WHEEL RIM.

synthetic oil-resisting rubber tyre let into the rim and ground to give a circumference of 1 yd. The wheel revolutions are recorded by a "Veeder"-type counter clamped to the handle, the axle motion being transmitted by a worm and wheel driving a shaft having universal joints, which, in turn, operates the counter through a second worm gear. The counter records yards and inches up to 10,000 yd and has a zero resetting lever. The circumference of the wheel is graduated, at the side of the rim, in feet and at every three inches (Fig. 3). One of the foot marks is a red arrow, which may be aligned with the starting point when commencing a measurement and enables the wheel markings to be used to verify the inches reading on the recorder. The aluminium handle is telescopic, to cater for tall or short operators, and has a scraper fitted at the back to keep the periphery of the wheel clean.

COMPARISONS WITH CHAIN AND TAPE

Comparative measurements have been made over various types of surfaces, using a 66-ft steel tape, 66-ft measuring chain and three types of measuring wheel, to determine the relative accuracies of these items. The three wheels used were the 1895 model referred to above, one of the aluminium type and a pneumatic-tyred wheel, similar to a bicycle wheel, 18 in. in diameter, with a flexible drive to a counter recording up to 1,000 yd. At an early stage this last wheel was found to be very inconsistent and was omitted from later trials. The comparison showed that the steel tape was the most consistent item on all types of surface, with the chain and wheel following in that order. The method of making the comparisons was to mark out a distance of, say, 600 ft with one of the tools and use this distance as a standard, to be measured with the other items. By measuring over various surfaces and using each tool in turn as a standard the relative accuracy of performance of the items was determined. All the wheels were found to be subject to errors arising from the speed of walking and from

the nature of the surface over which they were operating. On gravel or loose pebbles large errors were possible. The early Post Office model (Fig. 1), although of antique appearance, was the most consistent of the three wheels. Its "T" handle made it easier to keep on a straight course than the modern item with a single hand grip, and the large wheel circumference (2 yd) enabled it to negotiate surface irregularities with less error than the smaller and lighter wheels. Measuring wheels of this size and weight are not now made and whilst special wheels could no doubt be obtained the small increase in accuracy achieved over the modern 1-yd wheel would not justify doing so.

ACCURACY

It is difficult to give figures for the accuracy of the measuring wheel as this depends on a number of variables such as speed of walking, type of surface and the operator's ability to move the wheel in a straight line or smooth curve. A general figure would be an error of the order of ± 1.5 per cent. The centre-to-centre measurements between man-holes as recorded on the cable duct plans are used for ordering cable and the maximum error should not exceed 1 ft in 500 ft, i.e. 0.2 per cent. Works supervisors are also required to work to an error of something less than 0.1 per cent, i.e. 6 in. in 500 ft, which is only attainable with tape or chain. Wheels are unsuitable for very accurate work, but possess considerable advantages over chains and tapes where accuracy is not important. The wheel is easy to handle and quick in use and effects a considerable saving in time (50 per cent. in some cases), it also eliminates the danger of omitting a chain or tape length. Its degree of accuracy is not consistently high enough to permit it to replace measuring tapes or chains for all purposes, but it is suitable for preliminary survey work in connexion with main and local underground and overhead schemes where great accuracy is unnecessary.

An Experimental Gas Plumbing Outfit for Cable Jointers

J. G. DONOVAN, A.M.I.E.E.,
and R. THARBY†

U.D.C. 621.791.334:621.315.687.1:614.83

This article describes a liquefied petroleum gas plumbing outfit which has proved successful as a replacement for petrol blowlamps during field trials in the Colchester, Swansea, and Glasgow Areas. A new gas detector for use with the gas plumbing outfit is also described.

INTRODUCTION

IN recent years the major oil distributing companies have increased the amount of petroleum refining that is carried out in this country; in consequence, large quantities of gaseous petroleum by-products have become available for use as inflammable fuels.

These petroleum gases, which are readily liquefied for storage and transport, are used extensively in rural districts where a main gas supply is not available for the operation of domestic gas appliances, and in workshops and factories for brazing and similar heating purposes.

Two gases are available in useful quantities. One is commercial butane, which is marketed in the United Kingdom under such trade names as Calor Gas, Bottogas, Scottish Rural Gas, and Dexagas, and is used mainly in domestic installations. The other is commercial propane, which is marketed as Pyrogas, etc., and is used mainly for industrial purposes.

The gases are mixtures of saturated and, to a lesser extent, unsaturated hydrocarbons within specified vaporizing limits. As considerable variations occur in the composition of crude oils from different parts of the world, and in the apparatus used at different refineries, the specifications for these gases have wide tolerances and the commercial gases differ considerably from the single hydrocarbons bearing the same name. The physical properties of the gases permit a considerable quantity of energy to be stored conveniently in liquid form in cylinders, whilst at the same time no special equipment is required to vaporize the liquid for use as a fuel.

The field trial was arranged to determine whether these apparent advantages could be utilized efficiently by the Post Office for plumbing cable joints. Three Areas were chosen to participate in the trial, and every jointing team in each Area was equipped with a gas plumbing outfit, basically similar to the type described.

GENERAL DESCRIPTION

The complete equipment is illustrated in Fig. 1. It comprises a cylinder containing liquefied gas, a pressure



FIG. 1.—GAS PLUMBING EQUIPMENT.

regulator, outlet valves, flexible hoses, and a gas torch. A gas furnace is also included and may be operated

† Mr. Donovan is an Executive Engineer, London Telecommunications Region; he was formerly in the External Plant and Protection Branch, E.-in-C.'s Office. Mr. Tharby is an Assistant Engineer, External Plant and Protection Branch, E.-in-C.'s Office.

simultaneously with the torch. The lengths of flexible hose supplied enable the jointer to use the gas torch in the majority of underground or overhead situations without unloading the cylinder from the van.

A spare cylinder is carried in the van to ensure that an adequate reserve of fuel is available, and a spare torch is provided to enable two jointers to work simultaneously from the same equipment when necessary.

Gas Cylinder.

The cylinder, which can be seen in Fig. 1, is of pressed steel and welded construction, with a wearing ring fitted to the base. A full cylinder weighs 38 lb and holds 14 lb of gas. A brass control valve and outlet connexion is screwed into the top of the cylinder by means of a tapered thread.

It is impracticable to measure the amount of gas in a cylinder, except by weighing it, and a cylinder is therefore used until it is noticed that the power of the torch flame is decreasing, whereupon the reserve cylinder is brought into use. The empty cylinder is exchanged for a full one on the jointer's next visit to the Section Stock.

The cylinders are recharged at the various refineries by a method involving the evacuation of the cylinders, and no provision is made in the design of the cylinders for decanting gas from one cylinder to another.

Properties of the Gaseous Fuels.

Table 1 gives the important properties of commercial butane and propane. It will be seen that commercial butane consists of approximately equal proportions of normal-butane and iso-butane, with a small proportion of propane. These two gases are isomers; that is, they have the same chemical formula, C_4H_{10} , but the atoms in the two molecules are arranged in different patterns. Normal-butane is a straight-chain compound, $CH_3CH_2CH_2CH_3$, while iso-butane is a branched-chain compound,



The two gases have very similar physical and chemical properties; so far as gas plumbing is concerned, the most important difference is that the boiling point of iso-butane is $13^\circ F$ while normal-butane boils at $32.9^\circ F$. Hence, when commercial butane is used as a fuel at temperatures between $13^\circ F$ and $32.9^\circ F$ only the iso-butane will vaporize, the normal-butane remaining in the cylinder in the liquid state.

Butane and propane are odourless in the natural state, and small quantities of mercaptan are added so that leakages of the gases may be detected by their smell. Neither gas is poisonous, and no undue quantities of poisonous compounds are produced when the gases are burned efficiently.

The major differences between these otherwise very similar fuels are the lower vapour pressure of commercial butane and the lower boiling point of commercial propane. On account of the higher vapour pressure of commercial propane, slightly stronger storage cylinders are used and the capacity of a charged propane cylinder of a given weight is therefore slightly less than that of a charged cylinder of butane of the same weight.

Provided in each case that the pressure regulator is adjusted to give the correct output pressure of 6 lb/in^2 it is difficult to distinguish between the flames from two torches

TABLE 1
Properties of Commercial Propane and Butane

Gas	Chemical formula	Calorific value B.t.u./lb	Lower explosive limit per cent vol. in air	Upper explosive limit per cent vol. in air	Specific gravity of gas Air = 1	Vapour ratio ft ³ /lb	Boiling point °F	Vapour pressure in lb/in ² at			Maximum flame temperature °C	
								30°F	60°F	80°F		
Commercial propane (mainly propane)	C ₃ H ₈	21,633	2.3	9.5	1.55	8.59	- 48°F	66.3	107.1	142.8	1925	
Com- mercial butane	45 per cent normal-butane	C ₄ H ₁₀	21,331	1.9	8.4	2.084	6.52	32.9°F	14.4	26.3	37.6	1895
	40 per cent iso-butane ..	C ₄ H ₁₀	21,331	1.9	8.4	2.077	6.52	13°F	22.3	38.7	53.9	1900
	15 per cent propane.. ..	C ₃ H ₈	21,633	2.3	9.5	1.55	8.59	- 48°F	66.3	107.1	142.8	1925

Note.—The analysis shown for commercial butane is typical only.

with one burning commercial propane and the other commercial butane.

Commercial butane was chosen for the field trial because of its lower vapour pressure, and the trials were continued throughout the winter of 1955-56 to enable the inconvenience of the higher boiling point of commercial butane to be assessed. During the field trial several teams of jointers working in exposed parts of the Colchester and Glasgow Areas experienced difficulties in very cold weather, when the ambient temperature was too low to vaporize the liquefied gas and maintain an adequate pressure for the torch. Under these conditions a selective vaporization of the propane and iso-butane constituents occurred. The cylinder appeared to be empty and was therefore changed when only the more volatile constituents had been consumed. Cylinder charges appeared to have much shorter lives in cold weather, and on investigation several supposedly empty cylinders were found to have 40 per cent of their original contents unused.

Although commercial butane would be a satisfactory fuel during mild weather, particularly in the western part of the country, commercial propane will be used in the interests of reliability and uniformity for all future applications of the equipment.

Pressure Regulator.

The pressure regulator operates on the principle whereby the gas is passed from the cylinder into a chamber through an entry valve controlled by a link mechanism attached to a spring-loaded diaphragm forming the roof of the chamber. Control of the output pressure is effected by an adjusting screw, fitted with a locking nut and mounted at the top of the regulator, which controls the pressure exerted by the spring on the diaphragm. When the pressure of gas in the chamber has risen to the pre-set value the movement of the diaphragm closes the entry valve. The outlet to the equipment is taken from the gas chamber and as the gas is consumed and the pressure inside the regulator gas chamber falls, the diaphragm restores and permits gas to enter until the pressure again reaches its pre-set value. This interaction of the diaphragm continues while the gas is being consumed, at a rate dependent upon the rate of consumption. No gauges are fitted to the regulator since the pressure does not vary after the pressure screw has been set. The regulator is constructed of brass to avoid corrosion and the diaphragm and the gland sealing washers of the two valves in the parallel outlet tubes are made of neoprene to resist the dissolving effects of the gas.

The two parallel-connected outlet tubes terminate in nozzles which facilitate the connexion of $\frac{3}{16}$ -in. bore flexible hose.

An excess-flow valve may be fitted to the regulator, consisting of a spring-loaded valve which is normally held

open by the back pressure of gas restricted by the narrow aperture of the jet in a torch or furnace. Any sudden reduction of this back pressure such as would occur if a supply hose was severed or pulled off an appliance allows the spring to close the valve almost completely. If the appliance is reconnected or the disconnected hose is sealed off, the small flow of gas through the excess flow valve allows the back pressure of gas to restore and reopen the valve automatically.

Flexible Hose.

The hose is of $\frac{3}{16}$ in. bore and $\frac{1}{2}$ in. outer diameter and is constructed in three layers: the inner layer is $\frac{1}{16}$ in. thick and is made of neoprene to resist the dissolving effects of the gas; the middle layer consists of canvas webbing to give the hose strength to withstand high internal pressure; and the outer layer is $\frac{1}{16}$ in. thick and consists of either neoprene or natural rubber to withstand abrasion and wear when the hose is dragged along road surfaces and draped over manhole frames.

"Jubilee"-type hose clips are used to secure the hose to appliances on account of the inherent simplicity of these clips and the ease with which they can be efficiently and safely refitted without special tools.

Two 30-ft lengths of hose are supplied with each outfit together with a brass union to enable the hoses to be used as a single 60-ft length for plumbing high aerial cables or for similar tasks.

Gas Torch.

The gas torch (Fig. 2) is a relatively simple appliance comprising essentially a feed pipe, handle, control valve and nozzle. The handle and control valve are fitted away

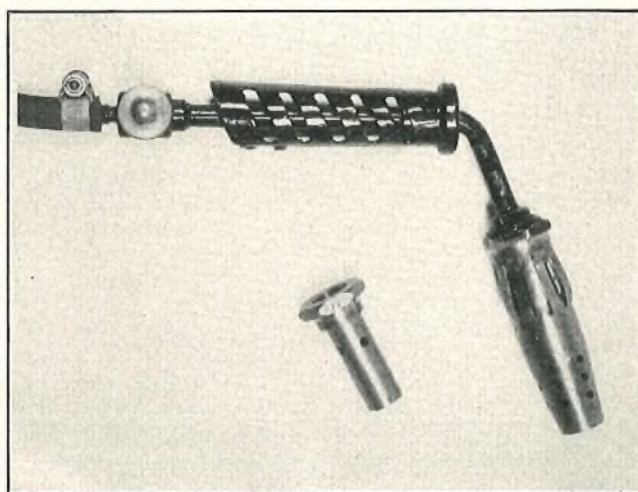

FIG. 2.—GAS TORCH.

from the heat of the nozzle to minimize damage to the gland-sealing washer of the valve and reduce any discomfort to the user.

The nozzle that was found most suitable, after experiments with many types, is similar to that fitted to the petrol blowlamps at present in use. It is a brass hurricane-type nozzle in which the flame burns partly within the nozzle, the flame being approximately 5 in. long and $\frac{3}{8}$ in. in diameter, and clean, tapered, and even in temperature. This shape of flame is very suitable for plumbing, where highly concentrated heat would damage the work. An alternative nozzle is also provided which produces a slender flame approximately 4 in. long and $\frac{3}{8}$ in. in diameter, and is suitable for intricate soldering work.

The torch is much lighter in weight than a petrol blowlamp but it has the disadvantage of the trailing hose, although this did not appear to handicap jointers once experience with the new equipment had been gained. With the large-flame nozzle the torch consumes a maximum of 0.3 lb of gas per hour; when the small nozzle is used the maximum consumption falls to 0.1 lb/h. A folding galvanized-steel tripod stand is used to support the torch when it is temporarily not in use.

Gas Furnace.

The furnace, illustrated in Fig. 3, is used for heating plumber's solder for pot-and-ladle plumbing, for heating wax for terminal blocks, and for heating water.



FIG. 3.—GAS FURNACE AND PLUMBER'S POT.

The furnace is strongly constructed to carry the weight of a plumber's pot and 25 lb of plumber's metal. The design is based on the plumber's stand used at present and consists of a sheet-steel cylinder reinforced at each end by heavy steel rings riveted to the cylinder. Four feet are riveted to the lower steel ring.

The plumber's pot is carried on four castellations protruding from the upper ring, so that the pot is raised relative to the cylinder and a free flow of exhaust gases is permitted. The inner edges of the castellations are rounded and tapered inwards so that the plumber's pot is central above the cylinder. The inner surface of the cylindrical body is lined with asbestos to improve the efficiency of the furnace and maintain the temperature of the outer surfaces as low as possible. A hinged steel grid fits across the top of the furnace to support smaller vessels or soldering irons, and a

hinged aperture is located in the side of the furnace to facilitate lighting the gas. The furnace has a black stove-enamelled finish.

The gas system consists of a detachable flame-nozzle mounted centrally in the base of the cylindrical body, and a control valve and connexion nozzle are fitted externally. The consumption of the furnace is 0.75 lb/h and the furnace is able to heat 25 lb of plumber's metal to correct plumbing temperature in 20 min.

GAS DETECTOR

The gas detectors normally used by jointers are unsuitable for the detection of petroleum gases. As commercial butane and commercial propane are both highly inflammable and heavier than air, Areas participating in the field trials were equipped with a new type of gas detector so that the atmosphere in plant where gas leaks were suspected could be tested.

The detector, which is illustrated in Fig. 4, gives an instantaneous indication of the inflammable nature of the atmosphere under test but does not provide a permanent record of the result of the test. It operates on an electric



FIG. 4.—GAS DETECTOR.

"hot wire" principle, the wire being made of activated platinum and connected as part of an electrical bridge circuit. The bridge is connected and balanced by means of a combined switch/rheostat, the balanced conditions being observed on a galvanometer mounted on the face of the instrument. The switch is fitted with a locking bar to prevent accidental connexion of the circuit.

Samples of the atmosphere being tested are passed through the instrument and over the electrically-heated platinum wire by means of a thiokol sampling tube and aspirator bulb. Any inflammable gas present in the sampled atmosphere burns on the surface of the wire, raising its temperature and, therefore, its electrical resistance. This increase in resistance unbalances the bridge, and the out-of-balance current, which is proportional to the amount of inflammable gas present, is observed on the galvanometer. The detector will register the presence of any inflammable gas and will give reliable indications of concentrations equal to 25 per cent or more of the lower explosive limit of the gas concerned. Flame traps are fitted in the gas-flow tubes of the detector to prevent the passage of burning gas back into the atmosphere under test.

The power for the bridge circuit is derived from a battery of six 1.5V No. 2 type torch cells, connected in parallel and fitted in the lower compartment of the instrument, which is separated from the upper compartment to minimize the risk of corroding electrical components. A ballast lamp, generously rated to ensure long life, is used as a balancing component for the platinum wire element and has a similar resistance/temperature characteristic.

The life of the cells depends to a large extent on the way the detector is used, but frequent renewal of the cells

is not necessary if the instrument is correctly used. It is necessary only to leave the detector switched on during the actual test, and discharge of the cells need occur for only short periods at a time if the circuit is disconnected as soon as possible. To ensure efficient use of the electric power available the circuit is arranged so that 85 per cent of the total current output is passed through the platinum element and is thus usefully employed.

The life of the platinum element is dependent upon the number of tests made where inflammable gas is detected, as on these occasions the temperature of the wire is raised substantially. These positive tests have rarely been experienced during the field trial and no failure of a platinum element has yet occurred. Each detector is, however, provided with a spare platinum element which is carried in the upper compartment for use if the element in the circuit should fail. As the frequency with which the detectors were needed has been so small the detectors have been located at local centres in the Areas for use on a "pool" basis.

CONCLUSIONS

The experimental gas plumbing outfits have proved very efficient and popular, and were shown to have the following major advantages over petrol blowlamps:

(a) No difficulty in lighting the gas appliances was experienced, whereas petrol blowlamps are unreliable in this respect, especially in exposed places.

(b) The flame power of the gas torches was consistent under all conditions. The flame power of a petrol blowlamp decreases and may even be extinguished by a high wind, since the rate of vaporization under these conditions is inadequate to maintain the flame.

(c) Less interference with the progress of plumbing was experienced due to the fuel chamber becoming exhausted. The cylinder of the gas equipment contains fuel for 46 hours use, whereas a petrol blowlamp requires refilling after 45 min.

(d) Although the initial cost of the gas equipment is about the same as a kit of petrol blowlamps, the maintenance cost is considerably lower as the gas outfits are much more robust.

(e) The cost of the fuel, either commercial propane or commercial butane, is much less than that of petrol. The cost of petrol is high because an unleaded special-boiling-point type must be used in blowlamps for health and other reasons.

(f) The adoption of gas plumbing equipment generally will allow the introduction of many useful appliances such as gas lamps to provide light if an electricity supply is not available, joint-drying devices, etc.

ACKNOWLEDGMENTS

It is desired to acknowledge the valued assistance given in the Areas and Regions participating in the field trial.

Book Review

"Progress in Semiconductors, Vol. I." Edited by A. F. Gibson, P. Aigrain and R. E. Burgess. Heywood & Co. 260 pp. 86 ill. 50s.

Next to nuclear physics, solid-state physics is probably now the scene of greatest interaction between the theoretical physicist, the experimental physicist and the engineer (not to mention the chemist and the metallurgist) and "semiconductors" occupy a central position in "solid state." The present book, the first of a planned annual series, is a collection of review papers by specialists in various branches of semiconductor research and development, and is designed to help those working in and around this position to keep up to date.

Silicon is at present at about the same stage of development, as regards preparation in controlled purity and crystalline perfection, and as regards our understanding of its electrical properties, as germanium was some three to four years ago. The paper on "Recent Advances in Silicon," by N. B. Hannay, of Bell Telephone Laboratories, is accordingly timely, and contains some results not yet published elsewhere. The place of silicon in devices for civil applications is as yet far from clear; it may be limited to rectifiers and transistors for high voltage applications and to some small-signal rectifiers where very high reverse impedances are required; but such matters are not discussed in the paper, which is confined mainly to the physical and electrical properties of the monocrystalline material.

C. A. Hogarth, of the Radar Research Establishment, Malvern, in a paper on "The Germanium Filament in Semiconductor Research," summarizes the principles of some of the most elegant (and now well-known) experiments on the properties of injected minority carriers. The elegance arises from the simple way in which the effects of drift, diffusion, recombination and trapping can be separated almost directly by inspection of the experimental presentation of the results. It might, however, have been more clearly stated in the paper that the decrease to zero of the pulse drift mobility (in contrast to the conductivity mobility) as the resistivity goes through the "intrinsic" value, is also a result of equation (2) on page 45 (where n_s should have been more clearly defined as the excess density of electrons over that of holes).

The paper by V. A. Johnson, of Purdue University, on the "Theory of the Seebeck Effect in Semiconductors," discusses the factors, including "phonon drag," that influence the

magnitude of the thermo-electric e.m.f. generated in a homogeneous material subjected to a temperature gradient.

G. F. J. Garlick, then of Birmingham University, reviews the "Electrical Properties of Phosphors"—a subject which has developed for many years past on a mainly empirical basis but is now, as a result of advances in the techniques of controlling the composition of the materials and preparing single crystals and of parallel advances in the understanding of germanium and silicon, taking some larger forward steps which may lead to important applications in illumination and colour television.

The paper by J. Evans, of Standard Telecommunication Laboratories, Enfield, on the "Design of High Frequency Transistors," will interest the application-conscious reader who may, however, find the approach unsatisfying at a number of points. Thus an outline derivation of the expression (equation (9)) for the gain-bandwidth figure of merit, and a more quantitative discussion of the dependence of C_c and r_d on dimensions and resistivity, would have been welcome. No mention is made of punch-through or avalanche multiplication as factors limiting maximum collector voltage in common-emitter circuits, and the relations given for $V_{c,max}$ (equation (10)) are obsolete. A considerable amount of empirical data is given for point-contact transistors, but no indication of their possible future as practically manufacturable devices of good reliability. The diffusion process was unfortunately announced too late for inclusion in this paper.

O. Garreta and J. Grosvalet, of Paris, present an original and clear restatement of the known theory of the "Photo-Magneto-Electric Effects in Semiconductors," bringing out some points not obvious in previous presentations (e.g. the significance of the simple and "ambipolar" diffusion constants for the minority carriers), and correcting some previous theoretical results. Equipment for measuring bulk lifetime and surface recombination velocity is described.

The final paper, by L. R. Godefroy, of Paris, reviews the theory of the "Field Effect in Semiconductors," confining itself mainly to the surface conductance changes associated with "channel" and "anti-channel" layers in the presence of external normal electric fields. The materials considered experimentally are selenium, tellurium and copper-oxide.

Each paper is well provided with references and the book contains a short subject index. In view of the general delays inevitable in book-publishing and the continuing rapid advances in the subjects covered, this collection is remarkably well up to date.

F. F. R.

U.D.C. 621.315.212:621.395.44:621.397.24

The coaxial line equipment described in this article (C.E.L. No. 4A) has been developed from an earlier type of equipment (C.E.L. No. 4), which was first used to provide a television circuit between Birmingham and the Holme Moss television station. The new equipment is suitable, without alteration, for the transmission of either 17 telephony supergroups (1,020 circuits) or a television signal of 3-Mc/s video band-width. At each station on a route main and standby line amplifiers and line simulators with automatic change-over provide a safeguard against interruption of service, and a comprehensive supervisory system enables faults to be rapidly localized and corrected. The equipment operates entirely from an a.c. mains supply, power being fed over the cable to a maximum of three dependent stations on each side of a power-feeding station.

INTRODUCTION

THE urgent need to use standard $\frac{3}{8}$ -in. coaxial cable pairs in the United Kingdom for the transmission of television signals led to the introduction, in 1951, of a standard line equipment, Coaxial-Equipment, Line, (C.E.L.) No. 4, for this purpose. The equipment was first used for a link between Birmingham and the television station at Holme Moss.^{1,2} Although C.E.L. No. 4 was intended for the transmission of television signals only, the amplifiers were designed to meet the requirements of both television and telephony. Other features of the system, however, precluded its use for telephony and the subsequent policy that all new coaxial cable links on main routes should be suitable, without alteration, for the transmission of telephony or television led to the further development of C.E.L. No. 4 and resulted in C.E.L. No. 4A, the equipment described in this article.

The main changes made to C.E.L. No. 4 are as follows:

- Redesign of the transmit line amplifier to provide the increased gain needed at the transmit terminal station when the system is used for telephony.
- Improvement in the arrangements for measuring and displaying the levels of the 308-kc/s and 4,340-kc/s pilot signals at terminal stations, including redesign of the pilot-stop and pilot-selection filters to meet the more stringent requirements of telephony.
- Rearrangement of the equipment so that when provided for television it can be installed as either two channels in the same direction of transmission or two in opposite directions.
- Redesign of the supervisory system to give separate control and supervision of the two h.f. channels.
- Replacement of the unbalanced power-feeding system by one that is balanced with respect to earth, to avoid interfering with audio-frequency circuits on the layer pairs of the cable.

The opportunity was also taken to make a number of minor improvements, some of which were the result of experience gained with C.E.L. No. 4.

C.E.L. No. 4A is suitable, without alteration, for the transmission of 17 telephony supergroups (1,020 circuits) or a television signal of 3-Mc/s video band-width, which, with a pilot signal at 4,340 kc/s, results in the frequency band 60–4,340 kc/s being used. The equipment is primarily intended for use with the Post Office standard 375E-type coaxial cable pair, which has an outer conductor of 0.375-in. internal diameter and polythene disk separators, but it can be made suitable for other types of cable by the use of additional equalizing networks. With 375E-type coaxial cable the repeater station spacing does not normally exceed six miles.

Duplicate line amplifiers are provided at each station, with automatic change-over under the control of a 308-kc/s pilot signal. In addition, a comprehensive supervisory system enables the amplifiers to be remotely switched and supervised from the control terminal station.

The equipment operates entirely from an a.c. mains supply and power is fed over the cable at 1,000V r.m.s., 50 c/s, to a maximum of three intermediate stations on each side of a power-feeding station.

HIGH-FREQUENCY EQUIPMENT

The principles of design of the high-frequency path of a coaxial cable system have been outlined in the Journal in a recent article³ and will not be repeated here. The notable features of the high-frequency equipment of C.E.L. No. 4A are the shaped-gain line amplifiers with 75-ohm input and output impedances and the use of simple equalizing networks at each station to compensate for the effects of changing cable temperature.

The shape of the line amplifier gain/frequency characteristic is designed to compensate accurately for the transmission loss of six miles of standard coaxial cable (375E type) at 22°C, which was considered to be the highest cable temperature likely to be met in practice. The loss of repeater sections less than six miles in length is built out by means of line simulators, which are strapped into circuit as required. At lower temperatures the loss of the cable is less than at 22°C, but the total loss is kept constant by the addition of temperature equalizers. They are switched into circuit at stations along the route in accordance with a planned schedule to restrict changes of amplifier output level. At the receiving terminal station a variable temperature equalizer enables variations to be reduced to a minimum; its loss is adjustable in six steps, each equal to one quarter the loss of the fixed temperature equalizer.

At each station the standby line amplifier and line simulator are switched into circuit automatically on the failure of the 308-kc/s pilot signal. At the receiving terminal station the 308-kc/s pilot signal operates a h.f. regulator (automatic-gain-control circuit) which compensates for changes in the transmission gain of the system, changes of ± 3 db being reduced to ± 0.1 db. The levels of the 308-kc/s and 4,340-kc/s pilots, before and after passing through the variable temperature equalizer and h.f. regulator, are displayed on pilot-deviation meters. This enables the performance of the system to be checked and indicates when it is necessary to change the setting of the variable temperature equalizer or to switch temperature equalizers in or out of circuit at stations along the route.

Terminal Station Transmit H.F. Channel.

The transmit h.f. channel at a terminal station is shown in simplified form in Fig. 1. The telephony or television signal input to the coaxial line is combined with the two pilot signals by a resistive network before passing through

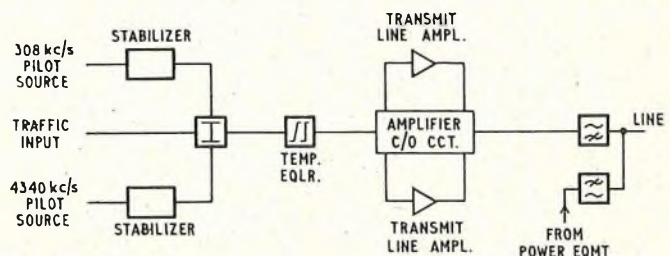

FIG. 1.—SIMPLIFIED BLOCK SCHEMATIC DIAGRAM OF TRANSMIT H.F. CHANNEL AT A TERMINAL STATION.

† Senior Executive Engineer, Transmission and Main Lines Branch, E.-in-C.'s Office.

the temperature equalizer, when in circuit, and the main or standby transmit line amplifier. The composite signal is combined with the 50-c/s power-feeding current by high-pass and low-pass filters in the cable termination box, in which are terminated the coaxial cable pairs.

The 308-kc/s and 4,340-kc/s pilot signals may be obtained from crystal oscillators mounted on the line-equipment rack, from the station carrier-generating equipment, or from a preceding coaxial cable link. The levels of the pilot signals are maintained constant by the pilot stabilizers shown in the diagram. The 308-kc/s pilot signal may, alternatively, be derived from a 60-kc/s standard-frequency signal from the carrier-generating equipment by means of a 60/308-kc/s frequency converter.

Intermediate Station.

At an intermediate station the two h.f. channels are identical, each being arranged as shown in Fig. 2. The h.f.

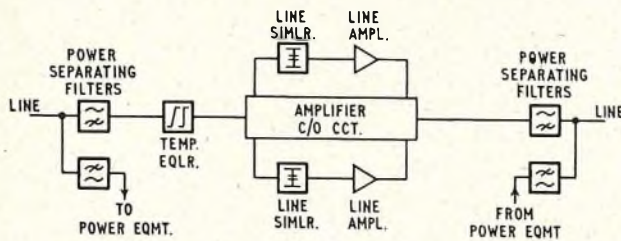

One h.f. channel only is shown; the other is identical.

FIG. 2.—BLOCK SCHEMATIC DIAGRAM OF H.F. CHANNEL AT AN INTERMEDIATE STATION.

signal is separated from the power-feeding current by the filters in the cable termination box and then passes via the temperature equalizer, if in circuit, and the line simulator to the line amplifier. After amplification it is re-combined with the power-feeding current and transmitted to line.

Terminal Station Receive H.F. Channel.

Fig. 3 is a simplified block schematic diagram of the receive h.f. channel at a terminal station. The power-separating filters, temperature equalizer, line simulator and line amplifier perform the same function as at an intermediate station, and are followed by the main or standby residual attenuation equalizer and delay equalizer, the combined losses of which are compensated by the following flat-gain amplifier. At the output of the amplifier the levels of the two pilot signals are monitored, each monitoring circuit consisting of a band-pass filter followed by a pilot measuring panel (an amplifier-detector) and a meter.

The variable temperature equalizer and h.f. regulator together correct the gain of the system at 308 kc/s and 4,340 kc/s. A flat-gain amplifier compensates for the loss of these circuits and is followed by the pilot-stop filters, which prevent the pilot signals passing into the translating equipment or another coaxial cable link. The loss of the filters is compensated by a final flat-gain amplifier.

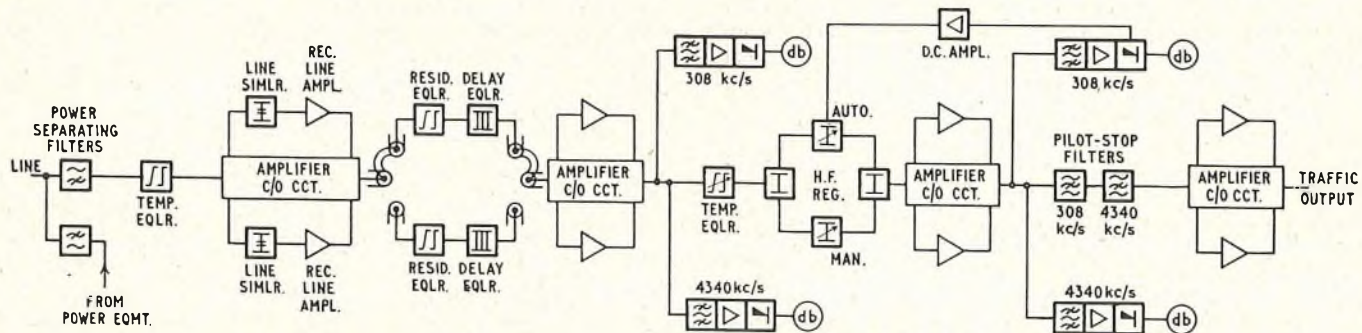

FIG. 3.—SIMPLIFIED BLOCK SCHEMATIC DIAGRAM OF RECEIVE H.F. CHANNEL AT A TERMINAL STATION.

At the output of the h.f. regulator amplifier the levels of the pilot signals are monitored in a similar manner to that already described. The 308-kc/s signal, after rectification and d.c. amplification, is used to control the h.f. regulator, which consists of an attenuator with an indirectly-heated thermistor as the variable element. When necessary, the thermistor control is replaced by manually adjusted coarse and fine gain controls.

Line Amplifier.

The line amplifier (Fig. 4) consists essentially of two 3-stage negative-feedback amplifiers in tandem. The input section provides the greater part of the rising gain/frequency

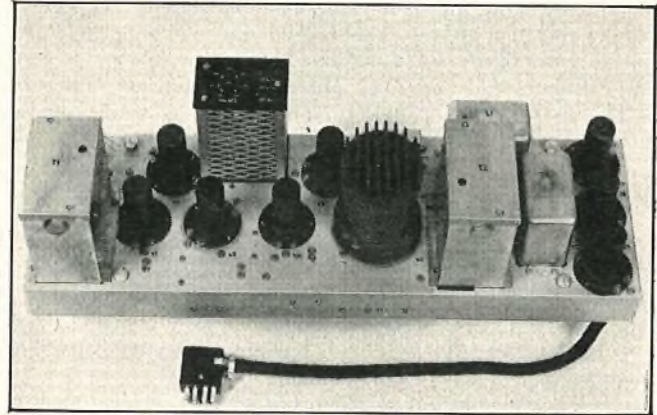

FIG. 4.—LINE AMPLIFIER.

characteristic and the output section has a gain/frequency characteristic that is substantially flat. The characteristic of the input section is shaped by the cathode-to-cathode feedback network between the first and third valves and the coupling network in the anode circuit of the third valve, supplemented at the lower frequencies by an equalizer in the input coupling network. The input and output transformer networks provide 75-ohm terminations for the cable; the return loss of these against a 75-ohm resistor is greater than 20 db.

The transmission gain of the amplifier is adequate to compensate for the maximum permissible transmission loss of six miles of 375E-type coaxial cable pair at 22°C plus the transmission loss of the power-separating filters and wiring of an intermediate station rack. At 60 kc/s the gain is about 8 db and at 4,400 kc/s it is about 52 db. The overload point is at least +26 dbm* at the amplifier output and the signal/harmonic ratio, measured with an output level of +10 dbm at 1,000 kc/s, is better than 75 db for second harmonics and 90 db for third harmonics. The power-handling capacity of the amplifier is sufficient to allow the use of a high-level-carrier type of television signal, such as that generated by the frequency-translating

* dbm—decibels relative to 1 mW.

equipment designed for the Birmingham-Holme Moss television cable system.⁴

The amplifier is very similar to the C.E.L. No. 4 line amplifier, the design of which has been described in detail elsewhere,⁵ but a number of changes have been made. The cores of the input and output transformers have been changed from rings of Rhometal tape to Ferroxcube pot cores, resulting in greatly simplified construction and some improvement in performance. The gain at frequencies below 60 kc/s has been reduced to avoid an excessive build-up of gain along a route, which on C.E.L. No. 4 links reached a maximum at about 30 kc/s and had to be corrected by low-frequency equalizers external to the amplifiers. Lastly, resulting from experience with the C.E.L. No. 4 amplifiers, a number of changes in components and mechanical details have been made which, it is expected, will result in increased reliability.

A 308-kc/s pilot-selector unit is mounted on the same chassis as the line amplifier. This provides a d.c. output to control the automatic change-over of the amplifiers.

Flat-Gain Amplifiers.

The flat-gain amplifiers are of two types. The first, used as a terminal-station transmit line amplifier, is similar in general circuit arrangement to the intermediate-station and receive-terminal line amplifier but the gain is 40 db at all frequencies from 60 kc/s to 4,400 kc/s. A 308-kc/s pilot-selector unit is mounted on the same chassis.

The second amplifier, which is used in the receiving h.f. channel at a terminal station to compensate for the loss of equalizers, the h.f. regulator and the pilot-stop filters, has a gain of 27 db. The circuit is the same as that of the flat-gain output section of the line amplifier, with the addition of an input transformer. The amplifier is very similar to the flat-gain amplifier used on C.E.L. No. 4 links⁵ but it incorporates a number of improvements, including a similar change of input and output transformers to that described above for the line amplifier.

Equalizers and Line Simulators.

The greater part of the attenuation equalization is provided by the shaped gain/frequency characteristic of the line amplifiers, but with the majority of repeater sections it is necessary to build out the loss to that of six miles of cable by the use of line simulators. These consist of bridged-T networks simulating the loss of 0.2, 0.4, 0.8 and 1.6 miles of cable and can be strapped into circuit as required. At terminal stations a 0.1-mile line simulator is fitted in the receive h.f. channel, in addition to the standard simulators, for fine adjustment. When the equipment is used with coaxial cables other than the 375E type it will usually be necessary for the loss/frequency characteristic to be matched to the gain/frequency characteristic of the amplifier by means of simple "difference equalizers" at each station. No change to the temperature equalizers should normally be necessary.

The small errors of equalization introduced by the line amplifiers and line simulators, about 0.25 db per repeater section, are corrected by residual attenuation equalizers, usually at the receiving terminal station only.

The delay distortion of a link is corrected at the receiving terminal station by delay equalizers consisting of a number of all-pass networks in tandem. These are designed specially for each route, the minimum number of networks necessary to meet the specified requirements being used as this assists in reducing television waveform distortion caused by multiple reflections between the different networks, and hence eases the problem of overall correction of video-frequency wave-form distortion.

Pilot-Stop Filters.

The pilot-stop filters at a receive terminal station suppress the pilot signals by at least 45 db. The 4,340-kc/s filter is a conventional crystal filter but the 308-kc/s filter is of special design to avoid spurious stop bands in the pass bands of the filter due to secondary resonances of the crystals; this is particularly important when the equipment is used for telephony. The filter consists of a matched pair of coil-and-capacitor band-pass and band-stop filters connected in parallel at both ends to form an all-pass network, the pass and stop bands being about 60 kc/s in width and centred on 308 kc/s. A number of crystal resonators are shunted across the band-pass filter and result in a narrow stop band centred on 308 kc/s. The secondary resonances of the crystals can be arranged to fall in the stop bands of the band-pass filter and do not interfere with the transmission of signals at these frequencies, which are then passing through the band-stop filter.

Crystal pilot-stop filters were not necessary on C.E.L. No. 4 because of the less stringent requirements of a system when used for television only, owing to the large separation between the pilot frequencies and the television band (556 kc/s to 4,056 kc/s), and it was possible to use simple coil-and-capacitor filters.

Pilot Measuring Equipment and H.F. Regulator.

To cater for the more stringent requirements of telephony, owing to the small difference in frequency between the pilot signals and adjacent telephone channels, the coil-and-capacitor pilot-selection filters used on C.E.L. No. 4 have been replaced by crystal filters. The pilot measuring panels have also been redesigned to have increased gain and to provide additional d.c. outputs to operate recording decibelometers. Alternating-current outputs at 308 kc/s and 4,340 kc/s have also been provided. The 308-kc/s output, in conjunction with a 308/60-kc/s frequency converter, can be used for frequency checking or synchronization in the carrier-generating equipment.

The circuits of the h.f. regulator and variable temperature equalizer have also been redesigned and the mechanical arrangement has been simplified.

Cable Termination Box.

The cable termination box has been redesigned to reduce crosstalk, to allow higher power-feeding voltages and currents to be used, and to reduce the possibility of inter-modulation occurring in the iron-cored inductors of the power-separating filters. The capacitors in the filters are now oil-filled to prevent the formation of voids in the dielectric with consequent danger of ionization, which would result in loss of reliability and interference with the transmission of television signals.

SUPERVISORY SYSTEM

The use of main and standby line amplifiers and line simulators makes it necessary to provide a comprehensive supervisory system to monitor the operation of the automatic change-over circuits at each station, to enable the amplifiers and associated line simulators to be remotely switched into circuit as required from the control terminal station, and to indicate whether the main or standby amplifiers are in use at each station. With such a system it is also possible, with little complication, to indicate whether the temperature equalizers at each station are in circuit. It is also desirable, particularly with links used for television, that it should be possible to control independently the amplifiers in the two separate h.f. channels. The C.E.L. No. 4A supervisory system provides these and other facilities, including the extension of alarms to the control terminal station. A 4-wire speaker circuit connecting all stations on a route is also provided.

In addition to providing safeguards against complete interruption of service, the supervisory system, in conjunction with the duplicated equipment at each station, is a valuable aid to maintenance. Intermittent faults, excessive basic or intermodulation noise, and faults causing only small changes in gain can usually be speedily located from the terminal stations and service temporarily restored to normal without visiting intermediate stations.

The supervisory system and speaker circuit together make use of six interstice cable pairs; four of them are amplified at each station.

Automatic Change-over of Amplifiers.

The main amplifier and its associated line simulator are normally in circuit at each station under the control of the 308-kc/s pilot signal, the level of which is continuously monitored at the amplifier output by the pilot-selector unit. If the level falls appreciably, due to a fault, the standby amplifier is switched into circuit. The output of the standby amplifier is also monitored and if the pilot is present, or appears subsequently, the main amplifier is retested and if the pilot is present at a satisfactory level the main amplifier is switched back into circuit.

At each station keys are provided for testing the automatic change-over circuit and for locking either amplifier in circuit, thus overriding switching signals from the control terminal station, if it is necessary to withdraw an amplifier for maintenance.

Remote Switching and Supervision of Amplifiers.

The remote switching and supervision of amplifiers is effected by combinations of d.c. and audio-frequency signals which are transmitted between stations over two amplified interstice cable pairs. Each station is identified by a particular frequency and the remote switching function is identified by one of eight combinations of d.c. signals.

Each dependent station continuously transmits its individual-frequency audio signal to the control terminal station while the main amplifier is in circuit. When the standby amplifier is brought into use the signal is disconnected, and if the main amplifier is locked in circuit the signal is connected and disconnected at approximately 0.75-sec intervals.

At the control terminal station one indicator lamp is provided for each station on the route to indicate the state of its amplifiers. A main amplifier in circuit under pilot control is indicated by the lamp being extinguished, a main amplifier locked in circuit is shown by the lamp flashing at 0.75-sec intervals, and a standby amplifier in circuit is indicated by the lamp glowing continuously. If at a particular station the state of the amplifiers of the two h.f. channels is not the same, then the more important condition only is signalled to the control terminal station—"standby amplifier in circuit" in preference to "main amplifier locked in circuit," and "main amplifier locked in circuit" in preference to "main amplifier in circuit under pilot control." Operation of a key at the control terminal station allows the state of the amplifiers of first one channel and then the other channel to be displayed.

The remote switching of amplifiers is controlled from the H.F. Supervisory Control Panel at the control terminal station. By operating the appropriate keys the following amplifier-switching functions can be performed on each of the two h.f. channels at one or a number of stations:

- (a) Lock main amplifier in circuit.
- (b) Lock standby amplifier in circuit.
- (c) Unlock amplifier (i.e. restore it to the control of the 308-kc/s pilot signal).

On a long route the d.c. line signals take about 1 sec to travel from one end of the route to the other. This, coupled with the operate and release lags of the supervisory

selectors (signalling receivers) at each station, which are operated by the audio-frequency signals sent out from the control terminal station to select the required station, makes it necessary to arrange the circuit of the H.F. Supervisory Control Panel to ensure that the signals are applied and removed in the correct sequence and are appropriately delayed to avoid false switching. The arrangement is such that amplifiers cannot be switched unintentionally by incorrect operation of the keys.

Miscellaneous Supervisory and Alarm Facilities.

Temperature-Equalizer Display.—At the control terminal station the temperature equalizers in circuit in each h.f. channel can be separately indicated on a lamp-display by operating a key on the H.F. Supervisory Control Panel. This transmits a combination of d.c. signals to all stations on the route, the effect of which is to disconnect the amplifier supervisory circuits from the line while the key is held operated and replace them by circuits under the control of relays associated with the temperature equalizers.

Power and L.F. Supervisory Alarms.—Failure of one of the power supplies at a station or failure of a speaker-circuit amplifier operates an alarm at the control terminal station by looping the wires of one of two interstice cable pairs. The station can be identified from the control terminal station by measuring the resistance to the station with the fault by means of a temperature-compensated Wheatstone bridge circuit.

Measurement of Cable Temperature.—The temperature of the cable can be measured by a Wheatstone bridge circuit, which measures the resistance of two wires of the interstice cable pairs used for the extension of the l.f. supervisory and power alarms, the two wires being permanently looped together at the remote terminal station. Knowledge of the cable temperature supplements the information obtained from the pilot-deviation meters about changes in cable loss and helps to ensure that temperature equalizers are not unintentionally switched to correct faults.

Improvements to the Supervisory System.

Apart from the radical changes to C.E.L. No. 4 that resulted in the features of the supervisory system described above, a number of other improvements have been incorporated in the C.E.L. No. 4A supervisory system. High-speed relays have replaced the 3,000-type relays used in C.E.L. No. 4 for repeating the d.c. line signals at each station and this, in conjunction with other changes, has greatly increased the speed of signalling. The circuit of the supervisory and ringing selector has been changed, the rectified-reaction detector circuit being replaced by a degenerative circuit of improved performance. The circuit used previously gave a good toggle action suitable for relay operation but was greatly affected by power supply changes and valve characteristics. The new circuit gives adequate current discrimination for relay operation and is much more stable. On C.E.L. No. 4 the low-level audio-frequency supervisory signals were connected to line via a number of silver relay contacts in series, but on C.E.L. No. 4A the signals are connected to line via only two platinum contacts in parallel to reduce the possibility of faults due to dry contacts. Lastly, the h.f. line amplifiers are now held in circuit by mechanically-latched relays, thus avoiding false switching if a control circuit fails and enabling new switching operations to be performed without disturbing conditions set up by previous switching operations.

Speaker Circuit.

A 4-wire speaker circuit connects all stations on a route. By a combination of audio-frequency and d.c. signals (on the phantom circuits) the control terminal station can selectively

call each station on the route, the remote terminal station can call the control terminal station, and each intermediate station can call the two terminal stations.

POWER SUPPLIES AND POWER FEEDING

The equipment at all stations is operated from 50 c/s a.c. supplies, and power is fed over the cable to dependent intermediate stations from terminal and intermediate power-feeding stations.

Rack Power Supplies.

Each rack of equipment obtains its power supplies from a standard power panel of conventional design which provides 6.3V and 4.0V a.c. heater supplies, a 250V d.c. h.t. supply and 40V and 60V d.c. supplies for the relay and miscellaneous circuits and for line signalling.

Power Feeding.

Power can be fed over the cable from the terminal stations to a maximum of three intermediate stations and from an intermediate power-feeding station to a maximum of three stations on each side. Power is fed from the power-feeding station at 1,000V a.c. over the centre conductors of the coaxial pairs, which are arranged as a balanced circuit to minimize interference with circuits on layer pairs in the cable. The general arrangement is shown in Fig. 5.

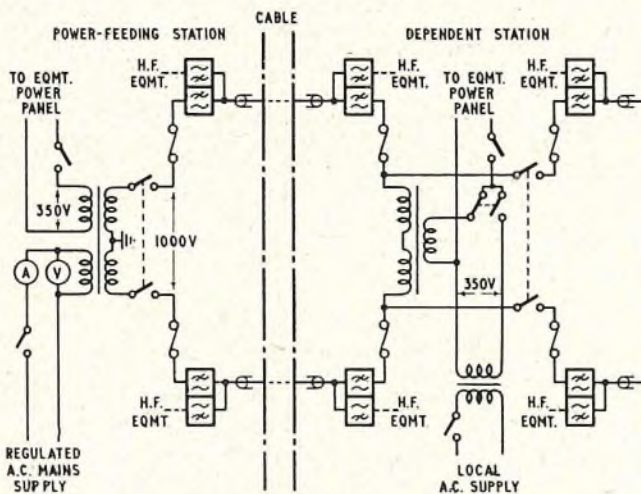

FIG. 5.—POWER-FEEDING CIRCUIT.

When it is necessary to work on the cable, power is disconnected from the section concerned and the stations are operated from a local supply (usually the local mains supply).

Safety Precautions.

Elaborate precautions are taken to ensure the safety of staff working on the cable and equipment. The connexion of power to the cable is controlled by switches operated by Yale-type keys, which form the basis of the power protection system. This is the same as that used on most other coaxial cable systems in the United Kingdom and has been described recently in the Journal.^{3,6}

EQUIPMENT ARRANGEMENT

Intermediate Station.

The line equipment at each intermediate station is normally mounted on one 7-ft 6-in. double-sided rack, as illustrated in Fig. 6, which shows the equipment for two line links (four coaxial pairs). Alternatively, the equip-



The installation shown is for four coaxial pairs.
FIG. 6.—INTERMEDIATE STATION.

ment may be mounted on 9-ft or 10-ft 6-in. racks to enable it to be installed *en suite* with other types of equipment. At the top of the rack the coaxial cable pairs are led into the cable termination box, which is divided into four separate compartments and contains the power-separating filters. The two large panels contain the remainder of the h.f. equipment and the smaller panels between them mount the relays, keys and other components used for the local and remote control of the amplifiers.

The remaining panels are associated with the power supplies for the rack, the supervisory system and the speaker circuit. Also included are connexion strips for terminating the interstice cable pairs used for the supervisory and speaker circuits, and coaxial connexion strips which, by inserting the appropriate straps, allow the amplifiers to be associated with the coaxial pairs in the same or opposite direction of transmission without changing the order in which the underground cable pairs are terminated in the cable termination box.

Terminal Stations.

At the terminal stations the equipment is divided among several double-sided racks on a functional basis. The h.f. equipment occupies one rack in the transmit direction and two racks in the receive direction of transmission and the equipment for the supervisory and speaker circuits occupies two racks at the control terminal station and one rack at the remote terminal station.

This arrangement of the racks enables the equipment for control and remote terminal stations to be assembled from a minimum number of different types of rack. It also allows the direction of transmission of a channel to be changed without serious difficulty by interchanging the appropriate racks between the terminal stations and altering straps at the intermediate stations.

A view of the remote terminal equipment on a route with the two h.f. channels working in opposite directions of transmission is shown in Fig. 7.

The line terminal equipment may be mounted on 10-ft 6-in., 9-ft, or 7-ft 6-in. racks to cater for installation in older-type repeater stations, modern repeater stations designed primarily for 51-type equipment, or at renters' premises such as television transmitting stations.

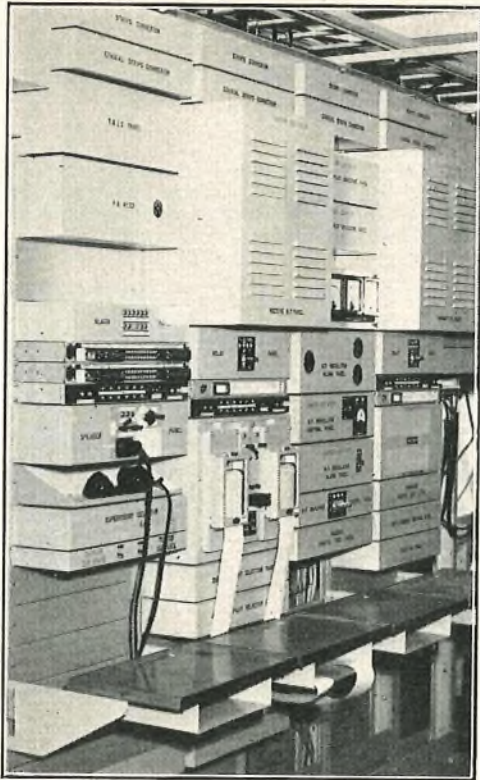

The equipment shown is on 7-ft 6-in. racks.
 FIG. 7.—REMOTE TERMINAL STATION.

Power-Feeding Equipment.

The transformers, switches, fuses and other items associated with the power-feeding circuit are mounted on 6-ft 5-in. single-sided racks, which are installed against a wall of the repeater station, either in the power room or adjacent to the line equipment in the apparatus room.

INSTALLATION TESTING

The installation testing and lining up procedure follows the methods used on 10-supergroup telephony links equipped with C.E.L. No. 2B. These have been described in a recent article in the Journal.⁶ There are, however, two important differences. The C.E.L. No. 4A line amplifiers and line simulators match the cable characteristics with great precision, and it is possible to calculate the settings of all line simulators and strap the appropriate simulator sections into circuit before the h.f. line-up commences, with confidence that few of the simulators will need to be altered. This, coupled with the fact that residual attenuation equalizers are usually needed at the receiving terminal station only, greatly simplifies the line-up and ensures that it can be quickly completed.

Book Review

"Introduction to Electrical Engineering." George V. Mueller. McGraw-Hill Publishing Co., Ltd. 466 pp. 435 ill. 56s. 6d.

This is an elementary engineering text book written by the Professor of Electrical Engineering at Purdue University, primarily for the use of his own students. The author starts with Ohm's Law, and develops his subject gently, by the juxtaposition of descriptive experiments and worked examples, to a level corresponding to that of the Ordinary National

Great stress is, however, placed on the need to check that the measured results agree closely with the expected results, which are obtained by calculation from the known characteristics of the cable and equipment. The other difference is that on C.E.L. No. 4A routes the group-delay/frequency characteristics of the h.f. channels must be measured and delay equalizers constructed and fitted.

Overall gain/frequency and group-delay/frequency characteristics for a typical link are shown in Fig. 8 and Fig. 9.

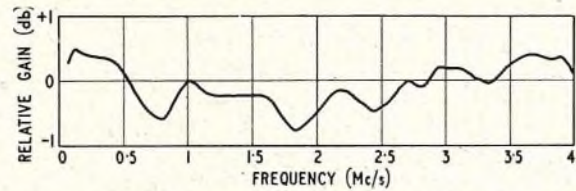

FIG. 8.—TYPICAL OVERALL GAIN/FREQUENCY CHARACTERISTIC.

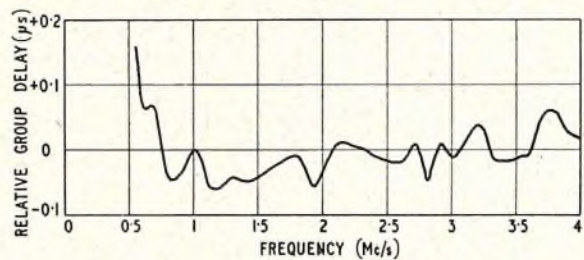

FIG. 9.—TYPICAL OVERALL GROUP-DELAY/FREQUENCY CHARACTERISTIC.

ACKNOWLEDGMENTS

Acknowledgments are due to the author's colleagues in the Transmission and Main Lines Branch and RC Division of Research Branch of the E.-in-C.'s Office who took part in the development of C.E.L. No. 4A, and to the manufacturers, The General Electric Co., Ltd., for their willing co-operation and valuable assistance.

References.

- ¹ HALSEY, R. J., and WILLIAMS, H. The Birmingham-Manchester-Holme-Moss Television-Cable System. *Proceedings I.E.E.*, Paper No. 1274, Apr. 1952 (Vol. 99, Part IIIA, p. 398).
- ² HALSEY, R. J., and WILLIAMS, H. The Birmingham-Manchester-Holme-Moss Television-Cable System. *P.O.E.E.J.*, Vol. 46, pp. 118 and 171, Oct. 1953 and Jan. 1954.
- ³ COLLIER, M. E., and SIMPSON, W. G. A New 4-Mc/s Coaxial Line Equipment—C.E.L. No. 6A. *P.O.E.E.J.*, Vol. 50, p. 24, Apr. 1957.
- ⁴ ROCHE, A. H., and WEAVER, L. E. Television Frequency-Translating Terminal Equipment for the Birmingham-Holme-Moss Coaxial Cable. *Proceedings I.E.E.*, Paper No. 1345, Apr. 1952 (Vol. 99, Part IIIA, p. 455).
- ⁵ DUERDOTH, W. T. The Design of Amplifiers for the Birmingham-Manchester Coaxial Cable. *Proceedings I.E.E.*, Paper No. 1288, Apr. 1952 (Vol. 99, Part IIIA, p. 385).
- ⁶ WATKINS, A. H. Setting Up and Testing a Coaxial Line Link for Telephony. *P.O.E.E.J.*, Vol. 49, p. 98, July, 1956.

Certificate in Electrical Engineering. A more advanced chapter has been added on magnetic and electrical field calculations. The style is clear, although at times it is somewhat verbose, and there are numerous calculations throughout the text. Elementary calculus is freely used where it provides advantageous methods of analysis.

This is a refreshing type of text book, but it is undoubtedly expensive by comparison with many English text books of the equivalent coverage and does not possess advantages commensurate with its relatively high price.

C. F. F.

The Use of Thermistors to Suppress Bell Tinkling on Shared-Service Lines

F. A. WILSON, C.G.I.A., A.M.I.E.E., A.M.Brit.I.R.E.†

U.D.C. 621.316.89:621.395.331.3

When shared service was first introduced on exchange lines, bell tinkling, due to one of the two subscribers dialling or operating the receiver-rest, was suppressed by means of a slow-to-operate relay. A thermistor connected in series with each subscriber's bell is now used for this purpose, at appreciably less cost, and this article describes the investigation made to ensure that the thermistors used would function satisfactorily under all conditions likely to be encountered in practice.

INTRODUCTION

THE present need for shared-service working in the British telephone system and the problems associated with the provision of this type of service have been discussed in a previous article.¹

One of the problems encountered at the outset was the prevention of the tinkling of one subscriber's bell while the other subscriber was dialling or operating the receiver-rest. The Bell Set No. 41 (rectifier network and slow-to-operate relay) was a complete answer to the problem technically and was the method used on the introduction of the scheme; it was, however, bulky, expensive and often required extra cabling. The attractions of a cheaper and more compact device, such as the thermistor,² were evident from the beginning. When connected in series with the bell, it appeared capable of solving the problem by maintaining a high resistance for tinkling pulses but a low resistance for ringing voltages. A field trial of 1,000 items soon confirmed its capabilities.

The thermistor is a device in which temperature determines resistance, and its characteristics other than that of resistance/temperature are also modified by ambient temperature changes; it was therefore essential that a complete survey of its efficacy in preventing bell tinkling should be made at all temperatures likely to be encountered in the U.K. This article describes the experimental work carried out to determine the maximum deviation allowable in the thermistor characteristics to ensure satisfactory operation in the network with little possibility of the device proving a maintenance liability.

PROPERTIES OF THERMISTORS

A thermistor is a thermally sensitive resistor made of a semi-conductor having a large negative coefficient of change of resistance with temperature; it is essentially non-reactive. When the property of large resistance changes is required, it is obtained by dissipating electrical power within the thermistor material itself (directly heated) or by raising the temperature by means of a heater coil wound round the material but insulated from it (indirectly heated). Resistivity changes of 500:1 are possible. Resistance changes also occur due to variations in ambient temperature, and formulae relating to these, together with other characteristics of any particular type of thermistor, are published by the manufacturer. The complete process of manufacture has already been described in this Journal.³ Further description is limited to the one type that appeared to have the desired characteristics, the A2552/100 (2×10^5 ohms at 20°C with zero power input, falling to approximately 5×10^2 ohms for 100 mW dissipation); it is a directly-heated bead-type thermistor, now coded by the British Post Office "Thermistor No. 1A." (Fig. 1.)

For this application two characteristics are of importance:

(a) The relationship between resistance and ambient temperature (no heat generated electrically). This is shown in Fig. 2. The resistance is seen to increase to more than four times its normal value at 20°C when the temperature falls to -10°C.

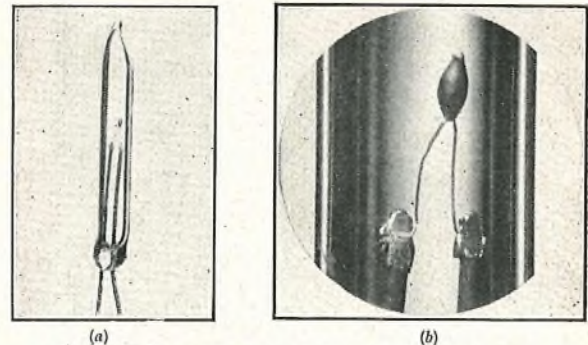

(a) Complete thermistor, about one and a half times full size.
(b) Thermistor bead, about eight times full size.

FIG. 1.—THERMISTOR NO. 1A.

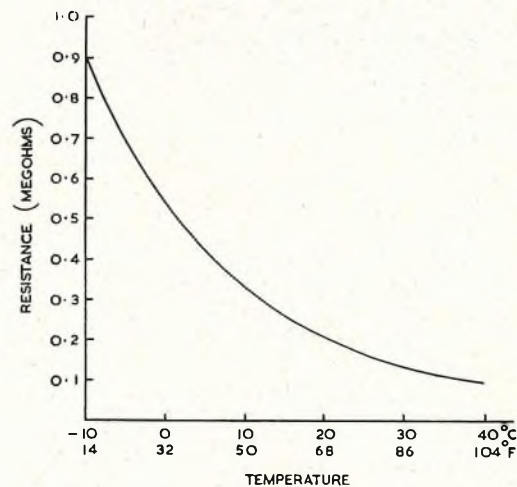

FIG. 2.—CHANGE OF RESISTANCE WITH VARIATION OF AMBIENT TEMPERATURE.

(b) The relationship between voltage applied to a thermistor and the resultant current. Fig. 3 shows a family of such curves for a typical Thermistor No. 1A. As the current is increased from zero the voltage at first rises rapidly and proportionally, and the thermistor is therefore behaving as a normal resistance obeying Ohm's Law. Further increase of current brings the voltage to a maximum value and thereafter the thermistor characteristic of negative incremental resistance (dV/dI) is obtained. This turnover point is usually designated E_{max} , and unless the applied voltage at first exceeds E_{max} the negative incremental resistance property cannot be achieved. Fig. 3 further shows how E_{max} rises as ambient temperature falls; in fact, it is approximately related to the "no-current" resistance, R_0 , at any given temperature by the expression

$$E_{max} = \frac{\sqrt{R_0}}{k}$$

where k is called the "maximum voltage factor" and is constant for any given type of thermistor. For the Thermistor No. 1A, $k = 20$.

† Executive Engineer, Post Office Research Station.

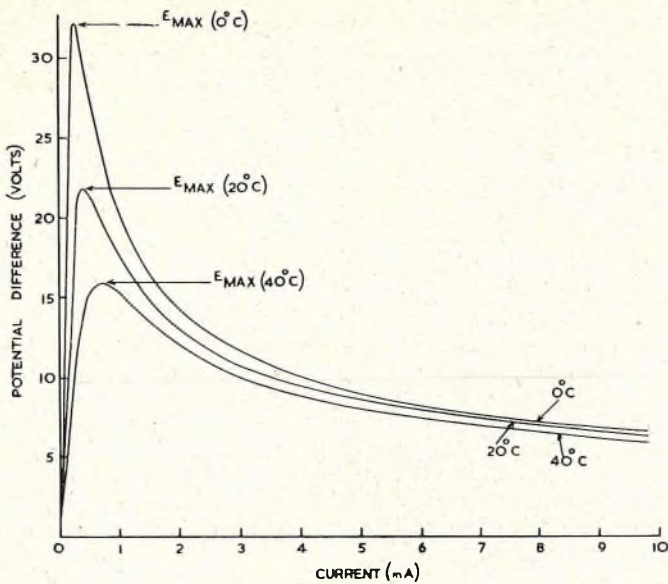

FIG. 3.—RELATIONSHIP BETWEEN APPLIED VOLTAGE AND RESULTANT CURRENT.

POSSIBILITIES OF THE THERMISTOR IN SHARED-SERVICE WORKING

Fig. 4 shows the bell and dial circuits of both subscribers on a shared-service exchange line. When one subscriber

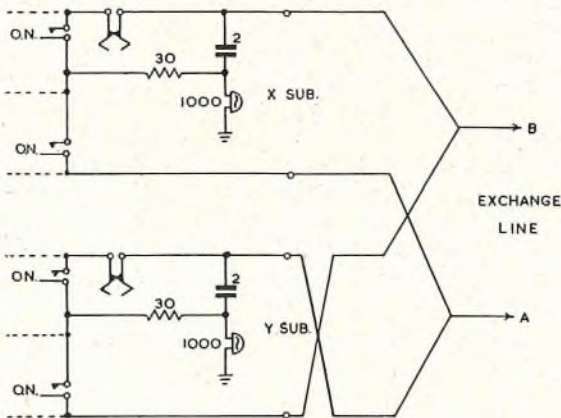

FIG. 4.—SHARED-SERVICE DIALLING AND RINGING CIRCUITS.

(say X) dials, rapid potential changes occur across the line and between each line and earth; the latter are capable of affecting the Y subscriber's bell. A typical train for the digits "42" is shown in Fig. 5 (a) (the inter-digital pause has been deliberately shortened). Since, under dialling conditions, the line is balanced to earth in the exchange

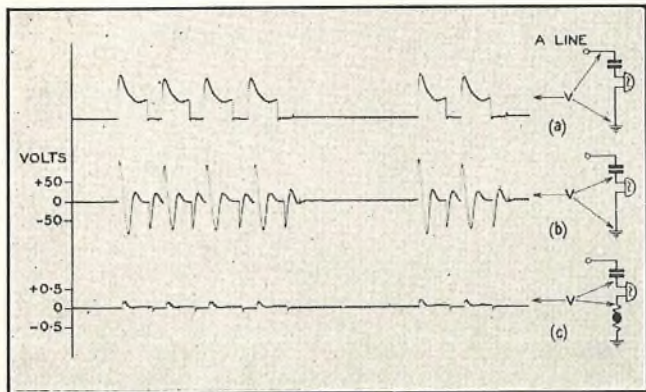

FIG. 5.—VOLTAGES ON Y SUBSCRIBER'S BELL CIRCUIT WHEN X SUBSCRIBER DIALS "42."

selector circuit, the line-to-earth voltages are of the same peak value for both wires. The pulses of Fig. 5 (a) are thus applied to the Y subscriber's bell and capacitor circuit, and after differentiation by the capacitor appear across the bell, as shown in Fig. 5 (b). It will be appreciated that subscriber X dialling has resulted in a low-frequency alternating-waveform being applied to the Y subscriber's bell, and to this the bell responds quite audibly.

The principle involved in connecting a directly-heated thermistor in series with each bell is demonstrated by Fig. 6, which shows the conditions in a thermistor circuit for continuously applied generator voltages at a single ambient temperature. Consider the generator of e.m.f. E connected,

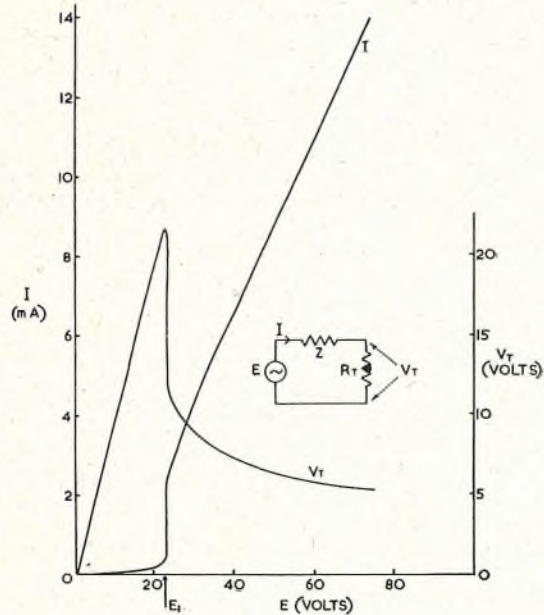

FIG. 6.—VOLTAGE AND CURRENT CONDITIONS IN A THERMISTOR CIRCUIT AT 20°C.

as shown, to a series combination of impedance Z and thermistor of resistance R_t . To make the example realistic, Z represents the total impedance in a party-line ringing-circuit between the generated e.m.f. and the thermistor (e.g., the series impedance of generator, ringing relay, line, capacitor, bell and earth return, say 5,000 ohms at 25 c/s.) Curves are shown of the current in the circuit (i.e., the bell-ringing current) and voltage across the thermistor for a practical range of generator voltages.

When the voltage E_1 is reached (a value corresponding to E_{max} of the static characteristics of Fig. 3), the rate of generation of heat within the thermistor bead exceeds the rate of heat loss, so causing the thermistor temperature to rise and therefore its resistance to fall. Consequently, there is a steep rise in the circuit current and fall in thermistor voltage.

It will be appreciated, however, that the process of change at E_1 occupies a finite time, depending as it does on temperature changes in the thermistor bead.⁴ For applied generator voltages well in excess of E_1 the order of time lag is a small fraction of a second, and thus at 20°C a 75V generator would quickly produce a ringing current of 14 mA, only 1 mA lower than the value when no thermistor is used. Voltages below E_1 result in negligible current owing to the very high thermistor resistance, and those exceeding E_1 but of short duration, as with receiver-rest or dialling pulses, will still be unable to produce large currents owing to the time lag of the change at E_1 . In practice, such voltages are produced virtually at the line terminals of the telephone and therefore Z will have a lower value corresponding to the impedance of the bell and capacitor only; however, this

consideration may conveniently be ignored here since the change in E_1 is small. The property of suppression of "tinkling voltages" is demonstrated practically by Fig. 5, in which the dialling waveforms of (b) are shown to produce an insignificant voltage across the bell in (c), when a thermistor is added to the circuit.

Now E_1 is slightly in excess of E_{max} , and thus E_1 falls as ambient temperature rises, so that, although satisfactory at normal temperatures, when it is very hot the thermistor may not suppress bell tinkling; conversely, at very low temperatures, suppression may be such that normal ringing, especially when intermittent as in automatic working, may be partially or completely suppressed (E_1 for an average thermistor becomes almost 50V at -10°C). This represents a fault condition, and obviously such conditions arising, even very infrequently when the lowest U.K. temperatures are experienced, are undesirable.

It will be appreciated that variations in characteristics may be obtained between items of any one type owing to the fact that the operation of forming the bead on the wires (Fig. 1 (b)) is carried out by hand. Thus, it is essential to reject thermistors whose characteristics are outside the range required.

PERFORMANCE OF THERMISTOR RINGING CIRCUITS AT EXTREME TEMPERATURES

Ringing failure at low temperatures is more likely to occur with automatic than with manual ringing, provided that the latter is of reasonable duration. The standard automatic-ringing cycle consists of 0.4-sec bursts separated alternately by silent periods of 0.2 and 2.0 sec. During the silent periods the thermistor bead is losing the heat accumulated from the previous ring, the effect being greater during the longer period and increasing with decrease of ambient temperature. Fig. 7 illustrates this by oscillo-

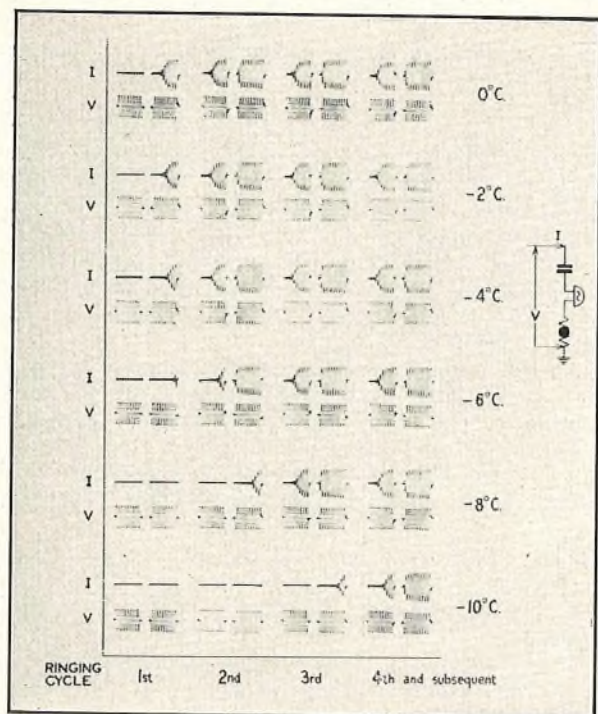

FIG. 7.—CURRENT THROUGH BELL AND THERMISTOR AT LOW TEMPERATURES.

grams showing the voltage applied to a series combination of capacitor, bell and thermistor, with the resultant bell current at temperatures from 0°C to -10°C . The 2.0-sec silent period has been shortened in the photographs for convenience. At 0°C , the thermistor bead heats up during the

first ringing cycle and ringing is then unaffected except for the clipping of the first burst of each subsequent cycle. As the temperature is reduced, the ringing delay increases, while the clipping of the first 0.4-sec burst of each cycle after ringing has commenced becomes greater until at -10°C there is some 9–11-sec delay. Thus there will be some critical low temperature at which the time delay between application of ringing voltage and onset of the audible ring becomes intolerable, and a still lower temperature at which ringing is impossible.

The foregoing considerations call for two decisions:—

- The maximum ringing delay allowable—it was considered that in no case should ringing be suppressed beyond the first burst of the third ringing cycle (i.e., the thermistor in Fig. 7 has a cut-off temperature between -8°C and -10°C).
- The lowest temperature likely to be experienced by a telephone in the British network—a figure of -10°C (14°F) was found from the Building Research Station to be the lowest temperature likely to occur in occupied premises.

Laboratory Tests.

Automatic ringing was used on the assumption that thermistors which gave satisfaction with this would do so when connected to manual exchanges. Ringing conditions were set up, using a 75V, 25-c/s generator, and a 650-ohm resistor was used to represent a long shared-service line (single wire with earth-return).

A batch of thermistors having cold resistances within the normal tolerance of ± 20 per cent was supplied by the manufacturer for the first series of tests. The thermistors were subjected to temperatures at two-degree intervals from $+10^\circ\text{C}$ to -10°C and the exact ringing delay caused by each thermistor at any chosen temperature was measured.

Defining "cut-off temperature" in this instance as "that temperature at which a thermistor, connected in series with a subscriber's bell, completely suppresses the sounding of the bell during the first two ringing cycles," the results for the first ten items gave a range of cut-off temperatures as follows:—

Cut-off temperature	No. of thermistors
$+8^\circ\text{C}$	1
$+4^\circ\text{C}$	1
-6°C	2
-10°C	1
lower than -10°C	5

Further tests on the same batch of thermistors at high ambient temperatures indicated that, except for those having cut-off temperatures lower than about -16°C , all suppressed bell tinkling completely. Evidently, thermistors could be used to suppress bell tinkling even at high ambient temperatures with no liability of causing ringing failure at low temperatures, provided that acceptance tests could be arranged to reject items having cut-off temperatures higher than -10°C .

Obviously, this type of test is not practicable on a production line since, apart from requiring a refrigerator, it is an extremely lengthy process, bearing in mind that each thermistor must be tested, not a small proportion of the total production as is usual with telephone components. Thus, it became essential to find some other, easily measurable parameter having good correlation with cut-off temperature. Several constants were tested for their correlation; e.g., cold resistance, E_{max} , power required to reduce the resistance to a given value, and the time taken for the resistance to fall to a predetermined value with constant applied voltage. Of these, the last showed promise. By means of an experimental tester, operate-times (defined here as "the time taken at a known ambient temperature

and applied potential for the thermistor current to reach a predetermined value") for various applied voltages were measured on thermistors whose cut-off temperatures had already been determined. Fig. 8 shows a typical scatter

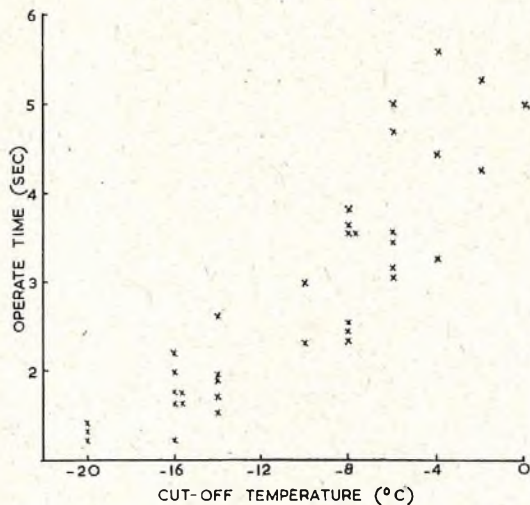

FIG. 8.—RELATIONSHIP BETWEEN OPERATE-TIME AND CUT-OFF TEMPERATURE FOR 36 THERMISTORS NO. 1A.

diagram obtained in this way for 36 thermistors, from which the degree of correlation can be clearly seen. This confirmed the practicability of acceptance-testing by the operate-time method, a fairly quick and convenient operation. Following further similar tests, a specification for the Thermistor No. 1A was written so that unsatisfactory items, both with respect to suppression of bell tinkling at high temperatures and acceptable ringing at low temperatures would be rejected. The specification requires that "the current in each thermistor shall rise to 10 mA in not less than 1.5, nor more than 4.0 sec, after the application of 36V through a resistance of 2,070 ohms, the ambient temperature being $20^{\circ}\text{C} \pm 1^{\circ}\text{C}$."

It is evident from Fig. 8 that, using this time range, some thermistors with cut-off temperatures somewhat higher than -10°C will also be accepted. Temperatures as low as this are, however, rare in occupied premises in the British Isles, and even if these particular thermistors are exposed to them it is probable that with normal ringing voltages the telephone bell will ring successfully after a few more periods of ringing than usual. Fig. 7 demonstrates this for a thermistor having a slightly higher cut-off temperature than -10°C ; it allows successful ringing on the fourth and subsequent ringing cycles at this temperature.

Book Review

"Improve Your Television Reception." John Cura and Leonard Stanley. Iliffe & Sons, Ltd. 112 pp. 134 ill. 5s.

This book has been written to enable the layman to obtain the optimum performance from his television receiver. Guidance is given on the adjustment of the usual tuning controls and also the pre-set controls, which only require re-setting at infrequent intervals; photographs taken from television screens illustrate the effects of setting them incorrectly. The non-technical person will, no doubt, feel diffident about rotating the deflexion coils to correct picture tilt and adjusting the focus assembly to centre the picture, despite the descriptions given in the book. Faulty interlacing, with the consequent

CONCLUSION

The economic advantages through savings in equipment and cabling of using a Thermistor No. 1A for suppressing bell tinkling on shared-service lines, instead of the relay circuit of the Bell Set No. 41, are great, and the results of the preliminary field trial were sufficiently encouraging to justify the introduction of the item into service in advance of the completion of the detailed investigations described in this paper. In the interim period thermistors were accepted to the manufacturer's normal limits of ± 20 per cent tolerance in resistance, and consequently early deliveries included some thermistors that would have been rejected for excessive operate-times if the full testing procedure had been available.

Notwithstanding this fact, and the decision not to set very narrow limits for acceptance when the tester was brought into operation, experience with the many hundreds of thousands of Telephones Nos. 312 and 314 in service during the winter of 1955-56 has generally been successful. There have been a few complaints of ringing difficulty with telephones exposed to extremely low temperatures, and consideration is now being given to the possibility of providing specially selected thermistors for cases where difficulty is experienced, or of such tightening up of the general acceptance limits as may be practicable now that manufacture is well established.

Thermistor No. 1A cannot safely be used in U.A.X. areas where ringing vibrators are in use, because the ringing voltage and waveform cannot always be maintained in such condition as to guarantee satisfactory operation when several lines are being rung at one time. The economic advantages of the thermistor are so great, however, that it is well worth while examining modifications which may ensure its success on this type of exchange. Trials of modifications are at present taking place.

ACKNOWLEDGMENTS

The author wishes to thank colleagues of the Engineer-in-Chief's Office associated with this work for their assistance, especially Mr. G. W. Eastwood, to whom the design of the tester is due, and Mr. K. M. Akester, who carried out the laboratory work. Acknowledgment is also due to Standard Telephones & Cables, Ltd., for data supplied.

References.

- ¹ CAMERON, C. J., and HUMPHRIES, W. A. Shared Service. *P.O.E.E.J.*, Vol. 41, p. 139, Oct. 1948.
- ² BECKER, J. A., GREEN, C. B., and PEARSON, G. L. Properties and Uses of Thermistors—Thermally Sensitive Resistors. *Bell System Technical Journal*, Vol. 26, p. 170, Jan. 1947.
- ³ GIBSON, W. T. Thermistor Production. *P.O.E.E.J.*, Vol. 46, p. 34, Apr. 1953.
- ⁴ COOPER, W. H. B., and SEYMOUR, R. A. Temperature Dependent Resistors. *Wireless Engineer*, Vol. 24, p. 298, Oct. 1947.

impairment of picture quality, is dealt with, and tests to determine lack of interlace are given.

A section of the book is devoted to interference, and the setting of the vision limiter has not been overlooked. It is a pity, however, that "ghost" images, to which Band 3 reception is very prone, and their elimination have not been dealt with in a more practical manner.

Other subjects covered are aerials, including guidance on their use, Band 3 convertors, and the best conditions for viewing. The book concludes with a section entitled "Facts and Fallacies" which is in the form of questions and answers.

Viewers should derive considerable benefit from the book even though, in parts, they may find it rather technical.

C. F. D.

Provision of Number Unobtainable Tone from Final Selectors

J. L. K. ASHWELL and
B. D. GORTON†

U.D.C. 621.395.34:621.395.36

This article describes a new method of connecting number unobtainable tone to spare lines and lines temporarily out of service, which results in savings of both labour and materials.

INTRODUCTION

FROM the earliest days of automatic telephony it has been the practice of the British Post Office to arrange for the connexion of number unobtainable (N.U.) tone to a calling subscriber who dials a spare number.

In pre-2000-type exchanges this is effected by connecting a switching battery to the P wire at the final selector rack and N.U.-tone battery to the negative line at the M.D.F., as in Fig. 1.

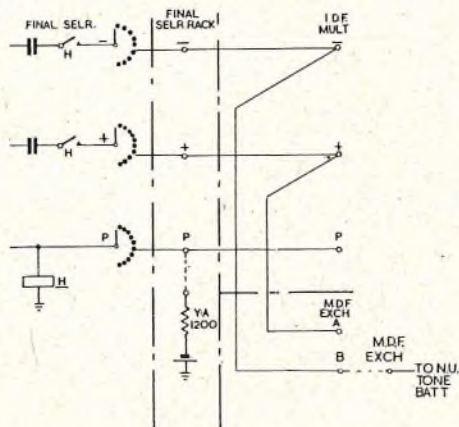
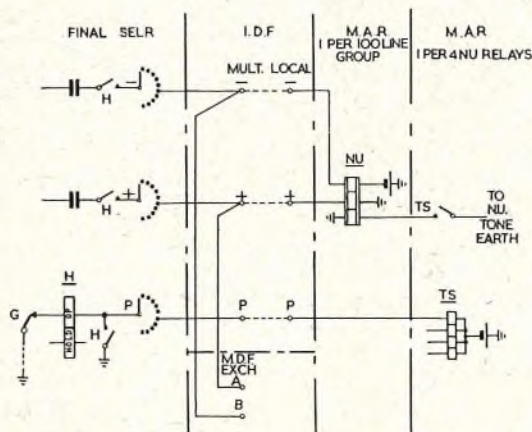

FIG. 1.—METHOD OF CONNECTING N.U. TONE ON CALLS TO SPARE LINES IN PRE-2000-TYPE EXCHANGES.



Note: M.A.R. = Miscellaneous Apparatus Rack.

FIG. 2.—METHOD OF CONNECTING N.U. TONE ON CALLS TO SPARE LINES IN 2000-TYPE EXCHANGES.

With the introduction of 2000-type equipment and the application of tones in a balanced manner, a new method of feeding N.U. tone to spare lines was necessary, and it was decided to connect both switching battery and balanced tone at the I.D.F., as in Fig. 2.

For some time it has been recognized that there are technical objections to each of these methods, that both are wasteful of labour and materials, and that a preferable

arrangement would be to provide the required conditions direct from final selectors. Such a scheme has now been devised and the necessary circuitry included in the new final selector diagrams that have recently been produced to cater for the increase of subscribers' line limits to 1000 ohms loop resistance.

BASIC CIRCUIT ELEMENTS OF NEW FINAL SELECTORS

The new circuits of ordinary and 2-10 P.B.X. final selectors are based on the principle that, when testing single lines, interrupted ring tone shall be returned to the caller when the line tests free, busy tone when the line tests busy, and N.U. tone when a disconnected P-wire condition is encountered. As explained later, the testing of lines forming part of a P.B.X. group is basically unchanged from earlier circuits.

Ordinary Final Selectors.

The testing circuit in ordinary final selectors is shown in Fig. 3. Relay E (not shown in Fig. 3) operates during

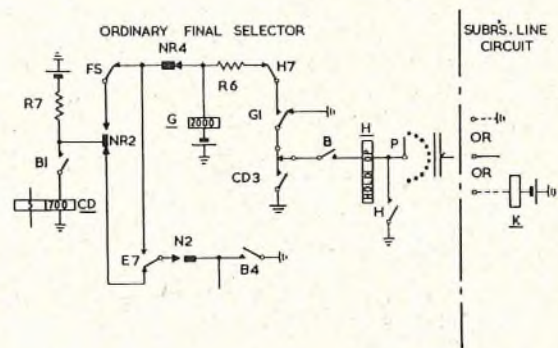
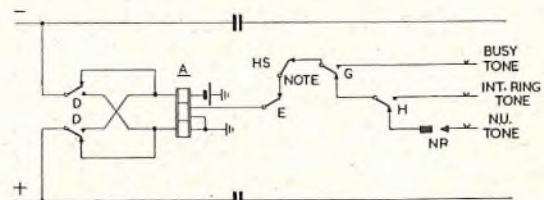

FIG. 3.—ORDINARY FINAL SELECTOR TESTING CIRCUIT.

the last inter-digital pause. Contact E7 removes the short-circuit from the 700-ohm winding of relay CD (which re-operates) and operates relay G via NR4. The NR springs operate on the first rotary step to disconnect the operate circuit of relay G, but relay G remains held via R6, H7, and G1 to earth at CD3. When relay CD releases at the end of the rotary train of pulses, relay G is in an operated condition and is connected to the P wiper via the operate coil of relay H. If the called line is engaged, the earth connected to the P wire of the called line holds relay G, and when relay E releases busy tone is returned to the caller (Fig. 4). The current in the circuit of relays G and H at this stage is sufficient to hold relay G but not to operate relay H. When relay E releases, relay CD re-operates and a local holding circuit for relay G is completed at CD3.



Note: Contact HS is not provided on ordinary final selectors.

FIG. 4.—ORDINARY AND 2-10 P.B.X. FINAL SELECTORS TONE-FEEDING CIRCUIT.

†Assistant Engineers, Telephone Development and Maintenance Branch, E.-in-C.'s Office.

If the line is free, battery via relay K in the called subscriber's line circuit shunts relay G, which releases, and at G1 completes a circuit for the operation of relay H to the K-relay battery. When relay E releases, interrupted ring tone is returned to the caller (Fig. 4).

If the line is spare (or the P wire disconnected for other reasons), relay G releases and connects earth to relay H, but relay H does not operate due to the disconnected condition of the P wire. When relay E releases, N.U. tone is returned to the caller (Fig. 4).

2-10 P.B.X. Final Selectors.

2-10 P.B.X. final selectors are used to give access to single lines as well as to P.B.X. groups, and for single lines the circuit operation is the same as that of an ordinary final selector. In the case of P.B.X. groups, however, a specific test for a disconnected P wire is unnecessary because a P.B.X. group cannot include a spare number.

The method of testing lines forming a P.B.X. group (Fig. 5) is similar to that employed in earlier 2000-type

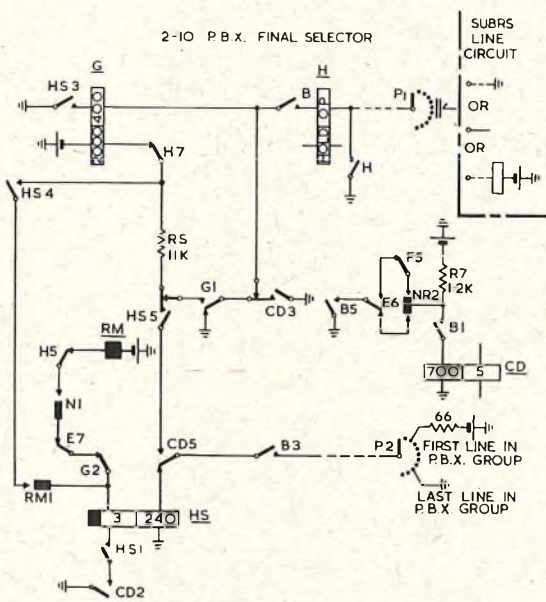

FIG. 5.—2-10 P.B.X. FINAL SELECTOR TESTING CIRCUIT.

final selectors. If the first line in a group is free, the circuit operation is the same as for a call to a single line except that on the release of relay CD, relay HS will operate via wiper P2. Due to the operation of relay H, however, there is no holding circuit for relay HS when relay CD re-operates on the release of relay E.

Should the first line of a group be busy, then, on the release of relay CD, relay G is held operated via its 2000-ohm winding to the busying earth from the P1 wiper, and relay HS operates to the 66-ohm battery via wiper P2 and CD5. The operation of relay HS disconnects the hold circuit of relay G at HS5, but at HS3 the 400-ohm winding of that relay is offered to the P1 wiper. When relay E releases, relay CD re-operates, disconnecting the operate circuit of relay HS at CD5, and providing an earth at CD2, to operate the rotary magnet and hold relay HS when relay G releases. Relay G, which was offered to the P1 wiper when relay HS operated, releases because there is a busying earth connected to the P1 wiper from the P wire of the busy line, and the rotary magnet is energized via G2. The rotary magnet steps the wiper to the second line in the group and RM1 completes a re-operate circuit for relay G via its 2000-ohm winding. The re-operation of relay G disconnects the circuit of the rotary magnet, which releases,

and RM1 disconnects the re-operate circuit of relay G. If the second line is free, relay G will be held via its 400-ohm winding and the operate winding of relay H to the K-relay battery connected to the P1 wiper, and relay H will operate. The operation of relay H allows the call to be completed in the normal way. Should the second line also be busy, relay H will not operate and relay G will release. The release of relay G again completes the rotary magnet circuit at G2 and the wipers step to the third line in the group. This stepping continues until a free line is found, or a busy condition met on the last line in the group. On the last line in the group earth is connected to the P2 wiper to hold relay G operated via its 2000-ohm winding (relay H cannot operate as there is a busying earth connected to wiper P1), and with G2 operated relay HS releases. With relay HS released, relay G continues to be held via its 2000-ohm winding to earth at CD3 and busy tone is returned to the calling party (Fig. 4).

"11 and over" P.B.X. Final Selectors.

In the case of "11 and over" P.B.X. final selectors, spare levels only are concerned and the circuit changes necessary to return N.U. tone from a spare level are confined to the discriminating relays. The new circuit is so designed that only relay DZ of the discriminating relays operates when a number involving a spare level is dialled, and in these circumstances N.U. tone is returned to the caller. The circuit principles of this are shown in Fig. 6.

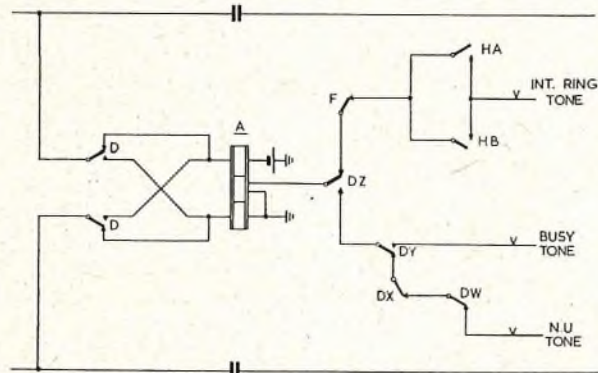

Relays DY and DZ operate on last level of P.B.X. group. Relay DZ operates on spare levels.

FIG. 6.—"11 AND OVER" P.B.X. FINAL SELECTOR TONE-FEEDING CIRCUIT.

SUBSIDIARY FEATURES

In addition to the advantages that result from the new final selectors when dealing with spare and ceased lines, economies can also be effected in dealing with lines which have to be placed temporarily out of service (T.O.S.), or which are out of order, if a ready means is provided for disconnecting any P wire on the multiple side of the I.D.F. For this purpose three additional tags, PF, PU and PE, are included in the connexion strip on the multiple side of the I.D.F.; this arrangement is shown in Fig. 7.

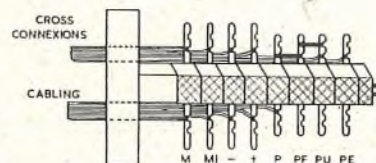
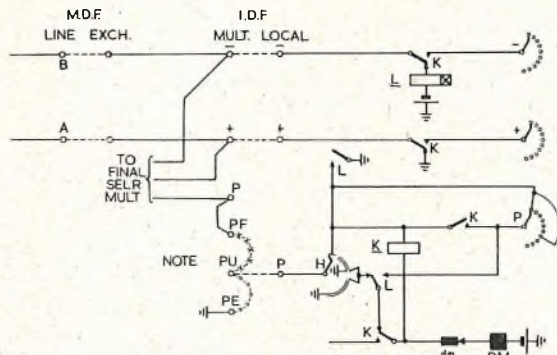

FIG. 7.—I.D.F. MULTIPLE SIDE CONNEXION STRIP SHOWING CONNEXIONS FOR WORKING DIRECT EXCHANGE LINE.

Treatment of Lines Ceased or made T.O.S.

The tag arrangements shown in Fig. 7 enable any line to be ceased, as far as the I.D.F. connexions are concerned, merely by removing the wire strap between tags PF and PU, or to be made T.O.S. by substituting the strap PF-PU by a strap PU-PE. In both cases the disconnection condition given to the P wire of the final selector multiple ensures the return of N.U. tone to any caller dialling a ceased or T.O.S. line, while the connexion of earth to the PU tag on a line made T.O.S. operates relay K in the subscriber's line circuit (Fig. 8) and prevents that sub-



Note: (a) Use connexions -x-x- for working lines.
 (b) Use connexions -o-o- for lines T.O.S.
 (c) Omit connexions -x-x- and -o-o- for ceased lines.

FIG. 8.—I.D.F. CONNEXIONS.

scriber from originating calls. In a P.B.X. group it is necessary to disconnect the P wires of all lines in the group, for, as already explained, a disconnected P wire constitutes a busy condition to a P.B.X. final selector.

Initially, it will be necessary to make the connexions between the PF and PU and the PU and PE tags by means of wire straps, but a spring U-link type connector is being developed for use on the cable side of the I.D.F. connexion strips. To allow for this it is essential that the cable side of the tags PF, PU and PE be kept completely free from solder, and it is for this reason that a strip connexion using four tags for the P-wire arrangements has been adopted.

Treatment of Lines Out-of-Order.

With the promise of a mechanical link for effecting disconnection and earthing of any P wire at the I.D.F., it has been decided to employ this facility for busying P.B.X. lines that are out of order. This will obviate the need for extending the P wires of lines in P.B.X. groups to the M.D.F., a saving that more than offsets the cost of the new I.D.F. arrangements.

With the introduction of the new scheme the treatment of lines that are out of order will be changed in some cases. Individual direct exchange lines and shared service lines will be plugged-up at the M.D.F. using Test and Plugging-up (T. and P.U.) cords as at present, but a T. and P.U. circuit

will not be used on any line in a P.B.X. group unless the whole group is out of order. When a P.B.X. line is out of order it will be disconnected by inserting wedges in the protector springs at the M.D.F. in order to home the uniselector in the line circuit; the link between tags PF and PU will be replaced by a link between PU and PE, and the wedges at the M.D.F. then removed. The disconnection of the P wire of the final selector multiple will act as a busying condition to a P.B.X. final selector, while the earth connected to the P wire of the line circuit will operate relay K. The operation of relay K will remove battery and earth from the subscriber's line (Fig. 8) and permit it to be tested from a test desk via the test selectors. To enable this facility to be given the test selector circuits are to be modified to switch to a disconnected P wire condition.

Where all lines of a P.B.X. group are out of order, the first line in the group will be "plugged-up" at the M.D.F. with T. and P.U. cords (more than one line may be dealt with in this manner if a large P.B.X. group is concerned) while subsequent lines will be dealt with by substituting the strap PF-PU by the strap PU-PE.

When the number of line faults affecting an exchange exceeds the available T. and P.U. circuits any faulty line may be dealt with by homing the uniselector in the line circuit and substituting the strap PF-PU by the strap PU-PE. This will ensure that N.U. tone will be returned on calls to faulty lines, and that testing facilities will be provided from the test desk, via test selectors, without the need for further co-operation at the M.D.F.

CONCLUSION

The new scheme of connecting N.U. tone from final selectors has many attractions both from a cost and facility aspect, but the main advantages can be summarized as follows:—

- (i) It will not be necessary to cross-connect spare lines to N.U. tone in new exchanges or on extensions of multiple in existing exchanges.
- (ii) Ceased lines need not be connected to N.U. tone.
- (iii) There will be a saving of N.U. tone connexion strips on the I.D.F. and of the NU and TS relays, etc., on the Miscellaneous Apparatus Rack (M.A.R.).
- (iv) There will be a saving of P.B.X. busying strips and of P wire cabling to the M.D.F.
- (v) N.U. tone will be returned to any number of simultaneous calls to spare numbers in the same hundreds group. (With present methods the first call to switch receives N.U. tone and subsequent calls receive busy tone.)
- (vi) There will be no need for a periodic check by traffic staff to ascertain whether N.U. tone is received when a spare number is dialled.
- (vii) The fault liability on frames will be reduced due to the less frequent need to disturb cross-connexions.

A Proposed New Telephone Cable between the United Kingdom and Canada

U.D.C. 621.315.28: 621.395.5

FOLLOWING preliminary discussions in London in January, 1957, a United Kingdom delegation went to Ottawa in April to discuss with representatives of the Canadian Ministry of Transport (which controls all communications) and the Canadian Overseas Telecommunication Corporation (C.O.T.C.) plans for the further

development of telephone and telex services across the North Atlantic. Headed by Mr. R. J. P. Harvey, Deputy Director-General, the party included Messrs. R. J. Halsey, J. W. Grady and H. G. Lillicrap from the Post Office and Messrs. H. H. Eggers and C. J. V. Lawson from Cable & Wireless (C. & W.), Ltd.

The first transatlantic telephone (T.A.T.) cable between the United Kingdom, Canada and the United States was opened for service in September, 1956, and has been described fully in this Journal¹ and elsewhere. The Atlantic crossing between Scotland and Newfoundland was engineered to the pattern of American development, the two 0.62-in. coaxial cables each being equipped with 51 flexible, one-way repeaters and requiring a 2,000V power feed at each end. This voltage, the highest permissible with the American repeaters, determined the circuit capacity of the system at 36 circuits.

The high quality of service provided by the cable has led to a greatly increased volume of traffic. The telephone traffic to the United States has doubled since the cable was opened; that to Canada has trebled and further capacity is already required. With the rapid economic development of Canada, the prospect is that the telephone and telegraph traffic will continue to grow rapidly; moreover, there appears to be a substantial potential demand for telex service.

Because of the comparative difficulty of laying, in deep water, the rigid submerged repeaters which are used by the Post Office, the British system was employed, in the original project, only in the shallow waters between Newfoundland and Nova Scotia. Further development of this system and means of laying the repeaters have now made it possible to think in terms of a transatlantic system which will provide 60 telephone circuits on a single cable, i.e., the same as on the Newfoundland-Nova Scotia link. Important among these developments is armourless deep-sea cable which, together with the results of some preliminary sea trials, has been described in the April, 1957, issue of the Journal. This cable can be made with a 1.0-in. core to have the same cost and overall diameter as conventional 0.62-in. deep-sea armoured cable—and with only two-thirds of the attenuation. Moreover the cable is torsionally balanced and is very much easier to handle than armoured cable; this greatly facilitates the laying of rigid repeaters.

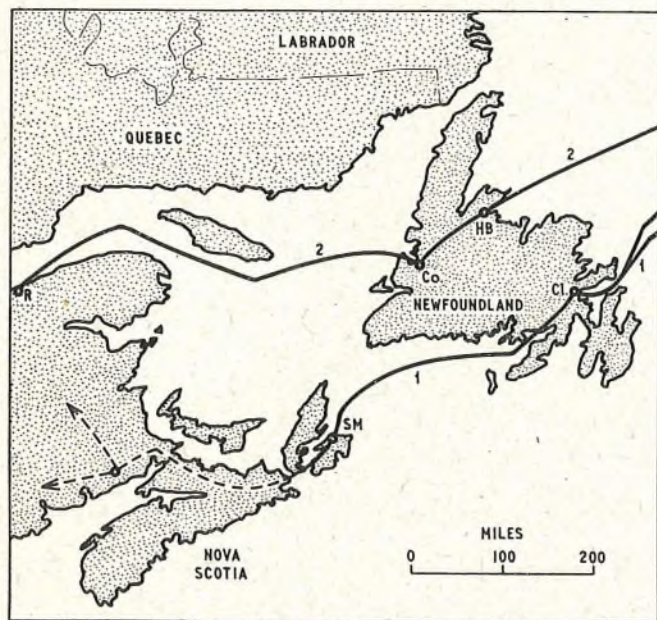

1. T.A.T.
Cl.—Clarenville.
SM—Sydney Mines.

2. CANTAT
HB—Halls Bay.
R—Rimouski.
Co.—Cornerbrook.

For the repeaters themselves, a new valve has been designed which will reduce the voltage drop across each repeater to about 70V instead of 125V, as well as giving even greater life expectancy. The line-voltage rating of the repeaters has also been increased to about 4,000V, thus enabling many more repeaters to be energized.

At the Ottawa meeting it was agreed, in principle, that a new submarine cable, incorporating the Post Office developments outlined above, should be laid as quickly as possible between the two countries; this would provide 60 circuits on a 2,100-n.m. route between Scotland and Newfoundland. Extension to the Mainland of Canada would also be by a submarine cable some 400–500 n.m. in length to a point in the vicinity of Rimouski, on the south bank of the Gulf of St. Lawrence. The map shows the approximate route, which has not yet been planned in detail; the existing T.A.T. cable route is also shown.

The proposed division of ownership and engineering responsibility for the construction of the system is as follows:—

Scotland–Newfoundland. The ownership of the system between the Scottish terminal (Oban or Fort William) and the Newfoundland terminal (Cornerbrook) would be in three parts:—

- (a) the land-based section in Newfoundland, including the terminal station and the cable hut on the east coast, vested in C.O.T.C.,
- (b) the land-based section in Scotland, including the terminal station and the cable hut (if any), vested in the Post Office, and
- (c) the submarine cable section between the two cable huts above, vested jointly and equally in C. & W., Ltd. and C.O.T.C.

The planning and engineering of the overall system would be the responsibility of a project team to be set up by the Post Office Engineering Department and incorporating engineers of both C. & W., Ltd. and C.O.T.C. This project team would be responsible for the construction and installation of the submarine cable section between the cable huts. The Newfoundland terminal station and cable hut and the cable section between them would be the responsibility of C.O.T.C. who would make such provision as required by the project team. The Scottish terminal station and cable hut and the cable section between them, if any, would be the responsibility of the Post Office operating through the project team.

Newfoundland–Mainland of Canada. The ownership of the system between the Rimouski terminal and the Newfoundland terminal (Cornerbrook) would be vested entirely in C.O.T.C., who would be responsible for all engineering and provision; the Post Office would act as agents, as requested by C.O.T.C. The number of circuits to be provided in this system is yet to be settled by C.O.T.C., but it is likely to be either 60 or 120.

The United Kingdom and Canada, having thus reached agreement in principle, have now invited the Commonwealth Telecommunications Board to concur in their view that the new cable should be proceeded with immediately.* With full-scale laying trials of lightweight cable planned for January, 1958, it is considered that the project can be completed in 1961.

R.J.H.

¹ *P.O.E.E.J.*, Vol. 49, Part 4, Jan. 1957.

* At a meeting of the Commonwealth Telecommunications Board, on 30th May, these plans were agreed.

A 4,000-Mc/s Radio System for the Transmission of Four Telephony Supergroups (240 Circuits)

R. L. CORKE, A.M.I.E.E.,
E. V. EPHGRAVE, A.M.I.E.E.,
J. HOOPER, A.M.I.E.E., and
D. WRAY, B.Sc.(Eng.), A.M.I.E.E.†

Part 1.—Outline Description of the System and Detailed Description of Radio and Intermediate-Frequency Equipment

U.D.C. 621.396.5:621.396.65.029.64

A radio system has been developed which permits the transmission of four telephony supergroups (240 circuits) over a 4,000-Mc/s radio link approximately 55 miles long. The whole system is described in outline in this part of the article, which also describes in detail the radio and intermediate-frequency equipment. Part 2 will describe the baseband equipment used for connecting to the coaxial line plant (Coaxial-Equipment, Line, No. 2) as well as the supervisory, control and alarm facilities for the radio link.

INTRODUCTION

FOR the first time in the United Kingdom microwave radio systems are being installed as part of the main trunk telephone network. In this function the radio link must accept a normal cable signal with all pilots and at the output end should pass on to the cable system a signal that satisfies cable requirements in respect of stability, frequency response, noise and freedom from breaks. Future radio links will be required to handle either telephone or television signals. The system described in this article is a frequency-modulated 4,000-Mc/s single-hop link across the Moray Firth and can satisfactorily carry 240 telephone channels. The southern terminal is near Elgin at a locality known as Braewynner, Fig. 1, which is on ground about

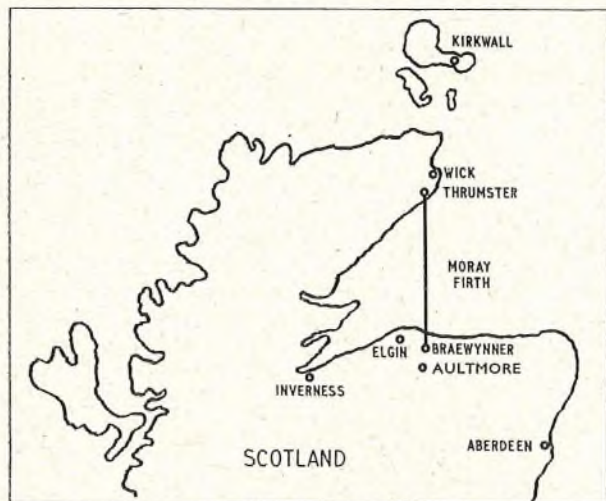

FIG. 1.—LOCATION OF THE ELGIN-WICK RADIO LINK.

800 ft above sea-level. To the north the ground drops quite rapidly to the coastal plain with the coastline about four miles distant. The radio path is over this plain and crosses the sea at a point where the Firth is about 50 miles wide. The northern site is at Thrumster, Caithness. Thrumster is a small village on the coastal road some four miles south of Wick and the radio station is built on a rocky outcrop round which there is much evidence of peaty subsoil. In the region of Thrumster the land is fairly flat and is at a height of about 200 ft above sea-level. The coast, about 1 mile south of the station, has rocky cliffs with a nearly vertical descent to the sea of about 150 ft. The site at Thrumster though good is not quite so favourable from a radio point of view as is Braewynner.

The length of the radio path is about 55 miles, which is unusually long for a single-hop link in a 4,000-Mc/s system.

† Mr. Corke is a Senior Executive Engineer and Messrs. Ephgrave, Hooper and Wray are Executive Engineers in the Radio Experimental and Development Branch, E.-in-C.'s Office.

Propagation conditions on a long path, especially over water, are at times likely to be unfavourable, especially for multi-channel signals, and it was necessary to adopt special techniques in the design to enable the system to operate satisfactorily. To get adequate clearance over the sea, masts are provided at each site so that optical paths can be obtained between the sites. For the determination of the best clearances to be used, and in the absence of any experience or information, it was necessary to erect one tall mast at Thrumster on which aerials could be mounted at various heights, and a short temporary mast at Braewynner. The mast at Thrumster was about 300 ft high and after the tests it was retained for service. The mast at Braewynner was 100 ft high and was recovered when the preliminary propagation tests had been carried out and a 300-ft mast erected in its place.

The radio system has been designed to link together the cable network round Elgin with the cable system at Wick. In addition, the radio link connects to a second microwave radio system from Wick to Kirkwall. This is a two-hop radio system which, at Thrumster, shares the same building and power supplies with the Elgin-Wick radio link.

A schematic diagram of the cable and radio systems in relation to each other is shown in Fig. 2. The radio station installations include baseband equipment as well as a comprehensive control and supervisory system.

In designing the Elgin-Wick 240-channel radio link an attempt has been made to produce a link that has a performance not inferior to that expected of a modern coaxial cable system. To do this over a long radio path requires somewhat exceptional measures to combat the effects of fading. At the same time these measures, which entail a certain duplication of equipment, improve the automatic protection of the system against equipment failure. Basically there are two radio systems in parallel (Fig. 3), which operate at different carrier frequencies. A fast-operating, and therefore substantially noiseless, switch in the baseband selects whichever channel gives the best received signal. Although the carrier frequencies are close, see Fig. 3, it was noticed during preliminary propagation tests that significant selective fading was at times present. For this reason it was considered that a fast-operating baseband switch would be desirable to enable the two channels to work together in the best possible way. At the

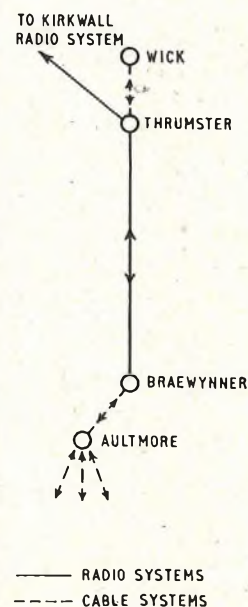

FIG. 2.—SCHEMATIC DIAGRAM OF CABLE AND RADIO SYSTEMS.

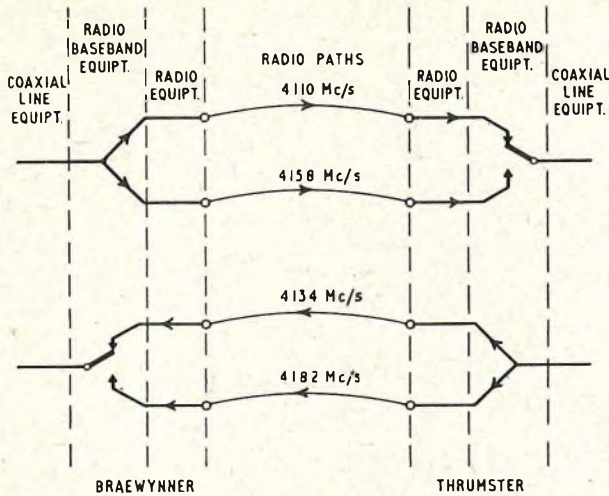

FIG. 3.—SCHEMATIC DIAGRAM OF SYSTEM.

same time this arrangement gives some protection against equipment breakdown since a large part of the equipment is duplicated. As a further protection against loss of performance caused by propagation difficulties, vertical-spaced-aerial diversity is used. The whole amounts to a quadruple-diversity system.

Mains power supplies, particularly in rural areas, can introduce a measure of unreliability due to breaks and voltage changes. The simple diesel set would introduce a delay of several seconds before it could pick up following a failure of the mains supply. At Braewynner and Thrumster mains power is obtained through a continuously rotating "flywheel" set. In this, a flywheel is used to store energy for starting the diesel engine and for keeping the a.c. generator turning until the diesel has picked up. This arrangement gives a nominally "no-break" supply to the equipment.

A view taken of the Braewynner station from the east

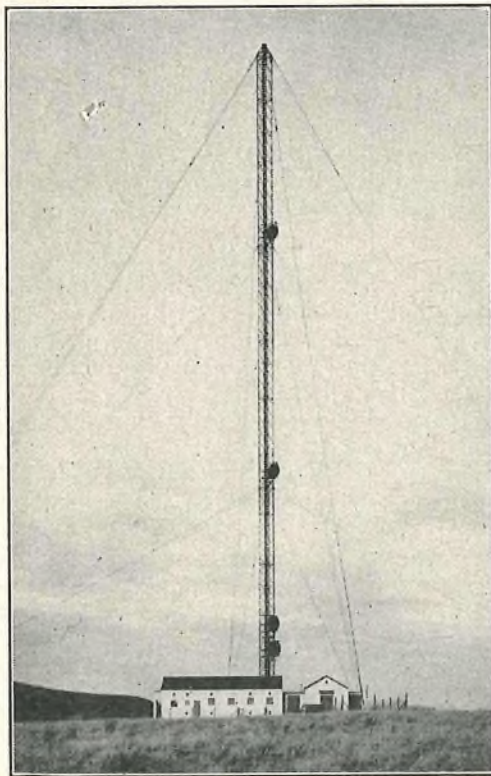

FIG. 4.—BRAEWYNNER RADIO STATION.

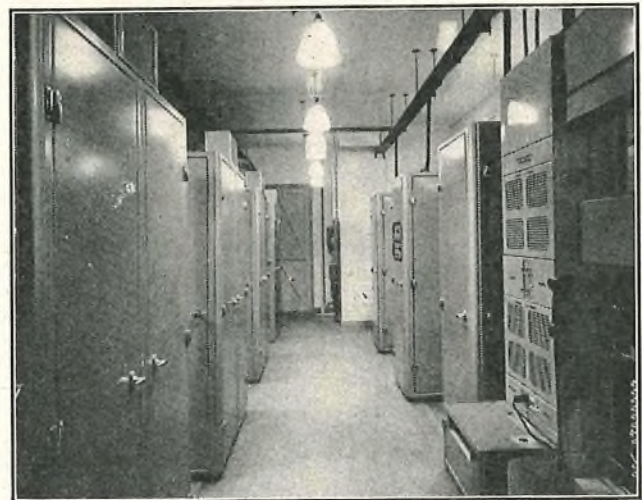

FIG. 5.—EQUIPMENT ROOM AT BRAEWYNNER.

is shown in Fig. 4, in which four paraboloidal aerials can be seen on the mast. Waveguides connect these aerials with the equipment shown in Fig. 5, which is a general view of the apparatus room with the two transmitters on the left separated by two pairs of receivers. On the right are the supervisory cabinet (centre) and the baseband equipments. Line equipment is on the extreme right but ventilation and waveguide pressurizing equipments are not shown in this photograph.

Before describing the radio aspects of the link in detail, it is desirable to refer to Fig. 6, which is a simplified block

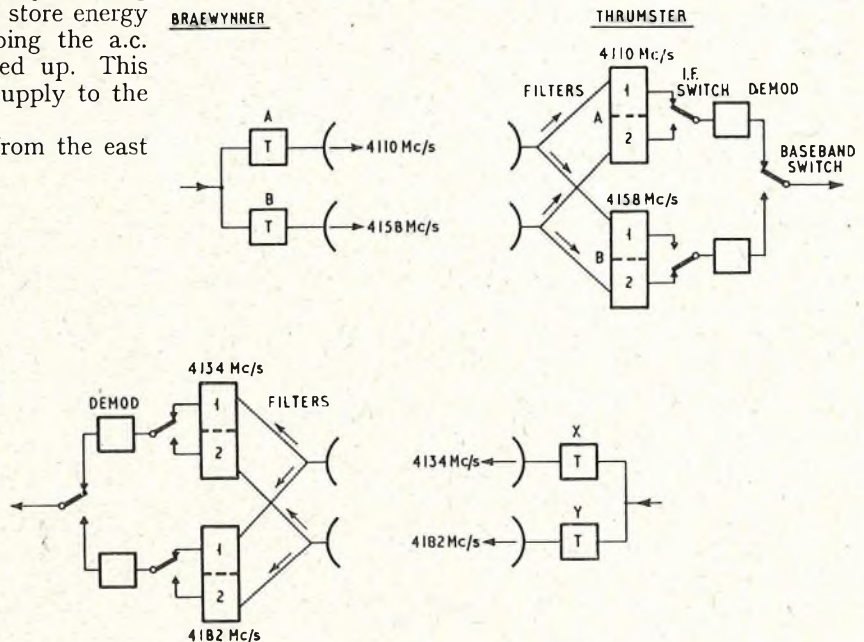

FIG. 6.—SIMPLIFIED BLOCK SCHEMATIC DIAGRAM OF RADIO EQUIPMENT.

schematic diagram of the complete system. This shows the two separate radio channels with the pair of transmitters A and B at Braewynner, simultaneously handling the north-going baseband signals which frequency-modulate the carrier frequencies 4,110 and 4,158 Mc/s. At Thrumster the two transmitters X and Y operate at 4,134 and 4,182 Mc/s and both carry the south-going baseband signals. The receivers at both ends are in pairs A1, A2; B1, B2, etc., with some equipment common to each pair, notably the beating oscillator of the superheterodyne receivers. Two

aerials feed the pair of receivers working on one carrier frequency but these two aerials also serve the other pair of receivers working on the other carrier frequency. Branching waveguide filters are used to separate the radio channels. The high-speed intermediate-frequency (i.f.) switch follows in the 60-Mc/s portion of the receivers, where the higher-level signal is selected and connected to the demodulator. In the demodulator the 60-Mc/s frequency-modulated signal is restored to the original baseband signal. This is an assembly of 240 channels in the range 60 to 1,052 kc/s, i.e. four supergroups complete with pilots. Additionally, in the band below 60 kc/s are channels for supervision, control and for speakers. At this point the baseband signals from both pairs of receivers are compared. The noise in a small band just above the highest baseband telephone channel received on Receiver A (or X) is compared with that received on B (or Y). Provided that a pilot is present, the high-speed baseband switch connects the signal with the lower noise component to the line equipment.

DIVERSITY

The transmitting and receiving aerials of a microwave system are usually placed with an unobstructed path between them so that the transmitting aerial illuminates directly the receiving aerial.* Fading of the signal is an ever-present possibility. The causes of fading are broadly divisible into two main classes, the first due to atmospheric changes and the presence of the earth, the second due to atmospheric changes alone. In the first case two main paths for radio-waves are possible, one direct and the other after reflection from the earth's surface. On a long path there is little angular difference between the directions of arrival of the direct wave and the reflected wave and both are received without discrimination by the aerial. On an over-sea path the coefficient of reflection at the surface of the sea is substantially unity. The amplitudes of the radio waves at the receiving aerial are, generally speaking, likely to be nearly equal to one another with the off-sea wave tending to be the smaller, because the curvature of the earth causes divergence of the beam which is therefore somewhat less concentrated at the receiving aerial than the direct wave. The phases of the two waves that arrive at the receiving aerial will, in general, be different because the path length of the direct wave is shorter and the reflected wave undergoes a change of phase of 180° on reflection at the earth's surface. The vector addition of the two waves in the receiver produces a resultant whose amplitude varies with time for the following reason. The actual path traced out by a wave is not straight because the refractive index of the atmosphere is not uniform. Generally, the refractive index varies uniformly with height and in such a medium the wave path curves towards the region of increasing refractive index. Normally the refractive index decreases with height so that the path is then curved towards the earth. When the refractive index of the atmosphere changes, which it does constantly, the relative lengths of the main and indirect paths will change also, and because the relative phase then changes, the vector sum of the two waves will alter. This is illustrated in Fig 7. With the two waves nearly equal the field received can vary from nearly twice that of the direct wave, when the waves are in phase, to nearly zero when they are out of phase. Small variations in atmospheric conditions will therefore cause variations in phasing and therefore of received signal levels. An extreme form of fading is sometimes encountered

* An exception is the system using tropospheric forward-scatter propagation in which the transmitting aerial is made to illuminate a volume of the troposphere which scatters the radio signals. The receiving aerial is directed toward this scattering volume. Systems using this method would be narrow-band and require high transmitter power.

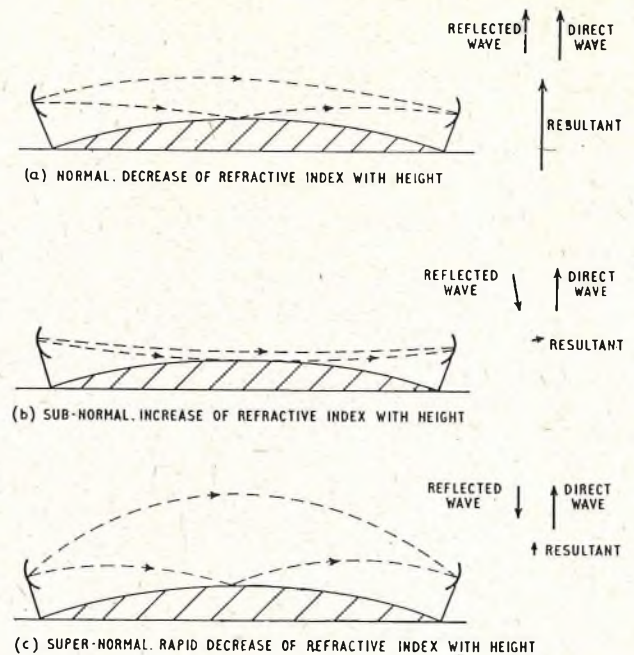

FIG. 7.—ILLUSTRATION OF RELATIVE PHASE BETWEEN DIRECT AND REFLECTED WAVES AND VARIATION WITH GRADIENT OF REFRACTIVE INDEX.

on paths such as this in "sub-normal" refractive index conditions, as illustrated in Fig. 7(b). If the upward bending of the paths is large the "direct" wave can be obstructed by the sea and little or no signal will then arrive at the receiving aerial on either the direct or the indirect path, and fading will be severe. Fading on a long over-sea path is likely to be more frequent and deeper than on a shorter path over land.

The second kind of fading results from more localized changes in the refractive-index gradient. Certain weather conditions give rise to so-called "inversions," when the refractive index, instead of decreasing continuously with height begins to increase through a layer of the atmosphere. This relatively abrupt change of index at the layer boundary will cause wave reflections and additional interfering fields will arrive at the receiver if the layer or layers are suitably located. Sometimes two parallel layers, or one layer and the earth, will, between them, duct the main direct wave like an enormous waveguide and cause either very large or very small received signals depending upon whether the receiving aerial is inside or outside the "waveguide."

The more important type of fading for the Elgin-Wick link is the first kind, since fading of the second kind is an intermittent phenomenon likely to occur only in prolonged fine-weather conditions, while the former effects are almost always present. Furthermore, the effects of the first kind are to some extent predictable and it is possible to devise means of mitigating them. For example, suppose a distant transmitting aerial is working to two identical receiving aerials which are supposed to be vertically spaced on the receiving mast in such a way that when, for given atmospheric conditions, the direct and indirect waves add on the lower aerial to produce a good signal, the signals tend to annul one another at the second aerial. When the refractive-index gradient changes, the phasing conditions will alter; the greater signal will tend to get worse and the other to improve. When the refractive-index gradient changes sufficiently the aerial outputs will interchange. Thus the fading patterns on each aerial tend to be complementary. This method of using a pair of receiving aerials is the one that has been adopted in the Elgin-Wick link to reduce the effects of fading.

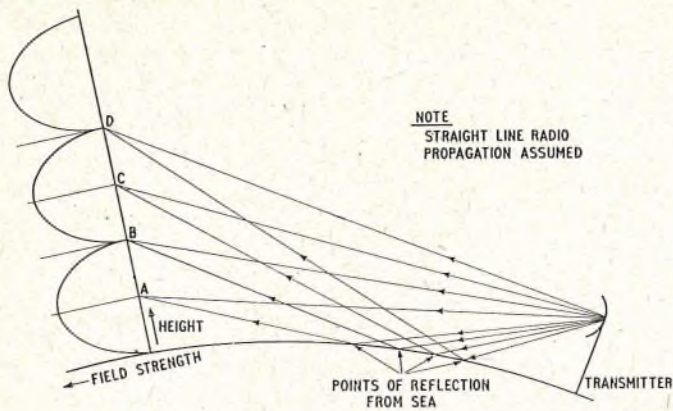

FIG. 8.—VERTICAL INTERFERENCE PATTERN.

In Fig. 8 four receiving points A, B, C, and D, are considered operating in normal refractive-index gradient conditions. At A, the lowest point, the height is chosen so that the path-length of the off-sea wave is 0.5λ longer than that by the direct path. Bearing in mind that there is a phase reversal at reflection, the two waves will arrive in phase at A, when λ is the operating wavelength, which, for a 4,000-Mc/s carrier frequency, is about 7.5 cm. Below A the signal level falls, reaching a low value when the horizon intrudes between the transmitting and the receiving aerials. At heights above A the condition of phasing changes, because greater path-length differences develop between the direct and the indirect paths, until at B a point is reached where the path-length difference is λ and the two signals are in antiphase. At C, higher still, the signals are once more in phase with a path-length difference of 1.5λ . With increasing height points of maxima and minima signal strength are closer together. A rough signal-level/height diagram is shown at the left of Fig. 8 representing a vertical interference pattern for a normal condition of the refractive-index gradient. The pattern will move as the refractive-index gradient changes, moving up or down for sub-normal or super-normal conditions respectively. As well as moving bodily the pattern experiences a concertina-like action tending to compress when the pattern moves downward and expand when the movement is upward, resulting in a greater variation in signal level, corresponding to given atmospheric changes, for the higher aerials. On the other hand, there is the likelihood, in extreme sub-normal conditions, that the pattern will move upward so far that the lower aerials shift into the low-field-strength region that normally exists below position A. If only two aerials can be used, therefore, the choice of height is a compromise.

Some experiments were conducted in November, 1952, over the radio path proposed for this radio link. Two receiving aerials were mounted at 277 ft and 360 ft above mean sea-level at Thrumster to correspond geometrically with points A and B of Fig. 8. Tests soon showed, as predicted, that there was a marked tendency for signals to fade in a complementary way on the two aerial outputs.

The next task was to find the optimum heights for a pair of aerials, it having been decided that not more than dual-aerial diversity would be used. In choosing the heights for the final installation it was considered desirable to limit the height as much as possible since long waveguide feeders, besides being expensive, are undesirable electrically for reasons given later in the section dealing with aerials and feeders. To complete the information required to enable a compromise choice to be made a further experiment was conducted in the autumn of 1953 and the spring of 1954, when four receiving aerials were fixed on the 300-ft mast as in A, B, C and D, and signals were recorded on all aerials for a period

of six weeks in each season. The tests were continuous throughout the periods and combinations of aerial outputs were automatically compared minute-by-minute. It was found that the lowest pair of aerials that gave consistently good results was B and C and these heights, together with the corresponding heights for the other end of the system were adopted for the final installation of the receiving aerials. The tests showed that the B-C combination gave no fade exceeding 13 db during the period of observation and 10-db fades lasted for only 0.05 per cent of the time of the tests. During the same period aerial A alone gave very deep fades at times and these exceeded 20 db for as much as 0.3 per cent of the time. More details of the improvement of the B-C combination as compared with the single aerial are shown in Fig. 9 where the fading dis-

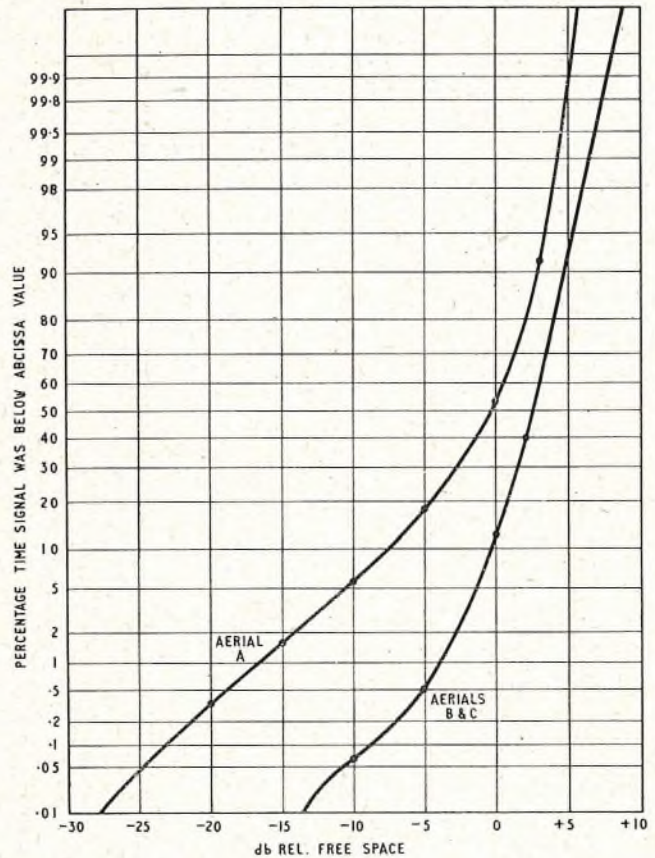

FIG. 9.—FADING ON AERIALS B AND C IN DIVERSITY COMPARED WITH AERIAL A.

tributions, obtained by analysis of the fading records made in 1953 and 1954, are drawn to show the fading depth, with respect to the free-space field, likely to be exceeded for various percentages of the time of observation. The curve is compared with that obtained using aerial A alone.

It had been decided to provide two channels in parallel continuously energized, as already outlined, for security against equipment failure. The carrier frequencies allocated for these channels were within 48 Mc/s of each other. It was thought desirable to attempt to ascertain what frequency-selective fading might occur because, if frequent relative differences between the channels were likely, due to radio propagation differences, it would be desirable to use a high-speed automatic baseband switch to select the better receiving circuit so as to take advantage of frequency diversity. As said earlier, the high-speed baseband switch was in fact fitted in the final system. The diversity tests were made by sending from a single aerial at Braewynner two carriers of equal power and spaced by 48 Mc/s.

These carriers were received in a superheterodyne receiver with a local oscillator whose frequency was repeatedly swept over about 60 Mc/s. The pulses produced at a detector when the intermediate frequency corresponded to that of the i.f. amplifiers were displayed on a cathode-ray tube with its time-base locked to the sweep control of the local oscillator. The relative amplitudes of the carriers were thus displayed and could be recorded. It was roughly estimated from the results that significant improvement to the system would result if a high-speed baseband channel-change-over switch were fitted to the system, and that the switch could be expected to operate several times a week on the average. Recommendations were accordingly made that the baseband switch for the channel change-over should be sufficiently fast in operation so that the noise contributed by it would be negligible. This high-speed baseband switch and its characteristics will be described in Part 2.

AERIALS AND FEEDERS

A total of eight similar aerials are used on the system. At each station two transmitting aerials, one for each channel, are mounted close together on the lower part of the mast, with two receiving aerials, corresponding to positions B and C of Fig. 8 mounted above. Fig. 10 shows

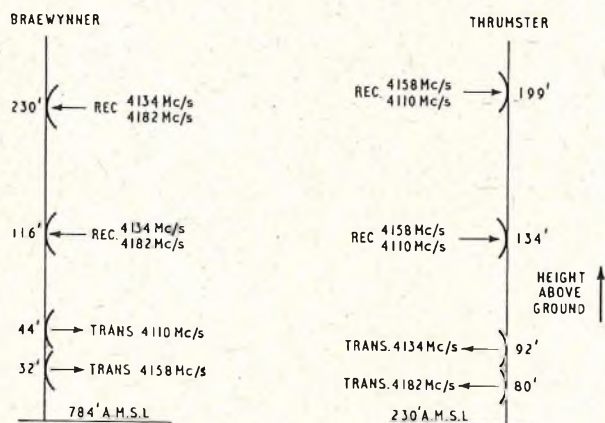

FIG. 10.—AERIAL HEIGHTS.

the heights of these aerials at each station and the role that each plays. The aerials each consist of a 7-ft diameter paraboloidal reflecting dish, illuminated by a specially shaped termination of the waveguide feeder. The radio waves are directed from the reflector in a narrow beam of about 3° between half-power points, with the result that the efficiency of power transfer between distant points is some 4,000 times greater than it would be if the radio energy were allowed to radiate equally in all directions. This power gain, of 36 db, is obtained at both transmitting and receiving aerials, giving a total gain of 72 db more than if non-directional aerials were to be used. The total attenuation of the 55-mile path using a 7-ft dish at both transmitter and receiver is 71 db, assuming only the direct transmission path, that is, free-space propagation conditions. The supporting framework for the reflector is square in shape and is constructed of angle-iron suitably braced to ensure rigidity. The aerials are mounted on the masts by a three-point suspension to allow easy directional adjustment of the aerials through small vertical and horizontal angles.

The waveguide feeders, consisting of 2½ in. × 1¼ in. rectangular copper tubing with ⅛-in. walls, presented an interesting engineering problem because the stringent electrical requirements of the radio system impose the necessity of attaining a high order of mechanical precision

in the construction of the feeder. This precision must be retained in spite of temperature changes, wind effects and exposure to the atmosphere. In the first place, system requirements imposed the need for using waveguide instead of coaxial cable for the feeders because of the high loss of coaxial cable at 4,000 Mc/s. The loss is about 5 db/100 ft, whereas for copper waveguide the loss is 1 db/100 ft. Because of the rigid nature of waveguide it is necessary to install it in conveniently short lengths, about 10 ft, and these must be suitably joined together. The joints have to be mechanically sound and must align adjacent sections of the tube to within ± 0.003 in., the tolerance on the inside dimensions of the tube. Good joints are necessary in a frequency-modulated system to avoid significant junction mismatches, resulting from imperfectly aligned waveguide joints, in long feeders because multiple reflections would otherwise occur between the joints. This would cause intermodulation distortion in the radio system. The target for each junction mismatch was that the maximum permissible voltage reflection coefficient should be 1 per cent. Another consideration in the design of the joints was the need to protect the inside of the waveguide from water condensation and from long-term corrosion effects. The junctions need to be airtight to keep out the weather, and to check continuously that this is so and at the same time to protect positively the inside of the tube, the waveguides are separately pressurized to about 0.5 lb/in² with dry nitrogen.¹

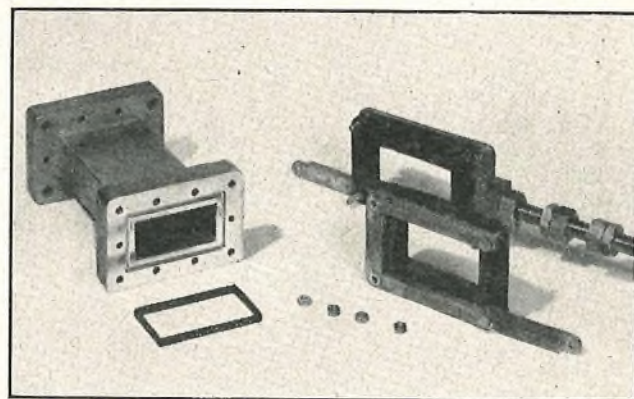

FIG. 11.—WAVEGUIDE FLANGE AND GASKET (LEFT), WAVEGUIDE SUPPORT BRACKET (RIGHT).

To meet these requirements a special rectangular flange was designed. This flange, shown in Fig. 11, is a high-quality brass casting ¾ in. thick with machined faces. This thickness of brass is necessary to avoid distortion when the flanges are bolted together. Ten stainless-steel bolts are used to join two flanges, and two of the holes, those on the major axis, are precision-drilled using a jig to locate the waveguide aperture after the flange has been soldered to the waveguide. Two fitted bolts are used in these holes and the alignment of the waveguide apertures at a joint is thus ensured. Care is necessary when tightening the bolts to avoid distorting the flange. Between a pair of flanges is a moulded plastic gasket fitted into the narrow groove cut in the surfaces of both flanges and within the area enclosed by the bolt holes, as shown in Fig. 11. The gasket groove is flared to allow the gasket to flow so that the gasket cannot prevent full metal-to-metal contact across the waveguide apertures. Fig. 11 also shows a clamp used to support the waveguide both in the horizontal and vertical runs. The clamp consists of a demountable brass frame between which are sandwiched two hard plastic grommets which support the waveguide against lateral

¹ HOBBS, J. G. A Pressurized Waveguide System. *P.O.E.E.J.*, Vol. 47, p. 52, April 1956.

movement but allow sliding movement. The supports are placed at frequent but irregular intervals along the guide and are attached to the mast or support. The non-uniform spacing discourages flexural vibrations caused by wind. A novel feature of the waveguide feeders is the method used to eliminate destructive working stresses on the soldered joints between waveguide and flange due to differential expansion of the steel mast and copper waveguide. The vertical portion of the waveguide, which is run inside the mast framework, is rigidly fixed near its top to the mast, using an anchoring flange. The bottom of the waveguide has a floating support with a counterpoise weight so that the bottom of the waveguide is always subjected to a small vertical force. The waveguide therefore slides through the grommets frame supports to absorb differential movement.

Careful attention was necessary in the early stages of planning the layout of the system to ensure that the waveguide runs should connect aeriels and equipment with the minimum number of abrupt changes of direction. The layout of the building at Braevynner with its equipment, the position of the mast and the waveguides are shown in Fig. 12. At the Thrumster terminal the orientation of the building was chosen to suit the convenience of the contractor constructing the microwave link to Kirkwall. The relative position of the 300-ft mast and building at Thrumster was chosen, as in Fig. 12, so that the necessary change of

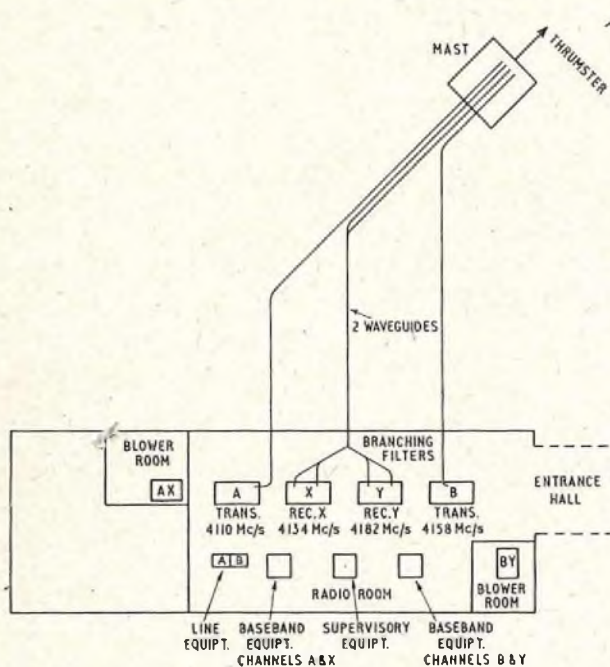

FIG. 12.—LAYOUT OF MAST, WAVEGUIDE RUNS AND BUILDING AT BRAEVYNNER.

direction of the waveguide feeders from the equipment room to the direction of the line of shoot could be accomplished at the same time as the feeders were gathered together to run up the mast. The building and mast at Braevynner were constructed at a later date, and were then laid out in the same manner as for Thrumster in order to simplify design and production. Where it is necessary to change the direction of the waveguides, gently curved bends of a radius of 1 ft have been used in order to reduce the mismatches. Two long twist-sections were necessary to change by 90° the polarization of the central waveguides on entry to the building.

Like the vertical run, the horizontal part of the waveguide is supported at about 6-ft intervals using similar supports attached to stayed wooden poles. The horizontal supports closest to the mast allow vertical movement

of the waveguide run to avoid significant bending of the waveguide due to the differential movement of the bottom of the vertical waveguide. Immediately inside the building the pressurized part of the waveguide is terminated by a pressure-tight waveguide window and thence connected to the filters. The final connexion to each equipment is made via a short length of flexible coaxial cable to prevent wind vibration transmitted along the waveguides from reaching the equipment and to avoid the need for precise mechanical link-up.

Tests made on the completed aeriels and feeders showed that the voltage standing-wave ratio (v.s.w.r.) of each aerial was better than 0.95 and that there was no single source of mismatch in any part of the waveguides with greater than one per cent voltage reflection coefficient.

THE TRANSMITTERS

The transmitter is frequency modulated and has an output power of 1W which is applied by waveguide to the aerial system. A block schematic diagram of a transmitter is

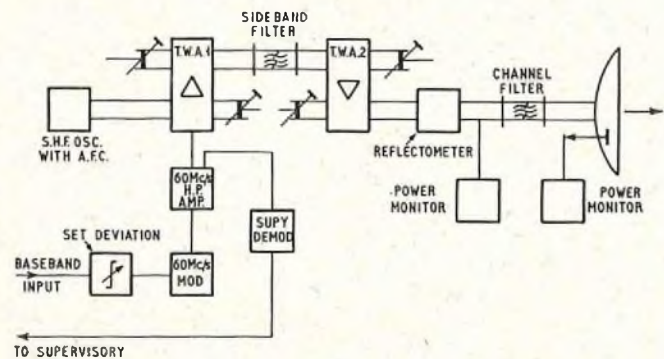

FIG. 13.—BLOCK SCHEMATIC DIAGRAM OF TRANSMITTER.

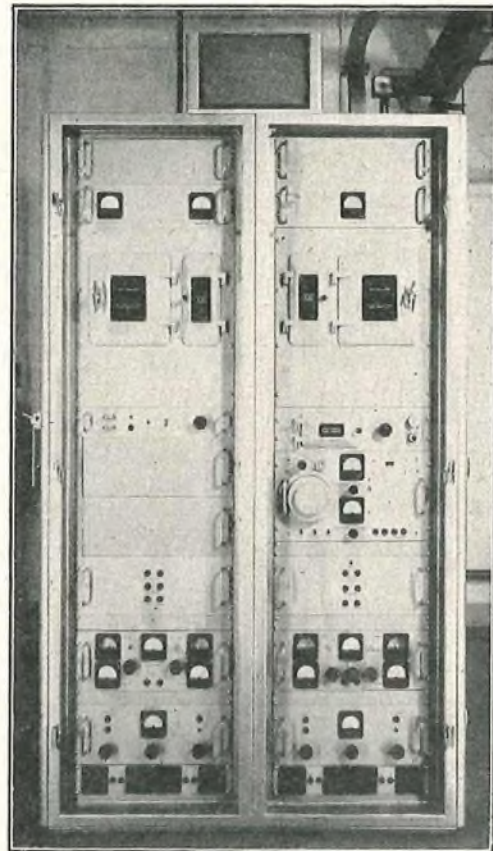

FIG. 14.—FRONT VIEW OF TRANSMITTER WITH DOORS REMOVED.

shown in Fig. 13. The baseband signals, comprising up to 240 telephone channels as well as pilot and supervisory signals, are connected to a modulator that produces a frequency-modulated 60-Mc/s carrier. This is amplified and is used to phase-modulate the 4,000-Mc/s carrier in a travelling-wave amplifier (TWA1). From the resulting sidebands one is selected by a waveguide filter and is amplified to a power level of 1W by a second travelling-wave amplifier (TWA2).

Each transmitter is housed in a double-cabinet unit, Fig. 14, about 4 ft × 2 ft × 7 ft high. Safety locks are fitted to the side and rear doors so that they cannot be opened with power connected to the cabinet. Front doors are provided but these can be opened without switching off. Most units are readily removable from the cabinet for maintenance work.

Modulator.

The frequency-modulated oscillator operates at a mean frequency of 30 Mc/s and its output is frequency-doubled to provide the required 60-Mc/s signal. The oscillator consists of one pentode and two triode valves arranged in a loop, the grids of the triode valves being grounded for the carrier frequency, but used for injection of the baseband signal. This type of frequency-modulated oscillator has already been described in the Journal.²

Since the oscillator frequency is inherently sensitive to supply voltage changes, some form of carrier-frequency stabilization is required. A signal from the oscillator is therefore applied through a buffer amplifier to a discriminator circuit centred on 30 Mc/s, and the voltage derived from this is d.c.-amplified before being applied back to control the oscillator.

The complete modulator unit is assembled on a vertical chassis, 17 $\frac{3}{8}$ in. × 6 $\frac{1}{2}$ in., with the valve screens protruding on one side and all the wiring on the other side under a box-type cover. The i.f. output level is 0.5V r.m.s. across a 75-ohms load, and a baseband input level of -28 dbm* is required for the standard channel deviation of 200 kc/s r.m.s. No pre-emphasis is used.

High-Level I.F. Amplifier.

The high-level i.f. amplifier is designed to accept an input signal of 0.5V r.m.s. from the modulator; and to provide an output voltage for phase-modulating a travelling-wave valve, 20-25V r.m.s. are required at the electrodes of the travelling-wave valve, and adequate gain/frequency and group delay/frequency characteristics must be maintained over the working band of frequencies. The amplifier uses three small pentodes (CV2020) and five pentodes of 12W maximum dissipation (CV2129) and as an i.f. power level of more than 1W is reached, the amplifier is fully screened to avoid interference with low-level 60-Mc/s equipment. Forced-draught cooling is required. The valvoholder for the travelling-wave valve (CV2358) is mounted on this amplifier, and a jig is provided for precise mechanical location of the amplifier with respect to the travelling-wave valve. Adequate isolation of the high voltages used in the travelling-wave valve introduced additional problems in minimizing stray shunt capacitances.

S.H.F. Carrier Oscillator.

The s.h.f. carrier is provided by the unit, photographed in Fig. 15, and shown in schematic form in Fig. 16. The oscillator is a reflex klystron oscillator, type CV2116, and in the unit is associated with an electro-mechanical method

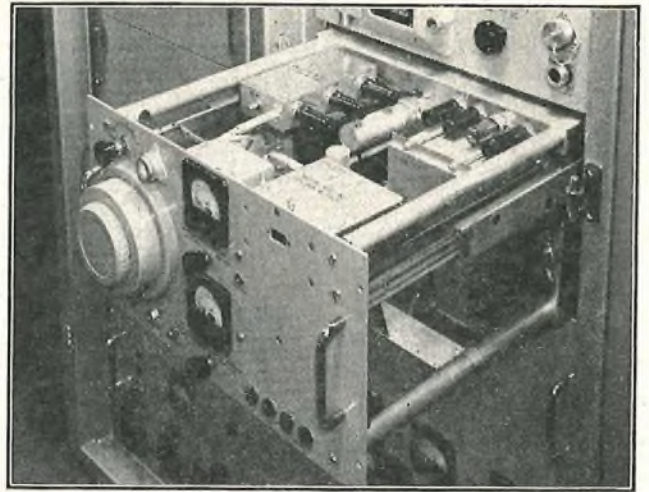

FIG. 15.—S.H.F. CARRIER OSCILLATOR WITH A.F.C.

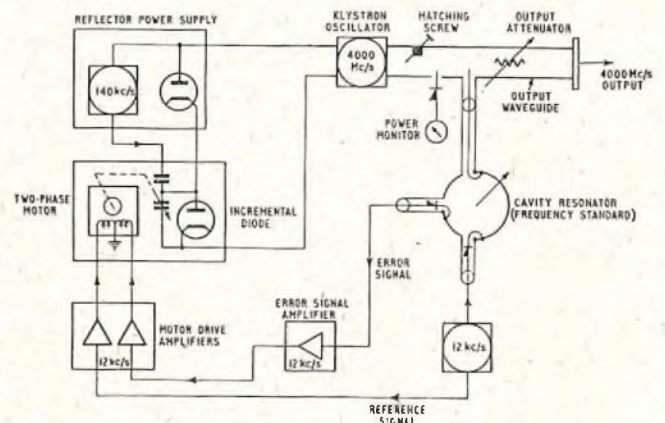

FIG. 16.—S.H.F. CARRIER OSCILLATOR AND A.F.C. SYSTEM.

of automatically controlling the frequency, which is stabilized to within ± 100 kc/s of its nominal value. A high-stability cavity resonator which functions as a microwave discriminator is used as the reference of frequency. Two silicon crystal valves are coupled by coaxial lines which are terminated within the resonator cavity in small coupling loops. One of these crystals acts as a frequency-modulator for the cavity. The crystal is pulsed by a 12-kc/s square wave, and the resulting resistance changes of the crystal are transformed by the coaxial coupling line to reactance changes which alter the resonant frequency of the cavity. The second crystal operates as an a.m. detector to give a 12-kc/s signal output having an amplitude which is greater as the s.h.f. input frequency departs from the mean resonant frequency of the cavity. For small differences, or errors, the amplitude of the 12-kc/s signal is proportional to the error frequency. There is a change in phase of 180° in the error signal as the s.h.f. moves from one side of the cavity resonant frequency to the other. After amplification the error signal is applied to one winding of a two-phase induction motor, the other winding being energized by a 12-kc/s reference voltage. The direction of rotation of the motor is determined by the phase relationship between the error signal and the reference signal voltages, i.e. accordingly as the frequency is low or high. Mechanically linked to the motor is a small variable capacitor which is connected in series with a fixed capacitor to form a variable potential divider across the output of a 140-kc/s oscillator. The voltage appearing across the variable capacitor is rectified and injected in series with the d.c. voltage supply to the reflector electrode of the klystron

² RAVENSCROFT, I. A., and WHITE, R. W. A Frequency Modulator for Broad-Band Radio Relay Systems. *P.O.E.E.J.*, Vol. 48, p. 108, July 1955.

* Decibels relative to 1 mW.

oscillator. Because the frequency of oscillation of the klystron depends on the reflector voltage, when the motor moves the capacitor to a new position the oscillator frequency error will be corrected automatically if the motor is connected so that the frequency error is reduced when the motor runs.

The "pull-in" range, i.e. the frequency range (centred at the required s.h.f. channel frequency) over which the unit will correct the frequency of the klystron oscillator, is ± 5 Mc/s. This is sufficient to cover the long-term drift of the oscillator after initial adjustment to the correct frequency; and over this range there is no significant change in power output from the klystron oscillator. The maximum power available is almost 50 mW.

Travelling-Wave Amplifiers.

The first of the two travelling-wave amplifiers in the transmitter (TWA1) is the 60/4,000-Mc/s frequency-changer. It is proposed to describe briefly, first the principle of the amplifier and then the principle of its use as a modulator. A diagram of a travelling-wave amplifier is shown in Fig. 17. Amplification is produced in the valve by inter-

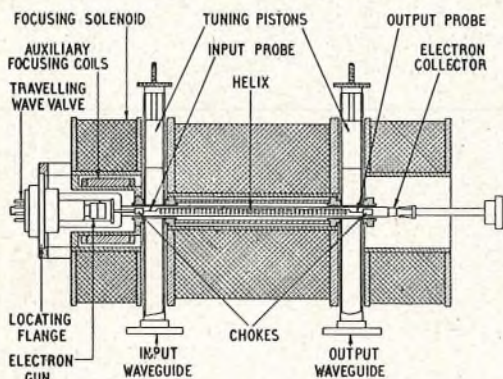

FIG. 17.—TRAVELLING-WAVE AMPLIFIER.

action between an input electromagnetic wave, which is propagated along a helical slow-wave structure and an electron beam directed down the centre of the helix at nearly the same velocity as the axial component of the wave. The helix is coupled to the input and output waveguides by short probes. The input wave causes velocity modulation and bunching of the electron beam, which in turn increases the r.f. field on the helix and an amplified wave appears at the output.³ This increase in power in the wave is accounted for by a decrease in the average kinetic energy and reduction in the average velocity of the electrons forming the beam. The electron beam is mainly confined to the axis of the helix by a uniform longitudinal magnetic field produced by a solenoid. Two pairs of auxiliary coils are fitted round the electron gun inside the solenoid to provide small lateral magnetic fields which can be adjusted to control the angle at which the electron beam enters the valve to valve.

The first travelling-wave amplifier (TWA1) is used as a frequency-changer by injecting the already frequency-modulated 60-Mc/s signal (to act as the modulating signal) in series with the beam voltage of the travelling-wave valve and applying to the input waveguide, at a power level of 2 mW, the microwave carrier to be modulated. The modulation by the 60-Mc/s signal produces corresponding variations in the velocity of the beam and thus phase-modulates the microwave carrier appearing at the output of the valve. The resulting sidebands are displaced from

the carrier by multiples of 60 Mc/s, and the wanted sideband (in this instance the first upper sideband) is selected by a waveguide filter. TWA1 uses a travelling-wave valve, type CV2358, which operates with a beam current of 5 mA at 1,400V. The power dissipated at the collector is only 7W and no special cooling arrangements are required for this valve. When operated as a frequency-changer in the manner described above the sideband power obtainable is 30 mW.

The valve used in the second and final amplifier (TWA2) is type CV2188 which gives an output power of 1W when driven by the 30-mW signal obtained from TWA1. The valve is operated with a beam current of 15 mA at 3,000V. The d.c. power dissipated at the collector is 45W and this electrode is fitted with a finned copper cooler for air-blast cooling by a small blower.

Reflectometer.

The function of the reflectometer is to facilitate adjustment of the impedance match between the output of the final travelling-wave amplifier and the waveguide feeder to the aerial. Readjustment of the matching may be necessary when the travelling-wave valve is replaced. In addition the reflectometer provides facilities for measuring the match of the aerial to the feeder. The unit is used in conjunction with test equipment on a trolley. A block schematic diagram of the reflectometer is shown in Fig. 18.

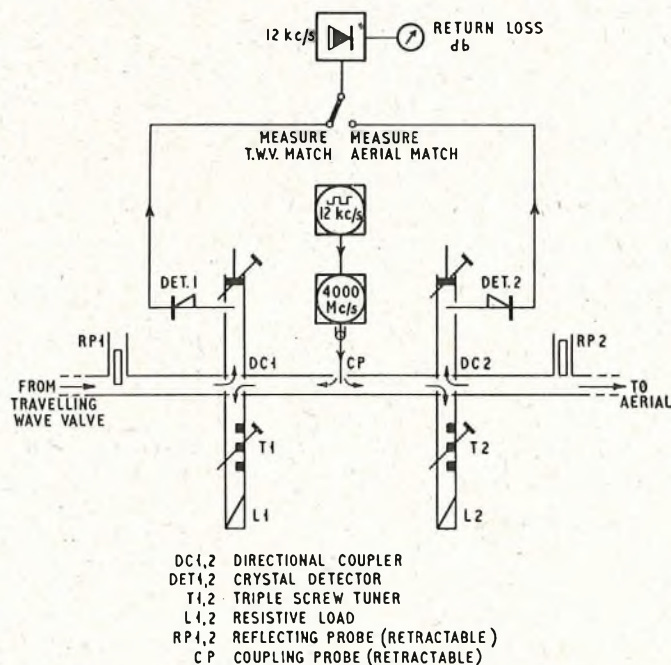

FIG. 18.—REFLECTOMETER.

The basis of the reflectometer is that for each measurement there is provided a directional coupler able to distinguish between waves moving in opposite directions in the waveguide. By comparing the magnitudes of incident and reflected waves, the magnitude of the reflection coefficient can be measured. The reflectometer is a length of waveguide with a probe unit (CP) for injecting a square-wave amplitude-modulated s.h.f. test signal into the waveguide. The two directional couplers DC1 and DC2 are arranged to sample the wave reflected from the travelling-wave valve and from the aerial, respectively. The secondary arms of the directional couplers are each terminated in a crystal detector. An output from one of the crystal detectors is selected by a switch, amplified and measured with a valve voltmeter which then indicates the mismatch looking

³ BRAY, W. J. A Survey of Modern Radio Valves. Part 6(a). P.O.E.E.J., Vol. 43, p. 148, Oct. 1950.

towards the travelling-wave valve or the aerial feeder. This impedance is measured relative to that of the waveguide and in terms of return loss, that is, the amplitude ratio of the signal incident upon the junction between waveguide and amplifier, to the signal reflected from the junction back towards the reflectometer. The ratio is expressed in decibels. Reflecting probes RP1 and RP2 of known return loss are provided for calibration purposes. A stepped attenuator associated with the valve voltmeter gives a direct indication of return loss for a reference reading on the meter. The unit has a range of return loss measurement from 20 to 36 db and is accurate to $\pm \frac{1}{2}$ db.

THE RECEIVERS

In essence, the principle of operation of the microwave receiver is the same as that of a normal superheterodyne receiver: the required signal is selected from the aerial output by a filter, is mixed with a local oscillator frequency in a frequency-changer, and the difference frequency is amplified in the intermediate frequency amplifiers and finally demodulated in a limiter-discriminator circuit to give the baseband output. The need for spaced-aerial diversity, and the fact that two different frequencies are used to convey the information over each direction of the link, mean that there will be four such receivers at each terminal. But since a common local oscillator can be used for the two receivers working on the same frequency, it is convenient to enclose a pair of receivers in the same cabinet. A block schematic diagram of such a double receiver is shown in Fig. 19, and Fig. 20 is a photograph showing the front of the receiver.

Since the upper and lower receiving aerials respond equally well to the two frequencies of transmission, it is necessary to channel the incoming signals into the appropriate receivers by means of two pairs of branching filters connected between the aerial feeders and the receivers. Five-cavity waveguide filters⁴ are used for this purpose, joined by a delta-section to form a branching pair, and two such pairs are mounted outside the receiver cabinets.

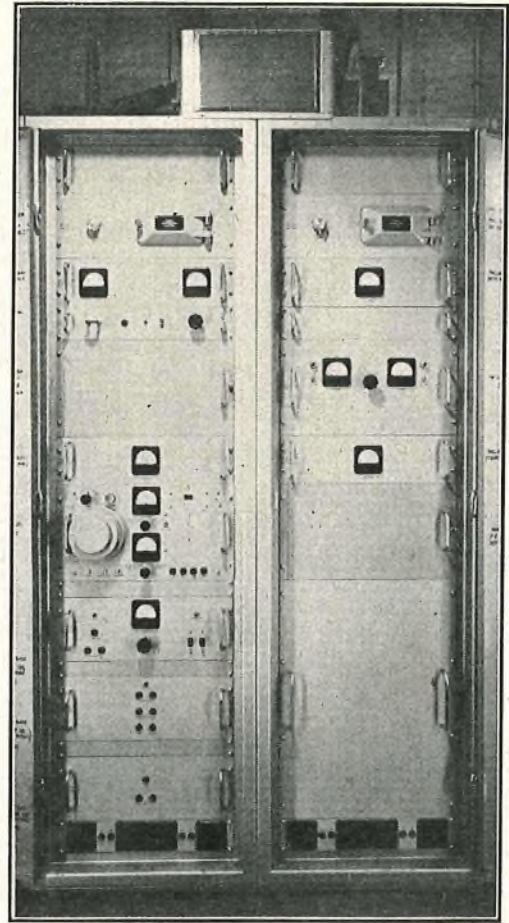

FIG. 20.—RECEIVER—FRONT VIEW.

⁴ FLOYD, C. F., and RAWLINSON, W. A. An Introduction to the Principles of Waveguide Transmission. Part 2. *P.O.E.E.J.*, Vol. 47, p. 153, Oct. 1954.

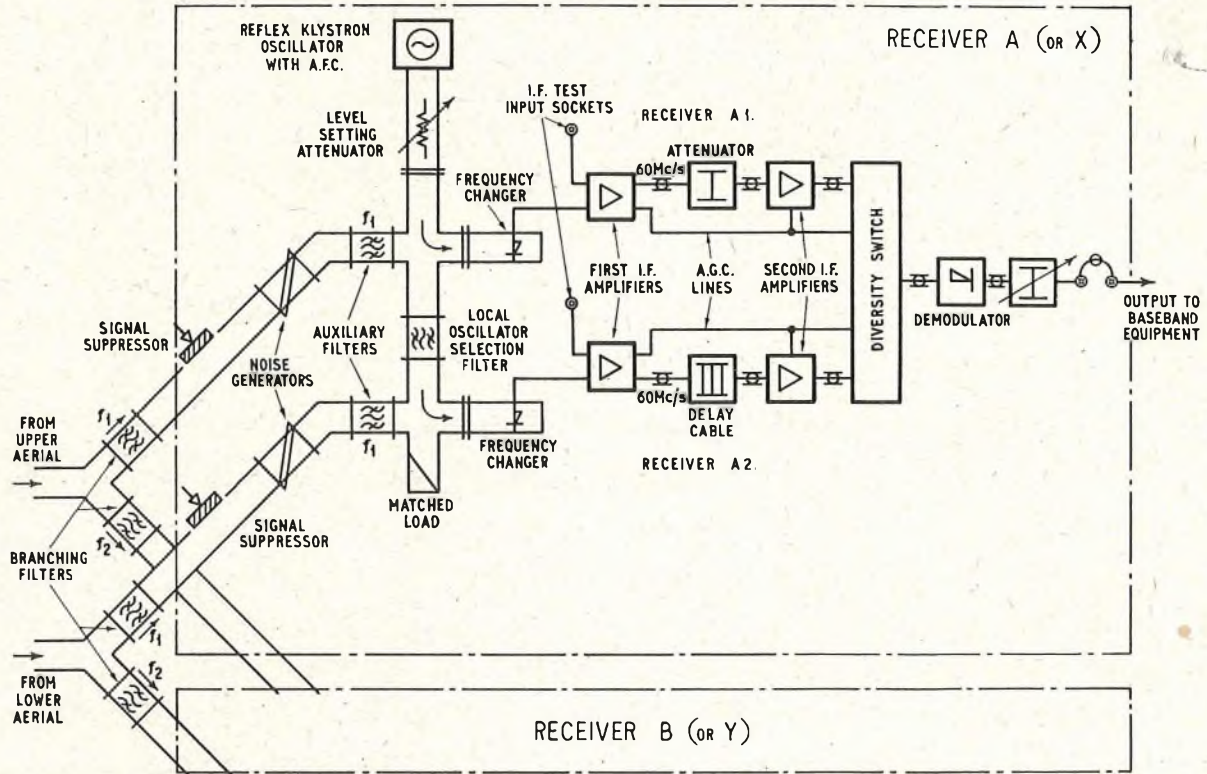

FIG. 19.—BLOCK SCHEMATIC DIAGRAM OF RECEIVER.

The insertion-loss characteristics of these filters are such that although the filters do not present more than 0.25 db of loss over a range of frequencies ± 6 Mc/s about the nominal centre-frequency of their pass band, they introduce nearly 50 db discrimination against signals 48 Mc/s away from the centre frequency (frequency spacing between the channels in each direction of transmission is 48 Mc/s).

Each receiver cabinet therefore has two microwave signals entering on two separate waveguide input runs; these signals are at the same frequency and carry the same information, but, as already explained, are received from aerials at different heights on the mast. The two waveguide runs descend vertically through the receiver cabinet and terminate in crystal frequency-changers; these receive their local oscillator supplies through waveguide cross-couplers from a reflex-klystron oscillator mounted in an s.h.f. carrier oscillator unit identical with that fitted in the transmitter.

The frequency of the local oscillator is 60 Mc/s below that of the incoming signal, so a difference frequency of 60 Mc/s emerges from the crystal frequency-changer. This signal is amplified in two i.f. amplifiers. There is an automatic gain-control system operating between these amplifiers which compresses a 30-db fade of the incoming signal into an output i.f. variation of 6 db; this keeps the range of levels presented to the demodulator well within that required for efficient limiting. Only one demodulator is provided for the complete receiver and this is presented with the i.f. output from the side of the receiver having the greater incoming signal level, the selection being performed by means of a diversity switch. A length of delay cable is inserted between the two i.f. amplifiers in the side of the receiver that obtains its signal from the lower aerial; this introduces the same delay time as the difference in transmission times for the upper and lower aerials and thus prevents clicks in the baseband channels when the diversity switch changes over.

Like the transmitter, the receiver is housed in a double cabinet unit and a similar method of construction is employed, with withdrawable power and s.h.f. oscillator units. The i.f. equipment is also arranged to be easily replaceable.

Waveguide Components.

Reference to Fig. 19 shows that there are several waveguide items between the branching filters and the frequency-changers that have not been mentioned in the outline description of the receiver given above, chiefly because they are ancillary rather than essential to the functioning of the receiver.

The first two items, the signal suppressor and the noise generator, are contained within a single waveguide unit. The noise generator is used to find, during periodic maintenance checks, one of the most important parameters of the receiver—namely, its noise factor. It consists of a fluorescent discharge tube of mercury-argon fitted obliquely across the waveguide, and, when excited, it generates a constant noise output over a very wide frequency band. Noise factor measurements are made by breaking the circuit at the output of the second i.f. amplifier and connecting this amplifier to a detector and galvanometer. By comparing the deflections on this galvanometer with the noise tube excited and quiescent (i.e. with noise due to the discharge tube and the receiver combined, and then from the receiver alone), the noise factor of the receiver can be determined.

When making noise factor measurements in this way, it is necessary to prevent the incoming signal from adding to the noise generated by the discharge tube or the receiver itself; this is ensured by operating the signal suppressor, which, by means of short-circuiting posts and a resistive vane, introduces more than 80 db of attenuation into the wave-

guide and produces a good termination to the branching filter so that the other pair of receivers is unaffected by the operation of the signal suppressor. A mechanical interlock prevents both signal suppressors from being operated simultaneously, and the diversity switch automatically selects the channel that is still receiving the radio signal. The electrical circuit for striking the noise tube is not completed until the appropriate signal suppressor is fully inserted.

The next three waveguide items, namely the auxiliary filter, the cross-coupler, and the frequency-changer, should also be considered together. The frequency-changer consists of a short length of waveguide, short-circuited at one end, with a cross-bar that conveys the incoming signal into a short coaxial stub mounted on the broad side of the waveguide. This stub contains a coaxially-screened silicon-crystal rectifier that is designed for use at microwave frequencies. To keep unwanted circuit elements to a minimum, the coaxial stub containing the crystal detector is arranged to protrude through the chassis of the first i.f. amplifier, so that the connexion between the crystal output lead and the first stage of the amplifier can be kept extremely short. The amplifier and the frequency-changer are held together by brackets and form one unit which continues the vertical run of the waveguide in the cabinet; the amplifiers can be seen at the bottom of Fig. 21, which

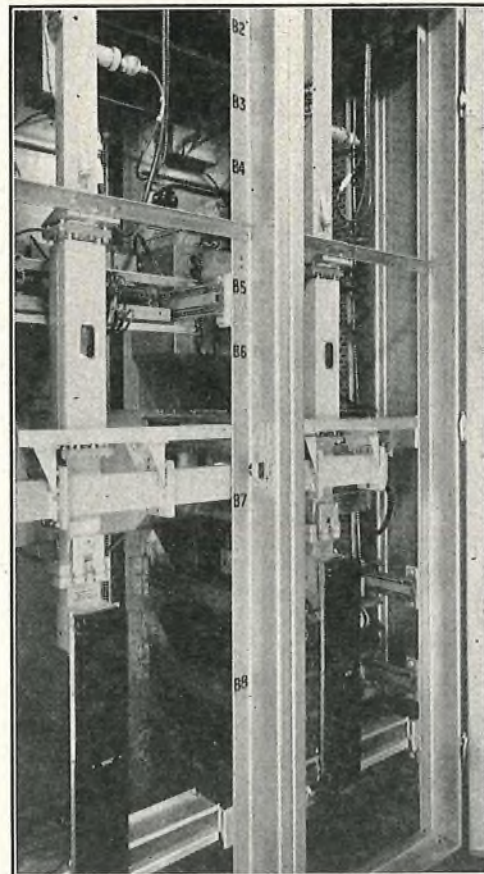

FIG. 21.—RECEIVER—REAR VIEW.

shows the rear view of the receiver with the cabinet doors open. The frequency-changer and amplifier can be taken out very rapidly for alteration or replacement, by releasing a spring-held quick-break flange on the frequency-changer (seen just below the cross-couplers in Fig. 21), and a multi-point power socket at the base of the amplifier.

The local oscillator supply to the two frequency-changers is fed via two cross-couplers in tandem. These consist of

two pieces of waveguide crossing at right-angles with a cruciform slot cut in the common interface, and have the property that they present negligible attenuation in the two straight directions of the waveguide, have a coupling loss of about 17 db between the local oscillator and the frequency-changer and a very high loss between the local oscillator and the aerial.

The overall noise factor of the frequency-changer and the first i.f. amplifier is a compromise between two opposing factors—the conversion loss, which decreases as the rectified current increases, and the crystal noise temperature,* which increases with the crystal current. The optimum crystal current is 0.55 mA, and as the local oscillator power is very much greater than the received signal power (which is of the order of -70 db on 1W for free-space propagation), this optimum current is set by adjusting the level-setting attenuator in the output of the local oscillator unit.

The auxiliary waveguide filters, which precede the cross-couplers in the signal path, add to the discrimination produced in the branching filters, but have the more important property of reflecting the image signal (which is at a frequency 120 Mc/s higher than the incoming signal frequency) back towards the frequency-changer; there it recombines with the local oscillator frequency and produces a useful i.f. output, thus improving the noise factor of the receiver.

There is an additional waveguide filter in the local oscillator connexion between the two cross-couplers. This has a narrow pass-band centred on the local oscillator frequency and prevents any signal descending from one aerial from coupling into the frequency-changer associated with the other aerial, an effect which would cause distortion of the demodulated output if no steps were taken to prevent it.

With optimum positioning of the auxiliary filters and with a crystal current of 0.55 mA, the noise factor of the receiver is about 12.5 db.

Low-Level I.F. Amplifiers.

Two i.f. amplifiers are used in tandem in each half of the diversity receiver. The first (Amplifier No. 87A) follows the crystal mixer and provides the bulk of the i.f. gain required under free-space propagation conditions. It uses triode valves (CV2008) in the first two stages, followed by nine pentode valves (CV2020). The pentodes are arranged as four feedback pairs and an output stage, the group-delay equalizer network being inserted between the second and third feedback pairs. An earthed-grid triode is preferred to a "cascode" or neutralized triode arrangement in the input stage because it provides an almost constant resistive load for the frequency-changer—a factor of importance when accurate matching is required between a long aerial feeder and the input microwave impedance of the crystal mixer.

The second amplifier (Amplifier No. 88A) provides additional gain to deal with fading and includes the circuits necessary to provide amplified automatic gain control. The signal path in this amplifier uses six CV2020 pentodes, the last four forming two feedback pairs; the group delay equalizer is placed between the first and second valves.

Each amplifier is assembled on one side of a flat vertical chassis, with the valves mounted in clips across, and parallel to, the chassis. A screening cover of long box form encloses each amplifier, and supplies are taken through a multi-

way plug of generous size. The crystal mixer and first i.f. amplifier are arranged as an integral unit, having a waveguide input for the microwave signal and a 75-ohm coaxial output at i.f. The average gains of the first and second amplifiers are about 44 and 24 db.

Receiver Tracking.

The function of the 60-Mc/s diversity switch, which is described in the next sub-section, is to select the greater of the two received radio signals. This is not necessarily the same as the greater of the two 60-Mc/s outputs from the second two i.f. amplifiers, for the gains of the two halves of the receiver from frequency-changer to the output of the second amplifier are unlikely to be identical at all levels. Such equality is very difficult to ensure, particularly if the effects of valve aging are to be catered for, and it is preferable to actuate the diversity switch by the a.g.c. voltages that operate between the i.f. amplifiers rather than by their 60-Mc/s output levels. By tracking the a.g.c. voltages of the two halves of the receiver very accurately against each other, the diversity switch can select the greater of the two incoming signal levels when they differ by only a few decibels, even though there may be more than 70 db of gain between the receiver input and the diversity switch.

The tracking of the two receivers is carried out by injecting identical test signals at 60 Mc/s into test sockets at the input end of the first two i.f. amplifiers. The gain of the two halves of the receiver is then approximately equated by altering the attenuator that separates the two i.f. amplifiers on one side of the receiver to give the same i.f. output as is obtained from the side with the length of delay cable between the amplifiers; this should be done when all the amplifiers are working at full gain, i.e. with a very low test signal level. Then the amplitude of the input test signal can be varied over a range extending from that equivalent to free space propagation (after conversion to intermediate frequency) down to a deep fade below this, and the a.g.c. voltages developed in the two halves of the receiver are adjusted until they agree to within very close limits over this range. Curves showing the permissible variations of i.f. output voltage and a.g.c. voltage for various input levels are shown in Fig. 22.

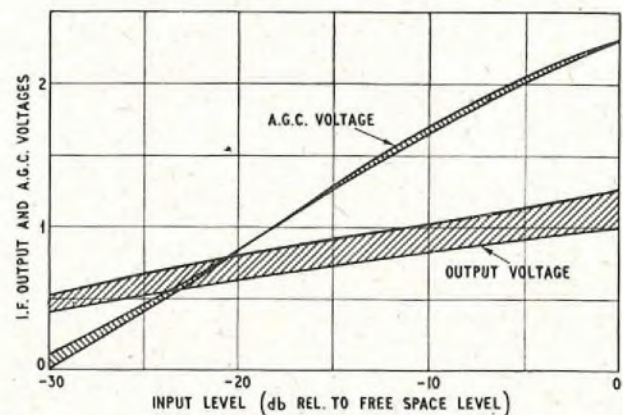

FIG. 22.—RECEIVER TRACKING.

When, subsequently, the diversity switch is balanced, its test signals are these a.g.c. voltages derived from the preceding i.f. amplifiers, and its switching sensitivity is checked against differential level changes of the two i.f. test signals. In this way the receiver is aligned in a manner that approximates as nearly as possible to its normal working conditions.

* If the maximum available noise power from a crystal frequency-changer and from a resistor are compared under the same conditions of room temperature and bandwidth, a "noise temperature" may be assigned to the crystal such that:—

$$\frac{\text{Crystal Noise Temperature}}{\text{Resistor (room) Temperature}} = \frac{\text{Frequency-changer Noise Output}}{\text{Resistor Noise Output}}$$

I.F. Diversity Switch.

The i.f. diversity switch is required to select the i.f. channel to which the higher level input signal is applied and connect it to the demodulator, the latter being common to both channels of the spaced-aerial dual-diversity receiver.

If clicks in the speech channels are to be minimized, the transit time of the i.f. diversity switch should be as short as is reasonably practicable, and in this case the change-over time does not exceed $0.3 \mu\text{s}$. A longer delay is permissible before the switching operation takes place, but telegraphy considerations during rapid fading restrict this delay to less than 5 ms. When both input signals are fairly low in level, accurate selection of the higher one is important; but when both signals are high the signal-to-noise ratio of each should be good and correct selection is less important. The sensitivity of selection (i.e. level difference required for change-over) is about 2 db at the bottom of a 20-db fade and about 5 db for normal signal levels, but provision has been made for increasing these level differences if so desired.

The gating attenuation (i.e. discrimination against the unwanted channel) which must be provided is determined by noise break-through to the wanted channel when the input signal to the other channel has been interrupted. The minimum permissible value is about 40 db, but the switch which is used provides well over 50 db. The transmission characteristics in the signal paths through the switch must conform to the same standards as are required in other parts of the i.f. equipment, and although nominally a zero-gain device a small value of gain is provided to allow for valve aging.

Demodulator.

A frequency demodulator is required to convert the frequency modulation of the signal to a baseband output signal with as little distortion as possible. The normal input to this demodulator unit is 0.5V r.m.s., falling to about 0.25V during a deep fade. The incoming signal passes through a 75-ohm group-delay equalizer and an input amplifier valve, thence via four limiter stages to a pair of amplifier valves whose grids are paralleled. These last two valves drive circuits resonant at 50 and 70 Mc/s, which are arranged to provide a reasonably linear discriminator of the two-tuned-circuit type. Germanium diodes are used as rectifiers and separate baseband amplifiers provide isolation of the two halves of the discriminator. After combining the signals, a final amplifier and a step-down transformer with a flat bandwidth of 30–1,500-kc/s supply baseband signals to the 75-ohm output cable. The demodulator uses a total of 11 valves, all type CV2020, and is similar to the modulator in size and general mechanical arrangement.

PERFORMANCE

Attention will be confined in this section to the performance of the radio equipment and particularly to the way in which the characteristics of the f.m. part of the system affect the overall performance. The system performance from baseband to baseband, although necessarily including the radio equipment as a circuit element, will be described in some detail, in Part 2 of this article.

Performance Target.

No rigorous advance specification for the performance of the radio link was imposed because the novel nature of the techniques employed made it impossible to give any guarantee of performance. Nevertheless the design target was the C.C.I.F. recommendations for long telephony-transmission systems combined with a reliability and freedom from short breaks that would make it acceptable as part of the trunk network.

At the time of the inception of the link, these recommendations were interpreted as being those of the 3rd study group at the 16th plenary assembly of the C.C.I.F., namely that, for a 2,500-km circuit, the psophometrically weighted noise power, measured in any 300–3,400 c/s channel at the zero level point, should not exceed 10,000 pW for more than 1 per cent of the busiest hour. Of this noise, one quarter is allocated to terminal translating equipment, and for transmission systems less than 2,500 km in length, the noise introduced can be considered to be proportional to the length of the link, the proportionality being $(10,000-2,500)/2,500$ or 3 pW/km. For the Braewynner-Thrumster portion of the Elgin-Wick link, this is 3 pW/km $\times 88.5$ km or 265.5 pW, a signal/noise ratio of 66 db, when the signal is taken to be a test tone 1 mW in level at the zero level point, and the term "noise" includes thermal noise and all distortion products. To allow for unweighted measurements in a 4-kc/s band rather than psophometrically-weighted figures in a 300–3,400 c.p.s. band, a correcting factor of -3.5 db can be introduced; under these measurement conditions, the required signal/noise ratio for the link becomes 62.5 db.

A further point of interest is the relationship between the signal/noise ratio, as defined above, and the noise-power ratio (n.p.r.). An extended discussion of these factors has appeared in an earlier article,⁶ but, briefly, the n.p.r. of a system loaded with a particular level of noise test signal is defined as the ratio of the noise power in an arbitrary small band in the output of the system to the noise power in the same bandwidth when a stop filter suppresses this part of the noise test signal at the input of the system. This is related to the more familiar term "signal/noise ratio" by a conversion factor, which, at the time that much of the testing to be described was being carried out, was taken as that given in an interim recommendation by the British study group of the C.C.I.R. to the effect that the unweighted signal/noise ratio in a 4-kc/s bandwidth was considered equal to the noise power ratio + 12 db for a system carrying 240 channels or more. A more recent recommendation of the C.C.I.R.⁶ has increased this conversion factor to 15 db. It is evident that the n.p.r. is a convenient factor which is independent of conversion factors that may vary from time to time and from country to country, and is therefore a more fundamental unit to use when making measurements on a system; it is the n.p.r. that is referred to, for the most part, in the following discussion.

Using the current C.C.I.R. conversion factor, the n.p.r. for the Elgin-Wick system in the worst channel should be at least $62.5 - 15 = 47.5$ db.

Sources of Noise and Distortion.

Imperfections in a f.m. system result in noise appearing in the voice channels, and their effects in a busy wide-band telephony system cannot be distinguished subjectively from the sound of random noise. Thermal effects also give rise to random noise appearing in the voice channels, so that the total noise introduced into the circuit comes from the following causes:—

- (i) First-circuit thermionic and valve fluctuation noise in the receiver.
- (ii) Intermodulation distortion noise due to amplitude and group-delay variations with frequency in the i.f. equipment, the waveguide filters and cables.
- (iii) Intermodulation distortion due to reflections in the waveguide feeders, reflections from objects near the radio path, and multi-path propagation.

⁶ WHITE, R. W., and WHYTE, J. S. Equipment for Measurement of Inter-Channel Crosstalk and Noise on Broad-Band Multi-Channel Telephone Systems. *P.O.E.E.J.*, Vol. 48, p. 127, Oct. 1955.

⁷ C.C.I.R. Recommendation No 197 Warsaw 1956.

(iv) Distortion due to non-linearity in the transfer characteristics of modulators and demodulators.

It was found that for the circuit techniques and valves available at the time the link was projected, the most important of these noise sources were the receiver first-circuit noise and the intermodulation distortion caused by group-delay variations. Provided that the reflection coefficient at the ends of the feeders did not exceed 3 per cent, the distortion introduced from this source would not be appreciable for four supergroup traffic loading, and the linearity of the modulator and demodulator transfer characteristics was intended to be sufficient to be well away from limiting the overall performance of the system. All the forms of noise and distortion arising from causes (i), (ii) and (iii), produce noise in the demodulated baseband output that increases with frequency, and since the distortion introduced by (iv) is comparatively small, it is the telephone channel that is translated up to the top frequency of the fourth supergroup that suffers the most signal/noise degradation and which therefore receives the greatest attention during measurements.

The aim during the design was to achieve a n.p.r. of 54 db for first-circuit noise alone (i.e. "basic noise"), and about the same figure for intermodulation distortion, both in the worst (highest-frequency) channel. The intermodulation requirement would necessitate group-delay variations for the complete link of 4.6 millimicroseconds of linear departure and 6.4 millimicroseconds of square-law departure of the group-delay at the edges of an 8-Mc/s bandwidth compared with its value at midband. At the time that the design of the link was started, it was thought that these figures would be difficult to achieve, but it was estimated that by relaxing the group-delay performance to three times the figures quoted above, the n.p.r. due to intermodulation distortion would be worsened by about 5 db, which would still give a reasonable commercial circuit. As it turned out, the more stringent figures were attained.

Laboratory Performance of Equipment.

Before the equipment was installed on site, a series of measurements were made on its performance in the laboratory. First the 60-Mc/s modulator and demodulator were investigated when working back-to-back, then all the i.f. equipment was included between them, and finally the complete transmitter and receiver were assembled and tested with a cable connexion between them giving a loss of 70 db, which was taken as being the expected path loss, including feeder losses, for the radio path. Random-noise measuring equipment⁵ was used for all these tests, and the noise level was set at a level 12 db higher than that needed for a test tone to give a single-channel deviation of 200 kc/s. This value of noise loading (+ 12 db on test tone level) was the figure considered at the time the tests were made as

TABLE 1
Noise Power Ratios of Equipment Measured in Laboratory

Test Condition	N.P.R. at Test Channel Frequency of:—		
	70 kc/s	534 kc/s	1,002 kc/s
60-Mc/s Modulator and Demodulator back-to-back ..	61 db	60 db	58 db
All 60-Mc/s equipment in tandem	61 db	57 db	53 db
Basic noise of receiver ..	64 db	59 db	54 db
Transmitter and receiver back-to-back with 70-db loss between them	59 db	54 db	51 db

being equivalent to 240 channels of telephony. Since then this figure has been reduced to + 8.8 db, on the recommendation of the C.C.I.R., so the results quoted in Table 1 are, if anything, slightly pessimistic.

The effect of changing the deviation of the f.m. modulator on the signal/noise ratio of the transmitter and receiver working back-to-back can be seen from Fig. 23; these curves were obtained by simply varying the level of the test noise modulation. The optimum test-tone deviation for such a large path loss, and for the equipment used, is about 230 kc/s, but there is little degradation of performance at 200 kc/s, and as this is now the value recommended by the C.C.I.R., it has been adopted for the Elgin-Wick system.

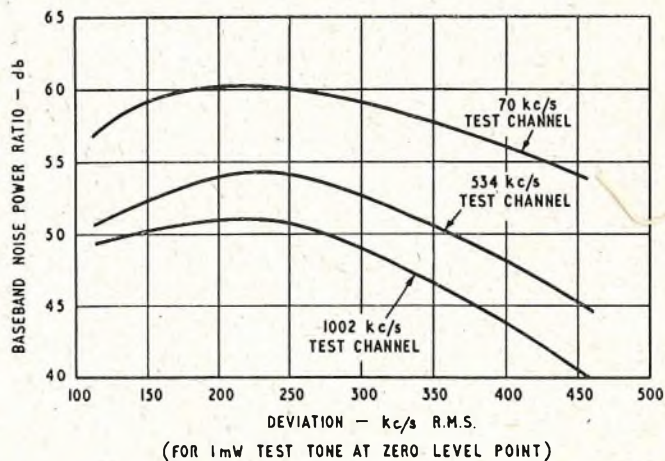

FIG. 23.—EFFECT OF DEVIATION ON OUTPUT NOISE POWER RATIO (TRANSMITTER AND RECEIVER BACK-TO-BACK WITH 70 DB BETWEEN THEM. SIGNAL FREQUENCY = 4,158 Mc/s)

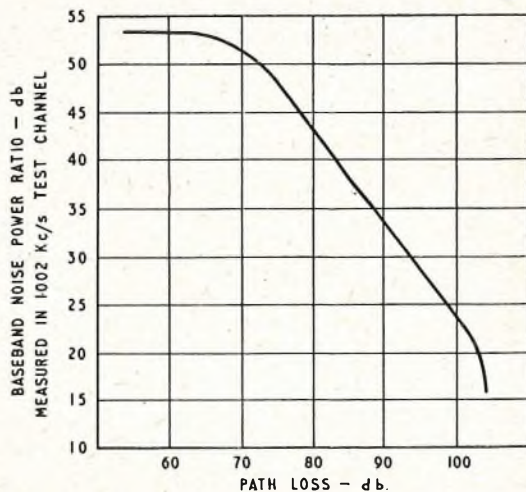

FIG. 24.—EFFECT OF RECEIVED CARRIER LEVEL ON OUTPUT NOISE POWER RATIO.

The effect of varying the path loss (i.e. in the experiment, the attenuation of the cable connecting the transmitter and the receiver) is shown in Fig. 24. For losses varying between the equivalent of free space propagation down to 33 db below this level there is a "db for db" relationship between the path loss and the output signal/noise ratio. For path losses greater than 103 db, the signal/noise ratio worsens rapidly because the limiters in the demodulator no longer function efficiently; and with input signal levels above that corresponding to free space propagation, there is no further improvement in the output signal/noise ratio since the intermodulation products become the dominating factor and these are virtually unaffected by input level.

Performance over the link.

Slight worsening in the performance of the equipment in comparison with its laboratory performance is to be expected when it is working over an actual link. Interaction between the units working together in the same room, additional waveguide filtering and reflections from buildings and other objects near the radio path may each introduce some degradation, which, although too small to measure individually, can all contribute to a worsening of the final n.p.r. The results quoted in Table 2 were obtained by using the noise-measuring equipment with the noise loading at +12 db on test-tone level, and all figures are for non-fading conditions; the measurements were between the input to the 60-Mc/s modulator in the transmitter and the output of the 60-Mc/s demodulator at the receiver at the distant terminal, i.e. no baseband equipment was included in these measurements.

TABLE 2
Noise Power Ratios over Elgin-Wick Link with Free-Space Propagation

Channel	N.P.R. with Full Noise Loading, at Test Channel Frequencies:—			Basic n.p.r. at 1,002 kc/s
	70 kc/s	534 kc/s	1,002 kc/s	
	Braewynner-Thrumster			
A1	59 db	52 db	49 db	52 db
A2	59 db	50 db	49 db	54 db
B1	58 db	50 db	47 db	53 db
B2	59 db	50 db	49 db	52 db
	Thrumster-Braewynner			
X1	58 db	56 db	49 db	52 db
X2	58 db	55 db	48 db	51 db
Y1	62 db	56 db	50 db	54 db
Y2	60 db	54 db	51 db	54 db

These n.p.r. values can be converted to give the un-weighted signal/noise ratios by adding 15 db. A further 3.5 db is added to give the weighted signal/noise ratio in a 3.1 kc/s band.

The figures quoted in Table 2 were measured when the a.g.c. voltage meters on the appropriate receiver indicated that the incoming signal level was constant at the free-space propagation value. To obtain more realistic performance figures, allowance should be made for fading so that a distribution of noise against time can be assessed. Recordings have been made over the Thrumster-Braewynner path of the n.p.r. fluctuations in the highest frequency channel at the output of the baseband equipment (i.e. after the most favourable of the four paths available has been selected by the i.f. and baseband switches), but a full analysis of these recordings has not yet been made nor has the length of time of the investigation been sufficient for a reliable assessment of the link performance. However, it can be stated qualitatively that for most of the time the overall n.p.r. stays at 48 db or more in the worst channel, and rarely drops below 46 db.

One of the items mentioned in the list of sources of noise and distortion, but which has not subsequently been discussed, is that due to multi-path or frequency-selective fading. The Elgin-Wick link, having a long oversea path, is likely to be quite susceptible to such fading, but reliable information is lacking on this subject. Some measurements were made over this path for a few weeks during the late summer and early autumn of 1956 with a skeleton transmitter and receiver. Recordings were made of the n.p.r. at the receiver (without diversity) and compared with recordings of the received signal level. For about 0.6 per cent of the period of the tests, the n.p.r. was significantly worse than would be expected if purely path-loss attenuation variations were assumed. The test period was particularly hot and dry for the district, and the fading was exceptionally rapid and severe, so the conclusions drawn

may be rather pessimistic. But even during more recent tests on the final installation when the propagation conditions were normal, it was noticed when making group-delay measurements over a loop Braewynner-Thrumster-Braewynner with a visual display instrument⁷ that occasionally the display changed its shape and showed fluctuations in the group-delay response over the working frequency band, and then subsequently returned to its original form. The normal group-delay curve for the complete loop is given by the full line in Fig. 25, and the maximum departure

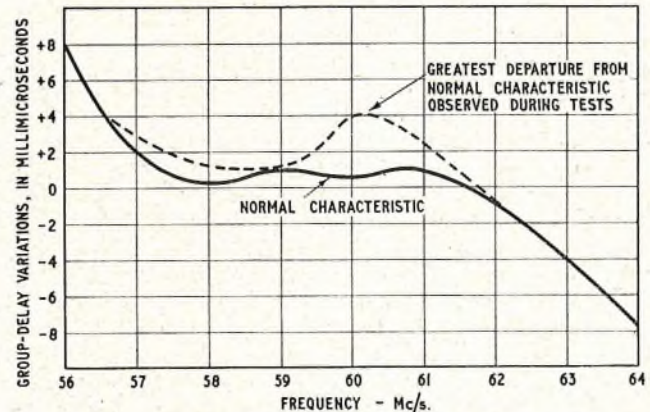

FIG. 25.—GROUP DELAY VARIATIONS OVER BRAEWYNNER-THRUMSTER-BRAEWYNNER LOOP SHOWING EFFECT OF MULTI-PATH PROPAGATION.

from this that was noticed (presumably due to multi-path propagation) is shown in the broken curve. This occasional distortion may not be of great importance in the present system, but will become increasingly marked as the number of channels handled by a microwave system increases.

CONCLUSION

In concluding Part I of this description of the Elgin-Wick radio system it is opportune to comment on the basic design of the transmitters and receivers for other purposes. The receiver as described with a dual pair is easily modified into a single receiver. The left-hand half contains all the equipment, oscillator, power units, etc., required for one receiver. The right-hand half contains the additional equipment, such as frequency changer, i.f. amplifiers and diversity switch to complete the dual pair. A receiver 60-Mc/s output can be connected to the transmitter 60-Mc/s input to form a repeater (the levels are suitable). A repeater with a single receiver would therefore comprise a 3-unit cabinet. The transmitters, receivers and repeaters on the Isle-of-Wight Television Link from London are in fact of this form. Only the 60-Mc/s modulators and demodulators differ from those fitted to the Elgin-Wick link.

ACKNOWLEDGMENTS

The authors wish to thank Messrs. R. W. White, R. Hamer, J. S. Whyte and I. A. Ravenscroft for their important contributions to the i.f. equipment and some test equipment for the radio link. They also wish to acknowledge the work of Mr. H. E. Pearson, Radio Planning and Provision Branch, E.-in-C.'s Office, who supervised the mast, aerial and waveguide installations and who was responsible for the waveguide counterpoise supporting device.

Thanks are also due to the staff of the Director, Post Office, Scotland, who were responsible for the provision of buildings and power plant and who co-operated closely in the installation and testing.

END OF PART I

⁷ WHYTE, J. S. An Instrument for the Measurement and Display of V.H.F. Network Characteristics. *P.O.E.E.J.*, Vol. 48, p. 81, July 1955.

A Broad-Band Variable Group-Delay Equalizer

R. HAMER, B.Sc., A.M.I.E.E.,
and R. G. WILKINSON†

U.D.C. 621.372.55:621.396.4:621.376.3

A broad-band variable group-delay equalizer has been developed for use in microwave radio systems employing frequency modulation. It is intended for insertion in the 70 Mc/s intermediate-frequency signal path in long radio-relay systems, in order to facilitate the correction of small residual non-uniformities in the overall group-delay characteristic. The equalizer, coded "Equalizer No. 43A", provides calibrated group-delay slope and curvature correction over a 12 Mc/s band. The transmission performance is satisfactory for use in 600-channel frequency-division-multiplex telephony or sub-carrier colour-television systems.

INTRODUCTION

IN the transmission of complex signals over f.m. radio-relay systems, small departures from uniformity in the group-delay/frequency characteristic can cause serious signal distortion. Even when the best available techniques are used in the design of individual units, including the insertion of fixed group-delay equalizers in the f.m. signal path, the cumulative group-delay distortion may still be too great. For example, in the transmission of frequency-division-multiplex telephony signals of 600 channels, a slope in group delay of as little as one millimicrosecond ($m\mu s$) per megacycle/sec gives rise to intolerable intermodulation distortion. In the transmission of sub-carrier colour-television signals, a similar group-delay slope would cause measurable cross-talk between the luminance and chrominance signals. At the present stage in the development of microwave radio systems it is consequently desirable to be able to insert a continuously variable group-delay equalizer at some convenient point. Such a device not only facilitates initial alignment of a system for optimum performance, but also enables corrections to be readily applied to counteract any small group-delay distortions that may develop from time to time. With further advances in technique, a voltage-controlled variable equalizer of the type to be described offers the possibility of devising a "closed loop" method for the automatic correction of group-delay distortion.

The maximum benefit is obtained by placing the variable equalizer in the intermediate frequency (i.f.) signal path at a demodulating station. This enables the group-delay distortion of the i.f. equipment, and to some extent that of the microwave components, in a six- or seven-link system to be corrected.

Attention has been confined to radio systems suitable for the transmission of 600-channel telephony signals, or sub-carrier colour-television signals of 405-line standard. With these signals, the bandwidth over which close control of the group-delay characteristic is required is about 12 Mc/s, and, particularly for television signals, the amplitude characteristic should be substantially uniform over a 20 Mc/s band.

It is not practicable to design an equalizer to correct any arbitrary curvature in the group-delay characteristic. Fortunately, however, the characteristic is in most cases approximately a quadratic function, which may be conveniently regarded as superimposed linear-slope and parabolic functions. Furthermore, the parabolic curvature of practical networks is almost always positive, i.e., with minimum group-delay at the apex. The variable equalizer has therefore been designed to provide the following types of correction, over a 12-Mc/s band centred on the standardized i.f. of 70 Mc/s:—

- (a) variable group-delay slope, positive or negative; and,
- (b) variable curvature, approximately parabolic, with maximum delay at the apex.

The range of correction provided may be extended or modified, when required, by the addition of separate fixed equalizers.

† The authors are, respectively, Senior Executive Engineer and Assistant Engineer in the Radio Experimental and Development Branch, E.-in-C.'s Office.

GENERAL DESCRIPTION

Equalizer No. 43A is constructed on a small copper chassis, mounted in a mild-steel instrument case of external dimensions 15 in. \times 8 in. \times 9 in. high. Two views of the unit are shown in Fig. 1 and 2. Six high-slope pentode

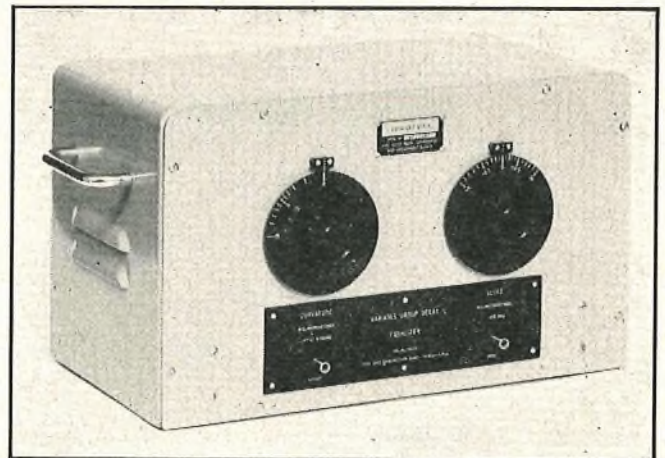

FIG. 1.—VIEW OF LABORATORY MODEL.

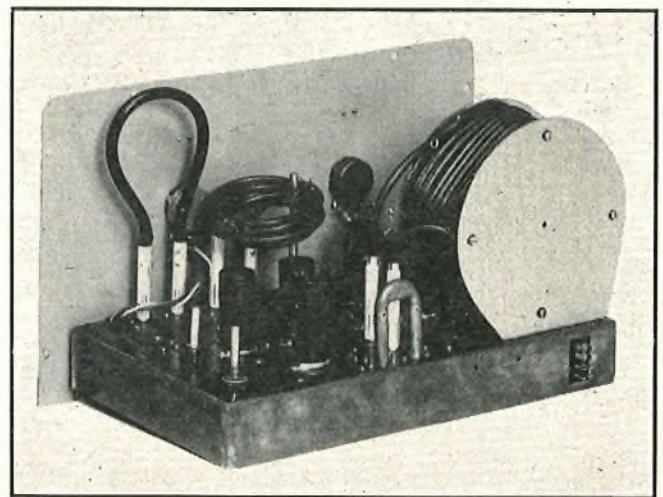

FIG. 2.—VIEW OF CHASSIS OF LABORATORY MODEL.

valves, type CV 3998 (Mullard E180F or S. T. & C. 5A/170K) are used, and supplies of 75 mA at 180V h.t. and 1.8A at 6.3V a.c. are required.

The front panel carries the two controls. The group-delay slope control (on the right in Fig. 1) is calibrated in $m\mu s$ per megacycle/sec, and the curvature control (on the left in Fig. 1) in $m\mu s$ lift at 70 Mc/s relative to 64 Mc/s and 76 Mc/s. Standard coaxial plugs are mounted in the front panel for input and output connexions, the impedance being 75 ohms unbalanced.

PRINCIPLE OF OPERATION

The principle of operation¹ of the variable equalizer can best be explained using the simplified block schematic diagram, Fig. 3. The input power is divided equally into

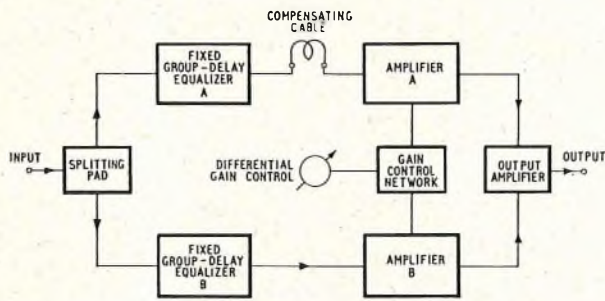

FIG. 3.—BLOCK SCHEMATIC DIAGRAM OF BASIC CIRCUIT.

two branches by a suitable "splitting pad," and fixed group-delay equalizers, A, B, are placed in each branch. It can be shown that, provided certain requirements are met, the overall group-delay characteristic may be varied smoothly between the limits set by the fixed equalizers, by differentially combining the output signals from each branch. This may be carried out by inserting two amplifiers, A, B, in the branches, as shown in Fig. 3, and controlling the amplifier gains differentially. The signals are combined in the output circuits of the two amplifiers, and are then taken via a common amplifier to the output. For a smooth transition between the fixed group-delay characteristics to be possible, and for the amplitude characteristic to remain substantially uniform throughout the operation, the requirements are:—

- (i) The group-delay in each arm, between the dividing and recombining points, must be approximately the same.
- (ii) The two signal-voltage vectors at the combining point must be in phase at the mid-band frequency.
- (iii) The phase angle between the signal-voltage vectors at the combining point must be small at all frequencies in the required transmission band.

The first two conditions may be realized by placing a cable of selected length in the branch having the smaller delay. The cable is first chosen to be approximately the correct length for equalizing the delays, then its precise length (normally within a few inches) is chosen to equalize the phase angles. The second condition is found to be more important than the first.

The third condition sets a limit to the amount of group-delay variation permissible, for a given frequency band. A variation of 20-30 μs over a 20 Mc/s band, with correspondingly greater variations for smaller bandwidths, represents the order of the limitation encountered in practice.

Equalizer No. 43A contains two basic circuits of the type indicated in Fig. 3, in tandem. In the first section, one branch contains a negative-slope equalizer together with the compensating cable, and the other branch a positive-slope equalizer. Thus, the first differential gain control produces a smooth transition between positive and negative slopes, with a uniform characteristic in the mean position. The second section contains a compensating cable only (uniform group-delay characteristic) in one branch and a parabolic equalizer (maximum delay at the apex) in the other branch. The second differential gain control therefore produces a smooth transition between a uniform delay and a negative parabolic characteristic. The complete unit consequently enables a wide range of quadratic correcting characteristics to be obtained, since the delay characteristics of networks in tandem add

algebraically. (This may be deduced logically, and has been confirmed experimentally.)

CIRCUIT DETAILS

The function of the six valve stages in the variable equalizer are given in Table I.

TABLE I
Valve-Stage Functions

Valve	Function	Remarks
V1	Controls the contribution of the negative-slope equalizer in the first section.	Gain differentially controlled.
V2	Controls the contribution of the positive-slope equalizer in the first section.	
V3	Output amplifier in the first section.	
V4	Controls the contribution of the cable (uniform group-delay) in the second section.	Gain differentially controlled.
V5	Controls the contribution of the parabolic equalizer in the second section.	
V6	Output amplifier in the second section.	

The fixed equalizer networks are of the all-pass, bridged-T type.² At high frequencies, these networks are readily arranged to produce a negative parabolic type of group-delay characteristic. The sloping characteristic is obtained by off-setting the apex of the parabola relative to the midband frequency. In order to minimize unwanted curvature, two basic networks are used in tandem, each producing half the required slope. A parameter m , analogous to Q -factor in the amplitude characteristics of tuned circuits, is in general use to specify the magnitude of the group-delay variation produced. The performance of a basic network is fully defined by stating its m -value, together with a reference frequency, f_0 , and the characteristic impedance, R_0 . The reference frequency is the resonant frequency of:—

- (a) the parallel tuned circuit remaining in the series arm when the shunt inductor is disconnected, and,
- (b) the series tuned circuit remaining in the shunt arm when the series inductor is short-circuited.

Using the parameters defined, the equalizer sections used are described in Table II.

TABLE II
Design of Fixed Equalizer Sections

Section	m	R_0 (ohms)	f_0 (Mc/s)
First and second sections preceding V1	0.8	75	61
First and second sections preceding V2	1.0	75	87
Parabolic section preceding V5	1.75	180	70

The action of the variable equalizer is seriously affected if echo-signals in one branch are allowed to enter the other branch with appreciable amplitude. The isolating attenuation of 6 db provided by the delta-pad used for splitting the input signal is found to be inadequate, and additional pads of about 6 db are required preceding the equalizer (or compensating cable) in each arm. The amplifying

¹ Improvements in or relating to Signal Transmission Group-Delay Equalizing Apparatus. Provisional Patent Application No. 10507, April, 1956; R. Hamer and R. G. Wilkinson.

² STARR, A. T. "Radio and Radar Techniques," p. 374, 1953.

valves, V3, V6, are necessary to offset the losses due to the delta-pads and the isolating pads.

The grid voltages applied to the controlled valves (V1, V2 and V4, V5) are adjusted by the panel controls (carbon-track potentiometers), in order to change the gains differentially.

Each section of the equalizer is electrically self-contained, providing nominally zero loss between 75-ohm impedances. This arrangement facilitates maintenance, a U-link being provided between the sections. A wide-band, top-inductance coupled transformer is used to couple the controlled valves to the output valve in each section. The transformer is designed for a maximally-flat amplitude characteristic, and is damped on the grid side only. A similar transformer, loaded also on the anode side, is used in the anode circuit of each output valve. The output transformers are aligned to provide an adequate reflection coefficient, relative to 75 ohms, at the output sockets.

PERFORMANCE

Measured group-delay characteristics over the working transmission band are shown separately in Fig. 4 for each section of the variable equalizer. These curves show that,

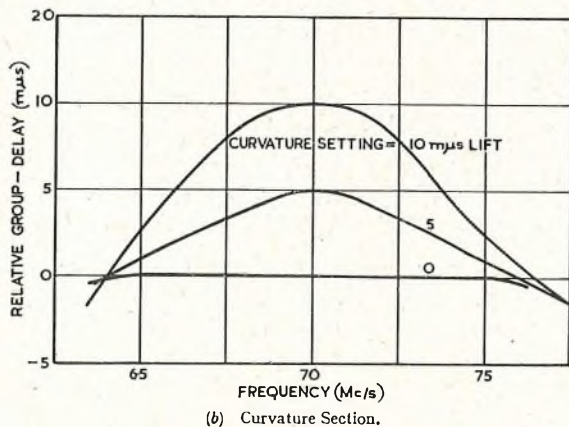
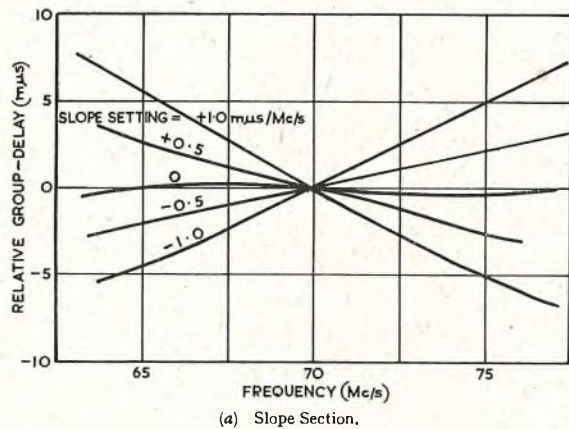

FIG. 4.—GROUP-DELAY TRANSMISSION CHARACTERISTICS.

in the first section, maximum slopes of $\pm 1.0 \mu\text{s}/\text{Mc}/\text{s}$ are obtained with reasonably good linearity. The zero-slope condition provides a sufficiently uniform group-delay for the most exacting requirements. The second section provides an approximately parabolic characteristic over the design bandwidth of 12 Mc/s, with a maximum lift of about 10 μs at mid-band. The zero-curvature condition again provides a uniform group-delay within close limits. For both sections the panel controls provide a smooth transition between the selected characteristics shown. Some slight asymmetry arises in the parabolic characteristic

near the maximum setting. This is not a serious limitation, since it is readily corrected by means of the slope control. The slope control is calibrated with zero curvature applied, an error of about $0.1 \mu\text{s}/\text{Mc}/\text{s}$ arising when maximum curvature is applied.

The amplitude characteristics of each section are shown separately in Fig. 5. As the group-delay correction is varied, the amplitude characteristics change smoothly between the curves shown.

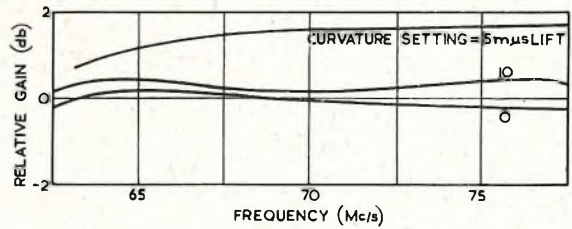
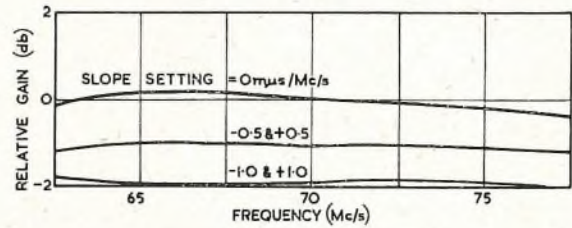
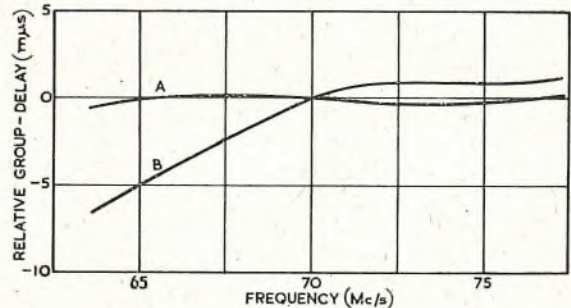

FIG. 5.—AMPLITUDE TRANSMISSION CHARACTERISTICS.



Curve A: Zero slope, zero curvature.
Curve B: Slope $+ 1.0 \mu\text{s}/\text{Mc}/\text{s}$. Curvature 3 μs lift.

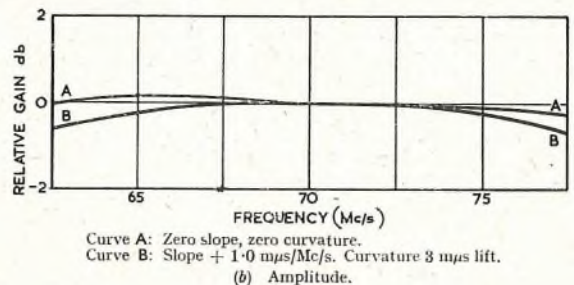
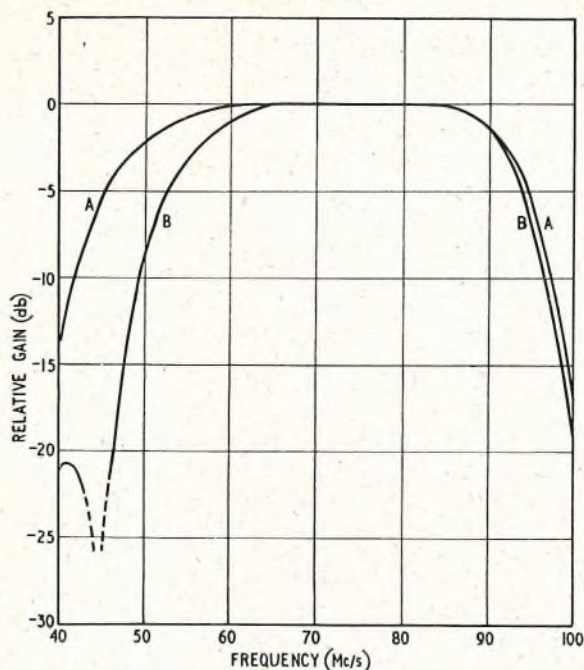

FIG. 6.—TYPICAL OVERALL TRANSMISSION CHARACTERISTICS.

The group-delay and amplitude characteristics through both sections of the equalizer are shown in Fig. 6. Curves are shown for zero slope and zero curvature, and for an arbitrary setting of the controls. The maximum amplitude/frequency variation occurring with any setting of the controls is about 1.0 db, but for most settings it does not exceed 0.3 db.

The amplitude characteristic over a very wide frequency band is shown in Fig. 7. The characteristic is seen to be of the maximally-flat type, modified by the action of the equalizer. The broadest and narrowest characteristics are shown, the normal band-pass response being that of the



Curve A: Broadest Characteristic: Slope -1.0 , Curvature 7 .
Curve B: Narrowest Characteristic: Slope -0.1 , Curvature 10 .

FIG. 7.—BANDWIDTH.

broadest. A cancellation of the branch output voltages occurs below the transmission band, and at its closest approach to the band—at about 45 Mc/s—it reduces the

bandwidth, as shown. The maximum half-power bandwidth is about 45 Mc/s and the minimum about 36 Mc/s.

The signal gain of the variable equalizer is nominally zero. The actual gain varies slightly with the setting of the controls, due to limitations in the differential gain-control networks. The measured gain of the prototype model lies in the range $+1.0$ db to -2.0 db.

The input and output impedances are nominally 75 ohms. The measured reflection coefficients are less than 5 per cent over the 12 Mc/s band.

CONCLUSION

The variable group-delay equalizer described is suitable for use in broad-band radio-relay systems employing frequency modulation. The performance is regarded as adequate for use in systems for the transmission of frequency-division-multiplex telephony up to at least 600 channels, and for sub-carrier colour-television of the types now being investigated.

The range of group-delay variation provided is likely to be adequate for the correction of small residual non-uniformities arising in radio-relay systems. If necessary, however, the correction range can be readily extended by the addition of fixed passive equalizers.

ACKNOWLEDGMENT

The assistance of those members of the staff of the Post Office Radio Laboratory, Castleton, who have been concerned in the construction and testing of the variable equalizer, is acknowledged.

Book Reviews

"Mechanical Design for Electronics Production." John M. Carroll. McGraw-Hill Publishing Co., Ltd. 348 pp. 172 ill. 49s.

This is a most intriguing book.

All development engineers and designers engaged on electronic equipment are likely at some time or other to have to decide how best to convert "bread-board" assemblies into satisfactory production designs that can be built by manufacturing organizations. The production engineer's approach must be quite different from that of the research man, and he carries great responsibility as his mistakes are likely to be costly to correct. In fact, good mechanical design is quite as important in modern telecommunication equipment as good electrical technique.

Mr. J. M. Carroll, an associate editor of the American periodical *Electronics*, has clearly had much experience of producing commercial electronic equipment out of the rough models handed to him by development laboratories. He has recorded some of the interesting facts and observations resulting from his experience in this new book, *Mechanical Design for Electronics Production*. The result is a collection of much unusual information on a wide range of subjects, including such diverse things as the gauge of metal sheet suitable for chassis construction, aspects of component layout, printed circuit techniques, the cooling of thermionic-valve equipment, and designing in a manner suitable for multiple production. Tropicalization and the use of resins and protective coatings are also discussed.

Few electronics engineers have any appreciable mechanical engineering training. Mr. Carroll recognizes this, and has written a chapter, entitled "Moving Parts," in which he supplies some elementary study of the science known in British colleges as Mechanics of Machines. This is of value in analysing the behaviour of gearing and link motions which are widely used in some applications of electronics, e.g. servo-mechanisms. In another chapter the characteristics of electric

motors are briefly described, presumably because the author has found that few electronics engineers know much about them. He concludes with chapters on factory production, the shockproofing of equipment for mobile and airborne applications, and special factors applying to equipment for use in guided missiles.

The book is expensive, as are most of the McGraw-Hill publications on sale in this country; but it is well worth an evening's study, and might prove a useful reference book to engineers entering the field of quantity production for the first time.

C. F. F.

"Frequency Modulation Receivers." J. D. Jones. Heywood & Co. Ltd. 114 pp. 29 ill. 17s. 6d.

The opening of very-high-frequency broadcast transmissions by the British Broadcasting Corporation, operating in the band 88–104 Mc/s, has given the radio enthusiast a new incentive to try his skill at the design and construction of radio receivers. The B.B.C.'s v.h.f. transmissions employ frequency modulation (f.m.) and receivers designed for the reception of f.m. signals are more complex than those intended for the more familiar amplitude-modulated medium-frequency broadcasts. Mr. J. D. Jones has planned this book as an introduction to the principles of frequency modulation, and as an amateur's guide to the design of receivers suitable for use on f.m. broadcasting.

He describes frequency modulation simply and briefly by means of vectors, and explains why, and under what circumstances, this type of radio transmission can lead to more satisfactory reception and higher fidelity reproduction than can amplitude modulation. The relative advantages and disadvantages of the two systems are given. No serious analytical treatment is undertaken; he just states results, using only the simplest explanations to support them. After the first few pages, he turns, one suspects with some degree of thankfulness, from generalities to detailed descriptions and he outlines some

(Continued on p. 126)

A Broad-Band Intermediate-Frequency Amplifier for use in Frequency-Modulation Microwave Radio-Relay Systems

R. HAMER, B.Sc., A.M.I.E.E.,
and C. H. GIBBS,
Associate I.E.E.†

U.D.C. 621.375.221.029.62:621.396.4:621.376.3

A broad-band intermediate-frequency amplifier, centred on 70 Mc/s, is described. It has been developed for use in frequency-modulation microwave radio-relay systems meeting current C.C.I.R. standards. The amplifier, coded No. 107B, is suitable for the transmission of 600-channel frequency-division-multiplex telephony or sub-carrier colour-television signals.

INTRODUCTION

IN broad-band frequency-modulation (f.m.) microwave radio-relay systems it is current practice to provide a large part of the signal gain at an intermediate frequency (i.f.). To facilitate the interconnexion of different systems at the i.f., the C.C.I.R.¹ has proposed that a frequency of 70 Mc/s should be standardized for use in microwave systems operating in frequency bands above 1,000 Mc/s.

The i.f. amplification is conveniently provided in three separate units:—

- A low-noise fixed-gain pre-amplifier, associated with the microwave-to-i.f. crystal mixer in a receiver; this may be omitted in later systems employing a low-noise input travelling-wave valve amplifier.
- A main i.f. amplifier, following the pre-amplifier and providing automatic gain-control to counteract signal fading.
- A fixed-gain amplifier, associated with an i.f.-to-microwave crystal converter.

The main amplifier, which provides most of the gain at i.f. and presents the problem of obtaining automatic gain-control without distortion of the transmission characteristics, is described in this article.

PERFORMANCE REQUIREMENTS

The amplifier is primarily required for the transmission of a 70-Mc/s carrier, frequency-modulated by a 600-channel signal of standard form, occupying a frequency band of 60–2,540 kc/s. The significant frequency band occupied by the resultant complex f.m. signal is dependent on the effective deviation, and in practice may only be defined statistically. The C.C.I.R. has recommended that the r.m.s. frequency deviation produced by a test-tone at reference level in a multi-channel radio system shall be 200 kc/s. It is further proposed that the mean multi-channel signal power during the busy hour should be taken to be +13 db relative to the test-tone level. The total r.m.s. deviation is then about 0.9 Mc/s, and it may be shown from this that the f.m. signal spectrum occupies a band of about 12 Mc/s. The working frequency-band of the i.f. amplifier may therefore be regarded as 64–76 Mc/s.

Non-uniformity in the amplitude/frequency and group-delay/frequency transfer characteristics over the working band, including the effects of reflections in connecting cables, produces intermodulation distortion of the multi-channel signal. This results in noise in the telephone channels after demodulation. To keep this noise power at an adequately low level, the amplifier transfer characteristics must be substantially uniform over the working band. Tolerances of a fraction of a decibel in the gain/frequency characteristic, and about one millimicrosecond in the group-delay characteristic are typical for one amplifier.

Amplifiers designed for 600-channel telephony are also

† The authors are, respectively, Senior Executive Engineer and Assistant Engineer, Radio Experimental and Development Branch, E.-in-C.'s Office.

¹ Documents of the VIIIth Plenary Assembly, C.C.I.R., Warsaw, 1956.

² Colour Television Standards. *Wireless World*, August 1955, p. 355.

likely to be suitable for 405-line sub-carrier colour-television² signals, provided that the amplitude/frequency characteristic is substantially uniform over a 20-Mc/s band.

DESCRIPTION OF THE AMPLIFIER

In the mechanical design of the amplifier, coded No. 107B, an unorthodox method of construction has been adopted, with a view to ease of maintenance when wired-in valves are used. Although plug-in valves are used in the experimental amplifier, it is likely that with the development of longer-life valves, wiring-in will become standard practice. With this trend in mind, the amplifier has been constructed in the form of a brass framework on which are mounted a number of sub-units. Each sub-unit consists of a small brass chassis containing a valve and its associated components, including the anode-coupling-circuit components. The cost of the sub-unit, without the valve, may be less than the maintenance costs that would be involved in replacing a wired-in valve in a conventional chassis. It may therefore become feasible to discard the whole sub-unit when a valve fails, replacing it by a new pre-aligned sub-unit. Each sub-chassis is fixed in position by four captive screws, and only four easily-accessible soldered wiring connexions are made to it.

A copper cover is placed over the underside of the assembled amplifier, and locked in position by two captive knurled screws, one in each end plate. A second copper cover, containing sprung valve shrouds, is placed over the top of the amplifier. These shrouds fit over and are in close contact with the valve envelopes, in order to conduct heat from the valves to the cover. Good heat dissipation is achieved in this way, the valve envelope temperature being lower than that occurring with some types of conventional screening cans. The valve cover is locked in position by one captive screw.

The experimental amplifier is finished in grey hammered stoved enamel. The design adopted leads to an unusually neat external appearance, as may be seen from Fig. 1. Internal

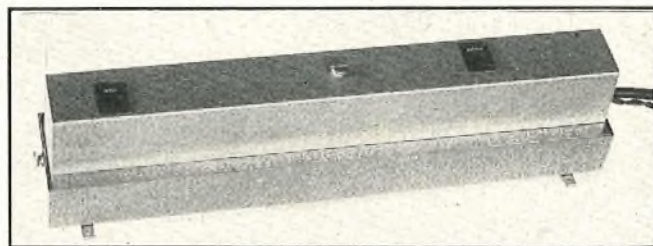

FIG. 1.—AMPLIFIER No. 107B (PROTOTYPE MODEL), EXTERNAL VIEW.

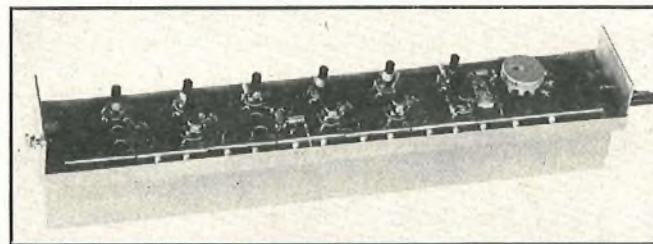

FIG. 2.—UNDERSIDE VIEW OF AMPLIFIER No. 107B, COVER REMOVED.

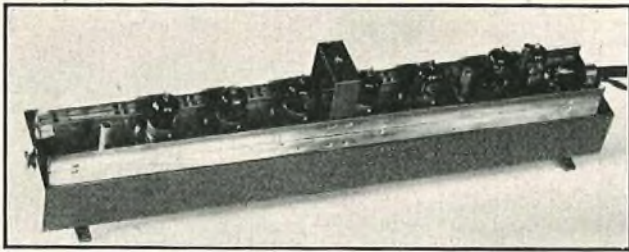

FIG. 3.—TOP VIEW OF AMPLIFIER No. 107B, VALVE COVER REMOVED.

views are shown in Fig. 2 and 3. The overall dimensions of the amplifier are $17\frac{1}{2}$ in. \times 3 in. \times 4 in. high.

Circuit.

Amplifier No. 107B contains seven valves, five of which are in the signal path, and the functions of the various stages are given in Table 1, in which the division of the circuit between the sub-units is indicated by the horizontal lines.

TABLE 1
CIRCUIT FUNCTIONS

Valve Stage	Type of Valve	Coupling Circuit	Remarks
		Wide-band, 75-52 Ω transformer	Input matching circuit
V1	CV 3998 as triode	Under-damped band-pass network	First stagger-damped pair
V2	CV 3998		
V3	VC 3998	Over-damped band-pass network	Second stagger-damped pair
V4	CV 3998		
V5	CV 3998	Wide-band, 560-75 Ω transformer	Output stage. A.G.C. detector across output load
V6	CV 4014		D.C. amplifier in a.g.c. circuit Diode clipper to establish a.g.c. voltage delay
V7	CV 140		

The valve used in the signal-amplifying stages is the CV 3998 (Mullard E180F or S.T. & C. 5A/170K). It is a beam tetrode, with pentode-type characteristics, particularly suitable for use at v.h.f. It has a gain-bandwidth figure of merit about twice that of the CV 4014 (reliable CV 138), and has closer tolerances in inter-electrode capacitances. The normal operating characteristics of the CV 3998 are given in Table 2. It has a B9A base, with gold-plated pins.

TABLE 2
CV 3998 OPERATING CHARACTERISTICS

Anode voltage	190V
Suppressor voltage	0
Screen voltage	160V
Grid voltage	-1.0V
Anode current	13 mA
Screen current	3 mA
Mutual Conductance	16.5 mA/V
Input damping at 50 Mc/s	6 $k\Omega$
Input capacitance (cold)	7.9 ± 0.6 pF
Output capacitance (cold)	2.9 ± 0.4 pF
Anode-to-grid capacitance (cold)	0.018 pF average

The CV 3998 valves in Amplifier No. 107B operate with

an anode potential of 150V and a screen potential of 145V. The first valve is connected as an earthed-grid triode, and operates with a cathode current of 14-15 mA.

The inter-stage coupling circuits are arranged as stagger-damped pairs³, the circuit damping resistances being staggered above and below the value required for a critically-coupled response. This minimizes the reduction in bandwidth that occurs in a multi-stage amplifier, compared with that of one inter-stage circuit. By suitable choice of the circuit parameters, this design also results in a more uniform group-delay/frequency transfer characteristic. As a result of this, the group-delay equalizer normally necessary in amplifiers of this type is not required.

The amplifier contains two stagger-damped pairs, each inter-stage circuit comprising a form of impedance transforming π -section. Damping is applied to the output (grid side) only of each coupling network, to achieve a higher gain-bandwidth than results with symmetrical damping.

As indicated in Table 1, amplified voltage-delayed automatic gain-control is provided in the amplifier. The controlled valves (V2 and V3) have individual negative feedback applied in the cathode circuits. The cathode feedback resistance is chosen to minimize input reactance changes due to the varying a.g.c. bias applied to the grids.

PERFORMANCE

Amplifier No. 107B provides a maximum gain of 50 db between 75-ohm impedances, and the a.g.c. accommodates fades of up to about 25 db below the normal input signal level. A typical input/output level characteristic is shown in Fig. 4. The a.g.c. is fast-acting to counteract rapid fading,

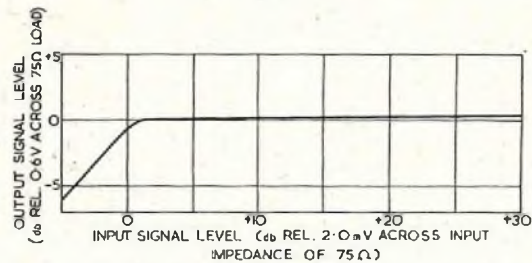

FIG. 4.—A.G.C. CHARACTERISTIC OF AMPLIFIER No. 107B.

such as arises from aircraft reflections in the microwave path. The effective time constant is less than 1 ms.

The noise factor of the amplifier, measured at maximum gain, is 8.9 db.

The gain/frequency characteristic is shown in Fig. 5,

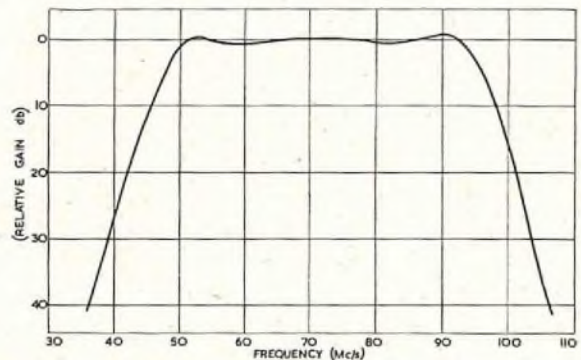
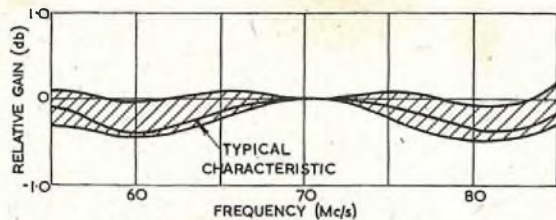

FIG. 5.—GAIN/FREQUENCY CHARACTERISTIC OF AMPLIFIER No. 107B.

from which it may be seen that the bandwidth to -1.0 db is about 44 Mc/s. The amplitude and group-delay transfer characteristics over the central 20 Mc/s band are shown in more detail in Fig. 6. The spread in the measured character-

³ STARR, A. T. Radio and Radar Technique, p. 401, 1953.



(a) Gain/Frequency Characteristic.

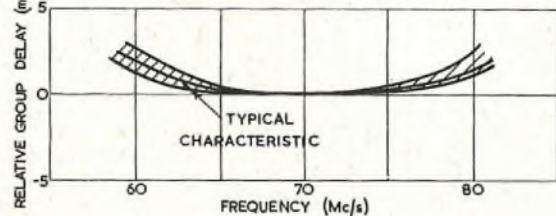

(b) Group Delay/Frequency Characteristic.

Note: Shaded band shows envelope of all characteristics measured (including slight asymmetries introduced by a.g.c. action).

FIG. 6.—TRANSFER CHARACTERISTICS.

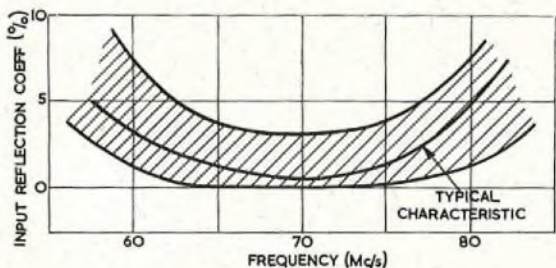

(a) Input Impedance.

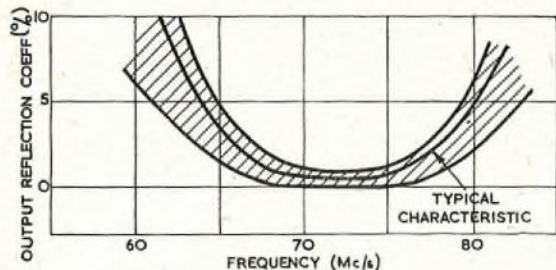

(b) Output Impedance.

Note: Shaded bands show envelopes of measured reflection coefficient characteristics.

FIG. 7.—TERMINAL IMPEDANCES.

istics applies to five amplifiers, and includes estimated measuring errors.

The input and output reflection coefficients, relative to a 75-ohm resistance, are shown in Fig. 7. The spread in the measured characteristics again applies to five amplifiers.

Measurements have been made of the overall performance of Amplifier No. 107B, using intermodulation noise test equipment,⁴ in which a uniform band of random noise simulates the multi-channel signal. Five amplifiers were placed in cascade, with suitable attenuation interposed, between a high-grade 70-Mc/s frequency modulator and a demodulator. A modulating noise signal corresponding to the mean busy-hour loading in a 600-channel system (+13 db relative to a test-tone level producing 200 kc/s r.m.s. deviation) was applied to the modulator. The noise power ratio,⁴ after demodulation, was 59 db*—only 1 db less than was obtained with the modulator directly feeding the demodulator. The measured noise power ratio corresponds to a psophometrically weighted test-tone/noise ratio of over 70 db in a 3.1 kc/s telephone channel.

Tests have also been carried out in which a 70-Mc/s signal, frequency modulated by a 405-line sub-carrier colour-television signal, has been transmitted via four Amplifiers No. 107B in tandem. No distortion of the reproduced colour image could be discerned in this test, and other associated measurements have confirmed that the amplifier is suitable for use in colour-television systems.

CONCLUSION

A new broad-band i.f. amplifier has been designed, suitable for inclusion in f.m. microwave radio-relay systems. It is concluded that the performance is adequate for the transmission of 600-channel telephony or colour-television signals. Telephony tests have shown that a test-tone/noise ratio of over 70 db is not significantly degraded after transmission through five of the amplifiers in tandem.

ACKNOWLEDGMENT

The assistance of the staff of the Post Office Radio Laboratory, Castleton, who have been concerned in the development and testing of the amplifier described, is acknowledged.

⁴ WHITE, R. W., and WHYTE, J. S. Equipment for Measurement of Inter-Channel Crosstalk and Noise on Broad-Band Multi-Channel Telephone Systems. *P.O.E.E.J.*, Vol. 48, October 1955, p. 127.

* In the highest measuring channel, at 2,338 kc/s.

Book Review

"Frequency Modulation Receivers"—continued from p. 123.

possible circuits for the various stages of a complete v.h.f. frequency-modulated receiver. The function of each stage is carefully explained and alternative circuit designs are discussed, from the first r.f. amplifier, through the mixer and intermediate frequency amplifiers to the final f.m. detector, often known as a discriminator. Circuit values are worked out in detail and very useful alignment and test instructions are included for the radio frequency and intermediate frequency stages. He wastes no time on the audio sections as these would comprise a conventional high-fidelity amplifier.

The book concludes with the circuit of a complete f.m. broadcast receiver suitable for amateur construction, employing a radio-frequency amplifier, a self-oscillating mixer, three intermediate-frequency stages, a ratio detector, an audio amplifier and output pentode stage.

The book is worth reading by anyone who wishes to understand the basic principles of frequency modulation and how the radio receiver works. It is likely to be of especial interest to the home constructor and the receiver maintenance man, both of whom are concerned more with the practical problem of making a receiver work satisfactorily than with theoretical aspects of frequency modulation techniques.

Some minor editorial points have been overlooked; for example, there are errors in textual references to letters in diagrams—the omission of suffixes in Fig. 6 is such a case—but these are not serious points, and do not detract appreciably from the clarity of the subject matter.

No appreciable mathematical knowledge is demanded of the reader and the book can be read in comfort as a relaxation. *I.P.O.E.E. Library No. 2418.* C. F. F.

Notes and Comments

Birthday Honours

The Board of Editors offers congratulations to the following members of the Engineering Department honoured by H.M. The Queen in the Birthday Honours List:—

Coventry Telephone Area	Frost, H. S. J.	Technical Officer ..	British Empire Medal
Engineering Department	Harris, Brig. L. H., C.B.E.	Engineer-in-Chief ..	Knight Commander of the Most Excellent Order of the British Empire
External Telecommunications Executive	Mann, R. G.	Executive Engineer ..	Member of the Most Excellent Order of the British Empire
Liverpool Telephone Area	Duncan, J.	Technician, Class I ..	British Empire Medal
London Telecommunications Region (Centre Area)	Voller, C. H.	Leading Technical Officer	British Empire Medal
Newcastle-on-Tyne Telephone Area..	Thompson, W. B. ..	Technical Officer ..	British Empire Medal
Plymouth Telephone Area	Hoare, J. H.	Assistant Engineer ..	Member of the Most Excellent Order of the British Empire

Brigadier Sir Lionel H. Harris, K.B.E., T.D., M.Sc., F.C.G.I., M.I.E.E.

The knighthood conferred upon Brigadier L. H. Harris, the Engineer-in-Chief, in the Birthday Honours List, has given pleasure to all members of the Engineering staff of the Post Office and to his many other friends.



Since 1923, when he commenced his career in the Post Office, Sir Lionel has become well known both as an engineer and as an administrator and has been in close touch with all phases of Post Office work. In addition, he had a distinguished war record, joining the staff of General Eisenhower as chief of the Telecommunications Section of SHAEF, and numbers among his friends many of the military leaders.

The new honour is a well-deserved tribute to his contribution in the broad field of telecommunications and is particularly appropriate in view of his life-long interest in the Commonwealth. His many friends throughout the world will join with us in offering to him our warmest congratulations.

Recent Award

The Board of Editors has learnt with pleasure that Mr. J. C. Kane, Technician, Class I, Scotland West Telephone Area, has had conferred upon him the award of Ordinary Member of the Military Division of the Most Excellent Order of the British Empire, for services in the Highland Light Infantry (Territorial Army).

Special Commendation

The Postmaster-General has personally commended Mr. E. M. Thomas, Technician IIB, Chester Telephone Area, to whom the Royal Humane Society has awarded its Resuscitation Certificate for restoring to consciousness a boy rescued from the sea at Borth-y-gest Bay, Caernarvonshire, on 10th July, 1956.

Institution of Post Office Electrical Engineers

Essay Competition 1956/57—Results

A Prize of £5 5s. 0d. and an Institution Certificate have been awarded to the following competitor in respect of the essay named:—

J. R. Haggart, Technical Officer, Edinburgh. "An Electronic Crossbar System."

Prizes of £3 3s. 0d. each and Institution Certificates have been awarded to the following four competitors:—

E. G. Clayton, Technical Officer, Norwich. "Hearing Speech Sounds."

A. L. Watson, Technical Officer, Lincoln. "The Planning of Buildings for Unit Automatic Exchanges."

R. J. Lukehurst, Technical Officer, Canterbury. "Some Aspects of Line Plant Planning and its Allied Works."

J. S. Kendall, Technical Officer, Birmingham. "The Develop-

ment of the Direct-Coupled Amplifier for High Quality Sound Reproduction."

Institution Certificates of Merit have been awarded to:—

E. R. Lamb, Technical Officer, Engineer-in-Chief's Office. "Subscriber's Duplicate Metering System."

W. Hoy, Technician IIA, Long-Distance Area, London. "Frequency Instability in Feedback Oscillators—Causes and Remedies."

D. R. Johnson, Technical Officer, Southampton. "On Camels and Tents."

J. L. Care, Technical Officer, Eltham, Kent. "The ENG Officer."

C. F. Carr, Technical Officer, Newcastle-upon-Tyne. "Cathodic Protection as applied to Post Office Cables."

The Council of the Institution records its appreciation to

Messrs. W. S. Proctor, S. Welch and E. W. Anderson, who kindly undertook to adjudicate upon the essays entered for the competition.

H. E. WILCOCKSON,
Secretary.

N.B.—Particulars of the next competition, entry for which closes on the 31st December, 1957, and a review of the above-mentioned prize-winning essays, will be published later.

Additions to the Library

- 2380 *An Introduction to the Electronic Theory of Valency.* J. C. Speakman (Brit. 1955).
Gives the elementary rules for drawing electronic formulae, and explains the application of such idealized formulae to actual chemical substances.
- 2381 *Electricity, Magnetism and Atomic Physics, Vol. 1: Electricity and Magnetism.* J. H. Fewkes and J. Yarwood (Brit. 1956).
Covers the requirements of the B.Sc. Special Degree in Physics and Pt. 1 of the Natural Sciences Tripos of the University of Cambridge; some sections, particularly in Electronics and Radio Communication, which are somewhat outside the immediate requirements of the degree student, have been included.
- 2382 Vol. I—*Radio Pt. I.*
2383 " II—*Radio Pt. II.*
2384 " III—*Television Pt. I.*
2385 " IV—*Television Pt. II.*
2386 " V—*Radio and Television 1953/54.*
2387 " VI—*Radio and Television 1955/56.*
2388 *Automation, Friend or Foe.* R. H. MacMillan (Brit. 1956).
Attempts to explain exactly what automation is, and what consequences are likely to follow in its wake. Covers the technical, social and economic aspects.
- 2389 *Electronics and Electron Devices.* A. L. Albert (Amer. 1956).
Provides a textbook for college and university courses on basic electronics and electronic devices; suits the needs of students in the communication, control and power fields.
- Strength and Elasticity of Materials: Solutions to Examination Questions of the University of London.* W. H. Brooks (Brit. 1954 and 1956).
- 2390 Vol. III contains solutions to Pt. II (internal) B.Sc. (Eng.) examination papers from 1940–1950.
2391 Vol. IV contains solutions to Pt. II (external) B.Sc. (Eng.) examination papers from 1941–1952.
- 2392 *Solution of Problems in Telecommunications.* C. S. Henson (Brit. 1956).
Contains classified selections of problems in telecommunications and electronics taken from the University of London final examinations and I.E.E. examination, together with some original problems.
- 2393 *Elements of Pulse Circuits.* F. J. M. Farley (Brit. 1956).
An introduction to pulse circuits; a knowledge of radio valves and elementary receiving technique is assumed.
- 2394 *Television Engineering: Principles and Practice. Vol. II: Video-Frequency Amplification.* S. W. Amos and D. C. Birkinshaw (Brit. 1956).
A B.B.C. training manual describing the fundamental principles of video-frequency amplifiers and examining the factors that limit their performance at extremes of the passband.
- 2395 *Facing the Atomic Future.* E. W. Titterton (Australia 1956).
An attempt to present an up-to-date and comprehensive account of atomic energy and atomic weapons, to enable a clear understanding and assessment of the present position to be arrived at.
- 2396 *Abacs or Nomograms.* A. Giet (French 1956).
Treats the subject in an elementary way and is intended for practical engineers rather than mathematicians.
- 2397 *Thermionic Valves 1904–1954.* I.E.E. (Brit. 1955).
The lectures, opening address and list of exhibits of The I.E.E. special meeting to celebrate the jubilee of Fleming's application, in 1904, for a patent for his diode; and an appreciation of Sir Ambrose Fleming and Dr. Lee de Forest.
- 2398 *I am a Mathematician.* N. Wiener (Amer. 1956).
An autobiography.
- 2399 *Public Address and Sound Distribution Handbook.* Ed. A. J. Walker (Brit. 1956).
A practical guide to the planning, installation and maintenance of modern sound amplification and distribution equipment.
- 2400 *An Introduction to the Theory of Structures.* W. Merchant and A. Bolton (Brit. 1956).
Covers the requirements of students up to the second year of a University Honours Course.
- 2401 *Development of Power Cables.* P. V. Hunter and J. T. Hazel (Brit. 1956).
A record of the historical development of electric power cables; of interest to engineers and students.
- 2402 *Faster, Faster.* W. J. Eckert and R. Jones (Amer. 1955).
A simple description of a giant electronic calculator and the problems it solves.
- 2403 *Mechanical Design for Electronic Engineers.* R. H. Garner (Brit. 1956).
Deals concisely with the mechanical aspects of sound construction, interchangeability of units, accessibility of components for adjustment or replacement, and the measures necessary to combat adverse operating conditions.
- 2404 *Engineering Inspection and Testing.* H. C. Town and R. Colebourne (Brit. 1956).
Meets the needs of students taking metrology at technical colleges and should be of practical interest to engineers engaged on precision measurement and inspection.
- 2405 *Variable Resistors and Potentiometers.* G. W. A. Dummer (Brit. 1956).
Designed to help designers and users to choose the best components for particular requirements.
- 2406 *Electrical Principles.* H. Cotton (Brit. 1956).
An introduction based on the rationalized m.k.s. system of units.
- 2407 *Building Law Illustrated.* B. G. Phillips (Brit. 1956).
A concise guide to building legislation as it affects architects, builders and local government officers.
- 2408 *Automatic Digital Computers.* M. V. Wilkes (Brit. 1956).
A general introduction to the principles underlying the design and use of digital computers. Covers primarily the subjects known as "logical design" and "programming."
- 2409 *Transistors in Radio and Television.* M. S. Kiver (Amer. 1956).
A largely non-mathematical description for the radio and television technician and other technical workers who need a working knowledge of transistors and transistor circuits.
- 2410 *Hi-Fi Loudspeakers and Enclosures.* A. B. Cohen (Amer. 1956).
Answers the questions of the hi-fi enthusiast and audio technician that pertain to hi-fi loudspeakers and enclosures; in three sections: "The Loudspeaker," "The Enclosure," and "The Room."
- 2411 *Electronics for Everyone.* M. Upton (Brit. 1956).
The story of electricity in action, from the electrical discoveries of the past to the present-day applications of electronics.
- 2412 *An Approach to Modern Physics.* E. N. de C. Andrade (Brit. 1956).
Leads from a simple account of classical physics to a description of physics as it is to-day.
- 2413 *The Supervision of Engineering Construction.* A. C. Twort (Brit. 1955).
Sets out the duties and responsibilities of the civil engineer who supervises construction of works on the site.
- 2414 *Hi-fi from Microphone to Ear.* G. Slot (Dutch 1956).
Intended to answer as many as possible of the questions posed by gramophone owners, and to explain the more important technical problems in relation to one another.

- 2415 *V.H.F. Television Tuners*. D. H. Fisher (Brit. 1956).
Covers the design, construction, testing and servicing of tuners.
- 2416 *Radio, Vol. III*. J. D. Tucker and D. F. Wilkinson (Brit. 1956).
Designed to cover the syllabus of the C. & G. Radio III examination.
- 2417 *FM Radio*. K. R. Sturley (Brit. 1956).
Explains the general principles, theory, design, construction and servicing of v.h.f. frequency-modulation receivers.
- 2418 *FM Receivers*. J. D. Jones (Brit. 1956).
A stage-by-stage description of the principles and operation of frequency-modulation receivers, giving full details of r.f. stage, frequency changer, i.f. stage and f.m. detector.
- 2419 *Automation in Theory and Practice*. E. M. Hugh-Jones (Brit. 1956).
A series of lectures covering the technical nature, and social and economic significance of automation.
- 2420 *New Worlds beyond the Atom*. Langston Day (Brit. 1956).
Describes research work carried out by the Delawarr Laboratories, Oxford, which has revealed new forms of radiation as yet unexplained.
- 2421 *Men, Rockets and Space*. L. Mallan (Brit. 1956).
The story of the contemporary aeronautical pioneers.
- 2422 *Calder Hall*. K. Jay (Brit. 1956).
The story of Britain's first atomic power station.
- 2423 *Interviewing for the Selection of Staff*. A. Anstey and E. O. Mercer (Brit. 1956).
Designed to help those who are not professionally engaged in interviewing, but have to do it sometimes.
- 2424 *Automation*. Dept. of Scientific and Industrial Research (Brit. 1956).
A report on the technical trends and their impact on management and labour.
- 2425 *Frequency Modulation*. L. B. Arguimbau and R. D. Stuart (Amer. 1956).
Discusses the f.m. system with particular reference to its use in reducing the effect of extraneous disturbances introduced during transmission.
- 2426 *Introduction to Printed Circuits*. R. L. Swiggett (Amer. 1956).
Describes the types of printed circuits encountered in electronic equipment to-day; their characteristics and functions, how they are made, and their effects on the techniques for servicing devices that contain them.
- 2427 *Fixed Capacitors*. G. W. A. Dummer (Brit. 1956).
Designed to enable the user to choose the best component for his particular requirements and to understand its fundamental characteristics.
- 2428 *Analysis of Bistable Multivibrator Operation*. P. A. Neeteson (Dutch 1956).
A thorough analysis of the dynamic behaviour of the bistable multivibrator.
- 2429 *From Zero to Infinity*. C. Reid (Brit. 1956).
The fascinating story of numbers.
- 2430 *The Modern Universe*. R. A. Lyttleton (Brit. 1956).
A popular account of some of the modern advances and problems of the astronomical universe.
- 2431 *Inside the Atom*. I. Asimov (Brit. 1956).
A simple description of atomic energy, with paragraphs on its dangers and its future.
- 2432 *Atomic Quest—a Personal Narrative*. A. H. Compton (Amer. 1956).
A story, as seen through the eyes of the Director of the Metallurgical Laboratory, of the atomic bomb project from 1942-45.
- 2433 *Practical Mechanics Handbook*. F. J. Camm (Brit. 1956).
Attempts to meet the needs of the handyman and those engaged in the mechanical hobbies.
- 2434 *Radio and Television Servicing*. Ed. E. Molloy and W. F. Poole (Brit. 1957).
Diagrams and servicing details for 1956-57 models.
- 2435 *Digital Calculating Machines and their Application to Scientific and Engineering Work*. G. A. Montgomerie (Brit. 1956).
A general introduction.
- 2436 *Electronic Computers*. Ed. T. E. Ivall (Brit. 1956).
Gives a broad picture of electronic computing. (Assumes some knowledge of electronics and radio techniques.)
- 2437 *Automation and Social Progress*. S. Lilley (Brit. 1957).
Explains the character of the new techniques and discusses their immediate and their long-term social effects.

W. D. FLORENCE,
Librarian.

Book Reviews

"Electro-Technology for National Certificate Courses." Volume 2. H. Buckingham and E. M. Price. In Technical College Series, published by The English Universities Press, Ltd. 298 pp. 183 ill. 12s. 6d.

Our technical colleges have derived much stimulus from the re-orientation of the British system of engineering education brought about by industry's acceptance of the Ordinary and Higher National Certificates as qualifying young men for junior technological posts. The evening class teaching system prevalent before the war, whereby most of the national certificate courses were held in the evenings, tended to reduce the status of the National Certificates in the eyes of students and teaching staff. Many national certificate courses are now held in the day time. This has been made possible by the introduction of part-time day-release of students and apprentices by the engineering firms employing them, a privilege which Youths-in-Training in the Post Office also enjoy. These students now have more leisure available for study and, naturally, will widen their interests by increasing their range of reading. In the hope of assisting these and similar classes of students, the editor of the Technical College Series is providing an up-to-date range of textbooks based on the national certificate syllabuses in several branches of technology.

The course for the Ordinary National Certificate in Electrical Engineering is being covered in three volumes. The first, which is already well known, covers the elementary part of the course. The second, by the same authors, who are both experienced lecturers in engineering subjects at well-known colleges of technology, has been written to fill the needs of an

S2 course; that is, the second year of the three-year course leading to the Ordinary National Certificate. The equivalent in the City and Guilds of London examinations would be the courses for Telecommunications Principles Grades 1 and 2.

The m.k.s. system of units is used through the book, and the authors have taken care to describe the relations between the c.g.s. and m.k.s. units in the first chapter. Although the treatment is basically analytical throughout, in that first-principles proofs using calculus where necessary are freely employed, modern engineering applications are kept well to the fore.

This is one of the best of the post-war textbooks for technical college students studying for the National Certificate in Electrical Engineering; it can also be recommended as good value at the published price of 12s. 6d.

C. F. F.

"Fixed Capacitors." G. W. A. Dummer. Sir Isaac Pitman & Sons, Ltd. 259 pp. Illustrated. 45s.

Telecommunications equipment is as reliable as its weakest component. Nevertheless, it required the severe conditions imposed by the last war to force the introduction of systematic research into the behaviour of common components such as resistors and capacitors. The Ministry of Supply undertook much of the work and have now well-established laboratories permanently engaged on the development of ranges of components of outstanding importance. Amongst these are capacitors. In this new book, *Fixed Capacitors*, which is Vol. 3 of a series on Radio and Electronic Components, Mr. Dummer, of the Ministry of Supply Components Research Section, collects a wealth of information useful to design engineers

requiring fixed capacitors for almost any conceivable application.

The book is intended to be of practical use as a work of reference. It schedules hundreds of types of capacitors, with their range of usefulness, both from the electrical and mechanical standpoints. The properties of dielectrics of many varieties are listed and discussed, including those having the very high permittivities (of over 1,000) now obtainable with ceramics. Methods of construction employed by the leading manufacturers are described and compared. Standard specifications for various types of capacitor are given and methods of testing for electrical properties and reliability are outlined. One chapter, which is devoted entirely to bridge circuits suitable for capacitance measurements, is particularly interesting in that it includes methods of testing at frequencies up to 3,000 Mc/s using waveguide techniques. A short chapter on new methods of making large capacitance values with small physical size is likely to interest research engineers, e.g. the

spun film technique and anodized titanium are now being introduced for miniaturization purposes. The nature of faults most prevalent in commercial capacitors and how they are likely to be caused is of the utmost importance to telecommunication engineers. The author has collected some useful and interesting information on the cause of failures, noise generation, and so forth.

This book should be examined by all designers of equipment using capacitors; whatever their particular field, they will probably find some important information of which they were previously unaware. Newcomers to the subject will be astonished at the performances obtainable from the latest designs of fixed capacitors and the wide range of types now commercially available. It is an excellent reference book and every team engaged on electronic equipment design should have access to a copy.

C. F. F.

I.P.O.E.E. Library No. 2427.

Associate Section Notes

Bishop's Stortford Centre

Since the publication of the April, 1957, notes there have been only two visits to report. The first of these was a very enjoyable and instructive one to the television studios of Associated Rediffusion, Ltd., at Wembley, in March, and this was followed in early May by a visit to the newspaper offices of the *Daily Sketch*.

At this year's Annual General Meeting it was decided by the Committee that, because of the growing importance of Harlow New Town in this area, arrangements will be made to hold a few meetings there during the next session.

Considering the very scattered rural area served by this Centre, we are quite pleased with the results obtained.

J. P.

Guildford Centre

The Annual General Meeting of the Guildford Centre was held on 10th April, 1957, and the following Officers and Committee were elected for the 1957-58 session:—*President*: Mr. E. J. Masters; *Vice-President*: Mr. H. M. Wells; *Chairman*: Mr. F. D. Noble; *Secretary*: Mr. E. N. Harcourt; *Asst. Secretary*: Mr. H. L. Crowther; *Treasurer*: Mr. F. B. Amey. *Committee*: Messrs. F. M. Collins, R. J. Mercer, J. W. C. Moon, T. A. Rolfe, M. Spice and J. F. T. White. *Auditors*: Messrs. F. R. Lancaster and R. Owen.

The discussion regarding the program for the coming session included suggestions for debates, lectures, within-Centre and inter-Centre quizzes and various visits. The Committee is now arranging a program based on these suggestions.

E. N. H.

Medway Centre

The April meeting concluded the 1956-57 session with the exception of the customary summer outing, a visit to the Port of London Authority, in the form of a cruise through the Royal Albert and King George V Docks, followed by a show.

The attendances at recent meetings have been particularly gratifying but still greater support would be welcomed from our external members. Meetings during the past session have been as follows:—

September—Annual General Meeting.

October—"Any Questions," with the local A.E.s under fire.

November—"Cables," by Mr. Gates.

December—Film show by courtesy of the United States Information Service.

January—"The Atom," by Mr. Collett.

February—"Concrete," by Mr. Haliburton.

March—"Electronic Circuitry—Are Circuit Diagrams Really Essential," by Mr. F. L. N. Samuels and Mr. G. S. Gregson.

The Centre would like to thank those speakers who have often come great distances and sacrificed their leisure time to make these meetings possible.

E. J. R. S.

Canterbury Centre

The Annual General Meeting of the Canterbury Centre was held at Bobby's Restaurant, Folkestone, on 2nd May, 1957, when the Centre was honoured to have as its guest speaker, Mr. R. W. Palmer, the President of the Associate Section.

The following Officers were elected for the coming session:—*Chairman*: Mr. V. Dungey; *Vice-Chairman*: Mr. L. Martin; *Treasurer*: Mr. A. G. Lee; *Secretary*: Mr. M. S. J. Green; *Asst. Secretary*: Mr. W. Allen; *Canterbury*: Mr. F. Sullivan and Mr. L. Cockram; *Thanet*: Mr. H. Shugrue and Mr. P. O'Connor; *Folkestone*: Mr. C. Cox; *Dover*: Mr. J. Sharp.

At the dinner following the business meeting Mr. A. H. C. Knox, Regional Liaison Officer, in proposing the toast of the Canterbury Centre spoke of his long association with the Centre and stressed the importance of the part the Associate Section could play in the education and development of its members. Mr. A. G. Robins, Area Engineer, in reply thanked Mr. Knox for his support and pointed out the progressive record of the Centre in the past and wished it well for the future.

Mr. R. W. Palmer, President Associate Section, congratulated the Centre on its activities. He had addressed the Centre at more formal meetings and knew how keen the members were. He spoke of the value of the Institution to all members of the staff. The future would demand a very high standard from all grades and the Associate Section could help materially in enabling us to cope with the everyday problems of a complex automatic and electronic communications system.

Mr. L. Martin, Folkestone, thanked the President for his help and encouragement and said how much the Centre appreciated his presence.

M. G. S. L.

Hull Centre

The 1956-57 session ended very successfully on 6th March, with a joint meeting of the Centre and the Kingston Upon Hull Electronic Engineering Society. The meeting was well attended. The talk, "Electronic Circuitry—Are Circuit Diagrams Really Essential," was very ably given by Messrs. F. L. N. Samuels and G. S. Gregson, of the E.-in-C.'s Office, Telephone Development and Maintenance Branch. We were very sorry to hear from Mr. J. A. Lawrence, that he would not be able to participate in the paper due to official business.

During this last session, perhaps the other highlight of our program was the talk given by Mr. C. J. Towers, B.Eng., Radiffusion Yorkshire, Ltd., on "Wired Television and Sound Services."

Over this series of meetings, the average attendance has been about 40 per cent. of the membership. We thank members for their support and express the hope of seeing some of our younger associates, particularly the "Youths," during the next session.

I. J.

Leeds Centre

Since the publication of the April, 1957, notes from this Centre, the Committee wishes to report a steady increase in

the membership, which now numbers 136.

During the past months members have had a return visit to the B.B.C. North Regional Transmitting Station and visits to the works of the North Eastern Gas Board at Tingley, near Leeds, and B.I.C. Cables, Ltd., at Prescott. The latter visit entailed members taking one day annual leave but everyone agreed that it had been worth it.

The remaining events of the session were a return visit to Ledston Luck Colliery and a visit to Crompton Parkinson, Ltd., Guiseley.

The Annual General Meeting was held on 16th April, 1957, and a good attendance was recorded. A film show, given by the Yorkshire Electricity Board, was arranged to take place after the general business. The Committee elected for the 1957-58 session is as follows:—*Chairman*: Mr. C. Baker; *Secretary/Treasurer*: Mr. A. A. George. *Committee*: Messrs. Bateman, Bates, Crowther, Lancaster, Newton and Senior.

The provisional program for 1957-58 is:—

September, 1957—Talk on Coaxial Television Networks, by Standard Telephones & Cables, Ltd.

October, 1957—Visit to Skelton Grange power station.

November, 1957—"Seeing Through It All." Talk given by the Bradford Royal Infirmary, Radiology Department.

December, 1957—Dinner and Social Evening.

January, 1958—"Manufacture of Radio Valves." Talk given by Mullard, Ltd.

February, 1958—Return visit to B.I.C. Cables, Ltd., Prescott.

March, 1958—Talk on "Wired Television Service," by West-Riding Radio Relay Services, Ltd.

April, 1958—Visit to Ericssons Telephones, Ltd., Nottingham.

May, 1958—Talk on "Refrigeration," by The Pressed Steel Co., Ltd. (Prestcold).

June, 1958—Visit to Holme Moss Television Station.

August, 1958—Visit to Yorkshire Copper Works, Ltd.

It may be found necessary to alter this program at some later date, as provisional arrangements only have been made. The Committee hopes that it has prepared the program to the satisfaction of members and will welcome any criticism or suggestion.

A. A. G.

Sheffield Centre

The 1956-57 session has seen a great revival in interest in the Centre's activities. The membership has increased from 81 to 142 since the beginning of the session due to the introduction of new methods of circulating to members and the provision of up-to-date, provocative, and interesting talks and visits. No doubt the membership figures could be pushed still higher by greater propaganda and canvassing but the Committee feel that they would rather attract members by making the Centre's activities of such interest that people want to join. This policy has certainly been successful this year, as the figures prove. Now that we have a live, go-ahead Centre we must make certain of keeping our enthusiasm fresh with new ideas, and members are urged to contribute to the Centre's activities by bringing any new suggestions to the notice of the Committee. In conclusion the Committee thank all the stalwart supporters who have helped to make this a record year and hope that they will continue to give their unstinted support next session.

J. M.

Sunderland Centre

On 21st February, 1957, 13 members visited the factory of Edison-Swan Electric Co., Ltd. The company's Training Officer did not spare himself to make the visit worth while, and in this he succeeded for the tour of the factory was very informative and took close upon four hours to complete.

Members were first shown the various elements that went to make up a complete multi-electrode valve and then went on to view the construction of these elements, the construction of the glass envelopes and the assembly of all parts into the glass envelope before sealing. High-speed testing of completed valves was then witnessed, and during refreshments questions were answered by the guides. This was a most interesting visit, especially for the wireless enthusiasts.

Mr. L. Lodge, of the Newcastle Centre, visited us on 22nd February and gave a comprehensive and interesting paper on "Electrical Installations in Buildings." Mr. Lodge supported his talk with excellent circuit diagrams issued to each member. It is regrettable that there were not more members present for this talk because the subject chosen is an everyday one and must be of interest to many.

On 29th March, at the Annual General Meeting, the following officers were elected for the 1957-58 session:—*Chairman*: Mr. W. W. Lloyd; *Vice-Chairman*: Mr. A. Beattie; *Secretary*: Mr. D. A. Collins; *Librarian*: Mr. J. Howe. *Committee*: Messrs. G. R. Brown, W. Coulson, M. Cummings, J. Howe and K. Summers.

Two films were shown, "How the Motor Car Works," and "Mille Miglia 1953."

The program for 1957-58, commencing on Friday, 27th September, will be included in the next notes.

D. A. C.

Darlington Centre

The program of Centre meetings since October, 1956, has been:—

20th November, 1956—"Telephones on Tees-side," by Mr. F. W. Allan, Area Engineer.

Mr. Allan described the growth of telephone services on Tees-side from 1885 until the present day. He began by saying how private companies, first the North District, then the National Telephone Co., provided exchanges and lines to serve subscribers, and showed how and why the telephone services have been improved since the Post Office assumed responsibility. He then outlined the salient features of the various types of automatic exchanges that have been installed in the area and the growth of automatic switching from the first Western Electric machine-switching exchange, opened at Darlington in 1914, until to-day when 82 of the 101 exchanges are automatic. Improvements in long-distance telephony used in the area were also referred to.

Mr. Allan then explained how the numbers of telephones had increased in the larger exchanges, with emphasis on the growth during the last 10 years: there are now more than twice the number of telephones in the area than were in use in 1946, and in some exchange areas the number has been trebled.

Junction routes had been transferred from overhead open wires to underground cables until now almost every exchange, including those in the remoter parts of the dales, is linked to the main system by underground cables.

It was obvious that Mr. Allan's review of the progress made had been thoroughly enjoyed and a hearty vote of thanks was accorded.

11th December, 1956—"The Manchester-Leeds-Newcastle Coaxial Cable"—Mr. H. Thompson (Centre Member).

Mr. Thompson had accepted the invitation to him to give this talk on his work, and there was no doubt he had prepared a most informative paper. A good muster of Centre members were much enlightened and impressed by the able manner in which the talk was given and an enthusiastic discussion followed.

8th January, 1957—"An Outline of Trunk Mechanization"—N. Burley.

Mr. Burley explained the part played by trunk mechanization in the program of complete automatization of the telephone system, providing eventually subscriber trunk dialling.

The first steps in trunk mechanization were taken in 1935, when 2 V.F. dialling was introduced on Bristol-London trunks. Several other long-distance routes were similarly converted in the next few years, but the introduction of single-operator control of trunk calls over links in tandem could only be achieved when the trunk circuits were transferred from outgoing multiples to the banks of selectors, and tandem dialling was introduced.

The limited availability of the 2,000-type selector reduced its efficiency on routes exceeding 20 circuits and so the motor-driven uniselector was employed. It gives an availability of 20 or 40 as desired and searches over 200 contacts per second.

The new Signalling System A.C.1 permits tandem dialling. Faraday and Kingsway trunk exchanges are now working and

other provincial exchanges are being converted to trunk mechanization.

The cordless switchboards to be installed at Middlesbrough were then briefly described.

Mr. Burley was thanked for his outline of the shape of things to come which set members thinking what the future had in store.

12th February, 1957—"HI-FI Amplifier Design"—B. V. Northall.

The speaker needed no introduction and it was a foregone conclusion that his talk would be most interesting. Mr. Northall was congratulated on his recent promotion to Executive Engineer.

12th March, 1957—"Motoring Miscellany"—with sound films—R. Lawson.

Members were treated to a colourful display of various motoring events and Mr. Lawson was freely congratulated on his choice of these films.

26th March, 1957—"Passenger Lifts—Design and Practice"—W. J. Costello.

Members followed the talk with interest and were enlightened as to the amount of study involved in the construction, smooth running and the safety factors.

9th April, 1957—"Things Rural"—W. H. Everard.

This final talk proved to be one of the best of the session. Mr. Everard is a landscape architect, and in a very pleasing manner covered various aspects of country life—natural scenery we should cherish. He is an authority on stonemasonry and spoke of the stonework of various national buildings. A discussion followed and several devotees of gardening took advantage to ask questions and obviously felt happy with the knowledge obtained. Time had been forgotten in the enthusiasm and a most enjoyable evening had been spent—hearty thanks were accorded to Mr. Everard.

Attendances have been maintained throughout the session and a paper will be submitted for the national competition.

C. N. H.

Coventry Centre

The 1956-57 session of the Coventry Centre commenced last July with a very interesting visit to Rugby "B" Radio Station.

This was followed in September by a local visit to Coventry Power Station. The members of the station staff who conducted the party, imparted a wealth of technical knowledge.

In December, Mr. B. H. Berresford of the Senior Section gave an interesting talk on "Cable Laying in the Middle East." The difficulties encountered when laying cables in that area were brought very much to life by the film slides which were shown.

During March an afternoon visit was made to the Dunlop Rubber Co., at Fort Dunlop. The manufacturing processes involved in producing motor vehicle tyres proved very interesting and all members attending thought this an excellent visit. Also, during March, a party of members and friends visited St. Mary's Hall, a building of local historic interest. The City Chamberlain who conducted the party round made it a very enjoyable evening.

The Annual General Meeting was held in April and the following Officers and Committee were elected:—*Chairman*: Mr. D. Hubbard; *Vice-Chairman*: Mr. G. W. Parker; *Secretary*: Mr. R. J. Ellis; *Asst. Secretary*: Mr. K. W. Hartup; *Treasurer*: Mr. A. B. Howard; *Librarian*: Mr. E. H. Cook. *Committee*: Messrs. A. E. Robinson, A. J. Hartup, B. M. Mills, G. Watts, J. Bygraves; *Auditors*: Messrs. S. C. C. Bentall and K. Thomas.

Following the Annual General Meeting, several excellent films, borrowed from the Shell-Mex & B.P. Library, were shown.

Recently we have been very pleased to welcome several new members from Bearley Radio Station and we hope they will find our present session interesting and enjoyable.

For the future, arrangements have been made for visits to the British Industries Fair at Castle Bromwich, and the British Thomson-Houston Co., Ltd., works at Rugby, and for another film show, in October, by courtesy of Shell-Mex & B.P., Ltd.

R. J. E.

Ayr Centre

In the Centre's last notes it was hoped that attendances at meetings would be as high as on our first visit of the session, in September, to the I.C.I. factory, Ardeer.

These hopes were certainly realized and the average attendance—from a membership of 77—during the 1956-57 session was 30, a very encouraging figure.

In October, Mr. J. F. Boag brought us up to date with a fine talk on the "Transatlantic Cable," and in November a visit was made to Grays Carpet Works in Ayr.

In January a most interesting and question-provoking talk was given to the Centre by Mr. W. Marshall on "Radio-Astronomy," to be followed up later, in March, by a visit to Glasgow University Observatory. Unfortunately the visit to Scottish Aviation, Ltd., Prestwick Airport, was cancelled, but perhaps we shall manage this visit next year. The final visit, in April, to Littlemill Colliery, provided a splendid finish to the session's activities and leaves us looking forward to what next session can offer.

The Annual General Meeting takes place in May and we are confident that at this meeting sufficient suggestions for a full program for the 1957-58 session will be forthcoming.

Congratulations are offered to one of our members, Bob Bruce, who, in last year's City and Guilds examinations, won the Bronze medal presented by the Pewterers' Company for the best paper in the Telegraphy II examination.

A. E.

Dundee Centre

The Annual General Meeting was held on 2nd April, 1957, and the following Officers were elected for the 1957-58 session:—*Chairman*: Mr. R. L. Topping; *Vice-Chairman*: Mr. W. L. G. Bennett; *Secretary*: Mr. D. L. Miller; *Treasurer*: Mr. J. Brown; *Librarian*: Mr. G. Kerr. *Committee*: Messrs. K. K. Summers, S. T. McLean, W. Kiddie, J. McFarlane, R. Burns and D. T. Walker.

The committee has held its first program meeting for the next session and it is hoped to offer the following to our members:—

Visits:—Hydro-electric switching installation at Pitlochry; Coal mine in West Fife; Moncrieff Glass Works, Perth; Dundee Gas Works.

Papers:—Remote Control Switching; Internal Combustion Engine; Navigational Aids; Tape Recording; Subscriber Trunk Dialling; Modern Fire Fighting; Stereophonic Sound.

Film Shows:—British Transport Commission; Across Canada by Canadian Pacific; and others.

It is hoped that this program will attract many more new members and arouse interest among our existing members.

D. L. M.

Bath Centre

During the past year there have been two visits by members of the Bath Centre, to W. D. & H. O. Wills, of Bristol, and to the Communications and Flying Control sections of London Airport.

Members' papers, presented by Mr. L. W. Vranck, and Mr. Moxham, on Direction Finding and Radar, were well received. It is hoped that more members will present papers in future.

Mr. M. G. Smith, of Bristol University, showed an interesting film on the construction and use of the 200-in. Palomar telescope, and the film was followed by questions and a general discussion on astronomy.

The Centre met Portsmouth in two Quiz contests, which were won by a narrow margin. As is usual, these events were popular both with the teams and audience.

Among the guests who spent an enjoyable evening at the Annual Telecommunications Ball organized by the Centre were Mr. L. G. Semple, Regional Director S.W. Region, and Mrs. Semple.

The following Officers and Committee were elected at the Annual General Meeting held on the 29th April:—*Chairman*: Mr. G. Rugg; *Vice-Chairman*: Mr. L. W. Vranck; *Secretary*: Mr. C. E. Martin; *Asst. Secretary*: Mr. A. F. Arlett; *Treasurer*: Mr. R. P. Bowers. *Committee*: Messrs. A. L. Mainstone, H. C. Foote, P. E. Smith, R. Faulkner, J. D. Silcox and D. G. Rossiter.

C. E. M.

Regional Notes

Wales and Border Counties

INTRODUCTION OF TRUNK MECHANIZATION AT CHESTER

The old Roman city of Chester has long been known as the gateway to North Wales and its communication centre for road and rail traffic; but not for trunk telephone traffic as until recently it formed part of the Liverpool zone. It was not, therefore, surprising when, shortly after the last war, as a means of relieving the Liverpool zone centre exchange it was decided to establish a zone centre at Chester to serve North Wales and, incidentally, the Whitchurch and Oswestry groups. This required a substantial extension of the telephone exchange building to house trunk automatic-switching equipment, as well as the erection of a new repeater station to cater for the large increase in trunk circuits.

The new trunk unit, which was opened on 14th April, 1957, is the second unit of its kind to be brought into service in this Directorate, a similar, though somewhat smaller, unit having been opened at Swansea three months previously. The unit is equipped with about 2,000 motor-uniselector-type group selectors and gives access to 28 trunk routes via signalling equipment which is mainly of the A.C.1 and D.C.2 types. To ensure a high standard of maintenance, automatic routiners have been installed to test the group selectors and the A.C.1 signalling equipment. An outgoing trunk and junction routiner has also been provided. A suite of six trunk test positions, together with a record position, was installed in the room formerly used for the maintenance control, which, at an early stage of the work, was removed to the old repeater station across the road.

The new repeater station, officially designated "Chester/D" but known locally as "The Bars" on account of its proximity to the hostelry of the same name, is about half a mile from the old repeater station. The new station, which will also become the terminal for the Chester-Shrewsbury coaxial cable route, was brought into service in two stages, first by cutting in the audio circuits and secondly by the opening of the new 24-circuit carrier route to Old Boston. This route was provided mainly to cater for the increased number of trunk circuits to other zone centres, necessitated by the setting up of the new zone. The carrier equipment is of the new, No. 9 type (51-type construction). Only the 2-wire/4-wire terminating units and local tie-cable terminations now remain in the old repeater station.

Circuit provision work, as well as the engineering and traffic pre-transfer tests, was complicated by the need to switch certain carrier groups terminating in Old Boston from Liverpool to Chester, but these and other difficulties were overcome by the efforts of all concerned and the result was a very successful transfer.

T. A. P. C. and K. G.

Home Counties Region

EXPEDIENT TO EXTEND THE CAPACITY OF BURGESS HILL U.A.X. No. 7 TO 2,000 LINES

Non-standard methods are now almost a normal means of extending the life of an exchange, so that when Burgess Hill U.A.X. No. 7 in the Brighton Area became exhausted, with no hope of relief for some years, thoughts turned again to that magic word "expedient."

The exchange building could accommodate additional equipment, and Units No. 7 were available from recoveries within the Area.

By a previous expedient the originally designed maximum of 800 lines had already been increased to 1,600, which is the maximum for this method. The equipment has now been extended to 2,000 lines by a method entailing a mixed 4- and 5-digit numbering scheme; the existing 4-digit numbering is unaltered. The new multiple, above 1,600, is 5-digit, routed from level 8 of 1st selectors. The equipment dealing with the 4 digits after the digit 8 has been dialled is a normal 4-digit U.A.X. No. 7 with full facilities, access to it being from the original U.A.X. No. 7.

All subscribers' (above and below 1,600) incoming calls pass through normal 1st selectors, and have normal discrimination to all 4-digit numbers.

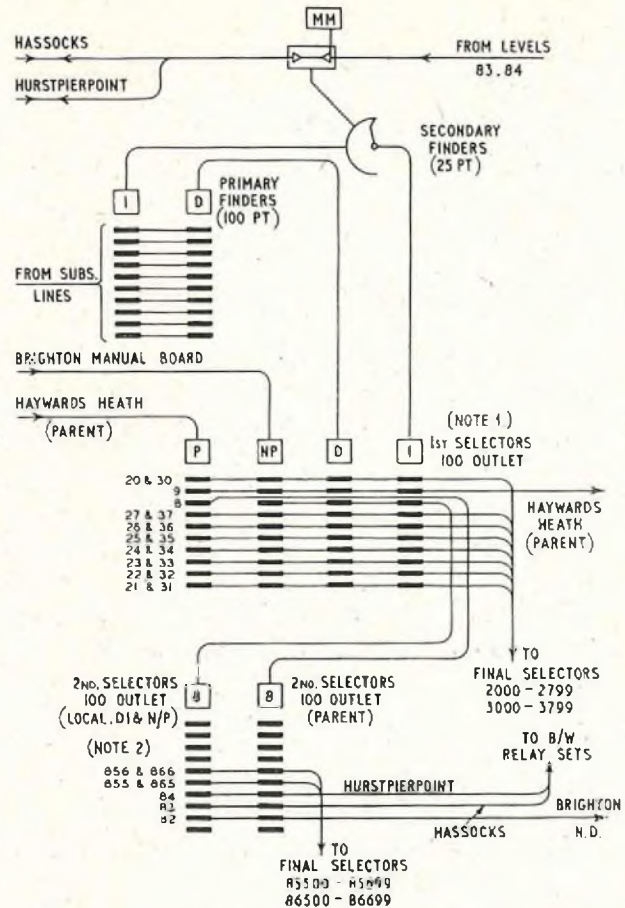

TRUNKING DIAGRAM. BURGESS HILL U.A.X. No. 7.

Access to subscribers on level 8 is via 3-wire trunks to 2nd selectors. For these 2nd selectors normal subscribers' 1st selectors (AGS 105) are used, instead of normal 2nd selectors (AGS 123), in order to provide digit absorption on levels 85 and 86, discrimination, and the transmission bridge to final selectors on levels 855, 856, 865 and 866.

Junction access is given from levels 82, 83 and 84 in the normal manner.

The trunk-offering facility is given on the parent route by trunking level 8 from parent 1st selectors to 2nd selectors (AGS 108).

Midland Region

ARBORETUM HYPOTHETICAL EXCHANGE

Arboretum Exchange, with 900 multiple, has been provided hypothetically on Walsall by a new method.

Walsall is a non-director exchange with line and final units; it was installed by Ericsson Telephones, Ltd., in 1929, and is the main exchange in a small multi-exchange area. Owing to lack of space the exchange could not be extended by standard methods, and the method adopted involved the rearrangement of existing final selector multiples so that space on the multiple side of one in every three line and final units was made available for additional uniselectors. Three line and final units were selected, preferably adjacent, e.g. units 24, 25 and 26. The final selector multiple on unit 25 was moved to a position below the existing multiple on unit 24. Gates with up to 100 uniselectors and L and K relays were then mounted in the space that had been made, and final selector multiple for the additional lines was accommodated in the space below the existing final selector multiple on unit 26. Subscribers' uniselectors for Arboretum exchange are cabled direct to a T.D.F. provided with tie circuits to existing 1st selector houses, and form a separate division in the grading.

Walsall has a 4-digit numbering scheme with no spare 1st selector level, but a 2nd selector level was made spare by the transfer of an outgoing junction group and was used to serve a group of 3rd selectors installed on single-sided racks,

giving Arboretum subscribers a 5-digit numbering scheme prefixed by the digit 5. Additional 1st and 2nd selectors were accommodated on single-sided racks and a complete regrading was carried out to incorporate the new switches into the existing grading. After this regrading, it was possible to bring each hundred group on Arboretum into service as soon as it had been completed and thus satisfy an urgent demand for additional exchange connexions.

To facilitate the shifting of Walsall final selector multiples, a recovered final selector multiple was fitted in the new position, the bank tails being terminated on connexion strips fitted across the bottom of the unit under the lower final selector shelf. The common services were then teed into the existing Walsall circuits, the bank tested and the final selectors fitted. As a change-over device, the incoming trunks to the new final selectors were disconnected by insulation at the D relay contacts, the multiple then being teed to the Walsall multiple by a local cable form. A Walsall final selector was then recovered, the automatic earthing device on U-points 9-11 of the vacated shelf jack being insulated, and the insulation was removed from the D relay contacts of one of the new final selectors. When all the new final selectors had been brought into service by this method, the old multiple bank tails were disconnected and the shelves recovered. Any disturbance of service to subscribers while changing over from the old to the new multiple was thus avoided.

Recovered equipment from other areas was used for the extension. Nine Peel Connor line and final units were obtained from Stockton-on-Tees and the necessary single-sided group selector racks (with selectors, meters, protectors, routiner and traffic recorder access equipment, and cable) were obtained from York.

A. D. O. and W. H.

EXPEDIENT FOR TEMPORARY RELIEF AT EXHAUSTED AUTOMATIC EXCHANGES

To bridge the gap between the exhaustion of an exchange and its extension or replacement, various expedients have been adopted and have proved a very useful contribution to the reduction of the order list. One such expedient which has been developed in the Leicester Area takes the form of a composite linefinder and final selector rack which can be transported to any exchange where temporary relief is required.

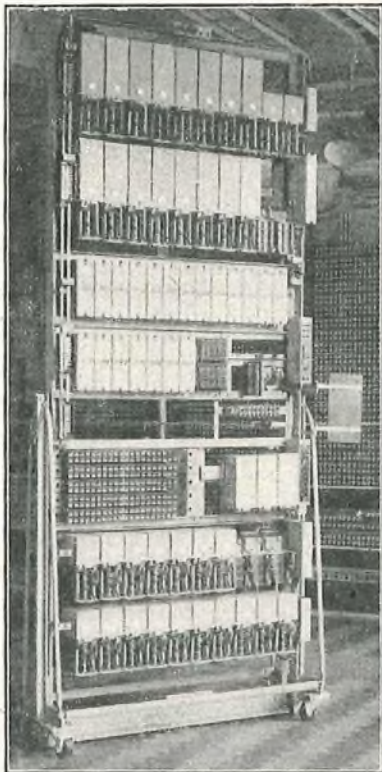

COMPOSITE LINEFINDER AND FINAL SELECTOR RACK.

The equipment is built on a standard 4-ft 6-in. rack on which have been mounted linefinder shelves, two final selector shelves, 200 meters, 200 L & K relays, control sets and associated miscellaneous equipment. The banks of the linefinders and final selectors are teed together, giving a certain loss of flexibility but avoiding the use of I.D.F. jumpering and reducing the cabling from the rack to a minimum.

The rack caters for direct exchange lines (D.E.L.s) or shared-service lines, although sharing must be with another subscriber on the same rack, and conversion from D.E.L.s to shared service is effected by a simple strapping at a connexion strip on the rack. Full routine-test facilities are available together with test and trunk-offering selectors.

Connexion from the linefinders to the exchange can be made either to ordinary subscribers' equipment, i.e. uniselectors or linefinders, or direct to 1st selectors. In practice it has been found desirable for early choices to be connected to 1st selectors and later choices to subscribers' equipments which then act as secondary finders. The equipment has been in use for a year at various exchanges and has been found to have a satisfactory fault liability and has avoided the closing of the exchanges. The simplicity of the cabling has meant that the rack can be installed in a very short time and the equipment has been in almost continuous use since it was constructed.

It is expected that for the next two or three years the need for the equipment will be maintained, and since standard 2,000-type equipment is used throughout, it can be put to good use in permanent extensions when the need for expedient relief is ended.

The illustration shows the rack in course of movement from one exchange to another.

W. L. S.

Northern Ireland

BOMB DAMAGE TO U.A.X. No. 12

Attempts to disrupt the telephone service in country areas of Northern Ireland have, hitherto, been confined to items of external plant, poles, wire, aerial cables etc., but on 26th February, 1957, the U.A.X. No. 12 at Drumaney, Co. Tyrone, was completely destroyed by an explosive charge placed within the building, which was of the "A" type in brick. The interior of the building and its walls were demolished, and the roof structure had descended upon the few remains of the units,



By Courtesy of "Belfast Weekly Telegraph,"
BOMB DAMAGE AT DUNLOY U.A.X.

engine and batteries. The floor and foundations were also badly damaged. The E.S. and W.C.Q. cables had been severed by the explosion, where they entered the "C" unit.

Temporary restoration of service was effected by a mobile U.A.X. No. 12 which had to be towed a distance of 45 miles together with staff, stores and power plant. It was also necessary temporarily to acquire a nearby site for the mobile exchange, and delay occurred while the police and military authorities took due precautions on the existing site to ensure that it was safe to permit Post Office staff to work. Nevertheless, temporary restoration was effected within 24 hours of the incident, which, in the circumstances, reflects great credit to the staff of the Belfast Telephone Area in terms of planning, execution and staff co-operation.

A further case of sabotage occurred at Rasharkin, Co. Antrim, on 21st March, 1957, when the damage caused was almost identical to that at Drumaney. Here again, temporary service was restored within 24 hours.

On 12th April, 1957, however, a determined effort was made to blow up four U.A.X.s No. 12 simultaneously in Co. Antrim, at Dunloy, Loughgiel, Bellaghy, and Glarryford. Service was interrupted at Dunloy, where, because of a freak in the blast from the explosion, the majority of the cells in the exchange battery escaped damage, whereas the exchange equipment suffered severely, as will be seen from the photograph. Here again, it was necessary to use a mobile exchange to effect restoration of service within 24 hours. The Dunloy incident is also of interest because the raiders actually took time to warn a family living immediately beside the exchange to "Lie down, a bomb is about to go off," a few seconds before the explosion occurred.

The explosions at Loughgiel and Bellaghy caused structural damage to the buildings, which although extensive did not too seriously impair the equipment or batteries. Fortunately, the weather was kind and building repairs were effected before water could get in.

At Glarryford the explosive charges were removed by two members of the Ulster Special Constabulary who, at great personal risk, actually carried the explosives complete with detonators from the side of the U.A.X. wall to a place of safety 200 yd distant, where the bombs were rendered harmless.

Permanent repairs, involving the replacement of the buildings after site clearance, are already well in hand, and in one instance the diversion of subscribers to an adjacent exchange area has been found an economical and practical solution.

In all cases the buildings were of pre-war type "A" pattern in brick construction, which is a stronger form of accommodation than that currently employed. The effect of blast on U.A.X. 12 switching equipment was really severe; the unit frames and racks buckled and the switch frames cracked and banks disintegrated. The screw-on unit covers either caved in or blew off according to the angle and direction of blast. The power plant panels and relays were smashed to pieces. At Drumaney and Rasharkin battery acid splashed over the wiring and some of the subscribers' meter number-wheels came off their spindles. The varying degree of damage in the incidents on 12th April, 1957, is attributed to the placing of the charges.

It will be readily appreciated that all of the factors involved cannot be mentioned in a note of this nature, but it is, nevertheless, thought to be of general interest. It is especially desired to record the appreciation of the Northern Ireland Directorate for the prompt and efficient assistance given by the Engineering Department, Equipment and Accommodation Branch, the North-Western Region and North-Eastern Region in making available at short notice replacement U.A.X. equipment, and shipping it to Northern Ireland.

H. G.

Scotland

PROVIDING A MOBILE UNIT AUTOMATIC EXCHANGE IN THE ISLAND OF LEWIS

During the next two years an extensive U.A.X. conversion program is to be undertaken in the island of Lewis, one of the larger islands in the Outer Hebrides. Among the exchanges to be converted is that of a small locality called Timsgarry on the west coast of the island. Its conversion was planned to take place during the latter part of 1957, so that there was

sufficient time available to obtain a site for the U.A.X. and to provide the necessary building, and accordingly the sub-postmaster was given due notice of the proposal.

Unfortunately, both the sub-postmaster and his wife were getting on in years and for domestic reasons were forced to give up the exchange earlier than had been anticipated, and conversion of the exchange before the end of March, 1957, was necessary. It was obvious that there would not be time to build the permanent U.A.X. building, nor was there any prospect of finding anyone in this isolated and scattered locality who would take over the manual exchange temporarily. It was decided to provide a mobile unit automatic exchange (M.A.X.) until the permanent building could be erected. In the Aberdeen Area, where there are 200 U.A.X.s, the staff have had plenty of experience in the use of M.A.X.s, but had not previously been faced with transporting one across the sea nor over tortuous and single-track roads such as those that are encountered on Lewis.

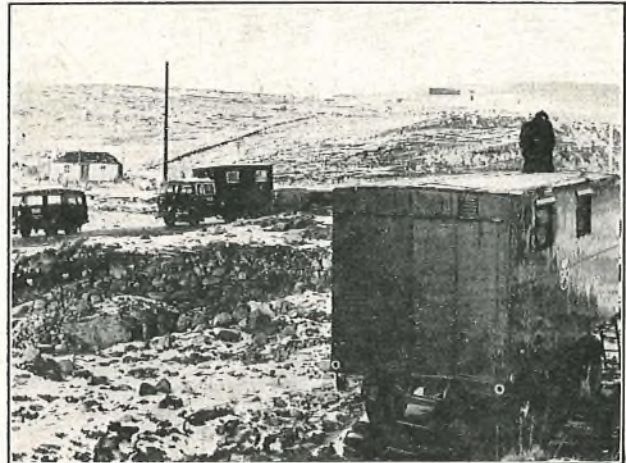

THE M.A.X. BEING INSTALLED AT TIMSGARRY.

The first snag encountered was that the *Loch Seaforth*, which plies between Kyle on the mainland and Stornoway, the main town on the island of Lewis, was only capable of handling loads of 5 tons, whereas the nominal weight of the M.A.X. was 6 tons. On investigation, however, it was found that the M.A.X. actually weighed a little under 5½ tons and by removing the spare wheel and other parts such as relay sets, doors to the units, etc., it was possible to reduce the weight to 5 tons. The journey across Lewis was likely to be a hazardous one where a false move at any point would result in the M.A.X. going off the road into the ditch or the peat bog which is prevalent throughout the island, or down the banking where the road rose above the surrounding country. However, a Lewis contractor, well acquainted with such conditions, agreed to tow the M.A.X. across the island.

On the morning of the 14th February the M.A.X. set off from Aberdeen on tow behind a B.R.S. lorry on the first leg of its journey. The first stop was Inverness, some 100 miles north of Aberdeen, where the spare wheel, etc., were removed. The next stage was over the tortuous and narrow roads to Kyle, nearly another 100 miles, there to be loaded on to the *Loch Seaforth* for its journey, of some 4 hours' duration, by sea to Stornoway. After off-loading at Stornoway, it was towed by the local contractor and without mishap finally arrived at Timsgarry, where it was set up on railway sleepers, also transported from the mainland.

Staff already working in Lewis soon had the M.A.X. checked over and the equipment, which had not suffered in transit, functioning satisfactorily. The subscribers' conversion, 18 subscribers including eight kiosks, two nurses, one doctor and several important service lines, was carried out, a temporary tie cable provided to the old exchange and a successful transfer took place on the 20th February.

It is in times like this that the ingenuity of the staff is most apparent and the co-ordinated effort, without which such a task could not be undertaken, is most appreciated.

S. T. M.

FIELD TRIAL OF 10-LINE SUBSIDIARY AUTOMATIC SYSTEM

A field trial of a 10-line subsidiary automatic system is taking place at Skerray, Sutherland. The equipment has been designed by the Telephone Manufacturing Co. to provide service in remote and undeveloped areas. It is similar to the country satellite exchange system, but is designed for connexion to an automatic exchange. Two bothway junctions are used and a subscriber obtains access to the parent exchange via one of them. Switching is effected by relays built into units fixed at the subscribers' distribution point (subsidiary unit) and at the parent exchange (parent unit). The subsidiary equipment can be fitted in a weatherproof case that is suitable for mounting on a pole or wall. A similar case contains fuses and heat coils. The main facilities provided by the equipment are:—

- (1) Service for 10 subscribers over two junctions.
- (2) The system will operate over a combination of junction line, subscriber's line and subscriber's instrument resistance of 1,200 ohms, subject to a maximum junction resistance of 800 ohms, at 46V (parent exchange voltage).
- (3) Full secrecy.
- (4) Normal dialling for originated calls, and individual ringing on incoming calls.
- (5) Calls are metered automatically.
- (6) Subscribers' numbers are in the range of the parent exchange numbering scheme.
- (7) Subscribers are connected to the system by normal jumpering at the parent exchange.
- (8) Two simultaneous calls are provided for, either in one direction or one call in each direction. A call between two subscribers on the system engages both junctions.
- (9) The power supply is provided by the parent exchange.
- (10) The equipment is mounted on jack-in relay sets, and normal telephone instruments, fitted with thermistors, are used.

The equipment at Skerray was brought into service on 25th April, 1957. The parent exchange is Bettyhill U.A.X. No. 12, about 12 miles away, and five subscribers and one kiosk are connected to the system. Initially the subsidiary and protector units were fitted in a hut, but they are being shifted on to a pole so that the trial will take place under the most stringent conditions available. At Bettyhill the parent unit is fitted in a Unit, Automatic, No. 12D. No information can be given yet on the performance of the equipment at Skerray, but the system has been used abroad and seems to require very little maintenance.

The equipment, if satisfactory in performance, will meet a definite need in Scotland, both as an alternative to the U.A.X. No. 12 in replacing country satellite and small manual exchanges, and as a means of giving relief on overloaded routes. The latter use might be applicable in urban areas where this type of equipment could be used as an expedient for giving relief at closed D.P.s, and also perhaps as a permanent feature of local line networks, e.g., in large blocks of flats.

M. W. K.

INVERNESS-ULLAPOOL 12-CHANNEL OPEN-WIRE CARRIER SYSTEM

A 12-channel open-wire system has recently been installed between Inverness and Ullapool, a small fishing community which also attracts an increasing number of holiday visitors in the summer months and is some 60 miles north-west of Inverness. This is the first 12-channel overhead system to be installed in this country, and it is thought that a brief description of the system will be of interest.

The system is designed to be used on the same overhead pair as the existing 1 + 3 system. The frequency band used is 36 to 84 kc/s in the A-B (Ullapool-Inverness) direction, and 92-140 kc/s in the B-A (Inverness-Ullapool) direction. The 12 channels, which conform to C.C.I.F. recommendations in all respects, are first assembled in the 60-108-kc/s range; they are then subjected to two stages of modulation: first with 340 kc/s, which translates the group to 400-448 kc/s (upper sideband), then at the "A" terminal with 308 kc/s, which translates the group to 92-140 kc/s (lower sideband),

and at the "B" terminal with 484 kc/s, which translates the group to 36-84 kc/s (lower sideband). A group transmit amplifier is inserted between the two modulators to compensate for the loss in the first modulator. The group is then amplified by the transmit line amplifier, which is a 3-stage power amplifier with two parallel valves in each stage. Finally the group passes through a directional filter, a high-pass filter (to separate it from the 1 + 3 system) and a matching transformer to the overhead line. The output level to line is + 17 db (see block schematic diagram).

An interesting feature of the system is the automatic gain control, which is designed to compensate for attenuation variations, up to 35 db, that will occur due to temperature variations and weather conditions, on the overhead line, a facility which is most desirable during the winter months on this route.

The automatic gain control is controlled by two pilot signals transmitted in each direction (see table). One pilot ("flat" pilot) controls the gain of the receive line amplifier and the other ("slope" pilot) the slope of the receive equalizer.

Pilot Frequencies

Direction	Pilot	Pilot Frequency kc/s	Line Frequency kc/s
A-B	Flat	60	92
	Slope	111	143
B-A	Flat	64	80
	Slope	104	40

The pilots are transmitted at a level of - 3 db at the output of the directional filter, i.e. 20 db below speech level. They are picked off at the output of the receive group amplifier and applied to the pilot control panel. This consists of a narrow-band crystal filter, an amplifier, rectifier, and a 2-kc/s oscillator associated with each pilot signal. The pilot signal, after amplification, is rectified and the d.c. potential applied, as d.c. grid bias, to the 2-kc/s oscillator. The output of the oscillator is connected to the heater of a thermistor which is connected in the feedback path of the receive line amplifier, in the case of the flat pilot, and to a thermistor in the variable equalizer, in the case of the slope pilot.

Should the level of the pilot signal vary due to a variation in line attenuation, the d.c. applied to the grid of the 2-kc/s oscillator will vary causing the output of the oscillator to vary; this in turn varies the resistance of the thermistor in the amplifier or equalizer in such a way as to restore the level of the pilot, and thus the level of the 12 channels, to their normal value.

At the B terminal an additional regulating amplifier is used because of the greater attenuation of the higher frequency band.

In the event of a failure of the pilot regulator, or pilot supply, or for test purposes, the system can be switched to manual control, when the thermistors in the regulating circuits are replaced by rheostats. Should there be a momentary disconnection of the line the gain of the regulating amplifier would rise due to failure of the pilots and cause the channels to howl when the line was reconnected. To prevent this the transmission path is automatically cut when the pilot fails and is not reconnected until the pilot regulators settle down.

The equipment used is 51-type and consists of six single rack-sides, one channel rack, a group transmit rack, a group receive rack, two frequency-generating racks and a line-filter rack. The frequency-generating equipment is similar to the standard 51-type generating equipment for small stations, with a 60-kc/s crystal-controlled master oscillator. A rack of Units, Signalling, 18A is permanently cabled to the channel equipment. The channel equipment is arranged so that by means of U-links 2-wire or 4-wire circuits can be derived.

The Hydro Electric Board has a number of high-tension power lines in the area and this caused some difficulty in the setting up of the system due to the large number of power crossings. The attenuation at the higher frequencies was

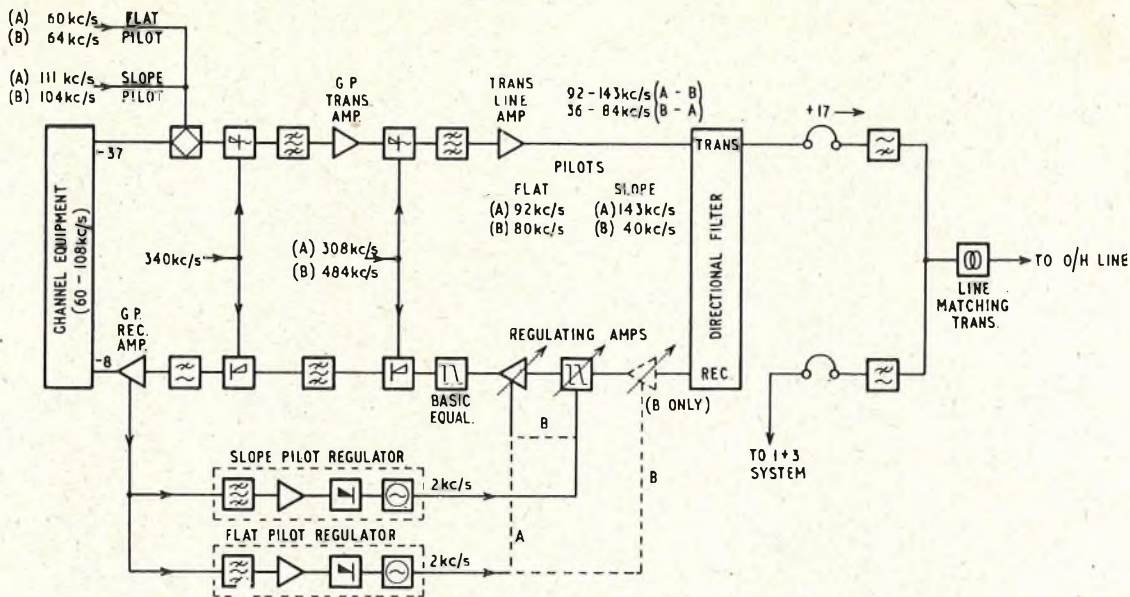

BLOCK SCHEMATIC DIAGRAM OF INVERNESS-ULLAPOOL 12-CHANNEL CARRIER SYSTEM.

considerably increased and it was necessary to use low-loss cable and fit matching transformers on the terminal poles at the power crossings and use special isolating transformers for power protection. The attenuation/frequency characteristic of the line is as shown in the graph.

A level-recorder run was taken on one of the channels over a period of two months and the result shows that the system is very stable.

Another 12-channel open-wire system is in the process of installation between Fort William and Mallaig, although the equipment in this case is manufactured by a different contractor.

The use of this system should enable good-quality circuits at low cost to be provided to outlying communities when it is uneconomical either to provide underground cables or to augment existing overhead routes.

A. S.

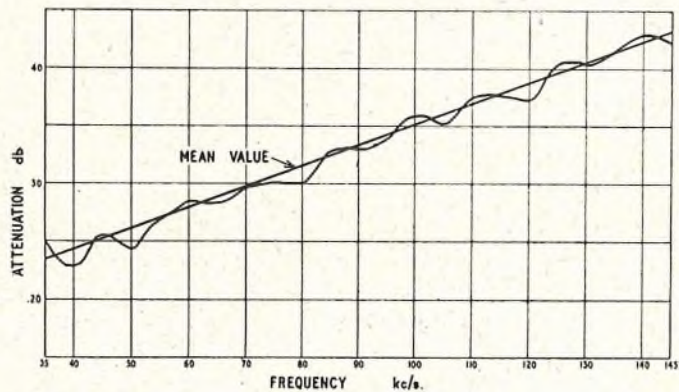

ATTENUATION/FREQUENCY CHARACTERISTIC.

BOARD OF EDITORS

D. A. BARRON, M.Sc., M.I.E.E., Chairman.
 L. F. SCANTLEBURY, Whit.Sch., A.C.G.I., D.I.C., M.I.E.E.
 H. G. BEER, Whit.Sch., A.C.G.I.
 T. H. FLOWERS, M.B.E., B.Sc.(Eng.), M.I.E.E.
 W. J. E. TOBIN, B.Sc.(Eng.), A.C.G.I., D.I.C., A.M.I.E.E.
 R. H. DE WARDT, B.Sc.(Eng.), A.C.G.I., A.M.I.E.E.
 R. F. WALDEGRAVE.
 W. A. HUMPHRIES, T.D., A.M.I.E.E., Managing Editor.
 J. H. BROADHURST, A.M.I.E.E.
 E. DAVIS, A.M.I.E.E.
 B. FARR, Secretary-Treasurer.

} Assistant Editors.

Copyright

The entire contents of this JOURNAL are covered by general copyright, and special permission is necessary for reprinting long extracts, but Editors are welcome to use not more than one-third of any article, provided credit is given at the beginning or end thus: "From the *Post Office Electrical Engineers' Journal*."

The Board of Editors is not responsible for the statements made or the opinions expressed in any of the articles in this JOURNAL, unless such statement is made specifically by the Board.

Communications

All communications should be addressed to the Managing Editor, *P.O.E.E. Journal*, Engineer-in-Chief's Office, Alder House, Aldersgate Street, London, E.C.1. Telephone: HEADquarters 1234. Remittances should be made payable to "*The P.O.E.E. Journal*" and should be crossed "& Co."

Binding Cases

Cases for binding are available, and may be obtained from the Local Agents for 3s. Subscribers can have their copies of volumes bound, at a cost of 10s. 6d., by sending the complete set of parts to the Local Agents or to the *P.O.E.E.J. Journal*, Engineer-in-Chief's Office, Alder House, Aldersgate Street, London, E.C.1. Orders for binding for Vols. 1-19 should indicate whether the original binding case with black lettering, or the later pattern with gold, is required. Cases with gold lettering are the only type stocked from Vol. 20 onwards.

Back Numbers

The price of the JOURNAL, which is published quarterly, is 2s. 6d. (2s. 9d. post free) per copy, or 11s. per annum, post free. Back numbers can be supplied, subject to availability of stocks, at 2s. 6d. (2s. 9d. each post free) except for Vol. 49, Part 4 (January 1957), the Transatlantic Telephone Cable issue, the price of which is 12s. 6d. (post free). Orders for back numbers may be sent to the *P.O.E.E. Journal*, Engineer-in-Chief's Office, Alder House, Aldersgate Street, London, E.C.1, or to the Publishers.

Employees of the British Post Office can obtain the *Journal* through Local Agents at the reduced price of 2s. per copy.

Advertisements

All communications relating to space reservations should be addressed to the Advertisement Editor, *P.O.E.E. Journal*, Alder House, Aldersgate Street, London, E.C.1. Communications regarding advertisement copy, proofs, etc., should be addressed to the Publishers, Messrs. Birch & Whittington (Prop. Dorling & Co. [Epsom] Ltd.), Depot Road, Epsom, Surrey.

Staff Changes

Promotions

Name	Region	Date	Name	Region	Date	Name	Region	Date
<i>Snr. Exec. Engr. to Asst. Staff Engr.</i>			<i>Asst. Engr. (Open Competition).</i>			<i>Tech. Offr. to Asst. Engr.—continued.</i>		
Webber, F. W. J. . . .	L.T. Reg. to E-in-C.O.	22.1.57	Redington, B. H. . . .	E-in-C.O.	3.12.56	Brighton, J. . . .	H.C. Reg.	19.10.56
Lawrence, J. A. . . .	E-in-C.O.	22.1.57	Hubbard, J. E. . . .	E-in-C.O.	3.12.56	Decamp, J. R. . . .	Mid. Reg.	3.4.56
Laver, F. J. M. . . .	E-in-C.O.	22.1.57	Morris, R. C. . . .	H.C. Reg.	3.12.56	Travis, E. B. . . .	N.E. Reg.	1.10.56
James, M. H. . . .	E-in-C.O.	7.2.57	Walker, S. . . .	Scot.	3.12.56	Cowley, G. . . .	N.E. Reg.	8.10.56
Hopwood, R. W. . . .	L.T. Reg. to E-in-C.O.	18.2.57	<i>Inspector to Asst. Engr.</i>			Mogg, D. J. . . .	W.B.C.	19.11.56
White, R. W. . . .	E-in-C.O.	15.3.57	Topsfield, A. W. . . .	H.C. Reg.	17.4.56	Hayward, J. A. . . .	W.B.C.	23.8.56
<i>Snr. Exec. Engr. to Reg. Engr.</i>			Barrett, V. G. . . .	H.C. Reg.	17.4.56	Long, K. H. . . .	W.B.C.	22.5.56
Mascall, J. H. A. . . .	L.P. Reg.	22.1.57	Sainsbury, J. . . .	H.C. Reg.	17.4.56	Stock, E. . . .	E-in-C.O.	11.1.57
<i>Snr. Exec. Engr. to Principal.</i>			Munnery, W. A. E. . . .	H.C. Reg.	17.4.56	Whitewick, H. E. . . .	E-in-C.O.	16.1.57
Truslove, E. H. . . .	E-in-C.O. to I.T.D.	11.2.57	Peacock, V. A. . . .	Mid. Reg.	23.7.56	Quarby, J. . . .	E-in-C.O.	26.1.57
<i>Exec. Engr. to Area Engr.</i>			Muir, A. . . .	Scot.	22.10.56	Pughley, S. R. . . .	E-in-C.O.	16.1.57
Gibson, J. . . .	E-in-C.O. to Scot.	28.1.57	Hall, H. H. . . .	H.C. Reg.	12.9.56	Cranmer, P. C. . . .	E-in-C.O.	25.1.57
<i>Exec. Engr. to Snr. Exec. Engr.</i>			Gardner, G. . . .	N.E. Reg.	23.1.56	Brookman, J. . . .	E-in-C.O.	25.1.57
Turner, R. J. . . .	E-in-C.O.	24.1.57	Bradshaw, W. . . .	N.E. Reg.	5.4.55	Norris, H. W. . . .	E-in-C.O.	2.2.57
Morton, J. Y. . . .	E-in-C.O.	24.1.57	Williams, T. W. . . .	N.E. Reg.	1.7.56	Billups, J. J. . . .	E-in-C.O.	25.1.57
Morgan, T. J. . . .	E-in-C.O.	28.1.57	Titman, B. A. . . .	N.E. Reg.	15.10.56	Hudson, H. . . .	E-in-C.O.	25.1.57
Frost, A. C. . . .	E-in-C.O.	16.1.57	Stewart, H. . . .	Scot.	5.11.56	Howe, F. . . .	N.E. Reg. to E-in-C.O.	25.1.57
Mitchell, G. . . .	E-in-C.O.	24.1.57	Hill, W. . . .	N.W. Reg.	21.11.56	Macleod, D. A. . . .	E.T.E. to E-in-C.O.	8.1.57
Granger, S. H. . . .	E-in-C.O.	17.1.57	Gabriel, G. W. . . .	W.B.C.	31.12.56	Bowles, V. P. . . .	N.W. Reg.	3.1.57
Thomas, J. F. P. . . .	E-in-C.O.	16.1.57	Pride, G. V. . . .	H.C. Reg.	19.10.56	Couston, J. L. . . .	Scot.	18.2.57
Allery, G. D. . . .	E-in-C.O.	16.1.57	Ewers, D. . . .	H.C. Reg.	19.10.56	Dryburgh, G. . . .	Scot.	18.2.57
Hamer, R. . . .	E-in-C.O.	24.1.57	Anderson, B. J. . . .	H.C. Reg.	19.10.56	Mitchell, S. E. . . .	L.T. Reg.	7.1.57
Holden, R. . . .	E-in-C.O.	16.1.57	Hurst, I. . . .	Mid. Reg.	1.9.56	Wade, D. V. . . .	L.T. Reg.	15.1.57
Langton, H. J. . . .	E-in-C.O.	16.1.57	Pope, W. V. . . .	Mid. Reg.	22.5.56	Cottenden, A. L. . . .	L.T. Reg.	1.4.57
Cobbe, D. W. R. . . .	E-in-C.O.	24.1.57	Calder, H. . . .	N.W. Reg.	5.12.56	Manners, R. J. . . .	L.T. Reg.	1.12.56
Allnatt, J. W. . . .	E-in-C.O.	16.1.57	Brownbridge, C. H. . . .	N.W. Reg.	11.12.56	Porter, T. F. . . .	L.T. Reg.	5.11.56
Gerard, P. S. . . .	E-in-C.O.	16.1.57	Bale, E. M. . . .	W.B.C.	22.2.56	Wenell, J. L. . . .	L.T. Reg.	17.10.56
Young, S. G. . . .	E-in-C.O.	4.2.57	Latham, J. . . .	L.P. Reg.	30.5.56	Marchant, P. R. . . .	L.T. Reg.	13.10.56
May, C. A. M. . . .	E-in-C.O.	17.1.57	Poultney, C. C. M. . . .	Mid. Reg.	31.10.56	Witt, G. E. J. . . .	L.T. Reg.	1.1.57
Attwood, J. W. A. . . .	E-in-C.O. (tu absentia)	17.1.57	Hudson, H. . . .	L.T. Reg.	31.1.57	Ayres, G. F. . . .	L.T. Reg.	1.10.56
Axe, G. A. . . .	E-in-C.O.	17.1.57	Smith, A. E. . . .	L.T. Reg.	9.12.56	Hudson, S. W. . . .	L.T. Reg.	19.9.56
Kearsley-Brown, R. H. G. . . .	E-in-C.O.	1.2.57	Bloomer, B. H. . . .	Mid. Reg.	30.4.56	Harris, A. W. . . .	L.T. Reg.	25.1.56
Barnard, A. J. . . .	E-in-C.O.	1.2.57	<i>Tech. Offr. to Asst. Engr.</i>			Huggins, S. S. . . .	Scot.	1.2.57
Stevens, E. C. C. . . .	E-in-C.O.	12.2.57	Milton, W. J. . . .	L.T. Reg.	20.12.55	McNeill, H. . . .	Scot.	5.2.57
Gould, B. B. . . .	E-in-C.O.	28.2.57	Turner, H. . . .	Mid. Reg.	2.7.56	Wild, J. W. . . .	N.W. Reg.	11.2.57
Clinch, C. E. E. . . .	E-in-C.O.	20.3.57	McClean, R. J. . . .	W.B.C.	28.11.55	Stafford, A. . . .	N.W. Reg.	18.2.57
Cheetham, H. . . .	N.W. Reg.	20.3.57	Warner, G. J. . . .	Mid. Reg.	24.9.56	<i>Tech. Offr. to Inspector.</i>		
<i>Exec. Engr. (Limited Competition).</i>			Turner, J. S. . . .	Mid. Reg.	3.1.55	Goode, H. W. B. . . .	L. T. Reg.	1.8.56
Davey, D. V. . . .	E-in-C.O.	1.4.57	Jardine, R. . . .	Scot.	17.0.56	Brunton, N. . . .	N.E. Reg.	2.8.56
Bunday, D. C. . . .	E-in-C.O.	1.4.57	McColl, W. J. N. . . .	Scot.	28.8.56	Tweedie, T. W. . . .	Scot.	1.12.56
Munday, S. . . .	E-in-C.O.	1.4.57	Bartlett, V. M. . . .	L.T. Reg.	23.4.56	Hendry, A. K. . . .	Scot.	31.12.56
Harris, T. . . .	E-in-C.O.	1.4.57	Ling, P. D. . . .	L.T. Reg.	9.6.56	Selway, G. E. . . .	Scot.	19.1.57
Hall, W. F. J. . . .	H.C. Reg.	1.4.57	Cooles, S. A. . . .	L.T. Reg.	7.4.56	Forrest, E. . . .	Scot.	4.12.56
Gwilliam, P. G. A. . . .	L.T. Reg.	1.4.57	Kirkby, L. F. J. . . .	L.T. Reg.	9.6.56	<i>Tech. I. to Inspector.</i>		
Mills, G. L. . . .	E-in-C.O.	1.4.57	Aubertin, K. F. . . .	L.T. Reg.	10.10.56	Davidson, G. . . .	Scot.	23.10.56
Northall, B. V. . . .	E-in-C.O.	1.4.57	Appleby, C. J. . . .	L.T. Reg.	7.9.55	Staples, E. . . .	Mid. Reg.	3.9.56
Marsh, H. . . .	E-in-C.O.	1.4.57	Popkin, E. J. V. . . .	L.T. Reg.	27.2.56	Young, W. . . .	W.B.C.	23.2.56
Bates, S. . . .	Mid. Reg.	1.4.57	Witt, C. A. . . .	L.T. Reg.	28.1.50	Gutteridge, R. . . .	Mid. Reg.	23.7.56
Rouse, G. H. . . .	N.E. Reg.	1.4.57	O'Connor, C. J. . . .	L.T. Reg.	1.8.56	Pearce, H. N. . . .	Mid. Reg.	10.9.56
Rose, D. J. . . .	E-in-C.O.	1.4.57	Papworth, A. J. . . .	L.T. Reg.	25.8.56	Forshaw, C. E. . . .	N.W. Reg.	1.10.56
Woods, A. S. . . .	N.W. Reg.	1.4.57	Stewart, J. . . .	Scot.	22.10.56	Butler, H. E. . . .	S.W. Reg.	23.9.56
Woods, A. S. . . .	N.W. Reg.	1.4.57	Walton, D. J. . . .	E-in-C.O.	27.10.56	Allison, W. . . .	H.C. Reg.	12.9.56
Middleton, C. A. . . .	N.W. Reg.	1.4.57	Summers, W. H. H. . . .	E-in-C.O.	7.11.56	Pringle, C. . . .	H.C. Reg.	12.9.56
Little, J. D. . . .	S.W. Reg.	1.4.57	Dodds, J. W. . . .	N.E. Reg.	13.8.55	Hitchock, E. J. . . .	H.C. Reg.	12.9.56
<i>Asst. Engr. to Exec. Engr.</i>			Beaver, H. M. . . .	S.W. Reg.	7.1.56	Slater, S. R. R. . . .	N.E. Reg.	28.4.56
Brown, H. . . .	N.W. Reg. to E-in-C.O.	15.10.56	Samuel, G. A. . . .	H.C. Reg.	12.9.56	Plowman, H. . . .	N.E. Reg.	22.5.56
Reed, D. . . .	N.W. Reg. to E-in-C.O.	15.10.56	May, W. F. . . .	H.C. Reg.	12.9.56	Dudley, F. . . .	S.W. Reg.	17.9.56
Missen, L. A. . . .	E-in-C.O.	30.10.56	Roden, P. J. . . .	H.C. Reg.	12.9.56	Grantham, N. H. . . .	H.C. Reg.	19.10.56
Marsden, S. . . .	E-in-C.O.	12.10.56	Smith, G. O. . . .	H.C. Reg.	12.9.56	Hignett, F. . . .	H.C. Reg.	10.10.56
Harpley, C. . . .	E-in-C.O. to E.T.E.	12.10.56	Price, L. E. J. . . .	H.C. Reg.	12.9.56	Mowat, J. . . .	H.C. Reg.	19.10.56
Smith, N. D. . . .	E-in-C.O.	25.10.56	Fenn, R. W. . . .	H.C. Reg.	12.9.56	Bates, F. G. . . .	H.C. Reg.	19.10.56
Dibsdall, A. T. D. . . .	E-in-C.O.	25.10.56	Daines, N. W. . . .	H.C. Reg.	12.9.56	Hensey, E. H. . . .	H.C. Reg.	19.10.56
Sandy, R. H. J. . . .	E-in-C.O.	25.10.56	Claydon, W. C. J. . . .	H.C. Reg.	12.9.56	Granger, N. F. . . .	H.C. Reg.	19.10.56
Porter, R. W. R. . . .	Mid. Reg.	22.5.56	Goss, S. W. . . .	H.C. Reg.	12.9.56	Mears, F. J. . . .	H.C. Reg.	19.10.56
Smith, H. P. . . .	H.C. Reg. to W.B.C.	8.10.56	Hewell, C. T. . . .	H.C. Reg.	12.9.56	Badham, E. G. . . .	Mid. Reg.	11.6.56
Regan, D. J. . . .	W.B.C.	23.8.56	Cook, A. T. . . .	H.C. Reg.	12.9.56	Fountain, A. G. . . .	Mid. Reg.	17.9.56
Potts, F. . . .	Mid. Reg. to W.B.C.	8.10.56	Lipscombe, M. D. . . .	H.C. Reg.	12.9.56	Whittaker, J. E. . . .	N.W. Reg.	5.12.56
Cridlan, D. E. . . .	E-in-C.O.	5.11.56	Brazier, L. B. . . .	H.C. Reg.	12.9.56	Lewis, B. . . .	N.W. Reg.	5.12.56
Kynaston, J. A. C. . . .	W.B.C. to E-in-C.O.	19.11.56	Annall, A. . . .	N.E. Reg.	26.8.56	Hewson, T. . . .	N.W. Reg.	5.12.56
Shinn, E. . . .	H.C. Reg. to E-in-C.O.	19.11.56	Thompson, W. L. . . .	N.E. Reg.	18.1.55	Pimblott, F. . . .	N.W. Reg.	7.12.56
Sudell, R. A. . . .	E-in-C.O.	12.11.56	Meadows, A. . . .	N.E. Reg.	13.6.55	Challinor, T. F. . . .	N.W. Reg.	11.12.56
Dyer, L. J. . . .	L.T. Reg.	30.11.56	Costigan, T. . . .	N.E. Reg.	18.1.55	Russell, G. . . .	N.E. Reg.	11.10.56
George, J. H. . . .	E.T.E.	5.11.56	Sharp, P. . . .	N.E. Reg.	10.6.55	Percy, E. H. . . .	N.E. Reg.	23.1.56
Scott, W. L. . . .	E-in-C.O.	30.11.56	Little, S. . . .	N.E. Reg.	21.5.56	Lewthwaite, W. G. . . .	N.W. Reg.	9.1.57
Chapman, J. F. . . .	N.E. Reg.	25.10.56	Grimes, H. W. . . .	N.E. Reg.	9.12.55	Landon, G. O. . . .	N.W. Reg.	16.1.57
Slater, T. A. . . .	N.E. Reg.	1.11.56	Sadler, J. . . .	N.E. Reg.	4.4.56	O'Neill, K. . . .	N.W. Reg.	31.1.57
Stott, J. . . .	L.T. Reg. to E-in-C.O.	10.12.56	Bell, L. B. . . .	N.E. Reg.	18.4.56	May, C. T. H. . . .	L.T. Reg.	8.10.56
Adams, L. J. . . .	E-in-C.O.	10.12.56	Robson, J. . . .	N.E. Reg.	1.6.55	Taylor, C. J. . . .	L.T. Reg.	12.12.56
Buck, P. E. . . .	H.C. Reg.	14.12.56	Garnett, H. . . .	N.E. Reg.	1.5.55	Lucas, E. J. . . .	L.T. Reg.	17.12.56
Gray, J. A. . . .	E.T.E. to E-in-C.O.	31.12.56	Cook, F. . . .	N.E. Reg.	31.8.55	Carmichael, G. L. . . .	L.T. Reg.	2.12.56
Mills, L. R. N. . . .	E-in-C.O.	7.1.57	Hardaker, E. . . .	N.E. Reg.	26.10.56	Hill, G. H. . . .	L.T. Reg.	14.10.56
Powell, G. F. . . .	N.W. Reg.	10.12.56	Pearson, F. . . .	N.E. Reg.	21.10.56	Guy, E. W. . . .	L.T. Reg.	2.12.56
Blair, G. M. . . .	H.C. Reg. to E-in-C.O.	31.12.56	Tompkins, H. . . .	N.E. Reg.	5.12.55	Ross, W. . . .	L.T. Reg.	8.10.56
Rangecroft, W. . . .	H.C. Reg. to S.W. Reg.	21.1.57	Grimshaw, E. O. M. . . .	N.E. Reg.	10.6.55	Howard, B. S. . . .	L.T. Reg.	9.12.56
Webb, A. J. . . .	L.T. Reg. to E-in-C.O.	23.1.57	Sharpe, J. E. . . .	N.E. Reg.	24.11.55	Devereux, L. E. . . .	Mid. Reg.	22.6.56
Jewers, A. . . .	S.W. Reg.	3.12.56	Rhodes, F. B. . . .	N.E. Reg.	26.8.56	McGillivray, D. . . .	Scot.	4.2.57
Painter, C. H. . . .	Mid. Reg.	3.1.57	Cestello, W. J. . . .	N.E. Reg.	1.11.56	Heathcote, A. M. . . .	N.W. Reg.	6.2.57
Cadman, P. T. . . .	W.B.C.	18.1.57	Bumby, F. L. . . .	N.E. Reg.	20.9.55	<i>Explt. Offr. to Snr. Explt. Offr.</i>		
Warner, H. F. . . .	N.W. Reg.	1.2.57	Smith, F. . . .	E.T.E.	24.10.56	Frost, E. J. . . .	E-in-C.O.	20.11.56
Warwick, H. A. . . .	H.C. Reg.	15.2.57	Tranter, S. G. . . .	E.T.E.	24.10.56	<i>Asst. Engr. to Explt. Offr.</i>		
Blackburn, J. A. . . .	E-in-C.O.	15.2.57	Millard, D. J. . . .	W.B.C.	12.11.56	Lane, J. . . .	E-in-C.O.	5.11.56
Black, C. W. . . .	L.T. Reg. to E-in-C.O.	15.2.57	Ellis, R. W. . . .	N.E. Reg.	27.8.56	<i>Explt. Offr. (Open Competition).</i>		
<i>Asst. Engr. to Welfare Officer.</i>			Hiley, R. . . .	N.E. Reg.	20.8.56	Mackay, E. M. . . .	E-in-C.O.	28.1.57
Pilcher, C. J. F. . . .	L.T. Reg.	2.4.51	Hatton, D. A. . . .	E-in-C.O.	10.11.56	Keen, D. S. . . .	E-in-C.O.	28.1.57
McChesney, J. . . .	E-in-C.O.	12.3.51	Wackett, G. F. . . .	E-in-C.O.	1.12.56			
			Barnett, N. V. . . .	N.W. Reg. to E-in-C.O.	1.12.56			
			Colton, K. E. . . .	N.W. Reg.	21.11.56			
			Goodall, R. . . .	N.W. Reg.	21.11.56			
			Gallagher, H. E. . . .	N.I.	30.6.56			
			McAllister, C. P. . . .	N.I.	1.8.50			
			Harvey, J. . . .	N.I.	1.8.50			
			Marphy, T. . . .	N.I.	7.8.56			
			Woodthorpe, W. A. . . .	E-in-C.O.	13.12.56			
			Mitchell, D. H. . . .	E-in-C.O.	13.12.56			
			Cutmore, N. . . .	E-in-C.O.	13.12.56			

Promotions—continued.

Name	Region	Date	Name	Region	Date	Name	Region	Date
<i>Asst. (Sc.) (Open Competition).</i>			<i>Ldg. Dsman. to Snr. Dsman.</i>			<i>Mech.-in-Charge I to T.A. II.</i>		
Balsom, P. M.	E.-in-C.O.	8.2.57	Nichols, D. J.	H.C. Reg. to L.T. Reg.	1.11.50	Shiells, E. D.	Scot.	11.12.56
Cowell, C. H.	E.-in-C.O.	18.2.57	Taylor, E. D. E.	E.-in-C.O.	28.1.57	Potts, A.	N.E. Reg.	1.1.57
Cozens, P. A. (Miss)	E.-in-C.O.	18.2.57	<i>Dsman. to Ldg. Dsman.</i>			Miles, S. B.	E.-in-C.O. to N.E. Reg.	1.1.57
Hutchings, M. J.	E.-in-C.O.	18.2.57	Murray, M.	N.E. Reg.	1.10.50	Jarman, A. R.	W.B.C. to N.W. Reg.	1.1.57
Rohrer, B. R.	E.-in-C.O.	19.2.57	Purkis, A. D.	L.T. Reg.	17.10.50	Shipway, A. R.	H.C. Reg. to E.-in-C.O.	13.12.56
Marr, D.	E.-in-C.O.	19.2.57	Murphy, W. T.	N.E. Reg. to N.W. Reg.	12.11.50	<i>Mech.-in-Charge II to T.A. II.</i>		
Fairbrother, L. R.	E.-in-C.O.	19.2.57	Kilsby, S. A.	N.E. Reg. to N.W. Reg.	12.11.50	Yaxley, A. E.	H.C. Reg.	1.1.57
Murrell, D. L.	F.-in-C.O.	27.2.57	Batty, A.	N.E. Reg.	12.11.50	Phillips, E. A.	N.W. Reg.	1.1.57
Cameron, J. C.	E.-in-C.O.	4.3.57	Asby, J.	H.C. Reg.	31.12.50	<i>Snr. Mech. to T.A. II.</i>		
Parry, H. W.	E.-in-C.O.	8.3.57	Craig, G.	N.I. to H.C. Reg.	5.3.57	Edwards, W. T.	E.-in-C.O.	1.1.57
Mitchell, A. S.	E.-in-C.O.	27.3.57	Bradley, A. G.	N.E. Reg.	14.3.57	<i>Mech. A to T.A. II</i>		
<i>Snr. Draughtsman to Chief Dsman.</i>			Wilson, H.	Mid. Reg.	15.1.57	Smith, P. F.	E.-in-C.O.	1.1.57
White, R. G.	L. T. Reg.	1.11.50	<i>M.T.O. III (Open Competition).</i>					
			Shann, D. E. W.	E.-in-C.O.	17.9.50			
			Hidson, C.	E.-in-C.O.	15.10.56			

Retirements and Resignations

Name	Region	Date	Name	Region	Date	Name	Region	Date
<i>Asst. Staff Engr.</i>			<i>Asst. Engr.—continued.</i>					
Smith, P. E. C.	E-in-C.O.	23.1.57	Glanville, E. W. T.	E.T.E.	11.11.50	<i>Snr. Sc. Offr.</i>		
<i>Regional Engr.</i>			Kavanaugh, T. E. J.	L.T. Reg.	8.12.50	Walters, R. E. S.	E.-in-C.O.	3.1.57
Hodge, G. W.	W.B.C.	20.10.50	Leggett, B. G.	L.P. Reg.	19.12.50	<i>Exptl. Offr.</i>		
Millard, C. W.	Scot.	28.2.57	Wilson, W. C.	W.B.C.	22.12.50	Wild, N. H.	E.-in-C.O.	18.1.57
<i>Snr. Exec. Engr.</i>			Whitnall, E. J.	Mid. Reg.	31.12.50	<i>Asst. Exptl. Offr.</i>		
Corkett, H.	E-in-C.O.	30.11.56	Best, W. R.	L.T. Reg.	31.12.56	May, R. J.	E.-in-C.O.	31.12.56
Taylor, T. A.	E.-in-C.O.	22.10.56	Goodwin, H.	N.W. Reg.	31.12.50	<i>Asst. (Sc.)</i>		
<i>Exec. Engr.</i>			Davis, G. J. I.	W.B.C.	31.12.56	Laking, P. M. (Mrs.)	E.-in-C.O.	31.12.56
Kitching, J. K.	E.-in-C.O.	13.11.50	Penney, B. H.	E.-in-C.O.	29.12.56	(Resigned)		
Step, E. C.	E.-in-C.O.	30.11.56	Deal, P. C.	L.T. Reg.	14.1.57	Clifton, T. D.	E.-in-C.O.	31.1.57
Beaven, J. H.	L.T. Reg.	7.9.56	Bull, W. J.	L.T. Reg.	30.1.57	(Resigned)		
Davis, A. H.	L.T. Reg.	15.10.50	Rowland, V. G.	L.T. Reg.	30.1.57	MacDonald, J. M.	E.-in-C.O.	28.2.57
Linsell, W.	L.T. Reg.	16.10.50	Davidson, A. N. B.	Scot.	31.1.57	(Miss) (Resigned)		
Margetts, A. W.	Mid. Reg.	1.11.50	Brearley, H. H.	N.E. Reg.	6.2.57	<i>Snr. Dsman.</i>		
Cook, A. C.	Scot.	7.11.56	Marshall, B.	N.W. Reg.	31.1.57	Martin, T.	L.T. Reg.	31.10.50
Yewdall, H. P.	E.-in-C.O.	7.12.56	(Resigned)			<i>Ldg. Dsman.</i>		
McNaull, J.	E.-in-C.O.	26.12.56	Burrows, J. H.	L.T. Reg.	11.2.57	Godwin, T. H.	L.T. Reg.	31.10.56
Richards, P. F. A.	E.-in-C.O.	31.1.57	Brown, T. F. P.	L.T. Reg.	13.2.57	Sweeney, E. S.	Mid. Reg.	1.11.56
(Resigned)			Adams, K.	L.T. Reg.	16.2.57	Dunford, C. B.	N.E. Reg.	29.12.56
Madgwick, J. M.	N.E. Reg.	1.2.57	Johnston, T. D.	Scot.	19.2.57	Smith, G. H.	E.-in-C.O.	31.10.56
Dupere, T. R.	E.T.E.	4.1.57	Clucas, T.	N.W. Reg.	28.2.57	(Resigned)		
Dalton, A. W.	E.-in-C.O.	31.3.57	O'Hagan, V.	E.-in-C.O.	25.2.57	Judge, A. J.	H.C. Reg.	9.11.56
<i>Asst. Engr.</i>			Hutcherson, P.	L.P. Reg.	28.2.57	<i>Inspector.</i>		
Briscoe, H. R.	N.W. Reg.	22.8.56				Berrington, A.	N.W. Reg.	1.9.56
Jarvis, H. W.	H.C. Reg.	31.10.50				Marshall, A. S.	L.T. Reg.	4.10.56
Norman, E. N.	E.-in-C.O.	7.11.56				Cooper, C.	N.E. Reg.	10.10.50
Stacey, P. A.	L.T. Reg.	12.11.50				Thompson, A. J.	L.T. Reg.	13.10.56
Beaumont, J. W.	L.T. Reg.	30.11.56				Hill, T.	N.W. Reg.	14.10.50
Pannett, C.	L.T. Reg.	27.11.56				Roberts, F. J.	W.B.C.	23.10.56
						Sargeant, T.	Mid. Reg.	23.10.56
						Watkins, H. W.	Mid. Reg.	15.11.56
						Corke, W. G.	L.T. Reg.	1.12.56
						Beal, E. E.	H.C. Reg.	4.1.57
						Duddridge, A. S.	S.W. Reg.	6.1.57
						Williams, C.	L.T. Reg.	28.2.57

Transfers

Name	Region	Date	Name	Region	Date	Name	Region	Date
<i>Reg. Engr.</i>			<i>Exec. Engr.</i>			<i>Asst. Engr.—continued.</i>		
Blake, D. E.	S.W. Reg. to W.B.C.	10.12.50	Gill, J. S.	E.-in-C.O. to Admiralty	1.1.57	Britton, A. W.	S.W. Reg. to Nigeria	9.1.53
<i>Asst. Staff Engr. to Regional Engr.</i>			Kyme, R. C.	H.C. Reg. to Guernsey	1.1.57	Norman, R. H.	H.C. Reg. to Ceylon	
MacWhirter, R.	E.-in-C.O. to Scot.	1.3.57	Corby, P. D.	E.-in-C.O. to L.T. Reg.	3.1.57	(seconded)		1.12.56
<i>Snr. Exec. Engr.</i>			Baker, D.	Scot. to L.T. Reg.	7.1.57	Farmer, C. C.	E.-in-C.O. to N. Borneo	4.1.57
Roberts, W. G.	Secondment (Suez) to E.-in-C.O.	1.3.57	Baldwin, A. T. W.	E.-in-C.O. to L.T. Reg.	23.1.57	Parrott, C. E. B.	E.-in-C.O. to Sarawak	14.1.57
<i>Snr. Exec. Engr. to Area Engr.</i>			Ward, C. V.	E.-in-C.O. to H.C. Reg.	11.2.57	Hornsby, R. J.	L.T. Reg. to Mid. Reg.	14.1.57
Broadhurst, F.	Scot. to N.W. Reg.	17.12.50	Owen, E. A.	Scot. to H.C. Reg.	25.3.57	Taylor, R. G.	Mid. Reg. to L.T. Reg.	14.1.57
Arnold, C. W.	E.-in-C.O. to L.T. Reg.	31.12.56	Smith, C. E.	E.-in-C.O. to Brune	5.4.57	Bannerman, C. L.	E.-in-C.O. to Scot.	3.3.57
			<i>Asst. Engr.</i>			<i>Ldg. Dsman.</i>		
			Leclenby, G.	E.-in-C.O. to N.E. Reg.	1.11.57	Wilkins, J. W.	N.W. Reg. to Mid. Reg.	2.11.56
			Varley, L. J.	Mid. Reg. to Malaya	24.3.51			

Deaths

Name	Region	Date	Name	Region	Date	Name	Region	Date
<i>Chief Regional Engr.</i>			<i>Asst. Engr.—continued.</i>			<i>Inspector.</i>		
Morrill, A. E.	S.W. Reg.	22.1.57	Grinsell, A. H. J.	L.T. Reg.	12.10.56	Briggs, W. S.	N.W. Reg.	3.11.56
<i>Exec. Engr.</i>			Corkill, G. H.	N.W. Reg.	8.11.56	Yeates, J.	N.E. Reg.	20.11.56
Howard, J. K.	W.B.C.	8.1.57	Witherow, J.	Scot.	9.11.56	Marshman, S. P.	L.T. Reg.	1.12.56
			Eastwood, W.	N.E. Reg.	24.11.56			
			Chambers, C. R.	H.C. Reg.	14.2.57			
			Myers, A. J.	E.-in-C.O.	21.2.57			

Correction. In the April 1957 issue of the Journal, Mr. H. C. Davis was incorrectly shown as H. C. Davies in the list of promotions from Asst. Engr. to Exec. Engr.

INDEX TO ADVERTISERS

	PAGE
Adcola Products, Ltd.	xxx
Airmec, Ltd.	xl
Alton Battery Co., Ltd., The	ix
Austiniite, Ltd.	xv
Automatic Coil Winder & Electrical Equipment Co., Ltd.	xxiv
Automatic Telephone & Electric Co., Ltd.	xi
British Electric Resistance Co., Ltd., The	xxx
British Institute of Engineering Technology	xxxvii
British Insulated Callender's Cables, Ltd.	xviii
Brodie & Askham, Ltd.	iii
Cathodeon Crystals, Ltd.	xxiii
Dale (Electric) Yorkshire, Ltd.	xx
E.M.I. Institutes	ii
Ericsson Telephones, Ltd.	vii, viii
Ferranti, Ltd.	xvii
General Electric Co., Ltd., The	xiii, xiv, xxxv, xxxvi
Great Northern Telegraph Co., Ltd.	xxxix
Hallam, Sleigh & Cheston, Ltd.	x
Hivac, Ltd.	xxxiii
Hot Dip Galvanizers Association	xii
Marconi's Wireless Telegraph Co., Ltd.	xxvii, xxviii
Marconi Instruments	xxii
Mullard, Ltd.	iv, xix
National Salt Glazed Pipe Manufacturers' Association	xxxiv
Painton of Northampton	xvi
Pirelli-General Cable Works, Ltd.	xl
Pitman, Sir Isaac, & Sons, Ltd.	ii
Pye, Ltd.	vi
Rawplug Co., Ltd., The	xxi
Redifon, Ltd.	ii
Siemens, Edison Swan, Ltd.	xxv, xxvi
Smith, Frederick, & Co.	xxxvii
Standard Telephones & Cables, Ltd.	xxxix, xxxii, xli
Sullivan, H. W., Ltd.	xxxiii
Telephone Manufacturing Co., Ltd.	xvii, xxxix
Tungstone Products, Ltd.	xxxviii
Turner, Ernest	iii
Vactric (Control Equipment), Ltd.	v
Westinghouse Brake & Signal Co., Ltd.	xxxvii
Winn & Coales, Ltd.	xx



GENERATING EQUIPMENT
from 500w to 60 kW

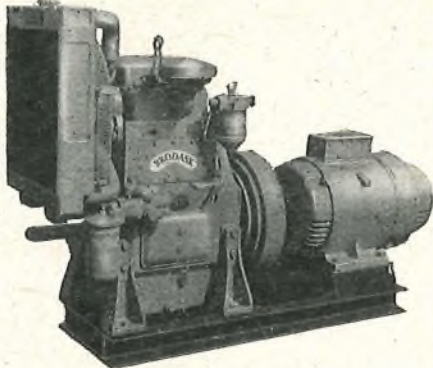

A Typical 12 kVA Set

FULLY AUTO — NON AUTO

BRODIE & ASKHAM LTD.,
330 KENNINGTON LANE,
LONDON, S.E.11

PHONE: RELiance 1844/5865 GRAMS: BRODASK, LONDON



The
DETECTOR No. 4 Mk. 10

—a TURNER instrument produced for Post Office engineers and combining a high level of sensitivity with accuracy and robust design for work in the field.

ERNEST TURNER ELECTRICAL INSTRUMENTS LTD.
HIGH WYCOMBE BUCKS ENGLAND

Telephone: HIGH WYCOMBE 1301-2-3

Telegrams: GORGEOUS, HIGH WYCOMBE

TRANSISTORISED

rural carrier telephone system

TRC-7

now being
used by
Overseas
Administrations

Increased traffic facilities over short haul routes are provided quickly and easily by the TRC-7. Full exploitation of transistors has resulted in a design with exceptional advantages. The TRC-7 is tropicalised and may be operated in ambient temperatures up to 50°C.

SEVEN EXTRA CHANNELS

A maximum of seven extra speech channels can be provided on an existing open wire pair. Channel units may be stacked and added as required. Channels may also be dropped at different points along the line.

LOW POWER CONSUMPTION

Junction transistors are used throughout, giving such an economy of power consumption that batteries may be used for subscribers' terminals where there is no mains supply. Each channel unit consumes only 0.4 watt.

PHYSICAL CIRCUIT UNAFFECTED

Operation of the TRC-7 does not interfere with the existing physical circuit. The system is suitable for lines with an attenuation of up to 30dB.

SIGNALLING FACILITIES

Signalling facilities are provided by a range of standard relay sets and include ring down, C.B. and simple auto.

SIMPLE INSTALLATION

The equipment is compact and easily transportable, and is especially suitable for the provision of temporary extra lines. It can be supplied for operation from A.C. mains or 24 or 48V station batteries.

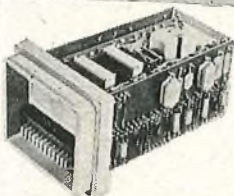

Each channel unit
is self-contained

Three-channel
terminal complete
with relay sets



Mullard Limited,
Equipment Division,
Mullard House,
Torrington Place,
London, W.C.1



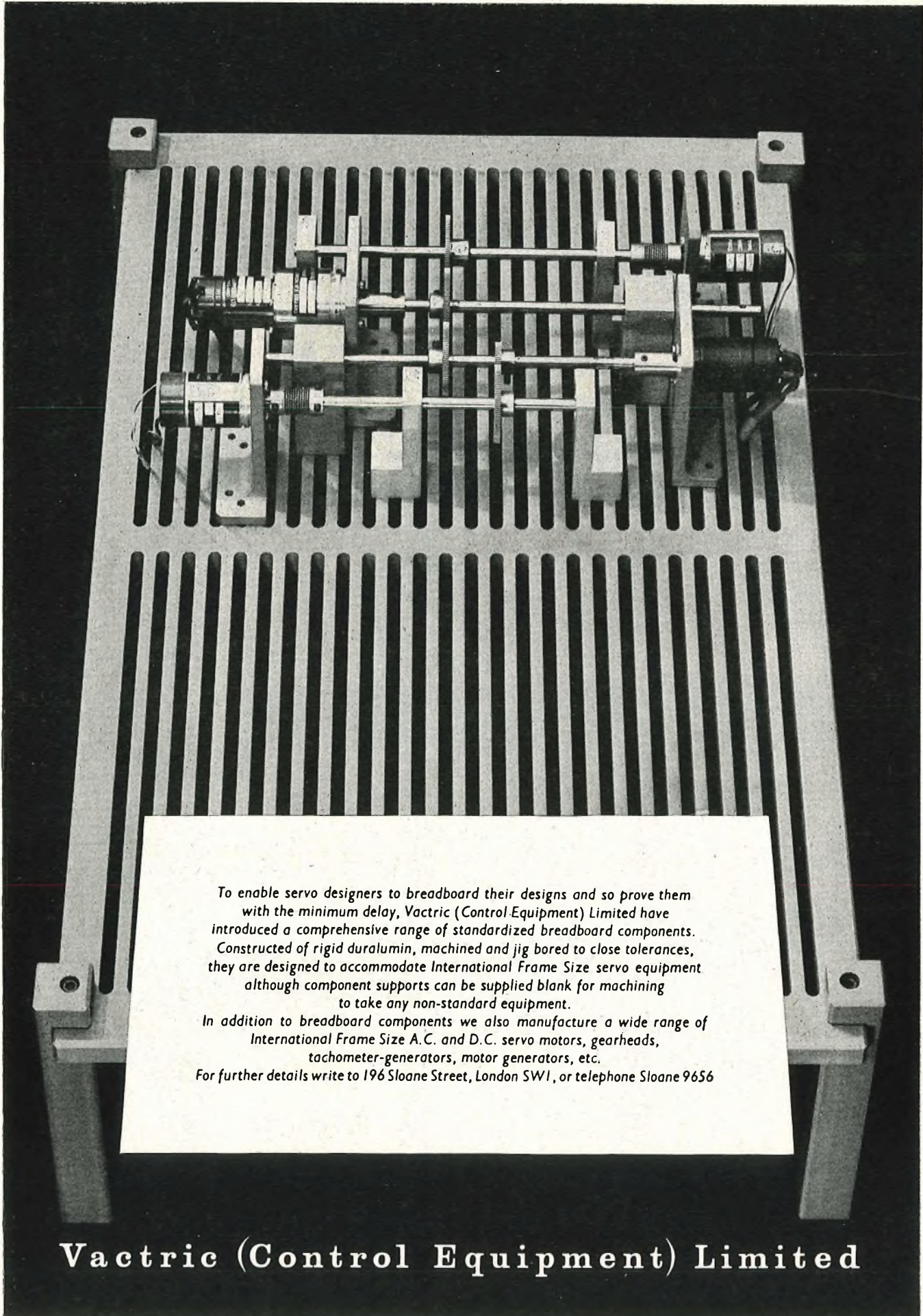

To enable servo designers to breadboard their designs and so prove them with the minimum delay, Vactric (Control Equipment) Limited have introduced a comprehensive range of standardized breadboard components. Constructed of rigid duralumin, machined and jig bored to close tolerances, they are designed to accommodate International Frame Size servo equipment although component supports can be supplied blank for machining to take any non-standard equipment.

In addition to breadboard components we also manufacture a wide range of International Frame Size A.C. and D.C. servo motors, gearheads, tachometer-generators, motor generators, etc.

For further details write to 196 Sloane Street, London SW1, or telephone Sloane 9656

Vactric (Control Equipment) Limited

world-wide approval

Pye Telecommunications Limited are now marketing the widest and most modern range of V.H.F. fixed and mobile radio-telephone equipment available in the world. This range of equipment has been designed to expand the application of Pye Radio-Telephones already in constant use in 77 different countries.

Pye Ranger V.H.F. equipment has now received approval from the British G.P.O. for Land, Marine and International Marine applications employing A.M. or F.M. systems, type approval from the Canadian D.O.T., and type acceptance of the F.C.C. of the United States of America.

No other Company holds so many approvals for this range of equipment, which now covers every conceivable requirement.

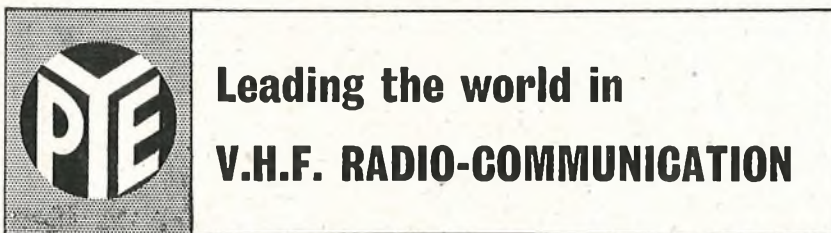

We can offer

FREQUENCY RANGE

All frequencies from 25 to 174 Mc/s

POWER RANGE

All powers up to 1 Kilowatt.

CHANNEL SPACING

All channel spacings including 20 and 25 kc/s in full production.

MODULATION

A.M. or F.M.

No matter what your V.H.F. requirements are, Pye Telecommunications Ltd., can fulfil them. Your enquiries are invited.

a new design



IN

TELECOMMUNICATIONS

**MODERN BUSINESS
DEMANDS MODERN
COMMUNICATIONS**



At every stage, in the design and production of these compact and elegant Cordless Switchboards, careful consideration has been given to the requirements of simple and positive operation.

The smooth lines and pleasing contours typify their efficiency, and make them a worthy addition to the wide range of modern Telephone Equipment manufactured by this Company.

Attractive colours and handsome styling will blend so well with the decor of modern offices and reception rooms, yet harmonize pleasantly with less contemporary surroundings.

The combination of dependability and low maintenance requirements, inherent in all Ericsson products, is clearly evident in these new switchboards, ensuring a service you will find hard to ignore.



The use of new components and materials has very considerably reduced the size of these modern Cordless Switchboards, making them particularly suitable for easy operation on table or desk. Their beauty will complement the most handsome office.

The styling and construction follows contemporary practice, having a 'drop on' cover with moulded ends and aluminium centres finished in an attractive mottle enamel. Components are mounted on a two-way hinged metal chassis and cast baseplate, providing trouble free operation and easy maintenance.

All inter-connections are made by keys with indicators providing positive supervision. Exchange line indicators are manually restored by depressing the transparent covers. In addition to the latest moulded hand-micro an auto dial is provided, mounted at the front of the key panel for automatic working. A hand generator at the right-hand side is used for calling extension telephones and a buzzer gives audible alarm when any indicator is actuated.

Two models are available at present :

2 Exch. Lines		3 Exch. Lines
4 Extn. Lines	or	9 Extn. Lines
3 Connecting ccts.		5 Connecting ccts.

The size of both switchboards is :—
13" × 13" × 8½".

With an alternative colour scheme :—
Grey-green, Brunswick green and Black.
Grey-green, Brunswick green and Biscuit.

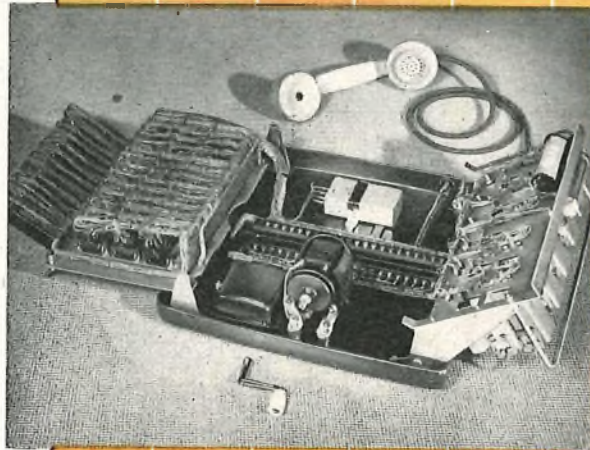
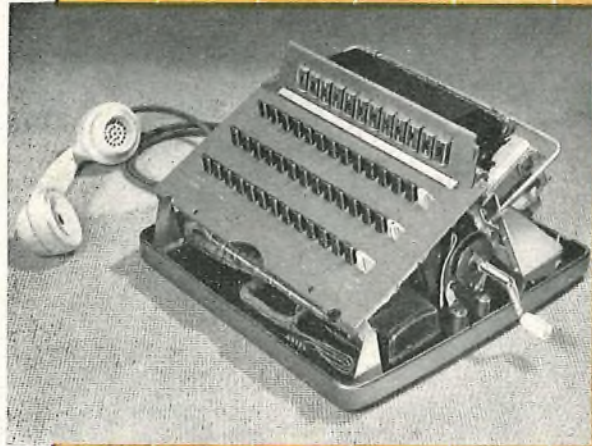

FULL PARTICULARS ARE AVAILABLE ON REQUEST

ERICSSON TELEPHONES LIMITED

HEAD OFFICE: 22 LINCOLNS INN FIELDS, LONDON, W.C.2. TEL: HOLBORN 6936
WORKS: BEESTON, NOTTINGHAM & SUNDERLAND



Now what on earth, you may ask, have bluebells to do with batteries? Well . . . if you were with us in Alton this evening it would be easier to explain. That grizzled character at the end of the bar—the one with ‘Prickly—handle with care’ written all over him. Hard to picture him knee-deep in bluebells and picking like billy-oh. But that is how his father saw him, under the beeches in Dogford wood, some distant Sunday in May. As surely as he himself saw his own son—that chap by the dartboard, the one with the light ale. Dogford wood is an Alton custom—as old as the Hampshire hills. Life, do you see, still has continuity down here. Continuity in birthplace and occupation. Continuity in manual skills and a man’s solid pride in them. Continuity, as the years have proved, in the workmanship that Alton men put into Alton batteries.

ALTON *Batteries of Merit*

Alton stationary batteries: 10 to 15,000 ah. Also in regular production, renewal plates for all makes of battery, British and Continental.

THE ALTON BATTERY COMPANY LIMITED, ALTON, HANTS · Telephone: ALTON 2267 and 2268 · Telegrams: BATTERY, ALTON

A27

**Additional
Capacity
for YOU**



Our new and additional factory of over 30,000 square feet is now in full operation in Birmingham, for the manufacture of Cabinets and Consoles.

The modern and extensive plant produces the finest quality Cabinets by all standard methods, including argon-arc-welded light alloy assemblies and Steel Cabinets. In addition, of course, individual Cabinets in the famous Widney Dorlec construction are made. This new factory supplements those already established in Birmingham and Maidenhead and offers an unrivalled manufacturing service in the metalwork sphere.

Widney Dorlec

ELECTRONIC ENCLOSURES • MOUNTINGS



HALLAM, SLEIGH & CHESTON LTD., WIDNEY WORKS • BIRMINGHAM 4 • ENGLAND

PHONE: ASTON CROSS 0914. GRAMS: SUPERFINE, BIRMINGHAM

SALES OFFICE: OLDFIELD ROAD • MAIDENHEAD • BERKS. PHONE: MAIDENHEAD 4311

WD 13a

STROWGER

*and the pattern
of world
telecommunications*



No Strowger exchange has ever had to be replaced because it was out of date—the system's characteristics of simplicity, flexibility and adaptability are fundamental. Some Strowger exchanges have been operating continuously for more than 25 years. Progressively, as new inventions have been developed, these exchanges have incorporated whichever were necessary to enable them to provide modern automatic service.

In the world's rapid development of telecommunications techniques, only a system of proved flexibility can adapt itself to the changing conditions. Strowger is such a system.

*Strowger—designed and built
for continuous service*



AUTOMATIC TELEPHONE & ELECTRIC
CO. LTD · LONDON AND LIVERPOOL

HOT GALVANIZING PREVENTS RUST

ASK ANY ENGINEER ABOUT RUST—he knows its dangers on electrical installations. He also knows that hot galvanizing is the surest means of preventing rust—galvanized pylons for instance have enjoyed rust-free life for 20 years or more. In fact, wherever steel is used . . . in factories and mines, on railways and farms . . . there is no substitute for hot galvanizing. The tenacity and durability of *hot* galvanizing ensure lasting protection with minimum maintenance.

Protection in Depth

Hot galvanizing gives defence in depth. The firmly alloyed zinc keeps out rust—tightly sealing crevices and seams. And if the coating *does* get damaged the steel still won't be attacked because the zinc protects it sacrificially. Hot galvanizing *saves* steel—by eliminating the need for large corrosion allowances and the replacement of rusted parts. Hot galvanizing resists normal atmospheric conditions *twenty times better than steel.*

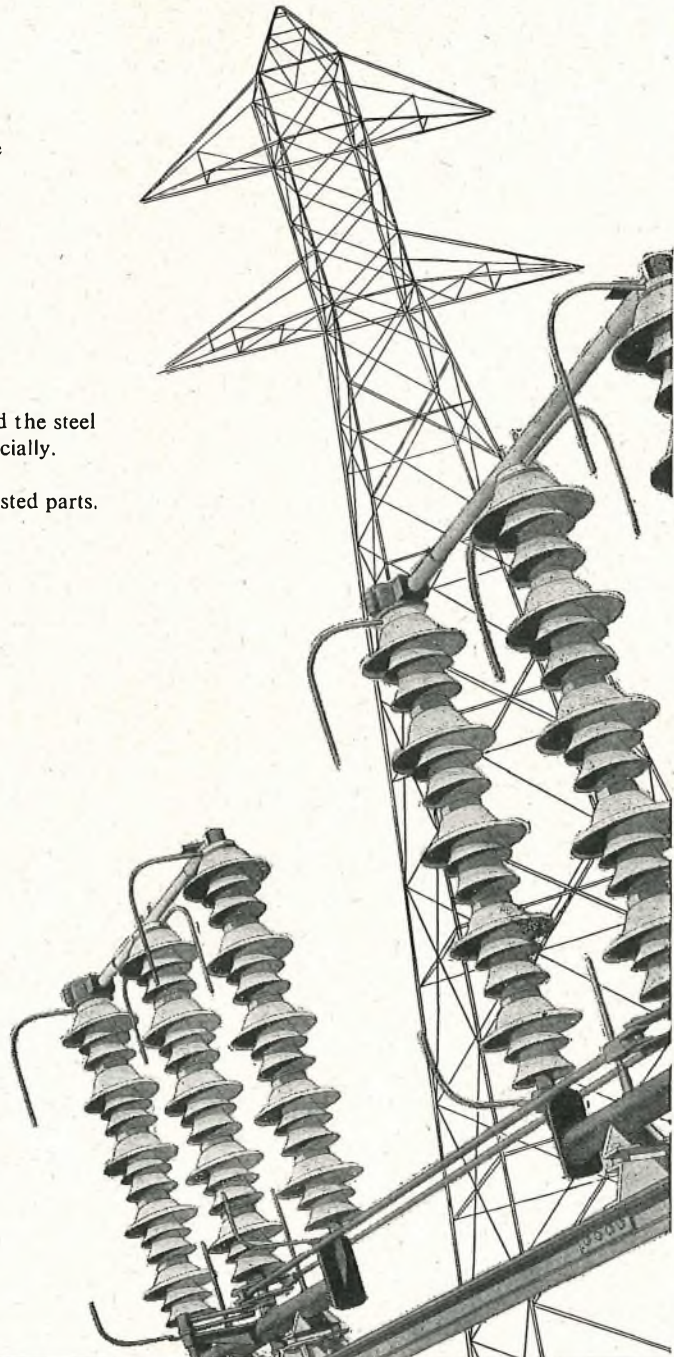
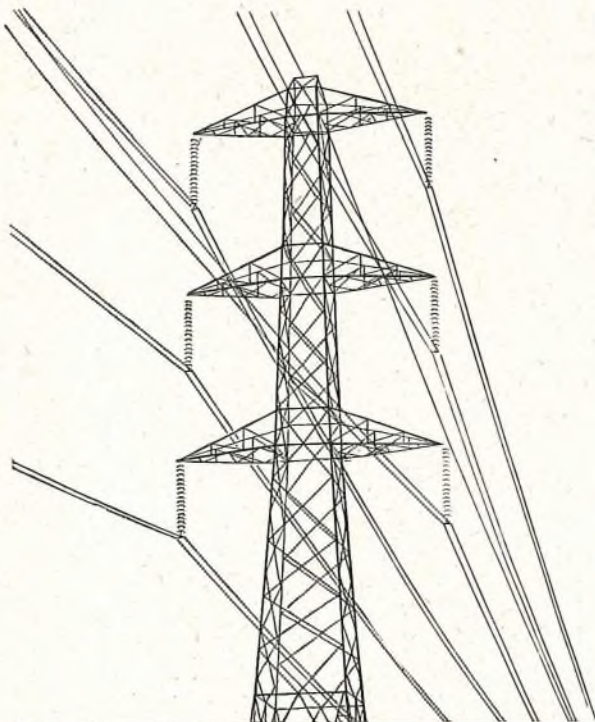

Hot Dip Galvanizers Association

*The Hot Dip Galvanizers Association,
a non-trading body, welcomes enquiries.
Write to 34 Berkeley Square,
London, W.1
Tel. Grosvenor 6636*



Member of the Zinc Development Association



TRANSMISSION EXTREMELY

RURAL CARRIER TELEPHONE EQUIPMENT FOR OPEN-WIRE LINE

This reliable equipment provides up to ten high-quality speech circuits for junction or subscriber working in rural areas. Channels can be assembled on either a stackable or a group basis; when arranged as a stackable system one or more circuits can be terminated at each intermediate point along a route.

VOICE-FREQUENCY TELEGRAPH EQUIPMENT

This provides up to twenty-four duplex telegraph channels operating at a modulation rate of 50 bauds over any 4-wire circuit capable of transmitting within the frequency band 300 c/s to 3,400 c/s, whether metallic, or carrier over cable, open wire, or radio link. Frequency-shift modulation, rather than amplitude modulation, makes the system less susceptible to interference and results in less distortion for corresponding variations in signal level. Operation is on a 21-volt d.c. supply.

THE USE OF TRANSISTORS IN BOTH THESE EQUIPMENTS GIVES:

Extremely low power consumption
Small physical size
Negligible heat dissipation

Everything for telecommunications by open-wire line, cable, and radio, single and multi-circuit, and TV link; short, medium and long haul. Automatic and manual exchanges; telephone instruments and apparatus.

COMMUNICATION EQUIPMENT

COMPACT & ECONOMICAL

★ Capable of operation in locations where mains supplies are unreliable or non-existent. Will work on the same pole pair as a single-circuit or three-circuit system, and on the same pole route as another rural-carrier system, a three-circuit system, or a twelve-circuit system.

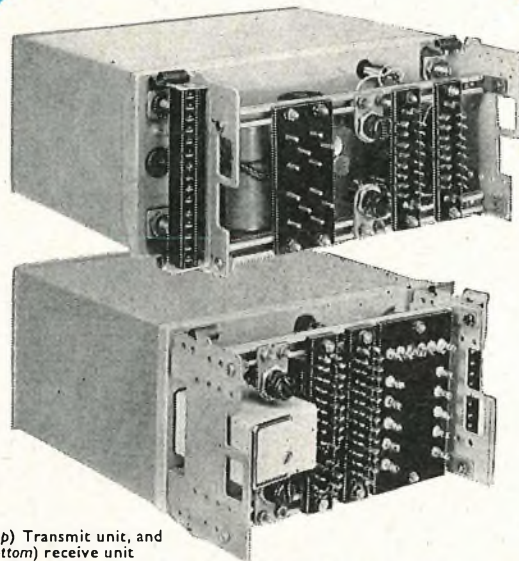

(Top) Transmit unit, and
(Bottom) receive unit

★ Complete terminal for 24 duplex channels can be mounted on a single-sided rack 9 ft. high. The d.c. extensions are normally arranged for double-current telegraph working, but may readily be converted to single-current working. In addition, adaptor relay equipment can be supplied to meet other telegraph signalling conditions.

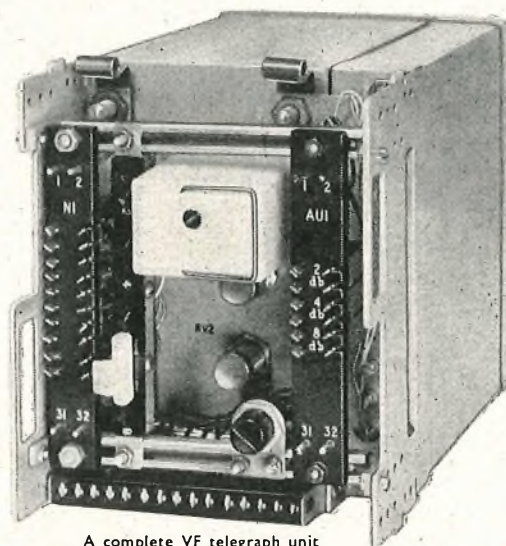

A complete VF telegraph unit
including transmitter and receiver

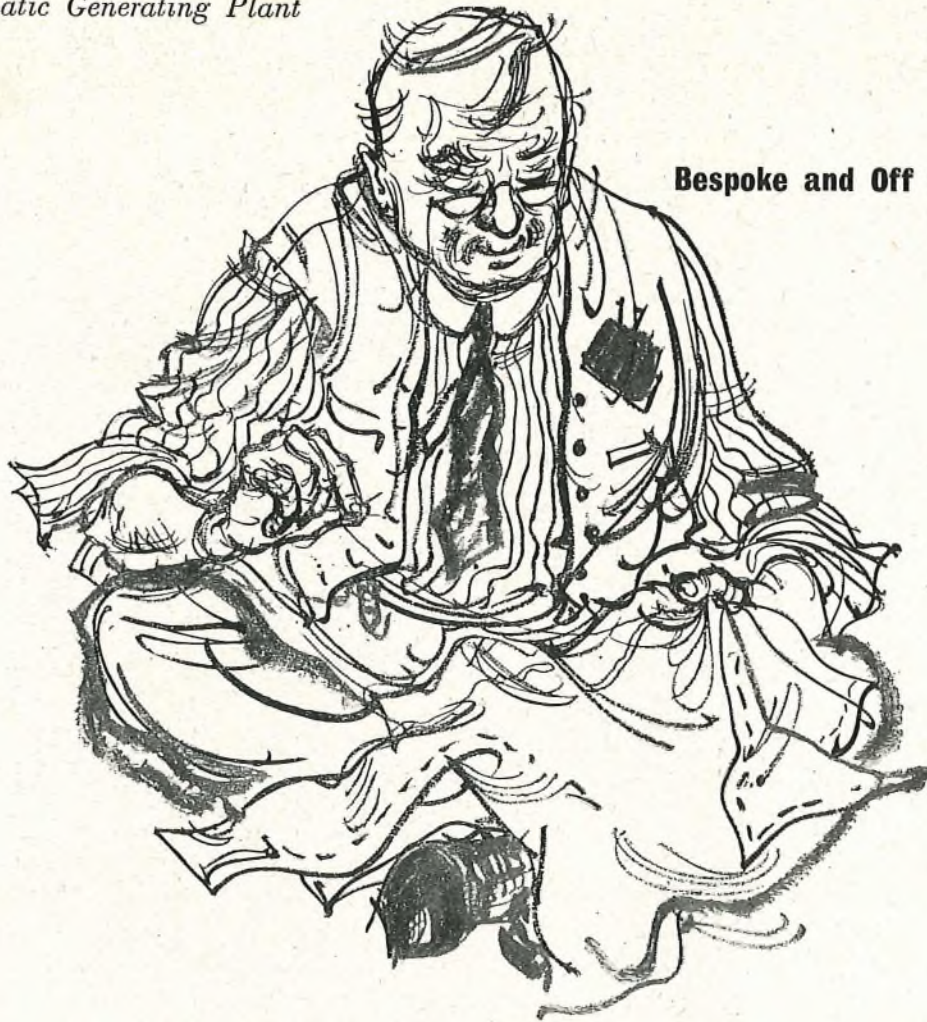

Bespoke and Off the Peg

We can supply, economically, standard types of automatically controlled generating plant that fit many of those jobs in which reliability and continuity of supply are essentials. But our *forte* is tailor-made equipment. Sizes? 1.4 to 250 kVA. Quality? Savile Row. We like the problems other people can't fit. The more difficult they are the better we like them. We are, in short, selling experience and brains as much as generating plant. Austinlite stands for an unbroken flow of power, not some rigid pattern of generator and diesel engine on a base. Where this utter reliability of the power supply is an essential our engineers are prepared to go anywhere in the World to discuss the best means of providing it. And our erecting teams will follow them to get the plant running.

Austinlite **AUTOMATIC GENERATING PLANT**
Tailor-made by STONE-CHANCE LTD.



By Appointment to the Professional Engineer

HIGH STABILITY CARBON RESISTORS

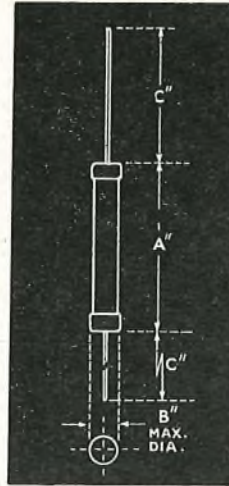
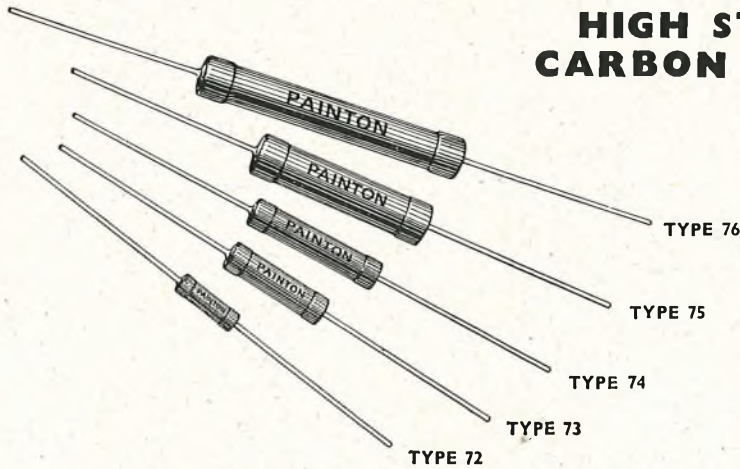

ELECTRICAL CHARACTERISTICS

The electrical characteristic of a High Stability Carbon Resistor depends upon the physical size of the units and upon the ohmic value. All the data given below relates to the Type 73 Resistor. To obtain the equivalent ohmic values to which the Information is applicable in the other four sizes of Resistor the following factors should be applied:

Type 72 x 1/2 Type 74 x 2 Type 75 x 4 Type 76 x 8

FULL LOAD STABILITY

Up to 100 K.ohms the resistance change at full load with an ambient temperature of 70°C. is less than 0.75% (average 0.25%) after 1,000 hours operation. At 1 Megohm the change is less than 1% (average 0.75%).

N.B. On D.C. loading the maximum voltages stated in RCL 112 should be observed.

AGEING AND SHELF DRIFT.

Up to 100 K.ohms the average change is 0.25% in 12 months (never greater than 0.75%). For 1 Megohm resistors the average change is 0.6% in 12 months (never greater than 1.25%).

CLIMATIC

Exposure to the two cycles of H.I. humidity as laid down in RCL 112 shows a change of less than 0.7% (average 0.4%) up to 100 K.ohms. At 1 Megohm the change is less than 1% (average 0.7%).

TROPICAL EXPOSURE

Eighty-four days exposure to the standard 25°C./35°C. 100% humidity cycling shows a change of less than 1% (average 0.5%) up to 100 K.ohms. At 1 Megohm the change is less than 2% (average 1.6%).

TEMPERATURE COEFFICIENT

The temperature coefficient is less than 0.04%/°C. up to 100 K.ohms. At 1 Megohm the coefficient is approximately 0.055%/°C.

NOISE

Noise which is generated in a resistor, as the result of a direct voltage applied across it, varies according to the ohmic value of the resistor, the noise decreasing as the ohmic value increases. The noise is also influenced by factors such as the size of the resistor.

For noise which falls within frequency range of 0 to 10 Kc./sec. the Painton high stability resistors have noise levels which are between 0.05 and 0.4 microvolts of noise per applied direct volt, when the resistor is dissipating power at its maximum wattage rating.

VOLTAGE COEFFICIENT

Not exceeding 0.002% per volt D.C.

DERATING FOR AMBIENT TEMPERATURES EXCEEDING 70°C.

WATTAGE RATING/AMBIENT TEMPERATURE GRAPH (FROM RCL 112, ISSUE 2)

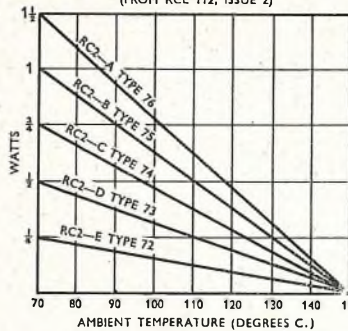

COMMERCIAL DERATING CURVE

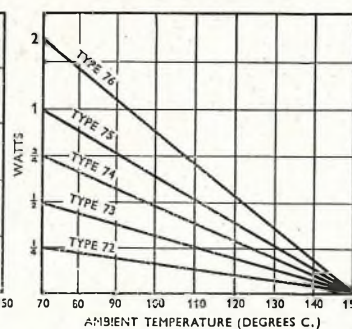

TYPE	RESISTANCE RANGE (ohms)	VALUES OUTSIDE THIS RANGE MAY BE QUOTED FOR SEPARATELY.				
		72	73	74	75	76
72	±1% 4—700K	±2% 4—1.0M	±5% 4—2.5M			
73	±1% 4—1.0M	±2% 4—2.0M	±5% 4—5.0M			
74	±1% 20—2.0M	±2% 20—4.0M	±5% 20—10.0M			
75	±1% 20—3.0M	±2% 20—5.0M	±5% 20—10.0M			
76	±1% 20—5.5M	±2% 20—9.0M	±5% 20—50.0M			
TYPE		72	73	74	75	76
Normal Commercial Rating 70°C—watts		1/2	1/2	1/2	1	2
R.C.S.C. style		RC2-E	RC2-D	RC2-C	RC2-B	RC2-A
R.C.S.C. Rating at 70°C—watts		1/2	1/2	1/2	1	1 1/2
R.C.S.C. Rating at 100°C—watts		1/2	1/2	1/2	1/2	1/2
DIMENSIONS IN INCHES	A	1/2	1/2	1/2	1/2	2/16
	B	1/8	1/8	1/8	1/8	1/8
	C	1 1/2	1 1/2	1 1/2	1 1/2	1 1/2

PAINTON
Northampton England

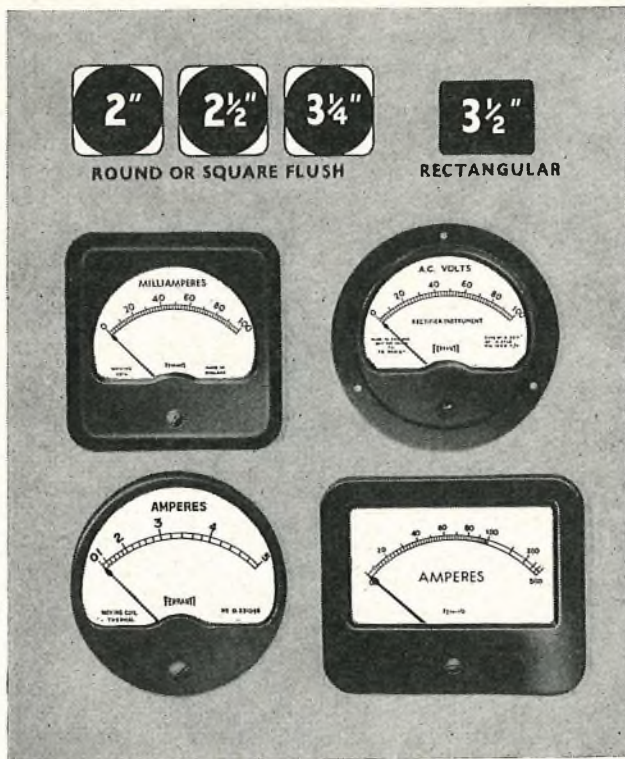

Ferranti Panel Instruments

Ferranti Panel Instruments are supplied in a wide variety of types and sizes. Moving coil, rectifier, moving iron, thermal and electrostatic. 2", 2½", 3¼" and 3½" dial. Round, square and rectangular. Catalogues supplied on request.

There are large stocks of standard models of 2½" round or square flush instruments. Please write for a stock list.



FERRANTI LTD. · MOSTON · MANCHESTER 10

London Office:
KERN HOUSE · 36 KINGSWAY · W.C.2.

F1166

If you are interested
in **CAPACITORS**
to

TELECOMMUNICATIONS STANDARDS

TMC offer you **RELIABILITY** +

BRITISH POST OFFICE TYPES

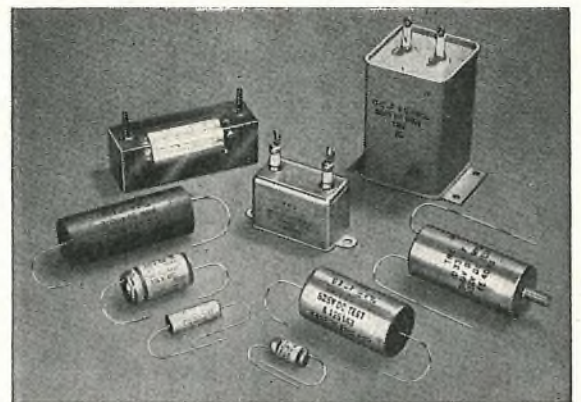
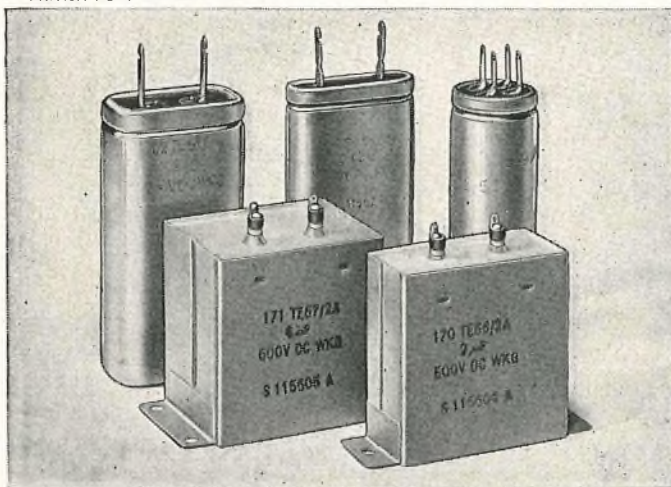

POLYSTYRENE CAPACITORS

TMC POLYSTYRENE CAPACITORS offer the circuit engineer an insulation 50 times greater than Mica with comparable stability plus an attractive price advantage.

If you have a capacitor problem we can provide the answer from extensive ranges including MICA, METALLIZED PAPER and PRECISION PAPER types.

Write to

Component Sales Division

TELEPHONE MANUFACTURING CO. LTD.

CRAY WORKS · ST. MARY CRAY · ORPINGTON · KENT

Telephone: ORPINGTON 26611

A

BICC

development

P.T.F.E.

(POLYTETRAFLUOROETHYLENE)

EQUIPMENT WIRES

FOR OPERATION UP TO 240°C

*Unaffected by fuels
oils and solvents*

Flexible

*Thin radial
coverings*

*Complying with
M.O.S. requirements*

*Coloured for easy
identification*

Non-inflammable

Further information on BICC
P.T.F.E. Equipment Wires is con-
tained in Publication No. 384, available
on request.

BRITISH INSULATED CALLENDER'S CABLES LIMITED, 21 BLOOMSBURY STREET, LONDON, W.C.1

THESE HIGH Q COILS

are now even easier to install

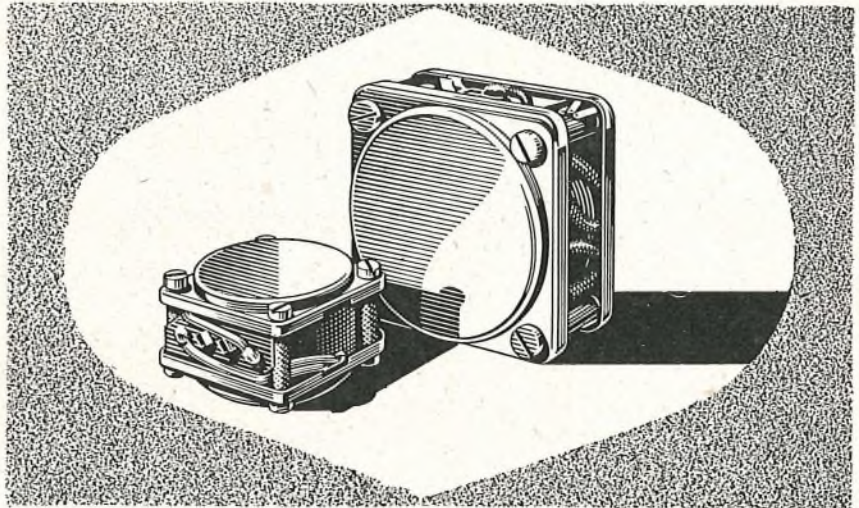

Designers of communications equipment, will welcome the new mounting and terminating arrangements of the Mullard 25mm and 36mm pot cores.

Unique design features that make installation easier than ever, include positions for tag boards on three sides and a new system of fixing, which eliminates the need for additional mounting plates.

Combining constructional advantages with sound technical performance, these 25mm and 36mm pot cores take full advantage of the low loss of Ferroxcube to produce inductances of up to 30 henries, together with high Q values over a wide frequency range. As an additional service these pot cores can be supplied wound to individual specifications, if required.

Write now for full details of the comprehensive range of Mullard pot cores currently available.

Outstanding features

- * Controllable air gap, facilitating inductance adjustment
- * Self screening
- * Controllable temperature coefficient
- * Operation over a wide frequency range
- * Ease of winding, and assembly

Mullard



'Ticonal' permanent magnets
Magnadur ceramic magnets
Ferroxcube magnetic cores

MULLARD LTD., COMPONENT DIVISION, MULLARD HOUSE, TORRINGTON PLACE, W.C.1

MC 257A

They did it this way -
-in 1900!



Photograph by courtesy of British Insulated Callender's Cables Ltd.

It's 1957 - time to get the...

ROLL-A-DRUM

SUPPORTS CABLE DRUMS
WITHOUT JACKS

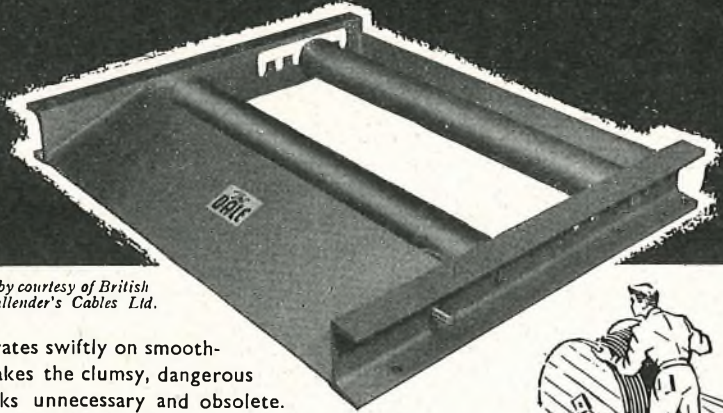

The Roll-A-Drum operates swiftly on smooth-running rollers from ground level. It makes the clumsy, dangerous old method of hoisting cable drums on jacks unnecessary and obsolete.

Only £11. 10s. or £23 according to size. Details of discounts and full information from:



ELECTRIC (YORKSHIRE) LIMITED

ELECTRICITY BUILDINGS FILEY, YORKS.

Tel: 2301 (3 lines)



cable to CANADA...

The latest development in modern telecommunications: the new Transatlantic Telephone Cable. The part played by DENSO in this gigantic enterprise, while not visually spectacular, was vitally important: the protection of cable joints on the British side and of steel channelling on the cable route in Newfoundland.

We are proud and happy to have been members of a highly successful team.

DENSO Anti-Corrosion Products

May we help with that corrosion problem?

WINN & COALES LTD

Denso House, Chapel Road,
London, S.E.27

Telephone: GIPsy Hill 4247 (PBX)

Telegrams: Denselte, Westnor, London



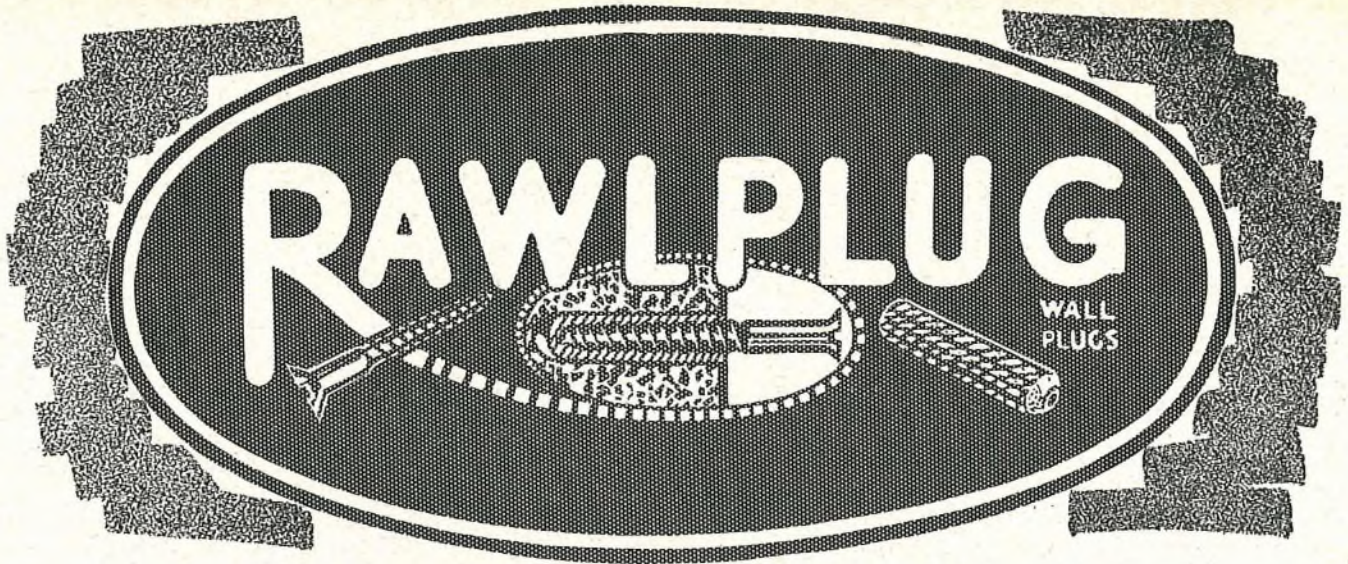

THE NAME THAT CARRIES THE WEIGHT

Over the years the name Rawlplug has become internationally synonymous with efficient fixing in every kind of material. Rawlplug Fixing Devices and Tools provide firm, safe fixings in far less time than by any other method. If you have a fixing problem, please write to our Technical Service Department for free advice.

RAWLPLUGS • RAWLTOOLS • RAWLBOLTS • RAWLTAMPS • RAWLNUTS • BOLT ANCHORS • SCREW ANCHORS • WHITE BRONZE PLUGS • RAWLTOGGLES
RAWLCLIPS • CEMENT IN SOCKETS • DURIMUM DRILLS AND HOLE BORING TOOLS FOR HAND, ELECTRIC HAMMER OR PNEUMATIC HAMMER OPERATION

**"A CREDIT TO
THE MAKERS OF
DURIUM DRILLS"**

BEFORE USE

AFTER 6/700 HOLES

Here is one of the many unsolicited testimonials showing the amazing performance of Durium Tipped Drills, the fastest cutting masonry drills ever made. Correctly used, Durium Drills are unique for reliability, speed and long life.

Descriptive folder gladly sent on request.

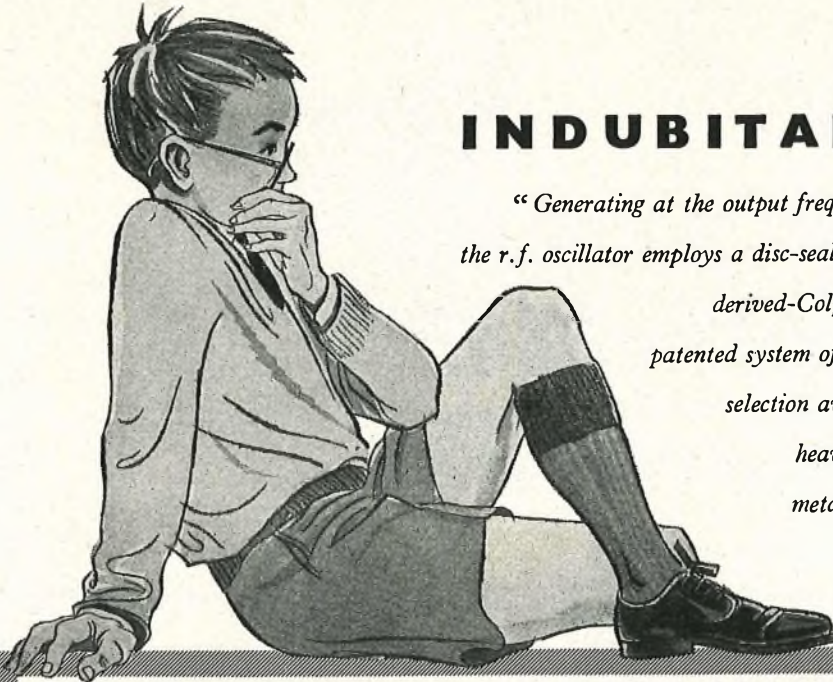

INDUBITABLY . . .

“Generating at the output frequency without multipliers, the r.f. oscillator employs a disc-seal triode in a shunt-fed derived-Colpitts circuit in which the Marconi-patented system of contactless waveband selection avoids the necessity for passing heavy r.f. circulating currents through metal-to-metal contacts”.

OUR young friend may ponder the problem of which Marconi instrument is being described but many well-informed electronic engineers will have realised already that the subject under discussion is the Marconi TF 1066 FM/AM Signal Generator—an instrument notable for its stability, its unique incremental tuning system and the complete absence of spurious sub-multiples in its output.

You didn't know Marconi Instruments made such a signal generator? Write out one hundred times “The Marconi TF 1066 is an outstanding instrument capable of the broadest application”—or better still, write to us for full details.

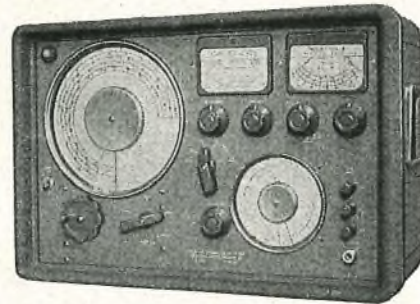

FM/AM SIGNAL GENERATOR
Type TF 1066

10 to 470 Mc/s. Output: 0.2 μ V to 200 mV at 50 ohms. Internal 400-c/s modulation: f.m., variable up to 100 kc/s deviation; a.m. variable up to at least 40% depth. External modulation: 30 c/s to 15 kc/s. Incremental tuning: \pm 100 kc/s max. with direct calibration valid at all carrier frequencies. An exceptionally versatile general-purpose instrument and, in particular, a high-quality f.m. generator.



AM & FM SIGNAL GENERATORS · AUDIO & VIDEO OSCILLATORS
FREQUENCY METERS · VOLTMETERS · POWER METERS
DISTORTION METERS · FIELD STRENGTH METERS
TRANSMISSION MONITORS · DEVIATION METERS
OSCILLOSCOPES, SPECTRUM & RESPONSE ANALYSERS
Q METERS & BRIDGES

MARCONI INSTRUMENTS LTD · ST. ALBANS · HERTFORDSHIRE · TELEPHONE: ST. ALBANS 56161

London and the South: Marconi House, Strand, London, W.C.2. Tel: COVent Garden 1234

Midlands: Marconi House, 24 The Parade, Leamington Spa. Tel: 1408

North: 30 Albion Street, Kingston-upon-Hull. Tel: Hull Central 16347

WORLD-WIDE REPRESENTATION

TC103

New!



The

CATHODEON CUB

CRYSTAL UNIT

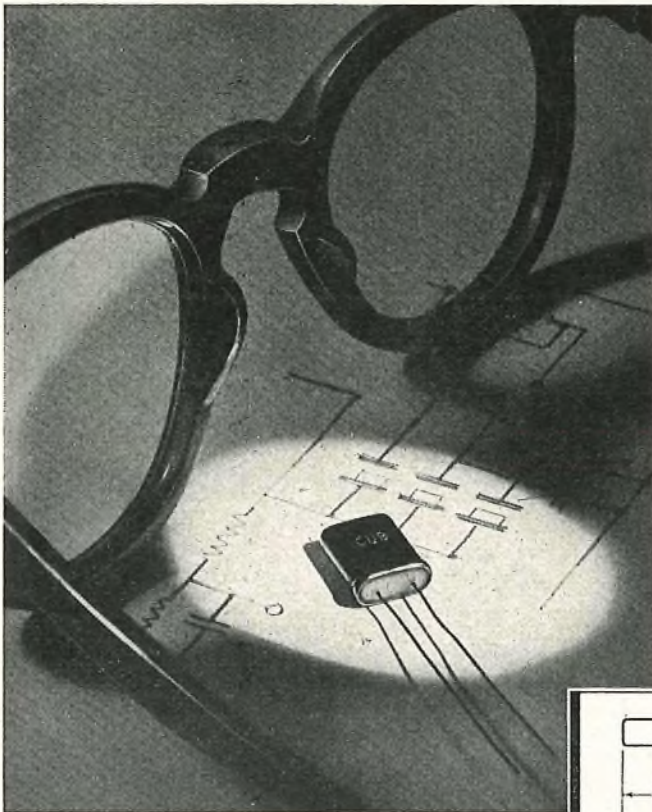

Might in miniature

- Precision frequency control from 5.0 Mc/s to 60.0 Mc/s.
- Above average frequency stability without oven control.
- Wide operating temperature range.
- Direct soldering to printed circuits or selector switches.
- Ideal size for packaged and transistorised circuits.
- Specially suitable for frequency synthesising as used in the latest transmitter-receivers.
- Fundamental 5 to 20 Mc/s
3rd Overtone 20 to 60 Mc/s.
- Frequency tolerance $\pm 0.005\%$ -55°C. to $+105^{\circ}\text{C.}$
- 2MM holder equivalent to R.C.S.C. Style J and American type HC-18/U.

ACTUAL SIZE

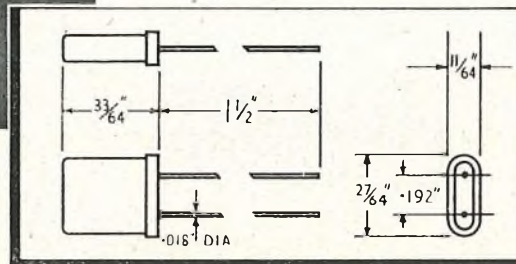

CATHODEON CRYSTALS LIMITED

LINTON CAMBRIDGESHIRE

TELEPHONE LINTON 223



WIRE
Cutting
AND
STRIPPING

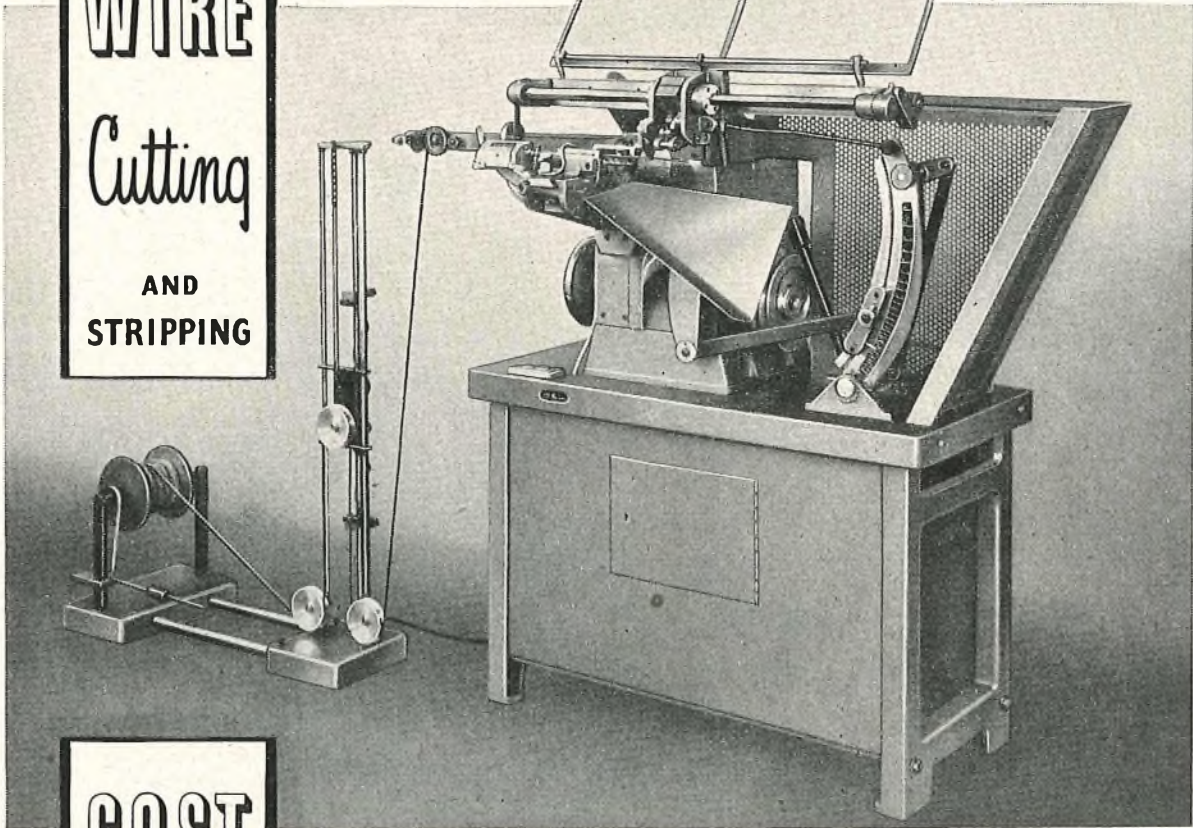

COST
Cutting
TIME
SAVING

Fuller information will be supplied on application, and samples of the types of wire to be handled should be included with the enquiry.

We commend these machines with confidence in the valuable contribution they make to today's need for increased production, precision and economy. Wires with all types of covering are measured, cut to the required length, and stripped at one or both ends.

Two types of machine are available:—
Type DA.53, which will cut any length from 1.2" to 14.5" with stripping lengths from 0.15" to 1.5" depending on the length of lead, and Type DA.53V which will cut pieces from 1.2" to 96" in length with the same stripping lengths.

Both machines will cut up to 14.5" long at the rate of 3,000 per hour, whilst the rate of cutting on the latter machine for longer pieces is naturally decreased.

The machines can be quickly and easily set for any length of wire, and the change over of tools for differing types is simple and rapid. The insulation of the conductor is in no way impaired or damaged.

AVO, LTD.
Formerly THE AUTOMATIC COIL WINDER & ELECTRICAL EQUIPMENT CO., LTD.
AVOCET HOUSE • 92-96 VAUXHALL BRIDGE ROAD • LONDON • S.W.1.
Victoria 3404 (9 lines)

SIEMENS EDISWAN introduce

the first printed



SIEMENS EDISON SWAN LTD

An AEI Company

Woolwich, London, S.E.18, England



THE CENTENARY NEOPHONE

A quality instrument at an economical price, especially suitable for use overseas.

circuit telephone



This entirely new instrument, a product of the designers of the world-famous "Neophone" which established new standards in telephone performance and appearance in the nineteen-thirties, incorporates the following attractive features —



Improved performance, using latest design of components.

Lower first cost, achieved by the most modern manufacturing methods.

Lower maintenance cost.

Suitably finished for tropical use. Sealed case keeps out dust and insects.

Reduced size and weight — handset weight halved — only 7 ounces.

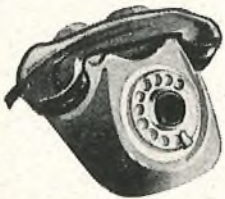

21 COLOUR COMBINATIONS

7 different handset shades and a choice of 3 case colours. The case can be changed WITHOUT DISTURBING THE DIAL SWITCH.

The **centenary NEOPHONE**



THE NEW INSTRUMENT WITH NEW FEATURES

Complete technical details are available on request.



MARCONI



SURVEYED



PLANNED

LONG-DISTANCE ISB TELEPHONY SYSTEMS

The development of telephony systems using ISB technique has been pioneered by Marconi's. By improving the utilisation of the radio frequency spectrum and achieving much better performance over individual circuits Marconi's have greatly extended the availability of telephone services on international circuits operating on H.F.

As with other types of communications systems, Marconi's can offer unrivalled facilities and experience to those contemplating ISB telephony. From the initial technical consultations to the maintenance of the system in service and the training of the staff to operate it, Marconi's alone can undertake the whole project.

COMPLETE COMMUNICATION SYSTEMS — *all the world over*



INSTALLED

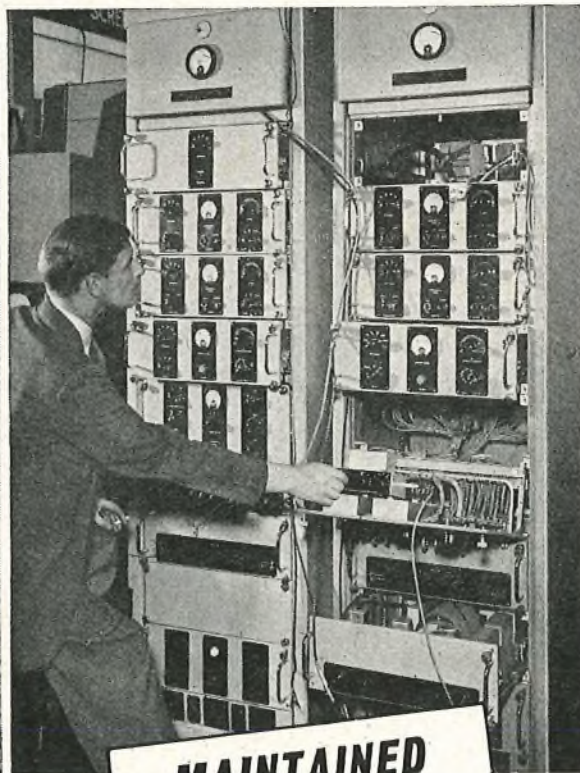

MAINTAINED

MARCONI'S & A.T.E. Co-operation between Marconi's and Automatic Telephone and Electric Co. Ltd., now brings together an unrivalled wealth of knowledge and experience for the benefit of all whose work lies in the field of telecommunications.

The Lifeline of Communication is in experienced hands



MARCONI

Complete Communication Systems

MARCONI'S WIRELESS TELEGRAPH COMPANY LIMITED, CHELMSFORD, ESSEX

LC 16



CONVERTERS

MODEL 2201

FOR CONVERSION OF MORSE CODE OR CABLE CODE PERFORATED TAPE TO 5-UNIT SIGNALS OR 5-UNIT PERFORATED TAPE AT TELEPRINTER SPEED

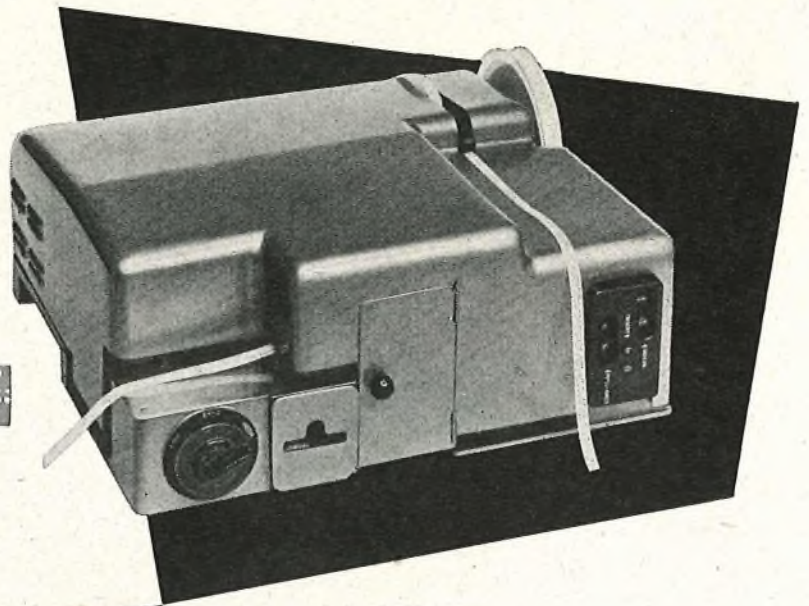
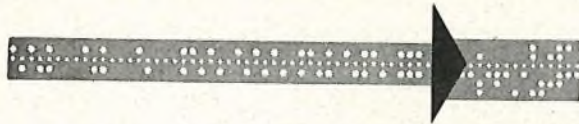

DIMENSIONS: 23" x 21" x 10"

MODEL 2206

FOR CONVERSION OF 5-UNIT PERFORATED TAPE TO MORSE CODE OR CABLE CODE PERFORATED TAPE, AT THE RATE OF 650 CHARACTERS PER MINUTE

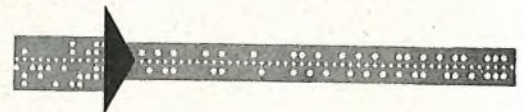
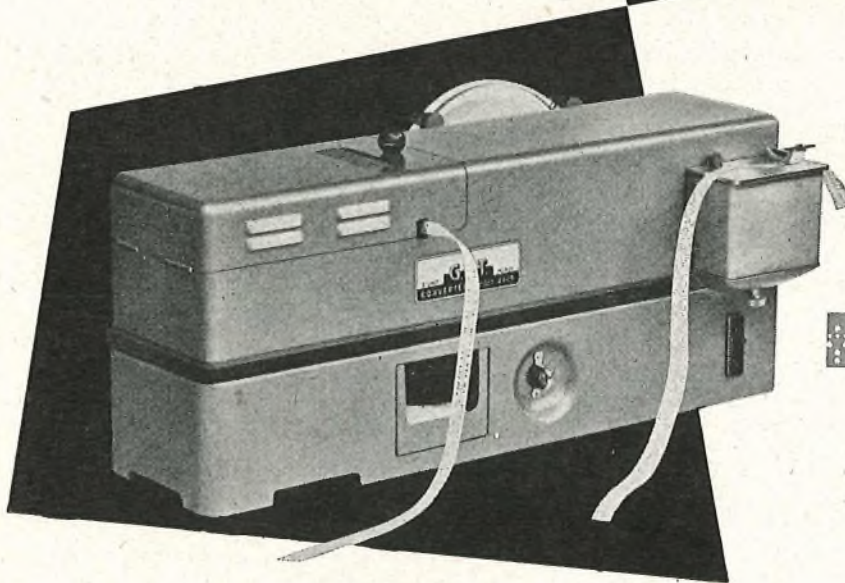

DIMENSIONS: 26" x 12" x 12"

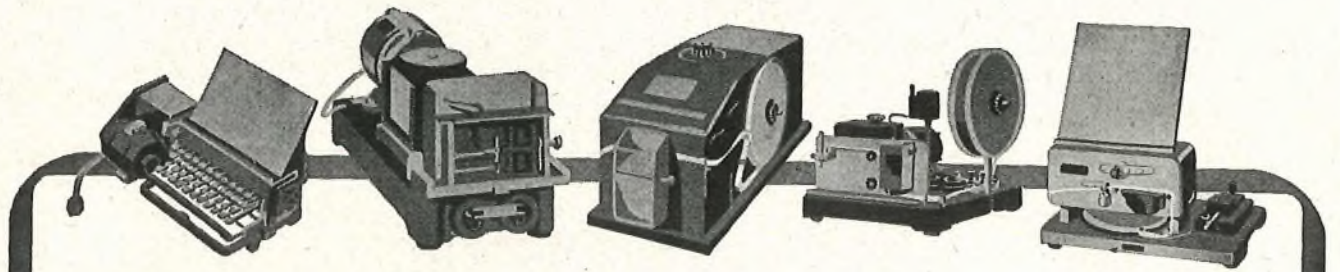

GREAT NORTHERN TELEGRAPH WORKS

DIVISION OF THE GREAT NORTHERN TELEGRAPH CO. LTD.

4, SYDHAVNS PLADS
COPENHAGEN SV, DENMARK

LONDON OFFICE: 5, ST. HELEN'S PLACE
LONDON E. C. 3.

ADCOLA

PRODUCTS LIMITED
(Regd. Trade Mark)

FOR
**SOLDERING INSTRUMENTS
and EQUIPMENT**

SUPPLIED FOR ALL VOLTAGES

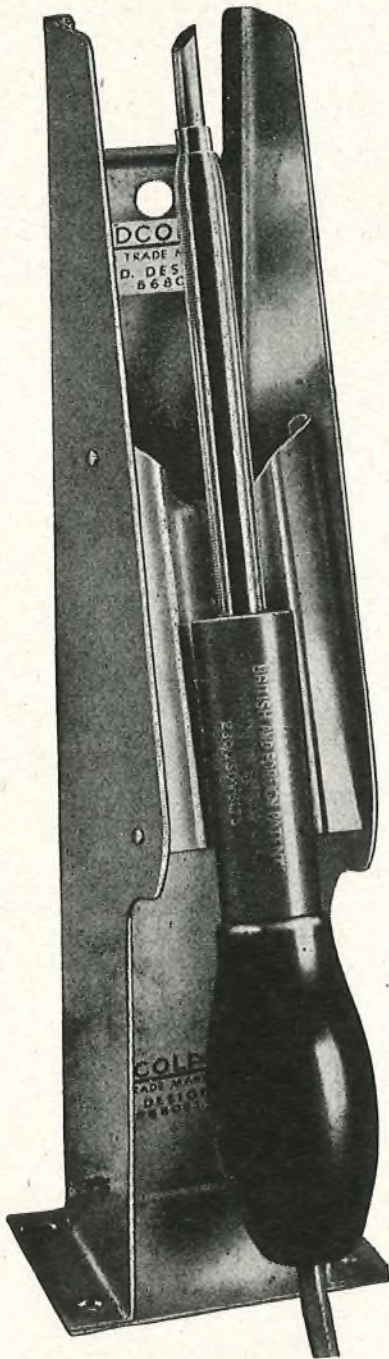

illustrated

**DETACHABLE
BIT
MODEL $\frac{3}{16}$ "**

List 64

**PROTECTIVE
SHIELD**

List 68

.....Write for Catalogues.....
HEAD OFFICE, SERVICE AND SALES
ADCOLA PRODUCTS LTD.
GAUDEN ROAD, CLAPHAM HIGH STREET, LONDON, S.W.4
Phone: MACaulay 3101, 4272

16 features prove Bercostat * strongest, most compact rheostat for precise current control

Bercostats are at work down coalmines . . . in the Viscount and Britannia . . . wherever designers want a sturdy, compact unit for accurate control of volts and amps. We will gladly advise on your own uses and give quick delivery. Study the features below, and you'll agree the Bercostat proves BERCO know how!

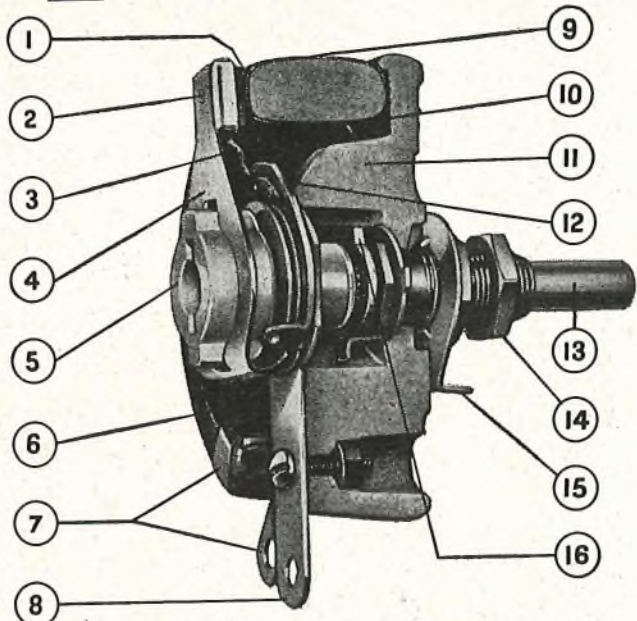

* Bercostat toroidal-wound power rheostats, now in 8 sizes. Ask for Lists 613A and 613C.

- | | |
|--|---|
| 1 Silver graphite brush contact. | 9 Winding embedded in vitreous enamel. |
| 2 Balance point for self-aligning brush. | 10 Vitreous enamel bond between former and base. |
| 3 Pigtail shunting brush arm. | 11 All ceramic construction withstands 5000v. flash test. |
| 4 Nickel silver brush arm. | 12 Non-grooving return contact plate. |
| 5 Glazed porcelain brush arm insulator. | 13 Stainless steel spindle. |
| 6 Winding welded to terminal band. | 14 Electro-tinned mounting assembly. |
| 7 End contact band and terminal. | 15 Panel locating washer. |
| 8 Brush terminal. | 16 Special stop feature. |

Berco pioneered toroidal-wound power rheostats . . .

BERCO KNOW HOW

THE BRITISH ELECTRIC RESISTANCE CO., LTD.,

in association with

THE BRITISH POWER TRANSFORMER CO., LTD.,
QUEENSWAY · ENFIELD MIDDLESEX

Telephone: HOWard 2411 · Telegrams: Vitrohm, Enfield

BR 1381

S.T.C.

Leader OF TRANS.

**PIONEERED
THE PAST**

First as the Western Electric Company

- 1884** The installation of the FIRST multiple switchboard in England.
- 1914** Installed the FIRST multiplex printing telegraph system in Great Britain between London and Manchester.
- 1922** Supplied the FIRST 3-channel telephone (plus 6 channel telegraph) system to British railway companies.
- 1923** Installed the FIRST British-made thermionic valve type repeater.

Then after 1925 when the Company became Standard Telephones and Cables Limited

- 1926** Supplied the FIRST 3 channel open-wire carrier telephone system installed in the Union of South Africa, between Johannesburg and Durban.
- 1930** FIRST public demonstration of "Micro-ray" communication.
- 1932** FIRST multi-channel V.F. telegraph cable system in the world installed between London and Dundee.
- 1934** FIRST commercial "Micro-ray" link across the English Channel.
- 1935** FIRST 12-channel cable carrier system supplied to the British Post Office.
- 1935** Developed and supplied the FIRST coaxial cable in Europe.
- 1936** FIRST coaxial cable terminal equipment supplied to the British Post Office.
- 1946** Introduced the entirely new construction transmission equipment practice with plug-in panels known as 'N.E.P.'
- 1950** FIRST major submerged repeater telephone system installed in Europe between the Netherlands and Denmark.
- 1950** FIRST television pictures conveyed across the channel by *Standard* portable S.H.F. equipment.



Standard Telephones and Cables Limited

rs in design

MISSION EQUIPMENT

**LEADS THE
PRESENT**

- 1952** First 4 Mc/s coaxial telephone system in Europe.
- 1952** FIRST mainline microwave television system employing travelling wave amplifiers installed between Manchester and Kirk-O-Shotts.
- 1954** Developed the latest equipment practice using shelf constructions and its associated new, compact, plug-in units for channelling, carrier supplies and line amplifiers, etc.
- 1955** Developed the FIRST main-line microwave telephone system providing 6 independent radio channels each handling 600 telephone circuits.
- 1956** A transistorised telegraph regenerative repeater equipment.
- 1956** Supplied submarine repeaters for the Newfoundland-Nova Scotia section of the TRANSATLANTIC CABLE SYSTEM.
- 1956** Supplied terminal, channelling, and power feeding equipment in Canada, Newfoundland and Scotland for the TRANSATLANTIC CABLE SYSTEM.

the latest *Standard* systems include:

- A transistorised 12-channel 2-wire carrier-on-cable telephone system.
- A transistorised 3-channel open-wire carrier telephone system.
- A transistorised 10-channel rural carrier system.
- A 12 Mc/s coaxial system handling up to 2700 high quality telephone circuits or 960 telephone circuits and a television channel for a 625-, 525- or 405-line picture.
- A small-core coaxial cable telephone system for 240 channels employing transistorised repeaters.
- A 7000 Mc/s portable radio outside-broadcast system.
- A transistorised 24-channel voice-frequency telegraph system.

CONNAUGHT HOUSE • ALDWYCH • LONDON W.C.2

IMPROVEMENT IN THE ACCURACY OF DECADE RESISTANCES

We have pleasure to announce that the well-known and novel

SULLIVAN and GRIFFITHS

DUAL DIAL DECADE RESISTANCE BOXES

FOR ALL FREQUENCIES

Moreover, the windings are now of Manganin in order to reduce the temperature coefficient; more important still, to improve the long period of stability and make them as suitable for all direct-current purposes as they are for alternating currents of all frequencies.

Screened Resistances of guaranteed accuracy exactly similar to our well-known Decade Resistances but specially arranged so that one box of a given number of dials gives many different values of maximum resistance. Thus a three-dial box (as illustrated) may be used for instance for

three decades of Thousands, Hundreds and Tens	a total of 10,000 ohms.
or three decades of Hundreds, Tens and Units	a total of 1,000 ohms.
or three decades of Tens, Units and Tenths	a total of 100 ohms.
or three decades of Units, Tenths and Hundredths	a total of 10 ohms.

have now been improved in accuracy to

0.05 PER CENT

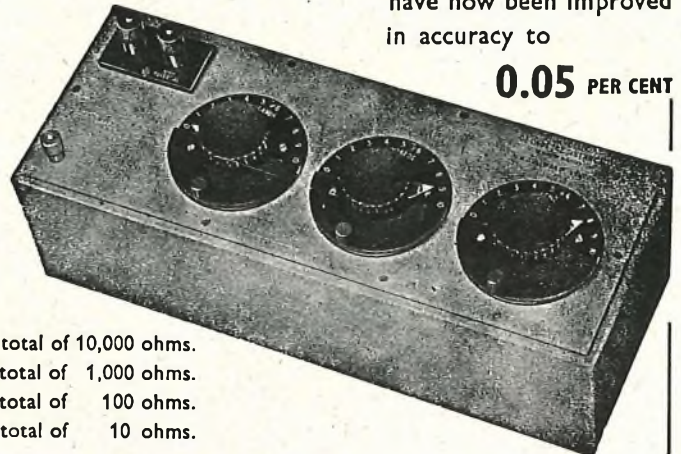

H. W. SULLIVAN
LIMITED

LONDON, S.E.15

Telephone: New Cross 3225 (P.B.X.)

The advantages of such a system will be obvious, for in addition to the economy involved much space is saved and the residual resistance and inductance is much reduced.

The resistances are available in 3-dial, 4-dial and 5-dial types with subdivision of 0.001% down to 0.001 ohm if necessary, depending of course on the number of dials incorporated.

You can count on

Hivac Cold Cathode Tubes

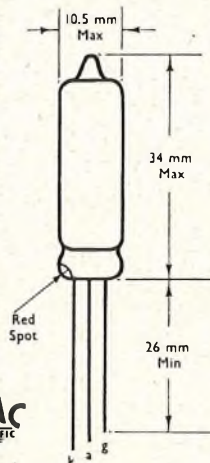

HIVAC
THE SCIENTIFIC
VALVE

Cold Cathode Triode XC18

The XC18 is a wire-ended subminiature cold cathode triode. It is an electrically reliable and mechanically robust tube of superior quality.

Minimum main gap breakdown voltage	210V
Maintaining voltage	73V ± 5
Trigger strike voltage	68V ± 6
Maximum continuous cathode current	1mA
Maximum pulsed cathode current	5mA
<i>(Assuming a maximum duty cycle of 1 : 5)</i>	

Our Technical Service Department will be pleased to supply further information and assist in any problems arising from the use of Hivac tubes.

Hivac Limited

A member of the Automatic
Telephone & Electric Group

STONEFIELD WAY

SOUTH RUISLIP

MIDDLESEX

Ruislip 3366

011

Legendary! Fabulary!

"Those pipes!" said Baron Rabbit. "Surely they are vitrified clay conduits?"

"They have been down here even longer than the museum," said the curator. "They are strong and very smooth. The surface people run electric cables through them."

"And in that way, the cables can be installed,

serviced and replaced with ease. Vitrified clay conduits save a lot of money. Acids in the soil cannot harm them — they almost last for ever."

"Salt glazed vitrified clay conduits are legendary," sighed the curator.

"Salt glazed vitrified clay pipes are fabulary!" agreed the Baron.

Put down Salt Glazed Vitrified Clay Pipes and Conduits—they stay down for centuries!

NATIONAL SALT GLAZED PIPE MANUFACTURERS' ASSOCIATION

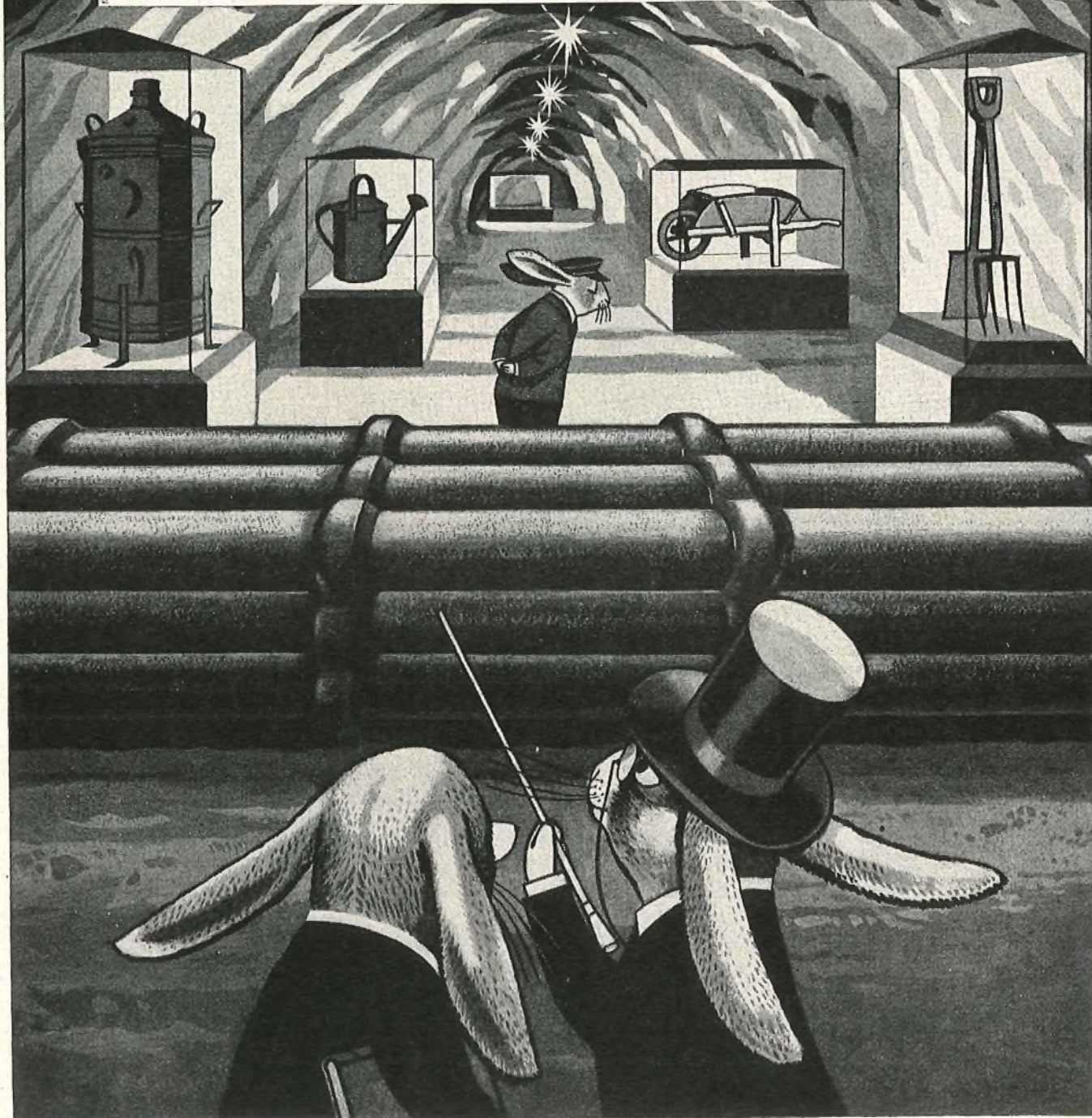

G.E.C.

TELEPHONE

— equally

New physical design



New standard of performance

THE G.E.C. 1000 TELEPHONE

Allows the length of local lines to be increased by about 70% for a similar performance. Despite the higher output, the maximum amount of sidetone suppression has been retained. In addition to the normal black instrument, a range of two-tone telephones can be supplied.

SE 50 SELECTOR

The heart of the modern Strowger automatic telephone exchange, this selector is outstanding for its universal application and ease of maintenance.

Highly efficient magnetic circuits

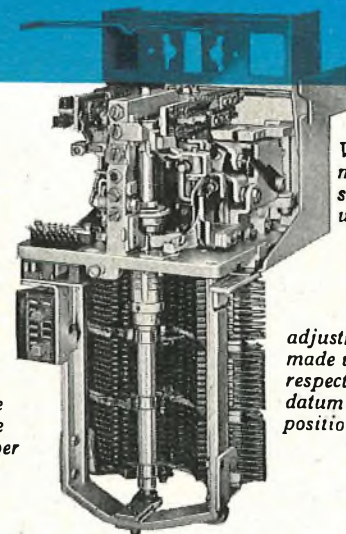

Vertical and rotary magnets are self-contained units

Ample reserve of power

adjustments made with respect to datum position

...cutting the costs of maintenance

G.E.C. telephone exchange equipment is the key to long and trouble-free service in every country and climate. Having supplied telecommunication equipment to all five continents for many years, the G.E.C. has a wealth of experience on which to call, whether the need is for a complete network or a small intercommunication system.

THE GENERAL ELECTRIC COMPANY LIMITED OF ENGLAND

EXCHANGE EQUIPMENT

suited to large or small systems

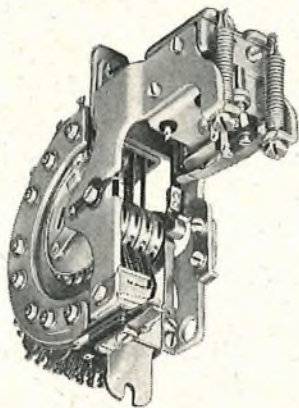

SUBSCRIBER'S UNISELECTOR

Compact, reliable, and easy to maintain, the G.E.C. subscriber's uniselector is ideal for line circuits in an exchange. 300 uniselectors, together with associated line relays, can be mounted on a single-sided rack 10' 6" high x 4' 6" wide.

RELAYS

Their proved reliability with minimum maintenance attention makes G.E.C. telephone-type relays suitable for many uses in all telecommunication systems, and for other special applications.



TRIGGER DIAL

The G.E.C. trigger dial operates at a nominal speed of 10 impulses per second and has a 2 : 1 break to make impulse ratio. The articulated trigger action provides a pause before the digit without the use of a slipping cam.

Whatever your telecommunication problems **G.E.C.** has the answer

Everything for telecommunications by open-wire line, cable, and radio, single and multi-circuit, and TV link, short, medium and long haul. Automatic and manual exchanges, telephone instruments and apparatus.

TELEPHONE, RADIO AND TELEVISION WORKS, COVENTRY, ENGLAND

VALUABLE FREE BOOK



Tells You How to Pass Your C. & G. or Promotion Exam. at First Attempt!

All Post Office Engineering personnel who are anxious to obtain early promotion should at once send for a copy of our handbook "ENGINEERING OPPORTUNITIES," which among other intensely interesting matter describes our unique methods of preparation for **TECHNICAL APPOINTMENTS IN THE POST OFFICE** (Assistant Engineer—New Style and Assistant Traffic Superintendent), **CITY AND GUILDS EXAMINATIONS** in Principles of Telecommunications (1-5), Radio (1-4), Telephone Exchange Systems (1-3), Telegraphy (1), Line Transmission (1 and 2), Lines Plant Practice (1 and 2), Mathematics for Telecommunications (1-5), Electrical Engineering Practice (Prelim. Inter. and Final), and outlines a wide range of non-examination courses in all branches of Electrical, Mechanical, Civil, Automobile, Aeronautical and Radio Engineering.

Assistant Engineer and Assistant Traffic Superintendent. Open competitions now resumed. Age extensions for established Civil Servants. Ask us for full details.

**We definitely guarantee
"NO PASS—NO FEE"**

If you intend to make the most of today's opportunities, you cannot afford to miss reading "ENGINEERING OPPORTUNITIES." It tells you everything you want to know to secure advancement, and describes many opportunities you may now be missing through lack of information. Send for your copy to-day—**FREE** and without obligation.

**BRITISH INSTITUTE
OF ENGINEERING TECHNOLOGY**
369 COLLEGE HOUSE,
29-31 WRIGHT'S LANE, LONDON, W.8

BIET

*for the
right
connection*

ANACOS
REGD.

*telephone
line
wire*

FREDERICK SMITH & COMPANY
ANACONDA WORKS, SALFORD, 3, LANCS.
*Incorporated in The London Electric Wire Company and Smiths Limited.
Associated with The Liverpool Electric Cable Co. Ltd. and Vactite Wire Co. Ltd.*

WESTINGHOUSE

Dependable
*in design and
performance*

**DC CONSTANT
VOLTAGE**
*power
supplies*

WESTINGHOUSE BRAKE & SIGNAL CO., LTD.
82 York Way, King's Cross, London, N.1
Tel: TERminus 6432

Cells Secondary
Stationary
Nos. 12, 13, 14



Cells Secondary
Stationary
Nos. 9, 10, 11

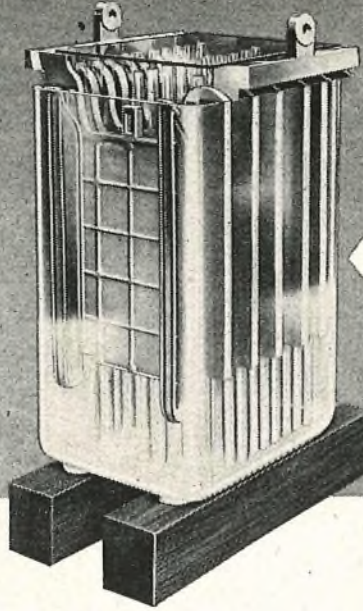

POWER BEHIND THE LINES

TUNGSTONE Batteries have been designed to conform fully with G.P.O. and British Standard Specifications.

These illustrations show the very wide range and type of Cells in regular production for Telephone Exchange work in Great Britain, Australia, New Zealand, India, South Africa, West Indies, etc.

Open Type Cells can be supplied in capacities from 50 a.h. to 700 a.h. in Glass Containers, and from 400 a.h. to 5,000 a.h. in Lead-lined Wooden Boxes — Enclosed Type Cells in capacities from 10 a.h. to 200 a.h.

Cells Secondary
Enclosed
Nos. 1 to 5

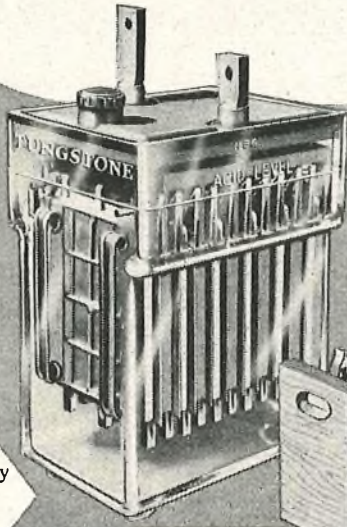

Battery
Secondary
Portable
No. 10

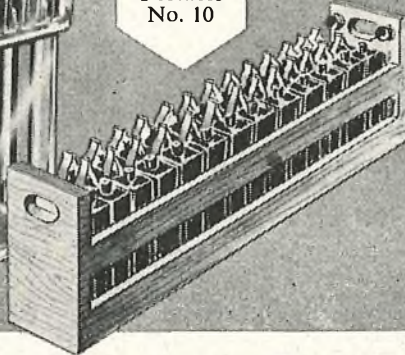

Battery
Secondary
Portable No. 14



TUNGSTONE

REGD TRADE MARK

BATTERIES

TUNGSTONE PRODUCTS LIMITED

10 SALISBURY SQUARE · LONDON, E.C.4 · FACTORY · MARKET HARBOROUGH · LEICS · ENGLAND

TC18

TELEGRAPHY

and the Carpenter Polarized Relay

The backbone of all telegraph and telex circuits is, of course, the Teleprinter, but it is a polarized relay which makes the teleprinter 'tick' so to speak.

In ever increasing numbers the Type 3 CARPENTER POLARIZED RELAY will be found to be the relay in question, and whether it be for use with teleprinters or teletype equipment, the Type 3 Relay can be relied upon to respond to weak, ill-defined, short-duration pulses of differing polarity, with accuracy, freedom from contact chatter, and a minimum of bias distortion.

Fast becoming recognised as a *standard* in the telegraph field, the Type 3 Carpenter Polarized Relay is available mounted on several different bases, to replace many other existing forms of telegraph relay, such as:

BRITISH POST OFFICE TYPE 299AN
CREED TYPE 1927
WESTERN ELECTRIC ... TYPE 209 & 255A, ETC.

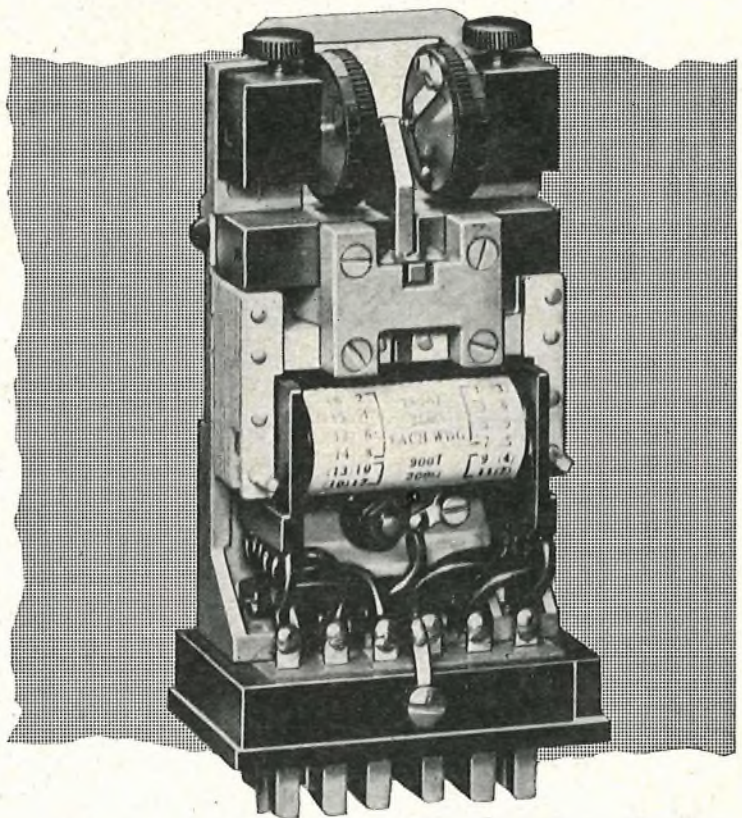

Type 3E1 Carpenter Polarized Relay

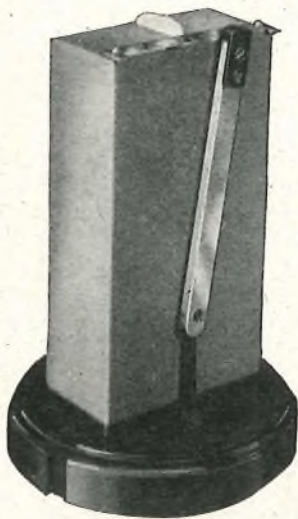

Type 3 Relay on 'Creed' base

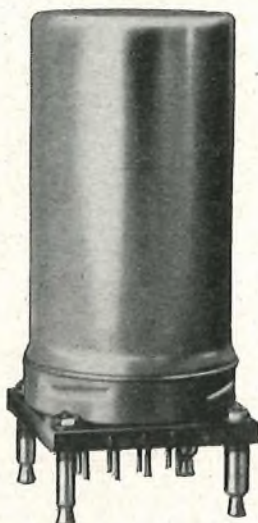

Type 3 Relay on 'Western Electric' base

The Type 3 Relay is, of course, supplied for numerous other applications outside the telegraph relay field, where sensitivity, high speed of response, and freedom from contact bounce are essential features. Here are just a few of its typical uses: High speed modulator and demodulator in d.c./a.c. amplifiers. High speed switching relay in electronic stimulators used in biological research.

A sensitive detecting relay, operating from photo-electric cells, used in smoke detecting equipment.

A sensitive detecting relay operating from resistance element heads in fire alarm equipment.

A sensing relay in servo-systems.

A reversing commutator in Maxwell Bridge measuring circuits, etc.

For further details of this and other relays in the range of Carpenter Polarized Relays, write to:



TELEPHONE MANUFACTURING CO. LTD

Contractors to the Governments of the British Commonwealth and other Nations

HOLLINGSWORTH WORKS · DULWICH · LONDON SE21

TELEPHONE: GIPSY HILL 2211

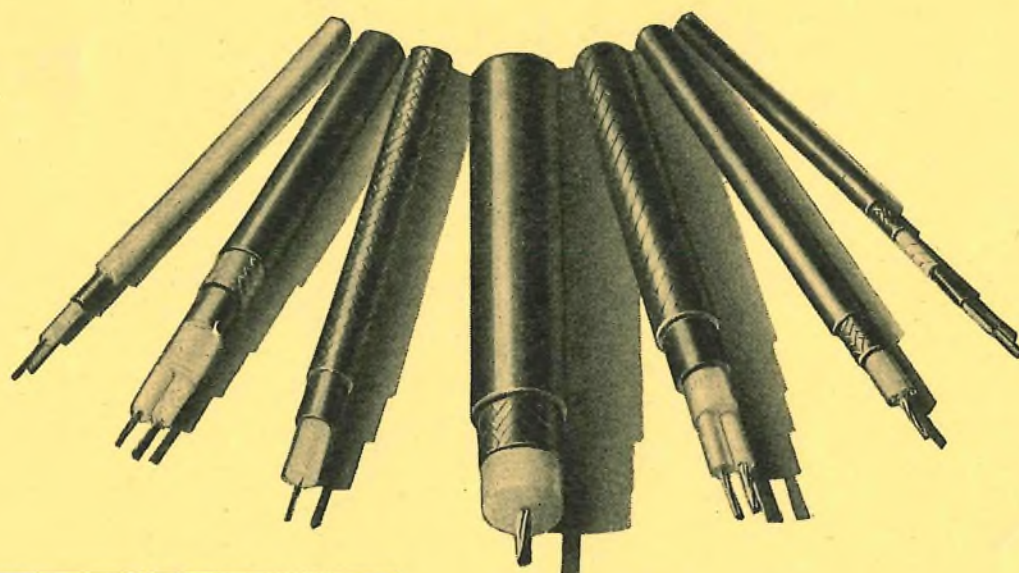

PIRELLI GENERAL
CABLE WORKS LTD.

PAPER INSULATED TRUNK CABLES
TELEVISION CABLES
RADIO FREQUENCY CABLES
COAXIAL CABLES

PIRELLI-GENERAL CABLE WORKS LIMITED, SOUTHAMPTON



OSCILLOSCOPE Type 830

THE OSCILLOSCOPE TYPE 830 has been designed for general wide-band frequency work and is particularly suitable for observing pulse waveforms with very fast rise-times. The frequency response of the Y amplifier is flat from 30 c/s to 20 Mc/s and the time-base provides writing speeds up to 20 cms per microsecond.

The mechanical design is the same as that employed in the Airmec Oscilloscope Type 723, the Cathode Ray Tube being mounted vertically and viewed through a surface aluminised mirror. The instrument may, therefore, be used in conjunction with the Airmec Oscilloscope Camera Type 758.

Y PLATE AMPLIFIER:

Frequency Response: ± 2.5 db from 30 c/s to 20 Mc/s
Sensitivity: 75 millivolts per cm.
Rise-time: 30 Millimicroseconds

TIME BASE:

Range: 0.05 second to 1.5 microseconds
Operation: Triggered or repetitive
Expansion: Variable up to five times
Traverse: A traverse control enables any portion of the expanded time-base to be viewed.

E.H.T. VOLTAGES

1, 2 or 4 kV

Full details of this or any other Airmec Instrument will be forwarded gladly upon request.



AIRMEC
L I M I T E D

HIGH WYCOMBE, BUCKINGHAMSHIRE, ENGLAND

Telephone: High Wycombe 2060

Cables: Airmec, High Wycombe

SenTerCel

LOW POWER SILICON RECTIFIERS



- High efficiency
- Small Size
- High temperature operation
- Hermetically sealed

Now available from Production

Write for Technical Data Sheet F/SIL 101



Standard Telephones and Cables Limited

Registered Office: Connaught House, Aldwych, London, W.C.2

RECTIFIER DIVISION: EDINBURGH WAY • HARLOW • ESSEX