

Boe RA
THE POST OFFICE ELECTRICAL
ENGINEERS' JOURNAL *Stratford*

VOL. 37

JULY, 1944

PART 2

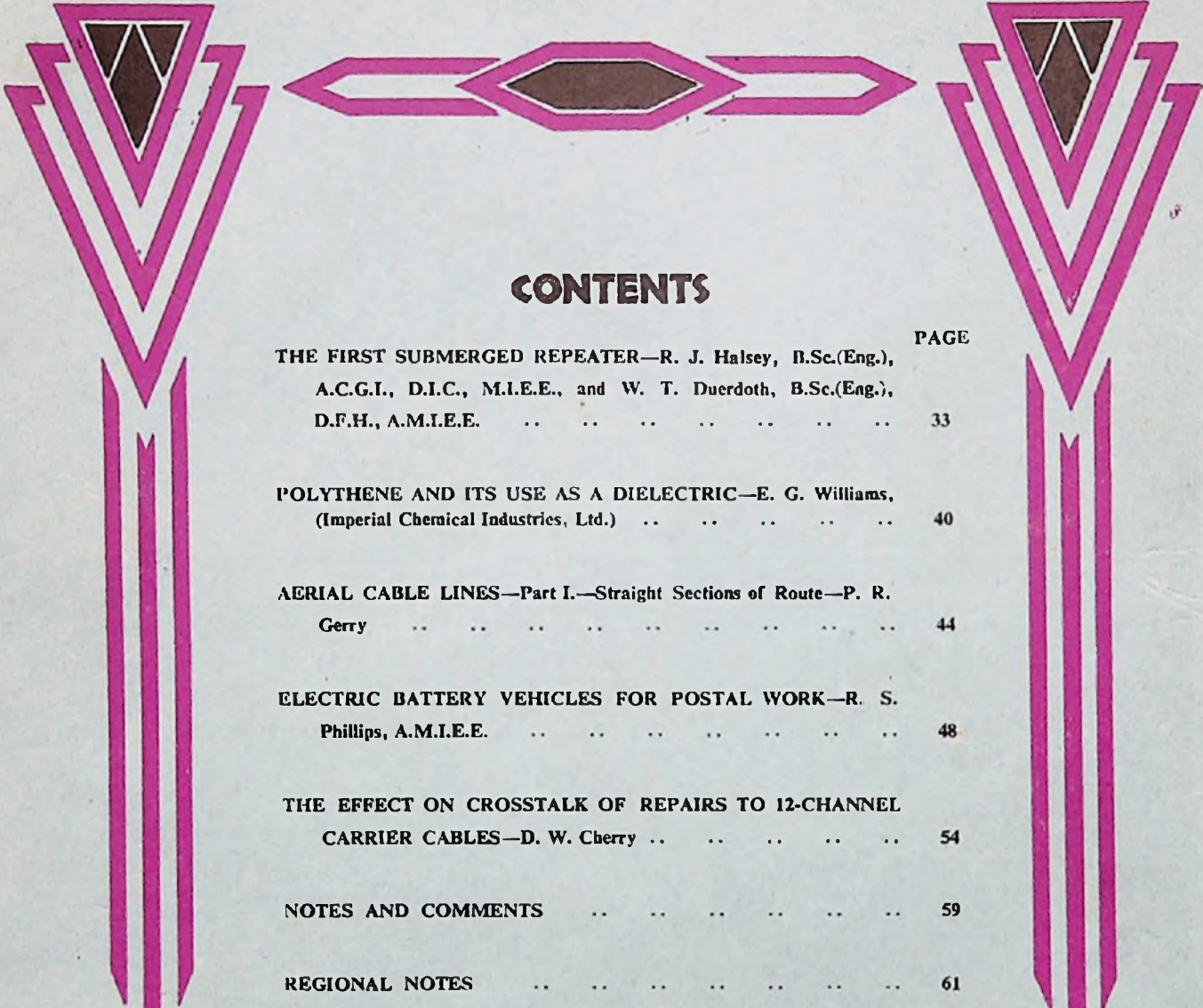

CONTENTS

	PAGE
THE FIRST SUBMERGED REPEATER—R. J. Halsey, B.Sc.(Eng.), A.C.G.I., D.I.C., M.I.E.E., and W. T. Duerdoth, B.Sc.(Eng.), D.F.H., A.M.I.E.E.	33
POLYTHENE AND ITS USE AS A DIELECTRIC—E. G. Williams, (Imperial Chemical Industries, Ltd.)	40
AERIAL CABLE LINES—Part I.—Straight Sections of Route—P. R. Gerry	44
ELECTRIC BATTERY VEHICLES FOR POSTAL WORK—R. S. Phillips, A.M.I.E.E.	48
THE EFFECT ON CROSSTALK OF REPAIRS TO 12-CHANNEL CARRIER CABLES—D. W. Cherry	54
NOTES AND COMMENTS	59
REGIONAL NOTES	61
STAFF CHANGES	63

Price 1/- net

THE INSTITUTION OF POST OFFICE ELECTRICAL ENGINEERS



SALFORD Selenium PHOTO-ELECTRIC CELLS

**ENLIGHTENMENT
ON LIGHT**

● A Range of Standard sizes available — mounted or unmounted.
Special sizes to order.

SALFORD ELECTRICAL INSTRUMENTS LTD.

PEEL WORKS, SALFORD, 3. Telephones: BLAckfriars 6688 (6 lines). Telegrams and Cables: "Sparkless, Manchester"
PROPRIETORS: THE GENERAL ELECTRIC Co. Ltd., OF ENGLAND



SILVERED MICA CONDENSERS

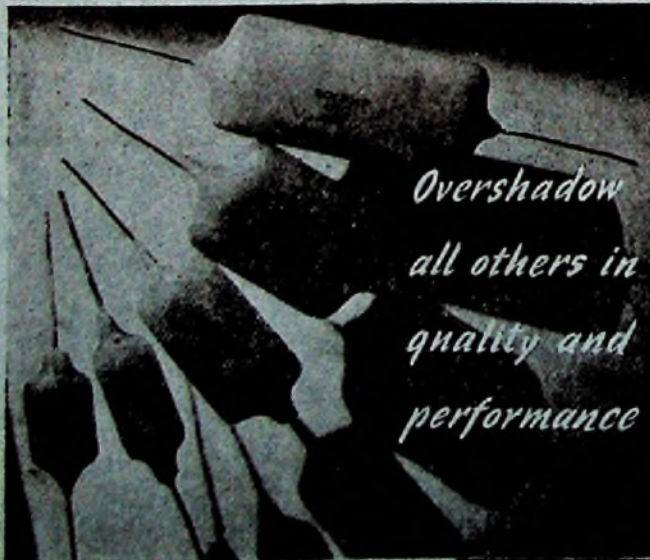

*Overshadow
all others in
quality and
performance*

Incessant progress in methods of manufacture and research linked with the most thorough mechanical and electrical inspection, are reasons for the outstanding superiority of U.I.C. Silvered Mica Condensers. Available in all standardized sizes. Suitable for tropical and arctic conditions. Type approved.

UNITED INSULATOR CO. LTD

12-22, LAYSTALL STREET, LONDON, E.C.1

Tel: TERminus 7383 (5 lines)
Grams: Calanel, Smith, London

THE PIONEERS OF LOW LOSS CERAMICS

. THE POST OFFICE ELECTRICAL ENGINEERS' JOURNAL

Vol. XXXVII

July, 1944

Part 2

The First Submerged Repeater¹

R. J. HALSEY, B.Sc.(Eng.), A.C.G.I., D.I.C., A.M.I.E.E., and
W. T. DUERDOTH, B.Sc.(Eng.), D.F.H., A.M.I.E.E.

U.D.C. 621.395.645 : 621.315.28

Hitherto it has not been considered practicable to include amplifiers at points between the shore terminals of submarine cables and this has placed severe restrictions on the economy of utilisation of such cables. A submerged repeater, believed to be the first ever included in a working cable system, was laid by the British Post Office in June, 1943; its construction and operation are described.

Introduction.

MODERN technique in submarine cable telephony has been described in an earlier article in this Journal.² Briefly, it consists of providing an efficient coaxial cable between the shore terminal stations and operating it at frequencies up to that corresponding to the limit of permissible attenuation. Transmission is at a high level and reception may be as low as about -80 db. without companders or -107 db. with companders (Post Office noise limits). Further substantial progress depends mainly on the development of suitable submerged repeaters which will enable circuit provision to be made on a basis similar to that usual on land. Plans for trans-Atlantic cables on these lines were described by Dr. O. E. Buckley in the thirty-third Kelvin Lecture³; such a project would involve repeater units subject to an external hydrostatic pressure of 2.5 tons/sq. in. and D.C. supply voltages of the order of 2,000 V at each end of the cables, with separate cables for the two directions of transmission. While this ambitious project is still in embryo, the British Post Office has constructed and laid a very different type of submerged repeater in the Irish Sea. This is quite unsuitable for trans-oceanic use; the maximum depth of water in which it can be laid is about 200 fathoms and it is intended for use on the Continental shelf only.

The cable in which the repeater has been included has a length of 43.9 nautical miles (n.m.) between the shore stations (referred to as A and B) and is a link in a more complex scheme. The attenuation is shown in Fig. 1, and prior to the insertion of the repeater the maximum frequency which could be operated without companders was about 250 kc/s. It was originally planned to transmit the frequency band 12-108 kc/s (24 channels) from A to B and 132-228

kc/s from B to A, and this system is in service. With the addition of the repeater, it will now transmit the frequency band 36-228 kc/s (48

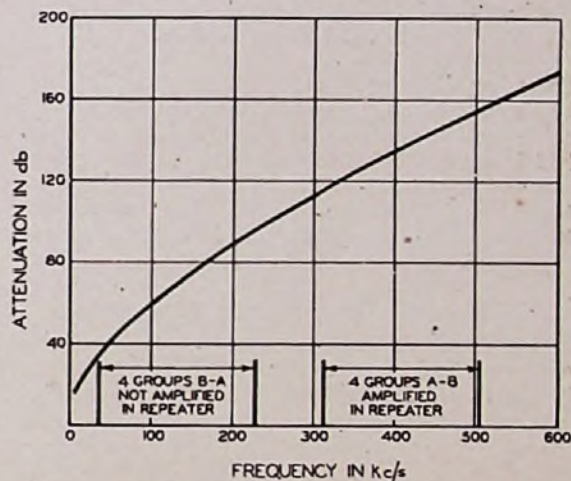

FIG. 1.—ATTENUATION CHARACTERISTIC OF IRISH CABLE.

channels) from B to A without amplification in the submerged repeater and 312-504 kc/s from A to B with gains of 57 and 70 db. at 312 and 504 kc/s respectively. Circuits will be provided by standard

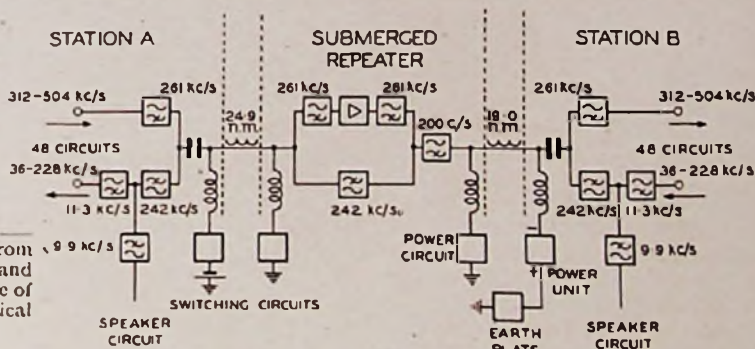

FIG. 2.—SCHEMATIC DIAGRAM OF IRISH CABLE SCHEME.

¹ The text of this article is partly taken from a paper, "Modern Submarine Cable Telephony and the Use of Submerged Repeaters," read by one of the authors before the Institution of Electrical Engineers on May 11th, 1944.

² P.O.E.E.J., Vol. 35, pp. 79 and 121.

³ J.I.E.E., Vol. 89, Part 1, p. 454.

primary super-group equipment (i.e. 312-552 kc/s), one group (504-552 kc/s) being omitted. The primary super-group will be transmitted directly from A to B and translated into the band 36-228 kc/s, in

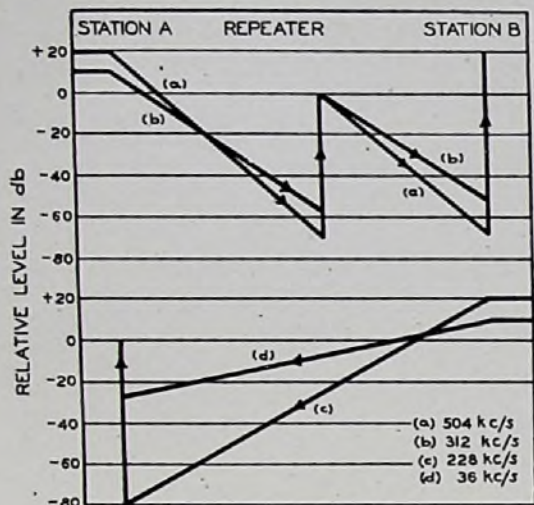

FIG. 3.—LEVEL DIAGRAM.

the other direction, using a super-group carrier of 540 kc/s. A block schematic diagram of the submarine cable section is shown in Fig. 2. The repeater is laid in about 35 fathoms of water corresponding to a pressure of 93 lb./sq. in. and is located 24.9 n.m. from A and 19.0 n.m. from B. (The level diagrams for the two directions of transmission after inserting the repeater are given in Fig. 3.)

MECHANICAL ARRANGEMENT OF REPEATER

Repeaters laid in shallow waters can be lowered on a rope and at no time need the weight be taken by the cable. In deep water this is not possible and

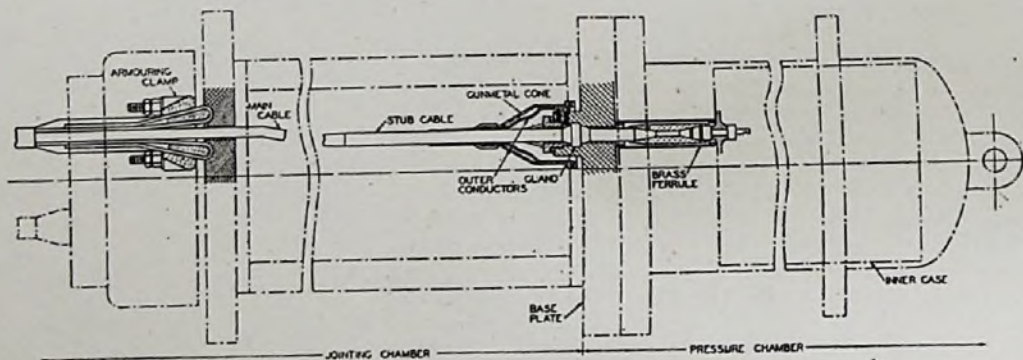

FIG. 4.—CABLE ENTRY FOR SUBMERGED REPEATER.

the repeater must be laid as an integral part of the cable. For the present purpose, weight is not of great importance and may in fact be helpful in reducing movement due to tides and storms. No attempt has been made, therefore, to minimise the weight of the unit, which is about 18 cwt. in air. The construction of the repeater case is shown in

Figs. 4 and 5. The electrical equipment is contained in an inner brass cylinder 4 ft. long and 13 ins. diameter. This is sealed but is not intended to withstand the water pressure; it will prevent damage to the equipment if a small quantity of water enters the outer case. The pressure chamber is built up with welded steel plates $\frac{5}{8}$ in. thick and is 5 ft. long and 14 ins. internal diameter. Both cables enter this chamber through glands in the base plate which is bolted to the pressure unit by sixteen one-inch diameter bolts, a paraggutta ring being fitted in a groove as packing.

A jointing chamber 3 ft. long and open to the sea is attached to the base plate and, at its far end, carries conical clamps (Fig. 4) for making off the armouring wires; within this chamber the centre conductors of the cables proper are jointed to the paraggutta stub cables, the outer conductors being made continuous and clamped under the gunmetal cones which maintain the coaxial structure right up to the glands. The cone bolts have paraggutta washers to minimise electro-chemical corrosion at these points. Paraggutta "puddings" are moulded on to the stub cables to act as gland stuffings. Inside the pressure chamber the cables pass through water-tight brass ferrules to the inner container. The case is heavily galvanised and the inner surface is sprayed black to facilitate the outward transmission of heat.

The inner assembly (Fig. 6) is mounted on four $\frac{3}{4}$ in. diameter longitudinal steel rods between cast gunmetal end plates. The ends of the four rods are bolted to a sub-plate which is aligned on studs in the main base plate of the outer casing, so that a spigot at the far end of the inner cylinder engages with a socket at the end of the pressure chamber. The brass inner cylinder is soldered to the end plates of the assembly; it is filled with dry nitrogen and sprayed black.

The filter components are carried on circular discs attached to the four rods and spaced by steel tubes; other components, including valves, relays, etc., which are less robust, are mounted on a chassis which is attached to two of the above discs by "Metalastik" supports. The sprung chassis has about 1 in. freedom of movement in all directions.

The repeater was designed to withstand a pressure of about 1,000 lb./sq. in. and before final assembly was subjected for one month to a pressure of 500 lb./sq. in. (equivalent to 187 fathoms); there was no ingress of water.

ELECTRICAL ARRANGEMENT OF REPEATER.

Commercial types of valves are used in the amplifier and, to ensure a reasonable life, each of the three stages has three alternative valves, any of which can be brought into circuit by D.C. switching controlled from A. D.C. power for the amplifier is supplied over the cable from B.

The frequency band below 228 kc/s is transmitted freely through the low-pass filter, whereas that above 312 kc/s is directed by the high-pass filters through the amplifier. This has negative feedback amounting to about 28 db. at all working frequencies and the gain-frequency characteristic is primarily determined by a network in the feedback circuit.

Valves.

No suitable valves are available in this country having a probable life much in excess of 20,000 hours and the production of such valves must, of necessity, be a long term development. It was therefore decided to use the best type of commercial valve available, as determined by existing life-test data, and to fit alternative valves in each amplifier stage.

The valves used are V.T. 200 (Mazda S.P. 41. 6.3 V, 0.63 A) selected from a batch of 100 after ageing tests lasting about 200 hours. The three working valves have their heaters in series, and, when run at a current of 0.63 A, the heater voltage is always between 6.15 and 6.45 V, which has been proved satisfactory on life test; the anode voltage is about 150 V. Thirty-two valves from the same batch have been subjected to life test under working voltages and after 16,000 hours they are all serviceable. If the probable life of each valve is assumed to

be $20,000 \pm 5,000$ hours with 50% confidence, the probable life of the amplifier is $49,000 \pm 7,000$ hours with 50% confidence, i.e. about 5 years.

Power Supply.

The power supply for the amplifier is by D.C. from B, where the current into the cable is regulated at 0.63 A; the voltage applied to the cable is about 230 V, the conductor resistance being 2.28 Ω /n.m. The advantages and disadvantages of D.C. as compared with 50 c/s are shown in the following table:—

Advantages of D.C.	Disadvantages of D.C.
(a) line attenuation is lower	(a) Dissipation of power in the repeater is high with standard 6.3 V valves.
(b) Filtration of power supply in repeater is simple.	(b) Valve heaters must be run in series.
(c) Audio frequency circuit can be more readily operated.	(c) Care must be taken to ensure that electrolytic corrosion does not occur at inaccessible points.
(d) Switching is more easily effected.	
(e) No check back of voltage at the repeater is necessary.	
(f) The valve manufacturer expects a longer effective life with D.C.	

Corrosion of the cable with D.C. feed is avoided by connecting the negative supply to the central conductor and the positive supply to an earth plate in the sea at some distance from the cable entry; any corrosion will then take place at the earth plate.

Switching and Alarm System.

The principles followed in the valve switching and alarm systems are as follows:—

- (a) a minimum of apparatus is located in the repeater,
- (b) the factor of safety of apparatus in the repeater is high,
- (c) where possible, switching apparatus in the repeater is normally in a non-excited condition.

Only those valves actually in use have their heaters energised, the appropriate connections being made by a uniselector on the amplifier chassis; this has the advantage over relays that it is not normally energised. The contacts and wipers are chromium plated and no brushes are fitted, i.e., the wipers merely, interconnect contacts on

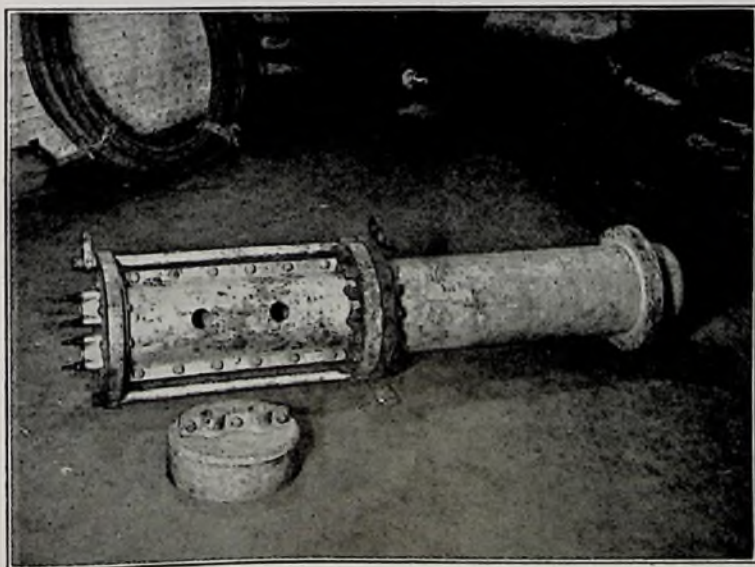

FIG. 5.—OUTER CASE OF SUBMERGED REPEATER.

different banks. Another uniselector at the control station follows the operation of that in the repeater and records its setting.

In addition to the 27 possible heater combinations, the uniselectors also provide facilities for modified open- and short-circuit cable tests from B. Open-circuit tests from the control station A can be made at any time as long as the alarm condition does not exist; short-circuit tests can be made from A if the alarm condition is set up by disconnecting the power at B. At each end an open-circuit test will include the insulation of certain repeater components and a short-circuit test will include the resistance of a choke or relay.

When the selected valve-heaters are energised, associated series relays operate to connect the corresponding grids and anodes. The relays in the heater

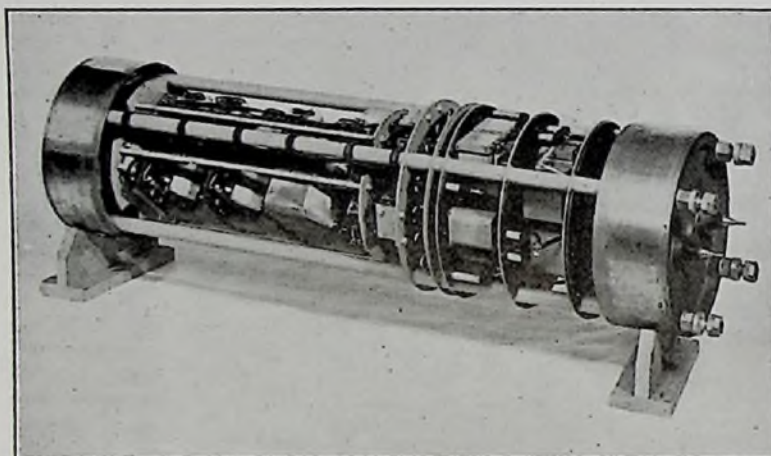

FIG. 6.—INNER ASSEMBLY OF SUBMERGED REPEATER.

circuits of the working valves are normally operated, but a failure affects only the associated valve. The relay springs are screened and operated by glass push rods; they introduce direct grid-anode capacitance of only $0.005 \mu\mu\text{F}$. The contacts are platinum, carry direct current for "wetting" and are adjusted to a minimum pressure of 50 grams. Switching of the valve electrodes is preferred to permanent parallel connections since the total capacitance is lower and risk of complete failure to electrode contacts is largely eliminated. All cathodes and screen grids are permanently connected. The screen grids of the first two stages are connected through large series resistances so that a short-circuit can be tolerated; those of the output valves are wired through "Microfuses" operating at 10 mA, high series resistors not being practicable.

An alarm condition is set up when the anode current in any stage falls to about half its normal value and the switching circuit is so arranged that it is not possible to change the valve combination unless such a condition exists; this is done to prevent mis-operation of the equipment. If it is desired to operate the switching when there is no real fault, an effective fault condition can be set up by disconnecting the power supply for a few minutes.

During the period required for re-heating the valves, the required conditions exist and by presetting the controls the uniselectors will step to the desired position.

The three anode circuit relays are Carpenter precision relays having mechanically balanced armatures. The operating and releasing currents are independent of the orientation of the relay—a very necessary requirement in this instance. Polarising windings are used to obtain the required marginal operation. These relays operate with a very small armature movement, but a high contact pressure is developed even when the current has exceeded the operating value by only a small amount.

At the control station A the switching control is so arranged that on receipt of the alarm condition—a D.C. earth at the repeater, which allows a line current of about 10 mA D.C. to flow from A—the valve combination can be changed by increasing the line current to 80 mA. This may be effected either manually or automatically. To allow adequate time for the valve heaters of the new combination of valves to warm up, thermal delay relays are fitted and a minimum time of 1 minute elapses between successive stepping of the uniselectors. If, however, it is desired to select rapidly one particular position, e.g. one of the test positions, facilities are provided for disconnecting the thermal delay relays. Three lamps on the control panel at A indicate repeater failure, power failure and waiting (thermal relay) conditions respectively. A 29-point switch enables any desired combination to be set up, and associated lamps indicate the actual position of the terminal uniselector. The 29 positions correspond to the 27 valve combinations, open-circuit test and short-circuit test and an extra lamp indicates when the uniselector is passing over spare positions.

A simplified diagram of the switching and alarm circuit is shown in Fig. 7. An alarm is given by the release of an anode relay (PA, PB or PC in Fig. 8) which closes a circuit through relay R in the repeater and causes D.C. to flow from the battery at the control station A via both windings of relay AL and the cable. Thus current operates relay AL but is insufficient to operate relay R.

When manual control is in operation key K2 is thrown momentarily to the start position on receipt of an alarm and causes relay XA to operate. This relay operates relay B and also cuts out the high resistance winding of relay AL; an increased current flows over the cable and causes relay R at the repeater to operate. R1 connects power (fed to the repeater over the other cable from station B) to the uniselector magnet, the interrupter springs of which open, allowing relay X to operate in series with the magnet. Relay X causes relay R to release, which in turn de-energises the magnet coil, causing the uniselector to step once. This causes a fresh

combination of valves to be selected. Relay X then releases after a short lag.

During the time when relay X in the repeater is operated the alarm earth is removed from the cable

Should the fresh combination of valves not be satisfactory, the alarm condition will again be passed to Station A and the attendant, by throwing key K2 again to the start position, can reset the above series of operations.

Alternatively key K2 can be thrown to the locking "automatic" position when the cycle of operations will automatically be repeated until a satisfactory combination of valves is found. Under these conditions, however, it is necessary to distinguish between a genuine repeater failure and an alarm due to failure of the power supply from station B. Additional relays (including G) operated by a power failure alarm direct from station B are fitted at station A for this purpose. An audio frequency speaker circuit is also provided between the two terminals for maintenance purposes.

Facilities are also provided to enable the uniselector in the repeater to be stepped rapidly to

any selected position. The required position is marked on one bank of the shore uniselector by the 29-position switch. On receipt of the alarm signal from the repeater, key K1 is thrown, extending an earth to the selected bank contact and also short-circuiting contact D3, thus rendering the delay of the thermal relay ineffective. The stepping action of the repeater uniselector, followed by that of the shore uniselector, then continues until the marked contact is reached, when relay H operates and prevents further circuit operations.

Amplifier.

The circuit of the amplifier is shown in Fig. 8.

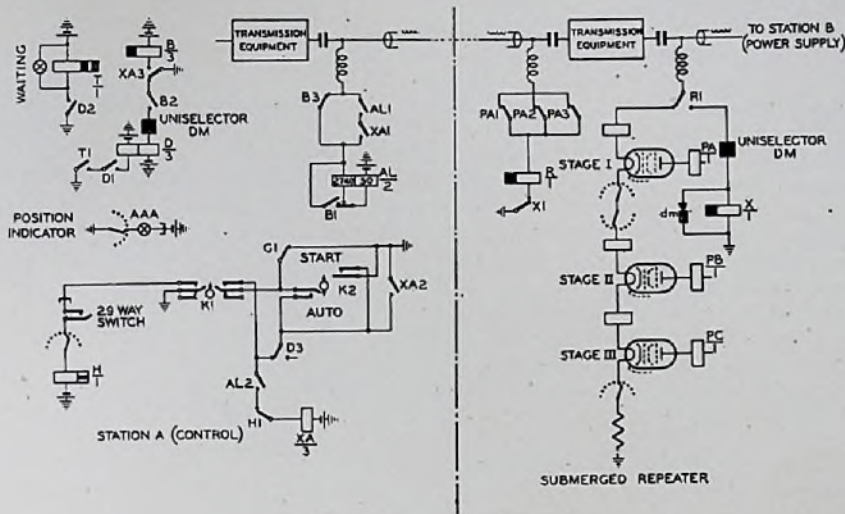

FIG. 7.—SWITCHING CIRCUIT.

and this allows relay AL at the shore end to restore and to release in turn relays XA and B, the latter after a short lag. During the slow release period of relay B the magnet of the shore end uniselector is energised and on release the uniselector makes one step to follow the movement of the repeater uniselector. Relay D was also energised in series with the driving magnet and in turn operates the thermal relay T, the contact of which does not open for at least one minute to release relay D. During this period contact D3 prevents further circuit operation and allows the fresh combination of valves in the repeater to heat up.

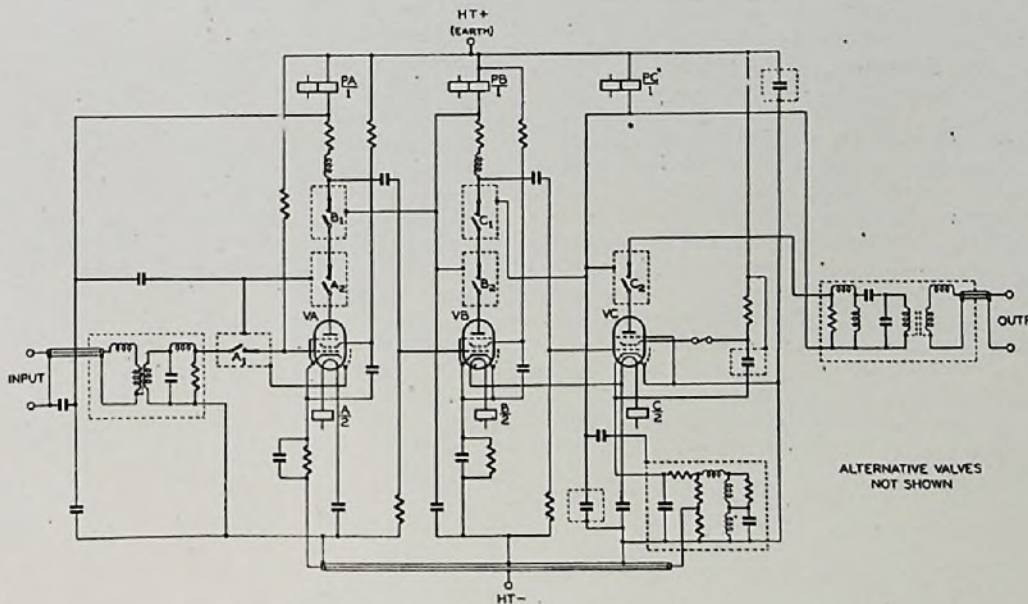

FIG. 8.—AMPLIFIER CIRCUIT.

The interstage couplings give the rising gain characteristic required in the forward path. Every valve has its own coupling network; this enables the grid connections of the last two stages to be switched at points where anode current from the previous valve is present. For the first stage an independent "wetting" current is provided for the grid-relay contacts.

Both the input and output transformers are designed as filter sections; in the output circuit two impedance-transforming sections are used to utilise the leakage inductance and circuit capacitance to maximum advantage and to enable a transformer having a lower impedance ratio to be used. The input transformer operates between 52 and 10,000 Ω impedances, the output network between 17,500 and 52 Ω ; the return loss is always greater than 20 db. at working frequencies.

The main feedback is from the cathode circuit of the output stage to that of the input stage and includes the network necessary to give the required overall gain-frequency characteristic in the working range. With the interstage couplings and the input and output circuits this network also determines the cut-off characteristics above and below the working band and hence the margin of stability against oscillation. The impedance in the cathode circuit of the output valve also causes local negative feedback within this stage.

The effect of series negative feedback is to add to the already high impedance of the output valve and so, because the amplifier works into a filter which must be correctly terminated, the anode circuit of the output valve is loaded with matching resistance.

The mechanical layout of the amplifier is arranged to minimise stray couplings and shunt capacitance.

Quality of Components.

Commercial types of components have been used throughout where possible. Where a component failure is equivalent to the failure of only one valve, high quality components have not been used, but special attention has been given to selection and testing; where a fault could cause failure of the complete repeater generously rated components have been fitted. For example, capacitors in the power filter are oil-filled with a working rating of 750 V; oil-filled capacitors are also used at vital points in the amplifier itself. Simple chassis-mounting valve holders are fitted, but the valve pins are soldered into the sockets.

For the directional filters, clamped mica capacitors and small air-cored toroidal inductors are used. The latter have *Q*-factors of the order of 200 at the important frequencies.

Compounding of Filters.

Although it is considered that the precautions taken to prevent ingress of water are adequate, a further measure was adopted to protect the non-

amplified path in the repeater in the event of water entering the inner cylinder and to allow 24 circuits to be operated as in the original scheme. This involved filling the sections containing the filters with paraffin wax. In future models, if confidence in the construction is established, this measure will probably be omitted.

ELECTRICAL PERFORMANCE OF REPEATER.

Gain of Amplifier.

The gain of the amplifier measured between 52 Ω impedances is shown in Fig. 9. Negative feedback amounting to 22 db. is applied from the

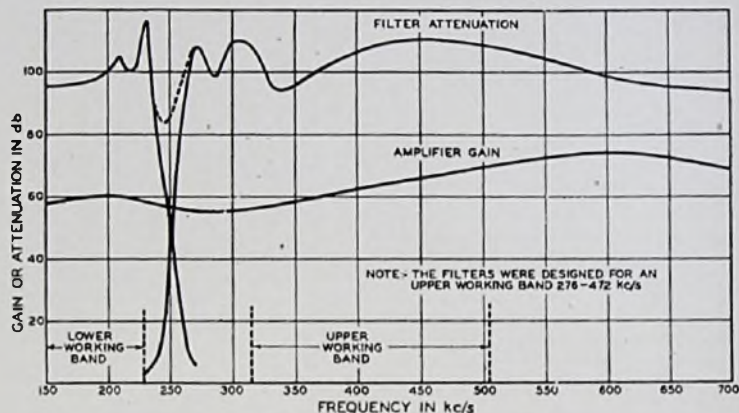

FIG. 9.—FILTER LOSSES AND AMPLIFIER GAIN.

cathode circuit of the output valve to that of the input valve; in addition, local negative feedback on the output valve is at least 6 db. in the working range. The linearity of the amplifier is thus improved by some 28 db. by the negative feedback and the gain of the output stage is stabilised to a similar extent; that of the first two stages is stabilised by the main feedback only, i.e. by 22 db. The gain variation with the various valves and their associated coupling circuits does not exceed ± 0.2 db.

Intermodulation.

Intermodulation is confined to the amplifier, as the filters have air-cored inductors. The equalisation has been arranged so that all channels are at the same relative level at the output of the repeater. To obtain this condition and also to maintain a constant ratio of feedback to input voltage, the first two stages have rising gain-frequency characteristics, the level differences at the input to the first, second and third valves being 14, 7 and 0 db. respectively.

This arrangement is justified only if the intermodulation occurring in V1 and V2 can be neglected in comparison with that in V3. Now V3 has local feedback of 6 db. and, therefore, the intermodulation will be 6 db. below the level that would exist without feedback. The gain of V2 varies from 28 to 35 db. with frequency and it is, therefore, loaded at least 28 db. lower than V3 (the actual loading is less because the higher frequencies arrive at still lower

level, down to 35 db.); the intermodulation is therefore at least $28-6=22$ db. lower than in V3 relative to the lower signal levels. Intermodulation in V1 is even less important.

Since the working frequency is less than one octave, no second-order products or third harmonic can cause interference between channels; the principal products which can cause such interference are third-order difference products. The quality of the amplifier in this respect can be tested at any time by equipment provided at the shore stations. Testing frequencies of 360 and 420 kc/s are transmitted through the repeater so that they are at equal levels in the output valve; 300 kc/s ($=2 \times 360-420$ kc/s) is selected by a crystal filter at the receiving station.

Loading of Amplifier.

The overload point of the amplifier is about +21 db. and with 48 channels channel output levels of about +3 db. are permissible. The planning level does not exceed 0 db., so that adequate margin exists for valve deterioration. The minimum input level (at 504 kc/s) is -70 db., which gives a satisfactory margin against resistance noise.

Filters.

The attenuation of the filters is shown in Fig. 9. The loop loss in the working range is at least 30 db., which limits the possible deviation in the transmission loss to ± 0.25 db.; outside the working range 20 db. is an adequate margin against oscillation. The distortion introduced by the filters in the working bands (about 1.5 db.) is corrected by equalisers at the shore stations.

With the repeater structure adopted, multiple earthing of the filter circuits is unavoidable and chokes wound with coaxial pair and a double-screened transformer are fitted to prevent loss of filter attenuation by couplings in earth leads. By this means the design performance is substantially realised.

Laying of Repeater.

The laying operation was carried out by H.M.T.S. "Iris." The cable was cut at a point determined by navigation and a length of about 0.16 n.m. was spliced on one side so that the two ends could be taken on board over the bow sheaves. Measurements of D.C. resistance and capacitance (and subsequently high-frequency attenuation) were made and the location determined; these measurements agreed with one another within 0.15 n.m. and showed the actual position to be some 0.75 n.m. nearer A than was intended; this is quite satisfactory, although an accuracy of ± 0.5 n.m. had been expected. (A more recent test shows that the location is within these limits.)

The repeater was then jointed in on the A side with a temporary connection on the B side. Power

was applied and testing tones transmitted from Station A to enable the output level of the amplifier to be checked. This completed satisfactorily, the power was removed and the final joint was made. The two cables were then lashed together and the repeater lowered in a horizontal position over the ship's side by a derrick, the weight being taken by a rope which was cut on reaching the sea bed. The cables were released as the repeater was lowered so that the weight of the repeater was at no time taken by the cables. The actual lowering operation took only ten minutes and was completed at 21 00 hours D.B.S.T. on June 24th, 1943. It was hoped to carry out the laying in calm weather, but the weather deteriorated during the operation and half a gale was blowing when the unit was finally lowered.

The sea bed is probably rocky and is swept by a strong tide, so that the conditions are by no means ideal. The temperature at the sea bed at the time of laying was 12.1°C ; it is known to vary seasonally between about 6°C and 14°C .

Replacement of Repeater.

The repeater developed a fault on November 15th, 1943, some five months after laying. On February 12th, 1944, it was picked up by "Iris" without difficulty and replaced by a new unit having similar, but slightly improved performance. The fault subsequently proved to be a punctured mica in a filter capacitor—the only known instance of such a failure of this particular manufacturer's product. In ordering these capacitors the importance of quality had been stressed and careful tests subsequently applied. Although the failure was unfortunate it cannot be regarded as having any great significance in connection with further development.

Conclusions.

A submerged repeater has been constructed and laid by the British Post Office in the Irish Sea; this is believed to be the first ever incorporated in a working cable system. Although laid in a depth of only 35 fathoms it is suitable for depths up to about 200 fathoms, i.e. for any cables likely to be laid on the continental shelf. By its introduction, the number of circuits operable over the single coaxial paragutta cable in which it is included has been increased from 24 to 48.

It is hoped that, after further refinement of the design it will be practicable greatly to increase the efficiency of operation of cables laid to the continent of Europe. Development of deep-water repeaters for use on trans-oceanic routes is engaging attention both in Great Britain and the United States of America.

Acknowledgment is due to Messrs. Siemens Brothers and Co., Ltd., who designed, manufactured and tested the repeater case.

Polythene and its Use as a Dielectric

E. G. WILLIAMS,
Imperial Chemical Industries Limited.

U.D.C. 621.315.616

The author outlines the principal physical, chemical and electrical properties of polythene, and gives details of its present uses as a dielectric. Outstanding properties are its low specific inductive capacity and its low power factor.

Introduction.

It is perhaps fortunate that the development of new plastics having exceptionally good low loss properties has coincided with a very marked increase in the development and application of high frequency radio and high frequency communications in general. Certainly the development of the new thermoplastic, polythene, owes a great deal to the encouragement and collaboration of the radio and communications engineer, and in turn the use of the material has been of considerable assistance in the development and application of high frequency techniques. Brief mention of polythene has been made in this journal before¹ but now that its use is becoming fairly widespread, a more detailed description of its properties and uses may be of interest, and may help to make the communications engineer more familiar with what promises to be a most useful new material.

Nature of Polythene.

Polythene is the generic name given to solid polymers of ethylene, which are prepared under very high pressures. The material may thus be regarded as the simplest of the vinyl polymers, formed by the linking together of double bond compounds to give long chains.

The chemical formula is:—

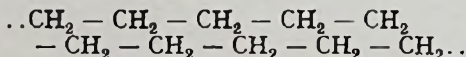

the chains being of variable length but of the order of 1,000 units long.

Polythene is partly amorphous and partly crystalline. In the crystalline portions the chains are all aligned side by side, as shown in the photograph of an atomic model Fig. 1, but individual chains can make up part of several crystals, and the material as a whole must be considered as a large number of small crystals tied together by a tangled mass of amorphous chains.

It is probably to this comparatively unique type of structure, which is shared with, among other materials, nylon and gutta percha, that polythene owes many of its physical properties. It is a tough white translucent material which is flexible, though without the elasticity of rubber, and like nylon and gutta percha it shows the curious phenomenon of "racking" or "cold drawing" under tension. (See Fig. 2.)

¹ P.O.E.E.J., Oct., 1940, p. 130.

Physical and Mechanical Properties.

The material is available in rough chip form, as a moulding powder, and as sheet, tape and rod (which can be easily machined) and is sold in this country under the trade name of "Alkathene." There are various grades which do not differ widely in proper-

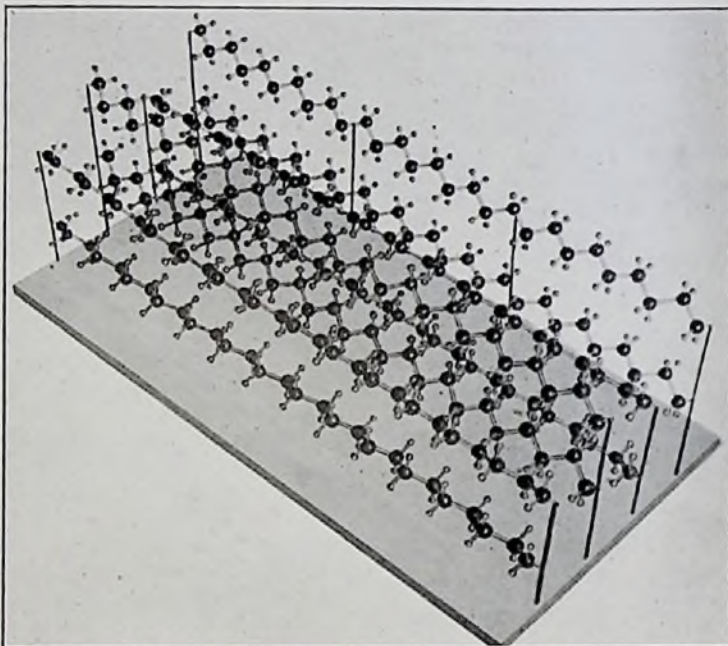

FIG. 1.—MODEL SHOWING ARRANGEMENT OF CARBON AND HYDROGEN ATOMS AND ALIGNMENT OF MOLECULAR CHAINS IN POLYTHENE.

ties except in melt viscosity which is itself the basis of the grading. "Alkathene Grade 20" is the material most commonly used and the list of properties given below were determined on a sample of this material. "Alkathene" Grades 7 and 2 require higher temperatures for processing, but they are progressively harder and tougher than grade 20.

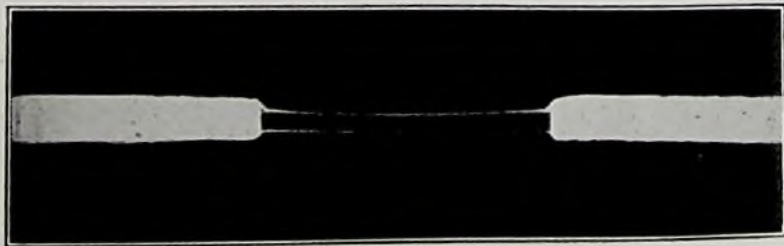

FIG. 2.—SAMPLE OF POLYTHENE AFTER COLD DRAWING.

Density	0.93
Tensile Strength ..	1,500 lbs./sq. inch
Elongation at Break ..	100-450 per cent.
Modulus of Elasticity ..	1,500 lbs./sq. inch
Impact Strength ..	50 ft. lbs./sq. inch
Hardness	Marked by finger nail
Softening Point (ball and ring)	110°C.
Melt Viscosity 190° C. ..	3,500 poises
Linear Thermal Expansion at 20° C.02 per cent. per °C.
Thermal Conductivity ..	0.0007 cal/sec/cm/cm ² /°C

Unlike most thermoplastics, polythene has a rather sharp softening point, which is almost equivalent to a melting point, although in the molten state it is extremely viscous. Below the softening point it shows very little tendency to "cold flow," and in fact specimens can be boiled in water for long periods without showing any distortion. Some cold flow will, however, take place under heavy loads at high temperatures and the normal upper safe working temperature is probably about 70-80°C.

Chemical Properties.

Polythene is very resistant to nearly all chemicals, and is not attacked by most acids and alkalis. Hot concentrated sulphuric acid will cause charring. No solvents will dissolve the material in the cold, but it will dissolve above 75°C. fairly readily in all hydrocarbon and chlorinated solvents.

It is not affected by ultra violet light or ozone, but in the molten state in contact with air a slow oxidation takes place. This oxidation leads to a falling off in the electrical properties and hence it is important to keep it down to a minimum. Recently it has been found that antioxidants prevent oxidation almost entirely, and the addition of 1 per cent. of "Alkathene Additive," a master batched material containing antioxidant, is now recommended during processing of the material.

When ignited polythene will continue to burn with a smoky flame. It is exceptionally resistant to water, the absorption being zero, and the transmission of moisture vapour being very low, e.g. 0.4 mgs. water/sq. inch/hour for a thickness of .03 mms.

Contact with some solvents such as ether, alcohol, or acetone may tend to cause surface crazing, and polythene will slowly absorb a certain amount of mineral oils with a resulting decrease in strength. Sulphur shows some tendency to diffuse through the material, the penetration being more rapid in the presence of oils.

Electrical Properties.

The following figures are the values at 20°C. :—

Specific Inductive Capacity	2.3 at all frequencies
Power Factor	0.0003 at all frequencies
Breakdown Voltage ..	1,000 volts/mil on specimens 20 mils thick
Volume Resistivity ..	$10^{17} \Omega/\text{cm}^3$
Surface Resistivity ..	$10^{14} \Omega/\text{cm}^2$

The effect of temperature on the S.I.C. and power factor has been investigated at one or two frequencies

and the following points have been established :—

1. There is a steady fall of S.I.C. at all frequencies as the temperature rises, typical figures being —30°C. 2.4, 0°C. 2.34, 20°C. 2.30, 50°C. 2.24, 80°C. 2.18.
2. At 50 c/s the power factor falls with increasing temperature and becomes less than .0001 at 70°C. At very high frequencies there is a tendency for this behaviour to be reversed and there may be a slight rise in power factor with increasing temperatures.

Polythene-Polyisobutylene Mixtures.

Polythene is not plasticised by the conventional types of thermoplastic plasticisers, but it can be mixed with polyisobutylene (P.I.B.) if an increase in flexibility, particularly at low temperatures, is required. Mixtures with up to 50% of P.I.B. can be employed, but it is common to use 10 to 15%. The unplasticised polythene has low temperature flexibility depending on the grade of material used, but normally "Alkathene 20" is flexible down to about —30°C. and 12½% of P.I.B. will push down the flexibility a further 15-20°C.

USES.

The excellent electrical properties of polythene, especially its very low power factor have led to its use in a wide variety of radio and communication systems. In particular, its flexible nature has been invaluable in the construction of various forms of cable, the two in which its properties show to greatest advantage being submarine telephone cables and high frequency coaxial feeders.

In the construction of such cables the material is heated above the softening point on rolls or in Pfeleiderer type mixers and extruded over the central conductor by means of conventional rubber forcing machines, or other specially adapted types. After extrusion the covered wire is chilled in air or water, and the dielectric sets solid. When putting on a thick layer of dielectric it may be advisable to extrude the covering in two or more layers, as otherwise there is a tendency for bubbles or voids to form round the central conductor. The temperature of extrusion is normally about 140°C., both for the pure polythene and its mixtures with polyisobutylene. The latter are perhaps rather easier to extrude satisfactorily as the polyisobutylene gives the rather sharp melting polythene a wider plastic range.

Submarine Cables.

Submarine cables have in the past often been insulated with compositions based on gutta percha. For telegraph cables a straight gutta percha dielectric is employed, but for multi-channel telephone cables the dielectric requirements are more stringent and paragutta, or K gutta, both mixtures of specially refined gutta percha with other materials are preferred. Polythene, or its mixture with polyisobutylene, is suitable for both types of cable, although it is only in the telephone cables that the advantages of its use are very marked. The economics of these telephone cables are, of course, bound up with the

number of simultaneous conversations which can be transmitted, and this in turn depends on the maximum frequency at which the cable can be worked without introducing excessive attenuation. The attenuation, once the diameter is fixed, is determined almost entirely by the specific inductive capacity of the insulating medium, and polythene with its low value of 2.3 has definite advantages if substituted for paragutta and K gutta. The resultant increase in the number of available channels would be about 15 per cent. A length of submarine cable core insulated with a polythene-polyisobutylene mixture is shown in Fig. 3.

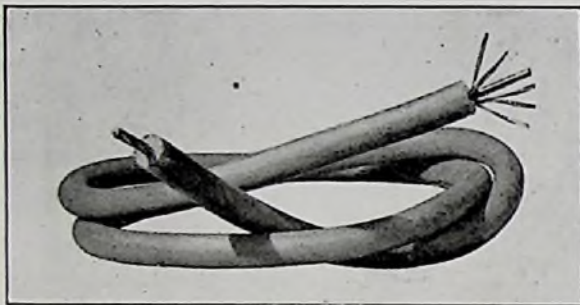

FIG. 3.—SUBMARINE CABLE CORE INSULATED WITH POLYTHENE-POLYISOBUTYLENE MIXTURE (BY SUBMARINE CABLES, LTD.)

Hitherto submarine telephone, as opposed to telegraph, cables have been limited to comparatively short lengths of the order of 100 miles or so, and transoceanic lines have not been practicable. This state of affairs may be changed completely by the development of submarine repeater stations, which will enable amplification of the signals to be carried out in specially designed apparatus incorporated at intervals along the cable and fed down it. These repeaters, if incorporated at intervals of 20-40 miles would enable a long distance transoceanic cable to be designed, which would carry a large number of simultaneous telephone conversations, and would make possible a first-class transatlantic service.²

Polythene is particularly suitable as the dielectric for these long distance cables, partly because of its low specific inductive capacity, which would enable the repeater stations to be spaced at reasonably long distances apart, and partly because moulding techniques have been worked out which would enable the cylinders containing the repeaters to be incorporated in the cable in such a way that the insulation was continuous. The repeater cylinder might be moulded in a waterproof polythene sheath which could be sealed on to the polythene insulation of the cable proper.

Great advances may be expected in long distance communications after the war, and this country with its imperial connections is in an admirable position to take the lead in setting up a world wide submarine telephone network.

² *I.E.E.J.*, Vol. 91, Part 1, No. 37.

High Frequency Cables.

Polythene has proved to be an ideal dielectric for high frequency work in coaxial feeders, screened twin cables, etc., and should have a great future when television becomes commonplace. Whereas in submarine telephone cables the frequencies employed are not great, and consequently the attenuation is determined almost exclusively by the specific inductive capacity, at higher frequencies the power factor of the dielectric becomes more important. Considerable attention has been given to the control of the power factor of polythene, which, if the material were an absolutely pure hydrocarbon, should theoretically be zero. In practice although a value of zero may be approached, a measurable power factor is always found. Careful control of the manufacturing process has in the past few years led to a progressive reduction, and values for the commercially available product now seldom exceed .0003 at 50 Mc/s. At frequencies of this order, the attenuation in a polythene solid insulated cable is still mainly due to line attenuation, and the dielectric attenuation will be small. In a coaxial line of 1 cm. external diameter, if the power factor is taken as .0003, the dielectric attenuation will equal the line attenuation only when the frequency is above 1,000 Mc/s.

The great advantage of polythene and polythene-polyisobutylene mixtures for this type of work is that they enable cables to be constructed with a solid flexible dielectric having low loss properties not far removed from those of an airspaced cable. The greater robustness, flexibility and ease of handling of a solid insulated cable often outweigh the lower attenuation figures for the airspaced type, and any difficulties which arise in the latter, when the distance between successive spacers becomes of the same order as the wavelength, are avoided.

Coaxial lines are usually constructed by extruding a layer of polythene or polythene-polyisobutylene over a single central copper conductor, though stranded conductors are sometimes employed. The central conductor is normally bare untinned copper. The outer sheath may be lead or braided copper wire, the latter type of construction being necessary for the more flexible types.

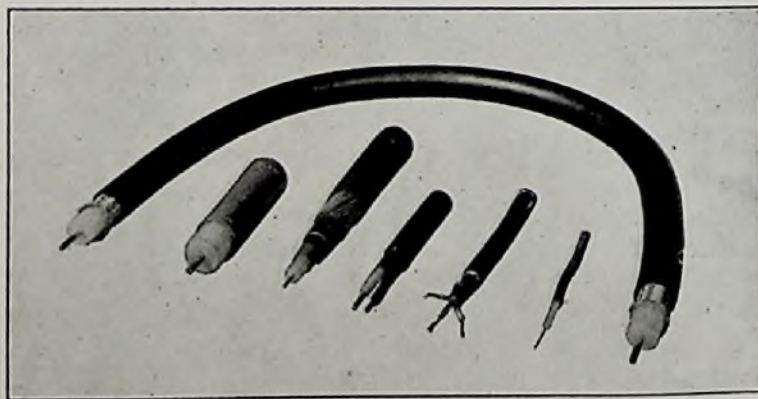

FIG. 4.—H.F. CABLES INSULATED WITH POLYTHENE CONTAINING 12½ PER CENT. POLYISOBUTYLENE (BY TELEGRAPH CONSTRUCTION & MAINTENANCE CO., LTD.).

The braiding can be applied by conventional cable braiding machines and it is usual to employ tinned copper wire. The cables are normally finished with a protective outer sheath which is conveniently made by extruding on a layer of a tough polyvinyl chloride composition.

Fig. 4 shows photographs of typical coaxial cables insulated with polythene containing 12½% polyisobutylene.

For ultra high frequency work some of the advantages of the airspaced type of cable can be obtained,

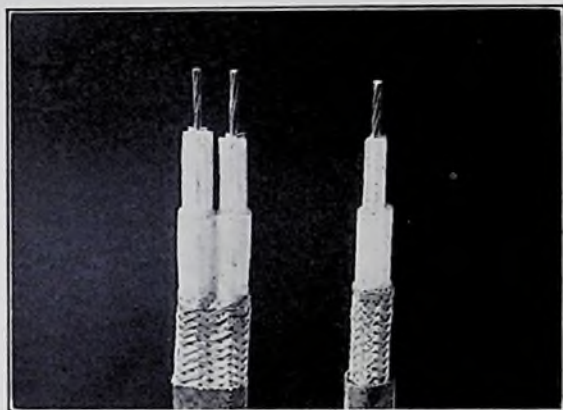

FIG. 5.—SEMI-AIRSPACED H.F. CABLES INSULATED WITH POLYTHENE (BY TELEGRAPH CONSTRUCTION & MAINTENANCE Co., LTD.).

without the disadvantages associated with separate individual spacers, by employing the type of construction shown in Fig. 5, where the central conductor is held in position in the centre of a hollow polythene tube by means of polythene extruded with a star-shaped cross section. Alternative types are also in

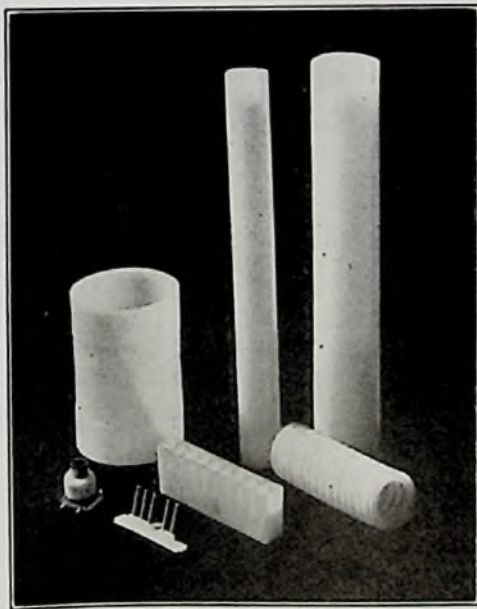

FIG. 6.—MOULDED POLYTHENE ARTICLES.

use in which the conductor is held central in the tube by means of a helically wound polythene string.

Many other types of cable can be made up including sheathed twins, and the extrusion process can easily be adapted to give any type of shape or assembly.

High Frequency Accessories.

In addition to cables there are numerous accessories in high frequency work where low loss properties are required, and polythene has found extensive use in mouldings for this type of application. In particular a useful technique has been developed whereby high frequency cable terminations, plugs, sockets, etc., can be moulded on to the cable, the insulation of the moulding welding on to the dielectric of the cable to give a perfectly sealed joint. Cable terminations of this type have the great advantage of being com-

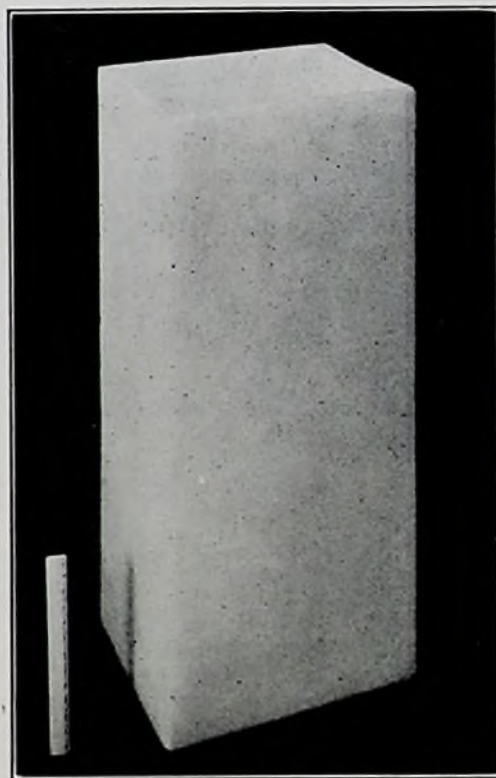

FIG. 7.—LARGE MOULDED POLYTHENE CONTAINER (CF. 1 FT. RULE).

pletely moisture proof. Special care is necessary in the design of polythene mouldings to take care of the very large shrinkage of the material as it cools, and where inserts protrude from the mouldings care must also be taken of the unequal expansion of polythene and metal. Owing to the great toughness of the material, cracking of mouldings even with very heavy inserts should never be a source of trouble. (Fig. 6 shows a miscellaneous collection of moulded samples.) Polythene, however, does not readily stick to metal, nor can it be cemented, or applied in lacquer form, facts which sometimes limit its applications. It can, however, be hot welded.

Miscellaneous Uses.

Apart from high frequency accessories, there are miscellaneous moulding uses where polythene shows to advantage. Its very great toughness is valuable when a very high resistance to impact is required, and it may also find uses in high voltage insulation. Very large mouldings can be made as illustrated in Fig. 7.

Apart from the two types of cable already mentioned, many others are likely to be developed. Power cables represent a very interesting field, and it is not beyond the bounds of possibility to construct a polythene solid insulated supertension power cable, which would be a great simplification compared with the present oil or gas filled types. For ordinary voltage underground cables, the material may be used without a lead sheath, owing to its very good water resistance, and a 440 volt test length has already been running for more than two years without giving any trouble. Fig. 8 shows an end of this cable which was made up by Messrs. Johnson & Phillips.

There may be various forms of telephone cable where the material can be employed with advantage, and it is also suitable for house wiring. For example, excellent wiring can be prepared by using a thin layer of polythene as a dielectric, thereby obtaining first

class insulation resistance, and sheathing it with polyvinyl chloride to give good abrasion resistance.

The development of many promising uses has been held up by the war, but there is little doubt that in the

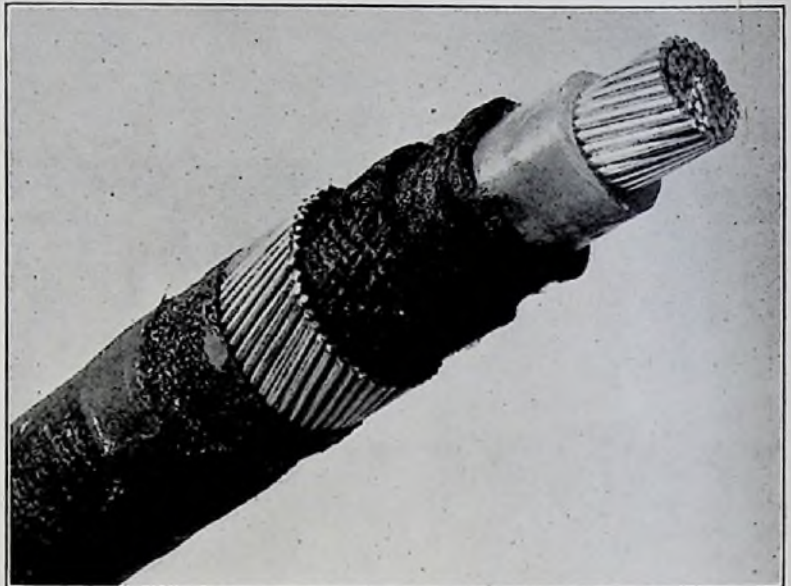

FIG. 8.—POLYTHENE-INSULATED POWER CABLE.

post-war period polythene will be found an extremely useful material to the electrical engineer in many different fields.

Aerial Cable Lines

Part I. Straight Sections of Route

U.D.C. 621.315.24

This article deals with the computation of the forces to which a straight section of pole line carrying an aerial cable may be subjected and the determination of the type of pole and spacing required. Conversely the maximum size of cable which can be carried by an existing line can be calculated.

Introduction.

THE erection of a new pole line complete with suspension wire and cable rings can be accomplished with approximately one fifth of the labour required to lay an equivalent length of new underground duct: when the poles exist the saving in labour is likely to be even greater. Saving in initial cost will of course be offset partially or wholly over a period of years by the greater annual charges of an aerial cable line, but in the present emergency the conservation of labour is of paramount importance, and the erection of aerial cable therefore offers an attractive alternative to the provision of duct.

This has resulted in far more and larger cables being erected on aerial lines than hitherto and has rendered desirable a review of standards particularly with a view to relaxing them where possible to avoid unnecessary strengthening and renewal of

pole lines. The results of this review as regards straight sections of line are given in this article. It is hoped to cover the computation of the forces on stayed poles and new methods of erecting aerial cable in a subsequent article.

Forces Imposed on Poles.

When designing a pole line, straight sections in which the pull of the wires on one side of the pole will be balanced by the pull on the opposite side need to be considered separately from those on which the pull is balanced by a stay or other means. The poles where the pull of the wires on opposite sides balance each other must be able to resist the bending forces caused by the winds which will strike the wires, cable and poles at right angles to the direction of the line. To ensure that suitable poles are used it is necessary to find the magnitude of the bending forces imposed by the wind, and to

P. R. GERRY

calculate the value of the forces necessitates a knowledge of wind pressure, the area exposed to the wind and the height at which this force is applied to the pole.

Wind Velocity.

In determining the appropriate sizes of poles and overhead wires the Post Office has always realised that it is impracticable to allow for the heavy coatings of ice and snow which occasionally occur in this country. It has therefore been recognised as inevitable that certain storm conditions (fortunately rare) will damage wires to the point necessitating renewal, and when wind accompanies the deposition of ice or snow on the wires, extensive failure of poles will occur. For all other weather conditions experience of the performance of even overloaded lines demonstrates that design on the assumption of a wind velocity of 80 m.p.h. has afforded an adequate margin of strength.

When considering whether any relaxation could be made in the design factor of 80 m.p.h. the Post Office took cognisance of the fact that, according to meteorological records, winds exceeding a velocity of 59 m.p.h. rarely occur in most parts of the country and winds approaching a velocity of 80 m.p.h. are exceptional and occur only near parts of the coast and over high ground. It was therefore decided to retain the 80 m.p.h. standard of wind velocity for exposed situations where heavy gales are known to occur, but to adopt a relaxed standard of 60 m.p.h. for all normal situations. Further, for sheltered situations the existing principle of doubling the

permissible number of wires was somewhat freely interpreted as justifying the adoption of a design standard of 40 m.p.h.

In adopting these relaxed standards for aerial cable lines it was borne in mind that the existence of a suspension strand, which is of very great strength compared with that of any wires hitherto used, performs a very valuable function of knitting the route together as a whole so that individual poles are supported to some extent by their neighbours. Further, the percentage increase in windage area under ice conditions is very much less for aerial cables than for relatively thin wires, e.g. the increase in wind pressure on a 2 in. diameter cable when coated with 3/16 in. radial thickness of ice is less than 20 per cent., whereas the increase for a 40 lb. copper wire with the same thickness of ice is 750 per cent.

Wind Pressure.

The wind pressure can be calculated with some degree of accuracy by the use of a formula which was derived from experiments carried out some years ago in the wind tunnel at the National Physical Laboratory to ascertain the effect of winds of different velocities on cylindrical surfaces varying from small gauge wires to poles. The experiments revealed that P , the pressure in lb. per foot run, equals KV^2D where K is a coefficient the value of which is dependent on the product VD , V is the velocity of the wind in miles per hour and D is the diameter of the cylindrical surface in inches. The values of K are indicated in the report¹ of the experiments.

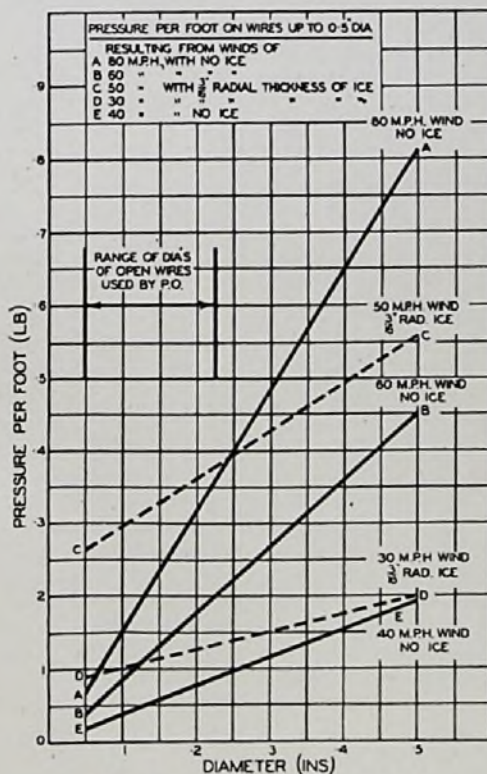

FIG. 1.—WIND PRESSURE CURVES.

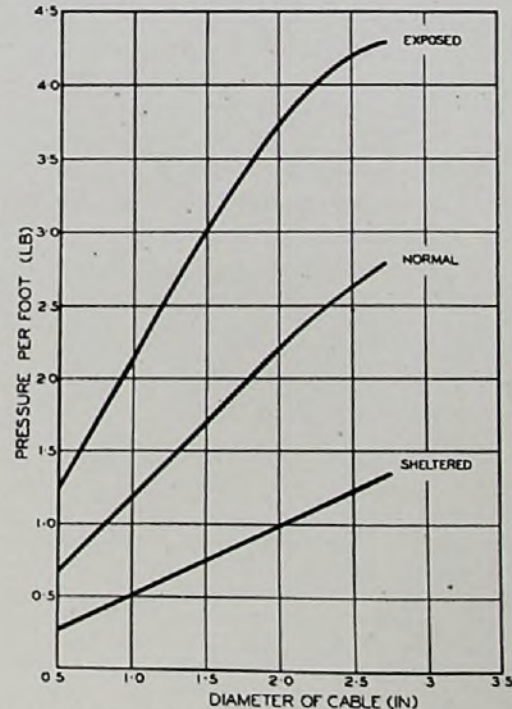

FIG. 2.—WIND PRESSURE CURVES FOR AERIAL CABLE ERECTED IN VARIOUS SITUATIONS.

¹ British Electrical and Allied Industries Association: Technical Report F/T16.

Typical results are given in Fig. 1, which indicates the pressure per foot due to wind velocities of 80, 60 and 40 m.p.h. respectively upon exposed wires up to $\frac{1}{2}$ in. diameter, and equivalent curves are given for wires with $\frac{3}{16}$ in. radial thickness ice loading, as a matter of interest. The effect of the adoption of these velocities of 80, 60, 40 m.p.h. for exposed, normal and sheltered situations respectively is illustrated by the following values. On a line carrying 42 wires varying in size from 40 lb. to 300 lb. per mile, and a 2-in. diameter cable with the poles 60 yards apart, the pressure from an 80 m.p.h. wind will be 1,465 lb., from a 60 m.p.h. wind 820 lb. and from a 40 m.p.h. wind 366 lb..

To facilitate the work of determining the pressures created by the wind for each of the three degrees of exposure adopted and for the many sizes of wires and cables likely to be concerned, the values have been calculated for each size of wire and cable used by the Post Office. For the wires the pressure per foot is as shown in Table 1, and for cables it is indicated in the form of a graph as shown in Fig. 2. The values in the graph include the windage on the suspension wire and cable rings.

TABLE 1.
WIND PRESSURE (IN LB.) PER FOOT.

Situation	Size of line-wire.								
	40 lb.	70 lb.	100 lb.	150 lb.	200 lb.	300 lb.	400 lb.	600 lb.	800 lb.
Sheltered ..	0.016	0.022	0.020	0.033	0.039	0.048	0.057	0.072	0.084
Normal ..	0.037	0.050	0.062	0.077	0.091	0.116	0.134	0.168	0.197
Exposed ..	0.067	0.090	0.113	0.144	0.168	0.210	0.240	0.307	0.350

With the aid of Table 1 and Fig. 2 the pressure created by the wind on any assortment of wires and

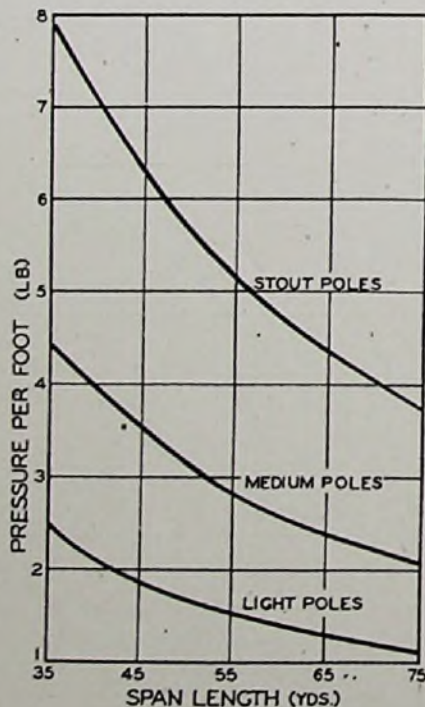

FIG. 3.—WIND PRESSURE PER FOOT OF SPAN FOR POLES CARRYING AERIAL CABLE AND OPEN WIRES.

cables can readily be found. When this value is known it is necessary to ascertain the class of pole required to resist the pressure and the permissible length of span.

New Pole Lines.

When designing a new pole line for aerial cable, use is made of Fig. 3, which indicates the pressure per foot of span which each class of pole will resist. The values shown have been calculated from the formula $S = \pi D^3 f / 112L$, where S is the safe working load in lb., D is the diameter of the pole in inches at the point of fracture, f is the ultimate stress in lb. per square inch in the extreme fibres at the point of fracture, and L is the distance in inches from the point where the load is applied to the point of fracture. The formula, which allows for a factor of safety of 3.5, is derived from the basic formula for the bending moment at the point of fracture of a cantilever. For a tapered pole it can be shown that the point of fracture is where the diameter is 1.5 times the diameter at the point where the load is applied. The safe load which can be applied to a pole at a point 2 ft. from the top, which is the position specified for an aerial cable on a new pole line, is approximately the same for all lengths of pole in the same class (light, medium or stout), hence the single curve showing the relationship between the length of span and the wind pressure per foot of span for each class of pole. A value equivalent to the windage on the pole has been deducted from the calculated safe working load, and the values shown in the graph therefore indicate the actual resistance which the pole can offer to the load imposed by wind on the aerial cable and on any wires that may exist.

Considering a typical case, a pole line is required to carry eight 40 lb. wires and a 2-in. diameter cable. The situation is normal and Table 1 indicates that the pressure on a 40-lb. wire will be .037 lb. per ft., so that the total wind pressure on the eight wires will be .296 per ft. Fig. 2 indicates that the wind pressure on a 2-in. diameter cable will be 2.21 lb. per ft. The total pressure on both wires and cable will therefore be 2.506 lb. per ft. Fig. 3 shows that this pressure requires medium poles at 61-yard intervals.

Existing Pole Lines.

The foregoing method of determining the class of pole and length of span required is used only when the load is applied 2 ft. from the top of the pole. On an existing line a considerable variation may occur in the number of arms fitted to the pole, the clearance required to be provided by the cable and the height of the existing pole, so that it becomes impracticable to specify a uniform height for the cable.

The magnitude of the load a pole can withstand depends upon the height at which the load is applied, and to enable due allowance to be made for the variation in height, the load is determined in terms of a bending moment. In determining the bending moment it is necessary to take into account the length of span, the windage on the wires and on the cable and the heights at which the windage loads are applied. To ensure that each of the factors is taken into account and to simplify the work of tabulation, a new form, known as A572 and illustrated in Fig. 4,

has been introduced. The details required in the columns marked "X" are readily obtained during an examination of the pole line, and the remaining columns can be completed away from the site by reference to Table 1 and Fig. 2, and by making the simple calculations indicated at the top of columns 7, 8, etc.

to increase the former or to reduce the latter. The fitting of transverse stays on both sides of the pole will, of course, increase the pole's resistance to bending, but space limitations often prevent this practice being used and it is usual to reduce the bending moment. This can be done by transferring some of the open wires to the proposed cable or to an

A 572
(Lines Overhead P 1181)

DETAILS OF POLE LINE TO BE USED FOR AN AERIAL CABLE—UNSTAYED POLES

Title of scheme.....

Locality..... to.....

Workman (548A) T10923/P18 2000 2/43 M25035 G & P 712

Locality		Situation—Sheltered (S) Normal (N) Exposed (E)	Size of open wires	Wind Pressure per foot run	Number of open wires of each size	Col. 5 x Col. 6	Sum of all values in Col. 7	Number of arms on poles	Height in feet of resultant load point of wires	Col. 8 x Col. 10	Diameter of proposed cable	Wind pressure per foot run	Height in feet of cable	Col. 13 x Col. 14	Col. 11 + Col. 15	Maximum span length (feet)	Average span length (feet)	Col. 16 x Col. 17 i.e. Total B.M.	Class and length of pole	Moment of resistance in lb.-ft.
From Pole No.	To pole No.																			
1	2	3	4	5	6	7	8	9	10	11	12	13	14	15	16	17	18	19	20	21
X	X	X	X		X			X					X			X	X		X	

FIG. 4.—FORM FOR POLE LINE DETAILS.

In column 21 is required the moment of resistance of the existing pole which is obtained from Table 2. The values in the table have been calculated from the usual formula, i.e. fibre stress of the material multiplied by the section modulus, assuming that poles of minimum diameter exist, adopting a factor of safety of 3.5 and allowing for the windage on the pole.

When the columns have been completed, the

additional cable drawn into the same cable rings, or by reducing the size of the proposed cable. Where none of these methods is practicable, the necessary balance between bending moment and moment of resistance is obtained by erecting a short pole to support the cable only, near the mid-point of the spans, or in extreme cases by erecting two short poles equally spaced between the existing poles.

TABLE 2.
MOMENT OF RESISTANCE OF POLES.

Class of Pole	Safe Moment of Resistance (in lb./ft.).												
	Length of Pole in feet.												
	10-20	22	24	26	28	30	32	34	36	40	45	50	
Light..	3,800	4,300	4,900	5,400	5,800	6,400	6,300	6,900	7,300	7,200	6,300	5,800	
Medium	—	—	9,000	9,800	10,600	11,200	12,000	12,700	13,200	12,700	14,500	12,300	
Stout..	—	—	—	—	18,200	20,400	22,700	22,500	23,500	24,600	25,000	21,700	

maximum bending moment on the pole as shown in column 19 is compared with the moment of resistance of the existing pole as shown in column 21. If the moment of resistance is greater than or the same as the bending moment the existing poles will be strong enough. If, however, the moment of resistance is less than the bending moment, steps must be taken

In addition to providing a simple means of determining the bending moment imposed on the unstayed poles, the details recorded on form A572 also provide a ready means of determining other factors, e.g. the maximum size of cable the line will carry or the maximum permissible span length for the proposed load.

Electric Battery Vehicles for Postal Work

R. S. PHILLIPS, A.M.I.E.E.

U.D.C. 621.335 : 656.8

This article surveys the development of electric battery trucks, vans and tractors used by the Post Office from 1902 to the present time. The author demonstrates that, although the electric vehicle is not likely to displace the petrol one generally, there are certain specialised uses for which it is particularly suited.

History.

It is of interest to record that the Post Office first employed a battery electric vehicle for postal work in 1902 and must therefore be among the earliest commercial users of electric transport in this country. In January, 1902, Messrs. Julius Harvey offered to run what was described as an "Oppermann" electric dogcart on a postal service in London, the firm undertaking to provide drivers and carry out all necessary battery charging and repairs, the Post Office for its part to pay a daily charge for the service. This offer was accepted, and after the body had been altered to meet P.O. requirements the service commenced on the 20th May, 1902, the vehicle's first run being from Mount Pleasant to Waterloo station.

Although there were several out-of-service periods during the following summer, due to various mechanical defects and the need to fit a larger motor when the route was altered to include slight gradients, the trial was not considered unsatisfactory and this van provided a service between Mount Pleasant, Waterloo station and various London district post offices until November, 1902, when the owner withdrew it from the Post Office.

Development of the electric road vehicle continued slowly during the intervening years up to the 1914/18 war. However, in 1912 the Post Office bought a Silvertown battery truck for use in Bristol and another three of the same make in 1914, and these were among the first electric trucks to be used in this country. They were made by the I.R.G.P. & Telegraph Co., who were sub-contractors to the Edison Accumulator Co., the firm manufacturing these trucks in the United States. No firm in this country had at that time much experience in the manufacture of this type of truck.

In the years immediately following the 1914/18 war, the Post Office maintained its interest in electrics, although chiefly in regard to fixed platform trucks, which were particularly suited to certain types of postal work. Several British firms were then producing reliable trucks, and some of these earlier types were brought into use at Leeds, Reading, Plymouth, Sunderland, Birmingham, Paddington, Derby and Chester. Since then there has been a steady increase in their use for postal services.

The period between 1920 and 1930 was one during which the large transport users—of which the Post Office was one of the biggest—viewed the development of electric vans with some uncertainty. A number of the bigger firms installed small or large

fleets because of the improvements made in the design of the 10-cwt. and 20-cwt. vans by many of the leading British manufacturers, the increasing of the battery makers' guarantee from two years to three years, and the expectation that the newly formed C.E.B. would result in better charging facilities being available. The Post Office participated to some extent in the trials during this period and in 1928 purchased three vans for use in Leeds and seven for service in London. The results of these experiments, however, were disappointing so far as the Post Office was concerned, and the maintenance costs were considerably higher than had been anticipated. Consequently, little more was done in regard to electric vans other than keeping in close touch with developments, until in 1934 a van was obtained for service in London and another one in 1935. Although an improvement on their predecessors, these vans were not found to be entirely suitable for Post Office work and compared unfavourably with the petrol vans already in use in large numbers in the Post Office, even making allowance for the relatively low average costs of a big petrol fleet compared to that of a small number of electrics. With the outbreak of the present war, and the need to economise in the use of imported fuels, an effort was again made to justify the use of electric vans on specially selected postal routes and services where it was thought the vehicles would show to advantage. In 1941, therefore, a fleet of nine vans was purchased and brought into use on parcel delivery work and collection of mails at branch offices in



FIG. 1.—"SILVERTOWN" TRUCK.

the Manchester area. The behaviour and operating costs of this fleet are being kept under close observation.

Trucks.

Prior to 1920 the only electric trucks in use for postal work in this country were five at Bristol. These were Silvertown trucks, originally equipped with Edison batteries. Fig. 1 shows one of these trucks, which gave good service until 1932, the last one being finally disposed of in 1934.

Immediately following the cessation of the 1914/18 war, British manufacturers began the development of the electric truck, and it became apparent that there was a definite field for its use in the Post Office. This was particularly so in towns where a letter or parcel sorting office was close to a railway station at which mails were received or despatched. It was recognised, however, that for the service to be satisfactory due regard had to be paid to the nature and gradient of the road surface over which the trucks had to pass. Other factors which had to be borne in mind were the possibility of having to provide a ramp to enable the trucks to pass direct from the sorting office into the street, and also to ensure that the dimensions and weight of the truck were such that it could be accommodated in any lift which sometimes had to be used either at the railway or sorting office end of the route. Where it was not necessary to use lifts it was possible to employ two or three trailers drawn by one truck and thereby increase the carrying capacity per journey. The handling of the trucks was relatively simple and the postal drivers found little difficulty in operating them after receiving instructions from the engineering staff. Consequently, since these earlier years, the Post Office has bought a number of electric trucks, the various types being mentioned below.

About 1921, a number of electric trucks were bought from Roadcraft, Ltd., Liverpool, six of these being used at Leeds and two each at Reading, Sunderland and Paddington. These trucks were somewhat similar in appearance to the Silvertown trucks and were fitted with four solid rubber tyred wheels and with 24 cell 115 Ah. capacity nickel iron batteries. The trucks, however, were not so reliable as had been expected and by 1930 most of them had been withdrawn from service.

In 1921, about the same time that the Roadcrafts were purchased, thirteen English Electric trucks were obtained for use in Birmingham. The carrying capacity was 10 cwt. and the battery consisted of 28 lead acid cells 96 Ah. capacity, which with a $1\frac{1}{2}$ h.p. motor enabled a speed of 6 m.p.h. to be maintained on the level. The mileage obtained per charge was about 35. These trucks gave good service on the particular duty scheduled for them, until 1941, when

nine were scrapped, the remaining four being disposed of the following year.

During 1925, four "Greenbat" trucks manufactured by Messrs. Greenwood & Batley were purchased and brought into service at Crewe and Derby. In the following year additional trucks of the same type were obtained and put on trial at Leeds and Plymouth. These trucks proved very successful for P.O. work as regards weight, size and reliability, and more trucks of the same make have since been brought into use at Paddington, Bristol, Newcastle, Reading, Bath, Mount Pleasant and Birmingham. Fig. 2 shows an early type of Greenbat



FIG. 2.—"GREENBAT" TRUCK WITH TRAILER.

truck with a trailer. The carrying capacity of the truck was two tons and it was also capable of towing a load of two tons on the flat at a speed of 5 m.p.h. The steering was by a horizontal tiller operating on two of the four wheels. Solid rubber tyred wheels were used and spiral springing with the battery independently sprung. The brakes were of the contracting shoe type operating on the motor shaft extension. A totally enclosed traction type motor was employed, wound for series-parallel control, and the controller gave three forward speeds and reverse. The platform dimensions were 77 in. long, 45 in. wide and 20 in. high. These trucks were equipped with Nife batteries of 200 Ah. capacity. Some smaller trucks, of 20 cwt. capacity of the same make, have since been installed at Birmingham and Mount Pleasant, and these were fitted with lead acid batteries of 160 Ah. capacity. Improvements have been made to the later trucks, notably in regard to the adoption on some trucks of four-wheel steering, the fitting of additional brakes operating on drums on the road wheels, and pneumatic tyres instead of solids, one of these newer Greenbats being shown in Fig. 3. There are at present some 40 trucks of this make in use and they have proved the most successful of those yet tried for postal work.

Tractors and Trailers.—Although the trucks described above are at some centres used for towing

trailers in addition to carrying a load, they are not sufficiently manœuvrable for this purpose on all routes, and on a few routes it has been found neces-

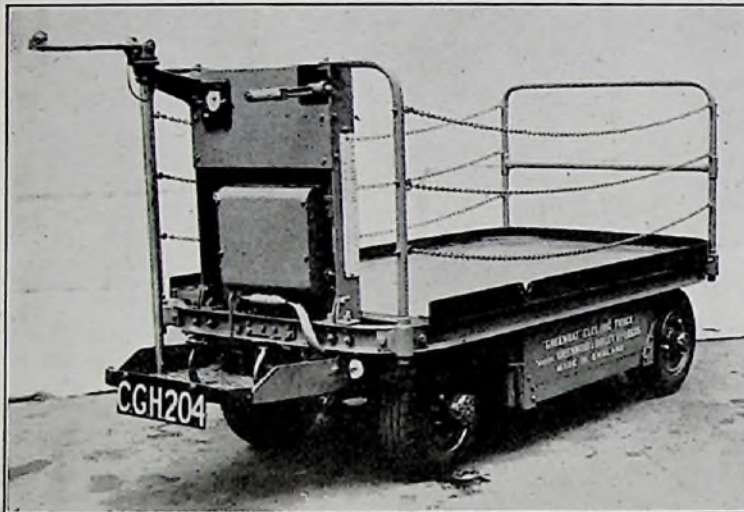

FIG. 3.—"GREENBAT" TRUCK WITH PNEUMATIC TYRES.

sary to use tractors designed for the purpose of towing only. They are smaller in size than the trucks and have a smaller turning radius.

Two of an early type of tractor made by Electromobile were brought into use at Chester in 1924, but since that year no tractors were bought until 1939, when eight B.E.V. tractors were obtained for Birmingham to replace the English Electric trucks, and a further four of the same make were purchased in 1941. The work at Birmingham consists of transporting bags of letters and bags of parcels between the letter office and the parcels office in the G.P.O. and New Street railway station, the route comprising lifts and a subway, and being wholly on either Post Office or railway property.

The B.E.V. tractor is designed to draw two fully loaded trucks weighing 18 cwts., which includes 15 cwts. of mail, at a speed of 6 m.p.h. on the level and 2 m.p.h. up a gradient of 1 in 8, the motive power consisting of 26 D.P. Kathanode cells of 252 Ah. capacity at the 5-hour rate. A 5 h.p. totally enclosed motor of the series wound traction type is used, and the transmission is by a single reduction worm gear. Hand wheel steering is employed, the turning circle of the tractor being 60 in. Three speeds in each direction are available with series-parallel field control of the motor. Braking is normally by internal expanding shoes on the transmission shaft, but emergency braking is available on drums on the driving wheels. The chassis is supported by four spiral springs, and the

wheels are fitted with pneumatic tyres. Fig. 4 shows one of these tractors, the overall dimensions of which are: length 6 ft. 6 in., width 3 ft., height 4 ft. 5 in.

"Lister" trailers of special dimensions to meet the stringent requirements of the lifts and subway were bought between 1939 and 1942 for use with these tractors. The trailers are capable of being drawn manually, and a total of 51 is now available. Each has a capacity of 15 cwts. and a platform size of 5 ft. 3 in. long, 3 ft. wide and 1 ft. 8 in. high. The wheels have pneumatic tyres, the front two wheels being fitted to the turntable. Trailer braking gear operating internal expanding shoes on the front wheels is fitted, and this comes into action automatically when the trailer overruns, or automatically when at rest and uncoupled from the tractor, or by vertical movement of the towing handle when the trailer is manually drawn.

Vans.

It has now been reasonably well established that where the route and type of service are suitable, electric vans can provide economical running. The routes on which they should be employed, however, are limited in length by the capacity of the battery and unless intermediate facilities are available for battery recharging or obtaining an exchange of battery, the route will not exceed about 40 miles. Electrics show considerable economy on routes where stops are very frequent, because of collections or deliveries or traffic congestion, and on this account are well suited to town or city work. For such duties their high acceleration often enables them to perform a higher average

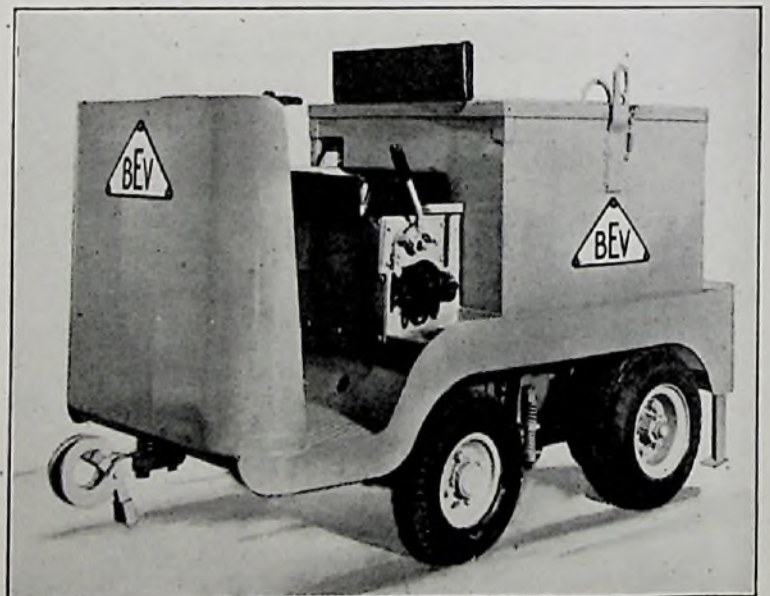

FIG. 4.—"B.E.V." TRACTOR.

speed than petrol vehicles employed on similar services. Other advantages over the petrol driven van are cleanliness, silence in running, ease of driving, and particularly during a war period, the fact that it does not use imported fuel and uses very little lubricating oil. Where longer distances have to be performed, however, and a high average speed maintained or the nature of the country is hilly, the electric cannot at present compete with the petrol van.

In the experiments which the Post Office have carried out with electric vans one of the difficulties has been the selection of towns and particular routes which would fulfil the above requirements. It has also been recognised that for the service to be economical, it is essential to employ a self-contained fleet of, say, at least 10 vans on its own particular service with its own drivers, and operated quite independently of any petrol vans that may already be in service. Interchangeability of drivers between petrols and electrics has been found to be undesirable. Furthermore, it has been necessary to choose suitable routes which would enable the electric van to perform an economical annual mileage of not less than 9,000. With the variety of postal services to be provided, it is impossible anywhere to schedule all the transport work as being suitable for electric vans and therefore any fleet that contained electric would also contain petrol vans. Under these conditions the lack of flexibility of the electric as regards use is a serious drawback to its employment in large numbers by the Post Office. With the present day performance of electric vehicles there must be a very much larger petrol fleet than any possible electric fleet, and the possibilities of specialisation and cheaper maintenance will, therefore, be far greater for petrol than electric vehicles. The low average cost of Post Office petrol vehicles is largely due to the fact that the fleet comprises some 18,000 vehicles, of which about half are postal vans. It must be borne in mind, too, that the lower rate of tax and insurance for electric vans, which are advantages to the general commercial user, do not directly benefit the Post Office, which is a tax-free Crown user, and does not insure its vehicles, although the lower maximum speed is conducive to fewer serious accidents.

Trials were carried out with electric vans commencing in 1928 at Mount Pleasant and Leeds, where suitable routes were available, the former comprising flat routes and the latter some relatively hilly districts. Seven "Victor" vans of 15 cwt. capacity, one of which is shown in Fig. 5, were purchased for Mount Pleasant and used for parcel delivery and collection services, involving an average of five stops per mile. The speed of these vehicles on the flat was 15 m.p.h. and the radius of operation about 20 miles per charge. The Leeds vans were three Electromobiles, two of 20 cwt. capacity and

one of 25 cwt. capacity, having speeds of 15 m.p.h. on the flat. These vans were employed on services to the railway station, parcel delivery and collection and distribution of mails from and to branch offices with an average of four stops per mile. The service given by these vans at both centres was so unsatisfactory and the running costs so high (approximately two and a-half times the average cost of an equivalent petrol vehicle), that it was decided in 1935 to be more economical to scrap them.

The results obtained from the Mount Pleasant and Leeds trials tended to show that the case for electric vans in the Post Office on a financial basis was poor. It was appreciated, however, that considerable improvements were being made in electric vehicle design, and therefore in 1934 an offer of the loan for test purposes of a new "G.V." 1-ton van was accepted. A similar offer was made the following year of a Morrison 1-ton van, and this too was accepted. Both vans were brought into use on letter and parcel work at Mount Pleasant, where they were found reasonably satisfactory and an improvement on the older Victor vans. The speed on the flat was about 20 m.p.h. and the mileage per charge 30 for both G.V. and Morrison. During the early tests these vans showed sufficient promise for the Post Office eventually to purchase them from the manufacturers in order that the experiments could be continued. To obtain information on their working in more hilly districts, both vans were transferred to Leeds in 1936, but the nature of the work here was too severe for the required mileage per charge to be obtained. They were, therefore, sent in 1938 to Southampton, but during the present year their conditions were such that it was considered more economical to scrap them. Their performance at Southampton was satisfactory, where on selected parcel delivery town routes the average speed during tests was higher than that of a petrol van. The costs, however, were considerably higher than those of equivalent petrol vehicles, due, no doubt, partly to the fact that it was not possible to allocate sufficient

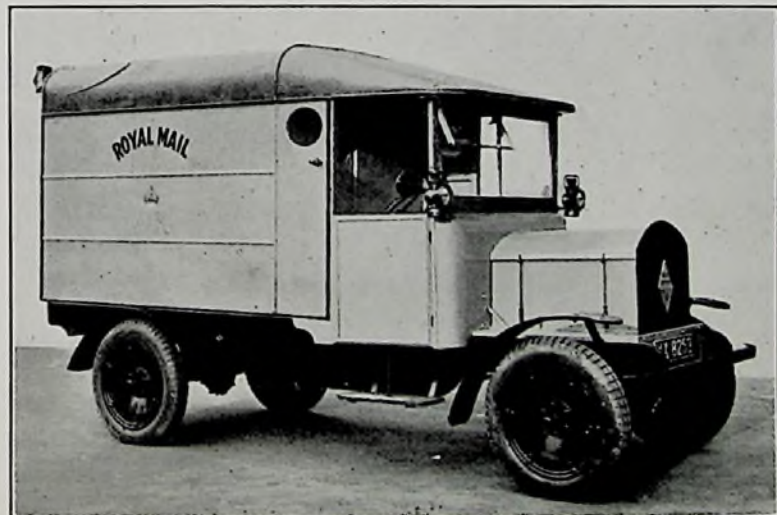

FIG. 5.—"VICTOR" VAN—1929.

suitable work to them to enable a reasonable annual mileage to be covered.

Shortly after the outbreak of the present war, it was decided to introduce a small fleet of nine modern electric vans at Manchester, where a similar number of petrol vans was due for replacement. The parcel delivery and collection services performed by these petrols were suitable for electrics and, in addition, the local electricity tariff for battery charging was very favourable. The successful tenderer was Metropolitan Vickers with their 10/14 cwt. type van and a special body to P.O. requirements, and the vehicles were delivered during 1941/42. Fig. 6 shows



FIG. 6.—"METRO-VICK." VAN—1941.

one of these vans, which is capable of a speed of 20 m.p.h. on the level, 10 m.p.h. up a gradient of 1 in 10 and 42 miles per charge with an average of eight stops per mile. The body capacity is 120 cu. ft. and the payload 6 cwt. with a crew of two. A series wound totally enclosed traction motor is employed, incorporating a relay in the field coils which lights a red warning lamp when the motor temperature exceeds 120°C. This device, although unnecessary at present, was desired to enable some experience to be gained regarding the possible use of the vans later on routes which included hillier districts, in which event the motors would be replaced by ones of the ventilated type. Lockheed hydraulic brakes work on the four wheels and a mechanical hand-brake on the rear wheels only. The controller is operated by a foot pedal combined with a changeover switch and hand lever for forward or reverse. On full depression of the pedal the controller inserts three resistance stages in circuit before free running at half speed, with the two battery sections in parallel, is reached. On release of the pedal and again depressing, another three resistance

stages are inserted before full speed is attained with the two battery sections in series. Lead acid batteries of 40 cell, 240 Ah. capacity are fitted, three each of Chloride, Young and D.P. manufacture, battery charging being performed by nine separate Westinghouse automatic metal rectifier charging sets. These vans are operated by women drivers on parcel delivery services and collections of mail from branch offices in the Manchester area. Their performance so far has been satisfactory, and although the costs are somewhat higher than was anticipated, they are much lower than the average costs of any of the earlier electric vans. As in the past, however, some difficulty

has been experienced in allocating sufficient journeys of suitable types to these vans which will result in the estimated annual mileage of 9,000 being performed. It must be stated, too, that present-day staffing problems do not permit of the maintenance being organised as efficiently as would be possible in normal times.

Batteries.

In some of the vehicles described above, lead acid batteries have been used, whereas others have been fitted with nickel iron alkaline batteries. The development of the former type has been more rapid than that of the latter, and this in some measure accounts for the fact that most vehicle manufacturers adopt lead acid batteries as standard, although alkaline batteries are fitted if required. Each type has advantages over the other, the main of these being mentioned below.

The cost of the raw materials required for the nickel iron cell is considerably more than that for the lead acid cell and this, together with the fact that the normal discharge voltages of the two types are 1.2 and 2.0 respectively, which makes it necessary to employ more nickel iron cells, explains why for the same voltage and capacity the alkaline battery costs approximately twice that of the acid battery. Against this, however, the manufacturers of the former type guarantee their batteries for six or eight years, whereas the lead acid battery manufacturers guarantee theirs for three years only. At the end of these periods the capacity is guaranteed not to fall below 80 per cent. of the nominal capacity, and in selecting the battery size it must be borne in mind, therefore, that if say, 40 miles per charge can be obtained with a new battery, this is likely to be gradually reduced to 32 miles by the end of the guarantee period. The nickel iron cell has advantages in regard to mechanical robustness and its ability to give almost full capacity at high discharge rates, whereas the capacity of the lead cell decreases rapidly as the discharge rate is increased. Although some success has been achieved in reducing the internal resistance of the alkaline cell, notably by the intro-

duction of the nickel cadmium type, it is nevertheless still appreciably greater than that of the acid cell. For this reason the P.O. have found it necessary to replace alkaline batteries by acid batteries where short steep inclines occur on the route, these resulting in short duration high discharge rates and considerable battery voltage drop. As regards efficiency, that of the lead cell is about 15 per cent. higher than that of the alkaline cell.

Where the mains supply is D.C., charging is performed from the mains by connecting a sufficient number of batteries in series with a resistance or by using a motor generator set. With A.C. mains, a motor generator or rectifier is used, the latter being either of the metal or mercury arc type. One charging set is frequently employed to charge the batteries from a group of trucks or vans, but the use of one charger for each vehicle is a more efficient arrangement and this method is adopted for maintaining the batteries of the fleet of Manchester vans. At this centre, charging of batteries is performed by nine Westinghouse metal rectifier 3-phase units, each capable of charging one battery in nine hours. The charging is controlled and automatically cut off at the end of charge by a Metropolitan-Vickers M.J.V. type relay which is connected in the A.C. side of the circuit of each charger. This relay registers the voltage at which gassing occurs and then switches in a synchronous motor time element which is set for the period of the required gassing charge. Damage to the battery due to over-heating is thereby prevented and at the end of charge the relay switches off the supply automatically.

Costs.

As with petrol vehicles, the operating costs of electric vehicles are computed under two headings, namely, standing charges and running costs, the former being independent of the mileage performed and the latter bearing a direct relation to the mileage run.

Typical examples of some of the annual standing charges in regard to a 10 cwt. electric van, obtained mainly from actual experience with the 10/14 cwt. Manchester vans, are mentioned below. As stated earlier, licences and insurance do not affect the Post Office, but in regard to these, the electric would show a saving of about £10 per annum over an equivalent petrol van. Wages should be approximately equal for electric and petrol, as also would be the garaging costs, but the former item frequently introduces complications due to differing wage scales. Interest and depreciation are £11 and £70 per annum respectively, more than half the latter charge being on the battery, which costs about a quarter of the total vehicle cost and has a relatively short life. It has been authoritatively stated that the maintenance for a van of this type should not exceed about £15 per annum, but experience with the Manchester vans has resulted in a figure more than double this, although it must be stated that some of the costs were due to repairs after accidents which

occurred before the drivers became familiar with the vehicles. The capital outlay in providing an electric fleet is about double that of a corresponding petrol fleet, this resulting in high interest and depreciation figures and consequently heavy standing charges.

If the above items are accepted as standing charges for the electric, this vehicle is left with only the cost of current for charging and of tyres, as its running costs, and these will be dependent largely on the electricity tariff in force in the district where the vans operate. These costs for the Manchester vehicles work out at 0.47 and 0.1d. per mile respectively for an annual mileage of 7,000. The running costs for petrol vehicles consist of charges for depreciation, maintenance, petrol, lubricants and tyres, and consequently these are heavier than for electric vans.

The average total cost per mile, including all the above-mentioned items except licences and insurance, for these electric vans is approximately 5.3d. for 7,000 miles per annum, but it is considered that in normal times with better opportunities for organising maintenance, this could be appreciably reduced. It is of interest to record that the present cost of similar items for an equivalent postal petrol van is of the order of 3.7d. Nevertheless, to compare the two types on this figure is unfair to the electric, as the duties performed are not identical in the two cases.

Conclusion.

On the particular class of postal work mentioned earlier, where competition from petrol vans is generally impracticable, the use of battery-driven trucks, and in special cases of tractors, is now well established, and on these routes they are giving satisfactory service.

As regards the electric vans, however, although the P.O. trials have not been very promising there are particular types of work which best suit the electric van. The greater reliability and improved performance of present day electric vehicles and batteries are such that if proper care is given to the selection of running routes and they are used in sufficient numbers to enable specialised maintenance to be adopted, they can be run economically. The tendency to regard the electric as a rival to the petrol vehicle and the unfortunate consequence of comparing on a financial basis the operating costs of the two types should be avoided. There is a definite field of employment which best suits each type, and in making cost comparisons the fact is often overlooked that the employment schedules in the two cases are very different, and a few electrics are frequently expected to show costs as low as the average cost of a large petrol fleet with its widely varying range of work and a highly organised maintenance system developed over a number of years. The chief difficulty as regards postal services is undoubtedly in organising the work so as to segregate the two types of duties to ensure that, with a composite fleet, the electric van is fully employed on the work to which it is best suited.

The Effect on Crosstalk of Repairs to 12-Channel Carrier Cables

D. W. CHERRY.

U.D.C. 621.395.8

When repairs to carrier cables are carried out necessitating the replacement of existing lengths of cable, a serious worsening of far-end crosstalk may result. The author gives examples and shows how, solely by adjustment of the balancing networks, the crosstalk may be brought well within the specification limits, even when a large number of lengths have been replaced, provided carrier type cable has been used for the repair.

Introduction.

WHEN 12-channel carrier cables are laid, the capacitance unbalances are measured at audio frequencies, and test selected joints made, but this is not sufficient to reduce the far-end crosstalk to a satisfactory level. Further improvement is obtained by introducing at some point in the repeater section, usually at the low level end, a nest of variable condensers arranged so that condensers are connected between each pair and every other pair in the cable, i.e. for a 24-pair cable, there are 276 condensers. By adjusting these the far-end crosstalk can be reduced to satisfactory limits.

As separate GO and RETURN cables are used, all circuits in the same cable have the same direction of transmission, so that the reduction of far-end crosstalk within cable is important. Near-end within-cable crosstalk has to be considered only in so far as it may affect the far-end crosstalk by reflections due to impedance mismatches between the line and the repeater. Near-end cable-to-cable crosstalk must also be small, but this is not affected to any extent by the replacement of cable lengths, or by jointing operations.

To expedite repairs, spare lengths of 24 pair/40 P.C.Q. carrier cable are held in each Region under the key cable reserve scheme. These are normally available for immediate use for renewing faulty lengths in any repeater section. When jointing replacement lengths no audio frequency balancing or capacitance matching is carried out, but care is taken to ensure that the replacing length is jointed with the same crosses as the original length. This means that it is possible for fairly large crosstalk paths to be introduced, and this necessitates the adjustment of the variable condensers. This operation is referred to as "rebalancing" throughout this article and this use of the term should not be confused with the testing and selection of joints which may be carried out during the repair of audio frequency cables.

This article will not deal in any detail with the crosstalk effects obtained, or with the testing apparatus usually employed, as this has already been dealt with very thoroughly elsewhere.¹ Details will be given, however, of the methods which are peculiar to the rebalancing of a working cable, and of typical faults which have been found during these operations.

The Necessity for Rebalancing After Repairs.

To indicate the magnitude of the crosstalk paths which can be introduced by one 176-yard length of cable, values are given in Table I showing (a) the maximum values of capacitance unbalances and

mutual impedances between pairs in the same quad which are permitted in the manufacturing specification for P.C.Q. carrier cable, and (b) the maxima obtained from a number of lengths from various manufacturers. For simplicity, only values between pairs in the same quad are shown, as these are normally the worst combinations.

TABLE I.

Characteristic	Max. Permissible	Typical Values	
	Value	Mean of Max.	Max. of Max.
Capacitance unbalances in microfarads ..	125	36	106
Moduli of magnetic couplings in microhenries	0 600	0 136	0 310

These values would give rise to crosstalk paths of the following order at 60 kc/s in a cable of 140 ohms impedance :—

Characteristic	Due to Max. permissible coupling allowed in the Spec.	Due to Typical Values	
		Mean of Max.	Max. of Max.
Crosstalk due to capacitance unbalance in db.	62	72	63
Crosstalk due to magnetic coupling in db.	62	75	67

The specification for the far-end crosstalk on a repeater section at 60 kc/s is that 90 per cent. of the values between all pairs shall not be worse than 75 db. and that 100 per cent. of the values shall not be worse than 70 db. On new cables very few values are worse than 80 db., and an endeavour is made to retain this standard after repairs have been carried out. It will be seen that, assuming the original length introduced no crosstalk, it would be possible for one length to produce crosstalk which is worse than the level permitted for the whole section. Further, the original length may have had couplings of the reverse sign to those of the replacing length, which were neutralised by adjacent

¹ I.P.O.E.E. Paper No. 169.

lengths during the initial balancing in the field, so that the effect of the replacing length may be worse than the values calculated above.

In general, the replacement of one 176-yard length is unlikely to cause serious interference. It would be desirable to carry out crosstalk tests after each fault, but this is not always possible, and from experience gained in the past, it is found that rebalancing can be postponed until at least three lengths have been replaced.

It should be noted, however, that one 176-yard length of P.C.Q. local cable may cause crosstalk as bad as 44 db., so that, if for any reason carrier cable is not available for restoring service at the time of the fault, any temporary repairs should be made good with P.C.Q. carrier cable as soon as it is possible to do so.

Testing Methods and Apparatus.

The method of measuring crosstalk on a non-working cable is shown schematically in Fig. 1 together with the crosstalk paths and levels at 60 kc/s relative to 1 milliwatt.

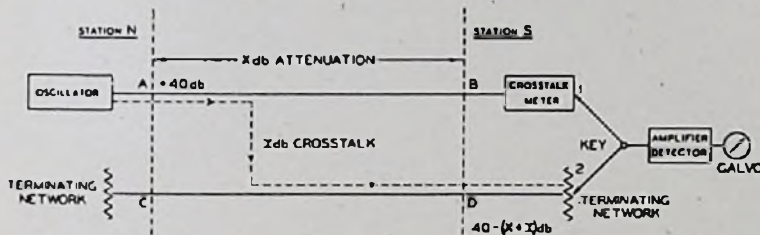

FIG. 1.—SCHEMATIC DIAGRAM SHOWING METHOD OF MEASURING CROSSTALK AND THE LEVELS RELATIVE TO 1 mW.

The measurement is made by adjusting the crosstalk meter, which is calibrated in db., until the same deflection is obtained with the key in either position 1 or 2. It is desirable to be able to measure values of far-end crosstalk down to 90 db., i.e. the level at D for a section of 60 db. attenuation at 60 kc/s will be 110 db. below 1 milliwatt, which means that the amplifier-detector must respond to a signal of 1 microvolt.

If there are pairs in use, care must be taken to ensure that rebalancing operations will not interfere unnecessarily with the working circuits. In the first place the oscillator must be connected at the high level end of the section and the measurements made at the low level end. Assume CD is a working circuit, that the section has an attenuation of 60 db., and that cable repairs have taken place. The crosstalk path x may then be of the order of 60 db., so the level of the interference at the low level point D of the circuit may easily be -80 db. The repeater output level at C will be $+5$ db. and the repeater input at D -55 db. This will give a signal-to-noise ratio of 25 db. Although 60 kc/s is just on the limit of the working range, interference might be caused if the testing frequency were somewhat below 60 kc/s. The tests are, therefore, normally carried out at 70 kc/s where there is no possibility of causing interference. At this frequency the attenuation length may be as much as 65 db., so that the amplifier-detector will need to respond to signals of 0.5 microvolt.

If only a few pairs are working in the cable it is possible to carry out the rebalancing operations by using normal apparatus, and by changing over the working circuits when it is necessary to test on these pairs. The method employed in practice is to measure the crosstalk as shown in Fig. 1, and if the value is worse than 80 db., the balancing condenser for the combination under test is adjusted until minimum crosstalk is obtained. Owing to the poling effects introduced by secondary crosstalk paths, if the oscillator is now connected to pair CD and the crosstalk is measured on AB, the same result is not obtained, and if this second measurement is worse than 80 db. the condenser is again adjusted until the best compromise balance is obtained for the two conditions. In practice the number of cases, out of the total of 552 readings where readjustment due to poling is necessary, is small, and does not cause any serious difficulty or delay. It is found that this procedure enables crosstalk to be restored to the same order as on a new cable. In one repeater section over 30 lengths have been replaced since the cable was installed, but it has been possible to reduce the crosstalk to the original level.

If all the pairs in a cable are working, it is necessary to get two pairs released for the cable to be re-balanced as described above, but it is a slow and laborious process, as it involves changing over working circuits 550 times, and as mistakes are likely to occur, some interruption to working circuits is bound to arise. As, however, the tests are made at 70 kc/s, which is above the working range, it is possible to measure the crosstalk on a pair which is working provided that (a) the amplifier impedance is high, (b) the tuning is sufficiently sharp to give complete discrimination between a test signal of 110 db. below a milliwatt at 70 kc/s and a speech signal of 55 db. below a milliwatt at 60 kc/s, (c) the sensitivity is sufficient to give a reading with an input signal of 70 kc/s of 0.5 microvolt.

The oscillator cannot be connected direct to a working circuit even when used at a frequency above the working range, as owing to the high sending level the repeaters would overload. It is necessary, therefore, for one pair to be made spare. Each system is then patched out in turn when the pair concerned is being used as the disturbing circuit. The design of suitable filters which will make it possible to send on a working circuit is, however, being investigated.

The measurement on working circuits is dependent on the input impedance of the equaliser line amplifier arrangement, and the reflections at C due to the output impedance of the line amplifier not matching that of the line will also affect the result. As this is the working condition this is an advantage and has enabled apparatus faults to be found and cleared. Care is necessary to distinguish between crosstalk which has been introduced by replacement lengths and that due to an apparatus impedance mismatch. If, however, most of the readings are consistently

higher, or consistently lower when measuring on a particular pair, than when disturbing on that pair, it is fairly certain that the crosstalk is being affected by the apparatus. This method of test means that each working system has only to be changed over twice, i.e. 46 changes in all. A further difficulty will arise in future, as all the phantom circuits are likely to be used for test purposes, speaker and music circuits, etc. This will mean that two pairs will have to be released for the duration of the rebalancing work, unless the sending filters referred to above prove to be satisfactory.

Spur Cables.

For security reasons it is often undesirable for the terminal equipment for all pairs to be situated in the same building. Arrangements are sometimes made, therefore, for the equipment to be installed in two stations, and a spur cable provided as shown in Fig. 2.

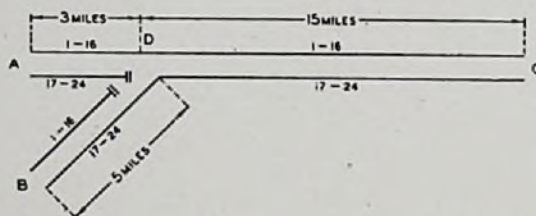

FIG. 2.—SCHEMATIC DIAGRAM SHOWING SPUR CABLE.

With this condition it is the practice to install the balancing frames for both the GO and RETURN cables at station C, i.e. at the high level end of one cable. When the fault is between A and D or B and D the procedure is the same as above. When, however, the fault is between C and D, the rebalancing becomes more complicated. Consider first the direction of transmission A or B to C. It is desirable, to avoid delay, to have two oscillators, one at A and one at B. A spare pair to each place is essential. Measurements are made at C and the set calibrated from the oscillator at A, when disturbing on the AC pairs, and from the oscillator at B when disturbing on the BC pairs. This condition gives the true signal-to-noise ratio for crosstalk between the two groups of circuits only if, under working conditions, the input levels at C are the same for both groups. It is usual to insert attenuators at the sending end of the shorter group to adjust for the difference in attenuation of the two spurs. The repeater output levels at A and B can then both be the same. This has not always been done, and then the crosstalk under working conditions on the BC circuits from the AC circuits will be worse than measured as above, by the difference in attenuation lengths, i.e. in Fig. 2, by approximately $5\frac{1}{2}$ db. at 60 kc/s. It will be noted that when disturbing on the AC circuits, and measuring on the BC circuits, the pairs must be terminated at B, so all three stations must be staffed. If, as on some of the older cables, the balancing frames are at some point between C and D, then staff is required at four points.

In the reverse direction of transmission, i.e. when A and B are at the low level ends, measurements have to be made at A and B. When disturbing on a CA circuit, and measuring on a CB pair, it is necessary to calibrate the set by first connecting the oscillator to a CB circuit. This will give a correct signal-to-noise ratio if under working conditions the sending levels at C on both groups of circuits are the same, and this is invariably so. Similar considerations for terminating and staffing apply as in the reverse direction of transmission.

Some cables are forked to three different terminal stations, and although this may be necessary for security reasons, it is very undesirable from the maintenance aspect.

Balancing Condensers.

Two main types of balancing condensers have been used in the past and both have disadvantages so far as rebalancing is concerned. The first type is a single ceramic condenser. The sign of the coupling for each combination decides between which two wires the capacitance must be connected. This has the disadvantage that replacement lengths may alter the sign so that condensers have to be rewired. For example, if a condenser had originally been connected between two A wires, it might later be necessary to join it between the A of one pair and the B of the other.

The second type is a differential air condenser. This enables the crosstalk to be balanced out whatever the sign without rewiring. In the zero position there is the same capacitance in each side of the condenser and this is equal to half the maximum value. This introduces unwanted capacitance and to minimise this the smallest suitable value of a range of sizes is selected for each individual combination. This has the disadvantage that, after a few repairs, it may be necessary to fit larger condensers for some combinations or to add fixed capacitances in parallel with the existing air condensers. The latter alternative is the simpler in practice, if only a small number have to be fitted.

These disadvantages have been overcome in the Post Office design of balancing frame² which has been standardised for use in this country. In this type two ceramic condensers are fitted for each combination so as to give a differential arrangement. The unwanted condenser is set to its minimum value of about 10 pF, so that little unnecessary capacitance is introduced. Condensers large enough to cope with all values likely to arise are fitted initially.

The Effect of a Number of Repairs without Rebalancing.

The effect of a number of repairs without rebalancing is shown in Fig. 3. It will be seen that it is possible for the far-end crosstalk with the balancing networks unadjusted to become worse than that of the cable alone. In the example shown, the rebalancing was delayed owing to indecision as to whether certain lengths were to be replaced by protected cable. In the meantime further lengths

² Post Office Engineering Department Specification R.C.217.

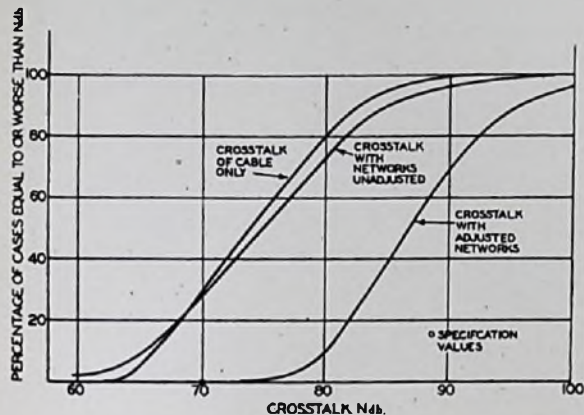

FIG. 3.—EFFECT ON DISTANT END CROSSTALK OF LARGE NUMBER OF REPAIRS.

became faulty, so that an abnormal number of lengths were replaced before rebalancing was carried out. This difficulty has now been overcome by arranging for all faulty lengths to be immediately replaced by carrier type cable. If further investigation shows that protected cable is required, but plain cable has been used, the length is not replaced with protected cable until it is again faulty, except where the anticipated life is less than three years.

FAULTS FOUND DURING REBALANCING OPERATIONS.

(1) Cable other than Carrier Type Used.

There have been occasions when carrier cable has not been used for a repair. With P.C.Q. trunk cable alternate quads have the same lay, whereas in carrier cable all the lays are different. Even with one length of trunk cable the crosstalk between quads is noticeably worse. Figure 4 shows the result

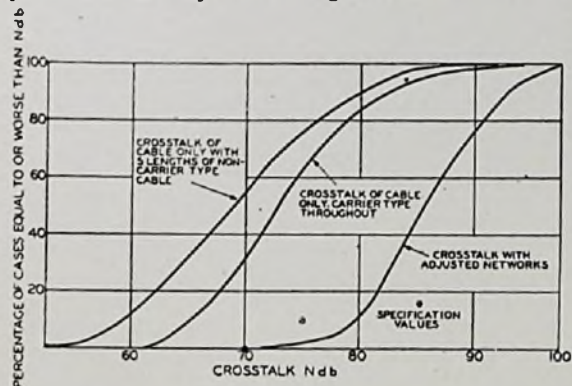

FIG. 4.—EFFECT ON DISTANT END CROSSTALK OF LENGTHS OF NON-CARRIER TYPE CABLE.

of introducing four lengths of P.C.Q. trunk and one of P.C.Q. local cable.

The crosstalk of the cable without the balancing networks had deteriorated by 9 db. as compared with the same condition before the wrong type of cable was installed. Unfortunately the crosstalk with these five wrong lengths, but with the networks in circuit, was not measured, but as shown in Fig. 3 this condition would probably have been worse than that of the cable alone. This means that the worst

value with networks had deteriorated at least by 20 db. and the most probable value by 16 db.

In favourable circumstances the length of cable causing the crosstalk can be localised by a crosstalk/frequency method similar in principle to that used in audio frequency testing. The test is somewhat the same as the better known impedance/frequency method of fault localisation,³ except that in this instance the frequency interval is inversely proportional to the distance between two crosstalk faults. It is necessary, therefore, to connect an artificial fault at some point. The frequency interval is also dependent on the cable characteristics and a constant for each particular cable can be found by connecting artificial faults at each end of two good pairs. The crosstalk/frequency curves for an actual fault location are shown in Fig. 5; (a) and (b)

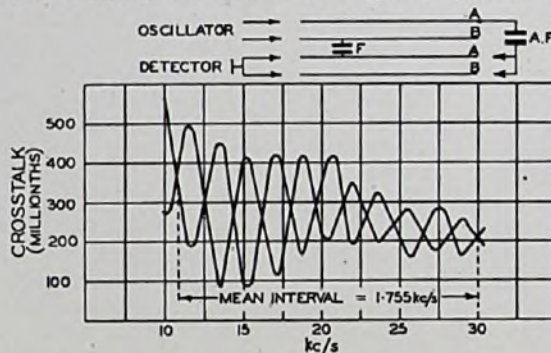

(a)

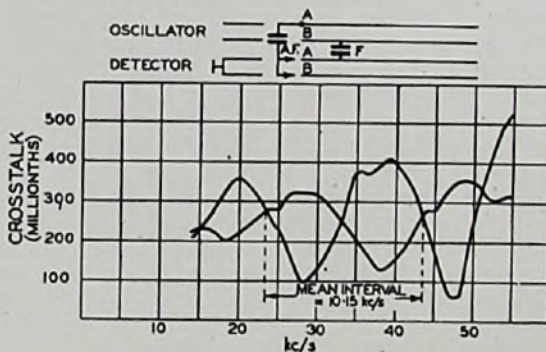

(b)

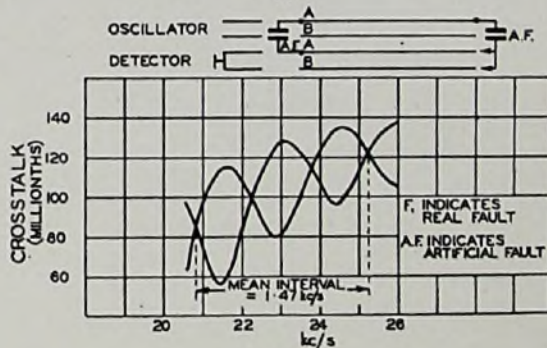

(c)

FIG. 5.—CROSSTALK FREQUENCY METHOD OF FAULT LOCATION.

³ I.P.O.E.E. Paper No. 138.

show the result of crosstalk measurements made with the artificial fault at the near and far end of the line and (c) gives similar curves for a good pair from which the cable constant can be calculated. As the curves are irregular, a better frequency interval is obtained by making measurements with an artificial fault first between two A wires and then between the A wire of one pair and the B of the other. The points of interception give the frequency interval. The value of the capacitance for the artificial fault is chosen so as to give the same crosstalk/frequency slope on a good pair as the real fault gives on its own. The mean of the two locations shown in Fig. 5 was 3.45 miles from the testing end.

The only length replaced near this point was approximately 3.3 miles away. On investigation, this length was found to be P.C.Q.T. cable.

If it is suspected that the wrong type of cable has been used, and an approximate localisation has been made, it can be confirmed without opening a joint, as the circumference of 24/40 carrier cable is about $\frac{1}{2}$ in. greater than that of 24/40 P.C.Q.T.

(2) Crossed Wires.

After repairs it is sometimes found that the A and B wires of a pair have been crossed. This gives rise to high crosstalk. Assume the simple condition of an AB cross introduced at the balancing frame. The worst value of crosstalk on the cable alone is of the order of 60 db. To neutralise this, a condenser of 150 pF will have been fitted. The introduction of the AB cross will mean that these two crosstalk paths add instead of opposing, and the resultant interference will be 54 db. The most probable value due to a cross at this point will be about 63 db. In practice crosses may occur at any joint in the cable. The resultant crosstalk is likely to be somewhat better than in the above example, but a worst value of 60 db. is not abnormal. As rebalancing is carried out only after at least three repairs, the need for avoiding crosses can readily be seen. If a cross is found during the tap-through tests, it should be taken out at the joint where the mistake has been made.

(3) Incorrect Connection of Test Circuits.

Intermediate repeater stations are usually unattended, and test and alarm circuits are extended to attended repeater stations. This is usually done by the phantom circuit derived from one pair and earth.

On one repeater section the cable had been rebalanced with both the disturbing and disturbed pairs freed from all equipment. Crosstalk measurements were then made with the disturbed pair working normally, and were found to have deteriorated by about 20 db. Investigations showed that the trouble was due to the test circuit arrangements. The crosstalk paths are shown in Fig. 6.

Interference takes place between the disturbing pair and the circuit made up of the test phantom

and earth. This by-passes the repeater and a crosstalk path exists to any other pair at the low level side of the repeaters. The interference is amplified

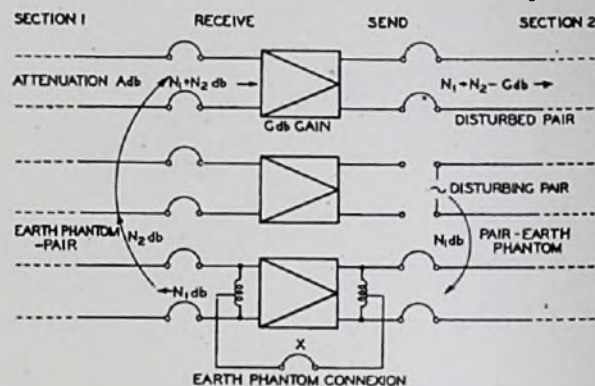

FIG. 6.—EFFECT ON CROSSTALK OF EARTH PHANTOM CONNECTION WHEN CABLE LINKS INSERTED AT REPEATER STATION.

and appears as far-end crosstalk at the high level side. The sum of the paths N_1 and N_2 may be about 110 db., while the gain of the amplifier is of the order of 60 db. This means that the far-end crosstalk may be reduced to 50 db. The worst case measured was 59 db. and the most probable value 64 db., but only 23 combinations were measured and it is probable that worse values existed.

A high frequency choke which should have been fitted at X (Fig. 6) had been omitted. This would introduce a further loss of about 40 db. in the crosstalk paths and the interference would then have been negligible.

When a number of spare pairs exist one of these may be used for the test circuit. The pair in the low level cable on one side of an unattended station is connected to the low level cable on the other side. Similarly, the test pairs in the two high level cables are joined together. If, however, high and low level cables are linked conditions similar to those described above are obtained. In one instance this was done and although no measurements were made the crosstalk was sufficiently bad for some of the channels to be unworkable.

Conclusion.

It has been shown that if repairs are not carried out correctly, or the rebalancing of carrier cables is neglected, excessive crosstalk will soon develop but, with proper attention, interference can be reduced to a satisfactory level. The introduction of 24-channel working will mean that still closer attention will have to be given to rebalancing work, but no difficulty is anticipated in maintaining a high standard of crosstalk immunity.

In conclusion, thanks are due to the staff of the Engineer-in-Chief's Cable Test Section, whose work and experience have provided the data for the examples quoted, and in particular to Mr. A. A. F. Everett for the preparation of the diagrams.

Notes and Comments

Roll of Honour

The Board of Editors deeply regrets to have to record the deaths of the following members of the Engineering Department :—

While serving with the Armed Forces, including Home Guard.

Aberdeen Telephone Area ..	Bewick, C. ..	Unestablished Skilled Workman	Sergeant Pilot, Royal Air Force
Birmingham Telephone Area	Leworthy, L. W... ..	Skilled Workman, Class II ..	Sergeant, Kings Regiment
Birmingham Telephone Area	Murray, E. J. ..	Unestablished Skilled Workman	Pilot Officer, Royal Air Force
Birmingham Telephone Area	Poulton, W. A. ..	Unestablished Skilled Workman	Sergeant, Royal Air Force
Bristol Telephone Area ..	Wilson, A. J. F. ..	Inspector	Sergeant, Royal Corps of Signals
Cambridge Telephone Area	Joplin, J. H. ..	Skilled Workman, Class II ..	Captain, Royal Army Service Corps
Edinburgh Telephone Area	Smith, S. ..	Skilled Workman, Class II ..	Lance Sergeant, Royal Corps of Signals
Engineering Department ..	Bardsley, V. ..	Motor Mechanic.. ..	Chief Motor Mechanic, Royal Navy
Engineering Department ..	Bolam, W. H. ..	Clerical Officer	Sergeant Pilot, Royal Air Force
Engineering Department ..	Heasman, E. E. ..	Clerical Officer	Private, Gordon Highlanders
Engineering Department ..	Procter, N. W. ..	Unestablished Skilled Workman	Sergeant, Royal Air Force
Engineering Department ..	Spillett, L. F. S. R.	Unestablished Skilled Workman	Craftsman, Royal Electrical and Mechanical Engineers
Engineering Department ..	Wood, G. F. ..	Unestablished Skilled Workman	Able Seaman, Royal Navy
Exeter Telephone Area ..	Colwell, A. W. J... ..	Skilled Workman, Class I ..	Flight Sergeant, Royal Air Force
Exeter Telephone Area ..	Sabine, D. S. ..	Unestablished Draughtsman ..	Flight Sergeant, Royal Air Force
Glasgow Telephone Area ..	Baxter, J. F. ..	Skilled Workman, Class II ..	Corporal, Royal Corps of Signals
Glasgow Telephone Area ..	Landies, W. L. H. B.	Unestablished Skilled Workman	Flying Officer, Royal Air Force
Glasgow Telephone Area ..	Prior, J. F. ..	Skilled Workman, Class II ..	Corporal, Royal Corps of Signals
Leicester Telephone Area ..	Rudkin, S. I. ..	Unestablished Skilled Workman	Pilot Officer, Royal Air Force
London Telecommunications Region	Allden, B. E. E. ..	Unestablished Skilled Workman	Warrant Officer, Royal Air Force
London Telecommunications Region	Bennett, F. C. ..	Skilled Workman, Class II ..	Company Quarter Master Sergeant, Royal Corps of Signals
London Telecommunications Region	Bond, S. G. ..	Unestablished Skilled Workman	Sergeant Navigator, Royal Air Force
London Telecommunications Region	Cameron, E. T. ..	Skilled Workman, Class II ..	Signalman, Royal Corps of Signals
London Telecommunications Region	Carpenter, R. F. ..	Unestablished Skilled Workman	Sergeant, Royal Air Force
London Telecommunications Region	Cracknell, H. E. ..	Unestablished Skilled Workman	Sergeant, Royal Air Force
London Telecommunications Region	Cramp, A. J. ..	Skilled Workman, Class II ..	Petty Officer, Royal Navy
London Telecommunications Region	Hayward, R. F. ..	Unestablished Skilled Workman	Pilot Officer, Royal Air Force
London Telecommunications Region	Newton, K. H. ..	Unestablished Skilled Workman	Aircraftman Class II, Royal Air Force
London Telecommunications Region	Peek, E. P. H. ..	Skilled Workman, Class II ..	Flight Sergeant, Royal Air Force

London Telecommunications Region	Petts, L. A. H.	..	Unestablished Skilled Workman	Sergeant, Royal Air Force
London Telecommunications Region	Powell, H. G. C.	..	Unestablished Skilled Workman	Sergeant Flight Engineer, Royal Air Force
London Telecommunications Region	Puddephat, L. T.	..	Unestablished Skilled Workman	Pilot Officer, Royal Air Force
London Telecommunications Region	Randolph, W.	..	Skilled Workman, Class II	.. Flying Officer, Royal Air Force
London Telecommunications Region	Rogers, D. R.	..	Unestablished Skilled Workman	Pilot Officer, Royal Air Force
London Telecommunications Region	Shattock, J. L.	..	Skilled Workman, Class II	.. Flying Officer, Royal Air Force
London Telecommunications Region	Stewart, W. T.	..	Skilled Workman, Class II	.. 2nd Lieutenant, Army Air Corps
London Telecommunications Region	Watts, T. R.	..	Skilled Workman, Class II	.. Bombardier, Royal Artillery
London Telecommunications Region	Willett, F. J.	..	Skilled Workman, Class II	.. Sergeant, Royal Air Force
Manchester Telephone Area	Bates, J. Skilled Workman, Class II	.. Lance Sergeant, Royal Corps of Signals
Manchester Telephone Area	Wood, F. E.	..	Unestablished Skilled Workman	Signalman, Royal Corps of Signals
Oxford Telephone Area	Liebermann, W. C.	..	Unestablished Skilled Workman	Pilot Officer, Royal Air Force
Peterborough Telephone Area	Maxey, H.	..	Skilled Workman, Class II	.. Sergeant, Royal Army Service Corps
Peterborough Telephone Area	Rowland, G. R.	..	Skilled Workman, Class I	.. Flying Officer, Royal Air Force
Preston Telephone Area	Robinson, H.	..	Unestablished Skilled Workman	Lance Sergeant, Royal Corps of Signals
Sheffield Telephone Area	Marshall, H.	..	Labourer	.. Sergeant, Royal Artillery
Shrewsbury Telephone Area	Machin, L. W.	..	Skilled Workman, Class I	.. Flying Officer, Royal Air Force
Southampton Telephone Area	Spence, K. H. Y.	..	Skilled Workman, Class II	.. Signalman, Royal Corps of Signals
Tunbridge Wells Telephone Area	Garner, W. F.	..	Unestablished Skilled Workman	Sergeant, Royal Air Force

Recent Awards

The Board of Editors has learnt with great pleasure of the honours recently conferred on the following members of the Engineering Department :—

While serving with the Armed Forces, including Home Guard.

Birmingham Telephone Area	Thirks, R. D.	..	Inspector	Flight Lieutenant, Royal Air Force	Distinguished Flying Cross
Engineering Department	Ogden, R. S. I.	..	Inspector	Captain, Royal Corps of Signals	Mentioned in Despatches
Engineering Department	Wood, G. H.	..	Mechanic I/C, Grade III	Pilot Officer, Royal Air Force	Distinguished Flying Medal
Liverpool Telephone Area	Urwin, R. L.	..	Unestablished Draughtsman	Sergeant, Royal Air Force	Distinguished Flying Medal
Leicester Telephone Area	Graham, J. W.	..	Labourer	Lance Sergeant, Royal Artillery	Mentioned in Despatches
London Telecommunications Region	Ball, D. A. J. W.	..	Unestablished Skilled Workman	Flight Sergeant, Royal Air Force	Distinguished Flying Medal
London Telecommunications Region	Ball, D. S.	..	Unestablished Skilled Workman	Flying Officer, Royal Air Force	Distinguished Flying Cross
London Telecommunications Region	Howes, E. J.	..	Skilled Workman, Class II	Pilot Officer, Royal Air Force	Distinguished Flying Cross
London Telecommunications Region	Mitchell, E. A.	..	Skilled Workman, Class II	Sergeant, Royal Corps of Signals	Mentioned in Despatches
London Telecommunications Region	Nicholls, J. E.	..	Skilled Workman, Class II	Corporal, Royal Corps of Signals	Military Medal

Middlesbrough Area	Telephone	Dobson, R. S. L. B.	Skilled Workman, Class II	Major, Corps of Military Police	Mentioned in Despatches
Newcastle-on-Tyne	Telephone Area	Petrie, W.	Skilled Workman, Class I	Sergeant, Royal Corps of Signals	Mentioned in Despatches
Plymouth	Telephone Area	Stokes, E. F. J.	Skilled Workman, Class II	Flight Sergeant, Royal Air Force	Mentioned in Despatches
Scottish Region	Wood, E. W.	Regional Motor Transport Officer	Lieut. Colonel, Royal Engineers' Postal Service	Mentioned in Despatches
Sheffield	Telephone Area	Rae, H. S.	Skilled Workman, Class II	Sergeant, Coldstream Guards	Mentioned in Despatches
Stoke-on-Trent Area	Telephone	Savage, G. H. R.	Unestablished Skilled Workman	Corporal, Royal Corps of Signals	Military Medal

Regional Notes

Home Counties Region

ERECTION OF DOUBLE-SPLICED 113-FT. POLES.

An interesting job has just been completed in the Bedford Area which involved the erection of four poles 105 ft. in height above ground level, to carry a radio aerial.

The poles were specially requisitioned as 113 ft. poles, from the Stores Department, via the Engineer-in-Chief. This length allowed for 8 ft. in the ground, leaving the required 105 ft. in height. Three poles matched and ready cut for splicing were supplied for each mast, the three individual poles being made up of: One 55 S, one 45 M, and one 24 L.

The poles were scarfed and bored at the pole depot before dispatch and each half of the scarf was marked with a number so that the poles could be readily assembled on site. It was found after assembling that, partly owing to war-time poles and partly to the angle at which the scarfs had been cut, some of the poles presented a rather crooked appearance. Part of this crookedness was taken out by careful adjustment at the splices and in one case by changing the 24 ft. top pole for a better one from a local pole stack, which was scarfed locally to match.

Each mast was bolted together on the ground, pole steps fitted to within 10 ft. of the ground-line, and aerial attachment and stays fixed. Three stays were fixed at each splice, spaced for ground attachment at 120°, with four stays at the top of the mast, the additional stay being used to take the aerial strain. The splices were strengthened by three bands instead of the usual two, the bands being made by a local blacksmith.

It was seen that the poles tended to bend in more than one direction. These tendencies appeared to be rectified by blocking or rolling to a new position. It was therefore apparent that any lifting strain must be evenly distributed. To enable this to be done, two straps of 7/8 stay-wire were used to provide three points of attachment of the lifting tackle, one end of each strap being attached between the two splices and the other ends to the top and bottom component poles. The ends of a sling formed of 7/8 stay-wire were then attached to the straps and a snatch-block fitted to run freely on the sling.

For the actual erection of the masts, two derricks were used, the first being erected about 65 ft. in front of, and the second about 40 ft. to the rear of, the mast site.

On the first derrick a double and treble set of main rope tackle, with luff tackle, was mounted in the stan-

dard way, the double block of the main tackle being attached to the snatch-block fitted to the previously-mentioned 7/8 wire sling. The snatch-block, being free to run on the sling, gave a self-adjusting lift on the mast. The mast was then raised to a position making an angle of about 25° with the ground line, with the butt within a foot of the bottom of the hole. At this stage side guys were made fast.

On the second derrick three sets of tackle were used. A single 2-in. rope attached near the top of the mast was supported at the derrick head in a single block so arranged that the rope would lift clear as the mast was raised. A 3-in. single and double tackle was rigged between the top splice and the derrick and a 3-in. double and treble tackle between the bottom splice and the derrick. The running ends were taken down the derrick via snatch-blocks to luff tackles. The falls of these tackles were bent to the lories, which were operated in reverse gear for hauling.

As soon as the weight was taken by the second derrick, the first derrick was cleared and the mast was taken up into position under the control of one man signalling to the lories. The top stays were used as guy lines as the pole went up. All the stays were broken up into 20 to 30 ft. lengths by W.T. insulators, U-bolt clips being used for making-off the wire at each insulator. 7/14-strand G.I. wire was used for the stays, and normal terminations on the poles were made.

Very careful adjustments were necessary to individual tensions of each of the ten stays to keep the masts as straight as possible, it being found that the masts would easily buckle at the splices if the tensions were not correct and the final job would not have been shipshape and Bristol fashion.

Altogether an interesting work and one which demonstrates the versatility of the Post Office staff and the ability to cope with any demand on their services.

E. H. P.
E. T. G.

ERECTION OF 4/40 SP + 490/20 AERIAL CABLE.

To meet demands for defence circuits in the Oxford Area it was necessary to provide quickly 10½ miles of 4/40 SP + 490/20 cable. Only 1½ miles of duct space was available and in view of the urgency of the requirement it was decided to lay 7½ miles of tape-protected cable in the ground and to the remaining 1¼ miles on existing pole line. The cable has a diameter of 2.72 in. and weighs 26.47 cwt. per 100 yards. As this cable was larger than any which had been erected before, the following notes may be of interest.

The cable was above the maximum weight that can be supported by a single 7/8 wire and the E.-in-C. decided that a double-wire suspension support should be used. The main wire was erected in the normal manner and the second wire (7/13 steel) was run-out along the line and enclosed in the cable-rings as they were attached to the main wire. When the ringing had been completed, the lighter wire was tensioned to a predetermined value so that its sag was slightly greater than that of the main wire. At the ends of each span the two wires were clamped together. The cable was then drawn into the rings and on completion of the cabling the lighter wire was located at the top of the inside of the eye of the rings immediately below the main wire. In this manner the stress imposed by the cable is distributed between the two wires.

Officers from the Construction Branch of the E.-in-C.'s Office attended during the progress of the cable erection, which was carried out by Standard Telephones & Cables, Ltd. The photograph indicates the

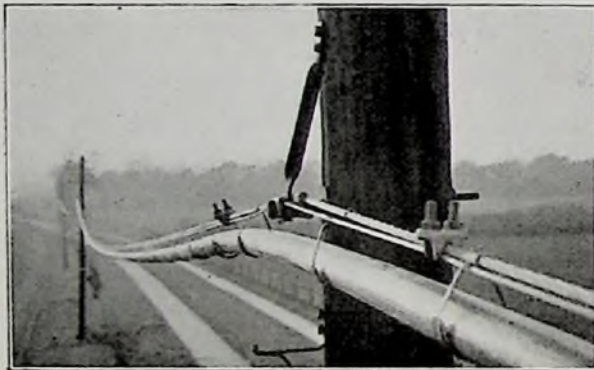

FIG. 1.—AERIAL CABLE AT "THROUGH" POLE

position at a through pole on the line. Two methods of attaching the rings were tried, as the E.-in-C. desired to obtain information of the relative merits of the two methods.

S. E. N.

SHIFTING MAIN AERIAL CABLE ROUTE.

Due to the County Council concerned having acquired land to improve a dangerous bend in a main road, a request was made to set back to a new fence line three stout poles situated on a high bank, which it was necessary to excavate to improve the vision round the bend. Carried on these poles were 16-100 lb. copper wires and a 216/20 main aerial cable supported

by a 7/8 strand steel wire, pulled up to a tension of 6,000 lb.

Ordinarily the method adopted would have been to provide a new length of cable, cut and re-terminate the steel suspension strand spans and fit three stays to each pole. This method would have been costly, and in addition intermittent interruption to important circuits working in the cable could not be ruled out.

It was therefore decided that an endeavour should be made to shift the cable intact, this being done in the following order:—

Operation 1.

Preparing new section of pole line—transferring of O.H. wires—stripping of old poles on sites and slackening of cable bracket bolts between the two points of termination.

Operation 2.

Rigging up main blocks and tackle. Treble block fitted to head of gallows stay-pole and double block carried across road and fixed to steel suspension wire at a point near cable bracket. Running end of main tackle to luff tackle via snatch-block at base of stay-pole.

Operation 3.

The weight of the cable on release from the old pole was taken by fitting a snatch-block between the steel suspension wire and an over-road stay-wire. As the known weight of the cable is 14 cwt. per 100 yds. it was quite apparent, even though supported by the over-road stay, that on release a certain amount of sag would result, which would require lifting to its new position. A guy line was therefore fixed on the off-side of the new pole and a light set of blocks and tackle fitted between the head of the new pole and the steel suspension-wire, the running end taken via a snatch-block at the base of the new pole.

Operation 4.

Release of the suspension wire from its old fixing was effected by a pull on the luff tackle. The cable now held, allowed removal of the old pole. Simultaneous release of the main tackle together with a steady pull on the lifting tackle worked effectively, as within a matter of minutes the suspension wire was seated comfortably in its new position on the new pole. These operations were repeated at each point affected.

Operation 5.

Slack suspension wire and cable accumulated was distributed equally between the two terminating points and effected by rigging up light sets of block and tackle at each pole in turn—one set either side of the cable brackets—the suspension steels lifted and eased through.

O. J. W.

Staff Changes.

Promotions

Name	Region	Date	Name	Region	Date
<i>Area Engr. to Asst. T.M.</i>					
Kilgour, A.	Scot. Reg. to Glasgow	21.1.44	Waterman, W. R.	L.T.R.	24.3.44
<i>Asst. Engr. to Exec. Engr.</i>					
Reed, R. E.	W. & B.C. Reg.	12.3.44	Price, S. E.	L.T.R.	14.5.44
Crook, H. G.**	H.C. Reg. to Scot. Reg.	5.3.44	Greaves, H.	N. Ire. Reg.	9.5.44
Stanbury, H. C. O.	Mid. Reg. to Scot. Reg.	5.3.44	Body, G. E. H.	S.W. Reg.	20.4.44
Partridge, F. V.	L.T.R.	16.3.44	Trott, S. L.	S.W. Reg.	14.5.44
Arnold, W. H.**	Mid. Reg.	16.4.44	Porter, J. M.	N. Ire. Reg.	12.5.44
Trott, L. J.	W. & B.C. Reg. to S.W. Reg.	16.4.44	<i>Draughtsman, Class II, to Draughtsman, Class I.</i>		
Jeffs, H.	W. & B.C. Reg. to N.E. Reg.	20.4.44	Wood, S. P.	L.T.R.	29.1.44
McLean, H.	N.E. Reg.	1.4.44	Kiff, N. C.	L.T.R.	1.3.44
Dolton, H. J.	E.-in-C.O.	25.4.44	Haley, H. H. J.	L.T.R.	20.3.44
<i>Chief Insp. to Asst. Engr.</i>			<i>S.W.1 to Inspr.</i>		
Watling, G. E. C.	L.T.R.	16.3.44	Duncanson, R. W.**	W. & B.C. Reg. to N.E. Reg.	3.1.44
Smart, H. W.	S.W. Reg. to W. & B.C. Reg.	16.4.44	Hudson, C. E.	N.E. Reg.	3.1.44
Emery, E. A.	L.T.R. to E.-in-C.O.	7.5.44	Price, A. A.	N.W. Reg. to Scot. Reg.	14.5.44
Duggan, W. G.	Scot. Reg. to Mid. Reg.	9.4.44	<i>Flanagan, E. G.</i>		
Fox, W. H.	E.-in-C.O.	3.3.44	<i>Chadburn, C. G.</i>		
Eagle, R. J. A.†	L.T.R.	24.3.44	<i>Hinchcliffe, R. V.</i>		
Doherty, G.	N.E. Reg. to W. & B.C. Reg.	8.4.44	<i>Crook, S.**</i>		
Edwards, A. G.	Scot. Reg. to E.-in-C.O.	2.4.44	<i>Symons, G. E.**</i>		
Broadhurst, J. H.	Scot. Reg. to E.-in-C.O.	20.3.44	<i>Scanlan, F. J.</i>		
Murray, J. B.	E.-in-C.O.	6.3.44	<i>Evans, H. W.</i>		
Connelly, A. E.	N. Ire. Reg. to E.-in-C.O.	9.5.44	<i>Salter, F. C.</i>		
Wearn, R. G. O.**	Mid. Reg.	14.5.44	<i>Moulds, R. E.</i>		
Tipple, J. W.	N.W. Reg. to Mid. Reg.	14.5.44	<i>Watkins, A. H.</i>		
Attwood, J. W. A.	E.-in-C.O.	28.3.44	<i>Terrington, D. G.**</i>		
<i>Chief Insp. to Asst. Sales Investigation Officer.</i>			<i>Pharoah, K. C. A.**</i>		
Baker, E. C.	E.-in-C.O. to P.R.D.	1.3.44	<i>Longmore, D. S.**</i>		
<i>Chief Inspr. to Chief Inspr. with Allcc.</i>			<i>Wyness, A. W.**</i>		
Smith, A. E.	H.C. Reg.	24.4.44	<i>Tribe, H. T.</i>		
<i>Draughtsman, Class I, to Senior Draughtsman.</i>			<i>Partington, E. V.</i>		
Soper, W. A.	L.T.R.	31.1.44	<i>Walker, N.</i>		
<i>Inspr. to Chief Insp.</i>			<i>Tarbet, A. G.</i>		
Cooke, E. M.	S.W. Reg.	27.2.44	<i>Hardie, J. B.</i>		
Garner, B.	W. & B.C. Reg.	20.1.44	<i>Gill, T.</i>		
Bishop, J. E.	Mid. Reg.	23.2.44	<i>Peak, C. H.</i>		
Coster, F. A. J.	E.-in-C.O.	1.3.44	<i>Thomson, D.</i>		
Stiles, O. A.**	E.-in-C.O.	6.3.44	<i>Dawes, O. K.</i>		
Mowbray, A. H.	E.-in-C.O.	1.3.44	<i>Myerson, R. J. W.</i>		
Bryan, B. H.†	E.-in-C.O.	6.3.44	<i>Irwin, A.</i>		
Cox, E. B.	E.-in-C.O.	6.3.44	<i>Roberts, M. E.</i>		
Barrass, J. A.	N.W. Reg. to Scot. Reg.	2.4.44	<i>Higson, R. P.</i>		
Cooper, N. A.	W. & B.C. Reg. to Scot. Reg.	16.4.44	<i>Cunnington, J. L.</i>		
Simpson, E.	Mid. Reg. to Scot. Reg.	9.4.44	<i>Sutcliffe, N.</i>		
King, J. W. G.	L.T.R.	1.2.43	<i>Wilson, J.</i>		
Halliday, C. L.	W. & B.C. Reg. to N.W. Reg.	16.4.44	<i>Green, D.</i>		
Loughlin, J. J.	Scot. Reg.	28.4.44	<i>Smith, G. E.</i>		
Abbotts, G. E.	H.C. Reg.	8.4.44	<i>Fowler, R. H. Q.</i>		
Parker, A. A. E.	L.T.R.	16.3.44	<i>Sale, K. W.</i>		
Hunter, W. J.	N.E. Reg.	5.4.44	<i>Hughes, A. V.</i>		
			<i>Kitchenn, R. G.</i>		
			<i>Smith, K. W.</i>		
			<i>Moxon, R. L.</i>		
			<i>Ashwell, J. L. K.</i>		
			<i>Jefferys, J. G.</i>		
			<i>Emmett, K. F.</i>		
			<i>Mech. I/C Grade I to Tech. Asst.</i>		
			Jenkinson, W. Birmingham 26.4.44		

** Mobilised.

† On loan to another Government Department.

} Promoted in absentia.

Retirements

Name	Region	Date	Name	Region	Date
<i>Area Engr.</i>			<i>Chief Insp.</i>		
McDonald, C. G. A. W. & B.C. Reg.	..	9.3.44	Akester, G. B.	.. N.E. Reg.	.. 4.4.44
Graham, R. B.	.. N.E. Reg.	.. 31.3.44	Jacobs, G. E. J.	.. S.W. Reg.	.. 22.5.44
<i>Asst. Engr.</i>			<i>Insp.</i>		
Browning, W. H.	.. L.P.R.	.. 4.3.44	Grant, C.	.. N.E. Reg.	.. 18.2.44
Woodhouse, B. W.	.. E.-in-C.O.	.. 31.3.44	Mattison, J. G.	.. L.T.R.	.. 12.3.44
Deakin, R. E.	.. H.C. Reg.	.. 13.4.44	Milwood, W. E.	.. H.C. Reg.	.. 20.3.44
<i>Chief Insp. with Allee.</i>			Allen, A. G. R.	.. L.T.R.	.. 23.3.44
Cornish, G.	.. H.C. Reg.	.. 23.3.44	Lown, S. J.	.. N.W. Reg.	.. 25.3.44
Perkins, B. H.	.. H.C. Reg.	.. 23.4.44	Perry, W. H.	.. W. & B.C. Reg.	.. 31.3.44
			Hammond, F. R.	.. N.W. Reg.	.. 2.4.44
			Farr, A. G. K.	.. S.W. Reg.	.. 27.4.44

Transfers

Name	Region	Date	Name	Region	Date
<i>Exec. Engr.</i>			<i>Insp.</i>		
Harmston, A. T.	.. L.T.R. to E.-in-C.O.	.. 16.4.44	Noble, W. A.	.. E.-in-C.O. to Scot. Reg.	19.3.44
<i>Asst. Engr.</i>			Prickett, S. L.	.. E.-in-C.O. to L.T.R.	.. 2.4.44
Bawtree, K. O.	.. E.-in-C.O. to L.P.R.	.. 6.3.44	Harbord, C.	.. E.-in-C.O. to W. & B.C. Reg.	.. 30.4.44
Osborne, A. D.	.. E.-in-C.O. to Mid. Reg.	.. 1.4.44	Purves, R. F.	.. Mid. Reg. to E.-in-C.O.	.. 1.5.44
Whittingham, L.	.. Mid. Reg. to W. & B.C. Reg.	.. 23.4.44	Dowden, B. F.	.. L.T.R. to E.-in-C.O.	.. 1.5.44
<i>Chief Insp.</i>			Chinchen, H.	.. E.-in-C.O. to H.C. Reg.	21.5.44
Shiple, F. H.	.. Scot. Reg. to N.W. Reg.	26.3.44	<i>Tech. Asst.</i>		
Cook, A. C.	.. E.-in-C.O. to Scot. Reg.	1.5.44	Pounder, L.	.. Birmingham to Leeds	26.4.44
Walker, R. C. W.	.. N.W. Reg. to L.T.R.	14.5.44			

Deaths

Name	Region	Date	Name	Region	Date
<i>Chief Insp.</i>			<i>Insp.</i>		
Tonkinson, G.	.. N.W. Reg.	.. 9.5.44	Wilson, A. J. F.	.. S.W. Reg. (on Military Service)	.. 27.2.44
			David, A. J.	.. W. & B.C. Reg.	.. 18.3.44

CLERICAL GRADES

Retirement

<i>E.O.</i>					
Bayly, A. E.	.. E.-in-C.O.	.. 31.5.44			

BOARD OF EDITORS

A. J. GILL, B.Sc., M.I.E.E., F.I.R.E., Chairman.
 F. E. NANCARROW, O.B.E., A.R.C.Sc., M.I.E.E.
 P. B. FROST, B.Sc., M.I.E.E.
 A. H. MUMFORD, B.Sc.(ENG.), M.I.E.E.
 C. W. BROWN, A.M.I.E.E.
 G. H. S. COOPER.
 H. LEIGH, B.Sc.(ENG.), A.M.I.E.E., Acting Managing Editor.
 G. E. STYLES, A.M.I.E.E., Acting Assistant Editor.
 A. J. BAKER, Secretary-Treasurer.

Copyright

The entire contents of this JOURNAL are covered by general copyright, and special permission is necessary for reprinting long extracts, but Editors are welcome to use not more than one-third of any article, provided credit is given at the beginning or end thus: "From the *Post Office Electrical Engineers' Journal*."

The Board of Editors is not responsible for the statements made or the opinions expressed in any of the articles in this JOURNAL, unless such statement is made specifically by the Board.

Back Numbers

The price of the JOURNAL, which is published quarterly, is 1s. (1s. 3d. post free) per copy, or 5s. per annum post free. Back numbers can be supplied, subject to availability of stocks, at 1s. each (1s. 3d. post free). Orders for back numbers may be sent to the Local Agents or to the Publishers.

Advertisements

All communications relating to space reservations should be addressed to the Advertisement Editor, *P.O.E.E. Journal*, Alder House, Aldersgate Street, London, E.C.1. Communications regarding advertisement copy, proofs, etc., should be addressed to the Publishers, Messrs. Birch & Whittington (Prop. Dorling & Co. [Epsom], Ltd.), 49 Upper High Street, Epsom, Surrey.

Communications

All Communications should be addressed to the Managing Editor, *P.O.E.E. Journal*, Engineer-in-Chief's Office, Alder House, Aldersgate Street, London, E.C.1. Telephone: HEADquarters 1234. Remittances should be made payable to "The *P.O.E.E. Journal*" and should be crossed "& Co."

So much depends on them



"AVO" Electrical Testing Instruments are actively engaged on the fighting and factory fronts, sharing a great responsibility with a proud sense of duty and high confidence in the future.

It will therefore be appreciated by our numerous trade friends that we can now only accept orders which bear a Government Contract Number and Priority Rating.



Sole Proprietors and Manufacturers

THE AUTOMATIC COIL WINDER AND ELECTRICAL EQUIPMENT CO. LTD.
Winder House, Douglas Street, London, S.W.1

Phone: VICTORIA 3404-8

WIDE-RANGE TRANSFORMERS

TYPES D-106 & D-139

For Modern Communications Equipment



- **FREQUENCY CHARACTERISTICS**

Practically linear from the lower audio frequencies to over 100 Kc/s.

- **IMPEDANCE RATIOS**

Many impedance ratios are available, from 1 : 1 to 500 : 1.

- **POWER**

Types D-139 will handle up to one watt AC power above 40 c.p.s. Types D-106 are designed as input and interstage transformers where the power is negligible.

- **SCREENING**

All types double screened against electromagnetic and electrostatic interference.

- **DIMENSIONS**

2½" × 3½" × 3" high overall.

- **WEIGHT 2½ lb.**

MUIRHEAD

Full information is given in Bulletin B-538-A which will gladly be sent on request.

MUIRHEAD AND COMPANY LIMITED, ELMERS END, BECKENHAM, KENT. BECKENHAM 0041-0042
FOR OVER 60 YEARS DESIGNERS AND MAKERS OF PRECISION INSTRUMENTS



PRINTING
TELEGRAPH
APPARATUS

TELEPRINTERS
HIGH SPEED MORSE INSTRUMENTS
RELAYS
AND REPEATERS

CREED AND CO. LTD
CROYDON

iv



Hundreds of thousands of Westinghouse Metal Rectifiers are in daily use by G.P.O. and telecommunication engineers. They are playing a silent and efficient part in keeping British telecommunication practice to the fore; and their increasing use is undoubtedly due to their long life and high efficiency.

Telegraphy and telephony power supply and battery charging . . . attenuators, modulators, V.F. rectifiers . . . radio communication power supply . . . there's a Westinghouse Metal Rectifier for each application . . . and behind each unit is the backing of over 17 years' rectifier development and technique.

Descriptive pamphlet No. 11H contains much of interest to telecommunication engineers. We shall be pleased to send you a copy.

WESTINGHOUSE BRAKE & SIGNAL CO. LTD.
Pew Hill House, Chippenham, Wilts.



The Light

In peaceful To-morrow, we must not grope in the darkness of Ignorance or stumble in the labyrinth of Misunderstanding. And we shall not. For the light of Victory that gleams ever brighter, is also the light that has shown us the errors of Yesterday. We face a future of new ideas and new ideals. It is to be our reward for long years soured by the bitterness of War . . . The creative genius of electrical science has not slept through the agony of conflict. It has never paused since the days of Ohm and Watt, Franklin and Faraday, Cavendish and Kelvin. It did not cease even when the wonder of ship talking to ship, plane to plane, and nation to nation had been achieved. It continues to flourish and fill with awe and admiration, all those who witness its work. And proud of their place in the field of electrical science are A.T.M. Engineers who, in developing still further those inventions which help neighbour talk to neighbour, hope thereby to further the cause of Freedom.

AUTOMATIC TELEPHONE & ELECTRIC CO. LTD.

MANUFACTURERS OF AUTOMATIC TELEPHONE EQUIPMENT, CARRIER TELEPHONE EQUIPMENT, A.T.M. REMOTE CONTROL EQUIPMENT, ELECTRO-MATIC VEHICLE ACTUATED TRAFFIC SIGNALS, MINE SIGNALLING EQUIPMENT, RYTHMATIC CONTROL, A.T.M. STREET FIRE ALARM EQUIPMENT, AND APPARATUS INVOLVING LIGHT-CURRENT SIGNALLING TECHNIQUE.

London & Liverpool



For large scale Electrical Purposes

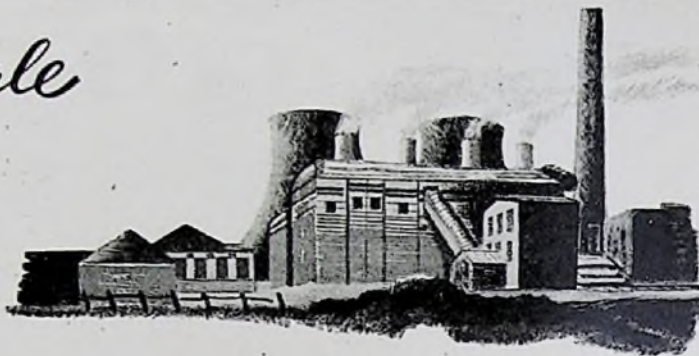

It is noteworthy where Tudor accumulators are to be found fulfilling the most important duties: over 500 British Power Stations installed Tudor. Many Tudor installations rank among the largest in the land and have an enviable reputation for long-lived reliability. No matter whether they were installed only yesterday, or over thirty

years ago—as many of them were—they are to-day functioning with consistent efficiency.

SAFETYLYTE (Patent No. 313248) is the Tudor Emergency Lighting System, which is automatic and instantaneous in operation. It is installed in thousands of schools, hospitals, factories and other large buildings.



TUDOR ACCUMULATORS

THE TUDOR ACCUMULATOR CO. LTD
50 GROSVENOR GARDENS, LONDON, S.W.1

WT38/44

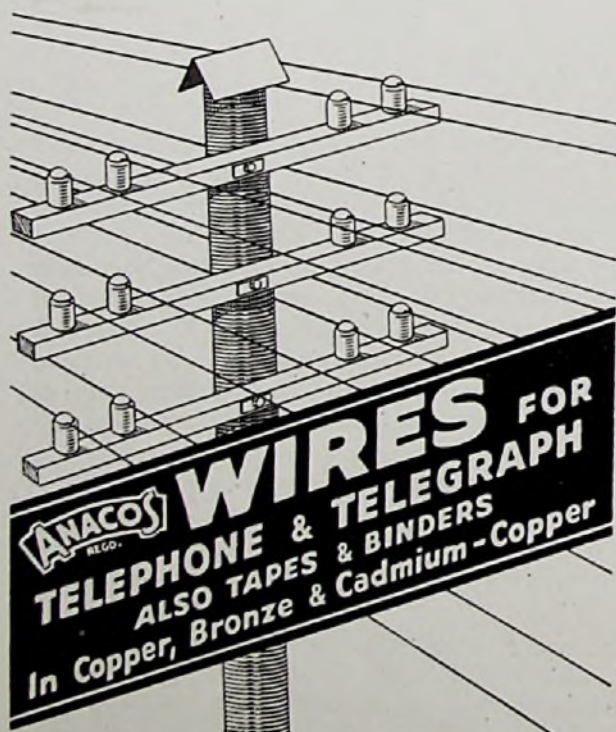

FREDERICK SMITH & CO. LTD. (Incorporated in The London Electric Wire Company and Smiths, Limited.)
ANACONDA WORKS, SALFORD, 3, LANCS.
Telephone: BLACKFRIARS 8701 (8 lines) Telegrams: "ANACONDA" MANCHESTER



TENAPLAS Electrical Insulation

TENAPLAS LTD., 7 PARK LANE, LONDON, W.1

SIEMENS PRODUCTS

backed by over 80 years' Electrical Experience

Contractors for
the manufacture, laying and main-
tenance of Submarine and Land
Cables for Telegraphy, Telephony
and the Electric Transmission of
Power, for the erection and main-
tenance of Overland Telegraph,
Telephone and Power Transmission
Lines, Marine Wireless Telegraph
and Telephone Installations, Public
and Private Telephone Exchanges
and Carrier Equipment for
Telephone Lines.

Manufacturers of

Electric Lamps of all types for
Domestic, Industrial and Street
Lighting, including "Sieray" Electric
Discharge Lamps, Fluorescent Tubes,
Motor Car Lamps, Projectors, etc.



**ELECTRIC
WIRES & CABLES**

**CABLE
JOINT BOXES**

TELEPHONE CABLES
Aerial, Underground, Submarine

**OVERHEAD
LINE MATERIAL**

CELLS & BATTERIES
Dry, Fluid & Inert

**ELECTRICAL
MARINE APPARATUS**

**ELECTRIC
LAMPS**

**PRIVATE
TELEPHONE SYSTEMS**

**PUBLIC
TELEPHONE EXCHANGES**

**CARRIER-CURRENT
EQUIPMENT**

**WIRELESS EQUIPMENT
FOR SHIPS**

"ZED" FUSES
L.T. SWITCH & FUSE GEAR

SIEMENS BROTHERS & CO., LTD.
WOOLWICH, LONDON, S.E. 18

SIEMENS ELECTRIC LAMPS & SUPPLIES LTD., 38-39 UPPER THAMES STREET, LONDON, E.C. 4



The War has not been allowed to interfere with Ericsson quality . . . our telephone apparatus remains at that peerless efficiency that ensures trouble-free service. ERICSSON TELEPHONES LIMITED, 56, KINGSWAY, LONDON, W.C.2. (Tel.: HOLborn 6936.)

capco

REGISTERED TRADE MARK

QUARTZ CUTTING MACHINES

Q.2.B Machine. This is the original Q.2, but redesigned, giving full protection to all slides, lead screw, etc. New type gear box enlarged and strengthened.

Cutting can now be carried out in a totally enclosed clear view splash guard enclosing the whole table. There are other new and interesting features too—details on request.

**LIGHT & HEAVY DUTY MACHINES
HAVE BEEN RE-DESIGNED & IMPROVED
LATEST DEVELOPMENT, HAND AND
AUTOMATIC NOTCHING MACHINES
· · · DETAILS ARE NOW AVAILABLE**

CAPLIN ENGINEERING CO. LTD.

25 years of service to the engineering and allied trades.

Well over one thousand "CAPCO" machines in use to-day, including hundreds of special machines and apparatus. "CAPCO" is synonymous with accuracy.

Designers and manufacturers of Capco Sound-on-Film recorders and equipment. Capco built recorders are in use at Elstree, Pathe News and Universal Talking News, etc. Patentees and manufacturers of Capco Enamelled Wire Cleaning machines.

BEACONSFIELD RD WILLESDEN, LONDON, N.W.10

Sole Agents : CAPCO (Sales) LTD.

Telephone : WILlesden 0067-8

STANDARD WITH THE BRITISH POST OFFICE

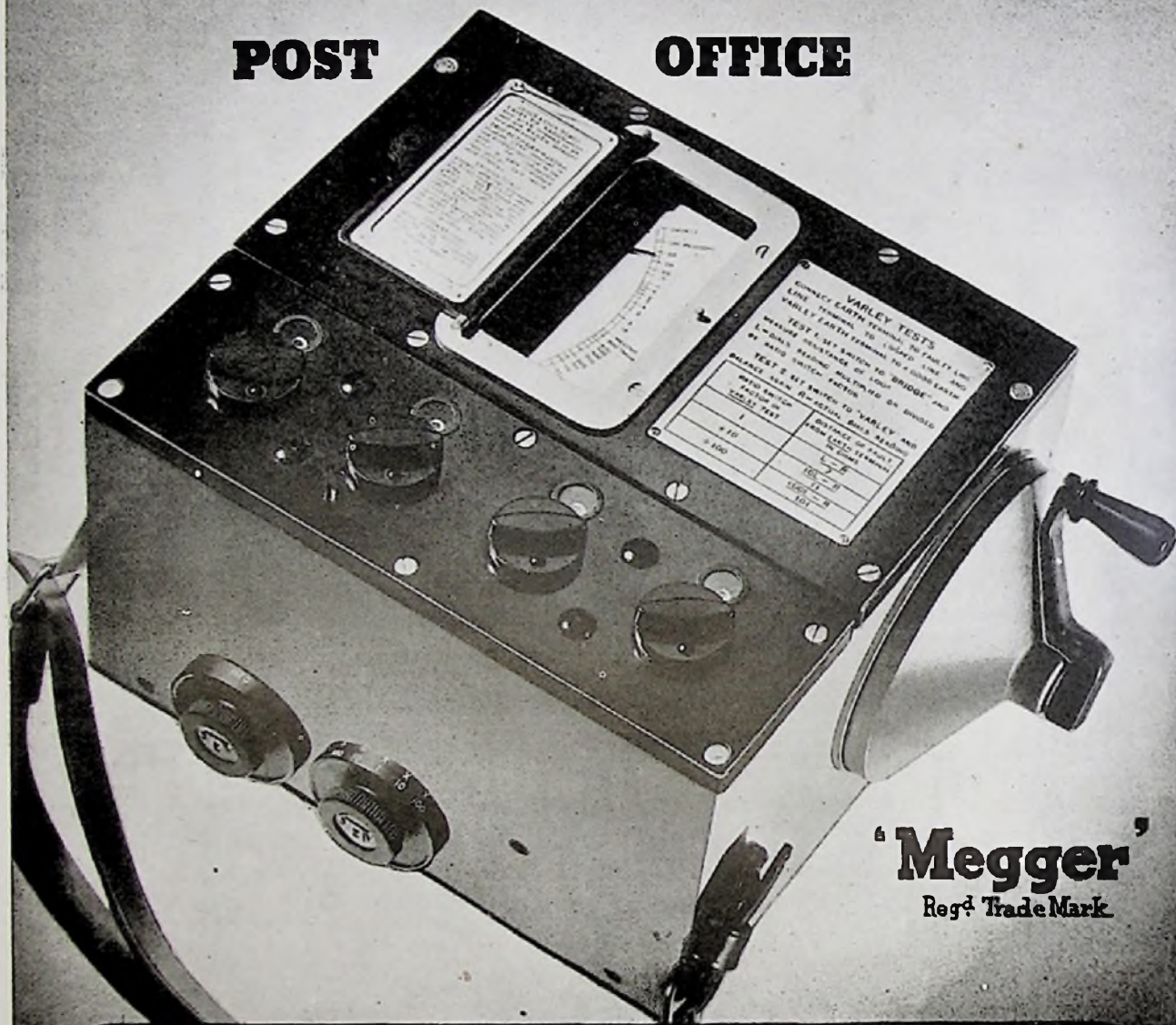

'Megger'
Regd Trade Mark

THE BRIDGE-MEG TESTING SET used by the British Post Office is a portable, self-contained instrument combining the functions of an Insulation Tester and a Wheatstone Bridge; it can be used for fault location by the Varley Loop method. Facilities can also be provided whereby, with the use of an external galvanometer and resistance box, the instrument may be used for making Murray Loop tests. Insulation range 100 megohms at 500 volts. Bridge range 0.01 to 999,900 ohms. Size 7x8 $\frac{1}{2}$ x12 ins. Weight 12 $\frac{3}{4}$ lbs. Mains operated instruments are also supplied to the British Post Office. Ask for list X 267.

EVERSHED & VIGNOLES LTD., CHISWICK, LONDON, W.4
TELEPHONE: CHISWICK 1370 * TELEGRAMS: "MEGGER" CHISK, LONDON

WR. 5-14



*'The best
of prophets
of the future
is the past'*—BYRON

BEHIND Alton stationary batteries stands a great tradition of painstaking effort and progressive improvement. To-day the result is reflected by the high standard of performance of Alton batteries in Power Houses, Telephone Exchanges and Broadcasting Stations. Because Alton practice is rooted in such fine tradition, to-morrow Alton batteries will be chosen for the maintenance of power supply in vital installations.

ALTON

BATTERIES OF MERIT

THE ALTON BATTERY COMPANY LIMITED
(Sole Suppliers of FULLER Stationary Batteries)
ALTON, HANTS

Phone: Alton 2267 and 2268 Grams: 'Battery, Alton'

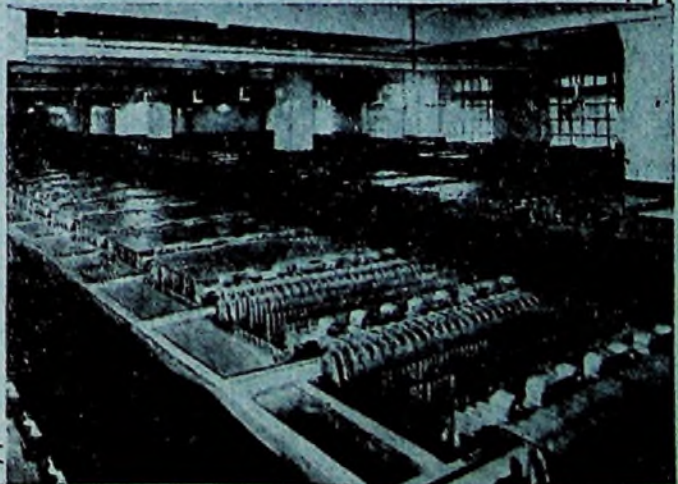

MAINTAINING EFFICIENCY

THE HIGH STANDARD OF EFFICIENCY
OF PIRELLI - GENERAL TELEPHONE
CABLES IS MAINTAINED BY THE
CONTINUOUS RESEARCH WORK OF
AN EXPERIENCED TECHNICAL STAFF.

TELEPHONE
SOUTHAMPTON
2141 (5 lines)

PIRELLI-GENERAL
CABLE WORKS, Ltd., SOUTHAMPTON.

TELEGRAMS
"PIGEKAYBEL"
SOUTHAMPTON.

$\frac{3}{100}$ of an Inch X 1 mile

and the Three Cores
of Flux are there

We make Ersin Multicore Solder Wire as fine as 22 S.W.G. (.028 in.) and it has three cores of Ersin Flux throughout a continuous length of one mile. We mention 22 S.W.G. to emphasise the fact that, if the three cores of flux are always there in this fine gauge, then they are certainly present in the more commonly used larger gauges—13 to 18 S.W.G. Use Ersin Multicore and

1. You need not worry whether or not the flux is present. 3 cores ensure it.
2. You get Ersin Flux—the fastest action, non-corrosive, safety flux (approved by A.I.D. and G.P.O.) which speeds up soldering and obviates "H.R." or "dry" joints.

If you are engaged on Government contracts, write for technical information and samples.

ERSIN MULTICORE

The Solder Wire with 3 Cores of Non-Corrosive Ersin Flux.



MULTICORE SOLDERS LTD. COMMONWEALTH HOUSE, NEW OXFORD ST. LONDON, W.C.1. Tel: CHAncery 5171/2