

K. Simpson
Answers to the 1933 C. and G. Examination Papers will commence
in the Supplement presented with the July issue.

THE POST OFFICE ELECTRICAL ENGINEERS' JOURNAL

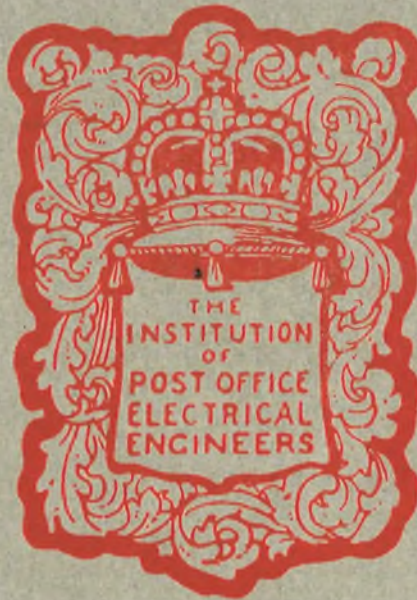

VOL. 26
PART I

APRIL
1933

Price 1/- net.

ADVERTISEMENT INDEX
see page xiv.

THE WORLD OVER



ALTON Batteries are in service in:

BRITISH ISLES	GREECE
AMERICA	GRENADA
ARGENTINA	INDIA
AUSTRALIA	ITALY
AFRICA	JAMAICA
BURMA	MALAYA
CANADA	MALTA
CEYLON	MANCHURIA
CHINA	NEW ZEALAND
COLOMBIA	NYASALAND
EGYPT	PERU
FIJI ISLANDS	PORTUGAL

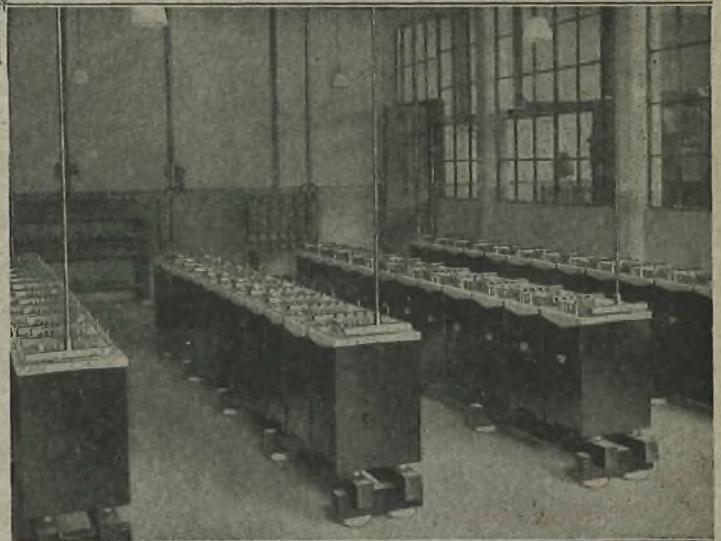

So fast and so far has the reputation of Alton Batteries of Merit gone, that in a comparatively few years Telephone Exchanges in the four corners of the world are depending upon them for unremitting service. Far and wide, batteries not originally of Alton manufacture are being replated with Alton plates.

THE
ALTON BATTERY COMPANY
 LTD.

Telegrams:
 "BATTERY
 ALTON."

Telephone:
 ALTON
 67.

LONDON OFFICE: DONINGTON HOUSE, NORFOLK STREET, STRAND, W.C.2
 TELEPHONE: TEMPLE BAR 9265-6
 TELEGRAMS: BATTERICOL, ESTRAND, LONDON



That there are more
Strowger Telephones
in use to-day than any
other automatic type
has a bigger significance
than anything else we
can tell you

STROWGER



Acknowledgments to Morris Motors Ltd.

AUTOMATIC ELECTRIC CO. LTD., LIVERPOOL, ENGLAND.

The Post Office Electrical Engineers' Journal.

A QUARTERLY JOURNAL.

COPYRIGHT.—The entire contents of this Journal are covered by general copyright, and special permission is necessary for reprinting long extracts, but Editors are welcome to use not more than one third of any article, provided credit is given at the beginning or end thus: "From the 'Post Office Electrical Engineers' Journal.'"

The Board of Editors is not responsible for the statements made nor the opinions expressed in any of the articles in this Journal, unless such statement is made specifically by the Board.

CONTENTS FOR APRIL, 1933.

	PAGE
DETERMINING THE TRANSMISSION EFFICIENCY OF TELEGRAPH CIRCUITS—E. H. JOLLEY, A.M.I.E.E.	1
MODERN DEVELOPMENTS IN PHONOGRAM AND TELEPHONE-TELEGRAM WORKING—G. SPEARS	7
TELEGRAPH AND TELEPHONE PLANT IN THE UNITED KINGDOM... ..	14
DESIGN OF RELAYS FOR AUTOMATIC TELEPHONE EQUIPMENT CIRCUITS, WITH SPECIAL REFERENCE TO RELAY TYPE 3000—R. BARKER, B.Sc.	15
MISCELLANEOUS FACILITIES AT AUTOMATIC AND MANUAL TELEPHONE EXCHANGES—A. HOGBIN	21
THE TOLL REPEATER—A. C. TIMMIS, B.Sc., A.M.I.E.E.	29
ELECTRODE TESTING METHODS APPLIED TO TELEPHONE CABLES—W. T. PALMER, B.Sc., Wh.Ex., A.M.I.E.E., and Major F. E. A. MANNING, M.C., B.Sc. (Eng.), A.M.I.Mech.E., A.M.I.E.E.	36
CONSIDERATIONS IN THE INSTALLATION OF TELEPHONE CABLES—CHARLES F. STREET, M.I.E.E., A.M.Inst., C.E.	43
ADVANCE AUTOMATIC EXCHANGE—M. C. COOPER, A.R.C.Sc.I., and A. G. LYDDALL	48
TRUNK EXCHANGE TEST RACKS: NEW DESIGN—G. BROWN, A.M.I.E.E.	53
THE CHRISTMAS DAY BROADCAST	56
AUTOMATIC GAIN CONTROL OF RADIO RECEIVERS—I. J. COHEN, B.Sc., A.C.G.I.	58
MUSIC TRANSMISSION OVER SHORT WAVE COMMERCIAL RADIO TELEPHONE CIRCUITS—A. J. A. GRACIE, B.Sc.	60
RESEARCH	63
NOTES AND COMMENTS	65
COL. A. S. ANGWIN, D.S.O., M.C., T.D., M.I.E.E.	66
MR. A. J. GILL, B.Sc., M.I.E.E., M.I.R.E.	67
DISTRICT NOTES	68
LOCAL CENTRE NOTES	76
JUNIOR SECTION NOTES	77
BOOK REVIEWS	78
STAFF CHANGES	80

All communications with regard to Advertisements to be addressed to:

The Advertisement Manager,

Post Office Electrical Engineers' Journal,

4, Ludgate Hill, London, E.C.4.

PUBLISHERS:

THE ELECTRICAL REVIEW, 4, LUDGATE HILL, E.C.4.

Single copy 1/- net, post free, 1/3.

Annual Subscription, postage inclusive, 5/-, payable in advance.



INSTANT CONNECTION!

Through to your man **AT ONCE** no waiting, no "cross-talk." That's the job of the Ericsson Intercommunication System—and it does it well.

An Ericsson Telephone on your desk places your organisation at your finger tips—directors, secretary, accounts, warehouse. Clear-speaking, efficient, foolproof, a really faithful servant earning its keep all the time.

Our new instrument is handiness itself—a wonderful improvement on the older "candlestick." It looks well on the orderly desk too.

We are supplying this system to progressive firms everywhere. Can be supplied in delightful colours to match your interiors. May we quote for installation? *Write for quotations and particulars of our moderate rental and maintenance service terms.*

ERICSSON TELEPHONES LTD.
67/73, KINGSWAY LONDON, W.C. 2

Telephone—HOLBORN 3271/8.

Ericsson



ENTIRELY BRITISH MADE



THE NEW

MALTA TELEPHONE

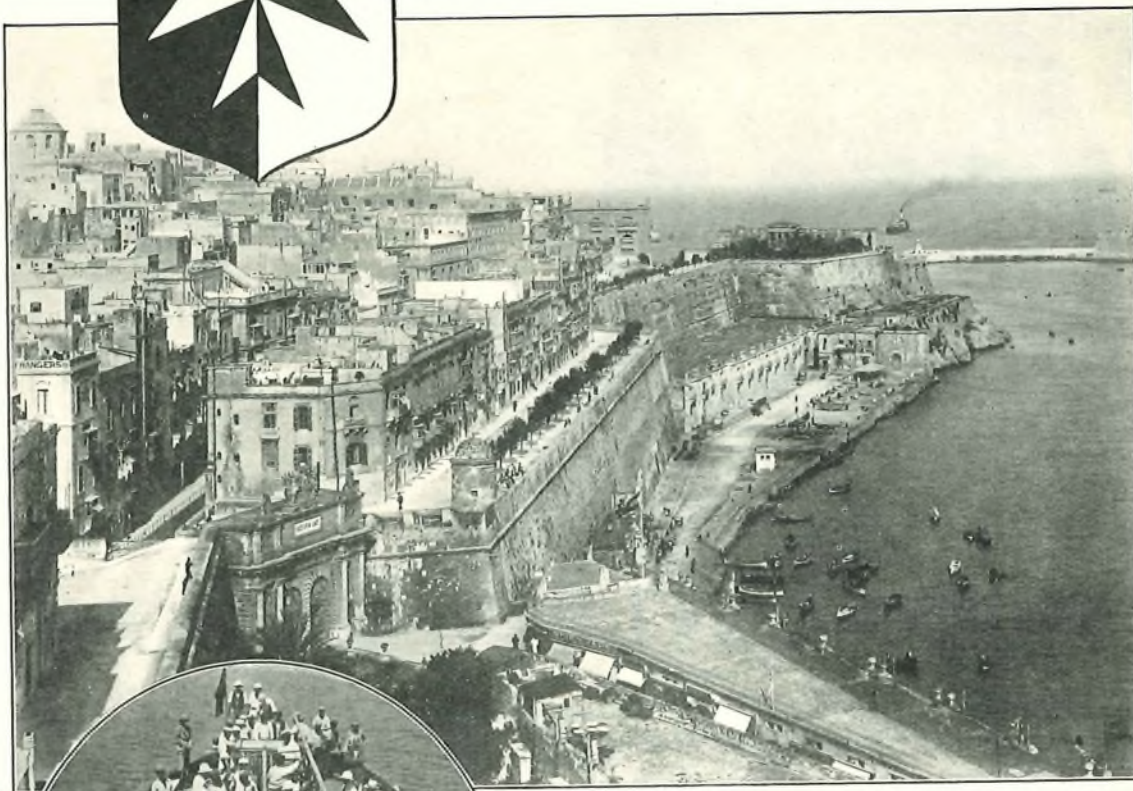
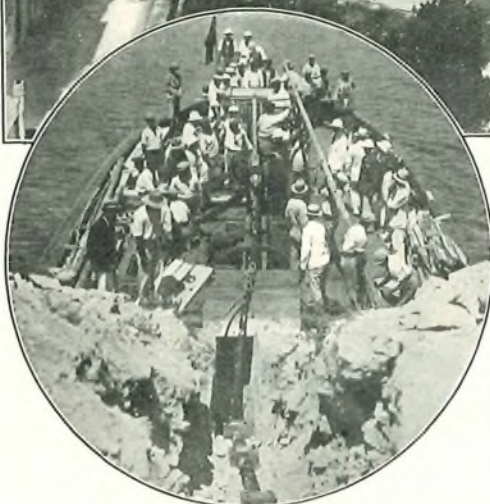

Photo by GRAND STUDIO, MALTA



Laying a 400-pair Submarine Cable across the Marsamuscetto Harbour.

The New Malta System incorporates throughout **SIEMENS "NEOPHONE"**



The Worlds most efficient Telephone

SIEMENS BROTHERS & CO

Representation Abroad: Melbourne, Sydney, Brisbane, Adelaide, Newcastle (N.S.W.)
Buenos Aires, Colombo, Shanghai, Tientsin, Harbin, Moukden, Cairo, The H





TELEPHONE SYSTEM

MALTA

"The Island of History"

TO meet the increasing needs of the population and to make adequate provision for the future

telephone development of the island, the Government of Malta recently placed a contract with Siemens Brothers & Co., Ltd., for a completely new and up-to-date Telephone System.

The new system has just been completed and comprises an 800-line central battery manually-operated

exchange equipment, all the telephones being of the "Neophone" high-efficiency type.

In addition to the exchange equipment and telephones, the contract included the supply and erection of complete new line plant, the latter including underground and sub-

marine multi-core cables, overhead lines and the wiring of subscribers' premises.



SIEMENS TELEPHONES

CO., LTD. · WOOLWICH · LONDON · ENGLAND

(N.), Perth (W.A.), Johannesburg, Cape Town, Port Elizabeth, Durban, Winnipeg, Calcutta, Bombay, Madras, Rio de Janeiro, Nagasaki, Tokyo, Singapore, Penang, Ipoh, Kuala Lumpur, Seremban, Malacca, Malta, Siam, Wellington, N.Z., Auckland, etc.



EVERYTHING **G.E.C.** ELECTRICAL



G.E.C.

DESK STAND INSTRUMENTS

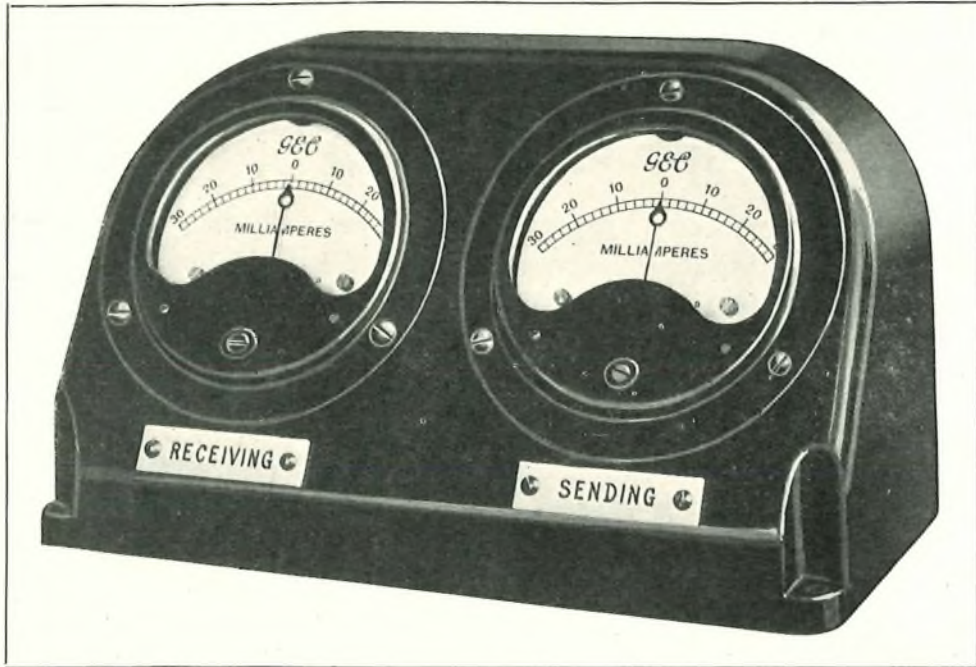

A neat, compact instrument comprising two milliammeters in a Bakelite case $7'' \times 3\frac{1}{4}'' \times 4''$.
As used for telegraph work in the British Post Office.

Instruments of various calibrations can be incorporated according to requirements.

Many of the finest instruments used in research and industry are made at the Salford Electrical Instrument Works. The most exacting standards of accuracy and reliability have been established here. Robust construction and fine finish are also distinctive features of all G.E.C. Instruments. Enquiries are welcomed for instruments of all types, including those for special purposes.

Made at the
SALFORD ELECTRICAL INSTRUMENT WORKS

of

THE GENERAL ELECTRIC CO., LTD.

Head Office: MAGNET HOUSE, KINGSWAY, LONDON, W.C. 2

Branches throughout Great Britain and in all the principal markets of the World

For the Holborn Exchange

Pulling in, at Holborn Telephone Exchange, part of the supply of 6 Drums of Henley Telephone Cable recently supplied to the G.P.O.

It is a safe policy to let Henley Cables carry the current in all spheres of Transmission.

HENLEY CABLES



W. T. HENLEY'S TELEGRAPH WORKS, COMPANY, LIMITED
HOLBORN VIADUCT LONDON, E.C.1

TURNER DIFFERENTIAL MILLIAMMETERS G.P.O. No. 17 & No. 18

Meet the most exacting demands for balancing currents in multiplex telegraph circuits.

—A quality product of outstanding merit—

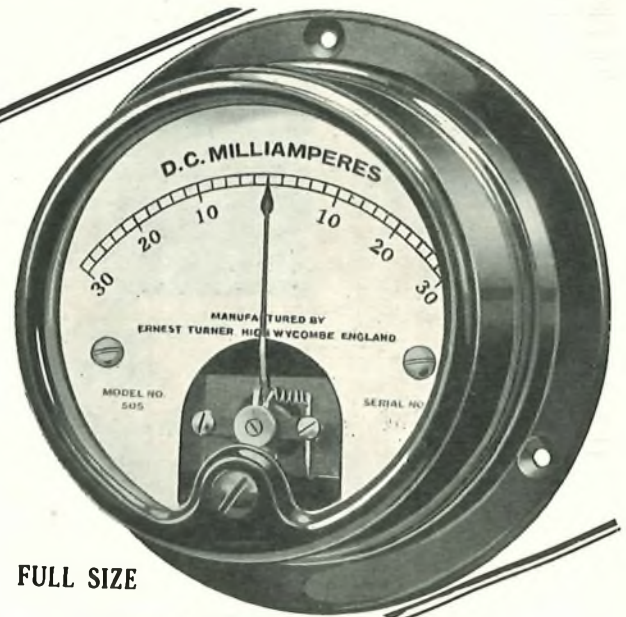

FULL SIZE

Also manufacturers of G.P.O. Detector No. 4, and a comprehensive line of instruments for precision electrical measurements.

ERNEST TURNER ELECTRICAL INSTRUMENTS, Ltd.

CHILTERN WORKS,
55-73, TOTTERIDGE AVENUE,
HIGH WYCOMBE,
BUCKS, ENGLAND

Telephone: High Wycombe 301.
Telegrams: Gorgeous, High Wycombe.

Standard

BYPATH AUTOMATIC SYSTEM

This new automatic telephone system has been designed to cater for all modern requirements. It offers definite economies in initial cost, floor space, junctions, weight of equipment, and maintenance charges.

The Bypass system is a uniselector system using one type of switch throughout.



← TERMINAL STRIPS FOR EASY CABLING

← UNIT BAY CONSTRUCTION

← ONE TYPE UNISELECTOR THROUGHOUT

← BYPATH CONTROL

← JACK-IN RELAY PANELS

← TRANSPARENT WINDOWS

← ALL ROTORS JACKED-IN AND INTERCHANGEABLE

Typical Bypass Bay

BYPATH EXCHANGES

The Bypass System can be used in large or small exchanges of every type. Bypass Exchanges now in operation or under construction, include :

Advance Exchange - London

Burton-on-Trent - Multi-office area

Tutbury }
Swadlingcote } Satellite exchanges

Great Wakering }
Stapleford } Rural exchanges

Theydon Bois - Urban exchange

Standard Telephones and Cables Limited

THE HYDE, LONDON, N.W.9

Telephone : Colindale 6533

For the Holborn Exchange

Pulling in, at Holborn Telephone Exchange, part of the supply of 6 Drums of Henley Telephone Cable recently supplied to the G.P.O.

It is a safe policy to let Henley Cables carry the current in all spheres of Transmission.

HENLEY CABLES



W. T. HENLEY'S TELEGRAPH WORKS, COMPANY, LIMITED
HOLBORN VIADUCT LONDON, E.C.1

TURNER DIFFERENTIAL MILLIAMMETERS G.P.O. No. 17 & No. 18

Meet the most exacting demands for balancing currents in multiplex telegraph circuits.

A quality product of outstanding merit

Also manufacturers of G.P.O. Detector No. 4, and a comprehensive line of instruments for precision electrical measurements.

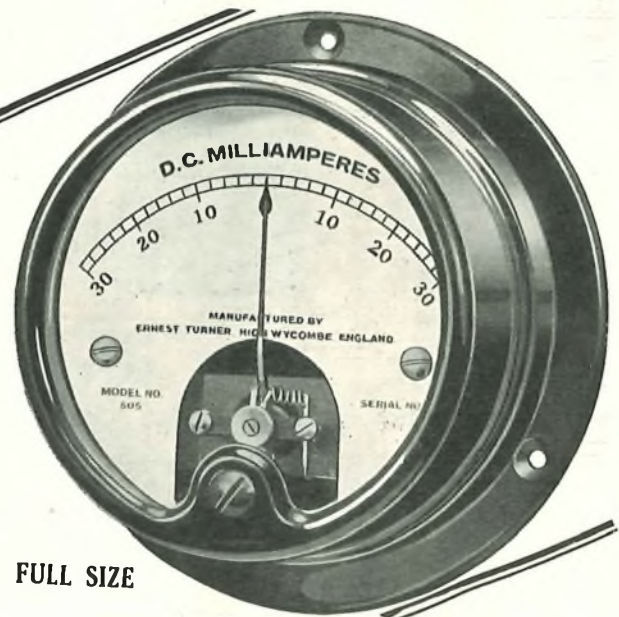

FULL SIZE

ERNEST TURNER ELECTRICAL INSTRUMENTS, Ltd.

CHILTERN WORKS,
55-73, TOTTERIDGE AVENUE,
HIGH WYCOMBE,
BUCKS. ENGLAND

Telephone: High Wycombe 301.
Telegrams: Gorgeous, High Wycombe.

Standard

BYPATH AUTOMATIC SYSTEM

This new automatic telephone system has been designed to cater for all modern requirements. It offers definite economies in initial cost, floor space, junctions, weight of equipment, and maintenance charges.

The Bypass system is a uniselector system using one type of switch throughout.



← TERMINAL STRIPS FOR EASY CABLING

← UNIT BAY CONSTRUCTION

← ONE TYPE UNISELECTOR THROUGHOUT

← BYPATH CONTROL

← JACK-IN RELAY PANELS

← TRANSPARENT WINDOWS

← ALL ROTORS JACKED-IN AND INTERCHANGEABLE

Typical Bypass Bay

BYPATH EXCHANGES

The Bypass System can be used in large or small exchanges of every type. Bypass Exchanges now in operation or under construction, include :

Advance Exchange - London

Burton-on-Trent - Multi-office area

Tutbury }
Swadlingcote } Satellite exchanges

Great Woking }
Stapleford } Rural exchanges

Theydon Bois - Urban exchange

Standard Telephones and Cables Limited

THE HYDE, LONDON, N.W.9

Telephone : Colindale 6533

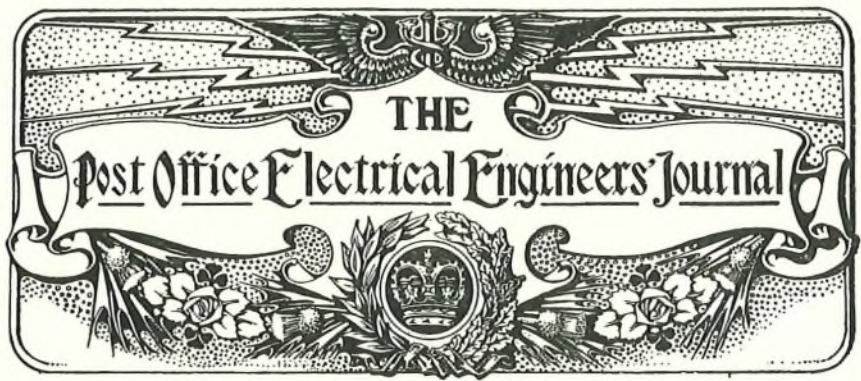

Determining the Transmission Efficiency of Telegraph Circuits

E. H. JOLLEY, A.M.I.E.E.

Synopsis.

A METHOD of expressing telegraph transmission efficiency in terms of effective distortion and margin is suggested. Telegraph distortion measuring sets are dealt with and a set which has been developed for measurements of distortion and margin on Teleprinter circuits is described.

Introduction.

The reasons for, and the method of expressing Telegraph Transmission characteristics in terms of Signal Distortion have been explained in a previous article.¹ In the present article it is proposed to deal with the question of applying these principles to a determination of the overall transmission efficiency of a telegraph circuit including the sending and receiving machines. The measurement of Signal Distortion will also be dealt with.

Overall Telegraph Transmission Efficiency.

In Telephony it is possible to define the transmission unit in terms of volume only, because, for the practical purpose of estimating the transmission efficiency of a line, the attenuation distortion and phase distortion may be neglected. If this were true in Telegraphy then the problem would be considerably simplified. But it is neither practicable nor necessary to design telegraph circuits so that attenuation distortion and phase distortion are negligible. The receiving equipment of a telegraph circuit is sufficiently accommodating to render this unnecessary.

When the Wheatstone Automatic System was widely employed on telegraph circuits, the maximum

possible speed of working a circuit was used as a criterion of its transmission efficiency. The almost universal adoption of direct printing systems such as Teleprinter and Baudot, where the speed of signalling is fixed at some definite value, has rendered this method of expressing transmission efficiency of considerably less importance.

In order to obtain a practical measure of the overall transmission efficiency of a telegraph circuit it is necessary to determine :—(a) The maximum *effective* signal distortion which occurs during transmission. (b) The maximum signal distortion which may be permitted before the receiving mechanism fails to operate correctly. This characteristic of the receiving mechanism has been given the name "Margin" by the C.C.I.T.

The amount by which (b) exceeds (a) on a given circuit is a direct criterion of the transmission efficiency of the circuit provided it is determined in a manner properly related to the system of telegraphy to be used. The term "Excess Margin" can perhaps be used to denote this characteristic of a telegraph circuit.

As explained in the previous article, Signal Distortion has been defined by the C.C.I.T. by reference to the earliest and latest operations of the receiving relay timed with respect to the corresponding operations of the transmitter. The terms "Encroachment" and "Distortion" are used in this connexion. It is possible, however, in certain systems of telegraphy, for the distortion, defined in this way, to be in excess of the margin of the receiving mechanism and yet secure perfect reception. For example in non-synchronous systems such as Wheatstone with Creed receiving perforator the limit of permissible distortion, that is the "effective" distor-

¹ "Signal Distortion in Telegraph Circuits." P.O.E.E.J., Vol. 25, Part 4, page 259.

tion, is determined by the relative time displacement of any two consecutive operations of the receiving relay. On the other hand, with the Start-Stop systems the limit of distortion is determined by (a) the time displacement of the code elements with respect to the commencement of the start signal which precedes them, and (b) the relative displacement of successive start signals.² The term "Effective Distortion" may well be applied to the maximum value of distortion measured on a system in this way. This point is illustrated in Fig. 1 where (a) is a theoretical encroachment diagram for the receiving mechanism of a teleprinter of the Creed type using 7.5 units per character. The shaded portions represent the periods during any part of which the receiving relay tongue may change over from marking to spacing or vice-versa as the case may be. The unshaded portions represent the periods during which the relay tongue must remain in the position demanded by the signal code corresponding to the required character. The approximate lengths of the shaded portions are shown as percentages of the duration of a unit element. The margin of the teleprinter will therefore be seen to be 35%, while the permissible distortion between successive start signals is approximately 40%. The teleprinter signal shown at (b), although suffering considerable irregular distortion, would still give correct registration. The teleprinter signal which would normally have the greatest characteristic distortion is the one shown at (c), but the distortion in this case may be as great as 70%. In the signal shown at (d) the characteristic distortion produced by an unloaded telegraph line is given. At (e) is shown another signal sent over the same line. Each of these signals has the same characteristic distortion yet the effective distortion is very different. In one case there is no excess margin whereas in the other there is an excess margin of 17%.

The object of the foregoing remarks is to illustrate that the amount of Total Distortion in a circuit measured as at present defined by the C.C.I.T. does not give sufficient information for determining the excess margin on a working circuit. Therefore in order to derive a value which will be properly expressive of the working efficiency of a circuit (*i.e.*, the excess margin) it is essential that measurements should be made of the Effective Distortion.

It would seem that a knowledge of excess margin characteristics is essential if the economical design of telegraph circuits is to be placed on a sound basis. The value of the excess margin to be provided in a given case is dependent upon the reliability of the machines, the efficiency of the maintenance service,

² The relative displacement of successive start signals is only of importance when the letters succeed one another as fast as the transmitter permits such as in automatic transmission. When sending from the keyboard of teleprinters as at present constructed, it is not usually possible to attain the maximum speed of the transmitter owing to lag in the keyboard mechanism.

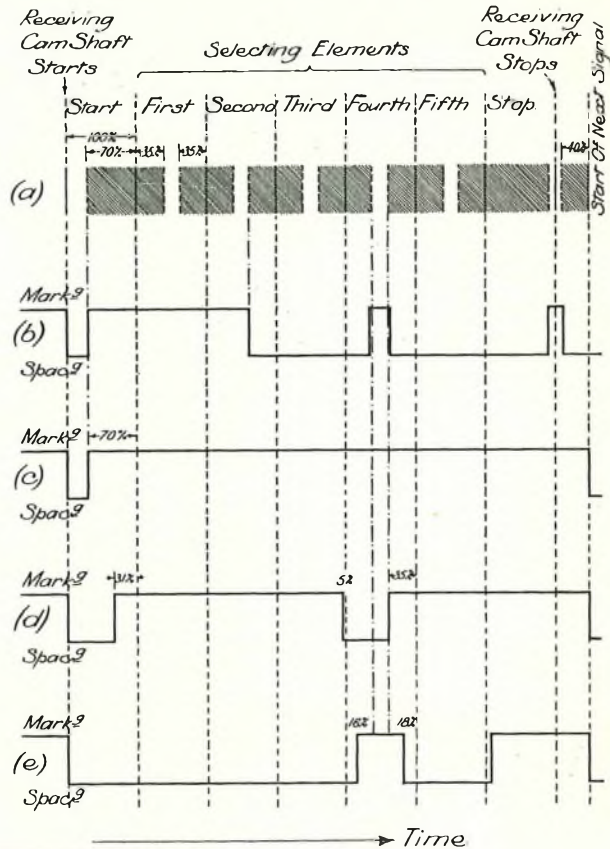

- (a) Theoretical Encroachment Diagram for Creed Teleprinter. The shaded portions indicate the periods during which the relay tongue may change over. The unshaded portions indicate the periods during which the tongue must remain on the required contact.
- (b) Hypothetically distorted signal which would give correct registration. Distortion $> 100\%$.
- (c) Signal with 70% Distortion which would give correct registration. (Character is *).
- (d) Actual signal (obtained in test) with 35% Characteristic Distortion which would give correct registration with zero Excess Margin. (Character is "Q").
- (e) Actual signal (obtained in test) with 34% Characteristic Distortion, but with Excess Margin of 17%. (Character is "/ " on Teleprinter 3A and Carriage Return on Teleprinter 7A).

FIG. 1.—ENCROACHMENT DIAGRAM AND DISTORTED TELEPRINTER SIGNALS.

the stability of power supplies, and the grade of service required.

The importance of the development of an exact technique based on the foregoing principles will hardly be denied. A distortion measuring set which readily permits the measurement of margin and effective distortion on teleprinter circuits has been developed and will be described in a later paragraph. The use of this instrument will enable the data required for building up a technique to be rapidly acquired.

The Margin of the Receiving Mechanism.

It is outside the scope of this article to deal with the mechanical and electrical considerations which enter into a determination of the factors governing the margin of telegraph apparatus. This is a problem which is intimately concerned with the design of the machines. The Teleprinter Distortion Measuring Set described later has been used for experimental determination of the related characteristics of the Teleprinter 3A and 7A (Creed Type) and some very useful information as to the behaviour of the machines under different conditions has been obtained. The margin characteristics of the Morkrum, and Siemens and Halske Teleprinters and the Baudot have also been the subject of various investigations.³

THE MEASUREMENT OF TELEGRAPH SIGNAL DISTORTION.

In all Telegraph Distortion Measuring Sets the aim is to determine the time distortion occurring in the signals as delivered by the tongue of the receiving relay. Distortion measurements can of course be made by taking an oscillographic or recorder record of the signals, but these methods are slow and inconvenient. Distortion sets have also been in use for some time which depend for their action on a process of integration of the positive and negative elements of the signals thus showing the preponderance of elements of one sign due to the shortening of elements of the opposite sign. These sets do not permit the distortion to be analysed and therefore do not enable measurements of effective distortion and are thus rather restricted in their application.

A set described by Nyquist, Shank and Cory⁴ enables the lengths of single elements to be measured by means of a timing circuit consisting of a resistance and a condenser. The value of the resistance can be adjusted so that the condenser is charged to a pre-determined voltage on signal elements of normal length. When a lengthened element occurs, this voltage is exceeded and a click is produced in a telephone receiver or a sounder caused to operate. The percentage distortion is measured by the percentage increase required in the value of the resistance to prevent the occurrence of clicks. Shortened signals are measured in a somewhat similar manner by reducing the value of the resistance. Such a set does not enable the distortion as defined by the

C.C.I.T. to be measured, but from the fact that the measurements depend upon the actual length of the signal elements it is admirably suited to the measurement of effective distortion with reference to such systems as Morse and Wheatstone.

Stroboscopic Distortion Measuring Sets.

In order to measure distortion in accordance with the definition of the C.C.I.T., it is necessary to observe the precise time of operation of the receiving relay for every signal element. In stroboscopic sets this is enabled by arranging for a flash to be produced on a stroboscopic screen each time the relay moves on to the marking or spacing contact. Two such sets are the Siemens and Halske Stroboscopic Distortion Measuring Set⁵ and the Standard Telephones and Cables, Ltd., Cathode Ray Oscillograph Distortion Measuring Set. In each of these sets the flashes appear on a circular scale graduated in percentage distortion and it is so arranged that if all the signal elements are of the correct length, that is equal to the unit element or some exact multiple of it, the flashes all occur at the one point on the scale. When distortion is present the flashes are spread over the scale, the width of the band giving the maximum distortion. This is because the most advanced flash is produced by the earliest operation of the receiving relay relative to the corresponding operation of the transmitter; similarly the most retarded flash indicates the latest operation of the receiving relay.

Fortuitous distortion is recognized by the irregular spreading of the images. Bias distortion can be observed by reversing the polarity of the transmitted signals and suppressing in turn the mark to space and space to mark flashes.

Each of these instruments incorporates a standard transmitter for producing essentially undistorted signals such as 1:1 reversals, 1:5 signals, and also a train of mixed signals. For the best results, absolute synchronism between the transmitter and stroboscope is necessary and on looped circuits where the transmitter and receiver are located at the same point this is easily secured by driving each by the same means. In end to end tests, means are provided for adjusting the speed of the receiver to be as near as possible to that of the transmitter.

TELEPRINTER DISTORTION AND MARGIN TESTER.

This set,⁶ which was designed at the Post Office Research Station, enables distortion measurements to be made on actual Teleprinter signals. This has been found necessary because distortion measurements on signals such as 1:5 are not sufficient, especially in voice frequency working or where vibrating relays are used in direct current working. By arranging for a display of the complete group of

³ *Margin of Telegraph Apparatus.*
Teleprinters in General. H. Stahl; Documents of Third Reunion C.C.I.T., 1931, Vol. 1, p. 38.
Morkrum. H. Stahl and W. Schallerer; Ibid. Page 42.
Siemens & Halske. H. Stahl and W. Schallerer; Ibid. Page 54.
Baudot. M. Bayard; Ibid. Page 64, also *Journal Télégraphique*, Vol. LIII., page 121, June, 1929.
Morkrum. H. Faulkner and G. T. Evans; I.P.O.E.E. Paper No. 136.

⁴ "Measurements of Telegraph Transmission," J.A.I.E.E., March, 1927.

⁵ A reference to this set appeared in an article by H. Stahl, T.F.T., Nov., 1930. A full description is given in the Documents of the Third Reunion of the C.C.I.T., Vol. 1, page 30, and also in T.F.T., May, 1932, page 121.

⁶ Author's Provisional Patent No. 1781/1933.

signal elements corresponding to any teleprinter character, it is possible to measure the distortion in accordance with its effect on actual teleprinter operation. A measurement of the effective distortion is therefore possible. In addition, the margin of a teleprinter can be measured and also the distortion given out by the teleprinter transmitter. It is thus possible at once to obtain a measure of the overall transmission efficiency of a teleprinter circuit and to quote a value for the excess margin and so give a basis for estimating the grade of service to be expected on the circuit.

Apart from this the facility of having the whole signal displayed instead of all the elements superimposed on one another enables much more information to be obtained as to the behaviour of a circuit under various conditions.

Transmitter.

A transmitter of the distributor plate and rotary brush type, motor driven through a Mendonça-Doignon governor is used. Fig. 2 shows the

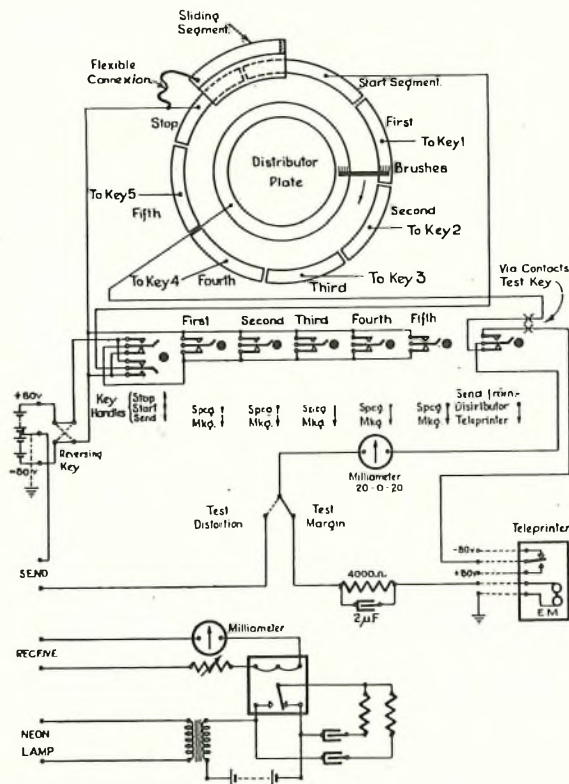

FIG. 2.—TELETYPE DISTORTION AND MARGIN TESTER; PRINCIPLE CONNEXIONS.

principle connexions of the set and Fig. 3 is a photograph of the transmitter with the brushes removed. It will be seen that there is a seven-segment ring on the distributor plate corresponding to the seven elements of the teleprinter code. The five code segments are wired to keys so that any

teleprinter code may be set up. A sliding segment is arranged to move over the "stop" and "start" segments, but is insulated from the start segment. The start segment has a length equivalent to $1\frac{1}{2}$ unit elements whilst the stop and sliding segments are equivalent to 1 unit. When the sliding segment is moved by means of the knob provided, a pointer moves over a scale graduated in percentage distortion. When the pointer reads zero the sliding segment covers one third of the start segment so that the start signal is now equal to 1 unit and the stop signal $1\frac{1}{2}$ units. By moving the sliding segment, the start signal may be lengthened or shortened by 50%. The transmitter operates on the $7\frac{1}{2}$ -unit code, but it would be possible to arrange it for 7-unit working by modification of the sliding and start segments.

A specially shaped brush is used to prevent chatter when it passes over the sliding segment.

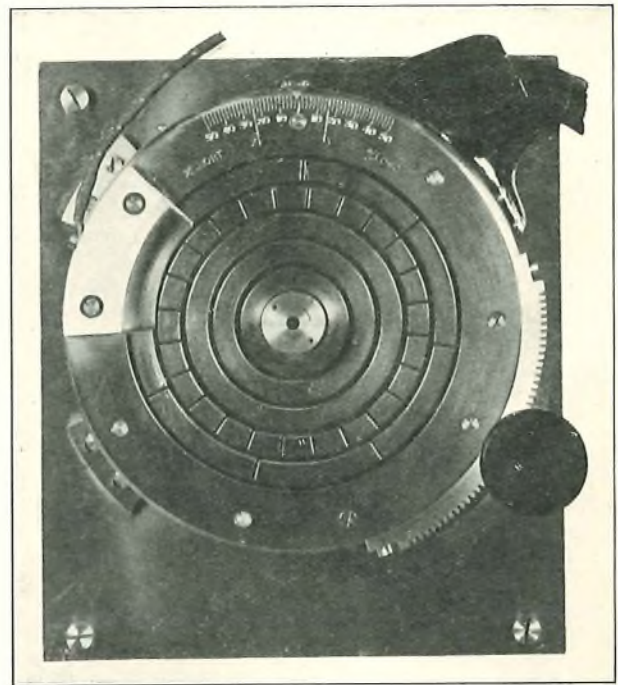

FIG. 3.—TRANSMITTER OF DISTORTION SET WITH BRUSHES REMOVED TO SHOW THE SLIDING SEGMENT AND SCALE. THE KNOB ON THE RIGHT CONTROLS THE MOVEMENT OF THE SLIDING SEGMENT.

Measurement of the Margin of a Teleprinter.

For this purpose it is essential that the circuit containing the electromagnet of the teleprinter be telegraphically distortionless so that the movements of the armature are in exact accordance with the signals. Using 80-volt batteries, a 4000Ω resistance shunted with a $2\mu\text{F}$ condenser and connected in series with the electromagnet has been found to give satisfactory results with Teleprinters 3A and 7A. Any suitable letter is set up on the transmitter and

sent in a continuous train into the teleprinter. Because the transmitter is rotating continuously it is necessary to ensure that the teleprinter only picks up on the start signal. A "Stop-start-send" key is provided for this purpose. In the "Start" position of the key only the start signal is sent out, so by putting the key in this position for a moment the teleprinter starts up correctly and when the key is moved to "Send" it commences to print the letter.

The sliding segment is moved forward until a position is reached where further movement produces errors in the operation of the teleprinter. A similar position is found moving the sliding segment backward. The readings obtained in these positions give the margin of the teleprinter. Fig. 4 illustrates the effect on the receiving mechanism of a

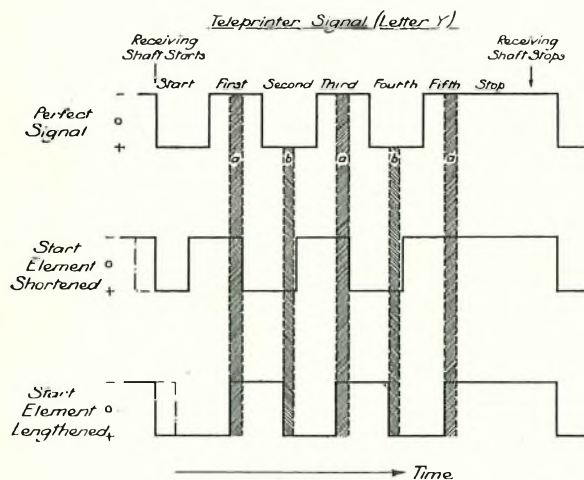

FIG. 4.—EFFECT OF SHORTENING OR LENGTHENING THE START ELEMENT OF A TELEPRINTER SIGNAL.

teleprinter of shortening or lengthening the start signal. The shaded portions "a" indicate the periods during which marking elements must be registered and the shaded portions "b" the corresponding periods for spacing elements. It will be seen that altering the length of the start signal is equivalent to displacing all the code elements with respect to the selecting mechanism of the machine. In testing the margin of a teleprinter it is usually sufficient to use the R and Y signals as these demand the maximum amount of work of the selecting mechanism. If necessary, the operation of each one of the selecting fingers may be observed in turn by using a suitable choice of signals; by careful interpretation of results it is frequently possible to diagnose the cause of loss of margin in a faulty teleprinter. In addition, by making the sliding segment coincide with various points on the signal, other than the stop signal, a time chart of the receiving mechanism of the teleprinter may be constructed. The information thus obtained is a valuable addition to that given by the "static" time chart. The

sliding segment may, of course, be made to coincide with either a marking or spacing element.

Stroboscope.

The stroboscopic disc is to be seen on the left of Fig. 6. Fig. 5 shows a typical display as it appears

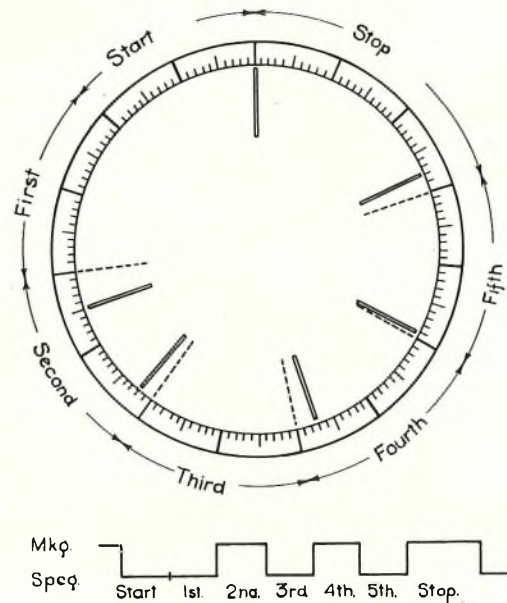

Letter "R"-Signal code shown at bottom.
Effective Distortion = 25%.
Total Distortion (C.C.I.T. Definition) = 35%.

FIG. 5.—TYPICAL DISPLAY OF TELEPRINTER SIGNAL ON STROBOSCOPIC DISC.

on the disc. A neon lamp is mounted behind a slot on the disc and rotates with it, the speed of rotation being equal to that of the transmitter, that is one revolution per letter. When the set is in operation, a momentary flash of the lamp is produced each time the armature of the receiving relay (shown at the bottom of Fig. 2) moves on to the marking or spacing contact due to the charging up of either of the two condensers, one condenser being discharged when the other is charged. Some difficulty was at first experienced owing to irregular flashing of the lamp, but this was finally overcome. A scale surrounds the disc and is divided into 15 large divisions. Two of these divisions correspond to a unit signal and for a signalling speed of 50 bauds a small division is equal to 1 millisecond. The scale is movable so that in a distortion measurement the commencement of the start signal can be made to coincide with one of the main divisions. In later models it will be arranged for the scale to be continuously rotatable to cater for cases where there is a slight difference of speed between a transmitter and the stroboscope.

Measurement of Effective Distortion.

To measure the effective distortion in a circuit the required letter is set up on the transmitter and sent into the line under test, the transmitter first being checked by observation on the stroboscopic disc. The signal is received over the line, the receiving relay of which is caused to operate the relay of the distortion set and flashes are produced on the disc corresponding to the commencement of each element of the signal. Fig. 5 shows a typical display of the signal received at the end of a line. The signal in this case is the letter R, the code for which is shown at the bottom of the figure (2nd and 4th Marking, 1st, 3rd and 5th Spacing). The points at which the flashes would occur on an undistorted signal are shown dotted. No flash appears at the beginning of the first code element as this is the same polarity as the start signal. The maximum effective distortion relative to the start signal occurs on the commence-

when an interval of spacing intervenes between each of the letters. In this way the distortion can be tested under the extreme conditions likely to be met with in practice. Conditions (b) and (c) can easily be secured by means of cam-operated contacts on the transmitter which suppress alternate letters and replace them by a marking or spacing current as the case may be. By similar tests the maximum distortion between successive start signals can be measured.

The process of finding the maximum effective distortion on a circuit is not such a difficult matter as might at first be supposed. There are generally two or three letters which are most subject to distortion and it is only necessary to carry out tests on these letters, which is the work of a few minutes.

Bias distortion can be shown up by reversing the polarity of the transmitted signal, when, if bias is present, there occurs a change in the length of the

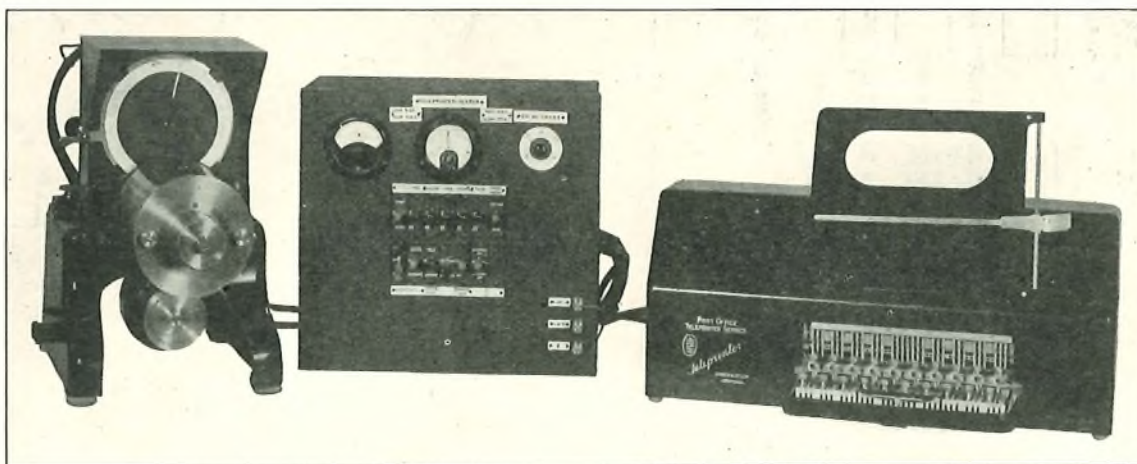

FIG. 6.—TELEPRINTER DISTORTION AND MARGIN TESTER SHOWING STROBOSCOPE AND AUXILIARY PANEL IN POSITION FOR TESTS ON A TELEPRINTER.

ment of the second code element and is 25%. The total distortion, that is the maximum difference between the earliest and latest signals, is 35% because the commencement of the third code element is 10% early. This illustrates the necessity for distinguishing between effective and total distortion if it is desired to obtain a reliable indication of the working efficiency of a circuit. In practice of course the flashes do not re-appear at the same point on the disc for each successive letter, on account of fortuitous distortion; it is, however, easily possible to recognize the extent of the fortuitous distortion and take account of it in quoting a value for the maximum effective distortion.

For precise measurements of distortion such as are required in design work, it is desirable that the signal be tested in three ways:—(a) when repeated as a continuous train, (b) when an interval of marking intervenes between each of the letters, and (c)

signal elements. Marking bias produces a lengthening of the marking elements and spacing bias a lengthening of the spacing elements.

In those cases where the electromagnet of the teleprinter is operated directly by the received line current, or by a valve device as in the Telex System, the distortion must be determined in terms of the actual movements of the electromagnet armature. This may be done by means of auxiliary contacts operated by the electromagnet or by replacing the electromagnet by a relay having similar characteristics.

Testing the Transmitter of a Teleprinter.

This may be done by sending into the distortion set from the teleprinter and observing the distortion on the stroboscopic disc.

For observing for transit time and breaking or bounce at the contacts a special flashing circuit can

be used. It is arranged that the neon lamp strikes as soon as the tongue leaves a contact and is not extinguished until the tongue makes contact again. In this case the breadth of the flash produced on the disc indicates the length of the transit time. Also if the tongue breaks from a contact or chatters, flashes are produced each time this occurs.

Another method has also been used. In this method similar letters are simultaneously transmitted from the distortion set and the teleprinter into opposite arms of a bridge across which a galvanometer is connected. Any distortion in the teleprinter signal shows up as a deflection on the galvanometer which can be calibrated to read percentage distortion. Bias in the transmitter is readily shown up whilst faulty operation of any of the cam levers can be observed using signals in which only one code element is marking and therefore only one cam lever is operated at a time.

Speed-Tests.

For tests on Teleprinters 7A the speed of the transmitter is 400 r.p.m. and if 50- or 25-cycle, frequency-controlled A.C. mains are available, the speed can be checked by driving the receiving relay from the mains and thus flashing the neon lamp. When the speed is correct 15 flashes are seen on the disc and these should appear to be stationary.

For test on Teleprinters 3A the speed of the transmitter is 392 r.p.m. For checking the speed in this case, and also for tests on Teleprinters 7A when suitable mains are not available, a frequency bridge of the Maxwell commutator type⁷ is provided, the bridge being operated from the 24-segment ring on the transmitter, to be seen in Fig. 3.

The speed of a teleprinter under test can be checked by sending into the stroboscope and com-

paring the speed with that of the distortion set. Alternatively the frequency bridge can be used by sending a continuous train of R's from the teleprinter.

Fig. 6 is a photograph of the set arranged for testing a teleprinter. In later models a more compact arrangement will be secured.

Conclusion.

With the passing of the older systems of telegraphy and the increasing use of Teleprinter (Start-Stop) systems, telegraphy is entering on a new phase. The application of the principles which have been discussed in relation to telegraphic distortion, and the use of methods which enable the distortion to be readily and quickly measured under working conditions, should permit the building up of a transmission technique suited to the new conditions. It is also hoped that by the use of telegraph distortion measurements it will be possible to extend the utility of the mathematical theory of telegraph transmission, particularly in the matter of establishing a more rigid relationship between steady-state theory and telegraphic performance so as to permit a freer use of such theory in telegraph transmission problems.

Limitations of space have precluded the many phases of telegraph transmission problems being dealt with in detail, but references have been given so that the reader may, if desirous, pursue the subject. A few additional references are given below.

ADDITIONAL REFERENCES.

- T. E. Herbert. "Telegraphy," Appendix A. London, 1930.
 A. E. Stone. "A Test Book of Telegraphy," Chap. XII. London, 1928.
 T. E. Bramhall. "A Telegraph Testing Machine." Electrical Engineering, August, 1931, Vol. 50, No. 8.
 H. Nyquist. "Certain Topics in Telegraph Transmission Theory" (Abridged). J.A.I.E.E., March, 1928, p. 214, Vol. 47, No. 3.

⁷ J. G. Bedford and H. Josephs: "A Simple Method of Producing Low Frequency Currents." P.O.E.E.J., October, 1930, Vol. 23, page 181.

Modern Developments in Phonogram and Telephone-Telegram Working

G. SPEARS.

INTRODUCTION.

THE modernizing of the purely telegraph side of telegraph plant has already been dealt with in an article appearing in a previous issue of this Journal¹ and a summary of the work undertaken as a result of the recommendations of the "Simon "

report has also been given.² It remains for details of the developments in the use of telephone aids to telegraph working to be set forth.

As there appears to be some dubiety as to the distinction between Phonogram and Telephone-Telegram working, it may be as well to commence by defining the two methods.

¹ "Telegraph Instrument Rooms." R. P. Smith and F. T. Cattell. P.O.E.E.J. Vol. 23, page 257.

² "Modernizing the Telegraph Service." A. O. Gibbon, M.I.E.E. P.O.E.E.J. Vol. 25, page 105.

- (a) Phonogram working provides for verbal dictation of telegrams between Post Offices subscribers' premises.
- (b) Telephone-Telegram working provides for verbal dictation of telegrams from one Post Office to another.

Method (b) is being extended with a view to the conversion to telephone working of all short distance Morse circuits of low traffic capacity, such as are now terminated on telegraph concentrators, and in London, on the Metropolitan Switch at C.T.O.

The received messages both phonogram and telephone-telegram are type-written direct from verbal dictation over the circuits at all Head Offices and at the larger out offices.

DESIGN.

The switchboard equipment which has been adopted as standard to meet phonogram and telephone-telegram requirements in large Telegraph Offices is of uniform design. In general, the switchboards used for one type of working are segregated from those used for the other, and different circuit arrangements are adopted to meet the varying requirements of the two schemes.

Any individual installation is built up into suites whose length is dependent on the traffic requirements and room lay-out. Each suite consists of desk elements which, when assembled, form a double-sided table. Each double table is assembled round a centrally-disposed V-belt conveyor. The conveyor is accessible to operators on both sides of the table and is used to convey received messages to the circulation point for distribution to the appropriate telegraph circuit. Fig. 1 shows an end view of a



FIG. 1.—END VIEW OF A TYPICAL TELEPHONE-TELEGRAM SUITE, SHOWING V-BELT CONVEYOR.

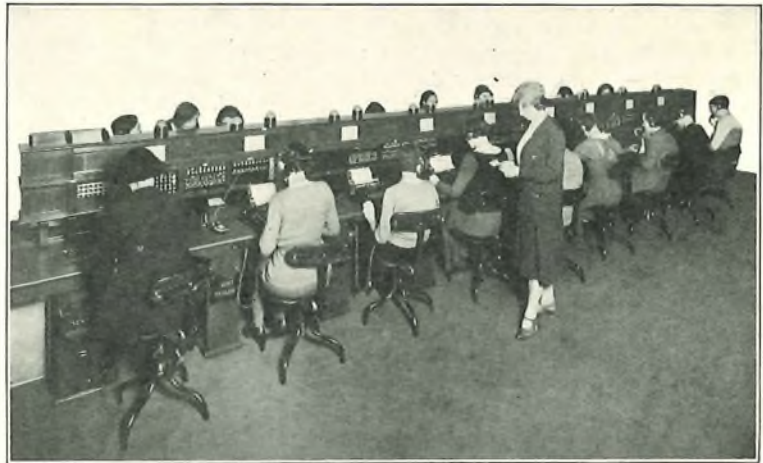

FIG. 2.—GENERAL VIEW OF A TELEPHONE-TELEGRAM SUITE.

typical telephone-telegram suite complete with belt conveyor. At a height of six inches above the conveyor is the switchboard multiple field. This is arranged to allow access to the multiple jacks by operators sitting on both sides of the table, but the width is kept down to that required for one-sided access by a design which is equivalent to two single-sided switchboards mounted one above the other, the jack field on one side being on the lower half of the panel and on the other side on the upper half of the panel. On each side, the spare panel space gives access to the wiring of the jack field appearing on the opposite side and also provides a field for the display of traffic notices and instructions. A 5-panel multiple is adopted, each operator's position occupying a space of $2\frac{1}{2}$ panels. A general view of the equipment forming a telephone-telegram suite is shown in Fig. 2.

A supervisor's desk, similar to that fitted in C.B. manual exchanges, is generally provided.

One operator's position is usually adapted for use as an enquiry desk.

A separate enclosure is provided for the I.D.F., relay racks, and auxiliary apparatus, such as flashing equipment, amplifiers, etc., that may be required.

The main components from which installations are built up consist of the switchboards, the desks (forming the table top), the cord boxes, and the auxiliary apparatus units.

The switchboards are known as Switchboards, Phonogram, Nos. 5 and 6 and consist of 2-panel units and 5-panel units respectively. They are used in combination to make up any required number of panels on both phonogram and telephone-telegram installations. At the end of each suite, the switchboard elements are closed by cable turning sections. The practice is to cable the installations from overhead, using switchboard cable from the I.D.F. and relay racks.

The desks are fibre-covered and differ in respect of the key circuit wiring in the two types of equip-

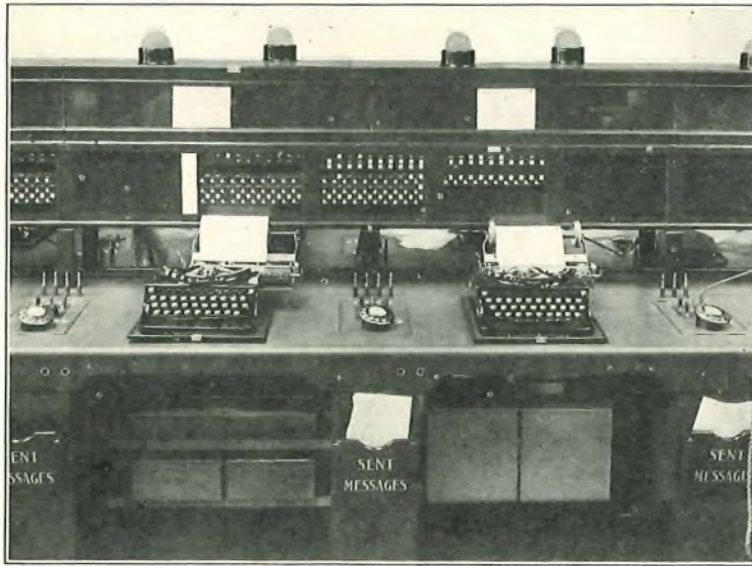

FIG. 3.—TWO POSITIONS OF TELEPHONE-TELEGRAM EQUIPMENT.

ment. The phonogram desks are known under the title "Desks, Pair, T.L.1414" and the telephone-telegram desks as "Desks, Pair, T.L.1601." The desks which are used to finish a suite are special fittings. These end desks have been given the titles "Desk, End Set, T.L.1414," which is used for phonogram purposes, and "Desk, End Set, T.L.1601," which applies to telephone-telegram equipment. The cord boxes, which are part of the desks, incorporate the cord tags and cabling to the keys and connexion strips. The height of the desk top above the floor has been fixed at 2 feet, 3 inches to allow of typewriters being used by the operators.

All the cord circuit apparatus not appearing on the keyshelf is incorporated, together with the operator's circuit apparatus, in an auxiliary apparatus unit. The units are arranged for jacking in, and are thus quickly interchangeable. They are mounted on ironwork fitted along the suit below the belt conveyer. "Unit, A.A., No. 74" incorporates the phonogram equipment and "Unit, A.A., No. 80" the telephone-telegram equipment.

Two positions of telephone-telegram equipment are shown in Fig. 3.

FACILITIES.

The following facilities are available in the case of both phonogram and telephone-telegram equipments.

Incoming circuits and the incoming ends of bothway circuits are ancillared

over one or more suites as required, and means of switching out all the appearances of the calling signals on each suite are provided. Calls which remain unanswered after a predetermined interval are marked by the steady glow of the calling lamp changing to a rapid flash.

A complete multiple of all outgoing circuits is normally made accessible to each operator.

The central position on each suite is equipped with special calling equipment and an additional operator's circuit, so that the assistant supervisor patrolling the suite may be called into circuit and speak by means of a hand set.

In some installations each operator handling incoming traffic can associate a valve amplifier with her head set. The amplifier is brought in circuit with the receiver when the operator throws a key and the volume is

adjusted by a potentiometer until the incoming speech is at a level suited to the operator concerned. In more recent installations, a volume control consisting of 1,000-ohm adjustable resistance is connected in series with a receiver of high efficiency, known as "Receiver, Headgear, No. 9A." The additional efficiency provided by these receivers enables the use of amplifiers to be avoided.

Transmitter cut-out facilities are provided.

Two pairs of cords are available to each operator. This provision is made to enable an operator to extend a caller to the Supervisor or to the Enquiry Desk and then proceed with her work of receiving

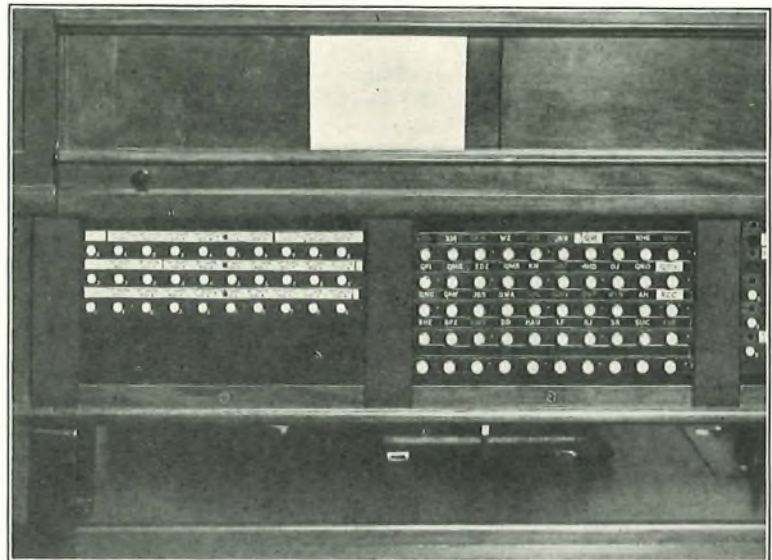

FIG. 4.—TELEPHONE-TELEGRAM DISTRIBUTION PANEL.

or dictating telegrams with the remaining cord circuit.

The supervisor's desk is equipped with a listening cord. Listening-in taps from all the operators' positions are brought out to jacks on the panel before the supervisor. Arrangements are provided which enable the supervisor to switch a 20 db. loss between her telephone and that of any operator, so that the efficiency of the operator's instrument can be estimated from a speaking test. Such tests are carried out daily.

Dialling or ringing may be applied to the calling cord by means of a change-over key.

An audible night alarm can be switched in circuit on the calling signals when required.

Certain additional facilities are provided on the telephone-telegram suites to assist in the distribution of traffic.

One panel of the multiple is equipped as a distribution panel. On this panel appears

- (a) A field of lamps, one lamp connected to each telephone-telegram position and labelled with the position number.
- (b) A field of press buttons each labelled with the designation of a telephone-telegram circuit.

A picture of the distribution panel on a typical telephone-telegram installation is shown in Fig. 4.

When a telegram for dictation to an office connected to the telephone-telegram suite reaches the distribution point adjacent to the distribution panel, the attendant depresses the circuit button labelled with the code of the office concerned and examines the lamp field. If a position lamp glows coincident with the pressing of a button, the circuit in question is being used by the operator at that position. Delay in transmission is thus avoided, as the attendant is able to pass the telegram to the operator in communication with the distant office. On the top of the switchboard above each telephone-telegram operator's position, a dome-shaped lamp fitting is fixed (see Fig. 3). The fitting contains two lamps, one green and one red. When a position is unstaffed there is no glow in the dome. If an operator has her instrument in circuit at a position but is not connected by a cord to any line, the dome displays a red light. The red light is changed to green immediately one of the four cords appearing before the operator is inserted in the line jack of a telephone-telegram out office. The attendant is thus able to locate operators not actually handling the traffic at any moment and to hand to such operators messages for offices which gave no glow on the distribution panel (indicating that the circuit was not in use) when the circuit button was depressed. The green glow changes to red on the position at the instant when the attendant depresses the circuit button. This momentary change from green to red serves two purposes (a) it indicates to the operator that a message is coming along for the circuit to which she is connected and (b) it assists the attendant in locating the required position.

CIRCUITS.

The phonogram cord circuit is shown in Fig. 5. The circuit employs Stone system transmission and the associated lamp supervision. Speaking current is not normally supplied from the cord circuit since

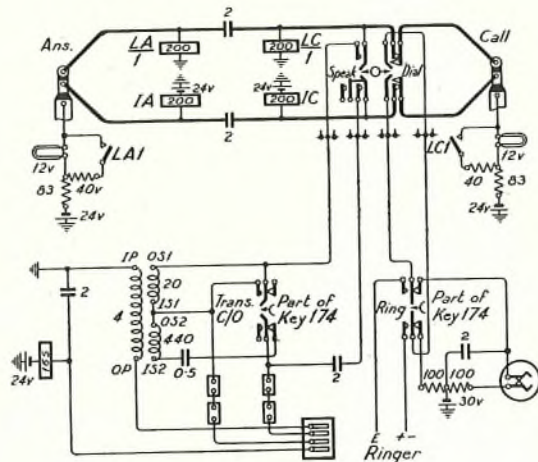

FIG. 5.—24-VOLT PHONOGRAM CORD CIRCUIT AND OPERATOR'S CIRCUIT.

only connexions to exchanges are concerned. The resistance of the feed coils is determined by signalling conditions and the transmission loss in the impedance bridge. A value of 200 ohms resistance for the feeding coils is used irrespective of the voltage of the installation. The extra springs fitted on the speaking key are used when amplifiers are fitted and these close the filament circuit when the key is in the speaking position. This provides against the wastage of filament current which otherwise results when an operator leaves her amplifier key thrown after the completion of a call. The dial and ring key is arranged so that dialling is normal to the calling cord, ringing being applied when both the dial and changeover keys are thrown. Battery dialling into automatic exchanges is adopted as standard practice.

The operator's circuit, which is also shown on Fig. 5, is basically the same as that used on standard C.B. switchboards. An 0.5 microfarad condenser is connected in circuit, as shown, to reduce the effect of side tone, an important point when amplifiers are used. The combination of "Coil, Induction, No. 16" with the 0.5 microfarad condenser in the circuit gives the following efficiencies for the operator's circuit as compared with a standard C.B. circuit.

Sending	2.6 db. better.
Receiving	2.0 db. better.

The circuit used to give amplification of speech is shown in Fig. 6. A gain of 13 db. can be obtained with the potentiometer at maximum. It will be seen that the amplifier is connected in circuit between the induction coil secondary and the operator's receiver. The output transformer is designed to match the valve impedance to that of the operator's receiver.

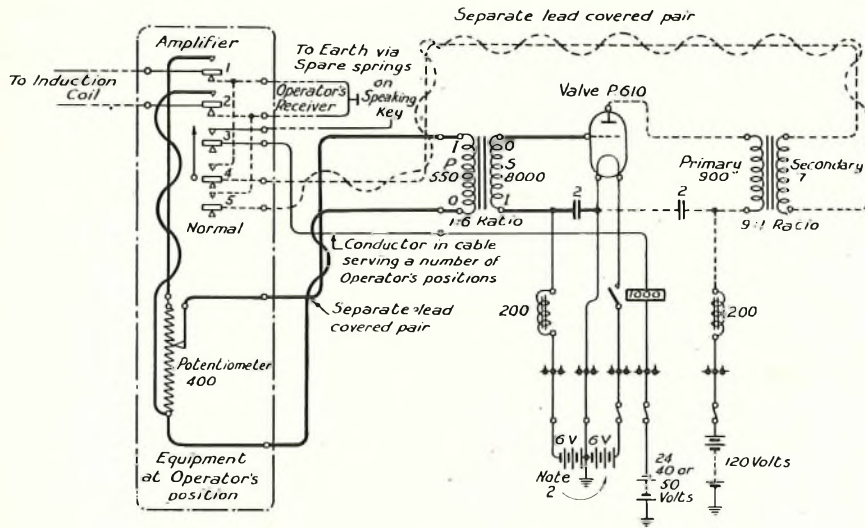

Notes
 1. Wiring of Output Circuit shown---to be kept entirely separate from wiring of Input Circuit shown
 2. The leads from this battery to the valves must be as short as possible.

FIG. 6.—OPERATOR'S AMPLIFIER.

Sufficient decoupling to prevent interference between amplifiers is obtained by the use of 200-ohm bridging coils and 2 microfarad condensers connected as shown. In cases where noise is experienced due to

the H.T. supply, which is usually the positive section of a universal telegraph battery, a smoothing network comprising a retardation coil and two condensers of 2 microfarads capacity is connected in the anode feed circuit.

A complete bothway phonogram circuit fitted with delayed call flash facilities is shown in Fig. 7. The combination of relays L, LL, LLR, LO and CO, is used to receive the call and prevent the reappearance of a lamp glow should the exchange operator clear the line before the phonogram operator. This is an important point on a switchboard where ancillary appearances of a calling signal occur. Relays K and G are the change-over and engaged test relays associated with all C.B. bothway junction circuits. The

two remaining relays FA and FL are part of the flashing circuit, and the action of this part of the circuit will be examined in detail, as it is a somewhat unusual one. Battery is received over the B-

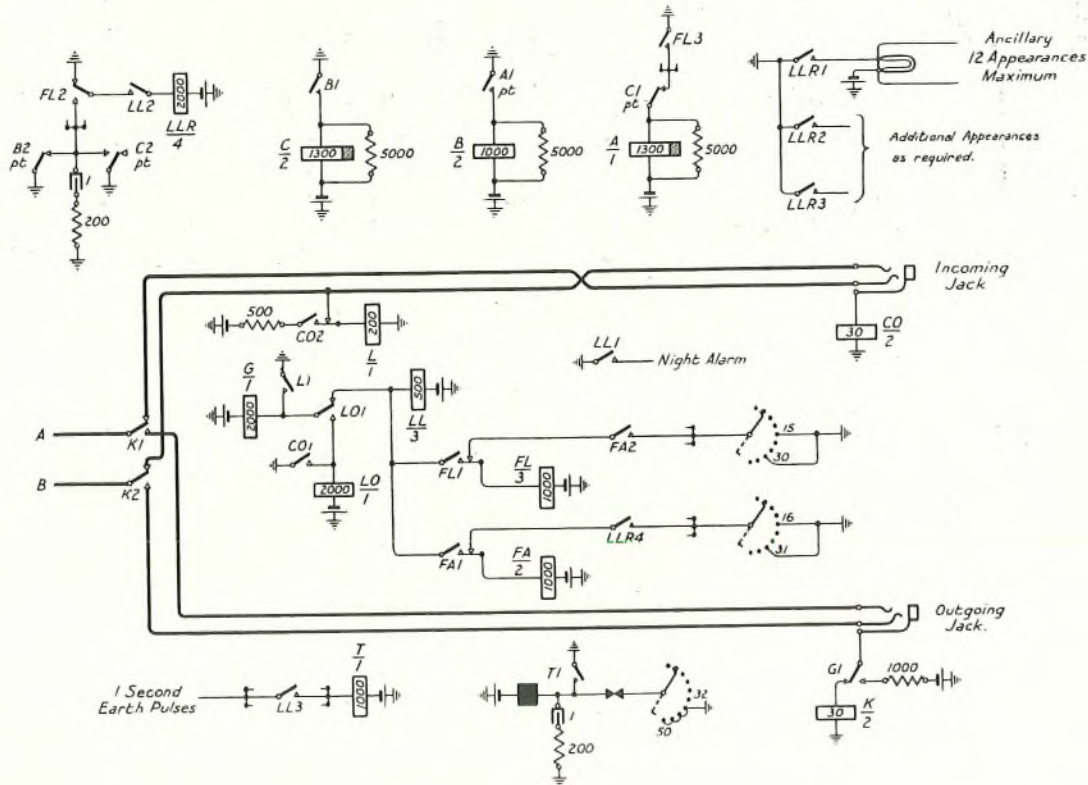

FIG. 7.—BOTHWAY PHONOGRAM CIRCUIT.

wire from the exchange to operate relay L. Contact L1 provides a path for relay LL *via* contact LO1. Contact LL1 closes the night alarm circuit; contact LL2 closes a circuit for relay LLR; contact LL3 closes a circuit giving 1-second earth pulses to relay T. Contacts LLR1, 2 and 3 close the ancillary lamp circuits. Contact LLR4 prepares a circuit for relay FA. Contact T1 closes the stepping magnet circuit once per second and the uniselector wipers rotate at the rate of one step per second so long as relay LL remains operated. When the wiper associated with relay FA reaches an earthed bank contact, relay FA operates and locks over its FA1 contact *via* contact LO1 normal, to contact L1 operated, and earth. Contact FA2 prepares a circuit for relay FL which is completed 15 seconds after relay FA has locked out. Relay FL then operates and locks over contact FL1, contact LO1 normal, and L1 operated, to earth. Contact FL2 makes the circuit of relay LLR, and hence the lamp glow, depend on the position of contacts B2 and C2 of the common flash relays. Contact FL3 starts the flashing train of relays A, B and C which continue to operate and release in that order and cause the ancillary appearance to flash. The facility given is an indication whether any calling subscriber

has been waiting for a period somewhere between 15 and 30 seconds, *i.e.*, in excess of 15 seconds but not more than 30 seconds for his call to be answered. This marginal period applies to all callers, whether one or more are calling together, and whatever position the uniselector stopped on last. It will be noticed that homing is provided over contacts 32 to 50 on the 50-point uniselector.

The telephone-telegram cord circuit, distribution panel and position lamp circuit, are shown on Fig. 8. The Stone system of transmission is again employed, but to provide for speaking current to the C.B. telephones used on some of the shorter out-office circuits, the feed coils are of 50 ohms resistance in 24-volt installations. Ringing is normal to the calling cord, but a dial switching key is provided so that dialling may be substituted for ringing when required. Considering the conditions which exist when the left-hand or answering plug is inserted in a circuit jack, when the plug meets the looped line condition from a calling telephone, relay LA operates. The supervisory lamp circuit is broken at contact LA1. Relays HA and HB are operated over the sleeve circuit to earth *via* a 30-ohm resistance. Relay HAA is operated *via* contact HA1, and relay HBB *via* contact HB1. Contact HAA1 prepares the path for the clearing lamp current. A path is pre-

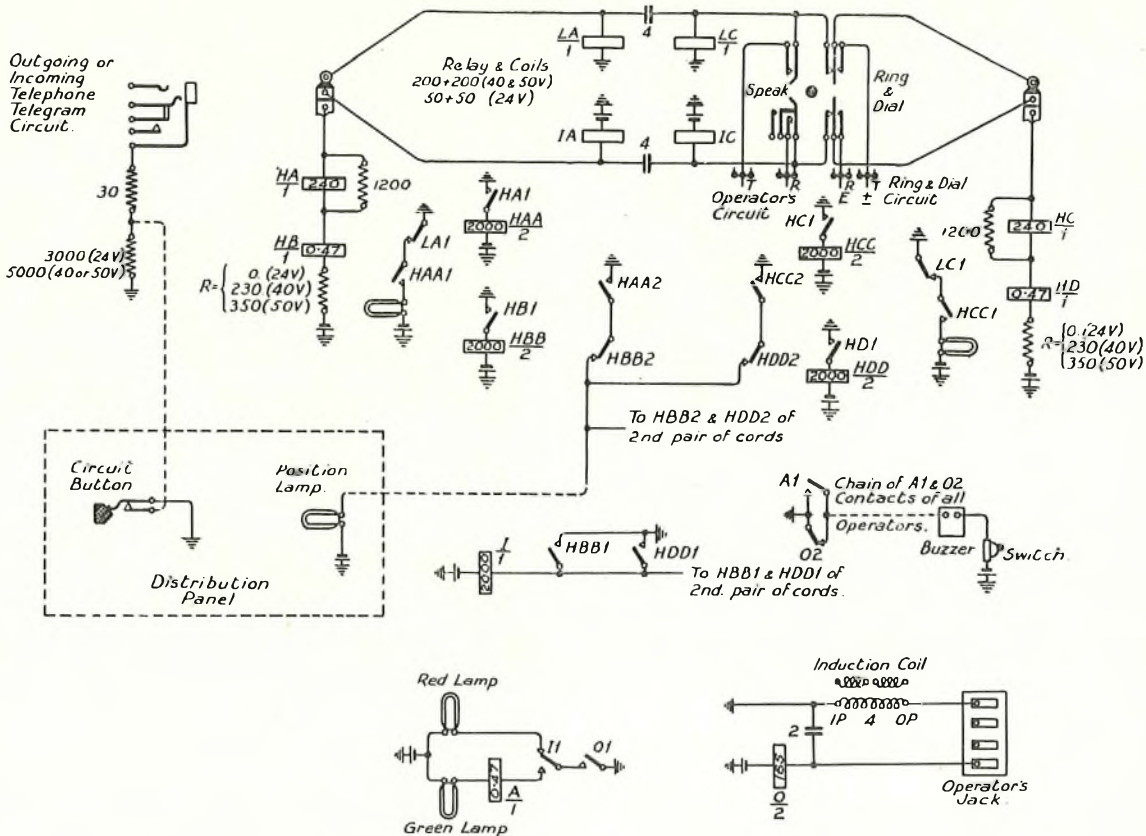

FIG. 8.—TELEPHONE-TELEGRAM CORD CIRCUIT SHOWING CONNEXIONS TO DISTRIBUTION PANEL.

pared *via* contact HAA2 for the lighting of the position lamp on the distribution panel. This path is held open at contact HBB2, at present operated. Relay I is operated *via* contact HBB1 to earth. The operator's instrument, being in the instrument jack, closes a circuit for the operation of relay O which replaces the retardation coil feed usually appearing in the C.B. operator's circuit. The green position lamp is lit *via* contacts I1 and O1. If now the circuit button associated with the circuit connected is depressed, a resistance of 3,000 ohms, assuming 24-volt working, is inserted in the sleeve circuit. This causes the release of relay HB, but not of relay HA. Relay HBB releases, and at contact HBB2 closes the circuit to the position lamp which now glows. Contact HBB1 releasing causes relay I to release, and changes over contact I1 from the green to the red lamp circuit. Release of the button restores the green lamp glow and extinguishes the position lamp. A similar sequence of events occurs when the calling cord is used. By means of a chain of contacts A1 and O2, a circuit is provided through positions which are closed down over resting O2 contacts, and through positions which are busy over operated A1 contacts, to an alarm buzzer on the supervisor's desk. When this alarm operates, it indicates to the

supervisor that all available staff are fully occupied with traffic and she may then consider it necessary to open a few more positions to meet the traffic load.

The circuit adopted to give loop calling with delayed call flash on telephone-telegram circuits from Post Offices is shown in Fig. 9. The line relay L is connected between earth and the B-wire, and battery is fed through a 200-ohm resistance to the A-wire. This is done in preference to the reverse arrangement, *i.e.*, battery to relay and earth to resistance, to prevent the calling signal from being permanently locked out should an earth fault develop on the line during a call. Considering an incoming call, a loop is applied to the line from the distant telephone, battery flows round the loop operating relay L, relay G operates over contact L1, a 100-ohm resistance and battery. Relay LL operates over contacts LO1 normal, L1 and 100-ohm resistance to battery. Contact G1 breaks the circuit of relay K to guard against the possible breakdown of the loop at K1 and K2 should a plug inadvertently be inserted in an outgoing jack. Contact G2 puts an engaged test potential on the bush of the outgoing jack. Contact LL1 closes the night alarm circuit. Contact LL2 closes the circuit for relay LLR. Contact LL3 closes the circuit to relay T which operates at 6-second

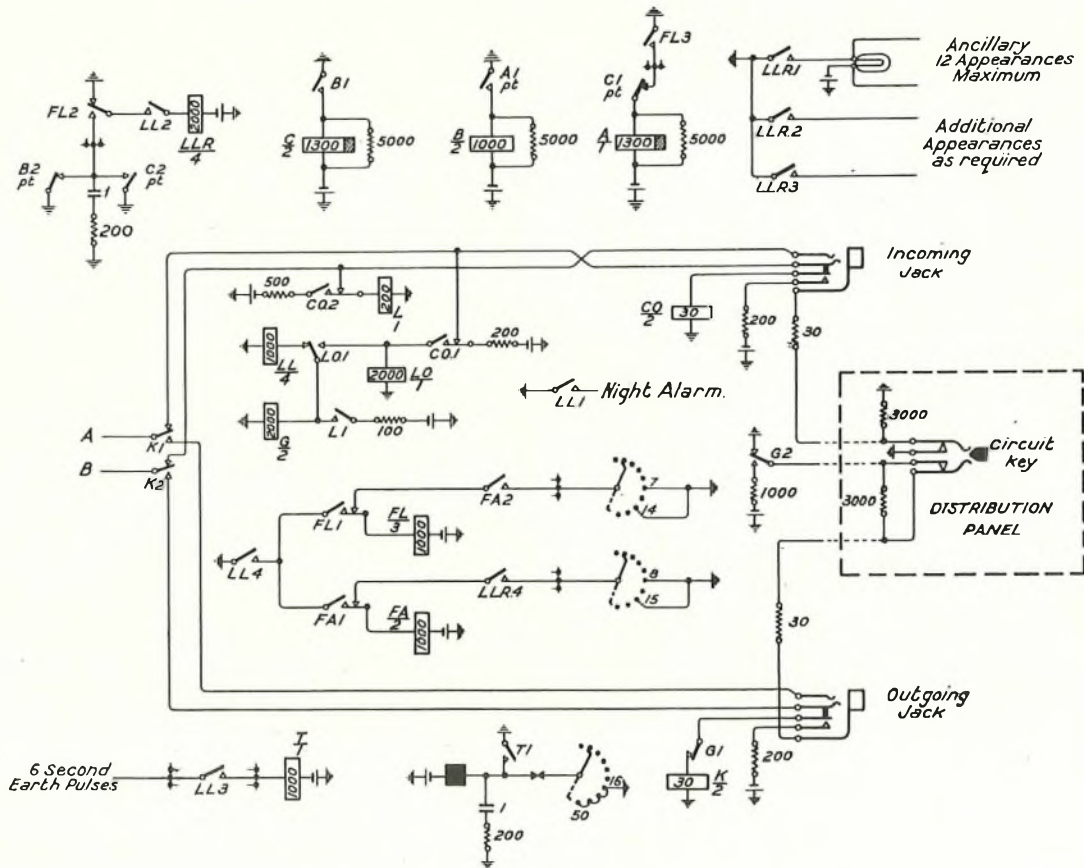
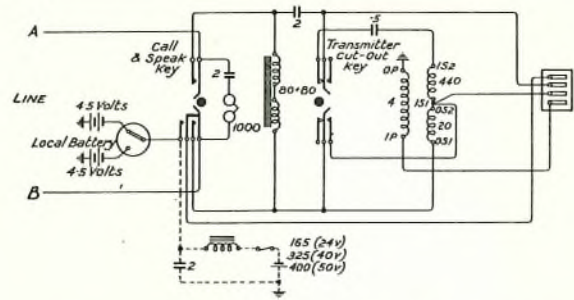

FIG. 9.—BOTHWAY TELEPHONE-TELEGRAM CIRCUIT.

intervals from a master clock, and, at contact T₁, operates the stepping mechanism of the uniselector which rotates at a corresponding speed. Contact LL₄ prepares a path for the subsequent lock-out of relays FA and FL. From this point onwards, the operation of the flashing circuit follows the lines already described for the phonogram bothway circuit. The marginal period during which the calling glow is changed to a flash is from 45 to 90 seconds in this case. The function of the distribution panel circuit key will be apparent from the details given above when dealing with the telephone-telegram cord circuit.

Telephone-telegram circuits which terminate at the distant end on exchanges are connected to battery calling or generator calling equipment as required. In these circumstances, the distribution panel feature is not included since the exchange circuit used for the connexion gives no indication as to the office connected at the exchange end of the circuit.

Out stations may be equipped with C.B. or L.B. telephones of pedestal or microtelephone pattern, or with the circuit shown in Fig. 10. Double headgear receivers of light-weight pattern are generally used in conjunction with pedestal telephones with the circuit of Fig. 10. The circuit shown provides for loop calling, but an equivalent circuit providing for generator calling is available. Typewriter reception



Note. The dotted connexions apply where a secondary cell source is available

FIG. 10.—TELEPHONE-TELEGRAM OUT-OFFICE OPERATOR'S CIRCUIT WITH LOOP CALLING.

is in use at the larger out offices and in some cases amplifiers are fitted.

Phonogram and telephone-telegram circuits terminating at C.B. exchanges are connected to subscriber's calling equipment modified to accord with junction signalling practice. At automatic exchanges, incoming circuits terminate on dialling-in relay-sets and 1st selectors. Outgoing circuits from automatic exchanges are connected via the 90 and 95 levels to relay-sets which give C.B. junction conditions towards phonograms and provide metering, ringing tone, holding and guard against following-on calls on the automatic side.

Telegraph and Telephone Plant in the United Kingdom.

TELEPHONES AND WIRE MILEAGES. THE PROPERTY OF AND MAINTAINED BY THE POST OFFICE IN EACH ENGINEERING DISTRICT AS AT 31ST DEC., 1932.

No. of Telephones owned and maintained by the Post Office.	Overhead Wire Mileages.				Engineering District.	Underground Wire Mileages.			
	Telegraph.	Trunk.	Exchange.	Spare.		Telegraph.	Trunk.	Exchange.	Spare.
786,236	708	8,936	41,942	3,016	London.	43,527	182,919	3,495,382	146,606
94,494	1,943	20,083	43,791	4,964	S. Eastern.	4,123	50,404	347,433	41,344
109,584	4,236	36,985	65,986	3,925	S. Western.	23,681	29,896	275,746	65,220
74,438	4,718	40,150	63,503	8,360	Eastern.	19,595	54,289	156,524	46,393
120,516	7,212	52,131	52,039	6,031	N. Midland.	32,083	131,582	324,091	70,257
95,695	4,088	32,632	62,626	2,646	S. Midland.	16,144	46,571	282,098	76,505
67,696	3,419	30,849	52,393	5,379	S. Wales.	6,741	40,838	164,593	52,332
131,859	6,540	30,096	54,694	5,522	N. Wales.	16,850	61,410	409,279	117,741
178,269	897	12,126	24,587	5,598	S. Lancs.	13,644	117,365	623,973	78,331
111,292	5,188	30,734	36,871	6,969	N. Eastern.	19,686	73,680	321,888	48,239
74,608	4,228	23,454	25,735	4,359	N. Western.	6,203	46,447	237,248	56,239
57,014	2,124	17,201	21,137	4,113	Northern.	10,667	35,311	181,972	37,536
27,971	3,403	11,164	11,530	813	Ireland N.	369	4,217	64,492	6,481
80,936	4,699	32,782	38,736	2,232	Scotland E.	9,374	35,994	176,602	39,432
103,518	5,525	24,204	30,212	1,971	Scotland W.	9,001	43,232	256,277	33,431
2,114,126	58,928	403,527	625,782	65,898	Total	231,688	954,155	7,317,598	916,087
2,095,327	59,163	400,395	617,589	62,082	Figures as at 30 Sept., 1932.	231,167	925,239	7,212,399	934,946

Design of Relays for Automatic Telephone Equipment Circuits, with Special Reference to Relay Type 3000

R. BARKER, B.Sc.

(Messrs. Siemens Brothers and Co., Ltd.).

THE electro-magnetic relay is perhaps the most important piece of apparatus used in automatic telephone exchange equipment, as nearly every circuit used on such equipments employs one or more relays.

This universal use, and the consequent tremendous quantities involved, makes it essential that the relay should possess the utmost reliability without any need of attention to individual relays.

The question of reliability involves two considerations, contact reliability and functional reliability; and as a relay is essentially a contact-operating device, the first step in design should be to ensure contact reliability. Having obtained this, the next step should be to arrange for functional reliability, *i.e.*, adequate factors of safety for the operations which the relay may be called upon to perform.

A number of different designs of relay are in use at present on the various automatic telephone systems, but there is a general similarity in that on practically all types the contacts are mounted on flexible springs which are moved into or out of contact with each other by the relay armature movement.

In this article, certain of the features of the Department's Relay Type 3000 are discussed and a method of calculating the design of individual relays in accordance with their circuit requirements is outlined. This method of design would, of course, be equally applicable to other types of relay.

Contact reliability demands suitable contact material and adequate contact openings and pressures, and these points have received very careful consideration by all designers subject to limitations imposed by space and current consumption.

Up till recently, however, contacts have not been completely satisfactory as they were subject to failure to make electrical contact when closed. This phenomenon, generally referred to as "dirty contacts," was universal and accounted for a large proportion of the total faults on an exchange. It has, however, now been practically eliminated by the introduction of twin silver contacts such as are used on the Post Office Relay Type 3000.

For contact material, Silver has been found equal or superior to any other metal as regards reliability for ordinary duties and is, of course, much cheaper than gold or platinum or mixtures thereof.

For heavy duty contacts, *i.e.*, those breaking large currents, Platinum is very satisfactory and no really efficient and cheaper substitute has so far been discovered.

These two metals, Silver for ordinary duty and Platinum for heavy duty, are used exclusively on Relay Type 3000.

However good the actual contacts are, it is still necessary to ensure adequate contact openings and pressures, and on Relay Type 3000 these latter requirements have been fulfilled by locating the front and back contact springs on a rigid support close to the contact. This automatically ensures a suitable contact opening which cannot vary appreciably unless the contact springs are deliberately distorted; adequate contact pressure is ensured by adjusting the front and back springs to rest on the rigid support (referred to as the Buffer block) with a certain pressure. Hence, when the front or back springs are lifted off the buffer block by the armature spring, the contact pressure obviously is bound to be rather greater than the buffer block pressure. This buffer support spring arrangement is shown in Fig. 1.

It will be observed that this method calls for individual tension adjustments on each front and back spring, and this is definitely desirable as tests have shown that small contact pressures (5 gms. and

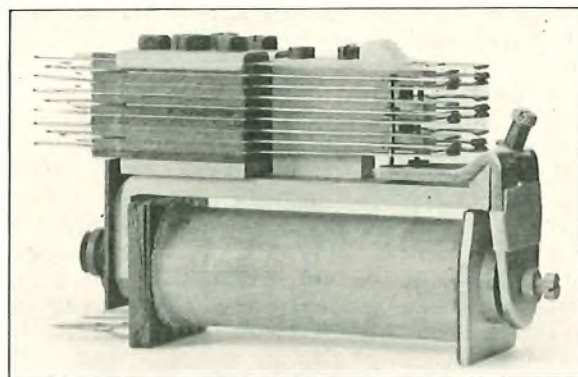

Side View of Relay.

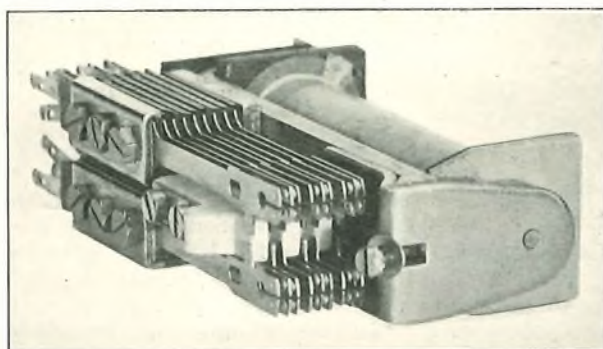

Relay in Mounted Position.

FIG. 1.—RELAY TYPE 3000.

under) do not guarantee reliable "electrical" contact although "mechanical" contact is quite definite. Hence, a method of specifying a total pressure to be distributed over a number of springs at the adjuster's discretion is not satisfactory as it is almost certain to result in some cases of light contact pressure. Adjustment to electrical tests is even less satisfactory as this not only permits uneven distribution as above, but also introduces the possibility of other defects, such as unduly large air gaps in the magnetic circuit, being compensated for by lighter spring tensions.

In studying relays from a circuit point of view, there is a natural tendency to regard their duty as being to operate, release, etc., on certain currents and that, therefore, a method of adjusting the relay to fulfil current tests is desirable.

This is a short-sighted view for, as stated above, the fundamental duty of a relay is to close and open its contacts reliably, and therefore adjustment should be a mechanical method applied directly to each contact. This principle has been applied to Relay Type 3000 as outlined above.

Satisfactory adjustments having been obtained by mechanical means, the object of electrical tests is to ensure :—

- (a) That there are no faults or weaknesses in the electro-magnetic elements of the relay.
- (b) That a relay so adjusted will fulfil its circuit functions with an adequate factor of safety.

If a relay correct in other respects has its spring-sets incorrectly adjusted the electrical tests may indicate the trouble, but this is incidental and current tests should not be regarded primarily as a means of checking adjustments.

When a purely mechanical method of adjustment is applied to apparatus manufactured in large quantities, it is obvious that some tolerances must be allowed on each adjustment, and that consequently individual relays will differ slightly, but if proper methods of manufacture are used the majority will tend to be at the mean value of the adjustment.

Thus in the case of a spring tension of mean value 15 gms., limits 17-13 gms. inspection of a large quantity of shop production gives results of a type indicated graphically in Fig. 2.

Such variations in adjustment are naturally reflected in the electrical performance of the relay and the operating currents of a large quantity of relays would give graphical results of the same character as Fig. 2.

Allowance for these variations must be made in specifying the test current for the relay, *i.e.*, if an ideally adjusted relay should theoretically operate on current I the test current specified for the manufactured article should be KI , K being a factor greater than unity. This value KI should be such as to pass any relay assembled and adjusted with reasonable care. In actual design this factor of safety is based upon armature load and not upon current for reasons discussed later.

It might be argued that the test current specified should pass a relay with all adjustments at the

extreme allowed by the specification, but this is undesirable for two reasons :—

- (a) A relay with all adjustments at one extreme is, by any reasonable criterion, badly adjusted as the obvious duty of the adjuster is to aim at the mean, not at one extreme.
- (b) If the principle were allowed, then either adjustment limits would have to be made very narrow with consequent increased cost of adjustment or with reasonable adjustment limits the performance of relays nominally the same would be liable to vary widely.

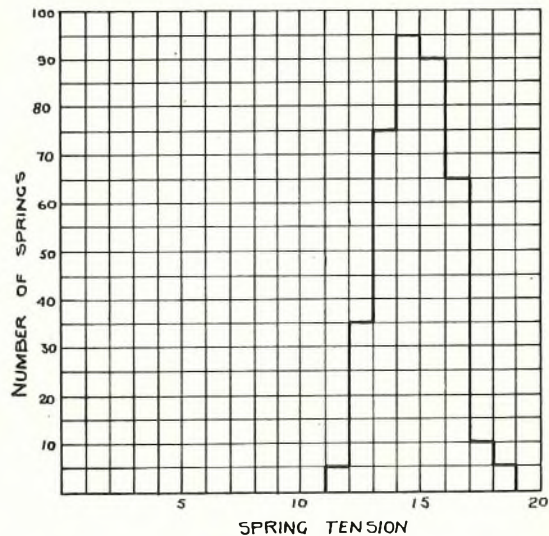

FIG. 2.—SPRING TENSION MEASUREMENTS ON 300 RELAYS. NOMINAL TENSION, 15 GMS; ADJUSTMENT LIMITS, 13-17 GMS.

The primary purpose of this test figure is, as stated above, to ensure that the relay will function correctly in the circuit, so there must be a definite margin between the test current and the actual circuit current, and this margin must be sufficient to cover all possible contingencies. The most important of these are :—

- (1) Change of relay performance due to handling and usage.
- (2) Variation of circuit current due to voltage and resistance, etc., variations.

If the state of affairs on a working equipment is considered, tests on a large number of relays would give results of the type indicated in Graph A, Fig. 3, and measurement of the circuit current in the relays would give results of the type indicated in Graph B, Fig. 3.

If points Aa and Bb are apart as shown, there will be no trouble, but if Aa and Bb overlap there will be a certain fault liability. In relay operation, a clearance between Aa and Bb is not the only factor affecting the margin which should be allowed between the test value and the circuit value, as time is important and a relay energized on its bare operating current may take as long as 100 milliseconds to close its contacts whereas 10% increase in current might

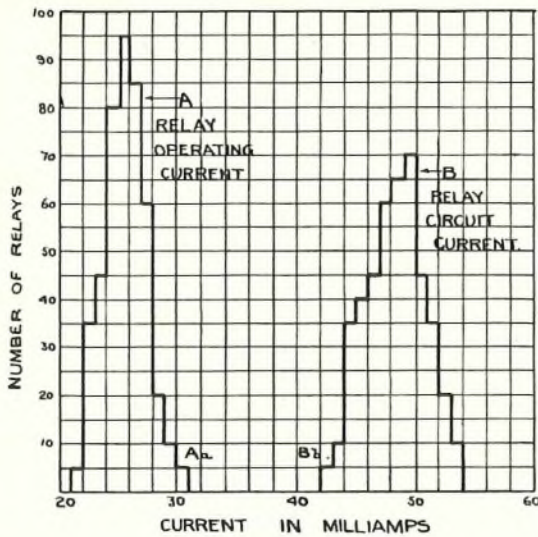

FIG. 3.—RELAY CURRENT CONDITIONS. NOMINAL CIRCUIT CURRENT, 50 MA. RELAY TEST CURRENT, 28 MA.

reduce this to 50 milliseconds. Such long periods and wide variations are obviously objectionable in automatic circuits, so it is desirable to make the margin between circuit current and test current wider than might be necessary for safe operation without time considerations.

The same remarks apply to the releasing condition.

It follows from the above considerations that, in designing a relay for a particular circuit condition, there are two margins to consider :—

- (a) Margin between ideal performance and test value.
- (b) Margin between test value and circuit condition.

And standard values for these margins are desirable so as to obtain uniform working and to simplify design methods as applied to individual relays. A complete system, such as the Department's Non-Director system, involves about 200 different circuits and several hundred different relay assemblies so that the need for avoiding haphazard design methods is obvious.

The safety margins have so far been discussed in terms of current values, but in considering standard values a current or ampere-turn basis is not the most suitable, particularly in the case of the test value.

The test value is intended to cover variations in performance of relays adjusted to a mechanical specification so that the variations are mainly armature load variations and therefore the factor of safety should be on a load basis. To maintain a direct relationship between the test value factor of safety and the circuit condition factor of safety, it is desirable to consider the latter also in terms of load.

As a common reference for these two factors of safety, the nominal armature load with the relay in ideal adjustment is the most suitable. The scheme will be clearer if expressed numerically.

In the case of the operation of a relay, typical

values for the Factor of Safety are 1.5 for test value and 4.0 for circuit value.

Let W = nominal armature load of springsets on a particular relay.

Then the relay winding should be designed so that under circuit conditions the ampere-turns on the relay will be capable of operating a load of $W \times 4$.

Having designed this winding, the current specified for the operating test value should give ampere-turns capable of operating a load $W \times 1.5$.

Standard Values of Factors of Safety.

The actual values to be used for the Test Factor of Safety, are largely governed by experience, as the values must be a compromise between the allowance necessary to permit reasonable manufacturing costs on the one hand and the need for uniformity in relay performance on the other.

In the Relay Type 3000, it has been found that a Factor of Safety of the order of 1.5 on the nominal springset load is a suitable figure for the test value for all current tests, viz., Operating, Non-operating, Holding and Releasing.

This figure may seem high, and it is much higher than the ratio of mean to maximum spring tension allowed, but it must be remembered that it has to cover other adjustment variations such as armature travel and also the effects of assembly and material variations which are bound to occur on apparatus manufactured in bulk.

It will be obvious that this Factor of Safety will result in a much wider gap between test currents for opposing functions, such as Operating and Non-operating, than would be the case if the relay were adjusted to fulfil current tests, because in the latter case adjustments can be modified to mask other variations.

It is quite easy to adjust a relay not to operate on 80% of its full operating current, but with the Factors of Safety quoted above the Non-operating current works out at about 50% of the operating current.

This means that wider margins must be given between circuit operating and non-operating conditions than if the relay were adjusted to current, but slight limitations of this type must be tolerated in order to obtain the advantages of thoroughly reliable contacts.

Working Factor of Safety values vary for different functions owing to the time factors and the nature of the Load-Ampere-Turn characteristics for the different functions.

Experience has shown that for Relay Type 3000 working under the Department's standard conditions as regards voltage and resistance limits, the following values are suitable for the majority of cases :—

Operating	$\frac{\text{Load equivalent of minimum circuit ampere turns}}{\text{Nominal springset load}}$	$\frac{4}{1}$
Holding	ditto	$\frac{2.5}{1}$
Releasing	$\frac{\text{Nominal springset load}}{\text{Load equivalent of maximum circuit ampere turns}}$	$\frac{3}{1}$
Non-operating	ditto	$\frac{2.5}{1}$

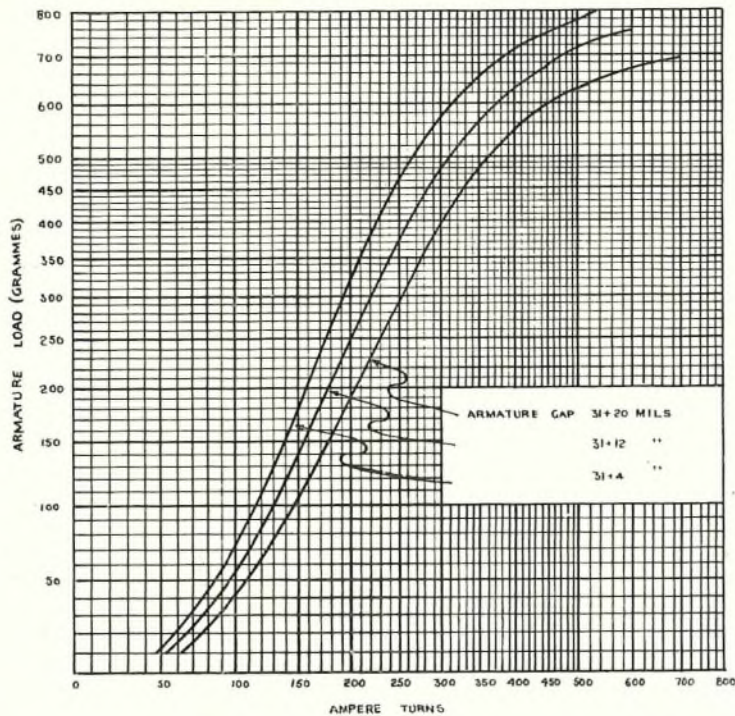

FIG. 4.—OPERATING AND NON-OPERATING LOAD AMPERE-TURNS CHARACTERISTICS FOR RELAY TYPE 3,000 WITH ORDINARY ARMATURE.

These figures ensure reliability in working and reasonable uniformity in speed, and every effort should be made to obtain these or higher figures.

In some cases, such as line relays required to work over a wide variation of line resistance, these figures cannot be obtained and the design must be specially considered to obtain the best all round factors of safety; it is, of course, essential to ensure that the test current values have some margin over their corresponding circuit currents under the worst possible combination of voltage and resistance limits.

Impulsing conditions and slow operating or releasing conditions also demand special treatment.

Data required for Design of Relay Type 3000.

In order to design individual relays in accordance with the above outline, the following information is required :

- (1) Graphs showing the relationship between Armature Load and energizing Ampere-Turns for the various functions, *i. e.*, Operating, Non-operating, Holding and Releasing.
- (2) The Armature load given by the springset for the four above functions.

The Armature Load-Ampere Turn characteristics take their shape from the magnetization curve of the magnetic system represented by the relay. Typical graphs for Relay Type 3000 are shown for Operating and Non-operating in Fig. 4 and for Holding and Releasing in Fig. 5.

Springset Loads.

There are four fundamental types of contact action used on Relay Type 3000. These are :—

(a) "Make."

A two-spring contact, the contact being open with the relay unoperated and closed when the relay operates.

Conventionally shown on reports, diagrams, charts, etc., by one of the devices shown in Fig. 6(a).

(b) "Break."

A two-spring contact having the opposite action to a "Make." It is conventionally shown by one of the devices in Fig. 6(b).

(c) "Change-Over."

A three-spring contact combining Break and Make action. It is represented by one of the devices

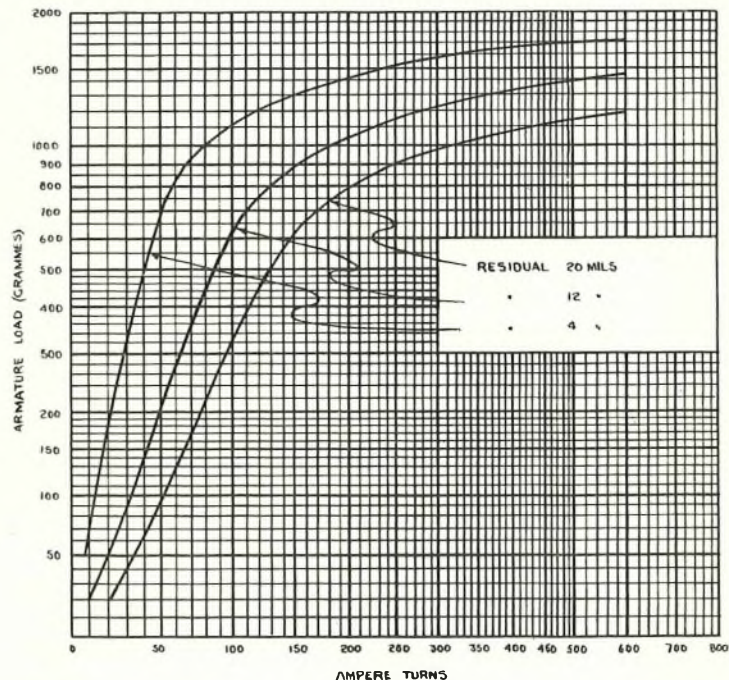

FIG. 5.—HOLDING AND RELEASING LOAD AMPERE-TURNS CHARACTERISTICS FOR RELAY TYPE 3,000 WITH ORDINARY ARMATURE.

shown in Fig. 6(c).

The operation of the armature first lifts spring 2 out of contact with spring 1 and then later in the stroke spring 2 contacts with spring 3. This type of action is referred to as Break before Make.

(d) "Change-over (Make before Break)."

A three-spring contact as for "Change-over" above in which the "Make" action is closed before the "Break" action opens. It is represented by one of the conventions shown in Fig. 6(d).

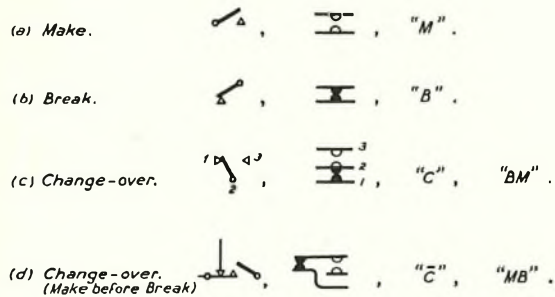

FIG. 6.—CONVENTIONS FOR RELAY CONTACTS.

The springsets used on Relays Type 3000 are built up of various combinations of the above.

Springset Load on Armature.

This cannot be stated as a single figure obtained by direct measurement, as the load increases all through the armature stroke.

Load Equivalents.

The load equivalents of the springsets are therefore obtained as follows:—

The critical ampere-turn value for each function (Operating, Non-operating, Holding and Releasing) is obtained for springsets accurately adjusted to mean nominal values. The grammes load equivalent to this ampere-turn value is then read off the relevant Load-Ampere Turn graph and this figure is taken as the Load Equivalent of the springset for the particular function concerned.

Criteria.

The criteria for the various functions in obtaining these figures were:—

Operation. Full operation of armature, *i.e.*, residual up against pole face.

Non-operation. Contacts not functioning, *i.e.*, "Makes" not closing and "Breaks" not opening.

Holding. Armature does not leave pole face.

Releasing. Contacts returned to normal condition, *i.e.*, "Makes" open the "Breaks" closed.

Operating Load.

Obviously the operating load so obtained is purely a conventional figure and is not measurable mechanically, as the actual armature load during operation varies from a small figure with the armature at normal up to the full holding load when the armature is fully operated.

Furthermore, these operating loads are not a fixed quantity for any particular springset, but vary with the total springset load on the relay and the Armature Air Gap (Travel + Residual).

This implies a separate load figure for every possible combination of contacts for each standard air gap length.

To avoid this very extensive tabulation, the load figures for each of the four types of contact unit are tabulated for the various conditions of number of contact units on the relay and the standard armature air gaps.

Non-Operating Load.

The absolute minimum non-operating load is, of course, the pressure on the armature when at normal and this could be measured directly.

This load, however, is very small and if used as a basis of design would give an unnecessarily high factor of safety. Actually, the relay can be energized to a certain extent without causing the contacts to depart from their normal condition.

The load equivalents for this condition are obtained in the same way as for the operating and show the same tendencies as regards effect of air gap and total load.

Breaks and change-overs show identical results as the criterion of non-operation is the same, *i.e.*, non-opening of the Break contact.

Makes and MB change-overs are also equal for a similar reason.

Holding Load.

This is a fixed measurable quantity for any particular springset, being the pressure on the armature pip with the armature fully operated. In this case, the load equivalent per contact unit is constant for a given armature travel and is the same irrespective of number of contacts on relay or armature residual gap.

Releasing Load.

Nominally this is the same as the Holding load, but experience has shown that it is desirable to take a lower value in order to ensure reliable restoration of contacts.

The complete range of load equivalents are shown in Table II.

Illustration of Method.

Assume that a relay of 1000Ω resistance and carrying 2 change-over, 1 Make, and 1 Break, con-

tacts is required to fulfil the following circuit conditions :—

- (a) To operate in series with 500Ω on 50v.
 (b) To hold in series with $1,000\Omega$,,
 (c) To release in series with $20,000\Omega$,,
 (d) Not to operate in series with $6,500\Omega$,,

To obtain the load equivalents, assume that a 12-mil residual will be satisfactory. Then the load equivalents for the various functions can be obtained from Table II.

$$\text{Non-operating } \frac{70}{.0073} = 9600 \text{ maximum.}$$

Inspection of these figures shows that a winding of 9000 turns fulfils all conditions, giving a margin on standard Factors of Safety for all four functions.

To obtain the test value currents at 1.5 Factor of Safety :—

$$\text{Operating :—Nominal load } (93) \times 1.5 = 140 \text{ gms.}$$

$$\text{Equivalent Ampere Turns from Fig. 4 } 150$$

TABLE I.

Action.	Load Equivalents Gms.			
	Operating.	Holding.	Releasing.	Non-operating.
2 C	$2 \times 27 = 54$	$2 \times 115 = 230$	$2 \times 90 = 180$	$2 \times 17 = 34$
1 M	$1 \times 17 = 17$	$1 \times 80 = 80$	$1 \times 55 = 55$	$1 \times 8 = 8$
1 B	$1 \times 22 = 22$	$1 \times 70 = 70$	$1 \times 55 = 55$	$1 \times 17 = 17$
Total	93	380	290	59

Apply the Working Factors of Safety.

$$\text{Operating load } 93 \times 4 = 372 \text{ gms.}$$

$$\text{Holding ,, } 380 \times 2.5 = 950 \text{ gms.}$$

$$\text{Releasing ,, } 290 \div 3 = 97 \text{ gms.}$$

$$\text{Non-operating ,, } 59 \div 2.5 = 24 \text{ gms.}$$

Now referring to the graphs on Figs. 4 and 5.

$$\text{Ampere Turns for Operating } 372 \text{ gms.} = 250$$

$$\text{do. Holding } 950 \text{ gms.} = 165$$

$$\text{do. Releasing } 97 \text{ gms.} = 31$$

$$\text{do. Non-operating } 24 \text{ gms.} = 70$$

The circuit currents for the above assuming

Voltage limits 46—52 are :—

Resistance limits 95—105%

$$\text{Operating } \frac{46}{1575} = 29.2 \text{ mA.}$$

$$\text{Holding } \frac{46}{2100} = 21.9 \text{ mA.}$$

$$\text{Releasing } \frac{52}{20,000} = 2.6 \text{ mA.}$$

$$\text{Non-operating } \frac{52}{7100} = 7.3 \text{ mA.}$$

Therefore to obtain the standard Factors of Safety, the number of turns required is as follows :—

$$\text{For Operating } \frac{250}{.029} = 8700 \text{ minimum.}$$

$$\text{Holding } \frac{165}{.022} = 7500 \text{ minimum.}$$

$$\text{Releasing } \frac{31}{.0026} = 12000 \text{ maximum.}$$

$$\therefore \text{ Test current } = \frac{150}{9000} = 16.7 \text{ mA.}$$

$$\text{Holding :—Nominal load } (380) \times 1.5 = 570 \text{ gms.}$$

$$\text{Equivalent Ampere Turns from Fig. 5 } 94$$

$$\therefore \text{ Test current } = \frac{94}{9000} = 10.5 \text{ mA.}$$

$$\text{Releasing :—Nominal load } (290) \div 1.5 = 193 \text{ gms.}$$

$$\text{Equivalent Ampere Turns from Fig. 5 } 48$$

$$\therefore \text{ Test current } = \frac{48}{9000} = 5.3 \text{ mA.}$$

Non-operating :—

$$\text{Nominal load } 59 \div 1.5 = 39.5 \text{ gms.}$$

$$\text{Equivalent Ampere Turns from Fig. 4 } 84$$

$$\therefore \text{ Test current } = \frac{84}{9000} = 9.35 \text{ mA.}$$

Reducing these to round figures the test specification for the relay would be :—

To operate on 17 mA.

To hold on 11 ,,

To release on 5 ,,

Not to operate on 9 ,,

The saturation current will be the circuit current

$$\text{at 52v. } = \frac{52}{1500} = 34.6 \text{ mA.}$$

$$\text{Say } = 35 \text{ mA.}$$

SUMMARY.

	Operating.	Holding.	Releasing.	Non-operating.
Limit circuit current	29.2 mA.	21.9 mA.	2.6 mA.	7.3 mA.
Ampere Turns at 9000 turns	263	197	23.5	66
Equivalent load	405 gms.	1030 gms.	65 gms.	21 gms.
Working Factor of Safety	4.35	2.7	4.45	2.8
Test current value	17 mA.	11 mA.	5 mA.	9 mA.

The foregoing deals with the performance of the relay with reference to current conditions in the circuit, but other functions such as slow-releasing can be dealt with in a similar manner.

Certain relays having special circuit functions are not amenable to any standard method of design and such cases must be dealt with specially, but it has been found in practice that the great majority of the hundreds of different designs required on an automatic system can be dealt with in a standard manner.

The main advantages of a standardized method of design are :—

- (1) Uniform margins of safety on all relays.
- (2) Uniform results obtained by different designers working independently.
- (3) Avoidance of unduly severe test specifications which increase the cost of manufacture and the amount of maintenance attention.
- (4) An easy means of finding out if new circuit designs are satisfactory from the point of view of the performance required of the relays.

TABLE II.

RELAY TYPE 3000 LOAD EQUIVALENTS OF CONTACT UNITS.
14-Mil Springs with Nominal Standard Adjustment.
Ordinary Armature 31 Mills Travel.

Contact Units on Relay.	OPERATING LOADS.											
	Break.			Make.			Change-over.			MB Change-over.		
	Residual.			Residual.			Residual.			Residual.		
	4	12	20	4	12	20	4	12	20	4	12	20
1	16	19	23	13	16	19	20	24	28	15	18	24
2	16	20	24	13	16	20	21	25	29	16	19	25
3	16	21	25	13	17	21	22	26	31	16	20	26
4	17	22	26	14	17	22	23	27	32	17	21	27
5	18	23	28	14	18	23	23	28	33	18	22	28
6	19	24	29	14	19	24	24	29	34	18	23	29
7	19	25	30	15	19	25	25	29	35	19	23	30
8	20	26	31	16	20	26	26	30	36	19	24	31

NON-OPERATING LOADS.

Contact Units on Relay.	Unit Load Equivalents in Grammes.					
	Break or Change-over.			Make or MB Change-over.		
	Residual.			Residual.		
	4	12	20	4	12	20
1	12	15	18	6	8	9
2	12	15	19	6	8	10
3	13	16	20	7	8	10
4	14	17	22	7	8	11
5	15	18	24	7	9	12
6	16	18	25	7	9	12
7	17	19	26	8	9	13
8	18	20	27	8	9	13

In the case of screw residuals of lengths intermediate between the standard lengths, find the total load for the standard length below the required figure and then add 3% per mil.

HOLDING AND RELEASING LOADS.

Function.	Unit Load Equivalent in Grammes.			
	Break.	Make.	Change-over.	MB Change-over.
Holding	70	80	115	90
Releasing	55	55	90	60

Miscellaneous Facilities at Automatic and Manual Telephone Exchanges

A. HOGBIN.

CENTRALIZED SERVICE OBSERVATION EQUIPMENT.

Introduction.

IN small telephone exchanges, the quality of the service given to subscribers is sampled by "Service Inspectors." From time to time, these officers pay visits to the subscribers to obtain their views on the efficiency of the service and to observe the progress of test calls originated by the subscribers. These periodical service inspections provide valuable information and enable the supervising officers responsible to maintain a "watching brief" over the service.

At comparatively large exchanges, however, it is necessary to observe the service continuously, and the most satisfactory and economical method is for a specially-trained observer to listen-in, at the exchange concerned, on a number of subscribers' lines. Where there are several exchanges in a district, further economy is effected by observing the exchanges from a central point, and it is in this way that observation centres are established. The London centre is located at Wood Street, E.C.1, and one of the suites of observation positions is shown in Fig. 1.

The institution of service observations instead of

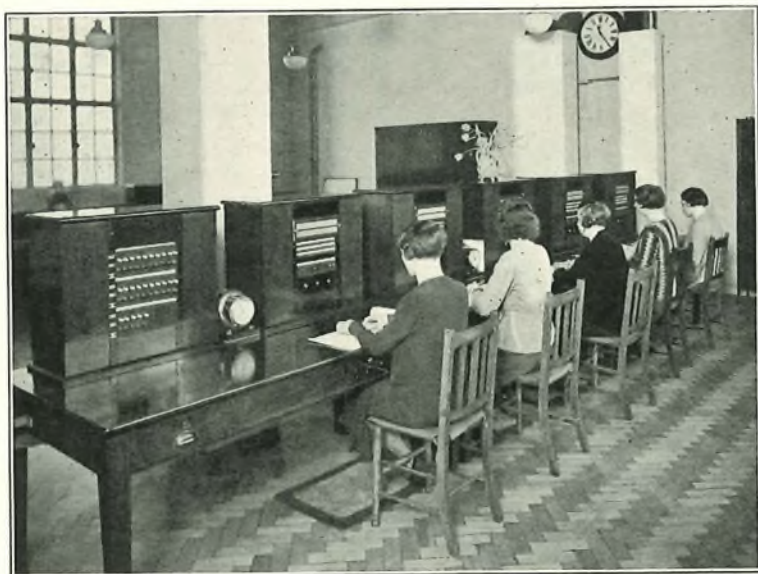

FIG. 1.—SUITE OF OBSERVATION POSITIONS.

service inspections is governed by several factors, the chief of which are—

- (a) The number of subscribers' lines working on an exchange. Generally speaking this number must exceed 500 before service observations are undertaken.
- (b) The type of equipment in use at the exchange concerned.
- (c) The route mileage between the exchange and the observation centre.
- (d) The existence of a suitable junction circuit. This circuit may not exceed 2,000 ohms (loop) resistance.
- (e) The regular attendance of an engineering officer at the exchange concerned for the purpose of changing the subscribers' lines which are to be observed.

Historical.

Like many other types of equipment used in telephony, service observation apparatus was originally quite simple. A tapping circuit, consisting of one or two relays, was associated with the subscriber's line and terminated by means of a jack on an observation desk. The commencement of a call was indicated by the glowing of the lamp and, seeing this, the observer inserted a plug in the jack in order to listen-in.

Apart from a rather high transmission loss of approximately 2 db. in the subscriber's line caused by the somewhat crude "tapping" condition, this arrangement was fairly satisfactory—provided that the observation desk was in the same building as the exchange being observed. But when service observations were centralized, a number of junction circuits were necessary between the various exchanges and the observation centre. To economise

in junctions, Messrs. Siemens Bros., in 1915, designed equipment for observing a number of subscribers, one at a time, over a single junction circuit, the tapping circuits being associated with this circuit by means of a line finder.

Further difficulties arose with the need for observing automatic exchanges as, apart from other additional facilities, it was now necessary to observe the subscribers' dialling operations. To do this, it was essential to connect a subscriber to the number recording equipment *immediately* he lifted his receiver, owing to the fact that the period between the lifting of the receiver and the receipt of the first dialled impulse may be extremely short.

Special releasing facilities are also necessary in order that "follow-on" calls can be observed. For instance, a subscriber may originate a call and be associated with the observation desk, and then dial an incomplete number. Having carelessly allowed the finger plate to slip during the forward motion, he replaces the receiver with a view to repeating the call. Observers are keenly interested in careless dialling by subscribers so that, when the receiver is again lifted, the "repeat" call must be observed and, what is just as important, it must be observed by the one who saw the first attempt. For this reason, the release of subscribers' lines from the observation equipment is placed under the control of the observers.

One of the first equipments of this type was designed and installed by the A.E. Co. at Torquay, during 1926, for the observation of several exchanges in the Torquay area. Rotary line switches are used both as line finders at the observed exchange to connect a subscriber's line to the junction, and as junction finders to extend the junction to the observers listening circuit and number recording apparatus. This "number display" is composed of strips of lamps and is arranged similarly to display panels used in connection with C.C.I. working.

Centralized equipment suitable for observing automatic as well as manual exchanges, was designed by Messrs. Siemens Bros. during 1926 and installed by them in a number of non-director areas in which Siemens No. 16 equipment was in use. (It has also been fitted by the Department at various manual exchanges.) Rotary switches were not used as at Torquay, but a relay switching scheme effected the connection of a calling subscriber's line to the junction and the extension of the junction to the observation desk.

A feature of the Siemens-type equipment was its construction in the form of self-contained units which were factory productions. These units facilitated its installation at working exchanges.

Standard Observation Equipment.

The experience gained with the various types of equipment referred to indicated the need for standard equipment suitable for use in centres where a large number of junctions terminated on two or more positions. In such cases, team-working between the observers is essential and this involves the automatic distribution of calls over the suite of positions. Simultaneous observation of automatic and C.B. manual exchange calls is also essential, and the equipment shown in Fig. 2 was designed by the Department's engineers to meet these requirements.

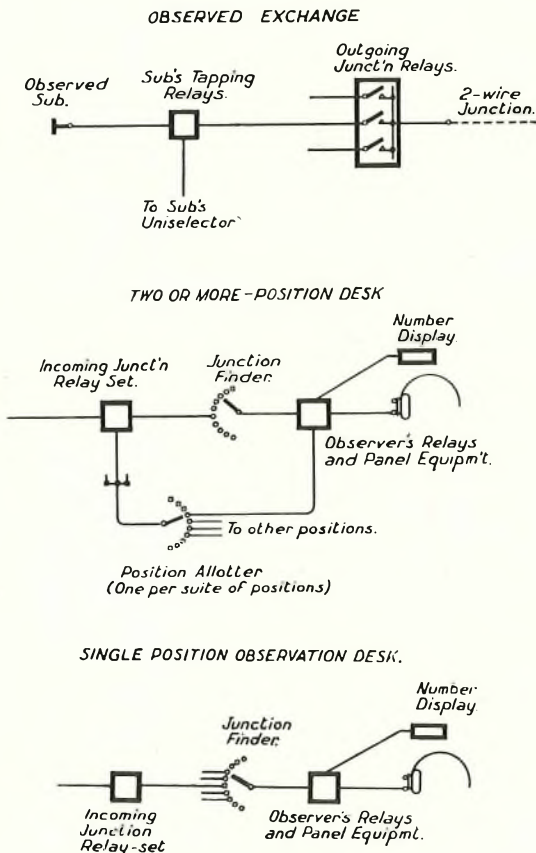

FIG. 2.—STANDARD OBSERVATION ARRANGEMENTS.

Very considerable difficulty was experienced in devising circuits which would give a reliable record of the numbers dialled by observed subscribers. Success was achieved, however, by inserting an impulsing bridge and transmission feed in the subscriber's line whilst that line is actually associated with the junction equipment. (Until a line is thus associated, it is connected direct to the uniselector circuit.) This bridge introduces a transmission loss of about 0.8 db. into the exchange connexion, although, due to the use of an amplifying unit in the junction equipment, it has been possible to keep the "tapping" loss as low as 0.2 db. approximately.

There is one set of subscribers' tapping relays for each line under observation, and, as soon as a call originates on one of these lines, a relay-switching scheme connects the line concerned to the common outgoing junction equipment—providing, of course, that the junction is not already engaged by another line. Fig. 3 shows a rack of this equipment.

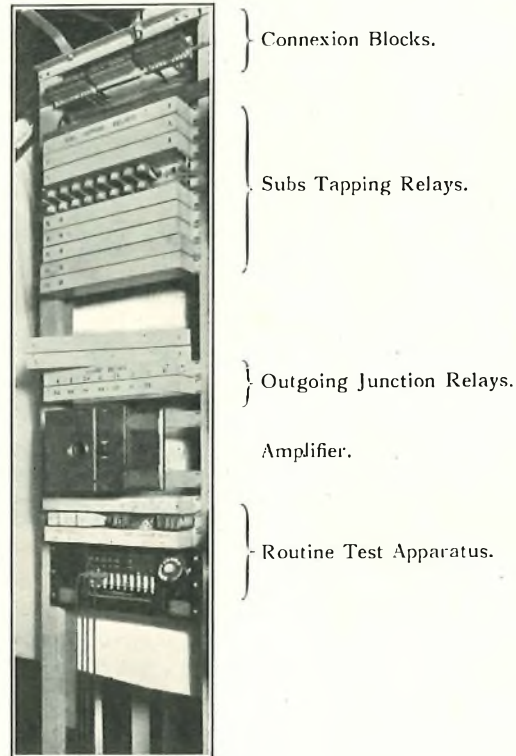

FIG. 3.—EQUIPMENT AT OBSERVED AUTOMATIC EXCHANGE.

At the observation centre, junction finders extend junctions to the observer's listening circuit and number display equipment. When there is only one position, the single finder hunts for a calling junction. If there are two or more positions, as on a "multi-position" desk, calls are distributed by an allotter to a disengaged position and only the junction finder of that position hunts for a calling junction. As soon as the junction is seized, the allotter steps to the next free position.

The rack lay-out of the apparatus for a suite of five positions is shown in Fig. 4. Beneath the junction finders, display and allotter uniselectors, are 25 incoming junction relay-sets (the maximum number of junctions observable from one suite of positions), together with the "observer" and "display" relay-sets. Routine testing equipment is mounted on, and contained in, the wooden case.

Before the equipment is described, some reference should be made to the basis on which it is provided. Sufficient subscribers' tapping relay-sets are fitted to

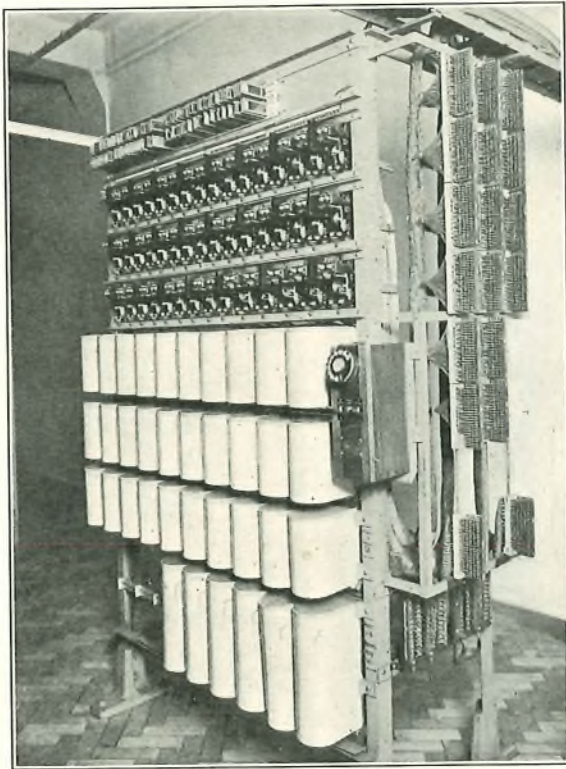

FIG. 4.—EQUIPMENT AT OBSERVATION CENTRE.

allow for approximately 1,200 originated calls being observed each month, the observers *daily* load being taken as 60 observations.

The number of tapping relay-sets actually fitted is thus chiefly dependent on the average day calling rate per direct exchange line and generally amounts to about ten tapping relay-sets at each observed exchange. Further details regarding this and similar considerations are contained in instructions issued by the Traffic Staff.

Observation positions are situated in a separate room at the exchange being used as the observation centre, each position consisting of a panel mounted on a table as depicted at the right-hand side of Fig. 5. Two observer's instrument jacks are fitted, the second being used for instructional purposes only.

Associated with a suite of from three to five positions is a "control" panel, also shown in Fig. 5, on which are mounted various junction keys. When there are only one or two positions, these keys are fitted on the observer's panel or panels.

The lamps and keys on an observer's panel function in the following manner :—

- (a) *Junction lamp* (green, one per junction). This glows as soon as the junction finder extends a calling junction to the position. (When the photograph was taken, a WHIttehall subscriber was connected to the position.)
- (b) *Pilot lamp* (white). This lamp responds to the movement of the subscriber's switch-hook on a line under observation.
- (c) *Pilot lamp* (red). The action of this lamp depends upon the type of exchange being observed. It glows in the following circumstances :—
 - (i) *Automatic exchanges.*—
 - When a called subscriber answers a call originated by an observed subscriber.
 - When a call incoming to an observed subscriber is extended to the desk.
 - (ii) *Manual exchanges.* When an operator plugs-in to an observed line either to answer an originating call or to complete an incoming call.
- (d) *Number display.* This indicates the number dialled by an observed subscriber. The display seen in Fig. 5 shows that the WHIttehall subscriber had dialled WHIttehall (944) 5056.
- (e) *Sub. release key.* This key enables the observer to release the subscriber's tapping relays from the outgoing junction equipment and yet maintain the association of the junction with the position. Observation of a particular exchange can thus be maintained from one position.
- (f) *Sub. and junction release key.* By means of this key, the observer can dissociate the subscriber's line from the outgoing junction equipment, and the incoming junction equipment from the junction finder and position

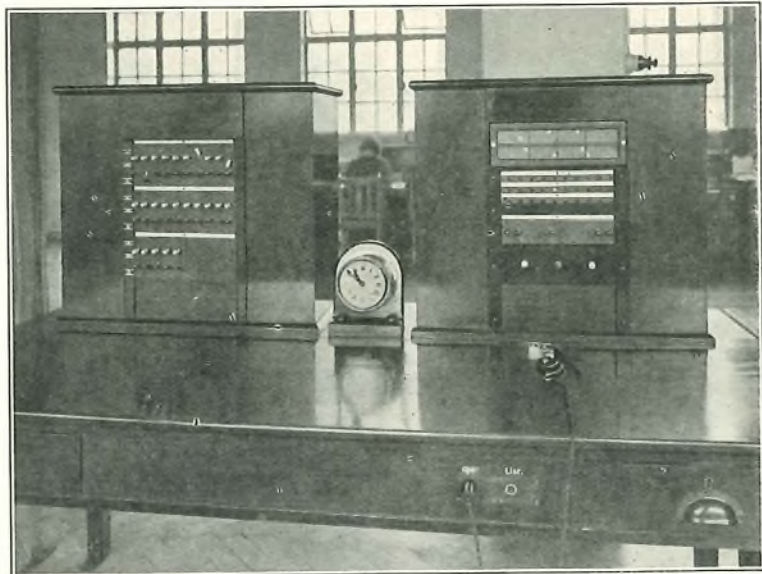

FIG. 5.—PANELS AT OBSERVATION CENTRE.

equipment. The position concerned is thus freed for the observation of further calls.

- (g) *Display release and display restore keys.* These allow the display lamps to be disconnected and reconnected at will. They do not affect the display switches.
- (h) *Routine test key.* For routine tests of the position equipment.

The sequence of events during observed calls at an automatic exchange is therefore as follows:—

- (a) *Call originated by observed subscriber.* Providing that the junction is disengaged, the subscriber's line is associated with a position immediately he lifts his receiver. The green junction and the white pilot lamps glow, the dialled number is displayed, and, when the called subscriber answers, the red pilot lamp glows and periods of tone corresponding to the operations of the subscriber's meter are heard by the observer. When the observed subscriber releases the connexion, both pilot lamps are disconnected. The observer throws either the "sub. release" or the "sub. and junction release" key to dissociate the subscriber's line and release the number display.
- (b) *Call incoming to an observed subscriber.* If the junction is free and incoming calls are being observed, the red pilot lamps lights when a final selector seizes the line; when the observed subscriber answers the white pilot lamp glows. The two pilots are then controlled by the respective subscribers.

The junction keys fitted on the control panel function as follows:—

- (a) *Incoming call key.* Normally calls incoming to subscribers are not observed, but the operation of this key brings these calls under observation in addition to outgoing calls.
- (b) *Disconnect key.* This prevents calls being observed over the junction concerned, and is useful when it is desired to suspend temporarily the observation of an exchange.
- (c) *Hold key.* If it is necessary for an observer to verify the number of a subscriber extended to her position, the throwing of the hold key maintains the connexion of the tapping relay-set with the junction, but allows the position concerned to be freed by the operation of the "sub. and junction release" key.

CIRCUIT NOTES.

Automatic Exchanges.

Subscriber's tapping circuits differ according to whether or not the exchange concerned is a director or non-director, main or satellite exchange. The circuits described below are typical and are those used in a director exchange having 4th-wire battery metering and single-sided racks.

The circuits at the observation centre, however, are applicable to junctions to all "standard" automatic exchanges, and C.B. manual exchanges.

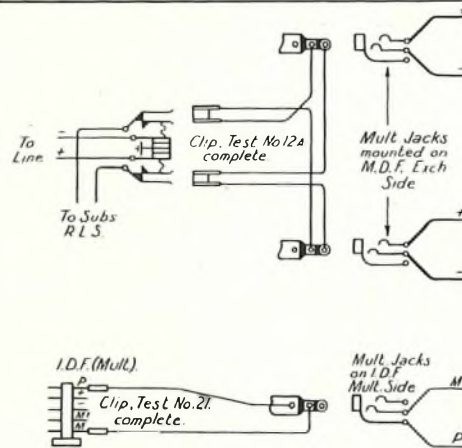

FIG. 6.—M.D.F. AND I.D.F. EQUIPMENT AT AUTOMATIC EXCHANGES.

Call originated by observed subscriber.

- (a) *Receiver lifted.* Immediately the subscriber's receiver is lifted, earth is connected to the P-wire and operates relay P (Fig. 7). If the junction is already in use, Pr operates relay M which at M1 disconnects relay H and prevents the tapping relays being associated with the junction should it become free during the remainder of the call. Providing that the junction is free at the commencement of a call, H operates via P2 and relay R, although the latter relay does not operate until H1 connects a 20-ohm earth to the "common" to prevent any other H relay operating. The H contacts associate the tapping relay-set with the junction equipment and H7 lights an "engaged on observation" lamp. Contact R1 operates relay NN which combines with R2 to operate G which, in turn, operates N. The contacts of N switch the junction lines through, whilst N2 connects a busying earth to the M relay common. By this time, relays A and B are operated to complete a holding circuit for the selector via the 400-ohm retard coil, so that the retaining earth at N5 can be disconnected.

While there is an observer available, relays GC and DE (Fig. 8) are operated and normal respectively. Therefore, when relay L (Fig. 8) is operated by the battery via NN2 and N1 (Fig. 7), L1 operates LA and LA3 operates S. Contact S1 causes the finder to hunt for the calling junction and, when this is seized, relay K extends the circuit to the observer's relays. The allotter is moved by K7, and rotates to allot another free position. Relay A causes AA to light the white pilot lamp and to operate BB.

- (b) *Subscriber dials number.* The relay operations just outlined take place during the short pre-dialling interval. By means of relay A (Fig. 7) the dialled impulses are repeated to the selector and to the first of the display switches via the A-wire of the junction, relay A (Fig. 8), contacts A1 and BB1, relay C

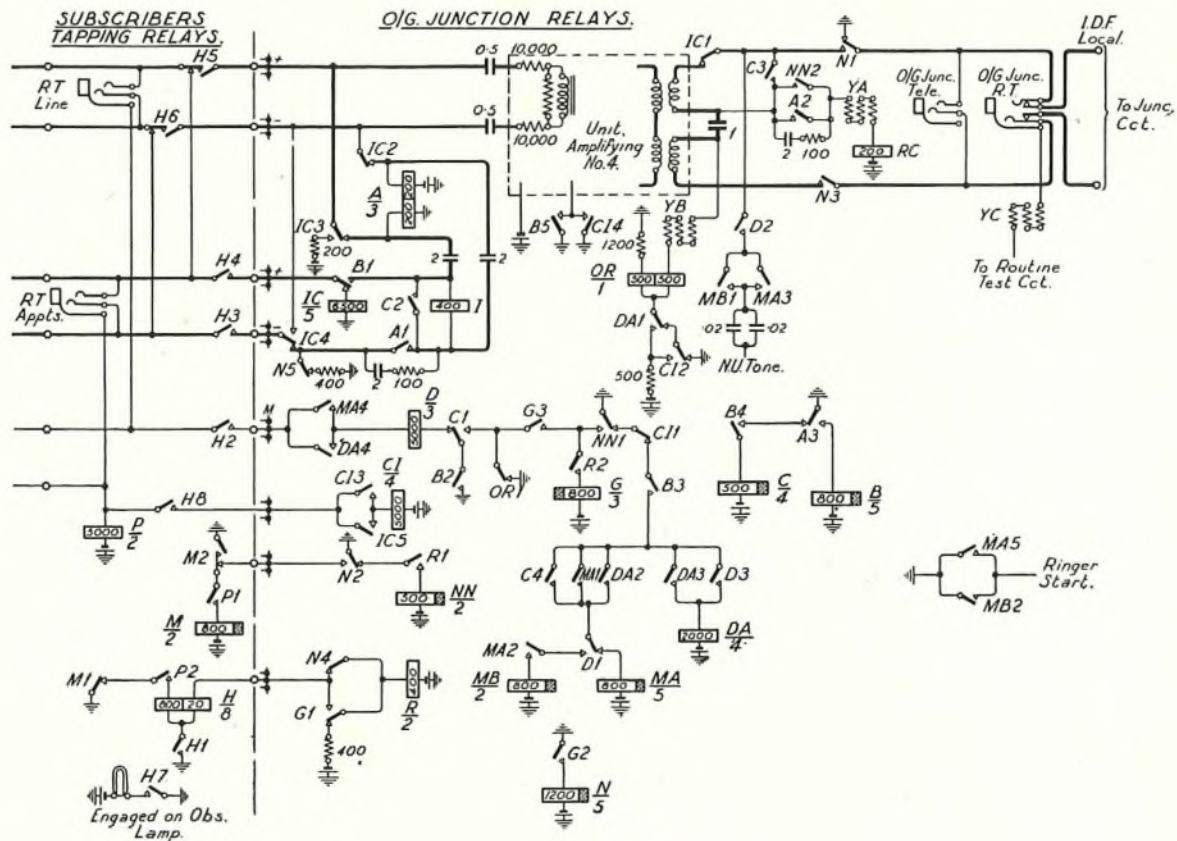

FIG. 7.—SUBS TAPPING AND OUTGOING JUNCTION RELAYS AT AUTOMATIC EXCHANGES.

(Fig. 9) and the digit distributor. At the end of the impulse train, this distributor moves to the next digit switch and also lights the appropriate display lamp. This process is repeated until the whole of the number has been dialled.

- (c) *Called subscriber answers.* Relay D (Fig. 7) responds to the battery on the meter wire, and sends a period of tone *via* the A-wire to the observer each time metering pulse is received. Relay D also operates DA which connects battery *via* Relay OR to the B-wire, thus operating BA and B (Fig. 8) to light the red pilot lamp. As the two coils of OR are differentially wound, and the total resistance of YB, the junction line, and BA is made equal to 1200 ohms, OR does not operate.
- (d) *Calling sub. replaces receiver.* Relay A releases and disconnects the holding circuit to the exchange plant as well as the battery on the A-wire, and thus disconnects the white pilot lamp. The red lamp is also extinguished due to the release of DA and the consequent disconnection of battery from the B-wire.
- (e) *Sub. release key operated by observer.* Contact K₃ (Fig. 8) has already operated H and RS, so that the disconnection of H by the sub. release key connects battery *via* H₅ and RS₂

to the B-wire. This causes the differential relay OR to operate and disconnect G, which in turn disconnects H in the tapping relay-set.

- (f) *"Sub. and junction release" key operated by the observer.* The disconnection of relay PC (Fig. 8) releases relay K (same figure). Contact K₃ releases the tapping relays as before, and, when the key is allowed to restore and re-operate PC, K₇ opens the position to the allotter.

Call incoming to the observed subscriber. Relay P (Fig. 7) is operated by the earth on the P-wire to control the seizure of the junction equipment, but this time relay IC is also operated by the "ringing return" from the final selector. Contacts of IC connect ringing conditions to the subscriber's line and also operate relay CI to connect battery to the B-wire *via* OR.

If the "incoming call" key is normal, current flows through only one winding of the differential relay OR which therefore operates and releases the tapping relays as before. If incoming calls are being observed, the current on the B-wire prevents OR from operating, and operates relay LL (Fig. 8). A free position is then seized as in the case of an outgoing call, and BA and B light the red pilot lamp.

When the observed subscriber answers the call, the ringing return battery is disconnected in the final

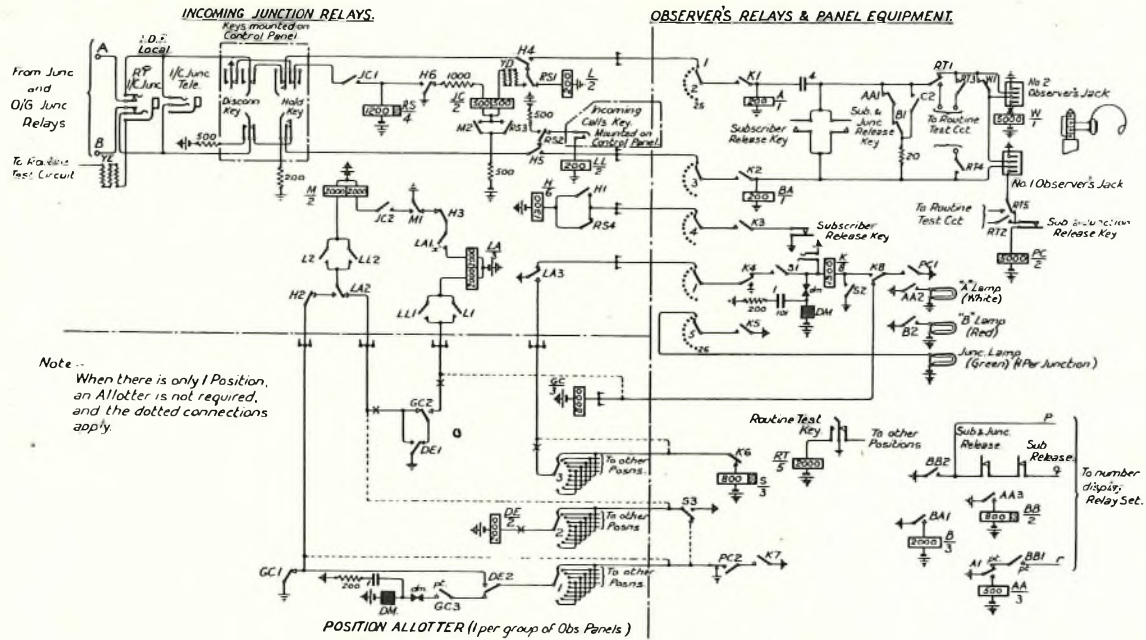

FIG. 8.—INCOMING JUNCTION AND OBSERVER'S RELAYS.

selector and IC (Fig. 7) is released. Relay A operates therefore and connects battery to the A-wire to light the white pilot lamp.

When the calling subscriber releases the connexion, CI (Fig. 7) disconnects the battery from the B-wire and extinguishes the red pilot lamp, but if the observed subscriber is still on the line, relay A retains

and the white lamp continues to glow until he replaces his receiver.

The operation of either of the release keys produces conditions similar to those in the case of an outgoing call.

Effect of throwing "disconnect" key. (Fig. 5). From Fig. 8 it will be seen that this operation dis-

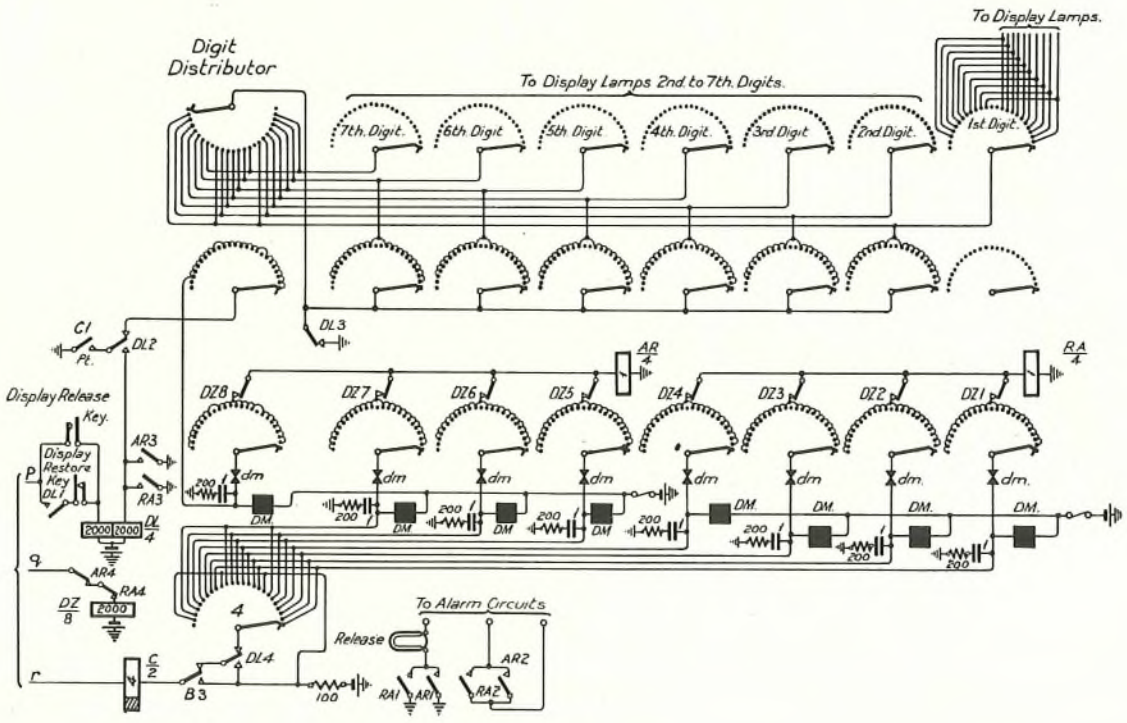

FIG. 9.—NUMBER DISPLAY CIRCUIT.

connects the A-wire of the junction and connects battery to the B-wire. Therefore as soon as N (Fig. 7) operates either on an outgoing or an incoming call, OR operates *via* the earth from CI₂ normal and restores all the relays to normal.

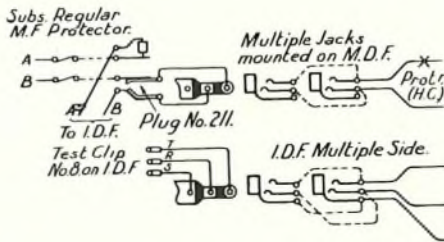

FIG. 10.—M.D.F. AND I.D.F. EQUIPMENT AT C.B. EXCHANGES.

Effect of throwing "hold" key. (Fig. 5). In this case, the A-wire is disconnected, but the 200-ohm earth *via* BA (Fig. 8) is substituted by a 200-ohm earth at the key. Conditions at the distant end of the junction are therefore unaffected. To free the position for observing other calls, it is necessary to throw the "sub. and junction release" key to release relay K (Fig. 8) and the junction finder.

Manual (C.B.) Exchanges. From Fig. 11 it will be seen that, in the case of manual exchanges, the tapping and outgoing junction circuits are very much simpler than at automatic exchanges, although the

signalling conditions over the junctions are practically identical.

On a call originated by the observed subscriber, relay L operates in series with the line and operates LS which then controls the connexion of the tapping circuit to the junction relays and the extension of the call to an observation position.

If the junction circuit is already engaged, relay H does not operate and, when the operator answers the call, she operates relays S and SA. Contact SA₂ short-circuits the series relay. But if the call is observed, L₁ also operates LA and connects battery to the A-wire to light the white pilot lamp.

When the operator answers the call, relay D operates and DA connects battery to the B-wire to light the red pilot lamp. The existence of the metering condition operates relay M to connect tone to the A-wire.

For an incoming call, relay S operates immediately a plug is inserted into the line, and SA controls the connexion to the observation junction. If the junction is seized, relays D and DA connect battery to the B-wire to light the red pilot lamp, whilst the white pilot lamp is controlled by relays L and LA.

Circuits are available for observing only C.B. exchanges from a one-position desk. The circuits are very similar to those described and, as their application is limited, they have not been reviewed in these short circuit notes.

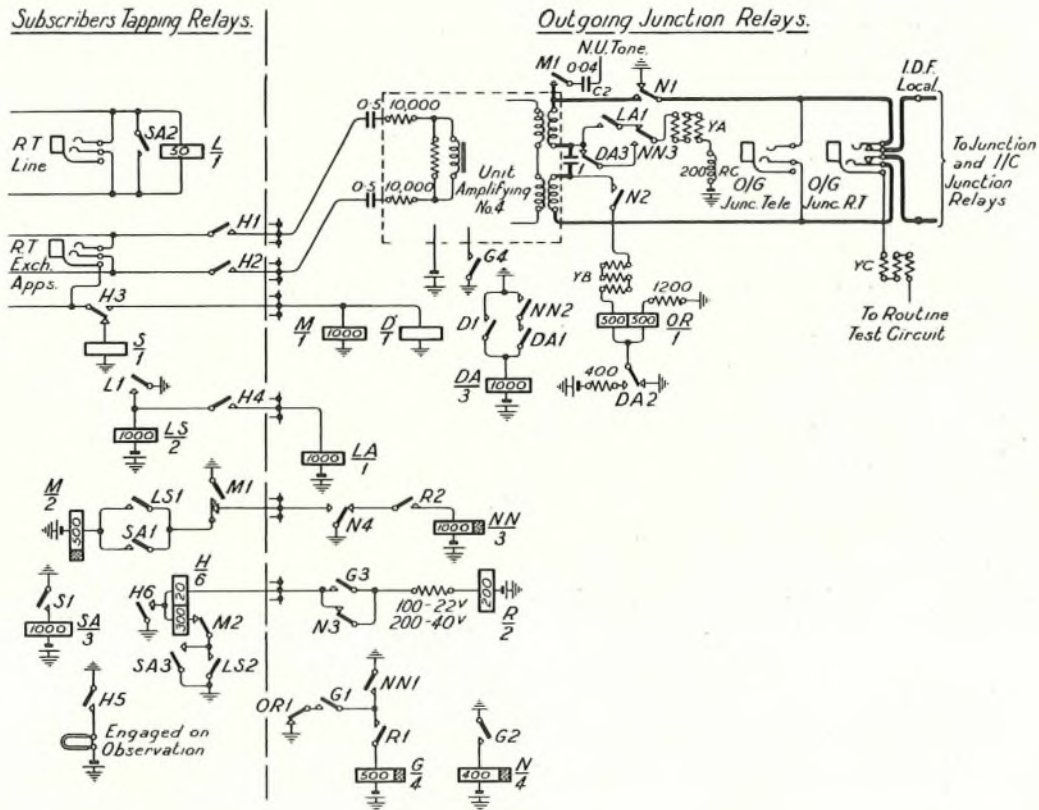

FIG. 11.—SUBS TAPPING AND OUTGOING JUNCTION RELAYS AT C.B. MANUAL EXCHANGE.

The Toll Repeater

A. C. TIMMIS, B.Sc., A.M.I.E.E.

IN view of the various meanings attached to the word "Toll" by different telephone administrations, it may be well to explain how the title arose. In this country telephone lines between exchanges are classed in descending order of length, as trunks, toll lines and junctions. The distinction is by no means hard and fast, but a typical trunk, nowadays, would be a London-Leeds four-wire circuit 200 miles in length, having an overall equivalent of zero. A typical toll line would be a London-Brighton, unrepeated, loaded cable circuit about 50 miles in length. The Post Office has for some time been considering the extension of two-wire, and, more especially, four-wire repeater working to toll lines, and perhaps in some cases, to junctions. With four-wire repeaters, an overall equivalent of zero, or a very few decibels, can be obtained for a chain of three or more circuits and such circuits lend themselves perfectly to the "on demand" system of operating. Cord circuit repeaters, cordially disliked both by the engineering and the operating staff, may be dispensed with entirely. But the average toll line is too short to justify equipping it with the same type of repeaters as used on the main trunk lines, and it became evident that a smaller, cheaper, type of repeater which could be installed in almost any exchange, and left practically unattended, was essential. To meet these conditions the "toll repeater" or, to give it the official name, "unit amplifying" was designed.

Perhaps the foremost of all the requirements was reduced cost. It is a truism that most of the benefits which engineers confer on mankind begin as expensive luxuries and become cheap necessities. Telephone repeaters were no exception to the rule. The first installations, both here and in America, were housed in special repeater stations, with staff in continuous attendance, special batteries, and power plant which could be entirely independent of the electric mains. For a long trunk, containing perhaps 5 or 10 repeaters, and liable to be extended to any part of the international system, elaborate arrangements of this kind may be justified. But a toll line is generally one of a group, would seldom contain more than two repeaters, and if it failed for a time would not seriously upset the traffic. In view of these considerations it was decided that the toll repeaters should be supplied with current from the mains, with a small battery as a standby, automatically switched over when the mains fail. Also, that each repeater would be permanently wired into circuit, would not be provided with potentiometer dials but would have all connexions soldered, the gain being fixed at the setting up of the circuit.

These points being decided, it remained to simplify and cheapen the construction of the repeater itself,

which was done mainly by using transformers and other components of the type made in large quantities for the wireless market. In its present form the toll repeater costs about one tenth as much as the corresponding main line repeater, and the maintenance cost appears to be negligible in comparison with that of the latter.

Electrical and Constructional Details.

According to present practice main line repeaters are of two types—

- (1) The four-wire repeater, consisting of two separate amplifiers, one for the "go" and one for the "return" line, and
- (2) The two-wire repeater, consisting of two amplifiers coupled to two differential transformers with balancing networks.

To convert a four-wire circuit into an ordinary two-wire circuit at the ends, terminations, each consisting essentially of a differential transformer and balance network, are used. These terminations are separate from the repeaters. In view of the different conditions which obtain in the case of toll lines, however, it was decided to combine the termination with the repeater to form a third type, which may be called a four-wire terminal repeater.

For the sake of uniformity each of the three types is designed to occupy a panel $3\frac{1}{2}$ " by 19". The first models were made with Ferranti transformers and chokes, and assembled in the P.O. factory. Later supplies have been made throughout by Contractors, but the design is electrically and mechanically the same apart from detail improvements to facilitate testing, etc. Fig. 1 shows a two-wire, a four-wire, and a four-wire terminal repeater of the original design. Fig. 2 shows a four-wire terminal repeater, made by Standard Telephones and Cables, Ltd. With the advent of the "grid" practically all the electric mains of the country will supply A.C. at 50 cycles. It naturally followed, therefore, that the toll repeaters should be designed for A.C. mains supply. Where D.C. mains exist at the moment a D.C.-A.C. motor generator is installed, and will be removed when the mains are converted to A.C. Rectifiers are of course necessary for the anode supply, but the valve filaments are heated by "raw" (*i.e.*, unrectified) A.C. The use of separately heated valves, now used in most wireless sets for A.C. mains, was considered, but in view of the doubtful longevity of these valves it was decided to use valves of the type used in repeater stations, which have a life of 10,000 hours, or more. It may perhaps be worth mentioning that the use of repeaters with relay arrangements for switching on the valves during calls only was also considered, but again

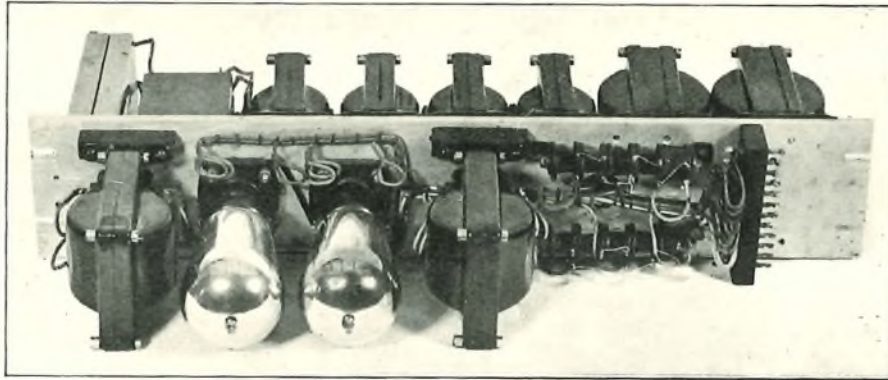

Two-wire Repeater.

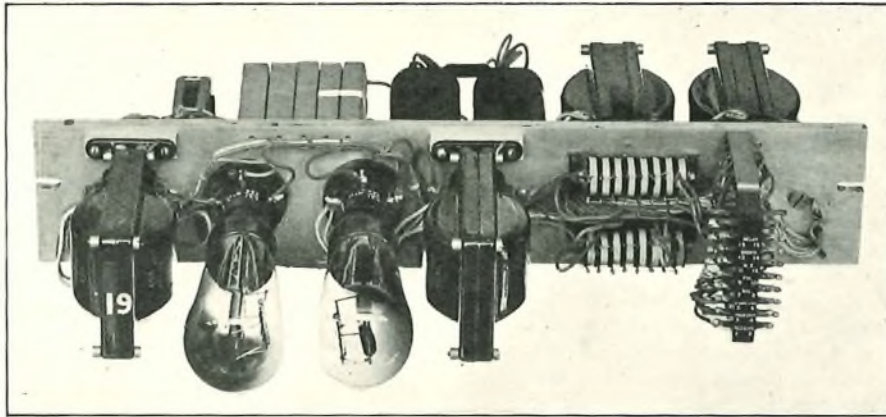

Four-wire Repeater.

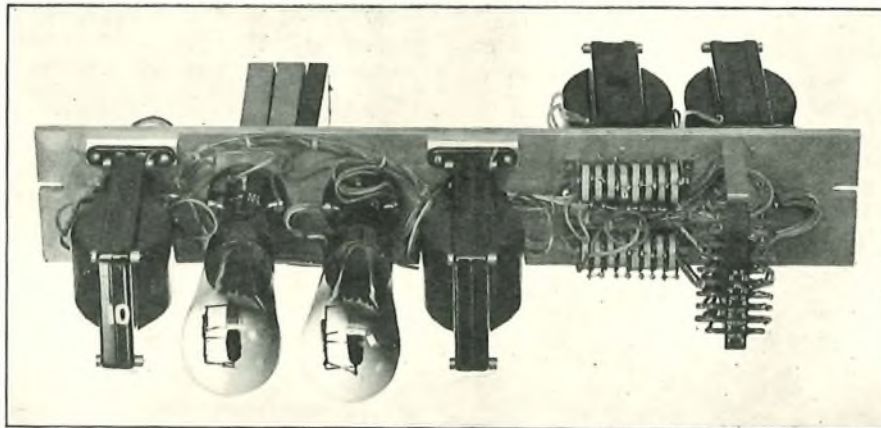

Four-wire Terminal Repeater.

FIG. 1.—TWO-WIRE AND FOUR-WIRE REPEATERS.

separately heated valves were regarded as inadmissible on account of the time taken to warm up.

No trouble has been experienced owing to the use of raw A.C. for the filaments. The 100-cycle hum

due to the temperature changes of the filament is practically inaudible on commercial telephone circuits, and the effect of the alternating filament voltage is eliminated in the usual way by connecting grid

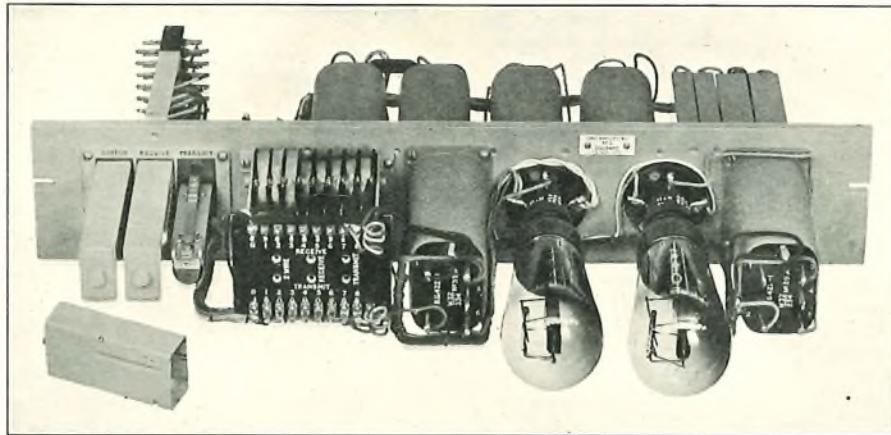

FIG. 2.—FOUR-WIRE TERMINAL REPEATER (S.T. & C., LTD.).

bias to a point near the middle of a resistance shunting the filament.

It was found advisable to include a filter in front of the filament current transformer to smooth out harmonics of particularly noisy mains. The third and higher harmonics of 50 cycles are increasingly audible and cannot be sufficiently eliminated by the same means as the 50-cycle effect. The filter is included as part of the standard equipment. Fig. 3 shows the circuits of a four-wire terminal repeater. It will be noticed that grid bias is obtained from the difference of potential caused by the anode current in the 225-ohm resistance. In later installations, instead of one resistance per repeater a single resist-

ance provides the grid bias for a number of repeaters, and carries the total anode current. The 2 μ F condensers carry the A.C. part of the anode current, and must be connected as shown, not to the mid-point of the 33 + 40 ohms resistance. Otherwise, cross-talk between two repeaters occurs due to the potential difference across the 33 and 40 ohm resistances (in parallel) caused by the anode current of the other repeater.

The connexion of the condensers to one end of the filament is the reason for the grid bias connexion not being the electrical centre of the filament. Referring to Fig. 3, it will be evident that the right hand end of the filament is fluctuating in potential at 50 cycles.

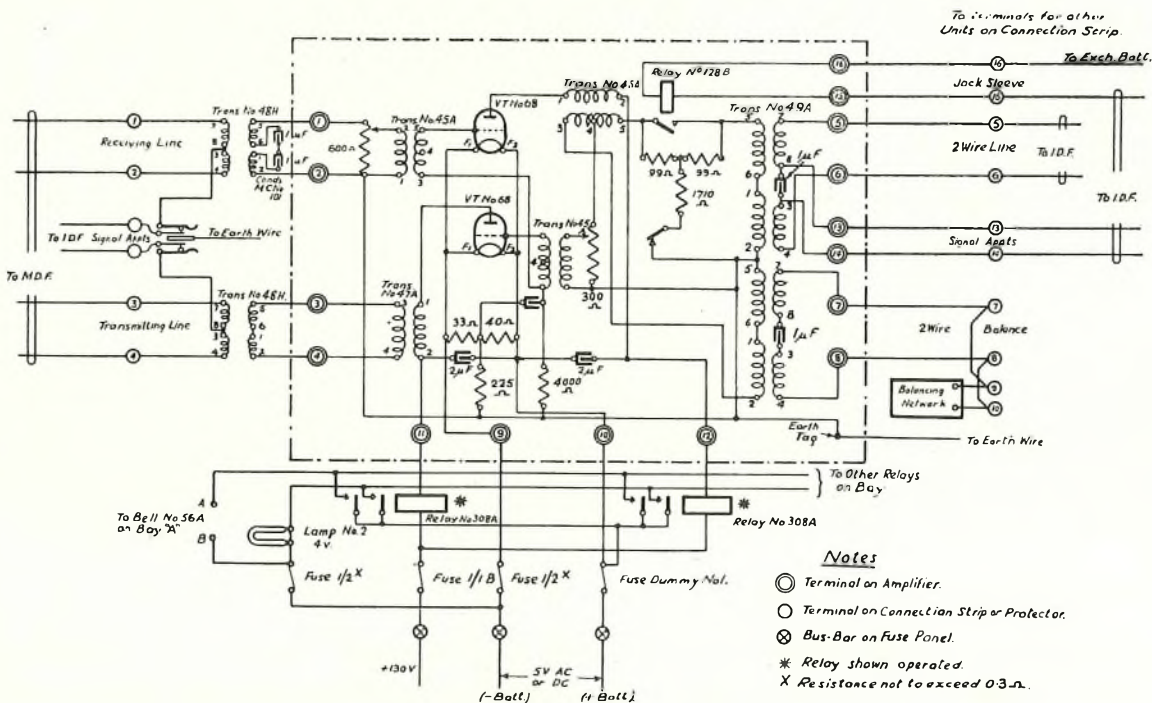

FIG. 3.—FOUR-WIRE TERMINAL REPEATER.

Thus A.C. will flow through the $2 \mu\text{F}$ condenser, the output transformer, and the anode of the valve. But the grid, being connected at a point on the other side of the electrical centre of the filament, picks up a voltage, 180° out of phase, of such a magnitude as will just cause the A.C. in the anode circuit to be neutralized. The absolute value of the resistances is not important, provided that the ratio of 33 to 40 is maintained.

The valves used are made by the General Electric Company, described by the P.O. as "V.T. 68," and have the following characteristics :—

Oxide-coated filament	4 volts 0.45 amp.
Internal impedance	4,500
Amplification factor	9
Grid bias with 130 volts on anode	-4

Valves having a lower filament consumption are now being tried and will probably be found suitable. If so, the current consumption will be somewhat reduced, but not in proportion to the filament current. At present the energy consumed by the anode circuits is nearly as much as that used by the filaments.

Dealing now with the speech circuit of the four-wire terminal repeater, it will be seen that there are two single-stage amplifiers coupled to a differential transformer which forms the two-wire four-wire termination. This and the input potentiometers are unbalanced, a simplification made possible by the line transformers, required for other purposes, on the go, return, and two-wire lines. Go and return line transformers are not mounted on the repeater panel. The attenuator, or pad, of 3 db. is arranged to be cut out, under certain conditions, by the relay 128B. Being adjacent to the differential transformer, it can be of the unbalanced type and its resistance does not add to the D.C. resistance (important from the signalling point of view) of the two-wire line. Condensers are inserted in the two-wire line transformer, and a balance transformer is provided to meet cases where the two-wire line is of appreciable length, requiring an accurate balance network. In the ordinary way the usual 600-ohm compromise balance is fitted.

The four-wire toll circuit will, except where old wires are taken up, consist of a 10 lb. star quad. The phantom is not loaded and is used for D.C. signalling.

Thus all the usual junction signalling facilities can be given, and the signalling circuit is equivalent to a 20 lb. pair. Condensers are fitted in the repeater side of the go and return line transformers to reduce the amplification at low frequencies and so prevent any slight power hum that may creep in from being cumulative. These condensers also help to prevent instability at low frequencies in certain cases.

Each amplifier by itself has a maximum gain of 30 db. over a wide range of frequencies. The resulting maximum gains, for the terminal repeater, with the 3 db. attenuator in circuit, are :—

Input transformer setting.	Potentiometer setting	Receive to two-wire db.	Two-wire to transmit db.
Maximum gain	1	12.5	9.5
	2	14	11
	3	15.5	12.5
	4	17	14
	5	18.5	15.5
	6	20	17
	7	21.5	18.5
	8	23	20
Reduced gain		12 db. less than above for each potentiometer setting.	

The potentiometers are altered by shifting a wire and resoldering. A sliding contact is thus avoided and a very cheap form of potentiometer results. Another expensive feature of the main line repeaters which can be avoided under toll line conditions is the attenuation equalizer. With moderately heavy loading, the attenuation of a 50-mile length may rise 3 or 4 db., at 2,400 cycles, above its value at 800 cycles. For a length of 100 miles or more, this rise would seriously affect the quality of the circuit, and main line repeaters are therefore fitted with resonant circuits which can be adjusted so that the gain of the repeater rises with frequency to keep pace with the

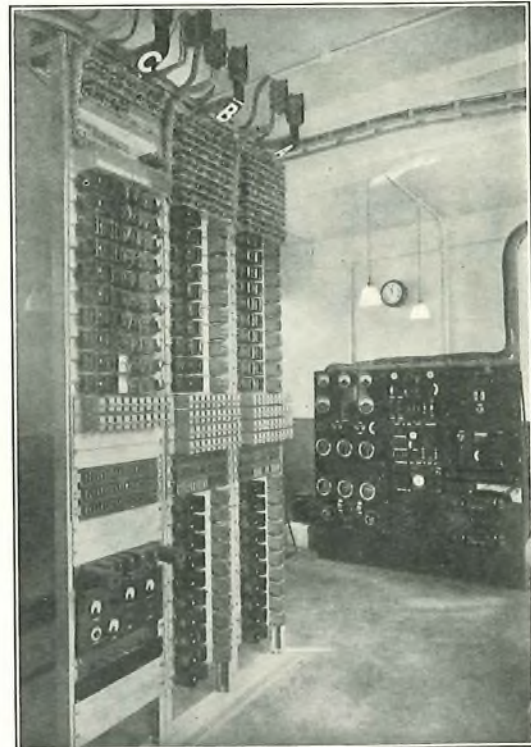

FIG. 4.—REPEATER INSTALLATION AT CRAWLEY.

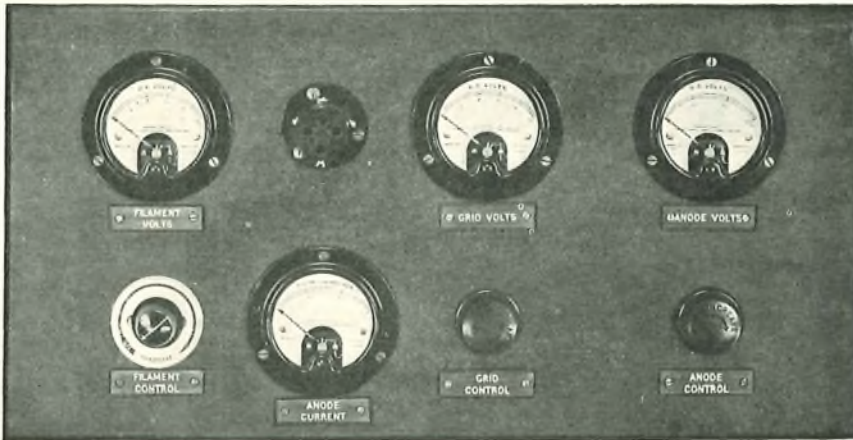

FIG. 5.—VALVE TEST PANEL.

attenuation of the line. Toll circuits will generally be under 50, and always under 100 miles in length, so that attenuation equalizers are not justified.

Bearing in mind the general principle that toll repeaters would be left almost entirely unattended, all jacks and unsoldered contacts were avoided as far as possible. In the filament circuit there is one fuse and one dummy fuse, and in the anode circuit one fuse only. The fuse panel can be seen in the photograph of the installation at Crawley (Fig. 4). The only alarm device is the relay 308A, fitted in each anode circuit, which also serves as the usual anode choke. On the failure of a valve filament, or the anode current, this relay gives a visible alarm. If the lineman is not available at the time he will, on

arrival, see at a glance, when one of the lines is reported faulty, whether it is due to one of his repeaters. If it proves to be a valve failure he replaces the valve, but does not alter the gain adjustment of the repeater. If he cannot clear the fault at once he changes the repeater for a spare one.

Once a toll circuit has been set up, it is intended that the gains should not be altered. The only variable component that need be considered is the valve, and this can be checked very simply by periodical measurement of the anode current at definite filament, grid, and anode voltages. The

panel shown in Fig. 5 is provided for this purpose. A valve is inserted in the holder; filament, grid and anode voltages are adjusted in accordance with the special mark on the voltmeter corresponding to each; and the anode current is read. When a valve shows a decrease of 1.5 mA from its original anode current, it is rejected. This change of current corresponds to a fall in gain of about 1 db. The amplification of valves taken from stock is allowed to vary $\pm 10\%$, corresponding to ± 1 db.

The four-wire repeater is covered by what has been said regarding the four-wire terminal repeater. The connexions are shown in Fig. 6 and those of the two-wire repeater in Fig. 7. It should be noted

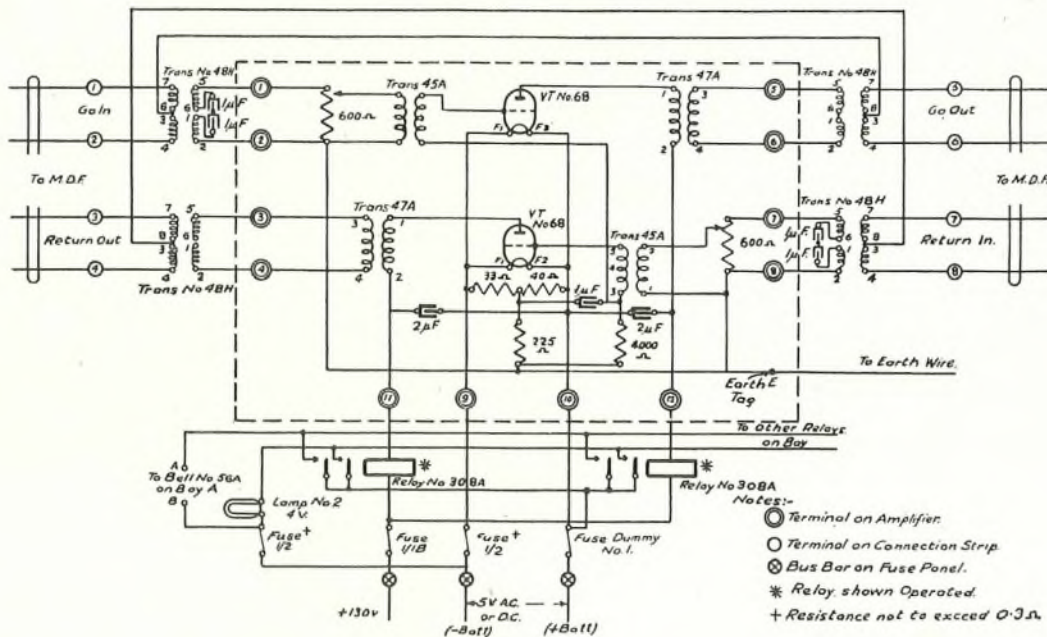

FIG. 6.—FOUR-WIRE THROUGH REPEATER.

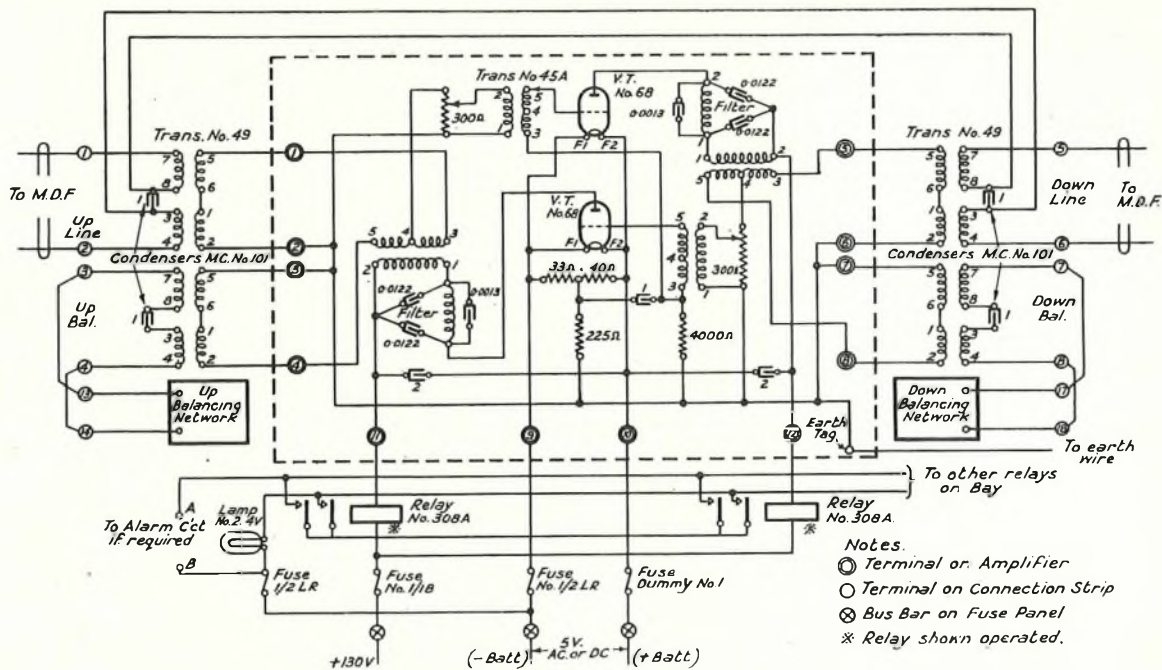

FIG. 7.—TWO-WIRE REPEATER.

that the front, or valve side, of the panel is exactly the same for all three types.

Power Supply and Installation.

Toll repeaters are mounted on racks of the usual width, a 10 ft. bay holding 20 repeaters with their associated line transformers. The general arrangement of the repeater bays and power panels will be seen in the photograph (Fig. 4) of the installation at Crawley. One bay of power equipment is normally provided for each bay of 20 repeaters. Fig. 8 is a photograph of the power bay at Brighton. The filament supply is taken from a transformer, in the primary (or mains) side of which the filter is fitted. The primary of this transformer is tapped at eight points so that the impedance terminating the filter may be suitably adjusted for 20, 16, 12, 10, 8, 6, 4, or 2 repeaters. The voltage on the filament busbars is adjusted, by means of tappings on the secondary, to about 4.3 so that the actual filament voltage is 4.0. If the mains are not between 200 and 250 volts, the filter is connected to the mains through a transformer which adjusts the voltage approximately to 230. From the same transformer (or the mains) the anode power is taken through a Westinghouse rectifier and smoothed by means of chokes and two condensers. The anode voltage at the busbars is 136 and the effective anode voltage on the valves, allowing for the fact that the filament centre points are about 4 volts above earth potential, and for the drop in the alarm relays, is 130. Four relays are connected across the 136-volt busbars and control a number of mercury contact relays which automatically change over to batteries when the mains fail.

A 6-volt battery is used to supply the filaments

and a 136-volt battery supplies the anodes. As soon as the mains voltage is restored, the relays immediately change over from battery to A.C. supply. The batteries are designed to carry on for about four hours, and rectifiers are provided for the

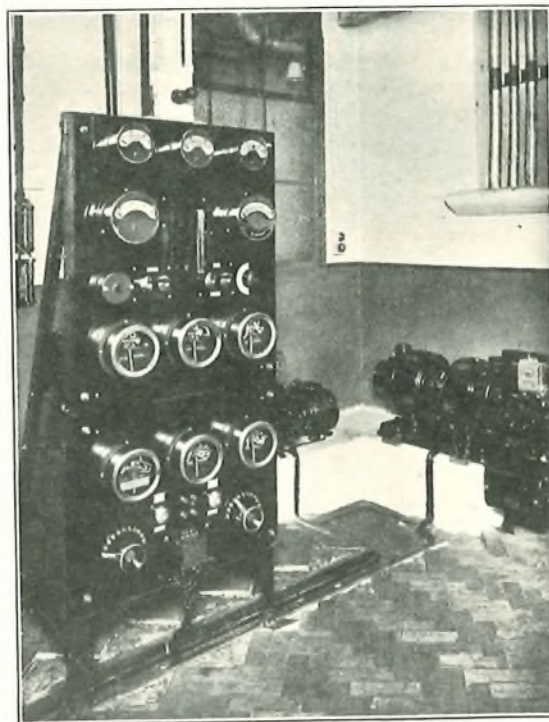

FIG. 8.—POWER BAY.

speedy charging of the batteries after emergency use. Normally they are "trickle charged."

The London-Brighton Aerial Cable.

During the preliminary discussions on the proposal to introduce the four-wire system for toll circuits, it was felt that a practical trial on a fairly large scale would be needed before the system could be adopted throughout the country. It was therefore decided to erect a 37-quad 10 lb. aerial cable between London and Brighton and equip it with toll repeaters at London, Crawley, and Brighton.

Between Coulsdon (about 12 miles South of London) and Brighton there is a heavy pole line which formerly carried the high-grade London-Brighton trunks. These having been replaced by a loaded underground cable, many of the wires were taken down or used for shorter circuits, so that the line was amply strong enough to carry the cable. Loading pots containing 120 mH coils were attached to poles at the usual interval of 2,000 yards. The successful completion of this cable (constructional details of which are dealt with in an article by G. W. Craddock and W. H. Brent in the *P.O.E.E. Journal* for October, 1931) proved that a 10 lb. star quad cable "systematically" jointed in 500-yard lengths was satisfactory as regards attenuation and cross-talk, and records which have been taken (by special recording instruments) over a period of 12 months have shown that temperature and other variations on such a length of aerial cable have no serious effect on the overall equivalent of the circuits. The average conditions in future will probably be much less severe. Protected cable laid in the ground will be used almost exclusively and temperature changes will be quite negligible.

The repeaters were installed at the London Trunk Exchange, Crawley Exchange, and Brighton Exchange. In each case, independent power plant and standby batteries were installed in order to test the working of the automatic change-over arrangements. At London Trunk Exchange the supply is A.C., but at Crawley and Brighton there are D.C. mains. Motor-generators are used at these places to convert to A.C. Some trouble was experienced at first due to the variations of mains voltage at Crawley, but this has been overcome by means of a special constant-speed motor-generator. No trouble is experienced from mains hum, even with the cumulative effect of three repeaters in circuit.

As regards voltage regulation, the D.C. case will be met by means of a constant-speed motor-generator. In the case of variable A.C. voltage, advantage will be taken of the fact that frequency can be relied on, generally, to less than $\pm 1\%$, although voltage may vary on account of the variable drop in distribution cables. A self-starting induction motor will be used to drive an alternator, the field of which is excited from the anode busbars. The speed of an induction motor, provided it is not overloaded, varies very little with change of supply voltage, and the field of the alternator being assured

of constant voltage (either from the machine or the standby battery) will have a uniform temperature and therefore constant current. The equipment for changing over to standby batteries on failure of the mains has proved satisfactory and the whole installation, line and apparatus, has demonstrated that a 10 lb. loaded cable in conjunction with unattended repeaters can provide satisfactory four-wire circuits with full D.C. signalling facilities.

London-Brighton circuits can be worked at an overall equivalent of 2 or 3 db. By joining together eight circuits so as to produce a total length of 400 miles a satisfactory circuit of zero equivalent was obtained, but unavoidable variations make it impracticable to maintain the circuits at zero equivalent under working conditions.

As regards their performance, toll repeaters differ from main line repeaters only in maximum gain and in having no equalizers. They can therefore be used in short sections of a long line, which is equipped with main line repeaters dealing with the longer sections where high gain and equalization are required.

The power equipment designed for mains supply and standby batteries is suitable for an unattended repeater station, but the power plant used in main line repeater stations is not. When used on a main trunk route, however, the standby batteries would be designed to carry on for 24 hours, instead of the 4 hours allowed in the case of toll repeater installations.

Attenuator Switching.

A four-wire toll circuit would normally be adjusted to an equivalent of, say, 3 db. with the attenuator in at each terminal. If extended to a junction circuit, the attenuator at that end would be cut out and the toll line thus reduced to zero, its stability being assured by the improved balance due to the junction circuit. When the toll line is connected to a subscriber, the attenuator would remain in circuit. This system of cutting out attenuators, in order to bring into use some of the amplification existing in a four-wire circuit, was tried several years ago by the P.O., and has recently been adopted by the American Telephone and Telegraph Co. all over their system. It enables the very inconvenient and expensive cord circuit repeater to be dispensed with almost entirely. A somewhat similar result can be obtained by the use of stabilizing resistances at the terminals of zero circuits. It has been found that the longest four-wire trunks can be worked at zero overall equivalent if

- (1) a 600-ohm resistance is connected across each two-wire end when the trunk is not in use, which can easily be arranged by shunting the calling relay, on the inner springs of the line jack, and
- (2) echo suppressors are fitted.

These do not prevent a howl building up, if the circuit becomes unstable (due for instance to a subscriber's instrument being hung up, or a junction

disconnected), but they limit its magnitude to such an extent that there is no danger of disturbing other circuits. An underground four-wire circuit may vary in overall equivalent by 1 or 2 db., owing to various causes, but a number of such trunks, each nominally zero overall, may be connected together without fear of instability, and with obvious advantages from the traffic point of view. A four-wire toll circuit, however, which may contain some aerial cable, is liable to somewhat greater variations, and might become unstable when connected to subscribers' lines at each end, if set to a nominal zero equivalent. Therefore, if such a circuit is to have the advantages of zero equivalent when connected to junctions or other toll circuits, it may be provided with attenuators to ensure stability when used between subscribers. In that case, when connected to junctions it may, through both attenuators being cut

out, have a better equivalent than zero, so that the four-wire circuit is made to serve as a repeater with a small gain, reducing the overall equivalent of the whole chain of connexions. Generally, however, satisfactory transmission would be ensured by reducing the toll line equivalent to zero, and in that case it is expected that stability will be assured by arranging that if a subscriber hangs up, and the trunk or toll line will be automatically closed with 600 ohms by means of a relay in the cord circuit. When the operator clears, the 600 ohms across the line jack of course closes the line.

The signalling arrangements involved are less complicated than would be required for automatic switching of attenuators, and experiments are now in hand to confirm that the simpler method will be satisfactory in practice.

Electrode Testing Methods Applied to Telephone Cables

W. T. PALMER, B.Sc., Wh.Ex., A.M.I.E.E., and Major F. E. A. MANNING, M.C., B.Sc. (Eng.)
A.M.I.Mech.E., A.M.I.E.E.

(1) INTRODUCTION.

IT is well known that a submarine cable fault in which the conductor is broken, and polarization effects are present, is very difficult to localize with accuracy by D.C. methods. Even when more reliable A.C. methods can be employed, as in the case of lead-covered paper-core cables, there still exists the further difficulty of interpreting, by the aid of a chart, the computed distance to the fault in such a manner that the repair ship is able to grapple the faulty cable in the near vicinity of the fault. Most D.C. and A.C. tests which are applicable from the ends of the faulty cable have been discussed from time to time in this Journal¹ and in Papers read before the Institution of Post Office Electrical Engineers.²

The difficulty mentioned above, of interpreting computed localization distances, increases with the life of the cable due to diversions from the original charted route brought about inadvertently by trawls or ships' anchors, which have hooked and dragged the cable, or introduced of necessity at one or more repair points along the route, or perhaps produced by natural forces acting along the sea-bottom. Consequently any device which would enable the cable ship to proceed to the exact point of damage, after sailing to an approximate neighbourhood of the fault as given by computed localization results from the ends of the cable, would have many distinct advantages. The chief advantages of such a device are:—

- (a) Saving of cable due to avoidance of grappling and cutting-in at a great distance from the actual fault.
- (b) Saving of grappling time in cases where a cable is sanded at, or considerably diverted from, the working ground first selected.
- (c) Saving of money due to avoidance of grappling, (with possible damage) and raising (with possible cutting) the wrong cable where two or more cables lie in close proximity to each other. This is the case particularly arising near some shore ends where several cables converge to one terminal station.
- (d) The saving of cable mentioned in (a) results in a shorter repair length inserted which, especially in balanced and loaded cables, enables the transmission standard to be maintained nearer to that of the original unimpaired cable.

An electrode method, described under, has been tried successfully to effect these savings and further uses for this method are outlined in Sections (5) and (6) of this article.

(2) PRINCIPLE OF THE "ELECTRODE" METHOD.

The "electrode" method is distinct from the usual "leader cable" method³ used for marine and aircraft guidance. In such leader-cables use is made of the magnetic field which is set up round a single core cable when an alternating current is sent through the core of the cable and returns through

the sheath and the sea. The magnetic field is picked up by a search-coil on the exploring craft and by means of an amplifying device the induced p.d. in the coil is arranged to give an audible or visual indication depending upon the particular circumstances: but the heavy input currents (of the order of 5 amperes or more) precludes the use of this method for following loaded telephone cables in which the safe input current is of the order of 0.1 ampere or less. On the other hand use can be made of the actual return current stream-line paths from the fault through the sea in order to obtain an indication of the route of the cable and the position of an earth fault.⁴ If one side of an alternating current generator is connected at A, one end of a faulty submarine conductor, and the other side of the generator is connected to an earth plate in the sea, then the form of the current paths returning to the generator from the earth fault B of the conductor, is shown in Fig. 1. This distribution of current

angles to CD these electrodes will be along a current line, $C'D'$, and the p.d. between them will be found to have reached a maximum. Further, a straight line perpendicular to the direction CD will pass through the fault electrode B and by choosing another place to obtain zero p.d. between the electrodes, as at $C''D''$, then similarly a second line is obtained which intersects the first line at the point B—the position of the fault. Thus by determining at two different places the angular position of the electrodes which gives zero deflection, the position of B can be located. The p.d. produced between the movable electrodes when they are along any current line in the immediate neighbourhood of B will rise rapidly to a comparatively greater value and die away as CD is moved along the current-line towards the middle of the cable and will rise again to a maximum as A is approached. (See also Fig. 9). Thus by observing the maximum value of the p.d. between the electrodes C and D as they are moved

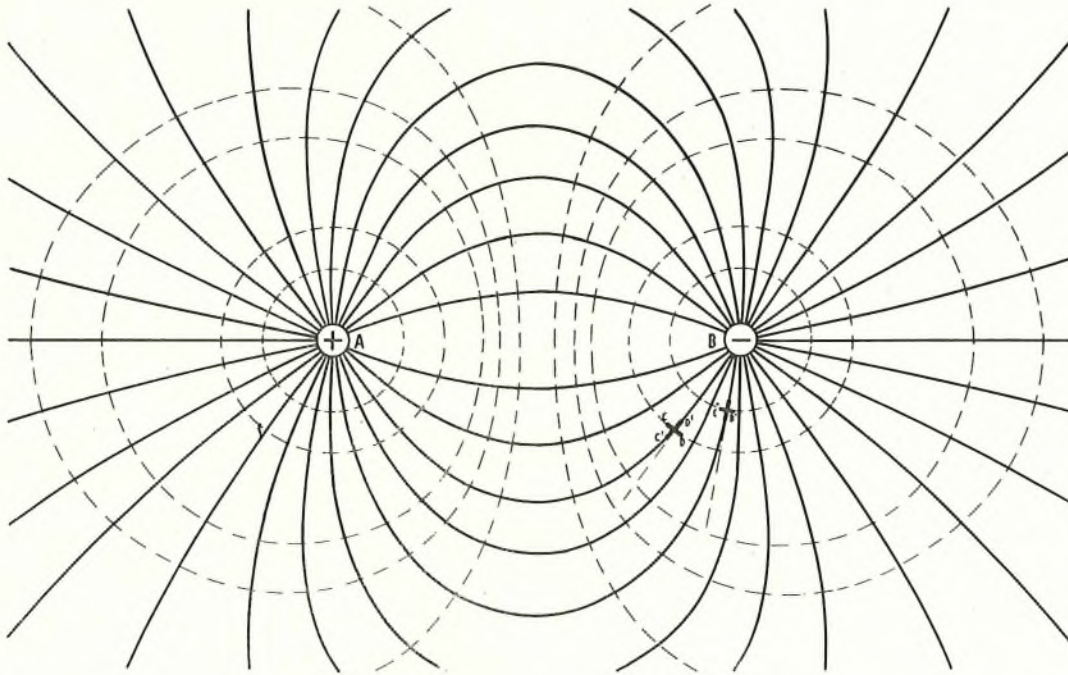

FIG. 1.—FORM OF CURRENT PATHS FROM EARTH FAULT.

stream lines is identical with the distribution of electrostatic lines of force between two electrodes charged to different potentials in air, if we assume that the sea is an infinite, homogeneous, conducting medium. Hence, as indicated by the dotted lines, there will be a number of equipotential surfaces in the field which are spherical near each electrode. In this case by exploring with two movable search electrodes at a fixed distance apart from each other, CD, when the electrodes are lying along an equipotential line the p.d. between them will be found to be zero: and when orientated into a position at right

over the conductor AB along a current line, the position of B is indicated by the large and rapid increase of this p.d.

In the case of an earth fault in a submarine cable the simple distribution shown in Fig. 1 cannot actually exist because of the restrictive influence of the boundaries of the electrodes and conductor; furthermore the sea is neither a perfectly homogeneous nor a perfectly conducting medium.

Hence before applying the method practically much experimental work has been required in order to determine to what extent the theoretical current

distribution holds good, and where it needs modification, by means of obtaining quantitative results for the p.d. produced between two movable search electrodes under various conditions, and this forms the basis of all the earlier work described here.

(3) EXPERIMENTAL RESULTS AND CONCLUSIONS.

Tests at Dover Harbour.

After some preliminary tests in a cable tank at Woolwich Submarine Cable Depot it was decided to make a trial on a larger scale in Dover Harbour and for this purpose two cables were laid in the Camber

frequencies between 50 and 2,000 p.p.s. The oscillator earth electrode, which completed the sending circuit, consisted of two lengths of bared power cable, each about 30 inches in length and having 37 strands of No. 16 S.W.G. copper. The search electrodes consisted of similar lengths of power cable, joined by an insulated twin lead to a four-valve amplifier-rectifier on the exploring vessel behind which the electrodes were towed. Except for the tests in para. (b), the spacing of these electrodes, for convenience of handling, was made 10 feet.

The method of detection is indicated in Fig. 3, and all readings of the p.d. between search electrodes

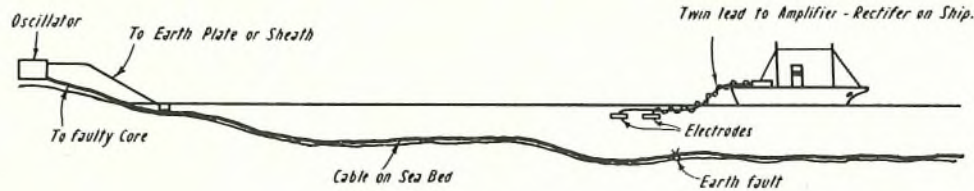

FIG. 3.—METHOD OF DETECTION.

at a depth varying from about 3 to 7 fathoms. The cables were each single core G.P. cables, 107/150, armoured with ten No. 6 S.W.G. wires and had a total cross-sectional area of 0.174 square inches. The lengths in water were 420 feet and 1,350 feet and at each sea end, respectively, the armouring wires were cut back about six inches and the conductor bared for about one inch to form an earth fault.

During the laying of the cables their positions were accurately charted from bearings taken from two fixed points on a base-line of 643 feet (See Fig. 2) and this base-line was used to determine the position of the search electrodes during the tests.

A heterodyne oscillator, with output amplified by a four-valve push-pull amplifier when necessary, supplied current up to 0.2 ampere to the cable at

have been converted to μV for the curves illustrating the following summary of the information obtained :

(a) *Best Orientation of Electrodes.*

When the electrodes are parallel to the cable, and are so towed that the rear electrode is the nearer to the oscillator, this direction is taken as zero (0° in Fig. 4), and all angles are measured clockwise from

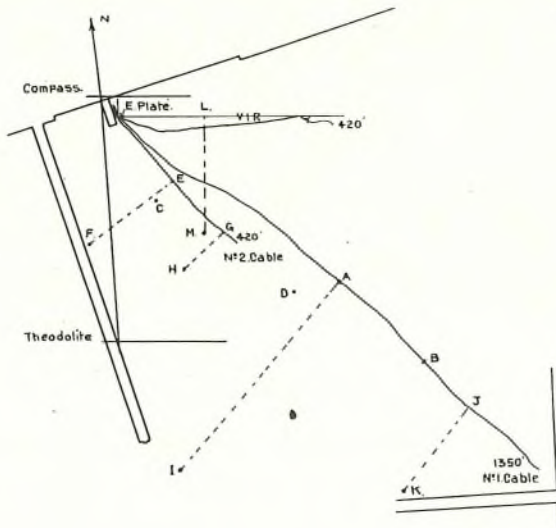

FIG. 2.—EXPERIMENTAL CABLES IN DOVER CAMBER.

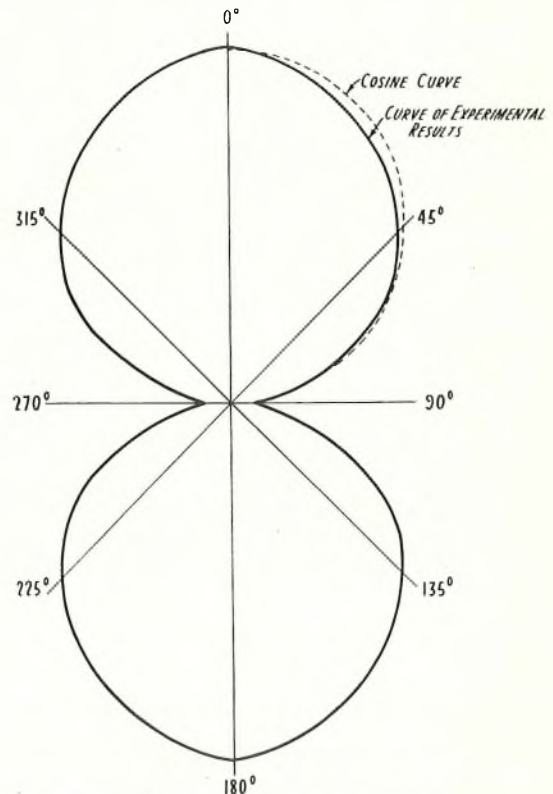

FIG. 4.—POLAR CURVE OF ELECTRODE P.D.

this direction. Polar distribution curves were taken at numerous positions in the current field on the surface and at various depths. In all cases the shape approximated to a cosine curve and Fig. 4 is a typical example.

From these tests it is concluded that it is disadvantageous to cross the cable with the towing electrodes at right angles to the line of the cable and that an angle of 45° , or less, forms the best angle of approach.

(b) *Best Span for the Electrodes.*

The electrode p.d. was found to be directly proportional to the span up to 100 feet and to drop from this slightly as the span was further increased. Fig. 5 gives a typical example.

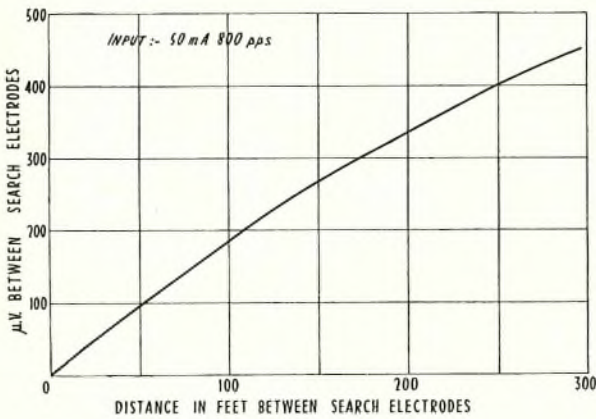

FIG. 5.—ELECTRODE P.D. VERSUS ELECTRODE SPAN.

Provided sufficient sensitivity is obtained with the receiving apparatus available, there is little advantage to be gained by increasing the electrode span beyond, say, 50 feet, if inconvenience in manipulation results.

(c) *Relation between Electrode P.D. and Magnitude of Input Current.*

With constant frequency and constant electrode span, the voltage obtained between electrodes was found to be directly proportional to the input current for any given position. Fig. 6 is typical of the results obtained using a span of 10 feet.

Hence the best input current is the maximum current obtainable from the supply, consistent with the safety of the circuit concerned.

(d) *Relation between Electrode P.D. and Frequency of Input Current.*

With a constant input current, the electrode p.d. was found to increase as the frequency was decreased and for frequencies below 300 p.p.s. the increase of p.d. was more rapid. Fig. 7 gives typical examples of p.d. versus frequency.

The best frequency of the input current is the

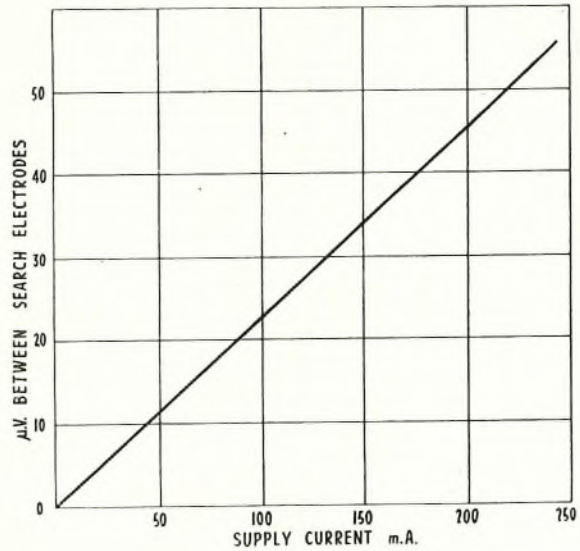

FIG. 6.—ELECTRODE P.D. VERSUS SUPPLY CURRENT.

lowest frequency obtainable from the supply, consistent with the efficient operation of the receiving amplifier-rectifier.

(e) *Relation between Electrode P.D. and Depth of Electrodes.*

Measurements of voltage between electrodes in a horizontal plane parallel to the cable, at various depths, proved that the p.d. obtained is essentially independent of the depth at which the electrodes are placed when a depth exploration is made away from the line of the cable at distances equal to or greater than three times the depth of the cable. In other words, the voltage variation with depth is dependent upon the linear distance of the electrodes from the cable and thus at a position immediately over the line of the cable the p.d. between the electrodes increases as the bottom is approached, whereas at distances remote from the cable no appreciable in-

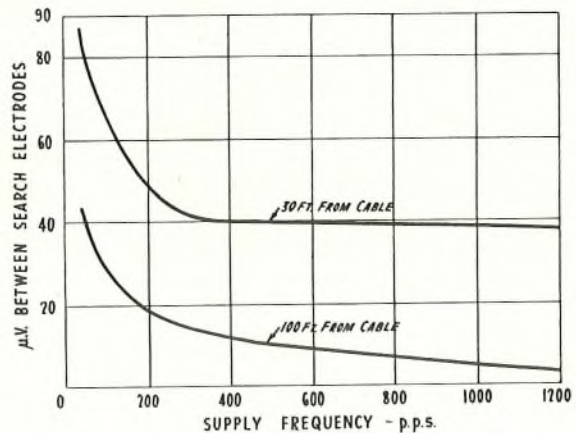

FIG. 7.—ELECTRODE P.D. VERSUS SUPPLY FREQUENCY.

crease takes place by sinking the electrodes. See Fig. 8.

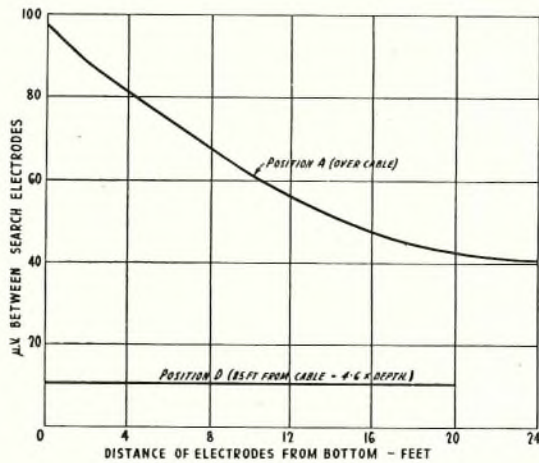

FIG. 8.—ELECTRODE P.D. VERSUS ELECTRODE DEPTH.

Hence electrodes sunk to any great depth offer no advantage when working off the cable line.

When the electrodes were towed over the surface it was noticed that quite small wavelets caused broken water conditions and, owing to partial exposure of one or both electrodes to air, violent flicks of the galvanometer needle were produced. At the same time if the electrodes are sunk to any great depth the difficulty of handling and risk of striking bottom in shallows must be considered. Moreover, by the time the cable line is reached any extra sensitivity which might be produced by depth is not generally necessary.

Provided the electrodes are completely immersed, it is doubtful whether any advantage is gained from electrodes submerged to any considerable depth even when working directly over the cable line.

(f) Linear and Lateral Distribution of the Current Field.

The potential distribution was measured at various positions along lines parallel to the cable and along lines at right angles to the cable. Fig. 9 gives an

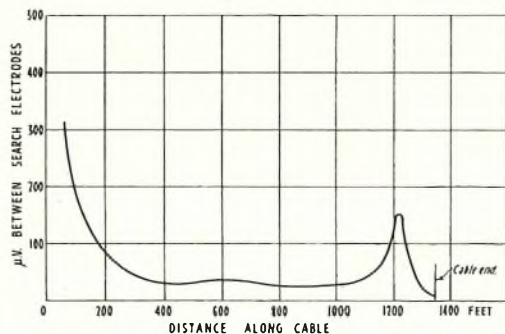

FIG. 9.—LONGITUDINAL DISTRIBUTION OF CURRENT FIELD.

example of the longitudinal distribution curve obtained and Fig. 10 shows the lateral distribution

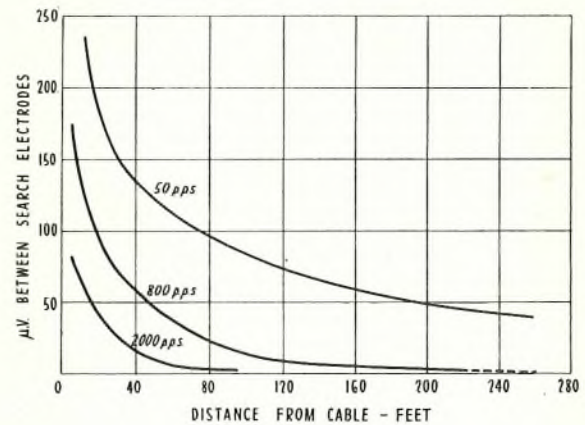

FIG. 10.—LATERAL DISTRIBUTION OF CURRENT FIELD TAKEN ALONG LINES AT RIGHT ANGLES TO THE CABLE LINE.

curves. These latter curves support the conclusion that the current lines spread further from the cable, in their return through the sea, with sub-audio frequency than with audio frequency.

For a given minimum input to the receiving amplifier, it is possible to detect the presence of a cable at a greater lateral distance if a low frequency supply is used rather than an audio frequency supply.

(4) PRACTICAL TRIALS.

Bearing in mind the important conclusions derived from the experiments just outlined, it was decided to apply the method to localize an earth fault on the Granton-Aberdour cable, which is about 5 nautical miles in length and is laid in depths varying between 3 and 25 fathoms. By electrical (D.C.) tests taken from the ends of the cable it was known that an earth fault existed near the Aberdour side.

Trials were quite successful. The cable route could be followed easily along its complete length, and the fault localized to the same spot in each trial. The method employed was the same in principle as that indicated in Fig. 3.

A frequency of 70 p.p.s. was selected and the tuned oscillator, constructed to supply currents up to 125 mA, is shown diagrammatically in Fig. 11.

The amplifier-rectifier, *i.e.*, a sensitive valve-voltmeter, is shown diagrammatically in Fig. 12, and it will be seen that there are three ranges of sensitivity available.

Further successful trials were made in the English Channel on an Anglo-Belgian lead-covered paper-core cable by H.M.T.S. "Alert," and although the arrangement worked satisfactorily it was obvious that work on this larger scale entails a number of constructional modifications both in the sending and receiving apparatus and in the manner of towing the electrodes. Operations in this direction are con-

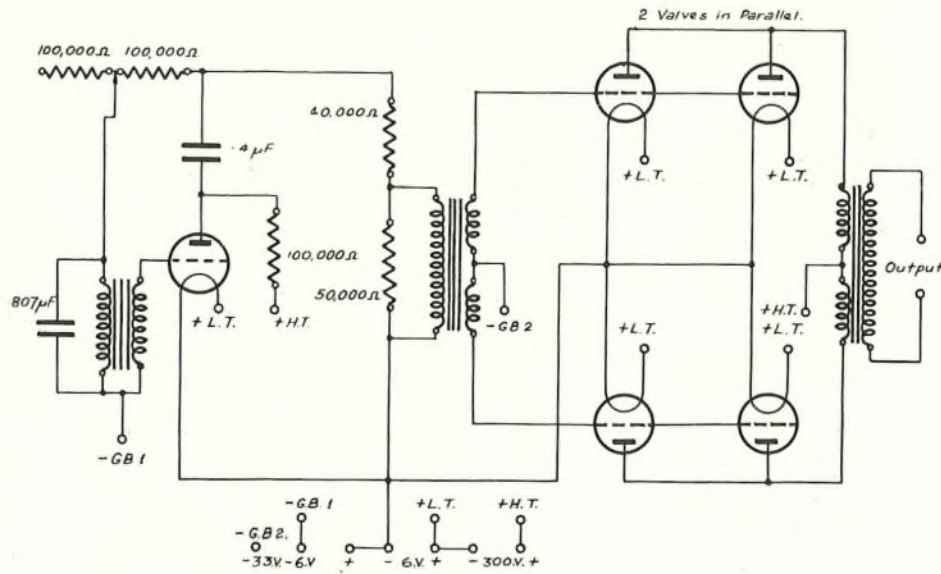

FIG. 11.—SCHEMATIC DIAGRAM OF OSCILLATOR.

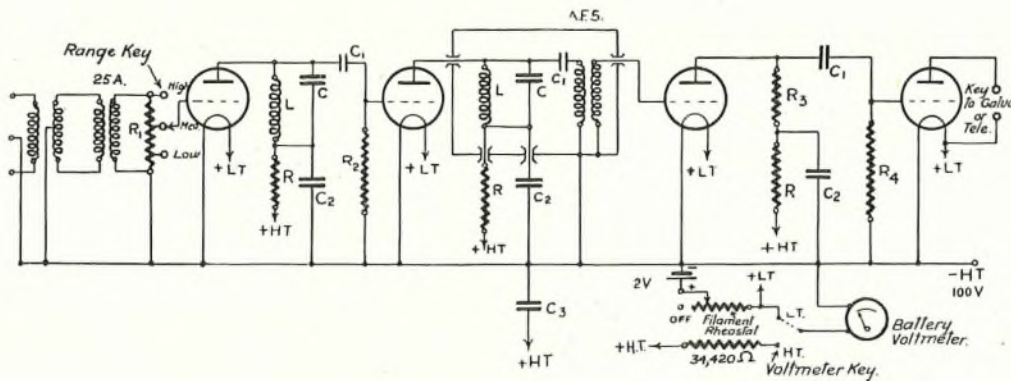

FIG. 12.—SCHEMATIC DIAGRAM OF AMPLIFIER-VOLTMETER, 70 P.P.S.

tinuing and it is hoped that further results will shortly be available for publication.

(5) APPLICATION TO U.G. ARMoured CABLES.

The recent adoption of armoured telephone cables buried directly in the ground,⁵ involves the necessity for quickly determining exactly the position of a point of breakdown, in order to avoid unnecessary excavation and re-instatement, since there are long sections of cable without readily accessible test points. The localization by earth pin electrodes in this case is closely analogous to the localization of a submarine cable breakdown by means of towed electrodes, except that :—

(a) The return current paths through the soil are not in such a homogeneous medium as the sea.

- (b) The line of the cable as laid is quite definitely known, and does not need time spent in preliminary localization of the route.
- (c) The depth of the cable below the surface of the medium is only about two feet, instead of the order of 100 feet or more.

The advantages to be gained from (b) and (c) should far outweigh any disadvantage which might be presented through (a) since the current distribution within such a short distance as two feet from the armoured cable, should not be appreciably distorted.

It is necessary to carry out field tests, however, in order to establish whether the actual distribution of the earth return current follows the same general laws as those already outlined in (3) for submarine cables or to determine to what extent these laws require modification.

(6) NOTE ON THE GENERAL CASE OF INTERFERENCE PROBLEM.⁶

The results which are obtained during trials of the electrode method have an interest apart from that of fault localization in-so-much as they form a study of the link between an inducing source (*e.g.*, a power line) and an induced p.d. (such as that produced in a neighbouring telephone line). Thus it is interesting to compare Figs. 13 and 14 and it will be seen that

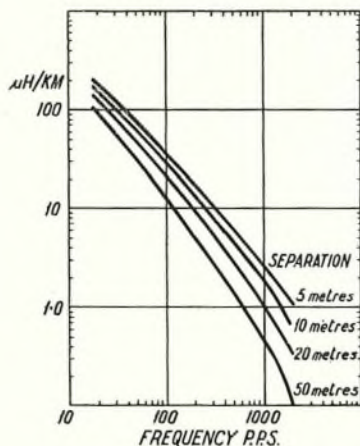

FIG. 13.—INDUCTION FROM POWER CABLE. VARIATION OF m WITH FREQUENCY.

the variation of the coefficient of mutual induction, m , with frequency, has very similar characteristics to the variation with frequency of the electrode p.d. Such curves would thus seem to form a ready means of studying the effect of any remedial measures introduced when a case of interference has to be seriously considered. In the case of Fig. 14 (with sea water as the return medium) the slight undulation present in the curves is difficult to explain. Similar results were observed by Messrs. Pollock and Robinson in connexion with some earth conduction experiments carried out at Hendon during the War, but which have not been published.

REFERENCES.

- ¹ "A.C. Methods of Fault Localization in Telephone Cables." W. T. Palmer and M. E. Tufnail. P.O.E.E.J., Vol. 23, Pt. 1, April, 1930.
- "The Anglo-French (1930) Submarine Telephone Cable," (Appendix). F. E. A. Manning. P.O.E.E.J., Vol. 24, Pt. 1, April, 1931.

² I.P.O.E.E. Printed Papers :—

- No. 104. "Cable Testing." E. S. Ritter.
- No. 110. "Testing of Telephone Circuits and Apparatus with A.C." E. S. Ritter and G. P. Milton.
- No. 138. "Telephone Cable Testing (including Fault Localization)." W. T. Palmer and E. H. Jolley.

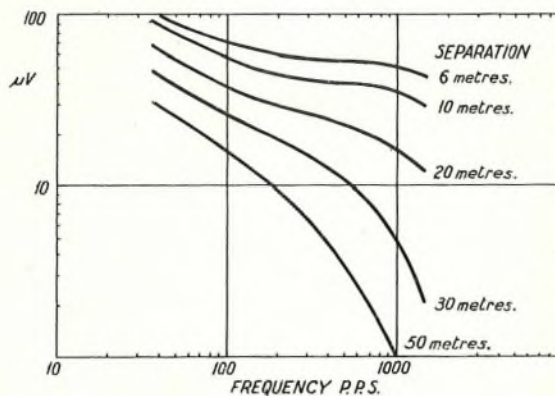

FIG. 14.—INDUCED P.D. FROM TELEPHONE CABLE IN DOVER HARBOUR. VARIATION OF P.D. WITH FREQUENCY.

- ³ "Electromagnet Piloting of Ships." E. Fournier. Comptes Rendus, Oct. 21, 1929.
- "Leader Cable Systems for Aerial Navigation." W. Loth, Comptes Rendus, Dec. 5, 1921.
- "Leader Cables in Navigation." J. J. Bennett. Electrician, Aug. 12, 1921. See also Engineering, Feb. 18, 1921.
- "The Problem of the Leader Cable." O. Oldenberg, Arch. f. Elek., Nov. 8, 1920.
- "Field of Submerged Cable carrying A.C." H. R. Rivers-Moore. El. Review, Aug. 29, 1919.
- ⁴ "Electrode Apparatus for Location of Submarine Cables." F. B. Young and W. Jevons. J.I.E.E., Vol. 61, 1923.
- ⁵ P.O.E.E.J., Vol. 25, Part 2, p. 147 (July, 1932) and Part 3, p. 240 (Oct., 1932).
- ⁶ "Interference between Power and Communication Circuits." W. G. Radley. J.I.E.E., Sept., 1931.

Considerations in the Installation of Telephone Cables

CHARLES F. STREET, M.I.E.E., A.M. INST. C.E.

THE following article indicates some of the points to be observed in the installation of a trunk telephone cable. In this country these cables are generally drawn into ducts, but there is a tendency to armour them and to lay them direct in the ground.

Cables are laid and jointed in Loading Coil Sections and limits are imposed upon the electrical characteristics of completed loading coil sections. These latter vary from 2,000 to 4,000 yards in length according to the loading system employed, and the accuracy of their length is a matter of some importance.

Each of these loading coil sections is made up of a number of duct sections which have a standard length of 176 yards each, but which vary with local conditions and obstructions. Broadly speaking, the problem of the installing engineer is to joint these component sections of cable to constitute loading coil sections so that the specified limits of electrical characteristics of each loading section are not exceeded. This is done by jointing pairs or quads of adjacent lengths of cable in such a way that their electrical irregularities to some extent cancel one another.

As a preliminary operation before commencing work, every section of duct should be definitely numbered and the corresponding numbers placed on the marking posts of the duct section. Such numbering is essential in the process of laying out drums, testing and jointing. In the absence of such numbers, testing and jointing at wrong points or even making "selected" joints "upside down" is by no means an unknown occurrence.

For the purpose of describing the procedure to be adopted, loading coil sections 1.6 miles in length have been assumed.

In an ideal case each loading coil section would consist of sixteen cable lengths each of 1/10 mile. In actual conditions, owing to bends and obstructions in the route, it will be found that there may be twenty cable lengths in the total of 1.6 miles. It is necessary, therefore, to arrange the cabling so that the loading section consists of sixteen lengths as near the standard as possible. This should be done by arranging to draw in two or more lengths in one piece whenever possible without jointing or to arrange for ordinary straight joints at specified points. The locality and nature of these points has some bearing on the matter. Jointing points which obstruct traffic, or are in rocky soil, on notoriously wet places, or which for any other reason it is not desired to visit more than once should be considered favourably for "pull throughs" or straight joints which can be made when the ground has been opened for purposes of drawing in.

Insulated Ends.

Before a capacity unbalance test can be made on

site, it is necessary that the conductors shall be "freed" or insulated from one another at the far end of the section under test. This operation on site is not always a light one, as it generally involves opening and closing the road at the far end of the section in addition to the opening of the cable under conditions which are not ideal. This can be entirely avoided by having the ends of the lengths in question insulated when the cable is on the drum and before it leaves the cable works. It is necessary, of course, that the last end of the drum shall be so treated as it is not possible to attach the hauling rope to this prepared end. The cost of insulating these ends in the works is negligible compared with the cost of doing so on site whilst the latter process generally involves not only waste of time of the testing staff but also risk of damage to the cable. The process results in certain lengths of cable being drawn-in in opposite directions and, although objection has been taken to this from a jointing point of view, it is considered that any such inconvenience is negligible where a "selected" or "crossed" joint is concerned.

Mutual Capacity.

Considering firstly the mutual capacity of cables in each loading section, there are two distinct limits to be observed.

(1) That the mean mutual capacity of any loading coil section must not differ from the mean of all the loading coil sections by more than $\pm 2\%$ and that the mean value of any loading section must not differ from the mean of an adjacent section by more than 3%.

(2) That the mutual capacity of any circuit in a loading coil section must not differ from the mean of all the circuits in that section by more than $\pm 2\%$ for 90% of the circuits and $\pm 3\%$ for the other 10% of the circuits.

Regarding the first item, consideration will show that the installing engineer on site has no control over this factor. The mean mutual capacity of the circuits of the sixteen or twenty drums of cable is a fixed quantity and cannot be altered however they are jointed up. Compliance with this requirement must therefore be made during manufacture. The difficulty which presents itself is that the mean capacity of the whole of the loading sections cannot be definitely known until they are all made and tested, although the mean can be predicted fairly closely from the test results of the first batch of drums. Experience shows that there is always a tendency for the mean mutual capacity value to decrease as the manufacture proceeds and this is generally attributed to the wearing of the covering dies. The procedure generally adopted is to calculate the mean capacity of loading coil sections as soon as they are manufactured and so ascertain a mean for the whole work. If it be found that the

capacity value of an individual section is unduly high, then one or more drums in that section are changed over with drums in a section in which the

Fig. 1 shows the results of a typical work and shows the beneficial result of changing over drums from one loading coil section to another.

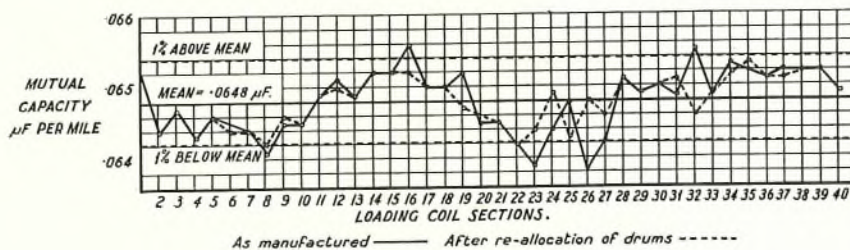

FIG. 1.—MUTUAL CAPACITY OF LOADING COIL SECTIONS.

capacity value is low and so the mean mutual capacities of individual sections can be varied to conform to the mean of the whole. Two practical points arise in this process. One is that on no account should the length number of a drum of cable be changed. The length number which a cable has borne since its manufacture commenced until it is finally tested at the works should never be altered. This is all the more necessary because sometimes double changes are made. When the final changes have been settled an allocation schedule should be issued, stating clearly which cable length is to be drawn into each duct section. Any attempt at re-numbering will give rise to all sorts of difficulties and openings for errors.

There is a case on record in which it was desirable to change over two drums of Cable A and B. Very unwisely the labels of the drums were interchanged and the test sheets were given new headings. This process was not made completely clear with the result that the installing engineer put the cable with the A label into the B duct. As the cables had already been renamed, the object of the scheme was defeated. In the same way, it is necessary when quoting a section number to make it quite clear whether it is the cable or the duct which is referred to.

The second point in this changing-over process is that it is always dependent upon the lengths of the cables being the same. In many cases it will be found that the variations in length of duct sections are so numerous as to prevent any changes being effected. That is to say there may not be a section of the same length in each of the two loading sections on which it is desired to operate. To overcome this difficulty, the duct section lengths are examined before manufacture is commenced and arrangements are made to increase the length of cable to be manufactured for certain sections to some convenient standard so that each loading coil section contains at least two of these arbitrary standard lengths and thus make it possible for at least two changes to be made. This, of course, involves wastage of cable, but by skilful selection of the standards and recognition of the recovery value of the scrap cable, the additional cost is not large.

In considering this matter of obtaining uniformity of mutual capacity for loading coil sections, it is a debatable point whether it is necessary to correct capacity test results for temperature. In the region of 50°F. to 80°F. the mutual capacity increase is about 0.55% for each 10°F. so that cables of the same capacity tested on different days on which the temperature of the cable differed by 20°F. would apparently differ by 1.1% and very seriously affect the process of allocation. Against this, however, it is argued that the temperature variations of drums of cable in a normal test bay is so small that the error due to this cause is negligible. It is, however, a matter worthy of consideration in individual cases.

Regarding the second item whereby it is specified that the mutual capacity of any pair in a loading coil section shall not differ from the mean of all the pairs in the section by more than 2% or 3%, much depends upon the quality of the single lengths of cable as manufactured. A deviation of 12½% is permitted on a pair in a single length and if such a pair be jointed to pairs with a capacity equal to the mean of the section for, say, five successive lengths, then the capacity deviation of the circuit so formed will be about 2%. Such a useful combination of circuits could hardly be hoped for without testing or manipulation, and in such cases it is desirable at the middle joint of the loading coil section to test the mutual capacity value of all the circuits in the cable.

One method of doing this is to set up a bank of (say mica) condensers having a capacity value equal to the mean of the whole cable and, by means of a bridge, to measure the variation of each of the circuits from the assumed mean which is, of course, the mean of all the loading sections and may differ appreciably from the mean of the section under test. To correct the figures obtained so as to refer to the mean of the section under test, the algebraic mean of the measured deviations is calculated. This quantity is the difference between the adopted mean and the mean of the section under test and if all the measured deviations be corrected by this amount, the true deviations from the mean of the section can be ascertained. An examination of these figures will determine whether any selection of pairs for

mutual capacity is necessary at the final joint of the loading coil section.

Capacity Unbalances.

It is not proposed to describe the methods of testing and selecting unbalances. A process is described in Technical Instructions Lines, Underground, Section G, issued by the Post Office Engineering Department.

Considering within core unbalances ($p - q$), the limits imposed on 176-yard lengths at works are mean/max $33/125 \mu\mu\text{F}$. and on a complete section the limit is 100 millionths crosstalk which corresponds to a ($p - q$) value of about $60 \mu\mu\text{F}$.

Clearly it would be impossible to join up sixteen lengths of cable which only just complied with the specification limit of $33/125$ without exceeding a limit of 60 on the complete section and the process of balancing has to be resorted to. It may be remarked here that in the opinion of the author insufficient use is made of the fact that the whole of the unbalances are of necessity measured at the cable maker's works in order to ascertain whether the cable complies with the specification. It is thought that these figures could advantageously be used more frequently as a means of balancing, at all events at the first joint.

Unbalances between Adjacent cores in the same layer.

As stated in an earlier article, the interference between cores in the same layer but separated by an intervening core is negligible. The interference between adjacent cores is by no means negligible. It is of the order of mean/max $11/40 \mu\mu\text{F}$ and if allowed to add up over sixteen lengths of cable would certainly exceed the limit of $60 \mu\mu\text{F}$.

There are two ways of controlling adjacent core-to-core unbalances. (1) They may be tested and selected in the same way as within-core unbalances. This is somewhat tedious but quite practicable. (2) They may be prevented from adding up continuously by what is known as "Separation" Joints.

A system of separation joints is one which provides that any two cores which are adjacent in one length are jointed to two cores which are not adjacent in the next length, and this process can be repeated for successive joints.

There is, however, a limit to this process, for after a certain number of joints it will be found impossible to proceed without adjacency recurring. This critical number of joints depends upon the number of cores in the cable.

In a general way (and with certain accepted discrepancies) the number of lengths of cable N which can be joined together before adjacency recurs is given by the expression $N = \frac{n-1}{2}$ where n is the number of cores in the cable.

This separation jointing scheme is very valuable as in a 56-pair cable, *i.e.*, 28 quads or cores, it is possible to join together 13 lengths of cable before adjacency recurs. That is to say thirteen lengths of cable can be joined together and the unbalance

of any one core to any other core on the thirteen jointed lengths is no greater than that of adjacent cores on a single length. In the case under consideration, the loading coil section consisted of sixteen lengths so that the system of separation joints would not in itself be adequate to prevent adjacency recurring once.

With a modern cable, however, the core-to-core unbalances are such that it is possible to join up the sixteen cable lengths into eight two-length straight-joint units without any core-to-core testing with the knowledge that the core-to-core unbalance of a two-length unit is still below the limits imposed for the loading coil section. Thus if the unbalance on a single length be $11/40$ then, using the square root law, the figures for a two-length unit will probably be $15/57$. If the separation jointing scheme be applied to the two-length units, then the core-to-core unbalance between any two cores in the loading coil section will be $15/57$ and be within the specification limit of $60 \mu\mu\text{F}$.

It may happen, however, that the core-to-core unbalances on single lengths are not small enough to enable two-length units to be formed without exceeding the limits of the complete section or it may be that the cable is a small one or the loading coil sections may contain many more cable lengths than the sixteen assumed. In such cases, both the formation of two-length units and the application of the separation joints is still inadequate, and core-to-core testing and selecting will have to be resorted to until the number of units in the loading coil section will permit of the separation jointing scheme being employed. It is most important that testing and selecting be done before the application of the separation joints scheme. The latter must never be applied until it is known that its application will enable the loading section to be completed without adjacency recurring. The importance of this is due to the fact that if the core-to-core testing be done before the application of the separation joints, then it is only necessary to test and select between adjacent cores. The values between non-adjacent cores are negligible.

After the application of the separation joints, however, the unbalances between cores are scattered all over the cable. Any one core will have an appreciable unbalance to numerous other cores and the testing work will be enormous whilst the work of selection will be complicated if not impracticable.

It is perhaps desirable to consider the real effect of this process of separation joints. The object is to prevent a circuit being adjacent to and being interfered with by any one other circuit for the whole of the lengths under consideration.

Now although the separation joint prevents continuous adjacency, the circuit in question must of necessity be adjacent to some circuit. The net result of the separation joint is therefore that instead of a circuit being persistently interfered with by one other circuit for sixteen lengths it is now interfered with to a smaller extent by sixteen different circuits. There is, however, a real advantage from the separation process. In the first place, the sixteen other

Circuits may not be working at the same time and, secondly, the interference which is known as "Babble" will not be articulate so that there is no loss of secrecy. Moreover, in the case of the sixteen interferences these will not all be additive. Some of them may compensate one another to some extent.

Pursuing this matter of adjacency separation joints, the result can be achieved in a number of ways each of which may excel in certain features. An example of the scheme used by the author is shown in Table No. 1. This refers to a 74-pair, *i.e.*, 37-quad cable.

For simplicity and ease of detecting adjacency, the quads in the cable have been numbered 1-37 and the whole cable is assumed to consist of one layer of 37 quads. In the first column consecutive numbers are adjacent to one another. The next column shows the quad numbers to which they are to be jointed in the next length and (with exceptions referred to later on) it will be noticed that no adjacent numbers are consecutive. Adjacent quads in the first length are thus jointed to non-adjacent quads in the next length.

One very great feature of these schemes is that every joint is the same and the elaborate schedule shown in Table 1 is not necessary for instructions to the joiner to whom it is only necessary to give a schedule for one joint which is used at all jointing points. For example, quad 17 is always jointed to quad 19 in every joint. The object of the schedule reproduced is to demonstrate how many lengths can be jointed together without adjacency recurring. It will be seen that all quads which were adjacent in the first length become adjacent again in the nineteenth length.

The scheme is, however, not quite so perfect as it appears because actually the 37 quads do not lie in one layer, as assumed, but in a centre and three layers with the result that the initial and final quads in each layer are adjacent to one another although they do not carry consecutive numbers. Thus quads 2 and 7 in the first layer, 8 and 17 in the second layer, and 20 and 37 in the third layer are adjacent quads, and it will be found on examination of the schedule that this fact is the cause of a few quads becoming adjacent again before the nineteenth length has been reached.

Thus quads 13 and 14 in the first length are jointed to quads 8 and 19 (which are adjacent) in the fourth length.

Against this it must be pointed out that the terminal quad of one layer and the initial quad of the next layer carry consecutive numbers, but are not adjacent to one another. Thus quad 7 in the first layer is not adjacent to quad 8 in the second layer and some thought has been expended on how this fact might be utilized by some changing-over process to nullify the effect of the adjacent quads which have not consecutive numbers. So far no ingenuity has indicated how this can be done.

In considering the merit of any system, it is necessary to consider what occurs over the number of lengths before all the original adjacent circuits become adjacent again, *i.e.*, in this case 19 lengths.

In the system described, of the thirty-six adjacent quads in the first length six pairs of quads become adjacent again during the succeeding seventeen lengths. It is quite true that certain non-adjacent quads at the beginning of the eighteen lengths in question also become adjacent during the eighteen lengths, but these quads are part of the thirty-six initial adjacencies if the 18-length section were considered from the length where these adjacencies occur.

Unless the method of describing the merit of a system is defined, the matter becomes very confusing. There is one practical point in connexion with adjacency separation joints which is worthy of note and that is a process known among selectors as "Twiddling."

In the employment of the standard separation joint it may be necessary to joint together two quads which from "within-core" considerations are quite unsuitable. Reflection will show that this is not really essential. For example, the scheme set out arranges that quad No. 33 shall always be jointed to quad No. 35. If, however, this quad joint is quite unacceptable there is no objection to jointing quad 33 to any other quad in the same layer providing all the quads are correspondingly renumbered. The geometry of the scheme is not affected by altering an arbitrary system of numbering the quads. The choice of the expression "Twiddling" is perhaps therefore appreciated.

Unbalances between cores in different layers.

The greatest interlayer interference occurs between those layers situated in the middle of the cable and diminishes as the layers concerned approach the outside layer. For a small cable of two or three layers, a typical unbalance for 176 yards is mean/max. = 4/17 $\mu\mu\text{F}$. This mean diminishes as the number of layers increases. Little or no steps are necessary in the ordinary course of events to manipulate these figures on site. In exceptional cases of either bad cable or more rigid specification limits for the complete loading coil section, it may be necessary to employ a layer separation joint and an example of this is shown in Fig. 2 which applies to a 24-pair cable, *i.e.*, 12 quads.

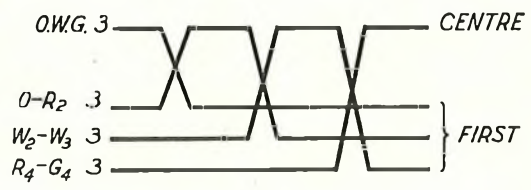

FIG. 2.—INTERLAYER SEPARATION JOINT FOR 24-PAIR CABLE.

The object is to minimize the interference between the three centre cores and the nine quads in the first layer. This is done by systematically changing over three quads in the centre with three different but specific quads in the first layer at every joint. After three such joints all the nine quads in the first layer have changed places with the centre quads. Exam-

ination will show that the interlayer unbalance between any quads on a four-length unit formed in this way occurs for only two lengths of cable instead of four.

Interference between one layer and another can also be controlled to a small extent by testing and selecting. A limitation is imposed by the fact that each quad in a layer may interfere with several of the quads in the adjacent layer, with the result that a cross on one quad will affect the unbalances to numerous other quads and the effects of one cross may be so conflicting in many cases that little or no benefit can be obtained.

Effect of Resheathing.

Sheath failure generally necessitates the withdrawal of the cable length from the ducts. Replacement with a new length of cable will generally involve rebalancing the loading coil section. It does not appear to be as commonly known as it should be that the stripping and resheathing of a cable is comparatively simple and is less costly than rebalancing. Moreover, contrary to common impression, this process has practically no effect on the capacity un-

balances of the quads.

The following shows the effect on the characteristics of a 168-yard length of 74/40 p.c. quad as a result of withdrawing and resheathing :—

	<i>p</i> - <i>q</i>	<i>u</i> & <i>v</i>	Adjacent Quads.	
Cable in duct with sheath failure	24/130	33/136	5.5/17	μμF.
After withdrawal Stripping and resheathing	26/128	34/133	6/17	μμF.

It will be seen that the mean of the characteristics is practically unchanged. In fact the differences in the two tests are probably within the limit of errors of the tests themselves. The practical difficulty is that a short length of the cable, say 2 feet, will be mutilated in the resheathing operations and the cable can only be restored by the use of a "pieced" joint.

It is possible, however, to arrange for the manufacturer to joint on a few yards of extra cable and to resheath over it and thus avoid a "pieced" joint at either end. The effect of the unbalances of the few yards of cable so introduced is negligible.

TABLE NO. I.
ADJACENCY SEPARATION JOINT FOR A 37 QUAD CABLE.

Length	1	2	3	4	5	6	7	8	9	10	11	12	13	14	15	16	17	18	19
Quad	1	1	1	1	1	1	1	1	1	1	1	1	1	1	1	1	1	1	1
"	2	3	5	7	9	11	13	15	17	19	21	23	25	27	29	31	33	35	37
"	3	5	7	9	11	13	15	17	19	21	23	25	27	29	31	33	35	37	36
"	4	2	3	5	7	9	11	13	15	17	19	21	23	25	27	29	31	33	35
"	5	7	9	11	13	15	17	19	21	23	25	27	29	31	33	35	37	36	34
"	6	4	2	3	5	7	9	11	13	15	17	19	21	23	25	27	29	31	33
"	7	9	11	13	15	17	19	21	23	25	27	29	31	33	35	37	36	34	32
"	8	6	4	2	3	5	7	9	11	13	15	17	19	21	23	25	27	29	31
"	9	11	13	15	17	19	21	23	25	27	29	31	33	35	37	36	34	32	30
"	10	8	6	4	2	3	5	7	9	11	13	15	17	19	21	23	25	27	29
"	11	13	15	17	19	21	23	25	27	29	31	33	35	37	36	34	32	30	28
"	12	10	8	6	4	2	3	5	7	9	11	13	15	17	19	21	23	25	27
"	13	15	17	19	21	23	25	27	29	31	33	35	37	36	34	32	30	28	26
"	14	12	10	8	6	4	2	3	5	7	9	11	13	15	17	19	21	23	25
"	15	17	19	21	23	25	27	29	31	33	35	37	36	34	32	30	28	26	24
"	16	14	12	10	8	6	4	2	3	5	7	9	11	13	15	17	19	21	23
"	17	19	21	23	25	27	29	31	33	35	37	36	34	32	30	28	26	24	22
"	18	16	14	12	10	8	6	4	2	3	5	7	9	11	13	15	17	19	21
"	19	21	23	25	27	29	31	33	35	37	36	34	32	30	28	26	24	22	20
"	20	18	16	14	12	10	8	6	4	2	3	5	7	9	11	13	15	17	19
"	21	23	25	27	29	31	33	35	37	36	34	32	30	28	26	24	22	20	18
"	22	20	18	16	14	12	10	8	6	4	2	3	5	7	9	11	13	15	17
"	23	25	27	29	31	33	35	37	36	34	32	30	28	26	24	22	20	18	16
"	24	22	20	18	16	14	12	10	8	6	4	2	3	5	7	9	11	13	15
"	25	27	29	31	33	35	37	36	34	32	30	28	26	24	22	20	18	16	14
"	26	24	22	20	18	16	14	12	10	8	6	4	2	3	5	7	9	11	13
"	27	29	31	33	35	37	36	34	32	30	28	26	24	22	20	18	16	14	12
"	28	26	24	22	20	18	16	14	12	10	8	6	4	2	3	5	7	9	11
"	29	31	33	35	37	36	34	32	30	28	26	24	22	20	18	16	14	12	10
"	30	28	26	24	22	20	18	16	14	12	10	8	6	4	2	3	5	7	9
"	31	33	35	37	36	34	32	30	28	26	24	22	20	18	16	14	12	10	8
"	32	30	28	26	24	22	20	18	16	14	12	10	8	6	4	2	3	5	7
"	33	35	37	36	34	32	30	28	26	24	22	20	18	16	14	12	10	8	6
"	34	32	30	28	26	24	22	20	18	16	14	12	10	8	6	4	2	3	5
"	35	37	36	34	32	30	28	26	24	22	20	18	16	14	12	10	8	6	4
"	36	34	32	30	28	26	24	22	20	18	16	14	12	10	8	6	4	2	3
"	37	36	34	32	30	28	26	24	22	20	18	16	14	12	10	8	6	4	2

Advance Automatic Exchange

M. C. COOPER, A.R.C.Sc.I., and A. G. LYDDALL.

ABOUT 2½ years ago the Department accepted a proposal from Messrs. Standard Telephones & Cables, Ltd., to instal experimental exchange equipments in London and the Provinces employing the Company's new bypath system of automatic switching.

Advance Exchange (Bethnal Green, London), which was opened on the 23rd February, 1933, is the first of these experimental equipments to be put into service. Its behaviour under working conditions will be watched with very considerable interest and attention during the next few months.

The Exchange, which is accommodated in a new building in Eric Street, Bethnal Green, and will ultimately cater for 10,000 lines, opened with equipment for 3,170 working lines and a subscribers' multiple of 3,400. The main distribution frame, meter rack, and test desk, together with the power plant, are located on the 1st floor; the manual board occupies a portion of the 3rd floor; whilst the intermediate distribution frame and all the initial switching equipment are accommodated on the second floor, the lay-out of which is indicated in Fig. 1.

another, the 1st numerical digit is also accepted in the 2nd code stage. It should be noted that the register, in addition to storing and repeating the numerical digits for calls routed *via* Tandem, functions as a coder when such calls are for manual exchanges.

A feature of the system is the direct dialling of local "0" level calls to the manual board and calls routed over direct junctions to automatic exchanges. In the latter case the register and the translator, although momentarily seized, are not utilized or held unless there are no free direct junctions. If all direct junctions are engaged, use is made of the register and translator to provide an alternative route *via* a Tandem Exchange.

Register.

The register, which stores and re-transmits the numerical digits consists of a receiving and a sending uniselector, together with digit storing and controlling relays. It re-transmits the subscriber's number, either as Strowger pulses for calls to an automatic exchange or as C.C.I. signals for calls to a manual exchange.

25 registers are provided to meet requirements for Advance Exchange.

Translator.

The translator consists of one uniselector and three relays, and serves nine exchange translations. The uniselector steps in synchronism with the impulsing springs of the register and sends out first a special digit indicating the call fee to be charged and then the digits of the translation for operating the Tandem switches. Ten wipers and bank arcs are available, one of which controls the drive, each of the other arcs being allotted to the translation of one London Director or Manual Exchange code by strapping together groups of contacts corresponding to the numerals of the fee and translation digits. These contacts are extended by means of a common wire to the bank contact of the appropriate

exchange on the R₃ switch of the 2nd code bypath; the inter-digital pause is obtained by leaving a sufficient number of contacts disconnected on the translator banks between the groups of strapped contacts. An earth on the wipers of the translator thus signals to the register, *via* the 2nd code R₃ switch, the beginning and end of each of the call fee and translation digits, while the translator moves through its cycle at 10 steps per second. The translator circuit is shown in Fig. 3.

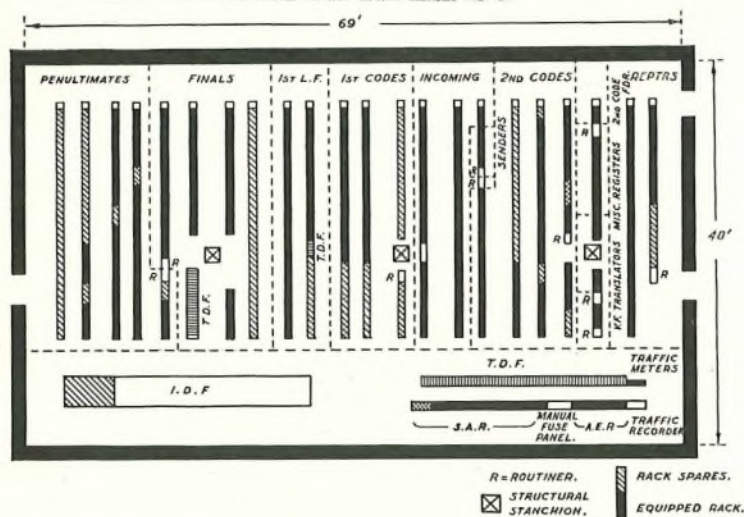

FIG. 1.—LAY-OUT OF APPARATUS ROOM.

As a description of the Bypass automatic telephone system has already been given in this Journal (Vol. 24, Part III), it is unnecessary to go over the ground again and reference can straightway be made to the Key diagram, Fig. 2, which gives an outline of the system as applied to Advance Exchange.

The A and BC code digits are accepted in the 1st and 2nd code stages respectively, a 2nd code stage being provided for each of the eight A code digits. For local calls made by one Advance subscriber to

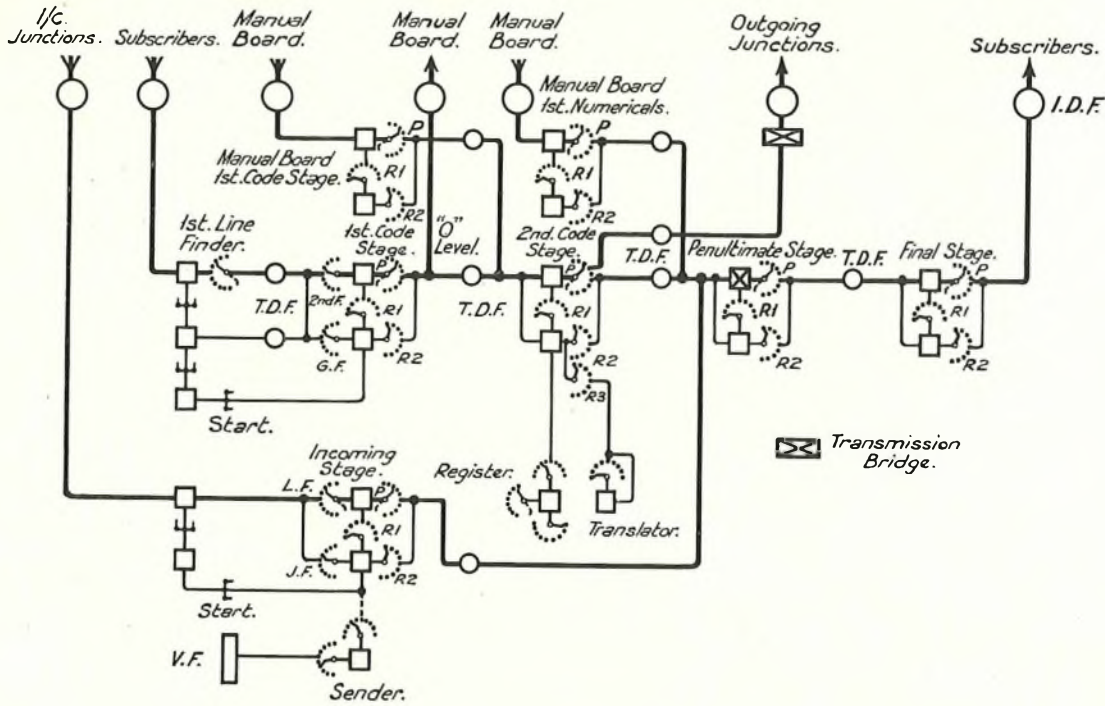

FIG. 2.—KEY DIAGRAM.

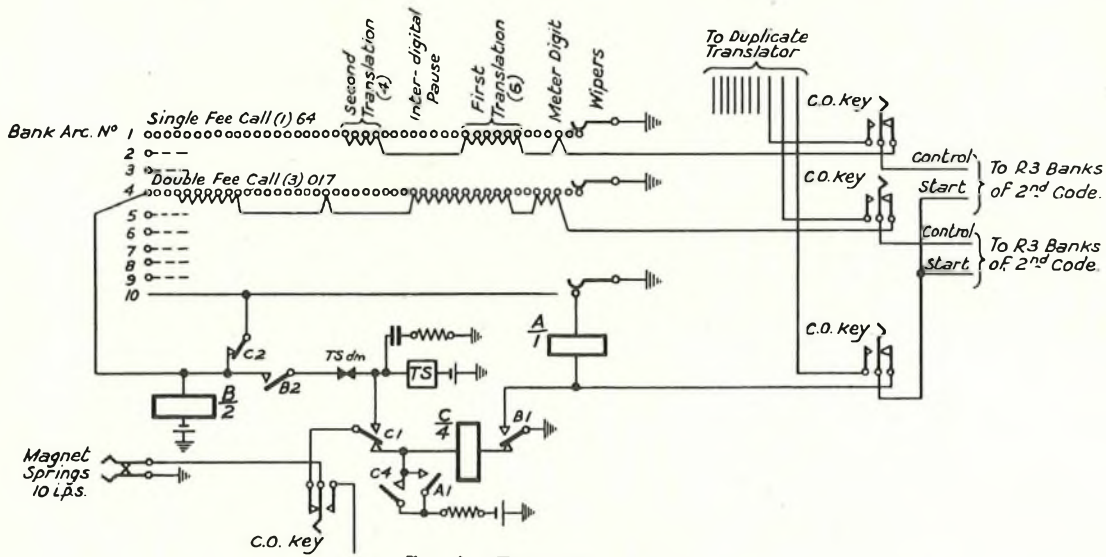

FIG. 3.—TRANSLATOR CIRCUIT.

There are two complete sets of 20 translators at Advance Exchange and facilities are provided for changing over from one set to the other.

Equipment Arrangements.

Subscribers obtain access to the 1st code stage via 1st and 2nd line finders. Each unit of 1st line finders serves 100 subscribers, the number of 2nd line finder groups being determined by the number

of 1st line finders required to serve the traffic originated by 100 subscribers' lines. The 1st finder wipers are cabled via a distribution frame to the 2nd finder bank multiples. In the system of distribution employed, the bank contact number of the 2nd finder corresponds with the first finder hundreds unit, and the 2nd finder group number indicates the associated 1st finder uniselector in that hundreds unit. Each group of 2nd finders and their associated path

switches of the 1st code stage are mounted on the same bay.

A P.G. fault is indicated after a predetermined period by the lighting of a supervisory lamp on the 1st code stage bay. The lamp number corresponds with the 2nd finder concerned. Tracing back is therefore facilitated as the setting of the 2nd finder wipers indicates the 1st finder hundreds unit and the bay number gives the uniselector in that unit. Fig. 4 is an illustration of a bay of 1st line finders. As the 2nd finders are 50-point uniselectors, 50 groups of 100 subscribers can be served from them. A complete 10,000-line exchange would therefore be divided into two equal units of 5,000 lines up to the 1st code stage. Fig. 5 indicates the lay-out of a typical bay of the 1st code stage.

Cabling from the 1st code stage path banks is taken *via* a grading frame to the 2nd code stage paths and bypaths which are spread over 23 bays in 4 suites of racking. Cabling is run from the terminal strips of these bays *via* a grading frame to 28 bays of penultimate stage switches, also to the

3 bays of registers and a single bay of translators. The paths and bypaths of the 2nd code stage are normally 100-outlet switches, but for Advance Exchange it was found that the total number of direct junctions to exchanges with names beginning with A, B or C, together with Tandem and Sub-Tandem junctions and the outlets to 1st numerals for local traffic just exceeded 100. This necessitated the use of 200 outlets for the 2nd code stage serving the ABC outlets from the 1st code stage. The 200 outlets are obtained by using two 100-outlet switches, the surplus contacts of the 200 outlets being utilized by arranging for the stage to accept the 1st numerical digit of local calls. The other 2nd code stage switches have 100 outlets.

It will be seen from Fig. 6, which illustrates the lay-out of a penultimate stage bay, that the relay-sets occupy slightly more space than the path switches. This is because the transmission feed, ringing and busy tone are applied at this stage. Fig. 6 also shows the transparent relay-set covers which will facilitate relay inspections. Cabling is

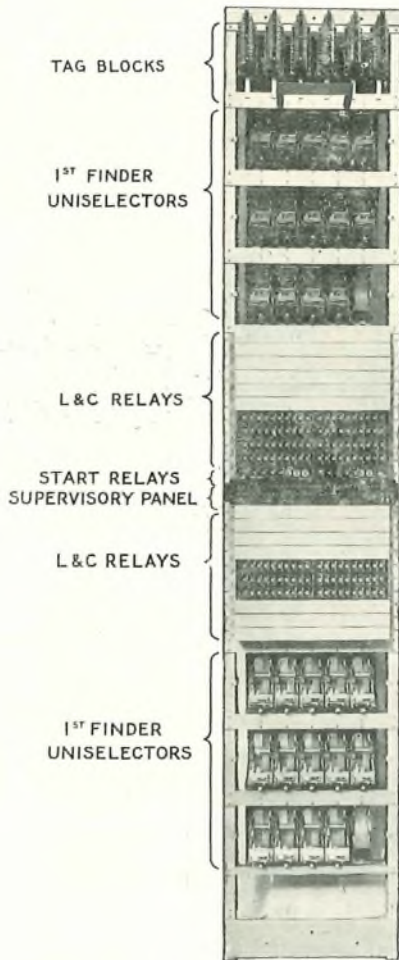

FIG. 4.—1ST LINE FINDER BAY.

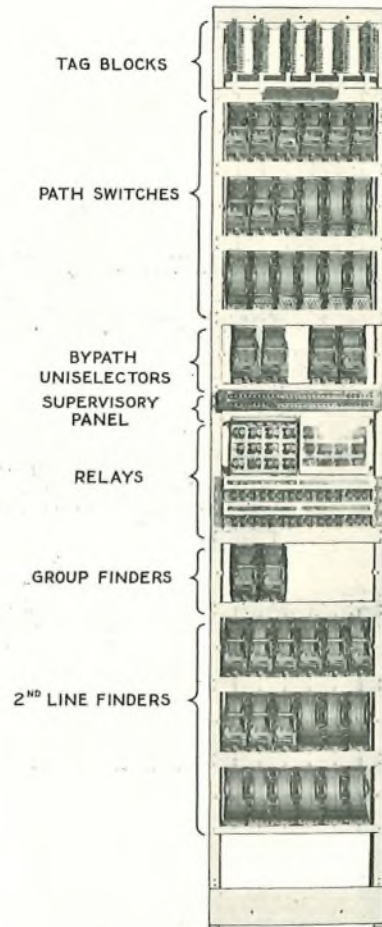

FIG. 5.—1ST CODE STAGE BAY.

run from the penultimate bays *via* a grading frame to the 17 final stage bays, a typical lay-out of one of these bays being indicated in Fig. 7.

Four bypaths of the final stage serve two groups of 18 path switches, one for the even and the other for the odd hundred group of subscribers' numbers.

Incoming junctions from automatic and from manual exchanges are cabled from the I.D.F. through auxiliary apparatus on the special apparatus rack to the banks of junction finders on 24 bays of incoming stage equipment.

By an arrangement known as "ghosting," the wipers of the junction finders in each group, when idle, are positioned on artificial home points spaced equally round the bank arcs. This arrangement reduces switch movement and the hunting time period. The arrangement is that the junctions which are the first choices of switches at the distant exchange are connected to the artificial home positions, thus requiring no switch movement for isolated calls made in slack periods. The remaining choices appear on the finder arcs in the reverse order to their appearance on the selector at the distant exchange, thus ensuring that a long hunt at the distant exchange

will be compensated by a short hunt at Advance. Any risk of lost impulses due to the hunting time of the junction finders is eliminated by holding up the transmission of the numerical digits from the director of the originating exchange until a reversal on the junction from Advance indicates that the junction has been found and a bypath is ready to accept the impulses. In the case of manual junctions, a pip-pip signal is returned to the operator to indicate when to commence "keying," as in the standard case.

The auto-manual switchboard, which is installed on part of the 3rd floor, consists of 10 operator's positions. The latest type of equipment has been provided which includes the use of sleeve control cord circuits and visual idle junction indicating signals both of which have been already described in this Journal (Volume 24, Part III).

The equipment provides for the standard traffic and engineering facilities as required by the Department for London Director type automatic exchanges. In addition, several new and interesting facilities have been introduced, a few of these being briefly described in the following paragraphs:—

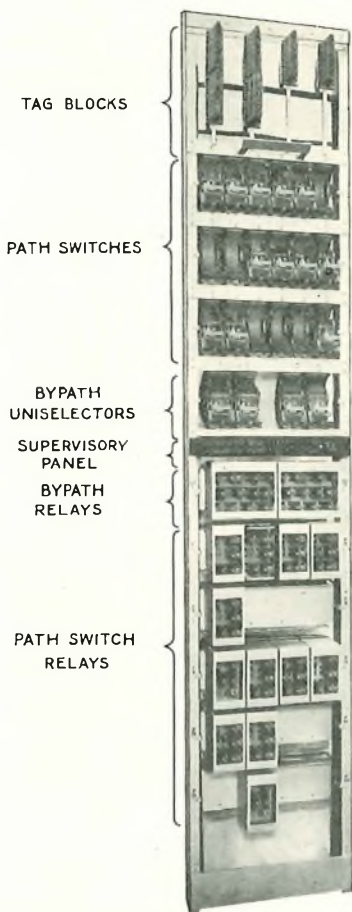

FIG. 6.—PENULTIMATE STAGE BAY.

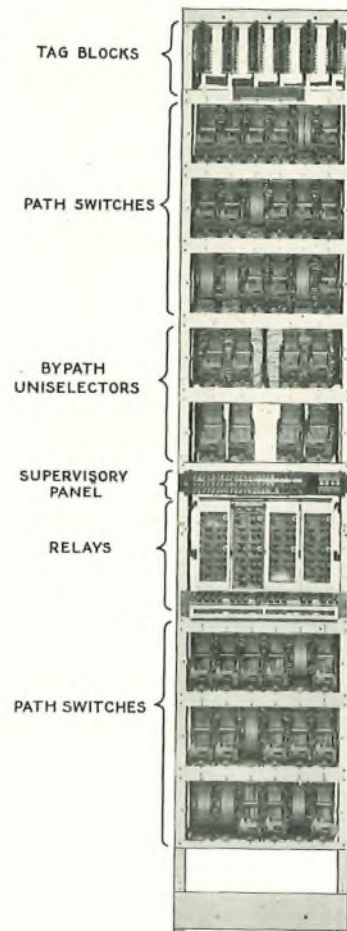

FIG. 7.—FINAL STAGE BAYS.

Trunk train for incoming Trunk calls.

The Trunk train consists of special incoming 1st selectors, and penultimate selectors which use the regular bypaths. It provides for the setting up of incoming Trunk calls by the remote Trunk operator without further dialling after the initial operation, whether the required line is free or engaged. The engaged connexion can be directly entered for the purpose of "offering," and when this connexion is cleared, supervisory conditions are returned to the operator who can then complete the Trunk call. Operator control of ringing signals and re-ringing features are included in the design. The control of the Trunk offering procedure is therefore transferred to the Trunk operator, and a speeding up in the completion time of about 10 per cent. of Trunk calls should thereby be effected.

Assisted Service Scheme.

In the present standard automatic exchange, a subscriber desiring assistance obtains the aid of the auto-manual operator by dialling 0. The operator sets up a further connexion to the subscriber by means of her trunk offering circuit, and then instructs the subscriber to replace his receiver and dial the number he desires while she supervises the setting up of the call.

The Assisted Service scheme at Advance Exchange enables the operator to transfer the subscriber, by means of a key operation, to an auxiliary auto calling equipment and to supervise his re-dialling operation directly over the "0" level circuit.

Alternative trunking for overflow traffic to other exchanges.

This interesting facility which has been subjected to very careful study, permits of a call being routed *via* a Tandem centre if all the direct junctions to a distant exchange are engaged. Advantage has been taken of the scheme to effect economy in line plant by deliberately reducing the number of direct junctions and forcing the overflow traffic over the alternative route *via* the Tandem centre. In the particular case of Advance exchange this has resulted in an approximate saving of 29% in the number of junctions.

A further advantage arising out of the scheme is that seasonal peaky traffic loads to a particular exchange can be disposed of without congestion on the junction line plant and its resultant lost calls. Rearrangement of the plant for the purpose of handling such traffic should, in general, also be avoided.

Private Branch Exchange Groups on Final Selectors.

All Final Selectors are designed to accommodate regular and/or P.B.X. lines. Special provision of P.B.X. selectors and allotment of blocks of multiple numbers has therefore been avoided. P.B.X. lines are thus spread over the complete multiple with a consequent reduction in the extent of the multiple.

The design provides for ordinary lines being interspersed with the lines in a P.B.X. group and any

number (*e.g.*, 2000) can be allotted as the first line in a P.B.X. group. The maximum number of P.B.X. lines catered for at Advance in any group is 50, but larger groups can be readily provided for when required.

It is anticipated that these features will enable the bank capacity to be used to greater advantage by providing for unexpected development of P.B.X. groups with minimum change in subscribers' numbers.

Busy Subscribers' Recorder.

This facility enables the incoming traffic on any subscriber's line to be recorded, for the purpose of determining when an additional line or lines should be rented by the subscriber in order to carry this traffic.

Combined Automatic Dial speed tester and faultsman's ring back.

This scheme enables the faultsman at the subscribers' premises to carry out dial speed tests without calling in the exchange test clerk. Fast, normal and slow dial speeds are orally indicated to the faultsman by the application of three distinctive tones, *viz.*, fast interrupted N.U. tone, continuous N.U. tone, and slow interrupted N.U. tone respectively.

Hitherto, the provision of the faultsman's ring back facility has been limited to non-Director areas owing to the limitation imposed by the transmission bridge in the present 1st Code selectors in Director areas. The equivalent bridge in the case of Advance exchange is in the penultimate selector and therefore makes such provision possible.

The faultsman dials XXT (998) to gain access to the equipment provided for these two services.

Supervision at the 1st stage selector.

Permanent signals due to the receiver being off, incomplete dialling and the called or calling subscriber held conditions are thrown back to the 1st stage after a short period, where the fault is indicated by a lamp and audible alarm.

This feature should assist maintenance practice, besides preventing undue false holding of a train of switches.

Conclusion.

The bypath principle of automatic switching was first put into practice on three rural automatic exchanges, but Advance exchange is the first Translator and Register Bypass exchange to interwork with the vast London Director and C.C.I. network. The new facilities described indicate the flexibility of the system and demonstrate how the system lends itself to development. The performance of the equipment in practice and the quality of service rendered to the subscribers by comparison with that given by the present standard apparatus in other exchange areas, will be watched by the Department with extreme interest.

Substantial economic advantages both in capital

costs and maintenance charges have been claimed for the system by its creators. Experience will be necessary, however, before a considered opinion can be given on this phase of the subject. Naturally the high standard attained by Strowger type automatic

exchanges will be required of the bypath equipment, and if it can exceed this standard another milestone in automatic telephony will be passed.

The Authors wish to thank Messrs. Standard Telephones & Cables, Ltd., for the photographs.

Trunk Exchange Test Racks: New Design

G. BROWN, A.M.I.E.E.

TEST Desks in Telephone Exchanges for many years back have been constructed to follow the well-known lines of a low-built manual switchboard. About three years ago, some improvement in design was effected by widening the internal cabling space and reducing the number of drawers to one per section, as these had become more or less superfluous items of furniture due to changes in record keeping practice. At the same time the filing section was superseded by a narrow miscellaneous section. These modifications were applied only to desks for local exchanges.

In 1930, Engineering Officers, handling the preliminary arrangements connected with the expansion of London Trunk Exchange equipment, drew attention to the need for a different form of Test Desk which would accommodate a greater amount of testing equipment than usual, and would require minimum floor space to stand on. Advantage was taken of the general re-design of exchange apparatus racks then proceeding and by using angle uprights of standard dimensions, a Test Rack 10' 6" high, each bay having capacity for three panels of jacks, lamps, keys, etc., was constructed and installed by the Post Office on the ground floor of the Trunk Exchange at G.P.O. South. It was decided to standardize this type of Test Rack for use in Trunk Exchanges.

Leeds Trunk Exchange was one of the first Provincial cases suitable for the new design and an illustration of the Test Rack recently installed there by Messrs. Siemens Bros., Ltd., is shown in Fig. 1. It follows the general lines of the London Trunk Test Rack.

Some idea of the standard framework assembly may be obtained from the two views shown in Fig. 2. The writing ledge, which is fitted a little over three feet from the floor level, is provided with a removable plate glass top, to be used for displaying instructions and data. A plug rail drilled for 10 testing cords is fitted behind the writing ledge. The ledge is not hinged. The face equipment panels, which extend to a height of three feet above the level of the writing ledge, have stile bars spaced to suit No. 10 type jacks. Positions are reserved in the panels for the voltmeter, test keys, fault card and

docket distributors. Otherwise, the arrangement of the panel equipment may be varied to suit local requirements. A typical test key panel arrangement is illustrated in Fig. 3.

Fitted immediately above the Panel equipment is a sloping fibre-covered canopy drilled for 20 pairs of "patching" cords. This arrangement makes the cords accessible in a convenient position when required for making up temporary alternative routes for interrupted trunk lines. The remainder of the space above the canopy will be utilized for mounting the relays, condensers and resistance spools, for the various testing circuits, and for cable connexion

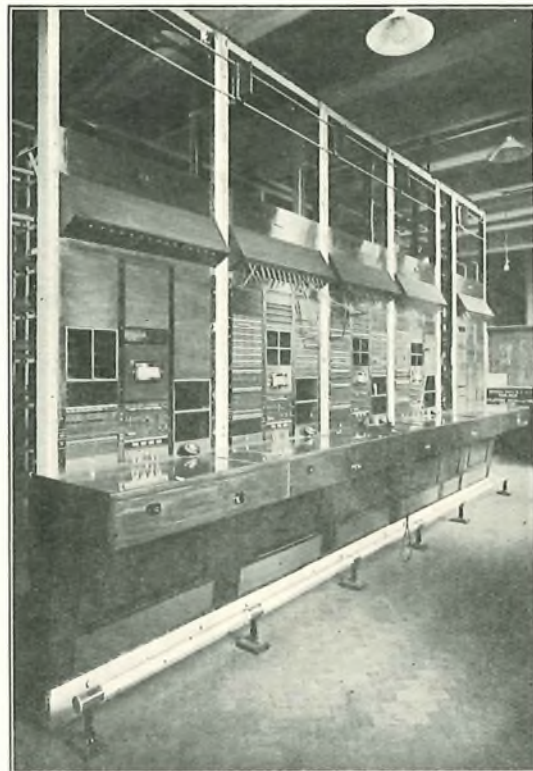

FIG. 1.—TEST RACK AT LEEDS TRUNK EXCHANGE.

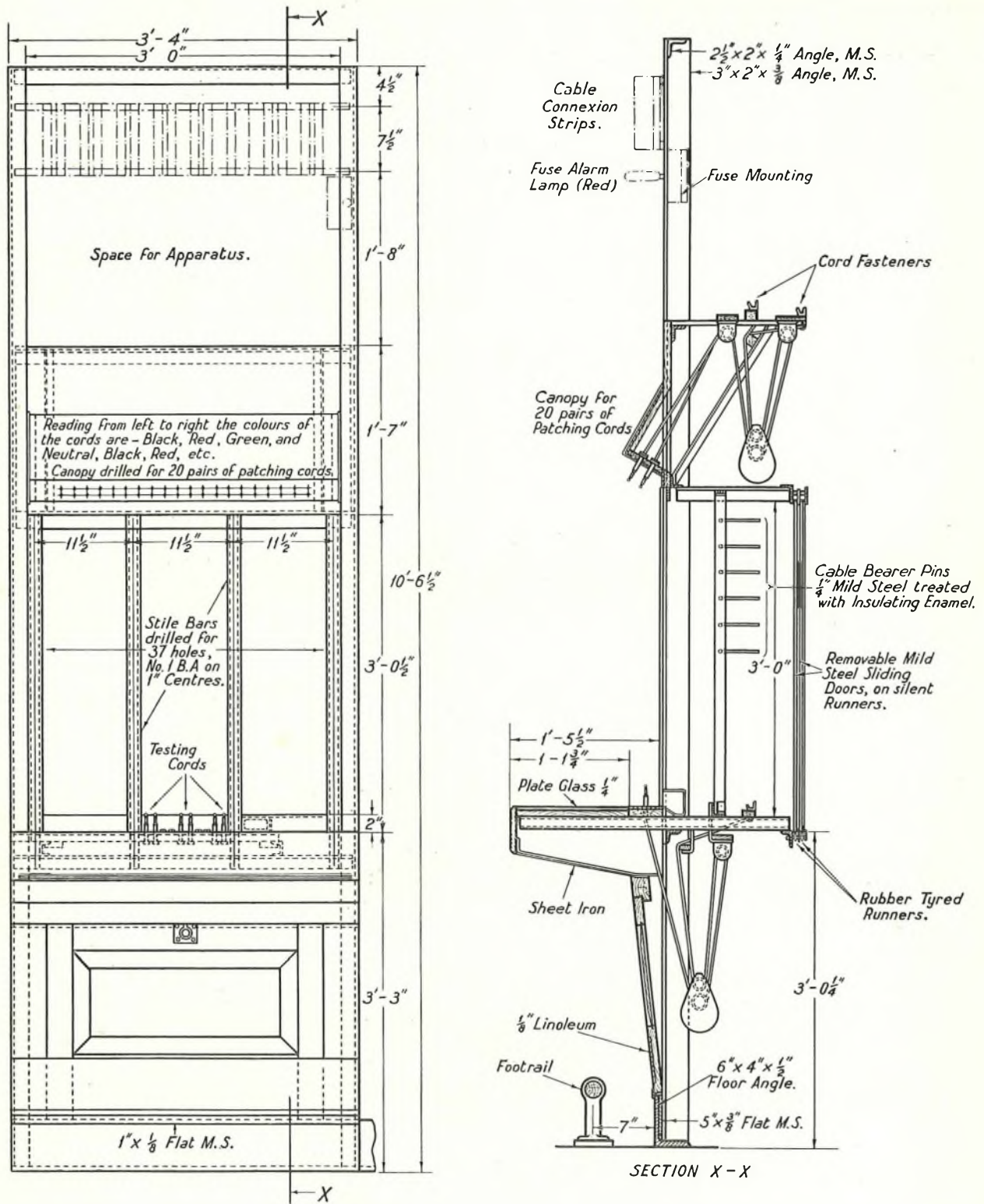

FIG. 2.—ELEVATION AND SECTION OF TEST RACK.

TL	TE	R	E	V	N	SN	F	L		U	
O	O	O	O	O	O	O	O	O		O	
TEST	TEST	LINE	EARTH	VOLT	TR. COIL	SEND	WATER	REVERSE			
LINE	EXCH	REV	METER	NEG.	REG.	REY	SCALE				
C	CD	X	K	D	CS					M	
O	O	O	O	O	O					O	
BATT	BATT	BATT	BATT	BATT	BATT						
DIAL	DIAL	DIAL	DIAL	DIAL	DIAL						
DIR	DIR	DIR	DIR	DIR	DIR						
SA	RB					EA	EA	SB			
O	O					O	O	O		O	
SEND	REC.					INT	INT	TR. COIL		RESPT	
BATT	BATT					TR. COIL	TR. COIL	TR. COIL		SCALE	
A	B					INT	INT	INT			
LINE	EXCH					INT	EARTH	TR. COIL			
CO	CO					CO	CO	CO			

TEST KEYS

DESIGNATION STRIP

FIG. 3.—TYPICAL TEST KEY PANEL.

strips, thus providing an ideal combined "S.A.R." and wiring terminal panel in the closest possible association with the Test Rack.

So far as the rear of the Rack is concerned the upper and lower portions will be uncovered, but the middle portion will be protected by sliding steel doors travelling on rubber-tired runners. This "silent runner" arrangement for the rear doors has been adapted from a design put forward by the General Electric Company in connexion with Switchboards for recent contracts.

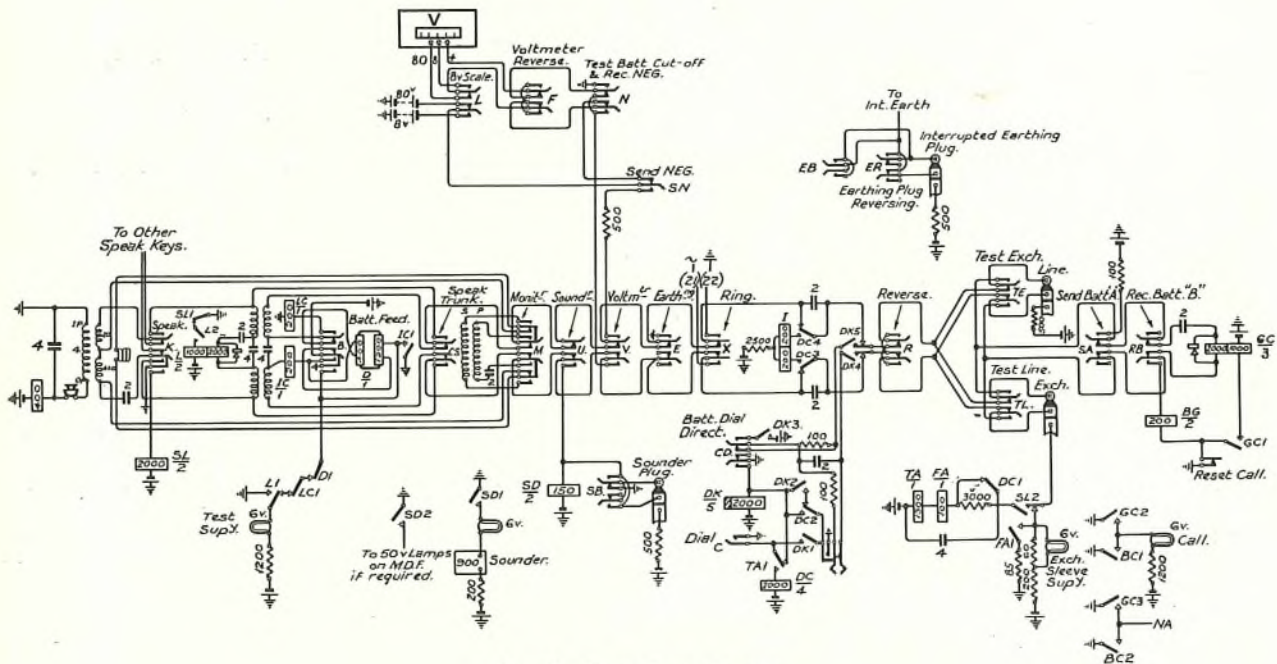

FIG. 4.—TEST CORD CIRCUIT.

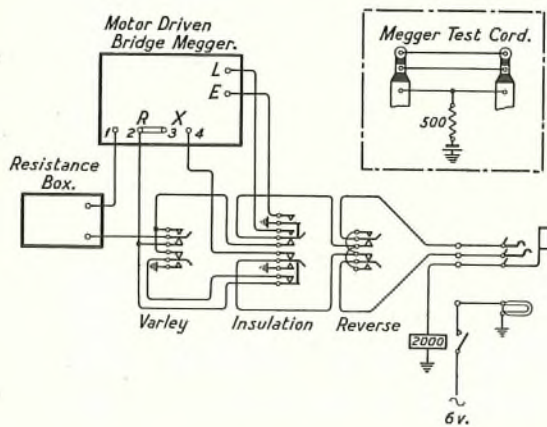

FIG. 5.—CIRCUIT OF BRIDGE MEGGER.

Fig. 4 shows the Test Cord circuit for use with the Trunk Test Rack. The outstanding features of the circuit, in comparison with earlier test circuits are:—

- (1) Provision has been made for testing sleeve control circuit conditions over a test extension line to the manual switchboard.
- (2) Either generator or battery signals may be received from one side of a line while the other side is under test.
- (3) A high impedance monitoring circuit is provided in place of the old transmitter cut-out circuit.

The voltmeter is mounted in the centre panel of each Test Rack (see Fig. 1). It is a D.C. moving coil, horizontal edgewise flush pattern type of instru-

ment, with a $4\frac{1}{2}$ " scale and double range reading 0—8 and 0—80.

The Megger panel is designed to line up with the regular Test Racks. Its equipment consists of a motor starting resistance and test keys in the panel with a motor-driven bridge megger fitted under the writing ledge; see Fig. 5 for the circuit arrangement.

A novel feature of the megger panel is the sliding shutter designed by Mr. L. P. Wilson which is so arranged that the testing keys, once set, cannot be changed without stopping the motor-driven megger. This allows time for lines which have been charged during test to become discharged through the coils of the instrument before the testing end of the line can be disconnected. The sliding shutter is illustrated in Fig. 6.

Consideration is now being given to the possibility of using a Test Rack of similar design in large local exchanges.

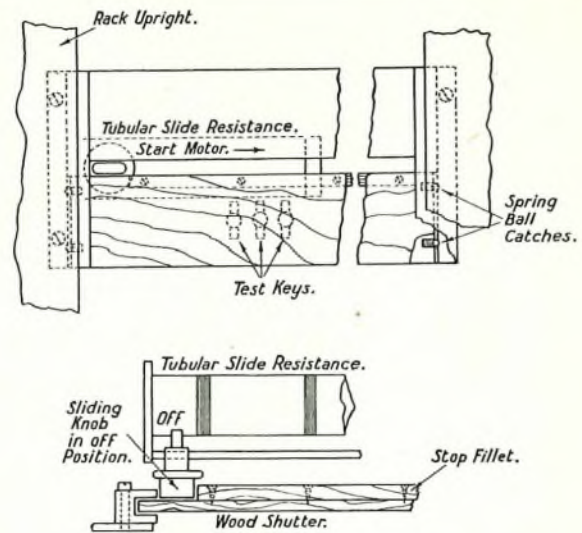

FIG. 6.—DETAIL OF SLIDING SHUTTER ON THE MEGGER PANEL.

The Christmas Day Broadcast

THE most remarkable and inspiring broadcast that has ever been given either by the B.B.C. or any other broadcasting authority was that which took place between 2 p.m. and 3 p.m. last Christmas Day, when greetings were exchanged between officials of the B.B.C. and colleagues all over the British Empire.

This broadcast was rendered possible by the use of Post Office plant and circuits, and a short description of the arrangements may be of interest.

As most of the programme was carried over the Post Office commercial radio telephony channels the time of the broadcast had to be chosen to coincide with the period when all the required channels were available. The choice was a difficult one to make as the best times for transmission on one channel were often unsuitable for other channels. After careful consideration the Post Office engineers recommended the time 2 p.m. to 3 p.m. and the results justified this selection.

The broadcast opened with the chimes of "Big Ben" at 2 p.m., and the officials of the B.B.C. then called up Edinburgh and exchanged greetings. Calls to Belfast and Dublin followed. Those three calls were handled by the ordinary trunk telephone lines. The next call was to the S.S. Majestic at sea in the North Atlantic which was carried by the Post Office ship-shore radio-telephone service through Rugby and Baldock. Then proceeding westward, the direct Canadian radio-telephone service was brought into use and calls exchanged between London and Halifax, Nova Scotia; Montreal; Toronto, including a

switch over to a microphone which transmitted the noise of the Falls of Niagara; Winnipeg and Vancouver.

The Anglo-Australian radio-telephone service was then enlisted and greetings were heard from Wellington, New Zealand; Sydney, Melbourne and Brisbane. The Anglo South African circuit was next brought into use and greetings exchanged with Cape Town. The telephone tour round the Empire closed with a call on the ship-shore radio-telephone channel to the S.S. Empress of Britain lying in harbour at Port Said.

The programme finally concluded with a speech by His Majesty King George V, from Sandringham addressed to his subjects throughout the Empire.

The scope of the programme is indicated on the map reproduced in Fig. 1.

The whole of the proceedings were handled through the Radio Telephony Terminal at the London Trunk Exchange. In order to simplify arrangements, the conversations over the radio channels were handled on four-wire circuits, the normal technical operators positions being included, but the voice-operated switching devices being cut out.

In order to give unified control to these services, all connexions between the B.B.C. Studio, Rugby and Baldock were passed through a set of demonstration equipment specially provided for work of this character. This equipment is shown in Fig. 2 whilst the arrangement of circuits is indicated on Fig. 3. The operator on the left was in charge of the order

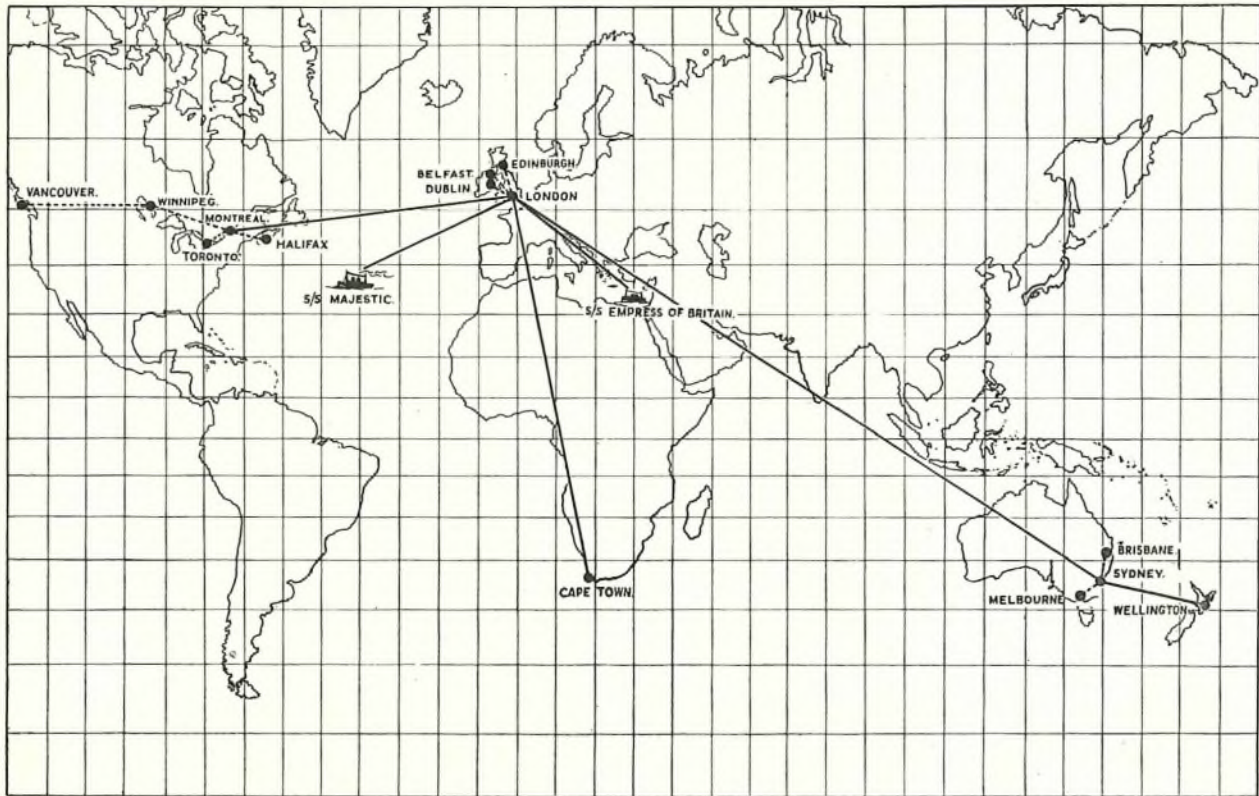

FIG. 1.—SCOPE OF THE CHRISTMAS DAY BROADCAST.

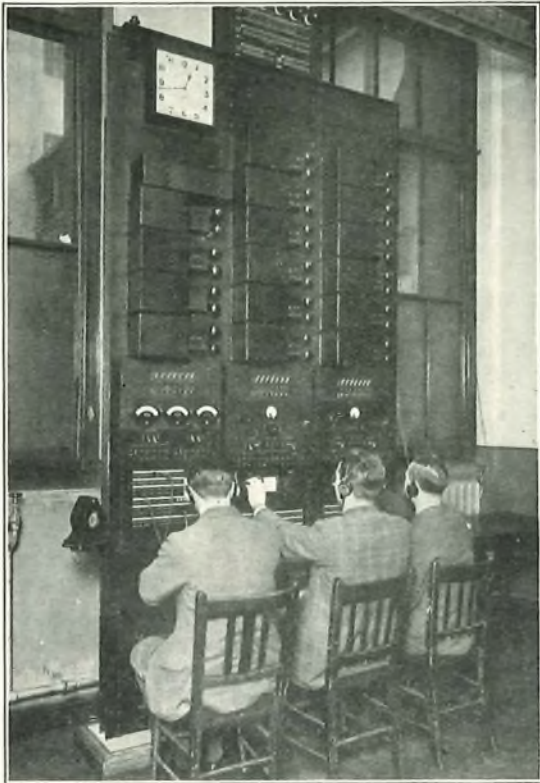

FIG. 2.—DEMONSTRATION EQUIPMENT.

wires or control lines to the B.B.C., Rugby and Baldock, so that he was in immediate touch with all points concerned. The operator in the centre was in control of the transmitting channels to Rugby, whilst the operator on the right was in control of the receiving channels from Baldock.

The switching operations were somewhat complicated because, in addition to bringing in promptly one circuit after another to preserve continuity in the proceedings, arrangements had to be made for the whole of the programme to be transmitted to Australasia and Canada for re-broadcasting in those dominions. This entailed rapid change from two-way to one-way condition and equally rapid return. The times of the various items in the programme were definitely fixed beforehand in consultation and agreement with the B.B.C. and these times were strictly adhered to. As a result, the switching was accomplished without the slightest hitch.

The whole of the proceedings were broadcast by the B.B.C. not only from the British Regional Station and from Daventry 5XX but also from the new Empire Short Wave Station at Daventry. This gave facilities for direct reception in India.

The whole programme was a wonderful demonstration of the advance of modern communication resources, of the closer linkage which radio telephony has provided between the Mother Country and the Dominions, and of the paramount position of London as the World's Telephone Centre. Even those among us whose daily duty it is to talk to the

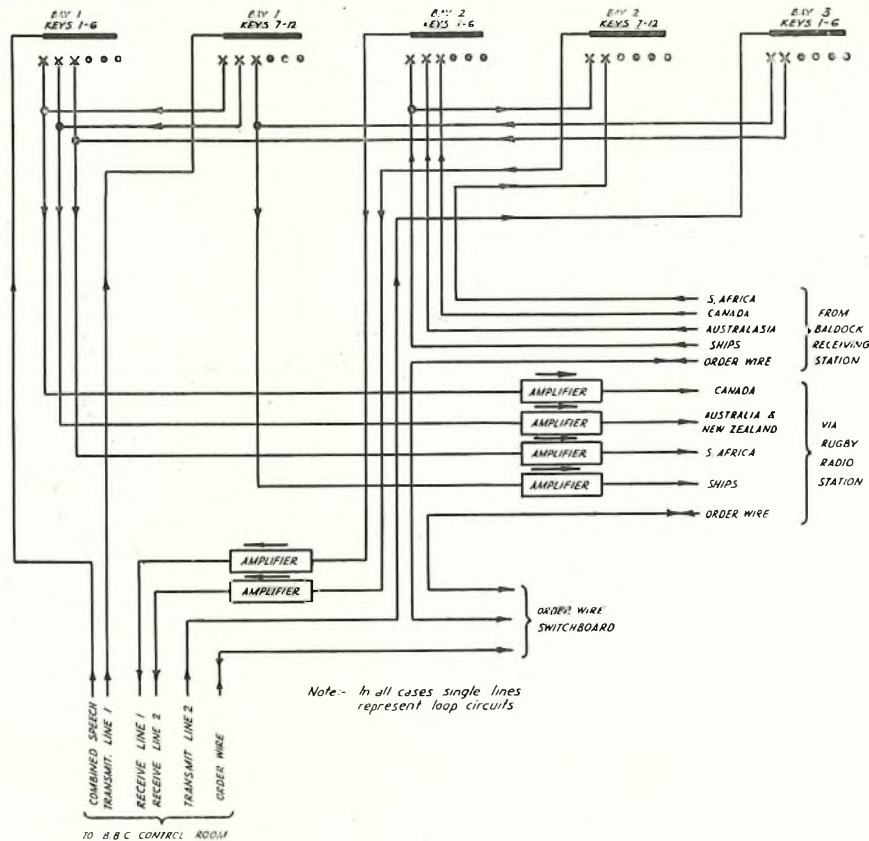

FIG. 3.—ARRANGEMENT OF CIRCUITS ON DEMONSTRATION EQUIPMENT.

utmost parts of the earth and who are apt in consequence to take such miracles somewhat as a matter of course, could not fail to be impressed and

thrilled by the proceedings and to feel proud to have played some part in the developments which made possible their accomplishment. A.J.G.

Automatic Gain Control of Radio Receivers

I. J. COHEN, B.Sc., A.C.G.I.

EVERYONE who possesses a high-gain selective receiver and has listened to distant radio transmitting stations, must have heard the tiresome effect, in which the signals wax and wane in strength, due to "fading." The present theoretical explanation is that the electromagnetic waves arrive at the receiving antenna in several directions, some waves following the ground contours and some being reflected down from ionized layers in the upper atmosphere. These waves interact, sometimes adding together and at other times subtracting, thus producing the variations in strength. The effects of fading are usually much more marked on the short wave-lengths (*i.e.*, 14 to 50 metres), being more rapid and deep than the fades on the broadcast waveband. For these short wave-lengths, the ground waves are soon attenuated

with distance and the interference is caused by the several reflected rays. The commercial radio telephonic channels operated by the Post Office utilize these short wave-lengths and it was realized from the beginning that means would have to be devised to overcome, to as large an extent as possible, the effects due to normal fading. It may be mentioned that "fading" causes several effects, the more usual one being that in which the whole band of received frequencies changes in strength. Another effect, known as "selective fading," is sometimes experienced; when this is occurring, the different frequencies within the received band change in relative strength and the quality of reception is usually completely spoiled. No means have yet been devised for correcting this type of fading.

Most commercial short-wave receivers are now

fitted with means for automatic amplification control which cause the gains of the receivers to adjust themselves to the strength of the incoming carriers so that the output remains sensibly constant in spite of fading.

The method of obtaining this control can be seen from Fig. 1, which shows the essential parts of the circuit, whilst Fig. 2 is a block diagram of the com-

tion. Without such a control the receiver would be hopelessly overloaded.

The time period of the automatic gain control circuit is important because if it is made too quick (say, less than one thirtieth of a second) it will respond to the lower audio frequencies and modulate the incoming signals, whilst if it is too slow it will not follow rapid changes in the incoming signal

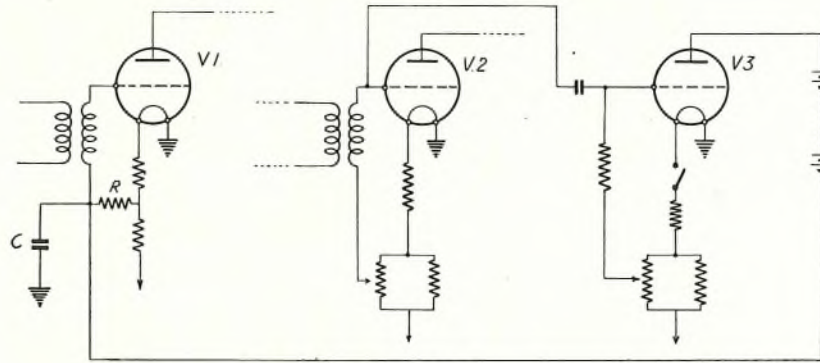

FIG. 1.—AUTOMATIC GAIN CONTROL.

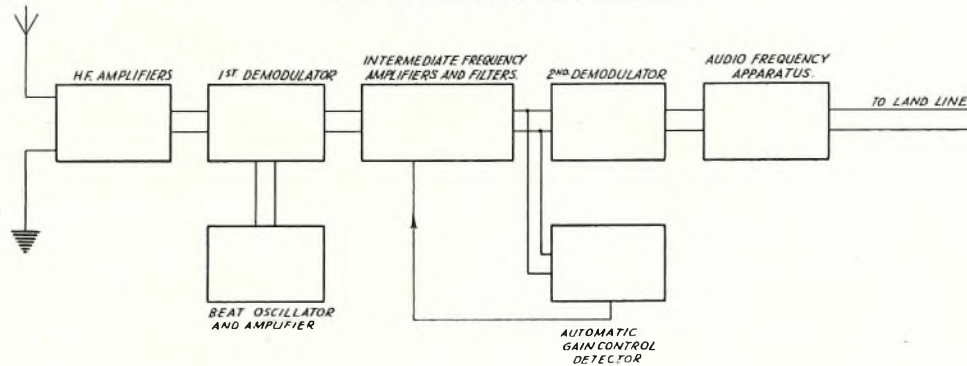

FIG. 2.—BLOCK DIAGRAM OF RECEIVER.

plete receiver—given in order that the position of the Automatic Gain Control in the overall arrangement can be visualized.

Referring to Fig. 1, V₂ is the normal second detector and V₃ is a separate detector; these two valves are connected with their grids paralleled. The valve V₃ has a high resistance R and a separate high-tension dry battery in its anode circuit. The voltage drop across this resistance varies with the strength of the incoming carrier and is applied as a negative grid bias to the first valve, V₁, of the main intermediate frequency amplifier. Thus, as the signal increases, the gain of the amplifier decreases because of the lowering of the mutual conductance of the amplifying valve resultant on the increase in negative grid bias.

The effect of the automatic control on the output of the receiver is shown in Fig. 3. For a variation of from 0 to +50 db. (above an arbitrary datum level) corresponding to an increase of 100,000 times in the power of the received signal the output only varies by about 5 db., representing an increase in power of three times, when the control is in opera-

tion. The value chosen for the time period usually lies between 1/20th and 1 second, and is determined by the product of the resistance R and

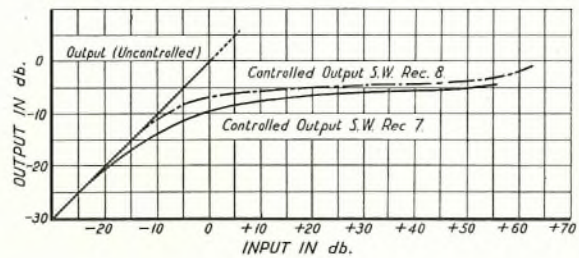

FIG. 3.—EFFECT OF AUTOMATIC CONTROL ON RECEIVER OUTPUT.

condenser C in Fig. 1. A modification is sometimes made to the circuit in order further to reduce the modulation effects. A high resistance is added in series with the condenser C, whilst the central tapping is taken from the upper side of this condenser.

Music Transmission over Short Wave Commercial Radio Telephone Circuits

A. J. A. GRACIE, B.Sc.

THE operation of a commercial long-distance radio-telephony service on short wave-lengths differs, in some respects, from the more familiar form of radio communication known as broadcasting. In both cases the object of the transmitting equipment is to create at the receiving point, an electro-magnetic field which will induce in the receiving aerial a voltage of such magnitude that full acoustic output can be obtained from the receiver. But whereas, in broadcasting, this voltage is usually of the order of a few millivolts, in the commercial circuit—due to the longer ranges spanned—it may not be possible at certain times, without exorbitant expense, to create a voltage exceeding a few microvolts. As such, the voltage produced by the transmitted signal is comparable in strength with the voltage induced in the receiving aerial by atmospherics and other local electrical disturbances; and it is the ratio of these two quantities—what is termed the signal-noise ratio—which determines whether or not communication is possible.

Endeavours are made, by the use of directional antennæ, to increase the strength of the received signal by concentrating the majority of the radiated energy in the direction of the receiving station; and to increase the received signal-noise ratio by limiting reception as far as possible to one direction—that of the incoming signal—and thus cutting out any "noise" which may arrive at the receiving point from other angles. By these methods an improvement in received signal-noise ratio of some 40 decibels may at times be obtained over that which would result if non-directional aerials were used at the transmitting and receiving points. Even so, the signal-noise ratio, at certain times of the day, may be still too low to secure reliable communication.

Since the commercial circuit is primarily a particular link in the general telephone network, the main function is the transmission of intelligible speech. It is well known that transmission of a wide frequency spectrum is not necessary, in such a case, to convey a high order of intelligibility—a frequency band from 300-2400 cycles is sufficient and a band from 200-3000 cycles is ample. Further, it is not necessary to pass the peak values of speech—which only occur a few times per minute at full volume. These two facts have resulted in two further measures which are taken to improve the received signal-noise ratio (*a*) filters are incorporated in the receiver to cut out all audio-frequencies below 200 and above 3000 cycles—thus reducing considerably the total noise content in the output from the receiver since atmospherics result in the generation of frequencies spread more or less uniformly over the whole audio-frequency band—and (*b*) the average

level of the transmitted speech is raised so that definite overloading of the transmitter is permitted to occur during peak values.

At certain hours of the day, the field strength at the receiving point may reach a comparatively high level, and the question of transmitting high quality speech and music over the circuits during such periods—suitable for re-broadcasting in the distant country—has recently received attention. For such transmissions to result in natural reproduction through a modern receiving set of good quality, equipped with moving coil loud speaker, it was estimated that frequencies from 50 cycles to 5000 cycles would have to be uniformly transmitted; and it was evident that the question of amplitude distortion—particularly with the higher ratio of peak to mean audio-frequency voltages resulting from music and the use of a high quality microphone—would have to be investigated much more carefully than hitherto.

The first step was to improve one of the land-line circuits between the London Radio Terminal and Rugby. This circuit while giving a very even response over the frequency range used in commercial speech, cut off rapidly below 100 cycles. This low frequency cut-off was due to the transformer-coupled repeaters at London, Fenny Stratford and Rugby, and further, these repeaters were subject to considerable overloading on the peaks of high quality speech and music when normal output level was given at Rugby. The repeaters were therefore replaced, a resistance-coupled amplifier being substituted at London; a resistance-coupled repeater of the type specially developed for use in B.B.C. lines being inserted¹ at Fenny Stratford; and at Rugby a special amplifier capable of giving an undistorted output of 1 watt and working into an output circuit impedance of 30 ohms was installed. So that any number of transmitters up to six—with 600-ohm input impedances—could be operated satisfactorily in parallel if desired. In this latter amplifier, an equalizing circuit was fitted to give a rising characteristic at the higher frequencies in order to compensate for the falling characteristic of the Fenny Stratford-Rugby section of the line. When these alterations had been made, the frequency response of the overall circuit from London to Rugby was found to be uniform within ± 1 db. from 50-5200 cycles. Further, the peak loading of the system was approximately 5 db. greater than previously.

Attention was then directed to the radio trans-

¹ See A. C. Timmis and C. A. Beer. "Underground Circuits for the Transmission of Broadcast Programmes." *P.O. E.E. Journal*, Jan., 1931.

mitting equipments at Rugby. These equipments are of the usual modulated carrier wave type, and were designed to deliver to the aerial circuits, under carrier wave conditions, a power of 8-10 kW at frequencies ranging from 5 to 20 megacycles per second; and the design catered for the modulation of the carrier wave to a depth of 90% when audio-frequency tone, at a level of 10 db. below one milliwatt, was applied to the input circuits of the transmitter. The transmitters had therefore to be capable of giving a peak high-frequency output of 29-36 kW and an audio-frequency gain as represented by the ratio of sideband power to low frequency input of approximately 75 db.² In order to meet these conditions most readily, the audio-frequency modulation is introduced into the high-frequency circuits at a comparatively low power level—about 150 watts—and the modulated wave is subsequently stepped up by three stages of radio-frequency amplification, the last of which employs four water-cooled valves each capable of handling 15 kW of high-frequency power. From earlier remarks it will be apparent that when the initial design and testing of the transmitters was carried out there was no real need to pay much attention to the transmission of frequencies below about 200 cycles or above 3000 cycles so long as frequencies within these limits were transmitted at a uniform level.

The method of investigating amplitude distortion is shown schematically in Fig. 1. It will be seen

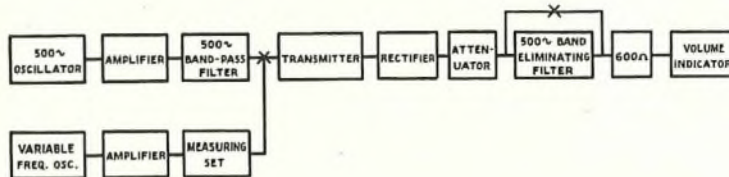

FIG. 1.—SCHEMATIC ARRANGEMENT OF DISTORTION MEASURING EQUIPMENT.

that 500-cycle tone, from which harmonics have been removed by a narrow band-pass filter, was caused to modulate the carrier wave. A special straight-line rectifier—fitted with a mercury vapour diode the anode of which was biased to just below the striking voltage—was coupled to the various stages of the transmitter in turn and the rectified output, after passing through an attenuator, was measured on a volume indicator (i) direct and (ii) after passing through a narrow band-eliminating filter which inserted a loss of approximately 40 db. at the 500-cycle frequency. It will be apparent that the ratio of the attenuation settings to give equal readings on the volume indicator under conditions (i) and (ii) represented the ratio between total low frequency output to total distortion and noise content in the

low frequency output, *i.e.*, what may be termed the "distortion ratio" of the transmitter.

In order to investigate frequency distortion, the 500-cycle oscillator and associated filter were replaced by a variable frequency oscillator the output of which could be measured by a thermo-couple and microammeter, and the band-eliminating filter was of course omitted.

When the audio-frequency part of the equipment was being investigated, the rectifier of course was not used, but part of the output from the stage under test was tapped off directly, using a potentiometer of such high resistance that the normal operation of the stage was not upset.

As regards the purely low frequency part of the equipment, the actual settings of anode and grid bias voltages were found to be nearly optimum values, and it was found comparatively simple to obtain a distortion ratio greater than 30 db. under conditions of maximum loading required, except where the anode circuit impedance was formed by an iron-cored choke. In one such case, due to the iron section being too small, an improvement in distortion ratio of 7 db. was effected by replacing the choke by a resistance. As regards frequency distortion, it was found that one type of step-up transformer used, carrying direct current through the primary winding, gave a loss of 4-6 db. at 50 cycles compared with the mid-band frequencies and this was transferred to the grid circuit of the succeeding stage and "parallel-fed" by the usual resistance-capacity arrangement. Some condensers, fitted across portions of the low frequency circuits to by-pass high frequency currents were also reduced in size in order to improve the response at the higher end of the audio-frequency scale.

The intermediate high frequency stages, amplifying the modulated wave were found to introduce very little increase in distortion under proper running conditions, *i.e.*, with input and output impedances correctly adjusted and the correct level of high frequency excitation applied under carrier conditions. This was anticipated as the initial design catered for a comparatively small gain and large margin against overloading in these stages.

In the case of the final high-power amplifying stages, the question of amplitude distortion depended of course on the peak high frequency power output obtainable, and this varied somewhat, even with the same transmitter, with the wave-length and the load presented by the aerial transmission lines. The usual method employed therefore was to take overall load curves, plotting input level against rectified output and to secure a compromise between carrier level, depth of modulation and distortion. Results varied somewhat with the various transmitters, but it was possible to obtain a carrier output of 8 kW modulated to a depth of 90% with a distortion ratio of 26 db. This last figure, representing a total

² Total sideband power = $\text{Carrier power} \times \frac{(\text{Depth of Modulation})^2}{2}$

harmonic distortion of 5%, was considered satisfactory since it was 6 db. better than the condition of maximum distortion permitted by the C.C.I.F. As regards frequency distortion, the main trouble was found to occur at low frequencies due to change of anode current at the audio-frequency setting up a voltage across the H.T. smoothing filter, and thus setting up anode modulation—out of phase with the modulation applied to the grids—by the superimposing of this voltage on the steady A.C. supply. This trouble would also produce amplitude distortion if two low-frequency tones, differing by only a small amount, were transmitted simultaneously, but it was found that the effects could be reduced to small proportions provided the output condenser of the smoothing filter had a capacitance of at least 10 μ F and provided earlier stages which derived their anode supply from the same source, were carefully decoupled.

When the modifications had been completed, local reception tests carried out at Rugby on high quality speech and music sent from London at an average level 5 db. below the normal level on commercial speech showed that the reproduction from a good quality loud speaker was quite pleasing and only a very keen musical ear would appreciate distortion due to overloading or the absence of frequencies above about 5500 cycles. In this latter connexion it is to be noted that the limitation in the upper register at present is only due to the actual land line itself. Arrangements have been made to have the use at times of a specially loaded screened circuit in the London-Birmingham cable and, when these arrangements are completed and a modified equalizing circuit fitted in the line amplifier at Rugby, it is anticipated that the overall circuit from London to Rugby will have a frequency response which is flat up to 8,000 cycles. No great difficulty is foreseen in obtaining a similar response from the transmitters.

To allow reciprocal transmissions to take place in the inward direction, the receiving equipments at Baldock were overhauled in a similar manner to that

used in connexion with the transmitters. The low frequency filters were of course patched out of circuit and special equalizing circuits were fitted to increase the low frequency response below 200 cycles and above 3000 cycles. It was also necessary to increase the time constant of the automatic gain control from the order of 1/20 second to about 1/2 second to prevent variation of the receiver gain under the action of incoming low-frequency signals. When this had been done, it was possible to obtain a sensibly uniform output from 50 cycles to 5000 cycles. It will be appreciated, from earlier remarks, that this response is only provided by patching in or out special equipment when a high-quality transmission is contemplated and revision is made to the restricted band width for normal traffic operation.

The land-line circuit from Baldock to London was modified in the same manner as the London-Rugby circuit.

The overall frequency response curves are shown in Fig. 2 and tests carried out with the modified circuits have shown that when the received field strength is high and fading is slight, the transmission of music of sufficiently good quality to permit

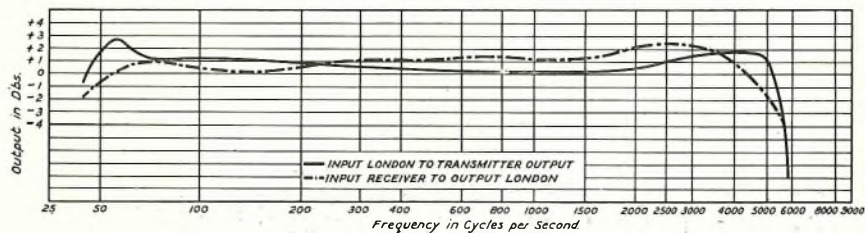

FIG. 2.—OVERALL FREQUENCY RESPONSE CURVES.

re-broadcasting in the distant country is feasible. It is doubtful, however, whether circuit conditions will frequently permit the extension of the band width above the present upper limit of about 5000 cycles in view of the small energy carried in frequencies above this value and the considerable decrease in the received signal-noise ratio which will result from the still greater increase in the receiver band-width.

Research

IN the following, brief notes are given on some of the recent activities of the Research Section which will probably be of general interest to readers of the Journal.

TELEPHONE APPARATUS TRANSMISSION.

Effective transmission. As already mentioned in the January issue, tests are now in progress at the Denman Street, L.E.D., P.B.X., where the number of repetitions required in a given conversation time is being observed under a variety of line and instrument conditions.

In order to speed up the work and obtain additional data, similar observations have been started under controlled conditions at Dollis Hill, but making use of deliberately arranged conversations between members of the staff selected at random.

Although the test has not been in progress long the indications are that valuable information as to the various factors causing impairment of a telephone conversation will be obtained.

Local Transmission Testing. The recently developed transmission measuring sets have been employed to make tests at 300, 800 and 2000 p.p.s. over a large number of junctions between various exchanges in the London area. It has been found that in all the cases tested the attenuation between exchanges is reasonably small.

Conference Systems and Loud Speakers for use on Subscribers' Lines. Owing to the acoustic coupling between a loud speaker and the transmitter when used on a subscriber's lines, singing is likely to occur. Three methods of overcoming this may be adopted. (a) The transmitter may be relatively insensitive, necessitating that it be spoken close to. (b) The transmitter may be spoken to at a distance, but the length of line over which it is possible to work must then be limited. (c) Voice operated switching may be used.

Sets working on all three principles have been developed and the two former are available for use. A set using the third system has now been tried out. Calls have been made over all types of lines throughout London and over trunk circuits. The apparatus uses new methods of voice operated switching employing thyratrons and metal rectifiers. A small cheap moving coil microphone is employed, giving good quality and a silent background.

SIGNALLING EQUIPMENT.

Two Frequency System of V.F. Signalling for On-Demand Trunk Working.

Manual to Manual. Contractors have now submitted samples of equipment for a one way trunk circuit. This apparatus is now under test in the laboratory and preparations for field trials are in hand.

Bothway Working. Laboratory tests on a both-way manual to manual circuit are proceeding. This circuit provides for full automatic signalling as in the one-way circuits.

Dialling-in. Improved circuits for dialling-in have been devised and are being tried out, in addition

to the facilities provided in the circuit demonstrated in November last. The called subscriber answer signal is given to the operator by a pulse of tone sent back over the line. The V.F. set at the incoming end contains a polarized relay in the anode circuit of a valve, and this relay is sufficiently fast operating in its response to A.C. impulses from the line that the impulse correcting device previously used may be dispensed with.

Standardization of Power Relays, to operate in series with the magneto bell in a subscriber's instrument when a calling signal is required in special circumstances, e.g., light a lamp from the supply mains. These relays have not hitherto been supplied by the Department, but only approved types have been permitted.

It is now proposed to standardize a locking and non-locking type of relay for this purpose. Samples from several contractors have been examined for performance and none have fulfilled all the desirable requirements.

An attachment to a type 3000 relay is being made. This when used in conjunction with a rectifier No. 12A will, it is hoped, provide a suitable power relay for all requirements.

TELEGRAPHS.

Use of Mercury Vapour Discharge Tube (Thyratron Principle) as a Telegraph Relay. A tube is now manufactured capable of "triggering" both "on" and "off" under the control of grid potential only subject to the condition that the discharge current does not exceed about 50 milliamperes. Experiments have been carried out using an input transformer with two secondaries connected to the grids of two gas discharge relays in "push-pull," giving conditions similar to double current operation.

Such an arrangement working as a terminal repeater and using a D.C. anode voltage of 50, gives good teleprinter operation with a line of 86000 ohms microfarads in front and a sending voltage of ± 40 . As an intermediate repeater, it supplies to line signals similar to double current and of form equal to that delivered by a non-vibrating mechanical relay having batteries connected to the fixed contacts.

INTERFERENCE.

Disturbance to Telephone Service in the Cambridge area caused by Magnetic Storms. From October, 1926, onwards frequent interruptions due to false calling signals on telephone junction circuits were reported from the Cambridge area. After enquiries the interruptions were traced to abnormal earth currents, and an Advance Report was issued in June, 1930, correlating them with disturbances recorded at the Magnetic Observatories at Eskdalemuir and Abinger. Since that date continuous voltage records have been taken for a year on three earthed circuits terminating respectively at Cambridge, Aberdeen and Penzance. These records show that during a "magnetic storm" potential differences of roughly the same order exist simultaneously in all parts of Great Britain. Local circuit conditions were partly

responsible for the sensitivity of the circuits at Cambridge to disturbance.

Induction from the Carlisle-Lancaster 132 KV. "Grid" Transmission Line. The 132 KV. overhead transmission line between Carlisle and Lancaster forms part of the British "grid" system. This line parallels Post Office main overhead and underground trunk routes throughout its length; and calculations indicated that very high voltages would be induced on the telegraph and telephone lines in the event of an earth fault on this section of the grid, the severity of the conditions being increased by the very high earth resistivity on Shap Fells.

A further series of tests has been carried out jointly by the Department and the Electrical Research Association, in which earth faults were put on the grid line experimentally, and the induced voltage on the Department's circuits and on special test lines actually measured. The results are given in a Final Report which has just been issued. Under the worst fault conditions the induction in the overhead trunk routes amounted to 2.45 volts per ampere of fault current. The Report referred to, with others issued during 1931 and 1932, completes an experimental study of inductive interference from earth currents.

MISCELLANEOUS PHYSICAL AND CHEMICAL INVESTIGATIONS.

An Electrical Method for Measuring the degree of Seasoning of wooden pole arms. Experiments have been carried out to investigate the possibility of devising a method for the rapid determination of the degree of seasoning of wooden pole arms without destroying the arms. It has been found that the seasoning of the usual type of oak arm used by the Department can be determined by means of a suitable D.C. resistance measurement. Measurements of A.C. resistance and specific inductive capacity had no advantage over the D.C. resistance method.

Protection. A new type of spark gap for the protection of Post Office lines used in conjunction with E.H.T. power systems has been tested and shows a distinct improvement over previous types examined.

Devices for detecting the presence of inflammable gas in manholes. Several devices have been examined, some depending upon the increase in temperature of an electrically heated wire and others on the effect on a safety lamp flame. In the latter class a device in which the heat due to the increase in flame size acting on a bimetallic strip makes an electrical circuit and lights an alarm lamp is very promising. A simple detector for coal gas has been designed in the Research Section in which the darkening of Palladium chloride by the carbon monoxide which is a constituent of coal gas, is utilized. The device is of pocket form on the lines of a photographic exposure meter and the test is conveniently made by placing a drop of the solution on a small exposed spot of filter paper and observing the degree of blackening. Less than 1% of coal gas can be readily detected.

The Cuprous Oxide Photocell. This photocell consists of a copper disc oxidized on one face. When the oxide layer is illuminated electrons are liberated and move from the oxide to the copper. An E.M.F. is thus provided which is capable of urging a current through an external circuit from the oxide to the copper. Quantitative tests of the behaviour of the cell under various conditions have been carried out and the results issued in a report in which possible applications of the cell are also discussed.

Insulation resistance, capacity, and power factor of impregnated cable forms. As considerable trouble has been experienced due to the low insulation of P.B.X. switchboard wiring in seaside areas, an investigation has been made of the merits of beeswax impregnated cable forms for use in such situations. Enamelled wire has been found to show rapid and complete recovery of insulation resistance after exposure to a damp atmosphere. In this case impregnation is justified on account of the improved power factor and lower capacity which result.

TELEPHONE LINES TRANSMISSION.

Repeaters and Echo Suppressors. Standardized types of main line repeaters and their associated equipment have been designed. A new type of echo suppressor in which copper oxide rectifiers take the place of valves is being developed and provision is being made for rendering the suppressor inoperative at the two frequencies of the new V.F. trunk signalling system. Copper oxide rectifiers are also being tried in connexion with 2-wire repeater working on unloaded circuits in order to allow of higher distortionless output levels.

Carrier Working. Equipment for six carrier channels on the Anglo-Dutch cables is now being accepted at the Contractor's works.

A new cross-channel cable, of unloaded paper-core lead-covered type, has been designed with a view to single-channel carrier working. The same system as proposed for loaded underground cables, using metal rectifier modulators, will be employed.

A multi-channel carrier system for use on unloaded land cables or G.P. submarine cables is being developed. In this connexion, a new type of balanced modulator using metal rectifiers promises to be of great use. Experiments on the effect of screens in G.P. cables, with a view to carrier working on screened quads, are in hand.

Single-channel Carrier System for "Aerial" Lines. A single-channel carrier system which is particularly compact and easily installed has been designed with a view to providing extra circuits on "aerial" lines containing only a moderate amount of underground cable. The circuits may be used permanently as high-grade trunks, or they may be provided temporarily for special purposes such as seasonal traffic at sea-side towns. The apparatus is arranged to take power from the mains and can be installed in any exchange or Post Office where mains are available. Considerable simplification compared with other single-channel carrier systems has been effected by the use of copper oxide rectifiers in place of certain valves.

Notes and Comments

Thomas Gray Memorial Prize

THE Secretary of the Royal Society of Arts, John Street, Adelphi, London, W.C.2, announces that the Thomas Gray Memorial Prizes for 1932-1933 will consist of a prize of £100 to any person who may bring to notice a valuable improvement in the Science or Practice of Navigation proposed or invented by himself during the years 1932-1933. A further prize of £100 will be given for the best essay on the following subject:—

“ Fire at sea, in port or in a builders' yard (a) in a modern passenger vessel, (b) in a modern cargo vessel. Possible causes, preventive measures, and means of detection. How to deal with fire when once started. Reasons and suggestions for changes in decorative, furnishing, lighting and ventilating schemes usually found in large and luxurious liners.”

Entries for the two prizes must be received by the Secretary of the Society at the above address not later than December 31st, 1933, from whom further details of the prizes are available.

Telephone Development Association

Mr. E. S. Byng, the Managing Director of Standard Telephones and Cables, Ltd., has been elected Chairman of the Telephone Development Association in succession to Mr. L. B. Atkinson. Mr. Byng has been an active member of its council since 1928.

Copies of Earlier Volumes of the Journal

The Board of Editors has on hand a number of copies of earlier issues of the Journal. Copies of Vols. 1, 5, 6, 7, 8, 9, 10, 11, 13, 14, 16, 17, 21, 22 (Parts 3 and 4 only), 23, 24 (Parts 2, 3, and 4 only) may be obtained, price 1/- per Part, on application to the Managing Editor.

Carrier System for Aerial Lines

It had been the intention to include in this issue a description of the simple type of all-mains single-channel carrier equipment developed in the Research Section for use on aerial lines, but pressure on the space available has prevented this. The article will, however, appear in the next issue.

Death of John J. Carty

Dr. John J. Carty, for many years connected with the Bell Telephone System in America, died on December 27th, 1932, in his seventy-first year. He had retired from active service in 1930.

Seldom is it the privilege of one man to play as important a part in the development of a field of technology as Carty played in the development of

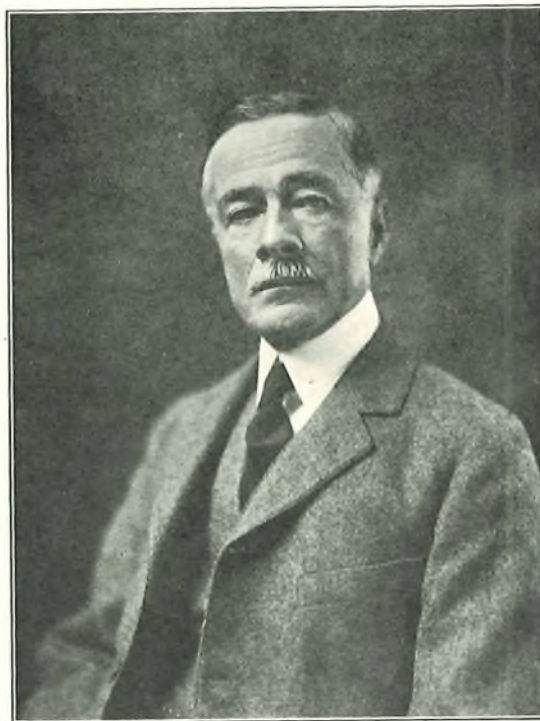

electrical communication. In fact, it may be said that he was the creator of a new profession which to-day is known as telephone engineering.

Honoured throughout the world both for his personal contributions and for the keen imagination and great foresight with which he directed the work of others, he was probably as instrumental as any one man in the creation of the present day American telephone system involving some twenty million stations and eighty million miles of wires.

He took up telephone work at the age of 18 upon leaving school, his first job being that of operator (or telephonist) as in those days boys were used for this work instead of girls. He rapidly acquired an extensive knowledge of electrical science, then in its infancy, and in the course of the next fifteen years made many fundamental contributions to telephony. Among these might be mentioned the all-metallic circuit, the common battery switchboard, the bridging bell, and the phantom circuit which permits two pairs of wires to carry three conversations simultaneously. He also introduced transposed circuits for reducing cross-talk and interference.

Carty was appointed Chief Engineer of the New York Telephone Company at a time when the problem of placing exchange wires underground was pressing for a solution, and he guided the successful development of the lead-covered paper-insulated cable. Later he became Chief Engineer of the American Telephone & Telegraph Company, and in this capacity he carried through to successful con-

clusion the building of the first transcontinental telephone lines in 1914-1915, including the adaptation of the vacuum tube amplifier to the telephone repeater.

He was also instrumental in the development of lead-covered cables for long distance telephony, the first undertaking of this kind being the Boston-Washington toll cable of large gauge wire which was placed in operation in 1913. This was followed by the New York-Chicago toll cable, the first to use small gauge wire, in 1921.

To those who worked for him, Dr. Carty will be as much remembered for his inspiring leadership as for his deep knowledge of electrical communication, and some of his work-a-day maxims will long be famous. One of these might be noted here. In his capacity as Chief Engineer he schooled his assistants to scrutinize every plan by looking for the answers to the following three searching questions, namely: "Why do this?" "Why do it now?" "Why do it this way?" No illogical or unsuitable scheme could survive this test.

Col. A. S. Angwin, D.S.O., M.C., T.D., M.I.E.E.



Photo. by Elliott & Fry.

Col. A. S. Angwin, D.S.O., M.C., T.D., M.I.E.E., was educated at the East London College, now one of the colleges of the University of London, and received his training as an engineer with Messrs. Yarrow & Co., the world-famous firm of engineers and shipbuilders.

He joined the Post Office Engineering Department in 1906 and was soon afterwards transferred to Glasgow. Here he gained a thorough experience in all branches of District work including manual

and automatic telephony and the installation of new exchanges. He also specialized particularly on underground construction which was then a new development and became a recognized authority on this subject.

On the outbreak of War in 1914, Col. Angwin, as a territorial officer, was immediately called up and shortly afterwards proceeded to Gallipoli in command of the Lowland Divisional Signal Company. He was eventually invalidated off the peninsula and after a period of convalescence in Egypt he took part in the Palestine campaign under General Allenby, where he was awarded the Distinguished Service Order and Military Cross. During the latter part of the War up to the Armistice he served on the French Front.

On the cessation of hostilities Col. Angwin was demobilized and shortly afterwards was attached to the Radio Section of the Engineer-in-Chief's Office. The section at that time was under the leadership of Mr. E. H. Shaughnessy who had been entrusted with the work of completing the Leafield and Cairo Stations of the pre-war Imperial Scheme in order to provide a radio service to the Near East. Col. Angwin, who is a chartered civil engineer, took a large part in the preparation of designs and specifications and subsequently visited Cairo in order to organize the work there. He was promoted to Executive Engineer in 1920.

Following the successful inauguration of the Leafield-Cairo Service the section was given the task of designing and constructing the high power radio station at Rugby. Col. Angwin took a large part in this work and was responsible for the erection of the 820 ft. masts and antenna system as well as for the water supply system.

In 1925, following the completion of the Rugby Station, Col. Angwin was promoted to Assistant Staff Engineer and took charge of all development and experimental work. He took a keen and stimulating interest in the development of short wave technique and its application to telegraph and telephone services and visited the United States in 1928 in connexion with this work.

In 1928 he was promoted to Staff Engineer in charge of the Radio Section. At that time the Post Office was operating a single telephone channel to the United States; in the four years that Col. Angwin has been head of the Section, the overseas radio telephone services operated by the Post Office have grown to a total of twelve services and have made London virtually the telephone centre of the world. Col. Angwin has identified himself particularly with the problem of interference with wireless reception caused by electrical plant. His paper on the subject before the I.P.O.E.E. last year was an outstanding contribution to technical information on this subject and has attracted a great deal of attention in other branches of the electrical industry in this country and abroad.

Col. Angwin attended the International Telegraph and Radio Conference at Madrid in the latter part of 1932, and as senior technical officer in the British delegation it fell to him to undertake what was perhaps one of the most onerous duties of the conference, the chairmanship of the committee on wavelength allocations.

His capable chairmanship combined with unflinching tact and geniality was sufficient to infuse a spirit

of compromise among even the most recalcitrant of the many opposing interests represented there, with the result that general agreement was reached on this very contentious subject.

Col. Angwin takes an active interest in the Institution of Civil Engineers and also in the Institution of Electrical Engineers. In 1925, in collaboration with Mr. T. Walmsley, he read a paper before the former institution on the Rugby Radio Station, while he has served for several years on the Committee of the Wireless Section of the Institute of Electrical Engineers and was elected Chairman of the Section during the 1931-32 session.

Among his many activities outside the office, he acts as examiner in Electricity and Magnetism to the City & Guilds of London Institute and still preserves a keen interest in the Territorial Force.

Following his appointment to London in 1919, he organized and commanded the 44th Home Counties Divisional Signal Company. At the present time, he is Deputy Chief Signal Officer to the Eastern Command.

Col. Angwin is very popular with his colleagues and for the last two years has been chairman of the Engineer-in-Chief's Office Sports Club. A.J.G.

Mr. A. J. Gill, B.Sc., M.I.E.E., M.I.R.E.



Photo. by Elliott & Fry.

To those misguided critics—there are still a few left—who visualize the Civil Service as a spiritual home of the weary, the career of Mr. A. J. Gill must be cited in reproachful refutation. Possessed of an unusually active mind which creates ideas in an unbroken stream, Mr. Gill has contributed in a very large measure to the high prestige enjoyed by the Post Office Radio Section. Mr. E. H. Shaughnessy, with that profound insight into human character which enabled him to gather round him a brilliant band of young men who, with wonderful enthusiasm and a rare disregard of personal convenience, threw themselves wholeheartedly into the task of the development of the Radio Section, chose better than even he in his wisdom could have anticipated, when he selected Mr. Gill to join his pioneer staff as Assistant Engineer in August, 1913. Upon the outbreak of War, Mr. Gill was given charge of the Direction Finding Stations at Peterborough and Seaham. His early training in Yarrow Shipbuilding Yard and his experience in steam turbine design in the British Thomson-Houston Works at Rugby, was just that type of experience needed for the design of the Leafield, and Cairo Arc Stations. The major portion of the specifications for the turbine, arc and associated plant was prepared by Mr. Gill at a time when comparatively little was known of high-power arc generators. In 1919, a year before the construction of the Cairo Station started, Mr. Gill was sent to make a survey of the proposed site and report on conditions. On his return he took a leading part in the construction of Leafield Radio Station. One of the difficulties encountered with the Leafield Arc

equipment was the interference with other radio services caused by the harmonics and "mush" associated with the arc circuit. Mr. Gill successfully attacked the problems of elimination of interference, and was responsible for the design and installation of the coupled circuit embodying a large oil condenser designed to withstand the application of 120,000 volts. The collaboration with Colonel Lee in this matter resulted in a joint paper read before the Institute of Electrical Engineers entitled "The Leafield Coupled Arc" for which the authors were awarded the Dudell premium.

One of the great achievements of Mr. Gill's career is his work at Rugby Radio Station. He it was who prepared the preliminary estimates and who personally designed that section relating to power requirements. With characteristic boldness he advocated the installation of three 500 k.w. D.C. generators capable of series running to give a total pressure of 18,000 volts. A feature of this installation is that the heavy iron machine foundations rest on porcelain insulators. In March, 1925, Mr. Gill was promoted to Executive Engineer and took charge of the Radio Experimental Establishment at Dollis Hill. During his tenure of office a complete reorganization was made of the establishment, and development of long wave reception equipment for

the Trans-Atlantic Circuit was undertaken. Later the many advantages of short wave working resulted in intense investigation by Mr. Gill and his colleagues into the problem of the design and construction of short wave transmitters and receivers. The world wide range of the Post Office Radio Telephone Service is evidence of their success.

Early in 1927 Mr. Gill visited U.S.A. to study American telephony and to co-operate with the American Telephone and Telegraph Company in schemes of radio development. Promotion to the rank of Assistant Staff Engineer with charge of the planning and development of experimental sections was made in December, 1929. In spite of his activities in the Department, Mr. Gill has served on many radio committees, the most noteworthy being those under the ægis of the C.C.I.R., the C.C.I., Institute of Electrical Engineers and the Department of Scientific and Industrial Research. When Colonel Angwin was promoted to Assistant Engineer-in-Chief in December, 1932, it was a foregone conclusion that Mr. Gill would succeed to the vacancy. To his colleagues and friends in the Department this promotion to the highest position in the Radio Section gives peculiar satisfaction as a fitting culmination to a long period of devotion to the interests of radio development. T.W.

District Notes

London Engineering District

On Saturday, October 29th, at 1.30 p.m., the new Colindale Automatic Exchange, which had been installed by Messrs. Ericsson, was opened for public service by the transfer of 1,053 lines. All these lines had previously worked on a hypothetical basis on Hendon Auto Exchange, and this taken in conjunction with the fact that the subscribers were already auto-trained assisted in the very satisfactory cut-over which resulted.

In addition to serving the Kingsbury, Hyde and Hendon areas, Colindale is the parent Exchange for Edgware Satellite. Until Monday, the 24th October, Edgware had worked as Satellite Exchange on Maida Vale, and the transfer to Colindale was effected at mid-day on that date. The actual transfer of junctions to and from Edgware was effected, without hitch, in two groups at 1.30 and 2 o'clock and the service was consequently not interrupted at all.

BISHOPSGATE SUB-TANDEM EXCHANGE.

An extension of the general scheme of providing junction routes through a Tandem Exchange has been introduced by the opening of Bishopsgate Sub-Tandem. Situated in the main Bishopsgate Automatic Exchange, it provides access from 20 Automatic Exchanges of Eastern London to some 53 Manual and Automatic Exchanges distributed

generally over London, except in the South. The apparatus has been installed by the Automatic Electric Co. and consists of 1,103 First Tandem Selectors with transmission bridge, 67 First Tandem Selectors without transmission bridge (for Bishopsgate Automatic Exchange only), 1,060 Second Tandem Selectors, 8 additional Coders and an additional bay of C.C.I. Repeaters.

The Exchange was first brought into service on the 27th September, and by the end of October had 661 incoming junctions and 800 outgoing junctions connected to it.

The additional load on the power plant has been met by increasing the main Bishopsgate Exchange batteries from a capacity of 8,000 ampere-hours to 10,000 ampere-hours.

G.P.O. SOUTH, TRUNK EXCHANGE.

Further progress has been made with the scheme to connect Inland Trunk and Continental calls "on demand." In addition, new power plant has been necessary as the whole of the new Trunk Equipment has been designed on a 50-volt basis.

On July 9th, "Record and Demand" positions were opened on the fourth floor. These were served by 380 incoming record lines from both Manual and Automatic Exchanges, and took the record work for all Trunk calls. Demand service was given to

Birmingham, Edinburgh and Glasgow and, in consequence, 260 new outgoing junctions were provided for call reversion purposes.

The opening of these positions freed the fifth floor record suite, so that it could be converted from 22 to 50 volt working.

On September 29th, the fifth floor suite was reopened by transferring 258 record lines from Automatic Exchanges, so that after this stage the fourth floor record positions handled all work from Manual Exchanges, and the fifth floor all work from Automatic Exchanges. The Birmingham, Edinburgh and Glasgow circuits were commoned between the two multiples and Demand Service given on these routes from both suites.

On October 29th "Demand" working was extended to Bristol, Aberdeen, Manchester and Liverpool, and Delay working on these routes was at the same time transferred from positions in the old Trunk Exchange on the third floor to the "Demand" suite on the fourth. The 36 "Delay" positions necessary were provided by opening 12 new positions and using 24 positions released from record work by the transfer from the fourth to the fifth floor of the Automatic Exchange record lines.

On November 5th the new Overseas Exchange was opened. This consists of 92 positions for handling the actual connexions, and a suite of 30 record and enquiry positions. 120 Continental circuits were transferred and access to 370 London junctions was provided. In addition, an Inland Trunk Multiple provides access to Aberdeen, Birmingham, Bristol, Cardiff, Edinburgh, Glasgow, Hull, Leeds, Liverpool, Manchester and Newcastle.

The various transfers have been made more complicated by the introduction of a new Trunk Test Box, which is gradually being brought into use for all circuits.

The new power equipment consists of two 7,800 ampere-hour batteries, 2 Charging sets with Auto Synchronous Motors, and a generator output at 1,200 amperes at 57 volts. Power and battery ringing machines have also been necessary.

In general, all Trunk calls originating in London are connected to the "Record and Demand" positions on the fourth and fifth floors. If a Continental call is required, the caller is transferred to the "Record and Enquiry" suite in the Overseas Exchange, where a docket is made out and passed on a travelling band to a distributing centre, and hence through tubes to the relative position. For a normal Inland Trunk call, the Record Operator on the fourth or fifth floor makes out a docket, and either connects the call immediately—reversing the call as a check on the number of the calling subscriber—or, if for a town not yet on the Demand Service, passes the docket *via* a distributing centre to the appropriate Delay position.

All dockets of completed calls are passed by tube to a Ticket Filing Table.

Features of the new exchange are Chargeable Time Indicators for timing all calls, Visual Idle In-

dicators on all the Trunk Multiples, a lamp signalling device for giving the delay on Continental routes and finally the length and the number of the ticket tubes employed.

The main equipment has been installed by the Standard Telephones and Cables, Ltd., the power plant by:—

Machines—Electric Construction Co., London.

Batteries—D.P. Battery Co., Derby.

Tubes—Booth of Birmingham.

Ducts—Air Ducts Ltd.

Blowers—Webster's, Purley.

INSTALLATION WORKING IN LONDON.

The system has advanced by leaps and bounds; whereas in March, 1931, 45% of the new lines were completed in six days, 91% were so completed in September, 1932.

The system to be successful needs a good organization of resources—staff, equipment, transport and plant.

The association of the fitting of the internal apparatus with the provision of the external line brought about a new type of gang, practically all skilled men, combining the duties of supervision, wiremen's work, fitting and driving. The way in which the members of the gang work individually and co-operate with each other has been a great asset.

The most suitable tools to be carried at all times had to be determined and standard stocks of stores and apparatus were decided on. These varied with the areas to be served, the type of exchange and the prevalent method of giving service. Again, the type of motor vehicle to be used was dependent upon the area to be served. Where poling is an important part of the work, the 30 cwt. Albion is a most useful vehicle.

To join up lines quickly, pairs must be available at the nearest D.P. and a continual review of the stock of spares is necessary if delay is to be avoided. A great advantage has accrued from defining the limits of a D.P. It cannot be said that spares exist at a D.P. if they only exist at some junction point where they (by opening main or branch cable joints) may be diverted to the D.P. The use of auxiliary joints for a limited number of D.Ps., about 10, and bringing all the pairs of the Distribution cables, except the unuseable pairs, back to the auxiliary joint is a great advantage for speedy and economical working. It confines all openings on subscribers' work to the auxiliary joint.

Where the auxiliary joint would come near to the exchange it is better to take the pairs for the longer period right into the exchange, as the cost of making the auxiliary joint would outweigh the additional annual charges of the difference in cable. Again, if the 10 and 15 year development figures are very close, whilst the rise from "present" to ten years is great, it is better to lay the full 15-year cable throughout at once.

The external charges per subscriber's line have

been reduced 40% in the same period, *i.e.*, March, 1931, to September, 1932. The best feature of this reduction has been the reduction of the underground shifting charges which have come down by over 50%.

There are 40 Installation Offices in London and with the exception of six brought in when the District was enlarged, they came into being as a whole on January 2, 1932.

TELEPRINTERS.

The installation of the new page printing type of teleprinter on private wire circuits is proceeding apace. Since last March, when the first machine was brought into service on a private wire, there have been provided in the London District 70 teleprinters of this type, the majority of them being on long distance private lines to Liverpool, Manchester, Birmingham, Leeds, etc. The circuits are passed through relay repeater equipments fitted on racks at the terminal centres, direct current being used for the signal impulses. In addition 40 Telex subscribers' installations, of which a full description appeared in the October issue of the Journal, have been completed in the London area. In this connexion a Printergram equipment comprising 15 teleprinter sets has been provided in the C.T.O. for the reception and transmission of telegrams from and to Telex subscribers.

A special installation of the new type of teleprinter has been equipped at Scotland Yard and at a number of Divisional stations. It is possible now for a police message to be broadcast, by means of the new instrument, to all or any of the stations from the Headquarters teleprinters. The new installation displaces the Steljes instruments and old type column printers which have been in use for many years.

An extension of the Standard Telephone & Cables, Ltd., type of voice frequency telegraph equipment has been installed in the C.T.O., affording teleprinter channels on this system to Glasgow and Belfast. There are now at the C.T.O. 30 channels working on voice frequency impulses to the Provinces.

Specially built suites of telephone cabinets are still being installed at railway stations and the larger Post Offices. During the past three months 24 suites comprising 105 cabinets made in teak or mahogany have been made and erected by the District Shops. Ornate suites of cabinets in English oak have also been built for the House of Commons.

The first section of rack-mounted panel telegraph equipment has been completed for service in the C.T.O. 80 of the most important Provincial circuits are now working on the new racks, the control of the panel balances and adjustments being in the care of the Testing and Maintenance Staff. The double instrument tables are of a special design and carry down the centre a V-band conveyor. Timing machines of the Blick type stamping the date, message serial number, and circuit code have been installed on the tables. These are electrically controlled from a master clock and auxiliary relays.

An extension of the rack equipment to provide capacity for a further 90 circuits is in hand.

AUTOMATIC EXCHANGES.

The following automatic exchanges have been opened:—Liberty, Tulse Hill, Hither Green, Colindale, Regent, Mayfair and Wordsworth. These exchanges have a total equipped capacity of nearly 31,500 lines and approximately 18,000 subscribers' lines have been transferred. This brings the total number of lines converted to automatic working in London during the year 1932 to nearly 35,000, the largest figure for any one year since the commencement of conversion in November, 1927. This heavy programme has made big demands upon the staff of the London District, both external and internal, but all the transfers have been carried out in a most successful manner and with the minimum of interference to subscribers' service during the period of installation of the new exchanges.

South Lancashire

CABLE CREEPING.

With the enormous increase in the heavy traffic borne by the roads serious trouble has set in due to cables creeping, generally in the direction of the traffic along the road. It is a fact that in many cases the amount of traffic carried by the roads is from ten to twenty times as much as it was before 1914. The huge lorries set up vibration and this vibration has resulted in the movement of the cables in the ducts. The result has been that in many cases the wiped joint has been pulled up to the mouth of the duct. In other cases a definite and serious elbow has been made in the cable at one of the manholes. This has been corrected to some extent by anchoring the cable by means of a wiped joint and a cone of lead resting against the mouth of the duct in the manhole. In one particular case, namely, a portion of the Manchester-Liverpool route between Roby and Penketh, this trouble has occurred over a distance of eight miles. The effective anchoring of the cables in the manholes appears, at the moment, to be the only solution of the trouble in existing cases. This, however, involves a stress on the cable and time alone will show how serious are the after effects. That the trouble is due to vibration seems to be established quite clearly, since in the case of a nest of ducts on the Manchester-Oldham road a covering of concrete on the sides and top of the ducts stopped the trouble entirely.

THE CALF-OF-MAN CIRCUIT.

E. H. VICK, A.M.I.E.E.

The erection of poles over four miles of country full of hard rock lying close to the surface, and the laying of practically a mile of submarine cable across one of the smallest and yet most treacherous channels of the British coast is not a job that falls to the lot of the average telephone engineer in the provision

of a single exchange line, but these tasks had to be accomplished in linking the Calf of Man—an islet with an area of a mere 1,000 acres and situated off the south-western extremity of the Isle of Man—by telephone with the outside world.

The Calf, as it is generally called, takes its name from the Norse "Manar-Kalfr," and traces of prehistoric dwellings are still to be found on its slopes—wild rocky moorland covered with heather and gorse. It has featured in Wilkie Collins' "Armadale"; and the late Sir Hall Caine's "The Deemster." It was fortified in the days when the Stanleys were Lords of Mann about four centuries ago, and it shows evidences of the influence of Christianity in a cross of the early era with fine carvings. It is also reputed to have been the refuge of a famous courtier banished from England by his King. The island has recently come into the possession of Mr. J. A. Popplewell, a well known north country business man. But the Calf of Man is not in an isolated backwater. Ships of all nations sail along its coasts and to this fact was due the existence of a Lloyds signalling station, which was provided about 40 years ago on the Calf. This in itself involved the laying of a telegraph cable at that time, but having been out of service for several years tests made showed that it was unsuitable for the transmission of the human voice.



FIG. 1.—VIEW OF THE SOUND FROM THE CALF, SHOWING THE STONE HUT IN WHICH THE CABLE IS TERMINATED AND THE MAIN TELEPHONE IS FITTED.

Mr. Popplewell wanted to be able to speak to and from his Island retreat, and although the task presented difficulties rarely met with in the provision of telephone facilities, it was completed within three months. The first link lay between Port Erin exchange and the Sound—the channel between the Isle of Man and the Calf—and in nearly four miles of route, the only available road was in many places but a track cut through the rock.

In almost every stay and pole hole, rock was encountered and was found to be exceptionally hard and, in the majority of holes, was immediately below the surface. To deal with the rock, a special Com-

pressed Air Rock Breaking and Drilling equipment was loaned from another District. This did not entirely meet the requirements, but without its use the work would have been much more difficult.

The ordinary rock breaking drill was found incapable of dealing with the rock met with, but the rotary drill was found satisfactory for drilling holes for blasting charges. This was the method adopted and found successful; arrangements being made with Isle of Man Highway Board for the services of the quarryman in a nearby quarry to take full charge of the blasting operations.

Even blasting was not an easy matter owing to the rock formation being in horizontal layers; and with adjoining walls and hedges, it was most difficult to get out a hole without damaging the walls. The method adopted was to drill one to three holes, as required for each case, three to four feet deep, so as to shatter the rock below the surface without doing damage above ground.

The shattered rock was then removed in the usual way and the success of the method can be gauged from the fact that out of more than 100 cases, in only five was damage done to the walling, and this was not extensive in any case.

Then there was the crossing of the Sound, a treacherous channel through which the tide flows at between $2\frac{1}{2}$ to $4\frac{1}{2}$ knots.

This channel is known fully to few, if any, of even the local fishermen, and, as was found during the actual cable laying operations, it is not completely charted. It may be of interest to mention that the question of crossing the Sound by means of open wires on high poles erected on the headland and the intermediate islet of Kitterland was considered, but abandoned.

Submarine Cable 42 $\frac{1}{4}$ /55—10/2 was finally decided upon. This cable has two stranded copper cores each weighing 42 $\frac{1}{4}$ pounds per nautical mile; with the gutta percha covering the weight of each core is 55 pounds per nautical mile. The armouring consists of 10 strands of No. 2 S.W.G. Brass tape protection is not provided. In order that communication between the Calf of Man and the exchange might still be possible, in spite of a breakdown of the overhead line on the Calf, the submarine cable was led into the storehouse near the landing point and the main telephone fitted there. The line was then continued overhead to the Mansion House about a mile away by 150 lb. bronze wire on 24 ft. medium poles cut down to 16 ft. and set 4 ft. in the ground.

Approximately a mile of open line was erected on the Calf, and during the execution of the work the men lived in a cottage on the island, kindly placed at their disposal by the owner.

All the stores, poles, etc., had to be floated or ferried across the Sound, and then dragged ashore over sea-weed covered rocks, upon which one had difficulty in standing let alone doing heavy work, and it is a testimony to the Department's men that during the whole of the work, both on the Calf and Main-

land portion and during the actual cable laying, there was never a hitch or an accident of any description.

The actual laying of the submarine cable was left to the Submarine Section and as the work did not justify the use of one of the Department's cable ships, the length of cable required was forwarded to Douglas coiled on a cable drum. Upon the arrival of a working party from H.M. Cable Ship "Alert," under the direction of Mr. W. H. Leech, arrangements were made for the chartering of a suitable boat.

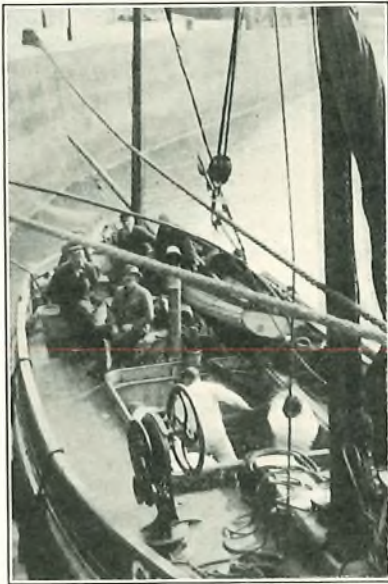

FIG. 2.—LOADING CABLE AT DOUGLAS.

A small fishing vessel, the "Lily," with an auxiliary motor engine was obtained in Port Erin and arrangements were made for her to sail to Douglas for the purpose of placing the cable on board and fitting her up with blocks and bow sheaves already forwarded by the Submarine Section. She arrived in Douglas the following morning at 7 a.m. and by 11 a.m., the scheduled time, the cable was aboard.

The erection of the cable drum, containing cable weighing $5\frac{1}{2}$ tons, with absolute safety was difficult, but was accomplished by making up suitable packing and chocks with stay blocks. Had the weather been satisfactory, the cable would have been laid on the following day, but, although the boat left Douglas, she had to return owing to stress of weather. A further attempt to cover the 20 miles between Douglas and the Calf was made on the Monday, but the "Lily" had to put into Derby Haven and did not reach the Sound until Tuesday morning.

Although a heavy sea was running, it was thought that an attempt to lay the cable should be made, but in spite of the assistance of an extra boat and after many hours of hard work the sea proved a

winner and at night the "Lily" sailed back to Port St. Mary with the cable still aboard.

At 8 o'clock the following morning the weather report from the Sound showed there was a freshening breeze and it was thought another day would be wasted. Less than two hours later conditions quickly changed for the better and the submarine crew were rushed to the Sound and the shore squad picked up from another job in the centre of the island. By 11 o'clock that morning the job of landing one end of the cable on the Isle of Man side of the Sound was in progress. The "Lily" was lying about 200 yards off the coast and several coils of cable were loaded on to the motor boat "Two Sisters," which approached as close as possible to the shore. The cable was man-hauled for about



FIG. 3.—THE "LILY" LYING OFF SPANISH HEAD.

half an hour before the end reached the shore, and it was then hauled by the hand winch on a three-ton P.O. wagon which had been driven over a terrible road between Creneish and the Sound. Three quarters of an hour later sufficient cable had been landed to make connexion with the land line.

But the cable was by no means laid! At that time the tide was tearing through the Sound and nothing could be done for over two hours until there came a period of slack water. At 3 o'clock the "Lily's" anchor was weighed and with the "Two Sisters" towing, Mr. Leech gave the order "Pay out the Cable." Slowly the cable ran over the sheaves and less than half an hour later the treacherous channel had been safely negotiated. Landing the cable on the Calf was another difficult task. It was carried to the shore in a small boat manned by men from the "Alert" and then hauled over the slippery rocks. At 4.30 p.m. tests made showed the cable to be O.K., and the following day the last connexions were made.

North Western District

RETIREMENT OF THREE ENGINEERS.

It is not often that three Engineers with an aggregate of over 135 years Post Office service retire from one Engineering District in the same

month; such, however, is the toll of time in the North Western District in January, 1933. Mr. W. J. Finlayson, Sectional Engineer, Lancaster; Mr. W. H. Lane, Executive Engineer in charge of the Technical Section; and Mr. E. Halton, Assistant Engineer in the Technical Section at District Headquarters at Preston, all retired in January. A pleasing feature of these retirements is that all are in good health and may look forward to many years of happy leisure. That this may be fulfilled is the wish of their many friends in the District.

Presentations were made by Mr. J. M. Shackleton, Superintending Engineer, at staff gatherings, and the speeches revealed very clearly the esteem in which our retiring colleagues were held and the good wishes of the staff for their future.

Scotland East District

EXTENSION OF TRUNK TELEPHONE FACILITIES TO THE OUTER HEBRIDES.

As time goes on, the number of localities in the British Isles which remain unprovided with Trunk Telephone facilities is being rapidly reduced and an important addition to the British Trunk Telephone system is now in course of being made by the provision of a telephone circuit between Stornoway on the Island of Lewis and Kyle of Lochalsh on the Mainland.



FIG. 1.—BURYING THE SHORE END AT STAFFIN BAY.

The main submarine link between Lewis and the Mainland was completed on the 28th October last, when a 4-core G.P. Submarine Cable was laid from Loch Erisort in Lewis to Staffin Bay in the North of the Isle of Skye. The cable is approximately 32 miles long, and was formerly in use as an Anglo-Belgian telephone cable. After being reconditioned and tested, it was laid successfully across the Minch by H.M.T.S. "Monarch." A further short submarine link between Kyleakin, Skye, and Kyle of Lochalsh was laid by H.M.T.S. "Alert."

The landline portions of the circuit in Lewis and Skye have been completed. Long sections of the



FIG. 2.—THE SHORE END AT LOCH ERISORT.

overhead routes are through wild and rugged country and nine overhead gangs were employed on the work.

Three wires have been erected on the landline portions, one of which will be used for the Stornoway-Aberdeen telegraph circuit which is to be superposed on the 4-wire telephone circuit in the submarine sections. The telegraph wire has been extended to Achnasheen in Ross-shire, where it will be connected through to Aberdeen on the existing Stornoway telegraph circuit. The circuit is at present carried in a submarine cable from Stornoway to Loch Ewe and thence *via* Achnasheen to Aberdeen. The existing section, Achnasheen-Loch Ewe-Storno-

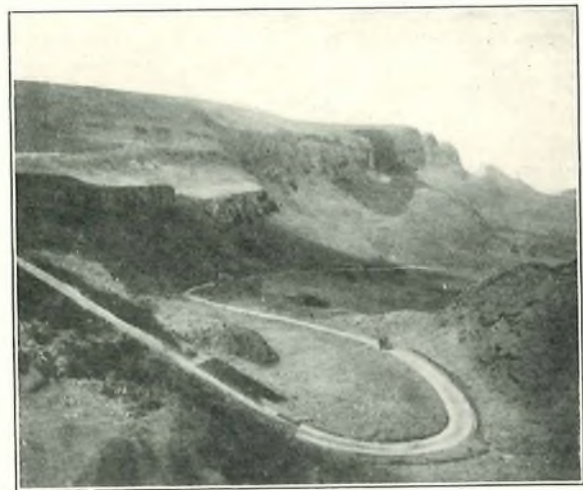

FIG. 3.—THE OVERHEAD ROUTE PASSES ALONG THE WINDING ROAD THROUGH THE QUIRANG, ISLE OF SKYE.

way will be superseded by the route *via* Skye. The old Loch Ewe-Stornoway cable had been repeatedly interrupted by trawlers and the new route *via* Skye was chosen because it is less likely to be subject to such interference.

Unattended repeaters are being provided in the Cable Huts at Loch Erisort and Staffin Bay.

J. J. McK.

South Western District

TWO WHEEL TRAILER FOR CABLING.

Consequent upon the Department's policy to provide Star Quad Cables with 10 lb. and 20 lb. conductors for main underground circuits, the maximum length supplied on one drum is in most cases in excess of a standard length.

This involved a considerable amount of transport in "fleeting" drums forward during cabling operations. To overcome this difficulty, a cable trailer was obtained on loan from the Standard Telephones and Cables, Ltd.

The trailer was a cranked axle type, to arrange for low centre of gravity, for drums up to a maximum size of 7 ft. x 3 ft. 4 ins. The saddles are cast steel mounted on cantilever springs, to take the shock during transport; and are arranged to roll the drum slightly forward of the centre point of balance and thus preclude any tendency of the trailer to tip when attached to the rear of a motor lorry.

The trailer is placed in position to swing the drum and the wheels are then blocked to prevent it moving forward and the drum raised by means of a rope attached to the rear of a motor lorry.

The trailer is safe in operation and the staff can stand clear of danger during loading and unloading. The total weight of the trailer unloaded is 27 cwts. and it is so well balanced that two men can easily haul it along a level road or manœuvre it into position to receive the drum. A comparison has been made on main cable work between the use of an S.D. Freighter and the two wheel trailer, and the Trailer has been found to be the more economical and adaptable for general use.

DUCTS BLOCKED BY TREE ROOTS AT BECKINGTON.

The blocking of underground ducts by the entrance of foreign matter is not an uncommon occurrence and the circumstances are usually of such a nature as not to call for special comment. The conditions which were recently found at Beckington, a village on the Bristol—Warminster underground cable route, are, however, thought to be unique, and of particular interest.

A 2-way duct exists on the route. One 'way' accommodates a Bristol—Warminster cable, whilst the other is about to be utilized for a Bristol—Salisbury cable, and the construction of additional loading pot manholes has been necessary.

One of these additional manholes has been pro-

vided at Beckington at a point where the ducts are in fine waterlogged sand. On breaking the ducts in connexion with the construction of this manhole, it was found that the spare 'way,' and also that containing the existing cable, were tightly filled with fine matted roots which extended the whole length of the manhole position and for some distance on each side. Some water was flowing through the



FIG. 1.—PORTIONS OF ROOTS OF DOUGLAS FIR TREE WITHDRAWN FROM 2-WAY DUCT LINE.

ducts and, as they were laid on sloping ground, the water had a distinct fall. The formation of the roots indicated that growth was in the direction of the flow of the water. As the ducts had to be lowered they were uncovered for a distance of approximately 30 feet in each direction from the manhole excavation, and on disconnecting the joints and slipping the ducts back over the cable, it was found that in the downhill direction the roots extended for a length of 30 feet from the manhole position and that they petered out to a pointed tuft. In the opposite, or up-hill, direction from the manhole excavation, the roots were found to continue beyond the 30 feet of uncovered ducts, and efforts to clear the ducts with-

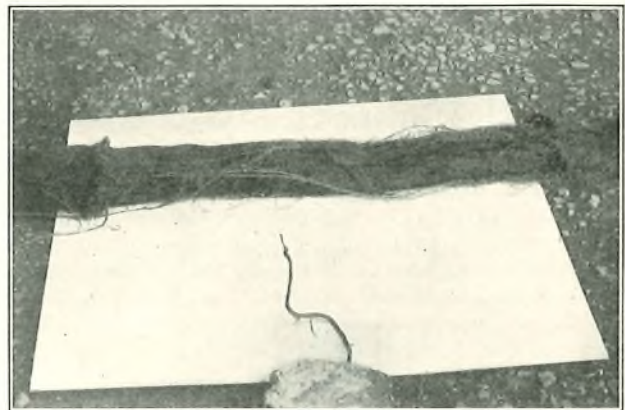

FIG. 2.—SHOWS THE FIBROUS AND MATTED CHARACTER OF THE ROOTS. THE OUTSIDE PORTION OF THE ROOT ENTERING THE DUCT LINE IS SEEN IN THE FOREGROUND.

out further ground openings were unsuccessful. After the ducts had been cleared in the direction of the manhole position, it was decided to open the ground and make a break at a point 6 ft. further along the track, and on this being done similar conditions were found to exist, but it was now possible to remove the roots from the 6 ft. length. The operation was repeated a further 6 ft. along the track where it was found that the ducts were clear of roots, but both ways carried a stream of clear water at almost full bore. By making a sump hole at the latter point, and pumping continuously, the water was kept down, and the ducts uncovered, when it was found that a root, slightly smaller in diameter than a lead pencil, which formed a part of the root system of a Douglas Fir Tree growing in an adjacent garden, had penetrated a joint in the ducts. On breaking the duct joint it was seen that the portion of the root inside the duct was similar in size to the outside portion, but at the point where it had passed through the joint it was flattened to the thickness of stout writing paper and had a width of $\frac{3}{8}$ ". Fibrous growth commenced inside the duct close to the point of entry, and it had penetrated to the second 'way' through the small clearance space between the internal bridges of the ducts at the spigot and socket joint. Removal of the duct at this point enabled the remaining roots to be removed.

The length of ducts blocked by the roots was approximately 80 ft.

Fig. 1 shows a portion of the roots which were removed from the ducts. Fig. 2 indicates more clearly the fibrous character of the roots, and parallel primary roots can also be seen. In this photograph is also shown the external portion of the root which passed through the joint in the duct line. The flattened end will be noticed.

The broken duct line was made good by split ducts which were surrounded by concrete.

The roots had been holding back the water which, after the ducts were cleared, had a free flow to the manhole excavation. The ducts were plugged as a temporary measure, and the difficulty was overcome by constructing an interception chamber and laying drain pipes therefrom to an adjacent road-side drain.

The 2-way duct line was laid towards the end of 1930.

It is interesting to surmise what would have occurred had the conditions not come to light. Would the pressure of the roots eventually have fractured the ducts and damaged the cable, and how far would the roots have traversed the conduits?

A.R.

South Midland District

GAS EXPLOSION IN READING.

A gas explosion which did considerable damage to the local underground system occurred in Reading on 30th January, 1933. The following details will be of interest to readers. Those closely concerned with the construction and maintenance of underground plant will, find food for thought in considering the problem of preventing such occurrences, since it will be realized that conditions similar to those in Reading exist in most large towns.

The plant affected by the explosion is shown in Fig. 1. The damage extended over approximately

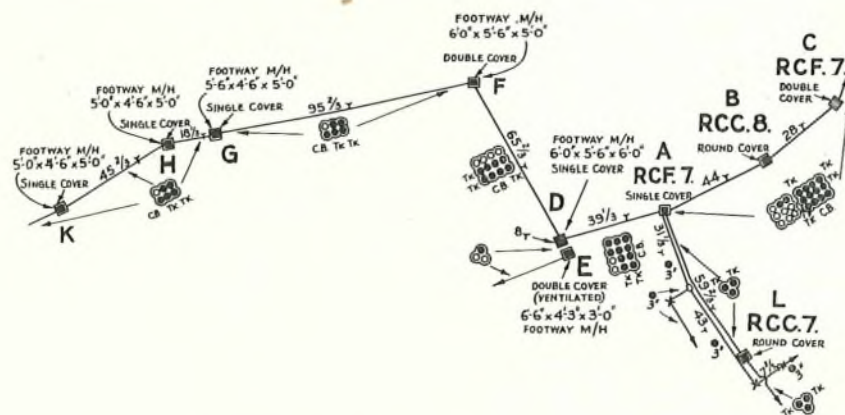

FIG. 1.—PLANT AFFECTED BY THE EXPLOSION.

415 yards of track and is scheduled below.

Manhole A, RCF 7. Cover blown off, but neither manhole nor cables damaged.

Manhole B, RCC 8, was completely wrecked. The cover was blown to a height of about 30 feet and in descending smashed the churchyard iron railings and damaged the wall, Fig. 2.



FIG. 2.—MANHOLE B.

Manhole C, RCC 7, had the cover blown off, but was not damaged.

Manhole D, ex-N.T. Co., 6' x 5' 6" x 6', foot-way, was completely wrecked, as illustrated in Fig. 3.



FIG. 3.—MANHOLE D.

Manhole E had the cover blown off, but was not damaged.

Manholes F, G and H will require new roofs and shafts.

Manhole K, ex-N.T. Co., 5' x 4' 6" x 5', was cracked from top to bottom.

The covers of manholes F, G, H and K were all blown off, those of G, H and K rising to such a height that they were smashed to pieces in falling.

Manhole L, RCC 7, was badly split vertically and horizontally and will have to be entirely rebuilt.

The 9-way self-aligning duct was badly broken for a length of about 20 yards from manhole B towards manhole A. It is interesting to note that the 12-way concrete block which lies alongside was undamaged, no doubt due to the fact that all ways were full of cable. Mandril tests have been made of all spare

ducts in other sections and no damage has been detected.

In spite of the severe mauling which the cables received, especially in the two manholes which were demolished, no interruption of telephone service occurred.

A gas leak was discovered in a 12" main about 10 yards from manhole L. The gas appears to have travelled through the earth and at some point to have entered the C.I. pipe and thence spread itself by way of the ducts throughout the 10 manholes concerned.

The cause of ignition is not known. Owing to the large quantity of gas which must have been present below the road surface, it is possible that ignition occurred some distance from the first explosion, the burning gas travelling until an explosive mixture was reached. The street in which manholes L, A, E, D and F are situated is a busy thoroughfare, with trams, the 12" gas main running parallel with and near the tramlines.

There were several explosions, but it has not been established definitely in what order they occurred. The evidence is somewhat conflicting, but it is considered most likely that manholes A, D and E exploded more or less simultaneously, that B, C and L followed after a short interval and then F, G, H and K. The centre of the disturbance was at A, the greatest damage being done at the adjacent manholes B, D and L. After the explosion a jet of gas was burning in manhole A from the mouth of the C.I. pipe for about 9 hours, that is until the leak in the gas main was stopped.

Damage to private property consisted mostly of shattered windows. About 10 shops and two public houses suffered badly in this respect. The scene in the latter, outside and close to which two of the worst explosions occurred, can easily be imagined. There was "many a slip twixt cup and lip."

Considering the extent and violence of the explosions, it is remarkable that no personal injuries were caused directly by them. The only casualties were a young woman who walked into an open manhole and suffered from slight shock and bruises, and a terrified dog which rushed out of a house into a manhole and was drowned. H.H.

The Institution of Post Office Electrical Engineers Local Centre Notes

Northern Centre

On the 15th February Dr. E. C. Edgar, F.I.C., Principal of Rutherford Technical College, Newcastle-upon-Tyne, gave a lecture before the Northern Centre on "Liquid Air." The lecturer showed that all substances could be obtained in one or other of the three states of matter; solid, liquid and gas; and that, in general, suitable changes of temperature could bring about the desired result. He added that

the change from the gaseous state to the liquid state was facilitated by compression. After giving a brief history of the discoveries in connexion with the liquefaction of gases, and in particular of the experiments of Faraday, the lecturer stated that matter in an attenuated state can exist in two distinct physical conditions. In the first the substance was a true gas and could be called a permanent gas, because it was incapable of liquefaction by pressure alone. In the second state a suitable application of pressure would

bring about its liquefaction. Its accurate description in the second state was that of a vapour. The difference between these two states is purely a question of temperature; and the chief discovery associated with the liquefaction of gases was the discovery of a "critical temperature" for each state of attenuated matter; below the critical temperature the material is capable of conversion into a liquid by pressure. For example, the critical temperatures for oxygen and nitrogen are respectively -118°C and -146°C . The principles on which the liquefaction of gases are based are that most gases when strongly compressed and allowed to expand through an orifice cool, and repetition of this process has a cumulative effect on the gas until at last it becomes a liquid. Examples of the commercial uses of Liquid Air were given; before proceeding with numerous experiments the lecturer stated that when Liquid Air was poured into a Dewar Vessel, popularly known

as a Thermos Flask, in a room, the effect was comparable to that of water being poured into a red hot vessel in a red hot chamber. He also mentioned that the electrical resistance of certain conductors disappeared at 4° absolute (-269°).

Dr. Edgar's series of interesting experiments were of two kinds; those showing the solidification of such things as flowers, meat, rubber, fruit, etc., when immersed in Liquid Air so that a hammer was necessary to break them, and those illustrating the highly combustible effect of Liquid Air, which after the evaporation of its nitrogen is practically pure liquid oxygen, on such things as biscuits and cigarettes. These on being taken out of the liquid burned intensely.

Dr. Edgar's lecture was most instructive and highly interesting, and the generous applause which greeted its termination expressed the enjoyment and appreciation of the meeting.

Junior Section Notes

Edinburgh Centre

At the December meeting Mr. W. West, Engineer-in-Chief's Research Department, gave his paper on "Room Noises and Reverberation."

On 9th January a paper, entitled "A Country Lineman's Load," was given by Mr. D. Mason.

Dundee Centre

On 23rd November, Mr. J. Donaldson read a paper entitled "From Overhead to Underground" —(Prize Essay).

At the meeting in December a paper on "Repeaters and Repeater Stations" was given by Mr. W. Bullock.

There were good attendances and discussions at all the meetings.

Aberdeen Centre

A general meeting of the Staff was held at the H.P.O. on the evening of 28th February, 1933, for the purpose of forming a Junior Centre.

After introductory remarks by Mr. W. J. Eves (Sectional Engineer), Mr. J. Airey outlined the aims and objects of the Junior Section. Great interest was displayed and the Centre was inaugurated with a membership of 30, which it is fully hoped to increase.

At the conclusion of the meeting a paper on the subject of "Automatic Telephony," illustrated by lantern slides, was read by Mr. R. C. Birnie. The discussion was well sustained.

Other papers have been promised and further meetings will be held to maintain the interest until the commencement of next session.

Brighton Centre

The first meeting of the session was held on the 4th October, 1932, when a paper entitled "London

Toll A to Brighton Junctions," was read by Mr. H. W. Jarvis, who illustrated his subject by means of two large diagrams. Keen interest was shown by the large audience and an animated discussion followed.

Mr. McCormack, Sectional Engineer, who attended as a visitor, congratulated Mr. Jarvis on his excellent paper, Mr. C. T. Wright as the first Chairman of the Centre, the Committee on the splendid arrangements, and the Secretary, Mr. W. J. Dawes, on the tremendous energy he had shown in bringing the membership from 28 to 110. The audience heartily endorsed these remarks.

At the February meeting, we were favoured by a visit from the Assistant Superintending Engineer, Mr. C. A. Taylor, who gave a short talk on "Filters" which evoked a good discussion and the members trust that further opportunity will occur for Mr. Taylor to give us more details of this most interesting subject.

Fenny Stratford Centre

The preliminary meeting of the Junior Centre was held at Fenny Stratford Repeater Station on the evening of October 18th and the election of officers for the ensuing session was proceeded with. As the Centre is to be self-supporting and self-governing, it was considered preferable to elect a Chairman from the membership. Arrangements for the programme for the session are now in hand.

Gloucester Centre

The Gloucester Junior Section of the I.P.O.E.E. have now held three meetings at Gloucester and one at Cheltenham, under the Chairmanship of Mr. W. Day, M.I.E.E. (Sectional Engineer).

Notwithstanding the widespread area of this Section, there have been excellent attendances at

each meeting. Our membership has now increased to 53.

The lectures so far delivered have all been interesting and instructive. Keen interest has been shown in the subjects, and discussions have taken place. The programme for the remainder of the present session is as follows:—

- “ Auto Manual Boards and No-delay Trunking,” by Mr. J. V. Lugg, Gloucester.
- “ Works Supervisory Duties,” by Mr. H. G. Collingbourne, Cheltenham.
- “ The maintenance of Stamp Cancellation and Stamp Vending Machines,” by Mr. F. E. Huckfield, Cheltenham.

Manchester Centre

The high hopes of success entertained at the inauguration of the Centre may be claimed as having been fully justified, and interest has been admirably sustained throughout the session. Whilst the offer of papers by members was rather limited at the outset, we have since had to postpone a number till next session.

The membership continues to increase, and has now reached the respectable total of 120.

A party of 23 members had the pleasure and privilege of viewing the A.E.C. Factory, Liverpool, on Saturday, 18th February, and this insight to the manufacturing side of the industry made a profound impression.

We are indeed indebted to the Company for the arrangements made for our instruction, the educational value of the visit being enhanced by the able exposition and various demonstrations given by our escorts.

Among many innovations we saw equipment for the proposed new 10 line party wire system, the Common Control and Line Finder systems, Auto. Traffic Control, etc.

As a fitting conclusion we were entertained to tea by the Company. In all a most enjoyable visit.

The sixth meeting of the Centre was held on 6th February, when a paper on “ The By-path System ” was most ably presented by Messrs. A. F. E. Evans, A.M.I.E.E., and S. W. Broadhurst. This paper proved a most popular subject, and evoked much discussion—much of it subsequent to the meeting.

Book Reviews

“ Communication Engineering,” by W. L. Everitt. Pp. 567. McGraw Hill Publishing Co., Ltd. 30/-.

The tendency in modern books on communication engineering is to cover a very wide range. The present book is no exception to this as it deals with line and radio transmission, telephonic transmitters and receivers, amplifiers, oscillators and measurements at high and medium frequencies. The general treatment is fundamental, no attempt being made to deal with specific applications such as telephone switching systems. The book is intended for those having a knowledge of the principles of direct and alternating currents and of the calculus. At the end of each chapter there are given problems illustrating the principles discussed and also a bibliography.

Chapters 1 to 11 deal with telephonic transmission.

Chapter 1 explains the fundamental problems of electrical communication and introduces the ideas of equivalent networks, linear and non-linear components, wave form, range of audibility, distortion, modulation, etc. Stress is laid on the necessity for faithfulness of reproduction rather than volume.

Subsequent chapters in this section deal with the theory of complex quantities; network theorems; resonance; transmission over an infinite line; reflections; filters; interference from power circuits; coupled circuits and applications of the Wheatstone Bridge principle.

All expressions for line constants such as attenuation and impedance are derived from the equivalent network. This method of treatment has the advantage of simplicity and of facilitating the realisation of the practical meaning of the mathematical expressions. Hyperbolic functions are first introduced in connexion with reflections, as they represent in a

convenient manner waves travelling in opposite directions.

Throughout the book numerical examples are given which are a great help to the theoretical expressions.

Among the applications of the Wheatstone Bridge principle are included A.C. measuring bridges; harmonic analysers; anti-sidetone devices; phantom circuits and telephone repeater systems.

There is very little to criticise in this section of the book.

The consideration of line-distortion might with advantage have been fuller especially as regards non-linear and phase-distortion, as these are at present the chief limiting factors of long-distance transmission.

The proof of the Reciprocity Theorem on page 40 is somewhat misleading as the generator and receiver impedances are included in the series network impedances. When the generator and receiver are transposed, as stated, these impedances will be modified and the proof is not strictly correct.

More details of alternating current bridge measurements would have been useful. Such necessary devices as screening and the Wagner earth balance are omitted.

Chapters 12 to 15 deal with microphonic transmitters, audio and radio amplifiers under the general heading “ Networks using Unilateral Impedances.” As examples of such devices there are mentioned “ Relays, switching mechanisms, steam valves, rifles and mouse-traps ”; but the scope of the book does not cover these. The design and functions of different types of thermionic valve, including the screened grid and pentode types, are described.

Chapters 16 and 17 deal with the application of

valves to modulation, de-modulation and detection under the general heading "Networks using non-linear impedances." The theory of modulation is described and its application to systems such as suppressed carrier and radio secrecy systems. The different methods of detection described include grid, anode and heterodyne detection.

Oscillators are dealt with in Chapter 18. After giving the theory of thermionic valve oscillators, different types are described, including audio, heterodyne, negative resistance, dynatron and Barkhausen oscillators.

Chapter 19 deals with electro-mechanical devices and includes telephone receivers and loud-speakers of different types such as Piezo-electric; moving coil, magneto-strictive and condenser types, as well as the normal Bell receiver.

Chapter 20 deals with Radiation and includes an account of the action of the Heaviside layer.

Chapter 21 describes instruments for the measurement of current and voltages at high and medium frequencies. The instruments include hot-wire, thermo-couple, copper-oxide rectifier and vacuum tube types, and methods of measuring field strengths and frequency are described.

The book is well produced and the figures are clear. It can confidently be recommended for the use of communication engineers. C.R.

"The Wonder Book of Electricity." 256 pages. Ward, Lock & Co., Ltd., London. 5/- net.

It is often a matter of difficulty for a specialist to obtain a bird's eye view of developments taking place in other branches of the same art, and the communication engineer is no exception. This lavishly illustrated book, although primarily intended for the adolescent, is admirably designed to give a rapid review of the modern developments in the applications of electricity without an over burden of technical detail, and it is pleasing to see that Communication Engineering has received its due share of space. The book is the work of several contributors, each fully qualified to deal with the sphere allotted to him, and it can be thoroughly recommended to parents and "uncles" desiring to please the younger generation, but I fear that the temptation to delve into its pages is likely to delay the presentation! J.I.

"Radio Engineering." By F. E. Terman. London, McGraw Hill Publishing Co., Ltd. 688 pages. 30/-.

This is a new and comprehensive text-book on Radio Engineering and in many ways is one of the best books on the subject which has yet appeared. It is written in a style which will appeal to all classes of students and is also a valuable work for practical engineers.

The author has not overloaded the book with mathematics, but where necessary has taken mathematical results and given references to where the full working can be obtained. As the book is of American origin the references in the text are usually to American practice and American investigators,

while equally important European work has been ignored.

Generally speaking the subject matter is well up to date, such matters as the selectivity of different classes of receivers, antenna array systems, crystal control and diversity reception being dealt with.

Useful chapters are also included on the propagation of radio waves of different frequencies, radio aids to navigation, radio measurements, sound, and sound equipment. The only important item which seems to have been omitted is the subject of privacy systems for minimizing overhearing on commercial radio telephony.

There are one or two cases where development appears to have advanced since the text was prepared. For example, the difficulty of light load running with mercury arc rectifiers has now been overcome and modern rectifiers can be built to remain in operation on only a voltmeter load.

The book bears signs of careful preparation. In Fig. 241 however, showing the method of generating single sideband telephony, the output of the second modulator is given as $55500 + 5$ and $55500 - 5$ cycles per second whereas the latter figure should be $122900 - 5$. Again on page 346, in speaking of the co-planar grid tube, the author states that when used as a detector there is no radio current flowing in the plate circuit. This is incorrect, as a matter of fact there is a high frequency component of twice the carrier frequency in the plate current and the valve in this respect is comparable with two valves used in a frequency doubler circuit. What the author probably intended to say is that there is no radio frequency current induced in the plate circuit through the valve capacity.

These are only minor points, however, and the book can be thoroughly recommended. The price is high, but the value is good in comparison to many other works. A.J.G.

"Economic Tables for Electrical Engineers." By D. J. Bolton, M.Sc., M.I.E.E. Messrs. Chapman & Hall, Ltd. 1/6 net.

This booklet contains a number of tables designed to facilitate the economic comparison of alternative methods of providing electrical plant accompanied with notes and examples explaining and illustrating their use.

The tables and methods of use are specially designed for application to power plant and kindred problems and should prove a valuable aid to those dealing with such cases.

The examples given illustrate the necessity of taking into account all the relevant factors such as first cost, interest, depreciation, maintenance and consideration of load losses in connexion with running costs.

The author does not discuss the difficulty of obtaining correct life statistics, but assumes in the examples given that the lives of similar plant are generally the same, although in the case of machines, instruments, etc., the standard of workmanship and repute of the manufacturer concerned may need to be taken into account. R.W.H.

Staff Changes

POST OFFICE ENGINEERING DEPARTMENT.

PROMOTIONS.

Name.	From.	To.	Date.
Thompson, H. S.	Assistant Superintending Engineer, S. West District.	Superintending Engineer, S. Wales District.	1-10-33
Reid, F.	Assistant Staff Engineer, Designs E.-in-C.O.	Staff Engineer, Designs E.-in-C.O.	1-9-33
Taylor, C. A.	Assistant Superintendent Engineer, S. East District.	Superintending Engineer, N. East District.	1-5-33
Nancarrow, F. E.	Executive Engineer, Radio E.-in-C.O.	Assistant Staff Engineer, Radio E.-in-C.O.	4-1-33
Rattue, A.	Executive Engineer, S. West District.	Assistant Superintending Engineer, S. West District.	1-4-33
Carter, H.	Executive Engineer, Construction E.-in-C.O.	Assistant Superintending Engineer S. East District.	1-5-33
Walmsley, T.	Executive Engineer, Radio E.-in-C.O.	Assistant Staff Engineer, Radio E.-in-C.O.	22-3-33
Speight, A.	Executive Engineer, Telephones E.-in-C.O.	Assistant Staff Engineer, Telephones E.-in-C.O.	11-3-33
Brown, G.	Assistant Engineer, Telephones E.-in-C.O. (This was omitted from previous issue).	Executive Engineer, Telephones E.-in-C.O.	1-6-32
Cohen, I. J.	Assistant Engineer, Radio E.-in-C.O.	Executive Engineer, Radio E.-in-C.O.	4-1-33
Fenn, E. E.	Assistant Engineer, Testing Branch, Birmingham.	Executive Engineer, Testing Branch, Birmingham.	14-4-33
Mumford, A. H.	Assistant Engineer, Radio E.-in-C.O.	Executive Engineer, Radio, E.-in-C.O.	22-3-33
Semple, L. G.	Assistant Engineer, E. District.	Executive Engineer, S. West District.	1-4-33
Williams, P. A.	S.W.I., S. Western District.	Inspector, Western District.	28-11-32
Gayfer, R. A. C.	S.W.I., London District.	Inspector, London District.	14-12-32
Worth, W. B.			14-10-32
Hutchings, W. S.			6-11-32
Hillis, J. B.			15-7-32
Dickson, J. A.			20-7-32
Milne, R.			28-10-32
Peake, A. W.			18-1-33
Arram, H.			14-9-32
Grinsell, A. H. J.			31-8-32
Helmore, C. A.			29-3-32
Osborne, A. D.	4-8-32		
Denny, E.	13-8-32		
Wash, H.	21-1-33		
Farrow, A. W.	1-9-32		
Cork, E.	1-12-31		
Butcher, E. E.	13-10-32		
Cowley, F. H.	10-2-33		
Edwards, E.	31-5-31		
Broad, W. H. G.	6-9-32		
Butcher, W.	1-6-32		
Holder, T. G.	17-12-32		
Dunkley, L. W.	Inspector, N. West District.	Inspector, N. West District.	To be fixed later.
Clarke, W.			
Ryan, R. L.			
Dickson, F. M.			
Whittaker, W. M.			
	S.W.I., N. Wales District.	Inspector, N. Wales District.	
	S.W.I., N. Wales District.	" " "	
	S.W.I. N. West District.	Inspector, N. West District.	
	S.W.I., N. Mid. District.	Inspector, N. Mid. District.	
	S.W.I., N. Mid. District.	Inspector, N. Mid. District.	
	S.W.I., N. West District.	Inspector, N. West District.	
	S.W.I., Leafield R./Stn.	Inspector, Leafield R./Stn.	
	S.W.I., N. Ireland District.	Inspector, N. Ireland District.	
	Draughtsman, Class II., S. I. es. Dist	Inspector, S. Lancs. District.	21-6-31

APPOINTMENTS.

Name.	From.	To.	Date.
Miller, G. J.	Probationary Asst. Engr.	Asst. Engr., S. Mid. District.	7-1-33
Boocock, R. O.		Asst. Engr., E. District.	
Anderson, E. W.		Asst. Engr., S.W. District.	
Perryman, C. F.		Asst. Engr., Scot. W. District.	
Robinson, A. K.		Asst. Engr., N. District.	
Coreser, P. R.		Asst. Engr., E.-in-C.O., Research.	
Helman, S. L.		Asst. Engr., N. District.	
McMillan, D.		Asst. Engr., E.-in-C.O., Research.	
Knapman, D. E.		Asst. Engr., S. Wales District.	
Hunt, R. H.		Asst. Engr., S. Lancs. District.	
Knox, A. H. C.		Asst. Engr., S. Lancs. District.	
Tobin, W. J. E.		Asst. Engr., S. Lancs. District.	
Rousell, S. M. E.		Asst. Engr., E.-in-C.O., Research.	
Lewis, N. W. J.		Asst. Engr., London District.	

STAFF CHANGES

81

APPOINTMENTS

Name.	From	To	Date.
Dickson, E.	Probationary Asst. Engr.	Asst. Engr., E.-in-C.O., Research.	1-1-33
Leigh, H.		Asst. Engr., E.-in-C.O., Equip.	
Cook, A.		Asst. Engr., E.-in-C.O., Radio.	
Lucas, F. N.		Asst. Engr., Scot. E. District.	
Calvey, C. E.		Asst. Engr., S.E. District.	
Pitcairn, A. C.	E.-in-C.O.	Asst. Engr., London District.	20-2-33
*Gould, E. F. N.	"	Assistant Engineer.	27-2-33
*Jones, R. E.	"	" "	13-3-33
*Brockbank, R. A.	"	" "	

* From Special Competition.

TRANSFERS.

Name.	From.	To.	Date.
Atkinson, J. W.	Superintending Engineer, N.E. District.	Deputy Superintending Engineer, London District.	1-5-33
Faulkner, H.	Assistant Staff Engineer, E.-in-C.O.	Assistant Superintending Engineer, N. Wales District.	22-3-33
Martin, P. C.	Executive Engineer, N.E. District.	Executive Engineer, London District.	1-4-33
Millard, C. W.	Kenya (Seconded).	Assistant Engineer, N.W. District.	13-3-33
Pidgeon, J. E.	Assistant Engineer, E.-in-C.O.	Assistant Engineer, E. District.	1-2-33
Graham, C.	Palestine (Seconded).	Assistant Engineer, S.E. District.	1-3-33
Tyson, W. R.	Assistant Engineer, E.-in-C.O.	Assistant Engineer, London District.	1-1-33
Bentlett, W. J.	Assistant Engineer, London District.	Assistant Engineer, E.-in-C.O.	1-1-33
Brown, A. H.	Assistant Engineer, E.-in-C.O.	Assistant Engineer, Scot. West.	1-3-33
Gray, G.	Chief Inspector, E.-in-C.O.	Chief Inspector, S. Mid.	1-1-33
Bateson, E. L. H.	Inspector, Baldock R./Stn.	Inspector, E.-in-C.O.	1-12-32
Choldcroft, E. W.	Inspector, Eastern District.	Inspector, E.-in-C.O.	1-12-32
Flanagan, W. J. C.	Inspector, Leafield R./Stn.	Inspector, E.-in-C.O.	21-1-33
Powning, S. H.	Inspector, Rugby R./Stn.	Inspector, London District.	17-12-32
Wallworth, A. R.	Inspector, N. Wales District.	Inspector, E.-in-C.O.	5-3-33
Hook, H. G.	Draughtsman, Cl. II., Oxford.	Draughtsman, Cl. II., Hqrs. Tech. Section, Reading.	19-9-32
Gibbins, F. J.	Draughtsman, Cl. II., Guildford.	" "	24-10-32

RETIREMENTS.

Name.	Rank.	District.	Date.
Lucas, J. G.	Assistant Staff Engineer.	E.-in-C.O.	10-3-33
Nimmo, R.	Executive Engineer.	S.W.	5-2-33
Scott, A.	" "	Scot. W.	17-2-33
Finlayson, W. J.	" "	N.W.	14-1-33
Lane, W. H.	" "	N.W.	12-1-33
Stevenson, W.	Assistant Engineer.	N. Mid.	18-2-33
Peel, J.	" "	N.	2-1-33
Halton, E.	" "	N.W.	25-1-33
Munro, D.	" "	Scotland West.	28-2-33
Bignell, L.	" "	S.E.	31-1-33
Carruthers, C.	Chief Inspector.	N.	9-2-33
Heyes, E.	" "	S. Wales.	30-3-33
Birkenshaw, W.	Inspector.	N. Mid.	16-12-32
Willis, H. T.	" "	London.	31-12-32
Milam, E.	" "	London.	31-12-32
Terry, G. F.	" "	London.	31-12-32
Whittaker, G. A.	Inspector.	N. Mid.	5-1-33
Graham, J.	" "	N. Western.	23-11-32
Gale, E. G.	" "	S. Wales.	21-1-33
Cookson, E.	" "	N. West.	4-2-33
Brinkley, E.	" "	Eastern.	27-2-33
Dalton, A. W.	" "	S. Eastern.	3-3-33
Maxwell, A.	" "	Scot. East.	4-3-33
Gammon, J.	" "	London.	28-2-33
Pratt, F.	" "	S. Mid.	7-3-33
Slater, J. T.	Draughtsman, Cl. I.	N. West.	19-7-32

STAFF CHANGES

DEATHS.

Name.	Rank.	District.	Date.
Soper, R. E.	Assistant Engineer.	E.in.C.O.	15-2-32
Diplock, H.	Inspector.	S. Eastern.	3-1-33
Jackson, S.	"	S. Lancs.	28-2-33
George, F. W.	Draughtsman, Class I.	L.E.D.	10-12-32
Massey, J. W.	Draughtsman, Class II. (Unest.)	E.in.C.O.	27-1-33
Pollard, W. T.	Inspector.	London.	21-2-33
Creek, A.	"	N. Eastern.	26-2-33

CLERICAL GRADES.

RETIREMENTS.

Name.	Rank.	District.	Date.
Goode, W.	Executive Officer.	Engineer-in-Chief's Office.	31-12-32
Harry, M.	Higher Clerical Officer.	S. Midland District.	31-1-33
Casserley, E. W.	" " "	London District.	5-2-33
Gwilliam, A.	" " "	S. Midland District.	28-2-33
Mogg, C.	" " "	S. Wales District.	31-3-33
Mullens, E. E.	" " "	S. Midland District.	31-3-33

PROMOTIONS.

Name.	From.	To.	Date.
Foord, F. C.	Acting Executive Officer, E.-in-C.O.	Executive Officer, E.-in-C.O.	1-1-33
Booth, C. H.	Clerical Officer, E.-in-C.O.	Acting Executive Officer, E.-in-C.O.	1-1-33
Peak, H. C.	Clerical Officer, S.E. District.	Higher Clerical Officer, S. Midland District.	15-1-33
Hellyer, J.	Clerical Officer, S. Wales District.	Higher Clerical Officer, S. Wales District.	1-4-33
Betts, G.	Clerical Officer, S. Midland District.	Higher Clerical Officer, S. Midland District.	1-2-33
Parkin, E. B.	Clerical Officer, A.M.T.O., Leeds.	Higher Clerical Officer, S. Midland District.	1-3-33
Buckeridge, R. P.	Clerical Officer, A.M.T.O., Glasgow.	Higher Clerical Officer, S. Midland District.	1-4-33

BOARD OF EDITORS.

B. O. ANSON, M.I.E.E., Chairman.
 P. J. RIDD, M.I.E.E.
 C. J. MERCER, M.I.E.E., M.I.R.E.
 A. J. GILL, B.Sc., M.I.E.E., M.I.R.E.
 J. PRESCOTT.
 J. T. KELLY.
 J. INNES, B.Sc., M.I.E.E., Managing Editor.
 W. S. PROCTER, A.M.I.E.E., Assistant Editor.

COMMUNICATIONS.

All Remittances and Communications should be addressed to the MANAGING EDITOR, P.O.E.E. JOURNAL, Engineer-in-Chief's Office, Alder House, London, E.C.1.

Binding covers and copies of the Contents for Vol. 3 to 25 are available, and may be obtained from the local agents for 1s. 6d. and 3d. respectively. Subscribers can have their copies of Vol. 25 bound, with index included, at a cost of 3s., by sending the JOURNALS to the local agents. Orders for bindings, Vols. 1—19, should indicate whether the original binding with black lettering, or the latter pattern in gold, is required. Covers with gold lettering will be the only type stocked from Vol. 20 onwards.

The price of the JOURNAL is 1s. (1s. 3d. post free) per copy, or 5s. per annum, post free. All back numbers 1s. each.

Now ready—New 6th Edition of—

Standard Handbook for Electrical Engineers

Edited by FRANK F. FOWLE.

2,790 pages, $4\frac{1}{2} \times 7$, pre-publication price 36/-.

Here is the sixth edition of the Standard Handbook for Electrical Engineers, representing a thorough revision and enlargement, bringing the Handbook right up to the minute. More than 600 pages (30%) larger than the fifth edition—every section fully revised—many entirely rewritten—whole new sections added—abundant new material throughout the book—more contributors—more specialised treatment.

McGraw-Hill Publishing Company Ltd.

Aldwych House, London, W.C.2

PITMAN'S BOOKS

TELEPHONY

By T. E. HERBERT, M.I.E.E., *Superintending Engineer, P.O. Engineering Department*, and W. S. PROCTER, A.M.I.E.E., *Engineer-in-Chief's Office, P.O. Engineering Department*.

Volume I. of this important work has been revised and considerably extended. It gives a detailed exposition of the telephone system of the British Post Office, and deals with the manufacture, uses and repair of telephone apparatus, with a full explanation of theoretical considerations. Second Edition. 1220 pp. 20s. net.

(Vol. II.—*Automatic Telephony—is in preparation*).

TELEGRAPHY

By THE SAME AUTHOR.

This book gives a detailed treatment of the Telegraph system in use by the British Post Office. It has long been accepted as the standard reference work on the subject and is a highly commended text-book for students of the City and Guilds Examination in Telegraphy. Fifth Edition. 20s. net.

Write for a complete list of Pitman's Technical and Scientific Books. Post free on application.

SIR ISAAC PITMAN & SONS, LTD., Parker Street, Kingsway, London, W.C.2

RELAYS IN AUTOMATIC TELEPHONY

By R. W. PALMER, A.M.I.E.E., *Assistant Engineer, G.P.O.*

Explains the construction, design and adjustment of relays, together with the theory of impulsing and the measurement of time lags. The scope of the work has been largely determined by the syllabus of the City and Guilds Examination with respect to telephone relays, which it covers. It is also a standard reference work for practical telephone engineers. 190 pp. 10s. 6d. net.

ACOUSTICAL ENGINEERING

By W. WEST, B.Sc., A.M.I.E.E., *of the Research Staff*.

This up-to-date work explains the theory of sound and its applications to telephone, architectural and electrical engineering and research. It particularly stresses the fundamental principles which form the basis of modern practice, and discusses the absorption of sound by solid materials, the measurement of noise, and distortion of sound. 350 pp. 15s. net.

G.E.

Manufa

BRITISH POST OFFICE AUTOMATIC

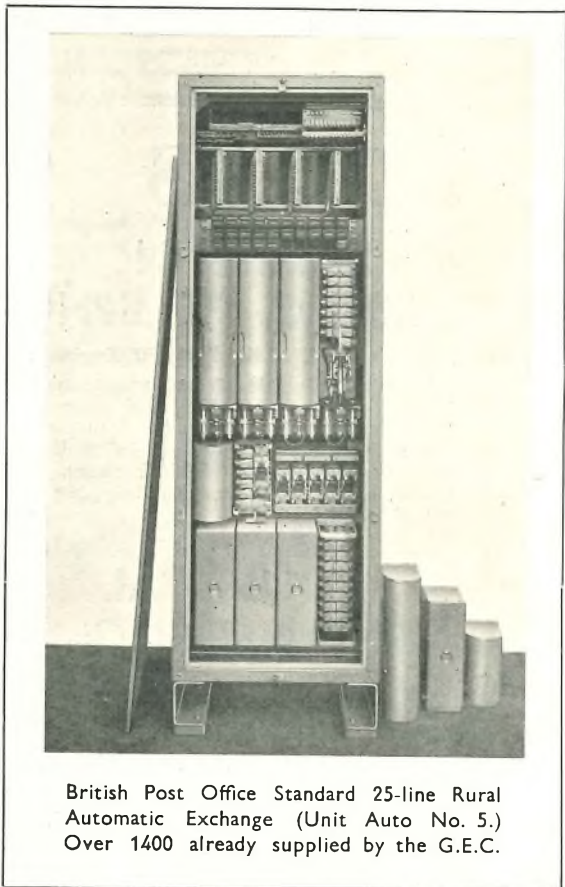

British Post Office Standard 25-line Rural Automatic Exchange (Unit Auto No. 5.)
Over 1400 already supplied by the G.E.C.

The Strowger Linefinder Service
service requirement and offers
proved reliability, and economy
and maintenance.

ALL-BRITAIN

FOREMOST THROUGHOUT

THE GENERAL ELECTRIC

TELEPHONE WORKS

Head Office: MAGNET HOUSE

OVERSEAS

AUSTRALIA : SYDNEY, MELBOURNE, PERTH. NEW ZEALAND : WELLINGTON
CAPE TOWN, PORT ELIZABETH, DURBAN. CANADA : MONTREAL, TORONTO
LAHORE, CAWNPORE, BANGALORE, TRIVANDRUM, KARACHI, COIMBATUR
CHINA, MANCHURIA & KOREA : SHANGHAI, PEKING, HANKOW

FROM THE SMALLEST

G.E.C.

urers of

OFFICE STANDARD EXCHANGES

em employed satisfies every
be advantages of simplicity,
y in cost, space, weight,
enance.

TISH

HOUT THE WORLD

ELECTRIC CO., LTD.

— COVENTRY

USE, KINGSWAY, W.C.2

ICES:

ON, CHRISTCHURCH, AUCKLAND. SOUTH AFRICA: JOHANNESBURG,
NTINA: BUENOS AIRES. INDIA: CALCUTTA, MADRAS, BOMBAY,
BURMAH: RANGOON. MALAYA: SINGAPORE, KUALA LUMPUR.
KONG, DAIREN. EUROPE: PARIS, THE HAGUE.

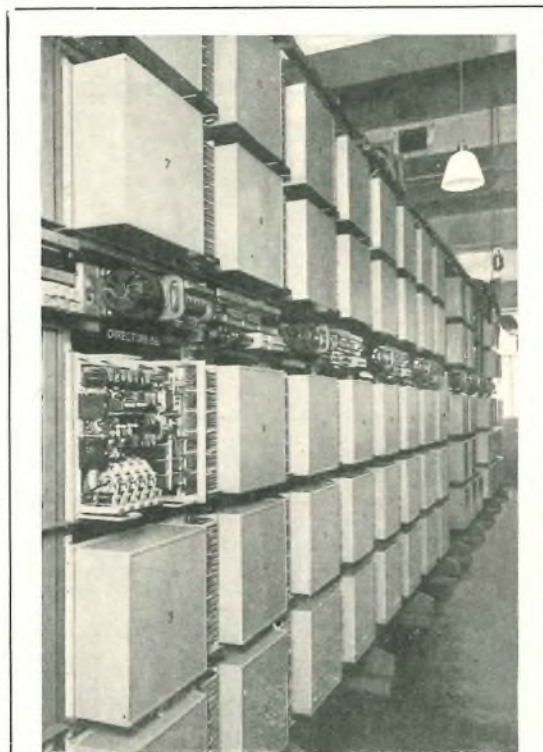

Director Racks at "Flaxman," the first fully equipped 10,000 line Automatic Exchange in London manufactured and installed by the G.E.C.

TO THE LARGEST

INDEX TO ADVERTISERS.

	PAGE		PAGE
Automatic Telephone Mfg. Co., Ltd.	iii	Pitman & Sons, Ltd.	xi
British Institute of Eng. Technology	xv	McGraw-Hill Publishing Co., Ltd.	xi
Chapman & Hall, Ltd.	xvi	Standard Telephones & Cables, Ltd.	x
Ebonestos Insulators, Ltd.	xiv	Siemens Bros. & Co., Ltd.	vi and vii
Elliott Brothers, Ltd.	xvii	Smith, Frederick & Co.	xvii
Ericsson Telephones, Ltd.	v	Telephony Publishing Corp.	xiv
Ernest T. Turner	ix	The Alton Battery Co., Ltd.	ii
Hall Telephone Accessories (1928), Ltd.	xiv	The Electrical Review	iv
Henley's, W. T., Telegraph Works, Co., Ltd.	ix	The General Electric Co., Ltd.	viii, xii & xiii
Pirelli-General Cable Works, Ltd.	xviii		

Hall Telephone Accessories (1928) Limited.

Suppliers to the British Post Office and
- Foreign Government Departments. -

Manufacturers of prepayment telephone
multi-coin collectors, automatic stamp
selling and ticket selling machines,
automatic slot machines and fire alarm
apparatus.

Registered
Office & Works : 70, DUDDEN HILL LANE,
WILLESDEN,
LONDON, N.W. 10

Tel.: WILLESDEN 5141/2.

Moulders to the Trade

*Established
30 Years*

MOULDINGS
IN WHITE OR
COLOURS.
BAKELITE —
BEETLE —
CELLULOSE
AND OTHER
SYNTHETICS.

PLASTIC MOULDINGS HAVING
HEAT — ACID — OIL — ALKALI —
WATER RESISTING QUALITIES.

EBONESTOS INSULATORS LTD

Excelsior Works,
Rollins Street,
Canterbury Road,

Telephone
NEW CROSS 1913 (5 lines) LONDON, S.E.15.



THIRTY-TWO YEARS—

is the span of time during which TELEPHONY has been the telephone industry's leading journal. This high standing has been earned because each issue contains so much valuable information on engineering, construction, commercial and maintenance subjects. TELEPHONY is read by progressive telephone people all over the world. Subscription price £1 5s. for 52 interesting and instructive issues.

Address: Electrical Trading and Electricity Technical Book Dept., 85,
Long Acre, London, W.C. 2, for a sample copy of TELEPHONY.
TELEPHONY PUBLISHING CORP., 608, S. Dearborn St. Chicago, Ill., U.S.A.

The Institution of Post Office Electrical
Engineers.

PRINTED PAPERS.

The following papers contributed to the proceedings of the Institution have been printed by authority of the Council and may be obtained from

The Librarian,
The Institution of Post Office Electrical
Engineers,
G.P.O., Alder House, London, E.C. 4

The prices do *not* include postage.

- No. 130. "COMPOSITE TELEGRAPH AND TELEPHONE WORKING."—J. M. OWEN, A.M.I.E.E., and J. A. S. MARTIN. 1930 ... 1/3
- No. 131. "CARRIER CURRENT TELEPHONY."—Capt. A. C. TIMMIS, B.Sc., A.M.I.E.E. 1930 ... 1s.
- No. 132. "THE HEATING AND VENTILATING OF POST OFFICES AND TELEPHONE EXCHANGES."—W. T. GEMMELL, B.Sc. (Hons.), A.M.I.E.E. 1930 ... 9d.
- No. 133. "RURAL AUTOMATIC EXCHANGES."—J. C. DALLOW. 1929 ... 9d.
- No. 134. "SOUND AND HEARING."—N. F. CAVE-BROWNE-CAVE, B.Sc., M.I.E.E. 1930 ... 1s.
- No. 136. "SOME DEVELOPMENTS IN TELEGRAPH TECHNIQUE AS APPLIED TO RADIO CIRCUITS."—H. FAULKNER, B.Sc. (Hons.), A.M.I.E.E., and G. T. EVANS. 1931 ... 1s.
- No. 137. "INTERFERENCE WITH WIRELESS RECEPTION ARISING FROM THE RECEPTION OF ELECTRICAL PLANT."—Col. A. S. ANGIN, D.S.O., M.C., T.D., B.Sc., M.I.E.E. 1932 ... 6d.
- No. 138. "TELEPHONE CABLE TESTING (INCLUDING FAULT LOCALISATION)." — W. T. PALMER, B.Sc., Wm. Ex., A.M.I.E.E., and E. H. JOLLEY, A.M.I.E.E. 1931 ... 1/3
- No. 140. "SOME NON-METALLIC SUBSTANCES AND THEIR CHARACTERISTICS."—Capt. N. F. CAVE - BROWNE - CAVE, B.Sc., A.M.I.E.E. 1931 ... 9d.
- No. 141. "THE TELEPRINTER No. 7A (Creed Teleprinter)." — R. D. SALMON. 1932 ... 9d.
- No. 142. "PRIVATE BRANCH EXCHANGE INSTALLATIONS." —R. T. A. DENNISON. 1932 ... 1/3

**GUARANTEED
EXAMINATION COACHING**

Since the B.I.E.T. was founded several years ago, we have specialised in preparing candidates for leading Technical Examinations, and our success may be gauged from the fact that over all this period of time, our candidates have returned the remarkable average pass record of

OVER 90% SUCCESSES.

Here are some recent results:—

In the Probationary Inspectors' Examination held in December 1931, 7 out of our 8 candidates were selected for interview.

In the I.E.E. Examination held in May, 1932, 18 out of our 18 candidates passed successfully.

Not one failed.

In the Assistant Superintendent of Traffic (Limited Competition) Examination held in April, the candidate who was placed 1st was trained by this Institute.

*In the Probationary Inspectors' Examination held in December 1932, one of our students obtained **1st place.***

We teach successfully by correspondence and definitely guarantee—

"NO PASS—NO FEE"

You are advised to send for a copy of our General Prospectus "ENGINEERING OPPORTUNITIES." This Hand-book contains 250 pages of most useful information. It also contains particulars of all leading Engineering Examinations, including

Probationary Inspectors (Open and Limited Competition)

Probationary Assistant Engineers (Open and Limited Competition)

Assistant Superintendent of Traffic (Open and Limited Competition)

City and Guilds, Special G.P.O. Examination, I.E.E., B.Sc., A.M.I.C.E., London Matric., etc., etc.

The Hand-book also outlines "up to the minute" courses of Home Study in *all branches* of Engineering.

Special Courses are offered in **Telegraphy, General Telephony, Automatic Telephony, Telephone Transmission, Electrical Technology, Wireless and High Frequency Radio Communication, Alternating Currents, Talking-Picture Engineering, etc., etc.**

Our 250 page Hand-book should be on your Book-shelf. It will be gladly sent on request, FREE and without obligation. (*Please state subject or Examination of most interest.*)

British Institute of Engineering Technology

369, Shakespeare House,
29/31, Oxford Street, London, W. 1

Four Important Books

TELEGRAPHY AND TELEPHONY

INCLUDING WIRELESS COMMUNICATION

BY E. MALLET

D.Sc., M.I.E.E., A.M.I.C.E.

Demy 8vo., 416 pages, 287 illustrations. 21s. net; postage 9d.

"An admirable text-book... We congratulate the author on producing a book which will be indispensable to all serious students of telegraphy and telephony."—*The Wireless Engineer*. "Prof. Mallett's book fills a gap in our technical literature by providing in a single volume an outline of the principles underlying the application of electricity to both line and radio communication."—*Journal of Scientific Instruments*. "The manner in which the subject is developed as one passes through the book from beginning to end is excellent... Prof. Mallett has achieved a remarkable success where many would have failed."—*Science Progress*. "This particular book is a most valuable work. It is arranged in an orderly manner, and where explanations are slightly irrelevant, but nevertheless of value, the author adopts the excellent principle of relegating them to an appropriate appendix... One is struck throughout the book with the evidence of laboratory experiment on telephonic and telegraph apparatus—information which for so long has been unavailable to the layman... It has been impossible to do justice to this book in a short review... enough has been said to show its comprehensive nature. The telegraph engineer in the past has been a specialist of a very narrow type. This book is a sign of the times—the telegraph engineer must enlarge his borders and cultivate a knowledge of mathematics and acoustics, to quote only two special subjects."—*World Power*.

THE HISTORY OF THE TELEPHONE IN THE UNITED KINGDOM

BY F. G. C. BALDWIN,
M.I.E.E.

With a Foreword by FRANK GILL, O.B.E., M.Inst.C.E., M.I.E.E. Medium 8vo., 756 pages, 186 illustrations. 42s. net; postage 1/-.

The author of this work has been intimately associated with the telephone service of this country for the past thirty years, and during that period has had wide experience of telephone engineering work in the provinces and in the metropolis, under the administration of both the National Telephone Company and the Post Office.

The book treats of the commercial and technical development of the telephone since its introduction into this country in 1878 practically up to the present date, and a section is devoted to the latest and remarkable application of telephony in broadcasting.

To the business man, the legislator, the student of social and technical history, as well as to those engaged in the telephone industry and the administration of telephone service, at home or abroad, the book should be equally valuable.

SHORT WAVE WIRELESS COMMUNICATION

BY A. W. LADNER

A.M.I.C.E., and

C. R. STONER

A.M.I.E.E.

Demy 8vo., 360 pages, 214 illustrations. 15s. net; postage 9d.

In presenting a book on the principles of short-wave wireless communication, it is the authors' aim to fill an obvious gap in current literature which shall satisfy the needs not only of engineers and telegraphists engaged in wireless, but cater for the scientific amateur and those who have already an outline knowledge of long-wave wireless working. Although the book deals especially with short-wave communication, the field has not been restricted to the peculiarities of short waves. Rather a self-contained treatise has been aimed at, principles common both to long and short waves being introduced where the matter is necessary for the clearer explanation of the main text. Chapter Headings: Introductory—A Brief History of the Development of Short Waves—Notes on Electro-Magnetic Waves—The Propagation of Short Wireless Waves—The Modulation of High Frequency Waves—Push-Pull—High Frequency Transmitting Circuits. Self-Oscillators—Short Wave Driven Circuits—Constant Frequency Oscillators—Modulation Circuits—High Frequency Feeders—Aerials—Aerial Arrays—Problems of Reception and Simple Receivers—Commercial Receivers—Commercial Transmitters and Circuits—Ultra Short Waves.

PRINCIPLES OF RADIO COMMUNICATION

BY J. H. MOREGROFT

Professor of Electrical Engineering, Columbia University.
Assisted by A. Pinto and W. A. Curry.

Medium 8vo., 1000 pages, 831 illustrations.

THIRD EDITION, REVISED AND ENLARGED.

46s. 6d. net; postage 1s.

All the advances made in radio science and art since the publication of the first edition have been noted and fully described in the revision. The result is a thoroughly up-to-date book, complete in every detail, which every person concerned with the design, production, distribution, operation of radio will want for constant reference. Chapter Headings: Fundamental Ideas and Laws—Resistance—Inductance—Capacity—Shielding—Laws of Oscillating Circuits—General View of Radio Communication—Spark Telegraphy—Vacuum Tubes and Their Operation in Typical Circuits—Continuous-wave Telegraphy—Radio Telephony—Antennæ and Radiation—Amplifiers.

Detailed Prospectuses will be sent free on application.

CHAPMAN & HALL, LTD., 11 HENRIETTA STREET, STRAND, LONDON, W.C.2

Differential Moving Coil MILLIAMMETERS For Telegraph Circuits

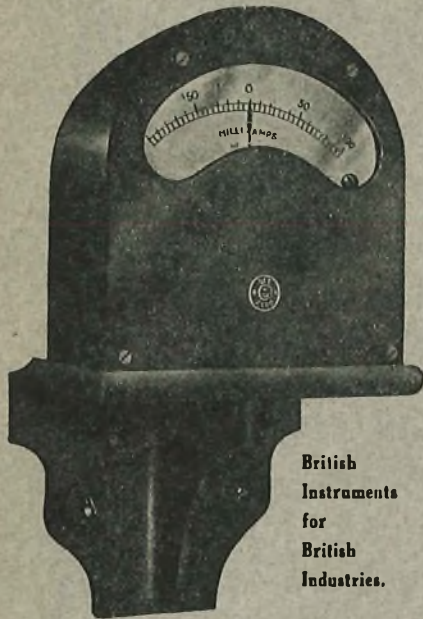

British
Instruments
for
British
Industries.

T. 1098. WALL MOUNTING TYPE.

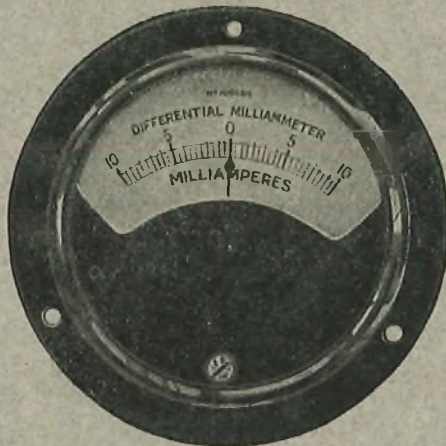

T. 1089. PANEL MOUNTING TYPE.

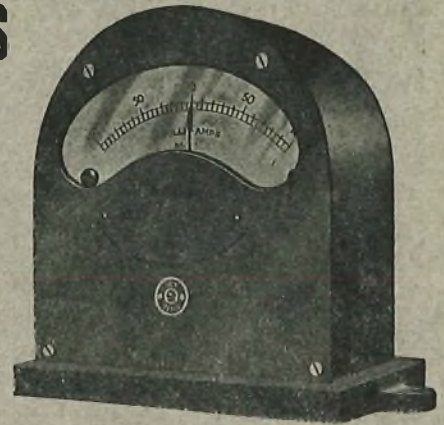

T. 1097. TABLE MOUNTING TYPE.

TABLE, WALL AND PANEL MOUNTING TYPES.

INVALUABLE as line Milliammeters on Differential Duplex, Sub-Audio Frequency and many other Telegraph Systems, also for testing purposes in connexion with Land Line and Radio Communication.

Particulars will be sent on request.

ELLIOTT BROTHERS (London) LTD., Century Works, Lewisham, S.E.13

Telephone:
Lee Green 4646

in association with

SIEMENS BROTHERS & COMPANY, LIMITED, Woolwich, London, S.E.18

Telephone:
Woolwich 1161

ANACOS

REGISTERED

BRONZE & CADMIUM COPPER WIRES

SEND US PARTICULARS
OF YOUR JOB, AND OUR
TECHNICAL ENGINEERS
WILL PROVIDE YOU WITH
THE DATA YOU NEED.

as supplied
to H.M. Post Office for
TELEPHONE LINES

SILICIUM-BRONZE, COPPER

COPPER - CADMIUM

TAPES & BINDERS

FREDERICK SMITH & COMPANY

INCORPORATED IN THE LONDON ELECTRIC WIRE
COMPANY AND SMITHS, LIMITED
ANACONDA WORKS SALFORD 3, LANCs,
Telephone: Blackfriars 8701 (8 lines) Telegrams: "Anaconda, Manchester."

MINUTES MEAN MONEY!

24 MILES OF DOUBLE STEEL TAPE ARMoured STAR QUAD TRUNK TELEPHONE CABLE COMPLETE WITH THE **GENERAL ELECTRIC CO'S** LOADING COILS, HAVE BEEN MANUFACTURED AND INSTALLED FOR THE BRITISH POST OFFICE TO REPLACE LINES DAMAGED IN THE RECENT BLIZZARDS.

MANUFACTURING TIME **2** *Weeks*

INSTALLATION TIME **2** *Weeks*

TELEPHONE
SOUTHAMPTON
2141 (3 LINES).

PIRELLI-GENERAL

CABLE WORKS, Ltd., SOUTHAMPTON.

Proprietors: PIRELLI, LTD., and THE GENERAL ELECTRIC CO., LTD.

TELEGRAMS:
"PIGEKAYBEL,
SOUTHAMPTON."