

MEC

THE MARCONI REVIEW

November-December, 1936



CONTENTS

THE ONGAR PULSE CIRCUIT	- - - - -	PAGE 1
A NOTE ON THE DESIGN OF SERIES AND PARALLEL RESONANT CIRCUITS	- - - - -	„ 7
MERSEA ISLAND SEA CORROSION TESTING STATION	-	„ 12
THE MARCONI FOLDED TOP AERIAL FOR MEDIUM WAVES	- - - - -	„ 19
A HIGH FREQUENCY RESISTANCE BRIDGE	- - -	„ 22
MARCONI VETERANS' EIGHTH ANNUAL MEETING AND REUNION	- - - - -	„ 27
MARCONI NEWS AND NOTES—		
BROADCASTING STATIONS IN INDIA	- - -	„ 31
MARCONI HIGH-POWER BROADCASTING STATION FOR CZECHOSLOVAKIA	- - -	„ 31
NEW COMMERCIAL RECEIVING CENTRE IN SWEDEN		„ 32
MARCONI EQUIPMENT FOR JERSEY AERODROME	-	„ 32

MARCONI'S WIRELESS TELEGRAPH COMPANY LTD.

Electra House, Victoria Embankment, London, W.C. 2

THE MARCONI REVIEW

No. 63.

November-December, 1936.

Editor: H. M. DOWSETT, M I E.E., F.Inst.P.

Assistant Editor: L. E. Q. WALKER, A.R.C.S.

THE ONGAR PULSE CIRCUIT

The following article describes a pulse keying circuit used in conjunction with the 40 kw. Ongar transmitter for ionosphere investigation.

THE pulse circuit here described is so called because it was originally designed to key the 40 kw. transmitter at the Ongar Station of Cable and Wireless, Ltd. With such a high power transmitter scattering effects can be studied which would normally be below noise level with the small self-oscillating type of transmitter used in ionospheric research (see T. L. Eckersley, MARCONI REVIEW, March-April, 1935, pp. 2-3). The circuit has since been used on other transmitters at Ongar and elsewhere, and it is felt that it would be useful to give an outline of the principles involved in the general problem of keying commercial transmitters with short pulses of about 0.0001 sec. duration.

In one sense it is a wasteful process to use a commercial transmitter for pulse transmissions, since for most of the time the power supplied to the transmitter is wasted in the absorber valve during the relatively long intervals between the pulses. The technique of using a series modulated self-oscillating valve transmitter and of increasing the anode voltage so that even on pulses the valve is running near to its maximum limit of dissipation could be developed to produce pulses with a peak value corresponding to the amplitude of a 40 kw. radiation on C.W. In practice, however, it is simpler to make use of the existing transmitters, and there is the additional advantage of their frequency stability and of the availability of big aerials which would be costly to erect and adjust even if a large enough site were obtainable.

General Considerations.

The obvious procedure is to key one of the early stages of the transmitter, usually the sub-absorber stage. The normal keying circuit is replaced by a circuit designed to inject short pulses into the grid circuit of the sub-absorber valve. Assuming that pulses of the required width are successfully produced at the grid it remains to be seen whether the succeeding stages of the transmitter can handle the pulse and finally radiate it at full amplitude and without widening it. This aspect of the problem is not dealt with here, but it is found in general that various transmitters respond excellently. Occasionally some small modification has been necessary, such as the removal of a condenser causing distortion of the pulse.

In designing the pulse circuit it was decided in the interests of stability of pulse width and frequency to use an entirely electrical device rather than any form of mechanical interrupter. A vital factor which emerged early in the experiments is

The Ongar Pulse Circuit.

that the circuit may be called upon to deliver not only volts but power to the grid circuit of the sub-absorber valve. Some transmitters are designed to key up to full C.W. by bringing the grid of the sub-absorber valve up to zero volts, but on the 40 K.W. transmitter at Ongar the grid has to be driven up to 60 volts positive, under which condition a grid current of 30 m.a. flows. This is therefore equivalent to throwing a load of 2,000 ohms across the output of the pulse circuit. Thus the circuit must be designed to give on test a pulse of over 100 volts peak when loaded with a resistance of 2,000 ohms.

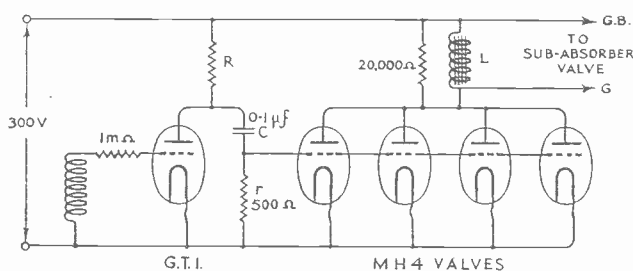

FIG. 1.

It would be possible to use as the basis of the design the Ratcliffe-White pulse circuit described in the MARCONI REVIEW, November-December, 1935, pp. 12-17. (For various reasons which cannot be elaborated here the improved circuit there described would not be feasible in the present case and is not necessary.) This was not done, however, because it was desired to keep the circuit as simple as possible and, as has since proved the case, there may not always be an A.C. power supply available. The Ratcliffe-White circuit is essentially designed to produce pulses locked to the A.C. mains, for which purpose it is ideal as regards perfect locking and phase stability. It is becoming increasingly obvious, however, that a more flexible circuit may be needed in which the repetition frequency can be controlled from a separate and adjustable source. In this respect the circuit actually used is readily adaptable.

Description of the Circuit.

A simple ticking grid thyatron circuit was used and is shown in Fig. 1. The H.T. supply of 300 volts can be obtained from the mains, but the essential point is that it is a D.C. supply. The condenser C, of $0.1\mu\text{F}$ is charged up through a high resistance R. The small resistance r is only 500 ohms, and is made the grid resistance of four M.H.4 valves joined in parallel. The anode load of these valves is a large iron cored choke L capable of standing a steady D.C. current of 50 m.a. through it. A G.T.I. mercury thyatron is joined across C and r and if it is triggered the condenser is discharged through the resistance. As the time constant Cr is 5×10^{-5} sec. the effect is to throw an instantaneous negative voltage on to the grids of the M.H.4 valves which very rapidly dies away.

The M.H.4 valves are chosen because they are completely backed off by quite a small negative voltage on their grids, while four are used in parallel to provide a large total anode current of about 50 m.a. The effect of stopping this anode current

suddenly is to produce a very large voltage surge across the choke L, the anodes of the M.H.4 valves being driven positive with respect to the + H.T. end of the choke. If, therefore, the anode end of the choke is joined to the grid of the sub-absorber valve of the transmitter and the + H.T. end is joined to the normal grid-bias supply of this valve, the voltage surge will appear as positive bias on the grid. The grid will be very rapidly brought up to zero volts, and provided that the energy which has been stored up in the choke is large enough it will be driven sufficiently positive to key the transmitter to full amplitude.

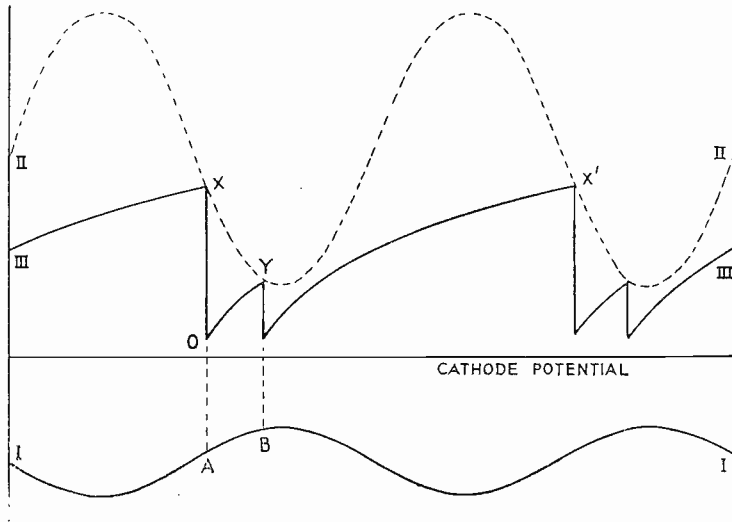

FIG. 2.

The choke chosen for L is a large coil wound on a bundle of iron wires. It is insulated between turns with waxed paper and is in a wooden box filled with paraffin wax. With no load across it this choke develops over a thousand volts when the 50 m.a. feed through it is broken. The M.H.4 valves seem to stand up quite well to this voltage, but as a precaution a permanent load of 20,000 ohms is kept across the choke. In actual use the grid load of the sub-absorber valve when the grid goes positive damps this voltage down heavily, and it is only by using a feed current as large as 50 m.a. and breaking it off rapidly by using M.H.4 valves with their short grid base that one can be sure of getting the necessary positive drive.

In practice it is found that the energy stored up in the choke is enough to drive the grid of the sub-absorber valve positive for about 0.002 sec., and the width of the pulse up to this limit is controlled by the value of the resistance r . If r is made too small the amplitude of the pulse is reduced, but full amplitude is obtained when r is somewhat less than 500 ohms. This is a convenient value as it serves to keep within safe limits the instantaneous current which the thyatron has to pass when C discharges through it. With 500 ohms the width of the pulse as measured on a fast time base on an oscillograph is a little under 0.0001 sec., which is excellent for most likely requirements.

Control of the Repetition Frequency.

Having described the process by which the transmitter is made to radiate a pulse whenever the condenser C is discharged through the resistance r , there remains the consideration of the method by which the thyatron is triggered at any desired repetition frequency. Taking for simplicity the case when the pulses are to be locked to the 50 cycle mains, it would be possible to inject a small A.C. voltage into the grid circuit and to adjust the time constant of the C R circuit and the grid-bias on the thyatron so that the natural period of the circuit is nearly 50 cycles (as when a similar circuit is used for an oscillograph time base). There is, however, the danger that the circuit may become unlocked and either drop to 25 cycles or produce two or more irregularly spaced pulses each cycle.

The production of such multiple pulses may be seen diagrammatically in Fig. 2. Curve I represents the grid potential of the thyatron, and the inverse dotted curve II represents the corresponding anode flashing potentials. Curve III shows the actual anode potential governed by the charging of the condenser C through the resistance R. The thyatron will flash at the point X when the grid potential is at the point A. The anode potential drops to O and the thyatron extinguishes because it has the high feed resistance R. The condenser then starts to charge up again, and the curve II may cut the curve III again at the subsidiary point Y due to the fact that the grid potential is still being brought towards zero and has reached the point B corresponding to Y. In a similar way more than one of these subsidiary points can be obtained between X and X¹, the corresponding point in the next cycle. It is also obvious that if the constants of the circuit are adjusted to avoid this trouble the point X may get so near to the bottom of the curve II that we may sometimes drop into the condition where curve III only cuts curve II every other cycle. In practice the margin between going over into multiple pulses on the one hand and dropping to half the frequency on the other is only small.

As, however, the circuit must work unattended for long periods it must be made absolutely safe in this respect. One method would be to keep the grid of the thyatron backed off so that it would not flash even when the condenser is fully charged, and then to inject a sharp pulse on to the grid by sharpening up in some way an A.C. voltage. But in a sense this involves producing what we are trying to make the whole circuit produce, and would in any case introduce complications and problems of phase variations.

The difficulty has been very simply solved by using the thyatron with no permanent grid-bias and injecting a large A.C. voltage of say 100 volts peak, the grid itself being protected by a high resistance of 1 m Ω as in Fig. 1. Under these conditions the grid follows the negative half-cycle but remains effectively at zero volts during the positive half-cycle. The thyatron will flash when the grid is still a few volts negative, but the grid is then rapidly brought up to zero before the condenser has charged up appreciably after the thyatron has extinguished. Now it is found that if R is made big the condenser does not charge up while the grid of the thyatron is held at zero volts during the positive half-cycle. This is because the thyatron passes an electron current, as in an ordinary valve, sufficiently big to prevent the condenser charging up again through R.

An example will make this clear. At Ongar where the circuit is locked to the mains R is made 0.5 m Ω . With the supply of 300 volts the condenser C of 0.1 μ F is

The Ongar Pulse Circuit.

charged up to about 50 volts during the negative half-cycle on the grid. This gives an ample voltage on discharge through the resistance r of 500 ohms to back the M.H.4 valves right off. It is found that even if R is reduced to $0.05 \text{ m}\Omega$ the pulses are still perfectly locked and there is no sign of multiple pulses. With only a small A.C. grid swing and no permanent bias there would be little danger of dropping to half-frequency, but a big risk of obtaining multiple pulses due to the relatively long time taken for the thyatron grid to be brought to zero volts after the moment of flashing. By making R $0.5 \text{ m}\Omega$ and using a large grid swing we can safely rely on the electron current taking charge and preventing the condenser from charging up again until the end of the positive half-cycle.

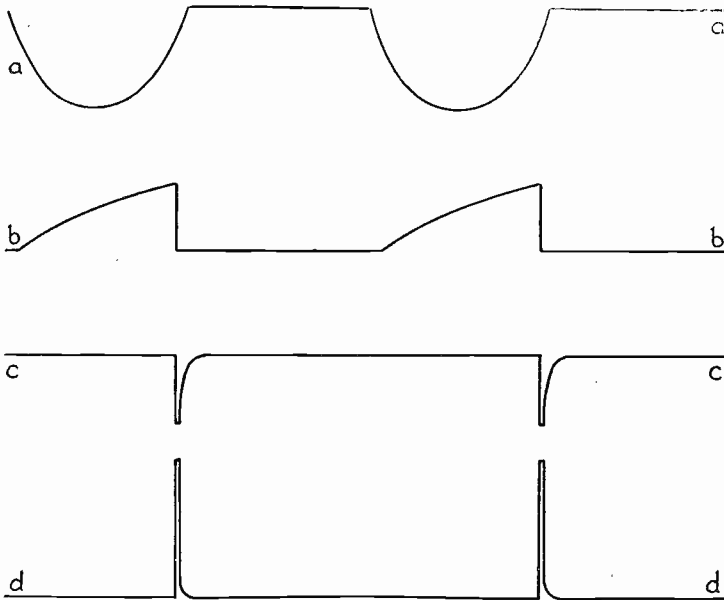

FIG. 3.

In constructing the circuit it is wise to test it out on an oscillograph to verify that it is behaving in accordance with these principles. The behaviour of the circuit should be given by the scheme shown diagrammatically in Fig. 3, in which (A) (B) (c) and (D) represent the following :—

- (A) The grid voltage of the thyatron.
- (B) The anode voltage of the thyatron.
- (c) The grid voltage of the M.H. 4 valves.
- (D) The anode voltage of the M.H.4 valves, i.e., the grid voltage of the sub-absorber valve, allowing for the load thrown back on the output.

Conclusion.

The simplicity and adaptability of the circuit are now apparent. For instance, the circuit has been used at the Dorchester Transmitting Station where there is

The Ongar Pulse Circuit.

no mains supply and an independent 300 volt H.T. supply has to be used. As it is desired to lock the pulses to the Chelmsford grid supply the London A.C. mains (which are locked with Chelmsford) are fed via a transformer over telegraph wires giving a 100 volt swing on the secondary of the line transformer at Dorchester. The resulting synchronism between Dorchester and Chelmsford is almost perfect. It is obvious that any other repetition frequency can be obtained by injecting into the thyatron grid circuit from a local oscillator. In this case the rule is to adjust R so that the condenser C still charges up to about 50 volts during the negative half-cycle, i.e. for any frequency f , R should be adjusted to $0.5 \times 50/f = 25/f \text{ m } \Omega$.

The following points may be noted as the result of experience in actual use :—

- (1) Provided that the later stages of the transmitter handle the pulse properly the resulting high frequency pulse has very sharp sides with no tail. This is due partly to the fact that the D.C. drop across the choke due to its ohmic resistance (in our case 2,000 ohms) when the normal feed of 50 m.a. is passing provides additional bias on the sub-absorber valve between pulses.
- (2) The synchronism is extremely good, the phasing being practically perfect. This is due to the fact that the moment when the thyatron flashes is controlled by the grid at a time when its potential is changing most rapidly. Small changes in the anode circuit conditions therefore produce only second order variations in phase.
- (3) The circuit is simple and certain in operation. The thyatron runs under very light conditions since its anode is only raised to 50 volts and the maximum instantaneous current through it when the condenser C discharges is limited by the resistance r of 500 ohms to 0.1 ampere. The circuit successfully keys the 40 k.w. transmitter at Ongar to full amplitude despite the fairly heavy load imposed by the sub-absorber grid circuit.

Other transmitters requiring less grid current have been keyed equally well, and should the circuit be required at any time to give a bigger power output, the necessary modifications should be fairly simple.

G. MILLINGTON.

A NOTE ON THE DESIGN OF SERIES AND PARALLEL RESONANT CIRCUITS

In "The Radio Engineering Handbook" by Keith Henney, 1935, a most useful method is given of evaluating the constants of either a series or parallel resonant circuit where two specific values of the impedance of the circuit are required at two frequencies. The method and curves given in this Handbook are possibly not sufficiently explicit for some readers, and it is the purpose of the following note to present a slightly different method of computation.

Series Resonant Circuit.

THE modulus of the impedance of a circuit shown in Fig. 1 can be written as

$$|Z| = \sqrt{R^2 + \left(\omega L - \frac{1}{\omega C} \right)^2} \quad (1)$$

and the argument (or phase angle) of the impedance as

$$\phi = \tan^{-1} \frac{\omega L - \frac{1}{\omega C}}{R} \quad (2)$$

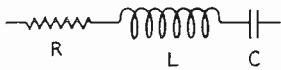

FIG. 1.

If we define the resonant frequency of the circuit as

$$\frac{\omega_r}{2\pi} = f_r, \quad \omega_r^2 = \frac{1}{LC}$$

the Q value of the inductance as $Q = \frac{\omega_r L}{R}$, and introduce a constant $\omega' = \frac{\omega}{\omega_r}$, we have from (1)

$$\frac{|Z|}{\omega_r L} = \frac{1}{Q} \sqrt{1 + Q^2 \left(\omega' - \frac{1}{\omega'} \right)^2} \quad (3)$$

an equation which is identical to equation 15, page 139 in the Handbook. Similarly ϕ may be written

$$\phi = \tan^{-1} Q \left(\omega' - \frac{1}{\omega'} \right)$$

From a design point of view, it is generally required to find values of L , C and R , knowing that $|Z|$ must have fixed values at two different frequencies corresponding to, say, ω_r and ω' .

Thus, taking the example given in the Handbook on page 140, it may be required to design a series resonant circuit to have $|Z_r| = 100$ ohms at $\omega_r = 2\pi \times 1000$ and $|Z| = 500$ ohms at $\omega' = 2\pi \times 900$, or $\omega' = .9\omega_r$. The curve given on page 139 of

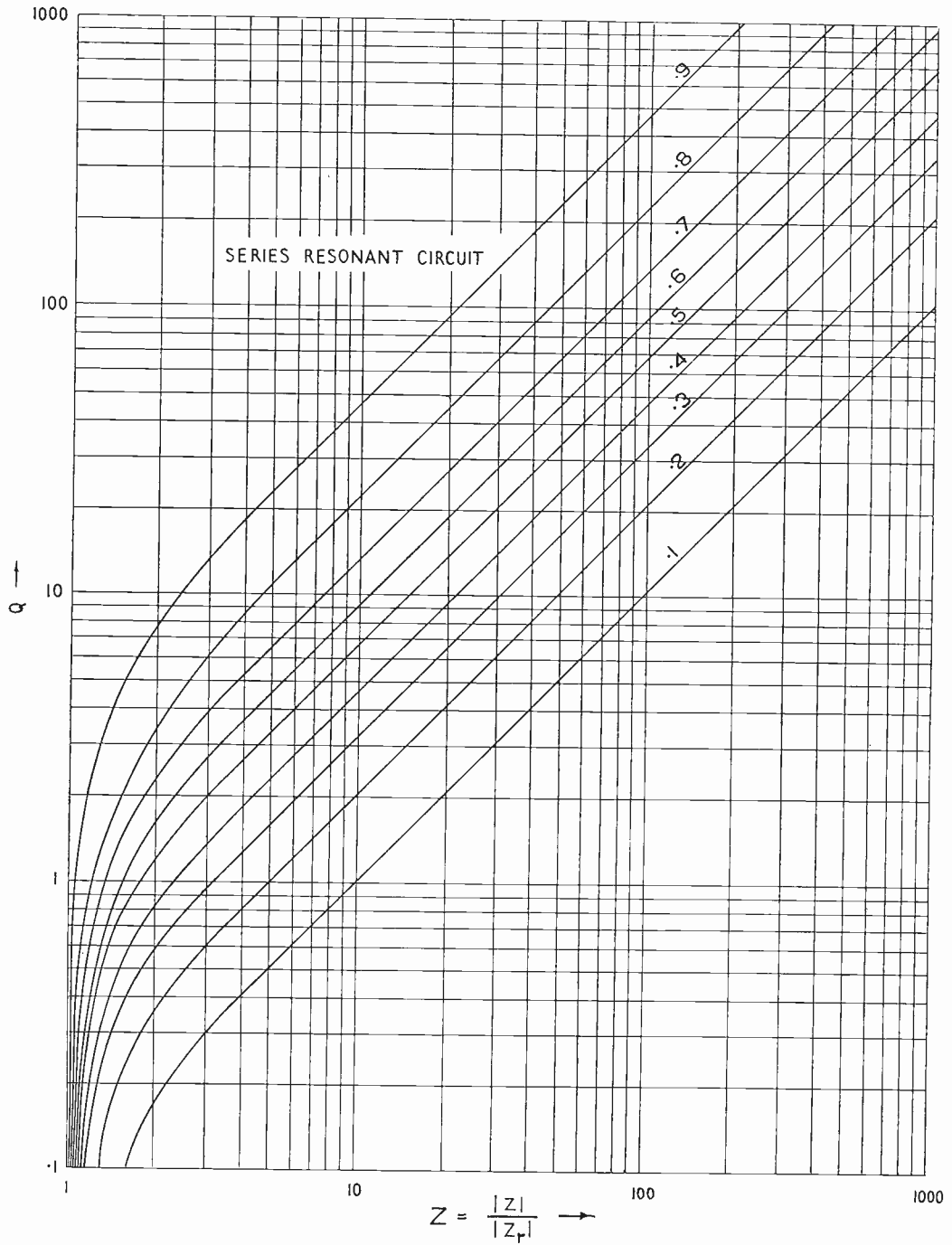

FIG. 2.

the Handbook can only be applied easily in those regions where $\left| \frac{Z}{\omega_r L} \right|$ is constant, or substantially so, for all Q's. If, however, we plot Q's against values of the ratio $\left| \frac{Z}{Z_r} \right|$ for different values of ω' we can obtain results more easily.

Referring to (3)

$$|Z| = |Z_r| \text{ when } \omega' = 1$$

Hence (3) becomes

$$\frac{|Z_r|}{\omega_r L} = \frac{1}{Q} \text{ (or } |Z_r| = R) \tag{4}$$

Hence

$$\left| \frac{Z}{Z_r} \right| = \sqrt{1 + Q^2 \left(\omega' - \frac{1}{\omega'} \right)^2} \tag{5}$$

a relation which we can plot as in Fig. 2.

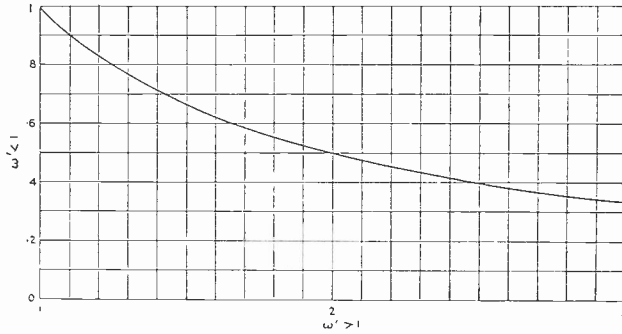

FIG. 3.

Applying this to the example quoted above. For $\frac{Z}{Z_r} = 5$ and $\omega' = .9$ we can read from the curves at once that $Q = 23$. But $Z_r = 100$, hence $R = 100\omega$ (from (4)). Also $L = Q \frac{R}{\omega_r} = \frac{23 \cdot 100}{2\pi \times 1000} = 0.366$ Hy. and C from $C = \frac{1}{L\omega_r^2} = 0.692 \mu fd$.

For values of $\omega' > 1$ we can still use the set of curves given in Fig. 2 by choosing that curve for $\frac{1}{\omega'}$. Thus for $\omega' = 2$ (i.e., if we are concerned with a frequency twice as great as the resonant frequency) we may use the curve for $\omega' = .5$. The relation between $\omega' > 1$ and $\omega' < 1$ for which the same curves hold, is shown in Fig. 3.

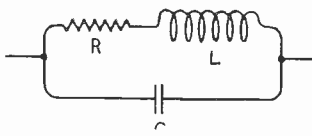

FIG. 4.

Parallel Resonant Circuit.

For the parallel resonant circuit as shown in Fig. 4 we have

$$|Z| = \sqrt{\frac{R^2 + \omega^2 L^2}{(1 - \omega^2 LC)^2 + \omega^2 C^2 R^2}} \tag{6}$$

$$\text{and } \phi = \tan^{-1} \left(\omega CR - \frac{\omega L}{R} + \frac{\omega^2 LC}{R} \right) \quad (7)$$

Putting into (6) the constants Q , ω' and ω , as before, we have

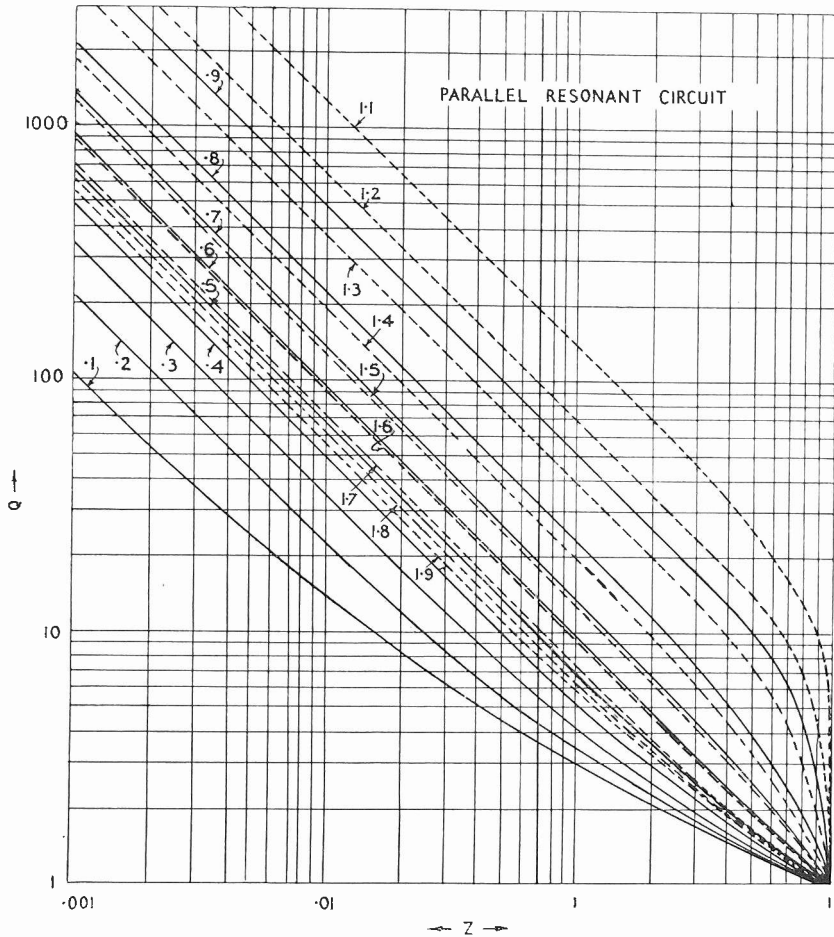

FIG. 5.

$$\frac{|Z|}{\omega_r L} = \sqrt{\frac{1 + \omega'^2 Q^2}{\omega'^2 + Q^2(1 - \omega'^2)^2}} = \frac{\sqrt{\frac{1}{Q^2} + \omega'^2}}{\omega' \sqrt{\frac{1}{Q^2} + \omega'^2 + \frac{1}{\omega'^2} - 2}} \quad (8)$$

an equation which is identical to (30A) on page 145 of the Handbook. Actually (8)

is only true if we make the approximation that $\omega_r^2 = \frac{1}{LC}$ in place of the correct value $\omega_r^2 = \frac{1}{LC} - \frac{R}{L}$. For high Q values the first is near enough.

Putting $\omega' = 1$ into (8), we have

$$\frac{|Z_r|}{\omega_r L} = \sqrt{1 + Q^2} = Q \text{ approximately.}$$

Hence
$$\frac{|Z|}{|Z_r|} = \sqrt{\frac{1 + \omega'^2 Q^2}{\omega'^2 Q^2 + Q^4 (1 - \omega'^2)^2}} \tag{9}$$

or
$$\left(\frac{|Z|}{|Z_r|}\right)^2 = \frac{\frac{1}{\omega'^2} + Q^2}{Q^2 + Q^4 \left(\frac{1}{\omega'} - \omega'\right)^2}$$

In this case again we may plot $\frac{|Z|}{|Z_r|}$ against Q for various values of ω' , and from the family of curves thus obtained we can calculate the Q value of the coil, and hence the circuit constant for any given ratio $\frac{|Z|}{|Z_r|}$ at two selected frequencies given by

$$\omega' = \frac{f}{f_r}$$

Let us take as an example the case of a parallel resonant circuit to possess an impedance of 1,000 ohms at the resonant frequency of 1,000 \sim , and to possess an impedance of 10 ohms at a frequency of 500 cycles. From the curves of Fig. 5 for $\frac{f}{f_r} = \omega' = .5$ and $\frac{|Z|}{|Z_r|} = .01$ we have $Q = 66$. Hence $L = \frac{|Z_r|}{Q\omega_r} = .0025$ Hys.

Also from $RQ = \frac{\omega_r L}{Q}$ we have $R = .23$ ohms, and from $C = \frac{1}{L\omega_r^2}$ we have $C = 10\mu fd$.

It will be noticed in (a) and Fig 5 that no simple relation exists between $\omega' > 1$ and a corresponding value of $\omega' < 1$. Therefore in Fig. 5 curves have been drawn for all values of ω' from .1 to 2.

L. E. Q. WALKER.

MERSEA ISLAND SEA CORROSION TESTING STATION

During the last six years over two hundred specimens of materials, component parts, etc., used by the Marconi Company have been exposed under various conditions at the Mersea Island Test Station, with the result that the materials employed in Marconi apparatus have been tested under actual working conditions for a minimum period of twelve months.

To keep abreast of the rapid strides in the development of new materials, samples are obtained towards the end of the experimental stage and subjected to an appropriate test, thus ensuring that first-hand information is available and a decision can at once be made regarding its properties when a new product is placed on the market, with a view to replacing an inferior and often more expensive material. By this procedure, full advantage is taken of the latest advance in the sciences associated with radio engineering.

The Deterioration of Materials under Sea Air, Sea Water and Tropical Conditions.

MARCONI apparatus is installed in practically all countries throughout the world and has to function efficiently under the most varied climatic conditions. At temperatures rising to 150° F., down to minus 40° F., in countries where the average annual relative humidity is over 85 per cent. and under the destructive agency of the atmosphere prevailing in ships at sea.

In permanent receiving station on land the problem is not so difficult as the most delicate parts are usually placed in a chamber where the air is dried artificially. But in the case of mobile sets such as portable, military, aeroplane and ships sets, this is not possible, so that the materials employed must be capable of withstanding all the above conditions.

Deterioration due to Sea Water and Sea Air.

The results obtained by artificial tests, although of some value, do not truly represent what takes place under actual working conditions.

To illustrate this point, an artificial test for sea water corrosion is described below.

The specimens are sprayed with synthetic sea water for a certain period and then the spray turned off for another period. In this test three conditions which go towards the acceleration of deterioration are missing. In the first place the sea water is just a solution of common salt and water. Even if it were taken from the sea, and used repeatedly, it would lose certain gases which are present in sea water. Secondly, the specimen is at more or less the same temperature during the test period; under working conditions a material might be subjected to a temperature variation of 50° F. This is very important in the case of a protective coating on steel against the corrosive action of sea air and water. As an example, we will take the case of a paint which has to protect the steel work of masts supporting the aerials at a wireless station near the sea coast. On a very hot day the temperature of the steel work might reach 110° F. and at night time fall to 60° F., with the resultant expansion

Mersea Island Sea Corrosion Testing Station.

and contraction of the steel, which tends to stretch the protective coating. At the same time the heat causes the coating to lose its flexibility and in due course fine cracks appear in the coating, thus exposing the steel to the corrosive action of the sea air. Thirdly, in the artificial test the action due to direct sunlight is absent; this is another important point, as nearly all paints discolour and partially disintegrate under the action of sunlight.

In addition to the three conditions referred to, gases such as hydrogen sulphide, chlorine and ozone, all of which are associated with sea air, are not present under artificial testing conditions.

On investigation it was found that most authorities regarded artificial testing as being an indication as to the "resistance to corrosion properties" of materials, but that such tests might fail to reveal certain corrosive actions which take place under actual working conditions.

As a result of the above investigations, Mersea Island Sea Corrosion Test Station was established, to provide facilities where specimens of materials could be exposed under all conditions likely to be met with in actual service. Mersea Island is about ten miles south of Colchester. The station is situated on the east side of the island at the mouth of the River Colne. This site is almost ideal for the following reasons:—

1. It is inaccessible to the general public, i.e., specimens are not damaged or interfered with.
2. No buildings are likely to be erected as there is a mud beach, which makes it unsuitable for bathing.
3. There is a rise and fall of tide of six feet very close to the station.
4. Large areas of mud are exposed at low water, from which emanates ozone, hydrogen sulphide, etc.
5. Provision can easily be made so that specimens could be immersed in running water, i.e., in the tideway.

When the station was established it was considered that tests under the following conditions would be necessary:—

1. Total or partial immersion in running sea water.
2. Alternative immersion in sea water and exposed to sea air and its associated gases with direct sunlight.
3. Exposure to sea air, associated gases and sunlight, but not in direct contact with sea water or spray.
4. Exposed to sea air and sunlight, but protected from rain and spray.
5. Exposed to sea air, but protected from rain and sunlight.

To provide for No. 1 a raft is moored near the channel where the tide runs at a maximum of four knots.

In connection with tests carried out under this condition, in the case of sea water in contact with certain metals, investigation indicates that there is some relation between the rate of corrosion and the velocity of the sea water. It would appear that maximum corrosion takes place when the sea water is running at somewhere between two and four knots.

Mersea Island Sea Corrosion Testing Station.

For No. 2 a test bench is erected on the beach to which specimens can be secured ; at high water (spring tides) this bench is covered to a depth of five feet, and the specimens are totally immersed for an average period of two hours at each tide ; in a twenty-four hour period specimens are immersed for four hours and exposed to sea air, sunlight, etc., for twenty hours.

For condition No. 3 specimens are secured to a sloping wood frame which is inclined at an angle of 45° to the horizontal and faces due south so that the action of direct sunlight is at a maximum.

Specimens exposed under No. 4 are placed inside the station building on shelves underneath a window which faces due south.

Other shelves inside the station are so placed that specimens do not receive direct sunlight, so providing for condition No. 5.

All five conditions are fulfilled in practice and it depends on how and where a material is used as to which condition it should be exposed under. It has been suggested that tests under these five conditions are not necessary, for instance, that a test under No. 2 condition would cover the conditions called for under No. 3, i.e., that if a material would stand up to No. 2 it would certainly meet conditions under No. 3, with the advantage that results would be obtained in a shorter period of time, and that tests could be carried out to ascertain (as an example) how long it would take for a protective coating to break down under conditions Nos. 2 and 3 and then employ No. 2 as an accelerated test for No. 3.

This is not quite true in the case of a protective coating. Under No. 2 test erosion takes place due to small particles of sand or mud in the sea water ; the continuous washing of the specimen as the tide ebbs and flows gradually wears away the protective coating ; this would not be a condition in the case of a protective coating on the steel work of a mast situated near the coast. Corrosion due to sea air, associated gases and sunlight would take place, but there would be no erosion present.

In the same way No. 3 could not be used as an accelerated test for No. 4. Having provided means for carrying out tests under the various conditions, the question arose as to shape of specimens, method of preparing and of securing to test benches, also how to measure the extent of corrosion.

So far as test for corrosion are concerned, specimens can be grouped under two headings :—

- (1) Materials where it is claimed that a protective coating is not necessary. This heading would cover certain aluminium alloys, copper aluminium alloys and stainless steel, etc.
- (2) Materials which serve as a protective coating against corrosion of metals and the deterioration of woodwork, etc.

With regard to (1), no special shape is necessary nor is any particular preparation required. In the case of cast rod or forged bar, it is usual to have a part machined, thus exposing the inside of the material, where possibly a screw thread is cut, as a sharp edge is more prone to corrosion than a rounded edge. In securing the specimen to the test bench, it is essential that no metal of a dissimilar composition be employed

Mersea Island Sea Corrosion Testing Station.

or electrolytic action may take place. It has been found from experience that the best method is to clamp the specimen down to the test bench with teak wood battens.

In the case of (2) greater precautions are necessary. It will be appreciated that it is desirable to cover a specimen with a protective coating in the same manner as the coating will be employed under working conditions.

The most vulnerable parts of steelwork to corrosion are sharp corners and edges, as the thickness of the coating in such places is much thinner than elsewhere. In practically all steel structures, bolts and nuts are employed, and rust invariably first appears on the screw thread of a bolt. It is, therefore, advisable to have a bolt and nut as part of a specimen.

When a test on a protective coating or paint is to be carried out, the following method has been adopted as standard practice.

A piece of mild steel sheet 6 inches by 6 inches by $\frac{1}{16}$ inch thick has a hole drilled in the centre; this is mounted on a mild steel rod 6 inches long by $\frac{1}{2}$ inch in diameter (which is screw-threaded the whole length) by two nuts; both sides of the sheet are then sandblasted, including the two nuts and the projecting screw threads; after this process the protective coating is applied; the whole surface on the top side of the specimen is covered, as are also all edges extending for a margin of 1 inch on the underneath side; part of the specimen is left uncovered so that at the end of the test it can be observed if the rust has crept underneath the protective coating. The coating is now allowed to dry out, for the time specified by the manufacturer of the paint in question.

The specimen is then mounted on a metal base, which is, in turn, secured to the test bench.

It will be seen from the above that from the time when the specimen has been secured to the steel rod, until the paint has dried, it has not been necessary to handle it in any way whatsoever, thus avoiding finger marks, etc., during its preparation. The specimen can be mounted so that the paint or coating is only in contact with the elements to which it is being exposed.

When the respective merits of two or more protective coatings are being compared a further precaution is necessary.

After the sandblasting operation, the bare metal is exposed to the atmosphere and the surface will oxidise rapidly. In view of this, for a fair comparative test, it is essential that the time elapsing between sandblasting and the application of the coating shall be the same for all specimens. A note should be kept of the relative humidity of the atmosphere, so that if all the specimens cannot be completed on the same day, the remainder can be completed when the humidity is the same as that noted when the first specimens were prepared.

It will be appreciated that this is necessary because the humidity, day by day, may vary from 60 to 90 per cent.

In comparative tests the specimens are always cut from the same steel sheet.

Measurement of Corrosion.

The extent of corrosion is obviously a function of time and the conditions under which the specimen is exposed.

Again the time of exposure is a function of the useful life of the apparatus in which the material is employed.

The present-day development of new materials and new processes is so rapid, as also is the advancement in the science of engineering, that the useful economic life of apparatus is much shorter than it would have been, say, twenty years ago.

For the same power, dimensions have been decreased, weight reduced, and overall efficiency increased, with the result that a piece of apparatus may become obsolete in five or six years.

It was, therefore, necessary to fix on a test period which had some relation to the useful life of the apparatus on which any particular material would be employed.

It is considered that if a material does not show any sign of deterioration after it has been under test for twelve months, it will probably, under ordinary working conditions, serve its useful purpose until the apparatus into which it is built becomes obsolete. This is, of course, not quite true for paints employed to protect steel structures, but it will give some indication as to when the steelwork will require repainting.

The twelve months period has only been adopted as a general rule to enable comparisons to be made.

In special cases the period is extended ; in fact, several materials are still under test after three years' exposure.

Having determined a practical exposure period, the problem then arose regarding the method to be employed to measure the extent of corrosion ; measurement by comparison is often sufficient when it is just a question of employing one of two materials, but comparisons do not convey very reliable information when recorded.

The following method, although not strictly accurate, has proved a good practical guide regarding the "resistance to corrosion properties" of materials where no protective coating is employed, such as stainless steel, aluminium and copper alloys, etc. Corrosion due to sea air and sea water proceeds in two directions : (1) oxides of the metal in question are formed, resulting in a reduction in weight of the specimen ; (2) corrosion depressions appear on the surface of the specimen of various areas.

The method of measurement is a combination of weighing before and after exposure, and an estimation of the area on the surface of the specimen occupied by corrosion depressions. In estimating the corrosion depression areas a microscope with one magnification only is employed, i.e., 10 diameters. The result of a corrosion test are recorded as follows :—

If at the end of twelve months' exposure a specimen has not decreased in weight and there are no signs of corrosion depressions as viewed under the microscope, the specimen is stated to be 100 per cent. resistant to corrosion. If, on the other hand,

there is a loss of weight of 10 per cent. and it is estimated that the corrosion area is 15 per cent. of total area of the surface of the specimen, the specimen is stated to be 75 per cent. resistant to corrosion. In the case of a protective coating, it is not necessary to weigh the specimen as the coating may break down without loss of weight, but the area of rust spots as they appear are logged every twenty-eight days and the final report is compiled from these entries at the end of the exposure period.

These methods have been in operation during the past six years and in general meet most of the requirements called for.



FIG. 1.

Fig. 1 shows a general view of the Mersea Island Test Station. The test benches for the sea water immersion test can be seen just to the left of the notice board.

The photograph was taken at low water ; at high water the bottom of the notice board is just awash.

Deterioration Due to Atmospheric Conditions in Tropical Climates.

The worst condition is where there is a combination of high temperature and high relative humidity ; specially is this so when the nights are comparatively cold. At the close of a hot day, with high humidity, the water vapour suspended in the air condenses and penetrates to the innermost parts of a piece of apparatus. Unprotected parts will corrode or rust and unsuitable insulating materials disintegrate. A heavy downfall of rain on a portable radio receiver will do far less harm than exposure to the above conditions.

Insulation consisting of cotton or silk fabric impregnated with linseed oil varnish is particularly susceptible to conditions prevailing in tropical climates, although it is a very good and suitable insulation in temperate zones. Pure rubber insulation is another unsuitable material. It rapidly disintegrates in hot, damp climates, particularly when exposed to direct sunlight.

There are numerous other materials which fail in the tropics, but the above examples will serve to illustrate the fact that certain materials which are suitable

in this country fail completely in other parts of the world. Another trouble which we are not faced with in temperate zones is the damage caused by white ants, and it is only through experience that it can be ascertained as to whether these insects will attack a given material or not.

During the past four years materials have been exposed in tropical atmospheres by the Marconi Company's engineers during the time they are in charge of the erection of radio stations in tropical countries. This procedure has certainly helped in the choice of materials, but is not entirely satisfactory owing to the time element. The engineer in most cases completes the station before definite results have been obtained. It was therefore decided to establish a permanent tropical test station. For several convenient reasons, Akure, in Southern Nigeria, West Africa, was chosen, the position being latitude $7^{\circ} 12'$ north, longitude $5^{\circ} 4'$ east, from which it will be seen that it is situated only some four hundred miles north of the equator. The climate is definitely tropical with a minimum relative humidity of 80 per cent. and a temperature of 110° F. White ants are included amongst the insect inhabitants. It is therefore eminently suitable as a site for a tropical test station.

At the Akure Tropical Test Station provision has been made for the exposure of specimens under the following conditions:—

1. Humid atmosphere up to a maximum of 90 per cent. humidity. Direct sunlight, high temperature, up to 140° F., rain, gases from tropical plants, and placed in such a position that white ants, etc., have access to the specimens.
2. Protected from rain, direct sunlight and other outdoor conditions with temperature up to 110° F.

Again twelve months has been chosen as being a suitable exposure period for the same reasons referred to in connection with the sea corrosion test station.

In the case of insulating materials, the usual electrical tests are applied before the specimen is exposed and the results compared with those obtained at the end of the test period. For other materials special tests are carried out before and after exposure, the nature of the test depending upon the duty for which the material is required.

To represent Arctic conditions, where very low temperatures prevail, artificial methods are employed. Tests are carried out on materials and component parts at temperatures down to -40° F. for a period of twenty-four hours. So far as experience counts, there does not appear to be any reason to suspect that an artificial low temperature test does not meet actual working conditions.

F. E. ROBINSON.

THE MARCONI FOLDED TOP AERIAL FOR MEDIUM WAVES

The following note describes a new type of aerial for medium wavelengths which has been developed by the Marconi Company and used recently in several cases with gratifying results.

WHERE high mast radiators are unsuitable, either because of economic or other reasons, it is common practice to employ a T aerial whose natural period, above earth, is the working wavelength. This well known type is satisfactory provided the horizontal member does not exceed an overall dimension of 0.25λ , that is 0.125λ on either side of the vertical member. This implies that the vertical member must not be less than approximately 0.375λ : if the vertical part is made shorter the unwanted radiation from the increased horizontal member simply takes away from wanted field strength.

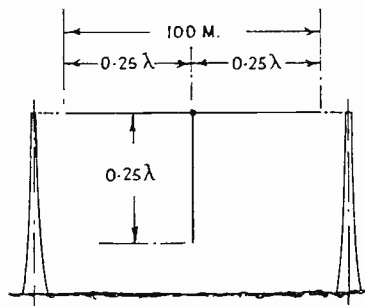

FIG. 1.

Perhaps the most familiar type of T aerial oscillating on the half wave mode is the inverted quarter wave aerial in which the length of vertical equals the length of either half of the horizontal member (see Fig. 1); such an aerial possesses marked anti-fading properties when compared with the plain earthed quarter wave aerial of similar height. However, it has been shown by Mr. E. B. Moullin in a recent I.E.E. paper* that the horizontal member contributes 9 ohms to the radiation resistance without contributing to the direct ray service.

He goes on to state:—

“The radiation from the roof (horizontal member) thus represents an unnecessary waste of power for direct ray communication, and an increase of interference for regions outside the desired service area of the station. It would be an advantage in every way to repress the radiation from the roof. Folding the top reduces radiation resistance from 41.4 ohms to 32.4 ohms, a saving of 22 per cent.”

* Proceedings Institution Electrical Engineers; Vol. 78 (1936), pages 553 and 554.

The Marconi Folded Top Aerial for Medium Waves.

If the dimensions of the top are substantially reduced by folding, the power, otherwise dissipated, becomes available as useful radiation from the vertical member, and the horizontally polarised radiation from the top is reduced, leading

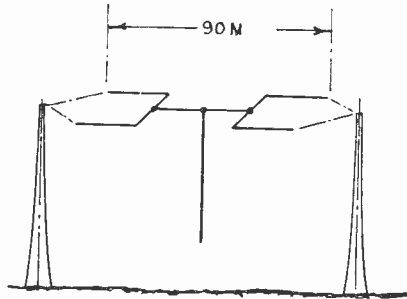

FIG. 2.

to less interference outside the direct ray area, a point of major importance when high-power transmissions are under consideration.

The figure of 22 per cent. is, of course, a value reached when there is complete elimination of top radiation ; in practice simple folding is only partially effective,

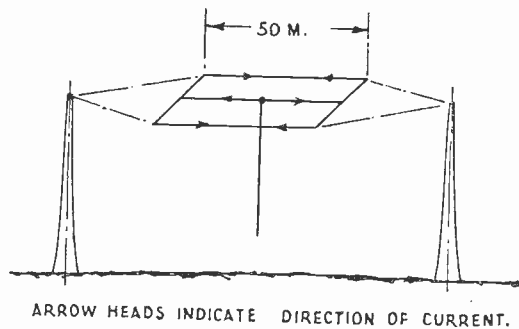
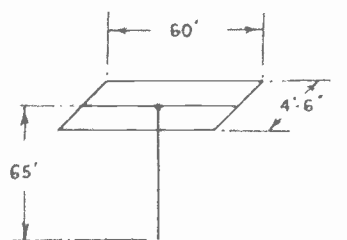

FIG. 3.

but in the Marconi Top the aim has been to suppress radiation almost completely by a symmetrical disposition of the two folded halves about the centre point, and by a more complete cancellation of current amplitude values ; thus, where current is of high amplitude the conductor is single, and where, upon reversal of direction by folding, current is of low amplitude the conductors are duplicated. The process of the idea is indicated in the sequence of Figs. 1, 2 and 3, which show aerials oscillating on a common natural frequency and having vertical members of identical length. If Fig. 1 is an ordinary inverted quarter-wave aerial oscillating

The Marconi Folded Top Aerial for Medium Waves.

on 200 metres, it will be assumed for simplicity that the overall length of the top member is 100 metres; in Fig. 2, the more advantageous disposition of single and double wires, that is, of inductance and capacity, reduces this to some 90 metres, while in Fig. 3 the completion of the Marconi Folded Top reduces the overall length of 50 metres, with an effective cancellation of current values.



DIMENSIONS FOR λ OF 98 METRES.

FIG. 4.

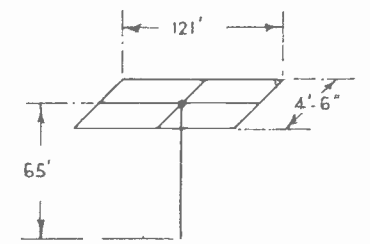

DIMENSIONS FOR λ OF 98 METRES.

FIG. 5.

The reality of this form of distribution, as distinct from a simple capacity effect, was shown experimentally when a folded top aerial was erected to oscillate at 98 metres, the actual dimensions being indicated in Fig. 4. Upon connecting the centre of the inner limb with the centres of the two outer limbs, as per Fig. 5, it was found necessary to lengthen the three limb top from 60 feet to 121 feet, in order to maintain the working frequency of 98 metres.

The patent Folded Top Aerial has been employed at Viipuri in Finland and at the new broadcasting station in Jerusalem, and the results in each case have been most gratifying.

N. WELLS.

A HIGH FREQUENCY RESISTANCE BRIDGE

The detailed study of the characteristics of coils for high frequency purposes, utilising iron dust cores, necessitated the development of a practical means of measurement of high frequency resistance, which allowed measurements to be made rapidly and accurately over a wide range of frequencies, and for this purpose apparatus employing a bridge method has been evolved ; although originally in use over the broadcast frequency bands the range has been extended to cover a continuous band of 20-2,000 Kcs. (15,000-150 metres) and it is not anticipated that any difficulty should be experienced in further extending this range, providing proper precautions are taken.

THE bridge consists essentially of :—

- (1) A carefully screened oscillator covering the required frequency range.
- (2) The measuring bridge.
- (3) A receiver covering the frequency range incorporating a heterodyne oscillator and a low frequency amplifier tuned to 1,000 \sim .

The operation of the apparatus as a bridge can be followed from the schematic diagram Fig. 1, in which, ignoring for the moment the test circuit " E " and the variable resistance " R," it will be seen that the arrangement of the two fixed resistances " B " and the two grid-anode paths of the valves constitutes a symmetrical bridge, the resistances " B " being accurately matched and the valves being adjusted by means of the screen grid potentials to give equal gain. When the test circuit " E " and the variable resistance " R " are considered, it will be seen that the operation of connecting these across the equal bridge arms " B " must necessarily upset the balanced condition unless the impedance of the test circuit is equal to that of the variable resistance " R " both in magnitude and phase ; this can only be the case when the reactance of the test circuit is zero, i.e., at resonance, and the resistance " R " is adjusted to be equal to the effective resistance of the circuit at the applied frequency.

In the input oscillator (Fig. 2) substantial linearity of the valve characteristics is obtained by means of a resistance in the anode circuit ; the tuning condenser is controlled by a slow motion drive incorporating a vernier scale, by which means accurate settings are obtained ; the output is varied by means of a potentiometer connected across a separate coupling coil. Special attention was paid to the screening of this oscillator with a view to avoiding undesirable interaction with other parts of the system, and, to ensure good isolation, a separate mains unit is employed for the power supply.

A circuit diagram of the measuring bridge is shown in Fig. 3. The output of the oscillator is taken, through screened leads, to the primary winding of a screened transformer " A," the secondary of which is connected to the control grids of a pair of screen grid valves. Carefully matched resistances " B " of 500 ohms are connected between each grid and earth, establishing a low impedance condition in the valve input circuit. A differential condenser " C," with the moving vanes earthed and the fixed plate connections taken to the control grids, enables stray capacities in the input circuit to be balanced. In order to obtain an exact balance between the two screen grid valves the screen voltages are variable over a limited range by means

A High Frequency Resistance Bridge.

of a potentiometer "P" with a differential connection. In order to assist in obtaining electrical equality between the two halves of the bridge circuit, the lay-out of the

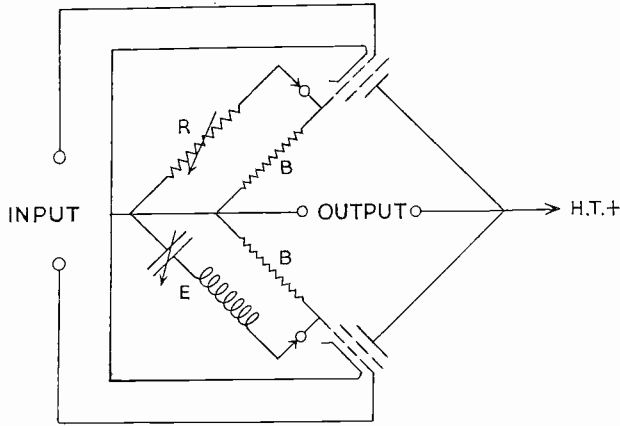

FIG. 1.

apparatus is as symmetrical as possible, and all subsidiary components such as cathode resistances and screen by-pass condensers are of equal value on each half of the bridge. All leads in the grid circuit are as short as possible. A variable

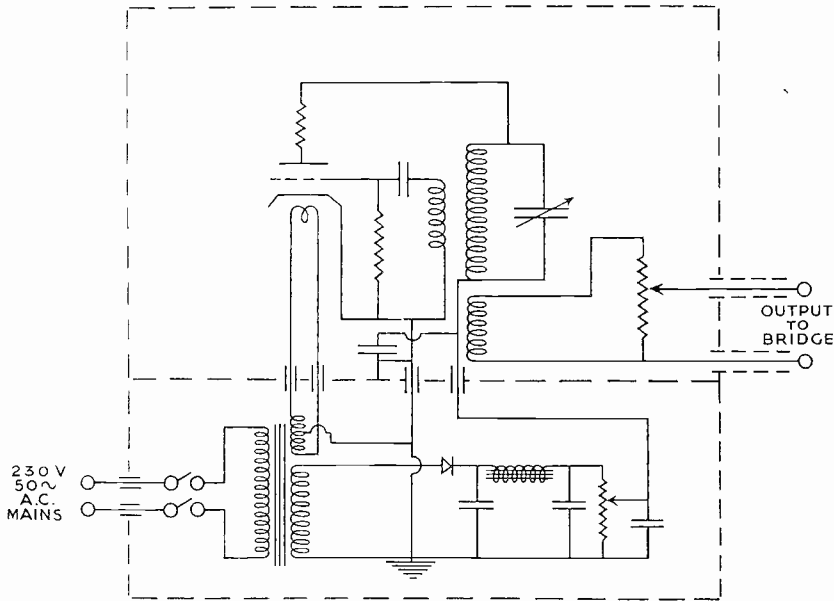

FIG. 2.

high-frequency resistance "R," shown in detail in Fig. 4, is connected between one control grid and earth; the coil for test in conjunction with a suitable calibrated variable air condenser of low power factor is connected to form a series circuit between

A High Frequency Resistance Bridge.

the other control grid and earth. The anodes of the valves are strapped together and connected by choke capacity coupling to the input circuit of the receiver.

Fig. 5 shows a diagram of connections of the receiver unit; the input is taken through a single stage tuned high-frequency amplifier to the mixing valve, a triode hexode, the triode section of which is connected as a simple back-coupled oscillator. The output is resistance capacity coupled to a pentode valve, which in turn is coupled to the output valve by a 1,000 \sim tuned circuit. Headphones are fed through an output transformer in the anode circuit of the last valve. Each stage is adequately decoupled.

The high frequency resistance consists of a thin platinum coating on a glass rod, mounted in a U-tube partly filled with mercury, which forms the earth connection. The resistance can be varied by altering the mercury level by means of

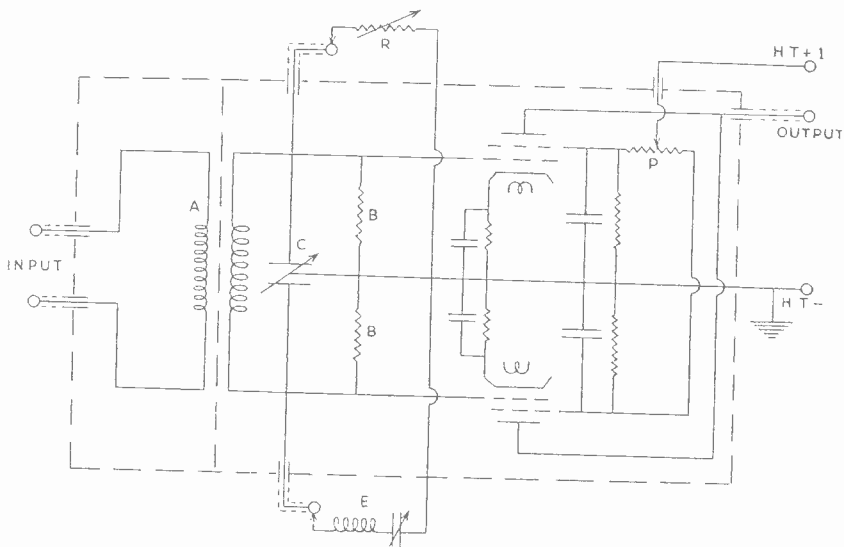

FIG. 3.

a screw plunger. Owing to the extreme thinness of the metallic coating the high frequency resistance very closely approximates to the resistance as measured by means of a D.C. bridge.

A glass rod approximately one-eighth inch diameter and 9 inches long is coated for about half its length with the compound known commercially as "Bright Liquid Silver" and then gently heated until the platinum deposit shows on the glass. If a lower resistance is required a second coating is similarly applied and heated, and the process repeated until a suitable resistance value is obtained. A length of three inches from the bottom of the rod is then coated with cellulose and copper plate electrically deposited on the remainder. The cellulose is removed with a suitable solvent, and the joint between the copper plating and the platinum covered with cellulose as a protective coat. A connecting wire can then be readily soldered to the copper plate. A range of resistance values of one-tenth ohm to 100 ohms can be

A High Frequency Resistance Bridge.

conveniently covered by four resistance rods having one, two, three and four coats of platinum deposit. The thickness of one deposit is of the order of 10^{-4} to 10^{-6} of one inch and a single coat is semi-transparent.

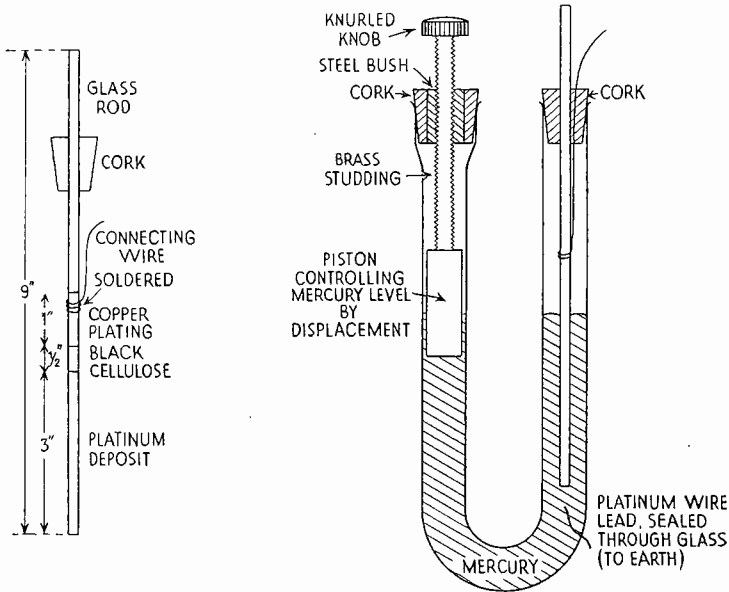

FIG. 4.

In order to set up the bridge for a measurement it is necessary to establish a balanced condition, for which purpose the variable high frequency resistance and

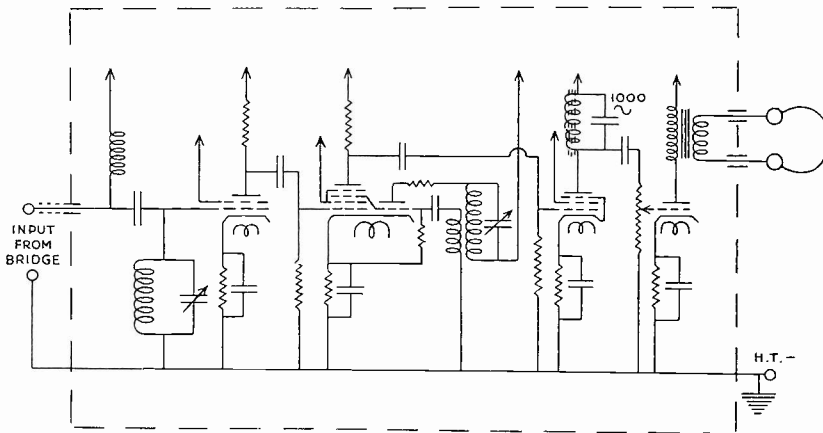

FIG. 5.

the test circuit are left disconnected. The input oscillator is set at the required frequency and the second or heterodyne oscillator adjusted to produce a beat note

A High Frequency Resistance Bridge.

the other control grid and earth. The anodes of the valves are strapped together and connected by choke capacity coupling to the input circuit of the receiver.

Fig. 5 shows a diagram of connections of the receiver unit; the input is taken through a single stage tuned high-frequency amplifier to the mixing valve, a triode hexode, the triode section of which is connected as a simple back-coupled oscillator. The output is resistance capacity coupled to a pentode valve, which in turn is coupled to the output valve by a 1,000 \sim tuned circuit. Headphones are fed through an output transformer in the anode circuit of the last valve. Each stage is adequately decoupled.

The high frequency resistance consists of a thin platinum coating on a glass rod, mounted in a U-tube partly filled with mercury, which forms the earth connection. The resistance can be varied by altering the mercury level by means of

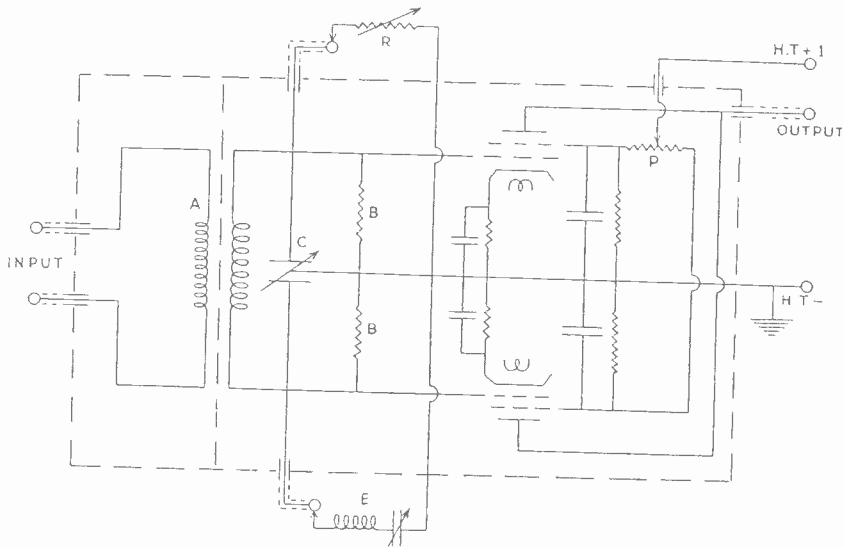

FIG. 3.

a screw plunger. Owing to the extreme thinness of the metallic coating the high frequency resistance very closely approximates to the resistance as measured by means of a D.C. bridge.

A glass rod approximately one-eighth inch diameter and 9 inches long is coated for about half its length with the compound known commercially as "Bright Liquid Silver" and then gently heated until the platinum deposit shows on the glass. If a lower resistance is required a second coating is similarly applied and heated, and the process repeated until a suitable resistance value is obtained. A length of three inches from the bottom of the rod is then coated with cellulose and copper plate electrically deposited on the remainder. The cellulose is removed with a suitable solvent, and the joint between the copper plating and the platinum covered with cellulose as a protective coat. A connecting wire can then be readily soldered to the copper plate. A range of resistance values of one-tenth ohm to 100 ohms can be

A High Frequency Resistance Bridge.

conveniently covered by four resistance rods having one, two, three and four coats of platinum deposit. The thickness of one deposit is of the order of 10^{-4} to 10^{-6} of one inch and a single coat is semi-transparent.

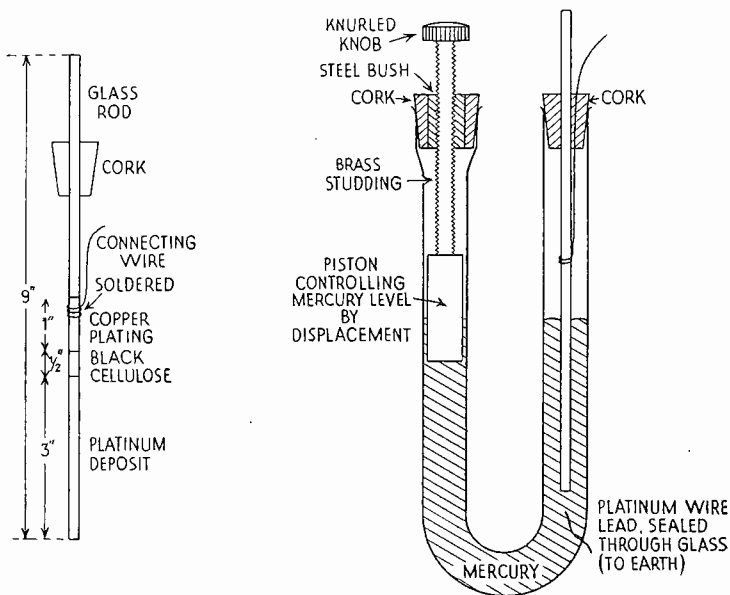

FIG. 4.

In order to set up the bridge for a measurement it is necessary to establish a balanced condition, for which purpose the variable high frequency resistance and

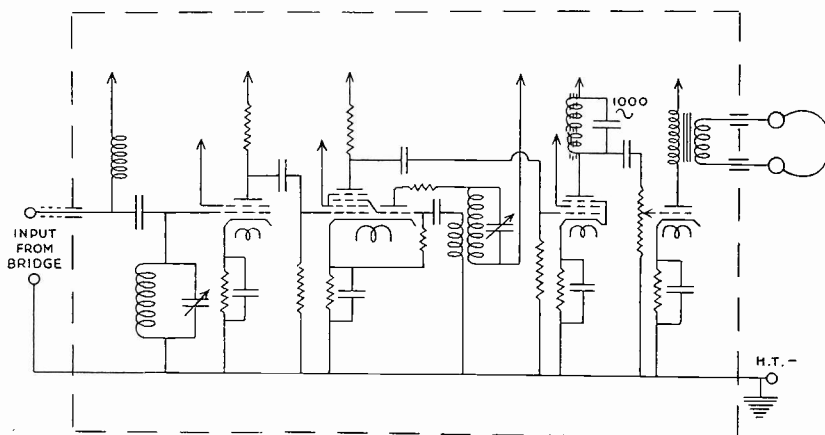

FIG. 5.

the test circuit are left disconnected. The input oscillator is set at the required frequency and the second or heterodyne oscillator adjusted to produce a beat note

A High Frequency Resistance Bridge.

of $1,000\sim$. The potentiometer "P" and the differential condenser "C" are adjusted until zero balance is obtained, when the input conditions and the gain of the two valves are equal and opposite in effect.

To take a measurement, the test circuit "E" and the variable H.F. resistance "R" are now connected and the variable condenser adjusted to give the series resonance condition, when a sharp minimum will be obtained; the variable H.F. resistance is then adjusted for zero signal, and it will be found that the point of balance is very sharply defined. Under these conditions the impedance of the test circuit "E"—i.e., coil and condenser—is the ohmic resistance only and this is equal to the resistance "R" on the opposite arm. The apparent inductance of the coil can be calculated from the capacity of the calibrated variable condenser and the known frequency. This condenser must be of a sub-standard grade, in order that the losses in the condenser should be negligible in comparison with those of the coil under test. A convenient method of checking the accuracy of the bridge is by interchanging the test circuit and the glass rod resistances, as, the bridge being entirely symmetrical, the balance conditions should be unchanged.

In practice the input to the bridge valves is maintained at a low level in order to minimise disturbance of the balance due to the additional loading of the screened transformer when the test circuit and the variable resistance are connected and balanced; under these conditions the 500 ohms resistances are in effect shunted by two equal low resistances and the input to the bridge valves will therefore be slightly less than for the initial balance condition. The effect of any slight differences in the curvature of the screen grid valve characteristics is rendered negligible by this expedient, a further advantage of which is that it minimises the production of harmonics. Any traces of harmonics are finally filtered by means of the tuned amplifier which follows the bridge.

Apparatus similar to that described has been continuously in use over a period of more than three years and has been found to give consistent results during this time. It has been used on coils of widely differing inductance and resistance values over the frequency range mentioned, and being symmetrical, the circuit lends itself also to the direct comparison of condensers.

C. AUSTIN.

A. L. OLIVER.

MARCONI VETERANS' EIGHTH ANNUAL MEETING AND REUNION



Mr. George H. Green.

THE Eighth Annual General Meeting and Reunion of the Marconi Veterans took place on the 31st October at the Howard Hotel, Norfolk Street, London, W.C.2, under the chairmanship of Mr. G. H. Green.

At the Annual General Meeting which preceded the Reunion and Dinner, the following officials were elected for the ensuing year:—

<i>Chairman</i>	Mr. G. Pells.
<i>Deputy-Chairman</i>	Mr. R. D. Bangay.
<i>Hon. Treasurer</i>	Mr. W. J. Collop.
<i>Hon. Secretary</i>	Mr. C. C. Howe.
<i>Hon. Auditor</i>	Mr. C. J. Simpson.

The addition of one hundred and twelve new Veterans brought the total membership on the roll up to three hundred and fifty; of these, one hundred and four were present at the Dinner.

The Chairman for the present year, Mr. George Green, late of the Messenger Staff, when proposing the toast of "His Excellency Marchese Marconi," said: "Until quite recent years this honour would have been limited to those able to speak with technical knowledge; it was, therefore, for me no easy task, but my daily paper came to the rescue when I read that messages from ships in distress brought drama to the ether this week—twenty-seven years after wireless first proved its worth in saving lives at sea, and it does not require technical ability to extol the work of Marconi that made this possible. We feel it a privilege to be associated with this Company and with the great inventor, our President and friend, whom the world at large regards as a great benefactor, especially those who travel by sea."

The following telegram was sent to His Excellency:—

"Marconi Veterans celebrating Eighth Annual Reunion send you respectful greetings and assurance of their devotion.—Green."

The following reply was received:—

“ Many thanks for kind message. Regret immensely not having been with Marconi Veterans at Annual Reunion. Please convey them all my heartfelt good wishes.—Marconi.”

Mr. G. Pells, in proposing the toast of “ The New Members,” said : “ We are this evening welcoming into our midst one hundred and twelve colleagues who have this year reached the veteran stage ; they belong to what I might term the 1911 class. A glance at the Roll will demonstrate that the year 1911 was a year of great expansion for the Marconi organisation, and I think it speaks well both for the efficiency of the staff engaged in that year and the way their interests have been considered by the Marconi Company that we have to-day still with us one hundred and twelve men who joined us in that year.”

Mr. J. G. Robb responded in suitable words.

In proposing the toast of “ Absent Members,” Mr. H. M. Dowsett first paid a tribute to the Veterans who had died during the year, and as a mark of respect all stood while the following names were being read :—

Vernon McMahon King, who died 24th November, 1935, aged 50.

James Edwin Auvache, who died 21st March, 1936, aged 48.

Alphonso Marconi, who died 24th April, 1936, aged 70.

Francis Samuel Stacey, who died 11th August, 1936, aged 57.

Brief notes of their careers were then given :—

“ Veteran King joined the Marconi Marine Company in 1910 as a wireless operator. In February, 1915, he was appointed a Warrant Telegraphist, Royal Naval Reserve. In that capacity Mr. King was on the s.s. “ Alnwick Castle ” in March, 1917, *en route* to take up duty abroad, when some 300 miles west of the Bishop Rock the vessel was torpedoed by a submarine without any warning. The vessel and 40 lives were lost. Mr. King was one of a number of survivors who took to a boat which was adrift for several days, but ultimately reached port. He suffered severely as the result of exposure and received permanent injury to his feet. In March, 1918, Mr. King was released from Admiralty service, and thenceforward until his untimely death from pneumonia last year he was mainly employed by the Company at their London Offices as a clerk in the Traffic Department.”

“ Veteran Auvache joined the Marconi Marine Company in 1910 as a wireless operator. He was serving at sea at the outbreak of war, and in March, 1915, he was appointed a warrant telegraphist, Royal Naval Reserve. On the conclusion of hostilities he returned to the service of the Company, and, in January, 1930, he was made the Company's representative at Hong Kong, a position he occupied for 5½ years. In January, 1936, he was assigned for duty at the London (East Ham) Depot, and the news of his death from meningitis a few weeks later, after a brief illness, came as a profound shock to his many colleagues and friends.”

Marconi Veterans' Eighth Annual Meeting and Reunion.

"Veteran Alphonso Marconi was known to us as a very kindly gentleman, who came to England shortly after the Marchese, and was made a Director of the Marconi Company in 1909."

Veteran Stacey was one of the pioneers of commercial wireless and a lovable personality. He was appointed an assistant to H.E. Marchese Marconi in July, 1899, and we have been reminded of the main features of his career—commencing with the installation of wireless on the whole fleet of Belgian Cross-Channel Steamers in 1900, transatlantic liners in 1902; work at Poldhu from 1910-12; followed by administrative activities in the Contract Department, which he helped to organise and develop to its present magnitude—by the account which was given recently in THE MARCONI REVIEW."

Letters were read from: -

Veteran 1 Marchese Marconi, Yacht "Elettra," off Santa Margherita, as follows: "I wish first of all to convey my sincerest thanks for your kind invitation, which I shall be only too glad to accept if I happen to be in England on that date. But apart from the above, I wish to assure you and all Marconi Veterans that it is always a great pleasure for me to partake in their yearly Reunions, when an excellent opportunity is always offered of reviewing old times and experiences and of strengthening the bonds which so happily unite in a truly splendid *esprit de corps* the 'Marconi family.' In giving vent to these feelings it seems superfluous to add how intensely I hope to be with you on the 31st October next."

Also from Veteran 2 Colonel H. Jameson Davis; Veteran 18—A. V. Blinkhorn; Veteran 19 M. Travailleur, writing from Brussels; Veteran 21—H. W. Corby; Veteran 30 A. H. Ginman, who cabled from Montreal; Veteran 88—J. N. Johnson, at Newfoundland; Veteran 103—Marchese Solari, at Rome; Veteran 177—G. J. Boone, who cabled from Kabul; Veteran 183—G. S. Whitmore; Veteran 197—B. Sadler; Veteran 240 G. T. J. Steverink, who wrote from Amsterdam on behalf of all Dutch Marconi Veterans; Veteran 176—R. H. White; Veteran 92—G. A. Manson and 332 T. J. Chapman, of Newcastle; Veteran 290—E. W. Sharp and 345 L. B. Cleary, of Hull; Veteran 227—W. Sparkes; Veteran 253—J. Asensio; Veteran 269 C. Alberola, who cabled from Madrid; and Veteran 348—B. M. Barbera, who cabled from Barcelona.

Mr. H. W. Allen proposed the health of the Chairman. He expressed the great pleasure it gave him to see Mr. Geo. Green in the Chair, emphasising, as it did, the democratic nature of the Veterans' Organisation. Mr. Green had not occupied one of the high executive positions, but during the whole of his long service with the Company he had carried out the duties entrusted to him with a thoroughness and

good humour which were an example to them all. As Veterans they were only concerned with the comradeship of service and to recognise sterling merit in whatever branch of the Marconi Organisation it was shown. They congratulated Mr. Green on his many years of faithful service, and expressed their thanks to him for the excellent manner in which he had taken the chair that night.

Mr. Geo. Green responded with well chosen words.

Following the Dinner an excellent programme of music was provided by Mr. Morlais Morgan and Mr. Jack Walker, with Mr. Harry Heap as accompanist, and the success of the function reflected much credit on the Hon. Secretary, Mr. C. C. Howe, and his Committee.

OBITUARY

COLONEL H. JAMESON DAVIS



IT is with much regret that we have to record the death at the age of 82 of Colonel Henry Jameson Davis, J.P., D.L., the first Managing Director of the original Marconi Company, which occurred on the 25th December, 1936, at his home, "Estrella," Woking, Surrey, after two months' illness.

When Mr. Marconi came to England in 1896 to demonstrate his invention to the British Post Office, and later proceeded to form a Company for its exploitation, it was largely through the financial ability of his maternal uncle, Col. H. Jameson Davis, assisted by the strong backing of Mr. Marconi's Irish relatives and friends in Ireland, that the venture was successfully floated.

The Wireless Telegraph and Signal Co., Ltd., was incorporated in 1897 with a capital of £100,000 to acquire Mr. Marconi's patents in all countries, except Italy and her dependencies, and Col. H. Jameson Davis was its first Managing Director. He held this position until August, 1899, when he was succeeded by Major D. Flood-Page, but remained a Director of the Parent Company and its subsidiaries until his resignation in 1909.

To the staff he was always approachable ; his methods were direct and kindly, and as frequently as his health would permit he renewed his early friendships with them at the annual Veterans' Reunion, where his absence at future meetings will be sorely felt.

MARCONI NEWS AND NOTES

BROADCASTING STATIONS IN INDIA

FOLLOWING a recent decision to extend the broadcasting service, the Indian Government has placed a contract with the Marconi Company for the supply of five broadcasting stations. Four of these will operate on medium waves with an unmodulated carrier energy of five kilowatts.

The sites chosen for the stations are at Lucknow, Lahore, Trichinopoly, and Dacca.

The aerial system planned for each of these four transmitters will consist of a radiating aerial mast with capacity top.

The fifth station will transmit on short waves with an aerial energy also of five kilowatts. This transmitter will be erected at Delhi, near the site of the 20-kilowatt Marconi medium broadcasting station which was installed last year.

Marconi High-Power Broadcasting Station for Czechoslovakia.

THE Czechoslovak Telegraph Administration has placed a contract with Marconi's Wireless Telegraph Co., Ltd., for the supply of a high-power broadcasting station to be installed near Brno, where for many years a 32-kilowatt Marconi transmitter has been in operation.

The new Brno transmitter will operate with an unmodulated carrier power of 100 kilowatts, but the design of the station is such that the unmodulated carrier power can be increased to 200 kilowatts without undue complications should it be desired at a later date to operate the station at a higher power.

The working wavelength of the new station will be chosen within the band of 300-545 metres, to which the transmitter is adjustable. A crystal drive with a stability of five in one million ensures that the most stringent international frequency stabilisation requirements are fully met.

The distortion factor of the new installation is kept to a low value and at 90 per cent. modulation does not exceed four per cent.

As may be expected the frequency response of the equipment is of a high order and is linear within \pm two decibels over a band of 35-10,000 cycles.

Design.

The design of the transmitter is one which has been largely adopted by the principal broadcasting authorities. It consists essentially of a switchboard, with the controls and indicating instruments, and an enclosed space behind the switchboard, in which the transmitting valves and their associated circuits are mounted.

In this manner ease of supervision and accessibility for inspection and overhaul are combined.

The improvements embodied in this new Brno station will make it a valuable addition to the highly efficient Czechoslovak broadcasting system.

New Commercial Receiving Centre in Sweden.

FOR the first stage in the equipment of a new commercial receiving centre at Enköping, ultimately to be used for world-wide reception, the Swedish Telegraph Administration has placed a contract with the Marconi Company for the supply of ten receivers operating on a waveband of 2,600 to 20,000 metres and four short-wave receivers for reception of waves from 14-80 metres.

The Swedish Administration has also entrusted to the Marconi Company the installation of four double and four single-element series-phase aerials for short-wave reception.

For the long and medium wavebands two large Bellini-Tosi loop aerials suspended from four 150 feet self-supporting towers are to be used.

Six uniform omni-directional short-wave aerials suspended from a triatic fixed between two of the 150 feet towers will also be available for use with the short-wave receivers.

The short-wave aerials will be connected by means of underground armoured feeder cable to the receiving house.

Marconi Equipment for Jersey Aerodrome.

TO enable the Airport Control to deal more effectively with the rapidly increasing air traffic between the Channel Islands and the mainland it has been decided to equip the St. Peter's Airport, on the island of Jersey, with up-to-date wireless transmitting, receiving and direction finding equipment.

The order for this equipment—which has been placed with the Marconi Company—consists of a continuous wave and telephone transmitter Type T.A.11, a Marconi-Adcock direction finder Type D.F.g.10, operating on the usual medium aircraft wavelengths, and a R.g.34 receiver for the reception of short waves.