

MEC

# THE MARCONI REVIEW

July-August, 1936

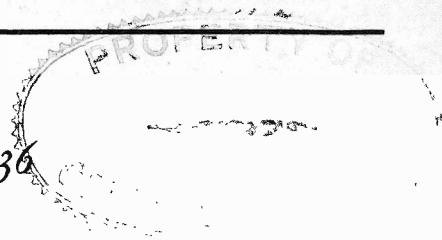

## CONTENTS

HIGH DEFINITION TELEVISION OVER LONDON	- PAGE I
THE DEVELOPMENT OF LARGE RADIO TRANSMITTING VALVES - - - - -	„ 6
MARCONI ULTRA SHORT WAVE STANDARD SIGNAL GENERATOR - - - - -	„ 30
NEWS AND NOTES—	
BROADCASTING IN EGYPT - - - - -	„ 36

MARCONI'S WIRELESS TELEGRAPH COMPANY LTD.

Electra House, Victoria Embankment, London, W.C. 2

# THE MARCONI REVIEW

No. 61.

July-August, 1936.

Editor: H. M. DOWSETT, M.I.E.E., F.Inst.P.  
Assistant Editor: L. E. Q. WALKER, A.R.C.S.

## HIGH DEFINITION TELEVISION OVER LONDON.

*The first London television station installed by the British Broadcasting Corporation following the recommendations of the Television Committee appointed by the British Postmaster-General in 1934, is now ready for sending vision and sound transmissions over the air. The first experimental transmissions were sent out for the benefit of visitors to the London Radio Exhibition at Olympia, which opened on August 25th. Two daily programmes each of one hour thirty minutes, consisting of studio transmissions, outdoor scenes, film and feature programmes and other items of topical and general interest, were radiated.*

THE Marconi-E.M.I. Television Co., Ltd., which was formed to combine the unrivalled resources of the experimental laboratories of Marconi's Wireless Telegraph Co., Ltd., and of Electric and Musical Industries, Ltd., has supplied a high definition television transmitting system, complete studio equipment with six Emitron instantaneous continuous action cameras for studio, outdoor and film transmissions, as well as the sound transmitter and the aerial equipment for the new B.B.C. television station, which is situated at Alexandra Palace—a north London landmark and pleasure resort for

*The new B.B.C. Television Station at Alexandra Palace.*

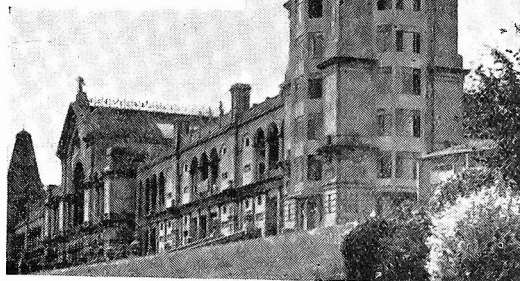

## High Definition Television over London.

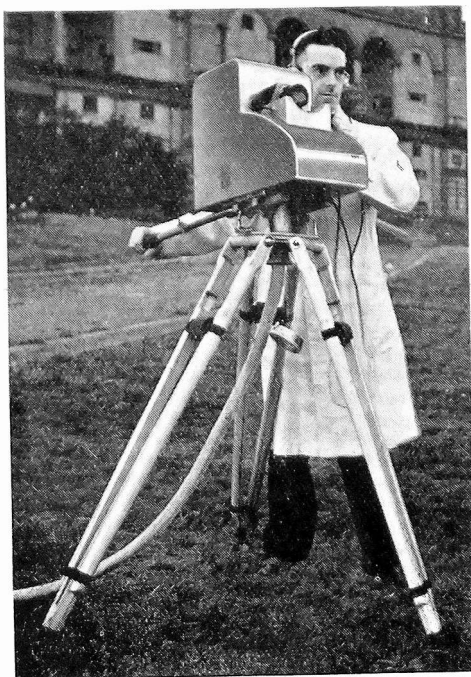

*Emitron camera in action in the grounds of Alexandra Palace.*

more than 60 years—built on a hill 306 feet above sea level. The aerial for the visual and sound transmissions—one below the other—are installed at the top of a steel lattice mast, rising to a height of 220 feet, mounted on the reconstructed east tower of the Palace, which is 80 feet in height.

### **Entirely of British Design and Construction.**

The whole of the equipment supplied by Marconi-E.M.I. has been designed and developed exclusively by British scientists in British laboratories and was built and erected at Hayes and Chelmsford.

### **The Emitron Camera.**

The most remarkable part of the Marconi-E.M.I. equipment is the Emitron camera. This camera has no moving parts and requires no costly intermediate films or other mechanism. It is absolutely silent in operation and can be used indoors or out of doors in any position under

normal lighting conditions. The Emitron camera does not photograph : it actually " sees " and therefore transmits reality.

### **High Definition and Absence of Flicker.**

Apart from the high order of definition—405 lines—another very important feature of the Marconi-E.M.I. system is the complete absence of flicker. By using interlaced scanning the flicker frequency is raised to 50 per second, which is well above the limit of visual perception, and these two features give the televised pictures a quality equal to cinema projection.

### **Enthusiastic Press Reports.**

A London paper reports on the Marconi-E.M.I. system as follows :—

" I am sure that when the public sees the result now obtainable there will be a wave of surprise and enthusiasm.

" I have now seen outdoor direct television by the Marconi-E.M.I. system. The views were taken in daylight from the verandahs of the

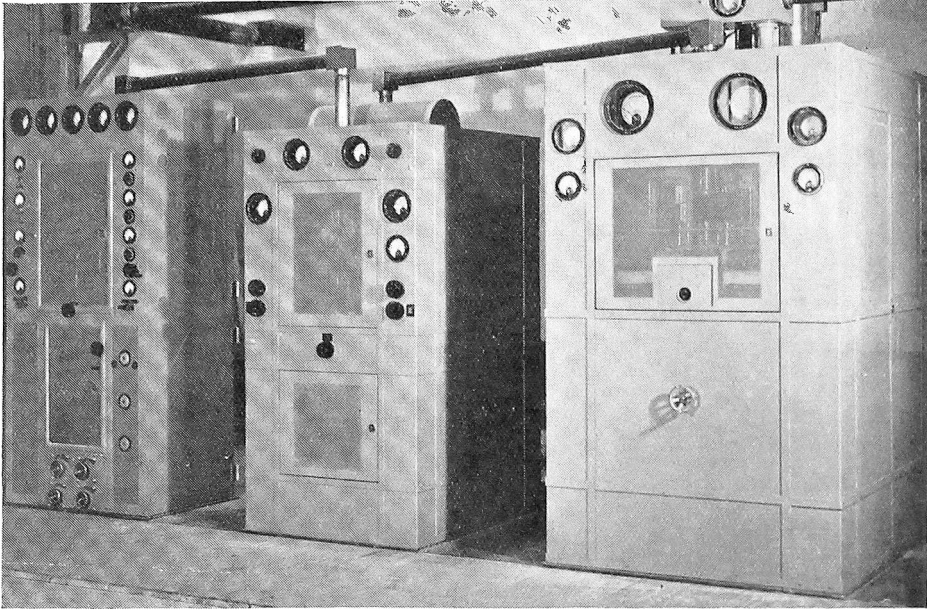

*Marconi-E.M.I. vision transmitter at Alexandra Palace.*

Alexandra Palace and a camera swung round showing the distant surroundings, motor cars passing by, people wheeling perambulators, a dog running after a ball and *a train on a railway line a quarter of a mile away*, were clearly seen on the 12 inches by 9 inches screen of my set.

“ This was the first direct daylight television by means of the marvellous new television camera which I have seen and it exceeded my expectations.

“ After the outside television the engineers switched over to a camera in one of the studios. *The details of such pictures are so clear that you can see the design on a tie or the ring on a man's finger.*”

Another abstract from the daily press reads :—

“ I saw a remarkable demonstration of the perfection achieved. Here at Radiolympia, I was able to see quite clearly the view as seen by the Emitron camera from the balcony of Alexandra Palace.

“ *Despite the lateness of the hour, eight o'clock, and the approaching darkness, a train was clearly seen passing 300 to 400 yards away from the television camera, and at even greater distances than this the smoke could be*

*High Definition Television over London.*

---

*seen rising from chimneys—and those chimneys were more than ten miles from Radiolympia.*

“ It was perfectly obvious that with this system of transmission it is quite possible to-day to televise a football match, a race meeting, or any other outdoor sport ; and, most important of all, it is absolutely instantaneous—you see what happens miles away at the exact moment it happens.”

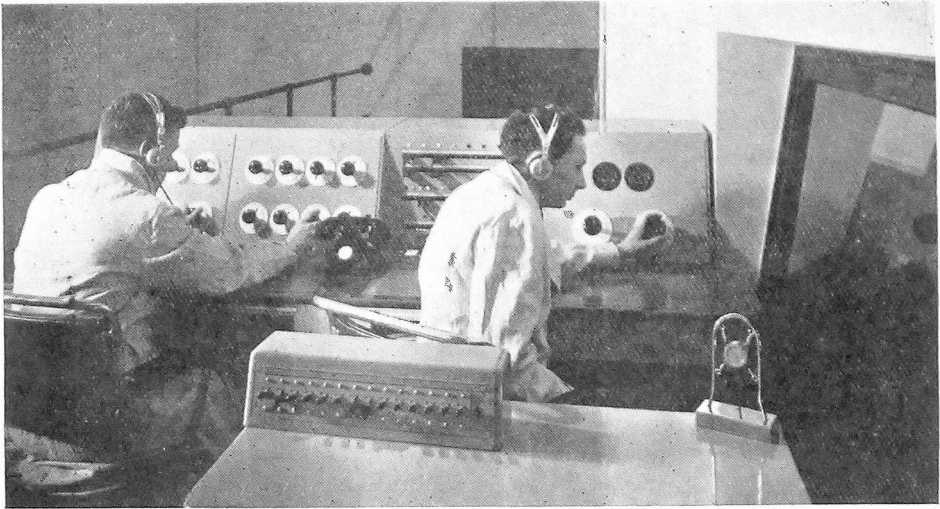

*Marconi-E.M.I. Control Room, showing Control Desk with studio-viewing window on right.*

Another paper writes :—

*“ Television has definitely arrived, not just television of an experimental or scientific kind, but television full of entertainment value. As I saw it demonstrated the Emitron camera is so sensitive that it can be used with a telephoto lens for distant scenes. So great is the sensitivity that dull weather is not an obstacle as I saw when watching the receiver. There is a complete absence of flicker. This places the picture in the category of a good cinema.”*

These three abstracts taken at random from the large number of eulogistic press reports on the Marconi-E.M.I. transmissions indicate not only that Great

*High Definition Television over London.*

---

Britain has a new television system of outstanding merit, but also that its performance is far in advance of any other system developed in Great Britain or other parts of the world.

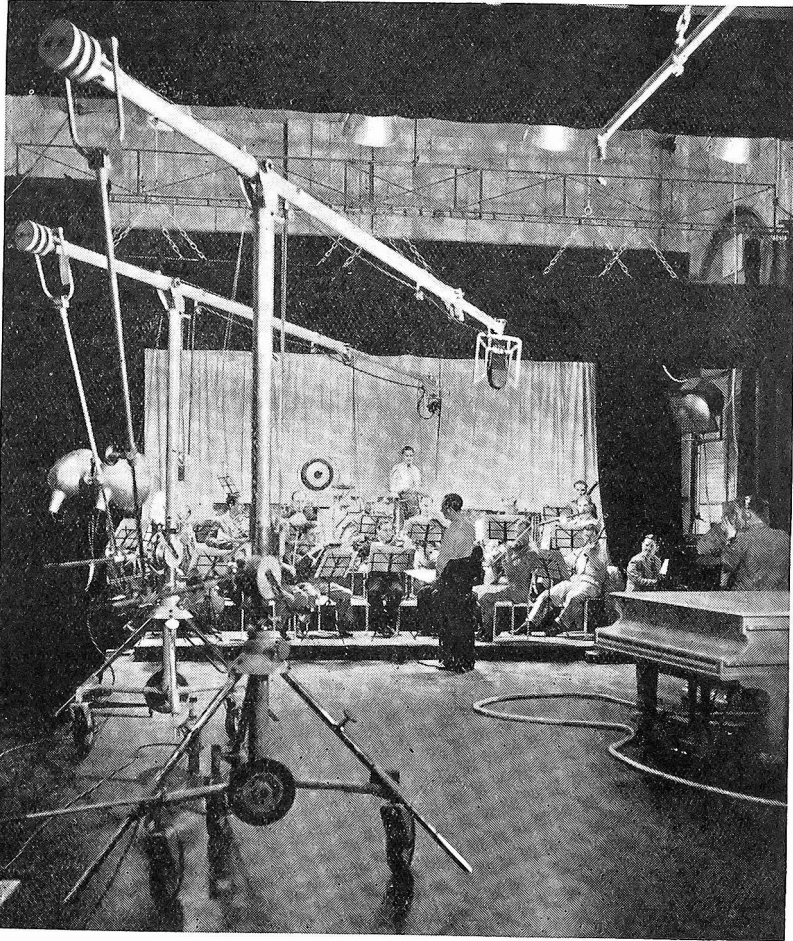

*Band in the Marconi-E.M.I. studio at Alexandra Palace, with Emitron camera on right.*

# THE DEVELOPMENT OF LARGE RADIO TRANSMITTING VALVES

*The following article is a résumé of the work carried out for the Marconi Company at the G.E.C. Research Laboratories, Wembley, by the Research Staff of the M.O. Valve Co., Ltd.*

---

## Introduction.

AT the end of the war the largest wireless transmitting valves commercially available were capable of dealing with an input of only 1 kilowatt. To-day a considerable number of valves are in use, each of which will handle 500 kilowatts. This increase in power has been due mainly to the progressive demands made by broadcasting. But apart from the question of power, the call for rapid long-distance communication generally, the directive properties of the short-wave beam used in telegraphy, and the increased use of wireless in ships and aeroplanes have each raised specific problems. It is the purpose of this article to review the progress made and describe many of the more interesting problems encountered.

By way of introduction it will be helpful to study the features of one of the largest valves in use about 1919.

## Early Types.

All valves were similar in construction to that shown in Fig. 1, which shows an MT<sub>2</sub> valve, one of the largest types of glass valves in common use soon after the war. This type is still in use in small installations or in the low power stages of high power transmitters. The anode dissipation of this valve is 300 watts and, as its construction is typical of all normal glass transmitting valves, it will form a basis for discussing the general design of glass valves and also the fundamentals of valve design.

The bulb is of lead glass 180 mm. diameter, the overall length being 440 mm.; supported from one end is the nickel anode 65 mm. diameter and 100 mm. long. At the other end are the grid and filament systems. The filament is of tungsten wire 250 mm. long and 0.47 mm. diameter, bent into the form of a hairpin. Surrounding this is the grid made of nickel gauze supported on four legs, which are fastened to the re-entrant foot tube by a clamp.

One of the major difficulties of a glass valve is that the glass must not reach more than a certain temperature (about 200° C. for the kind of glass employed in this valve), otherwise gas will slowly be evolved from it causing the vacuum to deteriorate, and in the end the grid will lose its control. This means that for a given anode dissipation the glass bulb must be large enough to meet this condition, consequently it will be readily appreciated that there must be a limit to the anode dissipation, unless enormous bulbs are to be employed. Certain hard glasses such as "Pyrex," are now available which can withstand

higher temperatures before gassing and thus it is possible to increase the anode dissipation without increase of bulb size; some of this advantage is, however, neutralised by the fact that these glasses are not so transparent to heat as lead glass. The size of the anode has also to be increased with higher dissipation, otherwise the metal of which it is made will evaporate too rapidly, causing the bulb to blacken and thus raise its temperature above the safe limit. Another important point is the energy absorbed in the grid. Too great a rise of temperature will cause the grid to become a source of primary electrons, the control of the valve being thus destroyed. Again the legs of the grid conduct heat to the glass on which it is mounted and if this gets too hot, gas is liberated with loss of control as already stated.

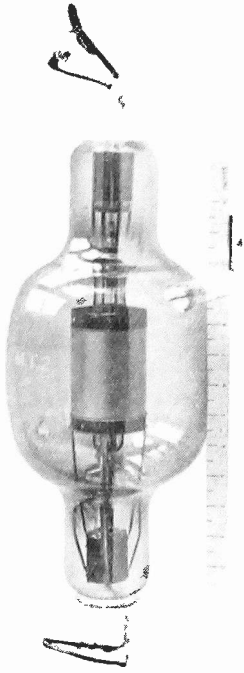

FIG. 1.

We have therefore to balance the extra power consumed against the longer life and the greater reliability of operation. As other factors are always present which affect the life of the valve, it is useless to increase the filament life beyond a certain value. In practice transmitting valve lives are considered economic when they are between 3,000-6,000 hours; usually larger valves are designed to have longer lives than smaller valves. The relationship of emission to life and watts forms one of the most important features of valve design; Fig. 2 shows the dependence of these on one another.\* The values are given for a filament of 1 mm. diameter. Experience has shown that a filament usually burns out when its evaporation has reduced its diameter by 10 per cent. As the rate of evaporation is independent of the diameter, it therefore follows that the life of a filament when run at a definite temperature, is proportional to its diameter, or put in another form, for the same life a thicker filament gives more emission per sq. cm. than a thinner one.

Filament temperature being such an important factor, it is of course necessary to determine this as accurately as possible for each individual valve. Formerly it was considered sufficient to have a definite number of watts per sq. cm. of filament

\* From determinations made by Dr. A. L. Reimann at these laboratories.



*The Development of Large Radio Transmitting Valves.*

surface, but as will be seen from Fig. 2, the rate of change of filament watts is very slow compared with that of evaporation; again the surfaces of different filaments

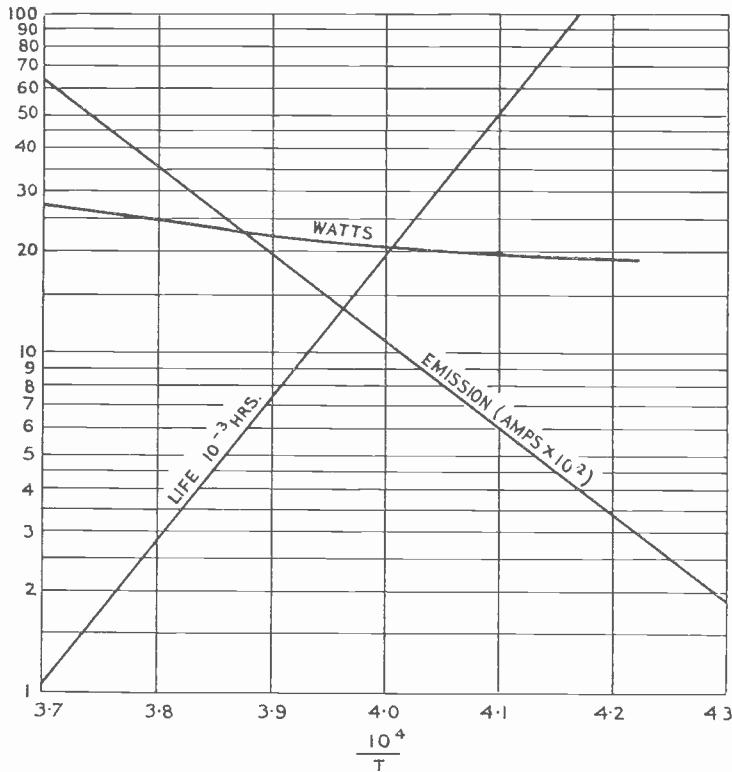

FIG. 2.

may differ considerably, so varying the thermal emissivity. Cases have actually occurred in which there was a change of over 15 per cent. Fortunately, there is one easily determined factor varying much faster with temperature than thermal radiation and which is (in the case of tungsten) to all intents and purposes independent of the surface; this factor is electron emission. As this is the property which is required from the valve, it now becomes possible to determine temperature by the electron emission per sq. cm.

For a number of years now, this method has been standard and valves of recent production are marked with the filament voltage which will give a definite number of amperes saturated emission, or more exactly, 90 per cent. of that value, since the efficiency of the valve drops off if the last 10 per cent. is used. This filament voltage is termed "marked volts." Users have now learnt how important it is to hold the filament as close as possible to this figure, since by doing so they have been able practically to double the average life previously obtained for their valves. Of course

if for a particular use the valve requires less emission, it is only necessary to reduce the running voltage as much as possible below marked volts, thereby gaining the advantage of longer life. It might be said that the necessary filament voltage could be determined at the transmitting station but experience has shown that this is very difficult when valves are run in parallel as they usually are.

### Efficiency and Characteristics.

So far we have not considered the factors which govern the efficiency of the valve, and also that very important parameter the magnification, or "m" value, as it is usually called. For a detailed treatment, the reader may be referred to any text book on the subject ; but it will suffice here to say that the efficiency of a valve varies directly as the length of the filament, and is also dependent on the grid filament distance. Usually it may be expressed by the formula :—

$$ia + ig = \frac{kl}{b\beta^2} \left[ \frac{Ea + mEg}{1 + m} \right]^{\frac{3}{2}}$$

where  $l$  is the length of the filament

$b$  the radius of the grid

$\beta^2$  is a function dependent on the ratio of grid and filament diameters.

$Ea$  and  $Eg$  are the anode and grid voltages.

$m$  magnification factor.

$k$  is a constant =  $1.47 \times 10^{-5}$

the  $m$  of a valve may be expressed as

$$m = \frac{2\pi nb \log \frac{a}{b}}{\log \frac{1}{2\pi ng}}$$

where  $a$  = anode radius

$g$  = grid wire radius

$n$  = number of grid wires per cm.

From these equations it will be seen that the  $m$  value is dependent on the anode-grid clearance and not on the filament-grid clearance, whilst the current depends on the latter, i.e., on the filament-grid clearance, and not on the former, provided that the  $m$  values are the same for the various valves under consideration. Usually the efficiency of a valve is measured by its slope or conductance, i.e.,  $\frac{m}{R}$  where  $R$  is the anode impedance. This factor (usually quoted in milliamps per volt) will be found to vary as  $\frac{l}{b\beta^2}$  and is most important in designing valves. The above formulae are only true for cylindrical systems and allowances have to be made for a multi-

plicity of filaments arranged in a circle inside a grid. Provided the distance between filaments is not more than the grid-filament circle distance, the formula gives a useful first approximation when calculating the slope of such a valve. The actual value is about 60 per cent. of the theoretical.

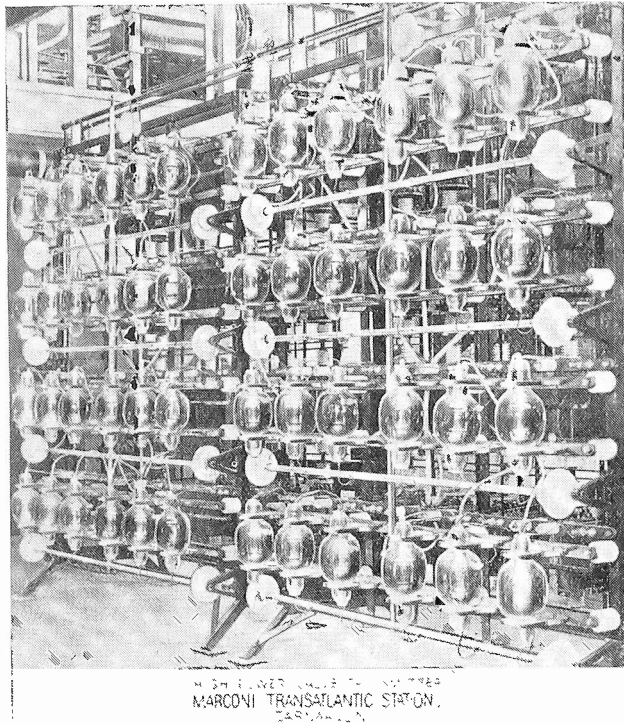

FIG. 3.

### **Inter-electrode Capacity.**

The electrical capacity between the various electrodes is a characteristic which becomes more and more important as the wave length on which the valve has to work decreases. Not only does it affect the lower limit of wave length of the valve but it calls for suitable dimensioning of the grid and anode leads. In the case of glass valves these may have to be capable of carrying 10-15 amperes at very high frequencies, where the depth of penetration of current is only several hundredths of a millimeter, whilst larger cooled anode valves, which will be discussed later, may need to have leads designed to carry several times that amount. Again the inductance of the leads is important at lower wavelengths and later it will be shown that by lowering the inductance of the leads considerably lower wavelengths may be reached than is possible with valves of ordinary construction, in spite of the fact that the capacity is slightly increased.

The Development of Large Radio Transmitting Valves.

TABLE I.  
GLASS TRANSMITTING VALVES.

Type.	Anode.			Filament.			M	Slope ma/volt.	Remarks.	
	Dissipation watts.	Volts D.C. (max.).	Material.	Volts.	Amps.	Material.				
MT2	300	10,000	Nickel	17	15	Tungsten	200	2	Transmitting valve. "	
MT3	40	2,000	"	6	2.2	"	100	0.3		
MT4	100	10,000	"	12.5	6.3	"	160	1.4		
MT5	15	1,500	"	5.8	2.0	"	40	0.4		
MT6	200	10,000	"	15.5	10.0	"	150	1.2		
MT7A	600	10,000	Molybdenum	12.5	24.0	"	80	2.0		
MT9	750	10,000	"	16.5	24.0	"	90	4.5		
MT9F	500	5,000	"	17.0	11.5	"	40	4.4		
MT10	200	5,000	"	12.5	9.0	"	200	1.4		
MT12	200	2,000	"	12.5	5.5	"	20	1.3		
MT13	800	10,000	"	16.0	22.5	"	40	2.2		
MT4B	80	10,000	Nickel	12.5	6.3	"	60	1.2		Modulator. " " " " " "
MT7B	500	10,000	Molybdenum	15	10	"	35	1.2		
MT9A	600	10,000	"	16	9	"	14	1.5		
MT9L	800	5,000	"	17	9.2	"	7.5	3.0		
DET1	35	1,000	Nickel	6.0	1.9	Thoriated tungsten	11	1.7		
DET2	150	2,500	Molybdenum	12.5	3.0	"	15	3.0		
DET3	250	3,000	"	15.0	4.0	"	16	5.3		
DET6	55	1,000	"	10	3.0	"	32	3.9		

TABLE II.  
WATER-COOLED ANODE TRANSMITTING VALVES.

Type.	Anode.			Filament.			M	Slope.	Remarks.		
	Dissipation kw.	Volts D.C. (max.).	Volts.	Amperes total.	No. of fils. in parallel.	Emission 90 per cent. saturated.					
CAT. 1	5	10,000	18-20	50	1	5 amps.	50	5	Short wave. "		
" 2	5	10,000	18-20	50	1		5	50		5	
" 4	8	10,000	18-20	75	1		10	45		8	
" 6	12	12,000	18-20	75	2		10	45		9	
" 9	18	15,000	18-20	100	2		12	45		10	
" 10	50	15,000	30	220	3		35	45		13	
" 12A	60-75	18,000	30	220	3		35	10		20	
" 14	150	20,000	32.5	460	8		100	45		50	
" 15	2.5	5,000	11	50	1		4.5	50		2.5	
Modulating Valves.											
CAM. 1	5	10,000	17.5-19	48	1		5	7		2.8	
" 2	5	12,000	17	24	2		2	25		5	
" 3	12	12,000	17	70	2		3-7	6.5		5	
" 4	16	15,000	20	75	2		10	10		6.5	

The above considerations are applicable to all valves whether transmitting or not, but of course are of varying importance with the different types.

Reverting to constructional details of glass valves, as mentioned earlier, care has to be taken not to overload the anode and thus produce rapid blackening of the bulb. As the dissipation was increased in valves a new material, molybdenum, was chosen for anodes which could withstand a higher temperature without undue evaporation. By this means it was possible to increase the anode dissipation to 600 watts in the case of the MT7A valve, which in size is similar to the MT2 valve capable of dissipating only 300 watts. A list of the more important glass valves is given with their special uses (Table I).

### **Cooled Anode Valves.**

It will be seen that of the valves mentioned in Table I, none has an anode dissipation of more than 800 watts. Since valve efficiency is seldom more than 70 per cent. and sometimes not more than 30 per cent., it was necessary to parallel a great number of valves for high outputs. As many as 48 large glass valves were run in parallel at the Marconi station at Caernarvon; Fig. 3 is a photo of the main oscillator bank at this station.

The development next to be described permitted the replacement of these 48 valves by 10 small valves of the new type, and subsequently by a single large valve.

It was obvious that an entirely different valve construction was called for which would allow much higher anode dissipations. Up to now as all the anodes of valves were in a vacuum, they could only be cooled by allowing them to radiate the heat produced. If, however, the anode could be made a part of the envelope of the valve, it could then be placed in water which would allow a very high surface dissipation. In order to do this it was necessary to make a vacuum-tight joint between the anode and the glass part of the envelope. Several types of seal were developed. The most novel one was that of Housekeeper in America who was the first to produce a satisfactory commercial article. He hit on the ingenious method of not necessarily choosing a metal of the same expansion as the glass employed, but instead made the metal very thin where it joins the glass; in this way the glass has, so to speak, the upper hand and forces the metal to its own thermal expansion coefficient.

At about the same time an alternative method was developed which was more akin to the much earlier known but little used platinum ring joint. Alloys of nickel and iron can be made which have approximately the same coefficient as the glass to be used, and which can be joined directly to glass. Usually the metal is thinly copper-plated at the joint, as glass adheres more readily to copper and this is facilitated by coating the copper with borax. The nickel iron is usually turned thin at the edge, in order to compensate for any small difference of expansion. This second method was the one adopted by the M.O. Valve Co. in the manufacture of the water-cooled anode valves with which we are concerned here. Still a third alloy, chrome iron, has been employed which functions in the same way as nickel iron. The making of a large glass-to-metal joint usually inspires awe in the uninitiated, but, as a matter of

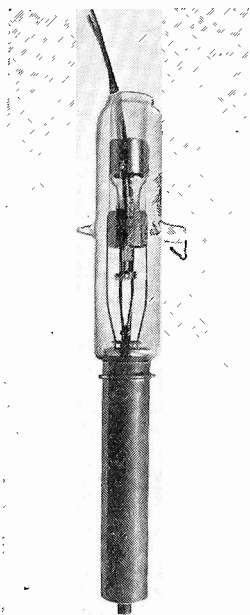

FIG. 4A.

fact, when once the technique has been grasped there is no great difficulty in making such joints. A far more difficult problem encountered at the beginning was to obtain a suitable brazed joint between the nickel iron ring and the copper anode. At the present time the largest glass-to-metal joint normally made has a diameter of about  $5\frac{1}{4}$  inches; while this is certainly not the limit, larger ones have not as yet been required.

**Earliest Commercial Type.**

Fig. 4A shows an early type (the C.A.T.R) of water cooled valve made by the M.O. Valve Company. The anode is of copper 2 in. outside diameter, and  $1\frac{3}{4}$  in. internal; inside can be seen the grid which is in the form of a "stocking" of fine tungsten wire. The grid proper is braced by 4 verticals also of tungsten, the whole being in turn mounted on four molybdenum supports clamped to the glass insulating tube by a nickel iron clamp. Inside is the cathode or filament system comprising two hairpins of tungsten 1.0 mm. diameter connected in series. In the centre is a molybdenum support for holding the far end of the filament system in place. The leads of this filament system, which carries 50 amps., deserve some attention. A number of difficulties were encountered

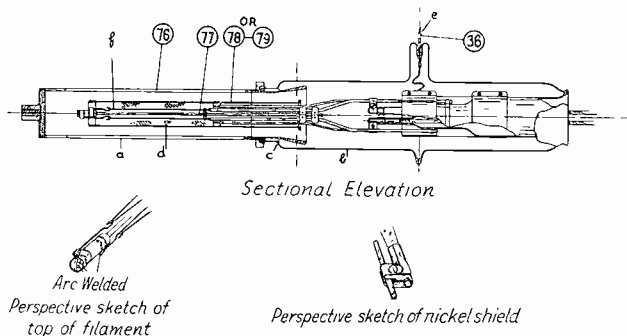

FIG. 4B.

when nickel iron or copper joints of this small size were used, so thimbles of platinum were tried with great success. If the necessarily heavy leads are mounted in position when the thimbles are sealed to the glass legs of the foot tube, cracking of the glass often occurs due to the rapid local cooling. The thimbles are therefore joined to the glass independently (which eases the glasswork enormously). After the glasswork is finished, a well-fitting silver-plated copper lead is inserted into the platinum thimble. This

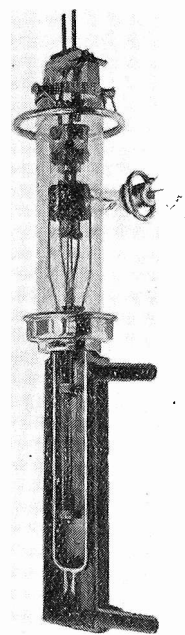

FIG. 4C.

is then squeezed on to the lead by the clamp which also holds the molybdenum conductors on the inside of the valve. Fig. 4b shows the construction and also a part sectioned valve in its jacket. The grid lead is brought through the side of the main glass envelope. A point of interest to engineers is the loading of the anode, the actual length which is bombarded being 4 in. Thus, with an external diameter of 2 in. we have about 25 sq. in. to dissipate the energy which on test may be over 12 kw. in other words about  $\frac{1}{2}$  kw. per sq. in. Later on we shall see that the effect of this abnormally heavy loading brings to light several interesting factors. The C.A.T. valve described was the first to be developed by the M.O. Valve Co. and is similar to the earlier American design\*. It was first employed at the Marconi wireless station, Carnarvon and at the old Daventry 5XX station of the British Broadcasting Co. also at the Rugby station of the G.P.O.



FIG. 5

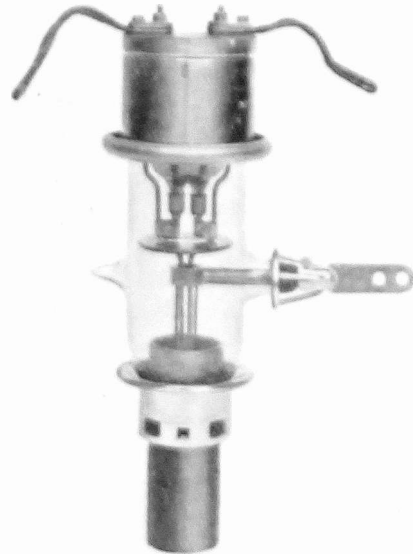

FIG. 6

Valves are also required for modulating the radio frequency output of a broadcast station. These are in most respects similar to the C.A.T. except that the grid is made more open thus lowering the modulation of  $m$  value and also the impedance.

\* It is interesting to note that although the Americans were the first to produce a satisfactory commercial article earlier attempts had been made. For instance, the M.O. Valve Co. at the request of the Marconi Co. constructed a water-cooled rectifier assembly in which a steel tube closed at one end had a platinum molybdenum silver-soldered cathode and this in turn was sealed into the glass bulb. The construction employed was the reverse of what is used at present in that the anode was in the centre and the cathode on the outside. On double anode loadings were obtained, but owing to difficulties encountered the experiments were dropped.

**Short Wave Valves.**

Soon after broadcasting began a new and highly important development in wireless communications demanded special valves ; this was the short wave " beam " of the Marconi Company. As these short waves have a frequency of about 20 mega cycles the capacity currents to the various electrodes become high, and so a special design had to be made which could deal with H.F. capacity currents in the grid of the order of 15-20 amperes. This was made possible by using a platinum thimble seal similar to the filament seals described above. Here again platinum is very suitable, as it is not magnetic, and is also a comparatively good conductor. For circuit reasons the grid lead was brought in at the end of the valve remote from the

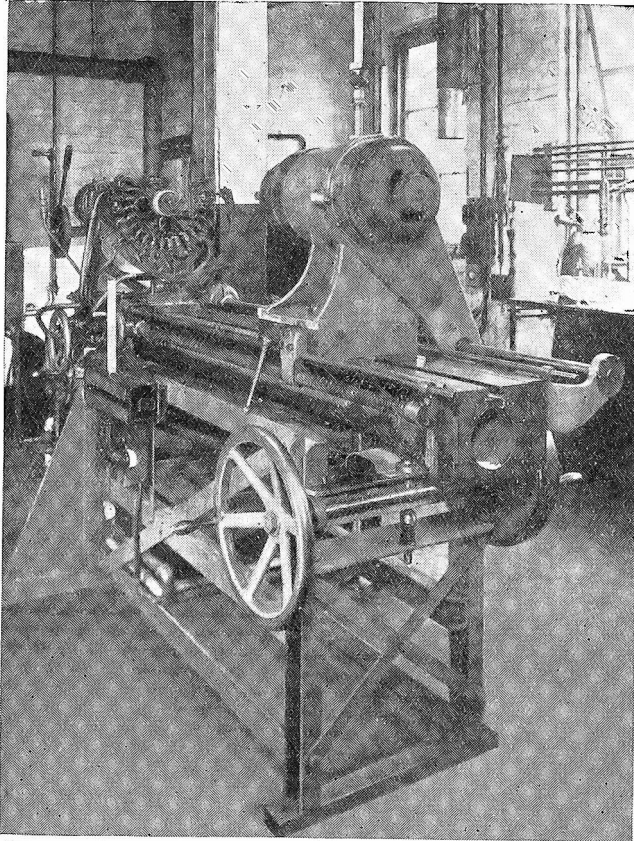

FIG. 7A.

filament leads. Fig. 5 shows the C.A.T.2 valve used for this purpose. It will be noticed that both ends of the anode are glassed. The C.A.T.15 (Fig. 6), of more recent development, has been introduced for oscillating at wavelengths down to 2 metres. Compactness of design and the minimum inter-electrode capacity and inductance have been achieved in a valve of which the overall dimensions are 390 mm. by 176 mm. to handle a maximum input varying from 3.75 kw. (5 kv.) at 3 metres down to 2 kw (3.5 kv.) at 2 metres.

**The Glass Lathe.**

Up to the present we have not mentioned the special glass-working apparatus necessary for making these joints, and for sealing in the electrodes. As the anode is opaque it is impossible to see whether the electrodes are sealed in centrally, so a special " glass lathe " was designed on which the various electrodes could be mounted



and centred and then inserted into the anode to be sealed in. This glass lathe has two heads, in accurate axial alignment, which can be rotated at equal speeds; these two heads replace the two hands of the glass-blower, who, owing to the size and weight to be handled, would be unable to cope with them. Mounted on the lathe is an array of gas blow-pipes for heating the glass, which can be adjusted and moved along the lathe bed by the glass-blower as he wishes. Figs. 7A and B show views of the latest types of these lathes, embodying all recent improvements to assist the glass-blower in his work.

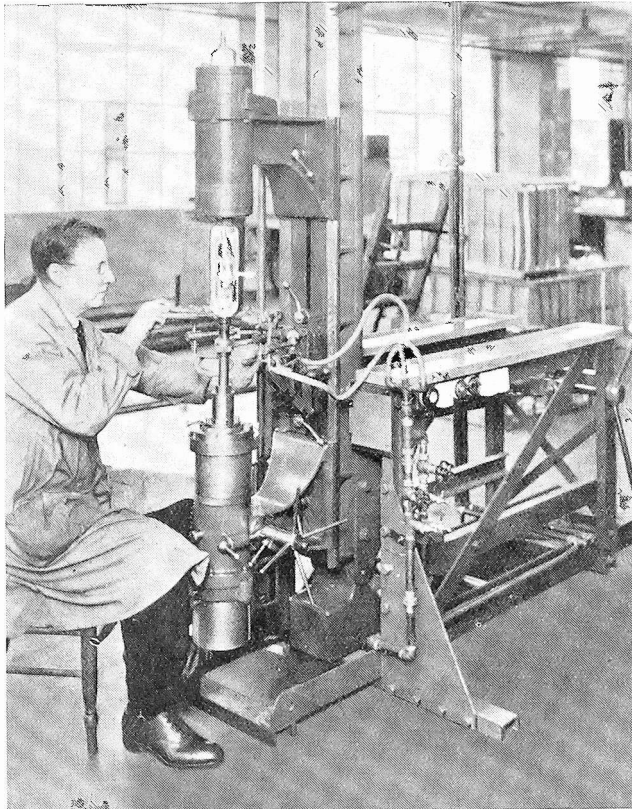

FIG. 7B.

#### **Other Water-cooled Anode Valves.**

With the increase in power of broadcasting stations larger valves were required. Another type, the C.A.T.6, of approximately  $1\frac{1}{2}$  times the power of the C.A.T.1 was developed, which is now in use in most of the B.B.C. stations; not only was the valve higher in power than the C.A.T.1, but its characteristics were also improved. These valves are able to operate at an anode voltage of about 10-12 kv., and when employed in suitable circuits did not give any trouble.\* In Table II is listed a range of water-cooled anode valves.

---

\* For details of circuits and the effect of high voltage the reader is referred to a paper by B. S. Gossling, J.I.E.E., V71, p. 460.

**High Power Broadcasting.**

About 1930-1931 super power broadcasting stations began to receive active consideration, and although it would have been possible, as was done at Carnarvon with glass valves, to parallel a large number of valves of C.A.T.6 size, it was obvious that the chance of interruption of service would increase with the number of valves employed. A much larger valve, the C.A.T.10, illustrated in Figs. 8A, B and C, was designed capable of operation at about 15 kv. To this end a new departure in the construction was employed. Up to that time all valves had had their filament systems supported at both ends; this called for a guide which was usually sprung so as to tension the filament. The design was further complicated by the necessity of an insulator between filament loops, and also in some cases between grid and

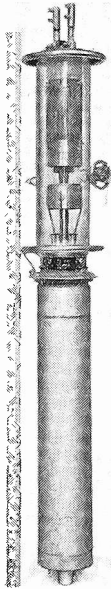

FIG. 8A.

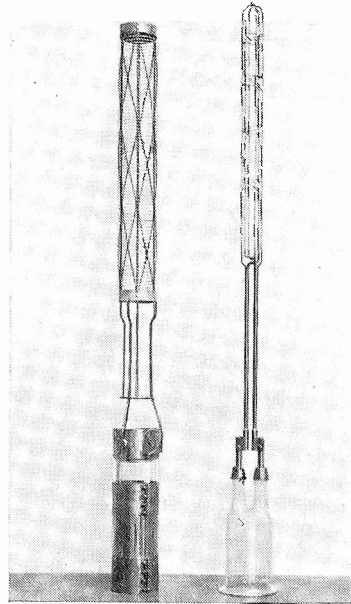

FIG. 8. (B). (C).

filament. Such an insulator, situated as it is in the discharge space, when it becomes coated with tungsten by evaporation of the cathode, is very liable to cause flash-arcs due to surface discharges. It therefore seemed desirable to construct a filament system which could hang vertically without requiring a guide, and in this way reduce the flash-arc trouble.

**The Unsupported Filament.**

A squirrel cage filament system was therefore made up having six parallel wires joined together at the bottom end by arcing. Alternate wires were connected to each of the two filament leads, see Fig. 8c. In order to determine whether such a system was stable inside the grid under the electrostatic forces present during the operating cycle of the valve, a chain system of similar shape and size to the filament system was made up and hung inside a metal tube filled with oil. An E.M.F. was then applied between the chain and tube and the deflection noted for various voltages. (Theoretically with everything central, the chains should bow out equally, but if the system is slightly out of centre, the whole system is pulled to one side.) Allowing for the dielectric constant of the oil, an accurate estimate

and centred and then inserted into the anode to be sealed in. This glass lathe has two heads, in accurate axial alignment, which can be rotated at equal speeds; these two heads replace the two hands of the glass-blower, who, owing to the size and weight to be handled, would be unable to cope with them. Mounted on the lathe is an array of gas blow-pipes for heating the glass, which can be adjusted and moved along the lathe bed by the glass-blower as he wishes. Figs. 7A and B show views of the latest types of these lathes, embodying all recent improvements to assist the glass-blower in his work.

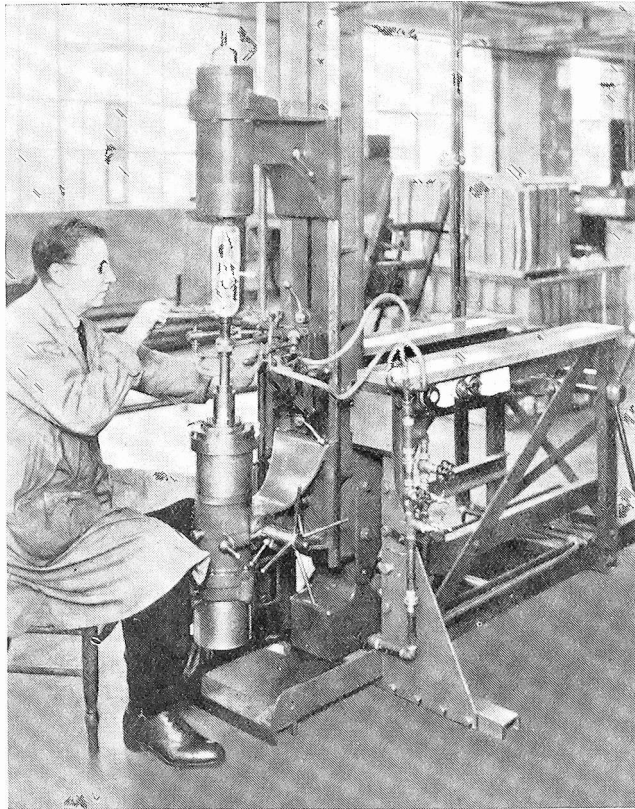

FIG. 7B.

#### **Other Water-cooled Anode Valves.**

With the increase in power of broadcasting stations larger valves were required. Another type, the C.A.T.6, of approximately  $1\frac{1}{2}$  times the power of the C.A.T.1 was developed, which is now in use in most of the B.B.C. stations; not only was the valve higher in power than the C.A.T.1, but its characteristics were also improved. These valves are able to operate at an anode voltage of about 10-12 kv., and when employed in suitable circuits did not give any trouble.\* In Table II is listed a range of water-cooled anode valves.

---

\* For details of circuits and the effect of high voltage the reader is referred to a paper by B. S. Gossling, J.I.E.E., V71, p. 460.

**High Power Broadcasting.**

About 1930-1931 super power broadcasting stations began to receive active consideration, and although it would have been possible, as was done at Carnarvon with glass valves, to parallel a large number of valves of C.A.T.6 size, it was obvious that the chance of interruption of service would increase with the number of valves employed. A much larger valve, the C.A.T.10, illustrated in Figs. 8A, B and C, was designed capable of operation at about 15 kv. To this end a new departure in the construction was employed. Up to that time all valves had had their filament systems supported at both ends; this called for a guide which was usually sprung so as to tension the filament. The design was further complicated by the necessity of an insulator between filament loops, and also in some cases between grid and

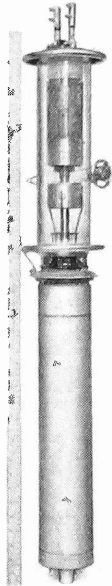

FIG. 8A.

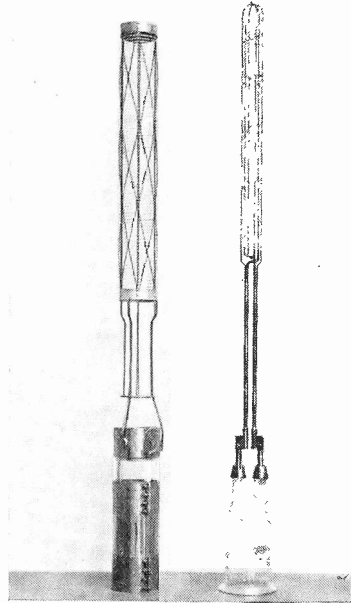

FIG. 8. (B). (C).

filament. Such an insulator, situated as it is in the discharge space, when it becomes coated with tungsten by evaporation of the cathode, is very liable to cause flash-arcs due to surface discharges. It therefore seemed desirable to construct a filament system which could hang vertically without requiring a guide, and in this way reduce the flash-arc trouble.

**The Unsupported Filament.**

A squirrel cage filament system was therefore made up having six parallel wires joined together at the bottom end by arcing. Alternate wires were connected to each of the two filament leads, see Fig. 8c. In order to determine whether such a system was stable inside the grid under the electrostatic forces present during the operating cycle of the valve, a chain system of similar shape and size to the filament system was made up and hung inside a metal tube filled with oil. An E.M.F. was then applied between the chain and tube and the deflection noted for various voltages. (Theoretically with everything central, the chains should bow out equally, but if the system is slightly out of centre, the whole system is pulled to one side.) Allowing for the dielectric constant of the oil, an accurate estimate

of the deflection in an actual valve can be obtained. It must be remembered that the chain system represents the worst possible case, as tungsten is still fairly rigid at its operating temperature. Of course, such a system requires the valve to be mounted truly vertical, but that does not offer any difficulty in a properly designed stand.

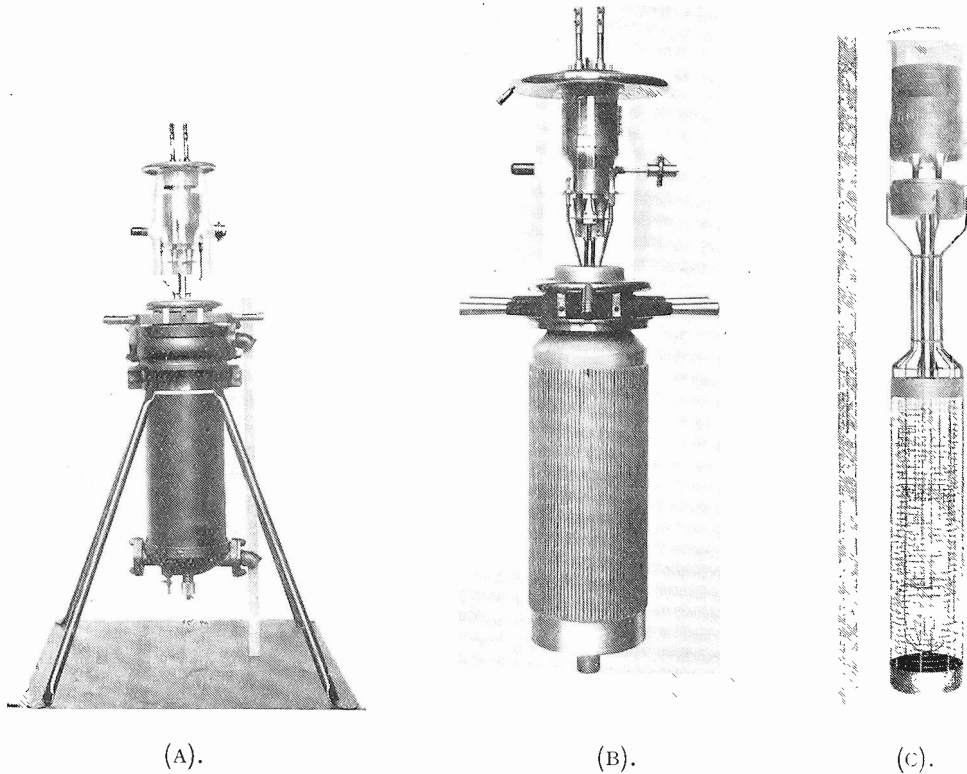

FIG. 9.

**The 100-kw. Valve.**

The C.A.T.io valve has an anode 4 in. diameter and about 20 in. long, the anode-glass seal being 4 in. diameter. The filament system requires 6 kw. to heat it, and for this purpose the filament seals must be able to carry over 200 amperes. As a considerable amount of heat, about 50 watts, is conducted down each of the leads from the hot filament, it was decided to water-cool the filament leads outside the valve up to where the leads pass through the glass. Also since these seals had to hold the filament central without any extra support, the platinum thimble seal was abandoned and comparatively large nickel iron cones were used. The grid, Fig. 8B, which owing to its length had to be specially rigid, was braced by diagonals between its main verticals; later on this bracing was dropped for the reason that owing to unequal heating of the various parts of the grid, strains were set up which caused permanent distortion. To compensate for this, the grid verticals were increased in size.

*The Development of Large Radio Transmitting Valves.*

The construction of this valve was a big step forward, the power which it was capable of handling being about four times that of the previous largest (the C.A.T.6). Later on a slightly larger edition, the C.A.T.12A, with improved characteristics, and capable of operating at 18kv., was made.

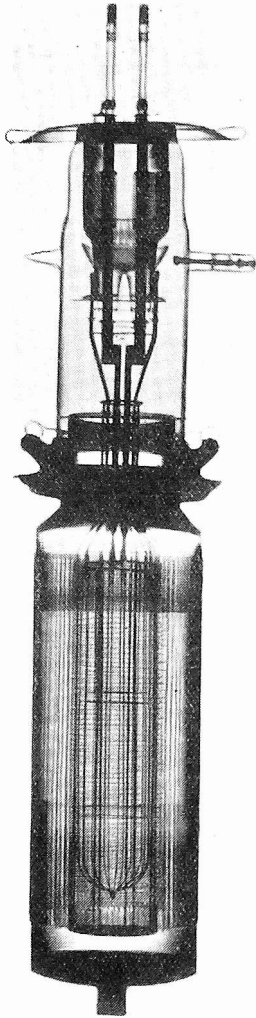

FIG. 10.

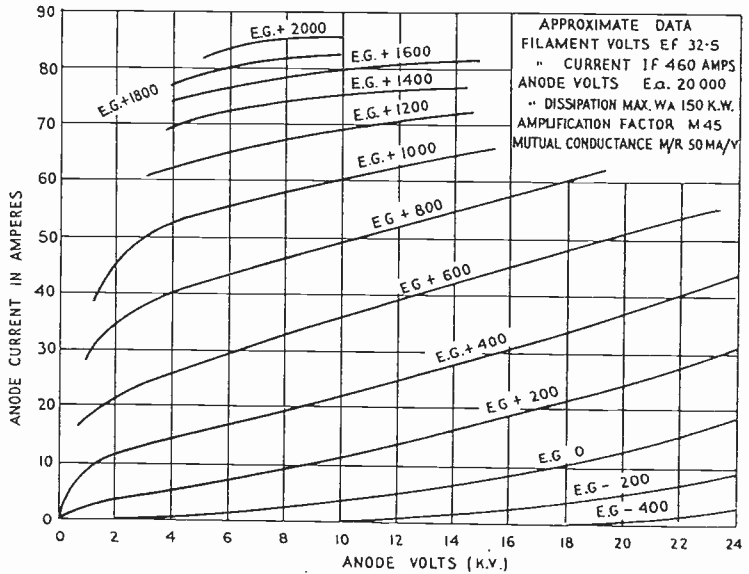
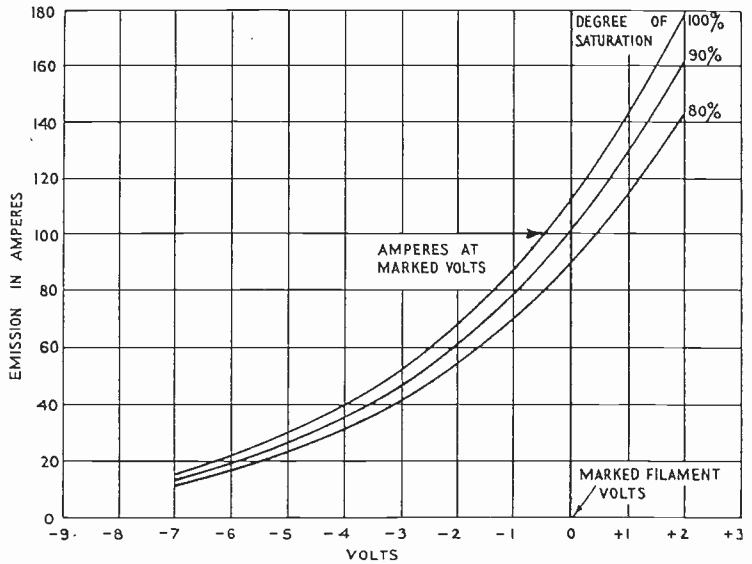

FIG. 11.

**The 500-kw. Valve.**

Owing to the success of this valve and to the increase in the power of broadcasting stations, a much larger valve, the C.A.T.14, was called for, capable of standing



per minute. Such a valve, if worked on telegraphy at an anode voltage of 20 kv., could handle an input of 500 kw. and give an output of about 350 kw. As used at present in broadcasting stations, it gives a "carrier" output of 50 kw. (which means a peak output of 200 kw. at 100 per cent. modulation), with less than 4 per cent. harmonics. Many of these large valves are now in use at Droitwich and various stations on the continent. Despite operation at this, the highest voltage used in broadcasting, these valves have been singularly successful, and their operation has been marked by complete freedom from flash-arcs. Fig. 11 gives characteristic curves for the type.

#### **Anode Loading and Cooling Methods.**

At this point we may appropriately discuss the cooling of the anode. As previously mentioned, the loading of the anode may be as much as  $\frac{1}{2}$  kw. per sq. inch, and if this figure is compared with that for other types of apparatus (such as immersion heaters), it will be found that the latter are normally loaded to about one-fifth of this figure; such heavy loadings may cause serious effects which were not appreciated at the beginning.

For the purpose of cooling valves of the C.A.T.2 type, oil, instead of water, had been adopted to eliminate trouble due to high frequency losses in the insulation of the water system; it was found, however, that the anodes of these valves were eroded so seriously that several anodes were perforated. In order to investigate this effect, one end of a eureka wire was embedded in the surface of the anode, at the point of highest loading, forming with it a eureka-copper thermocouple which was used to measure the surface temperature of the anode at various loadings. A surprising result was obtained. It was found that although the temperature of the bulk of the oil did not rise appreciably, the anode temperature rose very rapidly at light loads (0.1 kw. per sq. inch), the rise being proportional to the load, see Fig. 12, but at a certain point which was dependent on the cooling medium the curve bent sharply, and ran much more horizontally. This point of change of slope corresponded in all the different oils tried with that known as the "first drop" point. In other words the heat exchange between anode and cooling medium only becomes really efficient when incipient boiling takes place on the surface of the anode. If an ordinary high-class transformer oil is used, the temperature at which this takes place is so high as to cause the valve to evolve gas; if, however, an oil of lower boiling point (such as "kerosene") is used, this point may lie between 140° and 160° centigrade, at which temperature the vacuum remains unimpaired. Another point has still to be guarded against, namely "sludging." This effect is well known to electrical engineers, in connection with oil-cooled transformers. If unsuitable oils are used (especially if oxygen is present) a sludge is formed on the copper conductors. Exactly the same effect takes place with oil-cooled anodes, but with the added effect that when sludge is formed this acts as a lagging, and further raises the anode temperature causing the sludge to "crack," just as oil is "cracked" in refining processes.

This cracking liberates nascent hydrogen, which causes the copper of the anode to become brittle, due to the reduction of the copper oxide in the grain boundaries of the metal, and in the end copper particles become detached.

The actual rate of rise of the first part of the curve can be varied considerably by increasing the rate of flow past the anode, either by increasing the actual quantity of oil flowing through the jacket in unit time, or by constricting the space. Thus in later designs jackets were made with comparatively small anode-jacket clearances, (about  $\frac{1}{8}$  in.).



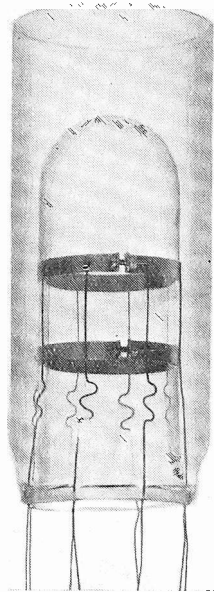

FIG. 13.

When water is used as a cooling agent a similar effect is noticed, but it is not so marked. The first change in rate of rise is noticed at about  $70^{\circ}\text{C}$ .; this corresponds to the point at which the dissolved air is being driven out of the water. After this the rate of rise is slower, but at very high loadings (which may be locally as high as 2 kw. per sq. in.), the temperature of the anode may reach  $140^{\circ}\text{C}$ .

#### **Air-cooled Anode Valves.**

So far we have considered two different methods by which the anode can dissipate its heat: (1) by radiation (as in glass valves); (2) liquid cooling. There exists a third method employed for valves of about the same wattages as glass valves. The method is similar to (2), but air is used to cool the anode instead of a liquid; the air circulation being either by convection or by forced draught. This last method is a development of the metal envelope valve made under the trade mark "Catkin," which was in its turn a development of the water-cooled valve.

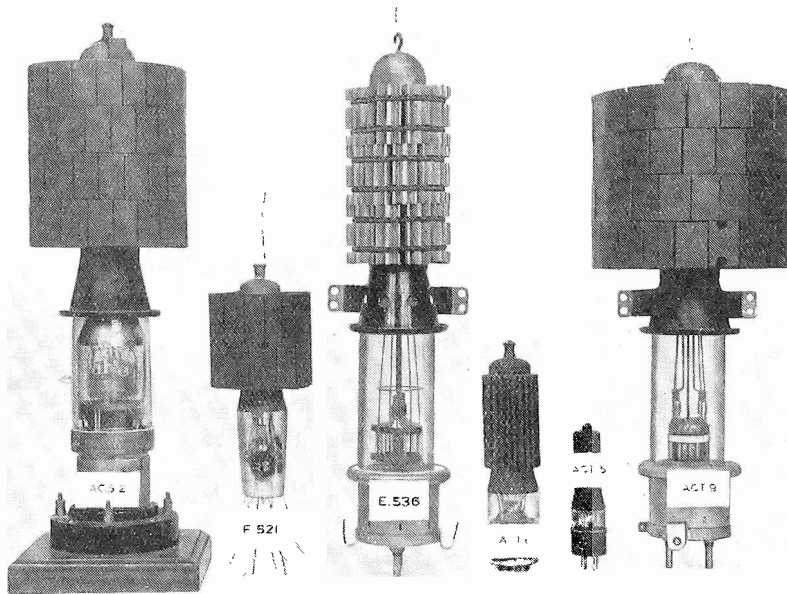

FIG. 14.

Valves with this method of cooling offer certain advantages over ordinary glass valves, due partly to the electrode arrangement and also to the "circular"

grid seal (Fig. 13), originally developed for metal envelope valves. Air-cooled anode valves, owing to the much lower inductance of the anode and grid leads, allow wave-lengths to be reached of the order of one-half to one-third of those possible with normal short wave glass valves. Although casual consideration of the effect on capacity would lead one to expect the anode grid capacity to be considerably higher, in actual practice the difference is not marked. This is due to the elimination of the long anode lead in the normal glass valve; this lead adding to the capacity as well as the inductance.

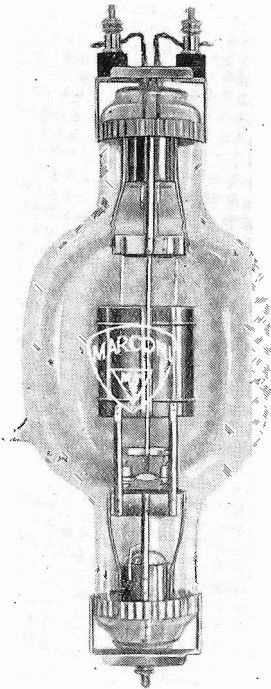

FIG. 15.



FIG. 16A.

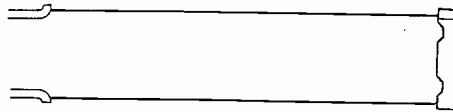
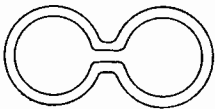

FIG. 16B.

Another advantage possessed by cooled anode valves over glass ones is the enormous "clean up" property of the surface of the cooled anode, which is able to adsorb large quantities of gas. The anode in a glass valve is unable to do so, owing to its high working temperature. This "clean up" effect allows of the easier attainment of emission from various "dull emitter" cathodes, and prevents the poisoning of these cathodes during life. During the last few years a number of different types employing air cooling have been developed, and a few of these have now passed out of their experimental stage. Table III gives their provisional ratings and Fig. 14 illustrates several of the types.

The Development of Large Radio Transmitting Valves.

TABLE III.  
AIR-COOLED ANODE VALVES.

Type.	Anode.		Filament.			M	Slope.	Remarks.
	Volts. (max.).	Dissipation watts.	Volts.	Amps.	Material.			
ACT9	6,000	1,000	16-17	22	Tungsten	40	3.5	With forced air cooling.
	6,000	800*						With normal convection cooling.
								*At reduced input the A.C.T.9 can be operated down to a wave-length of 10 metres at 5 kv.
								4 " " 4 "
								3 " " 3 "
ACT6	1,500	75 max. †	10	1.6	Oxide-coated	25	5.0	†At lower wave-lengths the A.C.T.6 can provisionally be operated under the following conditions:—
								4 metres 800 anode volts 10 watts output (approx.)
								6 " 800 " " 25 watts
								10 " 1,000 " " 65 "
								20 metres and above 1,500 anode volts 90 watts output (approx.).
ACT5	1,500	15	6	0.6	"	40	0.8	
§E521	2,500	150	12.5	3.0	Thoriated Tungsten	10-12	3.2	
ACS2	4,000	400	15	6.5	"	300	3.4	Screen grid.
ACS1	2,000	75	10	3.0	"	218	2.0	" "
§ E536	6,000	1,500	20	24	Tungsten	7	6.5	Modulator. Forced draught cooling.

§Types bearing an E number are still experimental.

TABLE IV.  
RECTIFYING VALVES.

Type.	Anode.		D.C. output from circuit.*			Filament.			Remarks.
	Material.	Cooling.	Volts.	Amps.	Rectifying circuit.	Volts.	Amps.	Material.	
MR2	Nickel	Radiation	10,000	0.2	Biphase ...	17	15	Tungsten	
MR6	"	"	10,000	0.3	"	15.5	10	"	
MR7a	Molybdenum	"	10,000	0.5	3-phase ½ wave	12.5	24	"	
MR9	"	"	10,000	0.8	Biphase ...	14	24	"	" "Binocular" Anode.
				1.2	3-phase ½ wave				
				0.35	Biphase ...				
CAR2	Copper	Water	12,000	2.0	"	20	50	"	
				3.3	3-phase ½ wave				
				4	Biphase				" "
CAR4	"	"	12,000	5	3-phase ½ wave	20	75	"	" "
				10	" " double Y				" "
CAR6	"	"	20,000	17	" " ½ wave	20	120	"	" "
				34	" " double Y				" "

\*In biphase circuits condenser input to filter.  
In 3-phase circuits choke input to filter.

### **Screen Grid Valves.**

Up to the present we have only considered the three electrode transmitting valve, but certain advantages can be obtained if screened grid valves are used. There is much less chance of "back coupling" or reaction, and thus higher gains of amplification per stage can be obtained without employing the difficult neutrodyning method, which in the end leads to instability. Up to the present two screen grid valves have been made of 75 and 400 watts dissipation. These valves were at first made in the normal glass construction, but with the introduction of the air-cooled anode they were redesigned with considerable improvement both in lower limit of wave-length and dependability (see table III).

### **Dull Emitter Cathodes.**

Only casual mention has been made of cathodes other than pure tungsten. Two other emitting cathodes have been developed during the last 18 years (which is the period under survey). These are the thoriated tungsten, and the oxide-coated cathode. The emission of the former is about 10 times, and of the latter 20 or more times that of pure tungsten for the same watts input, with an economical life. At the same time a valve with improved characteristics is attainable.

### **Thoriated Tungsten Cathode.**

This cathode is made by adding about 1 per cent. of thorium oxide to the tungsten powder used in the manufacture of tungsten wire. The process was first developed for lamps in about 1912, in order to overcome the brittleness of pure tungsten. If such a wire is used in a valve which is exhausted in the normal way, no special characteristics will be observed. If, however, during manufacture the filament is "carbonised" by heating in a hydrocarbon vapour so that it absorbs 0.5 per cent. or less of its weight of carbon, it can be made to exhibit a very marked improvement in emission. It is, however, necessary that the valve be pumped specially hard, or that a suitable "getter" (which has the property of "cleaning up" or absorbing any residual or evolved gas) be introduced. As mentioned above, this cathode can have a useful emission of about ten times that of ordinary tungsten. The filament is, however, comparatively brittle, and is also liable to loss of its emission if the valve is subject to overloads which cause gas evolution. Where the weight of the source of filament heating has to be considered or improved characteristics are required, the thoriated tungsten cathode has a great advantage.

### **Oxide-coated Cathodes.**

These cathodes, first used in receiving valves, depend usually on the emission from a coating composed of Barium and Strontium oxides on a nickel core (either wire, strip or tube). Up to the present their use in transmitting valves has been limited to 100 watts or less anode capacity and to comparatively low voltages. This emitter is the most recent one and offers a further saving of power over the thoriated tungsten cathode; it is at the same time comparatively robust. A column in table III shows the cathode material used in the various types.

### **Rectifier Valves.**

Up to the present we have considered only valves containing three or more electrodes; all of these valves can be used to amplify an incoming signal. There is, however, another type, the rectifier, which occupies a very important part in the equipment of most transmitting stations. In order to obtain high tension direct current, either special D.C. machines have to be used or, more usually, high tension alternating currents are rectified by means of a two-electrode valve. As with the

*The Development of Large Radio Transmitting Valves.*

other valves at first, these were of glass, with the electrodes inside the bulb, and were in fact very similar to the M.T.2, described on page 6, the grid being omitted.

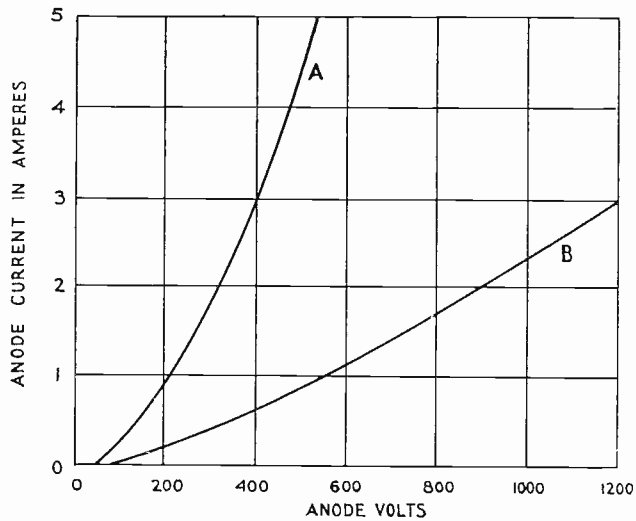

FIG. 17.



FIG. 18.

When the use of cooled anode transmitting valves in larger sizes became general, the development of high-powered cooled anode rectifiers followed as a logical step. Since the function of a rectifier is simply to rectify and not control, a theoretical

energy conversion efficiency of 100 per cent. might be thought possible. This would, however, necessitate the voltage drop in the rectifier being zero. Normal thermionic rectifiers have a very high impedance, but by suitable design this can be considerably reduced. In order to do this, as stated earlier, the length of the cathode should be as great as possible. There is, however, another important point in designing these rectifiers. When the valve is not conducting, i.e. on the reverse half cycle, a very large voltage difference occurs between the anode and cathode, resulting in an electrostatic pull between them. Unless this can be equalised all around it, the filament may be drawn over to the anode, causing a short circuit. In normal valves, where the cathode is in the form of a hairpin, a comparatively strong spring prevents the filament from bowing out too far.

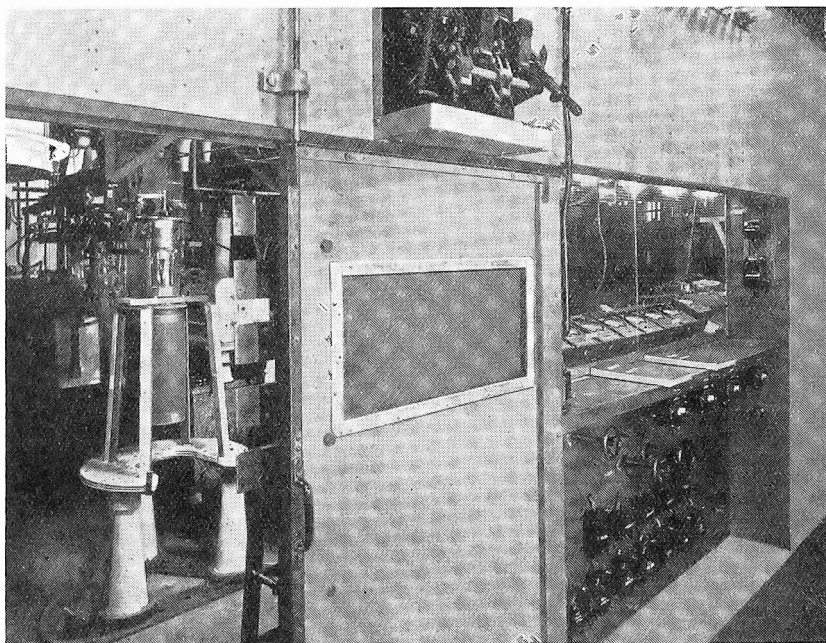

FIG. 19.

#### **Low-impedance Rectifiers (design).**

However, a design was evolved by which the limbs of the hairpin (if it may still be so called) were separated, and each was placed in an anode of its own. The two cathodes were connected by a rigid cross-piece and the two anodes placed side by side in one bulb, as in the case of the glass rectifier, the MR9, Fig. 15.

In the case of water-cooled valves, these anodes form, of course, part of the envelope. The construction was greatly simplified by forming the anodes out of a single large tube, pressed into two parallel cylindrical portions. Fig. 16 is a photograph of such a valve. Fig. 16A shows a section of the anode in the central portion in which the emitting cathode is mounted, and Fig. 16B the design of cathode.

By this type of design a rectifier has been obtained having a considerably lower impedance and since each filament is central in its anode, there is little tendency for it to be pulled sideways. Thus a smaller tension is sufficient to keep the filaments

central. Fig. 17 gives the characteristic curve of such a valve (curve A), while curve B gives that obtained with a rectifier of similar filament wattage, but in which a more bunched filament is used.

In table IV are given ratings of the various types, their maximum working D.C. voltage, and the current which can be obtained when using either biphas half wave, or three-phase half wave. By using a full wave circuit still higher voltages are possible, but as two valves carry the current in series the voltage drop across the unit is doubled.

Rectifiers of these types employing a tungsten cathode have a very useful characteristic, namely that of limiting the current on a short circuit, due to the fact that the cathode, for any given temperature, has a definite emission per sq. cm. and that this emission is practically independent of the voltage across the rectifier.

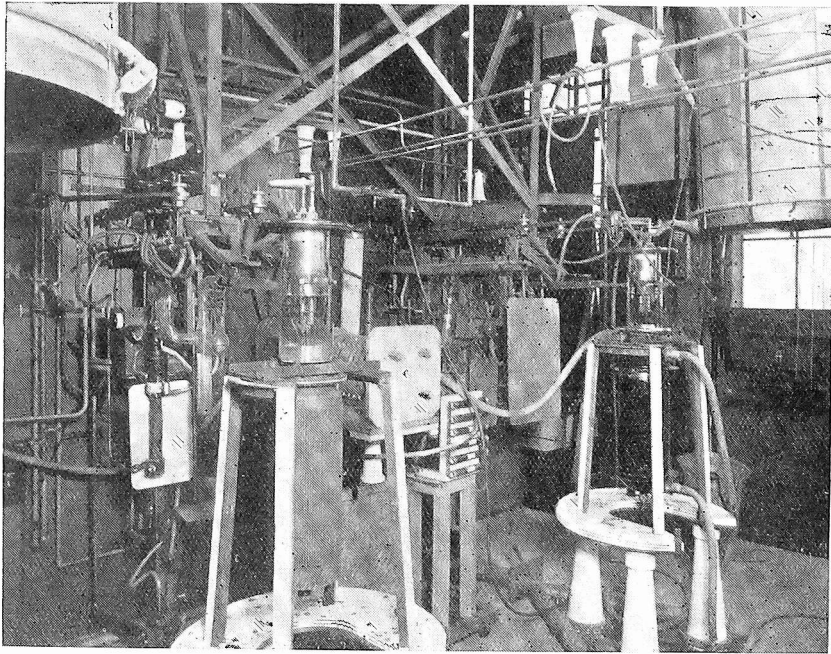

FIG. 20.

### **Mercury Vapour Rectifiers.**

Until recently rectifiers such as have been described have held the field, but new types containing mercury vapour have been developed, and, although their development is progressing rapidly, the vacuum type is still a very important one, owing to its proved reliability and its short-circuit-current limiting properties. It is not intended to discuss mercury vapour rectifiers in this article, but it may be mentioned that the cathode can either be oxide-coated, or a mercury pool. As the voltage drop is about 10 and 30 volts respectively and is independent of the current, it is readily seen that their efficiency is extremely high.

### **Manufacture.**

The manufacture of these valves would require an article to itself, but it might be of interest to contrast the plant in use 17 years ago with that of the present day. Fig. 18 is an old photograph (about 1920) of the exhausting plant for early glass valves which occupied about one day in pumping.

Fig. 19 is the exterior and Fig. 20 the interior view of a modern fully protected installation capable of exhausting two of the largest present-day valves simultaneously, an operation which, working night and day, takes a week or more to complete.

R. LE ROSSIGNOL,

E. W. HALL,

Research Staff of M.O.  
Valve Co., Ltd.

### REFERENCES.

- B. S. Gossling. *Journal I.E.E.*, 1932, V71, p. 460.  
W. J. Picken. *Journal I.E.E.*, 1927, V65, p. 791.  
N. Ashbridge, Bishop, MacLarty. *Journal I.E.E.*, 1935, V77, p. 437.  
W. G. Housekeeper, *J. Amer.I.E.E.*, 1923, V42, No. 9.  
R. V. Hansford and H. Faulkner. *Journal I.E.E.*, 1927, V65, p. 308.  
A. C. Bartlett. *Experimental Wireless and the Wireless Engineer*, 1927, V4, p. 430.  
P. P. Eckersley, N. Ashbridge. *Journal I.E.E.*, 1930, V68, p. 1155.  
E. L. Chaffee. *Theory of Thermionic Vacuum Tubes* (McGraw-Hill).



# MARCONI ULTRA SHORT WAVE STANDARD SIGNAL GENERATOR

*The Marconi Company has recently added an ultra short-wave standard signal generator to its existing range of this type of instrument.*

*A brief description of the instrument is given together with an outline of some of the checks which were carried out during development in order to establish its accuracy.*

---

**T**HE Marconi Ultra Short Wave Standard Signal Generator is a test signal source designed for a variety of uses over the band of frequencies lying between 100 megacycles and 20 megacycles. Over this range of frequencies the instrument provides a wide and continuously variable range of voltage output from 0.0005 to 100 millivolts at a low output impedance value.

The control settings of the attenuator, which is of a balanced capacity type, give a direct indication of the voltage output at all frequencies, a feature which renders the operation of the instrument simple and straightforward. Additionally the output control is calibrated in decibels to facilitate purely ratio measurements.

The efficiency of the screening is such that stray leakage from the generator is of an extremely low order. The instrument is, therefore, equally suitable for test operations on both screened and unscreened receivers.

The complete equipment, which is of compact portable form, comprises two units one of which carries the generator and attenuator and the other accommodates the supply batteries and spars.

## **Operating Features.**

Frequency setting of the generator is effected by variation of inductance operated by a high precision control scale. This arrangement is highly satisfactory in operation and provides a wide degree of frequency discrimination as is shown by the fact that a control scale rotation of 1,000 degrees is required to effect an average wavelength change of about one metre.

To assist in aurally tuning the generator to a receiver, modulation at a frequency of 1,000 cycles, switch controlled and continuously variable in depth up to an approximate maximum of 35 per cent., is included internally with the generator. The modulation is not, however, intended for qualitative or quantitative measurement purposes on account of the inevitable carrier scintillation which direct modulation of a short wave generator produces at all but very shallow modulation depths.

The generator frequency is only affected by a very small percentage with variation of the attenuator control when the generator coupling is adjusted for the higher levels of voltage output but at low coupling settings the frequency is not affected.

The generator is equipped with alternative output impedances whose values are 10 ohms and 1 ohm respectively. These impedances, owing to their special design, are effectively independent of frequency over the full range of the instrument. Provision is made at the output terminal for the use either of a rod aerial radiator or of a screened output connection.

### Accuracy.

During the development of the standard signal generator all components involving the accuracy of the voltage output were subjected to exhaustive tests and checks and it can be confidently stated that the accuracy of the voltage output is within  $\pm$  or  $-$  15 per cent. at any frequency on outputs between 100 milli-volts and 0.5 milli-volts and within  $\pm$  or  $-$  25 per cent. between 0.5 milli-volts and 0.0005 milli-volts. At lower output levels the generator can be regarded as a useful but not highly accurate voltage source. In view of the frequencies at which the instrument operates it is considered that it would be of interest to give a brief outline of some of the checks and tests which were carried out in order to establish these output accuracies.

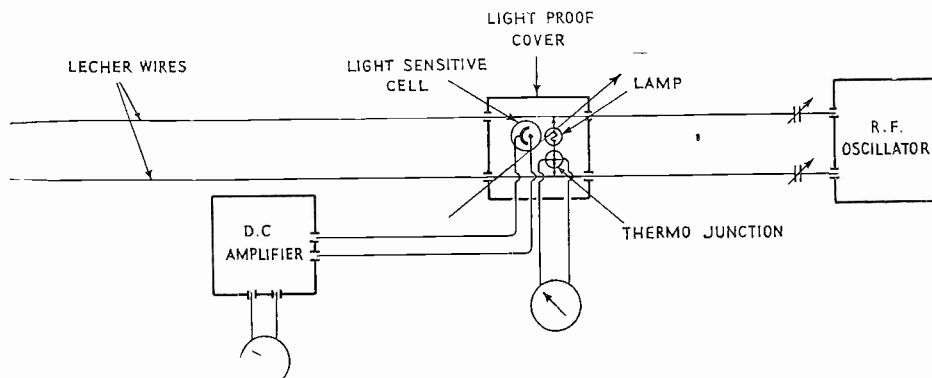

FIG. 1.

### R.F. Current Measurement.

The solution of the problem of checking the R.F. current measuring accuracy of the thermo-junction to be employed in the U.S.W. standard signal generator presented some difficulty. A suggestion, due to Mr. S. B. Smith, to secure through the agency of a light sensitive cell and a D.C. amplifier, a calibration of the filament current versus filament luminosity of a lamp and, employing this calibration as a standard, to compare the D.C. and R.F. current calibrations of the thermo-junction was adopted.

In securing the R.F. current calibrations for the required comparisons preliminary experiments were made employing a calibrating lamp and thermo-junctions of special design in which the lamp filament and junction heater and their respective immediate connecting wires were arranged in the same straight line. Further the couple element was arranged at right angles to the heater. This arrangement ensured that shunt capacity and "jump over" effects were reduced to the lowest possible minimum.

On the completion of the required D.C. calibrations the special lamp and, in turn, the special and standard type thermo-junctions were connected in series and cross calibrated at various radio frequencies ranging from 120 megacycles to 30 megacycles. During the R.F. calibrating precautions were taken to ensure that equal currents were simultaneously recorded in the lamp and junction. Satisfactory results in this direction were not secured until the two units were closely connected in series as a "bridge" across a pair of Lecher wires excited by an R.F. generator. A schematic circuit diagram is given in Fig. 1.

# MARCONI ULTRA SHORT WAVE STANDARD SIGNAL GENERATOR

*The Marconi Company has recently added an ultra short-wave standard signal generator to its existing range of this type of instrument.*

*A brief description of the instrument is given together with an outline of some of the checks which were carried out during development in order to establish its accuracy.*

---

THE Marconi Ultra Short Wave Standard Signal Generator is a test signal source designed for a variety of uses over the band of frequencies lying between 100 megacycles and 20 megacycles. Over this range of frequencies the instrument provides a wide and continuously variable range of voltage output from 0.0005 to 100 millivolts at a low output impedance value.

The control settings of the attenuator, which is of a balanced capacity type, give a direct indication of the voltage output at all frequencies, a feature which renders the operation of the instrument simple and straightforward. Additionally the output control is calibrated in decibels to facilitate purely ratio measurements.

The efficiency of the screening is such that stray leakage from the generator is of an extremely low order. The instrument is, therefore, equally suitable for test operations on both screened and unscreened receivers.

The complete equipment, which is of compact portable form, comprises two units one of which carries the generator and attenuator and the other accommodates the supply batteries and spares.

## **Operating Features.**

Frequency setting of the generator is effected by variation of inductance operated by a high precision control scale. This arrangement is highly satisfactory in operation and provides a wide degree of frequency discrimination as is shown by the fact that a control scale rotation of 1,000 degrees is required to effect an average wavelength change of about one metre.

To assist in aurally tuning the generator to a receiver, modulation at a frequency of 1,000 cycles, switch controlled and continuously variable in depth up to an approximate maximum of 35 per cent., is included internally with the generator. The modulation is not, however, intended for qualitative or quantitative measurement purposes on account of the inevitable carrier scintillation which direct modulation of a short wave generator produces at all but very shallow modulation depths.

The generator frequency is only affected by a very small percentage with variation of the attenuator control when the generator coupling is adjusted for the higher levels of voltage output but at low coupling settings the frequency is not affected.

The generator is equipped with alternative output impedances whose values are 10 ohms and 1 ohm respectively. These impedances, owing to their special design, are effectively independent of frequency over the full range of the instrument. Provision is made at the output terminal for the use either of a rod aerial radiator or of a screened output connection.

### Accuracy.

During the development of the standard signal generator all components involving the accuracy of the voltage output were subjected to exhaustive tests and checks and it can be confidently stated that the accuracy of the voltage output is within  $\pm$  or  $-$  15 per cent. at any frequency on outputs between 100 milli-volts and 0.5 milli-volts and within  $\pm$  or  $-$  25 per cent. between 0.5 milli-volts and 0.0005 milli-volts. At lower output levels the generator can be regarded as a useful but not highly accurate voltage source. In view of the frequencies at which the instrument operates it is considered that it would be of interest to give a brief outline of some of the checks and tests which were carried out in order to establish these output accuracies.

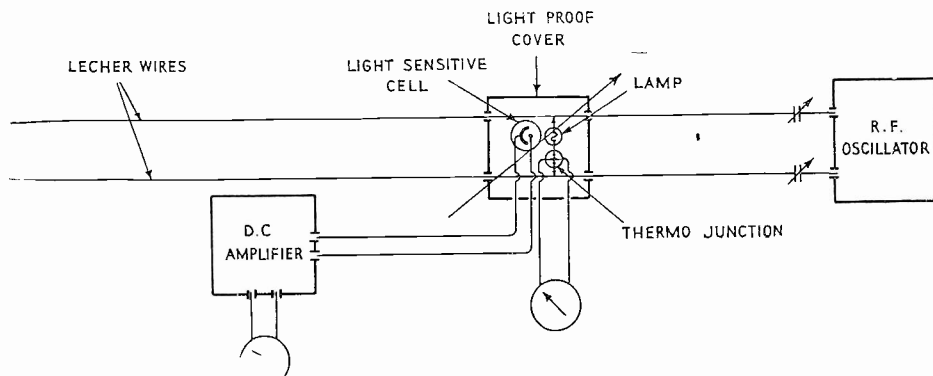

FIG. 1.

### R.F. Current Measurement.

The solution of the problem of checking the R.F. current measuring accuracy of the thermo-junction to be employed in the U.S.W. standard signal generator presented some difficulty. A suggestion, due to Mr. S. B. Smith, to secure through the agency of a light sensitive cell and a D.C. amplifier, a calibration of the filament current versus filament luminosity of a lamp and, employing this calibration as a standard, to compare the D.C. and R.F. current calibrations of the thermo-junction was adopted.

In securing the R.F. current calibrations for the required comparisons preliminary experiments were made employing a calibrating lamp and thermo-junctions of special design in which the lamp filament and junction heater and their respective immediate connecting wires were arranged in the same straight line. Further the couple element was arranged at right angles to the heater. This arrangement ensured that shunt capacity and "jump over" effects were reduced to the lowest possible minimum.

On the completion of the required D.C. calibrations the special lamp and, in turn, the special and standard type thermo-junctions were connected in series and cross calibrated at various radio frequencies ranging from 120 megacycles to 30 megacycles. During the R.F. calibrating precautions were taken to ensure that equal currents were simultaneously recorded in the lamp and junction. Satisfactory results in this direction were not secured until the two units were closely connected in series as a "bridge" across a pair of Lecher wires excited by an R.F. generator. A schematic circuit diagram is given in Fig. 1.

The series of calibrations secured establish that in the case of the special and standard type 50 m/a thermo-junctions (no socket being employed in the case of the latter) the respective radio frequency calibrations at all frequencies up to 120 megacycles are in remarkably close agreement with the respective direct current calibrations. Some of the actual calibrations of the standard type 50 m/a thermo-junction at different frequencies are illustrated in Fig. 3. This type of thermo-junction is adopted for R.F. current measurement in the ultra short wave standard signal generator.

As a matter of interest a few D.C.—R.F. calibration curves of a standard type 25 m/a thermo-junction are given in Fig. 2. It will be observed from these curves that this type of junction is unreliable for R.F. current measurement at any of the frequencies checked. This is also equally true of the special type 25 m/a thermo-junction whose calibrations show similar discrepancies.

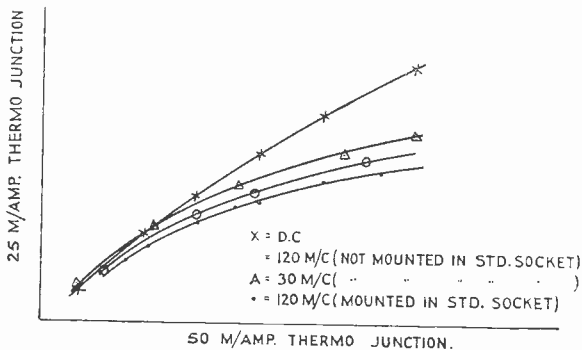

FIG. 2.

The socket would be expected to increase the accidental shunt capacity across the heater. Additional shunting capacity, added in later tests, quantitatively checked that shunt capacity does explain the discrepancy.

### Output Impedance Checks.

In the design of radio frequency measuring equipment the choice of resistance materials and their method of adaptation to the particular requirements is governed by considerations of "skin effect," the inductive properties of the element and accidental shunt capacity. If the presence or effect of these properties can be avoided or be reduced to negligible proportions the operation of the measuring equipment will be very much more accurate and simple.

The Marconi Ultra Short Wave Standard Signal Generator employs output impedance units in which "skin effect" is avoided by the use of a resistance material possessing a sufficiently high volume resistivity to ensure complete penetration at all relevant frequencies, inductive effects are reduced to negligible proportions by the method of mounting the elements and unavoidable shunt capacities have been kept within such limits that, at all relevant frequencies, their effect on the low values of resistance employed is inappreciable.

Calculations by various well-known formulae applicable to the type show that, for all practical purposes, the output impedances are independent of frequency. In view, however, of the extremely high frequencies at which the generator operates

*Marconi Ultra Short Wave Standard Signal Generator.*

and the fact that electrical measurement at these frequencies is a comparatively new art it was considered that some practical proof of the validity of the calculations was desirable. In order, therefore, to verify the calculations a number of special resistance units were prepared possessing differing characteristics so that each required a different magnitude of calculated correction for reactance at identical radio frequencies. Over a range of frequencies measurements were made by a ratio method of the effective impedance of each of the units at each frequency. The measured effective impedance ratios were then compared with the calculated effective impedance ratios. A few of the results obtained are given in the table below together with a table giving the calculated impedance correction factor applicable to each unit at frequencies of 100 and 44 megacycles respectively.

Frequency (megacycles).	Unit Nos. compared.	D.C. Res. ratio (dB).	Cal. eff. Z. ratio (dB).	Meas. eff. Z. ratio (dB).
100	3 and 1	8.0	8.0	8.5
"	5 and 1	15.2	15.2	16.0
"	5 and 4	4.6	4.6	4.8
"	8 and 6	22.7	7.9	7.6
"	8 and 7	10.7	-4.0	-4.7
"	8 and 9	13.0	13.0	12.5
"	8 and 10	—	1.3	2.5
"	1 and 11	—	3.2	4.5
44	7 and 6	12.0	12.0	12.0
"	9 and 6	9.7	1.6	1.0
"	7 and 9	2.5	10.4	11.3
"	10 and 1	—	8.5	8.0
"	8 and 10	—	8.5	7.5
"	1 and 11	—	8.5	8.0

Unit No.	Cal. eff. Z. factor at 100 M/C.	Cal. eff. Z. factor at 44 M/C.
1 } 3 } 4 } 5 }	1.315 (2.36 dB).	1.065 (0.53 dB).
6 } 7 }	5.58 (14.92 dB).	2.52 (8.1 dB).
8 } 9 }	1.02 (0.18 dB).	1.0 (0.0 dB).
10 } 11 }	These units are virtually pure reactances.	

Comparing the calculated and measured ratios given in the table for each pair of units it is clear that there is a very fair measure of agreement. Particularly interesting are the ratios respecting units Nos. 6 and 7 in which the correction factor is as high as 5.58 at 100 M/C, and units Nos. 10 and 11 which are effectively pure reactances.

**Overall Voltage Output Check.**

As a final check of the voltage delivered across the output terminals of the Ultra Short Wave Standard Signal Generator valve voltmeter measurements were made. The valve voltmeter employed for the purpose is one that has been specially developed by the Marconi Research Laboratories to operate at frequencies covered by the ultra short wave bands. It is considered to be accurate to within + or - 10

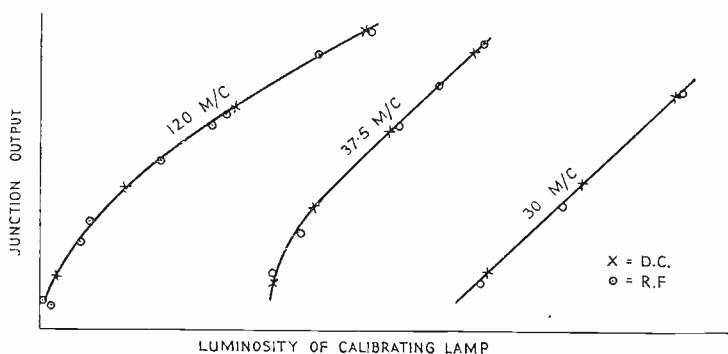

Fig. 3.

per cent. at frequencies up to 100 M/C. The following table gives a comparison between the nominal output of the standard signal generator and the valve voltmeter measurements:—

Frequency M/C.	Gen'r. nominal output (milli-v).	Valve V/meter (milli-v).
100	100	103—122
75	100	96
50	100	90
33	100	92
25	100	89
20	100	89

The independent checks supplied by the valve voltmeter measurements show that the accuracy of the standard signal generator voltage output is within the specified limits.

F. M. WRIGHT.

---

---

## OBITUARY.

### Mr. F. S. STACEY

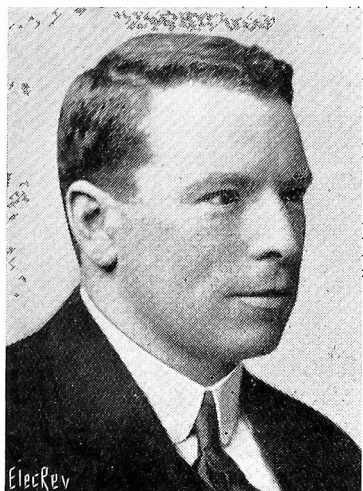

*The late Mr. F. S. Stacey.*

WE deeply regret to announce the death at Wimbledon on August 11th, 1936, of Francis Samuel Stacey, one of the pioneers of radio-telegraphy.

Mr. Stacey was a student of Finsbury Technical College, and joined Marconi's Wireless Telegraph Co., Ltd. (then known as The Wireless Telegraph & Signal Co., Ltd.), in July, 1899, at the age of 20. After a short period in the Company's Works he was employed for some time in experimental work as an Assistant to Marchese Marconi, and in 1900 was engaged in the execution of a contract for the installation of wireless on the whole fleet of Belgian cross-Channel steamers.

On his return from Belgium in 1902 Mr. Stacey assisted in the work of installing some of the earliest wireless telegraph equipment on transatlantic mail steamers. Shortly afterwards he was transferred to Marconi's Wireless Telegraph Company of Canada, where he remained until 1910, engaged in the construction of stations, experimental work, and the operation of the Glace Bay transatlantic wireless station.

Between 1910 and 1912 Mr. Stacey was employed at the Marconi Station at Poldhu in Cornwall in connection with experimental work and development of long range high-power stations which had their birth at Poldhu. From 1912 until 1914 he was Acting Chief of

the Constructional Section of the Marconi Company, and in 1914 became Chief of one of the Construct Section which deals with the supply of every kind of commercial wireless telegraph apparatus. Among other things, his department of the Marconi Company has been concerned with the execution of contracts for nearly all the broadcasting stations in England and a very large number in Europe, Japan, South Africa and South America.

His loss is very keenly felt by his colleagues and by his fellow members of the Marconi Athletic Club, who appreciated his kindly nature and enthusiastic work both at the office and on the Sports Ground. His premature death at the age of 56 is peculiarly sad, as up to the date of his illness, two years ago, he had enjoyed robust health and had never missed one day from his post, through illness, during the whole of his career.

Mr. Stacey was married in 1909 to Miss M. McLeod, a Canadian lady, and leaves a widow and two daughters, to whom we express our deepest sympathy.

Amongst those who attended the funeral at Putney Vale on August 14th were: Mr. C. E. Rickard and Mr. L. J. King, representing Marconi's Wireless Telegraph Company Limited; Mr. T. H. Melville, representing the Marconi Works at Chelmsford; Mr. E. G. Tyler, representing the Marconi Research and Development Department at Writtle; Mr. C. C. Howe, representing the Marconi Veterans; Mr. P. J. Woodward, representing the Dorchester Station of Cable and Wireless, Ltd., and Mrs. Woodward; Mr. Andrew Gray, Mr. A. Kift, Mr. N. Wells, Mr. P. W. Paget, Mr. and Mrs. P. E. Privett, Mr. F. Oliver, Mr. B. Pontifex, Mr. J. Rook, and Mr. F. Dann, friends, and members and ex-members of the staff of the Marconi Company.



*A photograph of the late Mr. F. S. Stacey taken in 1900 on board the Belgian mail steamer "Princess Clementine," the first cross-Channel steamer to be fitted with Marconi's equipment.*



**Overall Voltage Output Check.**

As a final check of the voltage delivered across the output terminals of the Ultra Short Wave Standard Signal Generator valve voltmeter measurements were made. The valve voltmeter employed for the purpose is one that has been specially developed by the Marconi Research Laboratories to operate at frequencies covered by the ultra short wave bands. It is considered to be accurate to within + or - 10

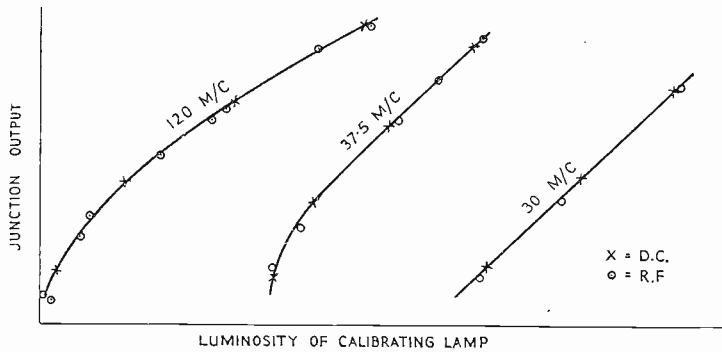

Fig. 3.

per cent. at frequencies up to 100 M/C. The following table gives a comparison between the nominal output of the standard signal generator and the valve voltmeter measurements :—

Frequency M/C.	Gen'r. nominal output (milli-v).	Valve V/meter (milli-v).
100	100	103—122
75	100	96
50	100	90
33	100	92
25	100	89
20	100	89

The independent checks supplied by the valve voltmeter measurements show that the accuracy of the standard signal generator voltage output is within the specified limits.

F. M. WRIGHT.

---

---

## OBITUARY.

### Mr. F. S. STACEY

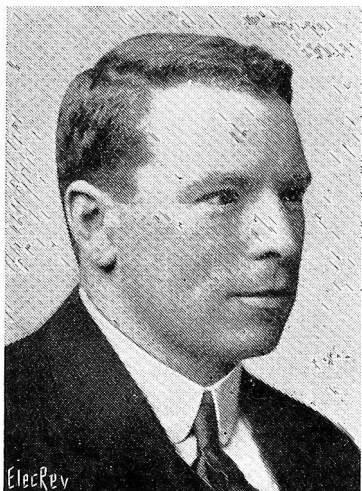

*The late Mr. F. S. Stacey.*

WE deeply regret to announce the death at Wimbledon on August 11th, 1936, of Francis Samuel Stacey, one of the pioneers of radio-telegraphy.

Mr. Stacey was a student of Finsbury Technical College, and joined Marconi's Wireless Telegraph Co., Ltd. (then known as The Wireless Telegraph & Signal Co., Ltd.), in July, 1899, at the age of 20. After a short period in the Company's Works he was employed for some time in experimental work as an Assistant to Marchese Marconi, and in 1900 was engaged in the execution of a contract for the installation of wireless on the whole fleet of Belgian cross-Channel steamers.

On his return from Belgium in 1902 Mr. Stacey assisted in the work of installing some of the earliest wireless telegraph equipment on transatlantic mail steamers. Shortly afterwards he was transferred to Marconi's Wireless Telegraph Company of Canada, where he remained until 1910, engaged in the construction of stations, experimental work, and the operation of the Glace Bay transatlantic wireless station.

Between 1910 and 1912 Mr. Stacey was employed at the Marconi Station at Poldhu in Cornwall in connection with experimental work and development of long range high-power stations which had their birth at Poldhu. From 1912 until 1914 he was Acting Chief of

the Constructional Section of the Marconi Company, and in 1914 became Chief of one of the Contract Sections which deals with the supply of every kind of commercial wireless telegraph apparatus. Among other things, his department of the Marconi Company has been concerned with the execution of contracts for nearly all the broadcasting stations in England and a very large number in Europe, Japan, South Africa and South America.

His loss is very keenly felt by his colleagues and by his fellow members of the Marconi Athletic Club, who appreciated his kindly nature and enthusiastic work both at the office and on the Sports Ground. His premature death at the age of 56 is peculiarly sad, as up to the date of his illness, two years ago, he had enjoyed robust health and had never missed one day from his post, through illness, during the whole of his career.

Mr. Stacey was married in 1909 to Miss M. McLeod, a Canadian lady, and leaves a widow and two daughters, to whom we express our deepest sympathy.

Amongst those who attended the funeral at Putney Vale on August 14th were: Mr. C. E. Rickard and Mr. L. J. King, representing Marconi's Wireless Telegraph Company Limited; Mr. T. H. Melville, representing the Marconi Works at Chelmsford; Mr. E. G. Tyler, representing the Marconi Research and Development Department at Writtle; Mr. C. C. Howe, representing the Marconi Veterans; Mr. P. J. Woodward, representing the Dorchester Station of Cable and Wireless, Ltd., and Mrs. Woodward; Mr. Andrew Gray, Mr. A. Kift, Mr. N. Wells, Mr. P. W. Paget, Mr. and Mrs. P. E. Privett, Mr. F. Oliver, Mr. B. Pontifex, Mr. J. Rook, and Mr. F. Dann, friends, and members and ex-members of the staff of the Marconi Company.



*A photograph of the late Mr. F. S. Stacey taken in 1900 on board the Belgian mail steamer "Princess Clementine," the first cross-Channel steamer to be fitted with Marconi equipment.*

# NEWS AND NOTES

## BROADCASTING IN EGYPT



*H.M. King Farouk broadcasting through the stations of the Egyptian State Broadcasting Service.*

**B**ROADCASTING in Egypt has made great progress since the State Broadcasting Service, operated by the Marconi Company on behalf of the Egyptian Government, was inaugurated on May 31st, 1934, and it is estimated that there are now some 100,000 receiving sets in use in Egypt.

The greater part of the population of Egypt is congregated in the two principal towns of Cairo and Alexandria, and the first aim of the broadcasting service is to provide programmes for the population of these towns and as much of the surrounding areas as can be covered by transmitters primarily intended for these centres.

This service was originally carried out by a main broadcasting station situated at Abu Zabal, near Cairo, with a relay transmitter at Ras-el-Tin, near Alexandria, and excellent results were obtained. The growth of interest in broadcasting, however, soon made it necessary for the broadcasting service to consider the provision of alternative programmes, of interest to both Egyptian and European listeners. Two other stations, in Cairo and Alexandria, have, therefore, been provided so that programmes in English or French, and in Arabic, can be radiated at the same time, and entertainment provided for both European and Egyptian listeners during those parts of the day when listening-in is most popular.