

# THE MARCONI REVIEW

---

No. 56.

September-October, 1935.

---

Editor: H. M. DOWSETT, M.I.E.E., F.Inst.P., M.Inst.R.E.

Assistant Editor: L. E. Q. WALKER, A.R.C.S.

---

## MARCONI SHORT WAVE SUPER-HETERODYNE RECEIVER, TYPE RG.34

*The type RG.34 superheterodyne receiver covers the wide range of 13 to 200 metres (23-15 megacycles) and is suitable for general purpose reception of telegraphy or telephony on important services, e.g., secondary commercial telephone circuits, aerodrome ground stations, military and marine interception services.*

*The wave band is accomplished in five steps, range selection being accomplished by efficient switching. Tuning is exceptionally simple, there being but two main tuning controls.*

*This instrument possesses a performance thoroughly capable of meeting all normal general purpose requirements. It is comparatively small in size, and whilst all the components are mounted in the most efficient and compact manner, there is no part of the receiver which is not completely accessible for inspection.*

### General.

THE chief characteristics of the type RG.34 receiver may be summarised as follows:—

- (1) A high order of sensitivity.
- (2) Simplicity of tuning.
- (3) By means of a two position switch the selectivity may be made wide for searching and narrow for final tuning.
- (4) No plug-in coils are used, wave range changing being accomplished by switching.
- (5) A calibration for each range appears automatically immediately below the main tuning controls.
- (6) Feeder balancing facilities are incorporated.
- (7) Optional automatic gain control is provided for reception of both telephony and telegraphy.
- (8) Metering facilities are provided for reading the supply volts and the anode feed to each valve.
- (9) The supply arrangements are simple, necessitating a two volt accumulator battery for filament heating and an accumulator battery of 140 volts for combined H.T. and G.B. Alternatively, supplies may be obtained from A.C. mains via a standard rectifier unit.

*Marconi Short Wave Superheterodyne Receiver, Type RG.34.*

- (10) Shock absorber mountings are provided for counteracting vibration troubles.
- (11) Ability to meet tropical conditions.

**Circuit Arrangement.**

The complete circuit arrangement is shown in Fig. 1, and may be divided into the following sections :—

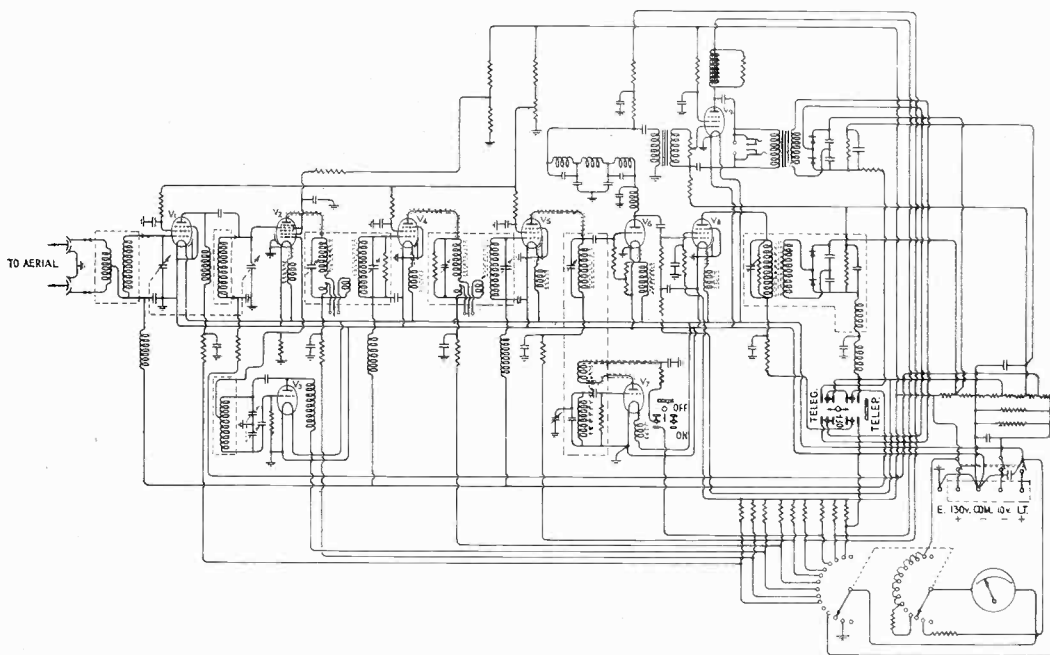

FIG. 1.

- (1) Signal frequency circuits comprising aerial input circuit ; signal frequency amplifier ; frequency changer system.
- (2) Intermediate frequency amplifier.
- (3) Second detector.
- (4) Second oscillator for continuous wave reception.
- (5) Automatic gain control amplifier for telephony.
- (6) Output stage.
- (7) Automatic gain control circuit for telegraphy.

**Aerial Input Circuit.**

The aerial is coupled to the first tuned circuit via a capacity potentiometer formed by two separately controlled differential air dielectric condensers.

These input controls may be used either

- (A) As a simple input control for a normal open (harmonic) aerial, or
- (B) As a means of correcting out-of-balance effects on the feeder of a dipole aerial.

### **Signal Frequency Amplifier.**

This consists of one tuned circuit followed by a valve of the variable mu high frequency pentode type, the output of which is fed by choke capacity coupling to the frequency changer system.

### **Frequency Changer System.**

Here the frequency of the signal is changed to that of the intermediate frequency amplifier. A heptode valve ( $V_2$ ) is used as the frequency changer, the oscillator grid of which is driven by a small proportion of the total oscillatory voltage generated by a separate oscillator using a small power valve ( $V_3$ ). This oscillator circuit is a modified Hartley type. For tuning purposes a two gang condenser is used, the sections being series connected and the two sets of moving vanes commoned and earthed. Thus, the usual coil tap is eliminated and, since choke-capacity feed is employed, no part of the tuned circuit is at a high D.C. potential.

### **Signal Frequency Tuning.**

The signal frequency wave range of 13 to 200 metres (23,000-1,500 k/cs.) is covered in five ranges, giving generous overlaps between ranges.

The tuning condenser for the two signal frequency circuits are permanently ganged. No attempt is made to include the first oscillator tuning in the ganging, since to do this over five ranges would involve considerable circuit complications to avoid loss in performance.

### **Intermediate Frequency Amplifier.**

The intermediate frequency amplifier is tuned to a mid-frequency of approximately 400 k/cs. It consists of two stages of amplification by variable mu high frequency pentodes ( $V_4$  and  $V_5$ ) and employs a total of five tuned circuits. Each inductance consists of Litzendraht wire wound on a laminated Ferrocart core held together by moulded clamps, the result being a small but highly efficient coil.

It will be seen from the diagram that the tuned circuits are arranged in the following order :—

The first is the anode circuit of the heptode valve ( $V_2$ ) and is magnetically coupled to the second tuned circuit connected to the grid of the first intermediate frequency amplifier valve ( $V_4$ ).

Similarly, the third tuned circuit forms the anode load of valve ( $V_4$ ) and is magnetically coupled to the fourth tuned circuit connected to the grid of the second intermediate frequency amplifier valve ( $V_5$ ). The fifth tuned circuit forms the anode load for ( $V_6$ ).

The amplifier is designed so that by a simple switching operation, the frequency response curve may be made narrow or broad at will. By mechanically spacing the magnetically coupled circuits so that they are slightly undercoupled, the narrow response curve is obtained. For the broad position a coupling coil is switched into circuit so that slight overcoupling or "double-humping" results with each pair of circuits. The overall response curve for the five circuits, however, has a peak which is practically level owing to the compensating effect of the single tuned circuit.

By slightly undercoupling in the one case and overcoupling in the other, the difference between the gain in the narrow and broad positions of the switch is not more than three decibels.

The control of high frequency gain is effected by variation of the voltage applied to the screening grids of the signal frequency and intermediate frequency amplifier valves.

#### **Second Detector.**

The valve  $V_6$  following the I.F. amplifier is a triode operating as a grid leak rectifier. The grid leak and condenser values are so chosen that the rectifier efficiency is constant for all modulation frequencies.

#### **Second Oscillator.**

This is of the tuned grid with anode reaction type, and may be switched into operation for the reception of continuous wave telegraphy or for locating an unmodulated carrier wave. The heterodyne note may be varied to suit the operator by the adjustment of a parallel tuning condenser located on the front panel.

A "zero beat" mark on the scale of the tuning condenser indicates the point at which the oscillator frequency is the same as the mid frequency of the intermediate frequency amplifier. This greatly facilitates tuning.

Frequency mixing is accomplished by mounting the oscillatory circuit in the same screening pot as the detector grid circuit, the mechanical spacing being adjusted to provide the correct coupling.

Precautions are taken to reduce the radiation of troublesome harmonics to a minimum by thorough screening of the components and decoupling of both the anode and filament supplies.

#### **Automatic Gain Control Amplifier for Telephony.**

The unsmoothed rectified output from the second detector is amplified by means of the valve  $V_7$ —a variable mu high frequency pentode. The grid circuit of  $V_7$  is aperiodic, and the anode circuit consists of a transformer, the primary of which is tuned to the mid-frequency of the intermediate frequency amplifier. The secondary of the anode transformer is untuned and is connected to a voltage doubler rectifying system, using metal oxide rectifiers.

A carrier wave thus provides across the rectifier load resistance a negative smoothed voltage which is fed back as grid bias to the valves being controlled—namely, the signal and intermediate frequency amplifiers. Thus, the gain of the receiver varies inversely as the carrier field strength and the output level remains practically constant.

The value of field strength at which the automatic gain control commences to function is set by a delay arrangement in the auto-gain rectifying system.

#### **Output Stage.**

The smoothed rectified output from the second detector is fed via a low pass filter and a step up transformer to the output valve  $V_9$ —a low frequency pentode. The low pass filter offers very little attenuation to frequencies up to 3,000 cycles per second, high frequencies being heavily attenuated. This does not affect the commercial speech band of frequencies, and results in a great improvement in the signal to noise ratio.

## Marconi Short Wave Superheterodyne Receiver, Type RG.34.

To provide control of the output, the grid of the output valve is connected to the moving arm of a high resistance potentiometer connected across the secondary of the intervalve transformer and mounted on the front panel.

Choke capacity output is employed, and the receiver is therefore suitable for working into high resistance telephones.

The output stage is capable of operating a moving coil loud speaker.



FIG. 2.

For cases where the receiver output is to be connected to a 600 ohm line, an external output transformer must be used.

### Automatic Gain Control for Telegraphy.

It is not possible to use the telephony auto-gain system previously described for the reception of telegraphy, for two reasons, viz. :—

1. For I.C.W. reception, the noise level will rise between signals owing to the small time constant.
2. For C.W. reception it is necessary to switch on the second oscillator. This has the same

effect upon the auto gain system as a strong carrier, and will render the receiver completely insensitive.

It is necessary, therefore, to use a separate auto gain system for telegraphy.

This system is similar to that used for telephony except that—

1. The audio frequency output is rectified, smoothed and fed back as grid bias to the three valves controlled.
2. A longer time constant is provided, such that the noise level does not rise between signals except in the case of very slow hand speeds.

All the circuits of the receiver are very thoroughly decoupled from their common supplies. This, in conjunction with the dual screening provided for all the radio frequency inductances, reduces direct pick up to a negligible amount.

### Mechanical Assembly.

The circuits of the receiver are mounted on a zinc sprayed steel chassis, which in turn is inserted into a steel cabinet. The case is sprayed with zinc inside, and cellulose enamel outside.

The approximate overall dimensions of the receiver are as follows :—

Height	..	..	..	..	1 ft. 2 in.
Width	..	..	..	..	1 ft. 6 in.
Depth	..	..	..	..	1 ft. 3 in.

Special resilient mountings are provided. These should be used for securing the receiver in cases where vibration is to be feared.

The top of the cabinet is fitted with a lid, providing good access to all valves and the supply terminals.

#### **Front of Panel Controls and Fittings.**

These are illustrated in Fig. 2 and consist of—

- (A) The single tuning control (on the left centre) of the two signal frequency circuits.
- (B) The tuning control (on the right centre) of the first oscillator.

These constitute the only actual tuning controls, the auxiliary controls being

- (C) The five-way range switch (bottom right hand).
- (D) The two aerial input and balancing condensers (top left hand).
- (E) The second oscillator tuning control (top right hand).
- (F) The second oscillator on-off switch (below the above), together with
- (G) The auto gain control switch—telephony-off-telegraphy.
- (H) The intermediate frequency band width switch (left centre).
- (I) The low frequency volume control (centre).
- (J) The high frequency volume control (centre).
- (K) The multi-position meter switch (right centre).
- (L) The supply switch (bottom left hand).

Other front of panel fittings are :—

- (M) Aerial sockets.
- (N) Meter.
- (O) Calibration scale.
- (P) Output terminals and jack.

For close inspection of the components, the chassis may be withdrawn from the cabinet, first removing the retaining screws around the edges of the front panel.

From the top (Fig. 3) there will be seen :—

- (A) Mounted on the front vertical panel :—
  - (i) Aerial input and balancing condensers.
  - (ii) The can screening the variable tuning condenser for the second oscillator.
  - (iii) Switches for the second oscillator and auto gain circuits.
- (B) Mounted on the chassis :—
  - (i) Signal frequency two gang tuning condenser.
  - (ii) Two gang condenser for first oscillator.
  - (iii) Screening cans containing tuned circuits for the intermediate frequency and auto gain amplifiers.
  - (iv) All valve screening cans.
  - (v) Supply terminals, and
  - (vi) Various air-core chokes.

All the screening pots are copper spun and zinc sprayed; this gives a finish which is highly attractive and non-corrosive.

The underside of the chassis is illustrated in Fig. 4. Here are mounted all the decoupling resistances, condensers and chokes, together with the low frequency transformers and auto gain system. The most important component, however, is the signal frequency coil assembly. This is assembled as follows :—

A bar in which are moulded four contacts, is fixed to the wound coil former, and the coil connected to such of the contacts as are necessary. Five of these coils are mounted in a screened cylinder by means of the contact bars, the latter being equally spaced around the periphery and parallel to the axis of the cylinder. The contacts project through the screening.

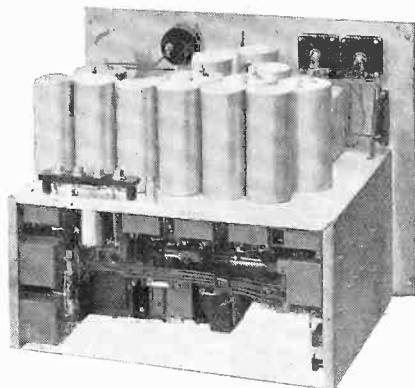

FIG. 3.

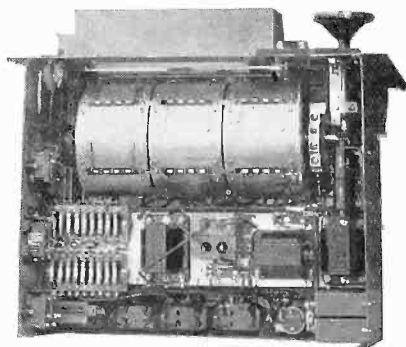

FIG. 4.

Three of these cylinders, one for each circuit, are assembled close together on a common spindle, and the whole mounted in two split bearings on a rigid cast aluminium U-shaped frame bolted to the base of the chassis. The coil assembly is rotated by means of a handle mounted on the front panel, and connected by a right-angled drive using two gear wheels of large diameter for strength and the elimination of backlash.

On the stationary frame are mounted three sets of insulated spring strips with gold wire insets, which make contact with the contact studs of the coils as the latter are swung into position by the wavechange handle.

Provision is made for each coil to be shorted when not in use. This avoids the possibility of an idle coil resonating and absorbing at the working wavelength.

Each range is held in position by a good mechanical register which operates on a slotted disc mounted on the side of the coil drum nearest the operating handle.

The advantages of this system of switching are :—

- (1) High efficiency, since the leads to the coils are short and are the same length for each range. This greatly facilitates the ganging of two stages over five ranges.
- (2) Each coil is accessible, and all soldering is done before the coil is mounted in the main assembly.
- (3) The complete coil assembly is quickly and easily removed from its frame merely by undoing the two screws holding the top half of each split bearing.
- (4) The contacts are easily accessible for periodic wiping.

Driven from the coil assembly spindle, by means of a chain and gear wheels, is the cylinder carrying the calibration of the signal frequency and first oscillator circuits. This calibration consists of two parallel scales traversed by a single pointer which is driven by means of a spring loaded copper plated steel tape, from a disc mounted on the spindle of the signal frequency tuning condenser.

The pointer indicates, on the lower scale, the tuning in megacycles of the signal frequency circuits, at the same time giving on the upper scale the corresponding setting in degrees of the first oscillator tuning condenser. For simplicity, only one setting of the first oscillator is given, namely, that which is lower in frequency but higher in degrees on the tuning condenser scale.

As the wave range is changed, the appropriate calibration appears through an inclined glass panel on the front of the receiver.

### **Supplies.**

The battery supplies consist of a 2-volt accumulator battery for L.T., and a 140-volt accumulator battery for H.T. A resistance in the receiver ensures that approximately 10 volts of the H.T. supply is used for grid bias purposes. Alternatively a battery of 130 volts may be used for H.T. and a separate 10-volt battery for G.B. ; the discharge from each battery will be the same however.

The battery drains are—

- L.T. — 2 volts 1.1 amperes.
- Combined H.T. and G.B. — 140 volts — 30 milliamperes, or
- { H.T. — 130 volts — 30 milliamperes.
- { G.B. — 10 volts — 30 milliamperes.

Alternatively, supplies may be obtained from a main A.C. supply by means of a standard rectifier unit. In this case, it is much simpler to use the combined H.T. and G.B. arrangement of 140 volts.

### **Aerial System.**

The type RG.34 receiver is suitable for use with both dipole and harmonic aerials. If a dipole is used, then at wavelengths where it is not efficient it may be converted into a harmonic aerial by connecting together the two feeder wires and inserting them in one of the aerial sockets on the receiver.



# CORRECTION CIRCUITS FOR AMPLIFIERS

(PART 2.)

*The first part of this article, published in THE MARCONI REVIEW No. 54, dealt with the general theoretical performance of resistance-capacity coupled amplifiers and discussed methods for correcting their frequency response at the low frequency end. In this, the concluding part of the article, the response at high frequencies is considered.*

## Amplifier Response at High Frequencies

### (1) *The Normal Uncorrected Circuit :*

A TYPICAL circuit arrangement with resistance load is shown in heavy line in Fig. 15A, while in thin line are shown the various capacities which will affect the performance. The condenser shown dotted represents the grid to cathode capacity of the valve under consideration ; it is, however, preferable to regard this as part of the load of the preceding stage in the same way as  $C_g$  representing the grid to cathode capacity of the following valve is regarded as part of the stage under consideration. The condensers  $C_a$  and  $C_{ag}$  represent the anode to cathode and anode to grid capacities respectively, the latter being responsible for the well-known Miller effect which is dealt with below. The condenser  $C_c$  represents the stray circuit capacity due to wiring and components. It will be seen that since the impedance of the grid coupling condenser  $C_2$  is negligible at high frequencies, the capacities  $C_a$ ,  $C_g$ ,  $C_c$  are in parallel across the anode load ; their sum is represented by  $C$  in Figs. 15 B and C. To obtain best response without correction the value of this capacity should be as low as possible. Since it is not generally practicable to modify standard valve bases with a view to improving on the makers' rated inter-electrode capacities, the attention of the designer should be concentrated on evolving a layout and choosing components which will provide the minimum stray circuit capacity. The layout should be such that points of high signal potential are as far away from earthed metal work as is practicable. With regard to components, cartridge type resistances should be avoided ; these usually consist of a hank of spirals wire in a tube of insulating material provided with metal end caps, a construction which possesses high self-capacity. Although it is desirable to keep the self-inductance of resistive elements low, the usual non-inductive type winding should not be employed as here again self-capacity is high. The form of resistive element favoured by the Marconi Company comprises a rectangular frame of  $\frac{3}{8}$  in. diameter ebonite rods approximately  $2\frac{1}{2}$  in. by  $1\frac{1}{4}$  in. wound with spirals wire figure-of-eight fashion. These possess negligible inductance and very low self-capacity. A typical element is shown in Fig. 16. The coupling condenser  $C_2$  should be non-inductively wound and should on no account be enclosed in a metal case. The capacity between terminals and such a case may be as high as 70 mmfd., while even if the case is supported on insulators the capacity between it and the earthed metal work will rarely be less than 10 mmfd. ; for this reason, as stated on page 19, MARCONI REVIEW, No. 54, the bulk or physical dimensions of this condenser should be as small as is consistent with electrical efficiency. Sealed tubular non-inductively wound paper condensers of 0.1 mfd. are quite suitable for amplifiers operating down to 10 cycles per second and introduce but small stray capacity at high frequencies.

The circuit of Fig. 15A may be represented by the networks of Figs. 15 B and C in which  $R = \frac{R_1 R_2}{R_1 + R_2}$ ,  $C = C_a + C_c + C_g$ . When estimating response,  $C_c$  may be taken as 17-20 mmfd. although measurements indicate that a value as low as 12 mmfd. may be achieved if particular care is taken in the layout.

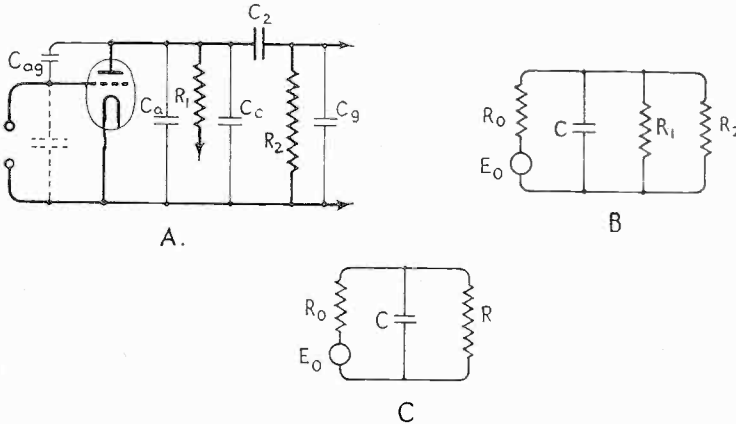

FIG. 15.

The effective anode load  $Z$  thus comprises  $R$  and  $C$  in parallel whence  $Z =$

$$\frac{I}{\frac{I}{R} + j\omega C} = R \frac{I}{I + j\omega T}$$

where  $T = RC$ . The voltage developed across this load is therefore

$$E = E_0 \frac{Z}{R_0 + Z}$$

Substituting for  $Z$  and putting  $R = aR_0$  and  $T' = \frac{T}{I + a}$

$$E = e_g \cdot \frac{\mu a}{I + a} \cdot \frac{I}{I + j\omega T'} \quad \dots \quad (4)$$

The first fraction in this equation represents normal stage gain and the second indicates frequency response and phase shift. An alternative equation

$$E = e_g \cdot S \cdot R \frac{I}{I + j\omega T} \quad \dots \quad (4A)$$

(where  $S =$  slope or mutual conductance in amps per volt) is suitable for use when employing multi grid valves in which the load resistance is small compared with  $R_0$  and the Miller effect is negligible. The

expression  $\frac{I}{I + j\omega T}$  is plotted for an arbitrary value of  $T = T_0 = 10^{-7}$  in Figs. 17 A and B. The curves may be shifted in a manner similar to that previously described to correspond to change in  $T_0$ . A suitable value for  $f_0$  is  $10^6$  cycles per second.

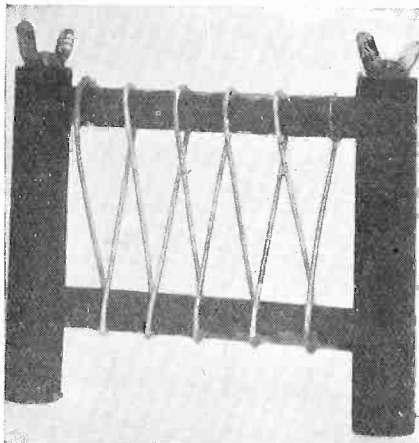

FIG. 16.

(2) Miller Effect.

In 1919 J. M. Miller published\* his classical paper entitled "Dependence of the input impedance of a three electrode vacuum tube upon the load in the plate circuit." In the section dealing with the case of pure resistance loads it is shown that the

\* Scientific Papers of the Bureau of Standards, No. 351.

input impedance can be represented by an apparent resistance in series with an apparent capacity, the latter comprising the grid to cathode capacity together with

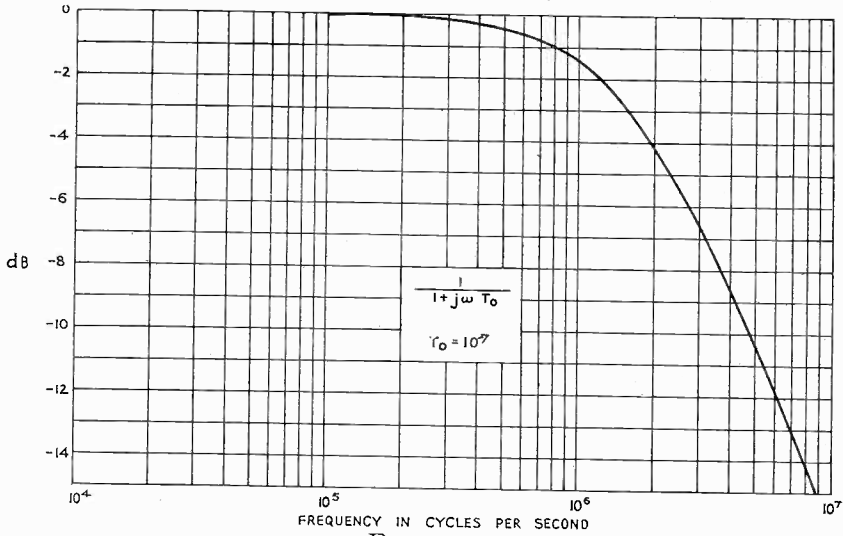

FIG. 17A.

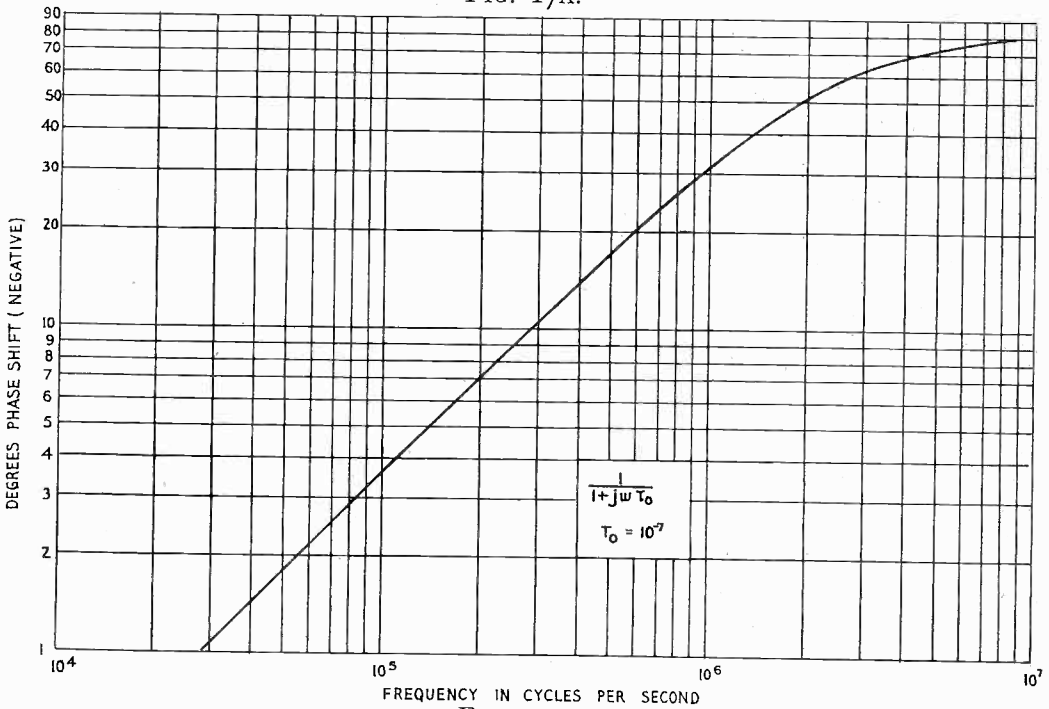

FIG. 17B.

$(1 + M)$  times the anode to grid capacity,  $M$  being the amplification of the stage. A more generalised network than that used by Miller will be employed to evaluate

## Correction Circuits for Amplifiers.

the input impedance. Consider a two stage amplifier and assume the anode to grid capacity of the first valve is so small as to be negligible, as indeed is the case at the maximum frequency that may be handled by a television amplifier when using a high frequency pentode valve. This valve may work into a power type valve in which the anode to grid capacity may be 1 mmfd. or more. The schematic circuit of Fig. 18A may then be represented by the network of Fig. 18B in which

$E', E''$  = equivalent generator voltages.

$\mu', \mu''$  = amplification factors.

$R', R''$  = internal resistances of the valves.

$Z', Z''$  = lumped anode loads.

$Z_3 = \frac{1}{j\omega C_{ag}}$  the impedance of anode to grid capacity.

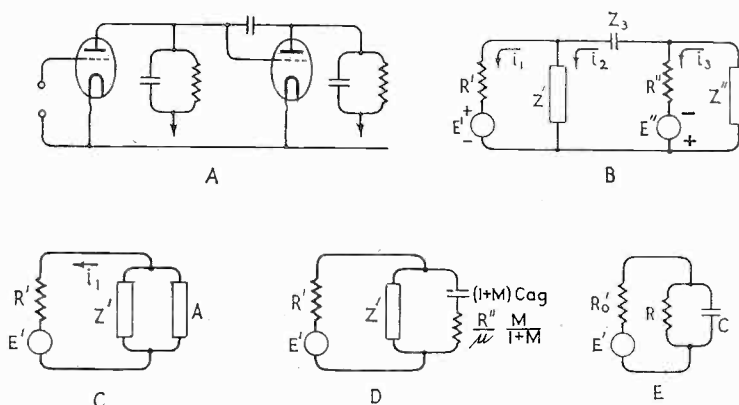

FIG. 18.

The lumped anode loads comprise a resistance shunted by a capacity, the resistance comprising the anode load and grid coupling resistance in parallel, and the capacity comprising anode-cathode capacity plus circuit strays plus grid-cathode capacity of following valve. Representing the circulating currents in the three nets by  $i_1, i_2, i_3$  and noting that  $E'' = -\mu'' Z' (i_1 - i_2)$  we have

$$E' + i_1 (Z' + R') - i_2 Z' = 0 \quad \dots \quad \dots \quad \dots \quad \dots \quad (5)$$

$$-i_1 (1 + \mu'') Z' + i_2 [(1 + \mu'') Z' + Z_3 + R''] - i_3 R'' = 0 \quad \dots \quad \dots \quad (6)$$

$$i_1 \mu'' Z' - i_2 (\mu'' Z' + R'') + i_3 (Z'' + R'') = 0 \quad \dots \quad \dots \quad (7)$$

By substituting the value of  $i_3$  obtained from equation 7 in equation 6 we may obtain a value for  $i_2$  in terms of  $i_1$ , which may be substituted in equation 5 with the result that

$$E' + i_1 \left[ R' + \frac{Z' A}{Z' + A} \right] = 0 \quad \dots \quad \dots \quad \dots \quad (8)$$

where  $A = \frac{R'' Z'' + Z_3 (Z'' + R'')}{(1 + \mu'') Z'' + R''}$

From the form of equation 8 clearly  $Z'$  and  $A$  are in parallel and may be represented as in Fig. 18c. Since  $Z'$  represents the lumped anode load of the first valve,  $A$  must therefore represent a shunting impedance due to the presence of the second valve.

$$\text{Now } A = R'' \frac{Z''}{(1 + \mu'') Z'' + R''} + Z_3 \frac{Z'' + R''}{(1 + \mu'') Z'' + R''}$$

and writing stage gain of second valve as  $M = \mu'' \frac{Z''}{R'' + Z''}$   
 and making appropriate substitutions, we have

$$A = \frac{R''}{\mu''} \cdot \frac{M}{1 + M} + Z_3 \frac{1}{1 + M}$$

$$= \frac{R''}{\mu''} \cdot \frac{M}{1 + M} + \frac{1}{j\omega C_3 (1 + M)}$$

i.e., A represents a resistance in series with a capacity, this capacity being  $(1 + M)$  times the anode to grid capacity of the second valve as shown in Fig. 18D. In general, the series resistance may be omitted since it will have but a slight effect on the response

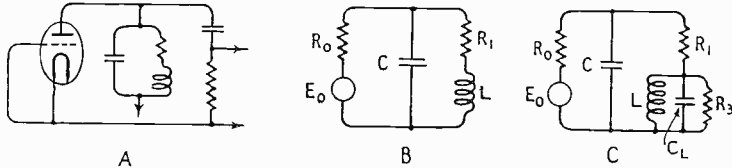

FIG. 19.

in the useful range of the amplifier and the circuit may be simplified to Fig. 18E, in which R is effective anode load resistance, and  $C = C_a + C_g + C_c + (1 + M) C_3$ . The time constant of the first valve circuit may thus be modified considerably by the additional capacity due to Miller effect in the following stage.

The voltage developed across the load  $Z''$  may then be obtained by treating the two stages as though no coupling due to Miller effect existed between them, i.e., the response of the first stage, the time constant of which has been increased due to the additional capacity  $(1 + M) C_3$ , is obtained from Fig. 17A and added to the response obtained for the second stage. It will be remembered that Miller effect in the first valve was assumed to be negligible. This method of determining response is sufficiently accurate for the type of amplifier under consideration in which a loss of 6 db. will represent the maximum useful range.

### High Frequency Correction.

#### (1) Correction in the anode circuit.

As in the case of low frequency correction, the object of correction is to increase the amplification of the circuit over the range of frequencies where attenuation exists. The correction may be applied in the anode circuit, in the grid circuit and also in the cathode circuit. It should be mentioned at this point that current practice favours the use of valves of high internal resistance (multi-grid valves) working into a load of a few thousand ohms and one is therefore justified in using the simplified formula of equation 4A. In this connection it should be mentioned that due to recent improvements in the technique of applying back coupling, the effective internal resistance of a valve may be reduced to a very low value (approaching zero) without reduction of the amplification factor. Bartels\* has drawn attention to the possibility of using a circuit back coupled so as to produce this condition for extending the frequency range of an amplifier.

A well known method of improving frequency response is to include an inductance in the anode circuit of a valve as shown in Fig. 19A. The simplified equivalent network is shown in Fig. 19B and the more rigid network in Fig. 19C. Before

\* H. Bartels. E.N.T. Sept. 1934.

discussing these it is necessary to give a warning that calculations of response at high frequencies are at the best merely estimates; the reasons for this are (1) the stray capacities depend on layout and cannot be calculated in advance; (2) these same capacities are regarded for purposes of calculation as being operative between two fixed points of the circuit whereas they are actually distributed; (3) the inclusion of inductance in the circuit will alter this distribution; (4) the h.f. resistance of the inductance varies with frequency; (5) the resonant frequency of the corrected circuit, which will in general define the useful upper frequency limit of the circuit, is dependent on layout, and further the amplification near resonance is dependent on the "goodness" of the inductance, i.e.  $Q$ , which again may be modified considerably by layout.

The circuit of Fig. 19A, subject to the anode load being small compared with the grid coupling resistance may be represented in its simplest form by the network of Fig. 19B. It has already been shown that without correction the output voltage of the stage is

$$E = S.R_1 \cdot \frac{1}{1 + j\omega T}$$

The impedance  $Z$  of the anode load for this simplified network is

$$Z = \frac{1}{\frac{1}{R_1 + j\omega L} + j\omega C} = \frac{R_1 + j\omega L}{1 - \omega^2 LC + j\omega CR_1} = \frac{R_1 (1 + j\omega T')}{(1 - \omega^2 LC + j\omega T)}$$

where  $T = CR_1$  and  $T' = \frac{L}{R_1}$

whence  $E = S.R_1 \cdot \frac{1 + j\omega T'}{1 - \omega^2 LC + j\omega T}$

It is clear that provided  $\omega^2 LC$  is small compared with unity and  $T = T'$  (i.e.  $L = CR_1^2$ ) the amplification of the circuit is independent of frequency. As, however,  $\omega^2 LC$  approaches unity there will be a slight increase in output with increasing applied frequency while, when  $\omega^2 LC > 1$  the frequency characteristic will fall rapidly.

In Figs. 20 A and B are shown response and phase shift curves for various values of inductance  $L$ . It will at once be seen that by making the time constants  $T$  and  $T'$  equal ( $L = 300 \mu h$ ) a rising characteristic is obtained, due to the fact that the real part of the denominator is rapidly approaching zero in the neighbourhood of  $10^6$  cycles per second. Such a characteristic is in many cases undesirable. The resonant

frequency  $f = \frac{1}{2\pi \sqrt{LC}}$ , obtained by equating the real part of the denominator to zero, thus plays an important part in determining response. To obtain some rough guide as to a suitable value for  $L$ , two other values have been selected. The uncorrected curve ( $L = 0$ ) shows a loss of 4 db. at  $2 \times 10^6$  cycles per second. For the circuit to resonate at this frequency an inductance of  $192 \mu h$  is required. If the inductance is  $123 \mu h$ , the circuit will resonate at  $2.5 \times 10^6$  cycles per second, where the uncorrected amplifier shows a loss of 5.5 db. It would thus appear that the most suitable value of inductance is that which will produce resonance at the frequency at which the uncorrected stage shows a loss of approximately 5 db. In this particular case a suitable inductance will have a value of  $145 \mu h$ .

As has been stated above, one cannot neglect the resistance and capacity associated with the correction element and therefore the network of Fig. 19C will

Correction Circuits for Amplifiers.

provide a truer guide to the operation of the circuit. The correction element is here shown as being shunted by its inherent capacity and equivalent shunt resistance.

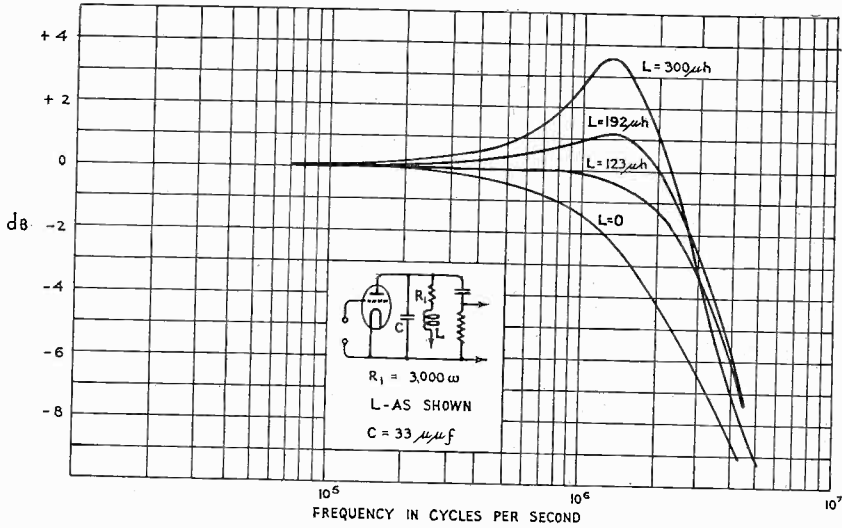

FIG. 20A.

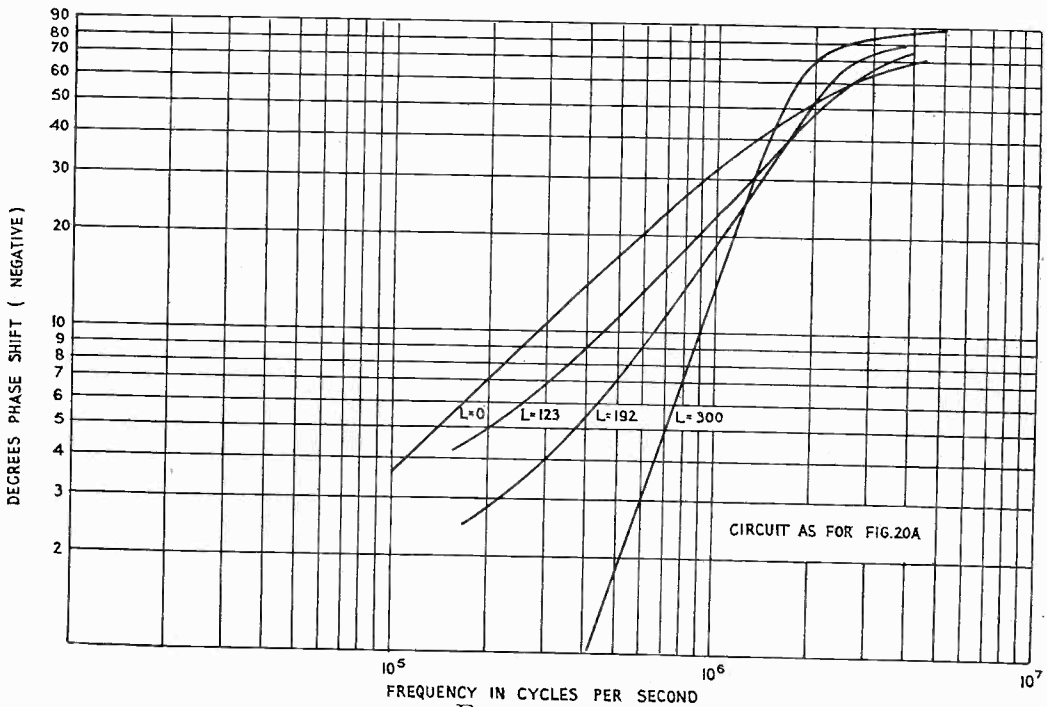

FIG. 20B.

The effect of this regarding the correction element is to lower the circuit resonant frequency below the value obtained for Fig. 19B. The  $Q$  of the complete circuit is

controlled mainly by  $R_1$  and partly by  $R_3$ ; if  $R_1$  is small and  $R_3$  high, the frequency response characteristic will rise rapidly near the resonant frequency, an undesirable feature. To preserve a level response curve one is therefore faced with the necessity of either trying out a series of coil windings until the desired characteristic is attained or using a coil of high  $Q$  and adding series resistance or using a coil of high  $Q$  and shunting it with a resistance. If the latter

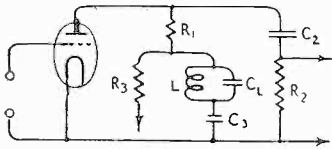

FIG. 21.

method is used, the shunt resistance may be used as a decoupling resistance, the circuit then being as in Fig. 21,  $C_3$  being the decoupling condenser. As a further point of practical importance, the inductance used for correction should not be placed between the anode of the valve and the anode resistance  $R_1$  since such an arrangement will inevitably increase the stray capacity of the circuit. It should preferably

be connected with one end of the winding at a point of zero signal potential, i.e., either as shown in Fig. 19A or in Fig. 21.

Referring to the network of Fig. 19c the voltage output is given by

$$E = SZ = S.R_1 \cdot \frac{1 + j\omega T'X}{1 - \omega^2 LCX + j\omega T} \quad \dots \quad (9)$$

$$\text{where } X = \frac{1}{1 - \omega^2 LC_L + j \frac{\omega L}{R_3}}$$

Provided  $C_L$  is small compared with  $C$ , then in the useful range of the amplifier, i.e., up to the resonant frequency obtained from  $\omega^2 = \frac{1}{LC}$  which, although not exact for

this network, is a sufficiently close approximation,  $X$  may be written  $X = \frac{1}{1 + j \frac{\omega L}{R_3}}$ .

A suitable value for  $R_3$  may be obtained by trial and error at a frequency somewhat below the resonant frequency; its final value will have to be decided after measurement of the response of the completed amplifier. If  $R_3$  is used as a decoupling resistance, its value will in general be decided by requirements at the low frequency end of the amplifier characteristic, in which case any improvement at the high frequency end must be made by variation of  $L$ .

The response of a stage estimated by use of equation 9 is shown in Figs. 22 A and B.

(2) Correction in the grid circuit.

The use of an inductive correcting element in the grid circuit to improve response has been known for many years and has been employed in broadcast receiving sets for improving the response at the higher audio frequencies. Figs. 23 A and B show a schematic diagram and equivalent network of a usual circuit. The output voltage can be shown to be

$$E = S.R. \cdot \frac{1}{(1 + j\omega CR) (1 - \omega^2 LC_3) + j\omega C_5 R} \quad \dots \quad (10)$$

and it will be seen from an inspection of this equation that the circuit relies upon the resonance of  $L$  and  $C_5$ , for its effectiveness. Below resonance the time constant of the circuit is  $R(C + C_5)$ . As resonance is approached the output increases to



Correction Circuits for Amplifiers.

$E = \frac{S}{j\omega C_3}$  and beyond resonance falls rapidly with increasing frequency. Such a

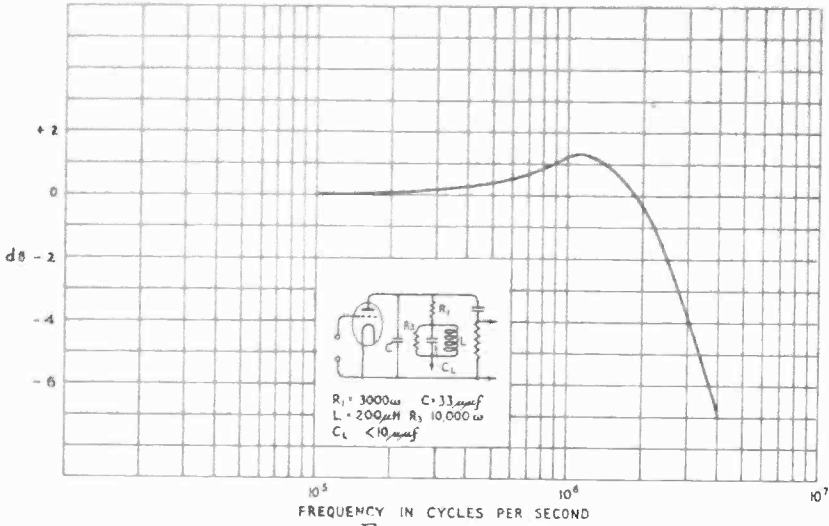

FIG. 22A.

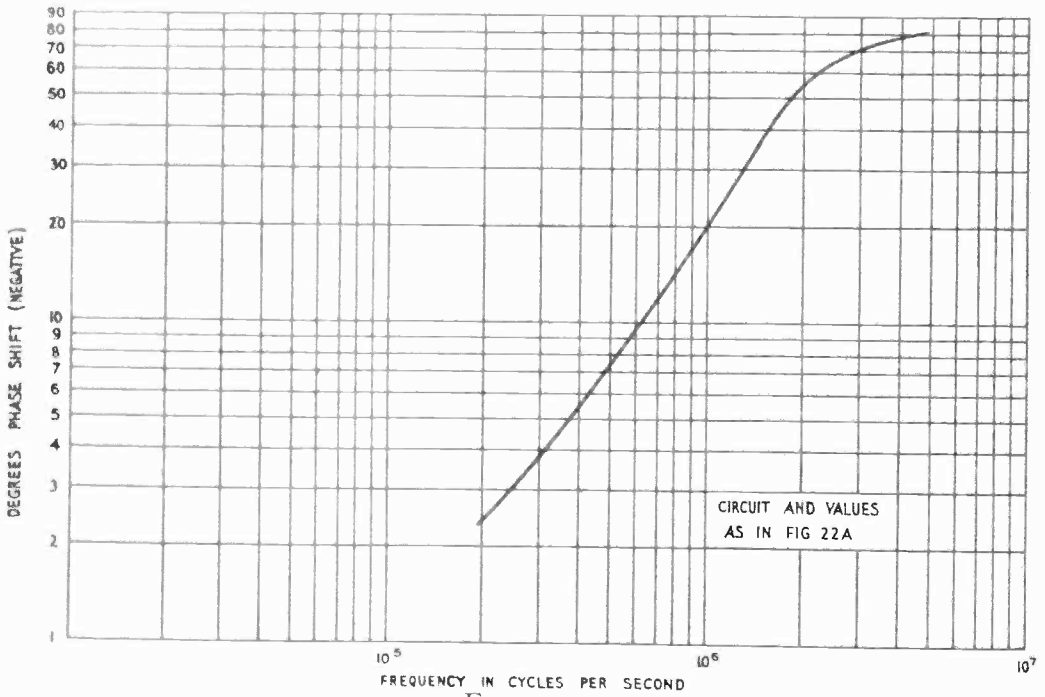

FIG. 22B.

circuit as applied to television amplifiers has been described by R. B. Dome (U.S. patent).

*Correction Circuits for Amplifiers.*

In practice, however, the circuit does not operate in such a simple fashion ; the inductance possess self-capacity and this may be comparable with  $C_5$  and modify the operation of the circuit. Further, the addition of an inductance in a point of

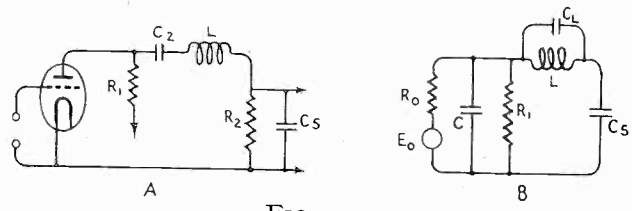

FIG. 23.

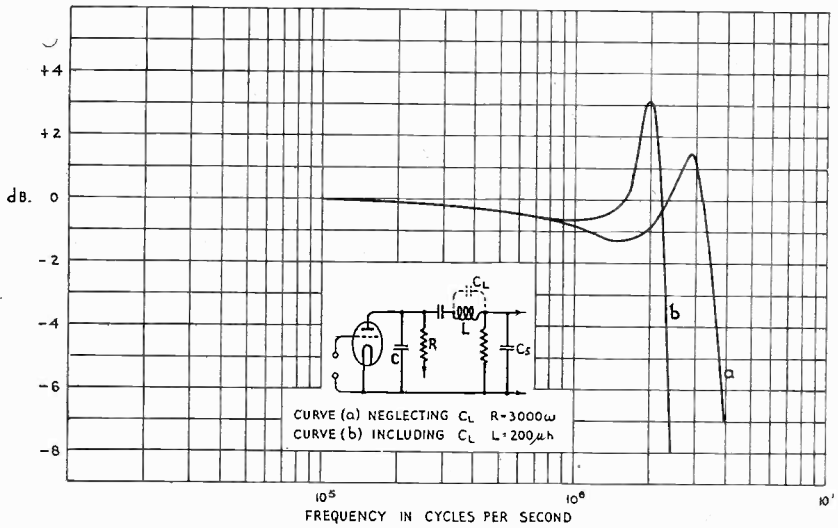

FIG. 24A.

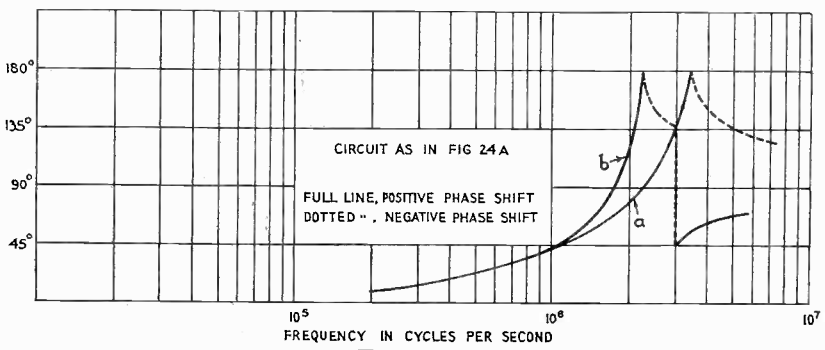

FIG. 24B.

high signal potential must inevitably increase the circuit stray capacities and defeat the end in view. This stray capacity ( $C_x$ ) may, for convenience, be divided equally

Correction Circuits for Amplifiers.

between  $C$  and  $C_5$  (though it will of course be distributed). In this circuit it will be appreciated that  $C = C_a + C_c + \frac{1}{2}C_x$  and  $C_5 = C_g + (1 + M) C_{ag} + \frac{1}{2}C_x$ . By

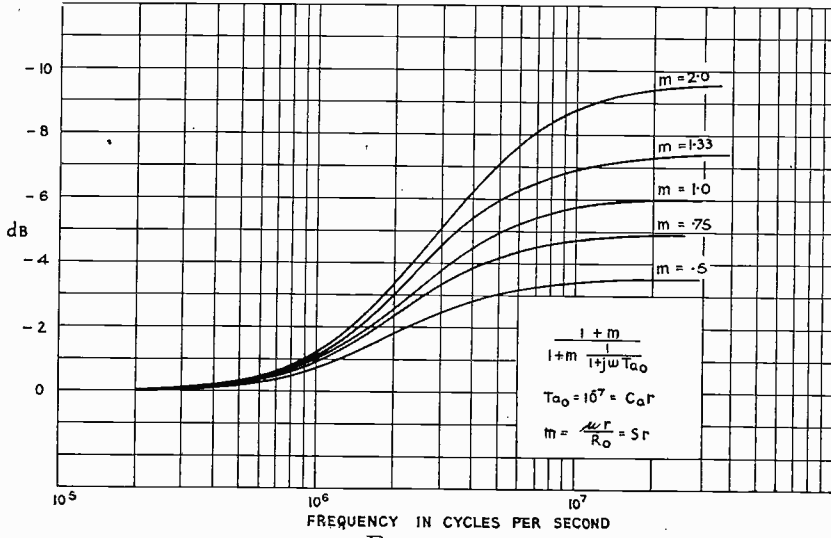

FIG. 25A.

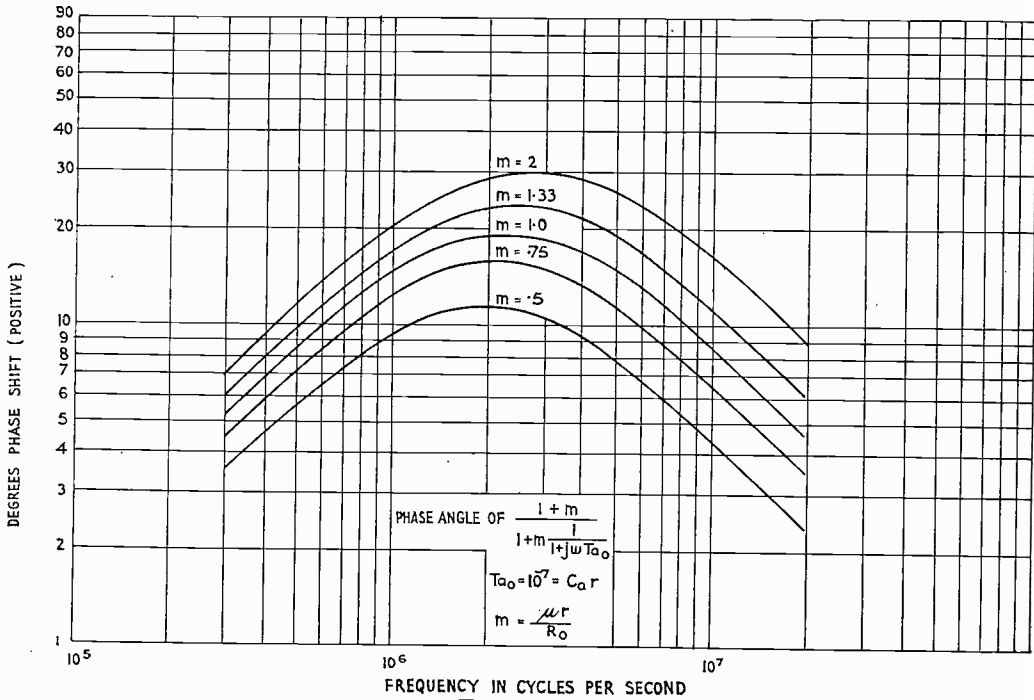

FIG. 25B.

taking account of the self capacity of the correcting element, it may be shown that the output voltage is

*Correction Circuits for Amplifiers.*

$$E = S.R. \frac{I}{(1 + j\omega CR) \left(1 - \frac{\omega^2 LC_5}{1 - \omega^2 LC_L}\right) + j\omega C_5 R} \dots \dots (11)$$

Where  $C$  and  $C_5$  are each larger by the amount  $\frac{1}{2}C_x$  than their normal circuit value. In Fig. 24 A and B, the response and phase shift as obtained by equations 10 and 11 are shown. That derived from equation 11 should be regarded as being nearer the true corrected response. It will be noted that phase shift is an objectionable feature of the circuit. These curves may be compared with that for  $L = 0$  in Figs. 20 A and B.

In estimating response the circuit values used were as follows:  $R_r = 3,000$  ohms,  $C_x = 10$  mmfd.,  $C = 20$  mmfd.,  $C_5 = 23$  mmfd.,  $C_L = 15$  mmfd.,  $L = 200 \mu h$ .

For the sake of completeness it can be mentioned that an improvement in response at high frequencies may be obtained in the circuit of Fig. 13, by including an inductance  $L_4$ , in series with condenser  $C_4$ , the effect of the inductance at high

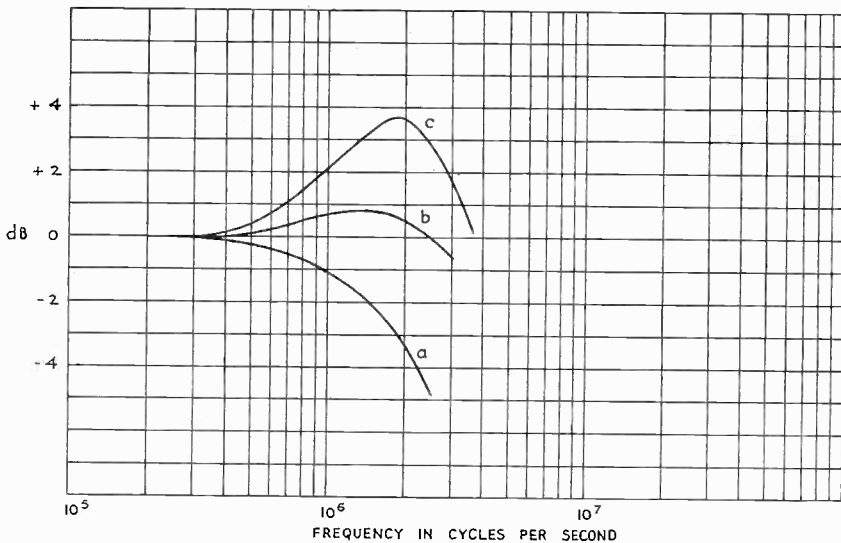

frequencies being analogous with that of the condenser at low frequencies. This circuit will not be dealt with in detail since it would not normally be used for any great range of frequency.

(3) *Correction in the Cathode Circuit.*

Correction in the cathode circuit provides one of the simplest forms of correction and has the additional advantage of being easily and quickly adjustable *in situ*, a valuable feature in view of the impossibility of being able to determine accurately in advance the amount of correction required. The correction is obtained by the use of an auto bias resistance shunted by a relatively small condenser which may be conveniently of the pre-set type of say .001 mfd. maximum capacity. Over the normal frequency range of the amplifier, the valve therefore operates with negative back coupling. The time constant  $T_a$  of the cathode circuit is so adjusted that this negative back coupling is reduced at the frequency where the response

would begin to fall off, with the result that output is restored to the normal level. It has been shown previously (p. 19, MARCONI REVIEW, No. 54) that the effective internal resistance of a valve operating with a shunted cathode resistance is

$R'_o = R_o + (1 + \mu) Z_a$  where  $Z_a = \frac{r}{1 + j\omega T_a}$ ,  $T_a$  being the time constant of the cathode

circuit,  $C_a r$ . The ratio  $\frac{R_o + (1 + \mu) r}{R_o + (1 + \mu) Z_a}$  expressed in db. will therefore represent the gain obtained in the circuit (provided the anode load is small compared with  $R_o$ ) as a result of the reduction in negative back coupling. We may extend the usefulness of

this expression by writing this ratio as  $\frac{1 + m}{1 + m \frac{1}{1 + j\omega T_a}}$  where  $m = \frac{\mu r}{R_o} = S.r.$

Curves for this expression with  $m$  as parameter and  $T_{a0} = 10^{-7}$  are shown in Figs. 25 A and B. These curves may be shifted to correspond to changes in  $C_a$  and hence  $T_a$  in the manner previously described in connection with the Auto-bias Circuit.

In Fig. 26 are shown response curves at the high frequency end of a two stage amplifier designed to handle frequencies between 25 cycles and 3 megacycles employing cathode correction as described above. Curve (a) shows uncorrected response, curve (b) the response with the cathode condensers adjusted, curve (c) the response with the cathode condensers set at maximum. It is seen that with the working adjustment, the variation in response is less than  $\pm 1$  db. in the required range.

An additional advantage obtained by using this form of correction is that, by virtue of the valve operating with negative back coupling over the greater portion of the frequency spectrum, distortion effects due to non-linearity of the valve characteristics are reduced.

It should perhaps be pointed out that the majority of the correction circuits described have been considered as being associated with valves of high impedance and low anode to grid capacity, i.e., multi-electrode valves, and care should therefore be exercised when applying these circuits to triodes.

It may be stated as a general rule that correction for loss in response should, whenever possible, be performed in the stage in which that loss occurs. It is possible to correct at one point for any such loss occurring in two or more stages, but a simple calculation will show that the correction circuit will be more complicated and less effective than if stage-by-stage correction were adopted.

ADDITIONAL LIST OF SYMBOLS.

$C_c$	Stray capacity due to components and wiring.
$C_{ag}$	Anode to grid capacity of valve.
$C_a$	Anode to cathode capacity of valve.
$C_g$	Grid to cathode capacity of valve.
$C$	Lumped capacity in anode circuit.
$CL$	Self-capacity of inductive correction element.
$C_x$	Additional stray capacity introduced by inductive correction element.
$S$	Mutual conductance amps. per volt.
$Z$	Impedance of anode load.
$T$	Time constant of anode load.
$M$	Stage gain.

O. E. KEALL.

# THE MAGNETRON

*In a previous article published in "THE MARCONI REVIEW," No. 51, pp. 9 et seq., medical apparatus employing the magnetron valve was described. The present article deals with the theoretical operation of this valve.*

THE magnetron or magnetostatic valve is the name given to a valve in which the control of the electron stream is partly by electric and partly by magnetic means and is, therefore, distinct from the ordinary vacuum tube control by grids electrostatically. The use of a magnetic field for the control of electron streams, that is currents in conductors, is, of course, as old as the art of electromagnetism, but curiously enough the use of a magnetic field in vacuum tube work appears to have been somewhat neglected.

During the war an attempt was made to control an oscillating triode for telephony by a magnetic field. This was brought about by wrapping around a valve a coil of wire and passing the modulation through this coil of wire, the valve itself being a triode adjusted for high frequency self-oscillation. As far as is known there is no publication regarding this.

In 1921, Hull published the first work on a magnetically controlled valve, when the name "magnetron" first appeared. Hull's magnetron, which was for straight amplification on very long wavelengths (about 13,000 metres), consisted of a diode valve with a straight filament and a cylindrical anode. For the purpose of amplification, the valve was surrounded by the coil of the input tuned circuit, and the anode of the magnetron was connected to the high voltage supply through a tuned circuit resonant to the incoming frequency, the coil of this circuit surrounding the envelope of the next valve. Thus the high frequency currents created a changing magnetic field in each anode filament space.

How this created amplification can be seen by studying the characteristic of such a valve.

Fig. 1 shows a section of a magnetron valve, where A is a cylindrical anode, and C a cathode coaxial with it. Assume we apply a high potential between anode and cathode, positive to anode, then anode current will flow of amount equal to the filament emission. This emission may be imagined streaming out from the cathode radially as shown in Fig. 1A, the anode current obtained being as shown by  $I_e$ , Fig. 2.

If around the valve envelope we now wind a coil of wire with turns encircling the anode, shown diagrammatically in Fig. 1B, then D.C. current through this coil will create a magnetic field such that the lines of force are parallel with the cathode. This field will produce a diverting force on the electron stream bending them clockwise, or anti-clockwise, depending on the field direction. If the field is weak, the bending action will be small, as shown in Fig. 1B, and since all the electrons still arrive at the anode, the anode current value remains unchanged.

At a certain critical field, however, the diverting force is sufficient to bend the electron stream past the anode, as shown in Fig. 1C, so that the anode feed is cut off. This cut off is very sharp, as shown at X, Fig. 2.

Hull arranged his magnetron circuit such that a steady field was applied, sufficient to set the valve half-way down the cut off curve, shown at Y, Fig. 2: The action of the incoming A.C. signal current superimposed on this steady current thus produced large changes of anode current which were communicated to the field of the next valve, and thus an amplifying action was obtained.

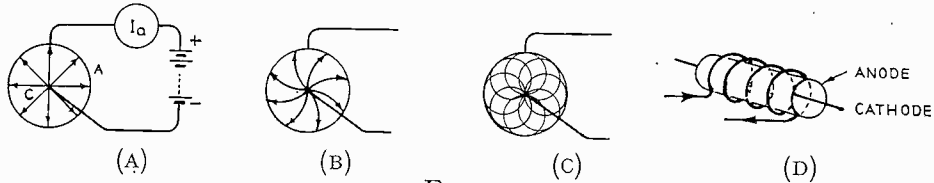

FIG. 1.

The difficulty of producing strong magnetic fields with air core coils prevented the use of the magnetron at high radio frequencies, and as the electrostatic control of electrons within a valve by grids appeared such a simple problem, the use of the magnetron as an amplifying device died out.

The next publication in English regarding magnetrons was by Yagi, in 1928, when he published an account in the P.I.R.E. of work done with a magnetically controlled diode for the production of ultra short waves, and it is of interest as reviving the magnetron for an entirely different purpose, and as operating in an entirely different way.

Actually parallel work, or even prior work, had been done on the same lines in Czecho-Slovakia by Zacek and accounts of his work were published in Czech in 1927.

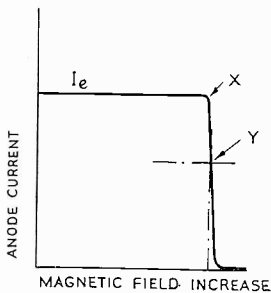

FIG. 2.

These workers found that if a diode valve was placed in a strong D.C. magnetic field in line with the anode-cathode, the valve self-oscillated to produce ultra short wavelengths, Yagi obtaining a wavelength as low as 15 cms. The type of valve used was similar to the Hull valve, namely, having a cylindrical anode and coaxial filament.

The oscillations obtained by Yagi were what are now known as electron oscillations, because the generated frequency depended on the transit time of the electron stream surging around inside the valve, and not upon the condition of external circuit, which only came into the matter as a means of extracting the energy efficiently.

In 1930 is the first mention of the split anode magnetron. Okabe found that if he took an ordinary diode valve and cut the anode longitudinally in two or more parts (2 and 4 parts are mentioned), greater output was obtained. At the time, Okabe explained the action of this split anode valve in much the same way as the action of the ordinary magnetron had been explained, namely as an electron oscillation within the valve, and suggested the effect of splitting the anode into these

strips tuned the leads and thus formed internal resonant circuits. It is possible, however, that Okabe was getting what are now known as dynatron oscillations. This is an entirely different type of oscillation, as will be explained later.

In this country the split anode valve was first fully investigated by Megaw, of the G.E.C. Research Laboratories, Wembley, and his paper to the I.E.E. summarises the literature on the subject.

In dealing with the split anode type of magnetron, it must be made clear at the outset that we have two distinct phenomena to consider.

First the use of the valve to produce the so-called electron oscillations. These oscillations can be produced equally well either with a complete cylindrical anode or a split anode, and the frequency obtained is primarily a function of the valve dimensions. With valves having small diameter anodes, say 1 cm., the optimum wavelength produced will range about 20 cms.

Secondly we may have, with a split anode valve only, an oscillation the wavelength of which is much longer than the electronic wavelength, and is now only dependent upon the external circuit constants. This second type of oscillation, for some unknown reason, is called a dynatron oscillation\*. As a split anode valve is highly efficient when so operated, this dynatron oscillation is by far the most important.

#### **Electronic Oscillations.**

If we consider the characteristics of the diode valve, used by Hull, under the influence of both electric and magnetic field, it will be observed that the cut off point X, is extremely critical. When the stream is just cut off, we can imagine that since the anode is now at an equivalent zero potential, the velocity of the electron stream surging around is low as the stream commences and finishes as at zero velocity.

Let us assume the valve is set to this cut off point. Then if we imagine a small alternating E.M.F. impressed between the anode and filament, it will be observed that the electron stream would then just touch or just miss the anode as the A.C. augments or diminishes the static E.M.F.

If the value of alternating field is very small compared with the static voltage on the valve, the time of transit of an electron from cathode to anode and back will not materially be altered during the oscillation cycle. Let us assume that the frequency of this alternating field is so related to the time of transit of an electron between filament and anode, that an electron leaving the filament when the alternating P.D. on the anode is positive would arrive at the anode when the alternating P.D. is negative. As long as the value of the alternating P.D. is very small compared with the steady anode potential, we can assume that it has no effect upon the transit time. Electrons leaving the filament when the alternating anode P.D. is positive will succeed in reaching the anode because its P.D. is greatest when the electrons are furthest from it, and most under the influence of the space charge, even though by the time the electrons reach the anode its potential is lower. The electrons which leave the filament during the negative half cycle of alternating P.D., however, fail to reach the anode. Thus the anode current will be greatest

---

\* The name dynatron oscillation is somewhat misleading, as the name was given to a special type of valve having two anodes which self-oscillated when connected to a tuned circuit by virtue of the negative resistance effect produced by secondary emission.



during the negative half cycle of applied P.D., and it can be shown that under these conditions the work done on the electrons by the alternating P.D. may be negative, that is, this need not be supplied from an external source of energy, but self oscillations capable of supplying energy to an external circuit may be generated.

In the case of a valve having two segments, Megaw considers the oscillation to take place between the anode segments so that the voltage on one segment rises above the static voltage, and on the other segment goes below the static voltage. This means that there will be an interchange between the two segments as they are accelerated by one segment and retarded by the other segment, the larger proportion reaching the segment with the lower voltage. He states that the type of electron oscillation in the split anode magnetron is essentially the same as in the full anode magnetron, but the interval between successive current pulses is only half as long, although the wavelength generated is the same.

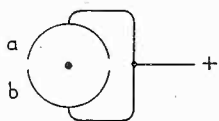

FIG. 3.

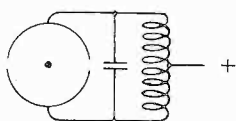

FIG. 4.

In all electron oscillations the value of alternating voltage is small compared with static voltage, because it must not disturb the average transit time of the stream or "flying time," as it is sometimes called, and this means that

the efficiency of the magnetron as an electron oscillator is very small. Experimental work suggests that efficiencies of 5 per cent. are the maximum possible. Although the frequency of oscillation can be varied to some extent by change of field and anode voltage, it is found the efficiency is a maximum for any given valve at a frequency which is dependent chiefly upon the dimension of the anode. For instance, a valve having an anode diameter of 1 cm. has an optimum wavelength of about 22 cms., whereas if the anode diameter is increased to 2 cms., the optimum wavelength is also increased (to about 50 cms.). It will be appreciated that for a normal valve, since anode diameter and anode dissipation are related, the lower the wavelength required, the less the H.F. power output that can be obtained.

At the moment we are not particularly interested in electronic oscillations from magnetrons, and it is not proposed to discuss the circuits used.

### Dynatron Oscillations.

As was stated previously, the so-called dynatron oscillation can only be obtained with a split anode type of valve. This oscillation is fundamentally different from the electronic oscillations and the efficiency of conversion from D.C. to H.F. can be extremely high, even as great as 60 per cent. on wavelengths of 1 and 2 metres with a small valve.

This means the split anode magnetron becomes one of the most efficient generators of ultra short waves.

Consider a split anode valve, Fig. 3, placed in a magnetic field such that the lines of force are parallel with the filament and anode length. We could obtain this field by winding a coil around the anode as considered previously, although it is usual to obtain the field nowadays by an electro-magnet with poles set across the ends of the anode filament space.

If both half anodes are connected, and a positive potential applied, anode current would flow, assuming the field is negligible. Application of a field greater

than the critical value would cut off the current as explained and if the field had been brought up from zero to a high value, the curve "a" indicated diagrammatically in Fig. 2 would be obtained. If now we connect a tuned circuit between the two half anodes as shown in Fig. 4 and carry out the same experiment of increasing the field,

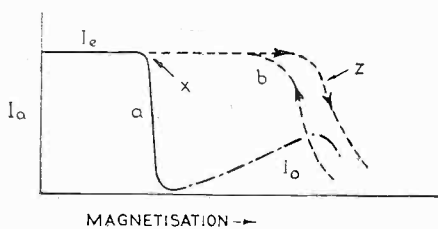

FIG. 5.

it is found that the current does not cut off at the static field value; but a field of more than twice the intensity needs to be applied before current ceases, and at points between the two cut off values X and Z, oscillations are produced weak near the first point X, and strong near the second Z shown by the curve  $I_o$ , Fig. 5.

To account for this curious condition it is easiest to study a characteristic which correlates changes of both segment voltages, segment currents, and magnetisation

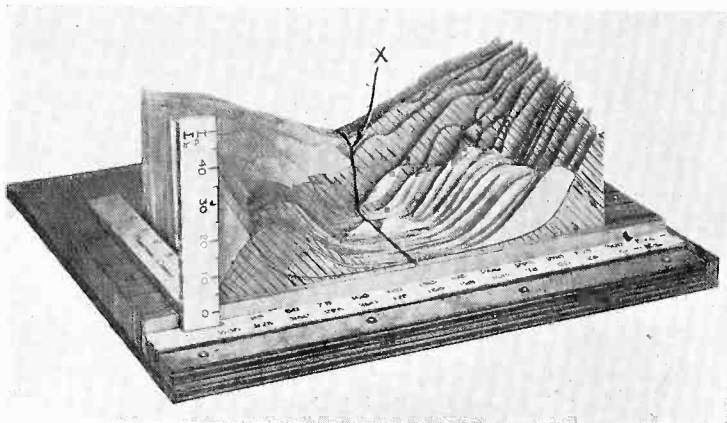

FIG. 6.

and the three-dimensional characteristic shown in Fig. 6 is here very helpful. It will be seen that segment voltages are plotted horizontally, segment currents vertically and magnetisation normal to the plane of the paper from zero at the rear. The voltage scale of segment "a" increases from left to right, whilst that for "b" increases from right to left, and the segment current segment voltage curves of "a" are hatched to distinguish them from the corresponding curves for "b." The line down the centre of the characteristic is for both segments at 150 v., and is therefore the same as Fig. 6, curve a, X being the "cut-off" point. It will be observed that for values of magnetising current below X the current taken by each segment is roughly proportional to its voltage but beyond this point a very different type of curve appears. Examination of the foremost curve, for example, shows that at  $E_a = 50$  and  $E_b = 250$  v.  $I_a$  is 20 ma., and  $I_b$  is 4 ma.—the higher voltage segment taking less current.

Consider now the circuit of Fig. 7 in which an alternator having zero internal resistance is applied between the segments. At the instant when conditions are as indicated in the figure, it will be seen that although the alternator is producing a voltage of 100 it is actually being driven as a motor since its current flow is opposed to the generated voltage. A similar state of affairs exists at all other points from the equi-potential value up to a voltage change of some 130.

It is now an easy step to replace the alternator by a tuned circuit (Fig. 4), which, when it is oscillating, will produce an alternating potential difference between the segments. If the "motoring" effect previously noted is sufficient, so that the magnetron gives at least as much energy out into the circuit as the circuit dissipates, oscillation will be maintained, the energy coming from the anode battery.

When the circuit is oscillating the combined characteristic of both segments is curve "b" of Fig. 5.

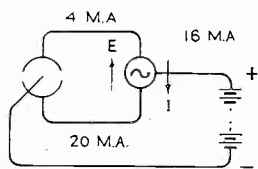

FIG. 7.

Dealing more specifically with the set of curves forward of the "cliff" in Fig. 6, it will be observed that at magnetisation currents just beyond the cut-off point, that is near the base of the "cliff," the negative slopes commence comparatively near the equi-potential point and quickly rise to a peak. As the magnetisation current is increased, it requires a bigger difference of voltage before current passes through that segment having the lower voltage, and the peaks of current are further removed from the equi-potential point. This indicates that greater efficiency will be obtained with greater values of magnetisation because maximum current values pass through the segment at a lower potential. This is found to be so in practice, but because no current whatever passes until a considerable change of voltage is created, it is difficult to start oscillations with high values of magnetisation current, although once the oscillations have been created it is possible to build up to much higher efficiency by increasing the field. This evidences itself in the curves of Fig. 5 by the hysteresis effect shown in curve "b" where the arrows represent direction of magnetisation change.

The operation of the magnetron valve in this way is very analogous to the ordinary push-pull self-oscillator and the conversion efficiency of the system is found to be very high for such high frequencies, values of over 50 per cent. being obtained on a wavelength of 3 metres.

These conversion efficiencies are very much higher than can be obtained with glass envelope triode valves, but it should be pointed out that the magnetic field is an essential part of the magnetron oscillator and in considering power conversion it is only fair to take into account the power required to produce this field. Because the field strengths necessary are of a fairly high value (1,000 gauss across a  $1\frac{1}{2}$  in. air gap for a 50 watt valve), even a well designed magnet system necessitates the use of quite appreciable power, and if this is taken into consideration, a reduction of overall efficiency of 20 per cent. must be allowed for.

At present two types of magnetron valves are available. One having an anode dissipation of approximately 50 w., and a larger valve having an anode diameter of 2 cms., and an anode length of 5 cms., and having a total anode dissipation of

The Magnetron.

150 watts. When designed for dynatron oscillations the filament of these valves is protected by guard wires, as shown in Fig. 8. These guard wires, of which there are two, lie one on either side of the filament parallel to it and placed so as to be in line with the slots between the anodes. The potential of these guard wires is made negative with respect to the filament and they are introduced with the

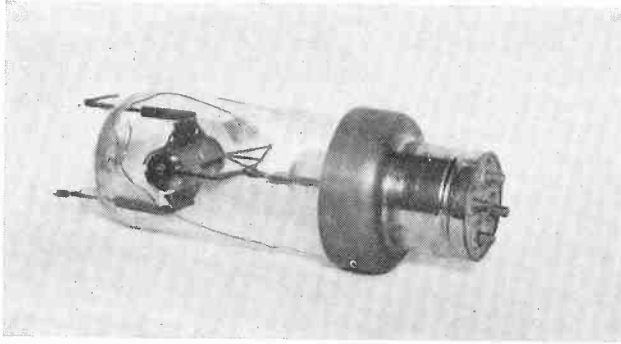

FIG. 8.

object of overcoming filament bombardment. With the earlier types of magnetron employing a straight filament and no guard wires, it was found that when the generated H.F. volts were high, the filament increased in brilliancy unduly causing a reduction of valve life, this increase of filament brilliancy being due to returning high velocity electrons from the anodes.

It was found that the introduction of two wires, one each side of the filament which could be connected to the filament or made slightly negative, was sufficient to cure this rather troublesome feature. If the guard wires are taken to a point on a resistance in the anode feed supply the drop down this resistance provides the

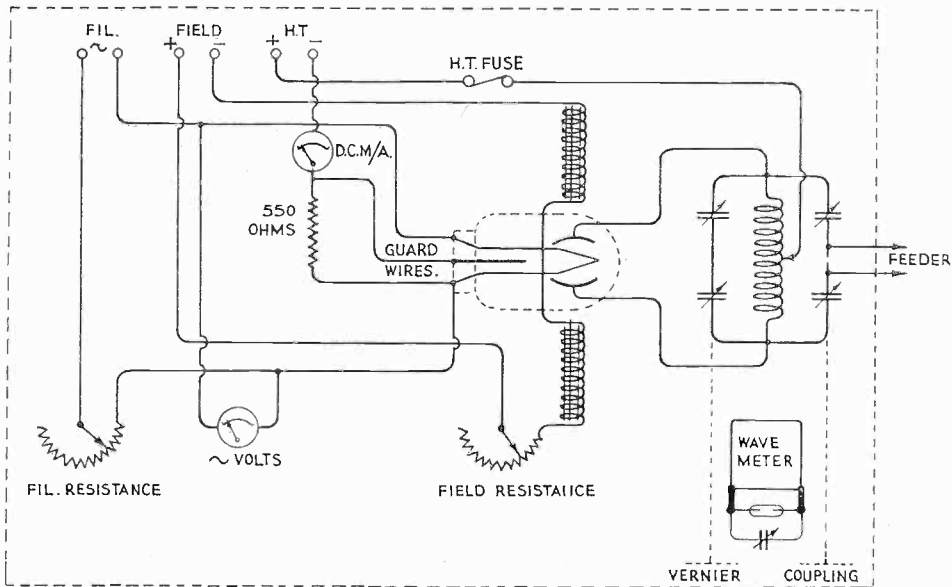

FIG. 9.

necessary negative bias ; should the feed rise unduly, an additional negative bias will be given to the guard wires which will tend to prevent the action from becoming

## *The Magnetron.*

---

dangerous. A similar phenomenon was found to occur causing the stems supporting the anode segments to become hot, due in this case to high velocity electrons escaping through the slots between the anodes, bombarding the anode stems, the heating taking place at a point close to the anode itself. This effect has been minimised by introducing on to each anode stem a small cylinder supported on steatite buttons, and therefore, being insulated from the anode stems. The escaping electrons thus bombard the cylinders themselves and since they are insulated, the effect is now to build up a negative field around the stems and prevent the heating action taking place.

It should be remarked that the introduction of guard wires in the magnetron valve is only necessary when the valve is used for dynatron oscillations, and in fact it is necessary to omit the wires if the valve is required for electronic oscillations.

The particular set developed for medical therapy employing the 150 watt magnetron covers a waverange of from 2.5 metres to 8.5 metres, and develops its maximum output at wavelengths between 3 and 5 metres.

The circuit diagram is shown in Fig. 9, the filament being fed from A.C. direct, and the field through a rectifier. It is found that best efficiency can be obtained by using an H.F. circuit with a high ratio of L.C., and hence the control of H.F. circuit wavelength is by means of variable inductance tuning. This takes the form of four sliding tubular bridges connected in series which can be pre-set to a given value with fair accuracy. Fine control of wavelength is accomplished by using a small vernier condenser in parallel with the two half anodes. The H.F. energy is conveyed from the main tuned circuit by a variable condenser coupling to the output, or patient circuit, through a screened tubular feeder.

The screened feeder consists of two No. 5 concentric tube feeders in series, the outer being earthed, and the inner acting as the live conductor. This gives a feeder having an effective surge impedance of 150 ohms.

The far end of the feeder is connected to the patient circuit. This consists of a tuning inductance and the patient as capacity, two insulated electrodes being used and placed in such positions as to direct the field to the required spot. Tuning is effected first by setting the electrodes relative to the patient and by the value of inductance chosen, the feeder termination being set to give correct feeder conditions.

A. W. LADNER.

# MARCONI NEWS AND NOTES

## IMPORTANT BROADCASTING DEVELOPMENTS IN BRAZIL

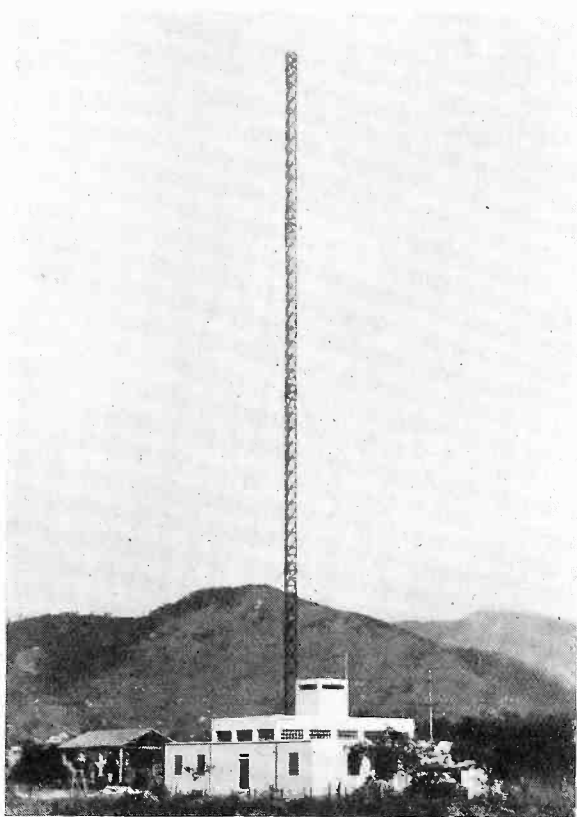

*Radio Tupi.*

**T**O meet the rapid growth of broadcasting in Brazil, several new stations are being established to give increased facilities for the ever widening circle of broadcasting listeners in that country.

### **New Station Inaugurated at Rio de Janeiro.**

The first of these stations, a ten kilowatt transmitter, operated by Radio Tupi Limited, was brought into service on the 26th September, when His Excellency Marchese Marconi, accompanied by Marchesa Marconi, performed the opening ceremony in the Radio Tupi studios at Rio de Janeiro, in the presence of a distinguished gathering of Brazilian officials. Marchese and Marchesa Marconi were visiting Brazil as official guests of the Brazilian Government, and the inaugural function

at the broadcasting station was followed by a banquet in honour of Their Excellencies at the Brazilian Foreign Office.

The Radio Tupi transmitter, which is situated some 22 kilometres from Rio de Janeiro, was manufactured at the Marconi Works at Chelmsford and incorporates the latest ideas in broadcasting technique. It operates on 234 metres.

Modulation up to 100 per cent. is permissible and the frequency response of the equipment is substantially flat between 30 and 10,000 cycles; moreover the transmitter is distortionless within the stringent recommendations of the latest International Convention up to 95 per cent. modulation.

The well-known Marconi series modulation system is employed.

Many reports have already been received of excellent reception at long distances, one letter having been received from a listener in Cornwall, England, stating that

when he was listening just after the station was opened he was able for a continuous period covering one or two hours to receive every item with remarkably good quality and on good loud-speaker strength.



*Marchese Marconi opening the Radio Tupi Station.*

**Further Developments.**

Following the successful inauguration of the new transmitter at Rio de Janeiro, the Marconi Company has received a further order from Brazil for two more high-power broadcast transmitters.

**Station for Bella Horizonte.**

The first of these stations will be installed at Bella Horizonte, in the State of Minas Geraes.

Its power is 22 kilowatts unmodulated carrier energy, and the frequency response is similar to that of the Rio de Janeiro station.

Maximum modulation up to 100 per cent., as in the case of the Rio transmitter, is arranged, with a similar linear frequency response.

**Station for Sao Paulo.**

The second new station ordered will be installed in Sao Paulo.

It will have a power of 24 kilowatts unmodulated carrier energy and will have generally the same advanced characteristics as the other two transmitters described.

**General Design.**

The new Brazilian transmitters have been designed at the Marconi Company's Works at Chelmsford. They are of a type which has to a large extent been standardised in modern broadcasting.

For ease of operation and supervision the transmitters assume the shape of a commercial switchboard, of ample proportions for mounting, in a convenient manner, the necessary controls, measuring instruments, indicating instruments, etc., etc. This greatly facilitates the task of the operating staff.

The high-frequency and low-frequency circuits, with their associated valves, and the rectifying equipments, are arranged in the space behind the switchboard to which access is gained through collapsible side gates. This method of construction provides a large measure of accessibility, while replacement can be carried out with the minimum of interruption in the broadcasting service.

The two new transmitters for Bella Horizonte and Sao Paulo, like the one already installed at Rio de Janeiro, are fitted with high-precision crystal drives, with a frequency constancy of  $5/1,000,000$ , so that in the matter of stabilisation the carrier waves will comply with the very high standards laid down.

For the three stations the Marconi Company is supplying the latest type of studio equipment, in which batteries are completely dispensed with, as they are fully A.C. operated.

The newest type of microphone—the Marconi Ribbon—is being supplied, and this instrument, which is used by some of the most important broadcasting services in the world, together with the special amplifiers developed for use with them, will, in conjunction with the rest of the Marconi equipment, provide transmission of unequalled purity and fidelity.