

# THE MARCONI REVIEW

No. 15.

December, 1929.

Technical Editor: H. M. DOWSETT, M.I.E.E., F.Inst.P., M.Inst.R.E.  
General Editor: W. G. RICHARDS.

## COMMERCIAL SHORT WAVE WIRELESS COMMUNICATIONS

### PART III.—FOREIGN SHORT WAVE SERVICES\*

*In the first two parts of this article, which appeared in THE MARCONI REVIEW, Nos. 13 and 14, the Empiradio and Via Marconi beam services were dealt with.*

*In this last part, the foreign short wave services, which have their centres in New York, Paris, and Berlin are described, as without this addition, the full scope of operation of the British services which are interconnected with them, cannot be completely understood.*

TO complete this review of the present position of commercial short wave communications, some details will now be given of the traffic organisations and equipment at the other great centres of the International wireless network.

#### The United States Commercial Short Wave Services.

In magnitude and importance, the commercial wireless services of the United States hold a leading place.

By far the greater number come under the control of the Radio Corporation of America, to whom I am indebted for much of the following information. The R.C.A. send out traffic on about 42 circuits and chiefly with Short Wave transmitters. The dates when these services were established are given in the table below:—

British	...	Between New York and London	...	...	March 1st, 1920.	
Norwegian, L.W.	...	"	"	Oslo	...	May 17th, 1920.
German	...	"	"	Berlin	...	August 1st, 1920.
French	...	"	"	Paris	...	December 14th, 1920.
Italian	...	"	"	Rome	...	August 10th, 1923.
Polish, L.W.	...	"	"	Warsaw	...	October 5th, 1923.
Swedish, L.W.	...	"	"	Gothenburg	...	December 1st, 1923.
Argentine	...	"	"	Buenos Aires	...	January 22nd, 1924.
Brazilian	...	"	"	Rio de Janeiro	...	May 3rd, 1926.
Holland	...	"	"	Amsterdam	...	November 1st, 1926.
Dutch West Indies	...	"	"	Curaçao	...	June 21st, 1927.
Dutch Guiana	...	"	"	Paramaribo	...	August 9th, 1927.
Venezuelan, L.W.	...	"	"	Caracas	...	August 18th, 1927.
Colombian	...	"	"	Bogota	...	August 27th, 1927.
Belgian, L.W.	...	"	"	Brussels	...	October, 3rd 1927.
Porto Rican	...	"	"	San Juan	...	October 10th, 1927.
Turkish, L.W.	...	"	"	Angora	...	December 10th, 1927.
Venezuelan, No. 2	...	"	"	Maracaibo	...	January 22nd, 1928.
Canadian	...	"	"	Montreal	...	March 10th, 1928.
Portuguese	...	"	"	Lisbon	...	April 2nd, 1928.

\* The following is a reprint of a lecture delivered by H. M. DOWSETT, M.I.E.E., F.Inst.P., M.Inst.R.E., before the Radio Society of Great Britain, at the Institute of Electrical Engineers, on September 27th, 1929.

*Commercial Short Wave Wireless Communications.*

Siberian ... ..	Between New York and	Monrovia ...	September 1st, 1928.
Cuban ... ..	" " " "	Havana ... ..	December 4th, 1928.
Chilean ... ..	" " " "	Santiago ... ..	January 1st, 1929.
	" " " "	(operated via Buenos Aires)	
	" " " "	San Jose, Costa Rica	September 3rd, 1927.
Spanish ... ..	" " " "	Madrid ... ..	August 1st, 1929.
	" " " "	San Francisco and Suva	April 22nd, 1929.
	" " " "	San Juan and San Domingo	May 15th, 1929.
Hawaiian ... ..	" " " "	San Francisco and Honolulu	March 1st, 1920.
Japanese ... ..	" " " "	" " " "	March 1st, 1920.
Dutch East Indies	" " " "	" " " "	July 16th, 1925.
French Indo-China	" " " "	" " " "	September 15th, 1926.
Philippines ... ..	" " " "	" " " "	June 27th, 1927.
Hong Kong ... ..	" " " "	" " " "	October 18th, 1927.
		(operated via Manila)	
Chinese ... ..	" " " "	" " " "	February 21st, 1928.
		(operated via Manila)	
	2/10/29 Discontinued working with French station, continued with Chinese Government station.		
	Between Manilla and	Osaka ... ..	October 30th, 1927.
	" " " "	Java-Bandoeng	October 17th, 1927.
	" " " "	Bangkok ... ..	
	" " " "	Saigon ... ..	November 1st, 1927.
	" " " "	Berlin ... ..	August 16th, 1927.
	" " " "	Buenos Aires	February 11th, 1929.

**Other American Services.**

The Tropical Radio Telegraph Co., works Central America with about seven circuits all on Short Wave.

The Mackay Radio & Telegraph Co. provides a wireless service to Hawaii on Short Wave and some overland Long and Short Wave circuits on the Pacific Coast.

There is also the transatlantic wireless telephone service from the American Telegraph & Telephone Co. at New York to the British Post Office at London, which employs two Short Wave sets and five wavelengths in addition to the Long Wave channel.

**The R.C.A. Broadside Projector Antenna.**

Following the example set by Great Britain in the use of aerials which transmit beam radiation, the principal short wave commercial stations of the United States, France and Germany, have now had installed aerials which have a similar object in view, called "projector antennæ," as their employment has become a necessity to meet the requirements of high speed traffic over as long a period as possible of the 24 hours, which compels the use of a strong signal.

Thus for many of their short wave services, the Radio Corporation of America employ the R.C.A. Broadside Projector antenna, which is illustrated in Fig. 26. This is a view of the 4 bay 16.8 m. aerial installed at Radio Central, Rocky Point.

It consists of two rows of equally spaced vertical radiators extending in parallel lines for a distance varying from 3 to 12 wavelengths, depending on the desired degree of directivity. Each row is energised from a common central horizontal feeder bus, the bus in turn being energised by a transmission line.

The two parallel rows of poles, cables and reflector elements represent the antenna proper, and its reflectors spaced 5 quarter wavelengths apart. These poles are of wood, and only  $1\frac{1}{8}$ th wavelength high.

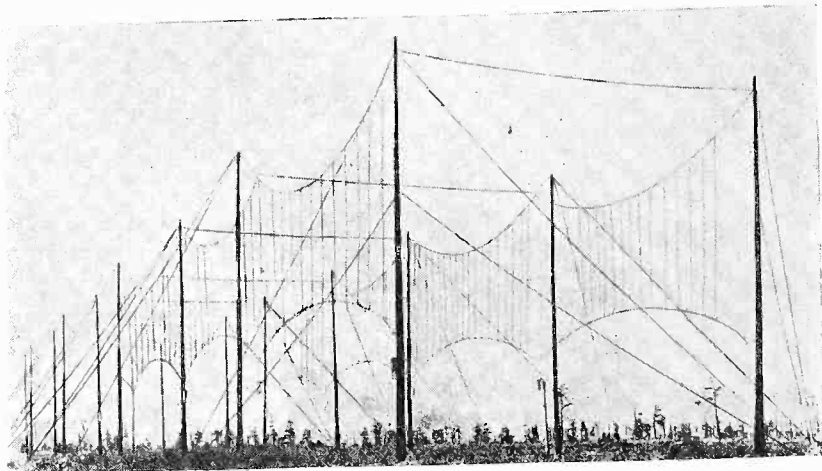

FIG. 26,

The feeder bus, which is too faint to be seen in the illustration, runs horizontally half way up the aerial array, and is bridged by a tuning coil at each vertical radiator.

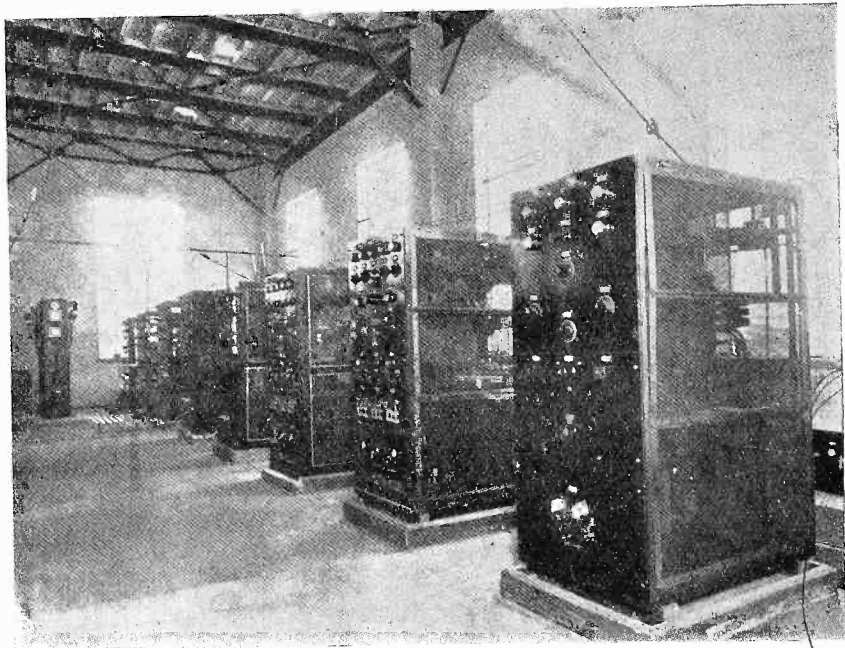

FIG. 27.

The radiators are so disposed that they form in effect, a half-wave aerial with a tuning-coil at the centre of each.

The radiators are arranged to produce electrical and mechanical symmetry with respect to the central feeder bus. The transmission lines may be several thousand feet in length to allow the aerial to be erected free of all obstructions, and phasing adjustments for the transmission lines are accomplished by a local tuning system in a coil-house located at the centre of each bay of the aerial.

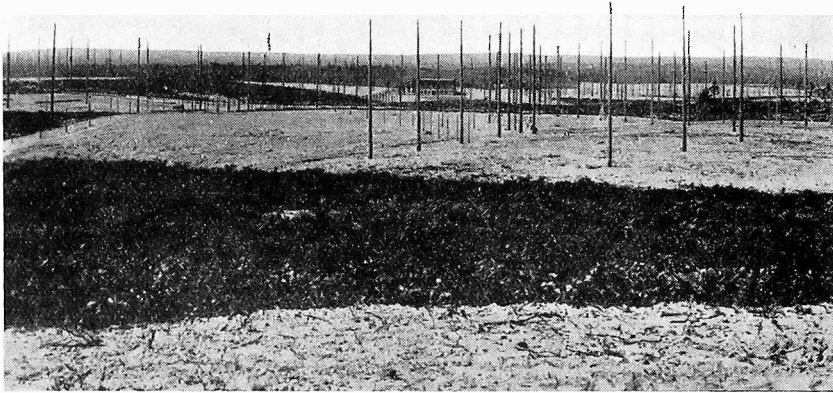

FIG. 28.

#### R.C.A. Short Wave Transmitters.

Four of the short wave transmitters at Radio Central are shown in Fig. 27. Each of them has two panels, the first containing the crystal controlled master oscillator, and the intermediate amplifier stages, and the second panel the power amplifier stage. The 10,000 volt rectifier valve panels are in another part of the building.

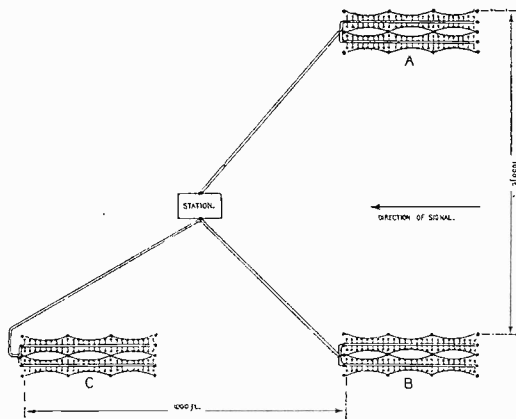

FIG. 29.

#### The R.C.A. Diversity System.

The short wave aerials at Riverhead, the Receiving Centre, cover a ground space of about one square mile. The illustration, Fig. 28, shows the short wave receiver building in the centre, and the five towers of a Marconi-Franklin Beam aerial, too faint to be seen, are in the background.

The special method of reception devised by the R.C.A. for commercial short wave working is called by them the Diversity system.

It aims at reducing to a minimum :—

- (1) Interference caused either by natural disturbances or by signals on approximately the same frequency as the station to be received.
- (2) Mutilation of the incoming signals caused by fading.

Three directional aerials are employed, spaced approximately 1,000 ft. apart, and full advantage is taken of the directional characteristic of each of them to reduce interference from either side and from the rear to a low value. Also, as it has now been proved that there is a difference in the time at which fading occurs on two aerials spaced only a few hundred feet apart, full use is made of this fact to reduce mutilation of signals due to deep fading by using three such spaced aerials to pick up the incoming signals.

A diagram of the arrangement employed is shown in Fig. 29. There are actually six aerial elements involved, the element being the short wave "Wave Antenna" developed by the R.C.A.

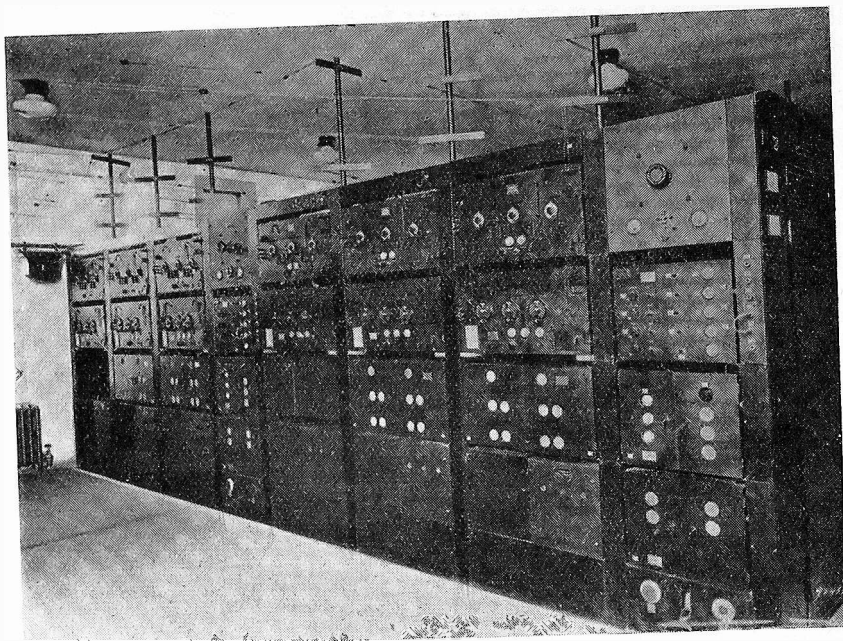

This consists of a number of horizontal doublets capacitatively coupled to a two wire transmission line. It is claimed that the horizontal system is superior to the vertical in signal noise ratio, on the assumption that local disturbances are vertically polarised, whereas distant signals are mostly horizontally polarised.

The principal on which this aerial works gives it directional characteristics similar to the Beverage Wave Antenna used for transoceanic reception on Long Waves.

Briefly, signals coming from the desired direction build up a voltage as they travel along the line of doublets, and the resulting current is fed into the receiving equipment, while signals from the opposite direction are dissipated in the terminating resistance.

The aerial is supported at a height of about 50 ft. by triatics broken by insulators. Space for a single unit aerial is 50 feet by 312 ft. Considerable improvement in directivity and voltage pick up is obtained by using two such aerial units in broadside. The Double or Broadside Antenna requires a space 100 ft. by 312 ft.

Where several stations on approximately the same great circle are to be received simultaneously, only one of these aerial arrangements is needed. A number of Diversity Receivers may be operated from each Diversity Aerial, and due to the fact that the aerial characteristics are not obtained by sharply resonant elements or circuits, the entire present band of frequencies utilized for transoceanic communication on short waves may be covered, with about equal response by a single aerial array. This makes possible reception of both day and night waves and reception from a number of stations with but one aerial system.

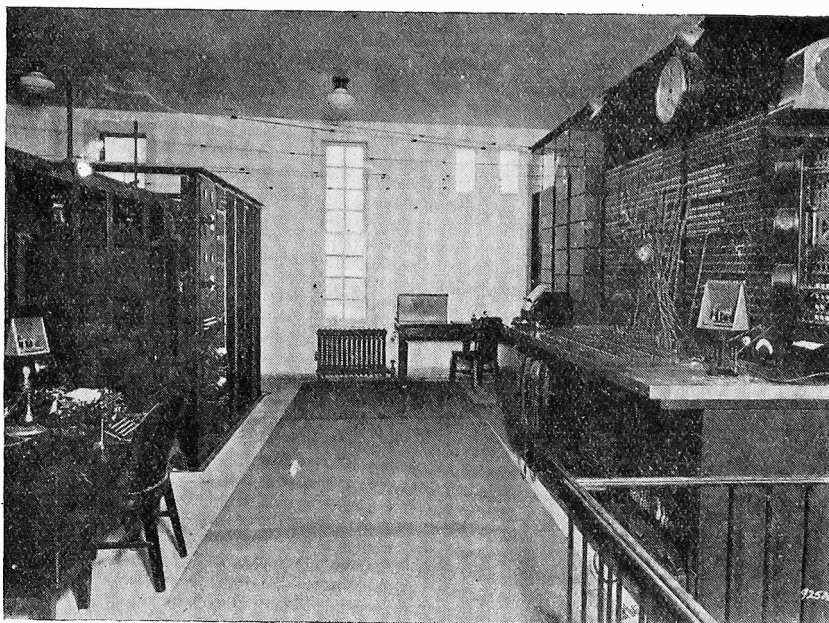

FIG. 30.

A carefully balanced 4 wire transmission system is employed to connect the aerial to the receiving equipment so as to prevent the characteristics of the aerial itself from becoming impaired by energy picked up on the transmission lines. The four wires are kept in exact spacing and symmetry by special fixtures mounted on poles 10 or 12 ft. high, set 25 ft. apart.

The aerial arrangement then consists of two short wave "Wave Antennæ" combined to form one Broadside antenna, and three of these Broadside antennæ combined at the output of their respective receivers to form one Diversity receiving system.

The combined output signal is made to control the output from a local source of audio-frequency energy.

This final signal, which is constant in frequency and strength, is sent to Central Traffic Office over the usual landline, and works the automatic recording equipment used for high speed reception, which is capable of being operated at telegraph speeds up to 300 words per minute.

### **Riverhead Receiving Equipment.**

There are at the present time at Riverhead, 48 separate short wave wave antennæ forming 8 diversity antennæ groups, and it is intended to erect a total of 68 Diversity groups.

A rack housing two Diversity receivers in one of the bays of the short wave receiving building is shown in Fig. 29.

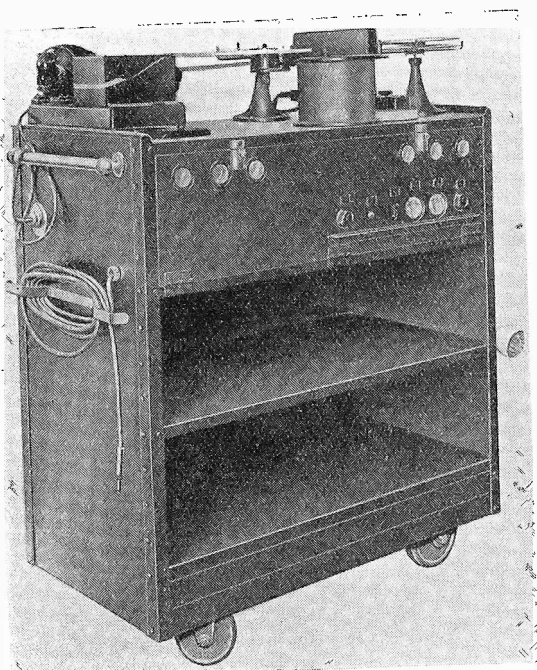

FIG. 31.

rectified currents are combined. The combined rectified currents pass to the tone keyer where they key an audio frequency supplied by a local oscillator. This audio frequency tone passed to the landline leading to the recording apparatus in the Central Office.

The line control board at the end of the receiver room where the tone signals are plugged through to New York, is shown in Fig. 30, and the portable monitoring equipment, which becomes a necessity where there are so many receivers in Fig. 31. This consists of a combination amplifier and push-pull valve relay output for operating the recorder signal coil with reverse current.

The Diversity Receiver to the right of the photograph for instance shows three similar metal screened boxes along the top, which are the radio frequency amplifiers of the three receivers corresponding to the three Broadside aerials, and below them are three other similar boxes. These are the three tuners.

The rest of the apparatus consists of three audio amplifiers, one master control unit, two converter units, one tone keyer, and one audio oscillator.

These receivers deliver audio signals to balanced potentiometers located on the control unit, which control the intensity of the audio frequency applied to the three separate converters.

The converters amplify and rectify their separate signals, and the three rectified currents then pass through separate meters on the control panel, after which the three



### **The Société Radio France Services.**

The information kindly furnished me by the Société Radio France of the organisation of French Short Wave Commercial communications, is as follows:—

The State works the Colonial services which are at present carried on by two transmitting stations, built by the French Government, and installed at Lyons (La Doua) and by an auxiliary low power station installed at Bordeaux (Lafayette).

The two Lyons transmitters are of the self-oscillator type, employing a 15 kw. water-cooled valve. Several waves lying between 15 and 40 m. are used, according to the time of day, and the corresponding stations. The call signals are FYR and FYQ. The principal corresponding stations are Saigon, Hanoi, Tananarivo, Bammako and Djibouti.

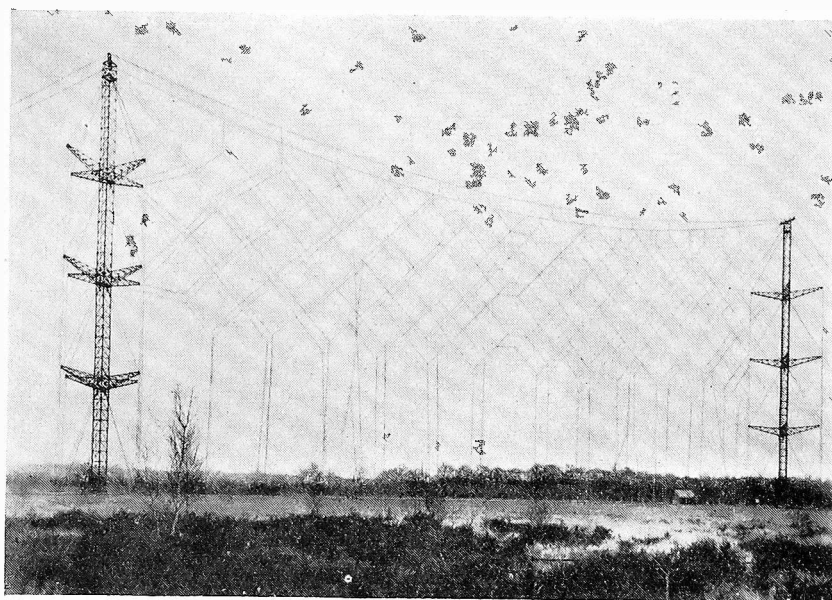

FIG. 32.

The Government has furthermore under construction at Pontoise (30 km. from Paris) a centre of short wave stations, which will start working at the end of 1929. This centre will be equipped at the outset by:—

Two S.F.R. self-oscillator transmitters employing two valves of the 15 kw. type, and one S.F.R. transmitter, with quartz master oscillator and two valves of the 15 kw. type.

The corresponding receiving centre is under construction at Noiseux (25 km. from Paris).

The services from France to all other parts of the world, other than those enumerated above, are worked by the Cie. Radio-France, which employs the apparatus of the Société Francaise Radioelectrique.



*Commercial Short Wave Wireless Communications.*

The transmitters of the Cie. Radio-France are grouped at Sainte-Assize (40 km. from Paris), and the receivers at Villecresnes (25 km. from Paris).

They at present comprise :—

- (A) Two S.F.R. Self oscillator transmitters with two 15 kw. valves, which will be referred to later.
- (B) One Marconi standard beam type transmitter.
- (C) Three S.F.R. transmitters, each with quartz master oscillator and two valves of the 15 kw. type.

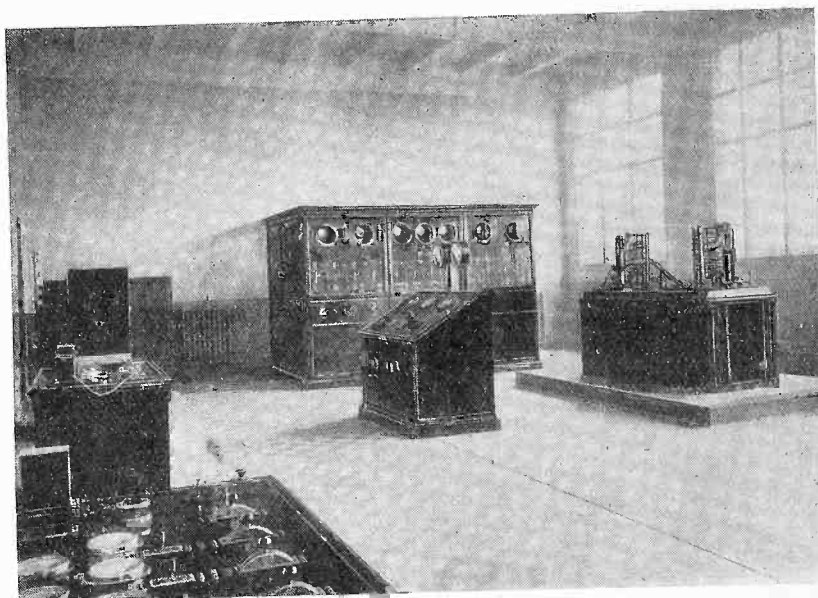

FIG. 33.

The services effected by these various transmitters are as follows :—

Type of Transmitter.	Call Signal.	Waves.	Corresponding Stations.
S.F.R. No. 1 self-oscillator transmitter...	FRO	15.45	Buenos Aires and Rio.
S.F.R. No. 1 self-oscillator transmitter...	FTL	30.10	Beyrouth—Vienna Belgrade.
S.F.R. No. 2 self-oscillator transmitter...	FFE	22.30	Beyrouth—Vienna Belgrade.
S.F.R. No. 2 self-oscillator transmitter...	FTD	15.10	New York.
Marconi Beam type transmitter ...	FQE	24.67	China—Japan.
S.F.R. No. 1 transmitter with quartz oscillator	FTM	15.50	Telephony Buenos Aires and telegraphy Bangkok.
S.R.F. No. 2 transmitter with quartz oscillator	FWR	24.50	Various telephony tests.
S.F.R. No. 3 transmitter with quartz oscillator	being	installed.	

### **The S.F.R. C.M. Type Projector Aerial.**

The particular form of projector aerial developed by the French is known as the S.F.R. C.M. type, and is illustrated in Fig. 32.

This shows a pair of masts supporting in the bay between them, two similar lozenge shaped networks, the transmitting aerial and its reflector, one behind the other. For a concentrated beam, an aerial occupying two bays would be used. The appearance of the receiving aerial is similar, but two sets of networks, one of small mesh for the day wave, and the other of large mesh for the night wave would be accommodated one above the other in a single bay.

The aerial and its reflector are constructed in a similar manner, but while the first is energised, the second is not.

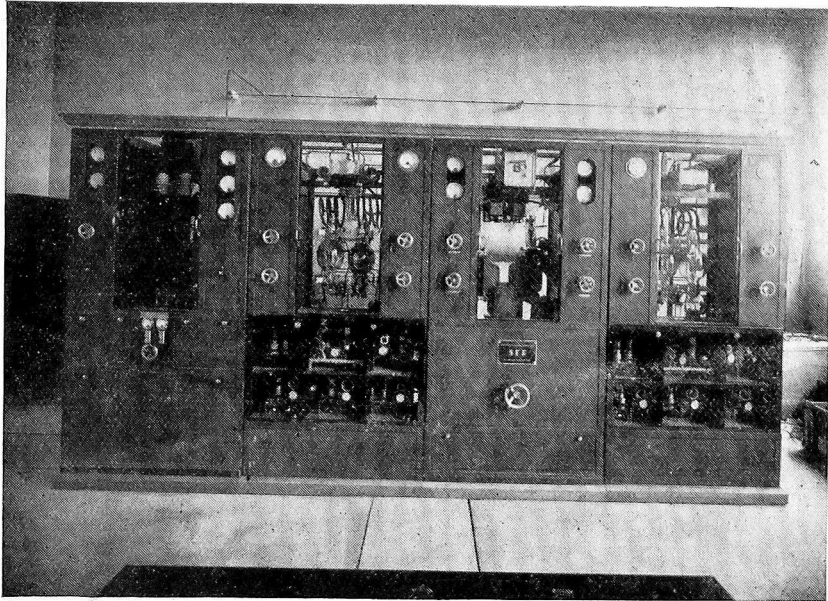

FIG. 34.

The principle of the construction of the aerial is that of a number of horizontal zig-zags connected together by insulators. The elements of wire in each zig-zag are half a wavelength long, and the currents therefore in all those elements inclined in the same direction are in phase.

The sum total of this construction, and the effect, is to produce two fields of radiation which cross each other at right angles, both of which give maximum effect in a horizontal direction.

A single pair of feeders at the centre of the aerial, or two pairs equally spaced are the usual practice, and the current distribution through the aerial is therefore not uniform.

**S.F.R. Short Wave Transmitters.**

One of the S.F.R. S.W. transmitters at Ste. Assize is shown in Fig. 33. It can be seen on the right of the photograph. It consists of two water-cooled valve self oscillators. One of the oscillators may be used for the day wave, and the other for the night wave, or the two may be combined together to form one oscillator.

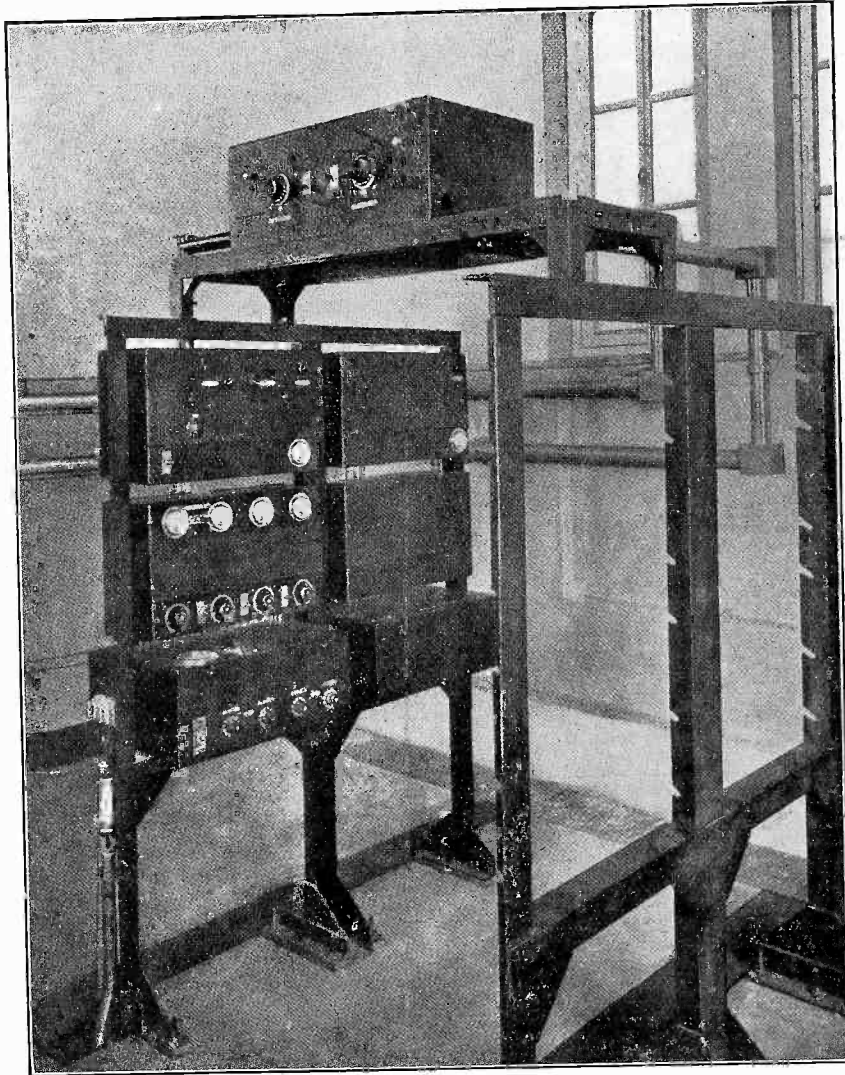

FIG. 35.

Its waverange is 12 to 50 m., and it is designed to work up to 150 words per minute. The three phase rectifier panel is against the wall, the control apparatus is in the centre of the photograph and the keying apparatus is on the left.

The second type of S.F.R. S.W. transmitter installed at Ste. Assize is shown in Fig. 34. This is crystal controlled with guaranteed constancy of wavelength of a high order ; it delivers 15 kw. to the aerial, and like the uncontrolled type, is also a two-wave oscillator suitable for day and night working.

### The S.F.R. Commercial Short Wave Receiver.

The long distance short wave receiver of the S.F.R. is illustrated in Fig. 35. This shows a rack for two receivers, only one being fitted.

On the top is an aerial coupling box, and the photograph also shows the concentric tube feeder connection to it.

Of the six boxes below, the top one to the left, No. 1, contains (A) a tuned amplifier, adjustable over a range of 12 to 50 m. ; (B) a frequency changer modulating the signal down to 750 kilocycles.

The box to the right, No. 2, contains (A) a two stage band amplifier ; (B) a second frequency changer which reduces the signal frequency to 25 kilocycles.

Box No. 3 contains a two stage band amplifier and a detector.

Box No. 4 a D.C. three stage amplifier, and an anti-fading regulator.

Box No. 5 the switchboard for distributing and adjusting the power feed voltages, while the different polarising batteries are contained in box No. 6.

A special modulating device is incorporated in box No. 1, which allows the operator to plug in his 'phones and listen-in to the signals.

The circuits are indicated in Fig. 36.

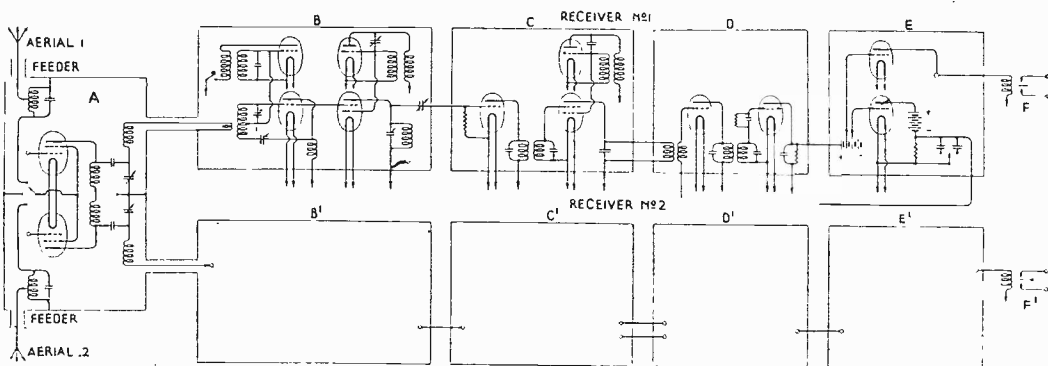

FIG. 36.

### Transradio Services.

Through the courtesy of Transradio, Berlin, I am able to give you the following particulars of the German S.W. services, which reached me by air mail, from Berlin, a few days ago.

The inter-European wireless service is worked by the German Reichspost itself, and is at present confined to long waves, but the German overseas wireless services are worked by Transradio by virtue of a concession granted by the Reich in 1921 to operate for a period of 30 years.

*Commercial Short Wave Wireless Communications.*

---

Besides the North America (New York) and Japan circuits which are at times still operated with long wave transmitters, the following purely short wave circuits are in operation :—

To Argentina .. ..	.. ..	.. ..	Opened in July, 1924.
„ Brazil .. ..	.. ..	.. ..	„ „ August, 1926.
„ Chile .. ..	.. ..	.. ..	„ „ April, 1929.
„ Egypt .. ..	.. ..	.. ..	„ „ March, 1923.
„ China (Mukden) .. ..	.. ..	.. ..	„ „ July, 1924, at first one-way to Mukden; two-way connection from January, 1928.
„ Dutch Indies (Malabar) .. ..	.. ..	.. ..	„ „ January, 1925.
„ Siam .. ..	.. ..	.. ..	„ „ January, 1929.
„ Manila .. ..	.. ..	.. ..	„ „ August, 1927.
„ Mexico .. ..	.. ..	.. ..	„ „ August, 1929.

The Berlin—New York service was initiated in August, 1919. A one-way service to Japan was opened in November, 1926, and service both ways began in April, 1929.

The following short wave transmitters are in operation at present :—

BERLIN TO NORTH AMERICA.

Directional DFA { 15.592 m. day wave.  
30.58 m. night wave.

BERLIN TO SOUTH AMERICA.

Directional DFI { 14.985 m. day wave.  
30.364 m. night wave.

Directional DGX 14.955 m.

Broadcast { DHA 27.701 m.  
DGI 22.429 m.

BERLIN TO EASTERN ASIA.

Directional { DGY 16.778 m.  
DHD 30.272 m.  
DHC 40.965 m.

TRANSOCEAN PRESS SERVICE.

Broadcast { DIH 15.040 m.  
DIS 29.557 m.

PROVISIONAL TRANSMITTERS.

Broadcast { DHC 26.224 m.  
DGW 14.896 m.

Telephony with Buenos Aires, which was opened in December, 1928, is at present carried on by means of DGW.

All the S.W. transmitters just mentioned are erected at the Nauen high power station.

*Commercial Short Wave Wireless Communications.*

The telegraph traffic carried by the wireless services, enumerated above, has risen from year to year, as will be seen from the following table :—

1919	..	..	1.2 million words.		
1920	..	..	2.9	..	..
1921	..	..	5.0	..	..
1922	..	..	6.5	..	..
1923	..	..	7.7	..	..
1924	..	..	10.8	..	..
1925	..	..	11.9	..	..
1926	..	..	12.7	..	..
1927	..	..	13.4	..	..
1928	..	..	16.3	..	..
In the first half-year	1929	..	8.6	..	..



FIG. 37.

The receiving installations are at Geltow, near Potsdam. The building of a new short wave receiving installation equipped with the latest devices has been commenced near Beelitz, about 46 km. from Berlin. The telegraph operating service itself is carried out at the Transradio operating centre, Berlin, which is opposite the Central Telegraph Office, to which it is connected by a pneumatic post installation. There has been a similar working centre at Hamburg since the end of 1924 for dealing with the important Hamburg and North German over-sea traffic, and both working centres have special telegram transmitting offices, with private lines for special clients.

**The Transradio Projector Aerial.**

The building housing the Short Wave transmitters at Nauen, is shown in Fig. 37, with two out of the three masts which support the two bays of aerials forming

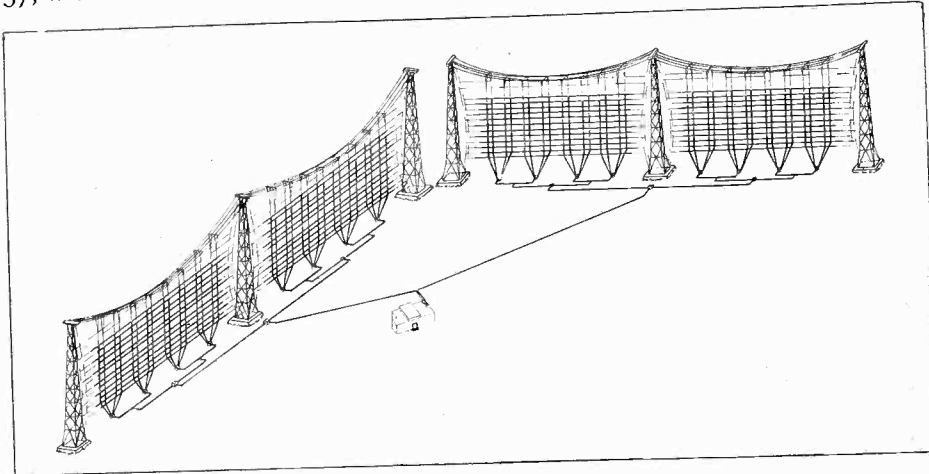

FIG. 38.

the Beam projector for the South American service. The mast to the right belongs to the projector used on the New York service.

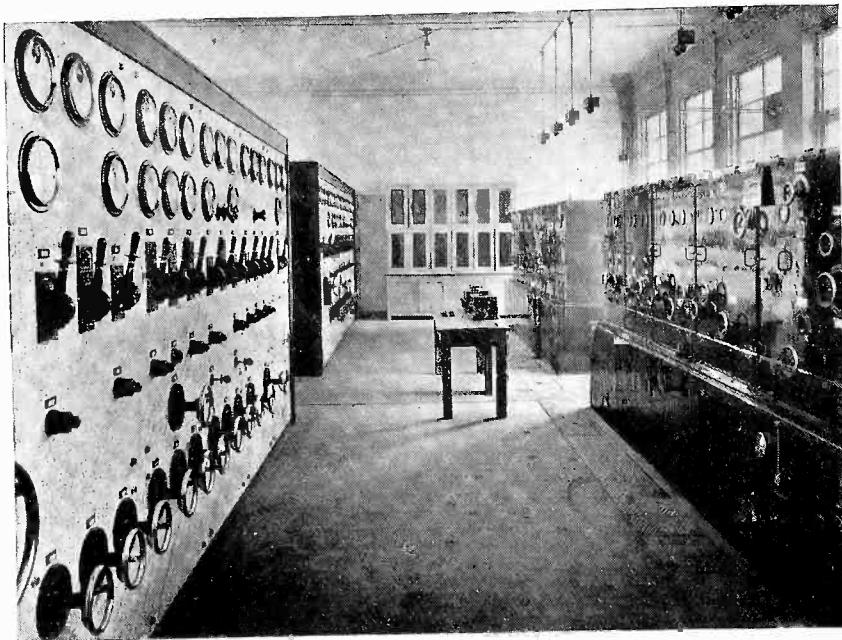

FIG. 39.



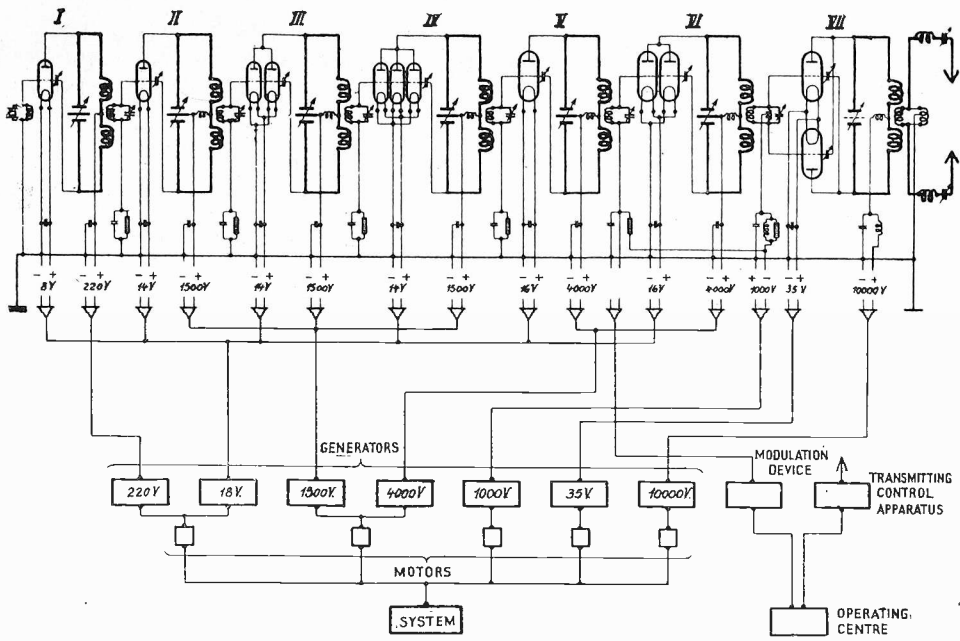

FIG. 40.

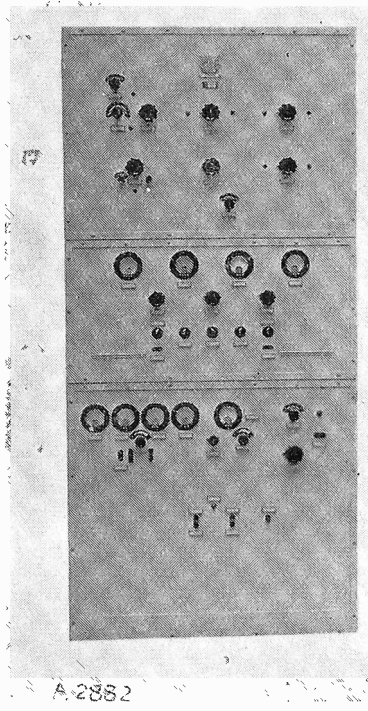
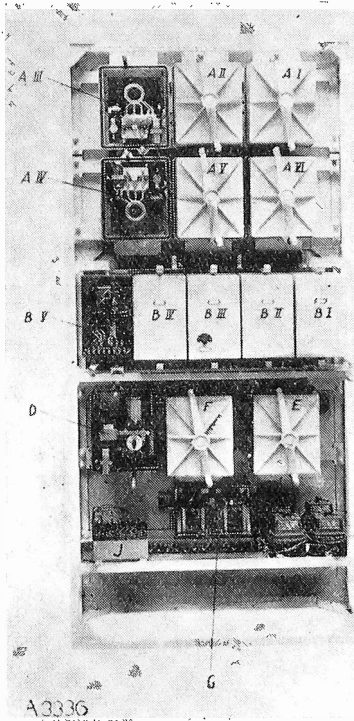

FIG. 41.

A fairly clear idea of the German type of projector aerial can be obtained from Fig. 38. The two bays of wires between the three masts on the left form the projector for the South American service, while a similar projector for New York is on the right.

The arrangement consists of a vertical sheet of horizontal doublets backed by a similar sheet of wires which acts as a reflector.

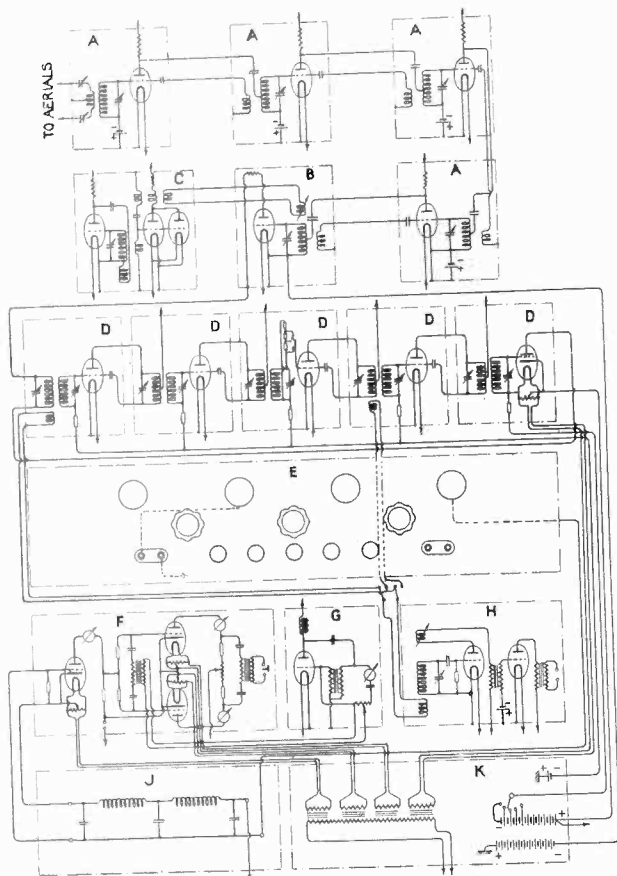

FIG. 42.

- |                     |                     |
|---------------------|---------------------|
| A. H.F. Amplifiers  | F. Keying Apparatus |
| B. Rectifier.       | G. Note Oscillator. |
| C. Heterodyne.      | H. Listening Unit.  |
| D. I.F. Amplifiers. | J. Sine Filter.     |
| E. Control Board.   | K. Transformer.     |

of these National and International services, the skill with which they are conducted, and the sound enterprise which relies on the guidance of advanced research for their development.

In conclusion, I have to express my thanks to the British Post Office, to the Radio Corporation of America, to the Cie. Radio France, to Transradio, and finally to Marconi's Wireless Telegraph Co., for much information and the many illustrations I have used in this paper.

Both the aerial and reflector wires are energised.

The feeders which originally coupled to the aerials right and left of the central mast, are here shown bifurcating to many feeding points in each bay, similar to the Marconi-Franklin feeder, but differing, however, in that both the feeder lines are insulated.

### Transradio Transmitters.

Two of the seven-stage crystal controlled short wave transmitters used on the American service are shown on the right in Fig. 39, with their main switchboards on the left. A schematic diagram of the transmitter is given in Fig. 40.

A back and front view of the commercial short wave receiver is shown in Fig. 41, and it will be noted that the panel system is adhered to. Each stage has its own screening box with a special method for ensuring that the covers are locked tight in place.

This ends the account I have attempted to give you of the commercial short wave services of the World.

Incomplete as it is, it may yet have enabled you to visualise better the present magnitude and the great possibilities

# THE CALIBRATION AND CORRECTION OF NAVAL DIRECTION FINDERS

*Practical experience in the control of ships by the use of wireless direction finders has shown that this method is just as efficient and reliable as any other system which can be used for the same purpose.*

*Any naval direction finder, however, suffers from certain inherent errors, just as does the mariners' compass, and these are discussed in the following article.*

*It is shown that the nature of these errors can be obtained theoretically and correction curves made which enable very accurate bearings to be obtained from such an instrument as the type D.F.M.4 direction finder to which the following article refers.*

**I**NSTALLATIONS of the D.E.M.4 type have recently been carried out in the Argentine Destroyers "Mendoza," "Tucuman" and "La Rioja."

The apparatus in question is of the standard type that has already been described in some detail in THE MARCONI REVIEW (see No. 8, May, 1929).

The design is such that great accuracy is possible so long as the installation is carefully calibrated and adjusted.

Without proper calibration, the best D.F. set is of no more value than an uncorrected magnetic compass, and, surprising as it may seem, nautical men have been somewhat slow to realise this. Happily this state of affairs is improving, and, by proper co-operation, it is now usually possible to compare a sufficiently large number of wireless test bearings with visual observations and gyro compass readings, to enable a reliable error curve to be drawn, so that the most appropriate corrections can be applied.

Good calibration results can be obtained either by using a low power transmitter fitted into a motor boat which can cruise round the ship at a suitable radius, or by swinging the ship and listening to a fixed transmitting station having a known direction. In many cases it is difficult to turn the ship sufficiently whilst under way, but sometimes the ship may be anchored in a tide-way and it is possible to take a series of bearings as the ship turns with the tide.

Precautions are of course necessary whatever method is used and much patience is required.

## **Nature of Errors due to Ship's Structure.**

Having obtained as many bearings as circumstances permit, differences as between wireless dial readings and true bearings relative to the ship's head are plotted against dial reading.

## *The Calibration and Correction of Naval Direction Finders.*

---

In general, this plotting gives an error curve which resembles two complete sine waves for one revolution of the search-coil. This resemblance only applies to ships producing small errors as we shall now see.

It is obviously important that we should have a good idea as to what shape of curve is to be expected, because we shall then be in a position not only to reject experimental errors, but also to deal intelligently with parts of the quadrants where it may have been impossible to obtain adequate checks. The metal work of a ship is a very complex structure from an electrical point of view, and, at first sight, it might appear impossible to forecast the nature of the errors caused by secondary fields set up by currents induced in the structure.

Fortunately, however, experience shows that the error is almost entirely of the type that could (in the absence of the ship) be produced by a single large closed conducting loop with its plane vertical and placed below the D.F. coils. From the point of view of primary errors, the ship's structure can in fact be replaced by a closed loop whose plane is roughly in the fore-and-aft line and whose dimensions and proximity to the D.F. set are such that the same *amount* of error is introduced.

The current in this equivalent loop will clearly be zero for transmitting stations abeam and will have a maximum value for stations ahead and astern. In consequence there will be no secondary field and no error for stations abeam, and when taking bearings ahead or astern, there is also zero error because the search coil is then coupled only to the thwartship B-T loop through which the secondary field does not pass.

If the ship is electrically asymmetrical as viewed from the D.F. site, the effective or equivalent loop will not be exactly in the fore-and-aft line, and instead of having zero errors at dial readings of  $0^\circ$ ,  $90^\circ$ ,  $180^\circ$  and  $270^\circ$ , we shall have zero errors at four other readings, for example,  $3^\circ$ ,  $93^\circ$ ,  $183^\circ$  and  $273^\circ$ .

It has been shown (MESNÉ) on reasonable grounds that the relation between the real and apparent bearings in a ship is given by:—

$$\tan \phi = A \tan \theta$$

where  $\phi$  = True bearing relative to ship's head.

$\theta$  = Apparent bearing relative to ship's head.

A = A constant depending on the ship's geometry and electrical conductivity and on the position of the D.F. loops.

From this expression, it is possible to derive error/dial reading curves of various maximum amplitudes (corresponding to various ships and D.F. positions).

Such curves may be plotted on transparent paper for maximum errors up to say  $20^\circ$ , and, armed with a curve "family" of this kind, it is a simple matter to find out which curve best fits the results in any given ship.

A family of these curves is shown in Fig. 1.

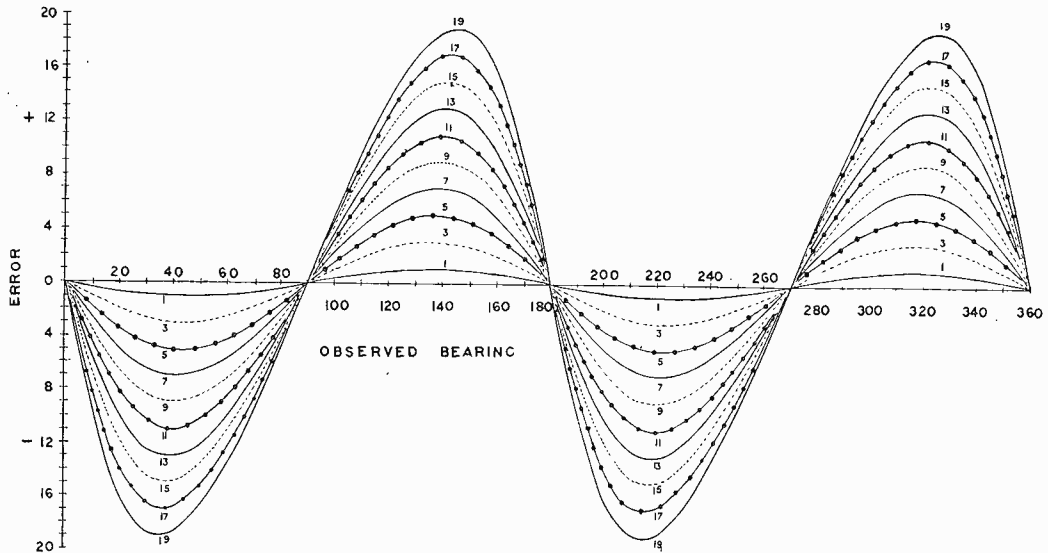

FIG. 1.

### Correction of Errors.

The derived curves, to which we have referred, have been found to apply remarkably well in practice to the vast majority of ships, hence it is possible to eliminate the errors in all ordinary cases by a common correcting method.

The corrections introduced must of course obey the same law as do the errors to be eliminated.

The Marconi method of shunting one of the B.T. loops by means of a choke, does follow the tangent law already indicated, and one merely has to adjust the value of choke in order to control the *amount* of correction.

Reverting now to the actual process of calibration, it is usually best to take all test bearings with the choke disconnected. The errors are then plotted and it is easy to see what correction is necessary.

In selecting a curve from the "family" it has to be remembered that a bodily displacement along the horizontal axis (dial reading) may be justified by electrical asymmetry of the ship and that a bodily displacement vertically (error axis) may be caused by an error of pointer or search-coil alignment.

## The Calibration and Correction of Naval Direction Finders.

If, after choosing the best curve, the latter is seen to be displaced horizontally, the B.T. loops must be rotated as a whole through an angle equal to this displacement, otherwise even a correct adjustment of calibrating choke will not have the desired effect. It is not often that one has to readjust the orientation of the B.T. loops, but it is likely to be necessary if the loops are installed off the fore-and-aft line of the ship, and may be quite important in large ships where the amplitude of the error curve is great.

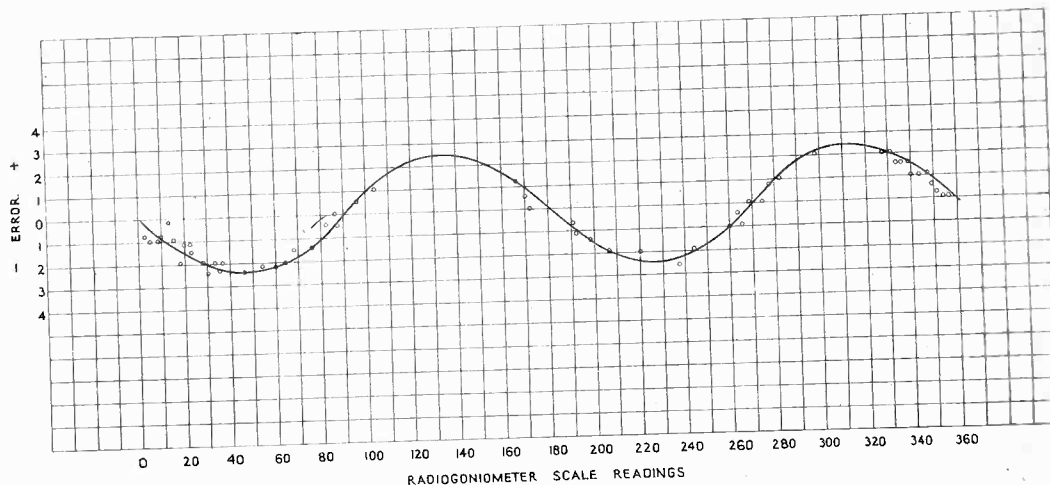

The D.F.M.4 installation in the Argentine Destroyer "La Rioja" was calibrated by taking bearings on the Daventry Broadcast stations as the ship turned with the tide.

The errors, prior to the application of the correcting choke are shown in Fig. 2.

It will be seen that the errors are entirely rational and, as might be expected, were eliminated quite accurately by using a suitable choke tap. Further checks on other stations indicated that the correction was not only accurate for the wavelengths used in calibration but also for all others within the range of the instrument.

NORMAN LEA.

# WIRELESS TELEPHONY AND DIRECTION FINDING IN THE FAR SOUTH

## PART I.

*The primary purpose of this article is to assist designers of the type of wireless installation used on Whaling Vessels, and to inform agents who are selling such apparatus as to the actual conditions under which the apparatus has to work.*

*To the general reader the article possesses special interest in that it is written by an engineer who has studied these conditions on the spot and who possesses first-hand information on the subject.*

---

**I**N 1925 the Marconi Company turned their attention to the possibilities of wireless telephony among the Whaling Fleets in the Antarctic, and in order to obtain first-hand knowledge, an Engineer was despatched to South Georgia with instructions to study the Whaling Industry. As a result of experiments carried out in these regions, the Marconi Company designed a series of foolproof wireless telephone sets suitable for installation on Whale Catchers and Trawlers.

The first of these transmitters was the now well known X.M.C. 1 "Whaler" Telephone Set, which had a power of between 100 and 150 watts to the aerial and was designed in such a manner that it was as simple to operate as the ordinary office telephone.

Immediately this transmitter was placed on the market orders were received from the principal British and Norwegian Whaling Companies to equip their Whaling Fleets with this type of installation, and in addition the Southern Whaling & Sealing Company ordered a Wireless Telephone Land Station to be installed at their Whaling Base at South Georgia.

During the summer and autumn of 1926, the Land Station at South Georgia was erected, and many British and Norwegian Whalers fitted with the type X.M.C. 1 "Whaler" Telephone Set. The reliability of these sets can be judged by the fact that although they have been in constant use without skilled attention of any kind, and subject to the most adverse weather conditions for three and a half years, not a single breakdown of any importance has been reported, and according to the



latest information the original transmitting valves are still in use on all the installations. This is indeed a wonderful achievement considering that these installations are operated by the crew of the whale catchers, who have absolutely no knowledge of the principles of wireless telephony.

Owing to the success of the X.M.C. 1 Telephone Sets, the Marconi Company developed two sets of lower power, for installation on Whalers and Trawlers which required to communicate only over distances of approximately 125 miles and under. These sets—with the exception of the power and size of the transmitter—are identical with the X.M.C. "Whaler" Sets and are just as simple and reliable in operation.

The X.M.D.1 has an aerial power of between 50 to 60 watts, and the X.M.B.1 an aerial power of between 30 and 35 watts.

To understand the use to which these Telephone Sets are put, it is essential that the reader should have some idea of the organisation of the Whaling Fleets.

Whaling Fleets of the present day are divided into two categories:—

- (i) A Fleet which works in conjunction with a land base; and
- (ii) A Fleet which works in conjunction with a floating base.

#### **Fleets Attached to Land Base.**

The Whaling Station, which comprises all the machinery, boilers, etc., for extracting the oil from the carcasses of the whale, is situated on a suitable island, the majority of the stations at present being centred at South Georgia in the South Atlantic.

From each Land Base operate four or five steam whale-catchers (British

*Marconi Wireless Land Station at Prince Olaf Harbour, South Georgia.*

and Norwegian regulations allow a maximum of five boats per station), each catcher being about the size of a trawler and carrying a crew of from nine to twelve men. All the stores, bunkers, ammunition, etc., for these whaleboats are kept at the Land Base and only sufficient supplies are placed on board the catcher for immediate

requirements. The whale-catchers hunt the seas within a radius of 100 miles from the Land Base and rarely exceed this distance owing to the fact that every whale

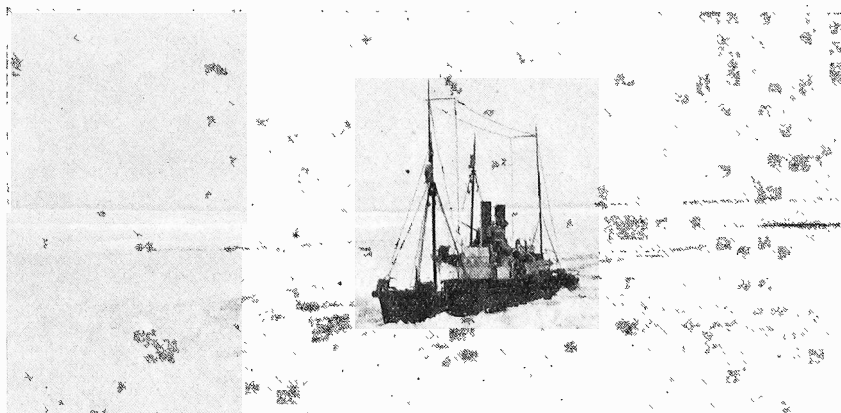

*Two Whale Catchers in the Ross Sea.*

they shoot they must themselves tow back to the Base, as the regulations do not permit the use of a vessel solely for the purpose of towing the whales to the base.

Before the introduction of wireless telephony into the whaling industry, it was the practice for the catchers to act as individual units with the result that the location of a productive whaling area was generally a matter of luck. Wireless telephony has revolutionised this important part of the industry as it is now possible for all units of the fleet to co-operate together and work as a team. The practice now is for the catchers to leave their base just before dawn and proceed in different directions in search of whales. Immediately one of the catchers sight a school of whales, communication is established with the other boats by means of wireless telephony and the position of the school given to the gunners so that they can converge on this area and obtain a good catch, instead of wasting their time searching in unproductive areas. When wireless telephony was first introduced into the Whaling Fleets, it was found rather difficult to get the gunners to work together as a team, but it did not take them very long to see that this was the only way to increase their catch, and to-day the gunners keep in hourly telephonic communication with each other, with the result that the whale catch during recent years has broken all records. The Directors of the Whaling Companies very quickly appreciated the advantages of their gunners working together as a team, and to encourage this they gave to each member of the whale-catcher's crew a bonus on the total production of the station, in addition to the individual bonus allotted to each vessel for every whale they

caught. This procedure encourages every gunner to inform the other gunners attached to his fleet when he has located a productive area, as by doing so he enables his colleagues to also obtain a good catch, and thereby increases the production of the station to which they are attached, thus increasing his own share of the bonus.

The whalers now consider that wireless is so essential to their trade that they will not sail without it, with the result that every whaling company of any importance has equipped its fleets with wireless telephone apparatus.

As is well known, wireless communication can be effected either by telegraphy, for which the Morse Code is used, or by telephony. Each of these methods has its own particular advantages and therefore its own field of application.

For communicating between the various units of a Whaling or Fishing Fleet, telephony has a decided advantage over telegraphy. The use of telegraphy necessitates the employment of a specially trained operator, and apart from the expense entailed on this account, it means that the ability of the vessel to communicate is dependent on one man, who might conceivably be incapacitated by sickness or accident. Wireless Telephony, however, overcomes this difficulty, since skilled operators are not required and direct conversation can be carried on by any member of the crew.

A wireless telegraph transmitter has approximately twice the range of a telephone transmitter of the same power, and for this reason it has been suggested that in spite of the disadvantages quoted above, wireless telegraphy should be fitted, as the greater range obtainable would enable the whale-catchers to operate hundreds of miles from their base and still keep in communication with their headquarters. Our experience has been that whale-catchers do not, and in fact cannot, efficiently operate hundreds of miles from their base. The radius of operation of the catchers is restricted to about 100 miles, due to the fact that every boat must tow in its own catch of whales, and even the most powerful whaleboat with four or five whales alongside cannot steam more than about five to six knots, with the result that if she were to operate say 500 miles from her land base, it would take her between three and a half to four days to tow her catch back to the factory. During this long tow the whale would decompose and the gases generated would result in the carcass being inflated to such a size that it would be very unwieldy to handle, and at the same time this decomposition would result in a great deal of valuable oil being lost.

In order to meet all conditions of service, the Marconi "Whaler" Telephone Sets have been designed to work also as continuous wave and interrupted continuous wave telegraph transmitters and keying units are provided for this purpose.

#### **Fleets Attached to Floating Factories.**

All the conditions stated above apply to whale-catchers which operate from a floating factory. The floating factory is a large ship, generally of the tanker class,

upon which is fitted all the machinery, boilers, etc., necessary for extracting the oil from the carcass of the whale. Four or five steam whale-catchers are attached to each factory ship and operate within a radius of 150 miles from this base.

From the above remarks it is easy to understand that what the whaler requires is a simple telephone set, capable of giving a perfectly reliable telephone service with the base and with the other vessels of the fleet up to a distance of approximately 150 miles. This range can always be obtained by a standard X.M.C. "Whaler" Set.

On the rare occasions when a whaleboat may proceed up to say 250 miles from her base in search of new fishing grounds, the X.M.C. type of telephone set is still capable of maintaining telephonic communication with the base, with the result that information can be conveyed to the Whaling Manager regarding productive fishing areas, and the factory ship can steam with her catchers to the required spot.

Reports show that under favourable atmospheric conditions, and over sea, good communication can often be maintained between whale-catchers at distances exceeding 500 miles, and even when atmospheric conditions are not too favourable, communication can generally be relied upon over distances of 150 to 200 miles.

Having satisfactorily solved the problem of inter-ship communication on the fishing grounds, the Marconi Company have now looked into the question of providing means of communication between the whale-catchers and shipping during the voyage out from Europe to the Antarctic.

*(To be continued.)*

---

---

## **ADMIRAL SIR HENRY JACKSON**

We very much regret to have to announce the death, on December 14th, 1929, of Admiral Sir Henry Bradwardine Jackson, G.C.B., K.C.V.O., F.R.D., LL.D., D.Sc., M.I.E.E., one of the early pioneers of Wireless Telegraphy, whose friendly assistance to Marchese Marconi when negotiating with, or carrying out tests for the Admiralty, commencing from the date of the inventor's arrival in this country in 1896 and continuing for many years thereafter, was of the greatest value to the progress of the art in those early days, and at the same time afforded one of the most pleasing aspects of the development of wireless in the British Navy in parallel with its world-wide development and application to maritime and commercial uses.

Sir Henry Jackson was born in 1855, and entered the Navy at an early age, reaching flag rank in 1906. He was appointed First Sea Lord in 1915 when Lord Fisher retired. In 1920 he became chairman of the Radio Research Board, and retired from the Navy in 1924.

He was an acknowledged authority in several branches of naval science, and of his many contributions to the learned societies perhaps the most outstanding on wireless subjects, although not the earliest, was that read before the Royal Society in 1902, entitled "On some Phenomena affecting the Transmission of Electric Waves over the Surface of Sea and Earth." He was a great experimentalist and a strong supporter of the amateur movement, and to a wide section of the wireless public his death will be felt as a personal loss.

# THE FIRST TRANSATLANTIC WIRELESS SIGNAL

## THE MARCHESE MARCONI'S BROADCAST OF HIS EXPERIENCE

*Thursday, December 12th, was the 28th anniversary of the historic wireless experiment conducted by Marchese Marconi between the Poldhu wireless station in Cornwall and St. Johns, Newfoundland, which resulted in the transmission and reception of the first wireless signal across the Atlantic Ocean.*

*This achievement, in December, 1901, only six years after Marchese Marconi's earliest experiments at his father's house in Bologna, Italy, definitely laid the foundations of world-wide wireless telegraph communication. The National Broadcasting Company of America marked the anniversary by special broadcast transmissions, and at its request Marchese Marconi broadcast from England, for re-transmission by means of the National Broadcasting Company's network of stations throughout the United States, a description of his experiences at St. Johns, Newfoundland, when he received the famous "S" signal, 28 years ago.*

*Marchese Marconi spoke from the British Broadcasting Corporation's studio at Savoy Hill, his speech being re-broadcast in the United States from the signals received from 5SW, the short wave experimental broadcasting station at the Marconi Works at Chelmsford.*

---

MARCHESE MARCONI said: "It gives me very great pleasure to recount to Americans, through the courtesy of the National Broadcasting Company of America and the British Broadcasting Corporation, my experiences at the time when I first attempted—and, as it proved, successfully—to send Radio signals across the Atlantic Ocean, twenty-eight years ago, almost to the very hour.

"From the time of my earliest experiments I had always held the belief—almost amounting to an intuition—that radio signals would some day be regularly sent across the greatest distances on earth, and I felt convinced that Transatlantic Radio Telegraphy would be feasible.

"Very naturally I realised that my first endeavour must be directed to prove that an electric wave could be sent right across the Atlantic and detected on the other side.

"What was at that time a most powerful wireless station, was built at Poldhu, in England, for this purpose, and an antenna system was constructed, supported by a ring of 20 wooden masts, each about 200 ft. high.

"In the design and construction of the Poldhu Station, I was assisted by Sir Ambrose Fleming, Mr. R. N. Vyvyan and Mr. W. S. Entwistle.

"A similar station was erected at Cape Cod, in Massachusetts. By the end of August, 1901, the erection of the masts was nearly completed, when a terrific gale swept the English coasts, with the result that the masts were blown down, and the whole construction wrecked. I was naturally extremely disappointed at this unforeseen accident, and for some days had visions of my test having to be postponed for several months or longer, but eventually decided that it might be possible to make a preliminary trial with a simpler aerial attached to a stay stretched between two masts 170 feet high, and consisting of 60 almost vertical wires. By the time

## *The First Transatlantic Wireless Signal.*

this aerial was erected, another unfortunate accident, also caused by a gale, occurred in America, destroying the antenna system of the Cape Cod Station.

### **Aerials Elevated by Balloons and Kites.**

“ I then decided, notwithstanding this further setback, to carry out experiments in Newfoundland, with a receiving aerial supported by a balloon or kite, as it was clearly impossible at that time of the year—owing to the wintry conditions, and the shortness of the time at our disposal—to erect high masts to support the receiving aerial.

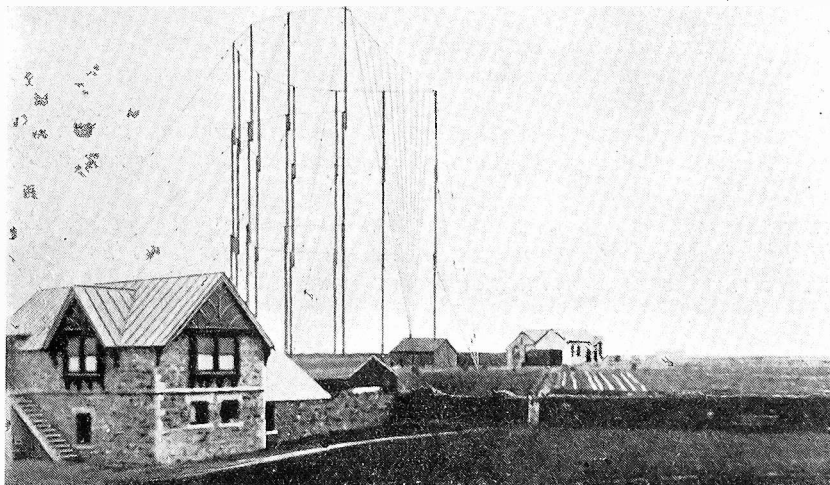

*Poldhu Wireless Station, December, 1901, showing vertical aerial used for Transatlantic experiment.*

“ On the 26th November, 1901, I sailed from Liverpool, accompanied by my two technical assistants, Mr. G. S. Kemp and Mr. P. W. Paget.

“ We landed at St. Johns, Newfoundland, on Friday, December the 6th, and, before beginning operations, I visited the Governor, Sir Cavendish Boyle, and the Prime Minister, Sir Robert Bond, and other members of the Newfoundland Government, who promised me their heartiest co-operation in order to facilitate my work.

“ After taking a look round at the various sites, I considered that the best one was to be found on Signal Hill, a lofty eminence overlooking the Harbour. On the top of this hill was a small plateau, which I thought suitable for flying either balloons or kites. On a crag of this plateau rose the Cabot Memorial Tower, and close to it was an old Military Barracks. It was in a room of this building that I set up my receiving apparatus in preparation for the great experiment.

“ On Monday, December 9th, barely three days after my arrival, I and my assistants began work on Signal Hill. The weather was very bad and very cold. On the Tuesday we flew a kite with 600 feet of antenna wire as a preliminary test, and on the Wednesday we had inflated one of our small balloons, which made its first ascent during the morning. Owing, however, to the strength of the wind, the

## *The First Transatlantic Wireless Signal.*

balloon soon broke away and disappeared in the mist. I then concluded that perhaps kites would answer better, and decided to use them for the crucial test.

### **Why the "S" Signal was chosen.**

"I had arranged with my assistants in Cornwall to send a series of 'S's' at a pre-arranged speed, during certain hours of the day. I chose the letter 'S' because it was easy to transmit, and, with the very primitive apparatus used at Poldhu, I was afraid that the transmission of other Morse signals, which included dashes, might perhaps cause too much strain on it and break it down.

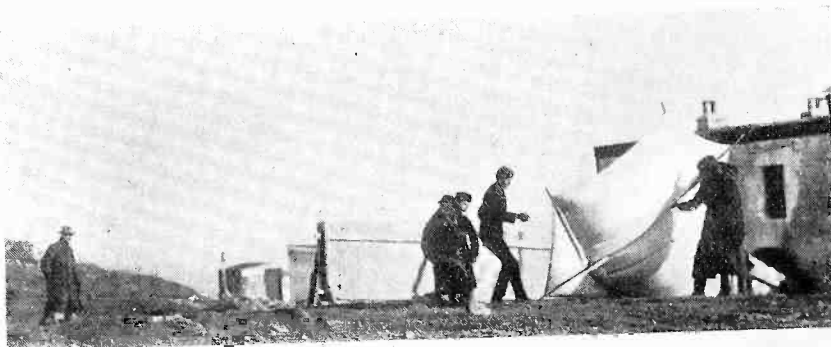

*Preparing to fly a kite at Signal Hill, December 12th, 1901. Marchese Marconi is seen on the left.*

"Mr. Entwistle, Mr. George and Mr. Taylor were in charge of the English Station at Poldhu during the transmission of signals to Newfoundland.

"On the morning of Thursday, the 12th of December, the critical moment for which I had been working for so long, at last arrived; and, in spite of the gale raging, we managed to fly a kite carrying an antenna wire some 400 feet long. I was at last on the point of putting the correctness of my belief to the test!

"Up till then I had nearly always used a receiving arrangement including a coherer, which recorded automatically, signals through a relay and a Morse instrument. I decided, in this instance, to use also a telephone connected to a self-restoring coherer—the human ear being far more sensitive than the recorder. Suddenly, at about half-past-twelve, a succession of three faint clicks on the telephone, corresponding to the three dots of the letter 'S,' sounded several times in my ear—beyond the possibility of a doubt!

"I asked my assistant Mr. Kemp for corroboration, if he had heard anything. He had in fact heard the same signals as I had. I then knew that I had been justified in my anticipations!

"The electric waves, which were being sent out into space from Poldhu had traversed the Atlantic unimpeded by the curvature of the earth—which so many considered to be a fatal obstacle—and they were now audible in my receiver in Newfoundland! Perhaps it will interest you if I now repeat the morse signal of the letter 'S' as I first heard it across the Atlantic 28 years ago.

[Marchese Marconi then transmitted the "S" signal by means of a key and an induction coil.]



## The First Transatlantic Wireless Signal

I then felt for the first time absolutely certain that the day when I should be able to send messages without wires or cables across the Atlantic and a fess of oceans and perhaps continents was not far distant.

The then enormous distance for a distance of 1,700 miles had been successfully bridged.

On the following day the signals were again heard though not quite so distinctly. However there was no further doubt possible but that the experiment had succeeded.

### What the Experiment Proved.

The result meant much more than the mere successful realization of an experiment. It was a discovery which proved that contrary to the general belief of that time signals could travel over such great distances as those separating Europe and America and constituted, as Sir Oliver Lodge has stated, an epoch in history by being an astonishing and remarkable feat.

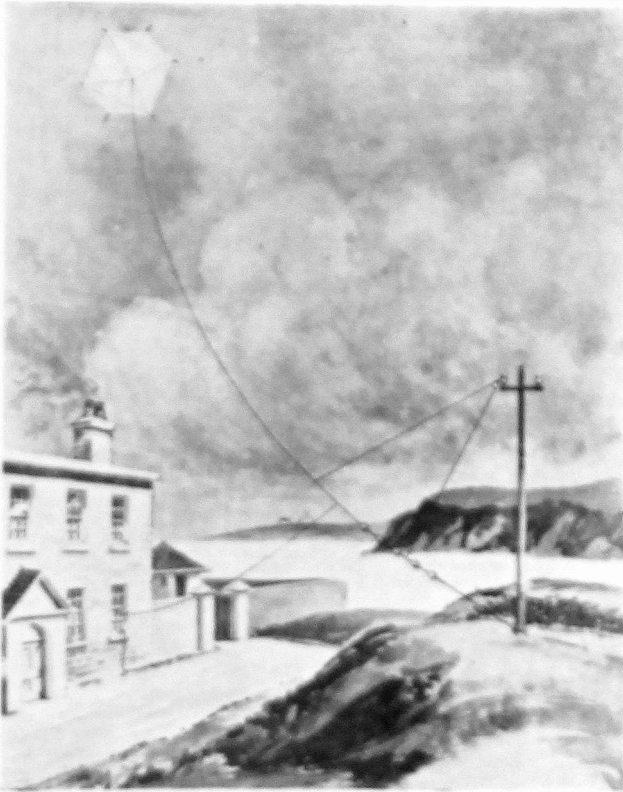

The kite elevated aerial at Signal Hill, Newfoundland  
December 1901

townland and places outside of the town, the work upon which I was engaged was a violation of their rights.

It must be remembered that at that time there was no suggestion of the existence of the Heaviside or 'sky' layer, nor of the reflection of electric waves from the higher regions of the atmosphere. The instruments we had at our disposal were very crude compared with those we have to-day. We had no valves or tubes, no amplifiers, no sensitive superheterodyne sets, no directional transmitters and receivers, and no means of making continuous waves. All we had for transmitting was the means of making crude damped waves by means of irregular spark discharges. The receivers that were then employed were insensitive as compared with those of the present day.

Following the success of my test I was promptly notified by the Anglo-American Telegraph Company that as they had the exclusive right to construct and operate stations for telegraphic communication between New

## *The First Transatlantic Wireless Signal.*

" I was asked to give an immediate undertaking not to proceed with my experiments and to remove my apparatus, or legal proceedings would be taken. I was absolutely astounded by this communication which, however, at least gave me the satisfaction of knowing that one of the great cable companies not only believed in my success but already feared the competition of radio transatlantic communication.

" I mention this to show why my experiments in Newfoundland were thus cut short. When, however, the reason became known, I received a very cordial invitation from the Government of Canada to erect a station in Nova Scotia—an offer which I gladly accepted.

### **Scientific Scepticism.**

" The announcement that I had succeeded in transmitting radio signals across the Atlantic, was received with scepticism by most scientists—principally in Europe. The same thing cannot be said of American electrical engineers, for the American Institute of Electrical Engineers was the only technical and scientific body which first believed in me and my statement of having received signals across the Atlantic Ocean. It was the first distinguished and authoritative society enthusiastically to celebrate the event and to extend to me their generous support and valuable encouragement. They celebrated the occasion by a dinner given to me in New York, at which most distinguished American scientists took part, including men whose names were and still are, household words in electrical science, such as Dr. Alexander Graham Bell, the inventor of the telephone ; Professor Elihu Thompson ; Dr. Steinmetz ; Dr. Michael Pupin ; Mr. Frank Sprague and many others.



*Marchese Marconi, with Mr. G. S. Kemp (left), and Mr. P. W. Paget, two of his earliest assistants, photographed at Marconi House on the 28th anniversary of the Newfoundland experiments.*

" In less than three months from the date of the tests to Newfoundland these long distance results were more than confirmed by experiments carried out by myself on the s.s. Philadelphia of the American Line.

" The spanning of great distances is now child's play compared with what it was then. Beam projector, and other commercial radio telegraph and telephone

stations are now exchanging daily hundreds of thousands of words between distant parts of the earth. Wireless telephony over world-wide distances is now a reality, together with transmission of pictures, and the day is approaching when television also will be a commonplace. It may even be that the transmission of power over moderate distances may be developed in the not far distant future. I must leave to your imaginations the uses which can be made of these new powers. They will probably be as wonderful as anything of which we have experience so far.

“ I am glad to think that Mr. Kemp and Mr. Paget, who, as I have already told you were with me at St. John's 28 years ago, are with me at the microphone now, while I am addressing you, and I wish to send my most cordial greetings to all those interested in radio in America (I feel sure they form the majority of the American people), and to all my friends at the other side of the Atlantic.”

#### **Reception of the Broadcast in the United States.**

Within a quarter of an hour of finishing the broadcast address Marchese Marconi received the first telegram of congratulation from the United States, and many others followed in quick succession.

The first telegram to be received was from an Italian listener in the Middle West, Mr. Francesco Occioni, who said the broadcast had been well received and enjoyed at his home in Denver, Colorado.

Mr. Merlin H. Aylesworth, President of the National Broadcasting Company of America, at whose request and through whose stations the Marchese Marconi's address was broadcast throughout the United States from New York to San Francisco, Seattle and Los Angeles on the Pacific Coast, telegraphed heartiest congratulations to the Marchese Marconi, and said the reception of the address was excellent, every word being understood. Mr. Aylesworth added that it had been broadcast throughout the whole of the United States over a network of fifty-nine broadcast stations.

Mr. David Sarnoff, Vice-President and General Manager of the Radio Corporation of America, telegraphed :—

“ American Scientists twenty-eight years ago were proud and glad to recognise your achievement. To-day they were thrilled to hear your personal description of this momentous event. Congratulations and my personal thanks.”

#### **American Scientific Tribute.**

The American Institute of Electrical Engineers, to which the Marchese Marconi referred in his address as “ the only technical and scientific body which first believed in me and my statement of having received signals across the Atlantic Ocean,” telegraphed :—

“ Your statement to-day regarding recognition given your first transmission of radio signals across the Atlantic by this Institute is deeply appreciated. We are pleased to know that the 1902 dinner remains in your mind as a memorable occasion. Sincere congratulations upon your many important achievements in radio communication.”

A group of radio “ fans ” sent the following message :—

“ Your radio talk to-day ; reception fine, subject excellent, Glenwood Springs, the spa of the West, congratulates Great Britain and you.”

These and many other telegrams from the United States, showed how great was the interest taken in America in Marchese Marconi's address.

stations are now exchanging daily hundreds of thousands of words between distant parts of the earth. Wireless telephony over world-wide distances is now a reality, together with transmission of pictures, and the day is approaching when television also will be a commonplace. It may even be that the transmission of power over moderate distances may be developed in the not far distant future. I must leave to your imaginations the uses which can be made of these new powers. They will probably be as wonderful as anything of which we have experience so far.

“ I am glad to think that Mr. Kemp and Mr. Paget, who, as I have already told you were with me at St. John's 28 years ago, are with me at the microphone now, while I am addressing you, and I wish to send my most cordial greetings to all those interested in radio in America (I feel sure they form the majority of the American people), and to all my friends at the other side of the Atlantic.”

#### **Reception of the Broadcast in the United States.**

Within a quarter of an hour of finishing the broadcast address Marchese Marconi received the first telegram of congratulation from the United States, and many others followed in quick succession.

The first telegram to be received was from an Italian listener in the Middle West, Mr. Francesco Occioni, who said the broadcast had been well received and enjoyed at his home in Denver, Colorado.

Mr. Merlin H. Aylesworth, President of the National Broadcasting Company of America, at whose request and through whose stations the Marchese Marconi's address was broadcast throughout the United States from New York to San Francisco, Seattle and Los Angeles on the Pacific Coast, telegraphed heartiest congratulations to the Marchese Marconi, and said the reception of the address was excellent, every word being understood. Mr. Aylesworth added that it had been broadcast throughout the whole of the United States over a network of fifty-nine broadcast stations.

Mr. David Sarnoff, Vice-President and General Manager of the Radio Corporation of America, telegraphed :—

“ American Scientists twenty-eight years ago were proud and glad to recognise your achievement. To-day they were thrilled to hear your personal description of this momentous event. Congratulations and my personal thanks.”

#### **American Scientific Tribute.**

The American Institute of Electrical Engineers, to which the Marchese Marconi referred in his address as “ the only technical and scientific body which first believed in me and my statement of having received signals across the Atlantic Ocean,” telegraphed :—

“ Your statement to-day regarding recognition given your first transmission of radio signals across the Atlantic by this Institute is deeply appreciated. We are pleased to know that the 1902 dinner remains in your mind as a memorable occasion. Sincere congratulations upon your many important achievements in radio communication.”

A group of radio “ fans ” sent the following message :—

“ Your radio talk to-day; reception fine, subject excellent, Glenwood Springs, the spa of the West, congratulates Great Britain and you.”

These and many other telegrams from the United States, showed how great was the interest taken in America in Marchese Marconi's address.