

13th JUNE 1962

VOL. 134

NUMBER 3470

THE ORIGINAL  
'DO-IT-YOURSELF'  
MAGAZINE

# HOBBIES *weekly*

FOR ALL  
HOME CRAFTSMEN

*Also in this issue:*

NOVELTIES TO MAKE

NEW STAMPS FROM  
MANY COUNTRIES

DISC BREAK —  
TONY ROCCO

THE ART OF  
FRENCH POLISHING

PHOTOS FOR  
YOUR ALBUM

ELASTIC MOTOR  
ETC. ETC.

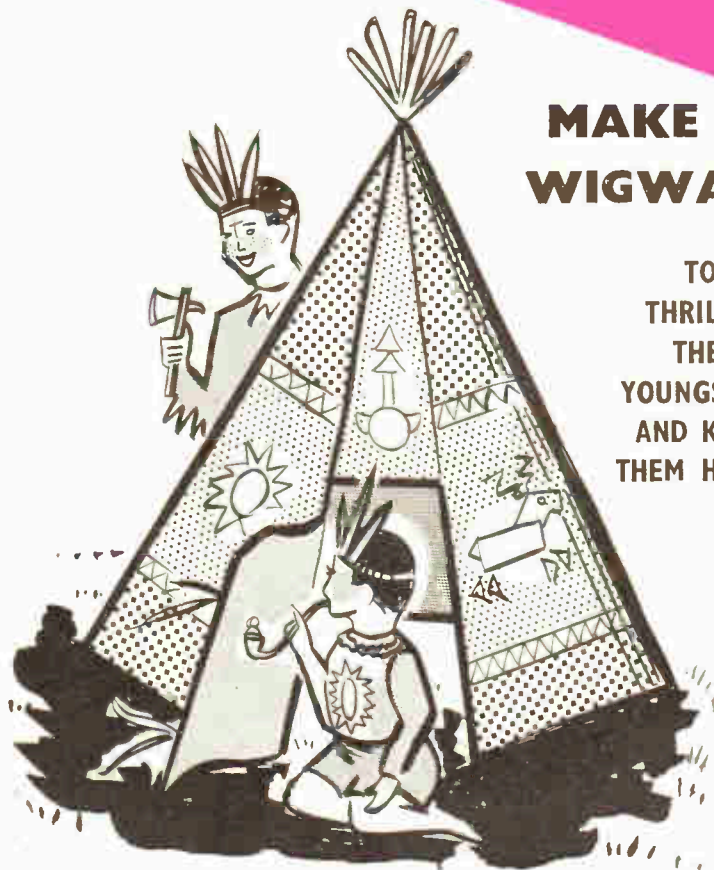

## MAKE A WIGWAM

TO  
THRILL  
THE  
YOUNGSTERS  
AND KEEP  
THEM HAPPY

**Full instructions inside**



*Up-to-the-minute ideas*

*Practical designs*

*Pleasant and profitable things to make*

World Radio History

5<sup>D</sup>



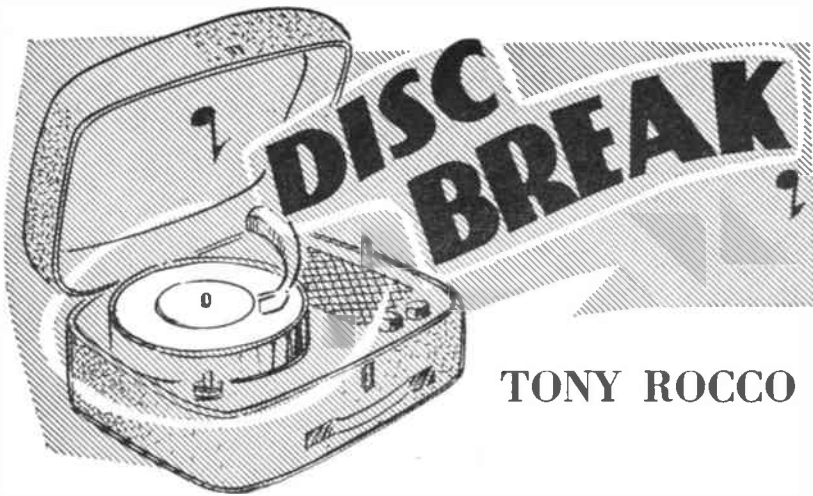

## TONY ROCCO



**T**HE first instrument that Tony Rocco owned was a guitar. That was in Sarawak, North Borneo, where he was born on 14th February 1941. His mother smashed it, so reasoning that its size might prevent further breakages, he invested in a double bass! It remained intact — but did nothing to diminish his parents' opposition to his interest in entertaining.

Then the family came to England — when Tony was about 17. After

three years he gave up his job as an apprentice engineer to become a professional musician and the atmosphere at home became distinctly cool. So Tony decided that in the interest of family harmony it would be wise to take his singing and playing where it might be better appreciated.

He embarked on a tour of the Midlands with his group. Then he returned to London full of enthusiasm after a friend had advised him to concentrate on

singing. Somehow he scraped together £30 to make a demo-disc, toured the agents' offices and received lots of promises — but no work.

'The promises kept me going, I suppose,' says Tony, 'because life was anything but sweet. I worked where I could, clubs, coffee bars, pubs, anywhere they would listen, but for eight months I more or less starved. Often my diet consisted of cornflakes and water, the cheapest meal I could think of.'

It would have been easy to have given up, but Tony had inherited the courage and tenacity of his father, former deputy Post Master General in Sarawak who, despite a beating from Japanese rifle butts, continued supplying news from English broadcasts and was awarded the M.B.E. and the Order of the Star of Sarawak.

Things began to look up when Tony heard there was a vacancy for a bass player in a West End Club. 'I turned up for the audition and found there were four others after the job. So I decided something extra was called for and when my turn came I sang as well. They signed me on.'

The next break came one night when, during the interval at the club, he called in at a nearby showbusiness rendezvous. He joined the band for a couple of songs and by the end of the evening had acquired a personal manager, for listening was Gerald Marks, a man with a keen appreciation of promising talent, who immediately realised the potential of the dark, handsome young man.

Tony was soon lined up for a recording test and his first disc followed, his own composition, *Stalemate*, and *Keep a Walkin'* (Parlophone 45-R4886).

Off duty, Tony likes badminton, football, swimming, ballroom dancing and driving in the country. He enjoys listening to singers like Brook Benton, Nat King Cole and Sammy Turner.

## WELL, STRIKE A LIGHT!



*Here's one of the best known of all police officials — Inspector Maigret — apparently 'cocking a snook' at the law as he shares a match with H.M.V.'s Joe Loss. Joe had just recorded 'The Maigret Theme' on 45-POP.995 and he met Rupert Davies, who has scored tremendous success as television's Inspector Maigret, in Hammer-smith where the new B.B.C.-TV Maigret series was in rehearsal*

## WHAT DO YOU KNOW ABOUT



Asks Ed Capper.

**I**N a previous article on softwoods I stated that their opposites, the hardwoods, are found mostly in temperate and tropical forests. The range of hardwoods extends from the beech and oak, mostly imported now from European countries, to ramin from the British Colony of Sarawak. Other large suppliers are Ghana, Malaya and Japan.

The story of hardwood is of a long history inextricably connected with mahogany. The forests of Britain were on the point of exhaustion as far back as Pepys' time. In one of the pages of his famous *Diary* he refers to the difficulty of obtaining suitable oak timber to build up his Navy and how he regretted the necessity of having to import European oak.

Yet the Navy of that time found the solution to the shortage. To make up a cargo from colonies won from the New World one boat took on a number of planks of mahogany, the local hardwood, besides bringing out the main prize, which was tobacco. In no time, mahogany was to change the face of the English home.

The earliest use of mahogany from Central America in this country was in Nottingham Castle in 1680, but the wood must have been known as excellent

material in its own location for at least a hundred years before that date.

Soon, no-one in Britain was worried about the shortage of the native oak and walnut. Everyone was trying to climb aboard the band wagon, to keep up with the Jones's and have furniture in their home made from mahogany.

Its popularity reached its peak with the wonderful craftsmanship in the work of Chippendale, the Brothers Adam, Hepplewhite and the other great Georgian stylists. Later on, in Victorian times, it is nice to recall that living standards improved and led to the extension of the use of mahogany in the more humble homes. This led to the need to look for alternative sources for the wood, particularly as the Central Americans, now aware of its popularity, realised it could fetch a higher price.

Thus the trade in West African mahogany came into being. Later, further types of hardwood were found there and this area became, and still is, the main source of supply of imported hardwoods. Other important areas are

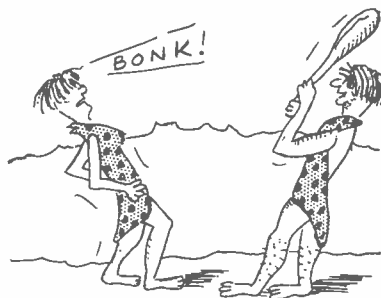

### AN EARLY USE OF HARDWOOD

the Far East, where the famous Indian woods, such as rosewood, have now superseded to a large extent the once famous meranti from Malaya and the ramin from Sarawak.

Logs must first be sawn into squared planks, called beams, and most of this work is done in the country of origin, so that our main import is of square-edged beams. There is, however, some small trade in unsawn logs.

Under certain conditions timber is liable to be attacked by biological agents, mainly wood rots or beetles. These can be eliminated with proper precautions. The basic requisite is the impregnation of the wood with some poisonous substance which prevents the growth of the destructive agents and which normally gives permanent protection. A classic example of this is in telegraph poles.

To be on the safe side when buying wood, it is always better to enquire if it has, in fact, been treated. Otherwise it will only cost a copper or two per yard to treat it yourself.

## A WOMAN'S SUCCESSES

**W**E are always pleased to receive details of the successes gained by our readers at exhibitions, and we are doubly pleased to be able to write in this connection about Mrs I. G. Allison of Winchmore Hill, London.

Mrs Allison not only takes a pride in

her work — she has the courage to put it in exhibitions in competition with male entrants. And quite successful she has been, too, with her models made from Hobbies designs.

For instance, with the 'Old Woman in a Shoe' Musical Cigarette Box (Design No. 259 Special) she has obtained Second and Third Class certificates. For the 'Swiss Church' (Design No. 256 Special) First and Second Class awards have been obtained at two different shows.

But the best piece of modelling was obviously the one illustrated, that of St. Paul's Cathedral (Design No. 240 Special) which was awarded First Prize and a bronze medal presented by a national magazine for the highest award in eight classes. This model, incidentally, has been equipped with windows and electric lighting.

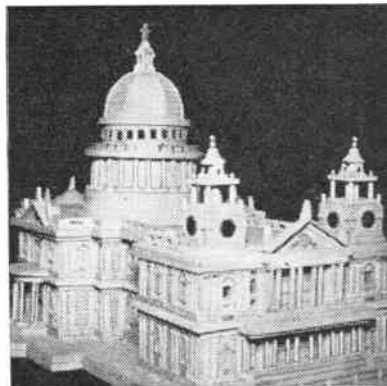

If this is a sample of what a busy housewife can do — it is time the men-folk took their eyes away from the television set!



# MAKING A WIGWAM

ALL children love to play with tents, and many a sheet or table cloth has been borrowed for this purpose. There should be no need to do this, for at very little cost a really excellent wigwam can be easily made which will be sure to thrill any youngster (see illustration on front page).

These dwellings of the North American Indians appeal to children more than the conventional tent, and when they dress up with war paint and feathers it makes it so much more real to possess a wigwam.

Common canvas or hessian which can be obtained from most upholsterers is ideal for the purpose, because it is not only cheap, but you can get it in very wide sizes.

## Marking out

A piece 4 yards long and 2 yards wide (72 in. material) will be sufficient to construct a generous sized wigwam. Lay the material on the floor, mark out with chalk and cut as shown. This will give you seven whole triangles and two halves at the ends, which are sewn together on the sides marked A to produce another whole piece.

About 4 in. is cut off the pointed end of each piece so that the wigwam is left open at the top for the poles to stick out. In a real Indian wigwam this opening also acts as a chimney for the smoke from the fire.

The 'door' in a wigwam is usually quite small, and to make this a piece (marked 4) is cut across just below the

centre, the bottom piece acting as a flap. All the seams can now be sewn up, making the joins about  $\frac{1}{2}$  in. from the edge. When you come to the door section, both sides of the small top piece are sewn up, but only one side of the flap. The other edge is turned over and

tapering off slightly to the other end. This will produce a loop through which the supporting poles or canes are slipped.

The top edges of the sections will have to be bound to strengthen them and prevent fraying. The bottoms, which will be the selvedge of the material, will

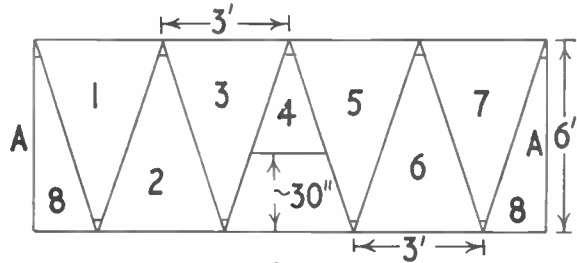

bound with tape to prevent it from fraying.

When the eight pieces have been joined together, turn the wigwam inside out and sew down each seam again, but at a distance of about  $1\frac{1}{2}$  in. at the base and

not need any treatment. Tapes can be sewn on to the flap to keep it closed if needed.

The best poles for supporting the wigwam are canes which are light and easy to carry around, and they should be not less than 6 ft. long. Canes 7 ft. long would be an advantage, and would leave plenty to stick through the top. It should not be necessary to tie the canes where they cross each other, but this can be done lightly if they need that extra support. As the canes do not pass through the bottom of the wigwam, it can be erected on hard ground, concrete or even indoors in wet or cold weather.

## Gay decorations

Indian wigwams are usually highly decorated in gay colours, and you can do the same with yours if you like. Oil paints or enamels are best for the job, then there is no fear of the colours running when the wigwam is exposed to wet weather. A few examples are given of the type of design used to decorate the wigwam. Bold and simple designs are best and easiest to apply to the rather rough material. Use gay colours and allow plenty of time for the paint to dry.

(A.F.T.)

## The Adventure Trail

leads thousands of youngsters, and their parents too, throughout country towns and villages, over moorland and by river valleys to exciting places and historic buildings.

They add to the fun of their tour by spending the nights at some of the 300 youth hostels in England and Wales, such as a Water Mill, a Norman Castle, a Lifeboat House, a Shepherd's Hut or one of the many other buildings from cottages to mansions which wait to welcome the cyclists or walkers.

You, too, can stay at these friendly hostels for only 3/- a night (2/- if under 16). Three-course suppers cost only 3/- and breakfasts only 2/6 each or you can cook your own food in the members' kitchen for 3d.

Take the first step on the Adventure Trail by sending off this coupon TODAY.

To Y.H.A., Trevelyan House, St. Albans, Herts.	HW626
Please send me 'Going Places' and details of Y.H.A. membership.	
Name .....	
Address .....	
.....	

# The Art of French Polishing

**T**HERE is no special outlay required for French polishing beyond the actual materials needed. The thing which is really necessary, however, is to have a room where the work can be done without being disturbed. I say a room because an even temperature is needed, which makes an unheated shed unsuitable for this work.

Perhaps the easiest way of understanding French polishing, is to bear in mind that the whole process can be divided into five separate operations. It is always a good plan to get these clear.

As in many other things, good preparation means everything to the finished work, which is why the initial preparation of the wood surface is so very important. If this is not done properly, the whole effect will be spoilt. The next step is the staining of the wood. This is followed by the oiling, and then the filling of the grain of the wood. Last of all comes the actual polishing itself. Each process takes a certain amount of time, with time between for drying off, and none of these can be hurried, which is another reason why the work is better done in a room not required for use.

## Preparation Important

The main reason why the initial preparation of the wood surface is so important is because what would be quite all right for ordinary staining, would not be nearly good enough for the highly polished finished article. Here the slightest roughness in the wood surface is apt to be magnified.

A scraper should be used to run over the surface. This pares off fine shavings here and there until a dead level surface is obtained. Now a sheet of the finest glasspaper should be used to rub down the whole surface, special attention being paid to all edges. A good test of the real smoothness of the wood surface is to take the hand gently over it; if there is no sign of a splinter on it, then the rest of the work can be started.

It depends a good deal on the natural colour of the wood to be polished whether staining will be needed. Where wood is very light in colour, however, and you feel it needs staining, there are three types of stain to use.

Water stains are distinctly easier to use than spirit stains. The reason for this is that, as they dry more slowly, they can be applied more evenly in consequence. Another point about water stains, which is an advantage to the amateur, is that the chance of over staining is minimised, even though it may be necessary to give two or three applications in order to obtain the right depth needed. It is true that water stains take a bit longer to dry

for the simple reason that the wood becomes very wet after several applications. There is also a tendency to swell, and this means that the surface will have to have another rub down with glasspaper, to ensure that the surface is once again perfectly even.

## Advantage of oil stains

Oil stains are excellent for several reasons. They dry slowly, too, and are therefore easily controlled. The real advantage of oil stains, however, lies in the fact that the oil sinks deeply into the wood and gives it a lovely depth and richness which is most attractive and lasting. It may be necessary to wait as long as three days between the processes of staining and polishing.

It is a good idea to remember that it is not actually necessary to stain the wood quite as dark as you wish it to look when finished, as the final polishing adds depth to the colour.

As soon as you are satisfied that the stain is dry, and it must be really and thoroughly dry, the surface of the wood can be oiled. This brings out the grain of the wood. Raw linseed oil should be used for this purpose and it should be applied with a soft rag, using it lightly and evenly. Any kind of rag used for French polishing must not have any odd threads hanging from it, or these will surely ruin your work. Oil should always be used sparingly, for it should be remembered that oil

sweats, and may sweat through the polish later and cause it to crack.

Next comes the task of filling the grain of the wood. This is done by rubbing the wood over completely with coloured filler. Another method of doing this job is by painting with a varnish made with 3 oz. of orange shellac, mixed with  $\frac{1}{2}$  oz. powdered resin and  $\frac{1}{2}$  pint of methylated spirits.

Now for the great moment; for we have arrived at the last stage, that of the actual polishing. This is the tricky part of the business. A rubber must be made by folding some cotton wool in a piece of linen (See Fig. 1). It must be evenly folded so that there are no creases in it.

A polish can be made up by dissolving 5 oz. of the best orange shellac in 1 pint of methylated spirits, to which add 1 teaspoon of gum arabic and 1 teaspoon of gum copal. Otherwise use a handyman's polishing kit or the prepared French polish sold by Hobbies Ltd.

## Keep moving

It is essential to remember that the rubber must never be left resting in any particular spot. Rub along the grain in a quick circular motion as indicated in Fig. 2, applying pressure all the time. The first stage is the bodying up. This is always the easiest as the oil in the wood prevents any sticking. The second stage of building up is a little more complicated. Glasspaper must once again be run over the surface and every particle of dust resulting from this must be scrupulously brushed off before any polishing starts. Have only two or three drops of polish on the rubber at a time.

The final stage, that of spiriting out, means the process of adding extra lustre to the finished work. Once a certain degree of shine has been attained, the article should be left in an even temperature and where it will be entirely free from dust. It is necessary to make a new pad for each polishing, and this must of course be soaked in the French polish as at first. Then a few drops of methylated spirits should be applied to the pad and worked backwards and forwards, always following the grain of the wood. Always work lightly, for in this way an even polish is obtained.

Should a dull spot be noticed during polishing, never rub this hard. Instead, work gently over the entire surface again, adding a fresh drop of polish to the pad.

Leave any furniture which has been French polished for at least a fortnight in a warm room, where it can dry off thoroughly before being either touched or used. The slower your work, the more successful will be the results, for the drier the surface, the better for polishing. (E)

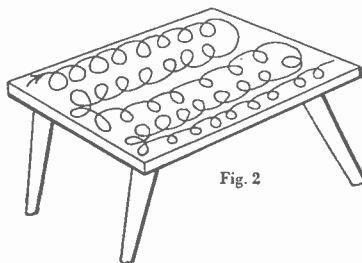
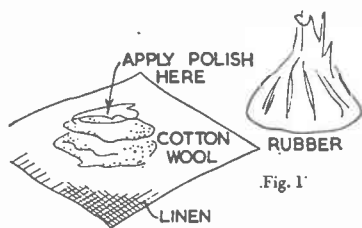

# Modelling a Swiss Steamer

SWITZERLAND could hardly be called a shipbuilding country, but there is a shipbuilding tradition on Lake Lucerne, where upwards of a dozen steamers maintain regular services to all parts of this inland sea.

Typical of the angular lines of Swiss nautical architecture is the flagship of the fleet, the *Stadt Luzern*. This makes an attractive and unusual model ship which is easy to build.

The hull A is a 12 in. length of  $\frac{1}{2}$  in. thick wood,  $1\frac{1}{2}$  in. wide. First, the bows are cut as shown, the shaping extending back for  $1\frac{1}{2}$  in. on each side. The stern is shaped by rounding off the last  $1\frac{1}{2}$  in. on each side, and a pronounced overhang is given to the counter stern by cutting it away for  $\frac{3}{4}$  in. at the waterline.

The deck B can either be cut from white card or tinplate. It is 12 in. long and 2 in. wide, and the curved shape of the bows is carried back for 3 in. to meet the sides, while the last  $1\frac{1}{2}$  in. are rounded off on each side to form the stern. The deck is then glued or pinned to the hull, so that it projects by  $\frac{1}{4}$  in. on each side.

The bulwarks C are made from the same material as the deck, namely card or tinplate. The two pieces are 12 in. long and  $\frac{1}{4}$  in. high, except for the 1 in. long section on each side of the bows, which is  $\frac{3}{8}$  in. high. The bulwarks are cut but not fixed in place until sections D and E are in position.

The saloon D is 9 in. long,  $1\frac{1}{2}$  in. wide and  $\frac{1}{2}$  in. thick. Its forward end is rounded off, and it is then pinned and glued in place 2 in. back from the bows. The two paddle boxes E are also  $\frac{1}{2}$  in. thick; they are 2 in. long and  $\frac{1}{4}$  in. wide.

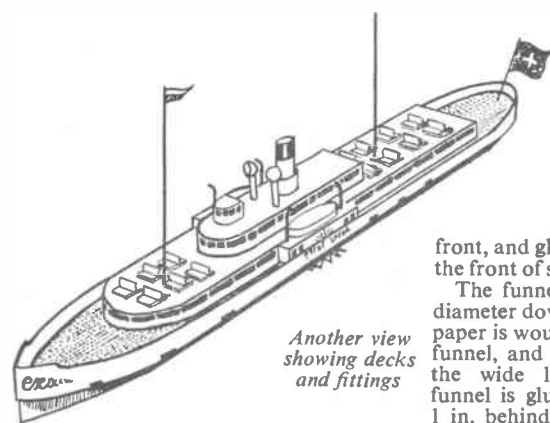

Another view showing decks and fittings

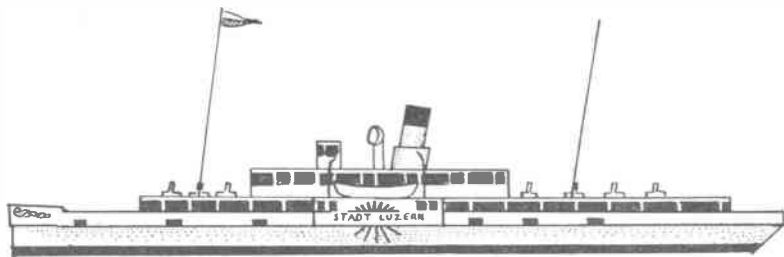

They are glued to the sides of the saloon 3 in. from its front end.

The bulwarks C can now be glued or soldered in place just inside the line of the deck, so that a slight lip is left projecting. They should meet the sides of

the funnel is filed away so that it is raked, or leans back noticeably. The paper strip round the funnel is cut away at the front with a sharp knife, so that its top edge is parallel with the deck.

The two ventilators I are  $\frac{1}{2}$  in. lengths of  $\frac{1}{4}$  in. diameter dowel rod, the upper edge being cut at an angle of 45 degrees. The ventilator tops are cones of  $\frac{3}{8}$  in. diameter dowel rod, filed and glass-papered to shape before they are cut off the end of the rod. They are glued to the upright sections, and the complete ventilators placed in front of the funnel,  $\frac{1}{4}$  in. in from each side of the upper deck.

The two lifeboats J are 1 in. long,  $\frac{1}{2}$  in. wide and  $\frac{1}{4}$  in. high. They are glued on top of the paddle boxes, and given davits made from 1 in. long pins, bent over at the end, and with the heads removed.

The masts are 3 in. long pieces of stiff wire, such as lampshade wire, and are inserted in holes in section D, each mast being 1 in. from the ends of section F. They should be set at the same angle as the funnel.

The seats K are  $\frac{1}{2}$  in. long and  $\frac{1}{4}$  in. high, and each is made from scraps of wood about  $\frac{1}{2}$  in. thick. Flat ice lolly sticks are ideal for this purpose. There are six seats on the forward section of the deck D, and eight on the after part.

The parts of the paddle blades which show below the boxes are made from strips of card,  $\frac{1}{4}$  in. wide and  $\frac{1}{2}$  in. long, which are glued to the sides in a radiating pattern, five strips to each side.

The model is painted white, with buff decks. The funnel is also white, with a black topping, and the windows — there are no portholes — are best painted in blue. The seats and paddle blades are enamelled in rose pink, and a black or gold scroll is painted one each side of the bows. Six black ports are painted on the bulwarks on each side, and a radiating pattern of black lines is marked on each paddle box, with the name STADT LUZERN printed below it.

A surprisingly large Swiss flag, a  $\frac{3}{4}$  in. square red flag with a white cross in the centre, is mounted on a pin at the stern, and the triangular blue and white pennant of Lucerne is always flown on the foremast. (A.L.)

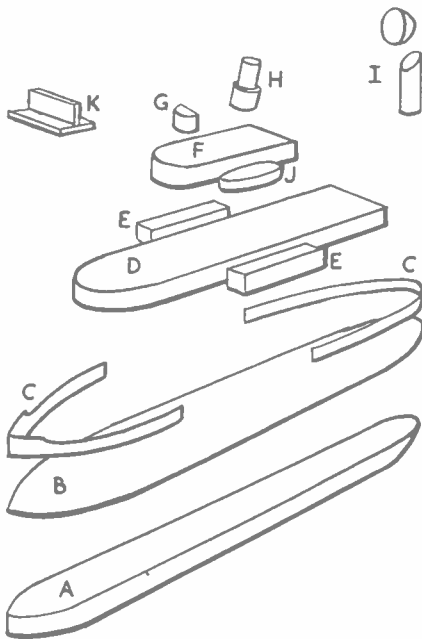

the paddle boxes, and any surplus trimmed off.

The upper deck F is 4 in. long, 1 in. wide and  $\frac{1}{2}$  in. thick. It is rounded off at the front end, and pinned and glued in place 2 in. from the front of section D.

The bridge G is a  $\frac{1}{2}$  in. cube, rounded off at the

front, and glued in place 1 in. back from the front of section F.

The funnel is a 1 in. length of  $\frac{3}{8}$  in. diameter dowel rod. A  $\frac{1}{4}$  in. wide strip of paper is wound round the bottom of the funnel, and glued in place to represent the wide lower funnel casing. The funnel is glued in place with its centre 1 in. behind the bridge; the bottom of

# THERE'S MORE THAN A TOOLCHEST IN THIS TIN



... THERE'S THE STRENGTH  
OF A HERD OF WILD ELEPHANTS

EVO-STIK IS MANUFACTURED BY THE INDUSTRIAL ADHESIVES DIVN OF EVODE LIMITED, COMMON RD, STAFFORD..STAFFORD 2241 (8 lines).

168



with an invisible ease and economy which makes most tools and fixing methods "old-fashioned"

You can say "thanks" to modern research and scientists for Evo-Stik 'Impact' Adhesive. The amazing new "toolchest in a tin" which permanently fixes almost anything to anything. And with a power which wild elephants couldn't separate.

Demand for this new scientific method of fixing means that hundreds of thousands of gallons of Evo-Stik 'Impact' Adhesive go to important British industries. And millions of gallons go to industries throughout the world.

Now, demands from home-users just like you mean that all this fixing power; all this "know-how", powering international industry is available to you. Here are some examples . . .



#### SURFACES THAT SHINE

Decorative wall-boards and laminated plastics fix to almost any surface, be it plaster, metal or wood. And although they can be screwed, nailed or pinned, few builders would care to spoil such fine surfaces. Instead, manufacturers invariably recommend fixing with Evo-Stik 'Impact' Adhesive. And it is mainly due to the speed, economy and amazing strength of Evo-Stik that 75 million square feet of these materials are fixed each year.



#### CEILING THAT SEAL SOUND

Only a few years ago industrial installations of Acoustic Tiles were laboriously and expensively fixed with screws and bolts. Often with a maximum speed of around 30 tiles an hour. Demand was low due to high installation cost. But to-day; two workers using Evo-Stik 'Impact' Adhesive install up to 300 tiles an hour. Result; new ceilings that silence sound; and new acoustic materials, shapes and decorative effects: through the speed of Evo-Stik.



#### CARS THAT LAST LONGER

Many of the component parts of motor vehicles such as draught excluders, foam rubber weather seals, etc., are under permanent atmospheric attack. Metal fixings used to hold these parts in position were constantly attacked by rust and corrosion. New fixing methods, resistant to atmospheric attack yet with all the strength of steel rivets and bolts were needed. Evo-Stik 'Impact' Adhesive answered this vital problem, throughout the motor industry.



#### DO THAT JOB YOURSELF

Because Evo-Stik is in your Ironmongers right now all these latest industrial joining techniques are being applied in the home. No wonder people say it's taken the "do" out of "do-it-yourself". Within seconds of applying Evo-Stik 'Impact' Adhesive you have a permanent, waterproof, and heat resistant bond. And Evo-Stik is efficient with practically every material you can think of. It's a toolchest in itself. Keep a tin handy.



TINS 7/- AND 4/3. TUBES 1/9

Obtainable at all Halfords Branches.



'IMPACT'  
**EVO-STIK**  
ADHESIVE

is a Registered Trade Mark

Remember . . . a small deposit secures any article.

LONDON OFFICE: 450/52 EDGWARE ROAD, W.2. AMB 2425 (5 lines).

Associated Company in Eire: Evode Industries Limited, Swords, Co. Dublin. Swords 331

# TOY WHIRLING ACROBATS

**S**USPENDED from parallel bars, like the swinging cars on a Ferris wheel, a pair of gay wooden acrobatic performers will whirl down an incline formed of dowel rods placed between two chairs. This active and colourful wooden toy has great 'play-value' for younger children, and its simple rotary mechanical actions are most instructive to watch. The toy is not difficult to construct from an assortment of easily obtainable 'scrap' materials. You will need to acquire some large and small wooden beads, cotton reels, a piece of broken broom handle, a length of  $\frac{1}{4}$  in. diameter dowel, some thin strips of wood such as a pair of old 12 in. rulers and some metal rods, nails and screws.

Study the plans. You will notice that the main parts of the toy are indicated by the letters A, B and C. Let us assume that you will use discarded rulers for making the 'parallel bars'. Drill  $\frac{1}{8}$  in. diameter holes at points in the middle of the wooden strips,  $\frac{1}{2}$  in. from the ends. Next, nail the centres of the rulers to the flat ends of a  $1\frac{1}{2}$  in. wide cotton reel. Take care that the arms of the parallel bars are well balanced on each side of the cotton reel.

To make part B you will need a 6 in. length of  $\frac{1}{4}$  in. diameter dowel and a pair of smaller cotton reels which have really deep grooves. Bore holes in the centres of the rulers, to correspond with the hollow in the reel which holds them apart, and through which the dowel 'spindle' may be tightly inserted at right angles to the plane of the rulers. Insert the spindle and fit the deep grooved cotton reels on each extreme end of the rod. You will probably need to secure the two reels in position.

The bodies of the acrobats are formed of 3 in. lengths cut off a broom handle

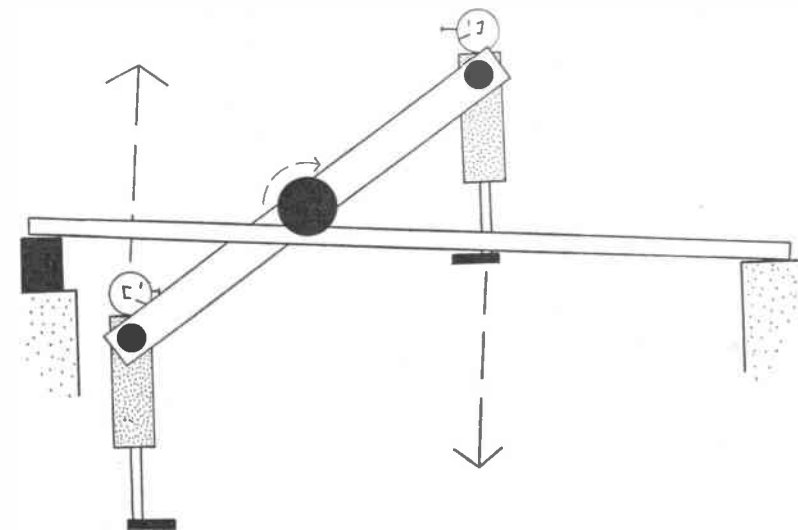

and their heads are suggested by 1 in. diameter beads which will be screwed on to the bodies. Lengths of  $\frac{1}{4}$  in. dowel, approximately  $2\frac{1}{2}$  in. long, will serve as legs. Bore holes into the bases of the bodies, into which the legs may be fitted and held firmly by glue. One inch lengths of  $\frac{1}{4}$  in. square section strip wood will make suitable feet, and these may be nailed upon the ends of the legs, as illustrated. Holes must now be bored,  $\frac{1}{8}$  in. in diameter, across the 'shoulders' of the bodies, about  $\frac{1}{2}$  in. below the 'necks'. Knock nails into the bead heads to suggest noses and fasten the heads firmly to the bodies with screws.

Parts C of the plan will indicate how the acrobats will be attached to the ends of the ruler 'bars'. Metal rods, less than  $\frac{1}{8}$  in. in diameter and about  $2\frac{1}{2}$  in. long,

may be used as spindles about which the bodies of the acrobats will swing when the toy is working. Place the wooden figures between the bars and fix them into position with the metal spindles. Small beads will be ideal to use as 'stops' upon the outer ends of the rods if the little spheres can be fitted really tightly.

Before final assembly of the toy, the parts should be smoothed thoroughly with glass-paper and painted in cheerful bright colours. The heads will be pale pink, and comic faces and 'mops' of hair may be painted upon the beads. Other details, like bow ties, buttons, knees and laced shoes may be indicated upon the acrobats' bodies. The overall construction should be reasonably strong if the toy is to last.

The apparatus will be operated upon a pair of dowel 'rails'. Rest a pair of  $\frac{1}{4}$  in. diameter dowel rods (or small billiards cues) between two chairs. The rods should be raised about four to six inches at one end. Mount the toy between the rods with the grooved cotton reels resting on the rails. A slight push may be necessary to start the acrobats performing. As the cotton reel wheels roll down the rails, the bars will turn about the central axis whilst the figures whirl, in constantly upright positions, round and round at an ever faster rate. Gravity pulls the puppets down the incline and 'centrifugal forces' cause the feet to swing outwards as the speed of rotation increases.

(A.E.W.)

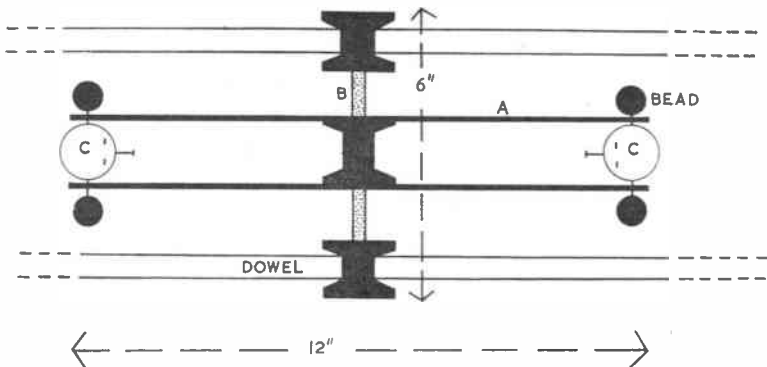

## Novelty for Mum

# A 'Crinoline Lady' Cotton Reel Garden

By

**T. S. Richmond**



*Mary, Mary, quite contrary,  
How does your garden grow?*

**I**N this little lady's garden, reels of colourful cotton grow! Her skirts carry pins and needles and a thimble forms part of her bonnet. Women readers, handy with a fretsaw, can easily make up this needlework novelty and stock it with sewing requisites.

With a pair of compasses draw two circles, one 6in. diameter and one 6½ in. diameter on a panel of ⅜ in. plywood. Cut these wood discs with a fretsaw. On the smaller disc, mark six positions for the pegs (P, Fig. 1.) On the horizontal line mark in the central slot, 1½ in. by ⅜ in. (S). Cut out the groove, and drill ⅜ in. diameter holes at the six points.

Glue the prepared disc on top of the

larger disc. Cut six pegs 1½ in. long from ⅜ in. diameter dowelling. Smooth round the upper ends of the pegs before gluing them into the holes.

Copy the reduced-size pattern (Fig.2) over ½ in. squares ruled on paper. Transfer to ⅜ in. plywood and cut out. Glue figure upright in the slot in the middle of the stand.

Paint the base stone-grey, lining in crazy-paving with a fine brush. Paint in other features to figure, etc, as desired, with bright plastic enamels. Cut two pieces of coloured felt material to the skirt pattern, and fasten to each side of figure for needle holders.

Fig. 1

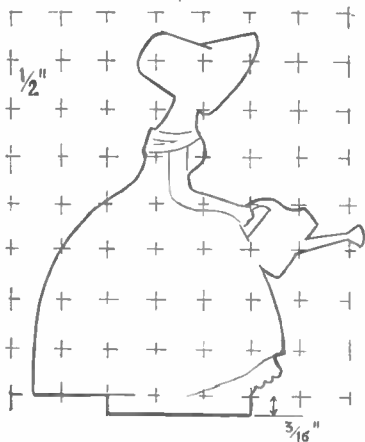
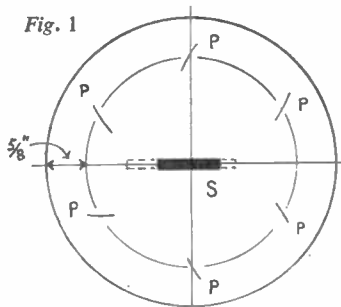
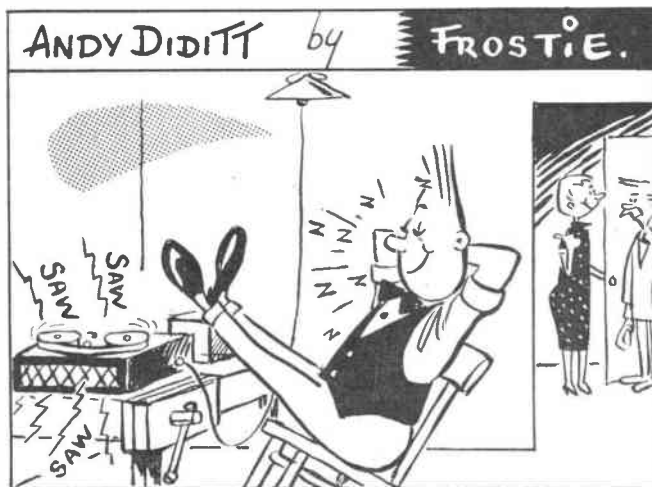

Fig. 2



"I DON'T KNOW WHAT ANDY'S MAKING BUT HE'S BEEN SAWING ALL AFTERNOON!"

## Miscellaneous Advertisements

**IT'S EXCITING. IT'S PROFITABLE.** Paint designs. Flowers. Anything. Even beginners' ideas can sell for £25/£60. Inexhaustible demand. Details free. **POPULAR ART SERVICES (HW), CLUN, SALOP.**

**M**AKE a complete oxy-acetylene welder from bits and pieces. New parts amount less than £1. Gas from chemicals. Ideal for home repairs, handicrafts, e.g. glass and wire ornaments, etc. Send 2s. 6d. for building instructions, diagrams, welding hints. — 'Dresdeena', The Harrow Way, Basingstoke, Hants.

**ENJOY WRITING?** Then write for Profit. Send for 'Writers' Handbook' (free) detailing countless opportunities for beginner or experienced. — Writers' Ring (HW), 5 Edmund Street, Birmingham.

**LEARN RADIO & ELECTRONICS** the NEW Practical Way! latest system of experimenting with and building radio apparatus — 'as you learn'. FREE Brochure from: Dept. H.W.10, Radiostructor, Reading.

**FRIENDS' WORLD.** International Pen-pals' Association, (HB), Postbox 708, Calcutta, India, offers world-wide congenial pen friends.

*Out with a camera*

# ADDING INTEREST TO YOUR ALBUM

**S**OMETIMES when your camera rises automatically at the sight of some lovely old building, some delightful corner or some sweeping view, you notice another photographer doing exactly the same—especially at holiday times in good photographing weather!

---

*By E. G. Gaze*

---

And suddenly you think, 'Is it worth spending the film?' After all he's probably carrying an expensive looking outfit, he's probably an expert, and yours will be just another record holiday snap for the album. And if he's not a pictorial expert the additional depressing thought comes that there are certainly thousands of albums dotted around with thousands of prints of the same place, all looking very much alike. Just holiday records of the same things and places.

If ever you feel that way, give yourself a shaking. Your albums are *Your* memories, stored, and memories are personal even if the scene evoking them is free to all. Ten to one he's no expert but an

ordinary snapper like the rest of us, enjoying himself now and sharing his family memories when his album comes out next winter!

In other words, when you get the feeling that it's all been done before and isn't worth doing again—forget it. Your album is different just because it revives *Your* memories. And if you still feel depressed at all those cameras clicking around about don't be content with the one main scene—look for the little parts of it that have some interest in themselves. You'll probably get prints for your album that others have passed by, plus the eye-training to spot the smaller often interesting little tit-bits that can add variety to your album.

Some folks add to their general interest in snapping by hunting for the unusual, or making a collection—inn signs, odd shaped letter boxes etc. But, if you don't want to spice your general snapping with collector's mania, you can still find the little bits that are worth adding to the album, just by keeping your eyes open on your travels, or by picking out odd details.

For example a general view of a Rolls-Royce, vintage 1905, would be a 'must'

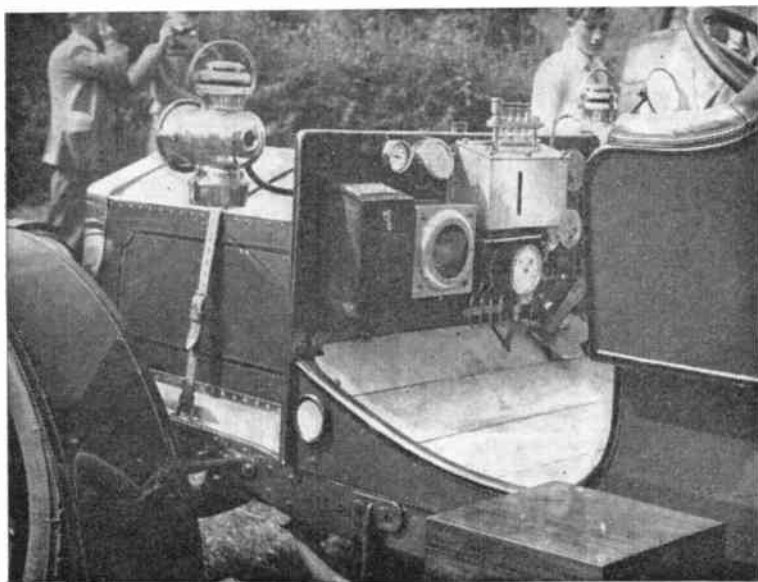

*Cockpit of 1905 Rolls-Royce, more like the bridge of a ship!*



*An unusual post-box, worth a few minutes stop for an added-interest family snap*

for a motoring enthusiast at a rally. Well, snap it even if dozens of others are jostling for the same view. Then have a closer look. That cockpit with its lovingly polished dials and brass-work, fancy facing that from the driving seat. It's more like the bridge of a ship! Click, and you've got an interesting snap that most of the others haven't noticed as being worth a film frame.

A lovely old Church, complete with yew and old tombstones, the sun just right—a lovely snap. You take it, so do all the others wandering around, but then you look around more closely. That's a peculiar, amusing gargoyle figure by the roof spouting. In fact there's a whole series of them along there. A long way up and maybe your camera hasn't a telephoto lens, so the gargoyle is going to be pretty small on the film frame. Never mind, be careful, give minimum exposure to get optimum sharpness (over exposure ruins sharpness and adds grain on development), use the fastest shutter speed consistent with your focusing aperture to avoid any camera shake and focus carefully. Even with a normal focal length lens a reasonable enlargement can be made of such a small object.

And keep the same look-out for the small, interesting things you see even though not connected with a general photogenic scene. The odd looking pillar box, for example. Press in one of your family with a letter and there you have a pleasant snap and a reminder of something unusual you'd spotted on the roadway. Maybe the lighting isn't what you'd like and you can't come back when it will be just right, but make the best of it.

**No. 1 MITRE-CUTTING TOOL AND CORNER CRAMP**

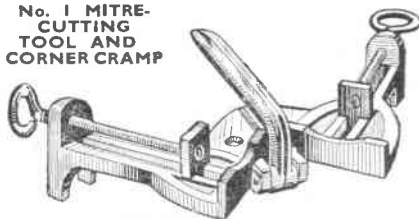

Will cut mitres on moulding and similar work up to 4 ins. wide. (post free) **55/-**

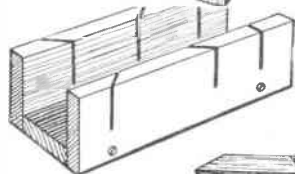

**WOOD MITRE BOX**

Made of selected hardwood. Size 9 ins. long. (postage 1/6) **5/6**

**MITRE BLOCK**

Made of selected hardwood. Size 9 ins. long. (postage 1/-) **3/-**



**HOBBIES LTD (DEPT. 99), DEREHAM, NORFOLK**

super smart . . .  
easy to use . . .  
easy to buy too!

**coronet**



**CAMERAS**

**4x4**

**MARK II**

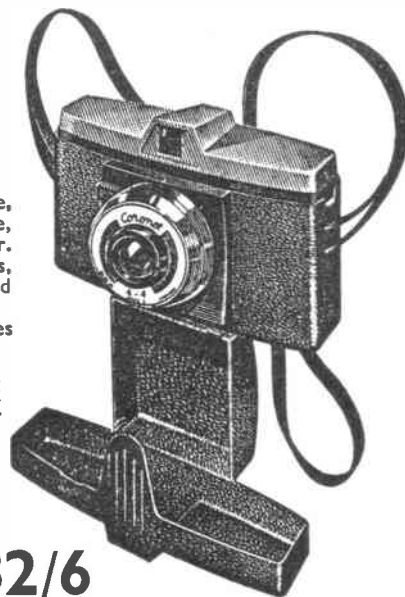

Superbly styled miniature, in two tone polystyrene, with optical view finder. High quality meniscus lens, instantaneous shutter and latest lever winder. Takes 12 first class pictures on 127 roll film.

**SOLD COMPLETE WITH A SMART EVER-READY CASE AND STRAP . . .**

**ONLY 32/6**

**inc. tax**

**SYNCHRONIZED MODEL 36/11 CASE EXTRA 6/2**

**CORONET 6x6**

**ANOTHER WINNER**

A best selling eye-level camera. Ultra modern styling. takes 12 album sized pictures on 120 roll film. Synchronized for flash.

Supplied by Photographic Dealers, Chemists, Opticians, Co-ops and Mail Order Organizations.

**Send now for the new full colour 'Young in Heart' leaflet.**



**42/6 inc. tax**

**MADE BY CORONET LTD. SUMMER LANE, BIRMINGHAM, 19**

**HEAR ALL CONTINENTS With H.A.C. Short-Wave Receivers**

Suppliers for over 18 years of radio S-W Receivers of quality.

One-Valve Kit, Price **25/-** Two-Valve Kit, Price **50/-**  
Improved designs with Denco coils. All kits complete with all components, accessories and full instructions. Before ordering, call and inspect a demonstration receiver, or send stamped addressed envelope for descriptive catalogue.

'H.A.C.' Short-Wave Products (Dept. 22), 44 Old Bond Street, London, W.1.

**The New SLIM LEGS**

supplied with metal blocks

**PLAIN FERRULED BEECH**

No. 601 — Per set of 4  
6 in. 9/6 15 in. 12/6  
9 in. 10/6 18 in. 13/6  
12 in. 11/6 20 in. 14/6  
24 in. 16/6

Postage and packing 2/6 extra

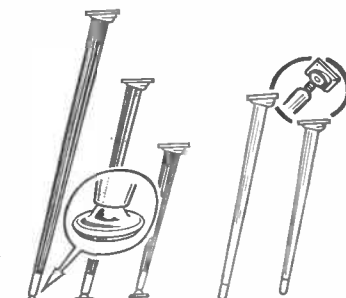

**EBONISED with Ferrules & Glides**

No. 604 — Per set of 4  
6 in. 14/- 12 in. 16/- 18 in. 18/-  
9 in. 15/- 15 in. 17/- 20 in. 20/-  
24 in. 23/-

Postage and packing 2/6 extra



**PLAIN BEECH with wood blocks**

No. 580 9 in. 7/-  
No. 581 15 in. 9/-  
No. 582 20 in. 11/-  
No. 583 29 in. 22/6

per set of 4

Postage and packing 2/3 extra.

**HOBBIES LTD.**

**(DEPT. 99)**

**DEREHAM**

**NORFOLK**

# AN ELASTIC MODEL MOTOR

**T**HIS is an inexpensive but useful little motor for driving models which do not need a constant source of power over a long period of time. All the materials required are a few pieces of wood for the frame and two gear wheels such as can be found in old clock mechanisms, clockwork toys, etc. These could of course be made from sheet brass but this is too tedious a process to recommend.

*By J. H. Parry*

Figs. 1 and 2 show the construction. The baseboard A is about 12 in. by 3 in. by  $\frac{1}{2}$  in. but these measurements are not critical. No dimensions are given for the supporting blocks, B, as these depend upon the size of the gear wheels, but they should be firmly glued and screwed to the baseboard.

Having done this, decide on the position of the large gear wheel and drill a hole for the axle through the front block. Screw a small metal shim, drilled in the centre, to the front of the block. The axle will have to be made from a piece of brass rod unless the wheel happens to be already fitted with one that can be adapted. Carefully shape the eye to take the elastic bands, making sure not to bend the straight portion. The axle is then passed through from the back of the block and a small bead fitted to act as a distance piece between the block and the wheel. This can be omitted if the wheel is fitted with a protruding hub which should be filed round to minimise friction.

Next, by trial decide on the position of the axle of the small gear wheel and drill a hole through the block. Fix metal shims to the block at each end of the hole. The pulley support is a piece of stout sheet metal screwed to the front edge of the base board and drilled with a hole for the axle. If a suitable pulley cannot be found, one can be made from two bevelled wooden discs glued together as shown in Fig. 3. The rear end of the axle is bent at right angles and a small bead fitted to act as a simple ball bearing. Pass the axle through from the back, solder or otherwise attach the small gear wheel and fit another bead in between the pulley and its metal support.

All that remains is to fix an eye bolt to the rear block and pass the rubber bands through the metal eyes. About eight bands should be enough, making sure that they are elastic. Give them an occasional rub with glycerine to prevent them from becoming brittle. Finally

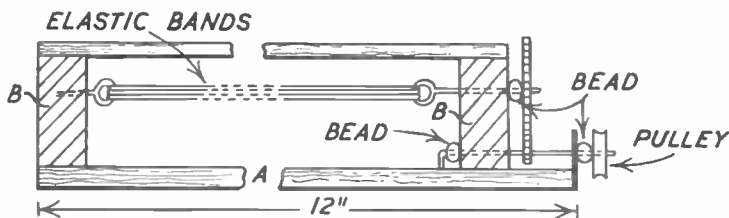

FIG. 1. SIDE VIEW

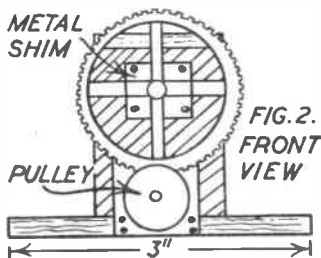

FIG. 2. FRONT VIEW

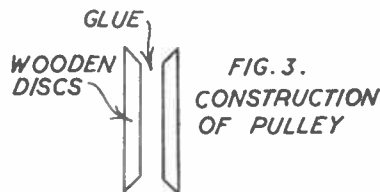

FIG. 3. CONSTRUCTION OF PULLEY

screw and glue the top wooden frame support to the blocks B.

The motor is wound by pulling the large gear wheel out of mesh and turning

until the elastic is really taut. When the wheel is put back into mesh, the pulley must be held otherwise the motor will 'race' unless it is under load.

## HOME-MADE CRAMPS FOR WOODWORK PROJECTS

**T**HERE are many woodworking jobs involving the gluing of joints, frameworks and edge to edge joints which cannot be satisfactorily tackled without the use of cramps. Indeed

several may often be required for a relatively small piece of work which would not justify the cost involved. The casual worker is therefore compelled to resort to the use of heavy piles of books and other unreliable methods which are never quite satisfactory.

The simple cramps described here are very efficient and easy to operate and well worth the few minutes spent in making them. All the materials required are two pieces of timber about 1 yard long and about 1 in. by  $1\frac{1}{2}$  in. with holes drilled at regular intervals of about 2 in. along each one into which fit pieces of stout dowel rod of about  $\frac{3}{8}$  in. diameter.

A side view of the cramps in action is shown. The dowels are moved into suitable holes so that the cramp fits loosely over the work. Wedges are then tapped in between each dowel and the edge of the work until sufficient pressure is being exerted on the joint.

(J.H.P.)

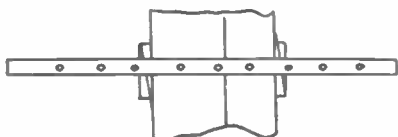
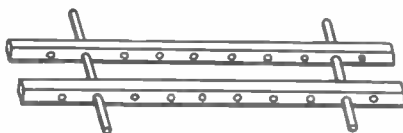

Make them yourself

# GARDEN LABELS

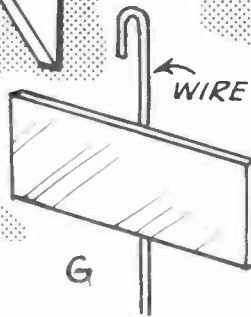
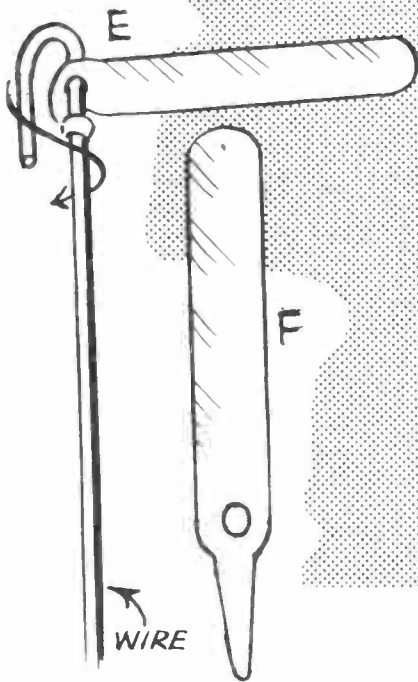
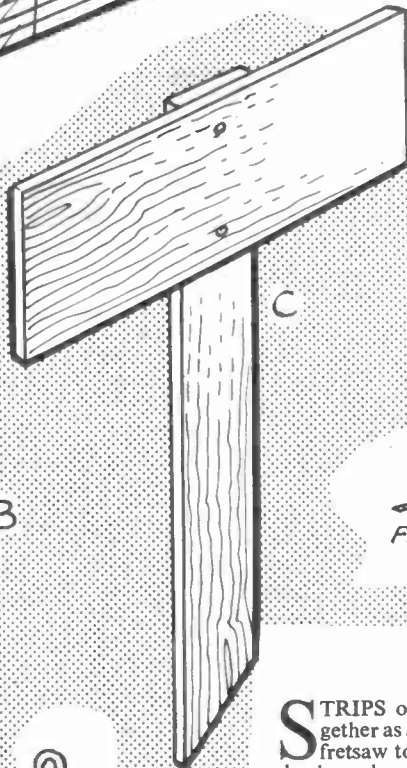
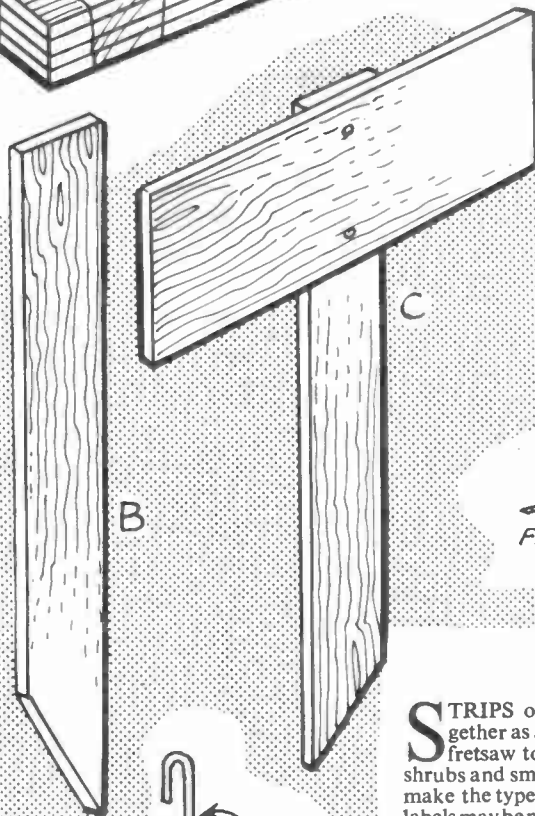
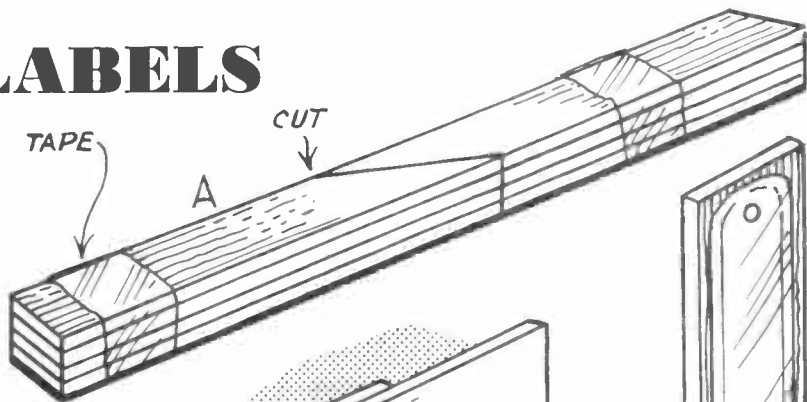

**S**TRIPS of  $\frac{1}{8}$  in. wood are taped together as at A and cut across with a fretsaw to make plain labels B. For shrubs and small trees use tiny fretpins to make the type shown at C. Tie-on metal labels may be pinned on to a wood stake as shown in D. E shows a metal label (Hartley) fixed permanently to a wire stake. F shows the type of label used. The small label in G is intended for cacti. A piece of metal label (cut one into two or three pieces) is held firmly by a piece of wire clamped tightly to the top. Paint all wood parts twice and use a wax pencil for marking. (M.p.)

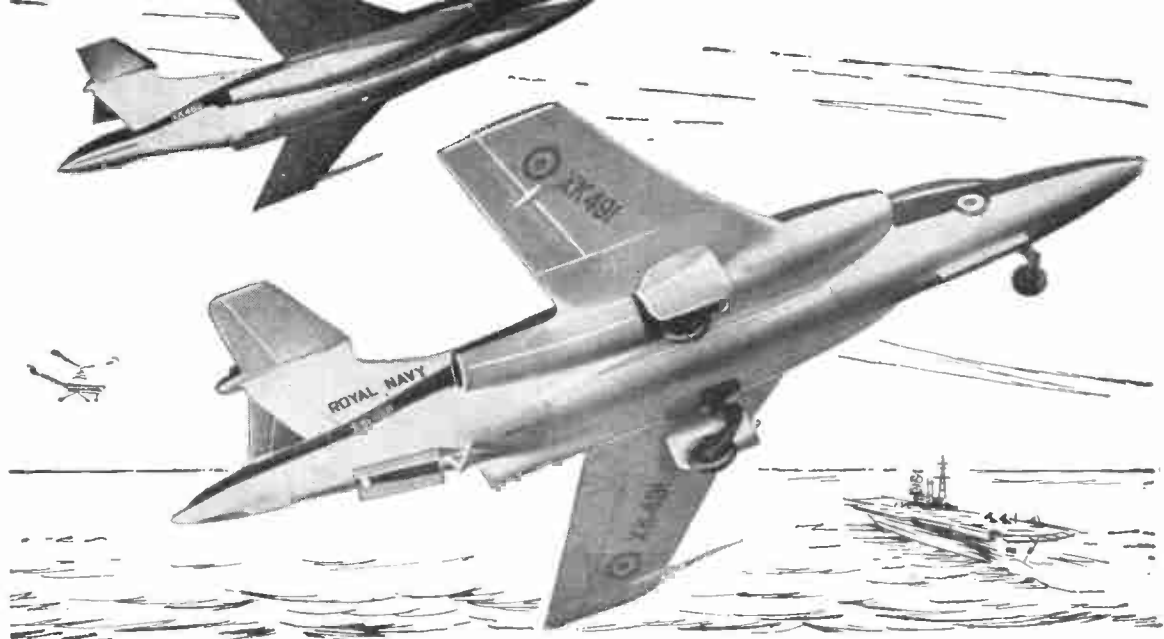

## Just like the real thing!

Believe it or not, the nearer one is the Airfix model of the Blackburn Buccaneer (N.A. 39), 1/72nd scale (Kit 4/6). Behind it is a picture of the real thing.

That's how wonderfully realistic Airfix models are. Close attention to every detail gives them their faithful-to-the-original look—makes them true collector's pieces. And every Airfix series is to a constant scale. This means Airfix models look proportionally right, one against another, because they are right! You can't beat Airfix for realism—or value.



### Constant Scale Construction Kits

From Model & Hobby Shops, Toy Shops, and F. W. Woolworth

### Now see the whole range in the NEW Airfix Construction Kits Catalogue

Every series fully covered in 28 pages of photographs of models, facts and kit details. The perfect Airfix reference! Ask your dealer for the Airfix Catalogue—only 9d.



There are over 140 Airfix models from 2/- to 10/6.

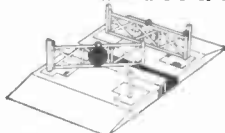

**TRACKSIDE SERIES**  
Level Crossing 2/-

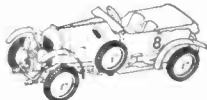

**VINTAGE CARS**  
1930 Bentley 2/-

**BRITISH WARSHIPS**  
H.M.S. Cossack 2/-



**MODEL FIGURES**  
Lifeguard 2/-

A160R

## STOP PRESS!

### Latest Airfix Production

Now! Richard I the 'Lion-heart', Champion of the Crusades. The model is equipped with helmet, battle-axe, sword and shield—3/-.



Also New! Railway Refrigerator Van for addition to your '00' scale rolling stock. Only just in the shops—3/-.