

11th APRIL 1962

VOL. 134

NUMBER 3461

THE ORIGINAL
'DO-IT-YOURSELF'
MAGAZINE

HOBBIES *weekly*

FOR ALL
HOME CRAFTSMEN

'Come Dancing' with this . . .

Also in this issue :

TWO FAVOURITES
IN DISC BREAK

NEW STAMPS
AND PEN FRIENDS

TWO BUILDINGS
FOR RAIL LAYOUT

AN ALBUM OF
WILD FLOWERS

MENTAL 'MAGIC'

MORE CHEMISTRY
RECIPES TO TRY

DOLL'S GRAND
PIANO PATTERNS

ETC. ETC.

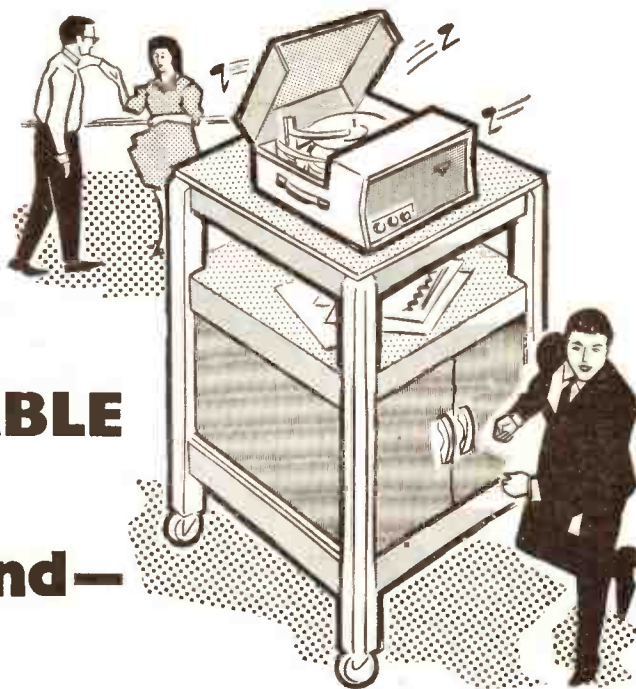

TABLE

—and—

RECORD CABINET

Up-to-the-minute ideas

Practical designs

Pleasant and profitable things to make



5^D



 ★ NOTE TO ★
 ★ CORRESPONDENTS ★
 ★ All correspondence on any sub- ★
 ★ ject covered in this magazine ★
 ★ must be addressed to: The Editor, ★
 ★ Hobbies Weekly, Dereham, Nor- ★
 ★ folk. If a reply is required, queries ★
 ★ should be accompanied by a ★
 ★ stamped addressed envelope and ★
 ★ reply coupon inside back cover. ★
 ★*****

HURRICANE Hattie struck British Honduras on 31st October 1961, and completely devastated large areas of the country. There is no doubt that this was a major disaster, and at a very early date the Red Cross estimated that 60,000 people out of a total population of 90,000 had been rendered homeless.

In Belize itself the damage was appalling; a tidal wave some 8 ft. to 10 ft. deep swept over the low-lying lands and though a certain number of well-constructed concrete buildings stood up

'Hurricane Hattie' Overprinting

to it, many of them lost their roofs, and suffered badly from the rains. A large number of wooden buildings were completely demolished, and others were very badly damaged. The loss of life was tragic — nearly 400 people died.

Almost before the hurricane had passed the standing regional hurricane relief organisation, already set up in Jamaica in conjunction with the Federation of The West Indies, had swung into operation. From then onwards help was received from many quarters.

At the beginning of December, at the request of British Honduras, the British Government sent out seven experts covering forestry, engineering, public health, agriculture, and housing, to report on the damage, and make recommendations for reconstruction. When their report is complete, it will be possible to assess the size of the formidable problem confronting the country.

The British Government made a grant of £10,000 to the British Honduras Hurricane Relief Fund as an immediate

contribution to start off the fund, and when it has been possible to see the full extent of the damage, Britain will consider what further help can be given.

It is in order to assist in the relief work and to bolster the economy of the devastated colony that the Government of British Honduras released as a special issue on 15th January, four values of the current definitive series of postage stamps overprinted in black with the words 'HURRICANE HATTIE'. These are shown in the accompanying illus-



trations.

The stamps have been printed by Thomas De La Rue & Co. Ltd, and values, subjects, and colours are as follows:

- 1 cent. Arms of the Colony (green and black).
- 10 cents. Stanley Field Airport (slate and bright blue).
- 25 cents. Blue Butterfly (bright blue and yellow-brown).
- 50 cents. Maya Indian (yellow-brown and purple).



SUKH RAM KHATRI, c/o Khatri Khangarmal Hukmani, Gandhi Chowk, P.O. Barmer, Rajasthan, India, is 20 and a collector of all hobbies.

M. A. HOOKER, The Lodge, Old School House, Winkfield, Windsor, Berks. Age 11. Stamps, coins, postcards.

SAMUEL HANNOCK, Mukeshwadi, C.S.T. Road, Bazar Ward, Kurla, Bombay 70, India. Age 35. Stamps, covers, records.

PEN FRIENDS AND THEIR HOBBIES

I AM 21 years old and my hobbies are stamp collecting and writing to pen friends', says **JAYANTILAL B. THAKRAR** of P.O. Box 290, Tororo, Uganda, B. E. Africa.

A. DELANEY, 18 Dunsford Ave., Bierley, Bradford 4, Yorkshire, would like a friend in Switzerland, France or Germany. Speaks French and German and collects stamps and cards.

MICHAEL CLIFFORD, Keenogue, Duleek, Co. Meath, Ireland, writes 'I am a musician, am interested in radio, records, postcards, etc.

LAWRENCE DUGGAN, 31 Monks Road, West Monkseaton, Whitley Bay, Northumberland. Swimming, stamps.

K. GOWER, 31 Chamberlain Road, Edmonton, London, N.9. Stamps.



M. W. VAN NIEKERK, P.O. Box 111, Springfield, Johannesburg, South Africa, collects match labels and stamps.

R. A. CORBYN, 30 Church Road, Rainbow Hill, Worcester. Age 15. 'I collect everything!'

IVAN SENIOR, 9 St. John's Grove, Eastmoore Road, Wakefield, Yorkshire, Age 15. Postcards, cigarette cards, stamps, coins.

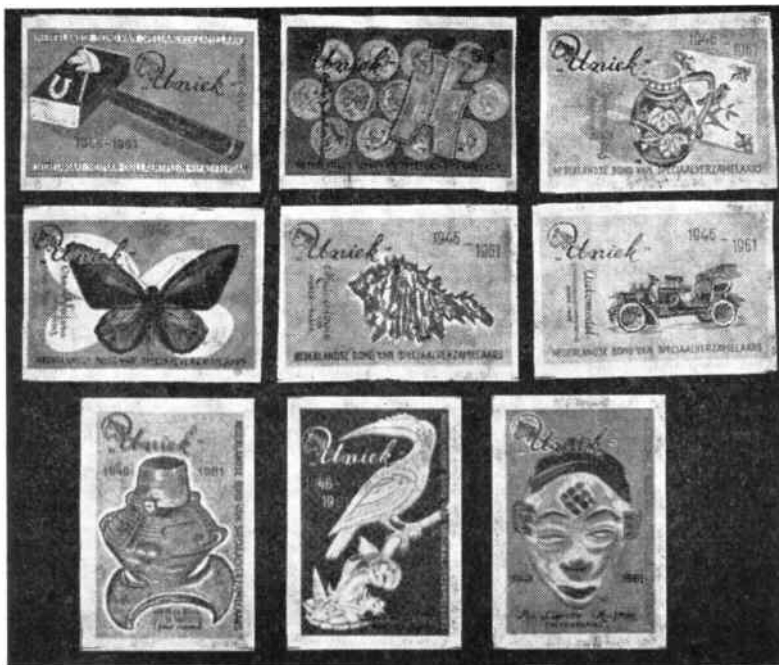

DUTCH LABEL CLUB'S JUBILEE

In a previous issue it was stated that J. Soeters (age 20), of Graaf Horisstraat 19B, Rotterdam 3, Netherlands, was a collector of beer mats. Mr Soeters informs us, however, that he collects match labels. Any inconvenience the error has caused is regretted.

Mr Soeters has sent nine Dutch labels issued to mark the fifteenth Jubilee of the Dutch Collectors' Club 'U.N.I.E.K.'.

Designs — from left to right — are: 1. The committee mark — the chairman's hammer. 2. Antique coins — including the rare Chinese Spade coin. 3. Vine jug and antique tile ceramics. 4. Exotic butterfly. 5. Tropical shell. 6. Antique automobile. 7. Urn and Axe — stone age. 8. Tukan bird of bone — arts and crafts. 9. Ba-Lumbo mask. 'If wished I can supply readers with this set for 2s. 0d.', says Mr Soeters.

Advertisers'

Announcements

125 DIFFERENT STAMPS catalogued over £1 free. Request bargain approvals. — Walker (A.), 11 Camphill Avenue, Glasgow.

100 STAMPS FREE, request approvals. — Nunn, 180 Chantry Road, Chessington, Surrey.

100 DIFFERENT stamps free! Request 1/6 upwards discount approvals. — Bush, 53 Newlyn Way, Parkstone, Dorset.

£ S. D. COLLECTING all stamps in 'Collector' booklets. When completed booklets purchased for cash. Instruction booklets 1/6 posted. — D. H. Elliott, 636A, Bristol Road, Northfield, Birmingham 31.

APPROVALS by countries and reigns — 1/6d. catalogue — Mint at face — K. Hoyer, 6 Merri-den Road, Macclesfield.



COMMEMORATIVE FROM FINLAND

This stamp, which appeared on 15th February, commemorates 600 years of the Finnish people's political rights. The design depicts the Mora Stones, where the first King was elected.

LABEL COLLECTOR HONOURED

Pictures of the Gevergeeff family appear on the front and back of an issue of book matches from Russia in recognition of their claim to own one of the largest collections of labels in existence. In a previous issue we mentioned this family as an interesting contact and pen friend for match label enthusiasts. Write to: Constantin I. Gevergeeff, of Basmany Tupic, 10/12 App. 62, Moscow, B 64, U.S.S.R.

NEW RELEASES FROM CZECHOSLOVAKIA

Further values have just been released by Czechoslovakia, marking the 'Praga 1962 World Stamp Exhibition'. 1 Kcs, brown and green — 'The Breweries of the town of PLZEN'.

1.60 Kcs, brown and green — 'The High Tatras' — Czechoslovakia's highest mountain range.

2 Kcs, black and violet — 'The K. Gottwald Ironworks'.

The above three stamps are illustrated below. A further 5 Kcs value 'Prague' is multicoloured, and shows an outline of the city and streams of flags of many nations. These stamps have been used on two official covers.



Making a Sycamore Whistle

IN these days of synthetic pleasures a lot has been lost of the simple enjoyments we had as children. When some of us were young, money was hard to come by and we had to provide most of our own amusements and construct many makeshift toys. We learned to make four-wheeled carts from odd planks and sugar boxes, and soon became adept at doing odd jobs.

trates to the full distance of the skin. The section of skin beyond this cut must now be removed without splitting or damaging it. The skin is moistened — we naturally placed it in our mouths — and then tapped all over with the back of the knife-blade. This wetting and tapping process is repeated several times, and between times the end should be grasped firmly and twisted. After a few

the pith dug out. On replacement of the skin the whistle is finished, to be blown with delight by any small boy.

I recently made a whistle of this type for a young boy and it was not long before nearly every small boy in the neighbourhood was blowing a similar one. With one lesson these youngsters were fashioning their own.

It may be noted that the simple freeing

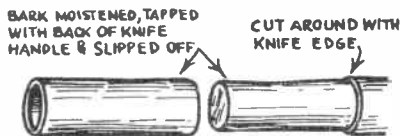

FIRST STAGE REMOVAL OF BARK



SECOND STAGE BARK REPLACED & MOUTHPIECE & AIR HOLE SHAPED

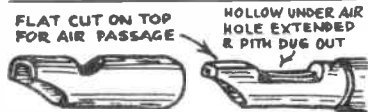

THIRD STAGE BARK REMOVED & WHISTLE HOLLOWED

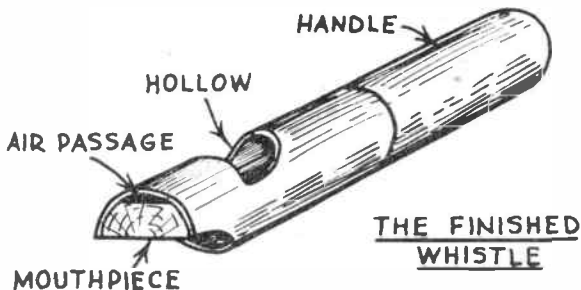

THE FINISHED WHISTLE

minutes it will part company with the stick and may be slid off. The skin is replaced for the shaping of the mouth-piece and the cutting of the outlet hole. This could have been done before loosening the skin, but it would have been more difficult to avoid splitting.

The skin is again removed for a final finishing of the inside wood. A sliver is cut from the top of the mouthpiece to form an air passage and the hollow beneath the outlet hole is extended and

of a portion of the skin as shown in the first illustration, forms a whistle which will sound a variable note when blown across the end. A warbling note may be sounded by sliding the skin up and down while blowing.

The note of the more orthodox whistle is determined by the diameter of the wood and the amount of hollowing. The various stages of making the whistle are shown in the illustrations. (E)

To those of us who lived in the country our first pocket-knife was a prize indeed as it opened the door to unlimited possibilities. With it we could produce bows and arrows, walking sticks, stilts, and a variety of fascinating objects.

It would be a good thing if we who can remember our childhood prowess with the pocket-knife would hand on to our children the secrets we discovered. They would appreciate the gesture and be proud of being able to produce toys which hitherto they have understood to be obtainable only from a shop and in exchange for money.

In spring when sap was in the sycamore shoots, we made whistles — and what could be better than a whistle made with our own hands. And if we broke our whistle or became tired of its note we could make another.

To make a sycamore whistle, a young branch or shoot of up to $\frac{3}{4}$ in. in diameter should be selected. The smaller the shoot, the easier it will be to slip off the skin. Having cut a length to suit, a ring cut should be made from 2 to 3 in. from the end, making sure the blade pene-

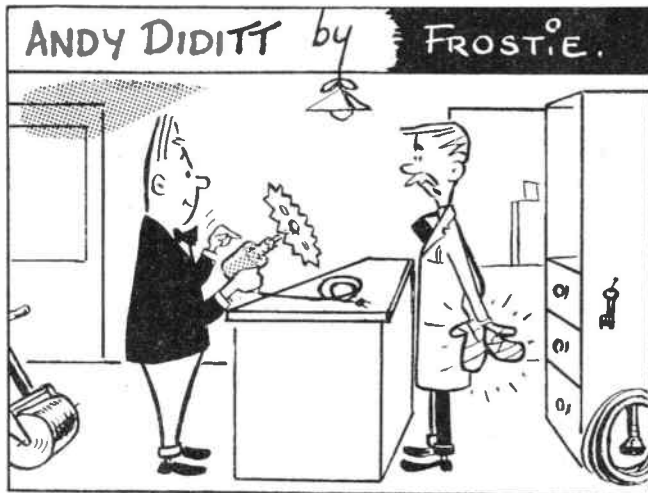

"OH! THEY'RE PERFECTLY SAFE MR. DIDITT — I USE ONE MYSELF."

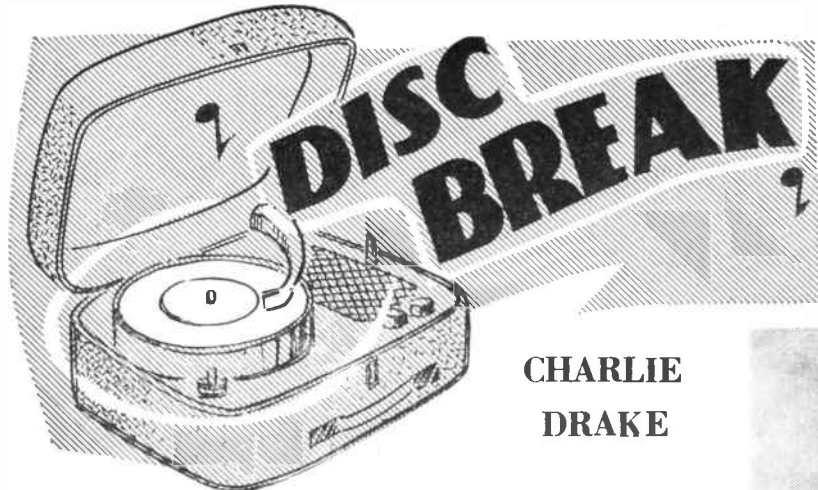

First off the mark to record this popular artiste was Parlophone recording manager George Martin. And the title of the first disc — *Splish Splash* coupling *Hello My Darlings* (Parlophone R.4461). The *General Custer* and *Boomerang* songs have added to his following.

Now for some personal details: Charlie married a ballerina in 1954. His hobbies are boxing, collecting daggers, painting (free design), fishing and entomology. He writes short stories and scripts for films — and is convinced that one day they will be published.

CHARLIE DRAKE

TELEVISION'S lovable little character, Charlie Drake, was born in London on 19th June 1925. He left school at the age of 14 and went straight into show business, starting with a season as a singer at the South London Palace. Following this he graduated into variety through a series of various theatre jobs, intermixed with any other job he could get to supplement his income.

After a four-year stay with the R.A.F. — in India and Egypt — he met script-writer Robert Buckland who suggested he should broadcast. And broadcast he did. He made his debut in a programme called *Spot The Winner* with the result that he was booked for a tour throughout the British Isles with a road-show.

He was later seen by John Foreman who immediately booked him for a number of programmes, including *Music Hall*, and *Up and Coming*. His broadcasting successes spread and then he made his first television appearance on 7th July 1953, in *Centre Show*. Since then his numerous TV dates have included *Showcase*, *Quite Contrary*, *The Jimmy Wheeler Show* and, of course, his own triumphant series *Drake's Progress*.



* * *
WHAT a really big record will do for a singer is well illustrated by the way in which Billy Fury has become accepted as a top pop idol since the advent of *Halfway to Paradise*.

DIFFERENT is the applause which greets his theatrical performances. . . .

DIFFERENT is the size of his fan mail, now nearly 1,000 letters per week. . . .

DIFFERENT are the age-groups which now enjoy his singing: 40 per cent of his theatrical audiences are adults. . . .

DIFFERENT is the interest being shown in him by film companies: One big company wants him to star in a full-length feature film, two further major film offers are having to be deferred until next year for want of available time. . . .

DIFFERENT is the interest now being shown in Billy Fury by countries overseas: he may accept invitations to perform in Italy, Scandinavia, South Africa, Australia, New Zealand.

But . . .

STILL THE SAME is his outlook on

life — he takes it all, including his success, in his stride. . . .

STILL THE SAME are his clothes. He still dresses casually, even if those cowboy boots of his have, during the past year, disappeared from his wardrobe to be replaced for the first time by suits. But even these are casual. . . .

STILL THE SAME is his car — his 1960 MG — and his West End flat near the Marble Arch. Incidentally, for his mum he recently bought a £6,000 house in Liverpool.

Says Billy Fury's recording manager, Decca's Dick Rowe, of Billy's fiery rendition of *Jealousy*: 'The result is a great recording of a proven song hit, sung in a manner typical of today, with an orchestral backcloth as exciting as anything I have ever heard'. It bids fair to increase the popularity of this young singer.

A Scots lass is being tipped for singing stardom in 1962 — see next week's Disc Break.

'PINTA' HOOP-LA

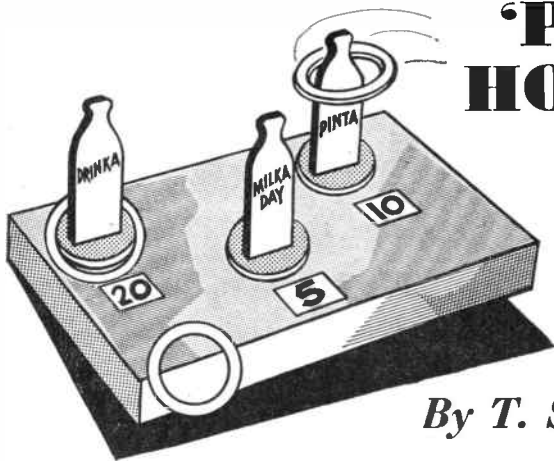

By T. S. Richmond

THIS Hoop-la is simple to make yet provides many entertaining ring-games of skill.

You need a strong cardboard container about 10 in. by 14 in. by 2 in. The box provides storage for hoops and targets when not in use, and the lid is a ready-made board for setting-up the targets. You will also need enough pieces of $\frac{3}{8}$ in. plywood to make sets of three rings and three targets.

Draw 4 in. diameter rings A with compasses directly on to the wood. Cut these with your fretsaw. The cut-away centre discs become supports B for the targets.

Draw the 'bottle' shape C to the size indicated, and cut three to this pattern from plywood. Cut a mortise in the middle of each disc to correspond with tenons at the base of the 'bottles'.

Glue discs to the box lid in equally-

spaced positions (see illustration). When dry, pierce cardboard under discs so that targets may be inserted. The box can be decorated with fancy paper, and other parts brightly painted after glass-papering.

Bottles are painted white, and the three sections of the well-known slogan — 'Drinka — Pinta — Milka day' stencilled on. Score tabs 5, 10, and 20 are cut from numbers on a calendar.

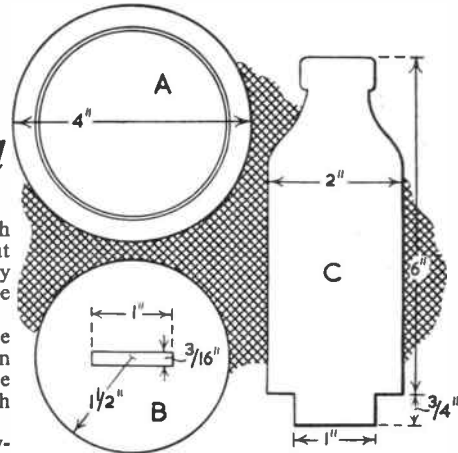

RECORD CABINET AND TABLE

THERE is ample room for your records in this strong and useful cabinet illustrated on the front page. The top is large enough for most record players and it is at the right height for comfortable working.

If you wish to use the cabinet for your television set, the shelf can be utilised for the various publications taken and the bottom can be converted to a sewing or knitting cupboard.

The front and side views in Fig. 1 show the main dimensions and indicate the method of construction. The various pieces are lettered for easy reference to the instructions and the other diagrams. Only two partitions are shown, but these can of course be increased as required. The wood used is a matter of choice, but we suggest oak as being the most suitable. The top C, and the shelves D, can be of oak-faced plywood.

Commence by making up twelve rails B, from $1\frac{1}{2}$ in. by $\frac{3}{4}$ in. wood, which will be tenoned into the legs as seen in Fig. 2. Note that the tenons are mitred. Legs will of course be shaped and mortised.

Having completed the rails and legs they are tested for accuracy and tem-

porarily assembled as in Fig. 3. The top C, and shelves D, are next cut from $\frac{1}{4}$ in. plywood. The corners are cut away from pieces D, as shown in Fig. 4.

Now insert the shelves and glue up the rails and legs. Secure the shelves with panel pins and glue. The top can be glued only, dispensing with the panel pins. Cramp up the parts as necessary and set them aside to dry. The tops of the legs A will be finished off later by rounding off.

ALL DIAGRAMS ON FACING PAGE

The back and sides are of $\frac{1}{4}$ in. plywood and are pinned to the middle rails. They are also held in place at the bottom by strips of $\frac{1}{2}$ in. quarter round beading glued to the bottom rail and to the plywood (Fig. 5).

The partitions E, which are of plain $\frac{1}{4}$ in. birch plywood or $\frac{1}{4}$ in. hardboard, are also seen in Fig. 4. Their shape is not critical, but can be similar to that shown. They are held in place by strips of $\frac{1}{4}$ in.

quarter round beading as in Fig. 4.

The doors are of matching plywood and are seen hinged in position in Fig. 5. The hinges will of course be recessed into the door framing.

A detail of one door in Fig. 6 indicates how the framing of 1 in. by $\frac{1}{2}$ in. strip-wood is halved together at the corners. The parts are glued and cramped together. The handles are Hobbies No. 711 in black or cream plastic, price 1s. per pair (post 4 $\frac{1}{2}$ d.). Use a double-ball catch for each door, fixing them to blocks glued behind the middle rails. Double-ball catches (No. 6225) cost 1s. 6d. each (post 4 $\frac{1}{2}$ d.).

Use 3 in. rubber tyred castors as suggested in Fig. 5. They cost 5s. 6d. per set of 4 (post 1s. 6d.). Catches, castors and handles may be purchased direct from Hobbies Ltd, Dereham, Norfolk or from any branch or stockist.

Finish is of course optional, but it is suggested that the wood should be lightly stained and then french polished or varnished. An enamel finish would also look quite well provided the wood is well sanded and filled beforehand.

(M.h.)

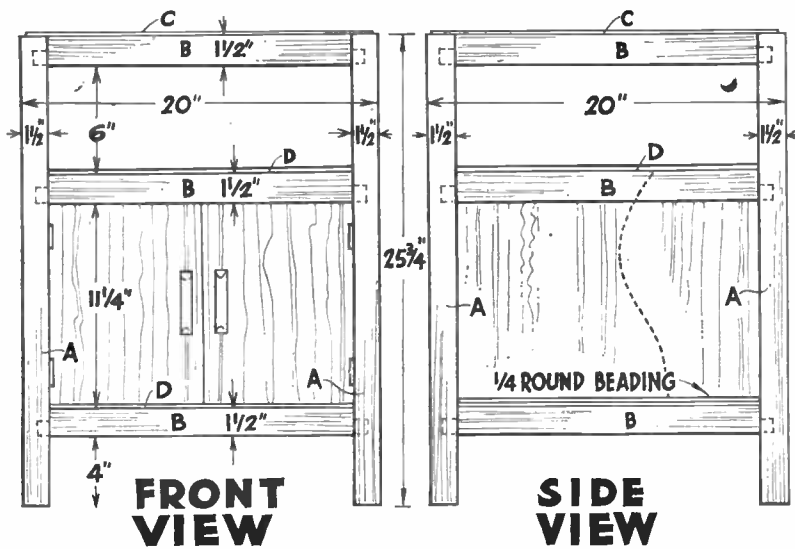
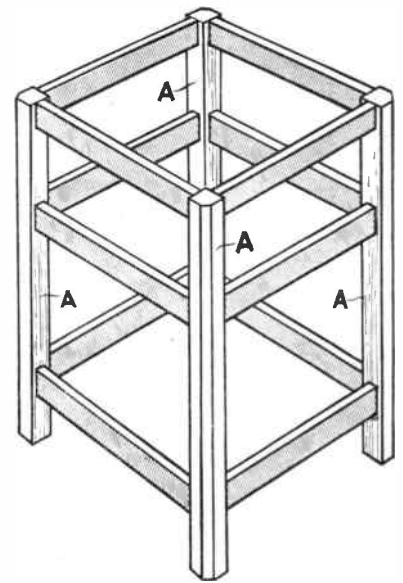

Fig. 1



PIECES B SHOWN SHADED

Fig. 3

RECORD CABINET

AND TABLE

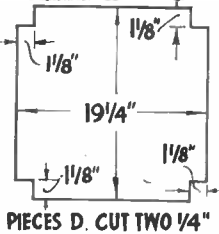
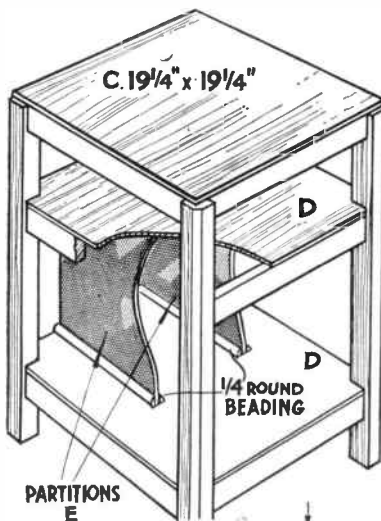

Fig. 4

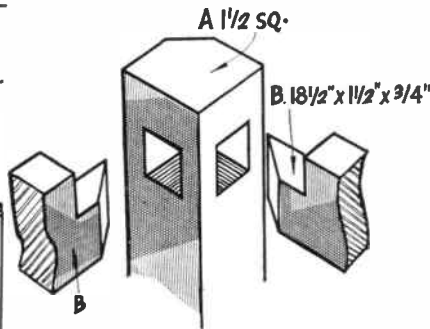

Fig. 2

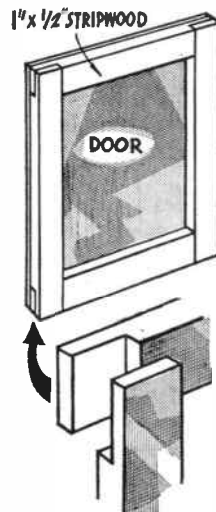

Fig. 6

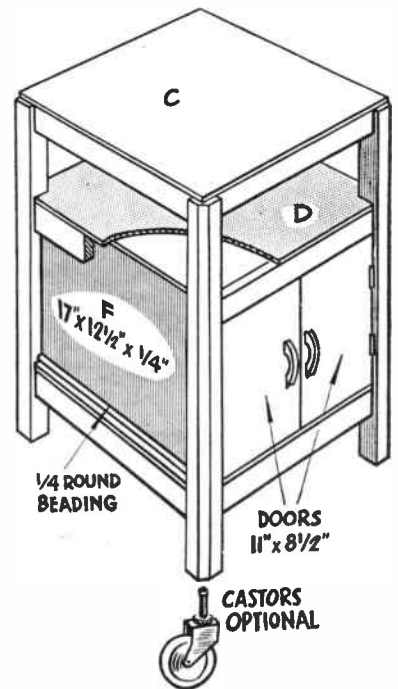
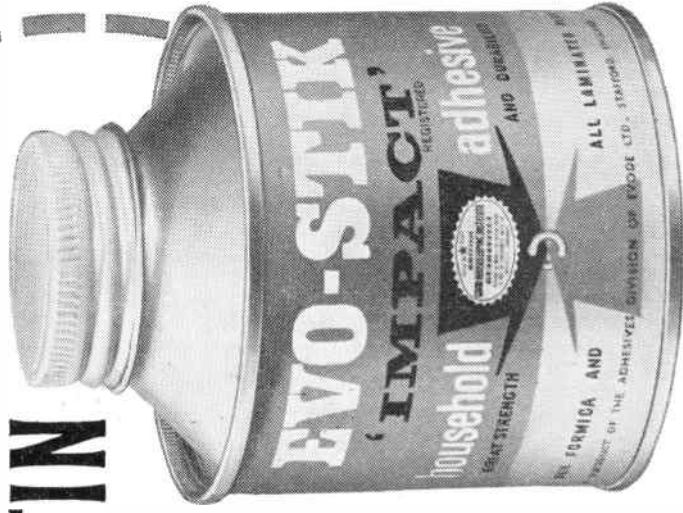

Fig. 5

**THERE'S MORE
THAN A TOOLCHEST
IN THIS TIN**



**... THERE'S THE STRENGTH
OF A HERD OF WILD ELEPHANTS**

with an invisible ease and economy which makes most tools and fixing methods "old-fashioned"

You can say "thanks" to modern research and scientists for Evo-Stik 'Impact' Adhesive. The amazing new "toolchest in a tin" which permanently fixes almost anything to anything. And with a power which wild elephants couldn't separate.

Demand for this new scientific method of fixing means that hundreds of thousands of gallons of Evo-Stik 'Impact' Adhesive go to important British industries. And millions of gallons go to industries throughout the world.

Now, demands from home-users just like you mean that all this fixing power; all this "know-how", powering international industry is available to you. Here are some examples . . .



SURFACES THAT SHINE

Decorative wall-boards and laminated plastics fix to almost any surface, be it plaster, metal or wood. And although they can be screwed, nailed or pinned, few builders would care to spoil such fine surfaces. Instead, manufacturers invariably recommend fixing with Evo-Stik 'Impact' Adhesive. And it is mainly due to the speed, economy and amazing strength of Evo-Stik that 75 million square feet of these materials are fixed each year.



CEILING THAT SEAL SOUND

Only a few years ago industrial installations of Acoustic Tiles were laboriously and expensively fixed with screws and bolts. Often with a maximum speed of around 30 tiles an hour. Demand was low due to high installation cost. But to-day, two workers using Evo-Stik 'Impact' Adhesive install up to 300 tiles an hour. Result; new ceilings that silence sound; and new acoustic materials, shapes and decorative effects; through the speed of Evo-Stik.



CARS THAT LAST LONGER

Many of the component parts of motor vehicles such as draught excluders, foam rubber weather seals, etc., are under permanent atmospheric attack. Metal fixings used to hold these parts in position were constantly attacked by rust and corrosion. New fixing methods, resistant to atmospheric attack yet with all the strength of steel rivets and bolts were needed. Evo-Stik 'Impact' Adhesive answered this vital problem, throughout the motor industry.



DO THAT JOB YOURSELF

Because Evo-Stik is in your Iron-mongers right now all these latest industrial joining techniques are being applied in the home. No wonder people say it's taken the "do" out of "do-it-yourself". Within seconds of applying Evo-Stik 'Impact' Adhesive you have a permanent, waterproof, and heat resistant bond. And Evo-Stik is efficient with practically every material you can think of. It's a toolchest in itself. Keep a tin handy.



TINS 7/- AND 4/3. TUBES 1/9



'IMPACT'
EVO-STIK
ADHESIVE

is a Registered Trade Mark

Remember . . . a small deposit secures any article.

LONDON OFFICE: 450/52 EDGWARE ROAD, W.2. AMB 2425 (5 lines). Associated Company in Elbe: Evode Industries Limited, Swords, Co. Dublin. Swords 331

NEW Thoughts on

RAILWAY MODELLING

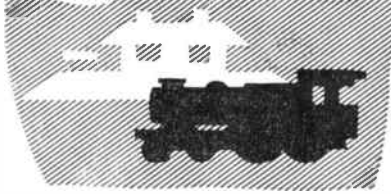

Now, what materials are we going to use? I would suggest cardboard, at least for the main walls, etc. Perspex or thick celluloid can be used for glazing the

TO my mind, one cannot have too many buildings on a layout. Frequently one sees a lot of track, and a lot of trains, but apart from, perhaps, a signal cabin and the odd station or so there the matter ends. A railway is built to serve a community with travel facilities, and therefore I feel that we should show in some way a reason for having a railway.

BUILDINGS FOR YOUR LAYOUT

By F. A. Barrett

A factory alongside the track immediately gives the impression that there is something that the railway has to carry from place to place, and a few houses indicate that there are potential passengers. My own railway is 'smothered' with buildings. But then, I have a model of a town as well as a railway. I am not suggesting that you copy this idea, but at least consider having a few buildings scattered about.

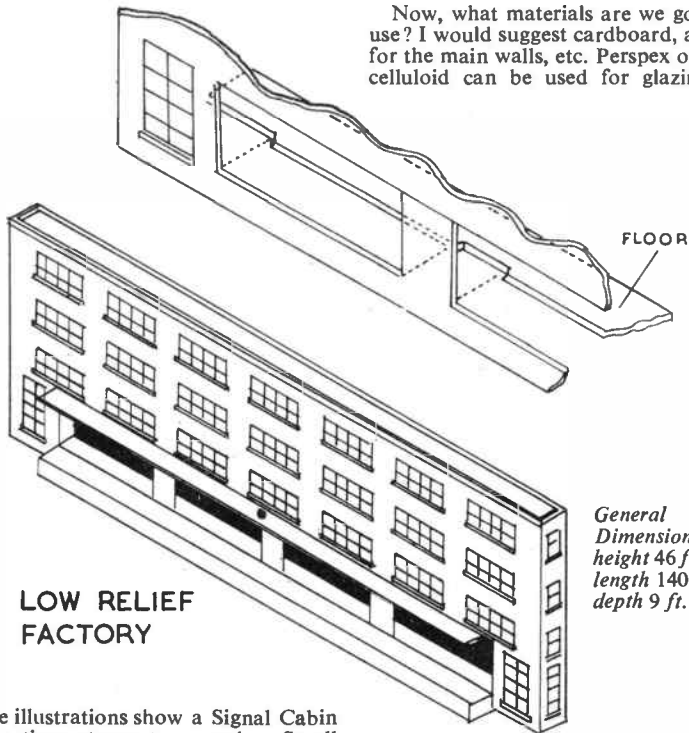

*General Dimensions
height 46 ft.
length 140 ft.
depth 9 ft.*

LOW RELIEF FACTORY

The illustrations show a Signal Cabin of the three-storey type, and a Small Factory that will go into the background. This can be built as a low relief type of building, which I will explain more fully.

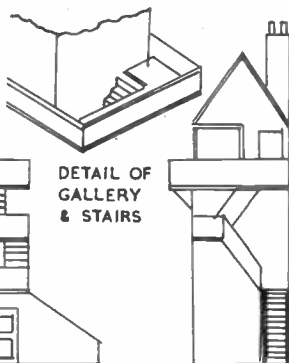
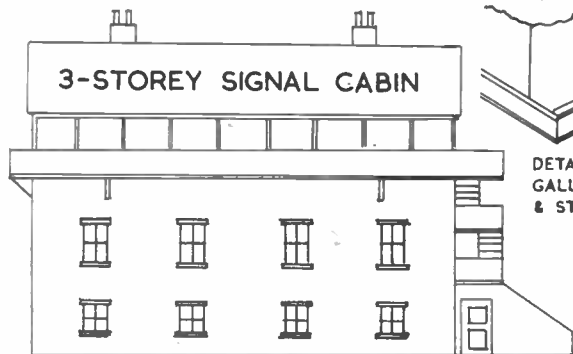

windows, and stripwood used for internal stiffeners.

Let us take the Signal Cabin first. I have drawn this as a three-storey type, but you could adapt it to suit your own surroundings. There is nothing very difficult about this model. The main thing is to make everything square, and get good joints. In order to improve the model you should try to fit the inside of the cabin where the lever frame is. This is represented by a piece of card painted black and glued to the floor, and pins with the heads cut off stuck in at appropriate intervals. The pins are then painted either blue, red, yellow or white to suit. If the floor of the cabin is made of wood, this will give strength to the structure, and also make a firm base upon which to build up the details inside.

General Dimensions — height to roof top 42 ft. length of main building 56 ft. depth 13 ft.

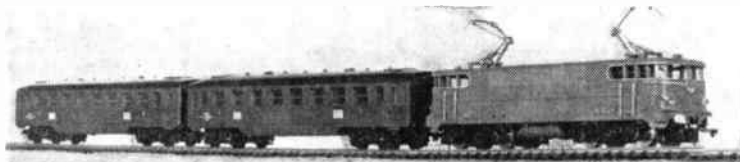

The Hornby-Dublo Bo-Bo Electric locomotive with dummy pantographs, and the 1st and 2nd class coaches come from Meccano Limited's French factory. They are suitable for use on British Hornby-Dublo layouts. Locomotive £5 10s. 0d., coaches 16s. 6d.

the actual parts of the building — front, back, sides, and roof — and mark in the position of all the windows to the dimensions shown. Then cut out the parts with a good sharp knife and a metal straight edge.

On the front wall, inside, you should put your window glazing in place. The framework can be either made up with thin wood, or else, in the case of Perspex, scribed on the material. If you are using celluloid you could scribe the lines on, but do not press too hard, or you will cut through the material, and it is apt to split at that line. Britfix Cement will hold Perspex to card. Glue the windows in place, and then glue the ends to the front of the cabin. Down the sides of the front glue a strip of wood about $\frac{3}{8}$ in. thick to hold sides and ends firmly. Make your floor, and fit your lever frame and a stove, etc. Paint the inside walls of the cabin or cover with paper to suit, and then fit the floor. You will have to cut out a small square from each corner to make room for the strengthening pieces of strip wood. Glue further strips to the back wall, and then glue this in position. If you fit a floor at the bottom of the cabin, glue wooden strips to the bottom edges of the walls, and then you will have something to glue the base to. Or you can leave the bottom of the cabin open to cover any point motor at the side of the track.

Cover the cabin with brick paper, or paint to represent concrete. Don't forget the doors. These can be glued on the inside after painting them. The outside stairs can be made of strip wood, the thickness being $\frac{1}{8}$ in., and the width about $\frac{1}{2}$ in., these dimensions being for a OO gauge model. The stairs can be built up in layers, allowing the treads to be $\frac{1}{8}$ in. The method is illustrated. Put on the sides of the stairs, and cover these in brick paper. Your roof can be made in one piece. Find the exact middle of your piece of card, which should be wide enough to make both slopes of the roof, cut halfway through with your knife, and then you can bend the roof to shape. Glue this in place, cut your end gable boards to shape, and glue in position, and there you have your Signal Cabin.

Building the factory

The low relief factory is designed to go along the back of the railway. The idea

is that this could be put alongside a siding, which will bring the trucks or vans of goods to be unloaded on the platform at the front of the building, and to this end make up some small imitation boxes from blocks of wood, and glue these to the unloading platform.

This is a very easy model to make, and once again the main material would be card. Draw the front and ends of the building on the card, marking in all the windows and openings, etc. Then with a sharp knife and a ruler cut out all the openings. The back is, of course, the same size as the front, but you will not need any windows in this if it is going to be placed against the backboards of the model.

Use of stripwood

It will be as well to stiffen up the structure with pieces of wood about $\frac{3}{8}$ in. square. You can get suitable stripwood from Hobbies in 3 ft. lengths. It is always useful to have some lengths by you, in various thicknesses. You will find many uses for it. Next cut some floors. These should be made to fit inside the building with a framework of wood strips. These will make the job rigid. Fix the window material in next, and for this I should use a cellulose acetate sheeting. This is also available from Hobbies. The framework of the windows can be put on in various ways. If you are using a thick material then the frames can be scribed on. If the material is thin I would suggest drawing them on in paint with a fine pen. A scriber can

ARIEL SUPER SPORTS

ALTHOUGH it has no connection with model railways, the new kit put out by Rosebud Kitmaster for the Ariel Arrow Super Sports Model motor cycle is well worth noting, writes F.A.B. The detail is excellent, and I was particularly intrigued with the method of making the wheels. This gives a true representation of a spoked wire wheel, and when finished and painted it looks correct. There is a sheet of transfers to add such things as the name and the licence plates. Available from Hobbies branches, the kit costs 5s. 0d.

easily be made from a sharpened steel knitting needle. Scribe the lines in the material, and paint the surface of the window with poster colour, making sure that it goes well into the scribed lines. When dry just lightly scrape the surface of the window with a piece of the window material, and you will find that the paint will come away and leave you with a framework of the window, looking clean and smart.

The windows should be glued into place behind the opening. You can if you wish make the windows opaque. Lightly rub the back of the window with glass-paper, and when making the windows leave a surround of about $\frac{1}{4}$ in. for sticking to the opening. Use Britfix or Durofix for the job, and when the window is in place and the glue has set, or rather when all the windows in one line are set, put either gummed paper strip or Sellotape along the edges to make doubly sure that they are well in position, and will stay there. Glues have a habit of drying out after a few years, and the Sellotape or gummed paper makes a secure bond.

In my next article I am going to show you a bit more of my own model railway with photographs of the various buildings.



The first passenger liner in the Airfix range is the Canberra the kit for which has 86 detailed parts and costs 7s. 6d. The finished model is 16 $\frac{1}{2}$ in. long and is to a constant scale of 50 ft.:1 in. Modellers will appreciate the faithful reproduction of many unusual features in this ship.

Another Airfix kit features H.M.S. Campbelltown, made to 50 ft.:1 in. scale. Containing 51 parts, the kit is 2s.

AN ALBUM OF WILD FLOWERS

WE are tempted to gather bunches of varied blooms of wild flowers when we take a ramble in the woods and meadows, and by the stream. These lovely flowers, unfortunately, do not last long in the home, and most of them quickly fade and wither. But have you thought of using such as a nucleus for a collection? An album of preserved wild flowers is permanently interesting, and your nature-loving friends will appreciate your efforts when you proudly bring forth the book of specimens of local flora, all neatly arranged and labelled.

Incidentally, this hobby often leads to a wide and intimate knowledge of the flowers to be found in your own neighbourhood, and will be the means of teaching you something of the inexhaustible delights of the countryside. Beginning with flowers you may be tempted to carry the hobby still further and delve into the realms of the ferns, mosses, leaves, and grasses — all absorbing subjects.

No matter where you live, there is much variety in the wild flowers you may gather for pressing. Roughly, there are about 750 different kinds in Britain, which can be placed for easy reference under headings, Yellow, White, Red, Blue, and Other Colours.

Making a collection during summer — or at other periods of the year — will take you into all sorts of delightful spots. There are the flowers of the sea-shore and dunes, flowers of the marshes, bogs, and the moors, the flowers of the dells and glens, the waste places and commons, and, more familiar, of the meadows, woods, and wayside banks, not forgetting the lovely streamside blossoms, fragrant like the fluffy meadow-sweet. All these areas have their special lines in flowers.

How to preserve

You will, of course, carry a suitable basket for your flowers, taking care not to crush them out of shape. Select the very best blooms — good specimens of the finest colourings, taking special care when rare species are discovered.

Having obtained a basketful of varied blossoms which you desire to preserve, it is important to deal with them before they have lost any of their fresh young beauty. The work may be divided into three main processes: (a) drying, (b) pressing, (c) mounting and arranging in the album.

The usual method of drying the flowers is to place them in a suitable absorbent material, gradually increasing pressure as the drying proceeds. Re-

member, if you apply too much pressure at first, the specimens are liable to be 'squashed', and will not keep nice and colourful. The idea is to deprive the freshly gathered flowers of their juicy matter without delay, for as long as they are damp the delicate tints will go on disappearing. The secret of preserving the natural colours as much as possible is by drying quickly.

One method is to use silver sand, heated. This is poured evenly over the bottom of a number of flat tins — these you will require in varied sizes. Place the specimens, one or more in each tin, according to size, on the layer of hot sand, and then pour more sand around and over the specimens until the tins are full. Shut the lids and arrange the tins in a warm oven, applying gentle heat. The flowers are thus dried quickly before the natural colours fade. After a few experiments you will soon learn to gauge the length of time needed for the drying process, and amount of heat required.

Layer method

When the first layer of flowers is covered with the sand, if the box is deep enough, you may place another layer of blossoms on top; but do not have more than two layers of flowers in any one box. After a few hours, test the blooms. If they feel crisp and dry to the touch, take them out. When satisfied that they are perfectly dry, press and mount.

A common method of drying and pressing is to place the flowers between some absorbent material. An old trouser press can be used effectively, or you can use two flat boards tightened by cramps or thumbscrews. Failing that, try two flat pieces of stout cardboard or hardboard, with the flowers placed in the absorbent material, and laid between the boards. Place several fairly heavy books or other weights on the top board, adding more as the drying proceeds. When treating a number of flowers, discard all with broken stalks, bruised leaves, or disfigured petals.

Arrange the specimens as neatly and artistically as possible on the absorbent material.

With this method, the drying will take about a week. At the end of this period, undo the press, remove wadding or whatever material you have used, take out the flowers gently, and remove any bits of material that may remain sticking to the flowers. This needs care, or you may ruin the appearance of your specimens. Take away the wadding, substitute a double thickness of white blotting paper, place specimens on this, and put a similar piece on top, and again screw up in the press, or weight them.

When the pressing, which takes a few days, is completed, arrange and mount the specimens in an album. Label the name of each flower neatly.

(E)

'We went on different holidays together!'

Not quite so strange as it sounds. The Y.H.A. has many families who are all keen hostellers: they sometimes tour as a family, staying at the same hostels but following their individual interests during the day. One of the wonderful things about the Y.H.A. is how it enables you to follow any outdoor pursuit, knowing that at the end of the day the friendly hostel is waiting to welcome you. Not all hostellers tour with their families, of course — from 12 years upwards you can tour on your own. But however you travel, it's time you found out more about Y.H.A.

To Y.H.A., Trevelyan House, St. Albans, Herts.
Please send me free leaflet 'Going Places?' and enrolment form.

HW624

Name.....

Address.....
.....

MAGIC with a mental or 'psychic' flavour is usually appreciated by older guests at party time, and a clever amateur performer can create quite an aura of mystery about himself with a well-presented effect in this 'supernatural' category.

By A. E. Ward

In 'Divination by Pulse' you are able to detect the whereabouts of a certain diagram by 'reading' the pulse beats of the person who holds it concealed in an envelope. Four envelopes of a size 4 in. by 9 in. will be needed, together with eight rubber bands and four boldly-drawn diagrams drawn upon strong white cards, which are cut so that they will just fit into the envelopes. The diagrams will be: a circle, cross, triangle, and square, respectively, and all the cards will be exactly the same size to begin with.

Now for some subtle preparations. Use a guillotine, or sharp knife guided by a metal straight edge, to trim $\frac{1}{4}$ in. off one long side of card two (the cross). Trim $\frac{1}{4}$ in. off one short side of card three (the triangle), and trim similar slices off one long side, and one short side of the fourth card (the square).

When each card is placed inside an envelope and all the envelopes are secured by pairs of rubber bands placed crossways you will be able to employ your secret knowledge of the exact proportions of each card in order to learn the whereabouts of any given diagram (see the drawings). Of course, you will observe the effects of the tight bands upon the paper envelopes, and you will be able to deduce where the various diagrams are placed.

After talking briefly about the powers of animal vibrations, so-called 'brain waves', and the machine known as the 'lie detector', you offer to leave the room while the diagrams are selected and secured in envelopes by four different volunteers. The cards will be scattered on the table when you make your exit. On your return to the room, you request your four helpers to stand in a row, and each hold up his envelope. You go down the line (slightly hesitatingly), and feel each person's pulse before correctly divining the diagram he is holding.

Mental 'Magic'

HOW TO CHOOSE THE CORRECT CARD

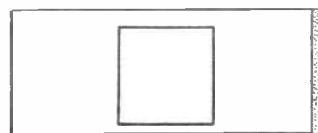
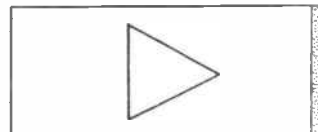
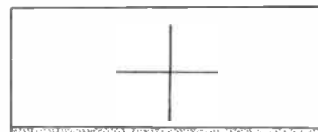
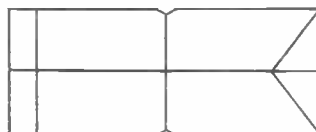
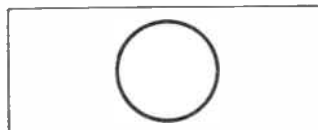

54 page Edition
WHERE'S THAT CAR FROM?

Price 1/- (Postage 4d.)

Entirely new! Brief Guide
MORE ABOUT INN SIGNS

Price 1/6 (Postage 4d.)

Of all Booksellers
or
RALEIGH PRESS, Exmouth, Devon

PERSONAL COLUMN LTD, Falcon House, Burnley, Lancs. Pen Friend — all hobbies. Correspondents in almost every Country. All ages. S.A.E. for details.

IT'S EXCITING. IT'S PROFITABLE. Paint designs. Flowers. Anything. Even beginners' ideas can sell for £25/£60. Inexhaustible demand. Details free. **POPULAR ART SERVICES (HW), CLUN, SALOP.**

PERSONS with sewing machines required at once. Regular work. Send S.A.E. for details to Dept. 28, Arnold 10, Shelley Road, Worthing, Sussex.

LEARN RADIO & ELECTRONICS the NEW Practical Way! Very latest system of experimenting with and building radio apparatus — 'as you learn'. FREE Brochure from: Dept. H.W.10, Radiostructor Reading.

ENJOY WRITING? Then write for Profit. Send for 'Writers' Handbook' (free) detailing countless opportunities for beginner or experienced. — Writers' Ring (HW), 5 Edmund Street, Birmingham.



No. 2 Corner Cramp

Made of cast iron. Will take mouldings up to 4 ins.

30/-

(post free)

HOBBIES LTD (DEPT. 99), DEREHAM, NORFOLK

LET **★ Plasticine**

HELP YOU DO-IT-YOURSELF Regd. Trade Mark
Special Trial Offer. We will send 4 lb. 'Plasticine' (any colour) with booklet 'Plasticine Modelling for Amateurs' Post free: 10/- U.K. only.

Harbutt's Plasticine Ltd, Bathampton, Bath

CHEMISTRY AT HOME

MANY and varied are the occasions when chemistry can help in the home or workshop, not only saving time and money, but often making available a product which is difficult or impossible to buy. Maybe one of the well varied recipes given in this article will be just what you have been looking for.

Rheumatism rub

Sudden attacks of muscular rheumatism are all too frequent in our damp climate. That painful twinge which seems to have come from nowhere will usually yield quite quickly to rubbing with a mixture of equal volumes of olive oil

MISCELLANEOUS RECIPES

and oil of wintergreen. Oil of wintergreen alone may be used, but its absorption by the skin is so fast that there is inadequate rubbing in. The incorporation of olive oil, which has a slower absorption rate, assures thorough manipulation.

Wax floor polish

A top grade floor polish with a pleasant smell may be made by melting together in a water bath 12 grams of carnauba wax, 20.8 grams of paraffin wax and 25.6 grams of ceresin. Meantime, warm up in a clean tin standing in a large pan of hot water (no flame) 120 c.c. of genuine oil of turpentine (not turpentine substitute), and 20 c.c. of solvent naphtha. Turn out the flame under the bath containing the melted waxes and stir in the turpentine/naphtha mixture. Pour out into a clean tin to set.

Another good recipe consists of 32 grams of carnauba wax, 19.2 grams of ceresin, 128 c.c. of genuine oil of turpentine, and 32 c.c. of kerosene (lamp paraffin). Melt the wax and ceresin, and warm up the turpentine and kerosene in a separate bath, as before. Turn out the flame under the wax bath and stir in the turpentine/kerosene mixture. Pour out into a tin and leave to set.

Imitation amber

If you have a project calling for a

substance which is to look like amber, a cheap substitute may be made from shellac and rosin. In a clean tin and using as low a flame as possible melt together 15 parts by weight of white rosin, 1 part of ordinary rosin, and 2 parts of shellac. When uniform the mixture can be cast in the required moulds.

Colouring household ammonia

Various recipes have been given in past articles for household ammonia. These were colourless. If a tinted product is desired, use may be made of the indicator litmus. To impart a violet colour simply add litmus solution a little at a time until a pastel shade is reached.

Mouth wash

For an antiseptic astringent mouthwash dissolve 1 gram of thymol, 8 grams of menthol and 12 grams of tannic acid in a mixture of 6 c.c. of tincture of benzoin and 100 c.c. of iso-propyl alcohol. The mixture is inflammable. For use, mix ten drops with half a tumbler of lukewarm water. Hold the mixture in the mouth for a few moments before ejecting it.

Cement finish

When casting objects such as garden ornaments from cement a fine grain finish is desirable. An aid to this is washing soda. Mix sand and cement in equal volumes, to each gallon of dry mix add a dessertspoonful of powdered washing soda, mix well and then proceed to add water in the usual way.

Mould composition

Old printer's type metal is often used for casting small objects, but the mistake is usually made of using a plaster of Paris mould. Plaster will not stand the high temperature needed to melt type metal. A sand and cement mixture should be used for the mould. Mix 1 volume of sand and 2 of cement. Make the mould and let it dry very thoroughly. The removal of all moisture is important and it is an advantage to complete the drying in a really warm place, such as the oven top. A cold mirror held close to the warm mould will show no misting when moisture is adequately removed.

Woodworm control

When small holes appear in wood,

suspect woodworm. Tap the wood. If wood dust falls out, it is time for action. Warm together in a water bath 2½ oz. of paradichlorobenzene, 2½ fluid oz. of medicinal paraffin or lubricating oil and 1 oz. of powdered soap. Stir well and pour into a clean tin. Rub the furniture at intervals with this preparation and buff up. It is especially important to treat the wood thoroughly in the spring.

Anti-fogging paste

Do your car or domestic windows, shaving mirror or glasses mist up? Here is a preparation to stop this nuisance. Heat up in a water bath 35 grams of soft soap, 37 grams of precipitated chalk, 10 c.c. of water and 12 c.c. of glycerine. Stir well and when uniform pour out into a warmed jar or clean tin. Smear a little of this on to the glass and buff up. You will now be able to breathe on the cold glass without its fogging.

Silver lacquer

In order to inhibit tarnish on domestic silverware a coat of clear cellulose lacquer may be given. If this is not to hand, clear cellulose adhesive may be thinned down with a mixture of equal volumes of amyl acetate and acetone. Alternatively, celluloid clippings may be dissolved in this thinning mixture.

After lengthy exposure to light the coating may yellow somewhat. In this case remove it by swabbing with the thinning mixture and relacquer the article. Since amyl acetate and acetone are inflammable, operate away from flames.

Another lacquer contains ¼ oz. of gum benzoin in 1½ fluid oz. of methylated spirit. Put the gum and spirit into a dry screw-capped bottle, shake occasionally until the gum dissolves and pour off from any residue into a clean dry bottle. Should eventual removal of the lacquer be desired, swab with methylated spirit.

Lacquer thinner

A thinner which may be used with almost any lacquer composition consists of a mixture of the following liquids: 13 volumes of toluene, 1 volume of methylated spirit, 4 volumes of n-butyl acetate and 2 volumes of n-butyl alcohol. Store in a well closed bottle. The mixture is inflammable.

Your Car Test

by John Mills

IS your old car worth repairing to pass the M.O.T. test? This book gives the pros and cons on this subject, and explains how the average car owner can, within limits, check and rectify faults which would otherwise fail his car in the test.

Published by Arco Publications, 29 Great Portland Street, London, W.1. Price 5s. 0d.

A DOLL'S GRAND PIANO

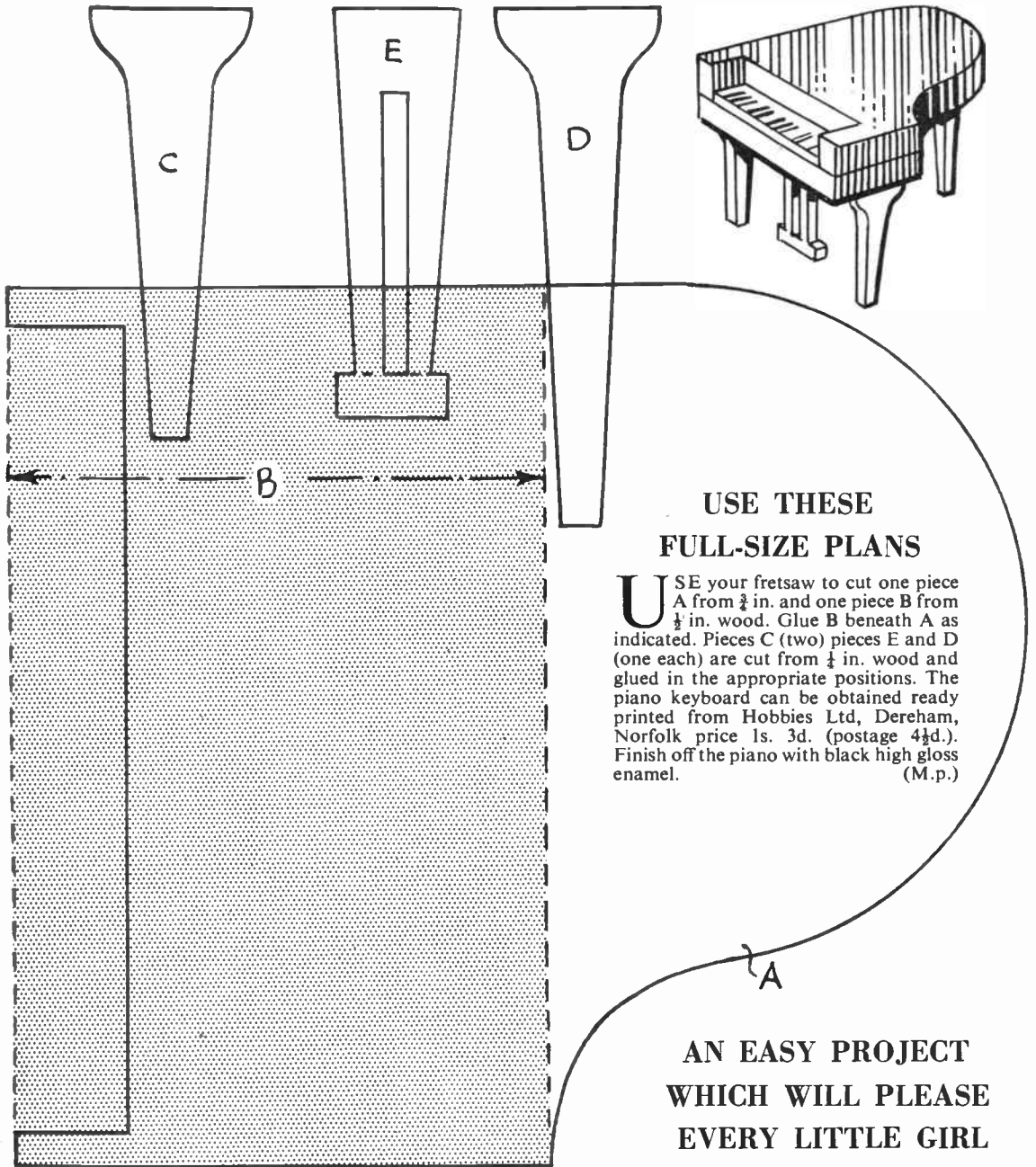

USE THESE FULL-SIZE PLANS

USE your fretsaw to cut one piece A from $\frac{3}{4}$ in. and one piece B from $\frac{1}{2}$ in. wood. Glue B beneath A as indicated. Pieces C (two) pieces E and D (one each) are cut from $\frac{1}{4}$ in. wood and glued in the appropriate positions. The piano keyboard can be obtained ready printed from Hobbies Ltd, Dereham, Norfolk price 1s. 3d. (postage 4 $\frac{1}{2}$ d.). Finish off the piano with black high gloss enamel. (M.p.)

AN EASY PROJECT
WHICH WILL PLEASE
EVERY LITTLE GIRL

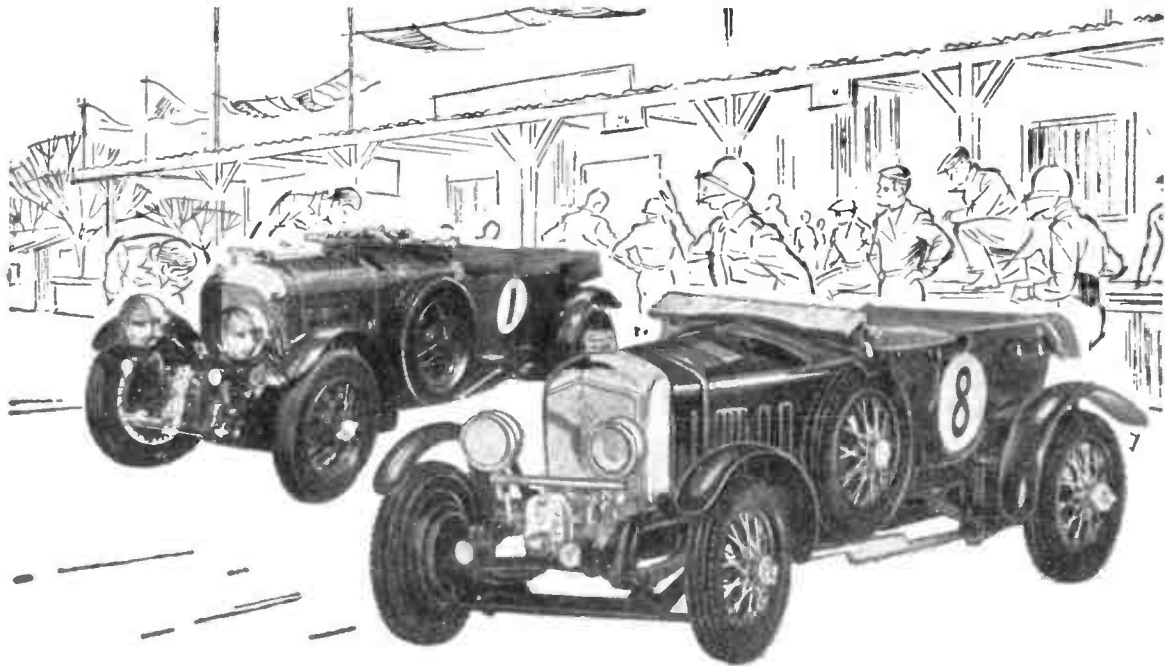

Just like the real thing!

Believe it or not, the nearer one is the Airfix model of the 1930 Bentley, 1/32nd scale (Kit 2/-). Behind it is a picture of the real thing.

That's how wonderfully realistic Airfix models are. Close attention to every detail gives them their faithful-to-the-original look—makes them true collector's pieces. And every Airfix series is to a constant scale. This means Airfix models look proportionally right, one against another, because they *are* right! You can't beat Airfix for realism—or value.



Constant Scale Construction Kits

From Model & Hobby Shops, Toy Shops, and F. W. Woolworth

Now see the whole range in the NEW Airfix Construction Kits Catalogue

Every series fully covered in 28 pages of photographs of models, facts and kit details. The perfect Airfix reference! Ask your dealer for the Airfix Catalogue—only 9d.



There are over 140 Airfix models from 2/- to 10/6.



AIRCRAFT

Bristol Superfreighter 7/6

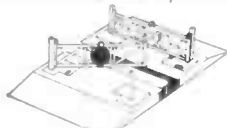

TRACKSIDE SERIES

Level Crossing 2/-



MODEL FIGURES

Lifeguard 2/-

BRITISH WARSHIPS

H.M.S. Cossack 2/-



C160R

STOP PRESS!

Latest Airfix Production

FOREIGN LEGION



This exciting Kit contains 48 'OO' scale figures in realistic fighting positions and includes horses with Officer Riders, Standing Officers, Bugler and numerous riflemen — 2/-