

21st MARCH 1962

VOL. 133

NUMBER 3458

THE ORIGINAL
'DO-IT-YOURSELF'
MAGAZINE

HOBBIES *weekly*

FOR ALL
HOME CRAFTSMEN

Make this ideal Gift for a Child **TOY MOBILE SHOP**

Also in this issue:

DISC BREAK
PERSONALITY

COLLECTORS' CLUB
— LATEST ISSUES

PLANS FOR MODEL
SWISS CHURCH

TRANSISTOR
CIRCUIT BOARDS

PROSPECTING
AS A HOBBY

SCIENCE TRICKS

ETC. ETC.

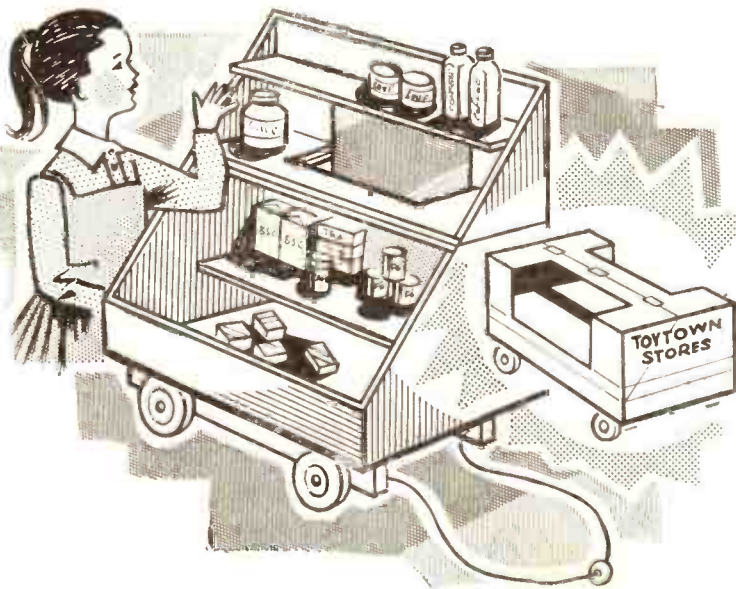

BONUS PLAN **SCISSOR HOLDER — PINCUSHION**



Up-to-the-minute ideas

Practical designs

Pleasant and profitable things to make

5^D



★★★★★★★★★★★★★★★★
 ★ NOTE TO ★
 ★ CORRESPONDENTS ★
 ★ All correspondence on any sub- ★
 ★ ject covered in this magazine ★
 ★ must be addressed to: The Editor, ★
 ★ Hobbies Weekly, Dereham, Nor- ★
 ★ folk. If a reply is required, queries ★
 ★ should be accompanied by a ★
 ★ stamped addressed envelope and ★
 ★ reply coupon inside back cover. ★
 ★★★★★★★★★★★★★★★★

CONTINUING our theme concerning clerical clothes we note that the Methodists, Congregationalists, Baptists and other Non-conformist communities in England have practically nothing in the nature of vestments. Even the heads of the churches, when they preside over the annual conferences, wear their ordinary black coats.

THEME TIME:

DRESS OF THE CLERGY — 2

The Puritans objected to the surplice as 'a relic of popery', and did what they could to get it banished from the Church of England. In the pulpit they wore a black gown, and this is the custom some Nonconformist ministers have maintained. This garment, there is no doubt, came originally from the universities. It is said that after the Reformation the clergy who did not hold degrees 'regarding enviously the comely, wide-sleeved gown, which was the mark of the graduate, adopted a gown of their own or of Geneva devising'.

In the Presbyterian pulpits of Scotland the black gown is still generally worn, and with it a pair of white 'bands' at the throat. The bands are a remnant of the old university ruff, or perhaps the broad white collar which fell over the shoulders of Puritan and Cavalier alike.

A few Presbyterian ministers now wear with the black gown the hood of their university.

The Moderator of the General Assembly is the one man in the church who is permitted to make some display in the matter of costume. In the Established Church of Scotland the Moderator wears full Court dress, with lace ruffles at the breast and cuffs, the vest open to show the ruffles.

100 DIFFERENT FOREIGN COINS, 100 different denominations of 65 different countries all brilliant uncirculated in exchange for any four Great Britain or British Commonwealth crowns or any eight George V and Edward VII half crowns. Free eight-page foreign coin price list. — Regency Coin, Rupert Ave., Winnipeg, Canada. (ADVT.)



Appropriate labels to illustrate the 'dress' theme

He is entitled to be called Right Reverend, and his precedence is the same as that of a Bishop of the Church of England.

The use of Court dress by the Moderator seems to rest upon no stronger law than that of usage. At one time it was certainly convenient that he should wear this costume during the sitting of the Assembly. For when Scotland had a Sovereign of its own the Moderator might be summoned at any moment to

Holyrood, and had, of course, to appear in Court dress.

In the Free Church of Scotland the Moderator of the General Assembly also wears Court dress, but seems to eschew lace ruffles at the throat and wrists.

In the third great section of the Presbyterian community in Scotland, the United Presbyterian Church, the Moderator of the annual Meeting — in this case called the Synod — is content with the ordinary Geneva gown and bands.

SWEDISH POST OFFICE CENTENARY

ONE hundred years have elapsed since the local mail delivery service was introduced in the Swedish Post Office. In commemoration two new postage stamps of the value 30 öre (violet) and 1 krona 70 öre (red) were issued on 29th January.

The design of the stamps — the same one for both — is by the artist Pierre Olofsson, and the text drawn by the artist Karl-Erik Forsberg. Czeslaw Slania has engraved the stamps. The picture size is 27-25 by 20-50 mm.

The stamps are furnished in coils of 100 stamps (perforations on two sides). The 30 öre stamp is also in booklets

containing twenty stamps (perforations on three sides).



ETHIOPIA'S NEW 'SPORTS' SET

THE first ever sports stamps from Ethiopia appeared from 14th to 21st January, to mark the 'Third Africa Football Cup'. The contest took place at Addis Ababa, the capital.

The following sports and games are featured:

'Guks' — Warlike Horsemanship — 10 cents green and red.

In royal circles in Ethiopia Guks was until recently a popular game with the young and old. In war the practice often became handy when the enemy was chased and stabbed with a spear. Duels were fought on horse-back, and the shield was used for protection. Consequently, from the Sovereign to the lowest member of the Imperial retinue everyone was familiar with this warlike game. In peace time Guks is a colourful game, the intensity of which sometimes brings fatal wounds to the less careful participants.

'Ganna' — Ethiopian Hockey — 15 cents rose and brown.

Ethiopian hockey can be a dangerous game in that the players are ill-protected against the hard ball.

'Cycling' — 20 cents red and blue.

'The Third Africa Cup — 1962' — 30 cents blue and violet.

'Marathon Winner' — 50 cents gold and green.

This stamp depicts Abbebe Bikila the Marathon Champion of the seventeenth Olympic competition held in Rome in 1960.

Get this set now.



See text for description of these issues.



Still on a 'sports' theme we show two stamp designs issued by France in January featuring the World Ski-ing Championships

MATCH LABELS FROM RUSSIA



A new set of Russian match labels has just been issued with this 'sporting' theme

Advertisers' Announcements

STAMP PACKETS OF QUALITY (All Different)

100 Great Britain	20 Br. Guiana	3/-
(All Obsolete)	10 Br. Honduras	2/3
50 — do —	10 Dominica	2/3
100 China	10 Saudi Arabia	2/-
100 Hungary	10 Nth Borneo	2/6
25 Finland	25 Ceylon	1/9
25 Sweden	50 India	1/6
10 Iceland	25 Egypt	1/3
25 Russia	25 Malaya	1/6
100 Germany	50 Roumania	1/9
10 Ascension	50 N. Zealand	3/-
7 Brunei	50 Sth Africa	3/-
250 World	4/6 100 Canada	6/-
100 Br. Empire	3/6 100 Australia	5/-

Orders under 5/- postage 3d. extra. We despatch per return of post. Satisfaction Guaranteed. 8-Page Illustrated List of Sets. Packets, Albums, etc. or Lists of USED G.B., India, Australia, Canada, S. Africa, N. Zealand, or U.S.A. are available upon request.

J. A. L. FRANKS LTD. (Dept. H.W.)
140 Fetter Lane, London, E.C.4

50 STAMPS FREE — Ask to see my approvals. — GBN(H), 41 Collins Road, Wednesbury, Staffs.

EUROPA GERMAN 1/5 set, other items C.W.O., S.A.E. — Stamp Supplies, 15 Queenshill Avenue, Leeds 17.

G.B. SILVER JUBILEE set complete (2½d. very scarce), price 2/- or if Commonwealth Approvals requested, 6d. only. — Sterling Stamp Service (H), Lancing, Sussex.

50 DIFFERENT FREE! Request discount approvals. — Barker, Thrushes Mead, Edgton, Salop.

FOR SALE — NEWFOUNDLAND STAMPS! 100 fine N.F.L.D. stamps \$1.00 — 1,000 \$9.00 — 2,000 \$15.00 — 50 all different \$2.00 — 100 all different \$6.00 order now from HARRY PHILLIPS SALES, BONAVISTA-2K, NEWFOUNDLAND, CANADA.

100 DIFFERENT stamps free! Request 4½d. upwards discount approvals. — Bush, 53 Newlyn Way, Parkstone, Dorset.

LARGE BRILLIANT WORLDWIDE Junior Bargain Approvals. 3d. postage. — J. P. McSherry (H-W), 28 Clarendon Road, Edmonton, London, N. 18.

FREE FREE FREE super stamp album plus a free packet of exciting stamps and 4½d. stamp for approvals. Reeder, 68 Blackmoor Road, Leeds 17.

100 STAMPS FREE request approvals. Nunn. 80 Chantry Road, Chessington, Surrey.

CIRCUIT BOARDS

TRANSISTOR amplifiers and receivers are often built upon a flat circuit board of thin insulated material. This is a very handy method to use with home built equipment, and is easy to follow, with little chance of making errors in wiring.

The circuit board can be of $\frac{1}{16}$ in. thick Paxolin, for all but unusually large equipment. Sheets of Paxolin may be obtained, and cut to the required size with a small saw. Drilling is also easy, and two small drills will do for most items — one about $\frac{1}{8}$ in., to give holes for 6 BA bolts which may be used to fix the board, or anchor leads, and one about $\frac{1}{16}$ in., to make small holes for wires.

When a circuit board is wired up as described here, it is quite in order for wires to cross each other. But the layout has been arranged so that no wires cross, because this is the system which is necessary with 'printed circuits'. These special circuits are described later.

Amplifier

The circuit board described here will take a 4-transistor amplifier, which may be used with a microphone, gram pick-up, or to amplify signals from a radio previously used to work headphones.

The amplifier has a push-pull output stage (similar to that dealt with in Fig. 26) and will give a really good output, with low battery drain.

If the constructor should want a smaller amplifier, it is in order to build only that part of the circuit which is required. For example, if the signal available is such as would give a good phone volume, the first stage of the 4-

transistor amplifier can be omitted. That is, the $8\mu\text{F}$ and $30\mu\text{F}$ condensers, 56K , 10K , 1.2K and 3.9K resistors, and the transistor. The input is then taken to the second $3\mu\text{F}$ condenser.

In the same way, one, two, or three transistors may be used in any of the

pected, even with very small input signals to the amplifier.

The circuit is shown in Fig. 44, and the various items in it have been explained in earlier circuits. A driver transformer couples the second transistor to the push-pull output pair. This driver transformer has coloured leads to identify connections. They are as follows: Brown for driver collector, Blue for battery negative, Yellow and Green for output transistor bases, and Red for base supply resistors (6.8K and 220 ohms). The output transformer also has coloured leads: Yellow and Green for output transistor collectors, Red for battery negative, and enamelled wires for loudspeaker.

Other transistor driver and output transformers will be perfectly satisfactory. Colour coding may then be different, so the maker's leaflet, which will

By 'Radio Mech'

circuit arrangements previously described, simply by omitting that part of the amplifier which is not required. For example, one or two transistors might be wanted to provide amplification for headphone listening.

In all normal circumstances, more than four transistors will not be wanted, as full loudspeaker output can be ex-

THIN PAXOLIN ABOUT 3 IN. X 6 IN.

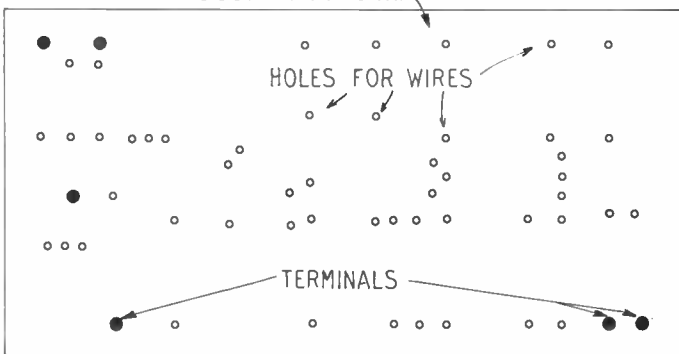

Fig. 45—Circuit board drilled for use

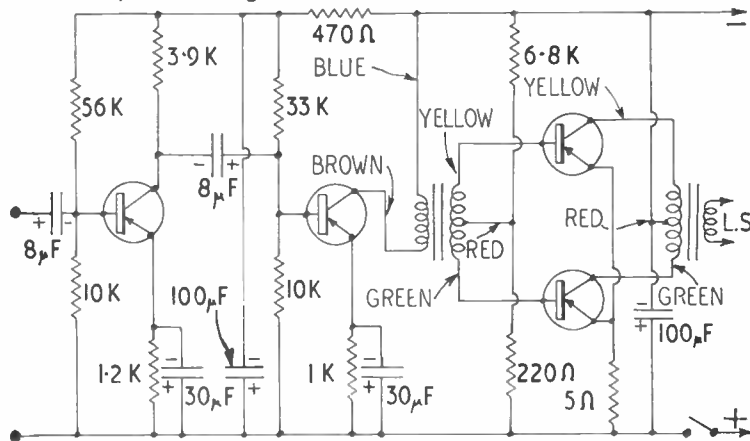

Fig. 44—Circuit of the 4-transistor amplifier

give connections, should be followed.

(The actual driver and output transformers in Fig. 44 are made by Osmor Radio, 418 Brighton Road, South Croydon, Surrey.)

Board drilling

A board 3 in. by 6 in. will easily take the components, and Fig. 45 shows how it is drilled. It is best to mark a piece of stout paper or thin card, then to place this on the Paxolin, and pierce a hole through at each required point. These marks can then be used as a guide, when drilling. Some error in the positions of holes will have no effect on results, though accurate drilling will give a neater appearance.

Six 6 BA bolts are used — two for input, two for battery leads, and two for speaker connections. All the other holes are for wires only.

Fragments of Paxolin can be cleared away with a turn or two of a larger drill, or any similar method. Counting the holes, or checking them with pencil on the card mentioned, will ensure none is missed. Should any be missed, so that they have to be drilled later, take care not to damage parts already fitted.

Component mounting

Fig. 45 shows the underside of the board. It is turned over, and the resistors and condensers shown in Fig. 46 are fitted. This is done simply by putting the wire ends of the parts through the holes, as was shown in Fig. 31.

The five condensers have positive and negative ends, and must be placed as in Fig. 46. The resistors may be placed either way round, but make sure each is of correct value for its position on the board.

The transistors indicated in Fig. 46 have red dots to show the collector wire. Collector, Base and Emitter wires go through the holes in the order shown in Fig. 46.

Leads from the two transformers are bent so that they emerge through the holes in the positions shown in Fig. 47. The leads, and a touch of cement under each transformer, will hold them in place.

Check that all parts are in the correct positions. With circuit boards of this kind, this is usually easy.

Wiring

The board is then turned over, and the projecting leads are wired up as shown in Fig. 47. In some cases, it will be convenient to bend over the leads, and solder them to the appropriate points. But in other places thin connecting wire will be needed. This is looped round terminals, or the wire ends of resistors, etc., and soldered.

Leave the transistor leads almost full

length. They are bent over and soldered to the various connecting points. Soldering details have been given previously. All parts to be soldered must be bright and clean. Joints can be made quickly and well, if the iron is hot enough, and a cored solder is applied to the joint (not to the iron). Remember to avoid lengthy heating of transistor wires.

When wiring is completed, it will resemble Fig. 47. If each lead in Fig. 47 is marked with a coloured pencil, as it is actually completed, there will be no possibility of missing any connections.

Using the amplifier

The amplifier may be operated from a 6V., 7½V., or 9V. dry battery. More than 9V. should not be used. An ordinary on/off switch is included in the positive battery lead, and can be fixed on the side of the box holding the amplifier, or elsewhere, as preferred. Use a proper battery plug or non-reversible clips, or be sure the battery is always connected the right way.

Any ordinary 2/3 ohm permanent

magnet moving coil speaker is satisfactory. If size is important, a miniature 2½ in. or 3 in. or similar speaker can be used. If not, a larger speaker, such as a 5 in. or 7 in. model, can be employed. The speaker should be in a cabinet or case. The flex-leads go from the speaker to the two terminals near the output transformer, as in Fig. 46.

If the gram pick-up or radio unit does not have a volume control, one should be fitted, as volume will probably be too great. A 1 megohm potentiometer can be used for this purpose. Wire the slider tag to the 8µF input terminal (Fig. 46) and one outer tag to the other input terminal. Take the pick-up or other input to the two outer tags of the potentiometer.

If the potentiometer has a switch, this can be used for on/off purposes. For a crystal pick-up or similar high impedance input, wire a ¼ megohm resistor between pick-up and volume control potentiometer.

Reproduction should be of very good quality. If it is wished to experiment in this direction, 'negative feedback' can be added. To do this, wire one loudspeaker terminal to the positive line in Fig. 47. Connect a 47K resistor from the other speaker terminal to the collector of the first transistor. There should be a small drop in volume. If howling arises instead, reverse the two leads which go to the speaker terminals in Fig. 47.

Printed circuits

It will be realized that other transistors could be used. The way to obtain best results from different or surplus transistors has been dealt with. A good transistor is particularly necessary in the first position. If this transistor is defective and noisy, all the noise it produces will be amplified by the following transistors, and will give a loud hissing in the speaker.

A printed circuit is a sheet of thin
● Continued on page 398

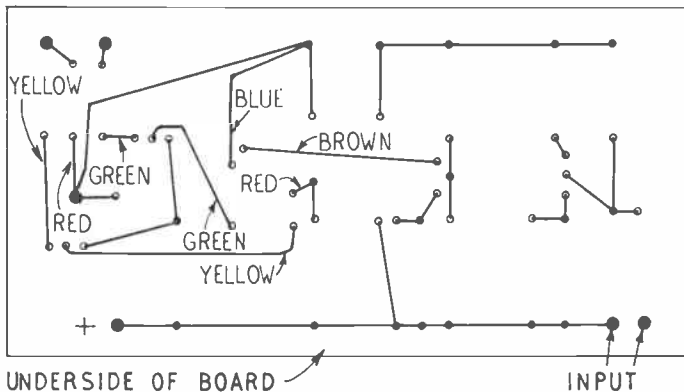

Fig. 47—Wiring under the circuit board

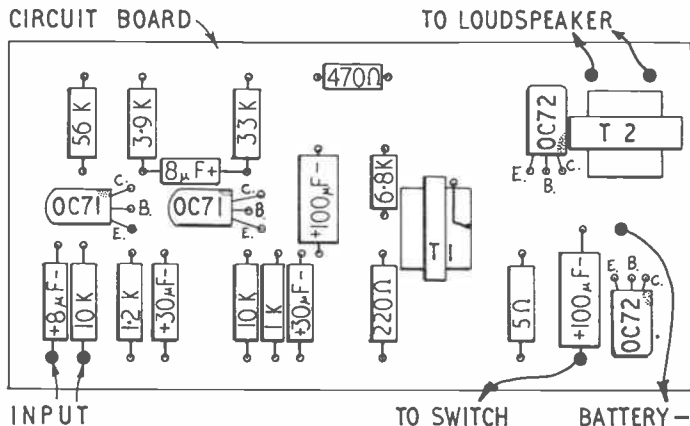

Fig. 46—Components on the circuit board

CAMPING Notes

by Ed Capper

NEARLY half your time on a camping holiday will be spent in bed — more if you are the lazy type. You can fall asleep quickly and soothingly or you can toss and turn all night. It depends on how you approach the matter.

Once your tent is erected, lay out your bedding. It will then absorb the day's heat and will expand to hold it.

MAKE THE MOST OF YOUR BED

Unless you really like to rough it, you will sleep on an air bed. Most people over-inflate them. It may feel comfortable at first until you start rolling off. So, inflate it just enough to keep you off the ground. The same applies to air pillows. If you find these too low for your comfort, pack them up with a blanket.

Bedding should be arranged fifty-fifty, with as much below you as above. Some people are used to sleeping at home under heavy blankets. If this applies to you take along a couple of thick woolly blankets. In any case, extra blankets at hand are always useful. Your tent may feel overwarm when you first retire but the two hours before the dawn can be very chilly.

Avoid cold feet

Most campers wake up with cold feet, which can be overcome by wearing thick bed socks. If you find your feet get too warm, make the bed correctly and dispense with the socks. Fold the blankets at the feet end down and under the portion of the bedding on which you will lie. In short, make them up like a sleeping bag, giving your feet no chance of escaping from under the blankets.

It is always better to change your attire before going to bed. It need not be strictly into pyjamas but into a spare shirt and shorts or slacks, kept for the purpose. Let's face it, we all perspire a little whilst we are asleep. You won't enjoy your breakfast if you are seated next to someone still wearing his slept-in clothes!

And do go to bed feeling warm. For one thing the bedding will absorb and retain your body heat and you will drop off to sleep more easily. Before retiring,

go for a brisk walk or arrange a lively game to keep your circulation in trim. Never go to bed with cold feet. The best cure for this is to rub them briskly with a dry towel.

Goodnight and pleasant dreams . . .



Not recommended !

● Continued from page 397

TRANSISTOR CIRCUIT BOARDS

insulated material, which was covered one side with a thin, conductive metal like copper foil. A protective varnish is applied where the foil is to remain, and the board is etched in a solution which dissolves away the unprotected foil. This leaves strips of foil in the required positions, to act as connections.

It will be seen that connections cannot cross over each other, so printed circuits are arranged with no crossing connections, as in Fig. 47. The actual foil connections are left rather wider than ordinary wires, and holes are drilled where resistors and other parts are to fit.

With a printed circuit board, it is thus only necessary to insert all the resistors and other parts, like the example in Fig. 46. The board is then turned over, and the projecting wires are cut off and soldered to the foil.

With such a printed circuit board wiring must be correct, because connections are already on the board, so no mistake is possible, if parts are placed with their leads in the correct holes.

Such printed circuits are produced for various units, such as amplifiers and receivers. Their great advantage is that they allow a particular unit to be made

Site report

Opened less than two years ago, the camping site at Penrhyn, Dinas Cross, Newport, Pembrokeshire, has fast become popular. Run by Messrs. A. R. and J. Tucker, it boasts modern sanitation, stand pipes at various points, showers and bathrooms, a drying room, common room and camp shop. Laundering facilities will be added for the coming season.

The camp is well drained and there are plenty of bunkers and hedges to afford shelter. Most of its charm lies in its glorious situation overlooking the sea on National Parkland. It is an ideal centre for swimming, boating, fishing, golfing, and walking. The coastline is still unspoilt with wonderful views. Wild flowers grow in profusion and there is an abundance of bird life.

There is a tarmac road approach to the site and cars are allowed to park alongside tents. The site has a private access to its own bathing cove. The camp lies immediately off the A487 road, 2½ miles from Fishguard and 4 from Newport. The nearest station is Fishguard and Goodwick from which buses run to the site.

Site rents are 5/- per night for two persons, including a car, or 30/- per week. Extra persons are charged 1/- per person per night.

Quik-Tip



CUT FLOWERS LAST LONGER IF 'FED' WITH A LUMP OF SUGAR IN THE WATER

Make This Travelling Toy Shop

A MODEL travelling shop makes an attractive toy for young children, for both outdoor and indoor use.

The structure is basically box-shaped in the closed position, with an opening section which hinges upwards to form a reasonably large shop with ample counter space when the shop is open for business.

Fig. 1 shows the method of construction. The base A is a 20 in. long and 12 in. wide piece of $\frac{1}{2}$ in. thick chipboard. The two ends B are 12 in. wide and 10 in. high, and can be made of hardboard or plywood. A triangular corner section, 6 in. wide and 6 in. deep, is cut from each end piece, as shown in Fig. 2. These corners are later used for the opening section. The two ends are pinned and glued to the base, then section C is added. This is a 20 in. by 6 in. piece of chipboard or $\frac{1}{2}$ in. thick wood, with a 12 in. by 4 in. panel cut out of the centre of one side. The side D is a 20 in. by 10 in. piece of hardboard or plywood with a 12 in. by 4 in. panel cut from the centre of the upper edge. This is also pinned and glued in place, with a

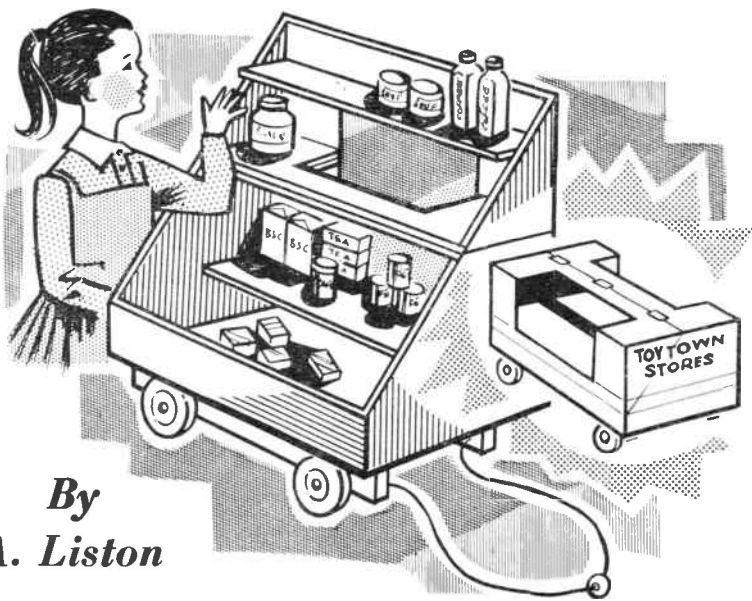

By
A. Liston

20 in. by 6 in. piece of $\frac{1}{2}$ in. thick wood fitted to its inner side, flush with the lower edge of the cut-out window panel E.

Section F is a 4 in. by 20 in. piece of hardboard or plywood, which is pinned to the base. At this point, the inside corners of the shop can be strengthened with triangular fillet strips, if desired.

The opening section, shown in Fig. 3, is now made. The two triangular end

pieces cut from the end walls are pinned and glued to the top G, which is a 20 in. by 6 in. piece of $\frac{1}{2}$ in. thick wood, with a 12 in. by 4 in. panel cut in its outer edge. The side H is the same size, with a similar cut-out, but is made of hardboard or plywood. The shelf J is a 20 in. by 3 in. piece of $\frac{1}{2}$ in. thick wood pinned in place level with the lower edge of the cut-out section in the side H. Strengthening fillet strips may also be glued inside the corners of this section before it is fitted in place with three brass hinges.

Two rubber-headed studs are tapped in place at each corner of the top of the opening section. This is to match the thickness of the hinges, so that the top section rests evenly and steadily when it is opened.

The four 3 in. diameter wooden wheels are screwed to two 16 in. lengths of 2 in. by 1 in. wood. These are screwed in turn to the underside of the base, 1 in. in from each side. Neat hub caps, which hide the heads of the screws in each wheel, are metal furniture glides tapped gently into place.

The exterior looks best enamelled in two colours, with the interior finished in white or cream. A length of cord stapled to the ends of the 'chassis', and with a wooden ball threaded on to it, should be fitted for pulling the shop along. Any lettering can either be painted on with a small brush, or transfers used.

A set of four hardwood wheels, size 3 in., can be obtained from Hobbies Ltd, Dereham, Norfolk, price 2s. 9d. (post 9d. extra).

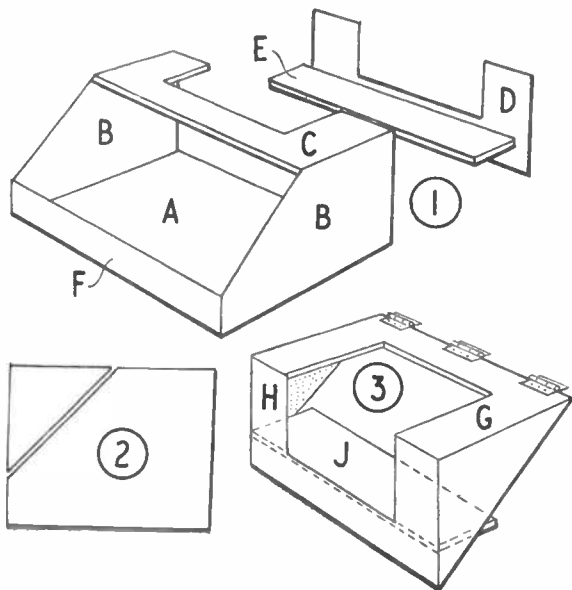



BONUS
PLAN

"Moggie" SCS



HOBBIES
WOOD
KNOB
No. 15

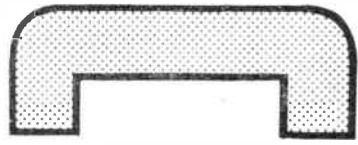

PIECE C CUT ONE
FROM 1/2" WOOD



C AT BACK

PAINT
ON
EYES

CUT DISCS
OF FOAM RUBBER
THIS SIZE AND
GLUE IN PLACE

PIECE
CUT ONE
1/2"

PAINT ON

"IT'S
SO
EASY"

PIECE A. CUT ONE
FROM 1/4" WOOD

B

SCISSOR HOLDER - PIN CUSHION

WOOD
KNOB
No. 15



FOAM
RUBBER
DISC



**AN
IDEAL
GIFT**

E B
NE FROM
WOOD

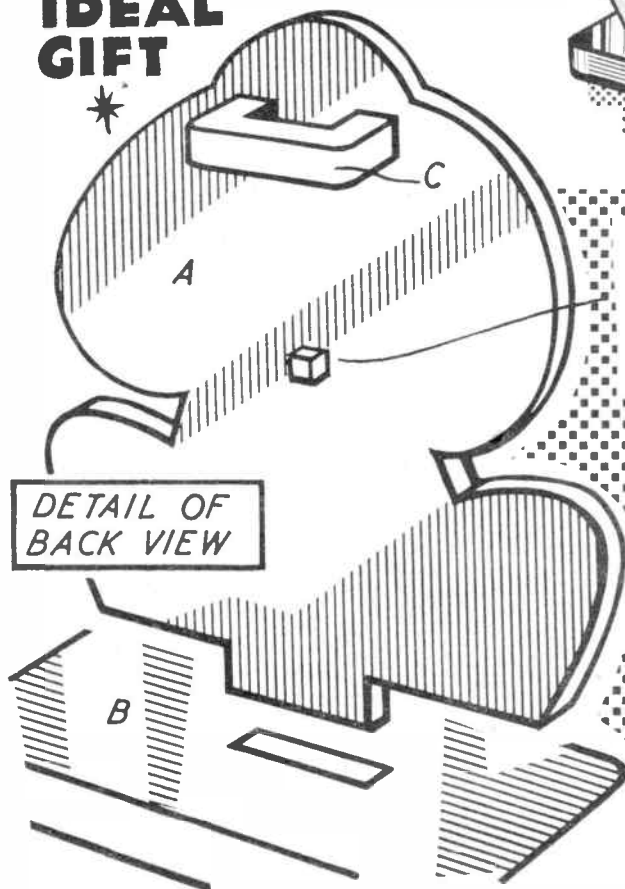

SMALL BLOCK TO
STOP SCISSORS
FALLING TOO
LOW

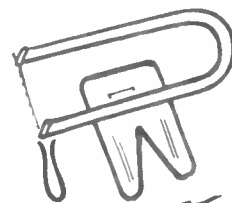

- * FRETSAW
- * CUTTING
TABLE.
- * DRILL.

FUN WITH THE AIR

TREMENDOUS heating effects, due to friction with the air, usually destroy high speed meteors and 'sputniks' as they plunge into the atmosphere from the emptiness of outer space. Records automatically transmitted down to earth from research satellites encircling the planet suggest that the 'sea of air' which surrounds our world is several hundred miles deep, though the air at the top of the atmosphere is very thin indeed. Nevertheless, the mass of air which extends above our heads exerts a pressure of almost fifteen pounds per square inch at sea level. Thus air will press down upon a man's outstretched hand with a total force of over two hundredweights.

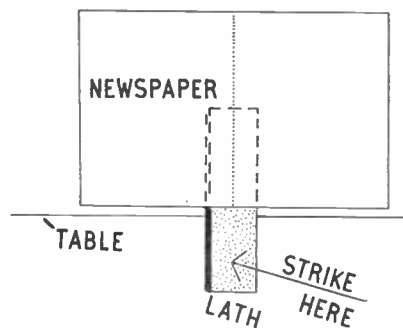

Why are we not crushed by the great forces of atmospheric pressure which act upon our bodies? The simple answer is that air inside us counteracts the terrific external forces. Your extended hand is not cruelly dashed to the ground by air pressure, because the compressed air below your hand equalizes the formidable downward pressure by pushing upwards. For it is a law of nature that, at any given depth, air pressure acts in all directions.

A convincing experiment with a newspaper and a wooden lath or old ruler will illustrate how real atmospheric pressure is. In order to make the downward pressure effective we will employ the newspaper to prevent the upward pressure acting at the crucial moment of the experiment.

Rest the lath across the edge of a flat table top. The wood should project into space for one third of its length. Open out the newspaper and spread it over the part of the lath which actually touches the table. It is important to smooth the paper as flat as possible against the table. When all is ready, stand beside the table and suddenly

strike the projecting end of the lath a powerful blow with the edge of your hand. The lath will be shattered into two pieces. At the moment that you strike the wood, there will be virtually no air underneath the paper, so air pressure equivalent to over one ton will, for an instant, press upon the paper and lath, as if it were a huge iron weight, thus making your feat possible.

By A. E. Ward

Stand well clear of the apparatus when you perform the experiment to avoid being struck by the fractured wood, should it fly violently outwards. It is perhaps a better idea to hit the lath with a length of broom handle. Also remember to carry out your demonstration where there will be no danger of accidentally causing damage to delicate property. A careless experimenter will never be popular in the home!

A 'Magic Tin' will provide an amusing and instructive toy for a youngster. Obtain a tall round tin with a press-on lid and begin by boring a pattern of little holes in the bottom, using a small nail and a light hammer. Bore a ring of similar holes near the base of the tin about $\frac{1}{2}$ in. above the lower rim, and make a single small hole about 1 in. below the top rim. Paint the apparatus jet black. Fill the tin with water and quickly press on the lid. Then lift the tin whilst pressing your thumb over the small hole near the top. In spite of the numerous perforations in the tin, the water does not escape.

Minute 'skins' of water molecules will bulge a little beyond the tiny holes in the metal and these diminutive forces of surface tension will help to confine the liquid to its container. But the main reason why the water will not run away is that air will be unable to enter the tin to replace the liquid. Use a penny to prise open the lid, using your left hand, and immediately the water will gush out of the holes. Suddenly ram down the lid again and the display of escaping water jets will abruptly cease. Now lift your thumb from the secret hole and observe how the water will flow again. You will actually be able to control the flow of water from the tin by scarcely perceptible thumb movements.

A demonstration of science 'magic' is now possible. Provide yourself with a jug of water and a large bowl in which the water issuing from the tin may be safely caught without making a mess.

Whilst keeping your thumb over the hidden hole (which should be on your 'body side' of the apparatus) proceed to show how the tin works when you alternatively lift and press down the lid. Accompany your performance with the proper scientific explanation of the effect. When your audience is really becoming interested, offer to make the tin work by magical means.

Secure the lid and playfully pretend to start the water flowing by merely blowing upon it or tapping the side with a pencil. Of course you will control the

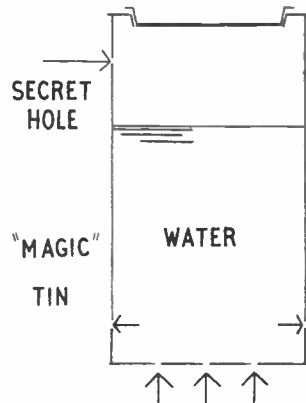

water flow with your thumb. Great fun can be had if you announce that the tin is a very temperamental performer and deliberately prevent it from working every time you blow or tap. Let the water start to flow at some moment when you have turned aside to speak, and affect surprise and annoyance at the tin's obstinate behaviour. It will not matter if your friends eventually discover your subterfuge, for the principal purpose of the 'Magic Tin' is to provide you with entertainment.

APRIL 30th

This is the last day for receiving entries in Hobbies 1962 Fretwork Competition, first prize for which is a cheque for £15 15s.

The design to be cut is a Thermometer Wall Plaque. Kit, design and full instructions price 4/6 from all branches or direct from Hobbies Ltd, Dereham, Norfolk (post 1/- extra).



Every handyman's right hand man for over 60 years

There's nothing like real SECCOTINE! For over sixty years Seccotine has been indispensable to every handyman. For sheer adhesive power buy Seccotine with the efficient new "pop-on" seal and open-nozzle tube ready for use.

STILL ONLY **1/3** PER TUBE

SECCOTINE

Sole Manufacturers — **McCAW, STEVENSON & ORR LTD., BELFAST**

HANDSOME VENEERED PANELS

ON $\frac{3}{8}$ in. PLYWOOD, in oak, sapele or walnut.

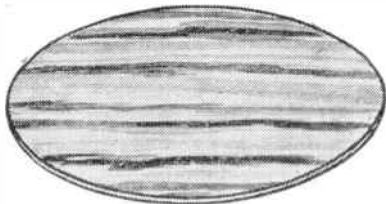

ROUND
Veneered both sides
22 in. diameter.

21/-
(post 2/9)

SQUARE
& OBLONG
Veneered both sides.
20 x 20 in. and
30 x 15 in.

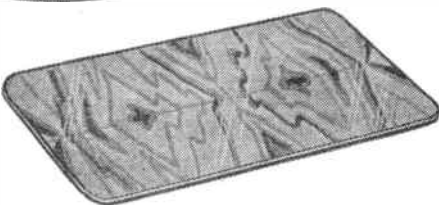

18/6
(post 2/6)

CURVED
ENDS
Veneered one side.

28 x 15 in. 27/6
36 x 15 in. 35/-
48 x 15 in. 52/6

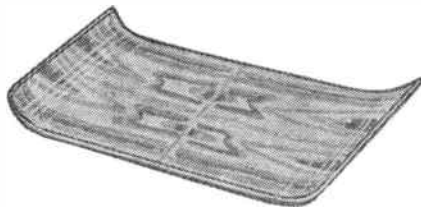

HOBBIES LTD (Dept. 99), DEREHAM, NORFOLK

***NOW** the most advanced range of finishes **EVER!**



HUMBROL

In handy $\frac{1}{2}$ oz tinlets 9d Economy size tin 2 oz 1/6d

Here's a first class family of fine finishes, something for every job the handyman tackles.

THE HUMBER OIL
COMPANY LTD
MARFLEET - HULL

The Pistol all your chums will envy!



AIR PISTOL



- ★ High Accuracy and Hitting Power
- ★ Perfect Balance
- ★ Robust Construction

Send for catalogue

WEBLEY & SCOTT LTD

34 PARK LANE, HANDSWORTH, BIRMINGHAM 21.

HEAR ALL CONTINENTS With H.A.C. Short-Wave Receivers

Suppliers for over 18 years of radio S-W Receivers of quality.

One-Valve Kit, Price 25/- Two-Valve Kit, Price 50/-
Improved designs with Denco coils. All kits complete with all components, accessories and full instructions. Before ordering, call and inspect a demonstration receiver, or send stamped addressed envelope for descriptive catalogue.

'H.A.C.' Short-Wave Products (Dept. 22), 11 Old Bond Street, London, W.1.

KITS for OLD TIME SHIPS

Hobbies range of Ship Models includes Elizabeth Jonas, Cutty Sark, Victory, Mayflower, etc. Complete kits of wood, sail material, guns, pulleys, cord, etc., with full-size patterns of parts and planed wood ready to cut out, shape and construct. A fascinating pastime.

Ask for free illustrated list at Hobbies Branches or from Hobbies Limited, Dept. 99, Dereham, Norfolk.

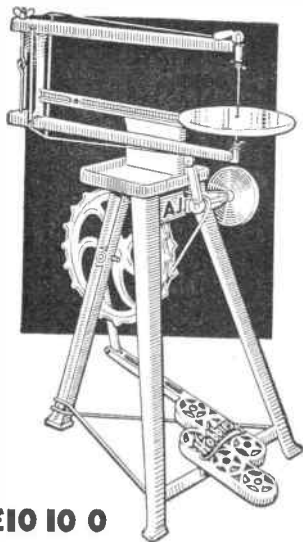

THE 'MARVEL' BENCH MOTOR-DRIVEN SAW
To meet modern needs. Just plug in and switch on from any house lighting point. For either A.C. or D.C. mains, with 230/250 volt motor, flex, switch etc.

£13 10 0

Also a Bench Machine without motor for £5 10 0.

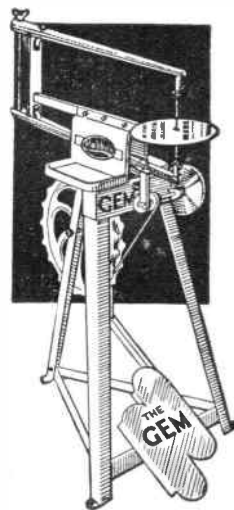
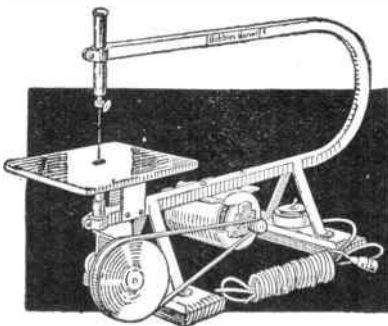

THE 'GEM'

£6 12 6

A lighter machine with pressed metal legs, but easy running and a reliable worker. Sound value and a machine for all kinds of work. Spare blades, instructions, and designs are included with each.

£10 10 0

'A.1' TREADLE SAW

A sturdy machine with cast metal legs, metal table, wooden arms, special saw tension action, etc. Easy to treadle, smooth running and rigid. Provides a factory at home for the handyman — a machine for profit and pleasure.

FAMOUS MACHINES AVAILABLE ON EASY PAYMENTS

A system is now in operation whereby a machine can be despatched carriage paid after the initial down payment and subject to the completion of a simple form of Agreement. The slight additional cost over cash price is to cover extra clerical work, books, interest charges, etc. It is impossible for us to allow this system to apply in any part of Ireland, or anywhere outside Great Britain.

Agreement Forms are obtainable at any Hobbies Branch, where machines may be seen, and money paid each month. Or you can do the business through Hobbies Head Office at Dereham, Norfolk, sending your instalments there.

Hobbies Ltd (Dept. 99) DEREHAM NORFOLK

MAKE new friends or marriage partners. Join V.C.C., 34 Honeywell, London, S.W.11.

IT'S EXCITING. IT'S PROFITABLE. Paint designs. Flowers. Anything. Even beginners' ideas can sell for £25/£60. Inexhaustible demand. Details free. **POPULAR ART SERVICES (HW), CLUN, SALOP.**

PERSONAL COLUMN LTD, Falcon House, Burnley, Lancs. Pen Friend — all hobbies. Correspondents in almost every Country. All ages. S.A.E. for details.

ENJOY WRITING? Then write for Profit. Send for 'Writers' Handbook' (free) detailing countless opportunities for beginner or experienced. — 'Writers' Ring (HW), 5 Edmund Street, Birmingham.

BRASS, COPPER, DURAL, ALUMINIUM, BRONZE

ROD, BAR, SHEET, TUBE, STRIP, WIRE
3,000 STANDARD STOCK SIZES

No quantity too small List an application

H. ROLLET & Co. Ltd.
6 CHESHAM PLACE, LONDON, S.W.1

Also at
Liverpool, Manchester, Leeds, Birmingham

200 —240v A.C. S/Ph 50c Geared Motors
2 R.P.H. at 13/6 each. — Universal
Electrical, 128b Camden Rd., London, N.W.1.

CHEMISTRY FOR BOYS. Chemicals Apparatus. Sets. Send stamp for leaflet. — Storer, 67 Clopton Road, Birmingham 33.

PERSONS with sewing machines required at once. Regular work. Send S.A.E. for details to Dept. 28, Arnold 10, Shelley Road, Worthing, Sussex.

LEARN RADIO & ELECTRONICS the NEW Practical Way! Very latest system of experimenting with and building radio apparatus — 'as you learn'. FREE Brochure from: Dept. H.W.10, Radiostructor, Reading.

FOR MODEL MAKERS
THE 'MIGHTY MIDGET' electric motor, only 1½ in. high. Runs at 10,000 R.P.M. from a 4½ V. torch battery. Minute current consumption. Complete with pulley, price 11/- postage 6d. **MODEL BOAT PROPELLER.** 3 blade shaft, pulley, and 5½ in. long stern tube, to run off above 'Mighty Midget'. Price 7/3; plus 6d. postage. **HOBBIES LTD. (Dept. 99), DEREHAM, NORFOLK.**

GLASS CUTTERS FOR THE HANDY MAN



With its six-wheel 'turret' this tool is just the thing for the handyman. It has a strong composition handle.

PRICE 2/9, postage 4½d.



Cuts circles 1½ in. to 10 in. diameter. Can also be used for straight cuts. The tool is housed in a pivot, the top of which serves as a thumb rest and adjustable nut lock. It has three cutting wheels.

PRICE 8/6, postage 6d.

HOBBIES LTD (Dept. 99), DEREHAM, NORFOLK

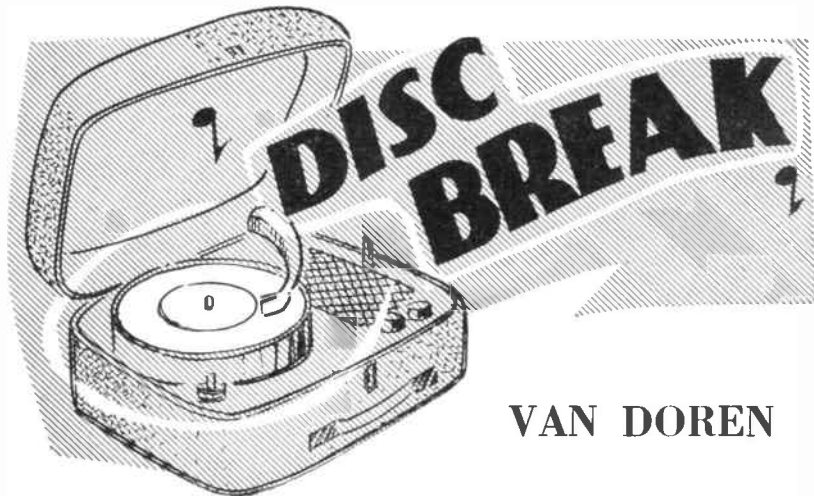

VAN DOREN



GOOD-looking, fair-haired Van Doren won his recording contract because E.M.I. A and R manager Norman Newell was watching television one night.

Says Van, Fulham-born 23 years ago and a graduate of the Royal Academy of Music, 'It happened during the run of *Something Old Something New* when I was with the Cliff Adams Singers. Cliff was taken ill and was unable to appear and I was called on to play piano in his place. 'It must have been my lucky night, for next day there was a phone call from Mr Newell inviting me to make a test recording.'

An early ambition for Van was to be a pilot, but his attempt to join the Fleet Air Arm failed through colour blindness.

At the time he was not old enough for National Service call-up, so he joined the Royal Academy of Music, studying singing, as a main subject, and the piano.

Before his studies were completed, Van was called-up. Commissioned, he was posted to Benghazi as lieutenant in charge of an RASC transport platoon. There he broadcast on Forces radio, acted in repertory and formed a jazz group.

'We ran a successful club and often civilians came to hear us play. On one occasion some oil prospectors invited us to play for them. So we borrowed the NAAFI piano and loaded it on to a truck in broad daylight, at considerable risk to ourselves since there were strict orders preventing it from being moved

even from one room to another. We drove off into the wilderness and about 150 miles out in the desert we found them — eight men living in tents. It must have been one of the strangest jam sessions ever held.'

A famous sporting personality sings — 'just for kicks' — with support from his wife and in-laws. See next week's Disc Break

After the army Van returned to the Royal Academy and completed his studies. Then came the need to find work. And Van, who is entitled to use the letters L.R.A.M. and G.R.S.M. after his name, was given a job playing piano in a Soho strip club — 'I was recommended by a coloured fire eater whom I'd met!'

Then came a part as a rock 'n' roll singer in a short-lived musical, *The Quiz Kid*, followed by a more settled existence with The Granadiers and, as they later became known, The Cliff Adams Singers. He was on *Song Parade*, *Two's A Crowd* with Marion Ryan, and *Something Old Something New*. As a solo pianist he joined Benny Lee and Robin Richmond in a radio series *Around Robin*.

Van has also composed the musical score for a science fiction film, *The Sleepwalkers*.

An admirer of Errol Garner, Vic Damone, Joe Williams and Dakota Staton, Van has ambitions to be a dramatic actor. In his spare time, which has been limited during the past two years, he likes driving, composing and the theatre.



"STOP POINTING THIS VERY MINUTE! IT'S RUDE TO POINT."



AMATEUR prospecting, or 'rockhounding' as it is known in the United States, is a hobby with a great deal to recommend it. As the amateur tracks down some uncommon mineral he feels something of the driving force which pushed the old 'Forty-niner' forward in his endless search for gold. And a collection of rocks and minerals attractively laid out has both interest and beauty, which becomes a source of continual satisfaction to its owner.

Prospecting is essentially an open air occupation, the best mineral sources being in the National Parks. It is a hobby that can be used as the object of a camping or hostelling holiday or even of a day's hike. The amount of equipment needed is very small indeed, in fact I think amateur prospecting could lay claim to being perhaps the most inexpensive hobby of all.

Hammer and bag

The basic equipment consists of a geologist's hammer and a collecting bag. The hammer, as shown, has a strong wooden hclve and a head which is squared at one end and tapers to a point at the other. This is used for cutting out and cleaning up mineral specimens, and is really indispensable, although it is possible to make do, I suppose, with an ordinary hammer and a cold chisel. The collecting bag can be any fairly small haversack, and an ex-W.D. gas mask case is ideal. With those two essentials, some warm clothing and a note book to record finds we are ready to go after our first sample.

The questions that arise now are where to look, and what to look for. As is true with most things, experience is the best guide. However, the beginner is lucky. There are several good, not-too-technical text books in and out of print, which, as well as giving comprehensive lists of what one may expect to find in a given locality, also give excellent descriptions of the physical characteristics of the different minerals. These descriptions

are particularly useful to the inexperienced, for whilst with a little experience the prospector can tell at a glance what this or that particular sample of rock consists of, the beginner will have a great deal of difficulty identifying even the commonest minerals without some sort of guide.

The area eventually chosen will depend on the individual prospector;

By D. Edwards

which part of England he lives in, what he wants to find, etc. From the point of view of scenery and mineral variety probably the best localities are North Yorkshire, Derbyshire, The Lake District, North Wales, and Cornwall. These have yielded a large range of ores from coal to gold, with even a little uranium (the latter found associated with tin in Cornwall).

When actually in the chosen area the best hunting grounds are the quarries and mines. The quarries offer large areas of freshly exposed rock to the prospector, while the mines generally have spoil heaps around the entrances to the levels, and these contain anything that the miner brought out that had no commercial value. In this last case it pays to know something about the mine. If the mining was for lead, say, then the spoil heaps, as well as containing small lumps of lead ore, will most likely also contain fluorspar and calcite, as these generally occur with lead. Thus when you start examining the spoil heaps you know more or less what you are looking for, which, of course, is a great help.

Old quarries

Much of the information about old mines and quarries can be obtained by talking to the local people in the area. The older ones may have actually worked

the mines and quarries, and as well as being able to direct you to the best localities, they will be able to give some indication of what minerals are to be found.

With mines and quarries that are still being worked, a letter to the owner will generally bring permission to explore, while sometimes a workman may be detailed to give a conducted tour.

Whilst mines and quarries are sure sources of mineral specimens, less obvious sites can also prove fruitful. River beds, rail and road cuttings, even the back garden; all can yield additions to the collection. Anywhere, in fact, that the surface soil has been disturbed is worthy of examination.

With so many possibilities, it is not surprising that the collection soon grows, and the question arises of where to keep the specimens. They are best kept in cardboard or wooden trays divided into sections, each sample occupying one section, and each bearing a label with name of mineral, locality in which it was found, and any other relevant information. The trays can be covered with sheets of glass to keep the specimens dust free, and trays can be stacked on top of one another to reduce storage space.

Minerals for exchange

Minerals can be arranged with respect to locality, or depending on composition. Some amateur prospectors collect ores of only one metal, such as lead or copper. Exchanges can be made with other collectors, and in this manner rare minerals, or minerals from distant localities can be obtained.

As will be seen, prospecting is a hobby of great scope. It is informative, since no matter how haphazardly the amateur goes about it he will quickly acquire a good basic knowledge of geology and mineralogy in the best possible way — by practical experience. It will bring him new friends, new experiences, and above all a deep satisfaction.

Plans for a simple project

MODEL SWISS CHURCH

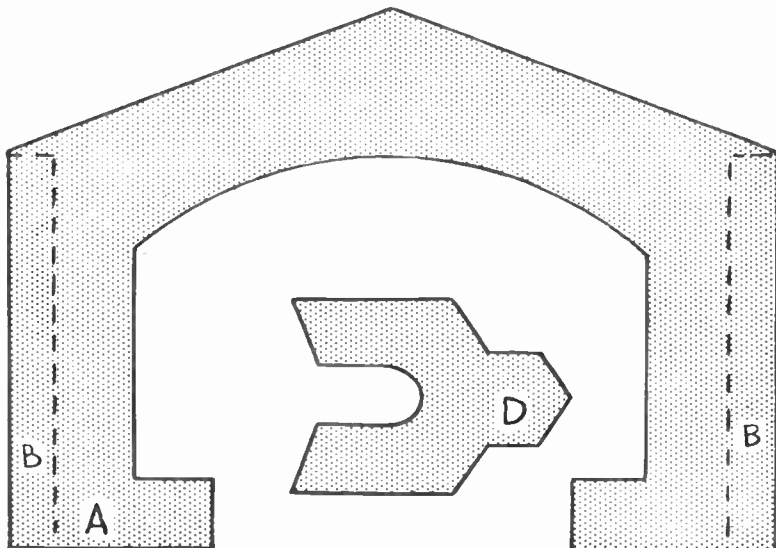
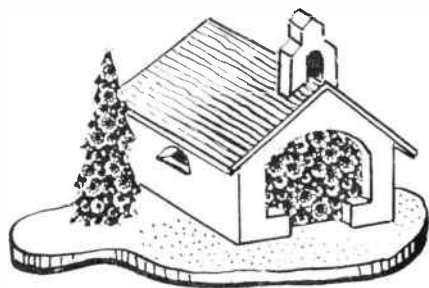
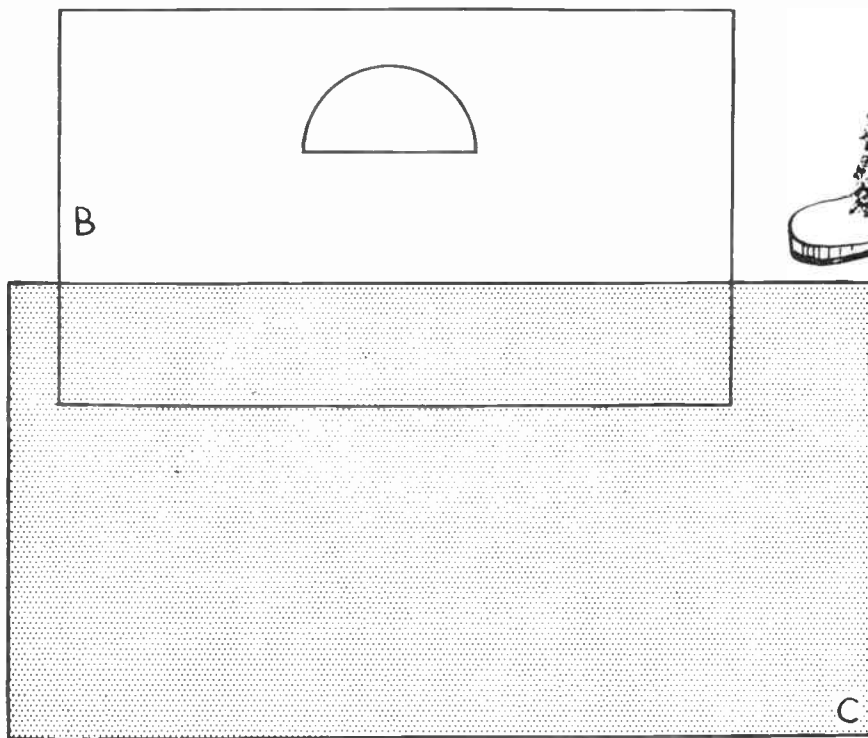

TRACE the various pieces, and transfer them to the appropriate thicknesses of wood by means of carbon paper. You will need two each of A and B, and one each of D and E, all cut from $\frac{1}{4}$ in. wood with a fretsaw. The two roof pieces C are $\frac{1}{8}$ in. thin wood or plywood. The base is an irregular shaped piece of $\frac{3}{8}$ in. wood, as seen in the illustration, no actual pattern being given.

The openings in pieces A and B should be blocked in by coloured card or material glued at the back. Assemble by gluing the sides B to the ends A, finishing with the roof pieces C, the bell tower D, and the tree E. The base is glued on last of all. Paint the church in suitable colours. If you wish to convert it to a musical cigarette box there is plenty of room inside for a Hobbies No. 1 movement. There are over 20 tunes available, price 14s. 11d. each. Send for list. (M.p.)

407

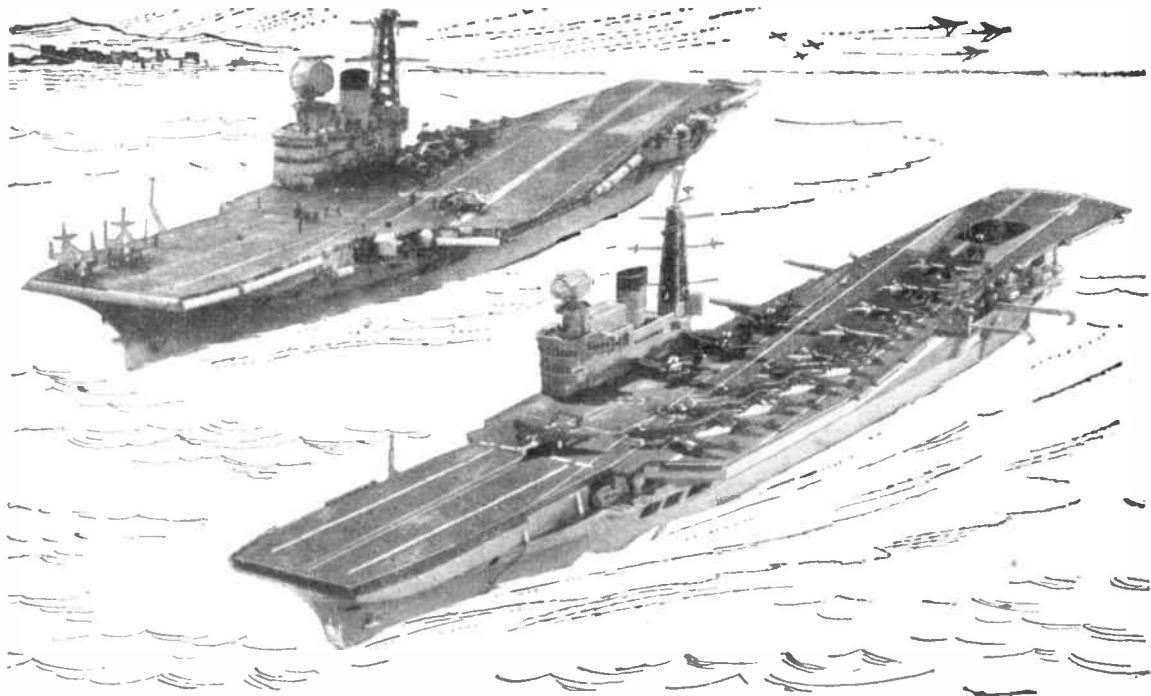

Just like the real thing!

Believe it or not, the nearer one is the Airfix model of H.M.S. "Victorious", 1/600th scale (Kit 6/-). Behind it is a picture of the real thing.

That's how wonderfully realistic Airfix models are. Close attention to every detail gives them their faithful-to-the-original look — makes them true collector's pieces. And every Airfix series is to a constant scale. This means Airfix models look proportionally right, one against another, because they are right! You can't beat Airfix for realism — or value.



Constant Scale Construction Kits

From Model & Hobby Shops, Toy Shops, and F. W. Woolworth

Now see the whole range in the NEW Airfix Construction Kits Catalogue

Every series fully covered in 28 pages of photographs of models, facts and kit details. The perfect Airfix reference! Ask your dealer for the Airfix Catalogue—only 9d.



There are over 140 Airfix models from 2/- to 10/6.



TRACKSIDE SERIES
Level Crossing 2/-



AIRCRAFT
Bristol Superfreighter 7,6



MODEL FIGURES
Lifeguard 2/-

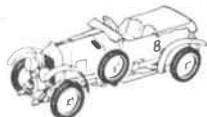

VINTAGE CARS
1930 Bentley 2/-

S160R

STOP PRESS!

Latest Airfix Production



H.M.S. CAMPBELTOWN

A new addition to the Airfix Famous War-ships Series. 2/-