

21st FEBRUARY 1962

VOL. 133

NUMBER 3454

THE ORIGINAL
'DO-IT-YOURSELF'
MAGAZINE

HOBBIES *weekly*

FOR ALL
HOME CRAFTSMEN

BONUS PLAN

Also in this issue:

A TILY FOR
THE BATHROOM

COLLECTORS' CLUB
— MANY NEW ISSUES

EXPERIMENTS IN
CHEMISTRY

CHOOSING YOUR
RAILWAY TRACK

FINISHING THE
PHOTO ENLARGER

CAMPING NOTES

PROJECT FOR
FRETWORKERS

ETC. ETC.

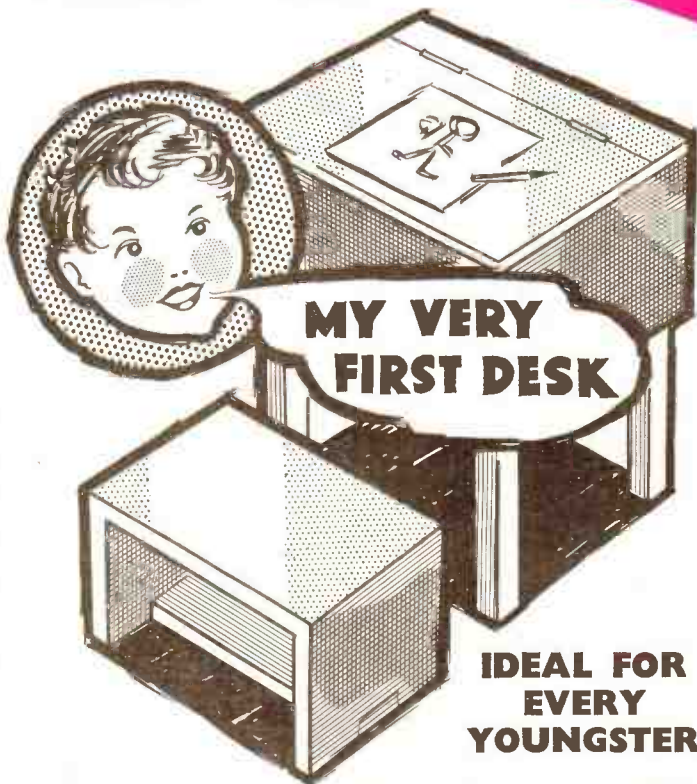

IDEAL FOR
EVERY
YOUNGSTER

DESK AND STOOL

Up-to-the-minute ideas

Practical designs

Pleasing and profitable things to make



5^p

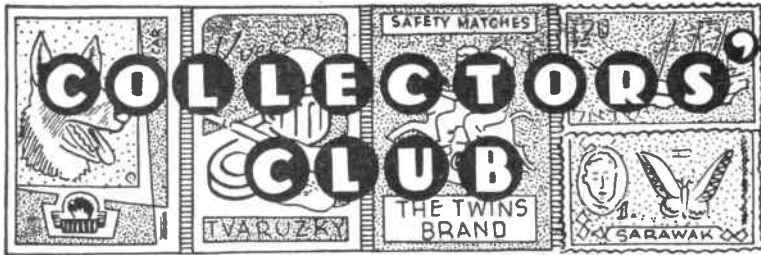

★★★★★★★★★★★★★★★★★★★★★
 ★ NOTE TO ★
 ★ CORRESPONDENTS ★
 ★ All correspondence on any subject covered in this magazine ★
 ★ must be addressed to: The Editor, ★
 ★ Hobbies Weekly, Dereham, Norfolk. ★
 ★ If a reply is required, queries ★
 ★ should be accompanied by a ★
 ★ stamped addressed envelope and ★
 ★ reply coupon inside back cover. ★
 ★★★★★★★★★★★★★★★★★★★★★★



ISRAEL

This stamp, on the left, commemorates the 25th anniversary of the Israel Philharmonic Orchestra, founded in December 1936.

Also released from Israel during December were two commemoratives (0.25 and 0.30 value) honouring the achievements of afforestation.



This colourful set of stamps depicting 'Mushrooms', released from Bulgaria towards the end of 1961, should prove very popular as it is easily one of the best of its kind.

* * *

POLISH NEW ISSUES

A NEW set of two perforated stamps from Poland, value 60 gr. each, commemorating the 40th Anniversary of the 'Post and Telecommunication Museum' as well as the 'Stamp Day 1961' — were issued on the 6th October 1961. An illustration is shown on this page.

There is a postal-cart on these stamps, the reproduction of Jan Chelminski picture, and an inscription: '40 lat Muzeum P.i T.' (The 40th Anniversary of the Post Museum) and 'Dzien Znaczkza 1961' (Stamp Day 1961).



An interesting series of stamps in full colour depicting 'Butterflies' was issued from Czechoslovakia during December

AUSTRIAN BICENTENARY

A SPECIAL postage stamp to mark the Bicentenary of Austria's Court of Accounts was issued on 23rd December 1961. It was 200 years ago that Empress Maria Theresa founded the Imperial Chamber of Accounts, which was the forerunner of today's Court of Accounts. It always has proved an objective and impartial control organ of the State. See illustration on left.



A Polish 'Chelminski' issue



A set of five pictorials has just appeared from Tonga to mark the '75th Anniversary of Postal Service'. Designs include:

- 1d. red and brown — 'Reproduction of Tonga's First Stamp of 1886'.
- 2d. blue — 'Whaling Vessel'.
- 4d. green — 'Post Office, NUKU' ALOFA'.
- 5d. purple — 'Mail Steamer'.
- 1/- red-brown — 'Mail Plane'.

TANGANYIKA became an independent nation on the 9th December 1961, and to mark this historic event a complete new issue of postage stamps was put on sale at all post offices in Tanganyika on that day.

The themes for these stamps have been chosen to reflect various aspects of Tanganyika's programme for social and economic development. Education is a field in which striking progress has already been made in Tanganyika. The future holds the promise of even greater advances and the 5 cent value of the new issue showing a teacher instructing villagers both old and young may be taken as symbolic of the nation's desire

Tanganyika has rightly been described as a land of opportunity, and great strides have already been made towards developing her agricultural and industrial resources. The 5/- stamp indicates the change from age-old hand cultivation to modern methods, while industrialization is represented on the 10/- value by one of Tanganyika's great diamond mines (see illustration). It was these mines that produced the unique rose pink diamond presented to Her Majesty the Queen on her marriage which is also shown on the latter stamp. (Colours: 5/-, black, blue, and orange; 10/-, black, blue, and pink.)

At present, and, undoubtedly, for many years to come, the chief source of

The scenic, game, and coastal water attractions of Tanganyika have made tourism a thriving and important industry. The vast game areas, such as the Serengeti, preserved for future generations as a National Park, are represented by the 50 cent stamp showing some of the famous Serengeti lions. (Colours: black and yellow.)

Great mountains such as Kilimanjaro, towering 19,340 ft. over the entire African Continent provide breathtaking views, while on the coast there are many superb beaches to be enjoyed. Some of the finest of these are adjacent to Tanganyika's capital city of Dar es Salaam, with its renowned harbour depicted on the 2/- stamp (illustrated here). (Colours: yellow, brown, blue, and green.)

The 1/30 and 20/- values of the new issue reproduce in full colour a burning torch held high above the peak of Kilimanjaro. The National Flag depicted on the 30 cent value is also symbolic of the achievement of independence. (Colours: 1/30 cents, yellow, red, blue, and black; 20/-, yellow, red, blue, and black; 30 cents, yellow, green, and black.)

INDEPENDENCE OF TANGANYIKA



Examples of the new stamp issue from Tanganyika

to raise the educational standards of all her people. (Colours: brown and green.)

The health and welfare of the people is also a primary concern of the new nation, and this is represented on two stamps, 10 cents and 1/-, illustrating the work of the District Nursing Service and the advances in maternity and child welfare. (Colours: 10 cents, green; 1/-, yellow, brown and blue, the latter being illustrated.)

Tanganyika's wealth lies in the country's agricultural productivity. Although almost every kind of economic plant is cultivatable within the many and varied farming areas of Tanganyika, this theme is represented in the new issue by the 15 cent stamp showing coffee being picked in the field, and the 20 cent value portraying a farmer harvesting a ripe maize cob. (Colours: 15 cents, blue and brown; 20 cents, brown.)

Advertisers' Announcements

SOUTH AFRICA

Set 1961 Animals. Decimal set of nine values 2/9 per set, post free. Set of Animals (1d. to 4d.) 1954 (6 values) 1/- set, post free.

May we send you our Discount Approval Books of NATURE subjects? (3d. postage please).

THE PRIORY STAMP COMPANY
(Dept. H/6), 86 Pauntley Road, Muford, Christchurch, Hants.

FOR SALE — NEWFOUNDLAND STAMPS! 100 fine N.F.L.D. stamps \$1.00 — 1,000 \$9.00 — 2,000 \$15.00 — 50 all different \$2.00 — 100 all different \$6.00 order now from **HARRY PHILLIPS SALES, BONAVISTA-2K, NEWFOUNDLAND, CANADA.**

50 STAMPS FREE — Ask to see my approvals. — GBN(H), 41 Collins Road, Wednesbury, Staffs.

Each week provision will be made on these pages for advertisers' offers. Classified rate 6d. per word prepaid. Display rates on application.



Greek 1861-1961 stamp centenary

100 DIFFERENT stamps free! Request 1d. upwards discount approvals. — Bush, 53 Newlyn Way, Parkstone, Dorset.

NEW Thoughts on

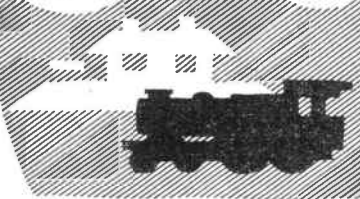

RAILWAY MODELLING

6 ft. way between the tracks. That is to say, the minimum space to allow from the outer rail to the outer rail of the next track should be about 28 mm., and this is important. The dimension given is for OO/HO scale, but you can work it out for other scales. It is about 7 ft. from the centre of the rails, and this will allow for overhang of trains at curves.

We next come to the question of curves and their radius. This should always be as great as possible. On the Maryville, Fredricton and Westbury Model Railway the minimum curves have a radius of 3 ft. This means that it will take a space of 6 ft. square to make a complete circle, but it also means that you can run any locomotive on it without having to turn off any of the flanges on the driving wheels, and there is not so much overhang of coaches and locomotive bogies. If, of course, you are using one of the proprietary brands listed above, their curves are already set for you, and you have no worries.

There are on the market today various forms of flexible track; that is to say,

(Models) Ltd of 23 Paddington Street, London, W.1, and Hamblings of Cecil Court, London, W.C.2 also supply good tracks, and they also supply the parts for the do-it-yourself method, such things as

CHOOSING THE PERMANENT WAY

By F. A. Barrett

chairs and sleepers, and rails in either brass or nickel silver. Peco supply all the parts for making tracks and points, so there is no shortage of track on the market for the OO gauge enthusiast. For OOO and TT3 modellers the same firms can supply tracks. Modellers in O gauge would do well to consult such firms as Bassett-Lowke Ltd or W & H (Models) Ltd, who can supply their demands.

Track, whatever its type or make

WE now come to the most fascinating part of model railways, and the most important—that of laying the tracks upon which your trains will run. I must here stress that unless this important job is done correctly you will be letting yourself in for a load of trouble.

To be able to lay a track, whatever type it is, proves the value of the modeller, and believe me nothing is worse than a poorly laid track, both from the appearance point of view, and what is even more critical, the running of the trains. Always aim for perfection, nice level track, smooth working points and nice curves, and you will be glad later that you took the trouble and time to do a good job well.

Now, naturally, I do not know what types of layout you are contemplating,

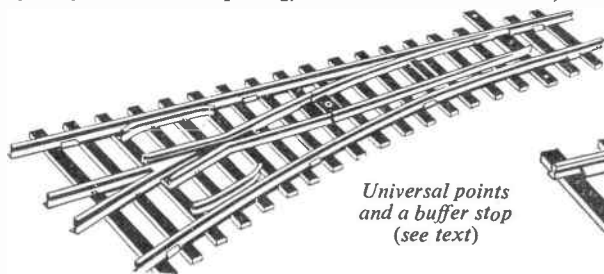

Universal points and a buffer stop (see text)

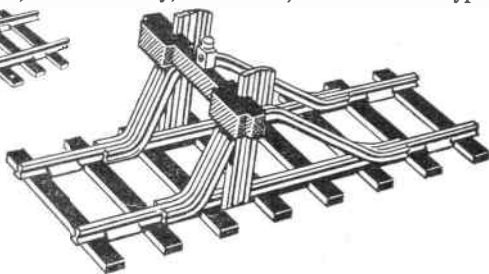

and I am sure that many of my readers already have tracks laid and trains running. It may well be that you have one of the proprietary brands such as Hornby-Dublo, Trix, Tri-ang, Rovex. In this case you will have the tracks that are supplied with the sets, or as accessories. I will tell you something about the scale side of the picture, and tell you what is available for your choice.

We will assume that you are just starting on this hobby, and have followed my instructions for building a baseboard, and are now ready to lay the tracks. I would advise you to draw on the baseboard the actual layout of the tracks; at least mark on the board the position the tracks will occupy. Plot your curves, and don't forget to position the tracks correctly, allowing the correct

they can be bent into almost any shape, and a lot of these tracks are also universal, which means that you can run locomotives of any sort through the points, and have no binding at the frogs and check rails. I have mentioned in a previous article the Peco Streamline track. This is universal. Messrs. G. A. Mellor are the makers of the famous 'Gem' track, also with universal points. I saw this demonstrated at the Model Railway Hobby Show, and every type of locomotive was run through the points. They ran beautifully, without any trouble. These points are illustrated, and also buffer stops made by the same firm.

There are, of course, other tracks that can be used. Wrenn track is good, and has been on the market for a number of years. Other firms such as W & H

should be fixed down to the baseboard with pins or nails. If you have a lot of patience glue it as well. Make sure it is rigid and does not move when a train goes over it. Points will need a firm fixture if they are to be worked with either levers or electric point motors, and this is to be recommended. It is much better to be able to control points remotely than to have to follow the train round the tracks, and move the points by hand. I shall be showing you in later articles how to go about making your own point motors quite cheaply.

There are many things that one has to think of when laying track. For instance one should, as far as possible, avoid facing points on main lines. One should try to keep gradients as gradual as possible. This is important. Try to make

your gradients to the minimum of 1 in 36 if possible, unless you just want to pull short trains up the slopes. With a fairly lengthy train you need the tracks to be as lenient as possible with the question of gradients in mind.

When planning your stations try to keep the length of these as long as possible. In OO gauge a Pacific locomotive is about 11 in. long, and main line coaches are about the same length, so you will see that if you want to run trains of six coaches and an engine, you will need a platform length of over 6 ft. I have platforms on my own layout of this length, but they should be longer. Of course, there is always a way out of this space problem — run only short local trains, and build up a country layout. In this way you will be able to make platforms shorter, and your gradients and curves can be more severe.

Please remember that I am stressing the scale aspect of the thing, I am sure that many of my younger readers could not care less about the lengths of trains in relation to platforms. So long as there is a station on the railway they are happy, and good luck to them. After all, model railways are made to have fun with. It is a case of every man to his taste.

There are many little items when track laying that are apt to be overlooked, and one of these is the crossings of wood that one sees at railway stations. These run across the tracks between the platforms, and are used by the station staff to get from one platform to another. They are very easily modelled by placing small pieces of either thin wood or card, suitably coloured with indian ink to make them dark, and glued between the tracks, leaving sufficient clearance for the flanges of the wheels of the rolling stock.

Ballast is available in various forms,

FOR YOUR LAYOUT

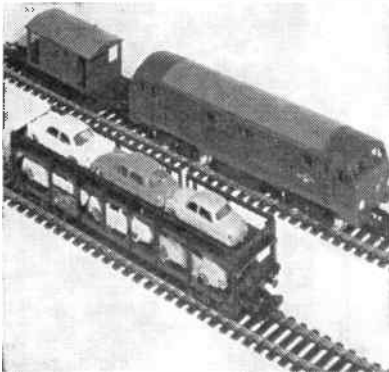

Playcraft Bishopsgate goods train set. OO and HO. Clockwork loco, open truck, brake van, and eight curved rails, 19s. 11d.

ROVEX SCALE MODEL EQUIPMENT

I HAVE received some excellent models from Messrs. Rovex Scale Models Ltd, writes F.A.B. These are, of course, the famous Tri-ang Railways. Their new track which has been on the market for over a year is known as the Series Super 4 track. The colour of the sleepers is brown, the sleepers are spaced closer together, and it is an ideal track.

Their R.180 viaduct is a very attractive model which is made in plastic. The representation of the brickwork is a masterpiece of detail. This is a 'must' for high level tracks. The price is 9s. 7d.

The River Bridge No. R.188 is also an excellent design. This is in concrete, with a shaped balustrade along the top, and would also be ideal for high level tracks. It would add great realism to your layout if you modelled a river under it. The price is 8s. 7d.

I have also received a wonderful model of the *Battle of Britain* Class locomotive, and tender named *Winston Churchill*. This is the very latest produced, and is complete with streamlined casing. It is fitted with smoke, and what a wonderful difference this makes. It looks like the real thing as it runs along the track puffing out clouds. The model is also fitted with Magnadhesion, and this is devised to help the locomotive to haul longer trains up gradients. A really wonderful model this, on which the designers are to be heartily congratulated.

The R.352 Budd Rail Diesel Car is in the Tri-ang Transcontinental Range — another lovely little model. The motor bogie is fitted with Magnadhesion, and the detail is superb. It is fully fitted inside with seats, and the same care is available in a non-powered version. This is a welcome addition to the range, and from the catalogue they have sent me I see that there are many more interesting and exciting things to come, both in OO/HO gauge, and also in TT3. Referring to the latter scale, they have sent me a lovely little model of a Goods Shed, which is up to the usual very excellent standard one associates with Rovex or Tri-ang. Even in such a small scale the detail is perfect, the brickwork is clearly defined, and it is correctly glazed throughout — in all a little gem.

The last item for review is the R.146 Modern Engine Shed. This is in OO/HO gauge, and the detail is excellent. Very good value at 13s. 8d., and one could add several of these together to make a larger shed. It is of open type with North Light roof.

and it does much to make the track look authentic. This can be obtained from most suppliers of model railway equipment, and it is possible to purchase strips of a foam rubber compound that can be laid under the tracks. This looks quite good, and serves to deaden the sound a little. In this respect there are many schools of thought. Some people like their railways to be quiet in operation and some, including myself, like them to sound like railways! One famous writer has even suggested that you file nicks in your rails at correct scale intervals, so that you will hear the wheel clicks as the trains proceed on their way. I would not go so far as this, and in any case, with the modern plastic and nylon wheels on coaches, they are almost silent, at least as far as rolling stock is concerned.

To sum up, the important things in track laying are: Curves of the widest possible radius; gradients as lenient as possible in slope; correct spacing of rails; the minimum number of facing points on main lines; track firmly fixed to the baseboard.

I have not dealt fully with the types of point formations that are used on railways, but you will possibly need many of them, such as Y points and Y parallel points where you want one line to run

into two lines. Double junctions are very useful when you want to turn two lines around a corner with the others running straight ahead. There are facing and trailing crossovers and, of course, one of the most complicated of formations, the scissors crossover. Then there are single and double slips, very difficult to model, and more difficult to control electrically, especially with two-rail working.

Perhaps at this point I should explain what is meant by two-rail, and three-rail working, in case there are some of my younger readers who do not know the difference. In two-rail working, you have two rails insulated from each other, and the wheels of all rolling stock have to be insulated also. The current is fed to each rail, one side being positive, the other negative, and the current is conducted to the motors via the wheels of the locomotive. In three-rail working there are the normal running rails, and then a centre rail, or an outside rail which is called the conductor rail. Usually the two running rails are bonded together, and they supply one side of the power, and the centre rail supplies the other. The modern development is the overhead wire system, and some of the proprietary brands market locomotives for this system.

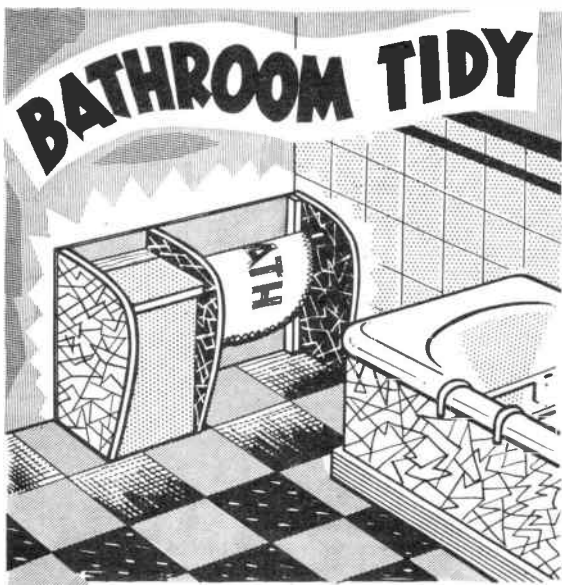

KEEP that bathmat dry, hide away those soiled towels, maintain the bathroom in a tidy condition. This cabinet fitting will help you to

to all those things. It is easy to make and attractive in appearance. The cabinet is quite roomy and strong.

The construction is so simple that there is no need for side and end elevations. The sizes of the various pieces are clearly shown in Fig. 1. The back is of $\frac{1}{8}$ in. hardboard, pieces B, C, D, E and G of $\frac{1}{2}$ in. plywood and pieces F and J can be oak or chestnut.

The shape of the pieces B and C is shown clearly in Fig. 2. Enlarge the squares to 1 in. and draw in the shape square by square. Try to draw a smooth curve, free from bumps. It does not

HOLE IN PIECES B ONLY

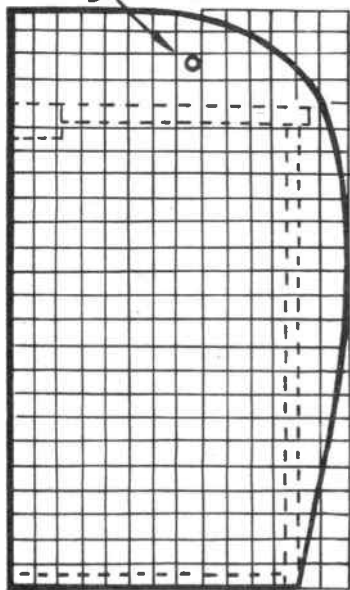

PIECES B & C 1" SQUARES

Fig. 2

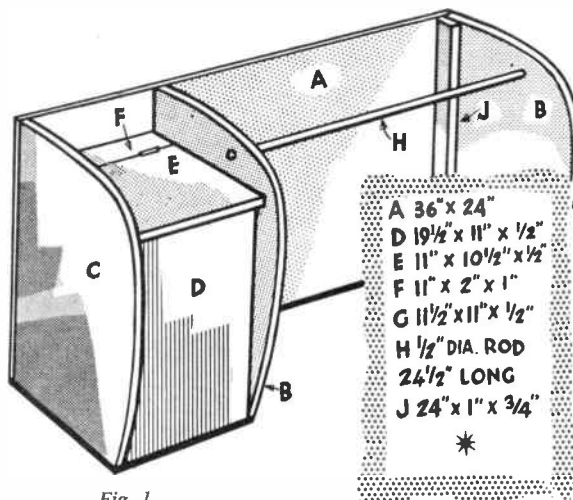

Fig. 1

matter if the curve is not exactly the same as that shown in the drawing.

Make up the cabinet, including the sides, as in Fig. 3. Use glue and screws throughout. Screws should be countersunk and afterwards filled and sanded level. Hinge the lid E to the rail F recessing the hinges as suggested in the inset diagram in Fig. 3. A piece of triangular fillet is glued along the back edge of the floor (G).

Now cut the round rod (H) to length and glue it into the pieces B and also fix the upright J as shown in Fig. 1.

Paint is the most suitable finish for use in the bathroom and the result will depend upon the care you take in the preparation of the wood.

Carefully clean up all the pieces with glasspaper and fill the grain with a proprietary brand of woodfiller. This will seal the grain and is the most important step towards a smooth finish. Lightly glasspaper after filling, give two flat undercoats and allow to dry. Now rub down with wet silicon carbide paper and give one top coat. Allow to dry, rub down again with wet silicon carbide paper and give the final coat of high gloss enamel. This final coat must be given in dust free conditions. The best way is to do it last thing at night so that dust is not disturbed while it is drying.

(M.h.)

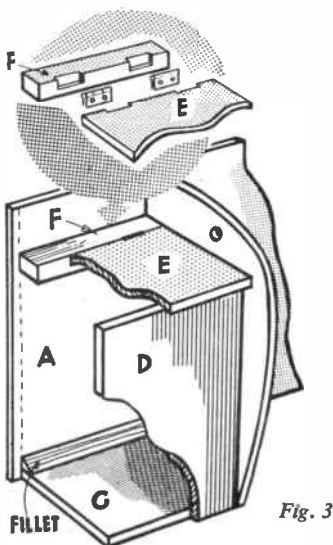

Fig. 3

RUST PREVENTER

A piece of 'Bannrust' — which is a specially coated paper — placed among your tools will keep them free of rust even in a very moist atmosphere. 'Bannrust' can be used for all rust problems. From ironmongers, etc. it costs 5s. 0d. for eight sheets size 15 in. by 2 in.

A BAFFLING BOTTLE TRICK

SCIENCE fiction writers are fond of reminding us that, in the absence of gravity, fluids like coffee, soup and water would assume perfectly globular forms and float about in the cabin of a spaceship like aimlessly drifting planets. In our common experience on Earth, fluids generally respond to gravity by flowing downhill or standing at rest in pools. However the amateur scientist can bewilder and entertain his friends by making water in a bottle appear to behave as if the law of gravity had been repealed.

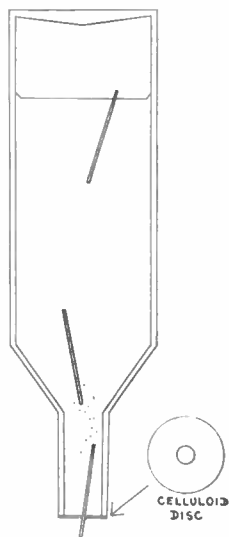

The effect of this experiment can be obtained if you fill two-thirds of a large bottle with water and then hold it upside down over a bowl. When you remove your fingers from the mouth of the bottle, a little miracle happens, because the water does not run away. To conclude this eerie effect you actually pass several matchsticks up into the neck of the bottle and they bob up inside the vessel to the surface. After this strange 'magic' has been accomplished, you give the bottom of the bottle a sharp knock and all the water gurgles down into the bowl.

In addition to the bottle, matches and bowl, you will need a neatly cut out disc of clear celluloid which will be the same size as the outside diameter of the bottle neck. Bore a hole $\frac{1}{16}$ in. in diameter in the middle of the disc, using a drill or a cork borer. The bottle should be a tall plain one, made of clear glass and with

a flat rim, but a dark wirtle bottle will serve if you work in a good light.

Fill two-thirds of the bottle with water and press a finger over the neck before turning the bottle upside down. Slip the little disc over the opening and gently remove your fingers, whilst supporting the bottle over the bowl. Forces of adhesion and surface tension, aided by the inability of air to enter the bottle from above, will combine to support the disc over the lower surface of the water, so that the water will not run away. Water will bulge beyond the hole in the disc but surface tension will prevent the 'skin' of water from breaking. With care you will be able to introduce matchsticks through the watery skin without causing the water to spill out of the bottle.

When you present this scientific trick

to your friends, make sure that all your apparatus is arranged upon a table at some distance from your audience. All the necessary items should be clean and free from grease. Talk about how submariners have to learn the technique of escaping from a sunken submarine and mention the special water towers used by the navy to train these daring seamen.

Calmly invert the bottle and secretly add the colourless disc, which you will have palmed in your right hand. Introduce the matchstick 'sailors' and wait until your spectators are gasping with astonishment before knocking the bottom of the bottle with your hand and letting the water and matches escape into the bowl. The dislodged disc will be almost invisible in the spill water, especially if the bowl is a patterned one.

(A.E.W.)



A TODDLER'S FIRST DESK AND STOOL

DESIGNED for the very young, this little desk will tuck away out of sight, and cause no inconvenience to anyone. It is quickly made from standard panels of wood or from odd pieces.

The measurements of all parts are clearly shown on the Bonus plan on pages 336-7, and it will be a simple matter to cut them out.

The assembly is quite straightforward, using glue and countersunk screws throughout. Make up the main portion of the desk first, consisting of pieces A, B, and the legs C. The bottom F is of $\frac{1}{2}$ in. plywood, with corners cut out to fit round the legs. Glue and screw in position. The lid also is of $\frac{1}{2}$ in. plywood 12 in. by 9 in., cut into two pieces, as indicated. Hinge these together, using $1\frac{1}{2}$ in. light brass butts, recessing to make a flush fit.

The stool consists of two pieces G, one piece H, and one piece F, all $\frac{1}{2}$ in. thick. For extra strength the rail H is slotted into the ends G, as indicated.

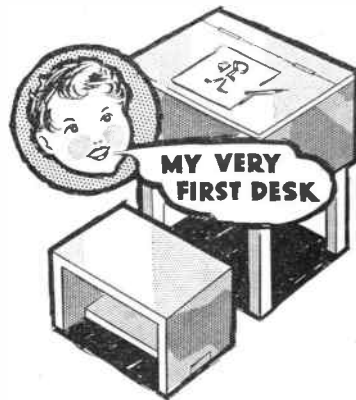

MATERIALS REQUIRED

Two 3 ft. lengths of 1 in. square stripwood. Price 1/6 each. Postage 2/-.
Two Hobbies R.8 panels 36 in. by 10 in. by $\frac{1}{2}$ in. Price 10/- each. Postage 2/3.
One piece $\frac{1}{2}$ in. plywood 24 in. by 12 in. Price 3/6. Postage 2/-.
Decorette transfers. 2/3 per sheet. Postage 3d.
Complete parcel of above materials may be obtained from Hobbies Ltd, Dereham, Norfolk. Price 30/- including postage and packing.

Clean up all parts and fill the grain. Give two coats of clear varnish, and then rub down carefully, using wet silicon carbide paper. At this stage a Decorette transfer may be added to the lid according to the maker's instructions. Suitable transfers for a subject such as this are No. 236 and No. 243. Finally give another coat of clear varnish all over to complete the finish and give protection to the transfer, (M.h.)

Toddler's FIRST DESK

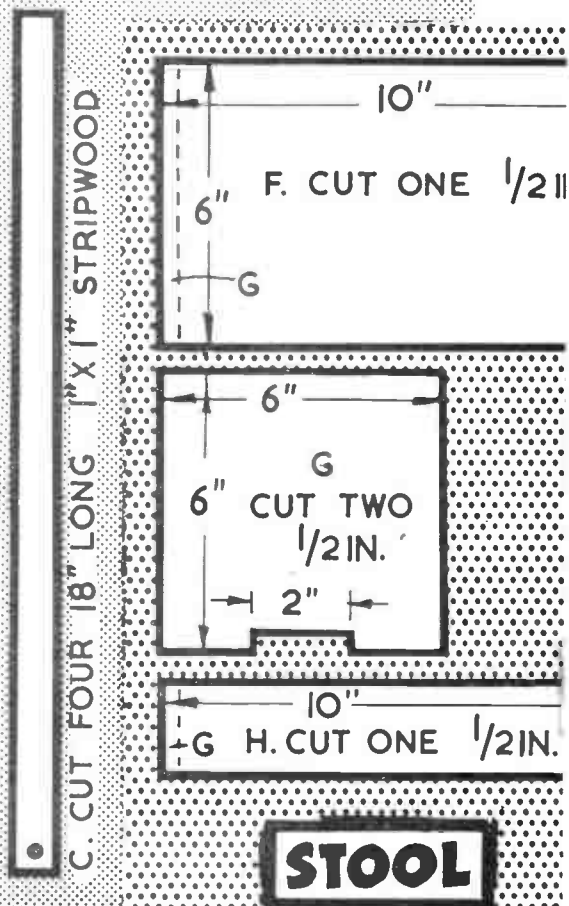
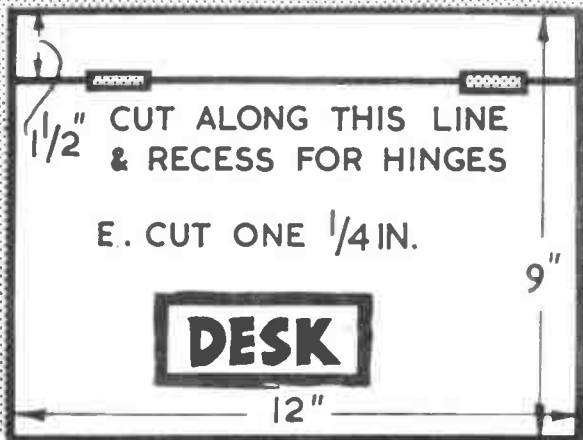
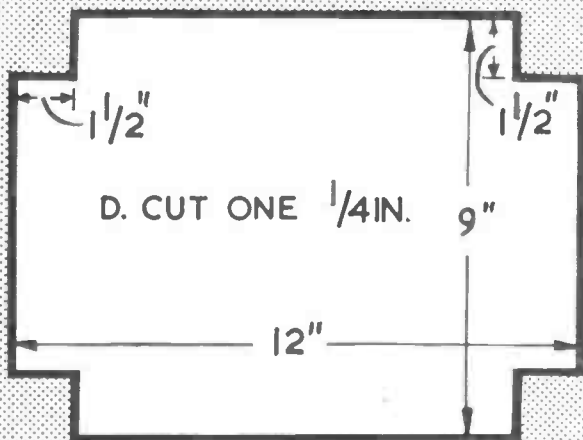
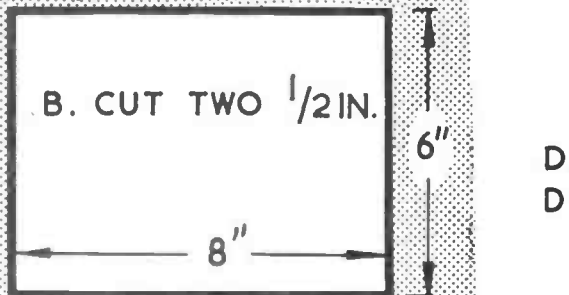
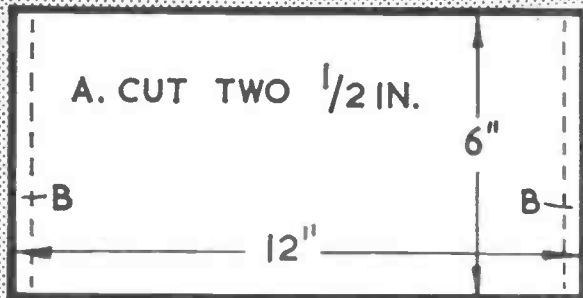

& STOOL

IDEAL FOR THE 2-3 YEAR OLD

Hobbies
**BONUS
PLAN**

DECORATE WITH A
DECORATIVE TRANSFER

PAINT A PASTEL
SHADE

ALL PARTS
GLUED
& SCREWED

SCREW THIS
PIECE DOWN
ONLY

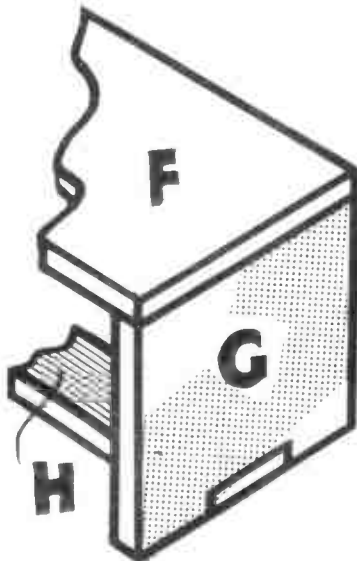
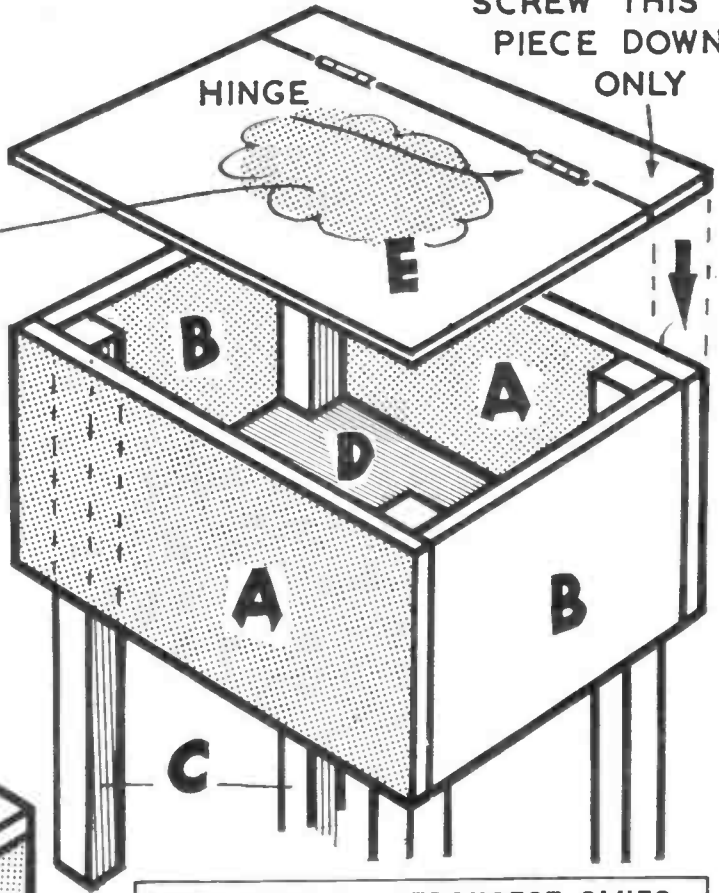

THE WORLD'S STRONGEST GLUES

Stick it with-



Croid AERO

This is a hot animal glue of tremendous strength. It's ready prepared in this handy Home Outfit, comprising 8 oz. tin of Croid Aero, a hot water container and a spreader—4 1/2" complete.

BUY CROID FROM YOUR LOCAL HOBBIES BRANCH

CHEMISTRY AT HOME

FOR Man, one of the most important products of the vegetable kingdom is starch, $(C_6H_{10}O_5)_n$.

You may have noticed that when a knife which has been used to peel potatoes becomes dry, it is covered with a film of white powder. This is potato starch. To prepare a quantity of pure potato starch for experimental purposes peel and wash some potatoes. Grate them to a pulp, collecting pulp and juice on a plate.

EXPERIMENTS WITH STARCH

Put the pulp and juice into a vegetable sieve supported over a basin and run water through by means of your wash bottle. Starch and some vegetable fibre run through into the basin. When the basin is nearly full, partially lower the sieve into the liquid in the basin and stir up the pulp, so as to remove as much as possible of the starch. Drain and reject the pulp.

Now run the cloudy brown liquid in the basin through a coffee strainer to remove the bulk of the fibre. On standing, the filtrate deposits the starch as a hard white layer on the bottom of the vessel, the liquid above being still brown.

To complete the purification it is only necessary to pour off the brown water, fill up with more water, stir up well and, after the starch has again settled, to repeat the process until the wash water is no longer coloured. Filter off the starch and let it dry on a clean porous tile or brick at room temperature. To dry by means of heat would produce a change which we shall examine later.

The starch dries out to a somewhat glistening powder which has a peculiar crisp feel when pressed.

We have seen that starch is insoluble in cold water. Nor is it soluble in other solvents — as you may see if you try with a few common ones such as methylated spirit (mainly ethyl alcohol, C_2H_5OH); benzene, C_6H_6 , and acetone, $(CH_3)_2CO$. Boiling water, however, causes a peculiar change — as every housewife knows. Hence the need for spontaneous drying in the starch isolation. Mix 1 gram of starch to a cream

with cold water and pour it into 100 c.c. of boiling water. The whiteness of the starch disappears and a translucent mucilage results, which is the common starch paste of the wash house.

On standing, the paste deposits a translucent solid, leaving a clear liquid above. Examination under a microscope of the original starch will reveal faintly striated granules (see diagram), whereas the deposit from the paste shows that these have burst, leaving irregular filmy debris. A drop of iodine solution added to a little of the clear upper liquid gives an intense blue coloration, showing that something has dissolved out of the granules.

This is granulose, $(C_6H_{10}O_5)_n$. The deposit or cell wall debris is called starch cellulose, $(C_6H_{10}O_5)_n$. That the two have similar formulae may seem strange in view of their differing properties. The explanation is that 'n' represents a variable number. In other words, granulose and starch cellulose molecules consist of multiples of the unit $C_6H_{10}O_5$.

Now add methylated spirit to some of the clear upper liquid in a test tube. A white precipitate appears. This is granulose. We thus have a means of isolating the granulose, though large volumes of starch paste and methylated spirit would be needed to prepare a reasonably sized specimen.

However, if you filter off the granulose and let it dry there will be enough to show that the dried solid is soluble in cold water and that the solution gives the

blue coloration with iodine. Granulose is often known as 'soluble starch'.

This iodine coloration is worthy of further experiments. Heat the blue solution. The colour disappears. Yet as the solution cools it reappears. On re-heating and cooling the same changes recur. This process may be repeated many times, though finally the blue colour will grow faint and disappear altogether on cooling, owing to loss of iodine by volatilization.

Although starch paste continues to give the iodine reaction for some weeks if 1 c.c. of chloroform be added to each 100 c.c. it is more sensitive if freshly prepared. More convenient is starch paper. To prepare a stock for testing for free iodine simply dip filter papers in the freshly prepared paste and hang them up to dry.

A variation of this reaction with iodine lends itself to an astounding conjuring trick — no less than hypnotizing water to turn blue at a specified moment. You have two decanters or bottles containing water. You empty both into a tumbler. The water remains unchanged. Putting on a concentrated stare you gaze steadily at the tumbler. After a minute (you must unobtrusively have a watch before you) you begin to make hypnotic passes. In about a minute and a quarter the water in the blink of an eye flashes to blue! The effect is startling.

To carry out the trick, cream 1 gram of starch with a little water, pour it into 100 c.c. of boiling water and allow to cool (Solution A).

Dissolve 0.2 gram of sodium sulphite $Na_2SO_3 \cdot 7H_2O$, in 50 c.c. of cold water, add 1 c.c. of 10-per cent sulphuric acid, H_2SO_4 , and make up the volume to 225 c.c. with a mixture of 10 c.c. of Solution A in 200 c.c. of water. This, Solution B, should be put into one decanter.

Dissolve 0.5 gram of potassium iodate, KIO_3 , in about 50 c.c. of hot water. Allow it to cool and make up to 225 c.c. with cold water. Put 150 c.c. of this Solution C into the second decanter.

It is an advantage to be prepared for the almost inevitable question: 'But can you turn it back to water?' Have a third decanter at hand, apparently empty, but which has been damped on the bottom and a little powder sodium thio-sulphate $Na_2S_2O_3 \cdot 5H_2O$, sprinkled in. Pour the contents of the tumbler into the third decanter and the blue disappears!

To heighten the effect of the whole trick exactly time the appearance of the blue shortly before the demonstration, making up a bulk stock of the solution and using portions from them. You will then know to the precise second when the blue will appear and a finger flick at that moment enhances the spectacular effect.

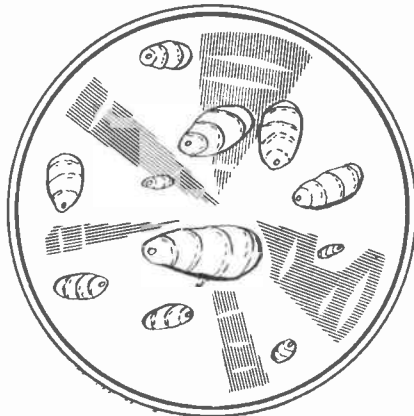

Starch granules highly magnified.

MOUNTING THE ENLARGER

By
**Norman E.
Jenkinson**

The enlarger attached to the column, showing the locking nut at the rear. The camera, condenser housing, negative carrier and part of the lamp-house can be seen.

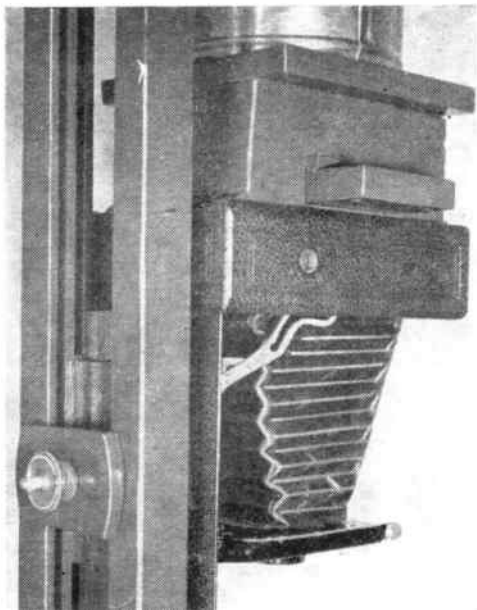

LAST week we gave details for making a photographic enlarger, which it is possible to use horizontally by focusing the picture on a piece of paper pinned to a wall. If it is used in this manner, the condenser lens should be secured inside its housing, with small nails, to prevent it moving.

However, it is much more satisfactory and convenient to use a vertical enlarger and the construction of this type is shown in Fig. 4. It consists of a baseboard to which is attached a column of grooved moulding. The enlarger slides up and down in the moulding.

The baseboard is a piece of 1½ in. thick wood measuring at least 12 in. by 9 in., the heavier the better. The column consists of two 1 yard lengths of grooved moulding as sold by handicrafts stores. It is usually 1 in. by ¾ in., and has two grooves, although only one is used for the present purpose. One side of the baseboard is cut as at A in Fig. 4, and the moulding is then jointed into the baseboard. A strengthening piece B is added to ensure rigidity. This piece is cut from ¾ in. ply. Two 2 in. screws pass through the lower holes in B and then through the moulding and into the baseboard. Two blocks of wood, 1½ in. long, are screwed to the top and bottom of the column as at D.

The column is capped by a piece of plywood, 4 in. by 1½ in., and in order to keep the electric flex clear of the baseboard, a U-shaped piece is added at E. The flex passes through the groove.

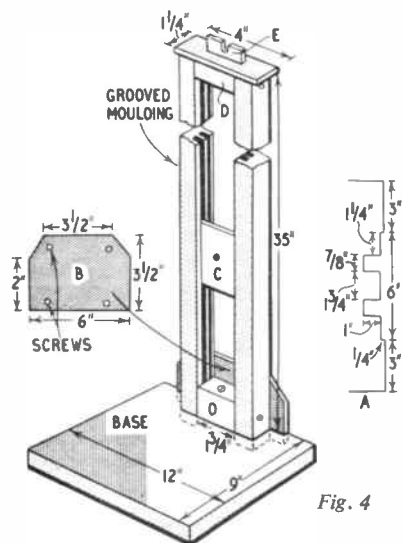

Fig. 4

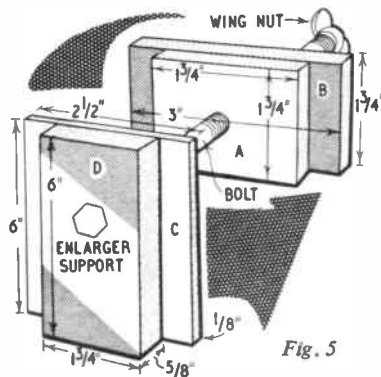

Fig. 5

Affix four rubber feet to the baseboard to prevent it moving on a shiny surface.

Fig. 5 shows the enlarger mounting. A piece of ¾ in. plywood, size 6 in. by 2½ in., shown at C in Figs. 4 and 5, slides up and down in the grooved moulding. To the front face of this piece is attached a thick piece of wood (D) to hold the enlarger. A bolt passes through these two pieces, the head being sunk into part D to prevent it rotating. The bolt then passes through parts A and B, which move freely along it. These two pieces, glued together, slide up and down at the back of the column. When the enlarger is in the desired position, a wing-nut screws down and secures the enlarger to the column.

The method of attaching the camera to piece D in Fig. 5 will depend on the type of camera. The one described was attached by drilling two holes in the baseplate of the camera and then affixing it to D with two screws.

Insert an on-off switch in the cable and the enlarger is ready for use. The lamp-house is of the simplest construction to avoid having to make elaborate light traps. Do not leave negatives in the enlarger for any length of time with the bulb switched on, otherwise they will get hot, and heat is detrimental to negatives.

A POWER TOOL EXTENSION REEL

WHEN working with a power drill the home handyman sometimes may find that the nearest power point is out-of-reach for the limited length of flex attached to the tool. When this happens it usually means that an extension flex must be obtained to enable the necessary connection to be made. It is therefore, advisable to make a handy extension reel to keep available in the workshop.

One of the simplest designs requires only the spent cardboard core normally supplied with reels of electrical wire and flex. These are very strongly made and can be obtained at any electrical store or from a local building site.

Cut two discs of plywood and glue these on the ends to strengthen the sides. Fix a three-pin power point to one side of the reel and then coil the extra flex around the central core. The free end of the flex should be fitted with a three-pin plug. (F.K.)

CAMPING Notes

by Ed Capper

USING ORDNANCE SURVEY MAPS

YOU are not a real camper unless you have the urge to roam and explore. So today, let's talk about maps and things. . .

Without any doubt the best map to use is the 1 in. Ordnance Survey. Shops in most areas of the country now stock the bang-up-to-date Seventh Edition. Each sheet covers an area of roughly twenty-four by twenty-eight miles, which should be sufficient for the most energetic of roamers! They are packed tidily in a nice folder and cost 4s. 6d.

If you are travelling some distance to your camp site it is best to buy the map of the locality at a stationers in a town near the camp. Your local shop will only stock maps of your home-town area.

The 1 in. map means that it is scaled at one mile, being represented by 1 in. on the map. The top of the map is always true North, so you will not need a compass. A map measurer is, of course, most useful, and you may recall that I described how to make one from a match-box in *Hobbies Weekly* dated 23rd November 1960.

I have illustrated some of the usual abbreviations and symbols used on the 1 in. map. How about testing your intelligence by endeavouring to decipher some of the symbols before you look at

the key? You should learn to recognize most of them at a glance.

It's good fun, immediately after you have made camp, to climb a nearby hill, taking the map with you, and picking out landmarks according to the map. You will be surprised at its accuracy.

The maps are coloured — woodland is green, water is blue. First-class roads are in red, second in brown, others in yellow.

represent heights above sea level, so that it will be seen the road starts at 50 ft. above sea level to the right, and then rises sharply to 200 ft.

It is great fun to make dates with campers at adjoining sites, and to arrange to meet at a certain Grid point on the map. I won't spoil your fun by explaining how it works, for it is described at the bottom of each map. Suffice to say that you can send a message to your friends to meet you at, say, Point

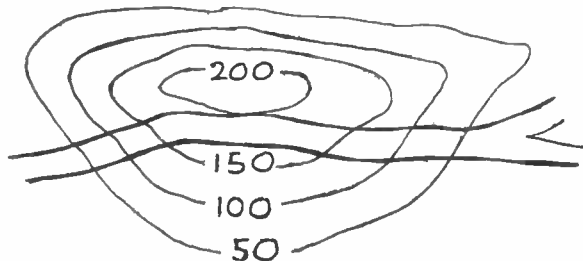

Contour lines showing how a road inclines

With the map you can really plan next day's hike. Road gradients are indicated and also the contour of the land — useful if you wish to skirt steep hills. Another illustration shows these contours. The figures on the wavy lines

60367941, and they will work out the rest!

Talking about hiking, what brings you more relief at the end of the day — to pull off your steaming boots or to release that now filled-with-lead rucksack from your shoulders?

Most of the discomfort from rucksacks is caused by the straps cutting into your shoulder blades. Here's a simple remedy.

Get two squares of foam rubber, cut slits in each of them, and thread the rucksack straps through them. Adjust them so that they will take the main weight of the straps where they cut into your shoulders.

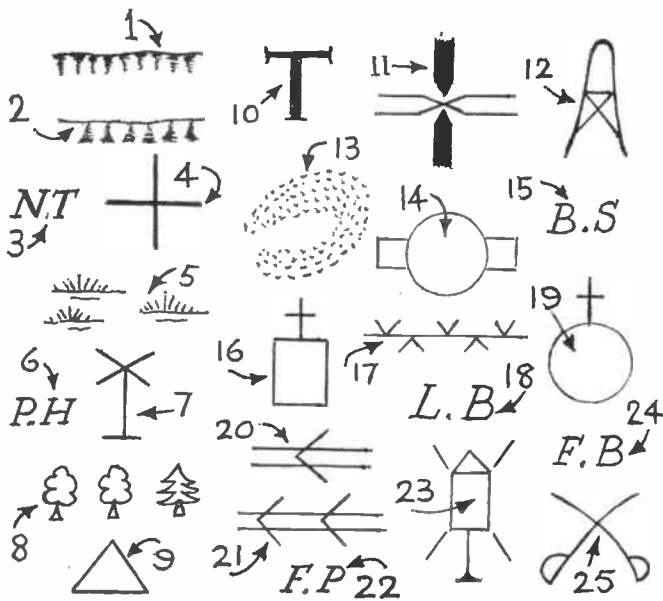

How many of these abbreviations and symbols can you decipher?

KEY TO MAP SYMBOLS

1. A Cutting; 2. An Embankment; 3. National Trust; 4. Church without tower or spire; 5. Marshland; 6. Public House; 7. Wind Pump; 8. Woodland; 9. Youth Hostel; 10. Telephone Call-box; 11. Level Crossing; 12. Wireless Mast; 13. Open Pit; 14. Bus Stop; 15. Boundary Stone; 16. Church with tower; 17. Electric Grid with Pylons; 18. Letter Box; 19. Church with Spire; 20. Gradient of 1 in 7 to 1 in 5; 21. Gradient of 1 in 5 or over; 22. Footpath; 23. Working Windmill; 24. Footbridge; 25. Site of Battle.



CANOES

FULLY FINISHED CRAFT
OR SPECIALLY PREPARED KITS

PBK 10 (11 ft. single-seater, as illustrated)
Complete (less paddles)

£24 5s.

(Carriage £2 extra)

KIT (except paint, varnish, paddles)

£15 10s.

(Carriage 15s. extra)

Double-bladed paddles

47s. 6d.

(Carriage 2s. 6d. extra)

Also

PBK 20

(15 ft. two-seater)
Complete (less paddles)

£32 10s.

(Carriage £2 10s. extra)

KIT (except paint, varnish, paddles)

£22 5s.

(Carriage 20s. extra)

Easy payments available.

Send for Agreement Form.

HOBBIES LTD (Dept. 99), Dereham, Norfolk

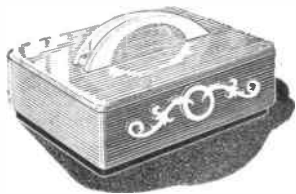

TRINKET BOX

KIT No. 3070

Materials and instructions for
making this 5½ in. long box cost

5/- (postage
1/- extra)

**HOBBIES LTD (Dept. 99),
DEREHAM, NORFOLK**

HEAR ALL CONTINENTS With H.A.C. Short-Wave Receivers

Suppliers for over 18 years of radio S-W Receivers of quality.
One-Valve Kit, Price 25/- Two-Valve Kit, Price 50/-
Improved designs with Denco coils. All kits complete with all components,
accessories and full instructions. Before ordering, call and inspect a demon-
stration receiver, or send stamped addressed envelope for descriptive
catalogue.
(H.A.C.) Short-Wave Products (Dept. 22), 11 Old Bond Street, London, W.1.

NYLON · P.T.F.E

**BRASS · COPPER · BRONZE
ALUMINIUM · LIGHT ALLOYS**
ROD, BAR, SHEET, TUBE, STRIP, WIRE
No Quantity too Small List on Application
H. ROLLET & Co. Ltd.
6 Chesham Place, S.W.1 BELGRAVIA 4300
ALSO AT LIVERPOOL, BIRMINGHAM
MANCHESTER, LEEDS

BARGAIN—Set of 4 Sheffield Wood Chisels.
Firmer 10/-. Bevel Edge 12/6. In Presentation
Box. Ideal Gift. Post 2/- Davy & Son, 1 Prince
of Wales Crescent, London, N.W.1.

FRIENDS' WORLD, International Pen-
pals' Association, (H.B.), Postbox 708, Cal-
cutta, India, offers world-wide congenial pen
friends.

LEARN CONJURING for pleasure or
profit. Details S.A.E.—**MAGICIAN**, 63
Withington Road, Fegg Hayes, S.O.T., Staffs.

LEARN

RADIO & T/V SERVICING
for your OWN BUSINESS/HOBBY

● by a new exciting no-maths system, using practi-
cal equipment recently introduced to this country
FREE Brochure from:—

RADIOSTRUCTOR
DEPT. G81, READING, BERKS. 21/2/62

200-240v A.C S/Ph 50c Geared Motors
2 R.P.H. at 13/6 each. — **Universaj**
Electrical, 128b, Camden Road, London, N.W.1.

FOR MODEL MAKERS

THE 'MIGHTY MIDGET' electric motor,
only 1½ in. high. Runs at 10,000 R.P.M. from
a 4½ V. torch battery. Minute current consump-
tion. Complete with pulley, price 11/- postage 6d
MODEL BOAT PROPELLER. 3 blades,
shaft, pulley, and 5½ in. long stern tube, to run off
above 'Mighty Midget'. Price 7/3, plus 6d. postage.
**HOBBIES LTD. (Dept. 99), DEREHAM,
NORFOLK.**

BUYING OR SELLING?

Classified advertisements on this page are
accepted at a cost of 6d. per word prepaid.
Use of a Box No. is 1/- extra. Send P.O. with
advertisement to **Hobbies Weekly**, Advert.
Dept., Dereham, Norfolk. Rates for display
advertising on application.

PERSONAL COLUMN LTD, Falcon
House, Burnley, Lancs. Pen Friend — all
hobbies. Correspondents in almost every Country.
All ages. S.A.E. for details.

ENJOY WRITING? Then write for Profit.
Send for 'Writers' Handbook' (free) detailing
countless opportunities for beginner or ex-
perienced. — **Writers' Ring (HW)**, 5 Edmund
Street, Birmingham.

IT'S EXCITING. IT'S PROFITABLE.
Paint designs. Flowers. Anything. Even begin-
ner's ideas can sell for £25/£60. Inexhaustible de-
mand. Details free. **POPULAR ART SER-
VICES (HW)**, CLUN, SALOP.

MAKING GAMES IN PEGBOARD

PERFORATED hardboard, or pegboard, as it is called, is an ideal material for making games of various kinds. All the games shown here can be made from a piece of pegboard which can be bought quite cheaply. In fact, many dealers will sell you an off-cut for a few pence.

By A. Liston

The simplest game shown here is a noughts and crosses board (A) which does away with the need for pencil and paper. All that is required is a square of pegboard with nine holes in it. A piece of plywood or thick cardboard is glued to the back of this, and the board is given a coat of white paint. When it is dry, four lines are drawn across it as shown.

Ten pegs are needed, and they can be made from a piece of $\frac{1}{4}$ in. diameter dowel rod, or from a round ice-lolly stick. The pegs should be about $\frac{3}{4}$ in. long, and glasspapered at one end to fit in the holes. Five pegs are painted red to represent the crosses, and five are black to represent the noughts. Each player simply inserts a peg in turn in one of the holes, trying to get three in a line, instead of making the noughts and crosses symbols on paper.

Draughts and solitaire

A pocket draught-board (B) is made in exactly the same way, with the usual chequer-board pattern painted in black and white. The two sets of 'men' are made as before, one set in white and one in black. The bottom tip of each peg man is painted red, however, so that when a man is 'crowned', the appropriate peg is reversed to show this by its coloured tip.

The ancient game of solitaire is still fascinating — and infuriating — to play. The board is a pegboard square with seven rows, each row having seven holes. The four holes at each corner are filled in with plastic wood to give the pattern of 33 holes shown at C. A small peg is made for each hole, and these are painted in bright colours.

Instead of mounting the board on a piece of plywood, it can be glued to the top of a wooden box, and two large holes made in alternate corners for dropping discarded pegs through into the box.

A peg is placed in each of the holes in the board, and the game is started by removing the centre peg. The other pegs

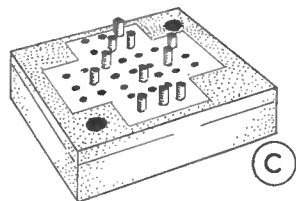
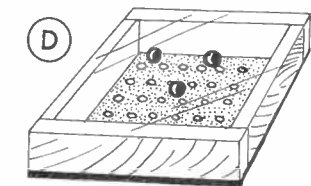
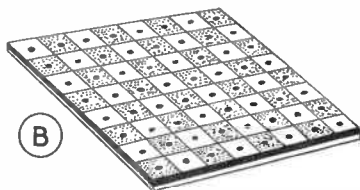
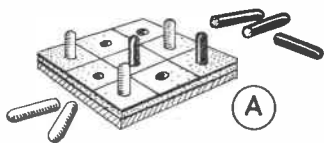

are taken away from the board, one at a time, in the same way as men are 'taken' at draughts, by hopping one peg over another to an empty space beyond, and the peg hopped over is removed from the board. The aim of the game is to remove all the pegs with the exception of one, which must finish up in the centre hole.

Pegboard puzzles of the kind shown at D are very easy to make. Four strips of wood are first nailed to a piece of pegboard which is about 5 in. square, using panel pins. The holes in the pegboard

are numbered with Indian ink, but not in order. For example, the numbers from 1 to 30 might be scattered over the board. Three beads, slightly larger than the holes in the pegboard, are inserted, and a cover of transparent plastic gummed in place.

The object, is to manoeuvre the beads so that they rest in the most highly numbered holes. This is not as easy as it sounds. It is best to set a time limit, the winner being the person who achieves the highest total in this time.

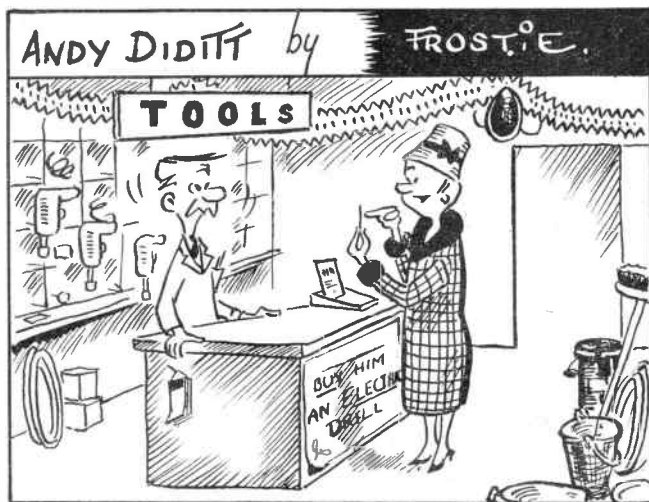

"I'LL TAKE HIM THIS ONE, THEN PERHAPS HE WONT BE SO DISAPPOINTED - HE WAS EXPECTING AN ELECTRIC DRILL?"

Instructions to make

A HANDY KITCHEN SHELF

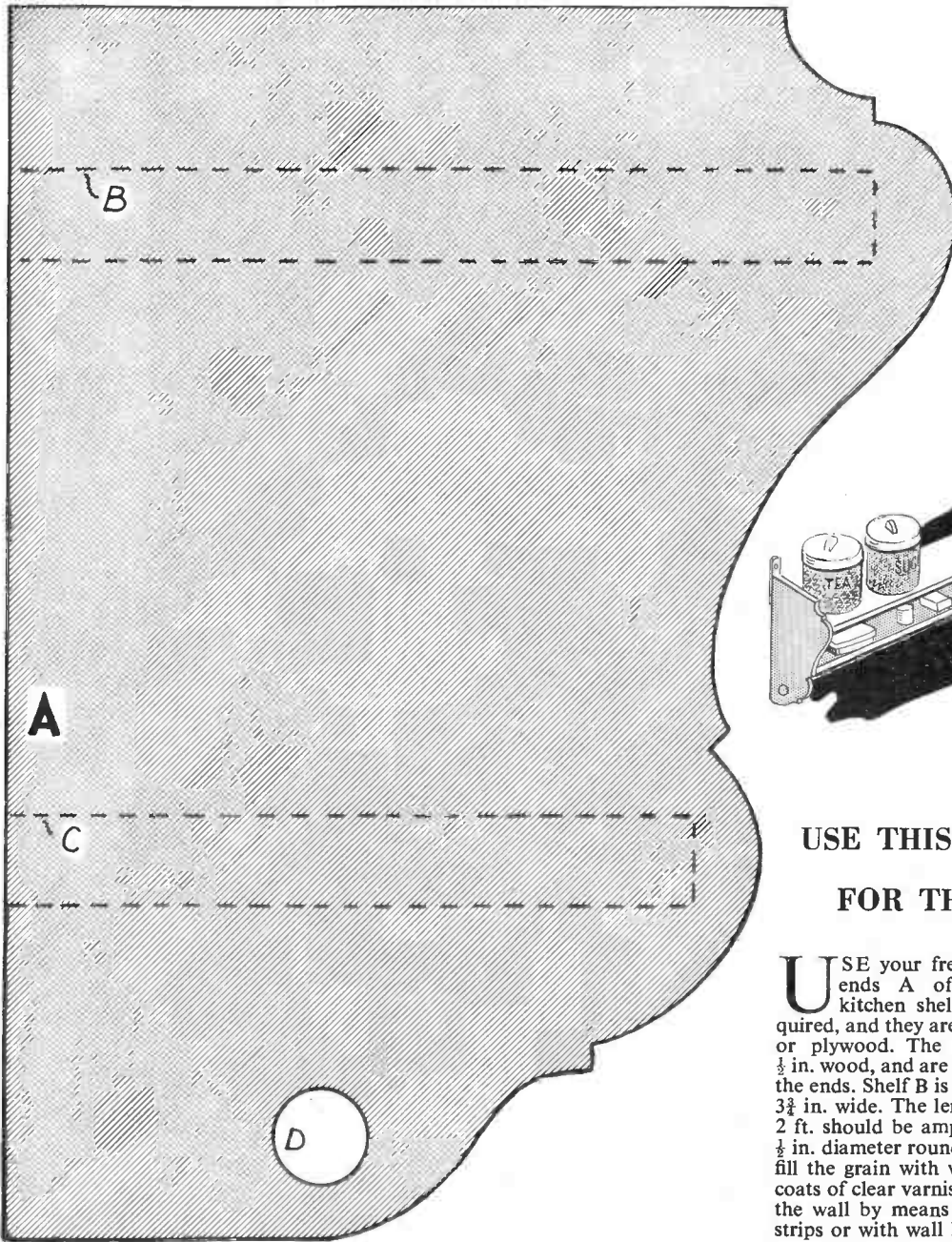

CUT OUT
THIS
SHAPE
WITH
A
FRETSAW

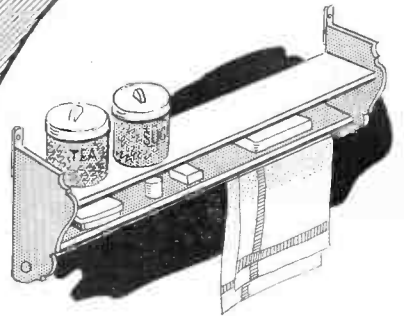

USE THIS PATTERN
FOR THE ENDS

USE your fretsaw to cut out the ends A of this easy-to-make kitchen shelf. Two ends are required, and they are cut from $\frac{1}{2}$ in. wood or plywood. The shelves are also of $\frac{1}{2}$ in. wood, and are screwed and glued to the ends. Shelf B is $4\frac{3}{4}$ in. wide, and C is $3\frac{3}{4}$ in. wide. The length is optional, but 2 ft. should be ample. The rail D is of $\frac{1}{2}$ in. diameter round rod. Clean up, and fill the grain with woodfiller. Give two coats of clear varnish to finish. Hang on the wall by means of $\frac{1}{2}$ in. wide brass strips or with wall hangers. (M.p.)

343

Printed by BALDING+MANSELL, LTD., London and Wisbech, and Published for the Proprietors, HOBBIES LTD., by HORACE MARSHALL & SON, LTD., Temple House, Tallis Street, E.C.4. Sole Agents for Australia and New Zealand: Gordon & Gotch (A'sia.) Ltd. For South Africa: Central News Agency Ltd. Registered for transmission by Canadian Magazine Post.

READER'S REPLY
HW FEB.
1962



Every handyman's right hand man for over 60 years

There's nothing like real SECCOTINE! For over sixty years Seccotine has been indispensable to every handyman. For sheer adhesive power buy Seccotine with the efficient new "pop-on" seal and open-nozzle tube ready for use.



FULL SIZE CHILD'S COT

4 ft. x 2 ft.

Drop-sided with lift-out webbing mattress. Collapsible for easy storage. Easy to make by the handyman from the Kit supplied which contains selected planed wood, dowel rod, webbing, drop-side fittings, hinges, and screws.



KIT No.
3202

63/6

(post free)

Drop-side fittings, available separately, price 7/9 a set, postage 1/6 extra

Obtainable from all Hobbies Branches or Stockists, or direct by Post from Dept. 99

HOBBIES LTD., DEREHAM, NORFOLK

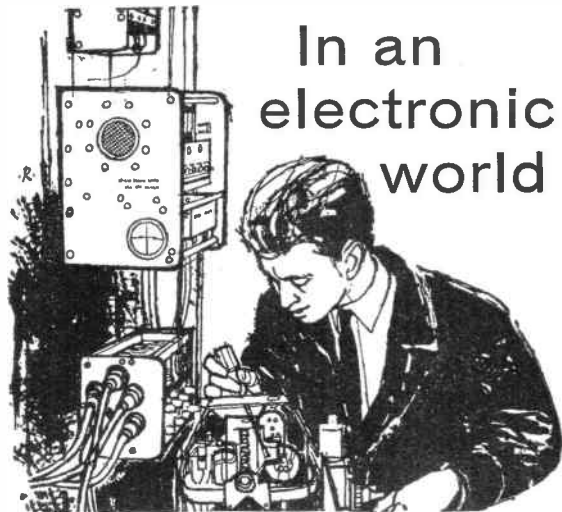

In an electronic world

YOUR MOST THOROUGH TRAINING IS AN R.A.F. APPRENTICESHIP

If you are between 14 and 16 you should enquire *now* about an R.A.F. apprenticeship in Electrical and Instrument Engineering, or in Radio Engineering—the finest training in the country in the vital field of electronics. It is a training that can help you to get to the top in a highly technical and specialised world.

3 years training

As an R.A.F. apprentice your course can start as soon as you are 15 and lasts for only 3 years against the 5 years usual in industry. You live well, you eat well, you have every opportunity for sport and recreation, and you are well paid from the day you join. You can earn up to £6.9.6 a week all found during your training. Most boys qualify as Junior Technicians at 18 and earn well over £9 a week *all found*.

Boys who wish to be apprentices must be between 15 and 17 on entry and able to pass a written exam—science and maths are the important subjects. (G.C.E. at 'O' level in certain subjects exempts you from this exam.) *Fill in the coupon now! Find out what the R.A.F. can offer you!*

The Future is with the R.A.F.

Write before **April 6th** to: R.A.F. Careers Information Centre HS 858b Victory House, Kingsway, London, WC2
Please send me without obligation, free illustrated booklets giving details of service as an Apprentice or a Boy Entrant in the R.A.F. Enquiries from U.K. only.

NAME _____

ADDRESS _____

DATE OF BIRTH _____

The Royal Air Force