

20th SEPTEMBER 1961

VOL. 132

NUMBER 3432

THE ORIGINAL  
'DO-IT-YOURSELF'  
MAGAZINE

# HOBBIES *weekly*

FOR ALL  
HOME CRAFTSMEN

★ *FREE plan inside*

Also in this issue :

WIND-DRIVEN  
MERRY-GO-ROUND

COLLECTORS' CLUB

NEW THOUGHTS ON  
MODEL RAILWAYS

MODELLING A  
CLIPPER SHIP

HORSE OVERLAY

NOVEL SCREENS  
FOR PHOTOGRAPHY

SCIENCE AND  
CHEMISTRY

ETC. ETC.

**IDEAL FOR  
THE 'MODEL'  
YOUNGSTER**

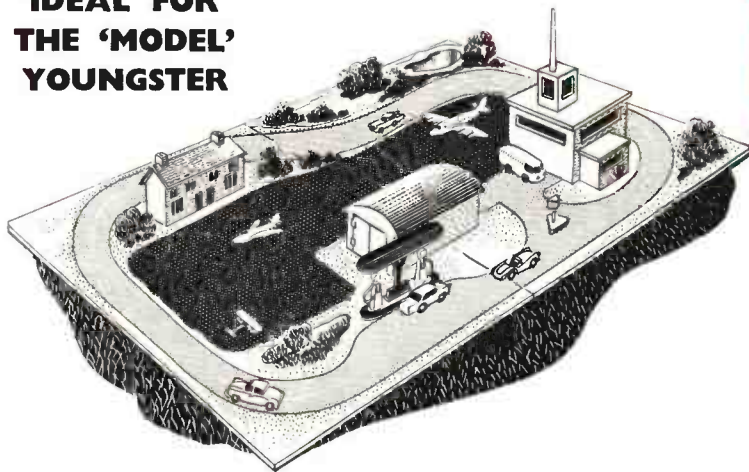

Make this thrilling  
**ROAD LAYOUT  
AND AIRPORT**



*Up-to-the-minute ideas*

*Practical designs*

*Pleasant and profitable things to make*

**5<sup>D</sup>**



WE get many inquiries about labels. A question always being asked is: 'Where can I obtain a catalogue?' The fact is, no official label catalogue exists.

## LABELS IN CIRCULATION

But in this series we hope to discuss with thematic description all new and obsolete issues currently available from dealers, and so provide readers with an adequate catalogue.

Some topics are frequently pictured on labels. Russia and other countries have produced many Road Safety sets. The set illustrated is common at present — but buy now.

Chess is popular with all ages. The Swedish label, although obsolete, is not difficult to find. So here's a start for your Indoor Games page.

Chess is believed to have originated in India. It was invented to divert men from the attractions of actual war by giving warfare in miniature. It is probably the most ancient of all games of skill. A chess-board and men have been found in Egypt which are about 6,000 years old.

The word chess is supposed to be derived from shah, the Persian word for king, and check-mate from shah mat, meaning 'the king is dead'.

Here are facts on other labels illustrated:

India's Own, depicting Mohandas Karamchand Gandhi — 1d. mint. Gandhi was born on 2nd October 1869 at Porbandar the capital of a small state in Kathiawar, in Western India. He was married at the age of 13. He was assassinated on 30th January 1948, just when Britain had voluntarily handed back the rule of India to her own peoples.

Cobra — 1d. mint. The hooded snake of India, better known as the cobra, is the most feared of all poisonous snakes. Few creatures can inspire more awe than a 6 ft. cobra standing guard in a jungle path. The



These brewery labels come from Czechoslovakia. Those who need these covers should write to ALOIS BLAHNA, CESHAKAMENICE, CZECHOSLOVAKIA, who will welcome British pen friends

most remarkable feature of the cobra is its curious hood, formed by the ribs of the neck which the snake can raise and expand at will, stretching out the folds of loose skin. Despite its terrible reputation, the cobra is the favourite of snake-charmers.

The piano originated from the harp, and if the strings of a piano are examined it will be seen that they are still arranged in the form of a harp. Russian cover — 1d. mint.

A violin looks simple enough in its construction. It is made up of only a hollow body of wood, a solid wooden neck, some strings with pegs to tighten them, and a small piece of wood called a 'bridge' to raise the strings from the body. All these things are easily shaped and put together. But while one violin may be a very fine one, another made just like it may be of little or no value. The reason for this depends on a great many things, such as the fineness and thinness of the wood, the size and form of the sound holes cut in the top, the strings, etc. The best violins were made about 150 years ago — Russian cover — 1d. mint.

Yugoslavia's Drava factory is producing many advertising labels which can be had for 3d. each. These labels are useful for pen friend exchange.





# Road Layout and Airport

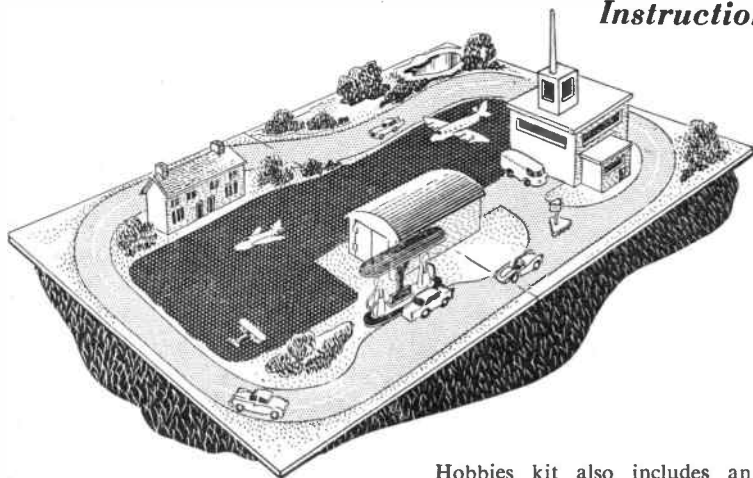

Hobbies kit also includes an attractively painted filling station unit, complete with petrol pumps. The vehicles and aircraft, and any other

**M**INIATURE model motor cars and aeroplanes are popular indoor playthings for youngsters, who love to invent all sorts of situations—including the inevitable crashes! They run their small models around the patterns in the carpet, and generally manage to get under everybody's feet.

Our layout has been designed with the idea of stimulating the youngster's interest by using models in a real situation consisting of a road layout and airport complete with typical buildings and scenery. The scale of the layout will enable smaller models such as the 'Match-box' series to be used to good effect.

As can be seen from the illustration, the layout consists of a highway surrounding a small airport. Vehicles drive up and park, and aircraft take-off and land at the air-strip. Buildings include a control tower, aircraft hangar, cottages, and a filling station. Our design gives a sound basis to which parents and children can add in the way of further buildings and other facilities. The size of the base is 36 in. by 24 in., and this can be extended as required. For instance, you might like to add another section showing an adjoining farm complete with buildings, machinery, stock, etc. Our basic layout can, therefore, be ideally extended in several ways.

The hardboard bases are not joined together. They remain separate pieces to facilitate easy dismantling and storing, and the buildings, etc., are positioned on the bases according to the layout.

In Hobbies kit No. 3432 there is sufficient wood and hardboard for making the buildings and base, as illustrated, together with clear acetate for the windows of buildings. Glue and paint are not included in the kit, but if not already to hand, can be obtained from any hobby shop.

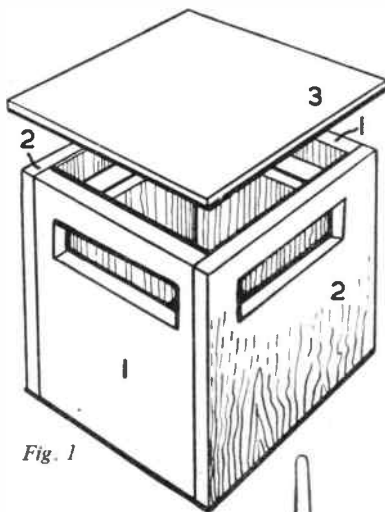

Fig. 1

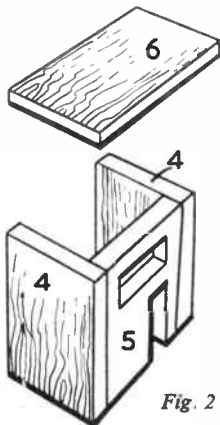

Fig. 2

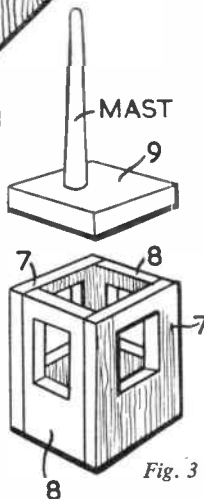

Fig. 3

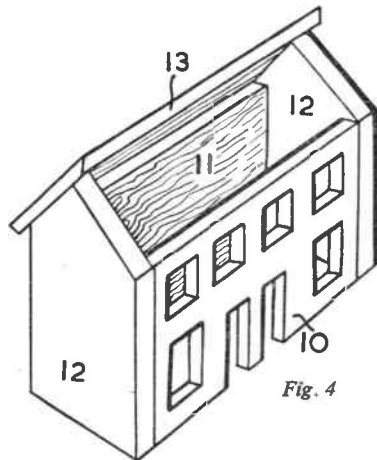

Fig. 4

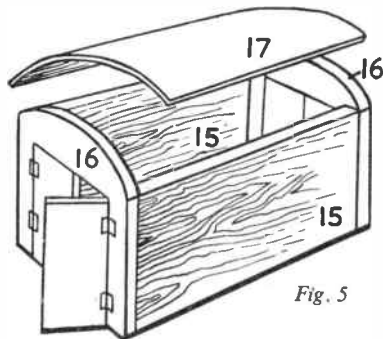

Fig. 5

Most of the parts are shown full size on the design sheet, from which they can be traced and transferred to the wood by means of carbon paper. For other parts measurements are shown, and should be marked out accordingly. When all the parts have been accounted for on the wood, cut them out with a fretsaw, and clean up with glasspaper.

Fig. 1 shows the assembly of the main part of the flight control building. Clear

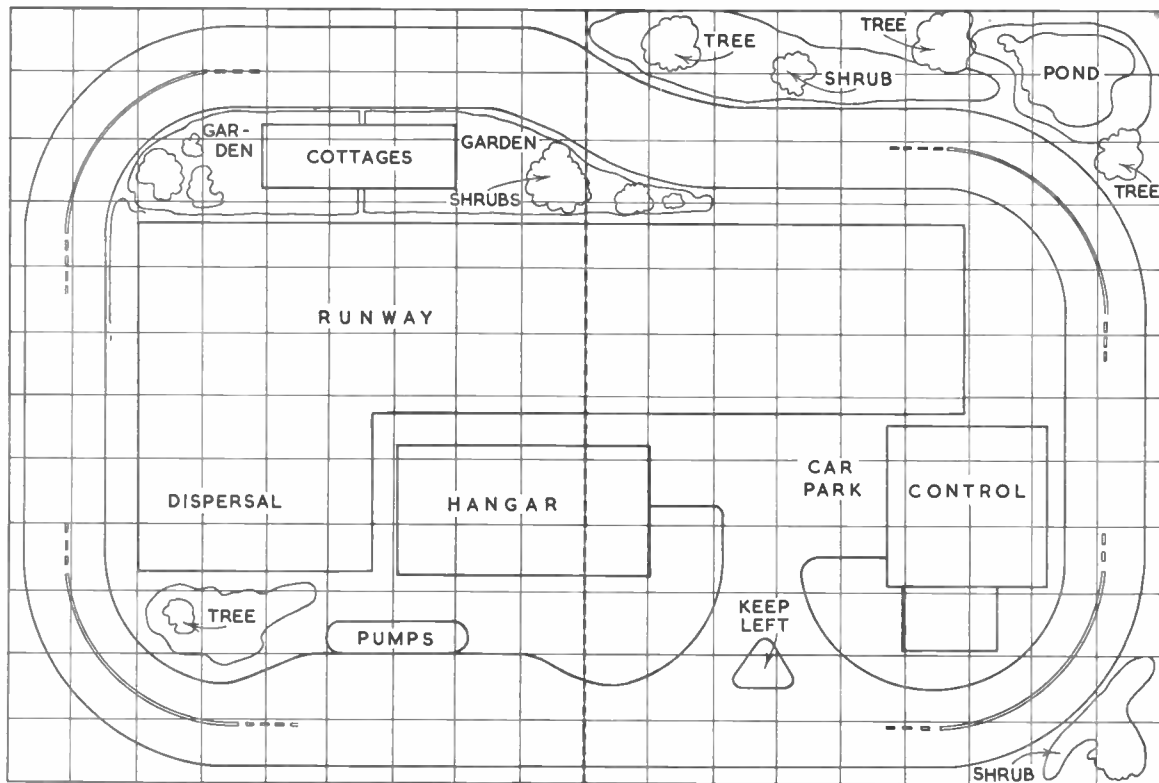

Fig. 6

acetate sheet should be pinned behind the windows after the assembly has been painted. To this section add the small office building (Fig. 2) and the control tower and mast (Fig. 3), making sure to add the window material to the control

on to which the roadway is painted as shown in Fig. 6, which also indicates the position of the buildings, runway, and other features. The squares shown in

should be a matt brown, and the waste areas outside the roadway should be green, and flecked with brown and yellow.

The 'islands' on which the shrubs and trees stand are irregular-shaped pieces of  $\frac{1}{4}$  in. plywood (Fig. 7), to which pieces of twig, moss, etc. to represent trees and shrubs, are glued, and then painted. Plastic wood and Plasticine could also be used for modelling vegetation. The pond is cut from  $\frac{1}{4}$  in. wood, the centre portion being removed and painted a light blue streaked with white.

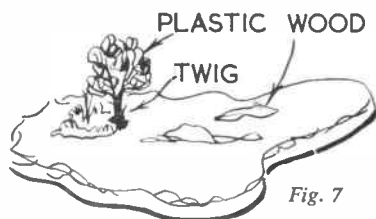

Fig. 7

tower before gluing it in place. All parts are assembled by gluing and pinning where necessary.

The cottages are made up as shown in Fig. 4, the chimney pieces (14) being added after the roof has been glued in place. Once again add acetate sheeting behind the windows.

The hangar (Fig. 5) has doors at both ends, which are hinged to the building in the positions shown by small pieces of glued tape. The roof of the hangar (piece 17) is cut from a piece of thin card, and glued on as shown.

The base for the layout consists of two pieces of  $\frac{1}{4}$  in. hardboard 24 in. by 18 in.,

Fig. 6 are enlarged to 2 in., the various outlines can be drawn direct on to the base, or first of all on to paper and then transferred to the base.

The roadway and car park should be painted a matt grey, with the runway and dispersal area a darker grey. The areas adjoining buildings can be smeared with glue or paint, and sprinkled with fine sand. The gardens around the cottages

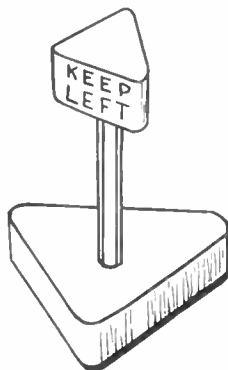

Fig. 8

**Hobbies Kit No. 3432 for making the Toy Road Layout and Airport includes all wood, plywood, hardboard, plastic wood, acetate sheet, filling station unit etc. and a full size plan of the layout. Kits price 33/3 (post free) from branches or direct from Hobbies Ltd., Dereham, Norfolk.**

The various buildings can be finished as desired. The control tower can be white with a grey roof, the hangar red with a grey roof, and the cottages finished in red brick with green tiles. A small 'Keep Left' sign is made from waste wood, as shown in Fig. 8.

# NEW Thoughts on

# RAILWAY MODELLING

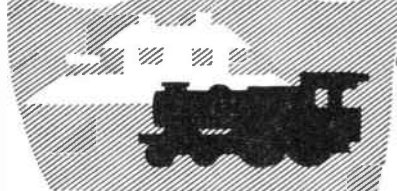

**T**HE modern railway modeller is much more fortunate than his predecessors in that so much more stuff is available. The plastics age helps to a very large extent, and there are countless kits on the market, as well as many finished articles that help in the scenic side of things.

Surely the most important things in model railways are the locomotives and rolling stock, both passenger and freight, and in this field the enthusiast is adequately catered for. Locomotives in kit form are available in many types. One of the best on the market is the Kitmaster series. These are readily obtainable from all toy and model shops, as well as branches of Hobbies Ltd. The range covers many types of engines, from the oldest to the latest, and the detail is absolutely wonderful. The prices are very modest and the finished article, made correctly, would grace any railway.

I have built up all the range, and have most of them on the Maryville, Fredrickton and Westbury Model Railway.

A little tip that I have found most useful, when making these models up, is to add a little weight. This gives them better adhesion to the track, and the coupling rods and valve gear then work much smoother, and they are pushed or pulled

you fit this into their coach kit No. 15 for OO gauge, or Kit No. 17 to TT.3 gauge. Put the coach so fitted behind the engine and this will push the engine and pull a train behind it. A similar idea is available for goods trains, and this is in the form of a box wagon, with the motors fitted. This is sold as a complete unit.

There are also on the market motorizing units for some of the models, but these take the more conventional form, and the motor is put into the actual locomotive. In the motorizing kit one gets the gears, weights, metal tyres for the wheels, and pickups, etc, and then you purchase the motor as a separate unit. I had one of these tested on my layout a couple of years ago, and it worked beautifully.

As regards the Kitmaster kits I would like to see the transfer sheets more comprehensive. It is very difficult for people without the knowledge to apply such things as lining to the locomotives, especially on boiler bands and the most difficult of all, wheel splashes. I think that they could include in the kits some lining for this purpose in transfer form. It would greatly add to the value of the kits, and the appearance of the finished models.

The range is very wide, and covers engines of British as well as foreign railways. It starts with the *Rocket*, that famous old engine of Stephenson, includes the famous G.N.R. single-wheeler of Patrick Stirling, and ends with the last of the steamers, the *Evening Star*. Prices range from 3s. 6d. for the *Rocket* to 12s. 6d. for the Beyer-Garratt, which is one of the latest to appear. I have just had the pleasure of building this one and it is a beauty about 13 in. long and a joy to behold. There is also an excellent range of coaches, grand value for 6s. 6d. But I have one criticism here. I think they would have been improved if seating had been provided for them, either included in the kit, at an increased price, or else available as an extra kit. Seats in a coach make all that difference. Without them the coach looks like an empty box on wheels.

An excellent adhesive for all plastic kits is carbon tetrachloride, but great care must be taken when using this stuff. It should only be used in open spaces, and the fumes should not be inhaled. It is quite safe to use it in a room with the

## PLASTIC KITS

more easily. Weight can easily be put into the boilers and tenders. Keep it as low as possible in the component, i.e., on the floors of tenders and right in the bottom of the boilers. Any scrap lead will do, and even if you forget to put it in whilst building, you can drop lead shot into the chimney of the boiler, and let it find its own level. But if you do this mind the engine does not fall over, or the lead shot will come out.

Kitmaster sell an electric motor bogie that fits into coaches, the idea being that

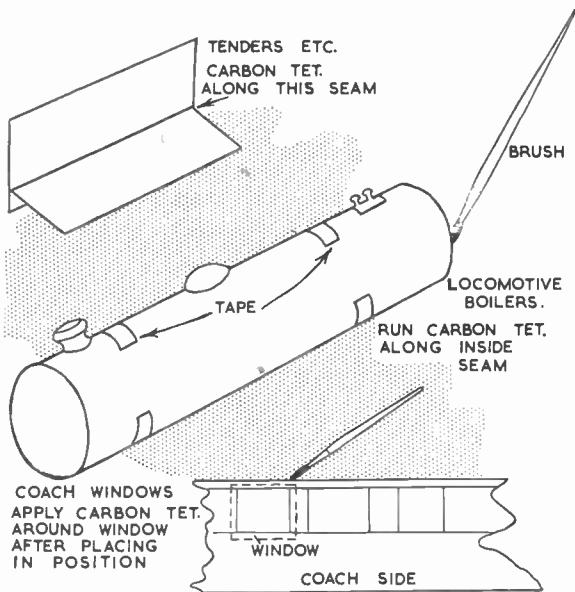

*Use of carbon tetrachloride for sticking plastic parts in various assemblies*



## TWO MODELS FOR YOUR LAYOUT



*Milk Delivery Truck, 'OO' scale, 6 cm. long, Matchbox model, 1/8*

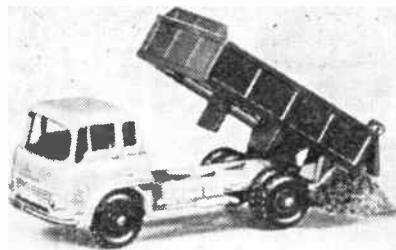

*Bedford Tipper Truck, 'HO' scale, 6 cm. long, Matchbox model, 1/8*

window open. Make sure to be near the window when applying the liquid, and keep the cork in the bottle when not in actual use.

The method of using is as follows. Place two parts together and apply the liquid with a brush along the seam to be joined. In the case of a boiler, which is usually made in two halves, place the halves together correctly and hold in place with Sellotape, ensuring that the parts line up correctly. Then apply carbon tetrachloride with a brush to the inside of the join, let it run down the seam, and leave to set. Be careful not to get the liquid on your fingers and then place them on the model. It softens the plastic immediately and will leave finger-marks all over the model. You will find that the parts stick perfectly.

One must also mention, of course, the wonderful range put out by Airfix. Now here we have a most comprehensive range of kits for all types of railway articles. We can purchase these at our local branch of Hobbies Ltd and at most toy and model shops. The range includes buildings of all kinds, houses, bungalows, stations, a locomotive shed, signals, bridges, and a good range of goods wagons, etc, not forgetting, of course, a vast number of aircraft to the scale of 1/72nd, which is nearly the correct scale for OO gauge.

The building kits are in the main adaptable for expansion, that is to say they may be modelled in various forms, and made larger as the will of the modeller plans. Stations may have their platforms extended at will. There is also an excellent range of scale figures to add convincing realism to the layout. To say nothing of animals for the authentic touch along the right-of-way. There can be obtained all platform fittings, telegraph poles, fencing and many other items, all of which when made up and painted make the model railway live.

The remark I made about putting weight into the locomotive kits also

applies with regard to the wagon and van kits, but do not overdo it. All that is required is a flat piece of lead, or something of the sort, and just sufficient to keep the wheels on the track all the time. The couplings on the Airfix rolling stock are changeable to suit existing couplings, or you can use their own type, which are very good. They are automatic couplers, but will not uncouple automatically. I would like to stress the value in these kits. Only 2s. for a wagon or a van kit is really wonderful value, especially when one appreciates the detail that is in them. Not a rivet has been left out, and you have the advantage of opening doors and in all cases a very complete transfer sheet to dress up the model when it is finished.

One of their later models is of the Booth Rodley 15 ton Diesel Locomotive Crane. This model is a winner and is most complete in every respect. Fine value for 3s. This model could be adapted for many different models. You could use the crane part, off its wheels, mounted either on a concrete base, or else mounted on a lorry chassis. If you intend to make one of these, and to run it on your railway, you should make up a truck to carry the jib whilst it is on the railway. I am hoping that perhaps Airfix will include one in their range.

In a later article I intend to cover the electrification of some of these kits, with the little motors that are on the market now. One can get them very small, and they will fit in most of the models.

Whilst on the subject of plastics, let me mention a new material that I saw demonstrated on the stand of Messrs G. N. Slater & Sons at a Model Railway Club Exhibition. This material is known as 'Plastikard' and it is in fact thin sheets of black or white plastic material. Such things as seats, stairs, signal cabins and the like are made from this material quite easily and one can think of many other items, such as

embellishments on buildings, girders and the like. This firm also make an excellent range of other products for the railway. Trees, human and animal figures, model carts, and wheels for same, are available in three scales, TT3, OO and O gauge.

Now all these items will require painting, and there is no better finish available than that produced by the Humber Oil Co Ltd. Known as 'Humbrol', it is available in all the railway colours. They also sell a range of paints for scenic work, which is very good for the job. All of these paints have the advantage of being quick drying, so long as the surface of the model to be painted is free from dust and grease.

Here is a tip that I pass on to you, which you will find of value. Finger marks are of a greasy nature and will prevent the paint from drying. Carefully brush methylated spirit over the surface of the model to remove all traces of grease, and refrain from handling the model again until after the paint is applied and dry.

In my next article I am going to describe the building of a model railway. In fact I shall be taking you through the building programme step by step, and shall start first with the layout plan and show you how to build the baseboard, and also give details of the hide-away type of railway which I am sure some of my readers will find of great interest.

## INTRICATE CUTTING



*This charming Cathedral clock being so much admired by two little girls, was made by Mr Carl Hyslop, of 81 Seventh Avenue, Brantford, Ontario, Canada. It measures 12 in. by 24 in. by 48 in. high, and entailed some very neat and delicate fretcutting which Mr Hyslop does on a machine. He would like to hear from other readers who enjoy cutting such intricate designs.*

# A WIND-DRIVEN MERRY-GO-ROUND

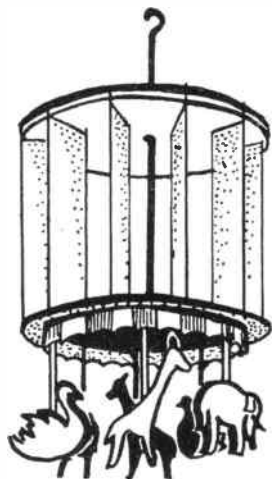

**A** MERRY-GO-ROUND driven by a wind-powered rotor makes an unusual novelty to hang in the garden or under an overhanging eave. The rotor will revolve no matter what direction the wind is from, spinning the animals round gaily.

The top and bottom circles of the rotor are made from thin plywood, and are 5 in. in diameter, although they may be made larger if desired. The two discs are screwed together at their centre points, and the positions of the slots for the vanes marked out. This is done as follows.

Four diameters are drawn on one of the plywood discs at 45 degrees to each other. A 1 in. long slot is marked and sawn at the outer edge of each of the diameter lines as shown at A. These slots should be at an angle of 30 degrees to the diameters.

After the slots have been sawn through the two discs, they are separated. Six  $\frac{1}{4}$  in. holes are drilled round the edge of the lower disc to take the dowel rods on which the animals are mounted.

such as a small tin filled with sand, is fastened to this. Two beads are threaded on to the wire above the weight, and the wire is passed up through the centre holes in the rotor discs. The upper end

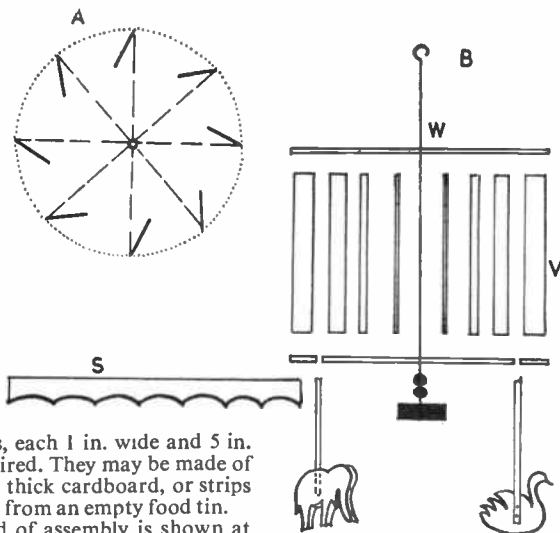

Eight vanes, each 1 in. wide and 5 in. long, are required. They may be made of thin plywood, thick cardboard, or strips of tinplate cut from an empty food tin.

The method of assembly is shown at B. The vanes V, are glued in their slots, or in the case of tinplate strips, glued and wedged with short lengths of matchstick if necessary.

Next, a length of stiff wire W, is bent into a loop at its lower end, and a weight,

of the wire is formed into a hook shape. At this point, the rotor should be tested to ensure that it revolves smoothly and freely on its bead bearings when exposed to a breeze.

The merry-go-round section is made by cutting six animals, planes, ships or cars, from plywood or cardboard. Each of these should be about the size of a matchbox, and to ensure good balance, two of each kind should be made and mounted on opposite sides of the rotor.

Each of the cut-out shapes is pinned and glued to a 3 in. length of  $\frac{1}{4}$  in. diameter dowel rod which is then glued in place in one of the holes previously drilled round the lower plywood disc.

A cardboard or tinplate strip S, which has been given a scalloped edge, can be pinned and glued round the tops of the dowel rods.

The whole assembly is brightly painted and hung in position. The speed at which it revolves will depend, of course, on the strength of the wind and the materials used. If the rotor tends to be blown to one side by gusts of wind, a heavier weight may be fitted, or alternatively, an anchoring cord can be led down from the bottom of the wire to any convenient point. (A.L.)

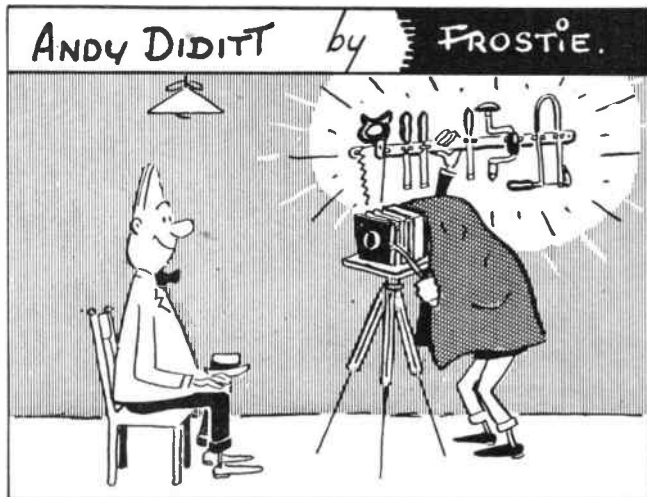

# Mainly for Modellers

IN continuing our Clipper details, let us now consider the deck fittings. We have in Fig. 1 a typical clipper ship hatch. This means that the blocks of wood marked hatches on your Hobbies design should be carved or sanded to this shape instead of being left flat. The top is covered with Bristol board so as to leave a slight overhang all round.

The next fitting is the fife rails (Fig. 2). These I have made from various materials on different models, wood, fibre, plastic, etc; a thin plastic will give a much stronger unit than any other material in relation to its thickness. The fife rails are cut from material about  $\frac{3}{8}$  in. thick. The stanchions on my Cutty Sark model were made from ordinary

pins, the assembly being painted to represent dark brown wood. The thickness of the pins was built up with paint after the first coat had dried. The fife rails are placed each side of the mast, the holes for the pins being first drilled with a No. 74 twist drill. The pins are then given a thin coat of cement or glue on the part which is inserted in the deck, and the unit is gently tapped into position. When the cement has set, the rails will be anchored securely enough for you to belay your appropriate rigging lines.

Pumps are important items, yet often left off models of this size. They can be quite easily modelled at this scale near enough to give the correct appearance. In Fig. 3 we have a typical pump from

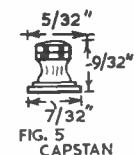
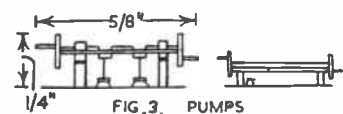

FIG. 5 CAPSTAN



FIG. 7 SHIPS BOATS

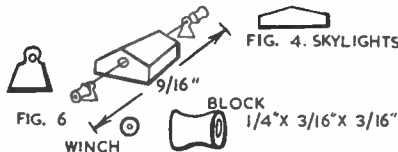

FIG. 6 WINCH

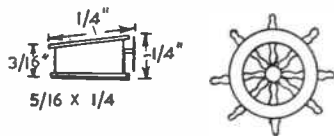
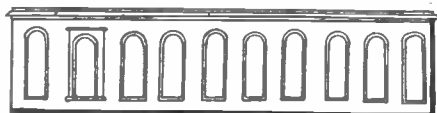
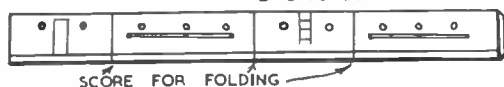

FIG. 8. WHEEL AND HOUSING



FIG. 9. DECK HOUSES



CUTTY SARK TYPE OF PANEL

a Clipper ship; also a simplified model made from small  $\frac{1}{8}$  in. dowel, wire and Bristol board. When painted, this little model is quite realistic. Modellers who are good at miniature work could make up a more detailed model pump from the first drawing.

## CLIPPER SHIP MODELS—2 By 'Whipstaff'

A typical Clipper type of skylight shown in Fig. 4 is easily modelled from a small block of wood. In the Hobbies design the block given should be shaped and painted as in one of the two styles shown.

The capstan in Fig. 5 can be turned on your Hobbies lathe, and suitably painted. If you have no lathe, it can be shaped with a small file from a piece of  $\frac{1}{8}$  in. dowel. Hold your hand drill in a vice, and turn the handle to rotate the piece of dowel held in the chuck. The base is a disc of Bristol board.

### HOBBIES GALLEON RANGE

	Kit No.	Inches long	Complete Kit	Post
'Mary Fortune'	2914	7	6/1	9d.
'Bonaventure'	3014	8	6/10	9d.
'Ed. Galleon'	2778	9	7/1	9d.
'Warwick'	3164	7	7/4	9d.
'King's Ship'	3108	7	7/7	9d.
'Regent'	3064	7	7/10	9d.
'Bounty'	2812	11½	12/8	1/6
'Nathan Ross'	3058	12	17/3	1/6
'Mathew'	2662	15	17/9	1/9
'Elizabeth Jonas'	2095	16	20/3	1/9
'Mayflower'	2147	15	21/10	2/-
'Elizabeth R'	250 Sp.	14	23/1	2/-
'Santa Maria'	2668	16½	23/10	2/-
'Cutty Sark'	2186	21	23/4	2/-
'Revenge'	235 Sp.	15	24/7	1/9
'Tea Clipper'	3234	22½	26/4	2/3
'Royal Sovereign'	2157	17½	27/2	2/-
'Golden Hind'	2337	16½	28/2	2/-
'Royal Charles'	252 Sp.	11	26/4	2/-
'Victory'	3198	22	29/11	2/6
'Great Harry'	2262	19	31/11	—
'Ark Royal'	211 Sp.	22	54/9	—

Each kit contains planed wood to cut out and shape, guns, masts, pulleys, nameplate, etc, and design sheet with full instructions for building these famous ships of history. Designs are also available separately for those wishing to work from their own materials. Prices from 1/- to 3/- Ask for details.

The deck winch is another unit which can be modelled and added to our Clipper models. This is made from a block of wood shaped as in Fig. 6. The wire is passed through a hole drilled lengthways through the wood, and small pieces of plastic wood could be added at each end. Alternatively use a piece cut

● Continued on page 394



# NOVEL SCREENS

IT is possible to prepare a variety of stock negatives to act as screens, these being used to overprint on an already exposed picture. At the same time, and more for amusement, the same screen negatives can be combined to make all kinds of abstract pattern pictures and the scope is virtually unlimited.

*By S. H. Longbottom*

The materials used for screen negatives are oddments of all descriptions and while you may use your own ingenuity the examples shown will probably be a guide. But note that we have different methods of making these basic negatives. In other words, we may make one negative by contact methods, the material being a piece of cotton net; another material may be placed in the enlarger negative carrier and projected on to the negative material while another may be photographed in the usual manner. We have, therefore, not only many materials at our command but also different methods of making negatives, thus increasing our control of this intriguing project.

A screen made in the fashion we are about to describe is overprinted on to a print already exposed for a picture to

make an entirely new effect, but it is up to you to combine suitable negatives.

Our top illustration shows the use of a screen giving what appears to be a crazing effect not unlike a crackle paint finish. The black lines you see in this example are actually the minute veins of a magnolia leaf. The negative is made by placing a dried leaf between the glass in the negative carrier of the enlarger and an exposure made on to a Commercial Ortho cut film. The image is enlarged for this purpose and as you will observe it is then used for overprinting with another selected negative.

The negative material is placed on the enlarger baseboard after focusing on to a piece of white card, and an exposure of  $2\frac{1}{2}$  seconds given while using a 60 watt lamp in the enlarger at a distance of 2 ft. between baseboard and lens. The negative is developed as usual in a dish to produce a reasonably dense black, leaving clear lines for the veining. You may also use small lantern plates, say 2 in. by 2 in., of a degree suitable for enlarging, as for example Ilford Special Lantern Plates. These are reasonably fast and suitable for the purpose of making images by projection through an enlarger, but careful tests are necessary to determine the correct exposure.

Ordinary wire mesh can be overprinted on to a picture but a different method is used. In this instance the wire

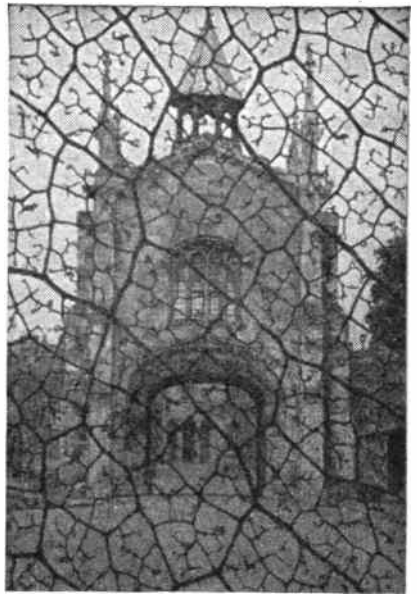

*Using the negative made from a dried Magnolia leaf*

mesh is set up before a white background and a photoflood light directed on the latter, producing a silhouette. If a close-up picture is then taken the resulting negative makes an image.

A screen of coarse canvas can again be obtained by normal close-up methods. To obtain such a texture it is necessary to direct a strong light at a low, acute angle. This casts shadows on one side of the yarn, giving the desired effect. Rough-textured papers may be similarly photographed but you will find it an advantage to apply a dusting of black graphite and then dust away from the high relief, producing a marked contrast.

We can produce a screen negative by placing the selected material directly in contact with the negative material, making a short exposure to artificial light as when making a contact print. All kinds of materials can be used provided they are reasonably flat, such as perforated zinc cotton net meshing (see illustration), chiffon, bandaging, lace and other open fabrics.

The foregoing does not absorb the methods of making screen negatives and if you like to experiment further we would suggest other novelties. If some crystals of Epsom salts are placed on a piece of clear glass and this is inserted in the slot of the enlarger normally occupied by the negative carrier, you will find, when projecting on to a piece of white card, that the light rays have been refracted to produce an abstract pattern. This can be transferred to a piece of cut film as

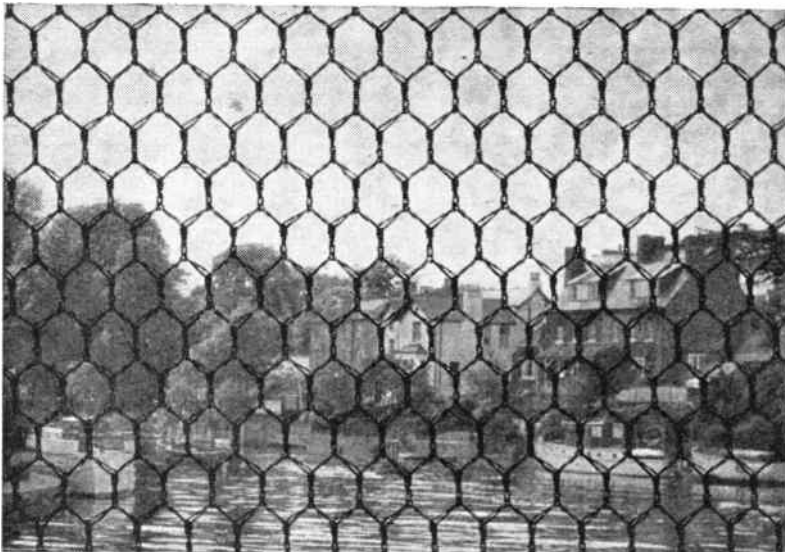

*This effect was obtained by overprinting a screen made from cotton net*



Fig. 1—Pronounced screen—'shadowy' image of tower

already mentioned. A similar effect can also be obtained by using pieces of decorative glass (arctic, ripple or hammered) in place of the crystals. Small coins, buttons or beads may also be arranged on the glass and these will enable you to make similar negatives.

Any one of these negatives may be reversed by making a further contact negative, but in this instance the aim is to produce white lines instead of black, and consequently the screen negative is

placed with the original negative in the carrier when enlarging.

An alternative to this method is to place materials directly in contact with the surface of the printing paper and leaving there during the whole, or part of the exposure. For example, you may lay a piece of cotton netting over the paper, but this must be in perfect contact and it is advisable to lay a piece of clear glass on top. If the material is allowed to remain there for the entire exposure the resulting marking will be white, but the effect is not so obtrusive if the material is taken away after, say, one-third of the total exposure time, when it will leave grey screening.

Another method is to use paper screens for these contact methods but here we require one which has a watermark. The selected paper should bear lines clearly seen if the paper is held to the light. In this case we make the paper translucent by applying a solution made from half castor oil and half petrol. Incidentally, this method is often used by professional photographers for portrait studies.

When the screens have been prepared you may apply the resulting textures to any picture you desire. It is merely a matter of testing to determine the amount of exposure required to print the screening in a good black without degrading the highlights in the remainder of the picture. You will always find it advisable to make additional tests before proceeding. To make this quite clear, we would advise that you make a first test for exposure of the original negative horizontally on a test strip, and then a vertical test of the screen negative on the same paper. This is most important when combining a textured base like the rough

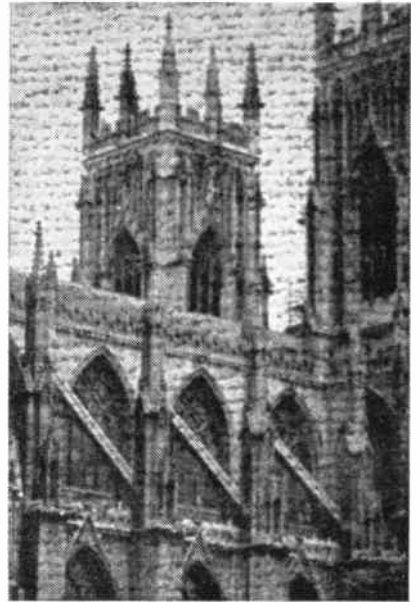

Fig. 2—Images are almost balanced

canvas.

It is also important to realize that we can produce vastly different effects by altering the degree of enlargement of the screen negative or the strength of same. So in the examples we show in Figs. 1 and 2 you will see the difference.

You will find that screen making and combination is quite a fascinating project, and as you will see from the illustrations, can create the illusion that you are actually looking through iron gates or grilles at the scene beyond and which would be impossible to focus correctly.

● Continued from page 392

## CLIPPER SHIP MODELS—2

from thin rubber or plastic electric light wire covering. The end supports are of Bristol board.

Ship's boats I have dealt with in an earlier article; for the 'Cutty Sark' they were carved from wood, and the davits made from wire (Fig. 7).

The only other item to include is the ship's wheel. A typical one is shown in Fig. 8, and I have given methods of turning or modelling these in an earlier series. There are, however, many who cannot model these at the small scale of these two models, and a useful idea is to draw the wheel on a piece of clear celluloid, using indian ink. When pinned to a block of white painted wood to represent the housing, the effect is quite good, and needs very close examination to detect that the small wheel is not

actually modelled.

All the dimensions given for the foregoing items are a suitable scale for Hobbies Clipper kits.

Fig. 9 shows several types of deck houses in use on Clipper ships. The one type you will see from your Hobbies design is that found on the 'Cutty Sark'; the other type is also featured on many Clippers, and could be used on the Hobbies Tea Clipper Kit 3234; thus providing a contrasting model to the 'Cutty Sark'. These deck houses can, as in so many kits, be merely blocks of painted wood. There is a more effective way of modelling these items which gives a far more realistic appearance. That is to build them up from Bristol board or thin wood, according to the scale.

For Hobbies two models I used Bristol board, the overlay effects being painted on. The round ports in the 'Cutty Sark' were cut out with a small punch, and blue cellophane glued over the inside of them before the deck house was secured into position. To make the deck house from Bristol board, take your measurements from your plan, and lay out the plan like an opened box. After painting, the card can be scored at the appropriate positions for bending to shape and gluing to make the house, the roof being separately cut and glued on top. Where there is a skylight on top of the deck house, this can be modelled from a small block of wood.

Full details for building a 7 ft. 9 in. Pram Dinghy will be given in next week's issue.

**Whether you solder to**  
**(a) keep things IN .....**

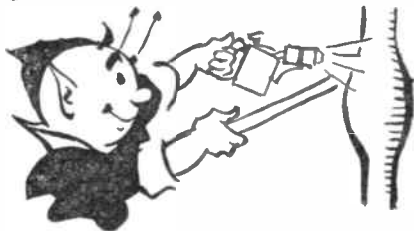

**(b) keep things OUT .....**



**(c) keep things GOING...**

**success  
 is certain  
 with**



**FLUXITE**

You can't go wrong with **FLUXITE**. Every engineer and mechanic confronted with a soldering job knows **FLUXITE** is the flux that never lets him down. **FLUXITE**'s great popularity is proof positive of its qualities.



MP.90.

*Obtainable from all good-class  
 Ironmongers and Hardware Stores*

**MANY  
 MODELS  
 from  
 ONE TIN!**



Pyrum, plastic and ready to use from its tin, can be fashioned into the widest variety of models imaginable. Buildings for your model railway set, houses, ship models, animals and figures, ashtrays and plaques — all of which when set or baked to stone-hardness can be finished in natural colours. Get the Pyrum Model Instruction book — see Coupon — and start making things like those shown below.

**SANKEY'S  
 PYRUMA  
 PLASTIC CEMENT**



Made by amateur modellers, this signal cabin and lighthouse show how with Pyrum you can get the effects of tiles, wood, brickwork, chimney pots, concrete — and even the rocks of the sea. The book offered below tells you how. Pyrum is obtainable from your local Ironmonger, Hardware Store or Art Material dealer.

**POST THIS BOOKLET COUPON TO-DAY**

To **J. H. SANKEY & SON, LTD (Dept. HW),**  
 ILFORD, ESSEX

I enclose P.O. 6d. (not stamps) for a copy of Pyrum Modelling Instruction Booklet, post free to:

NAME \_\_\_\_\_

ADDRESS \_\_\_\_\_

(BLOCK LETTERS PLEASE)



# CHEMISTRY

## AT HOME

TIN forms two chlorides. Namely, stannous chloride,  $\text{SnCl}_2$ , which is solid, and with which we have already dealt, and stannic chloride,  $\text{SnCl}_4$ , which is a fuming liquid. The preparation of liquid stannic chloride is an inconvenient preparation in the home laboratory, and it is difficult to store except in sealed tubes owing to its eagerness to absorb water from the air, and form solid hydrates.

## EXPERIMENTS WITH CHLORIDES

### Part 3

However, a solution for general use is quite easy to prepare. Into a flask put 1 gram of granulated tin, Sn, 5 c.c. of strong hydrochloric acid, HCl, and two drops of strong nitric acid,  $\text{HNO}_3$ . Take care when using these strong acids for they are corrosive. Any coming in contact with the fingers should be flushed off with water, and wet sodium bicarbonate applied.

As hydrogen,  $\text{H}_2$ , which is inflammable, is given off in the reaction, insert in the flask neck a cork carrying a short piece of glass tubing to which is fitted a long rubber tube leading out of a window. Clamp the flask on wire gauze, and heat gently. The tin rapidly dissolves, apart from a little black impurity. Filter the liquid into an evaporating basin, add 1 c.c. of strong nitric

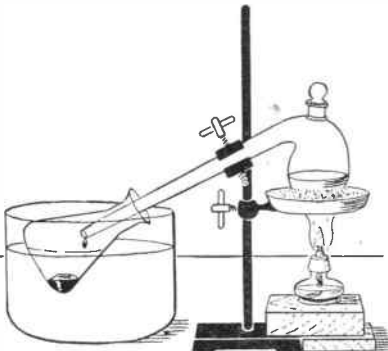
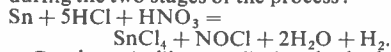

Fig. 1—Preparing chromyl chloride

acid and boil the whole. Stannic chloride; water  $\text{H}_2\text{O}$ ; nitrosyl chloride,  $\text{NOCl}$ ; and hydrogen are all formed during the two stages of the process:



Continue boiling until the liquid is reduced to half its original bulk. Near this stage an evolution of gas occurs. When this slackens, dilute the liquid to 30 c.c., and bottle it for future use.

Aluminium chloride,  $\text{AlCl}_3$ , too, is best prepared in the home laboratory as a solution, for a reason which we shall see. Into a beaker put about 2 grams of aluminium, Al, 5 c.c. of water and 20 c.c. of strong hydrochloric acid. No flames should be allowed in the vicinity, since hydrogen is given off:

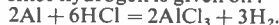

Action stops in a few hours. Filter the solution, and bottle it for use.

Now try evaporating a little of it to see if you can obtain the solid chloride. Fumes of hydrochloric acid are evolved, and if you continue the evaporation to dryness an insoluble mass is left. The aluminium chloride has decomposed into hydrochloric acid and aluminium hydroxide,  $\text{Al}(\text{OH})_3$ :

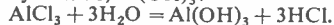

Chromium chloride,  $\text{CrCl}_3$ , is another chloride which decomposes on evaporation of its solution. It, too, is therefore best prepared as a solution in the home laboratory. You will first need some chromium hydroxide,  $\text{Cr}(\text{OH})_3$ , which may be obtained by the action of ammonium hydroxide,  $\text{NH}_4\text{OH}$ , on potassium chromium sulphate (chrome alum),  $\text{K}_2\text{SO}_4 \cdot \text{Cr}_2(\text{SO}_4)_3 \cdot 24\text{H}_2\text{O}$ , when chromium hydroxide is precipitated and ammonium sulphate,  $(\text{NH}_4)_2\text{SO}_4$ , and potassium hydroxide,  $\text{KOH}$ , are left in solution:

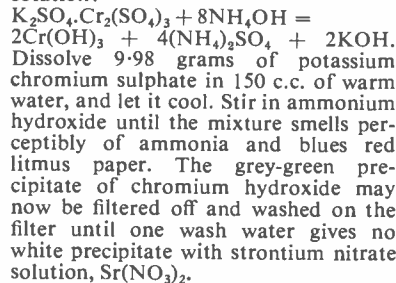

Remove the chromium hydroxide sludge to a beaker as completely as possible, and add strong hydrochloric acid drop by drop until the hydroxide has dissolved, but a slight turbidity remains. Let it now stand one hour. If the turbidity continues, add a few drops more of hydrochloric acid and stand again until it clears to a green solution.

Adjust the volume to 25 c.c. by adding more water or by allowing the solution to evaporate spontaneously. You will then have a solution of about 6 per cent weight in volume.

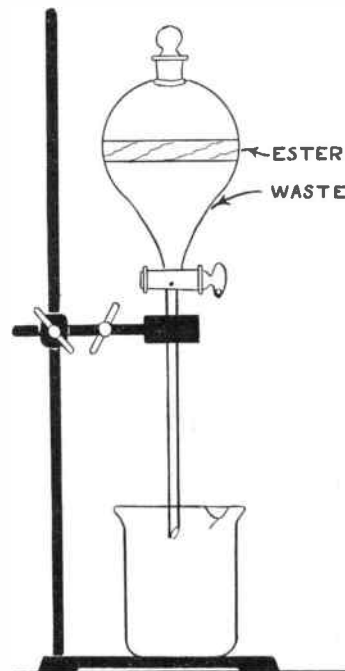

Fig. 2—Preparing tert.-butyl chloride

Chromium forms a curious compound with oxygen and chlorine. This is chromyl chloride,  $\text{CrO}_2\text{Cl}_2$ . It is a deep red, fuming liquid, very similar to bromine.

To prepare a specimen, intimately mix 5 grams of powdered potassium dichromate,  $\text{K}_2\text{Cr}_2\text{O}_7$ , and 18 grams of sodium chloride (common salt),  $\text{NaCl}$ . Put the mixture into a stoppered retort connected to a flask standing in water (Fig. 1). Remove the stopper and run in 25 c.c. of strong sulphuric acid,  $\text{H}_2\text{SO}_4$  (caution: corrosive; treat any on the fingers as for hydrochloric acid). Deep red-brown fumes of chromyl chloride at once form. By warming the sand bath the chromyl chloride distils over into the flask. Keep it in a bottle fitted with a

●Continued on page 398

LET **Plasticine**  
 HELP YOU DO-IT-YOURSELF Regd. Trade Mark  
 Special Trial Offer. We will send 4 lb. 'Plasticine' (any colour) with booklet 'Plasticine Modelling for Amateurs' Post free: 10/- U.K. only.  
 Harbutt's Plasticine Ltd, Bathampton, Bath

**HEAR ALL CONTINENTS**  
 With **H.A.C. Short-Wave Receivers**  
 Suppliers for over 18 years of radio S-W Receivers of quality.  
 One-Valve Kit, Price 25/- Two-Valve Kit, Price 50/-  
 Improved designs with Denco coils. All kits complete with all components, accessories and full instructions. Before ordering, call and inspect a demonstration receiver, or send stamped addressed envelope for descriptive catalogue.  
 "H.A.C." Short-Wave Products (Dept. 22), 11 Old Bond Street, London, W.1.

**BRASS, COPPER, DURAL, ALUMINIUM, BRONZE**  
 ROD, BAR, SHEET, TUBE, STRIP, WIRE  
 3,000 STANDARD STOCK SIZES  
 No quantity too small List on application  
**H. ROLLET & Co. Ltd.**  
 6 CHESHAM PLACE, LONDON, S.W.1  
 Also at  
 Liverpool, Manchester, Leeds, Birmingham

FOR MODEL MAKERS  
**THE 'MIGHTY MIDGET'** electric motor, only 1½ in. high. Runs at 10,000 R.P.M. from a 4½ V. torch battery. Minute current consumption. Complete with pulley, price 10/6 postage 6d.  
**MODEL BOAT PROPELLER.** 3 blades, shaft, pulley, and 5½ in. long stern tube, to run off above 'Mighty Midget'. Price 7/3, plus 6d. postage.  
**HOBBIES LTD.** (Dept. 99), DEREHAM, NORFOLK.

**LEARN**  
**RADIO & T/V SERVICING**  
 for your OWN BUSINESS/HOBBY

● by a new exciting no-maths system, using practical equipment recently introduced to this country  
 FREE Brochure from:—

**RADIOSTRUCTOR**  
 DEPT. G81, READING, BERKS. 20/9/61

**HANDBOOKS** on Photography, Model Aircraft, Lampshade Making, Painting, Sketching, Conjuring, etc. 4/6 post free. Or send S.A.E. for lists. — John Reade, 11 St. Michael's Gardens, Shrewsbury.

100 DIFFERENT stamps free! Request ½d. upwards discount approvals. — Bush, 53 Newlyn Way, Parkstone, Dorset.

**ENJOY WRITING?** Then write for Profit. Send for 'Writers Handbook' (free) detailing countless opportunities for beginner or experienced. — Writers' Ring (HW), 5 Edmund Street, Birmingham.

**PAINTING** offers relaxation and profit. Even beginners can make art pay, painting their preferences. Endless demand. Exciting free brochures. — Popular Art Services (HW), Clun, Shropshire.

**BUYING OR SELLING?**  
 Classified advertisements on this page are accepted at a cost of 6d. per word prepaid. Use of a Box No. is 1/- extra. Send P.O. with advertisement to *Hobbies Weekly*, Advert. Dept., Dereham, Norfolk. Rates for display advertising on application.

**MODEL MAKERS!!!** Make up your own Bomber Command game. Send 1/6 P.O. for full instructions and parts list. One giant isometric bombing target free with each. — Hobby Products, 7 Sunbury Rd., Eton, Windsor.

FULL SIZE **CHILD'S COT**

4 ft. x 2 ft.

Drop-sided with lift-out webbing mattress. Collapsible for easy storage. Easy to make by the handyman from the Kit supplied which contains selected planed wood, dowel rod, webbing, drop-side fittings, hinges, and screws.



KIT No. 3202

**63/6**  
 (post free)

Drop-side fittings, available separately, price 7/9 a set, postage 1 6 extra

Obtainable from All Hobbies Branches or Stockists, or direct by Post from Dept. 993

**HOBBIES LTD., DEREHAM, NORFOLK**

for holding **POWER**

**SECCOTINE**  
 REGD

There's nothing like real SECCOTINE! For over sixty years Seccotine has been indispensable to every handyman. For sheer adhesive power buy Seccotine with the efficient new "pop-on" seal and open-nozzle tube ready for use.

**SECCOTINE**  
 REGD

STILL ONLY **1/3** PER TUBE

Sole Manufacturers — **MCCAW, STEVENSON & ORR LTD., BELFAST**

# Thought Control Experiment

PLAYING with fire is not usually a pastime to be recommended, but that is precisely what you appear to do when you perform this daring experiment where you apparently control the thinking of three people.

An all-metal stand will be needed, upon which four small pay envelopes may be supported by means of paper clips. In addition you will require four £1 notes, a box of matches, plenty of confidence and a little courage. You will also need plenty of practice before undertaking a real performance.

*By A. E. Ward*

It will be convenient to assemble the stand with a few parts selected from a toy construction outfit, as it is essential that the apparatus be made of a fire resisting material. Of course you may improvise a stand, using oddments of scrap metal fastened together with solder or nuts and bolts. The illustration will suggest how the stand is to be made. Basically the apparatus consists of a horizontal bar 20 in. in length, raised upon a pedestal about 8 in. tall and mounted upon a heavy base.

Prepare for the demonstration by folding each of the treasury notes into a long compact pellet. Push one of the notes to the very bottom of each of four 3 in. by 5 in. pay envelopes, using a ruler as a ram rod. Damp the flaps and seal the envelopes. Next you must take great care whilst you secure the envelopes, upside down and equidistantly apart, upon the

metal bar, using four 3 in. long spring metal paper clips. It is very important to make sure that the clips completely entrap the bank notes enclosed in the envelopes.

To perform the experiment you set up the stand with the envelopes already in position and with their backs facing away from the audience, then you ask for three volunteers to step forward and set fire to three of the envelopes. You explain that one of the envelopes contains a genuine £1 note, but that you will persuade the volunteers by thought control not to destroy the money. Before your helpers actually set light to the envelopes, you pretend to try and influence their choices by talking and endeavouring to make them change their minds.

At last the fatal choices are made and the selected envelopes are burnt to cinders. There remain three delicate black ashes and a solitary envelope which you remove. You turn the envelope the right way up as you walk across to your audience, where you tear off the top of the envelope before probing into the packet and triumphantly removing the £1 note, taking care to unfold it as you do so. This impressive effect should be well applauded and

you may be congratulated on your daring.

But, you will be asking, what about the other three notes which were consumed by the flames? They will not be harmed. While the envelopes were burning, heat will have been safely conducted away from the money by the metal paper clips. Afterwards the duplicate notes may be retrieved by merely opening the clips.

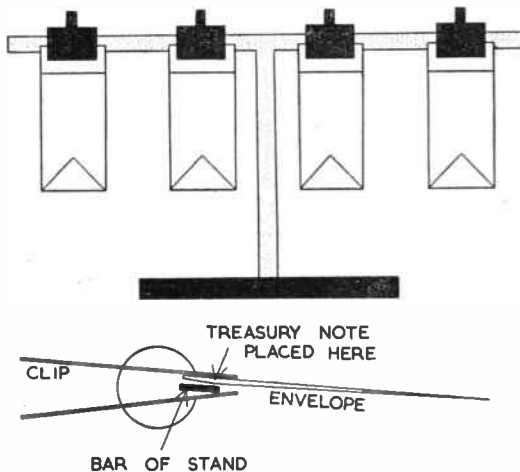

There will be no sign of unburnt paper before the clips are finally opened. You will, of course, practise the effect several times, using plain paper pellets, until you are absolutely confident of its success.

● Continued from page 396

## EXPERIMENTS WITH CHLORIDES—3

well-fitting glass stopper, for atmospheric moisture acts upon it, as you may see by adding a drop to 50 c.c. of water in a beaker. The chromyl chloride decomposes at once into chromic acid,  $\text{H}_2\text{CrO}_4$ , and hydrochloric acid:  $\text{CrO}_2\text{Cl}_2 + 2\text{H}_2\text{O} = \text{H}_2\text{CrO}_4 + 2\text{HCl}$ .

Chromyl chloride is itself corrosive and any coming in contact with the fingers should be treated as for hydrochloric acid.

While salts are combinations of metals or bases with acids, combinations of acids with alcohols are called esters. Ester formation is generally slow compared with salt formation, but an exception is tert.-butyl chloride,  $(\text{CH}_3)_3\text{CCl}$ . If you have some tert.-butyl alcohol,  $(\text{CH}_3)_3\text{COH}$ , it is easily pre-

pared by the action upon it of strong hydrochloric acid, with simultaneous formation of water:

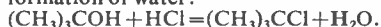

Into a stoppered separating funnel put 15.8 c.c. of tert.-butyl alcohol and 42 c.c. of strong hydrochloric acid. During the next 20 minutes shake the mixture from time to time, momentarily loosening the stopper after each shaking. Then add 5 grams of anhydrous calcium chloride,  $\text{CaCl}_2$ , and let the mixture stand until two sharp layers have formed, when the ester layer will be uppermost (Fig. 2). Run off the lower layer and discard it. Add to the ester 10 c.c. of 5 per cent sodium bicarbonate solution,  $\text{NaHCO}_3$ . Firmly hold in the stopper, invert the funnel, and open the tap. Shake well,

close the tap, re-erect the funnel, and clamp it until two layers again form. Run off the lower layer and discard it. Now shake the ester with 10 c.c. of water, allow two layers to form, run off, and discard the lower layer. Pour the ester into a small corked bottle containing 2 grams of anhydrous magnesium sulphate,  $\text{MgSO}_4$ , to dry it. After a few hours distil the ester from a distilling flask fitted with condenser and thermometer. Collect the fraction which distils over between 50 and 52 degrees Centigrade.

The tert-butyl chloride so obtained is a colourless liquid with a peculiar odour somewhat resembling benzene. Owing to its volatility it should be kept in a well-closed bottle in a cool place.

Dip a glass rod into the ester and then hold the rod to the flame. The ester takes fire and burns with a strange luminous green-mantled flame.



# THE HORSE OVERLAY

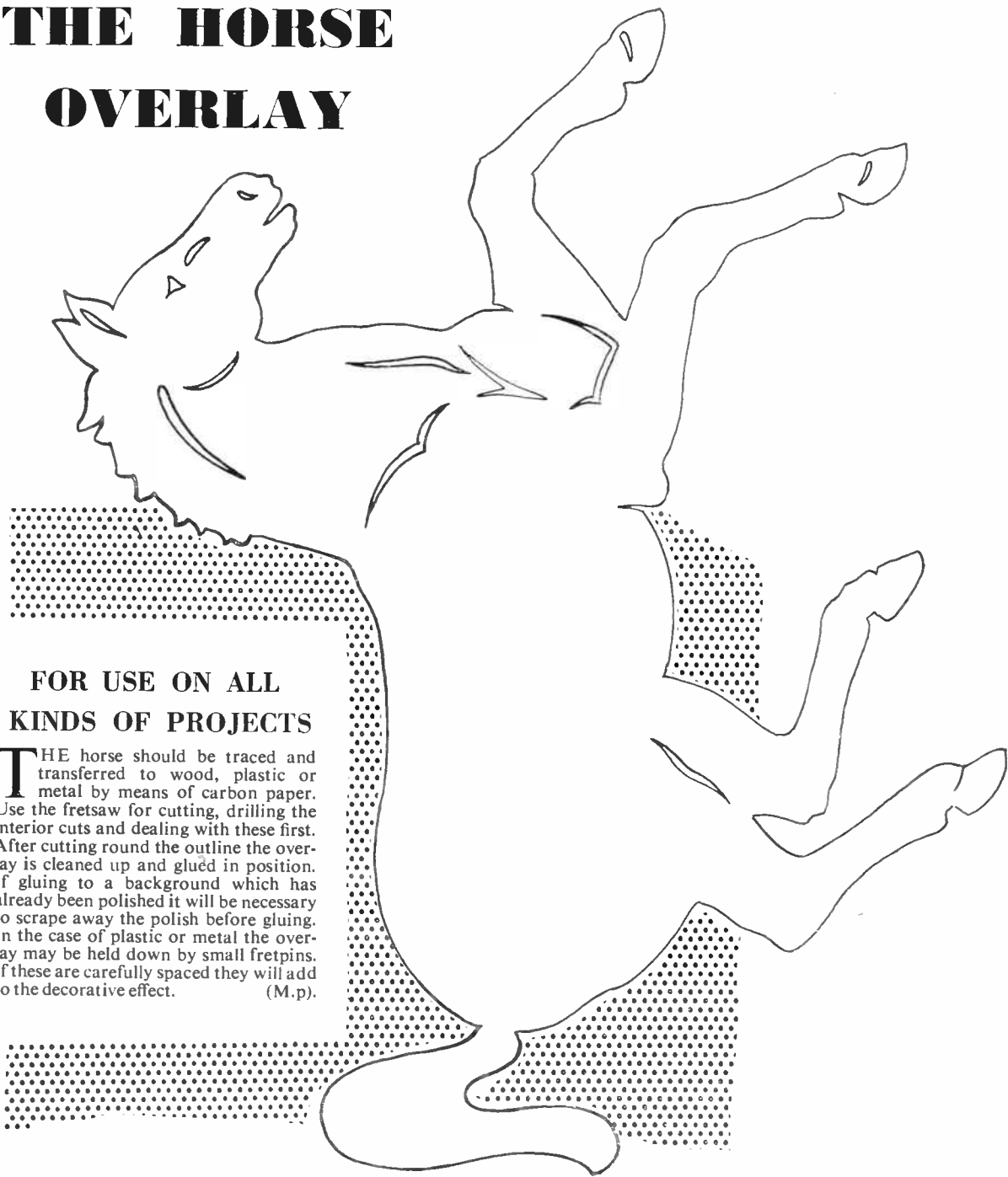

## FOR USE ON ALL KINDS OF PROJECTS

**T**HE horse should be traced and transferred to wood, plastic or metal by means of carbon paper. Use the fretsaw for cutting, drilling the interior cuts and dealing with these first. After cutting round the outline the overlay is cleaned up and glued in position. If gluing to a background which has already been polished it will be necessary to scrape away the polish before gluing. In the case of plastic or metal the overlay may be held down by small fretpins. If these are carefully spaced they will add to the decorative effect. (M.p.)

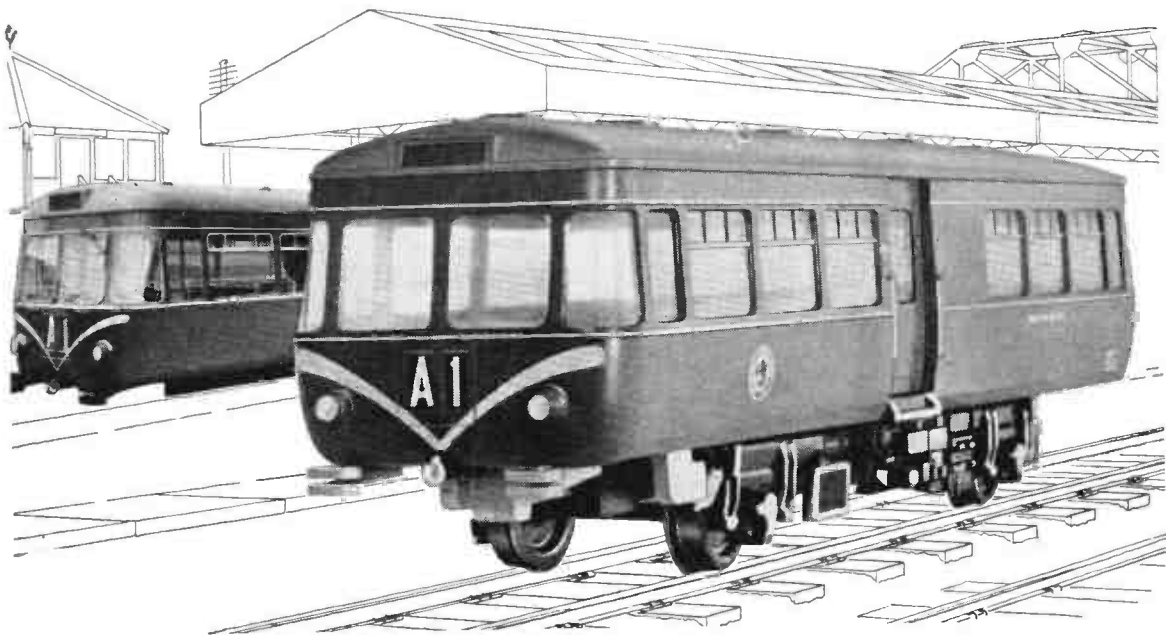

## Just like the real thing!

Believe it or not, the nearer one is the Airfix model of the Railbus, 00 gauge (Kit 3/-). Behind it is a picture of the real thing.

That's how wonderfully realistic Airfix models are. Close attention to every detail gives them their faithful-to-the-original look—makes them true collector's pieces. And every Airfix series is to a constant scale. This means Airfix models look proportionally right, one against another, because they *are* right! You can't beat Airfix for realism—or value.

# AIRFIX

## Constant Scale Construction Kits

From Model & Hobby Shops, Toy Shops, and F. W. Woolworth

There are over 100 Airfix models from 2/- to 10/6.

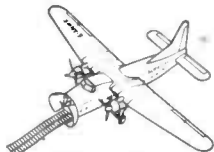

**AIRCRAFT**

Bristol Superfreighter 7/6

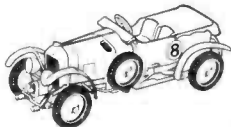

**VINTAGE CARS**

1930 Bentley 2/-



**MODEL FIGURES**

Lifeguard 2/-

**BRITISH WARSHIPS**

H.M.S. Cossack 2/-



## STOP PRESS!

### Latest Airfix Production

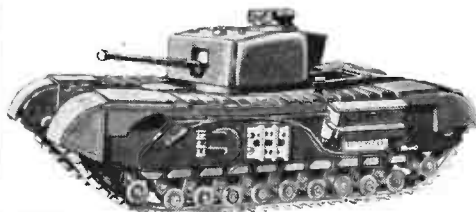

### CHURCHILL Mk VII TANK

Another model in the new Airfix OO/HO scale tank series. This finely detailed model measures  $3\frac{3}{4}$ " long, has an 80 part running gear; revolving turret; the 75 mm. gun raises and lowers; 11 piece transfer set. 104 part kit . . . 2/-

**Also New:** Drewry Shunter. OO/HO scale locomotive in magnificent detail. 67 part kit . . . 2/-

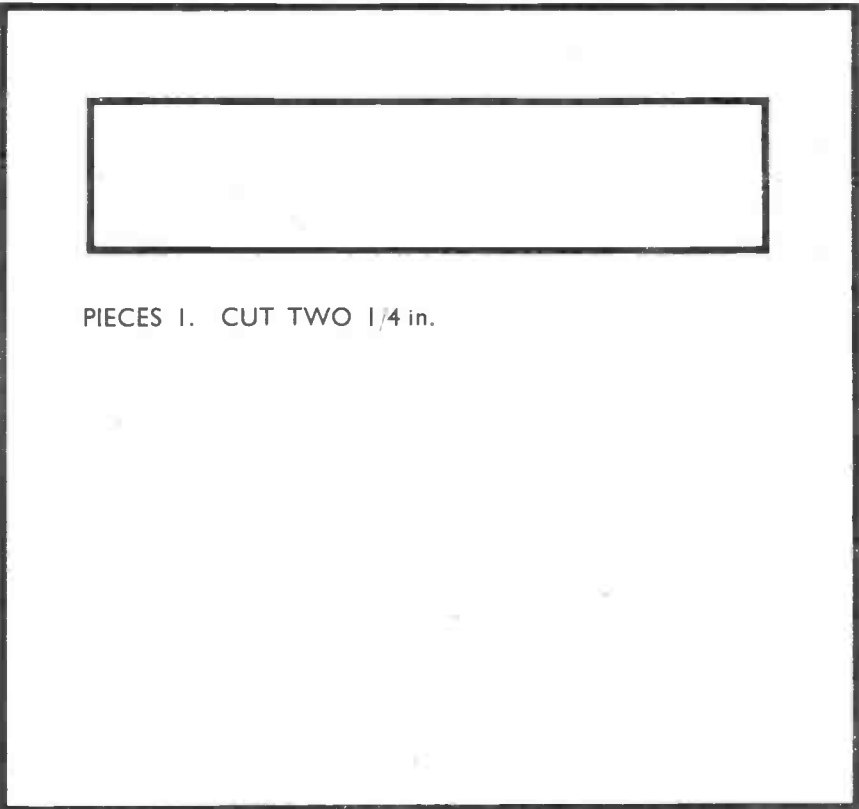

PIECES 1. CUT TWO 1/4 in.

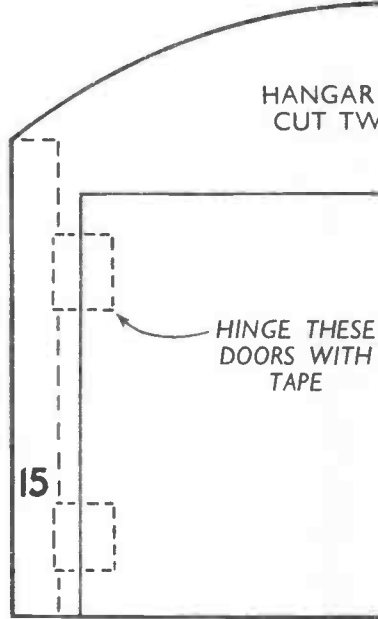

HANGAR  
CUT TW

HINGE THESE  
DOORS WITH  
TAPE

15

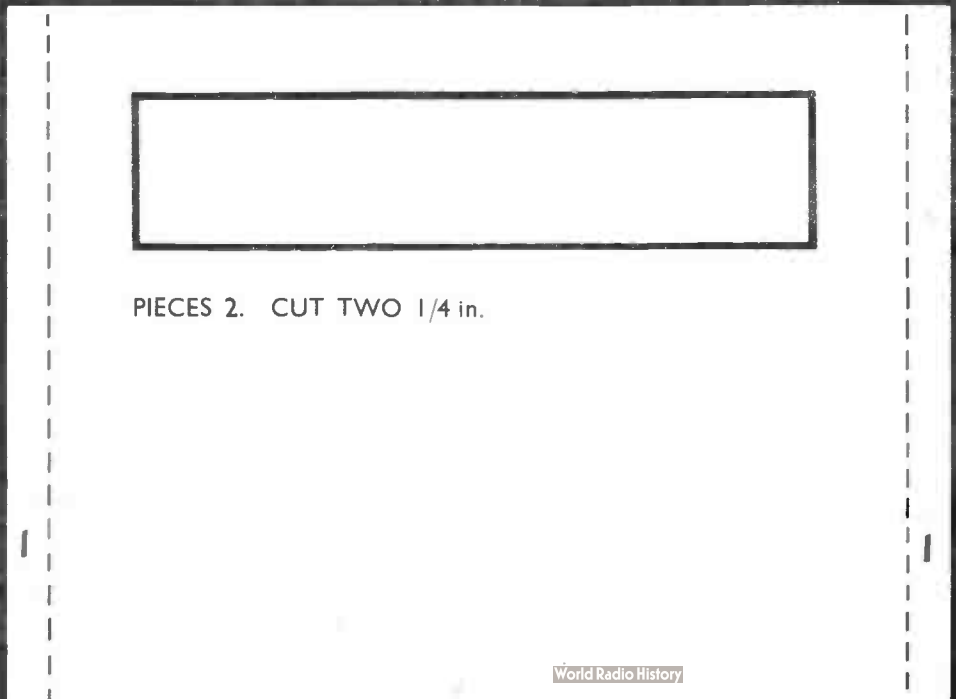

PIECES 2. CUT TWO 1/4 in.

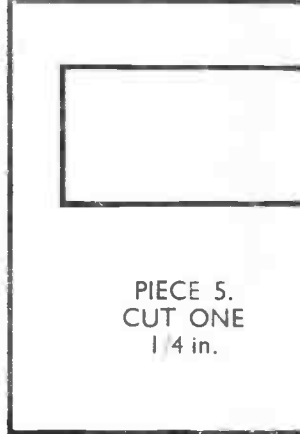

PIECE 5.  
CUT ONE  
1/4 in.

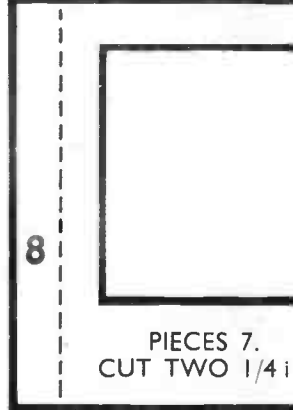

PIECES 7.  
CUT TWO 1/4 in.





DESIGN

No. 3432

# TOY ROAD LAYOUT AND AIRPORT

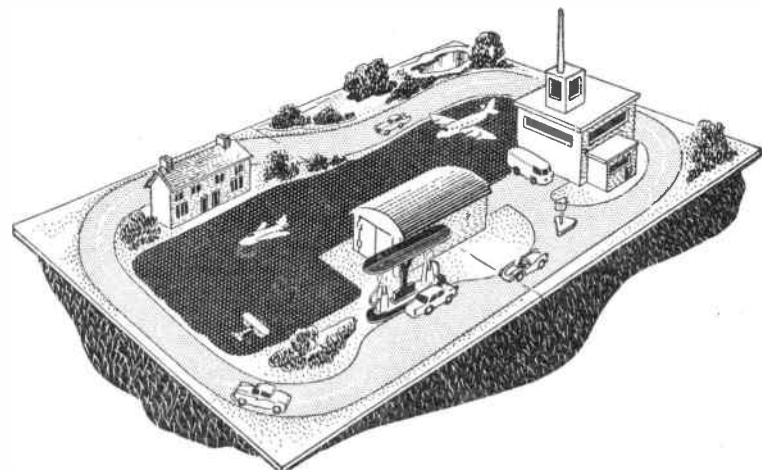

SIZE — 3 ft. LONG BY 2 ft. WIDE.

A KIT OF MATERIALS FOR MAKING THIS DESIGN IS SUPPLIED BY HOBBIES LIMITED, DEREHAM, NORFOLK. PRICE ON APPLICATION.

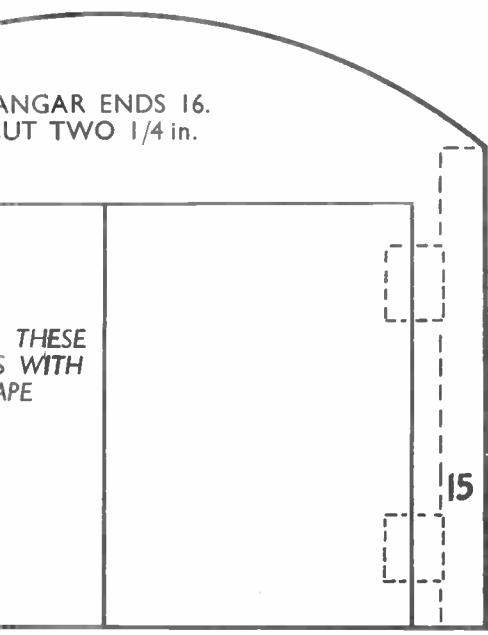

ANGAR ENDS 16.  
CUT TWO 1/4 in.

THESE  
S WITH  
APE

15



5.  
NE



CHIMNEYS 14.  
CUT FOUR  
1/4 in. AND  
GLUE  
TOGETHER  
IN PAIRS.



8

ES 7.  
O 1/4 in.

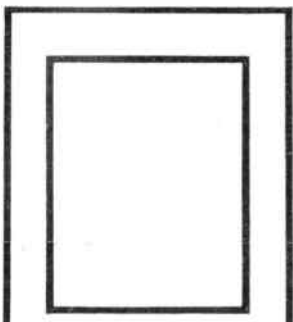

PIECES 8.  
CUT TWO 1/4 in.



RADIO MAST. CUT ONE  
1/4 in. ROUND ROD.

THE WORLD'S STRONGEST GLUES

*Stick it with-*

**Croid POLYSTIK**



A white P.V.A. adhesive, clean to use, non-staining, fast-drying and strong. For joinery and cabinet work. In easy-spread polythene bottle: 2/6d and 5/-.

BUY CROID FROM YOUR LOCAL HOBBIES BRANCH

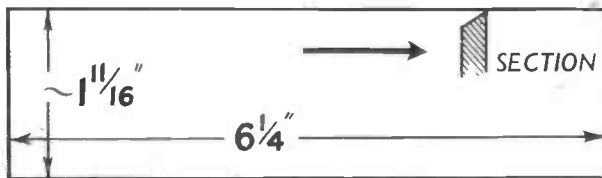
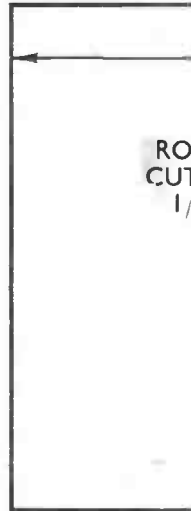
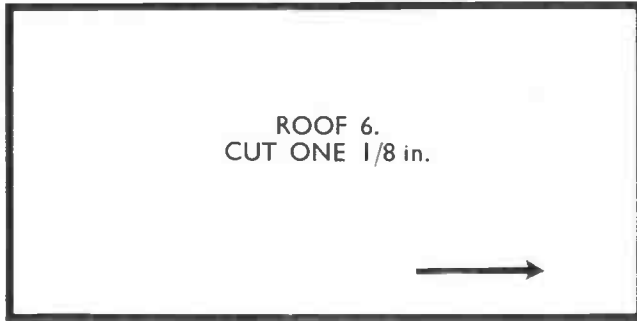
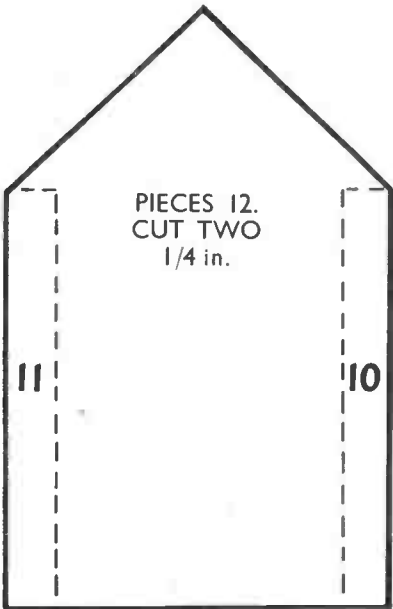
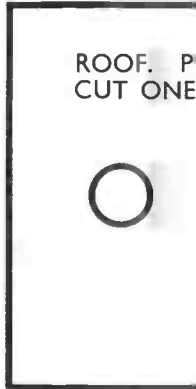
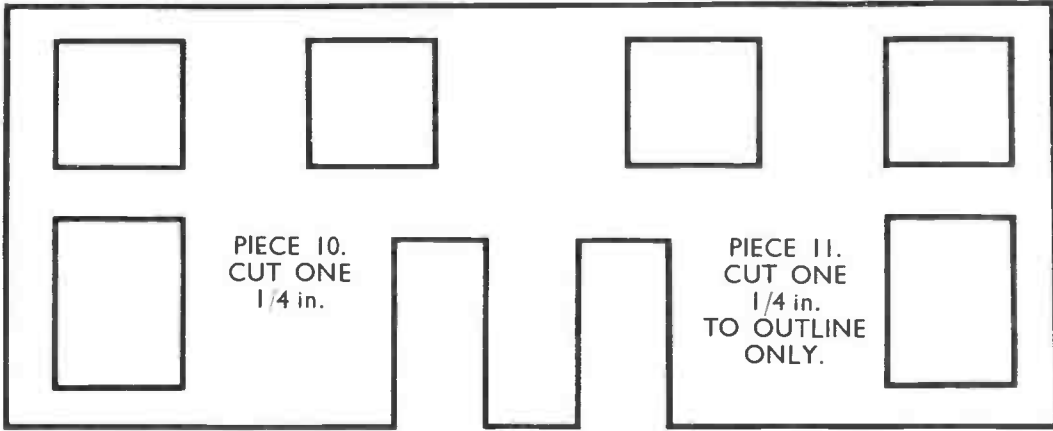
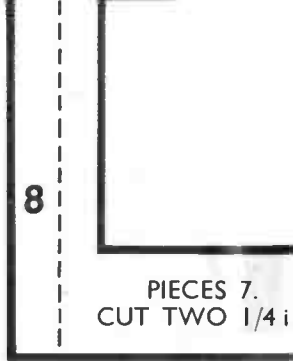
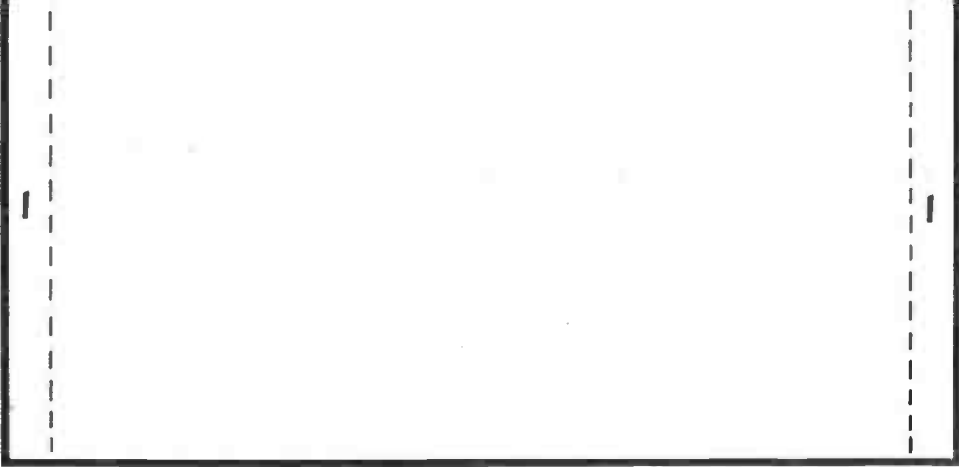

ROOF PIECES 13.  
CUT TWO 1/8 in.  
AND SHAPE  
EDGES TO SECTI

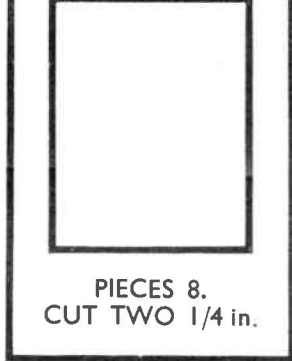
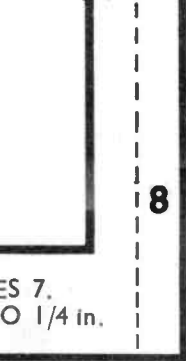

THE WORLD'S STRONGEST GLUES

*Stick it with-*

**Croid POLYSTIK**

A white P.V.A. adhesive, clean to use, non-staining, fast-drying and strong. For joinery and cabinet work. In easy-spread polythene bottle: 2/6d and 5/-.

BUY CROID FROM YOUR LOCAL HOBBIES BRANCH

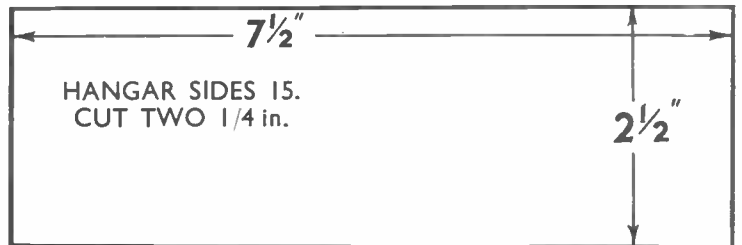
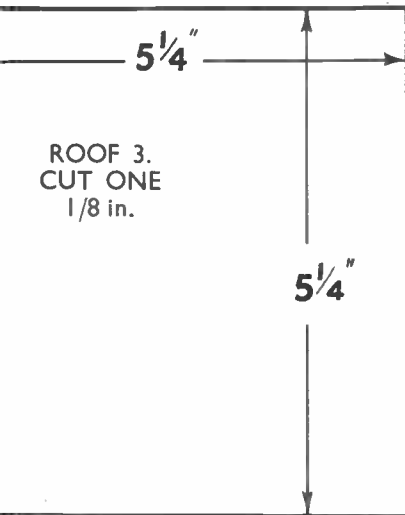
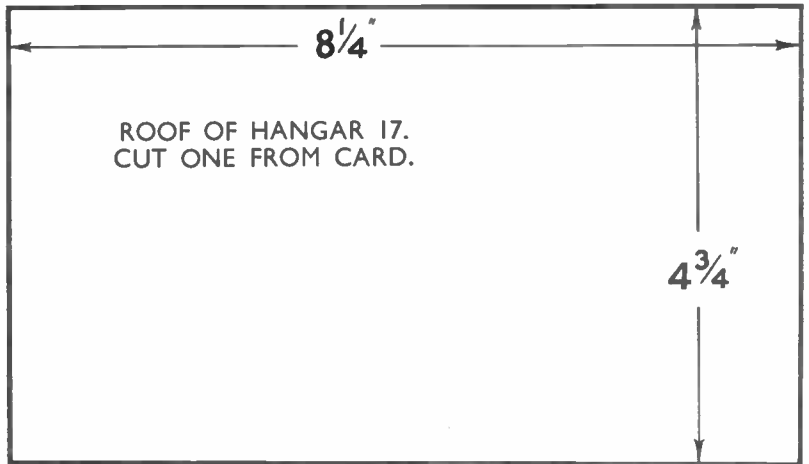
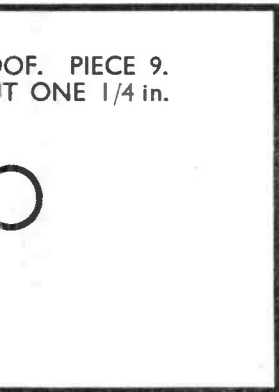

THE ARROWS  
INDICATE THE  
DIRECTION OF  
GRAIN OF WOOD.

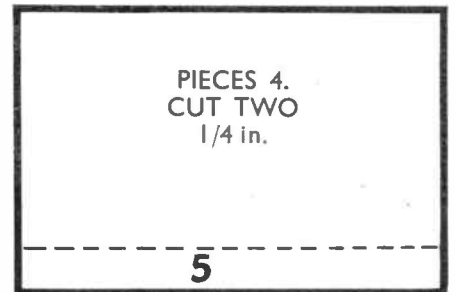

PIECES 13.  
CUT ONE 1/8 in.  
PIECE  
SECTION.

NOTE. CUT TO THE  
OUTSIDE OF THICK  
LINES

PRINTED IN ENGLAND.