

30th AUGUST 1961

VOL. 132

NUMBER 3429

THE ORIGINAL  
'DO-IT-YOURSELF'  
MAGAZINE

# HOBBIES *weekly*

FOR ALL  
HOME CRAFTSMEN

**Instructions  
for making . . .**

*Also in this issue:*

PICTORIAL GUIDE  
TO JIGSAWS

COLLECTORS' CLUB

'PENDULUM' — A  
GAME OF SKILL

RAILWAY MODELLING

MAKE YOUR OWN  
CAPTION SLIDES

A WALL-TYPE  
DRESSING TABLE

SEPTEMBER IN  
THE GARDEN

ETC. ETC.

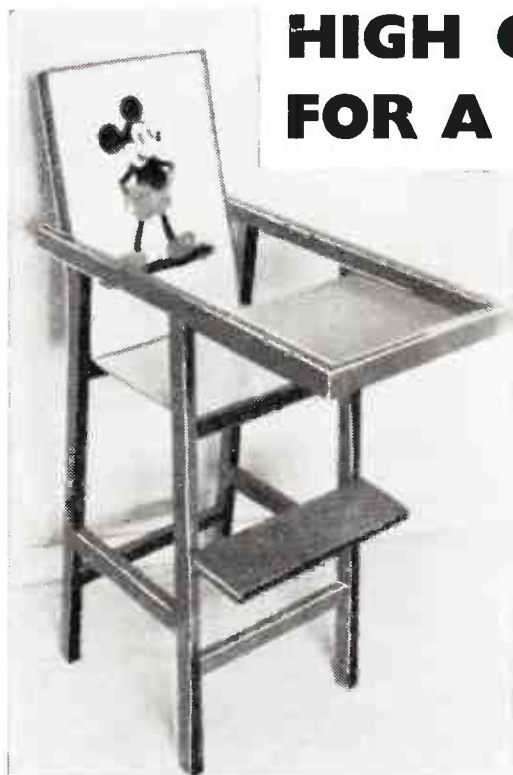

## **HIGH CHAIR FOR A CHILD**

**A WORTHWHILE  
PROJECT FOR  
ALL PARENTS**



**Up-to-the-minute ideas**

**Practical designs**

**Pleasing and profitable things to make**

**5<sup>D</sup>**



THE Prague Conservatoire was founded 150 years ago on 24th April 1811. This occasion was marked by the issue of three special stamps. Their antique designs express in a symbolic way the three main branches of musical art — vocal, instrumental music, and dancing. At the request of the Academy of Musical Sciences, Professor SVOLINSKY used for the cachet of the first day cover the emblem that is to become the symbol of the celebrations.

A COTTAGE in the Savoy Alps forms one of the strangest stamp albums in existence, as its walls are covered with rare and valuable issues. Collectors have bid a fortune for the right to steam the collection from the walls, but as the house is the home of a priest, and the church property belongs to the French Government, the stamps must remain there until they are spoiled by the ravages of time.

This queer 'album' was started more than fifty years ago by a young priest who took to stamp collecting in this way to pass away the time in the lonely mountain village. The little community live an hour's walk away, and climb from the nearest road, but the priest received many letters, and friends sent him stamps to add to his collection.

He started pasting stamps on the bare walls of his cottage in the place of wallpaper, and then, as the collection grew, he pasted more on top, making quaint designs out of issues of various countries. There are nearly 250,000 postage stamps on the four walls of the salon.

The collection contains copies of the famous balloon stamps issued for the 'Air Mail' by balloon when Paris was besieged by the Germans in the war of 1870-71. There is a rare triangular Cape of Good Hope stamp, some of the first Vatican issues, and 1870 War stamps from Alsace and Lorraine.



In commemoration of Jonas Alströmer who died 200 years ago the Swedish Post Office issued two special stamps on 2nd June.

ETHEL Maxwell writes from America — 'In my collection of postmarks I have the following groups:

- Trees — Ashland, Ky., Asheville, N.C., Elmhurst, N.J., Cedarville, N.J.
- Flowers — Rosemont, N.Y., Lancaster, Pa.
- Birds — Crowley, La., Warner Robins, Ga.
- Bodies of Water — Seaford, Del., Lakeview, Mich., Clear Spring, Md.
- Girls' Names — Annapolis, Md., Marietta, Ohio., Marion, Ohio.
- Boys' Names — Johnstown, Pa., Leonardstown, Md., Warren, Ohio.
- Clothing — Manhattan, Nev., Gloverville, N.Y.
- Occupations — Bakersfield, Calif., Barberton, Ohio.
- Colours — Red Bank, N.J., Bowling Green, Ky., Whiteville, N.C.
- Food — Hamilton, Ohio., Cocoa, Fla., Watertown, Wis.
- Famous People — Hope, Ark., Coopertown, N.Y., Carlisle, Pa.
- Points of the Compass — Westernport, Md., Easton, Md., Northville, N.Y.
- Seasons of the Year — Fall River, Mass., Springfield, Ill., Winter Haven, Fla.'

#### Czechoslovakia

10th May saw the release of six stamps marking the Fortieth Anniversary of the Communist Party of Czechoslovakia. Designs include:

- 30h. brown — 'People's House', at present LENIN'S Museum.
- 30h. blue — Klement Gottwald's Museum.
- 30h. blue-violet — Nationalization of industry, workers' demonstration in Wenceslas Square, Prague.
- 60h. red — Worker, factories in background.
- 60h. green — Member of an Agricultural Production Cooperative.
- 60h. brick-red — May Procession.

A new general stamp depicting the Town of Kladno was issued on 24th April 1961.



The Singapore Government issued two commemoratives on 3rd June, marking the Second Anniversary of National Day. This event is celebrated every year to commemorate the attainment of full internal self-government in 1959.

#### Coin offer

JOHN GOUWS writes — 'I have some cards of South African birds and flowers, which were issued in this country during the war, and I would like to exchange them with people who have some similar. If there are any coin-collectors who would like some of our new decimal-coins I would send them some. I thoroughly enjoy reading *Hobbies Weekly*.' Write to: 26A Prince Alfred Street, Queenstown, Cape Province, South Africa.

FRANCIS KISBAN of Budapest VIII Aurora-u-39, Hungary, would like to exchange match labels, and write to fellow readers throughout the world.

'I collect stamps, postcards, souvenirs, and records', says ANATOL TKACHENKO of 1/4, Kontaktnaya Street, Lvov, 39, U.S.S.R. Russia. He speaks English well, and would like pen friends throughout the world.

'I would like pen friends from any part of the world', writes DAVID SIEVEWRIGHT of 13 Greenfield Avenue, Owlet Hall Estate, Shipley, Yorkshire. 'I am 15 years old, and collect stamps, postcards, match labels, and like writing letters.'

# Show your skill in a game of 'Pendulum'

DISPLAY your skill in eye-and-hand co-ordination on this pendulum apparatus, and challenge your friends to an entertaining game of skill.

A set of skittles — or rather obstacle blocks — are set up directly under the top bar, suspended over the baseboard. The pendulum is set in motion, and as it swings backwards and forwards the operator has to direct it between each block in turn, without knocking any over. The distance that the block, from

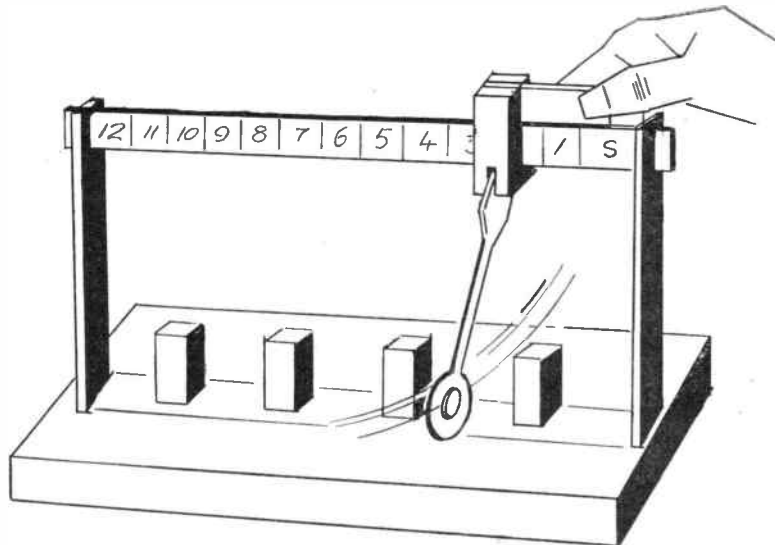

which is pivoted the pendulum, is moved, is indicated by a number. The method of scoring and arrangement and

CUTTING LIST	
1	17 in. by 9 1/2 in. by 3/8 in.
2	17 1/2 in. by 1 1/4 in. by 3/8 in. (two)
3	9 in. by 1 1/4 in. by 1/4 in. (two)
4	12 in. by 1 1/4 in. by 3/8 in. (two)
5	17 in. by 1 1/4 in. by 3/8 in.
6	3 1/2 in. by 1 1/4 in. by 3/8 in.
7	2 1/2 in. by 1 1/4 in. by 3/8 in.
8	3 1/2 in. by 1 in. by 1/4 in.
9	1 1/2 in. by 1/2 in. by 1/4 in.
10	7 1/2 in. by 2 in.

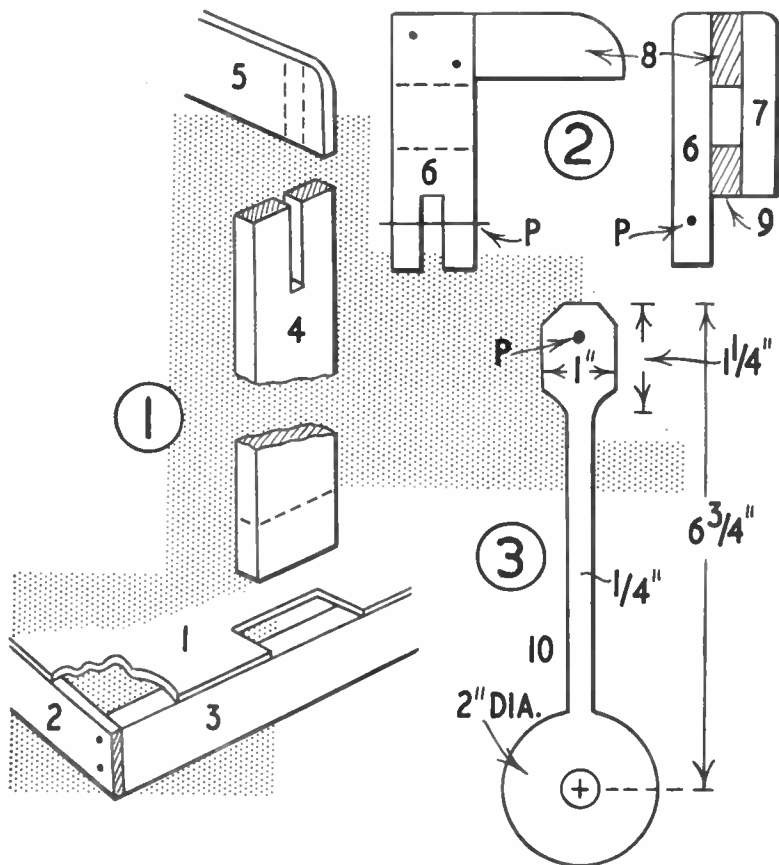

amount of obstacles used will be decided on before the commencement of a game.

Refer to the list of parts needed, and to the finished illustration for the arrangement on the baseboard. Make up the board with panel 1 and strips 2 and 3, assembling with glue and nails. Note from Fig. 1 the opening in each end of piece 1 into which fit the upright pieces 4. These can be fixed with nails or screws, or arranged for dismantling. Piece 5 also may be taken apart by omitting glue from the slots at the tops of pieces 4 into which it fits.

Fig. 2 shows the assembly of pieces that make up the sliding block. See that it slides freely along the bar from one end to the other. Mark out the pendulum (part 10, Fig. 3), and cut this from plywood. It is pivoted to the block with a piece of wire P. A hole is made for attaching a piece of lead or other metal weight to give the correct momentum.

The 'skittles' used in play are 2 1/2 in. lengths of 1 in. square stripwood — or you could use matchboxes. If you decide to paint the apparatus, keep paint away from the moving parts, unless allowance has been made at these points before assembling. (T.S.R.)

**NEW Thoughts**  
on

# RAILWAY MODELLING

baseboard was 6 ft. long by 2 ft. wide, and this houses the shed for the locos, a large coaling stage, and turntable, etc. The turntable has since been enlarged and moved to another site, but more of that later. To the back of the baseboard

laying. This was not bought in a shop ready laid, but was built the hard way. The material used was the famous Peco Individualay, a track that I can thoroughly recommend. It is the ideal track for any purpose, be it scale, or one of the proprietary types such as Trix and Hornby-Dublo.

I HAVE briefly mentioned my own layout in previous articles, and I propose now to give a full account of it, so that you will understand the type of thing I am talking about. It may also give some of my readers the incentive to expand their own layouts.

Work on the Maryville, Fredricton and Westbury Model Railway commenced over twenty years ago. Maryville was named after my wife. Fredricton is named after myself, and Westbury is named after the road in which I live, and in which the railway was built. The rest of my family are included in the set-up.

My one aim and ambition in building this model railway was to achieve

## THE MARYVILLE LAYOUT

was built a road, higher than the railway, and on an incline, and along the back of the road were placed models of buildings, houses, a public house, a cinema, a factory, a laundry, a brewery, and a garage.

The buildings were modelled in low

The sleepers had their chairs fitted, and then were glued down to the baseboard at correct scale spacing. There were ninety-seven sleepers to every yard of track. When the sleepers were firmly stuck the next job was to put in the ballast, which took the form of granulated cork. The method of application is to apply plenty of hot glue between the sleepers with a brush. Then the ballast is poured on to the glued part, and pressed well down with the fingers. It is a messy job, but most rewarding when the job is finished.

I would add here that the latest form of ballast is in the form of strips of cork

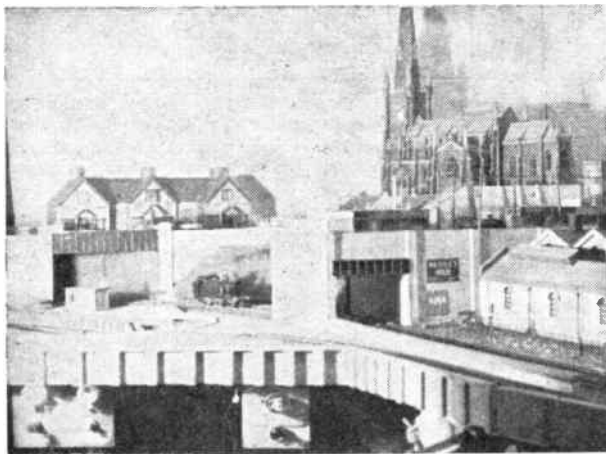

*Section showing turntable, public house, cathedral, two road bridges and a corner of the loco sheds*

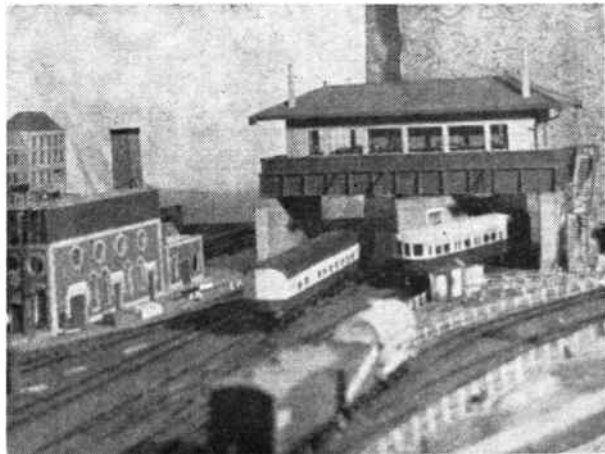

*Signal cabin and water tower with entrance tracks to the station*

realism in miniature. I wanted an exact scale representation of a railway. Not a model of anything that was in existence, but my own interpretation of what a railway running through a community would be like.

I will now describe the building of the first baseboard, and this will be typical of all the other sections of the model. The first section built was the locomotive depot, with a switchboard attached underneath. The size of the

relief. Behind these buildings is placed the scenic backgrounds. These give the effect of a city, and were painted on paper. The baseboard was built up on a framework of 2 in. by 1 in. timber, with trestles of the same material to bring the level up to 3 ft. from the ground. This framework was then covered with plywood which formed a rigid base upon which to lay the tracks. The positions of the tracks were then marked on the plywood, and work was started on track

with the holes for the sleepers punched out. I have used this on some of the newer sections of the railway, but I still like the old method best — it looks more authentic.

The next job was to clean off the surplus glue and ballast from the tops of the sleepers with a file and knife, and then drop the nickel silver bullhead rails into the chairs. The rails are held in place by closing the chairs into the flange of the rail with the tool that is pro-

vided for the purpose. Alas, the running rail chairs are no longer made, and so on later sections of the railway I have had to use flat-bottom rail, and either spikes each side to hold it to the sleepers or else little fibre baseplates that are glued down. I have not had much success

was attached to this first board, but recently this was removed, and a separate switch console has been built which is portable, and houses all the electrical gadgets, such as transformers, rectifiers, and relays, etc, that are needed to run the railway. I call it a

so that all types of transport are given a place. There are various other shops and buildings along the back road, and all the buildings on the model are fitted inside with goods for sale, etc.

We next come to Maryville station. The platforms are 6 ft. long and for the



*Background scenery. Buildings modelled in low relief and remainder painted on a backcloth. Note amount of detail*

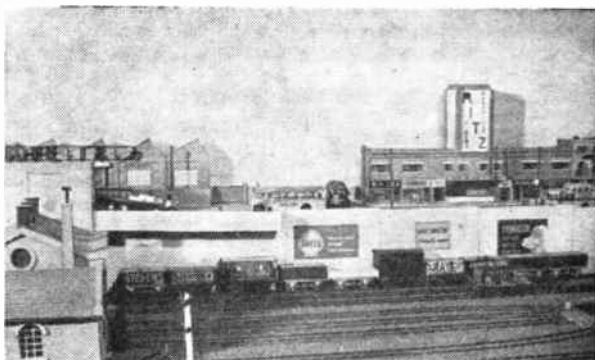

*A good example of the track work*

with the baseplates. Perhaps I used the wrong sort of glue, but I find that they tend to break away after a time. So I am now using the spikes which are driven into the baseboard. These are ideal, and if one uses a softish board for the base, they can be pushed in with pliers. My trackwork on the original boards, and in point of fact on any of the railway, has never given any trouble. It looks perfect, and makes the railway look authentic.

The electrification of the railway is of the two-rail method, which is of course, the latest method of wiring, and definitely the best way of getting the power across.

The switchboard was constructed, and

switch 'console' because it looks like an organ console. In fact, many people facetiously ask me what I am going to play on it. When I say 'Trains', they say they have never heard it. There are no less than 140 switches on this console, with a pilot light for each one. These switches control the power to the various tracks, the lighting of the buildings, sound effects and other features.

I have today no fewer than seven baseboards, and the railway has taken on colossal proportions. It is only used for exhibition work. I am not able to set it up at home, but of course I can use part of it for testing purposes. It is still growing, and what I have built so far is less than half of the completed thing when finished.

The accent has been on detail throughout the whole model, and to give readers an idea of what is to be seen I will list or mention some of the items. The first baseboard is known as Board A or the Town Board. This one has no railway tracks on it at all, but houses the town centre, or civic centre as it is called. Here we have the town hall which is flanked by two wings which are the Museum and Library respectively. Both of these wings are fully fitted with lighting, and have filled bookshelves in the library, and models, etc, in the museum. This group of buildings is modelled in low relief, and the total length is 3 ft. Next to this is the Fire Station.

Across the road from these buildings is to be seen the entrance to the Maryville Station, with a bus station in front, and lines of trolley and petrol buses. Trams are to be seen on the main road,

most part are covered with a glass roof supported on a framework of steel girders. I say glass and steel, but in reality the materials are perspex and wood. The terminus station has four platforms, and these are fully fitted with chocolate machines, seats, nameboards, passengers, and railway staff, ice cream and refreshment barrows, bookstalls, and the like. There is quite a large goods station behind the passenger station. This is fitted with goods and has a coal yard in front of it.

On the road at the back there are lots more buildings, a theatre, public house, shops of all types, a trolleybus depot, a church, police station, and fish and chip shop. The latter is equipped with frying pans, and has a customer sitting there eating fish and chips, and another waiting to be served. This is the type of detail that I revel in making. F.A.B.

#### FOR YOUR LAYOUT



*Sunbeam Rapier, length 5 in. Airfix construction kit, 2/-*

#### FOR YOUR LAYOUT

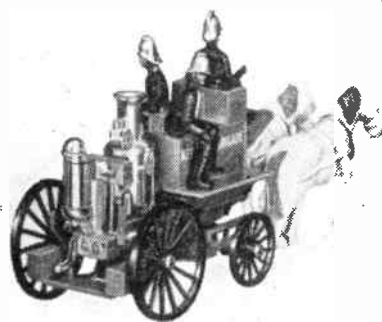

*A 1905 horse-drawn fire-engine. Scale 63:1 'Matchbox' model, 3/11*

# TRICKS WITH INERTIA

**B**ALANCE a playing card upon one of your fingers, and place a penny upon the pasteboard, with its centre over the part of your finger where the card is resting. Flick the card suddenly, and watch it spin beautifully across the room, leaving the penny poised upon your finger. If you had pulled away the card less violently the coin would have fallen unceremoniously to the floor.

The great English scientist Isaac Newton gave an explanation of this pretty feat when, as part of one of his Laws of Motion, he said that an object will stay where it is unless acted upon, or displaced, by a force. Obvious though this statement sounds, it will explain some remarkable experiments in jugglery that have the appearance of magic tricks.

## Leaving the coin

Rest a sixpence upon a playing card which is supported upon the mouth of a wine bottle. Flip away the card. If the coin was resting exactly over the bottle mouth, it will have dropped neatly into the container. Steady the end of a paper strip upon the edge of a drinking glass, and rest a penny upon the paper exactly above the glass rim. Hold the

other end of the strip, and give the middle of the paper a sudden sharp blow. With a little skill, gained by practice, the result of this action should be that the paper is pulled away, and the coin left behind on the rim of the glass.

In both the last-mentioned experiments the coins would have been clumsily toppled on to the floor if you had not acted with speed. The tendency

---

*By A. E. Ward*

---

of a stationary object to remain still forever unless acted upon by a force is called inertia, which may also be called the 'laziness' of matter. If you always exert your force abruptly there will be a fraction of a second when the object does not begin to respond to the force, and some surprising trick or useful purpose may be accomplished.

The force which should have shifted the relatively heavy coins in all the experiments mentioned was friction between the metal and the playing cards or paper. By acting swiftly you prevented friction from overcoming the inertia of the coins. If you had hesitated nervously when practising the experiments you would probably have failed. Perhaps it could be said that inertia is the great professional secret of jugglers.

You have taken account of inertia when you shovelled coal or snow. If you pushed the shovel slowly beneath the material the task was harder and quite often the stuff was merely pushed away. When a housewife shakes out a duster she contrives to whip the cloth swiftly backwards whilst the dust and dirt are left behind in space. An express steam train takes advantage of inertia when the driver lowers a curved chute into a water trough between the tracks as the locomotive races along at great speed. The water has no time to flow away from the mobile scoop, and is swept up into the engine's boilers.

## Static draughtsmen

Wooden draughtsmen may be utilized for two smart tricks with inertia. Bend your right arm, and hold it up horizontally before you, on a level with your shoulder. Stack four of the counters upon your elbow. Keep your eye upon the draughtsmen as you swing your right hand forward to catch the counters as they hang momentarily in mid air. A black counter at the base of a stack of several white ones can be

knocked cleanly out of the pile if you strike it a smart blow with a ruler swished scythe-like at ground level.

Inertia on the billiards table will fascinate your fellow players during a lull in the game. Stand a ball in the middle of a chalked circle 5 in. in diameter, and balance a sixpence upon the top of the ivory. Announce that the first person to cause the sixpence to fall outside of the circle by cannoning another ball into the coin's curious pedestal will win the money as a prize. If the task is attempted as suggested, inertia will always cause the coin to drop from its mount well within the circle. You must, however, be sure to prohibit trick shots, as a clever billiards player may succeed if he makes his own ball spin.

## The domino tower

The accompanying illustration shows how you may demonstrate an ancient but now scarcely-remembered effect, using a tower built with dominoes. If you press your finger deftly against point B on the domino balanced upon its side, it will swing upwards and knock the top of the archway A clean out of the structure, whilst the upper part of the tower will merely plummet down, virtually undisturbed, and 'sit' tidily upon the remaining cross piece above the arch. Your finger should be inserted through the archway when you press point B. You will need to practise this experiment rather more than the other stunts described. Use a well-constructed set of dominoes for the best results.

These pretty tricks of science whilst providing much interesting entertainment will help to explain many strange experiences met with daily, such as when going up in a lift or over a hump-backed bridge in a car.

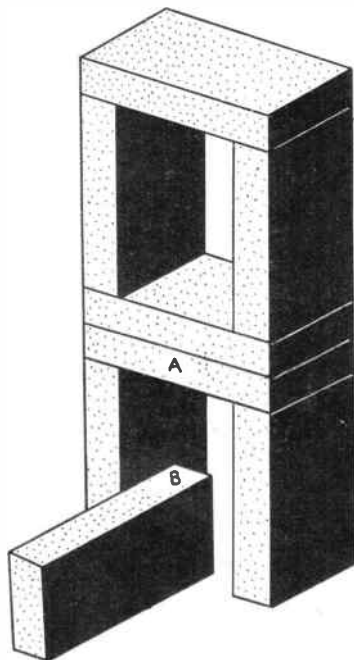

A free design for making a Zodiac Clock will be given with next week's issue. The intricate fretcutting will particularly please keen fretworkers and the finished article will be something to be proud of. Make sure of your copy.

# CHILD'S HIGH CHAIR

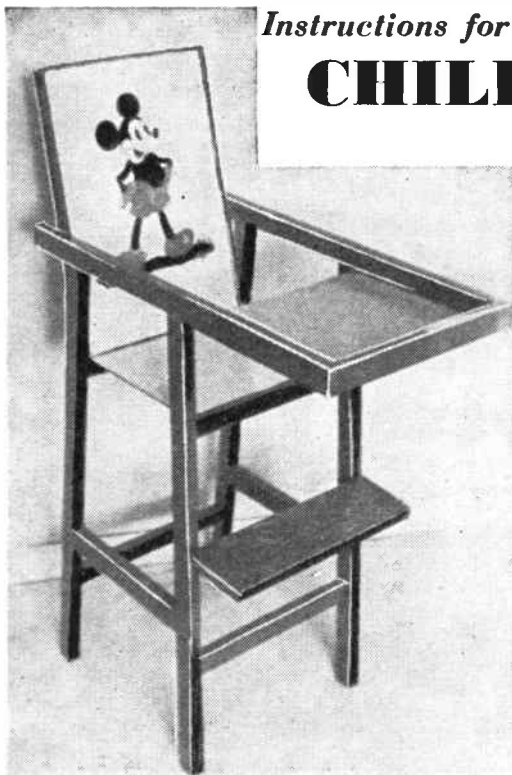

erial for easy cleaning and then fixed underneath the frame with panel pins to complete the feeding tray. Cut this piece of hardboard so that it fits up against the front legs of the chair.

The seat rests across the upper two cross pieces and is made of  $\frac{1}{2}$  in. plywood glued and panel pinned in position, measurements being taken directly from the work.

Fig. 4 shows the framework for the back which is made from  $1\frac{1}{2}$  in. by  $\frac{1}{2}$  in. timber. The amount of the backward tilt and also the height is left to personal choice and the width is best taken directly from the work to ensure a good fit. Fix the piece A to the sides first with glue and panel pins then fit the frame together with the piece B temporarily in place on the chair frame. Decide on the required angle of slope, keeping B flat

on the chair seat, and mark off the exact position of B on the side pieces. These can then be cut at the correct angle and B is glued and nailed in place. A piece of hardboard is then cut and pinned to the frame and its edges planed off flush. Finally attach the back firmly to the sides with screws driven from the inside.

The footrest is a piece of timber 14 in.

long and about  $\frac{1}{2}$  in. by 4 in. attached to the front legs with a pair of angle irons as shown in Fig. 5. When determining the position of the footrest, do not place too near the seat to allow for the growth of baby's legs.

To complete the job, screw two fittings to the inside of the chair arms about  $2\frac{1}{2}$  in. from the back to hold the baby's safety harness. These can be made by shaping and soldering two pieces of stout wire as shown in Fig. 6. Make sure that these are well secured as they will have to withstand considerable pulling as the child becomes older.

## Finishing touches

Punch in all nail and panel pin heads and fill the holes with plastic wood. Then thoroughly glasspaper the whole framework and round off any sharp edges (such as the edge of the seat, feeding tray, etc). Fill the grain with a woodfiller in the usual way and paint the frame in a suitable pastel shade, using a contrasting colour for the seat and the back which can be decorated with a suitable nursery transfer. Avoid using lead-based paint as this could prove poisonous if junior decides to bite the chair. Finally, it is as well to cover the footrest with rubber or any such protective material that might be available as otherwise the paint would soon be scratched off. (J.H.P.)

**H**ERE is a project that will be welcomed by the family man or father-to-be. Unlike many commercial articles, this chair is solidly built and capable of withstanding the heavy handling of the most destructive youngster. Almost any available timber can be used but Parana pine is recommended, being cheap, easy to work, and taking a good finish.

Start by making the two side frames from 1 in. by  $1\frac{1}{4}$  in. planed timber as shown in Fig. 1. Although the timber will have already been machine planed, remember to go over each piece with a smoothing plane, otherwise the marks left by the cutters will show up after painting. The dimensions given enable the feeding tray to slide over a 30 in. table, but the height can be altered if required. All the joints are simple halving joints glued and pinned, which should nevertheless be cut with care to ensure a neat appearance.

The side frames are joined by four cross pieces each  $1\frac{1}{2}$  in. by  $\frac{1}{2}$  in. by 14 in. which fit into the recesses (C), cut to fit them. See Fig. 2. These are then glued and pinned into place. A similar piece of 1 in. by  $1\frac{1}{4}$  in. by 14 in. timber is fixed across the end of the feeding tray as seen in Fig. 3 which also shows how a piece of hardboard is covered with plastic mat-

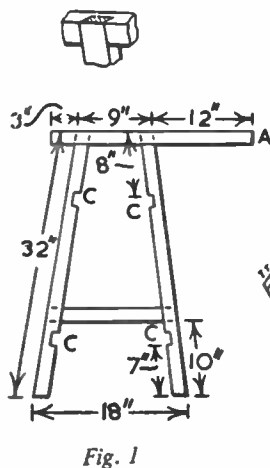

Fig. 1

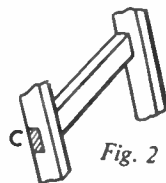

Fig. 2

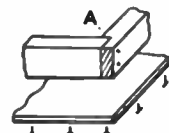

Fig. 3

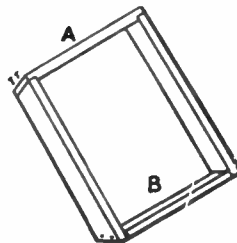

Fig. 4

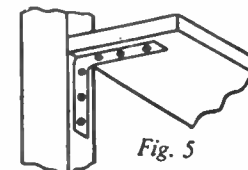

Fig. 5

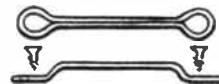
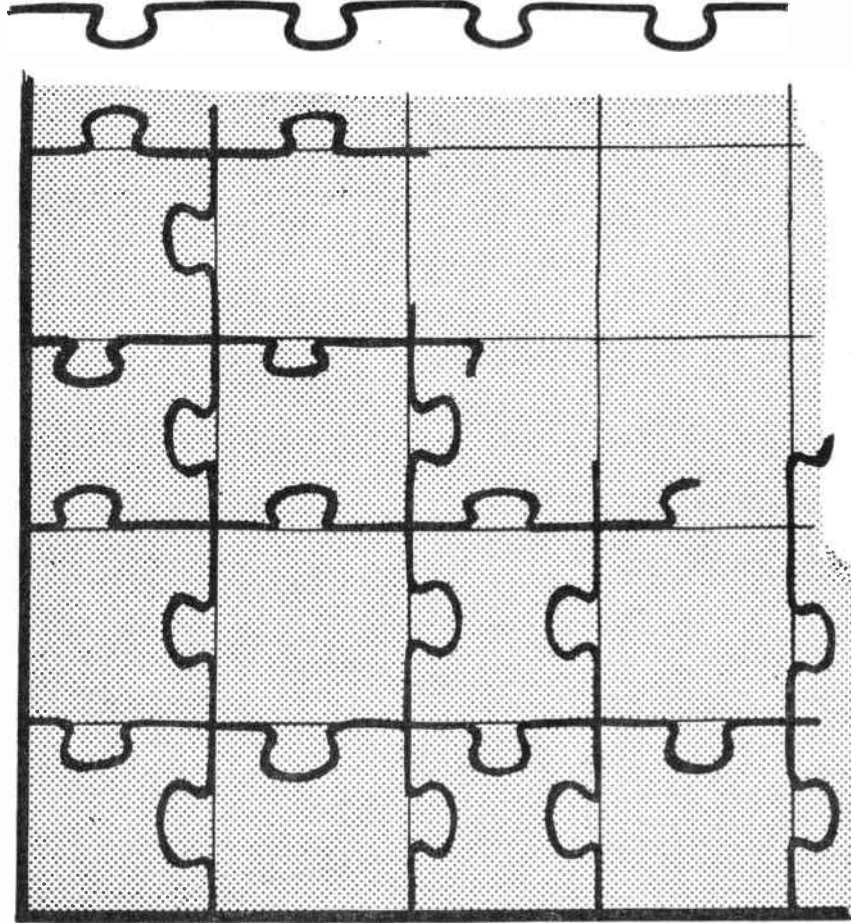

Fig. 6

# A GUIDE TO JIGSAW PUZZLES

## THE EASY WAY



DRAW OUT 1 IN. SQUARES AS  
GUIDES

SIMPLY REPEAT THIS PATTERN ALONG ALL LINES

PAST  
DOWN  
PL

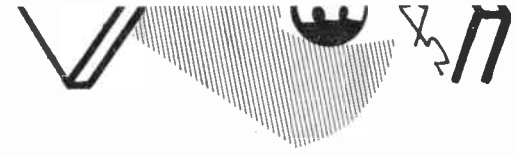

CUT  
FREE  
UPF



E PICTURE  
TO 1/4"  
WOOD

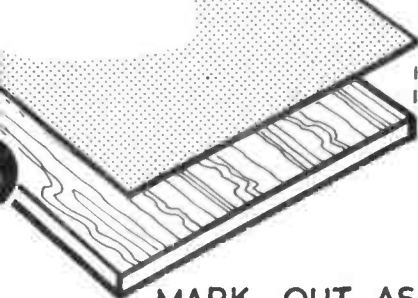

MARK OUT AS  
INDICATED

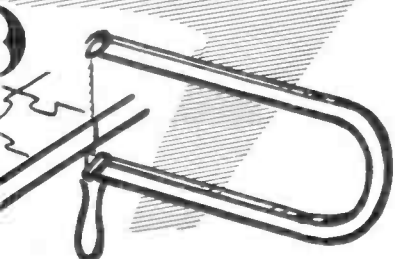
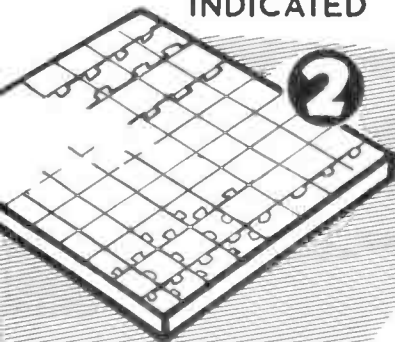

OUT WITH A  
SAW - KEEP SAW  
TIGHT

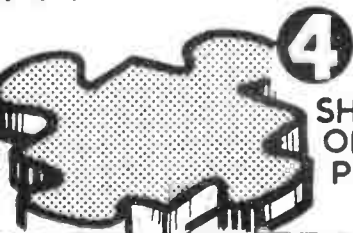

SHOWING  
ONE CUT  
PIECE

**A**

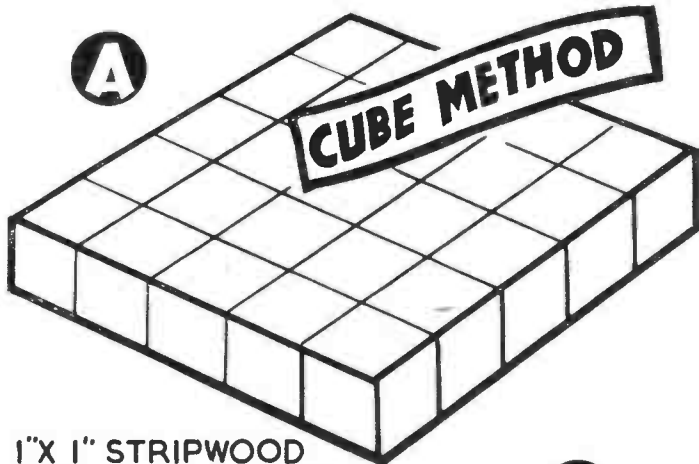

1" X 1" STRIPWOOD  
CUT INTO CUBES

**B**

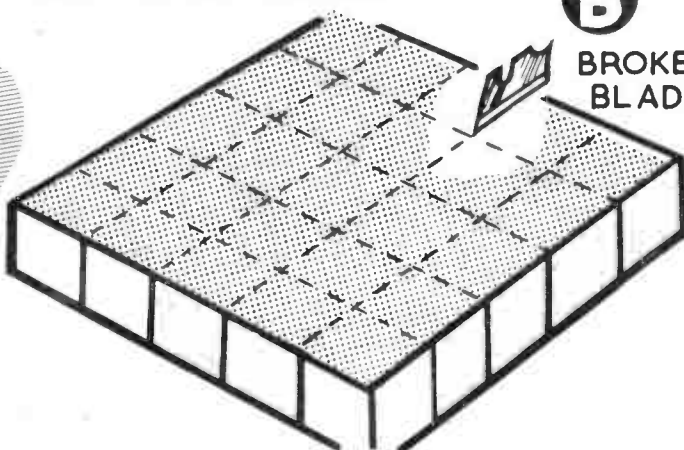

BROKEN  
BLADE

PICTURE PASTED DOWN CUT ALONG  
DOTTED LINES WITH RAZOR BLADE

**C**

BY TURNING ROUND CUBES  
SIX PICTURES CAN BE USED

HOBBIES STOCK A WIDE RANGE  
OF COLOUR PICTURES  
PRICED FROM ONLY 3 1/2<sup>D</sup>

D  
Z  
L  
C  
L  
A  
N  
Z  
I  
N  
G  
P  
R  
I  
N  
T  
E  
D

# MAKING CAPTION SLIDES

**T**HERE may be occasions when you wish to start your transparency projection with appropriately titled captions just like the cinema film. Moreover, it is often a good plan to include a humorous caption slide among the others to retain attention and promote a happy atmosphere. You can make small maps, cartoons or captions which will not only lengthen the entertainment but also add an individual touch.

lighter vein into your programmes.

We assume that you possess the popular 2 in. by 2 in. projector for your transparencies and that you are familiar with the binding of same between appropriately sized cover glasses. This means that we have to prepare a caption slide to fit between the 2 in. by 2 in. cover glasses.

This may be yellow, red, green or blue, giving a corresponding background on the screen. Small pieces of cellophane suitable for the job can be obtained from wrappings on biscuits, boxes etc. You may also combine two pieces of different hues.

You can also use coloured inks — although these may not be quite as effective as black on a white or coloured ground. But the suggestion is there for experiment.

*By S. H. Longbottom*

First of all plan the layout on a piece of paper, measuring off a 2 in. square. Allow for a  $\frac{1}{4}$  in. border all round to compensate for the binding. Mark a vertical and a horizontal centre line, ruling parallel lines  $\frac{1}{4}$  in. apart and starting at the centre. Note that this width is quite sufficient for normal titling and will look much larger on the screen. It will be advisable to rule these lines in Indian ink so that the paper may be used again for planning other captions when required and the suggested basic layout is shown in Fig. 1.

The caption is then printed in pencil after balancing as neatly as possible. A 2 in. square of transparent tracing is placed on top and the lettering completed on this in Indian ink. The original lettering on the plain paper may then be erased and another caption prepared as required. This gives us a caption on tracing paper which may be bound up as usual between a pair of cover glasses and it is ready for projecting. It must be perfectly square when binding otherwise the lettering will slant when projected.

### Use old negatives

It is possible to use thin celluloid instead of tracing paper and this will give a much brighter background on the screen. Discarded black and white negatives are ideal for this purpose if the emulsion is removed. Stand the negatives in a dish containing a sufficient volume of undiluted household bleach. The emulsion will dissolve quite readily and the film should be rinsed in cold water and dried ready for use. To remove any traces of grease, wipe the clear film with a rag dipped in methylated spirit.

Then proceed exactly as with the tracing paper, placing a square of celluloid over the basic paper layout and completing in Indian ink.

Such captions can then be treated in several ways if you wish to achieve further variety. A very simple way is to add a square of coloured cellophane when binding between the cover glasses.



FIG 3

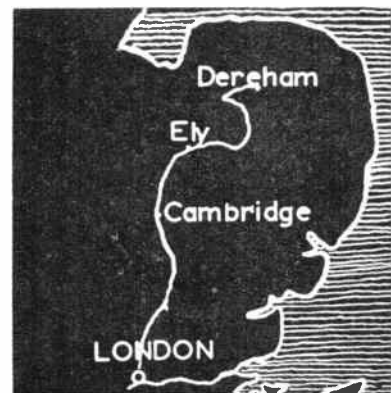

FIG 4

If you wish to make white lettering on a black background it becomes necessary to take the process a stage further by making a new slide. You may either use tracing paper or celluloid for the basic 'negative' which is then printed on a 2 in. by 2 in. contact lantern plate. You will find that Ilford Contact Lantern

● Continued on page 347

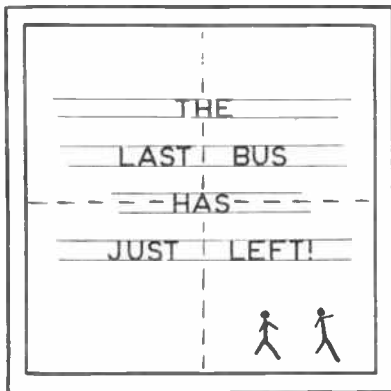
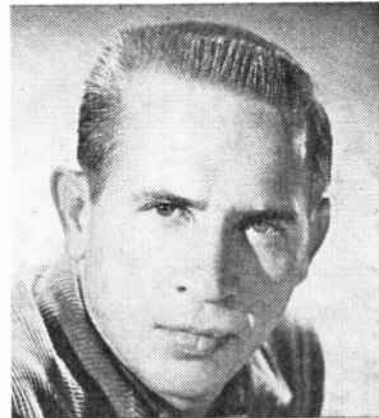
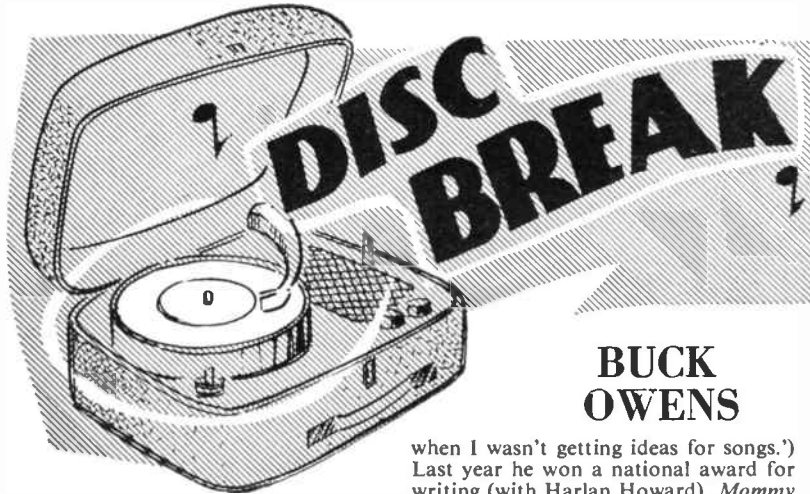

FIG 1



FIG 2

If we begin at the beginning there is the need for a title, such as — 'Our Exciting Adventure in B . . . . — in Glorious Kolorchrome'. Here and there you may need a map to illustrate your route and there is always room for a 'Tea Break' while nearer the end you could show a slide indicating that 'The Last Bus has just left!' These few examples show what can be done to add novelty and a



## BUCK OWENS

**B**UCK Owens learned to play the guitar by hanging around night-clubs, where his favourite musicians would teach him a few chords between shows and encourage him to practise on his own. He became a top-line guitarist and a studio pro at Hollywood recording sessions, where he accompanied such stars as Faron Young, Tommy Sands, Sonny James, and Stan Freberg.

Buck began singing on the second night of his first job with a band. He was hired as a guitarist, but the regular singer was unwell and Buck was pushed to the microphone despite his objections! He is currently one of America's most popular singers, his records having been continually among the U.S. best-sellers for the past year. And most of Buck's hits are his own compositions.

But he couldn't tell you how he started writing songs. ('I can't remember

when I wasn't getting ideas for songs.') Last year he won a national award for writing (with Harlan Howard), *Mommy for a Day*, the Kitty Wells hit, and later he saw two of his other songs, *Excuse Me* and *Under Your Spell Again*, competing with one another in the charts. An entertainer who combines his talents as deftly as Buck Owens is rare, but he maintains amiably that it 'just happened'.

Born in Sherman, Texas, on 12th August, 1929, he was plinking on his mother's piano at the Pentecostal Church as soon as he could reach the keyboard. By the time he was 13, the family had moved to Phoenix, Arizona, and the boy's musical ability was so apparent that his parents bought him a mandolin. Times were hard and they might well have used the money for necessities.

Buck had to leave school in his early 'teens. For several years he hauled fruit and produce between Arizona and California's San Joaquin Valley.

By the time he was 21 Buck played sufficient guitar to get a job with a band

in a Bakersfield, California, club. Later he joined Bill Woods' band in Bakersfield, played on the *Chuck Wagon* TV show there, and became a part-time disc jockey. He even owned his own station, 'Kaye', in Tacoma, Washington, for a time!

Owens has been commuting between Bakersfield — where he lives with his wife Phyllis and three children — and the Capitol Tower in Hollywood for three years. At first he was merely an exceptional musician who was welcomed at recording sessions; now he's the reason for some of the recording sessions.

In this country, too, Buck Owens is a popular disc name with such successful releases as *Above and Beyond/Till These Dreams Come True* (45CL15123), *Excuse Me/I've Got a Right to Know* (45CL15762) and *Foolin' Around/High As The Mountains* (45CL1517) to his credit.

The guitar and mandolin are obvious choices for illustrating the Buck Owens story in stamps and labels.

● Continued from page 346

## MAKE CAPTION SLIDES FOR PRIVATE SHOWS

Plates in a contrasty grade are very good for this purpose and as easy to process as a contact print. Merely place the prepared caption on the emulsion side of the lantern plate, place in a printing frame, or with a piece of glass on top, to ensure close contact between the two, and expose to artificial light. On development your new slide will be the exact reverse of the original (Fig. 2).

### Maps and diagrams

These additional slides are not necessarily confined to mere word captions or block lettering and it is possible to write the wording boldly in some kind of frame as shown in Fig. 3. The titles and endings of some television programmes may give you further ideas.

Another useful feature which can be accomplished by the same process is the preparation of maps or diagrams to illustrate your talk. Once again you may either use tracing paper or celluloid, taking direct tracings from suitable maps and binding between cover glasses. A suggested result is seen in Fig. 4, from which readers might like to note the location of Dereham, the head office of Hobbies Ltd, where this magazine is produced.

The tracing paper gives a soft, subdued background with the slightest trace of paper grain. Celluloid, being clear, produces an intense, brilliant background with the black lettering in contrast which is rather more trying on the eyes, hence the suggestion of coloured cellophane or

reduction of the bright areas by some kind of frame as in Fig. 3.

A border is not recommended, for although you may make it perfectly square on the slide there is always the possibility that the angle of the projector or screen will spoil the appearance. It is better to use small motifs or decorations.

### Re-enamelling a Bath

**I**F you decide to re-enamel your bath and intend removing the old enamel with a chemical stripper then remember to block up the waste pipe first. Many older types of houses have lead waste pipes and these may be damaged if they should come into contact with the chemical strippers.

# MAKE A WALL DRESSING TABLE

THE illustration shows a simple wall dressing table which can be very easily made and would be ideal for a teenage girl's bedroom. Since the fitment occupies only the minimum amount of space the idea is most suitable for small bedrooms. No special tools or wood-working skill is necessary for the making of this project, which basically consists of a simple shelf.

The table top is made from  $\frac{3}{8}$  in. thick plywood or blockboard and should measure 3 ft. long by 1 ft. 2 in. wide. Fig. 1 shows two alternative shapes for this member. The simplest shape, of course,

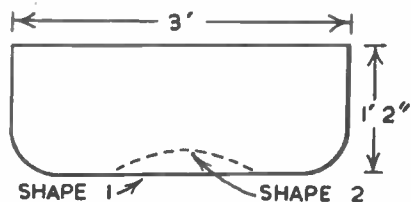

Fig. 1

is where the ends are merely rounded off but if a centre curve is removed from the front edge then a pleasing semi-kidney shape will be obtained. Smooth off the sawn edges, finishing with fine glasspaper.

## Wet the hardboard

The next step is to make the front pelmet board from a 3 in. wide strip of thin plywood or hardboard. The latter is probably the better material to fix around the curves and if it is wetted first you will find that it will bend more easily. Secure the pelmet in position with a little adhesive and some panel pins. A length of brass or nylon curtain rail is screwed to the underside of the top just behind the pelmet after it has been bent to the proper shape.

The simplest method of fixing the fitment in position is to use two shelf brackets. Fig. 3 shows wooden brackets being used (these can be easily made in the workshop) but of course metal brackets may be used if desired. Use Rawlplugs to secure the brackets to the wall. The height at which the top should be fixed will of course depend on individual circumstances.

By  
*Finlay Kerr*

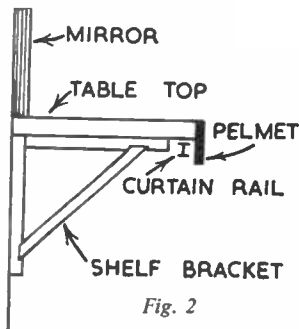
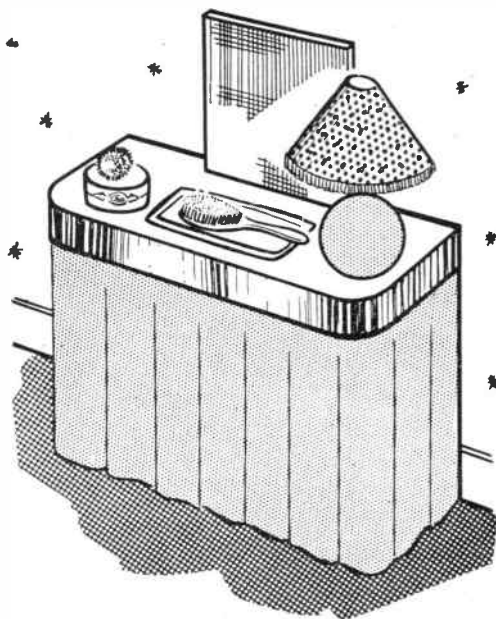
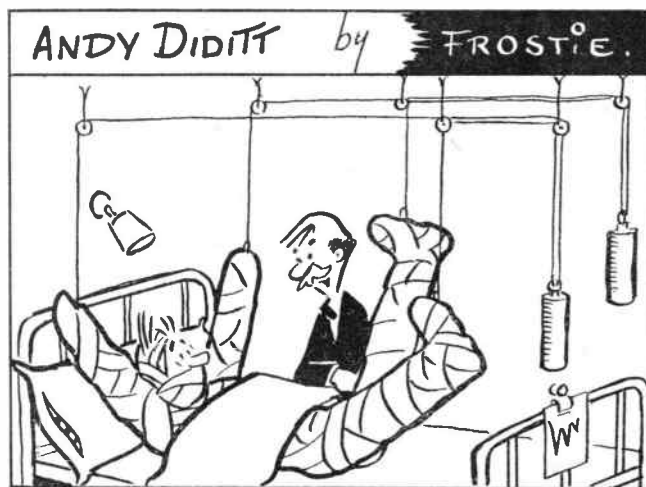

Fig. 2

A popular way of finishing off the top is to cover it with a sheet of plate glass cut to the same shape. A cheaper method would be to lay on a plastic finish such as Waverite. This will produce an attractive and easy-to-clean surface. The pelmet board could be painted a toning colour or covered with thin plastic sheeting such as Fablon.

To complete the project screw a wall mirror in position and then have the table draped with curtains to match the general decorations of the room.



"DON'T KEEP ON WORRYING ABOUT MY LADDER, ANDY - YOU CAN BORROW IT AGAIN - ANYTIME."

**54 page Edition**  
**WHERE'S THAT CAR FROM?**

Price 1/- (Postage 4d.)

Entirely new! Brief Guide to

**INN SIGNS**

Price 1/6 (Postage 4d.)

Of all Booksellers

OR

**RALEIGH PRESS, Exmouth, Devon**

**FOR MODEL MAKERS**

**THE 'MIGHTY MIDGET'** electric motor, only 1½ in. high. Runs at 10,000 R.P.M. from a 4½ V. torch battery. Minute current consumption. Complete with pulley, price 11/-, postage 6d.  
**MODEL BOAT PROPELLER.** 3 blades, shaft, pulley, and 5½ in. long stern tube, to run off above 'Mighty Midget.' Price 7/3, plus 6d. postage.  
**HOBBIES LTD.** (Dept. 99), DEREHAM, NORFOLK.

**100 DIFFERENT** stamps free! Request 4d. upwards discount approvals. — Bush, 53 Newlyn Way, Parkstone, Dorset.

**EARN EXTRA MONEY** with your sewing machine by making cushion covers. Profitable and interesting. Regular work guaranteed. Apply Dept. 28, Arnold Company, 10 Shelley Road, Worthing, Sussex.

**BUYING OR SELLING?**

Classified advertisements on this page are accepted at a cost of 6d. per word prepaid. Use of a Box No. is 1/- extra. Send P.O. with advertisement to *Hobbies Weekly*, Advert. Dept., Dereham, Norfolk. Rates for display advertising on application.

**THE RADIO CONSTRUCTOR**

1st of each month

Price 2/-

The practical magazine covering all aspects of building and experimenting with **Radio, Television, Audio & Electronic** sets and equipment.

Commencing with the August 1961 issue there is to be a series of articles especially designed for the beginner entitled:

**'Understanding Radio'**

These articles follow the highly successful 'Understanding Television' series, recently concluded, and are by the same author.  
 Obtainable through all newsagents

**DATA PUBLICATIONS LTD**

57 Maida Vale, London, W.9

**PROFITABLE LEISURE.** Learn to draw/paint flowers, birds, doodles, etc. Waiting markets. Profitable. Fascinating. Exciting. Booklet, specimens, free. — Popular Art Services (H.W), Clun, Shropshire.

**ENJOY WRITING?** Then write for Profit. Send for 'Writers' Handbook' (free) detailing countless opportunities for beginner or experienced. — Writers' Ring (HW), 5 Edmund Street, Birmingham.

**LEARN RADIO & ELECTRONICS** the NEW Practical Way! Very latest system of experimenting with and building radio apparatus — 'as you learn'. FREE Brochure from: Dept. H.W. 10, Radiostructor, Reading.

**LEARN**

**RADIO & T/V SERVICING**  
**for your OWN BUSINESS/HOBBY**

● by a new exciting no-maths system, using practical equipment recently introduced to this country  
**FREE Brochure from:—**

**RADIOSTRUCTOR**

DEPT. G81, READING, BERKS,

30/8/61

**LONDON**

**DO YOU KNOW?**

**HOBBIES LTD.** have branches at  
 78a NEW OXFORD STREET, W.C.1

87 OLD BROAD STREET, E.C.2

81 STREATHAM HILL, S.W.2

151 HIGH ST., WALTHAMSTOW, E.17

LONDON AIRPORT, HOUNSLOW where the managers and staff are always willing to give you the benefit of their experience with any of your handicraft problems. Why not pay a visit?

**There's always a big demand.**  
**Make sure of your copy NOW!**

**STILL ONLY 2/-**

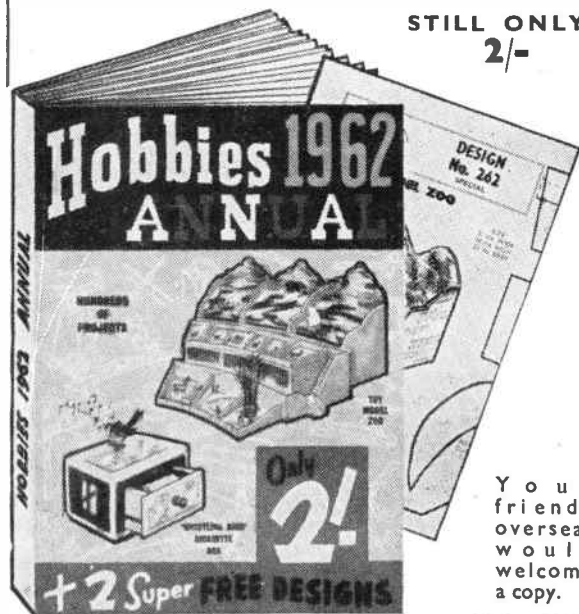

**HOBBIES 1962 ANNUAL**

180 pages packed with hundreds of exciting projects and interesting information for the handyman, hobbyist modeller and home craftsman.

**GIVEN FREE WITH EACH COPY**

Large designs for making a sensational novelty — the 'WHISTLING BIRD' CIGARETTE BOX, and a grand TOY MODEL ZOO. Each worth the price of the Annual.

Obtainable now from Hobbies branches, stockists, newsagents, bookstalls, etc, or by post direct (6d. extra for postage).

To Hobbies Ltd., Dept. 99, Dereham, Norfolk

Please send .....copy/copies Hobbies 1962 Annual containing two free plans

Name .....

Address .....

P.O. for.....enclosed

Your friends overseas would welcome a copy.



During this month the weather is usually conducive to quick and soft growth amongst plants and weeds. Control of weeds will now mean a clean garden during the winter. It is no use, however, expecting the sun to shrivel the weeds at this time of year. They must be removed to the compost heap or they will quickly root again.

Many plants will be encouraged to continue flowering if the seedpods are cut

off regularly. Dahlias will bloom until frost cuts them down and pansies will continue until late autumn if the weather is suitable.

New lawns may be made from seed this month. The best seed will mean less work in the future for the finer grasses do not grow so quickly. The more expensive and finer seeds will be sown at less weight per square yard than the coarser types with rye-grass.

## SOME JOBS TO GET ON WITH

Feed dahlias and chrysanthemums; disbud as required and remove dead flowers.

Lift and plant out layered carnations. Lift and dry gladioli.

Take cuttings of geraniums, violas, heliotropes, penstemon, fuchsias etc.

Plant bulbs in rockery for spring blooming.

Lift and divide alpine as necessary.

Clean up soft fruit bushes.

Prune side shoots of gooseberries and red currants.

Prepare and fix grease bands.

Plant rooted strawberries.

Cloche perpetual fruiting strawberries.

Earth up celery.

Sow lettuce for later cloching.

Plant spring cabbages.

Clean up onions and bend tops over.

Lift red beet, twist off leaves and store in sand or peat.

Commence lifting potatoes; Dry off before storing.

Cloche outdoor tomatoes where possible.

## KEEP THE BONFIRE BURNING



**M**OST gardeners have experienced trouble in keeping the bonfire burning, especially when the material is freshly cut and damp after rain.

Draught from the bottom is essential if the bonfire is to function in a satisfactory way, and if it is built right on the ground this is sometimes difficult to

arrange. Here then is a way that generally proves successful even with the most stubborn fire.

Before starting to build up the heap, lay one or more good sized pipes on the ground, one end being near to the centre of the fire, while the other end leads outside, and points towards the wind if possible.

Now you can build up a good heap of rubbish, leaving the outside ends of the pipes quite free. The draught thus created will in most cases keep the dampest bonfire burning merrily. A useful size of pipe to use is about 4 in. diameter. Old iron or stone drain pipes from a builder's rubbish heap are excellent.

To get the best result from any bonfire do not pack the material too tightly. Leave the interior open for the air to circulate freely and this, with the help of one or more draught pipes, should ensure complete success. (A.F.T.)

THESE NOTES REFER CHIEFLY TO MIDLAND GARDENS. DUE ALLOWANCE SHOULD BE MADE FOR CHANGE OF LATITUDE.

### In the warm greenhouse

Prepare for heating during cool nights. Clean glass and remove shading.

Set traps for mice.

Remove dead flowers and leaves.

### In the cool and cold house

Clear out cucumbers and tomatoes towards the end of the month.

Prepare for housing chrysanthemums.

Spray and fumigate before housing.

Withold water gradually from begonia; dry off and store.

Sow schizanthus for spring display.

Pot up bulbs.

Reduce water for cacti, if in doubt do not water.

### Colour all the year round

by Roy Genders

**A**S its title implies, this book is intended primarily to show the householder, in particular one who has not too big a garden, how to plant it so as to provide colour throughout the year. Plants, bulbs and trees which will furnish this year-long beauty are fully described, and mention of plants which are comparatively unknown will whet the appetite of all who are seeking a new interest in their hobby.

This beautifully produced book makes very easy and pleasurable reading, and the delightfully coloured dust cover gives more than a hint of the joys contained therein. A personal disappointment, however, was that although the many black and white photographs in the book helped to a great ease of understanding of the general theme, there were no coloured illustrations. Even a few would have enhanced the pleasure when taking down the book from the rack during the dark dull days of winter, in order to plan for the year ahead.

Published by Robert Hale Ltd, 63 Old Brompton Rd, London, S.W.7.

Price 21s.

### Fence Posts

The tops of fence posts should always be bevelled off if made of wood, to prevent rain lodging on top and causing rot. In addition, it is a good plan to cover the bevelled tops with off-cuts of sheet zinc.

# COAT HANGER FOR JUNIOR

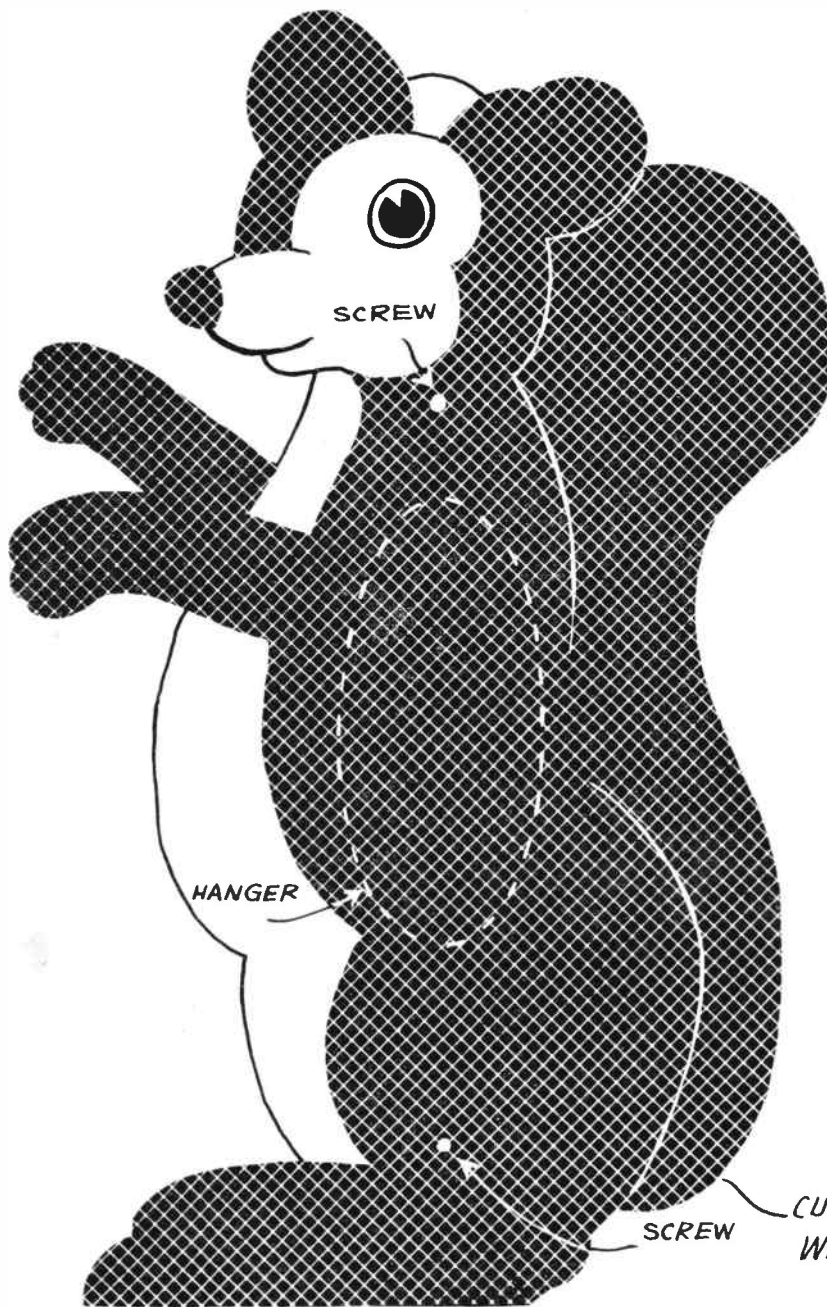

**E**NCOURAGE junior to hang up his raincoat in the proper place. Provide him with his own special hanger, in the shape of a coloured animal cut-out.

It is easy to cut from  $\frac{3}{8}$  in. plywood with a fretsaw. First mark the pattern out on to the wood and then cut round the outline. Clean up with glasspaper and paint in a bright colour. For preference the shaded portion should be bright red.

An ordinary coathanger is screwed in the position shown by the dotted lines and the shape is then screwed to the wall or hall stand. (M.p)

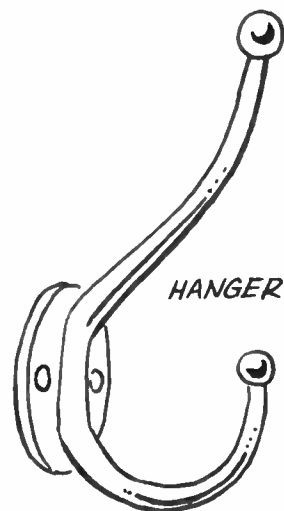

CUT FROM  $\frac{3}{8}$  IN. WOOD  
WITH A FRETSAW

# 'DREAM KITCHEN' UNITS

AVAILABLE READY-MADE OR AS KITS

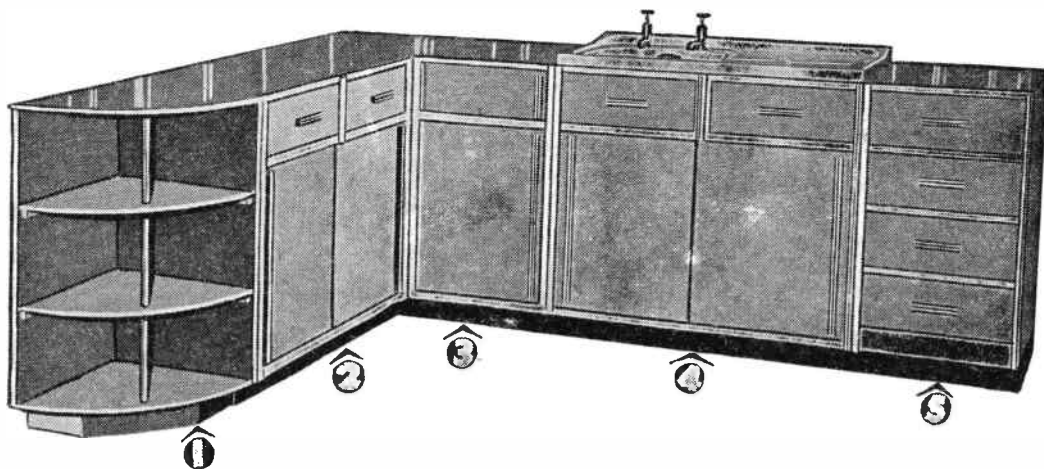

Winsome' kitchen units are designed and produced by Hobbies Ltd, Dereham, Norfolk, and are available by post direct from Head Office or from all branches. Each unit can be used singly or in conjunction with others, according to size and shape of kitchen.

Designed to give maximum cupboard, drawer, and shelf space, they stand at a comfortable working height of 2 ft. 9 in. on recessed plinths. Sliding doors and durable plastic worktops are other compelling features.

Each unit is available completely finished (with choice of colour) or as a specially prepared kit in its natural state, ready to put together with a screwdriver and glue, and finish to your own choice—a simple job.

## 1 END UNIT — No. 57

Complete £5 17s. 6d. (Easy Payments £1 10s. 0d. down (plus 7/6 part p. & p.) and 6 monthly payments of 15s. 6d.) Kit £4 12s. 6d. (part p. & p. 5/- extra)

## 2 CABINET UNIT — No. 51

Complete £8 15s. 0d. (Easy Payments £2 down (plus 10/6 part p. & p.) and 6 monthly payments of £1 3s. 11d.) Kit £6 19s. 6d. (part p. & p. 7/- extra)

## 3 CORNER UNIT — No. 54

Complete £8 13s. 6d. (Easy Payments £2 down (plus 10/6 part p. & p.) and 6 monthly payments of £1 3s. 8d.) Kit £6 18s. 0d. (part p. & p. 7/- extra)

## 4 SINK UNIT — No. 55 (without sink and taps)

Complete £6 15s. 0d. (Easy Payments £1 15s. 0d. down (plus 10/6 part p. & p.) and 6 monthly payments of 17s. 9d.) Kit £5 10s. 0d. (part p. & p. 7/- extra)

## 5 DRAWER UNIT — No. 52

Complete £8 14s. 6d. (Easy Payments £2 down (plus 10/6 part p. & p.) and 6 monthly payments of £1 3s. 10d.) Kit £6 19s. 0d. (part p. & p. 7/- extra)

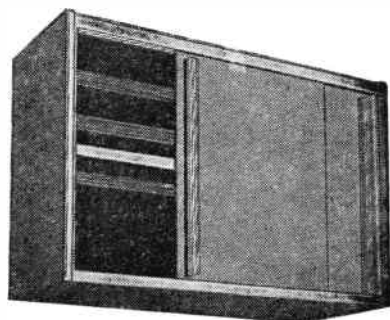

## WALL UNIT (to match)

No. 53 (36" x 23" x 12")

Complete £4 10s. 0d. Kit £3 5s. 0d.

No. 56 (36" x 17" x 8")

Complete £3 12s. 6d. Kit £2 12s. 6d.

Part p. & p. unit 7/6, kit 5/-

## EASY PAYMENT TERMS

The attractive easy payment terms apply only to COMPLETED Kitchen Units valued at £5 and over and are subject to completion of a simple form of agreement. Send the deposit mentioned (plus part carriage and packing charge) to Hobbies Ltd (Dept. 992), Dereham, Norfolk. An agreement form for you to fill in will then be sent.

ASK FOR FREE COLOUR BROCHURE

**HOBBIES LTD (DEPT. 99) DEREHAM NORFOLK**