

MAKE YOUR OWN STEIN

HAVE you ever wished that all those bottles you have to throw away could be put to good use? Here is a way to convert them into steins, the popular German drinking mugs.

The method is simple, the requirements are readily obtainable, and with the resultant stein in hand, you will be the envy of the customers at your favourite 'local'.

All you need is some $\frac{1}{2}$ in. copper stripping, $\frac{1}{8}$ in. diameter rivets or small nuts and bolts of the type used in construction kits, some wood from which the handle is fashioned, and of course, a bottle. A hammer, pliers, and tin-snips will be required in the line of tools.

By R. L. H. Jackson

Begin by deciding what size of stein you want to make. This is governed largely by the type of bottle used. The stein pictured in the diagrams is a two gill size, more popularly called half a pint in the pubs. A 26-ounce whisky bottle is ideal for this size.

Breaking the bottle

Next, measure out the amount of water the stein is to hold, i.e. two gills of water for a two gill stein (half a pint). Pour it in the bottle.

Now soak a piece of ordinary household string in petrol and tie it tightly around the bottle, about $\frac{1}{4}$ in. above the level of the water. Use as small a knot as possible and cut off the loose ends close to the knot. Place the knot over the seam of the bottle. Take care that no excess petrol runs down the bottle. A good way of ensuring this is to draw the string through thumb and forefinger after soaking it. Bring the level of the water up even with the string. This is done to provide a lip to the stein.

The next step has to be done quickly and carefully. Using a match, apply the flame to the string in as many places as possible, until the whole string is burning evenly. This is important. The whole string must be burning in the shortest possible time. If it doesn't, the bottle will break unevenly.

As the string burns, heat is absorbed by the glass above the water, and by the water itself. Thus, the bottle below the water level is much cooler than the glass above it. With these extremes in temperature, the bottle should break evenly at the water level.

With glasspaper wrapped around a piece of wood, smooth off the sharp edges of the lip.

Adding the handle

The body of the stein is now ready for the handle. This should be proportionate to the height of the stein. In the diagram, the stein is six inches high, and the handle five inches long. This allows for a clearance of $\frac{1}{2}$ in. top and bottom. The other measurements are constant — $\frac{1}{2}$ in. wide by $\frac{3}{4}$ in. deep. A $\frac{1}{2}$ in. groove is cut $\frac{1}{4}$ in. from each end and approximately $\frac{1}{8}$ in. deep to accommodate the copper stripping.

The handle may be painted or stained at this stage, or left plain with a coat of clear lacquer.

Measure the circumference of your stein and add $4\frac{1}{2}$ in. to allow for the length required to go around the handle.

Cut two pieces from the $\frac{1}{2}$ in. copper stripping to the required length. This measurement will leave some extra which can be trimmed off later.

Take the two lengths of stripping and in each make a right-angle bend 1 in. from one end. Measure off the length of the circumference from the right-angle bends. About $\frac{1}{8}$ in. short of this make another right-angle bend on the same side as the other one.

Using the stein body as a former, bend the stripping around it, $\frac{3}{4}$ in. from the top. The right-angle bends should almost meet. Drill a $\frac{1}{8}$ in. hole through the upright arms $\frac{1}{4}$ in. from the bends. Rivet the bands firmly together. The $\frac{1}{8}$ in. gap between the arms will allow the stripping to wrap firmly around the stein. Do the same with the lower strap, $\frac{3}{4}$ in. from the bottom.

To make sure that the arms of the straps are in line, it is advisable to use the bottle seam as a junction point for the arms.

With the straps now firmly in place, the fitting of the handle can be undertaken.

One inch from the stein body, make right-angle bends in the longer straps. These should be exactly even with the ends of the shorter straps.

Hold the handle in place so that the straps fit into the grooves cut in the handle and bend the straps tightly around

the handle. Drill a $\frac{1}{8}$ in. hole through the three thicknesses of strap, $\frac{1}{4}$ in. from the handle. Before riveting, trim off the extra stripping, using a circular cut.

Further decoration

Your stein is now complete. Further embellishments may be added if desired. Window leading can be used for this, giving your stein extra weight and durability.

A word of warning — this stein should never be washed in hot water.

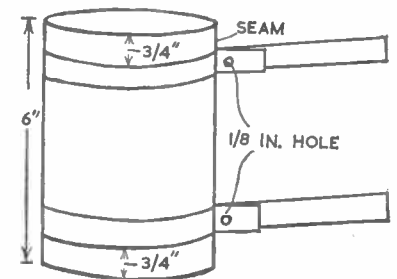
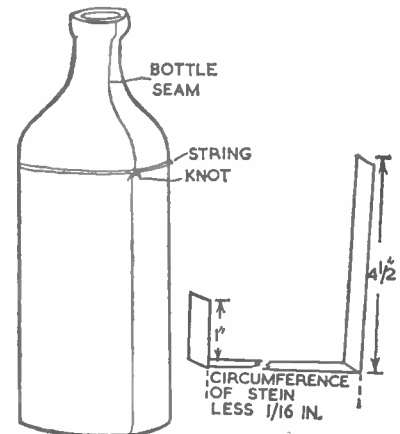
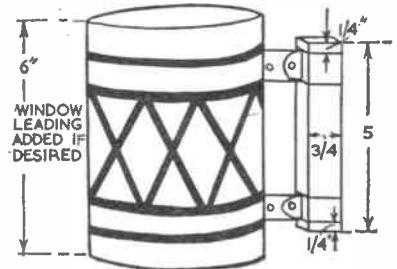

28th DECEMBER 1960

VOL. 131

NUMBER 3394

THE ORIGINAL
'DO-IT-YOURSELF'
MAGAZINE

HOBBIES *weekly*

FOR ALL
HOME CRAFTSMEN

*FREE plans
for three
home projects*

Also in this Issue:

A NEW LOOK
FOR TINWARE

COLLECTORS' CLUB

DIRECT POSITIVE
TRANSPARENCIES

GARDENING TIPS
FOR JANUARY

TOYS MADE FROM
WALNUT SHELLS

CAR HOLD-ALL
AND BOX SEAT

MAKING A
DRINKING STEIN

ETC. ETC.

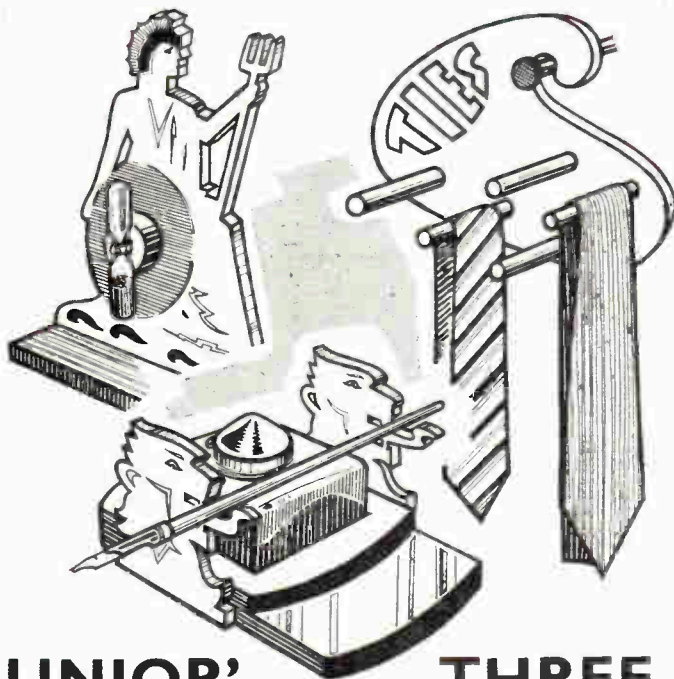

'JUNIOR'

THREE



Up-to-the-minute ideas

Practical designs

Pleasant and profitable things to make

World Radio History

5^p



THE latest stamps from East Africa are likely to prove popular. A medallion portrait of the Queen appears centrally in the upper half of each of the cent values. The names of the three East African Territories are printed along three sides and stylized

EAST AFRICA'S LATEST STAMPS

representations of the heads of the Kenya Lion, the Uganda Crested Crane, and the Tanganyika Giraffe occupy three of the corners, the remaining corner contains the value figures.

The Queen's portrait appears in the top right of each of the other values.

Here are full details of the subjects portrayed on these stamps.

5 Cent — Deep green/blue; subject Sisal. East Africa now produces nearly a half of the total annual world sisal output, the bulk of this crop being produced by Tanganyika, which in 1959 exported over 200,000 tons of sisal worth £13 million.

10 Cent — Olive green; 'Cotton'. Raw cotton forms nearly a quarter of the total value of East African exports. The largest part of this crop is grown in Uganda where approximately 200,000 tons are produced annually.

15 Cent — Slate purple; 'Coffee'. Coffee accounts for nearly one-third of the total value of exports from East Africa and is Kenya's most valuable export commodity.

20 Cent — Magenta; 'Wildebeest'. The East African or White Bearded Wildebeest (*Connochaetes taurinus albojubatus*) roams in vast herds on the East

African plains. It is brown-grey in colour with darker vertical markings. The bearded head is grotesquely disproportioned.

25 Cent — Bronze green; 'Ostrich'. The Ostrich (*Struthio camelus*) is numerous in East Africa. It is only the male bird which has the fine curled white feathers, with the rest of his plumage black. The female is smaller and has brownish feathers.

30 Cent — Vermilion; 'Thomson's Gazelle'. Thomson's Gazelle (*Gazella thomsonii*) abound on the plains. About 2 ft. high, they are bright sandy fawn above and white below, divided by a dark lateral band. The almost parallel horns are about 1 ft. long.

40 Cent — Turquoise/Blue; 'Manta Ray'. The Manta Ray, otherwise known as the Devil Fish (*Manta birostris*) which is found along the East African shores, is so called because it resembles a Manta (Spanish Shawl). Specimens can weigh up to 2 tons with a width of 20 ft.

50 Cent — Slate Violet; 'Zebra'. Two species of Zebra (*Equus Burchelli* and *Equus Grevyi*) are to be found in East Africa. Striped black and white in alternate bands, these animals are a favourite food of the plain-dwelling lions.

65 Cent — Bistre; 'Cheetah'. The Cheetah (*Acinonyx jubatus*) is widespread on the plains of East Africa. It is the swiftest of animals, and is said to be capable of speeds well over 50 m.p.h. for short distances.

1/- — Red/Violet and Mauve; 'Mount Kenya and Giant Plants'. The snow-capped summit of Mount Kenya, 17,058 ft. above sea level, is but a few miles south of the Equator. The great twinned peak, scarred with glaciers, is an ancient volcano from which the crater has eroded away.

1/30 — Red/Brown and Brown/Red; 'Murchison Falls and Hippopotamus'. The Murchison Falls, where the Victoria Nile falls through a 20 ft. wide gorge, in a series of three cascades to the level of Lake Albert 400 ft. below, are a magnificent sight. There are large numbers of crocodiles and hippopotami in the vicinity.

2/- — Grey/Blue and Green/Blue; 'Kilimanjaro and Giraffe'. Kilimanjaro, the highest mountain in Africa, stands 19,342 ft. above sea level. It is an extinct volcano with two peaks, Mawensi and Kibo. Grasslands extend to about 12,000 ft., above which there are moorlands, glaciers, and snow.

2/50 — Olive/Green and Deep Blue/Green; 'Candelabra Tree and Rhinoceros'. The Black Rhinoceros (*Diceros Bicornis*) favours bush and forest country. The two horns are composed of compressed hair, and the front one is

● Continued on page 219





NEW LOOK FOR YOUR TINWARE

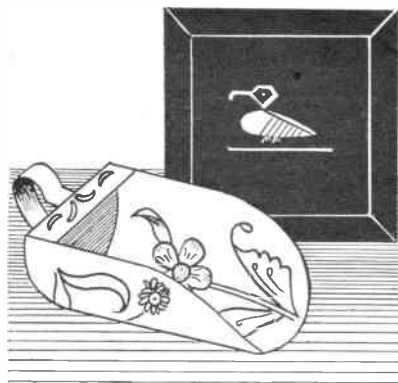

IF you have never considered the possibilities of decorating tinware the following suggestions will help you to convert both old and new objects into attractive novelties for brightening the home. For example, there is that black coal scuttle. Imagine how much better this would look if given a coating of bright paint and a colourful decoration. Small watering cans may be made really gay for watering the household plants, while scoops may be transformed into cheerful wall decorations.

Tins can be made into tea canisters, candle-holders made decorative, while a whole host of tin lids can be transformed into dainty trays. Tin sweet boxes can be made into trinket boxes, while larger and deeper ones can be made into wastepaper bins. Then we have mugs and roasting tins to test our skill, or empty biscuit boxes. Even the old dustpan can be transformed into a serving tray, and so on.

Rust removal essential

But before wasting time on painting and the preparation of suitable decorations it is essential to ensure that any selected article is sound and in good condition. A thorough cleaning is necessary, while it will be obvious that rust must be removed.

A priming coat of metal paint is advisable, since this will prevent the possibility of your painted design from cracking or peeling off. Subsequent coats may be of any desired colour. Aluminium paint is good for the priming coat if applied thinly, and after this you may proceed with two or three coats of thin, flat paint, allowing at least twenty-four hours between each coat. It is also advisable to give a light glasspapering after each coat has dried.

What colours should we use for the ground? Much depends on your own decorative scheme, and whether you seek a matching colour or a contrast — although we cannot ignore any floral design you may propose. Bright colours

give a cheerful appearance, and you may use vermilion, chrome yellow, green, or intermediate tints as desired, but we must remember the possibilities of a black background, which enhances the tones of any added designs.

While the basic painting is in progress you may be preparing, say, a floral design. If you cannot invent an original design of your own, it is quite possible to adapt one from embroidery transfers, decorated crockery, or, perhaps, from magazine pictures and advertisements.

By H. Mann

The design should be prepared on transparent tracing paper for transferring to the object. Rub the back of the paper with lead pencil or charcoal, temporarily attaching it to the object with Sellotape, and tracing the outline of the pattern. Where black grounds are involved it is better to perforate the tracing paper with a pin, rubbing powdered chalk through the holes, and reinforcing later with chalk or white pencil. Where large pieces are concerned it is sometimes quite convenient to prepare the original design — after drafting the scheme — directly on to the object, using curves and other available tools.

Materials required

You will need small paint brushes for applying designs, along with some tubes of artists' oil colours, and a small bottle of varnish — obtainable at an art shop.

Spread some paint from the tube on to an old plate or saucer, having a little varnish in a small jar nearby. The brush is dipped into the varnish, the excess removed on the side of the jar, and 'pulled' through the paint. The hand should be kept quite steady, supported by the little finger which rests on the object, and the design painted accordingly. Paint thinly, and never overload the brush, for you can always apply

another coat if necessary. Moreover, you will find it best to draw the brush towards you — never sideways or away from you. Two or more coats may be necessary in some cases, for example on a black ground, but allow each to dry.

Another method is to apply the design with the aid of stencils and fill in the detail work with finer brushes.

When the entire design has been completed, a final coating of protective varnish is applied, and in a warm, dust-free room.

A novel way of adding a design to small objects which will not receive hard wear is by cutting out pictures from magazines or books. Alternatively, you may paint your own designs on cartridge paper and cut out. Many suitable items will be found in advertisements, provided they are coloured. Stick the design on to the prepared tin with a good adhesive and allow to dry, finishing with a colourless lacquer.

● Continued from page 218

East African Stamps

usually the longer. A fully grown specimen weighs about 2 tons.

5/- — Carmine, Red, and Purple; 'Crater Lake and Mountains of the Moon'. The Ruwenzori Range (the Mountains of the Moon), unlike other great mountains of Central Africa, is not volcanic, but is a massif with six separate glaciated groups.

10/- — Deep Blue/Green and Olive/Green; 'Ngorongoro Crater and Buffalo'. The Ngorongoro Crater in the Serengeti National Parks is the best area in Africa for big game. The Buffalo (*Syncerus caffer*) is one of the most cunning and ferocious of big game animals when wounded.

20/- — 'Royal Portrait'. Lake and Ultramarine.

The 5, 10, 15, 20, 30 and 50 cents, and the 1/- and 5/- denominations are also available overprinted 'Official'.

DIRECT REVERSAL OF FILMS

At some time or other you may have had the misfortune to unwittingly expose a film to light during development and if so you will know that it changes into a positive. There is no remedy for this but with careful control it is possible to employ this knowledge for making direct positive transparencies of roll and 35 mm. films which may be mounted and projected on a screen. Film strips can be made in the same manner and no doubt you will be interested to learn that a tested process has been formulated by Ilford Limited.

positive print. When we employ the reversal method of processing it is essential to make accurate exposures if we are to produce a full film of transparencies of consistent quality.

An exposure meter or guide is recommended for all outdoor and indoor exposures while the published speed rating of the film should be used as a guide, and you will realize that an initial attempt is invaluable as a test. At the same time, the exposure for reversal is no more critical than for colour films where we must endeavour to produce a full film of perfect transparencies.

The ordinary developer ID-36, made up to the strength for developing contact papers is used but we add hypo crystals as follows:

Pan F, FP3 roll films, Selochrome and HP3 films:

70 grains of hypo to every 20 oz. of working strength developer.

HPS and FP3 35 mm. films:

½ oz. of hypo to every 20 oz. of working strength developer.

Fine Grain Safety Positive Film:

35 grains of hypo to every 20 oz. working strength developer.

The following solutions are also required:

Bleaching solution

Solution A

Potassium permanganate 35 grains
Water, up to 20 oz.

Solution B

Sulphuric Acid, conc. 192 min.
Water up to 20 oz.

These stock solutions will keep almost indefinitely and for use mix equal parts of A and B. Fresh working solutions are required for each film.

Clearing solution

Sodium (or potassium)
metabisulphite 1 oz.
Water, up to 40 oz.

Fixing bath

A hardening-fixing bath is favoured as the bleaching operation renders the emulsion tender.

We will now endeavour to explain the method of reversal processing and the first step is in the development of the negative image in the amended developing solution. This image is submitted to the bleach bath where it is dissolved away and the remaining silver halide is exposed and developed to produce a positive image. After the second development of the latter we fix in the acid hardening bath and that completes the operation. All that remains is a thorough washing for 30 minutes as usual.

The foregoing gives a brief description of the process but the following details must be noted.

A spiral tank can be used for the first development, when the temperature should be 68°F., the film being loaded as usual in total darkness or with the aid of the recommended safelight.

A development time of 12 minutes at 68°F. is recommended for all the films specified and it is rather important that this time and temperature is carefully maintained. As a matter of fact this first development and the time and temperature are just as important as the control of the exposure when taking the pictures. If you do use a tank it is best to be fully prepared as the time expires, removing the cover from the tank for speedy immersion of the spiral into water to stop development. Note that you will require the same developing solution for the next development so it must be poured into a convenient vessel. Wash out the tank and fill with the prepared bleaching solution.

When the film has been removed from the developing solution it is washed for a full 3 minutes in running water and then transferred to the bleaching solution (65° to 70°F.) which has been poured in the tank. Continue strong agitation for 5 minutes lifting and returning to ensure complete bleaching. It is absolutely essential to maintain vigorous agitation during this part of the process but after

By S. H. Longbottom

The entire process can be completed in half an hour, requiring only a few additional chemicals and a little care during development. You may use such popular films as Selochrome, FP3, HP3, or HPS roll films while Ilford Pan F, FP3, HP3, and HPS 35 mm. miniature films are equally adaptable. If you propose copying prints Pan F should be used but where greater contrast is required the Fine Grain Safety Positive Film is recommended.

You will appreciate that when employing normal methods there is a considerable latitude of exposure, and small errors are compensated when making the

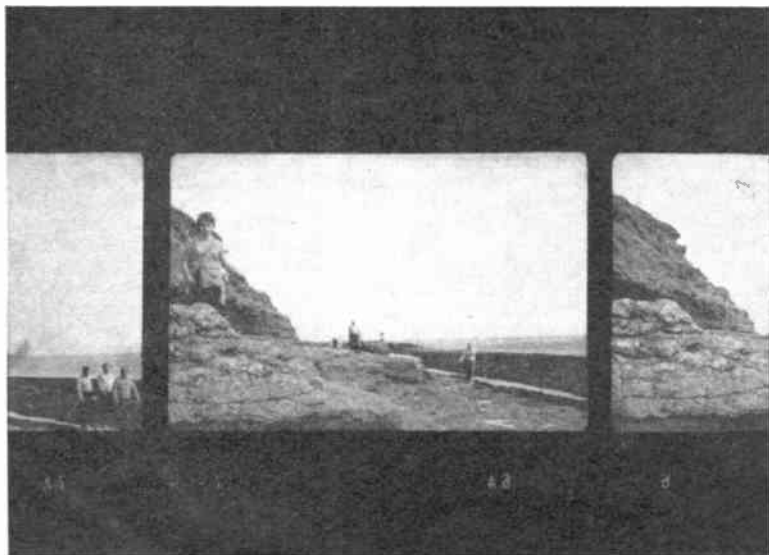

• Continued on page 221



THESE NOTES REFER CHIEFLY TO MIDLAND GARDENS — DUE ALLOWANCE SHOULD BE MADE FOR CHANGE OF LATITUDE.

WORK in the garden is never finished, for no sooner is one job complete than something else needs attention. Even during the winter when normal growth has practically ceased, digging, mulching, spraying, and pruning need to be done and there is plenty to occupy your time if you possess a heated greenhouse.

Certain jobs must be completed at a certain time, and planting, sowing, and pruning should be carried out to a strict timetable if your gardening is to

be successful. This, however, does not mean that gardening is dull. Quite the opposite in fact, for there are so many things to grow that one has never finished learning.

These monthly notes will continue to give brief reminders of work to do and will suggest something of special interest for you to try. Some jobs such as pruning, for example, are spread over two or three months and will of course appear in the notes more than once.

**SOMETHING TO TRY—
EARLY LETTUCES**

IT is not generally appreciated that lettuces properly grown under cloches can compete with commercially grown cold house crops. You can have early lettuces under cloches when they are still costing 1/- each to buy.

You make a start in January by sowing a small quantity (all the year round variety) of lettuce seed in a box of soil. You can use J.I. seed compost or ordinary garden soil if fairly light. Water well, before sowing, and sow thinly. Cover lightly with fine soil. Place the soil in the greenhouse with a little warmth or put on a sunny window sill indoors. Place a piece of glass over the top and cover with a newspaper. Inspect every day after five days and remove glass and paper when germination has taken place.

Prick out under cloches at the end of February. The cloches should run East to West and can be shaded on the south side later if necessary. Lettuces grown in this way heat up quickly and are much more tender than the outside varieties.

Some jobs to get on with

- Lift rhubarb for forcing.
- Apply winter sprays.
- Continue pruning apples.
- Stake young trees.
- Tie in raspberries.
- Mulch with old manure.
- Set potatoes to sprout.
- Make up hot bed.
- Protect herbaceous plants.
- Trim laurels.
- Mulch peonies.
- Make seed boxes.
- Burn prunings.
- Sow carrots, radish and lettuce (in hot bed).
- Order seeds.

- Prune black currants.
- Prune outdoor grapes.
- Protect celery from frost.

IN THE WARM GREENHOUSE — sow the following:

- Coleus, begonias, gloxinias, cyclamen, antirrhinums, petunias and carnations.
- Fumigate regularly.

IN THE COOL GREENHOUSE — take cuttings of chrysanthemums, carnations (perpetual).

Bring in bulbs. Fumigate regularly.

IN THE COLD GREENHOUSE — Pick off decaying leaves. Ventilate where possible.

• Continued from page 220

DIRECT REVERSAL OF FILMS

the film has been in the solution for 30 seconds all following operations can be conducted in electric light.

Now remove the film from the bleach and wash in running water for 2 minutes, afterwards soaking in the clearing solution for 2 minutes, which is then followed by a third washing for 2 minutes in running water.

The film can now be removed from the spiral when it is exposed to a 100 watt electric light for 30 seconds while held at a distance of 18 in. Experiments reveal that insufficient exposure will produce a reduced density after fixing although two, or even four, times the specified

exposure may be given without ill effect. Exposure beyond 2 minutes will tend to fog the highlights.

The film is now re-developed after this exposure in the first solution (ID-36) and to avoid any contamination with the other chemicals it will be found better to complete this in a dish using the 'see-saw' method. Development should be for 6 minutes at 68°F. and we would mention that the presence of the hypo traces remaining in this solution helps to clear highlights. In this instance the time of the final development is not so critical as the first and although 6 minutes is specified you may continue until maxi-

mum density results. Since you are able to work in artificial light it is quite a simple matter to watch the progress.

The process is completed by fixing the film in the acid hardening fixing bath for 10 minutes. This will remove any insensitive silver halide in the highlights and will harden the emulsion. A final washing is made in running water for 30 minutes and when the film has dried it is ready for making into transparencies or strips in the usual manner.

There are several advantages of using this method, which is particularly useful if you wish to avoid the lengthy process of making individual lantern slides. Moreover, all the films mentioned are much cheaper than colour films, they can be processed at home, and are very much faster, so that photography is possible in all kinds of lighting conditions.

TOYS FROM WALNUT SHELLS

DEFT fingers and a lively imagination can transform a handful of walnut shells into a variety of attractive toys and novelties. Do not break open your walnuts with nutcrackers, but split them neatly by inserting a penknife between the halves. Extract the edible portions, then scrape clean the interiors of the shells. Other materials which you will need include some scraps of cardboard and coloured paper, a few strands of wool, and a quantity of used matchsticks. Your tool kit will comprise a sharp knife, a hand drill,

and will provide a welcome new inhabitant of a toy zoo or Noah's Ark. In a similar manner you can make a Frog. Merely add bulging eyes and webbed feet to the pencilled oval and proceed as described for the Tortoise.

By A. E. Ward

The Spider is a cheerfully smiling creepy-crawly beast that will make a most unusual toy mascot. Bore a hole

Lilliputian armada. Glue a piece of a matchstick across the middle of a shell and glue a cardboard disc 'paddle' to each end of the stick. Form a tall funnel by rolling a piece of paper and glue this behind the paddles, in the middle of the boat. Make a mast and sail, and erect the rigged mast in front of the paddles. A miniature flag upon a short mast may be stuck above the stern.

A walnut-shell boat may be propelled by means of a fragment of gum camphor

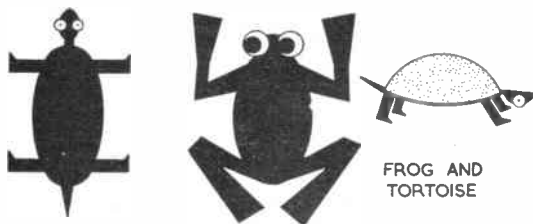

FROG AND TORTOISE

and a pair of scissors. Balsa cement is a suitable adhesive.

A traditional walnut toy is the Tortoise. Simply trace around a walnut shell, with a pencil, upon a sheet of thin cardboard, then mark on legs, head and tail. Cut out the cardboard tortoise with scissors and glue the walnut shell over the flat body. Bend down the legs, twist the head to one side, and turn up the tail. Paint your model with poster colours and mark on eyes and mouth. Your walnut tortoise will look most ornamenta]

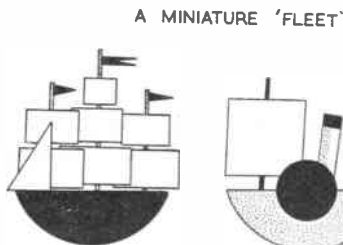

A MINIATURE 'FLEET'

in the middle of a walnut shell and thread a long piece of black wool through it. Tie a large knot in the end of the thread so that the shell may be suspended, open side down. Make four loops from 6 in. long woollen strands and fix these underneath the shell 'body', using Sellotape, to form eight dangling hairy legs. Cut off two red or blue topped match heads and glue these to the body, to serve as staring eyes. Cut out pieces of coloured paper to resemble a red smiling mouth and a set of sharp yellow teeth and glue these in position. The finished Spider is suspended from a shelf or the ceiling.

You can hold a miniature regatta in a bath tub by assembling therein a fleet of walnut-shell boats. An inverted shell will serve as a simple rowing boat and you can fashion a sailor out of cut paper. Make the paper man (as illustrated), and glue him, in a sitting posture, inside the shell. Glue coloured paper oars to the Sailor's hands and the sides of the 'boat' where the rowlocks would be. A paper flag on a matchstick mast glued to the bow of the little boat will complete the toy.

The easiest type of boat to make is the Yacht. Merely glue a matchstick upright inside a shell and fix a paper sail to the mast. Such a boat will sail well upon a pond. With a little patience, a toy Galleon is possible. Glue sets of minute sails to three matchstick masts and erect these inside the shell.

An old Paddle Steamer with a sail will provide a novel addition to your

which you can glue to the rear of the vessel. Place the boat in a grease-free bowl of water and watch it sail along as the camphor dissolves and reduces the surface tension over the water behind the boat.

An Obedient Walnut will cause some amusement. Bore neat holes in the middles of two matching halves of a walnut shell. Glue a piece of a match-

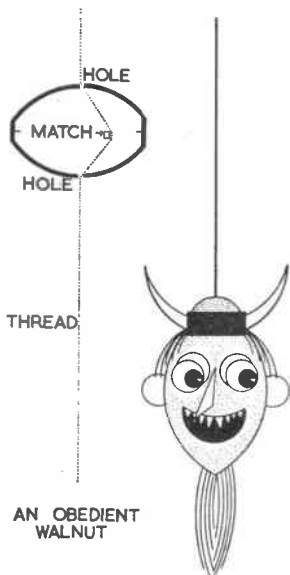

AN OBEDIENT WALNUT

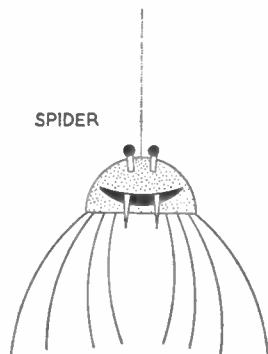

SPIDER

stick across one of the halves, in a position about a quarter of an inch out of line with the hole. Thread a long piece of cotton through the other hole, then glue the two halves together. Hold the thread fairly tightly, upright, between your two hands. The walnut will remain stationary. Slacken the thread and the nut will

● Continued on page 223

Making a Model Suspension Bridge

A MODEL bridge adds much interest to a railway layout, and can also be used as a road bridge for model cars. The one illustrated here is based on the new Forth road bridge. The finished model is 3 ft. long and 12 in.

By

A. Liston



FOR ROAD OR RAIL LAYOUTS

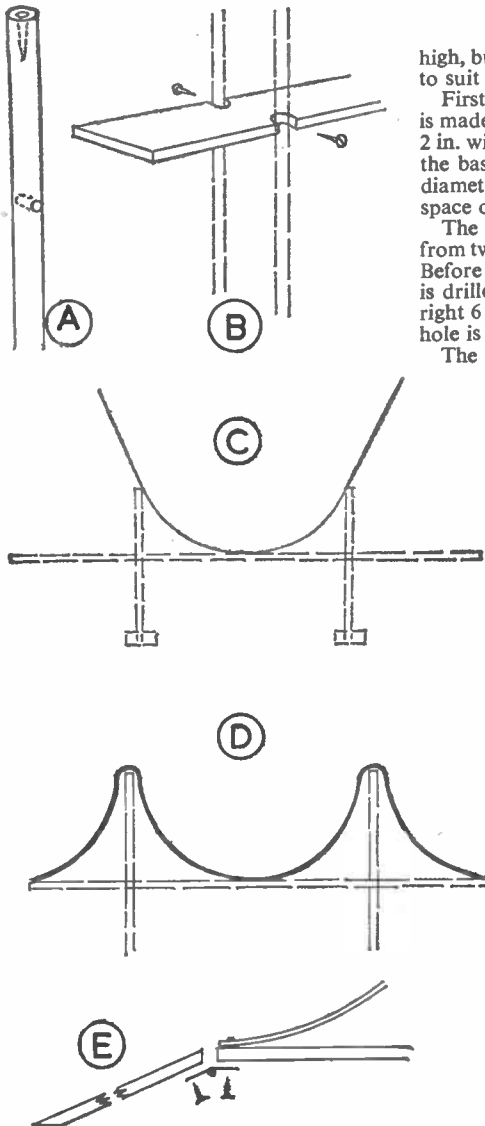

high, but these dimensions can be altered to suit individual needs.

First, the base of each of the two piers is made from a block of wood 5 in. long, 2 in. wide, and 1 in. thick. The corners of the base are rounded off, and two $\frac{3}{8}$ in. diameter holes are drilled in it, leaving a space of $1\frac{1}{2}$ in. between them.

The uprights of each pier are made from two 12 in. lengths of $\frac{3}{8}$ in. dowelling. Before they are fixed in the base, a hole is drilled horizontally through each upright 6 in. from the bottom, and another hole is drilled vertically in the top A.

The uprights are then glued and inserted in the base, making sure that the central holes are at the same height, and in line.

The carriageway is a 3 ft. length of 3 in. wide wood, $\frac{1}{2}$ in. thick. Four notches, $\frac{3}{8}$ in. wide and $\frac{3}{8}$ in. deep, are cut in the carriageway, each pair being 9 in. from the end B. The uprights fit into each of these recesses, and are screwed to the carriageway by means of the holes already drilled.

The suspension units are made from two 6 ft. lengths of flat brass valance rod, $\frac{3}{8}$ in. wide. First, the centre section of each rod is bent round a large shape — a dust-bin or a watering-can will do — then finally shaped so that it touches each upright and the central point of the carriageway C. The rod is then bent with pliers to fit over the tops of the uprights, and the end sections are bent down to touch the ends of the carriageway D, any surplus being sawn off.

Five holes are then drilled in each rod, and the rod is then screwed to the uprights and carriageway. Instead of wood screws, small nuts and bolts can be used to secure the rod to the carriageway at each end, and in the middle.

Two 3 in. lengths of valance rod, drilled at each end, form the cross pieces between each pair of uprights.

Two approach roads can be made for use with model cars by adding a 12 in. long strip, the same width as the carriageway, at each end. A small hinge on the underside holds each approach strip in place E.

The 3 in. wide carriageway section gives a clear width of $1\frac{1}{2}$ in., but a wider carriageway can be used if necessary.

The completed bridge should be finished in flat grey paint with matt black suspension cables.

Continued from page 222

Walnut Shell Toys

slide down the cotton. Practise this and discover for yourself how to control your Obedient Walnut by simply calling 'stop' or 'go'.

Bizarre little Demon Heads may be constructed from half walnut shells. Hair and beards can be represented by strands of coloured wool held in place with Sellotape. Bright eyes, beak-like noses, fierce mouths, and curved horns, can be fashioned in coloured paper and glued into position. String up clusters of the model heads to make grotesque little ornaments, reminiscent of Jivaro and Dyak shrunken heads sometimes seen in museums.

A HOLD-ALL BOX SEAT FOR A CAR

IN a saloon car your expensive tools or foot pump are hidden away in the boot and your fishing rods or golf clubs can be similarly placed out of sight, but in an estate car they may be in full view, providing a source of temptation to the petty thief, and giving a general look of untidiness.

The hold-all box can be made to any size for your specific requirements and serves the dual purpose of box and seat. It will be quite comfortable for a child for short journeys and your 'valuables' will be hidden from prying eyes.

The box is made from $\frac{3}{4}$ in. wood or plywood and is simply butted together as shown in the details. Screw and glue together, using countersunk screws and filling the heads before painting.

The side and end views in Fig. 1 show suggested measurements, but these should be modified to suit your own particular needs.

Assemble the box as in Fig. 2, making the recesses to take 2 in. brass hinges as

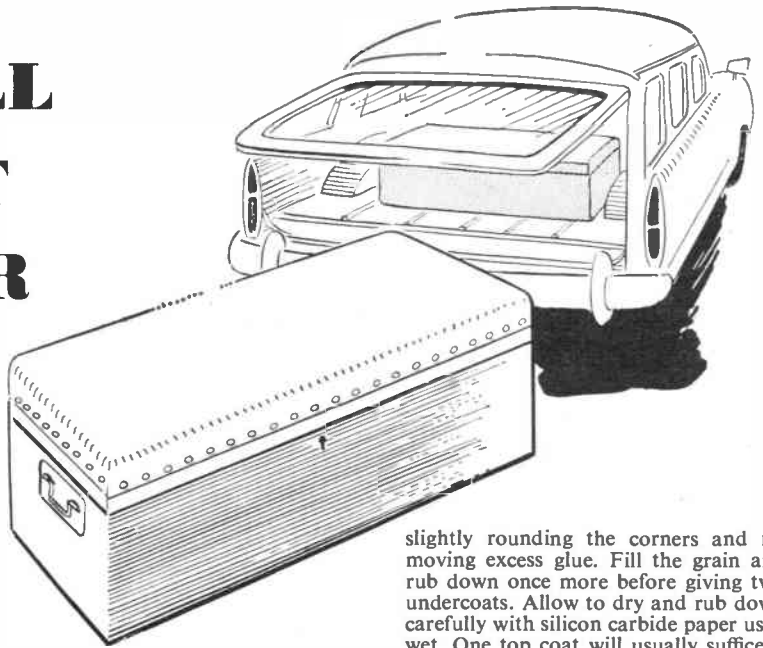

shown. The lid consists of a framing and top glued and screwed together as detailed in Fig. 3. Clean up with glasspaper and hinge to the box.

The interior may be left or may be fitted with any number of partitions or sliding trays. Partitions could be made up in tray form and removed when bulky objects are to be carried.

It is preferable to fit a lock of some kind but it need not be an expensive one. Finish off by glasspapering well,

slightly rounding the corners and removing excess glue. Fill the grain and rub down once more before giving two undercoats. Allow to dry and rub down carefully with silicon carbide paper used wet. One top coat will usually suffice if the preparatory work is carried out satisfactorily.

The seat is formed from slabs of plastic foam. They are shown in position in Fig. 4. They will of course be covered with material such as leathercloth or a plastic imitation, both of which can be wiped down and kept reasonably clean.

The material is doubled under at the edges and secured with large headed tacks. Ornamental tacks should be used if available. The section in Fig. 5 gives a clear idea of the procedure.

Finally fit two carrying handles as suggested in the picture of the finished box. (M.h.)

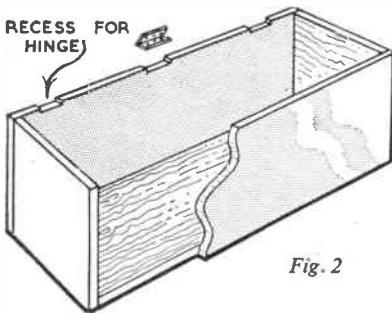
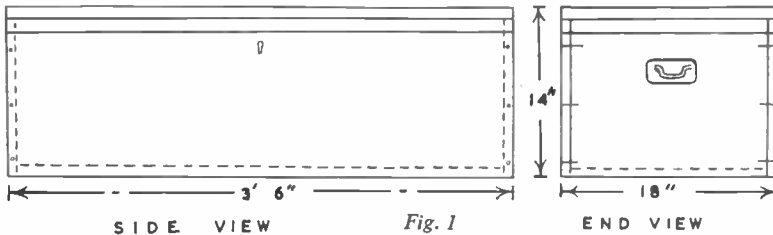

Fig. 2

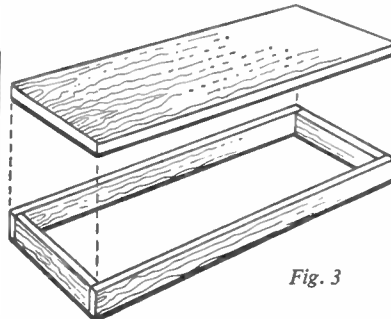

Fig. 3

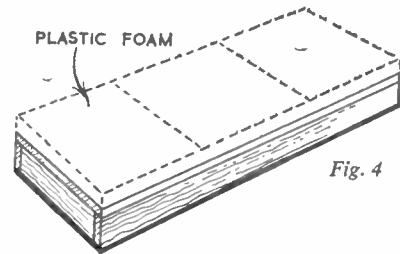

Fig. 4

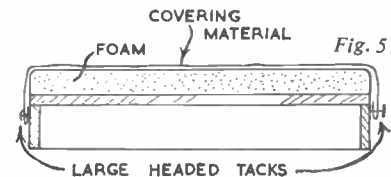

Fig. 5

Instructions to make

THE 'JUNIOR' THREE

THESE three designs for making home projects are ideal for the young fretworker. They will prove to be handy exercises in the use of the fretsaw, and give good experience in gluing parts together. Each of the subjects can be finished as desired — that is, by staining and varnishing or by the addition of paints. The more experienced worker will also appreciate these ideas as being excellent suggestions for easily made gifts at any time throughout the year.

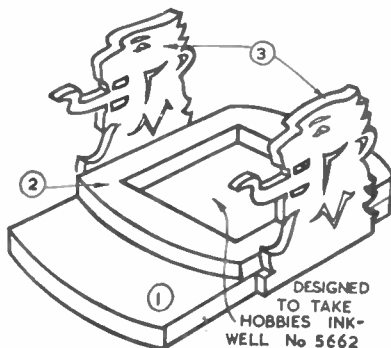

Fig. 1

All parts which go to make up the Pen and Ink Stand, the Egg Timer, and the Tie Rack are shown full size on the design sheet. They should be traced and transferred to their appropriate thicknesses of wood by means of carbon paper, taking particular note of the direction of the grain of the wood, which is indicated by arrows. Marking out the pieces according to the grain direction gives strength to the particular parts. After cutting out all the pieces with a fretsaw, they should be cleaned up thoroughly with glasspaper.

Pen and Ink Stand

The Pen and Ink Stand consists of a base (piece 1), inkwell holder (piece 2), and two identical sides (pieces 3) as shown in Fig. 1. Glue piece 2 to piece 1 in the position shown by dotted lines on piece 1. Then add the side figures by pinning and gluing, both of course facing the same way — towards the front. This project is designed to take a Hobbies No. 5662 inkwell which is 2 in. square and has a hinged metal cap. Separately it costs 2s. 6d. plus postage.

For finish, the article can be stained, followed by polishing or varnishing. Alternatively paint in pastel shades.

Egg Timer

For the Egg Timer the figure of Britannia (piece 4) is tenoned and glued into the slot provided in the base (piece 5). Fig. 2 shows the makeup of the arrangement for setting the sandglass. One piece 6 is glued to the end of the axle (piece 8). Piece 7 is next glued to piece 6 and the Terry clip screwed to the centre of piece 7.

Insert the axle from the front through the hole in piece 4 and then glue the other piece 6 to the end of the axle. Make

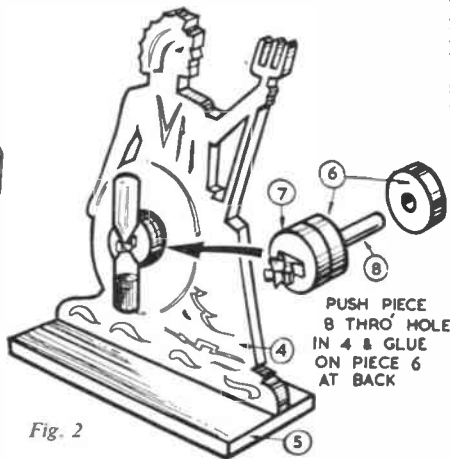

Fig. 2

sure that the assembly revolves freely in the hole. The sandglass is fixed by pushing into the holding clip. Painting is suggested as a finish.

Tie Rack

The Tie Rack is intended for hanging on the appropriate bar provided in a

A KIT FOR 7/10d.

Hobbies kit No. 3394 for making all three designs contains all necessary panels of planed wood, round rod, inkwell, sandglass, clip and screw, together with working design. Kits from branches, stockists, etc., or direct from Hobbies Ltd, Dereham, Norfolk, price 7/10 (post 1/6 extra)

wardrobe, or can also be used as a wall fitting for hanging on a nail. It has provision for holding five ties, but if longer dowels are used to protrude both sides, this will give a double hanging for wardrobe purposes.

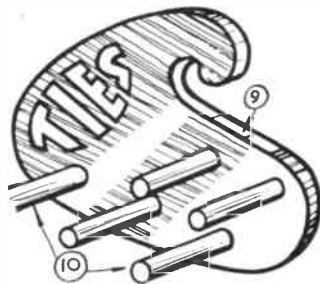

Fig. 3

The dowels (pieces 10) are inserted in the holes in piece 9 as shown in Fig. 3. A piece of coloured material such as flock paper can be pasted behind the lettering to bring this out more and give a good effect.

Finish can be by painting, staining, or varnishing.

Hobbies Hardboard Runabout 'Zip'



This is the new exciting craft 'Zip', for which instructions to build will commence in next week's issue. Skinned with oil-tempered hardboard, 'Zip' is a 2-seater, and Hobbies kits will be available. There is sure to be a big demand for this and subsequent issues, so make sure of your copy by placing a firm order with your newsagent.



NOTHING spoils the appearance of a bath more than the presence of badly chipped, crazed, or discoloured surfaces. At one time, baths in such condition either had to be replaced with a new one or disconnected and returned to the makers for re-enamelling.

Nowadays, however, enamels are available that can be applied by brush to give the necessary high degree of finish. In choosing a suitable bath enamel, however, the home handyman should ensure two important points: (a) the enamel must be capable of binding itself to the hard metal surface of the bath, and (b) it must be capable of standing up to severe conditions like those caused by varying temperatures, soap solutions, detergents, bath salts, etc.

One proprietary enamel which satisfies the above requirements is known as Luxol Polyurethane Coating for baths and is manufactured by Messrs British Paints Ltd, Newcastle-upon-Tyne. Both the primer-undercoat and the finishing coat are two-pack products each con-

sisting of a base and a hardener. In order to achieve a satisfactory degree of finish it is essential to follow the manufacturer's instructions very carefully. Each coat has its own individual hardener and thinner and these are not interchangeable. Let us assume, therefore, that you will tackle the re-enamelling of the bath using this two-pack method. The procedure is as follows.

By Finlay Kerr

Remove the old defective enamel right down to the bare metal. This is normally done with the aid of a suitable chemical stripper. The stripper should be applied over the surface in accordance with the instructions and after a while the softened enamel should be scraped away. If there are any rusty parts present these should be rubbed with emery cloth down to the clean metal.

The next job is to wash out the bath thoroughly in order to get rid of all traces of the chemical stripper. When dry, rub down the bare metal with some fine emery cloth and then rinse with cold water. *Dry the bath thoroughly with a non-fluffy cloth.* This preparatory work is often tedious and laborious but it must be done well otherwise the final quality of your work will be marred.

When the surface has been properly prepared and is quite dry the primer-undercoat, or first coat, can be applied. Add the hardener to the base (taking care to ensure that the correct hardener is used), stir thoroughly and apply with a 2 in. flat brush. It is usual to start at the bottom of the bath underneath the taps and gradually work round in an upward circular direction until the entire surface has been completely covered. Ensure that the paint is well brushed into any previously rusted areas. It is important, too, that the taps should not drip whilst the

bath is being treated. Once the primer-undercoat has been applied allow it to dry overnight.

The finishing, or enamelling coat is applied in much the same manner. The base enamel and the special hardener (take care once again to use the correct one) are mixed together and applied to the bath. Although this coating may appear to be thin at first the high solids content enables a full coat to be applied without cross-brushing or laying-off. In order to avoid joins becoming noticeable apply the enamel as quickly as possible and try and keep the edges wet so that they can be easily 'picked up'.

To assist in the drying of the enamel open the windows of the bathroom to permit free ventilation. Flying dust, however, should be avoided whilst the enamel is 'tacky'. If a superior finish is required and time permits, a second coat may be applied after six hours. The bath should not be used for at least twenty-four hours.

500 Picture Puzzles for Boys and Girls

BY DOUGLAS I. POWER

CHILDREN learn faster when they enjoy doing so, and here is a thrilling way to learn, which will make the too-quick child relax and speed up the thinking of the too-slow child.

If there is any money left in the 'Christmas kitty', it would be well worth buying this book for any child between the ages of 5 and 12. By question and answer the author has provided exactly what is wanted for that wet day indoors. These pictorial puzzles make fascinating entertainment, combined with a fund of knowledge for the young reader.

Published by Elliot Right Way Books, Kingswood Building, Kingswood, Surrey. Price 7s. 6d.

We say 'Farewell' to the Farthing

ON Sunday next, the first day of the New Year, the legal life of the farthing ends. The smallest denomination in United Kingdom coinage has at last outlived its usefulness. In fact its most recent common usage was during the 1939-45 war when rationing necessitated the purchase of small quantities at food shops.

The withdrawal by Royal Proclamation of a legal coin, 'demonetised' as it is officially termed, seldom occurs in this country. The last occasion was on 22nd November 1890, when all the gold coins which had been minted prior to the reign of Queen Victoria were withdrawn, and ceased to be legal tender

after 28th February 1891.

It is generally believed that a quarter cut from the Anglo-Saxon silver penny was the first farthing used. During the reign of Edward I it became part of our coinage, and until the reign of Mary remained a silver coin. Then in 1613 the copper farthing was introduced and used until 1860, when the bronze coin made its appearance.

During this last century the Royal Mint has made farthings to the value of £782,450, compared with £3,500,000 worth of halfpennies over the same period. Five months ago when the Government advised Her Majesty to issue the Royal Proclamation by which

farthings will no longer be legal tender, it was estimated that some two million were still in the vaults of banks, and in public hands.

In the four remaining days when farthings can be legally spent, whether they be silver, copper or bronze, they can, by the Coinage Act of 1870, be used as legal tender for payments up to 1/-. But, although not illegal to possess farthings after 1st January, if you have many surplus to your collection needs it is, perhaps, kinder to tradesmen if you return the coins for exchange at your nearest bank, who in turn will return them to the Mint.

(J.A.C.)

NEW Angles on OLD favourites

from these Books bulging with BRIGHT IDEAS

Any volume in this most interesting range of books, each dealing with a different aspect of gummed paper-craft, will show you a wealth of ideas, the way to carry them out, and give hours of intense enjoyment.

Each is the key to an economical hobby that is rich in variety, ranging from the making of a charming picture to framing it delightfully — from three dimensional models to wall decorations, from paper sculpture to charming flower studies.

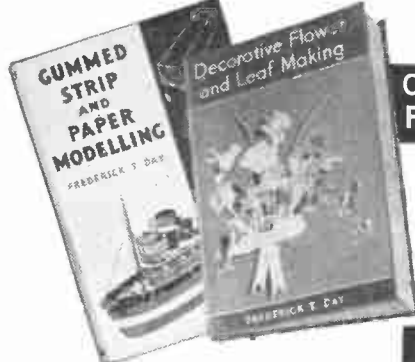

Other books by FREDERICK T. DAY

- Coloured Paper Decoration 7/6
- Coloured Papercraft for Schools .. 7/6
- Coloured Papercraft for Infants' Schools.. 6/-
- Lampshade and Parchment Craft .. 8/6
- Decorative Flower and Leafmaking .. 8/6
- Gummed Strip and Paper Modelling .. 7/6
- Paper Sculpture for Schools 7/6



8/6

All books obtainable from:
Newnes & Pearson Ltd.
 Tower House, Southampton St., Strand, W.C.1.
 Ask your stationer to show you the Butterfly range of
 handicraft materials.

SAMUEL JONES & CO., LTD.

STATIONERY MILL, CAMBERWELL, LONDON, S.E.5. RODNEY. 5064

WOOD MITRE BOX

Made with selected hardwood with slots for 45° and right-angle cutting. Size 9ins. long. **5/6**

A good tool at a modest price from branches or :- (post 1/6)
HOBBIES, DEREHAM, NORFOLK

All over the World...

Hobbies Weekly is a regular source of ideas and inspiration for readers all over the world. Free design plans worth at least 1s., for making all kinds of projects such as toys, novelties, models, and furniture, are included in every alternate issue. Costing only 5d. each Wednesday, *Hobbies Weekly* is therefore a sound investment for the craftworker and hobbyist.

A missed copy means forgoing hours of pleasure — and perhaps not a little profit. For there's bound to be something to interest you — and the rest of the family — in every issue of *Hobbies Weekly*. So place a firm order with your newsagent.

In some places, readers of *Hobbies Weekly* may experience difficulty in obtaining regular copies, in which case it is advisable to become postal subscribers. Rates are: 12 months 30s., 6 months 15s., 3 months 7s. 6d. (all including postage to any part of the world.) Complete the form now.

HEAR ALL CONTINENTS With H.A.C. Short-Wave Receivers

Suppliers for over 18 years of radio S-W Receivers of quality.
 One-Valve Kit, Price **25/-** Two-Valve Kit, Price **50/-**
 Improved designs with Denco coils. All kits complete with all components, accessories and full instructions. Before ordering call and inspect a demonstration receiver, or send stamped addressed envelope for descriptive catalogue.
 'H.A.C.' Short-Wave Products (Dept. 22), 11 Dld Bond Street, London, W.1.

Is This Saw in Your Kit?

You can cut almost anything in wood with this Coping Saw. The blade is 6½ins. long and can be turned to cut at any angle. No tool-kit complete without one. Get yours NOW.

5/3
 Post 9d.

Buy from any Hobbies Branch or by post from Hobbies Ltd., Dept. 99, Dereham, Norfolk

To the Publisher, *Hobbies Weekly*, Dereham, Norfolk

Please send me a copy of *Hobbies Weekly* every Wednesday for.....months, commencing date.....for which I enclose cost of.....

Name.....

Address.....

.....

(block letters please)

BUYING OR SELLING?

Classified advertisements on this page are accepted at a cost of 6d. per word prepaid. Use of a Box No. is 1/- extra. Send P.O. with advertisement to *Hobbies Weekly*, Advert. Dept., Dereham, Norfolk. Rates for display advertising on application.

100 DIFFERENT stamps free! Request 4d. upwards discount approvals. — Bush, 53 Newlyn Way, Parkstone, Dorset.

WHEELS (Hardwood and Rubber Tyred Metal). Cot, Pram, and Doll's House Fittings and Papers, Beads, Transfers, Prints and other accessories. Stamp for new lists. (Trade supplied.) New address — **JOYDEN CO.**, 91 Peplins Way, Brookmans Park, Herts.

LEARN RADIO & ELECTRONICS the **NEW Practical Way!** Very latest system of experimenting with and building radio apparatus — 'as you learn'. **FREE Brochure** from: Dept. H.W.10, Radiostructor, 40 Russell Street, Reading, Berks.

KUKLOS ANNUAL. Indispensable cyclists' handbook. Tours, resthouses, money-saving hints. 3/- post free. — Burrow, Publishers, 2 Imperial House, Cheltenham.

PROFITABLE PLEASURE from Popular Art. Easier to Learn and Earn than you think. Send for free copy 'SOMETHING NEW' Popular Art Services (HW), Clun, Salop.

PROFIT AND PLEASURE are obtainable from **WRITING** (typewriter unnecessary) or **ARTISTRY**. Send for free fascinating bumper package 'PROFITABLE LEISURE'. — Writers' & Artists' Ring (HW), 5 Edmund Street, Birmingham.

LEARN

RADIO & T/V SERVICING for your OWN BUSINESS/HOBBY

● by a new exciting no-maths system, using practical equipment recently introduced to this country. **FREE Brochure** from:—

RADIOSTRUCTOR

DEPT. G81, READING, BERKS. 28/12/60

WORKERS with sewing machines required for making cushion covers. Regular work guaranteed. Apply enclosing s.a.e., Dept. 28, Arnold Trading, 10 Shelley Road, Worthing, Sussex.

50 MIXED stamps 5/- Try our 6d. in 3/- discount approvals — E. C. F. Townsend, 92 Tenby Road, Edgware, Middx.

BIRMINGHAM

DO YOU KNOW?

**HOBBIES LTD. have a branch at
100A DALE END**

where the manager and staff are always willing to give you the benefit of their experience with any of your handicraft problems. **Why not pay a visit?**



Have you had your
free copy of

'PROFITABLE LEISURE'?

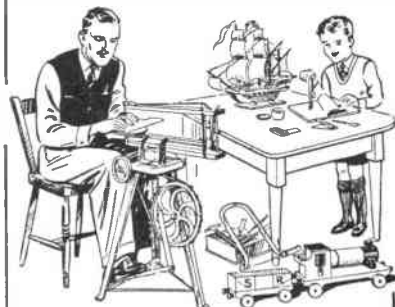

Contains details of some of the vast range of **HOBBIES** tools, machines, marquetry, designs and contemporary furniture projects.

Write for your free copy to:

**HOBBIES LTD
DEREHAM, NORFOLK**

Make sure of your copy

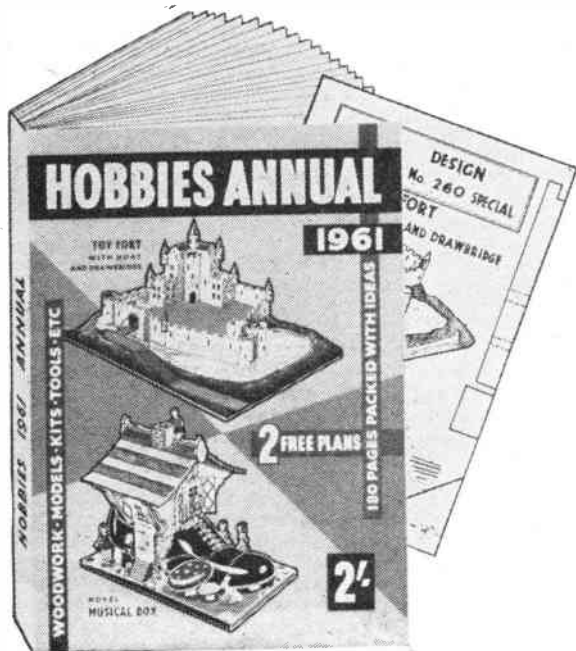

HOBBIES 1961 ANNUAL

Enlarged to 180 pages—and still only 2/-

Two free plans with each copy, for making

TOY FORT (with moat and drawbridge)

MUSICAL BOX (The Old Woman who lived in a Shoe)

Hundreds of exciting projects for all ages

From Hobbies branches, stockists, newsagents, bookstalls, etc, or send **NOW** for your copy by post (6d. extra)

To Hobbies Ltd., Dept. 99, Dereham, Norfolk

Please send.....copy/copies Hobbies 1961 Annual containing two free plans

Name.....

Address.....

.....

.....

P.O. for..... enclosed

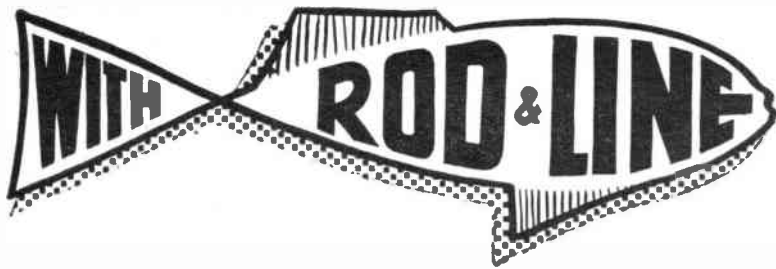

IN my search for new waters and new ideas I get about the country a good deal and have in fact quite recently visited angling spots in eight counties ranging from Yorkshire in the North to Devon in the South. Now on these trips I look for the out-of-the-way places and try to meet the local angler in his village inn. It is amazing what you can learn in these quaint old places.

A NEW IDEA IN PLUG BAITS By 'Kingfisher'

At one place I called in at the local inn after the day's fishing, and was most fortunate to meet one of the local anglers. Now you have to remember that these country chaps have a different approach to fishing from that of the townsman. The latter can usually only get away at the week-end and likes to get as many fish as possible during the time at his disposal.

On the spot

The countryman, living near the water he fishes, can have an hour or two almost any evening in the summer months and he has the advantage that if it's a bad morning at the week-end he may manage an hour or two if the weather clears later in the day, whereas the townsman who gets up and sees it pouring with rain may decide it is not worth making the journey.

The countryman, then, has a decided advantage and therefore he is not in too great a hurry to get a few fish, but is rather prepared to spend quite a long time in experiments which will finally bring him the *good* fish. The chap I met was such a one and he came into the inn with a live pike which he had the landlord weigh for him and then took it back across the road and returned it to the water. The majority of anglers would have killed the fish and taken it home to show their friends. Pike of around 20 lb.

are not an everyday capture.

Getting into conversation with this angler on our pet subject, of course we soon got to discussing the various baits and lures for pike fishing, and this chap had changed his tactics over the past few years from live-bait to spinning, and then to using plugs.

He told me that he had made a plug which had proved very successful and on which the pike I had just seen had been caught. On asking if I could see it he most readily agreed and told me how to make one for myself. It was so easy that I felt here was something which I could describe to you.

It was a two-piece plug jointed in the centre in the same manner as the ones you buy in the shops. It had the usual diving vane on the front and a treble hook at the tail. That is its only resemblance to the usual plug seen in the tackle shops.

The front section was the one in which he had incorporated his ideas. First he had taken a piece of wood of the required diameter and length, but before shaping the front he had bored a large hole about three parts of the way through which I show from the front in Fig. 1. Then he had shaped the back down a little, followed by drilling three small holes at an angle, and each of these led into the main centre hole (Fig. 2).

Now if you filled the hole with water it would run out through the three smaller holes. The head or front was then cut away as at Fig. 3 and the vane was

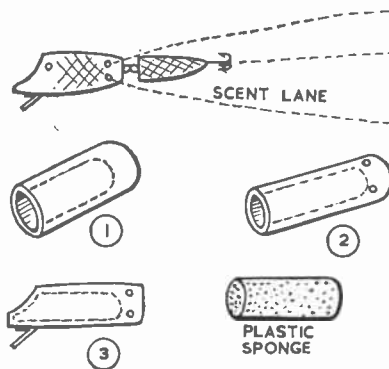

fixed into position with waterproof cement.

The result was a plug exactly like you buy in the shops so far as shape is concerned, but with the large hole and three smaller holes in the front piece. Opening his tackle box he next brought out three pieces of plastic sponge material cut roughly into a shape which would fit tightly into the large hole. This is the natty idea.

He then appeared to go off at a tangent and began to talk about the sight of fish, and mentioned that shark can detect blood in the water from a far greater distance than they can possibly see. In his opinion freshwater fish could do likewise. He asked what chance I thought a pike would have in muddy water of seeing a spinner fished deep or, what would be more difficult, a plug diving up and down, particularly as the lure is moving away from the fish very shortly after it has first seen it. I had to agree that the chances were slim, to say the least.

Following the scent

He went on to say that the fish would detect a taste or smell of something in the water and that was the purpose of the sponge. He could soak that with a flavour and as the lure was being recovered the water pressure at the front would slowly force out the substance used for flavouring. This would excite the interest of the fish and it would follow up the scent although unable to see at this stage whence it came.

It may be that the lure would be recovered before the pike got within sight of it, but it would be in the 'lane' which was scented and would remain in it so that a second cast in the same area would give the pike a sight of the lure and an additional supply of the scent.

The results I had just seen weighed bore out this angler's theories alright. The flavour he used was made from cream cheese, and although I have described the making of cheese paste to you for other species of fish it had never entered my mind that it might also be attractive to pike.

He makes the flavour in the following manner: taking a section of cream cheese, he heats it in a saucepan with a drop of milk. When this becomes a creamy fluid he soaks the bit of sponge, which is then pressed into the hole in the front of the plug. The water gradually forces the flavouring out as described.

You hobbyists will have no difficulty in making up one of these plugs and you could also try flavouring with the oils which are sold for the purpose in most tackle shops. I'm making one up for myself and will certainly give it a thorough work-out to see if it gives me the same results.

CUT two of A and one of B from $\frac{1}{2}$ in. wood using your fretsaw. Cut two of C from $\frac{1}{2}$ in. wood. Sandwich a piece of inner-tube between pieces A and screw them together.

A HOLDER FOR TEA CLOTHS

Glue the spacers between pieces A and B. Fix to the wall by means of screws through B. Cut cross-slits in the tube as indicated. (M.p.).

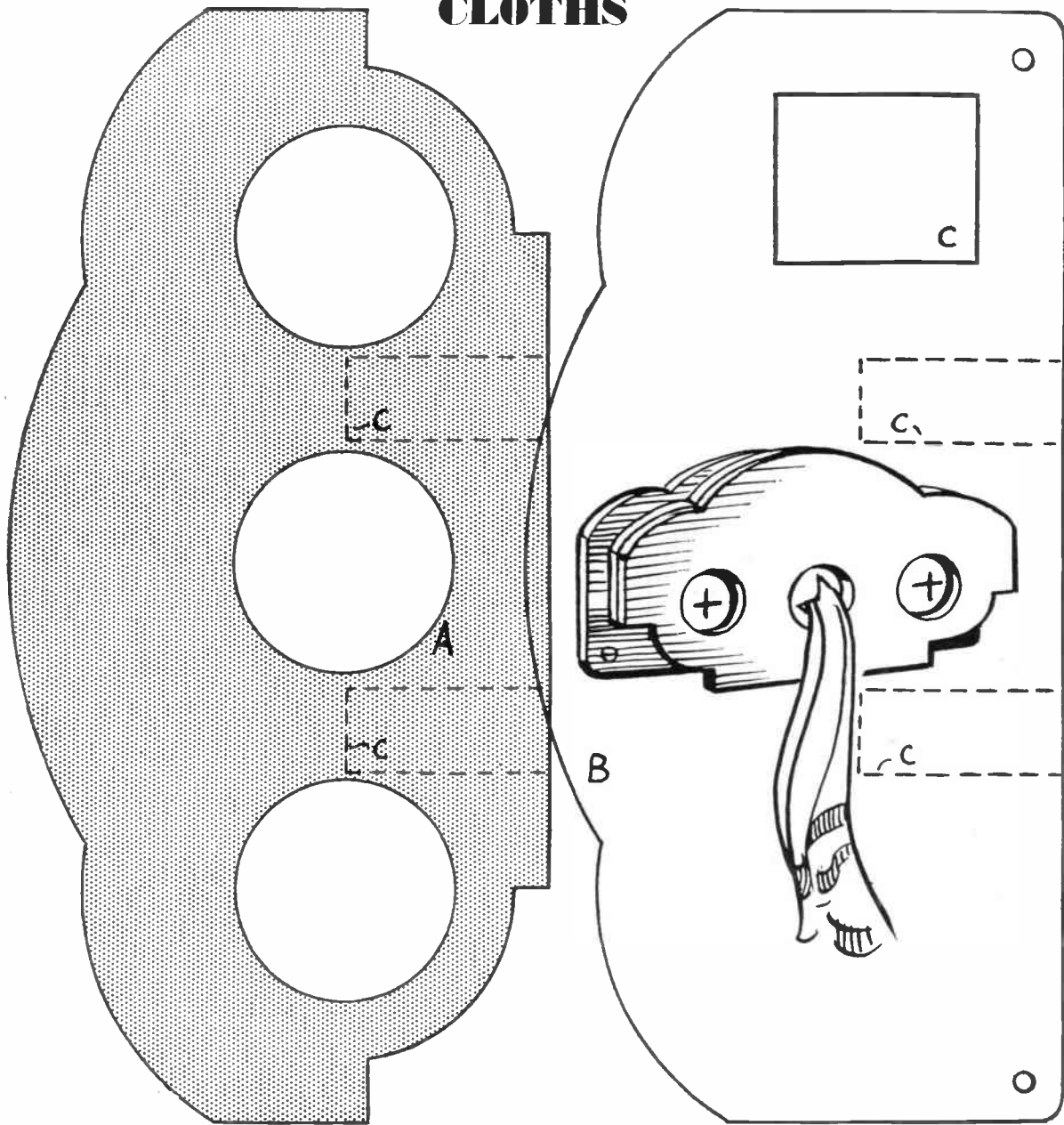



'FLYING CAT' CATAMARAN (Designed by F. M. & J. A. Montgomery)

For high quality and outstanding performance the 'Flying Cat' is one of the best 'buys' in its class.

Its twin hulls are 16 ft. long and it has a beam of 7 ft. 6 in. The draught is 6 in. with plates up and 2 ft. with them down. Carries about 200 sq. ft. of sail on metal mast.

Incorporating many advanced ideas, its most striking feature is the way the hulls are splayed outwards to give an efficient underwater hull shape with one float lifted.

Available complete, or in various kit forms.



HOBBIES RUNABOUT 'ZIP'

Designed especially for the beginner, as an inexpensive introduction to the water. Skinned with oil-tempered hardboard and suitable for a small h.p. outboard engine. Will carry an adult and one or two children. Length 7 ft. 8½ in., beam 2 ft. 10½ in. Weight (without motor) 80 lb.

Available as a kit, or full size plans.

Before you decide . . .

. . . you must consider these

EXCITING NEW CRAFT

by



HOBBIES RUNABOUT 'ROAMER'

An ideal craft for the family, designed for all waters. Best marine plywood and quality materials. Length 9 ft. 8 in., beam 4 ft. 2 in. Weight (without motor) 130 lb. Car rack transportation.

Available complete, or as a kit.



PBK 10 AND PBK 20 CANOES

These famous single-seater and two-seater craft are supplied complete, in kit form, or as full-size plans to build your own.

PBK 10 (single-seater) 11 ft. long, 28 in. beam, load 300 lb.

PBK 20 (two-seater) 15 ft. long, 32 in. beam, load 700 lb.

Ideal for young enthusiasts.

Full details of these craft at the National Boat Show, Earls Court (Stand UK15, 1st floor), from Hobbies branches, or from Head Office

HOBBIES LTD, Dereham, Norfolk



PIECES 3. CUT TWO 1/4 in.

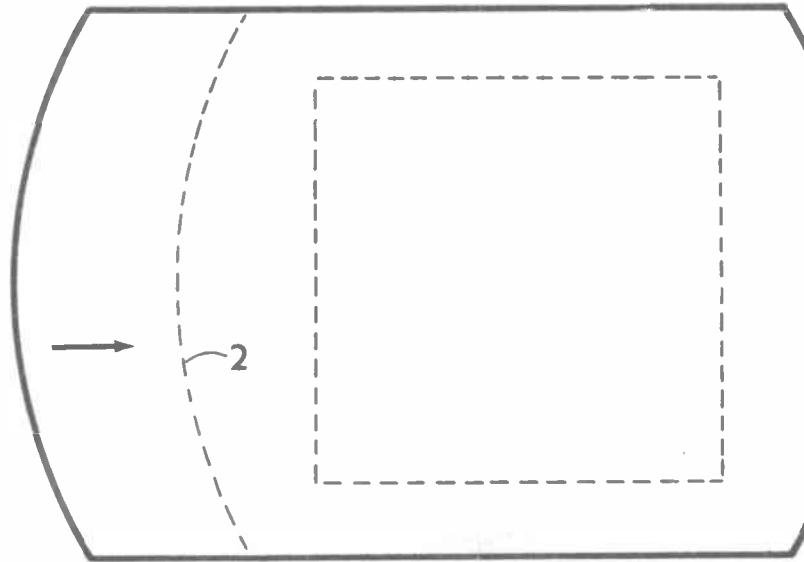

PIECE 1. CUT ONE 1/4 in.



PIECE 2. CUT ONE 1/4 in.

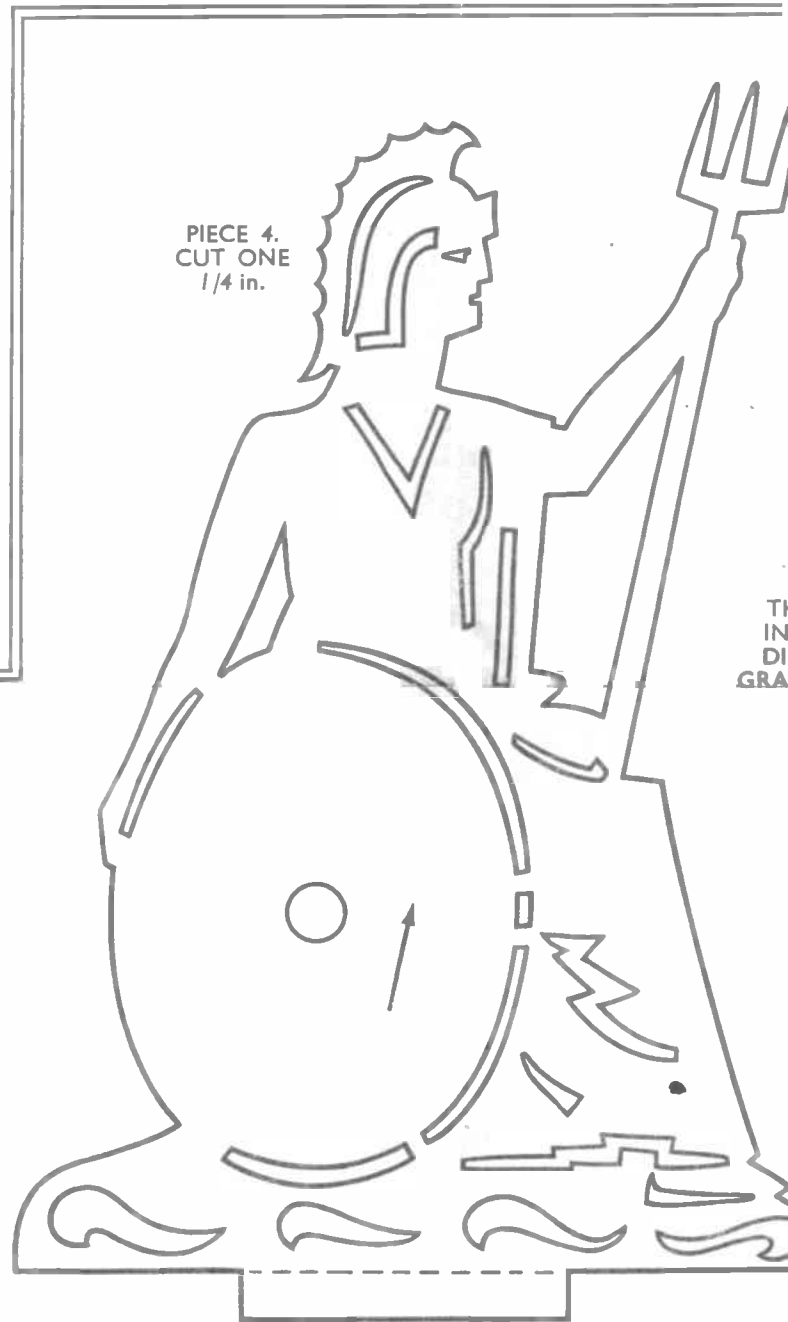

PIECE 5. CUT ONE 1/4 in.

* EGG
TIMER

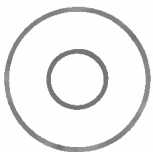

PIECES 6. CUT ONE OF EACH 1/4 in.

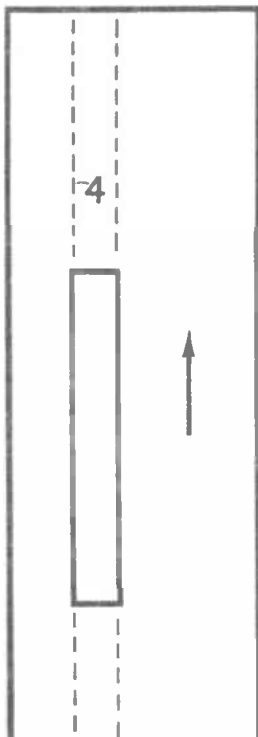

THE "JUNIOR" THREE

* PEN AND INK STAND

* EGG TIMER

* TIE RACK

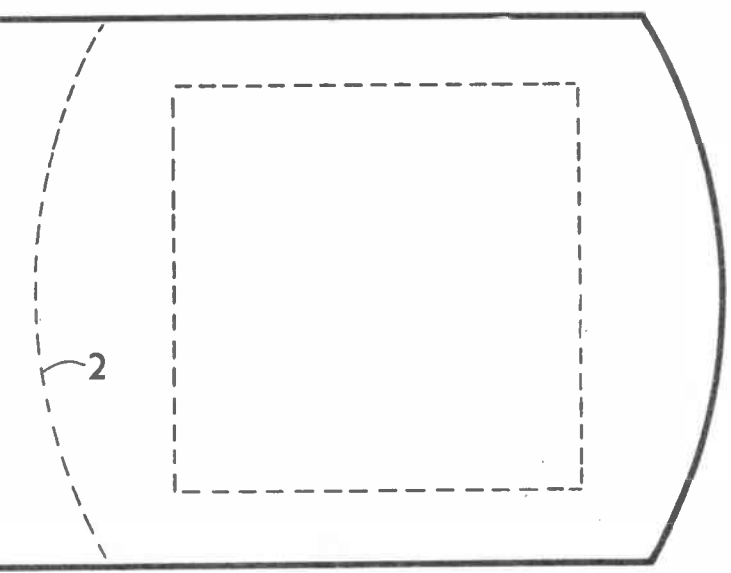

PIECE 1. CUT ONE 1/4 in.

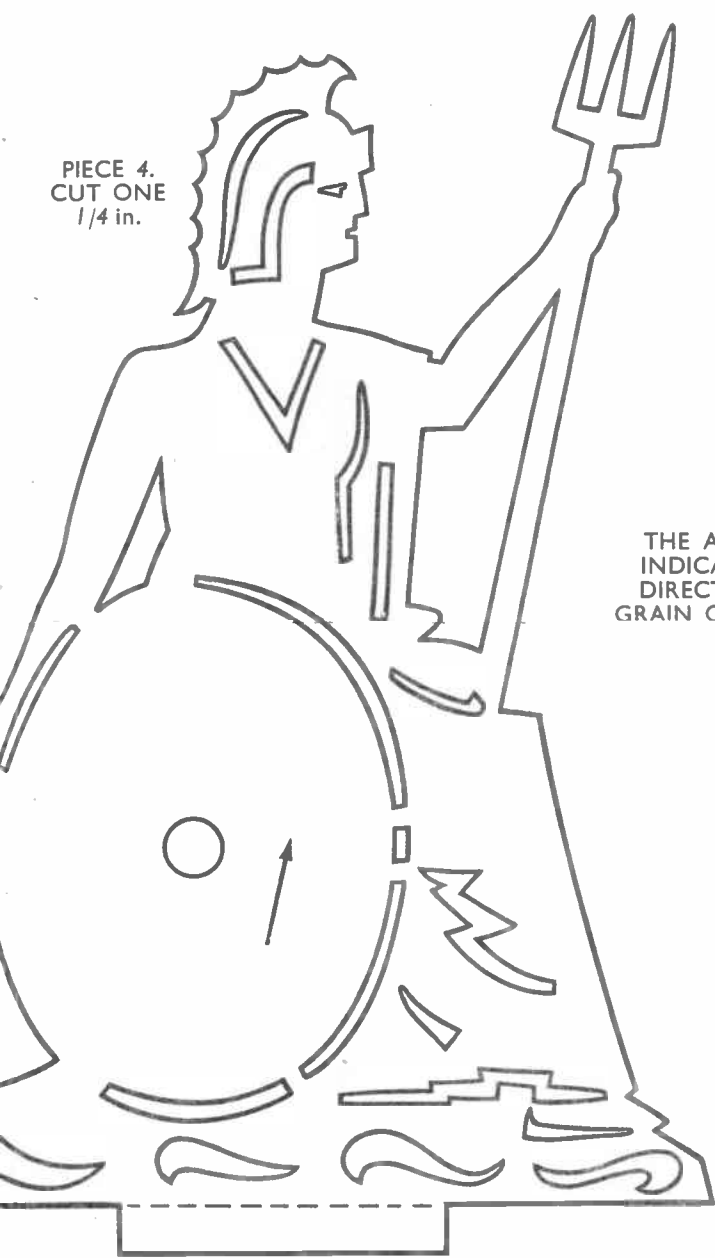
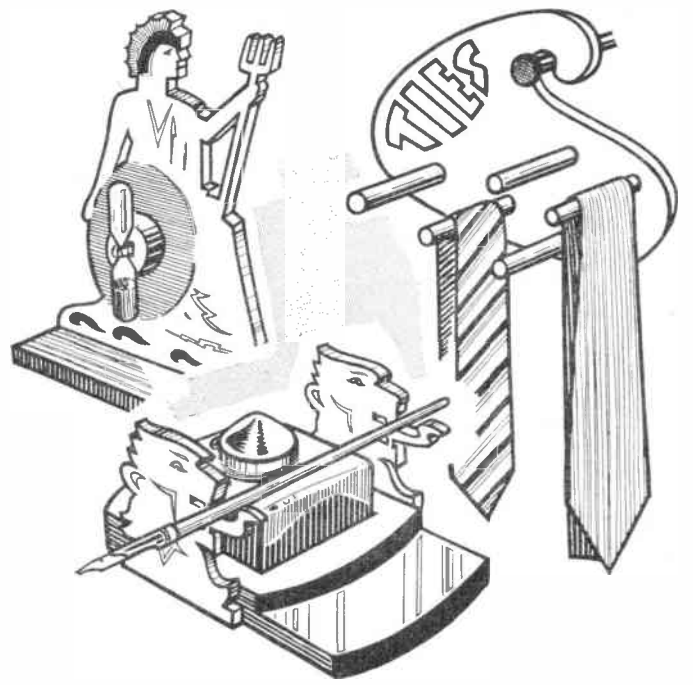

PIECE 4. CUT ONE 1/4 in.

THE ARROWS INDICATE THE DIRECTION OF GRAIN OF WOOD.

THE WORLD'S STRONGEST GLUES

Stick it with-

Croid

UNIVERSAL

A cold glue of great strength—for wood, leather, cardboard, plastic, etc. Made to B.S. specifications. Large tube 1 1/2d, 8 oz. tin 2/10d, 1 lb. tin 4/6d.

BUY CROID FROM YOUR LOCAL HOBBIES BRANCH

PANELS OF WOOD REQUIRED FOR THIS DESIGN

One H4 One G4

A KIT OF MATERIALS FOR MAKING THIS DESIGN IS SUPPLIED BY HOBBIES LIMITED DEREHAM, NORFOLK. PRICE ON APPLICATION.

* TIE RACK

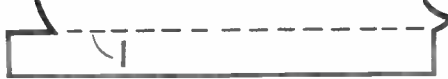

PIECES 3. CUT TWO 1/4 in.



PIECE 1. CUT ONE 1/4 in.



PIECE 2. CUT ONE 1/4 in.

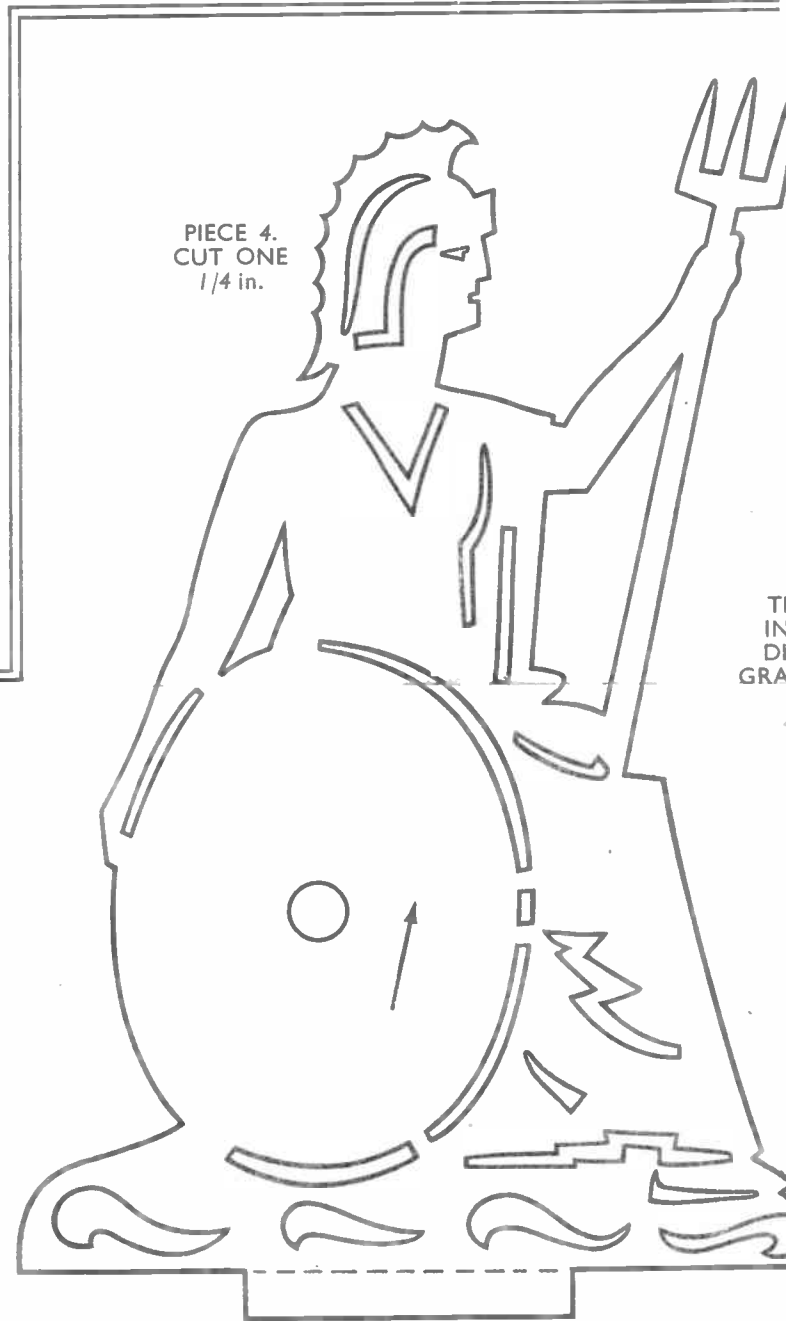

PIECE 4. CUT ONE 1/4 in.

PIECE 5. CUT ONE 1/4 in.

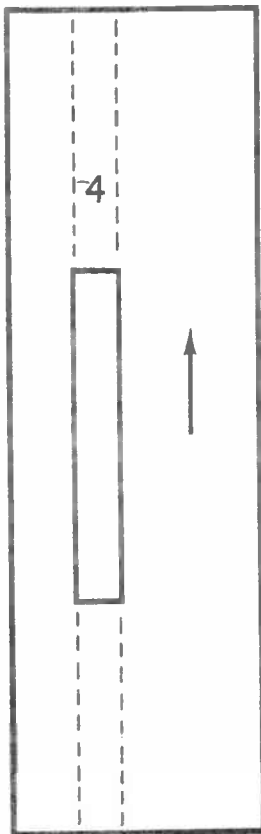

* EGG TIMER

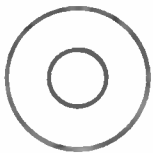

PIECES 6. CUT ONE OF EACH 1/4 in.

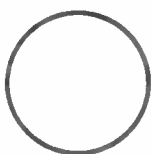
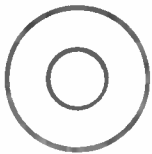

PIECE 7. CUT ONE 1/4 in.

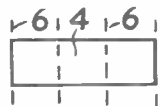

PIECE 8. CUT ONE FROM 1/4 in. DIA. ROUND ROD.



PIECES 10. CUT ONE OF EACH FROM 1/4 in. DIA. ROUND ROD.

PIECE 1. CUT ONE 1/4 in.

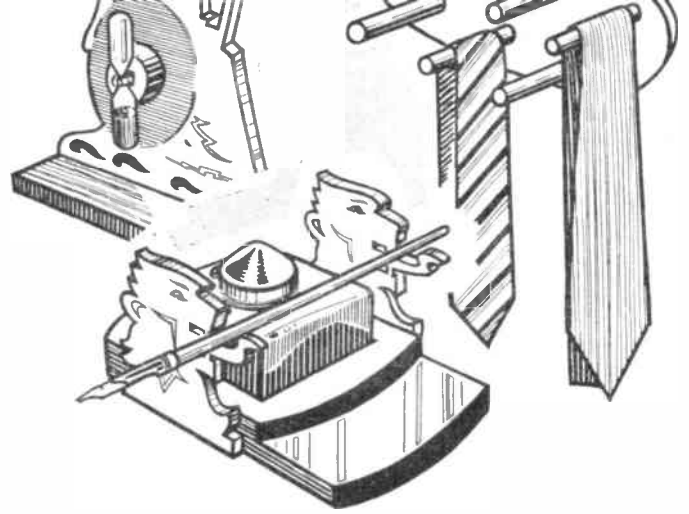

PIECE 4.
CUT ONE
1/4 in.



THE ARROWS
INDICATE THE
DIRECTION OF
GRAIN OF WOOD.

THE WORLD'S STRONGEST GLUES

Stick it with-

Croid

UNIVERSAL

A cold glue of great strength—for wood, leather, cardboard, plastic, etc. Made to B.S. specifications. Large tube 1/2d, 8 oz. tin 2/10d, 1 lb. tin 4/6d.

BUY CROID FROM YOUR LOCAL HOBBIES BRANCH

PANELS OF WOOD REQUIRED
FOR THIS DESIGN

One H4 One G4

A KIT OF MATERIALS FOR MAKING THIS
DESIGN IS SUPPLIED BY HOBBIES LIMITED
DEREHAM, NORFOLK.
PRICE ON APPLICATION.

* TIE RACK

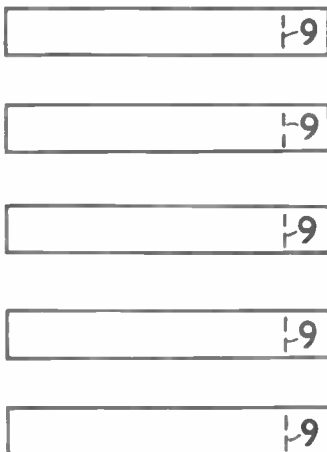

PIECES 10. CUT ONE OF EACH
FROM 1/4 in. DIA. ROUND ROD.

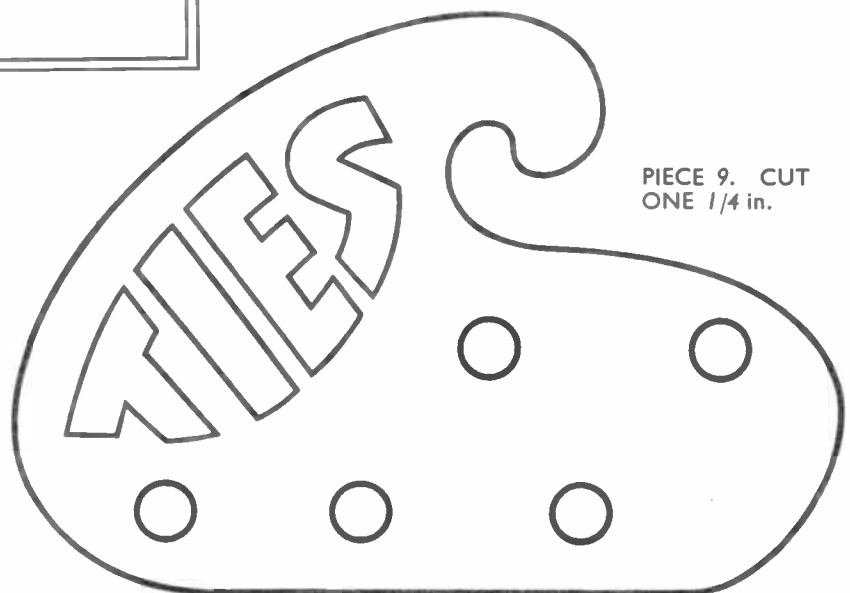

PIECE 9. CUT
ONE 1/4 in.

PRINTED IN ENGLAND.