

30th NOVEMBER 1960

VOL. 131

NUMBER 3390

THE ORIGINAL
'DO-IT-YOURSELF'
MAGAZINE

HOBBIES *weekly*

FOR ALL
HOME CRAFTSMEN

FREE plan to make

Also in this issue:

NOVEL CHRISTMAS
DECORATIONS

COLLECTORS' CLUB

CHEMISTRY AND
GARDENING

PHOTOGRAPHIC
GREETINGS CARDS

PROJECTS FOR THE
FESTIVE SEASON

PATTERNS FOR A
TUMBLER STAND

ETC. ETC.

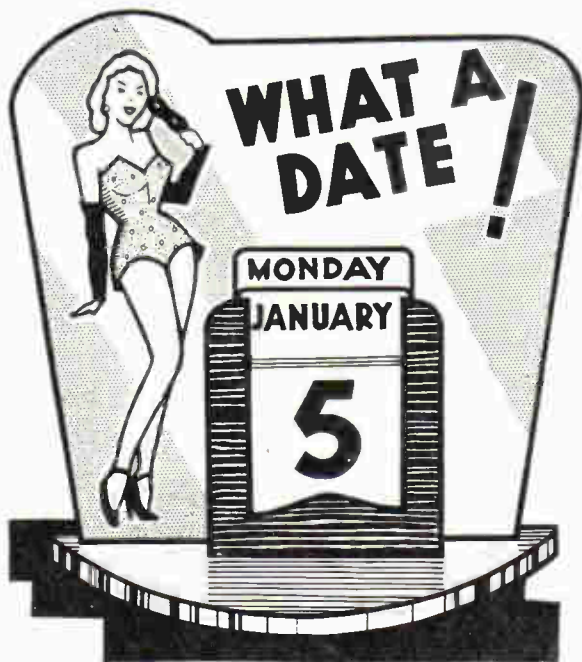

PIN-UP CALENDAR



Up-to-the-minute ideas

Practical designs

Pleasing and profitable things to make

World Radio History

5^p



THE postmarks of Great Britain and Ireland are the ones usually chosen by collectors. But the collector of British stamps who goes in for postmarks will find that he must limit his activities to some special kind or type.

The Maltese Cross is probably the most popular postmark. It was used from 1840 to 1844. Many of these stamps are still cheap.

POSTMARKS

Then came the famous 1844 cancellation. There are 4,112 major kinds of this cancel, and each of these has from 1 to 36 sub-types.

Numbers from 1 to 999, from 001 to 099 and from A01 to L04 (skipping the letter I), a total of over 2,100, were assigned to post offices in England and Wales. They appeared within an oval of bars.

Numbers 1 to 755 were used in Scotland within a square of horizontal bars. Numbers 1 to 564 were given to Ireland, and were used within a diamond of bars. There were hundreds of London district types.

On 31st January 1863 the Post Office introduced a new kind of numbered obliteration. It was only used in Edinburgh, and its like has not been seen before or since. This cancellation is known as the 'Brunswick Star'. Its general style is believed to be derived from the star incorporated in the St. Andrew's Cross.

Then came 'Arnot's Group' which had forty-eight fine rays in the design. The first change in it came in 1866, when small stars were added to the sides. There were many variations in this group.

The commoner types of the above postmarks can be bought for 3d. each. But the rarer ones are valuable. For example, a collection of 'Edinburgh Stars' recently fetched £2,500.

The affixing of postmarks and cancellations to mail going through the Post Office was expensive. So in 1869 Mr J. G. Azemar invented what he thought was a better machine for cancelling stamped letters. A typical Azemar postmark consists of an obliteration of horizontal bars broken by a diamond containing 'A1'. This was used from February 1869 to late in 1872.

It took seven persons to work this machine. But it could stamp over

49,000 letters an hour. This was as much work as ten men could do under the old stamping system.

All this worked out fine, except that the machine missed cancelling about 10 per cent of the letters fed into it. This meant that the time spent in checking these, and then hand-stamping them, made the whole operation uneconomical. So the government rejected the idea.

For 5/- you can buy a packet of 200 old English stamps and from them you can usually count on 150 different postmarks. Properly mounted and described this will give you a good start to a collection.

Hiking to Australia

WE have been pleased to receive the following letter from Enid Ramsay, of 1 Whitefield Gardens, Greenside, Ryton, Co. Durham.

'In two years I have received letters from five countries, where in some cases I receive a letter regularly every Friday. I visited my friend in France last year when I went hiking and spent an enjoyable six weeks travelling through France as well as a week with my friend. In my Christmas holidays I shall be visiting another friend in Holland, staying in her town for three weeks.



'I have had excellent letters from these friends and visits from two. When my studies are finished I hope to work one year in Portugal before hiking to Australia, visiting other friends on the way.

'As you can see, hiking is a main hobby with me, but my correspondence also plays a large part.

'Again I will thank *Hobbies Weekly* for the addresses of the friends and the endless pleasure I have received by writing and exchanging news, stamps, labels, badges, etc. to all countries.'

★
 ★ Such is the volume of correspond- ★
 ★ ence for this feature that we regret ★
 ★ we cannot give personal replies ★
 ★ unless queries and requests are ★
 ★ addressed to the Editor, 'Hobbies ★
 ★ Weekly', Dereham, Norfolk, and ★
 ★ accompanied by reader's reply ★
 ★ coupon and stamp for return. ★
 ★

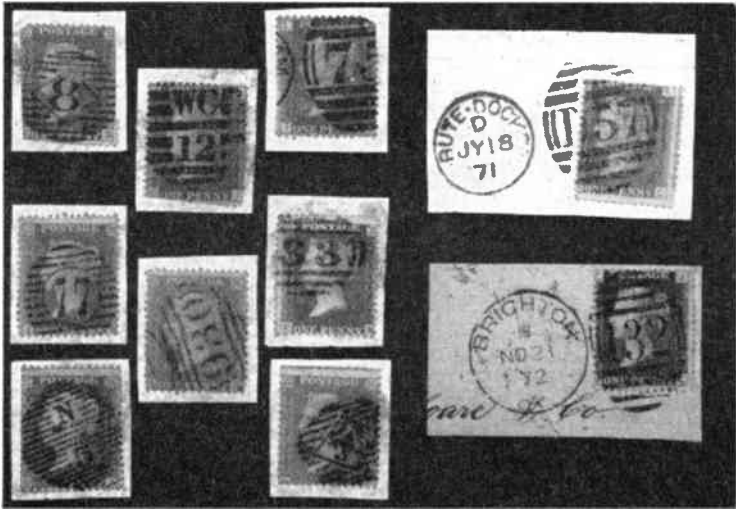

TRY something different this year for the decorations at Christmas. With a little ingenuity you can achieve first-class results without having to resort to paper chains hanging all over the place. Materials need not be expensive; offcuts of hardboard or odd pieces of plywood may be used.

For displaying some of the best of your Christmas cards a board may be cut from $\frac{1}{2}$ in. hardboard as shown in Fig. 1. Father Christmas carrying his sack makes an ideal subject and can be quickly cut out with a fretsaw.

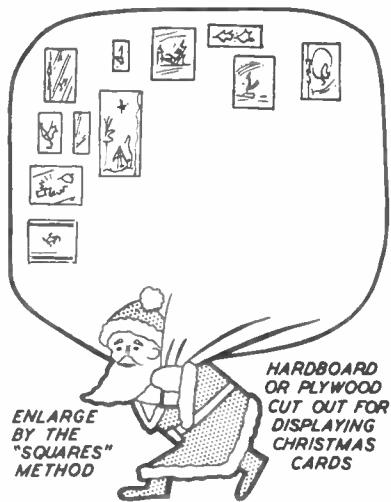

Fig. 1

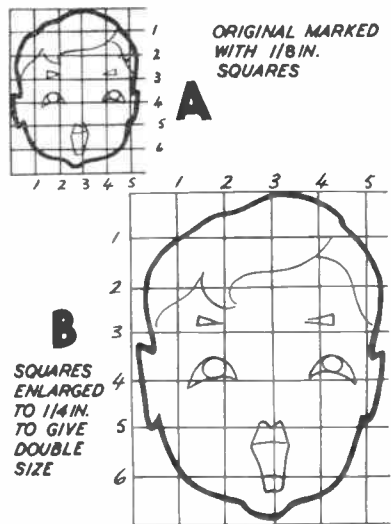
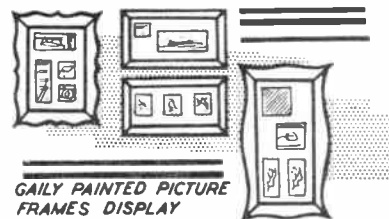

Fig. 2



If you use the 'squares' method it is a simple matter to draw out the shapes. You need not be an artist to achieve a reasonable outline. The original should



GAILY PAINTED PICTURE FRAMES DISPLAY CHRISTMAS CARDS

Fig. 3

be squared up as shown in Fig. 2. In this case one of the faces from Fig. 4 is being enlarged. Draw $\frac{1}{8}$ in. squares in the first instance as at A in Fig. 2. Enlarge the squares to $\frac{1}{4}$ in. to give drawing double size as at B, or $\frac{1}{2}$ in. to give four times the size and so on. In the case of

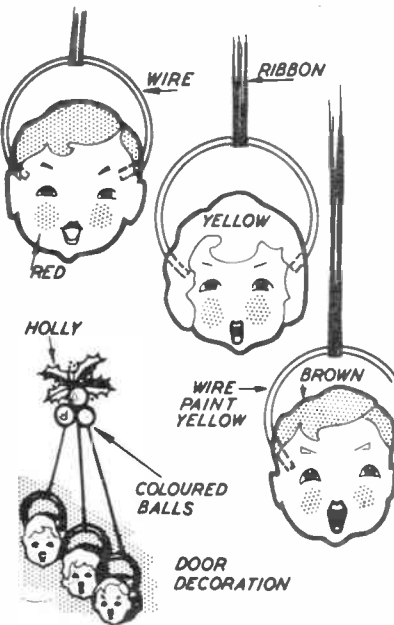

Fig. 4



Fig. 5

the Father Christmas it should be enlarged about 18 times to give an overall size of 3 ft. wide. Therefore $\frac{1}{8}$ in. squares on Father Christmas should be enlarged to $2\frac{1}{4}$ in. squares to give the required size. As seen in the sketches in Fig. 2 a little deviation makes little difference to the finished drawing.

Old picture frames may be painted in bright colours and used for displaying cards. Arrange them in groups on the wall as seen in Fig. 3. Bundles of picture

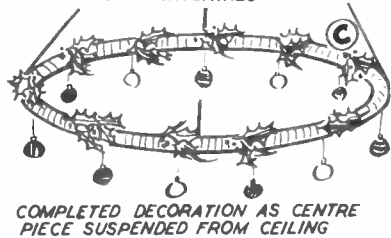
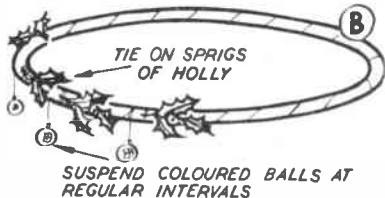
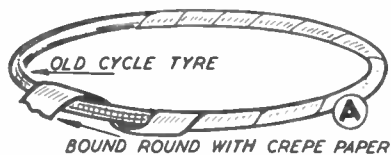

Fig. 6

frames can often be bought at auctions for a few pence, but most homes can produce a few unwanted ones lying about in the attic.

The group shown in Fig. 4 is intended to decorate the front door, or could be made to hang over a large mirror in the hall. Enlarge the faces about eight times to 6 in. wide and cut them from $\frac{1}{2}$ in. plywood. Use a fretsaw for cutting out.

Paint the faces in natural colours and insert the wire 'haloes' as indicated by the dotted lines. No. 10 gauge wire will be suitable for this purpose. Suspend the faces with ribbon and finish off with a bunch of holly and some coloured balls as illustrated.

Faces with yellow or gold painted haloes could be used on the lawn, or in window boxes. Size would of course depend upon the position. Leave a spike at the bottom for pushing into the earth as indicated in Fig. 5.

The illustration in Fig. 6 shows how to use an old bicycle tyre as a centre piece for the dining room or lounge. The finished creation is suspended from the central light.

Short lengths of chain can be made up as indicated in Fig. 7. If you wish to colour up with poster paints, use wall-paper, otherwise coloured crepe paper may be used. (M.h.)

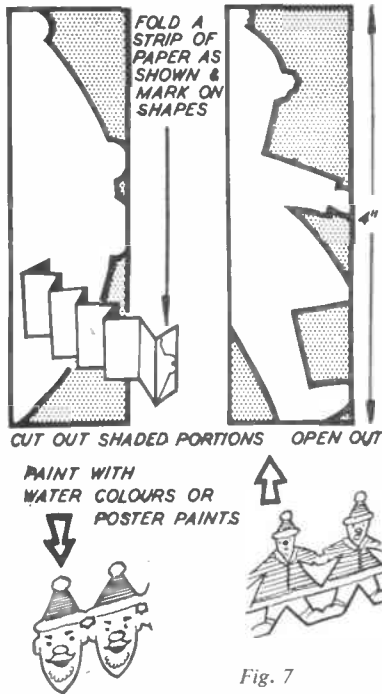

Fig. 7

Interesting Locos—No 28

A NOTEWORTHY 4-4-0 TYPE

AMONG the more noteworthy of the British 4-4-0 type express engines were, perhaps, the fine

6 ft. 8 in. Class 'D' engines designed by Hy. S. Wainwright for the South Eastern & Chatham Railway in 1901. A

total of fifty-one of these handsome machines were built, twenty-one at the Company's Works at Ashford, and thirty by outside makers.

They were employed on the principal express duties of the line for many years, including the heaviest and fastest Continental trains between London, Dover, and Folkestone. They were efficient and economical, and in addition their fine proportions, beautifully finished paintwork, and highly polished brasswork including dome, safety valves, and beading, made them very popular with Continental passengers. In this connection it is interesting to note that one of the French railways went so far as to build some express passenger engines in which many of these features were copied.

Mr Wainwright's engines had the following leading features: driving wheels diameter 6 ft. 8 in., bogie 3 ft. 7 in., cylinders, 19 in. diameter by 26 in. stroke, boiler pressure 175 lb. per sq. in., grate area 20.3 sq. ft., weight of engine in running order 50 tons., with tender attached 89 tons. Stephenson valve-gear was employed. (A.J.R.)

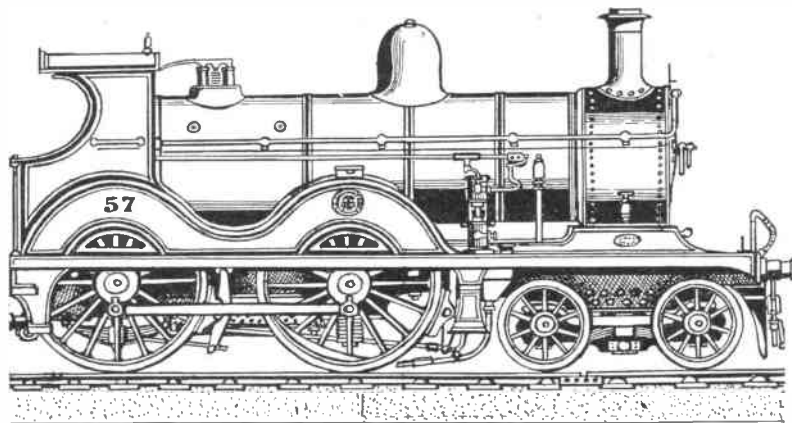

South-Eastern and Chatham Railway.

Express bogie passenger locomotive of 1901.

A PIN-UP CALENDAR

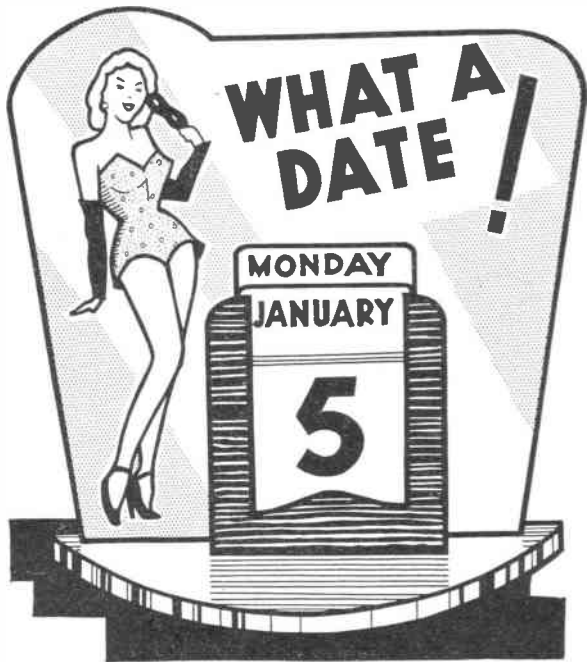

A PERPETUAL Calendar is always a welcome gift for friends and relatives particularly at Christmas time, and is much more appreciated if it is the individual work of the sender.

The motif for our design is a glamorous pin-up girl, and the white plastic calendar pads can be changed each day, so that it can be used from year to year. These sets of pads can be obtained separately from Hobbies Ltd, price 1/9 (by post 3d. extra).

The figure is intended to be cut out, suitably decorated with paints as suggested on the design sheet, and used as an overlay. Similarly the message, 'What a Date!' is cut out and glued on. As an alternative for those not too happy with their fretcutting, transfers can take the place of the pin-up figure. Decorette Sheet No. 165 gives a selection of eight coloured transfers of girls in various poses, and all suitable for using on this type of calendar. This method might be used for quickness if it is intended to make several. The sheet of eight transfers costs 2/3 plus 3d. postage from Hobbies Ltd.

All the parts are shown full size on the design sheet. They should be traced and

transferred to their appropriate thicknesses of wood by means of carbon paper, and cut out with the fretsaw. Be particularly careful when cutting out the outlines for the letters, as neatness is important for the finished article. Here again, where several calendars are to be made the overlays can be cut out in multiples by pinning three or so pieces of $\frac{1}{8}$ in. wood together.

The make-up of the calendar is very

Pottery for Pleasure and Profit

THIS simple and lucid guide to pottery-making contains all the essential basic information required by the amateur potter. Practical advice is given on the choice of equipment, on clays and glazes, and on the various operations and techniques involved.

Recognizing that many amateurs will want to sell their wares, and that some may even consider setting out to make a living from their craft, the author — David Eames — has provided a useful final chapter on the business.

Published by Museum Press Ltd, 26 Old Brompton Road, London, S.W.7 — Price 15/-.

simple, piece 1 being tenoned into the base (piece 5), as shown at A on the design sheet. Before doing this, however, decide on the finish for the calendar. If it is to be by painting, colour the background piece 1, and then the individual overlays to be added. Make sure to scrape away a portion of the background paint where the overlays are to be added, so as to give a good key for adhesion of the glue. This will prevent annoyance with individual letters, etc, dropping off the background at a later date.

Hobbies Kit No 3390 for making the Pin-up Perpetual Calendar includes panels of wood and set of calendar pads. Kits price 4/11 from branches etc or direct from Hobbies Ltd, Dereham, Norfolk (post 1/- extra)

The figure of the girl and lettering should be glued to the background under weights, and when dry piece 1 can be glued into the base.

The calendar holder consists of pieces 2 and 3 glued together, as shown in Fig. B, and thus forming a groove. This section is in turn glued to piece 1 in the position shown by dotted lines on the design sheet. Here again it is advisable to paint the holder before gluing it in place. The arrangement of the calendar pads in the holder is shown in Fig. C.

The Amateur's Lathe

HERE is a book that every amateur lathe worker, every small garage proprietor, and every light engineer will find of unending interest. The author has succeeded in giving a complete course of instruction embracing almost every process that can be accomplished on the highly adaptable small lathe.

He also deals with milling, shaping, and grinding on the lathe in emphasizing the usefulness and versatility of this machine in the hands of a keen model mechanic.

Published by George Newnes Ltd., Tower House, Southampton Street, Strand, W.C.2—Price 20/-.

CHEMISTRY

AT HOME

A PART from its use in the home, washing soda, or sodium carbonate, $\text{Na}_2\text{CO}_3 \cdot 10\text{H}_2\text{O}$, is a basic chemical in industry and laboratory. It is needed for the manufacture of hair shampoos and scouring powders, in bleaching, dyeing, glass making, and water softening.

WASHING SODA EXPERIMENTS

Industrially, it is generally employed in the anhydrous form, Na_2CO_3 . There are two reasons for this. First, ordinary washing soda contains a lot of water as water of crystallisation. There is not much use in transporting water from soda maker to user. Second, washing soda loses some of this water of crystallisation on exposure to the air. Its actual Na_2CO_3 content is then uncertain. To know this is essential, and it cannot be ascertained without analysis.

You will, doubtless, have noticed that washing soda becomes covered with a white powder if exposed to the air. This is due to this same loss of water. Leave some crystals on a saucer in a warm room. Eventually the crystals fall entirely to powder, or *effloresce*. This is approximately the monohydrate, $\text{Na}_2\text{CO}_3 \cdot \text{H}_2\text{O}$. It is this which is used in some hair shampoos. You may like to make and try some.

Weigh out 6 grams of the effloresced sodium carbonate, 8 grams of Castile soap powder, and 3 grams of borax powder. Mix them thoroughly either by pouring them about on a sheet of paper, or, better, by grinding them in a mortar. This amount will serve for three shampoos for an average head of hair. Dissolve the powder in about half a pint of warm water, wet the hair with warm water, and then use the shampoo in the usual way.

By heating some of the effloresced sodium carbonate to redness in a crucible the last molecule of water of crystallisation will be driven off, and you will have a residue of anhydrous sodium carbonate, or 'soda ash'. It is useful to make and stock a small quantity for the times when you need to make up a solution of definite strength.

Hard water is caused by the presence

of dissolved salts of calcium, Ca, and magnesium, Mg. These react with soap to produce mixtures of insoluble calcium and magnesium soaps, which constitute the scum. This wasteful reaction with soap can be avoided by softening the water by the addition of sodium carbonate, so producing insoluble calcium carbonate (chalk), CaCO_3 , and basic magnesium carbonate (formula indefinite, since mixtures are formed). This occurs whether the hardness is temporary (removable by boiling), and due to calcium bicarbonate, $\text{Ca}(\text{HCO}_3)_2$, or to magnesium bicarbonate, $\text{Mg}(\text{HCO}_3)_2$, or permanent (not removable by boiling) and due to calcium sulphate, CaSO_4 , or to magnesium sulphate, MgSO_4 , or chloride, MgCl_2 . For instance:

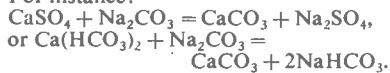

$\text{CaCO}_3 + 2\text{NaHCO}_3$.
Sodium sulphate, Na_2SO_4 , and sodium bicarbonate, NaHCO_3 , do not cause any scum with soap.

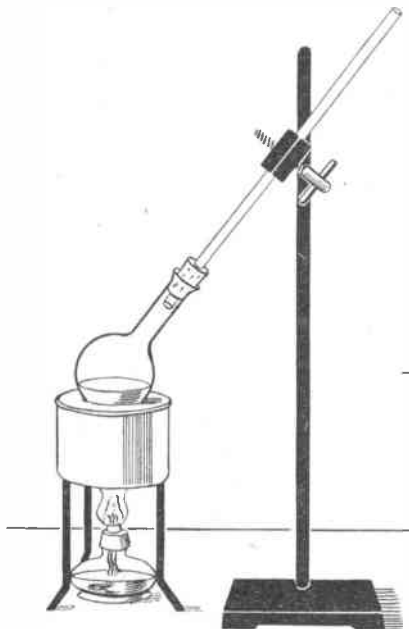

Fig. 1—Making heavy basic magnesium carbonate.

This production of insoluble carbonates is used in making many carbonates, both in the laboratory and industry. As most of these are insoluble, they may be prepared by precipitation. An everyday example is the basic magnesium carbonate which is so much used in indigestion mixtures. There are two forms of this, namely, light and heavy magnesium carbonate. Their compositions vary slightly, but consist principally of $3\text{MgCO}_3 \cdot \text{Mg}(\text{OH})_2 \cdot 3\text{H}_2\text{O}$ (light) and $3\text{MgCO}_3 \cdot \text{Mg}(\text{OH})_2 \cdot 4\text{H}_2\text{O}$ (heavy).

To make a specimen of the light, dissolve in 100 c.c. of cold water 12.5 grams of magnesium sulphate (Epsom salt), $\text{MgSO}_4 \cdot 7\text{H}_2\text{O}$, and 15 grams of sodium carbonate crystals. Mix the two solutions, bring to the boil, and continue boiling for fifteen minutes. Filter off the white precipitate.

Sodium sulphate and carbon dioxide,

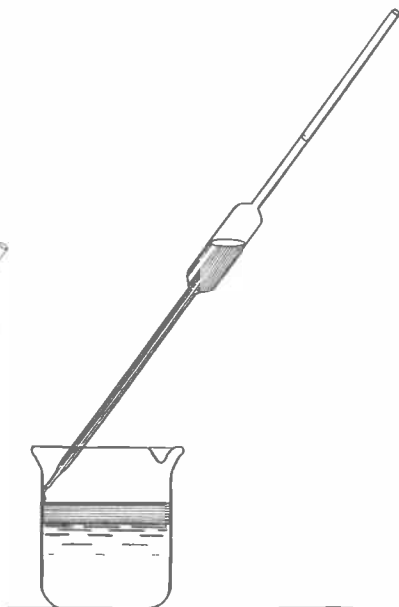
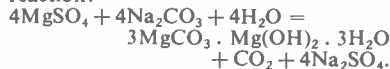

Fig. 2—Layering sodium sesquicarbonate solution with methylated spirit.

CO_2 , have also been produced in this reaction:



The carbon dioxide is driven off in the boiling, but the sodium sulphate must

now be washed out by means of hot water. How can one tell when all of the latter has been removed? Soluble sulphates react with strontium nitrate solution, $\text{Sr}(\text{NO}_3)_2$, to produce a white precipitate of strontium sulphate, SrSO_4 . For example:

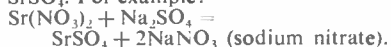

Hence, when one wash water no longer gives this precipitate, the light magnesium carbonate is pure enough to be allowed to dry for your stock. Note how easily it drifts about in the air, and how light the specimen feels.

The heavy variety is made by a variation of the method:

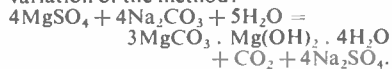

To bring about this reaction dissolve 12.5 grams of magnesium sulphate and 15 grams of sodium carbonate each in 25 c.c. of hot water. Mix the solutions in an evaporating basin, and evaporate to dryness on a water bath. Roughly powder the white residue, transfer it to a flask, together with 50 c.c. of water, fit a simple air condenser consisting of a

length of glass tubing (see Fig. 1), and heat on the water bath for half an hour.

Now filter off the heavy magnesium carbonate, and wash several times with hot water until one wash water is shown to be free of sodium sulphate by the strontium nitrate test. Then let it dry. You will note that this variety is much denser, and shows little tendency to float about in the air.

Sodium carbonate combines with its close relation sodium bicarbonate (baking soda), NaHCO_3 , to give sodium sesquicarbonate, $\text{Na}_2\text{CO}_3 \cdot \text{NaHCO}_3 \cdot 2\text{H}_2\text{O}$. Sodium sesquicarbonate is used to make bath salts, and has also been used in wool scouring. It exists native as 'natron', being deposited around certain lakes. The Alkali Desert of the United States is so named because of the prevalence of this substance in the surface.

It can be made either by evaporating mixed solutions of its two constituents at a temperature not lower than 35 degrees Centigrade, or by pouring methylated spirit on to the surface of the solution, when it separates out:

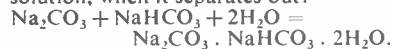

Dissolve 14.3 grams of sodium carbonate crystals in 50 c.c. of warm water. Adjust the temperature of the solution to 50 degrees Centigrade, either by reheating it or by letting it cool, and then dissolve in it 4.2 grams of sodium bicarbonate. Carefully run on to the surface a layer of methylated spirit about $\frac{1}{2}$ in. deep by means of a pipette (Fig. 2), controlling the flow by slackening or increasing the finger pressure at the top end of the pipette. Leave to stand overnight. Remove the crystals of sodium sesquicarbonate which have formed, and let them dry.

Should you wish to make your own bath salts you will find it more convenient to buy the sodium sesquicarbonate, which costs only about 2/- per kilogram (roughly 2½ pounds).

A typical formula consists of 160 grams of sodium sesquicarbonate, 0.1 gram of dye (Rhodamine, for instance, which gives pink bath salts), 1.2 c.c. of perfume oil (such as oil of lavender), and 2 c.c. of isopropyl alcohol. Stir the ingredients until the dye and perfume are evenly dispersed, and then bottle for use.



DECEMBER

THESE NOTES REFER CHIEFLY TO MIDLAND GARDENS — DUE ALLOWANCE SHOULD BE MADE FOR CHANGE OF LATITUDE.

EVEN with the advent of Christmas the keen gardener will find plenty to occupy his time. Much will depend upon the weather, but provided there is no snow or ice, planting may still continue. If sharp frosts do come along, take advantage of the hard ground to wheel manure into position.

Outside

FINISH forking over borders before Christmas to avoid disturbing bulbs. Plant roses during fine dry weather. Cut lawns once when dry, but sweep first to scatter worm casts. Cover Christmas roses with glass to protect the blooms. Put bait down to kill off marauding slugs.

ROCK GARDEN. Work consists mainly of protecting plants from extremes of weather. Damp is usually the worst enemy, and a single sheet of glass a few inches above susceptible plants will suffice. Woolly-leaved plants will usually

need this protection. See that the glass is adequately anchored against high winds.

Plants lifted by frost should be carefully firmed back in position. Continue to bait for slugs, especially during mild weather.

FRUIT GARDEN. Trees can be planted during mild spells until mid-March. Orders may still be placed with confidence. Nurseries will not despatch until weather is suitable. Ground may be prepared in readiness.

Spray where applicable with winter wash and dress with fertilizers. Strawberries may be mulched with short manure.

VEGETABLE GARDEN. Pick over sprouts and winter greens, removing dead and decaying leaves. Overhaul sacks of potatoes and throw out diseased tubers. Inspect other vegetables in store, such as carrots, beet, and onions. Continue winter digging, leaving soil rough

for exposure to frost. Burn prunings and other rubbish unsuitable for composting.

Inside-warm house

WATER sparingly this month and ventilate whenever weather permits. Remove decaying leaves. Bulbs needed for Christmas should be coming along well now and other plants should be brought in to give a continuous display.

Cool house

KEEP a watchful eye on fuchsias, etc., and remove dead leaves. Be sparing with the water at this time of the year. Plants, especially annuals, should be kept on the dry side. Cut down chrysanthemums and remove to frames.

Cold house

PICK over lettuces and remove decaying leaves. Stir soil lightly between plants, but do not water. Ventilate whenever possible. (M.h.)

PHOTOGRAPHIC GREETINGS CARDS

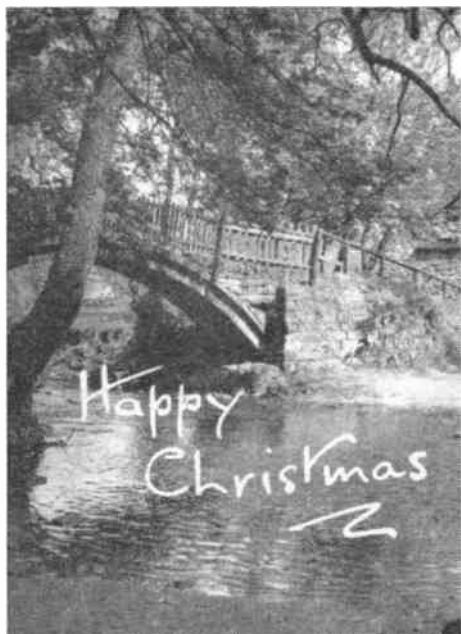

IT'S great fun making your own Christmas cards, and by employing the simple methods we are about to describe, any suitable picture can be used. You may have a seasonable snow scene although you may prefer a more personal picture of yourself or family bearing an overprinted greeting as shown.

While we must first deal with the question of different methods of overprinting the message on the picture, later we will mention some details for final treatment to produce a quality card.

In the picture on the left above you will see that the greeting is shown in white letters on a dark background. This effect is not at all difficult to produce, and the first essential is a suitable picture with an area of the dark tones. You will require a piece of thin celluloid, the same size as the negative, and the greeting is written on this in Indian ink. If a waste negative is immersed in a little domestic bleach for a few minutes the old image is easily removed. Rinse thoroughly in running water, dry with a cloth, and the message can be written. It is a good plan to judge the correct position by making a contact print of the same size and then you will be perfectly sure that the lettering will be in the correct position. It will be appreciated that this lettering is quite small and must be written with a fine pen nib.

The foregoing is the only preparation required for adding the greeting to a picture, the remainder being done in the printing stage.

When ready for printing, place the picture negative and the greeting together in the printing frame or negative holder

By S. H. Longbottom

of the enlarger and the resulting print will be as seen in above left.

If you desire to add a greeting in



Happy
Christmas
~

black lettering for superimposing on a lighter background, as for example the sky area, we have to carry our process a stage further. A suitable negative is selected and a message prepared on a piece of celluloid as previously mentioned. But we now make a new negative from the latter. This is achieved by making what we may term a 'contact negative' on a piece of unexposed film. Contrasty, process material is the best for this and the method is to place the original with the inked side in contact with the emulsion surface of the unexposed material, place in a printing frame, and expose to a 60 watt lamp for 2 seconds. On development this should produce a dense black negative with the lettering quite clear, permitting printing of the message but without fogging of the original picture.

With such a negative we have several alternatives at our disposal, but we will now describe how the other picture at the top of the page was made. The first step is the exposing of the original picture, after which a second exposure is made when the negative has been exchanged for the one bearing the message. In practice it is quicker to expose a batch of prints with the first negative, leave aside in a light-tight box and remember to keep right side up, then add the message by a second printing. If the exposed prints are carefully handled there is no chance of printing the message upside down, but it should be remembered that tests for exposure times are necessary for both negatives and these must be maintained.

Another method is shown where a portion of the picture is masked to produce a blank margin at the base. This is done by either placing a piece of opaque card over the printing paper during exposure or temporarily attaching a strip of opaque paper to the negative. Once again the message may be added in this blank space by a second exposure or you may add your greeting in your own handwriting, preferably in Indian ink.

It is possible to buy blank greetings cards which bear a printed message on the inside with a space for the picture on the outside. The picture size varies from about 2½ in. by 3½ in. upwards, and it will be realised that the cost rises proportionately and that the photographs require mounting.

Another way, and perhaps the cheaper, is to make your greetings cards wholly from photographic paper. You are recommended to use a smooth, double-weight, matt card for this purpose, remembering that the full sheet will only produce a half-size picture after folding.

The production of a card on a sheet of

paper is not only cheaper than buying the prepared cards but also the process of mounting is eliminated. We have to provide for accurate printing, however, and this is done by preparing a simple mask as shown. This protects one half of the paper during exposure. The method is to slip a piece of printing paper in the wallet-like mask and the prepared negative is then employed for printing

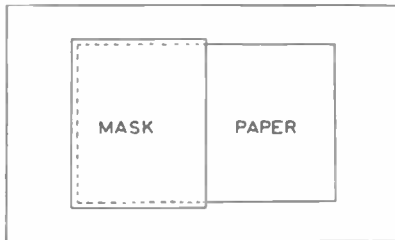

the other half in the normal manner. Printing may be either by contact or enlarging, with the usual methods of development. It will be found that the

prints will dry perfectly flat if they are stacked together between boards while still a little damp and then left under pressure. Note that the prints must only be damp and almost dry before stacking, for if too wet they will stick together.

Folding of the prints should not be attempted until they have been scored with a blunt tool down the centre on the wrong side. Cut a small cardboard template, equal to half the size of the print, scoring after fitting the two exactly together. If the prints are then folded and a knife handle run down the spine — on the back — you will find that this both strengthens the fold and makes the card perfectly flat.

Further touches can be added by deckling the edges, colouring the prints, or adding a little seasonal glitter by applying a thin coating of adhesive and dusting on the powder.

Even this does not exhaust the possibilities, for the pictures can always be toned to any desired colour while processing, and all these measures add to the fascination of making your own original greetings cards.

NEW Angles on OLD favourites

from these Books bulging with BRIGHT IDEAS

Any volume in this most interesting range of books, each dealing with a different aspect of gummed paper-craft, will show you a wealth of ideas, the way to carry them out, and give hours of intense enjoyment.

Each is the key to an economical hobby that is rich in variety, ranging from the making of a charming picture to framing it delightfully — from three dimensional models to wall decorations, from paper sculpture to charming flower studies.



Other books by FREDERICK T. DAY

- Coloured Paper Decoration .. 7/6
- Coloured Papercraft for Schools .. 7/6
- Coloured Papercraft for Infants' Schools .. 6/-
- Lampshade and Parchment Craft .. 8/6
- Decorative Flower and Leafmaking .. 8/6
- Gummed Strip and Paper Modelling .. 7/6
- Paper Sculpture for Schools .. 7/6



8/6

All books obtainable from:
Newnes & Pearson Ltd.
 Tower House, Southampton St., Strand, W.C.1.
 Ask your stationer to show you the Butterfly range of
 handicraft materials.

SAMUEL JONES & CO., LTD.

STATIONERY MILL, CAMBERWELL, LONDON, S.E.5. RODNEY: 5064

A CHRISTMAS MOBILE

IN recent years mobiles have ceased to be merely a revolutionary and often inexplicable modern art form and have become a popular decorative device.

In many homes space is too restricted to permit mobiles to be hung permanently, but at Christmas time even a large family will be prepared to endure an elaborate scheme of gay streamers and paper objects which increases the festive atmosphere of this happy season. Thus, at Christmas, if ever you have wished to make a simple mobile and hang it in your home, you will have a perfect opportunity to try your hand at this fascinating art. Here are instructions for making an effective Christmas mobile which will charm the whole family as its various parts are moved gently by incidental air currents in the room.

This mobile consists of a pair of large 'halo' shapes which 'frame' an arrangement of two silver stars and a fir tree shape with a single glass ornament suspended 'within' it. Use the illustration as a guide only and build up your own mobile any size you wish, incorporating original ideas that may occur to you. First obtain the centre piece, which will be a bright globular Christmas tree ornament. Estimate its

diameter and then use compasses to draw a circle having a diameter $\frac{3}{4}$ in. greater than this near the middle of a 1 ft. by 1 ft. sheet of stout cardboard. Draw your fir tree shape around this circle, as indicated in the diagram. Keep the shape simple and avoid a symmetrical outline for the best effect. The base of the tree must not be too wide. Cut out the tree neatly and care-

By A. E. Ward

fully cut out the neat round hole which you outlined.

Mark out two six-pointed stars upon stout cardboard. This can be done by ruling a pair of overlapping triangles of roughly similar size and shape. Let the stars be of different widths which are slightly greater than the diameter of the glass ornament. Remember as you make your stars that they will be required to hang with the fir tree within the innermost halo ring in such a manner that they will not bump against any adjacent part when they are free to move. Lay the tree and star shapes upon a large sheet of stout cardboard in the relative positions that you intend them to occupy when your mobile is finished. Now draw a great circle upon the cardboard all around the three parts, whilst allowing a wide margin. Draw a second circle, with the same centre as the first and with

a diameter between $\frac{1}{2}$ in. and 1 in. greater than the 'inner' circle. Cut out the halo shape you have drawn. Prepare a similar halo shape which will have an internal diameter 1 in. greater than the outer diameter of the smaller shape.

Paint the tree dark green on one side and pale green upon the other and colour the stars glistening silver or gold. Let the smaller halo be yellow, and paint the larger shape bright scarlet. You will now need some strong black thread with which to suspend the parts of the mobile.

Begin 'stringing up' your mobile from the middle and work outwards. Threads can

be attached to the cardboard parts if you first bore little holes into which the strings can be inserted and knotted firmly into place. Start by suspending the glass ornament within the hole in the tree shape. Lightly hold the top part of the tree between your fingers and determine the point at which the shape can be hung in such a manner that the glass ornament is suspended well clear of the cardboard. A needle may be used to puncture the shape in one or two places in order to locate the precise position. Suspend the tree from a point near the inner edge of the smaller halo so that it hangs well clear of the cardboard. Attach threads to the stars and find the points upon the smaller halo from which they can be suspended. This can be done by twisting the threads round small pins which are pressed experimentally into the cardboard ring. When finally securing the stars remember that no hanging part must be permitted to touch any other part. Use similar methods when suspending the smaller ring within the larger halo shape. Finally, suspend the whole mobile from a long thread which can be secured to the ceiling or lamp fitting.

Hang your mobile in the hall, or where it can form the centre piece of your festive decorations. You will never tire of watching the constant variety of its movements and accidental arrangements of its parts. These full instructions should acquaint you with the technique for making mobiles of this type, and you will derive greater satisfaction in constructing another mobile or two employing different shapes. Stars with winged angels will be in keeping with the real theme of Christmas. Or you may devise a gay arrangement of reindeer, gnomes, and Father Christmas to give particular pleasure to the younger members of the family.

Mobiles are never really easy to construct owing to the accurate balance required and the care which must be taken when designing the relative parts, but if you persevere your patience will be rewarded with most satisfying results.

Next week's issue will show how to make a Doll's Wardrobe and a Pegboard Village, two excellent ideas for Christmas gifts, among other features of a festive nature. Make sure of your copy.

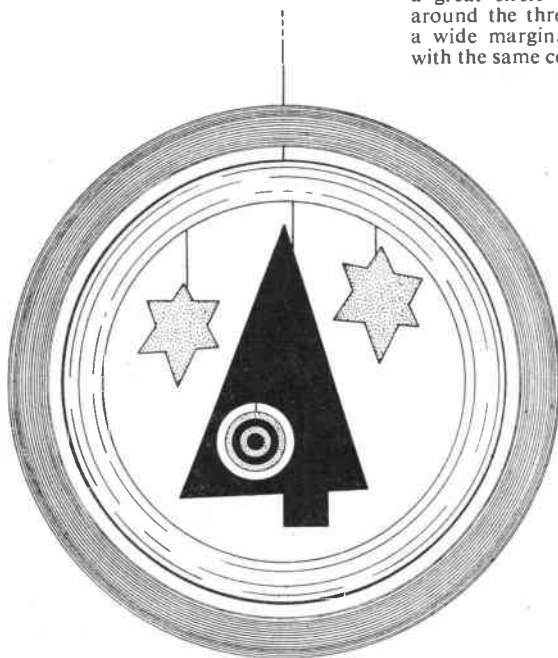

HOBBIES 1961 ANNUAL

Enlarged to 180 pages—and still only 2/-

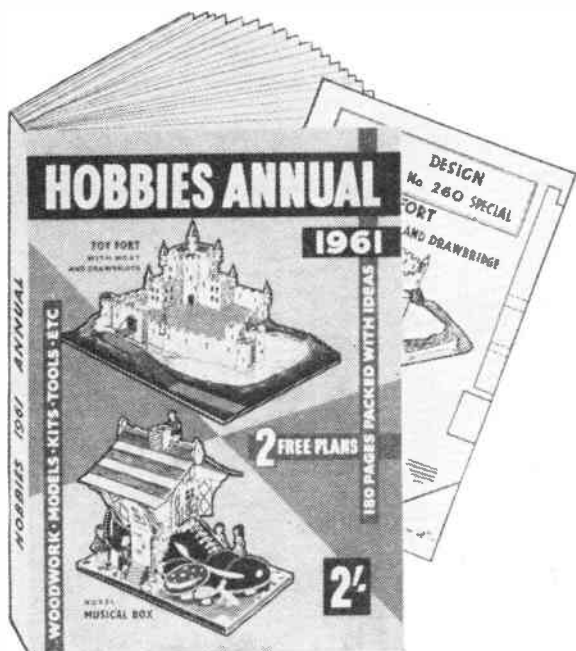

Two free plans with each copy, for making

TOY FORT (with moat and drawbridge)

MUSICAL BOX (The Old Woman who lived in a Shoe)

Hundreds of exciting projects for all ages

From Hobbies branches, stockists, newsagents, bookstalls, etc. or send NOW for your copy by post (6d. extra)

To Hobbies Ltd., Dept. 992, Dereham, Norfolk

Please send.....copy/copies Hobbies 1961 Annual containing two free plans

Name.....

Address.....

.....

P.O. for.....enclosed

He's right, you know!



One plus one *does* equal one—when it's CASCAMITE "One Shot". Each tin of this outstanding wood glue contains both the resin glue powder and the hardener, blended together in exactly the right proportions. For use, all you do is mix with cold water.

Only CASCAMITE "One Shot" has this unique advantage of combining simplicity of use with the excellent performance of a resin glue. For gluing wood, it provides a joint which is as strong as the wood itself, stain-free, heat resistant and waterproof. With "One Shot" you can also glue joints even though they have gaps of up to $\frac{1}{8}$ ". For woodworking (furniture making, joinery, boat building, etc.), there is certainly no better choice. Try a tin for your next job.

Packed in 3½, 7 & 18 oz. tins (2/6d., 4/0d. & 8/6d. respectively). Also in larger sizes.



113

But for a good general-purpose glue, be sure to get CASCO Grade 'A' (Powdered) Casein glue. It glues almost everything, is easy to use and is most economical (2½ oz. of powder make 7½ oz. liquid glue). Packed in 2½, 7½ and 16 oz. tins (2/0d., 4/6d. & 7/6d. respectively). Also in larger sizes.

Stocked by *Ironmongers, Builders' Merchants Handicraft Shops, etc.*



SYNTHETIC RESIN & CASEIN GLUES

Manufactured by

LEICESTER, LOVELL & CO. LTD
NORTH BADDESLEY SOUTHAMPTON

DOODLING WITH COINS

DOODLING can perhaps be defined as the act of making novelty drawings from odd shapes, and here are more suggestions for your amusement. There are no rules for this game of doodling with coins, which is simplicity itself. It is only a matter of running your pencil around the circumference of a penny to make a head or body. A sixpence is also useful, or you may use different sizes of buttons.

By H. Mann

Perhaps we should subscribe one or two hints to help you produce variety in your doodling, particularly with regard to features such as eyes, nose, and mouth. If you will refer to the illustrations you will see that we indicate centre lines, and that the eyes are on this line. You may verify this for yourself by looking in a mirror, when you will also see the position of the ears. Keep the eyes on this centre line and the mouth as shown. We must also emphasize the distinction between the smiling and the sad face. In the former the eyebrows and the mouth are curved, so that they are arcs of a circle, but when the arcs are in opposite directions we produce a miserable look.

The rim of the coin may be used for these details, while a round pencil is a good tool for drawing eyes if held

vertically. If you use buttons you will find the sewing holes most convenient for small features.

Another detail we should mention is the treatment of the eyes, and careful inspection of the drawings will reveal the many methods at our disposal. We may make our doodles look to either side, upwards or downwards, and that

We can give our little man a hat, a coat, and so on, the combinations being limitless.

We are not confined to faces, however, and you will quickly see how we made the chicken and the cats. You may also make birds, rabbits, dogs, and many other funny-looking animals.

While we have used the term coin doodling, it will be realized that a small collection of assorted buttons will enable you to make all kinds of figures, and if desired you may also make similar doodles with a pair of compasses. All you have to remember is the position of the eyes, mouth, and ears, and the treatment of the eyes. A drawing will develop as you proceed to add other features, so go ahead, and see whether you can make some really original doodles.

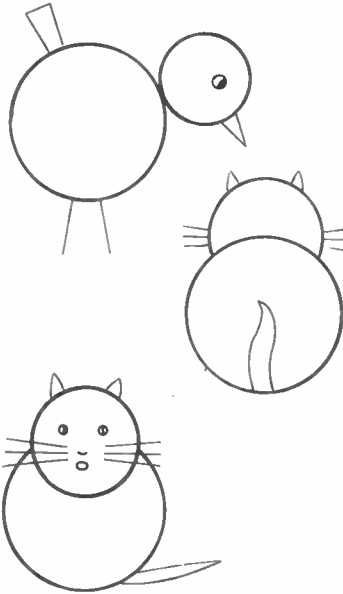

A 'LOLLIPOP'

CHRISTMAS TREE

WHEN you hold your Christmas party the children will love a lollipop and toffee tree. Obtain a shapely branch, about 2 ft. high, with many leafless twigs upon it and fix it, upright, into a hole drilled in the middle of a heavy block of wood. A slice sawn off a large log will be ideal. Your little tree should not be easily tipped over. Paint the branch white all over and let the base be dark green in colour.

When the tree is finished, commence suspending gaily wrapped toffees, sweets, and lollipops from the twigs by means of gold and silver string, such as is used to tie up Christmas gifts. As an added decoration stand a group of toy reindeer, or a single red candle, beneath the tree. If you use a candle, set it up in a hole bored in a half potato and conceal the vegetable by sticking little sprigs of holly into it. Glitter dust may be used to complete the general effect.

Your young guests will be delighted, but you must impress upon them that the 'fruit' is not to be 'picked' until the end of the festivities, when all the guests can gather round to have fair shares of the tasty harvest.

(A.E.W.)

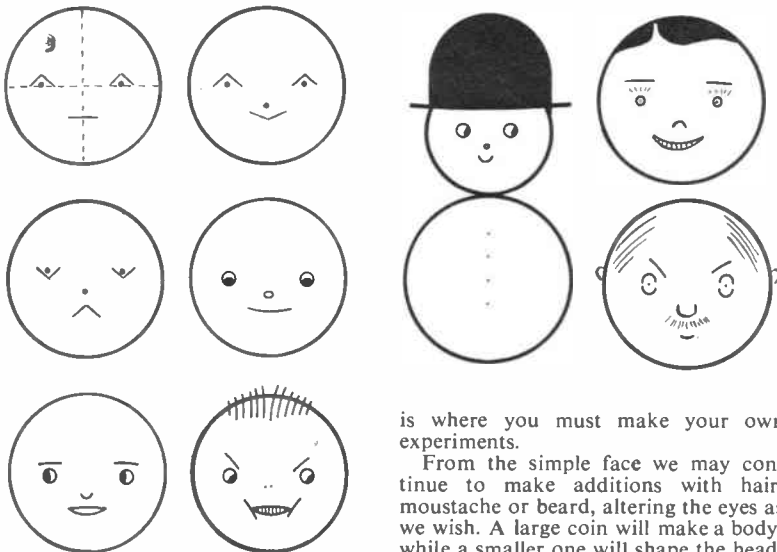

is where you must make your own experiments.

From the simple face we may continue to make additions with hair, moustache or beard, altering the eyes as we wish. A large coin will make a body, while a smaller one will shape the head.



"build modern!"

WITH REAL BRICKS AND MORTAR

What exciting up-to-date building you can do with Contemporary Brickplayer! Models are architect designed to '0' gauge scale. Included are bricks in all required shapes, roofing, windows, doors; plans and instruction booklet. For re-use of bricks, dismantle by soaking in water.

CONTEMPORARY BRICKPLAYER KITS

'A'—19/11; 'B'—27/6; 'C'—50/-

TRADITIONAL BRICKPLAYER KITS

Kit 3—27/6; Kit 3A—27/6; Kit 4—52/-;
Farm Kit—63/-



CONTEMPORARY

BRICKPLAYER

WIN A PRIZE! £21·0·0 £10·10·0 £5·5·0

also consolation prizes
are offered in the **BRICKPLAYER** contest

At good toyshops, hobby shops, department stores. Leaflet on request, together with name and address of nearest stockist if required.

J. W. SPEAR & SONS LTD. (Dept.H.W.), ENFIELD, MIDDLESEX

TERRIFIC! The New Relum Table Soccer



- Two complete teams
- Each player individually operated
- Non-magnetic
- Size 20" x 12"

Every
Match
a
Home
Game

From Sports and Games shops everywhere

For name and address of nearest stockist:

Price only

RELUM LIMITED

Ossulton Street, London N.W.1. Telephone: EUSton 9088

42/-

LEARN

RADIO & T/V SERVICING

for your OWN BUSINESS/HOBBY

● by a new exciting no-maths system, using practical equipment recently introduced to this country
FREE Brochure from:—

RADIOSTRUCTOR

DEPT. G81, READING, BERKS.

30/11/60

WHEELS (Hardwood and Rubber Tyred Metal). Cot, Pram, and Doll's House Fittings and Papers, Beads, Transfers, Prints and other accessories. Stamp for new lists. (Trade supplied.) New address — **JOYDEN CO.**, 91 Peplins Way, Brookmans Park, Herts.

LEARN RADIO & ELECTRONICS the NEW Practical Way! Very latest system of experimenting with and building radio apparatus — 'as you learn'. FREE Brochure from: Dept. H.W.10, Radiostructor, 40 Russell Street, Reading, Berks.

KUKLOS ANNUAL. Indispensable cyclists handbook. Tours, resthouses, money-saving hints. 3/- post free. — Burrow, Publishers, 2 Imperial House, Cheltenham.

EXETER

DO YOU KNOW?

HOBBIES LTD. have a branch at **No. 9 NORTH STREET**

where the manager and staff are always willing to give you the benefit of their experience with any of your handicraft problems. Why not pay a visit?

PARTS for radios in H.W. etc.—P.W.S.(R), 106 Shrewsbury Road, London, N.W.10.

50 KENYA Stamps 3/-. 25 Malta 4/6, 25 Philippine 5/-. Stamp Magazines 1/-. monthly. Try our 7 day approvals. E. C. F. Townsend (H), 92 Tenby Road, Edgware, Middx.

100 DIFFERENT stamps free! Request ¼d. upwards discount approvals. — Bush, 53 Newlyn Way, Parkstone, Dorset.

PROFIT AND PLEASURE is obtainable from **WRITING** (typewriter unnecessary) or **ARTISTRY**. Send for free fascinating bumper package 'PROFITABLE LEISURE'. — Writers' & Artists' Ring (HW), 5 Edmund Street, Birmingham.

WORKERS with sewing machines required for making cushion covers. Regular work guaranteed. Apply enclosing s.a.e., Dept. 28, Arnold Trading, 10 Shelley Road, Worthing, Sussex.

TRANSISTORS, Germanium Crystals, Headphones, etc. Lists and diagrams free. Germanium Diodes with three crystal set Circuits 1/-. Postage 4½d. P.R.S. (H), 33 Bourne Gardens, London, E.4.

MAKE ART PAY. Learn to Draw/Paint Flowers, Birds, etc. in Designs or Pictures for waiting manufacturers. Profitable. Remunerative. Even beginner's work can sell. Postcard brings free brochures. Clun Valley Features (H.W.), Clun, Salop.

CATALOGUED 9/2 — 10 China Free to applicants requesting low-priced Approvals. — Terrys, 63 Stoke-Poges Lane, Slough.

HEAR ALL CONTINENTS With H.A.C. Short-Wave Receivers

Suppliers for over 18 years of radio S-W Receivers of quality.

One-Valve Kit, Price 25/- Two-Valve Kit, price 50/-

Improved designs with Denco coils. All kits complete with all components, accessories and full instructions. Before ordering, call and inspect a demonstration receiver, or send stamped addressed envelope for descriptive catalogue.

'H.A.C.' Short-Wave Products (Dept. 22), 11 Old Bond Street, London, W.1.

Amazing new battery-operated **POWER TOOL** for light grinding, etching, polishing, and even very small drilling work on plastic and balsa-wood models, etc.

NO. 1 'JIFFYTOOL' Kit, 19/11

NO. 2 MODEL (more powerful) 27/6

Send now for one of these handy new tool kits.

Single tools sent post free on receipt of remittance and order

ACE PRODUCTS, 214 Bishopsgate, London, E.C.2

A DECORATIVE TUMBLER STAND

USING the full colour Decorette transfer No. 407 (four on a sheet) as a basis for design, these attractive stands may be made up for table decoration. Put one transfer on a piece of $\frac{1}{4}$ in. wood (A) and cut round with a fretsaw, leaving the background as suggested. Cut pieces B and C from $\frac{1}{4}$ in. wood and assemble as shown in the diagram on the right. Clean up and varnish. Note that the diameter of piece C will depend upon the size of tumbler used. Transfers may be obtained by post from Hobbies Ltd, Dereham, Norfolk. Price 2s. 3d. per sheet of four designs, postage 3d. a sheet. (M.p.)

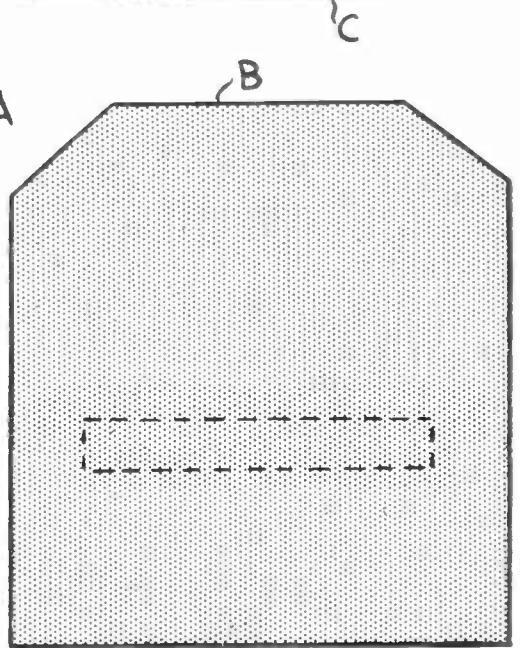
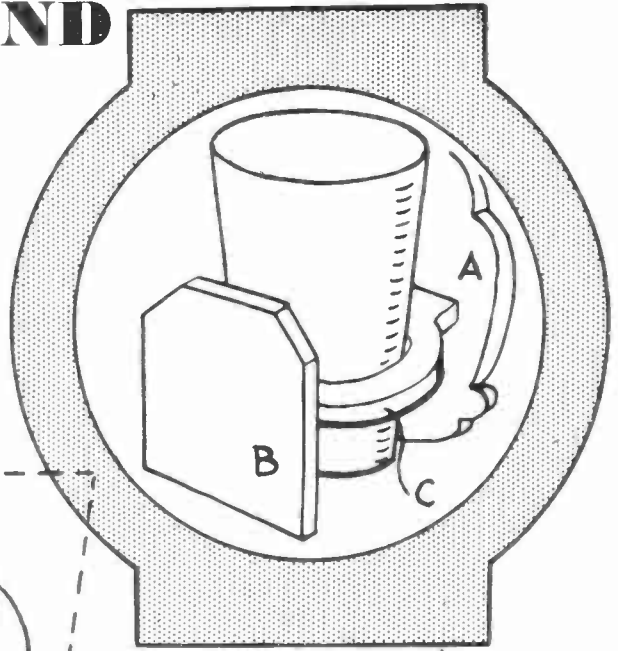

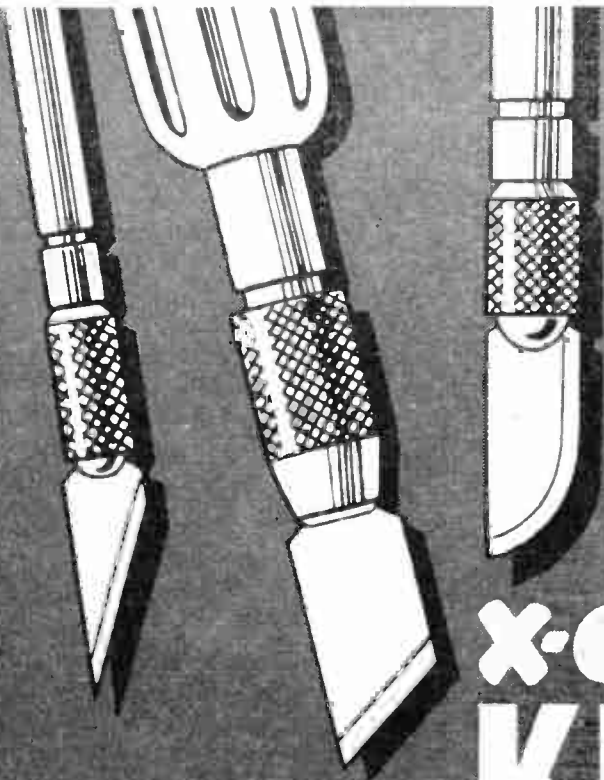

x-acto KNIVES

with the BIG RANGE of

INTERCHANGEABLE BLADES

X-acto Knives with their nine different blades and three different weights of handles are a delight to use. They enable you to tackle every modelling job with skill and precision. Made in razor sharp surgical steel you can get them from Hobby Shops and Ironmongers.

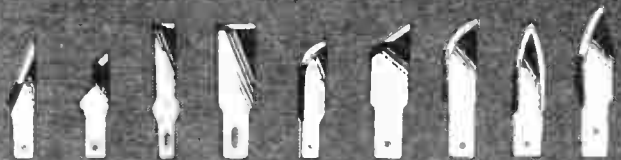

DUFAY (B'HAM) LTD.

(X-ACTO DIVISION)

308 SUMMER LANE BIRMINGHAM 19

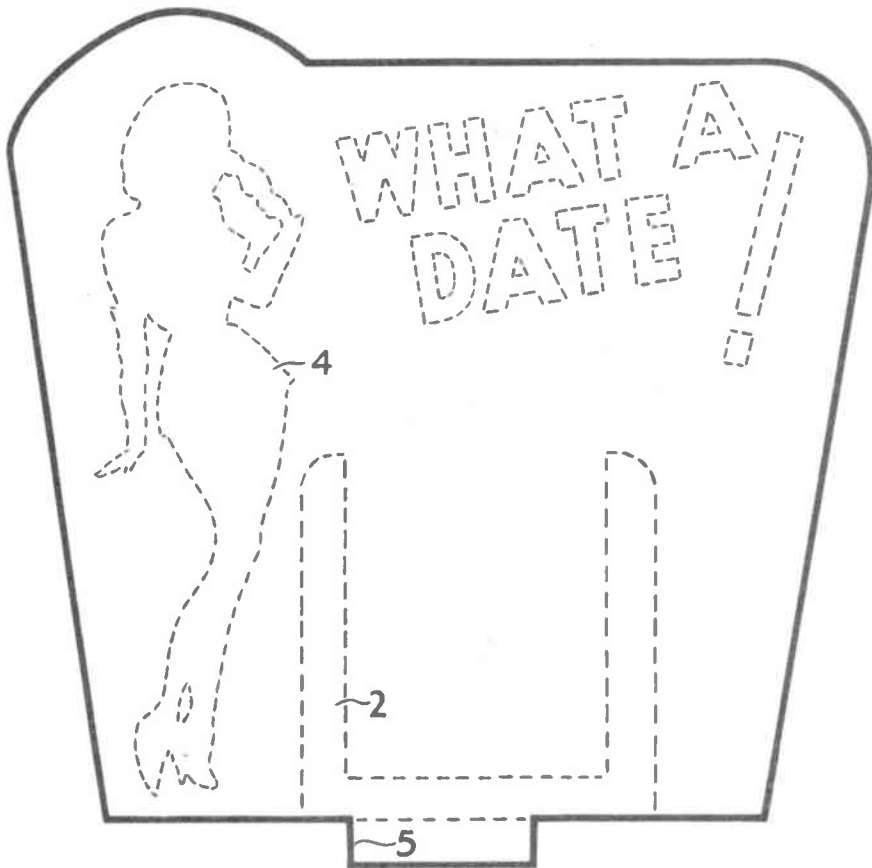

PIECE 1. CUT ONE 1/4 in.

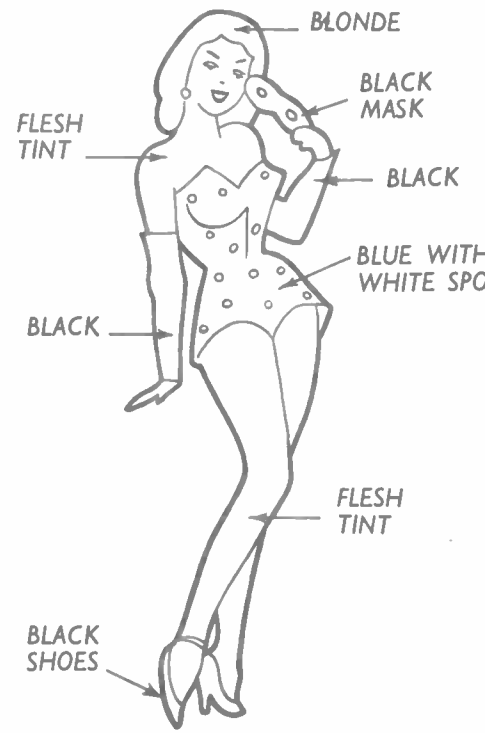

OVERLAY 4. CUT ONE 1/8 in. PAINT AS INDICATED.

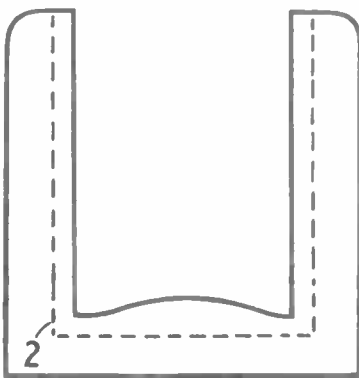

PIECE 3. CUT ONE 1/8 in.

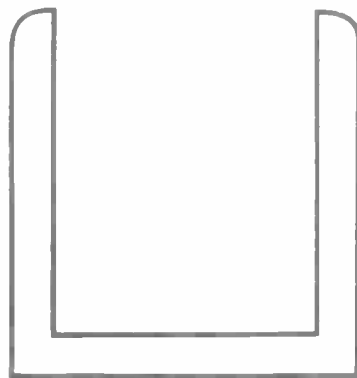

PIECE 2. CUT ONE 1/4 in.

WHAT
DATE

OVERLAYS. CUT ONE OF EACH 1/8 in.

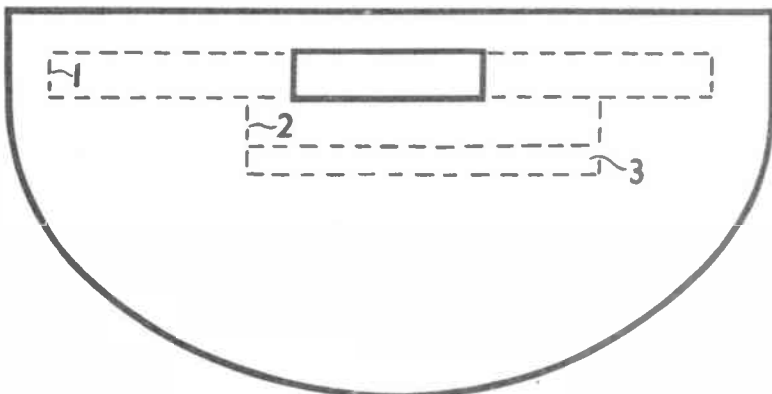

PIECE 5. CUT ONE 1/4 in.

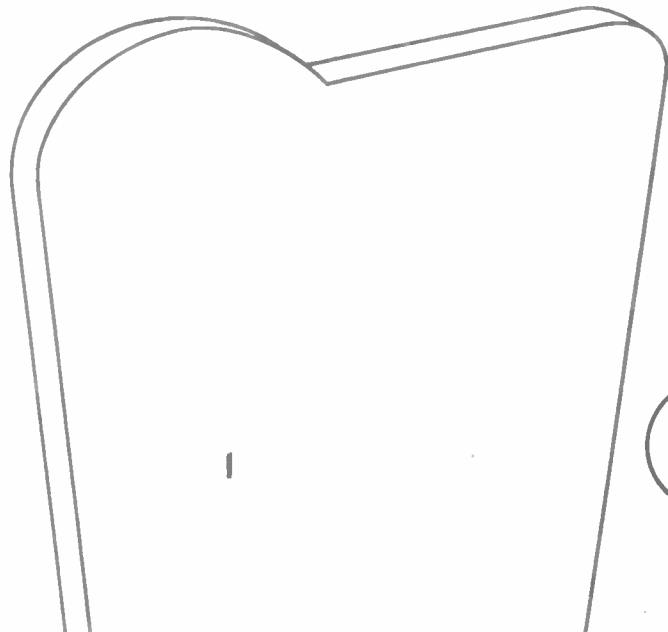



DESIGN

No. 3390

PIN-UP CALENDAR

SIZE 4 ins. WIDE. 4½ ins. HIGH.

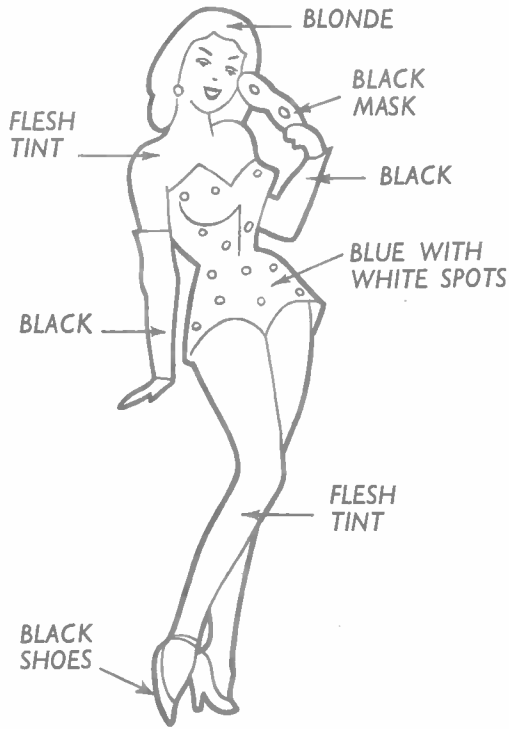

OVERLAY 4. CUT ONE 1/8 in. PAINT AS INDICATED.

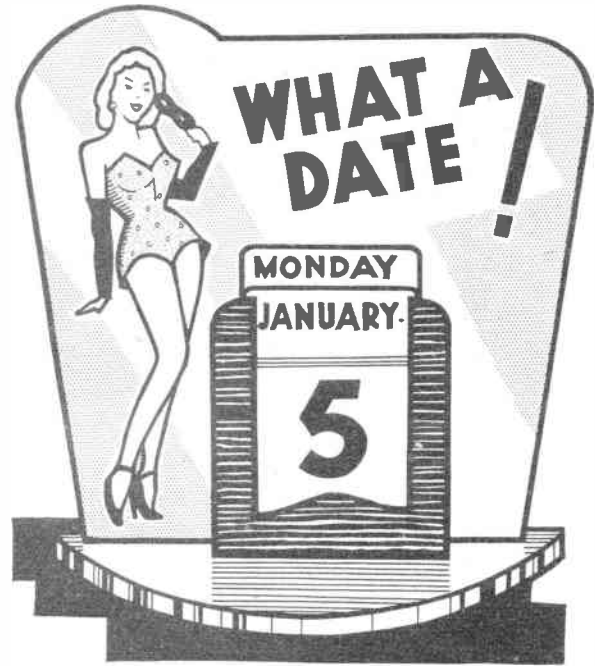

WHAT A
DATE !

OVERLAYS. CUT ONE OF EACH 1/8 in.

PANELS OF WOOD REQUIRED FOR MAKING THIS DESIGN

One Q4 One G2

A KIT OF MATERIALS FOR MAKING THIS DESIGN IS SUPPLIED BY HOBBIES LIMITED, DEREHAM, NORFOLK. PRICE ON APPLICATION.

THE WORLD'S STRONGEST GLUES



A white P.V.A. adhesive, clean to use, non-staining, fast-drying and strong. For joinery and cabinet work. In easy-spread polythene bottle: 2/6d and 5/-.

BUY CROID FROM YOUR LOCAL HOBBIES BRANCH

A

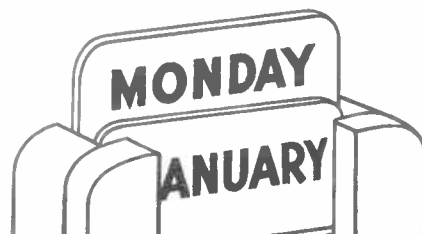

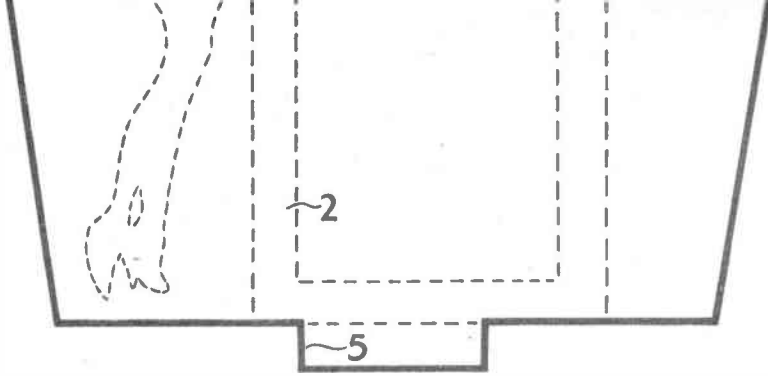

PIECE 1. CUT ONE 1/4 in.

BLACK SHOES



OVERLAY 4. CUT ONE 1/8 in. PAINT AS INDICATED.

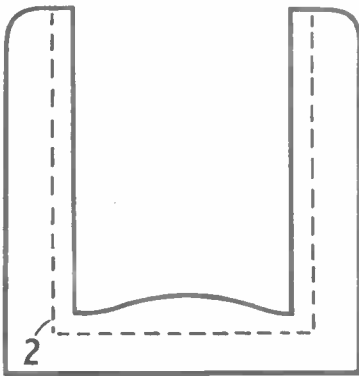

PIECE 3. CUT ONE 1/8 in.

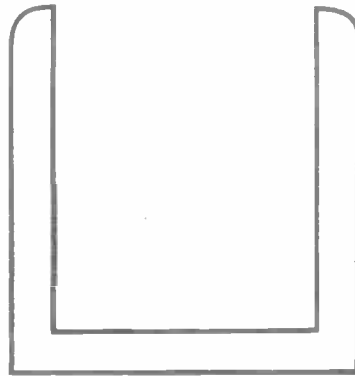

PIECE 2. CUT ONE 1/4 in.

WHAT
DATE

OVERLAYS. CUT ONE OF EACH 1/8 in.

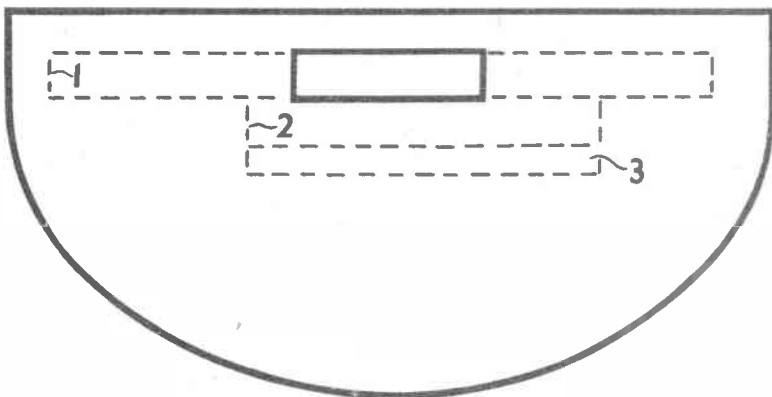

PIECE 5. CUT ONE 1/4 in.

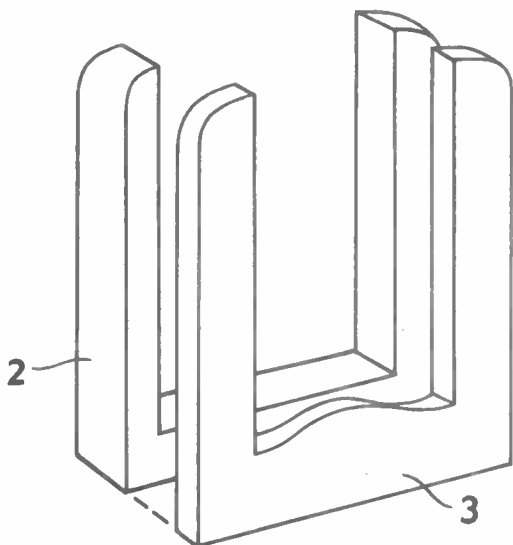

B

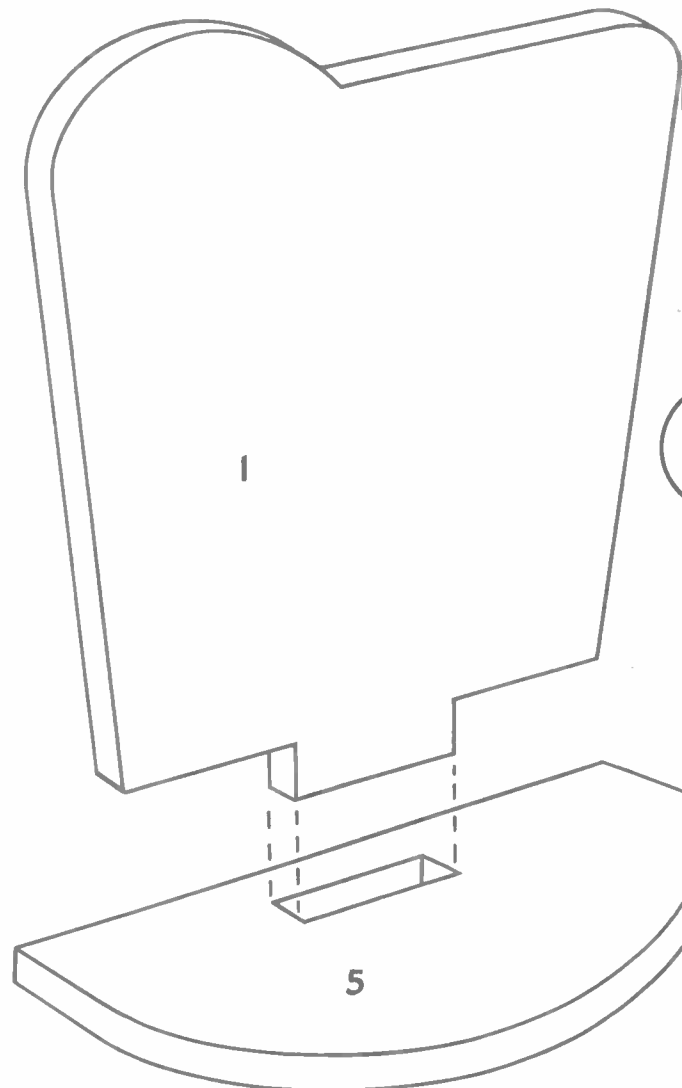

PRINTED IN ENGLAND.



OVERLAY 4. CUT ONE 1/8 in. PAINT AS INDICATED.

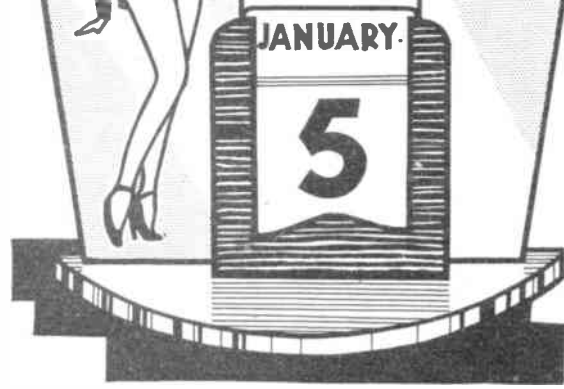

WHAT A
DATE!

OVERLAYS. CUT ONE OF EACH 1/8 in.

PANELS OF WOOD REQUIRED FOR MAKING THIS DESIGN
One Q4 One G2
A KIT OF MATERIALS FOR MAKING THIS DESIGN IS SUPPLIED BY HOBBIES LIMITED, DEREHAM, NORFOLK. PRICE ON APPLICATION.

THE WORLD'S STRONGEST GLUES

Stick it with-

Croid POLYSTIK

A white P.V.A. adhesive, clean to use, non-staining, fast-drying and strong. For joinery and cabinet work. In easy-spread polythene bottle: 2/6d and 5/-.

BUY CROID FROM YOUR LOCAL HOBBIES BRANCH

1/4 in.

