

13th JANUARY 1960

VOL. 129

NUMBER 3344

THE ORIGINAL
'DO-IT-YOURSELF'
MAGAZINE

HOBBIES *weekly*

FOR ALL
HOME CRAFTSMEN

Make it from
★ *FREE* design inside

Also in this issue:

AMPLIFIER FOR
A CRYSTAL SET

LITTER TRUCK
FOR THE GARDEN

COLLECTORS' CLUB

NOVELTIES WITH
JET PROPULSION

AN ECONOMICAL
NIGHT LIGHT

ETC. ETC.

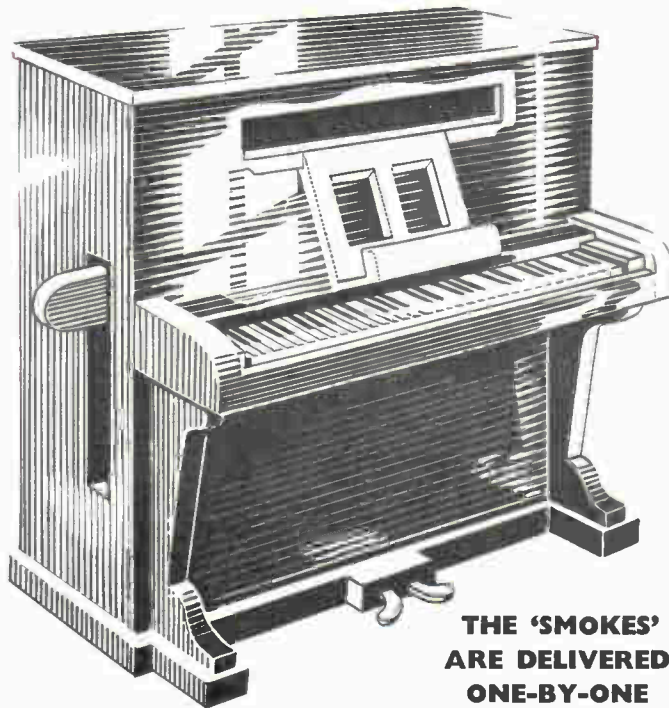

THE 'SMOKES'
ARE DELIVERED
ONE-BY-ONE

PIANO CIGARETTE BOX



Up-to-the-minute ideas

Practical designs

Pleasing and profitable things to make

World Radio History

5^p



THE people of modern Iran, as Persia is now called, are celebrated for their good looks. The men are witty, the women vivacious, fond of dress and display.

Persians are born diplomats, usually well informed, and skilful in business. Apart from their normal duties the priests often practise astrology. They write letters and contracts for the illiterate, and profess to protect the people from tyranny and oppression.

Every mosque, or church, has a staff of three. 'The Mostwillla', a kind of churchwarden, manages the temporal affairs. 'The Muezzin', or beadle, calls the people to prayers. 'The Mullah', or priest proper, conducts the service.

Marriage ceremonies are elaborate, and peculiar to Western ideas.

A girl is often betrothed to her future husband in infancy, and never sees him until the wedding day. She has the option of refusing her suitor — a privilege difficult to negotiate and

Forests cover the maritime plains and mountain slopes. Mineral deposits in addition to oil are considerable. Turquoise mines are worked in Nishapur.

Agriculture is a prime industry. The chief products are wheat, barley, rice, fruits, gums, drugs, wool, tobacco and cotton.

Persian carpets, made on hand looms,

IRAN

By R. L. Cantwell

are produced in Tabriz. Khurasan is famous for the quality of its wool and the Iranian oil fields are, of course, a rich source of income.

Over a million of Iran's total population of 15,000,000 live in Tehran, the capital. Here, as in all Iranian towns, the houses are built of sun-dried bricks, a few of burnt bricks. The homes of the poor contain but one large room.



practically useless. Great rejoicings follow every wedding. Feasting lasts from three to forty days, according to the rank of the parties concerned.

The Shah of Persia has complete authority over the lives and property of his subjects. His Kingdom occupies the western and larger half of the great Iranian Plateau between the rivers Indus and Tigris in South-Western Asia. It is bounded on the North by the U.S.S.R. and the Caspian Sea; on the East by Afghanistan and the sub-continent of India; on the south by the Arabian Sea and the Persian Gulf; on the west by Iraq and Turkey.

A desert, 800 miles long, varying from 100 to 200 miles wide, stretches across the plateau. There are many peaks from 9,000 to 10,000 ft.

Some of these houses have rooms built upon the flat roof, which is reached by a flight of stairs built on the outside.

Wealthy people live in well-built two-storey houses.

The houses are built closely adjoining, so that it is possible to walk over much of the town on the house-tops.

The National Flag: White, bordered with green (top) and red (bottom), with arms (lion and sun) in centre; appears on Persian stamps of 1949, 50 dinars violet, cat. 3d. mint.

Collectors will find the following stamps useful for illustrating 'The Persian Story'. 'Persia: 1948, 1 rial red; Persian Warrior (6d. mint). 1949, 25 dinars blue and brown; Chelkeltoun Mosque (2d. mint). Ditto: 1 rial 50 dinars red and green; Mosque of the

Shah (2d. used). 1953 Air, 50 dinars yellow and green; Oil Wells and Mosque (2d.). 1935, 5 dinars green and brown; Persian Woman (4d.). 1939, Royal Wedding; set of 5 (3/9 mint). 1951, Royal Wedding; set of 6 (2/6 used). 1950, 10 + 5 dinars chocolate; Shah and Map (2d.).

A few general themes applicable to Persian stamps: The Land of the Five Seas. The Story of Oil. Industrial Geography of the World. Wonders of Machinery. Famous Mountain Roads. How different peoples live. World Coinage. National Arms and Flags. The Races of Mankind. Wings over the World. Eastern Military Parades, etc.

And a few rarities — you may strike oil!

'1870, Imperf., 5 krans red; £6 mint, £3 used. 5 krans purple; 90/- mint, 65/- used. 1 toman bronze on blue; £30 mint, £20 used. 1917, 12 chahis on 1 kran red and blue — 'Surcharged with value in English only' — £12 mint, £6 used. 1918, 20 krans olive, green and gold; £5 mint, 12/6 used. 1927, Air, 10 krans olive, orange and gold; 85/- mint, 90/- used. 1942, 200 rials black and blue; 80/- mint.'

Famous Songs

'THE BAY OF BISCAY'

AN interesting anecdote of the youth of John Davy (who composed the famous song 'The Bay of Biscay') shows how decided and precocious was this musician's aptitude for the calling he ultimately practised with artistic, if not financial, success.

John Davy was born near Exeter in 1763. At the age of six he evinced a passion for music, which he sought every means of gratifying. He was in want of a musical instrument, and determined to provide himself with one, of however rough a nature. So, from a neighbouring smithy, he purloined twenty to thirty horseshoes. From these he selected as many as formed a complete octave, and having suspended them in an upper room, amused himself by imitating upon them the chimes of the neighbouring church of Crediton.

By these and other means he obtained a knowledge of music, which, some thirty years later, enabled him to produce many dramatic pieces, and such songs as 'Just Like Love', 'The Death of the Smuggler', and 'The Bay of Biscay', only the last of which has remained popular.

After twenty years' work in London, Davy died in St. Martin's Lane in 1824. He was buried in St. Martin's Churchyard.

I-TRANSISTOR CRYSTAL SET AMPLIFIER

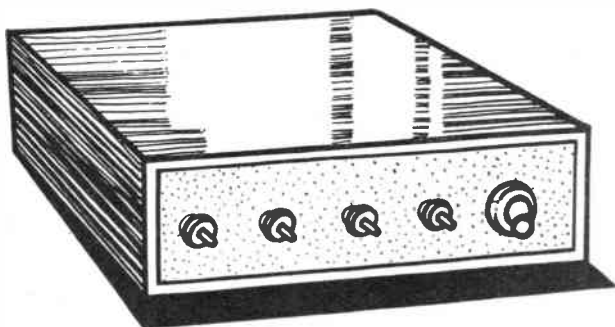

THE volume from a crystal set may be insufficient for comfortable listening, if a poor aerial has to be used, or if no earth can be arranged. In such cases a single-transistor amplifier will prove to be very helpful. Really loud headphone reception can then be expected, even with an indoor aerial.

By 'Radio Mech'

The transistor amplifier shown in Fig. 1 only needs a $4\frac{1}{2}$ V. dry battery, $2\mu\text{F}$ or similar paper condenser, $\frac{1}{2}$ megohm resistor, switch, and four terminals, in addition to the transistor. The latter can be the cheap Red Spot type, which is intended for audio amplification.

A small wooden baseboard about 5 in. by 3 in. will easily hold the parts. A strip of insulated material 5 in. by $1\frac{1}{2}$ in. is drilled for the terminals and switch, and screwed to the front of the baseboard. The completed amplifier will then fit in a small case made from thin wood.

Wiring up

In Fig. 1 the three leads coming from the transistor are marked E, B and C. These letters indicate the Emitter, Base, and Collector wires respectively. With the Red Spot type of transistor the collector lead is identified by the red dot, as shown in Fig. 1. If another type of transistor is used, with emitter, base and collector leads in different positions, it is necessary to take care that the wires are joined to the correct points in the circuit.

If connections are soldered, the iron should be really hot, and only kept in contact with the transistor leads for a few seconds. This will avoid damage from overheating. For the same reason the transistor wires should be left their full length. It is also possible to wire up the amplifier by using small nuts and bolts, and no soldering will then be necessary. If this is in view, the switch will need to have screw connections, instead of tags, and the condenser will need to have wire ends or terminals.

The battery should not be fitted until last. With the usual flat $4\frac{1}{2}$ V. dry battery, the short contact strip is positive, and the long strip is negative. It is important that the battery is not wired in the wrong way round. As the zinc case of a dry cell is negative it is easy to check the polarity, even if no voltmeter is available.

Using the amplifier

A check can be made to see that the crystal set is properly tuned in, by listening with the phones wired directly to the crystal set itself. The phones are then disconnected from the crystal set and taken to the 'Output' terminals in Fig. 1. If the phone leads are marked

loud for comfort, with headphones, the battery can be reduced to 3V. or $1\frac{1}{2}$ V. Or a pre-set condenser of about $0003\mu\text{F}$ can be joined in series with the aerial lead to the crystal set. This will sharpen tuning a little, as well as allowing volume to be reduced.

If a really good aerial and earth are available, and the crystal set is of efficient design, sufficient output can be obtained from a local station for moderate loudspeaker volume. The speaker should be a reasonably large one, of sensitive type, such as is used in battery receivers or portables, and it must have a matching transformer. The transformer primary is wired to the amplifier, and the secondary to the speaker. Some speakers have this transformer fitted to the frame, and permanently connected.

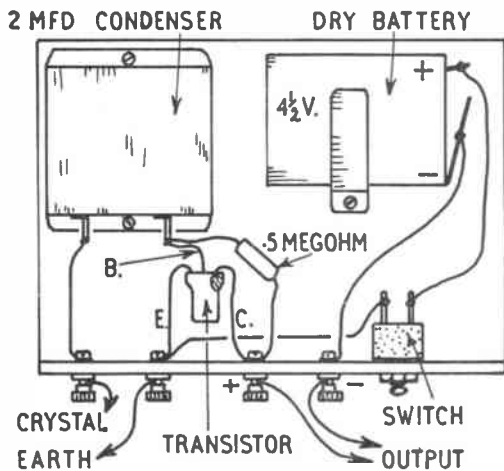

Fig. 1—Wiring plan of the amplifier

positive (red) and negative (black) connect them to the terminals as indicated.

The terminal marked 'Crystal' is then joined to one phone terminal on the crystal set, this terminal being the one which goes to the crystal detector or diode in the set. The 'Earth' terminal on the amplifier is joined to the other crystal set phone terminal, which will be connected to earth, variable condenser, and coil, inside the set.

When the amplifier is switched on the original signals will be heard at much increased volume. If reception is too

As a guide, loudspeaker reception should only be expected when the crystal set itself will give really good headphone signals, without the aid of the amplifier.

Next week's issue will contain projects of interest to all readers, including Old Transport plan, TV Table. Novelties on the Lathe, Fly Making for Anglers, a 'Pillow' Loudspeaker, Close-up Photography, etc.
Make sure of your copy

PIANO CIGARETTE BOX

THIS novelty cigarette container, which is in the shape of an upright piano and incorporates a mechanism for the automatic delivery of cigarettes, one at a time, will be a popular favourite among modelmakers.

The box can be 'loaded' with up to ten standard size cigarettes and by pressing a lever at the side a 'smoke' automatically emerges from the front and is deposited neatly on the music stand, ready to be picked up and popped between the lips.

Your friends will appreciate this novel action and it is a subject which ideally lends itself for making up as gifts, because it is something that is different from the usual run of cigarette boxes.

Apart from ensuring that the simple mechanism works freely so that a cigarette is delivered at each depression of the lever, care should be taken to obtain as nice a finish as is possible to the model. An ideal place for its

positioning would be on your own piano or sideboard, mantelpiece, etc.

The cigarettes are loaded into their special container by way of the hinged top of the piano. From here they drop individually on to the top of a platform, which is operated up and down by the lever at the side. The cigarette is lifted as far as the slot opening in the front of the piano, and then falls neatly into place on the music stand. When the platform returns to its resting position, another cigarette falls into place ready for ejection by a further pressing down of the lever.

Most of the parts which go to the making of the box and the mechanism are shown full size on the design sheet. These can be traced and transferred by means of carbon paper on to their appropriate thicknesses of wood. It will be noted that measurements are given for the back and top, and these should be marked out separately on to the wood.

Next cut out all parts with the fretsaw and be sure to keep as near as possible to the lines, as smooth working of the 'machinery' will depend to a large extent on the accuracy of cutting.

Hobbies Kit No. 3344 for making the Piano Automatic Cigarette Box contains all wood and materials, including special printed plastic keyboard. Kits from branches, etc., price 8/3 or from Hobbies Ltd, Dereham, Norfolk (post 1/6 extra).

Fig. 1 shows the first stage in the assembly, for which glue is used throughout. To the front (piece 1) are added pieces 3 and 4. All positions are marked clearly on the design sheet. The triangular fillets are glued in the corners to give additional support. After chamfering down to the sections shown on the design sheet, pieces 24, 6 and 5 are glued in position between pieces 3 and 4. It is desirable to obtain a smooth finish to the exposed (upper) surface of piece 6, as this will assist the cigarettes to roll down smoothly on to the platform for individual ejection. Piece 7, which is the lever block, is glued to piece 1 (Fig. 1).

Do not add the sides (pieces 2 and 10) until the platform mechanism has been assembled and tested for perfect working. Test before glue has hardened in case pieces 5 and 24 have to be moved nearer to piece 1 to prevent cigarettes jamming. Fig. 2 clearly shows the action obtained by movement of the lever (piece 9). This actuates the platform (piece 8) which is cut from $\frac{3}{8}$ in. wood. Its thickness has to be rubbed down approximately $\frac{1}{16}$ in. as shown in the section on the design sheet in order to ensure ease of working up and down in the chamber formed between pieces 5 and 1. The lever is pivoted with screws on piece 7 and again on piece 8 (see design sheet for positions of both screws). Note also the screws which work up and down on piece 8 in the slides cut in pieces 3 and 4. These help to ensure a smooth action to the platform's up and down movement. To test to see that the ejection action is working perfectly, hold the back (piece 11), temporarily in position, and load the chamber with cigarettes. Depress the

● Continued on page 261

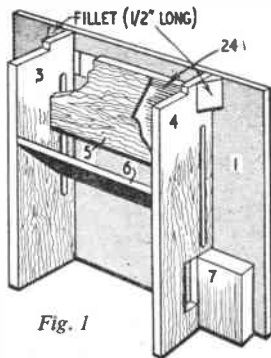

Fig. 1

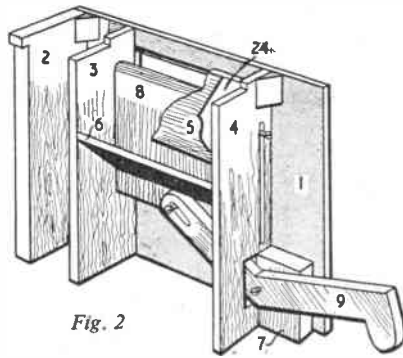

Fig. 2

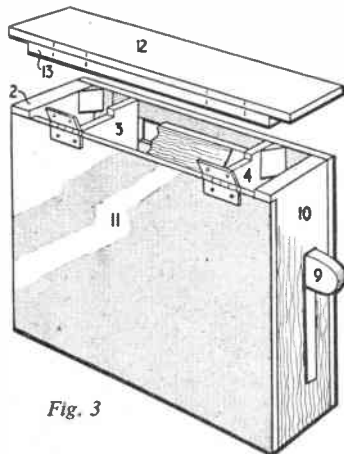

Fig. 3

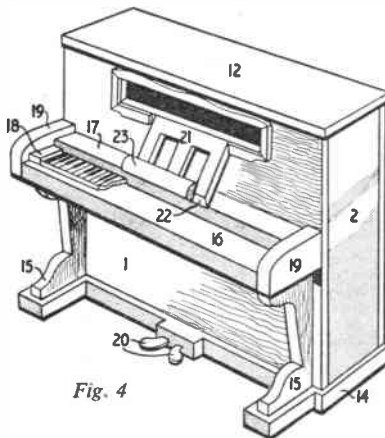
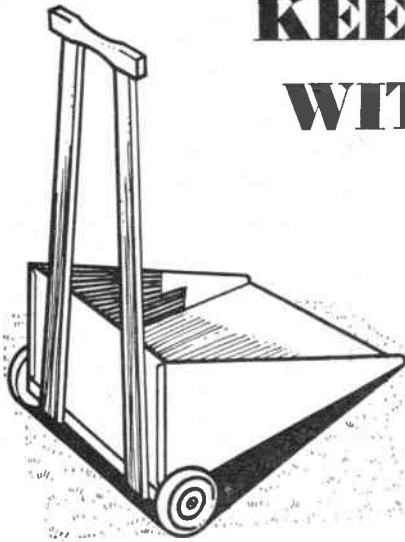

Fig. 4

KEEP THE GARDEN TIDY WITH A LITTER TRUCK



your ironmonger to cut it to that shape. Sheet iron, or aluminium of fairly stout gauge, can be bought from most ironmongers. Aluminium is easier to manipulate and doesn't rust, so this is to be preferred.

Mark out the pattern, given in Fig. 3, on to stiff cartridge paper, or direct on to the metal sheet. Allow $\frac{1}{2}$ in. wide laps where shown. Bend up on the dotted lines, then bend the laps A-B inwards to form flanges which can be riveted, or bolted, to the back piece. The remaining laps are hammered lightly over to the inside to stiffen the whole.

hardwood. Screw these at their bottom ends to the axle at a distance of 3 in. from each end; a single round-headed screw to each will suffice. From an 8 in. length of similar wood, shape the hand-grip, and screw the handles to it at the top.

The pan is now placed in position and holes marked for subsequently fixing it to the axle and handle as seen in Fig. 1. Bolting together is suggested; the pan can then be easily removed for storage. Finally, fix a pair of 4 in. rubber-tired wheels to the axle.

The woodwork should be painted or varnished. (W.J.E.)

● Continued from page 260

Cigarette Box

lever and make final adjustments before adding the sides (pieces 2 and 10) which are also strengthened by the addition of triangular fillets.

The lever goes through the slot in piece 10, as seen in Fig. 3, which also shows the addition of the back and the hinging of the top. This consists of pieces 12 and 13, which are glued together, piece 13 fitting neatly in the cutouts provided in pieces 3 and 4.

Further additions are shown in Fig. 4, and the positions of all pieces which make up the front are indicated by dotted lines on piece 1 on the design sheet. The decorative overlay round the cigarette ejection opening can be cut in one piece or mitred at the corners.

The music rest is made up from pieces 21, 22 and 23, and is glued in place in turn. Those working with a Hobbies kit will have the keyboard printed on plastic, which is glued in position on piece 16. Incidentally this part of the kit can be obtained separately, otherwise the keyboard can be marked out on card or stout paper and added as mentioned. The foot pedals are shaped from thin metal and pushed into the base (piece 14) which is then glued in position to complete the assembly.

Glasspaper and smooth down well before adding the finish. This is a matter of personal choice, such as staining and polishing, or painting, and for this model, jet black would be appropriate. Other workers who are accomplished at veneering might find this a suitable and satisfying subject.

FOR sweeping up light rubbish from the garden, such as accumulates in the winter, the design of truck shown here will be found very efficient. Being low to the ground, it enables rubbish to be swept in without much labour, and just as easily wheeled away and dumped on the compost heap, or burnt.

A rear view of the truck is shown in Fig. 1 and a side view in Fig. 2. Construction is easy, and the cost is very small, the metal pan being perhaps the most expensive part, but even that should not exceed a few shillings. The pan should be made first, as it is neces-

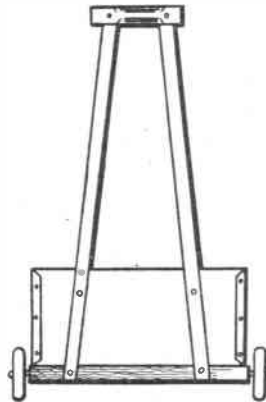

Fig. 1

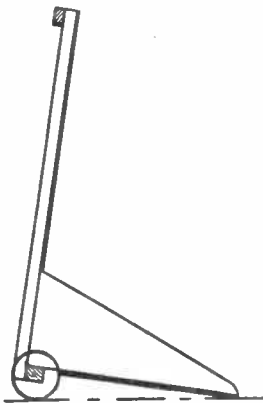

Fig. 2

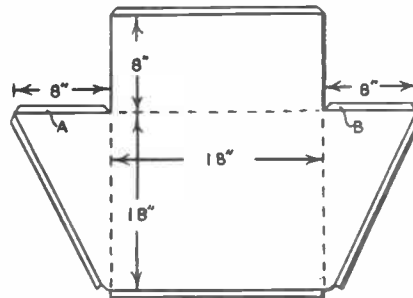

Fig. 3

sary to know its exact width in order to make the axle rod the correct length.

Unless you possess cutting shears for the metal, it is advisable to make a full-size pattern of the metal sheet and get

Now cut the axle rod from 1 in. square hardwood. It should be long enough to extend over each side of the pan by $\frac{1}{2}$ in. The handle is composed of two 2 ft. 6 in. lengths of 1 in. by $\frac{3}{4}$ in.

FUN WITH JET PROPULSION

SIR ISAAC NEWTON stated in his great book, the 'Principia', that every action has an equal reaction which acts in the opposite direction. The force of reaction is commonly met with in daily life. Guns recoil when fired. That is why a soldier must press the butt of his rifle firmly against his shoulder when he shoots. Rotating lawn sprinklers are driven by the reaction of the water jets. Unless a team of two or three firemen direct the nozzle of a fire hose, the powerful reaction to the high-pressure jet of water will be sufficient to knock a single operator backwards. Indeed, some emergency fire floats are actually propelled over water by the reaction of water jets directed backwards through hoses. Jet planes and space rockets would be impossible if the driving force of reaction did not exist.

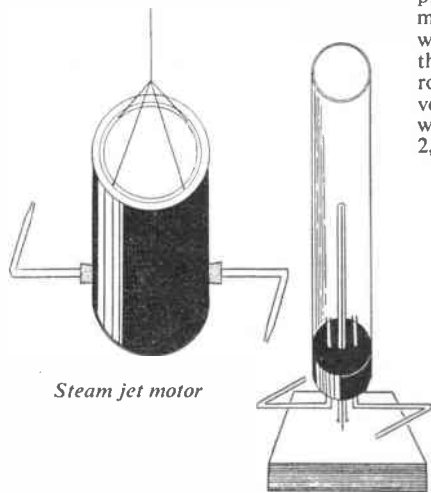

Steam jet motor

Water turbine

You can study action and reaction when you construct the simple models described here.

Steam jet motor

With a syrup tin, some corks and glass tubing you can make a steam jet motor that will be capable of spinning at considerable speeds. Bore two holes in the tin to take the corks. The holes should be in positions opposite one another, about $1\frac{1}{2}$ ins. above the base of the tin. Commence the holes with a drill and enlarge them, using a file.

Make twin jet tubes from two 6 in. lengths of $\frac{1}{4}$ in. diameter glass tubing as follows. Bend the tubes over a hot

bunsen flame to form identical L pieces with short arms 2 ins. long. Heat the ends of the short arms until they are red hot and almost sealed over, in order to make narrow openings for the steam jets. Use cork borers or a large red hot nail to make holes in the corks through which the glass tubes can be tightly inserted. Fit the corks with the jet tubes into the tin in such a manner that the jets point in opposite directions.

Drill four small holes at equal distances apart in the flange of the press-in lid of the syrup tin, and fasten 4 in. long wires to the lid by threading them through the holes and twisting with pliers. Twist the wires together above the centre of the lid and tie on a length of strong twine. It will now be possible to suspend the apparatus over a bunsen burner or other kind of heater.

Place $\frac{1}{2}$ in. depth of water into the tin, press on the lid and suspend the jet motor over a bunsen flame. When the water boils, jets of steam will rush from the glass tubes, causing the tin to rotate rapidly. This is a simplified version of the 'Ball of the Winds' which was invented by Hero of Alexandria 2,000 years ago, and was the world's

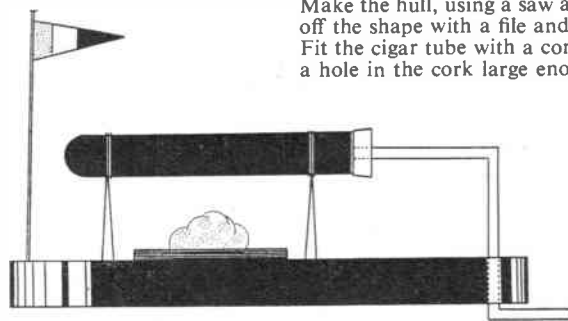

Jet driven boat

first jet driven motor and steam engine.

Water turbine

Another kind of reaction motor is a type of water turbine made from a 6 in. length of 1 in. diameter glass tubing. Obtain a cork to fit the tube and bore in it three $\frac{3}{8}$ in. diameter holes. Bend two 6 ins. long $\frac{3}{8}$ in. diameter glass tubes upwards and outwards at right angles. The bends should be 2 ins. apart. Make jet tubes to point in opposite directions by almost sealing an end of each tube in a hot gas flame. Heat-seal one end of a 4 ins. long, $\frac{3}{8}$ in. diameter tube to provide a spindle mount. Erect a 5 ins. long piece of steel knitting-needle upright in

the centre of a 4 ins. by 4 ins. slab of $\frac{1}{2}$ in. thick wood, to make a spindle.

Insert the sealed end of the straight tube into the cork, leaving a short open neck projecting from one side. Fix the bent jet tubes in the cork on either side of the straight glass tube and press the cork into the end of the wide glass tube, so that the jets swing out on both sides beneath the body of the apparatus. Mount the whole assembly over the upright spindle.

By A. E. Ward

Operate the turbine by pouring water into the wide tube and letting the liquid stream out through the jet tubes. If the model is placed under a tap, the reaction to the water jets will cause the little motor to spin round.

Jet driven boat

You can make a jet driven boat, using a metal cigar tube, a 9 in. length of $\frac{1}{4}$ in. diameter glass tubing and a piece of wood shaped in the form of a boat hull. Make the hull, using a saw and finishing off the shape with a file and glasspaper. Fit the cigar tube with a cork, and bore a hole in the cork large enough to take

the glass tubing. Bore a hole in the stem of the boat hull, through which to pass the jet tube. Bend the glass tubing at right angles, about 4 ins. from one end and pass the 5 in. arm of the tube downward through the hole in the stem. Whilst holding the glass in place, bend back the tubing at right angles 2 ins. from the lower end, taking care not to burn the wood. Heat the lower end of the jet tube until it is almost sealed over.

To assemble the boat, push the upper part of the jet tube into the cork, and press the cork into the metal cigar tube. Support the cigar tube upon two pairs of

●Continued on page 263

LUCKY ENVELOPE TRICK

YOU will probably have seen that popular trick where sealed envelopes are freely selected by members of the audience; one is said to contain a treasury note, but somehow or other it is always the performer who is left with the lucky envelope. At first sight it may not be obvious that not one of the envelopes holds the note, but instead they each contain a message which may read 'Better luck next time', 'You have drawn a blank' or 'Ever been had?' much to the disappointment of the receiver.

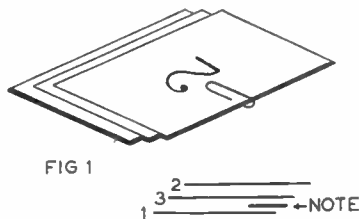

There is no sleight of hand required for this trick, and all that is required is careful preparation followed by some neat manipulation, so we will examine the routine which will enable you to perform this illusion with every confidence.

Preparation

Three envelopes are required — although you can use four or five as your skill increases — marked with large numbers on the fronts 1, 2 and 3. Short messages as mentioned above are prepared and inserted and the envelopes sealed and clipped together with a glider as shown in Fig. 1. Note that the numbers should be fairly large, and the arrangement is as shown so that number 2 is on top, number 3 in the centre and number 1 at the back. You will see the necessity for this later. In between envelopes 3 and 1 a folded ten shilling note is placed, if you can borrow one, and you will see that since the top envelope overlaps the others, the note is hidden from view. You will also require a pair of scissors for the climax of the trick.

The envelopes are taken up from the table in the *left* hand and exhibited to the audience, and while withdrawing the clip with the *right* hand remark: 'I have three envelopes here numbered 1, 2 and 3, one of which contains a 10/- note. I would now like two members of the audience each to select any envelope they choose, and we will see who is the lucky one. Oh, sorry, I should have

placed number 1 at the front.' With this last remark the performer takes a quick glance at the envelopes, apparently noticing that number 2 is at the front. This allows an opportunity to transfer the envelopes to the *right* hand, gripped so that the note is held firmly as shown in Fig. 2. And when number 1 envelope (which has deliberately been placed at the back) is brought to the front the secreted note is kept in place by the

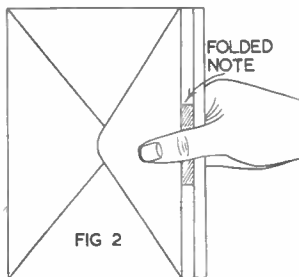

thumb. In this position the envelopes can be fanned out, but the note will not be visible to the audience.

Having disposed of one envelope and a second one has been chosen, it will be found that whatever number is selected, it can be released without the right hand losing grip of the note behind the odd remaining one, and this should then be transferred to the *left* hand in a horizontal position, when the left thumb takes control of the note at the back.

We are now approaching the end of the trick, and the two members are asked to open their envelopes to inspect

the contents to see whether their choice has proved lucky. You know that you still retain the note, but they may read the messages.

The envelope is now held in the left hand face towards the audience, and all

By 'Mystifier'

that remains for you to do is to slit open the long uppermost edge with the pair of scissors which are then returned to the table. The right hand is brought into action again and you should carefully note the following. The cut envelope is opened slightly by the first finger of the right hand, then pushing in the second finger, but allowing the thumb to catch hold of the note from the outside. The left thumb releases the grip of the note, and in one vertical, withdrawing movement, the note can be lifted the short distance, and is apparently removed from inside the envelope.

There is another modification of the latter action you may like to try. After slitting open the envelope with the scissors, the latter are lowered vertically *behind*, so that the points may catch hold of the folded note like a pair of tweezers. From the front the scissors appear to be entering the envelope, and the note is then lifted by the scissors and held aloft to prove that you are the lucky one. If you try this before a mirror, you will discover that the illusion is most successful, but suitable patter to accompany the trick is left to your own imagination.

● Continued from page 262

Jet Propulsion Models

wire legs. This can be done by twisting 7 in. lengths of strong wire once around the tube, and bending the ends down. Fit the four wire legs into nail holes made in the wooden hull. You will also need a pad of cotton wool thoroughly soaked in methylated spirit, and rested upon a metal jar cover, to serve as a heater.

Remove the cork from the metal tube, and half fill the 'boiler' with water. Replace the cork and float the boat in a bowl of water. Place the heater underneath the cigar tube and ignite the spirit. When the water boils, steam will issue from the underwater jet tube with a pleasant popping sound and the boat

will move forward.

It will not be difficult to devise a faster, more efficient, jet boat by increasing the number of jet tubes and using a hollow hull. On the other hand, a very simple version of the model can be made, using a metal cigar tube which has a minute hole bored with a small needle in the centre of the screw-cap. Support the tube upon wire legs, and stand it upon a flat piece of balsa wood which has been trimmed to make a rough boat shape. If a heater, similar to the one already described, is placed beneath the water-filled boiler a jet of steam in air will be sufficient to propel the little vessel over calm water.

For economical running

A 'PERPETUAL' NIGHT LIGHT

IN this night light a small bulb receives current from a mains transformer, and this is very economical indeed, as running costs can be less than 1d. for a thousand hours continuous burning. The illumination is quite powerful enough for a night light, and can be varied somewhat by changing the bulb or its cover.

By 'Modeller'

A heater, filament or bell transformer will be satisfactory. Small bell transformers are easy to obtain, and low in cost. They usually supply 3V., 5V. and 8V. The 3V. tappings will do for a

piece is secured with small screws when wiring has been completed.

For the bulb cover, two pieces $1\frac{1}{2}$ in. in diameter are needed, as shown at A in Fig. 1. Two pieces cut to the shape shown at B are also required.

To make up the cover and mounting, fix one piece B to the box-shaped base. A disc A is then placed on piece B, with a small space between it and the back. A round block to lift the bulb as shown in Fig. 1 goes on top of piece A. These pieces can be fixed together with glue and panel pins. The bulb holder is screwed in place, and two insulated leads are taken down through A, B and the top of the base, for connecting purposes.

The cover can be made from any material which is not too opaque. Clear

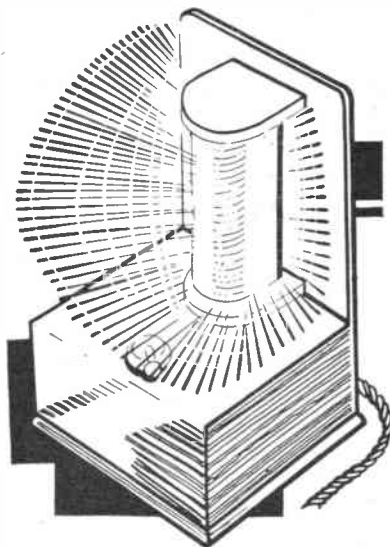
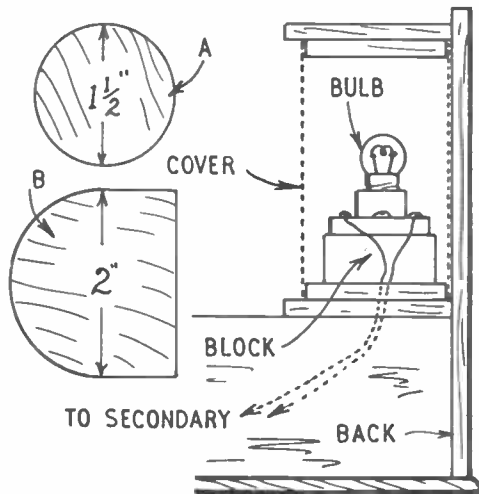

Fig. 1
Bulb and
cover
mounting



celluloid can be used with thin paper inside, and a decoration can be painted on the latter. The cover is formed into a cylinder to fit over disc A, the joint coming at the back.

The remaining pieces A and B are glued together, and fitted to the top of the cover. Two small screws secure piece B to the back, so that the cover can be removed to change the bulb.

3-5V. torch bulb. Or a 6-3V. .3 amp or 6V. .06 amp bulb can be run from the 5V. tappings. Most small heater transformers deliver 6-3V., and a 6-3V. .3 amp bulb is then suitable. If a radio transformer giving 12-6V. should be to hand, a 12-6V. dial light bulb should be used with it.

Wooden items

Wood $\frac{1}{4}$ in. thick can be used throughout, and is easily secured with glue and panel pins. Two pieces $2\frac{1}{2}$ in. by $1\frac{1}{2}$ in. form the sides. The front is 3 in. by $1\frac{1}{2}$ in. and the back 3 in. by $5\frac{1}{2}$ in. The top is 3 in. by $2\frac{1}{2}$ in., and the bottom $3\frac{1}{2}$ in. by $3\frac{1}{2}$ in.

The illustrations show how these items are fixed together, and there will be sufficient space to take a small bell or heater type transformer. The bottom

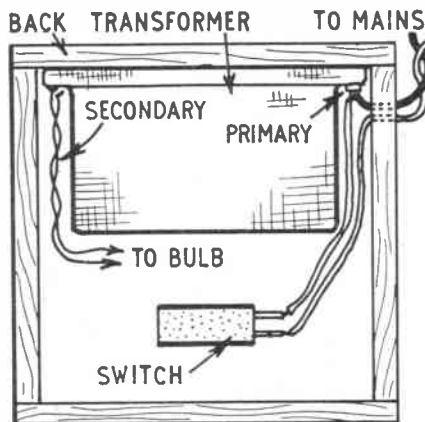

Fig. 2—Transformer and Switch connections

Mains type switch essential

Connections are shown in Fig. 2. The switch must be of the mains voltage toggle type. Bell transformers frequently have screw connecting points, and really tight joints should be made. A length of good quality twin flex forms the mains connections, with a short piece of flex between switch and transformer.

The two leads coming from the bulb holder are taken to the secondary screws or tags on the transformer. It may be necessary to wire up the transformer before actually screwing it inside the base, but this depends on the position of the wiring screws or tags.

The twin flex is taken to an adapter or mains plug. An adapter may be inserted in a room light fitting, but when a wall socket outlet is available it will often be more convenient to draw current from this point.

When the night light is finished, the bottom should be screwed on, and this must not be omitted because it prevents connections, etc. being touched.

TAKING PICTURES FROM TV

WITH the long dark evenings, amateur photographers turn to the indoor branches of their hobby. Prominent among these, of recent years, has been the taking of photographs from the T.V. screen.

Newcomers to this particular branch of photography may wonder what aperture and shutter speed should be used to obtain the best results and the advice most often given is '1/25th second with a minimum aperture of $f4.5$ '. This advice is, of course, perfectly correct and will produce extremely good results — but what about we poor mortals whose humble instruments are not equipped with such large apertures?

Well, even if you have the simplest and most ancient box camera in the country you can still take pictures from your T.V. screen by using the following method. I will assume that your camera is of the normal 'box' or simple folding type with one speed (usually 1/25th second) and 'B' (bulb) or 'T' (Time) and a fixed aperture (usually $f11$). If your camera lens and shutter are at all adjustable, use these settings.

First of all, you need a 1, 2 or 3 dioptre 'close up' lens fitted over the normal lens. If your camera is fitted with a 'portrait attachment', as so many simple cameras are these days, that will be perfectly satisfactory.

With the camera empty and the back removed, set it up in front of the T.V. screen — if you have a tripod, so much

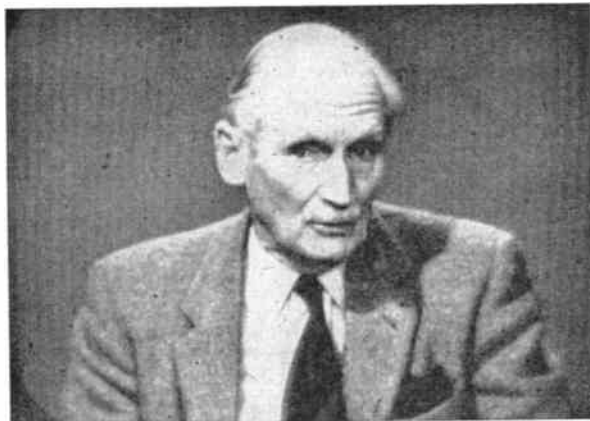

the better; if not, any small table or tea-trolley will do. You can always adjust the camera height with books! Now, with the shutter set to 'B' or 'T', place a piece of ground glass in the film plane and adjust the distance of the camera from the T.V. screen until the T.V. picture is sharply in focus. If you haven't a piece of ground glass a piece of greaseproof or tissue paper stretched across the film plane will serve equally well.

Once the camera-T.V. distance has been correctly adjusted, reset the shutter to '1' (1/25th second) and load the camera with one of the 'fast' films (TRI-X, HPS, HP3 and Gevapan 36 have all been tried and found suitable). If the camera has to be moved while loading, make quite sure that you replace it in exactly the same position. For example, if you are using a box camera resting on a tea-trolley (as I have done on more than one occasion), just make a chalk mark round the camera before moving it. You will then be able to replace it in its original position.

Once the camera is loaded and back in its correct position you can go ahead and take photographs of any reasonably static picture that takes your fancy.

Having used up your roll of film in this way, load it into your developing tank and proceed to develop as follows.

Using one of the popular 'Universal' developers, mix to a strength of 1 part of developer to 5 parts of water and develop for *three-quarters of an hour* at the usual recommended temperature of 68°F. with occasional agitation. It should be stated here that the development time and strength quoted is arbitrary. It can be altered to suit your own particular requirements, but that is a matter for each photographer to find out by experiment. The strength and time I

have quoted suit my own needs and will at least provide a basis for experiment.

At the end of the development time, rinse, fix and wash the film in the usual way. You will probably find that there is a bit of fog on the film, but a bath in a weak ferricyanide solution will soon remove this, although personally I have never found it to be necessary.

All the foregoing may sound a bit startling to those people accustomed to the more orthodox methods of development, but really there is nothing new in it — development to finality has been carried out for many years now.

The pictures shown here have been taken and developed by the method described. The camera I used is an ancient 2½ in. by 3½ in. Voigtlander of uncertain vintage with a 3 dioptre meniscus fitted over the normal lens.

(W.R.B.)

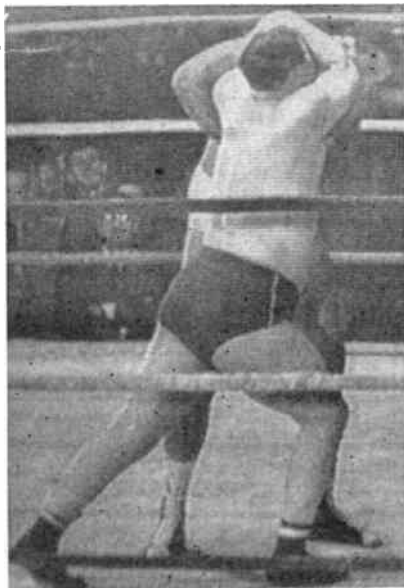

CHEMISTRY

AT HOME

A VERY pleasant and interesting spell can be spent in the home laboratory by trying out special reactions on chemicals taken at random from the shelves. As they can each be quickly carried through, the scheme can be adopted when one cannot spend a lengthy period at the bench.

Aniline is a compound which gives a number of interesting reactions. Try dissolving a drop in a little dilute hydrochloric acid (thereby forming a solution of aniline hydrochloride) and moistening a slip of pine wood with it. The wood turns bright yellow. This reaction is given by many other aniline salts.

Dissolve another drop of aniline in 25 c.c. of water by shaking the two together. Aniline is not very soluble in water and the aqueous solution should be poured off from any undissolved droplets. To some of the aqueous solution add a filtered solution of bleaching powder ('chloride of lime') drop by drop until a purple colouration appears. This is a delicate test for aniline. It may be made even more delicate by the use of a dilute solution of ammonium sulphide.

Try diluting the purple aniline solution until it is practically colourless. Now add the ammonium sulphide dropwise. A fine rose-red colour appears.

Striking change of colour

Another striking colour change can be seen by adding copper sulphate solution dropwise to a few c.c. of the aniline solution. A fine green colouration or precipitate appears.

Jacquemin's test for aniline is extremely delicate. To some of the aqueous aniline solution add a little phenol solution and then a filtered solution of bleaching powder drop by drop. Yellow stripes become evident in the liquid and these soon change to greenish-blue.

Caffeine, the alkaloid contained in coffee and tea and which is responsible for their stimulating properties, gives two easily tried reactions. Put a little caffeine — about as much as the point of a penknife will hold — into an evaporating basin. Moisten it with a few drops of strong hydrochloric acid and add a pinhead-sized particle of potassium chlorate. Place the basin on a boiling water bath until the contents are dry. An orange spot remains in the basin. Invert this over a bottle of strong ammonia. The spot turns a magnificent purple owing to the formation of murexoin.

Caffeine is sparingly soluble in cold water, dissolving in about eighty parts. Prepare a solution of the alkaloid by shaking a very little with water in a test tube. Filter the solution and add one of tannic acid. A white precipitate of caffeine tannate appears. You may have noticed that the tea left in the pot and allowed to grow cold has become turbid. This is also due to the separation of a caffeine tannate, the acid being derived from the tea itself.

SOME INTERESTING SPECIAL TESTS — 1

Like caffeine, uric acid gives a colour reaction when treated with an oxidizing agent. Using an evaporating basin, moisten a little uric acid with nitric acid and evaporate to dryness on a boiling water bath. An orange or reddish residue remains. Add a drop of ammonia. The residue changes to a fine purple colour owing to the formation of murexide. In the last century murexide was extensively used as a purple dyestuff.

Another interesting test for uric acid can be seen by dissolving a little in sodium carbonate solution. Moisten a slip of filter paper with silver nitrate solution and allow a drop or two of the uric acid solution to fall upon it. The silver nitrate is reduced to metallic silver, which appears as a black stain. This test is extremely sensitive. Try diluting the uric acid solution in several stages and repeating the test at each stage. First a brown stain of silver will be produced, and as the dilution proceeds, this pales through light brown and finally is yellow.

Benzoic acid and salicylic acid have a similar appearance, but give different reactions, even though chemically they are closely related. Grind a large pinch of benzoic acid with about four times its bulk of calcium oxide (quicklime), put the mixture in a dry hard glass test tube and heat. The odour of benzene will be noted, and if you turn the mouth of the tube to the flame the benzene vapour will take fire.

On repeating the test with salicylic acid quite a different smell will be apparent, for this is strongly 'carbolic'. It is, in fact, due to the formation of phenol, or 'carbolic acid'.

Another point of difference is the behaviour of the two acids with ferric chloride. Separately dissolve a little of each in dilute ammonia and then boil off the excess ammonia (indicated by the steam becoming odourless and by not bluing red litmus paper). Add a little ferric chloride solution to each.

In the case of benzoic acid a buff-coloured precipitate of basic ferric benzoate appears, whereas with salicylic acid a purple colour develops.

Reactions with acetone

Acetone, which is much used as a solvent in cellulose lacquers, gives two interesting reactions. It gives the iodoform reaction and may also be oxidized to acetic acid.

Mix a little acetone with a few c.c. of water and add 5 cc. of a 10 per cent solution of sodium carbonate (washing soda). Drop by drop add a solution of iodine in potassium iodide. When the solution is coloured strongly yellow, stand the test tube in a beaker of warm water, when a yellow precipitate of iodoform makes its appearance. This usually settles out in the crystalline state. Note that its odour is rather like a mixture of iodine and apples.

For the oxidation of acetone, mix acetone with an equal volume of potassium permanganate which has been acidified by the addition of dilute sulphuric acid. Put the test tube in warm water (no flame, since acetone vapour is inflammable) until the purple colour disappears, showing that oxidation has taken place. Transfer the test tube to a vessel of cold water and when the solution is cold, neutralize it by the dropwise addition of sodium hydroxide solution. When a drop of the mixture no longer reddens blue litmus paper, but turns it a pale purple colour, add a little ferric chloride solution. The mixture becomes of a deep red colour due to the presence of ferric acetate.

Boil about 1 c.c. of the mixture. The red colour gives way to a buff precipitate of basic ferric acetate.

Further interesting special tests will be given in a second article. (L.A.F.)

For Plastic Modelling

The Humber Oil Co. Ltd., have developed a new pack of polystyrene cement for plastics, marketed as Britfix 77. With the 1 oz. tube retailing at 1/- there is included a special fine flow applicator for making the use of the cement more speedy and accurate. Britfix 77 is an ideal adhesive for plastic models — it does not string, and is free-flowing. It is also available in ½ oz. tubes at 6d. each. These tubes have fine nozzles, but the separate applicator is not supplied.



Copyright photograph by permission of British Railways

Just like the real thing!

Airfix kits are not just models — they're exact replicas, each series to a constant scale.

Airfix 00 gauge Signal Box. 2/-.

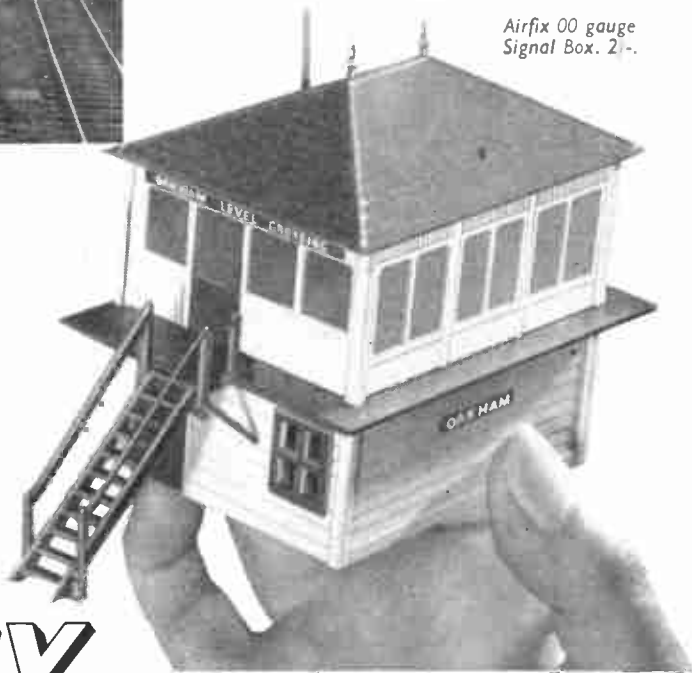

There are models galore in the Airfix range! Aircraft from fighters to bombers (all to the same 1/72nd scale), 00 gauge railway accessories, vintage cars, historical ships. Airfix value is unbeatable — ask your dealer for the latest list.

Nearly 100 kits from 2/- to 10 6d.

AIRFIX

THE WORLD'S GREATEST VALUE IN CONSTRUCTION KITS

From Model and Hobby Shops, Toy Shops and F. W. Woolworth



AIRCRAFT
Bristol Superfreighter 7/6d.

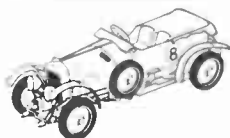

VINTAGE CARS
1930 Bentley 2/-

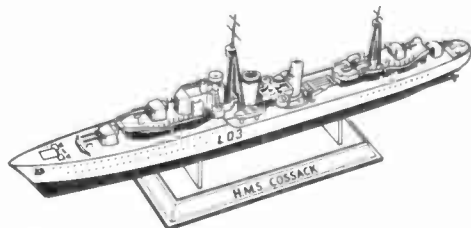

H.M.S. COSSACK A brand new Airfix series is here . . . Famous Warships, all to a constant scale (50 ft. = 1 inch). First in the series is this perfect 7 3/4 inch long model of a renowned destroyer. Packed in attractive box, only 2/-.

Also new: SUNDERLAND III, perfect 1/72nd scale model of the famous flying boat. Wing span 19 inches, 10/6.

MODEL FIGURES

Lifeguard 2/-



HISTORICAL SHIPS
H.M.S. Victory 2/-

Mainly for Modellers

FOLLOWING our outline of the building of the hull of the wooden vessels in which we are interested, let us now proceed to help the model maker with a study of the characteristic details of some of the early ships, dividing our survey into three sections—the head (or forepart of the ship), the broadside, and the stern and quarters.

First we will deal with details of the head. Looking at Fig. 1 we have the head or bow end of an English thirteenth-century vessel, showing the type of castle erected at this period, on the short foredeck. This sketch is taken from early seals and represents the type of vessel used to transport the Crusaders to the Holy Land. The upward sweep of the stem shows that this type of vessel

head of this ship we see the influence of the carrick type of vessel. This again appears in the design of the English fifteenth and sixteenth century ships as in Fig. 5, which type is also seen among the ships of many other nations.

In English ships of the sixteenth century, the early Tudor period carried, as shown in Fig. 6, a more upright stem and the usual dragon figurehead, but the castle still bears some resemblance to the carrick type.

In Henry VII and Henry VIII reigns, the Navy in England really began to take shape as the forerunner of the modern navy. It was about this period that we actually started to design vessels as war ships, instead of increasing the fighting navy by taking over existing

adapted the galleon type for war. Noticeable is the fact that these nations were very much attracted by decoration. While the English vessels relied on paintwork with practically no carving, the figurehead being mainly the lion, the French, Spanish, Dutch, etc, loved the heavy carvings and decorations that make these vessels so attractive when modelled as an ornament for the home, as distinct from true scale-modelling.

WOODEN SHIP-BUILDING — 5 By 'Whipstaff'

Notice in Fig. 8 the sweep and grandeur of the stem, and heavily carved figurehead of the Spanish Treasure Galleon. This is from a model made by myself and based on authentic information.

Fig. 9 is the head of a French galleon. Here again it is from authentic plans, and shows the elaborate decoration so



FIG. 1

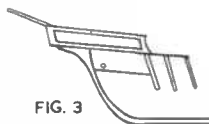

FIG. 3

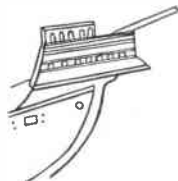

FIG. 4

based on the excellent seaworthy ships of the Vikings.

Fig. 2 shows the bow of a Venetian carrick at the period when Venice was one of the main maritime powers (the fifteenth and sixteenth centuries). Fig. 3 illustrates the Spanish type of the same period. Although exact details of the Santa Maria of Columbus are not available, models of this famous ship are usually based on the type shown here.

Coming nearer home we have in Fig. 4 the head of the famous Scottish vessel of 1511, the Great Michael. In the

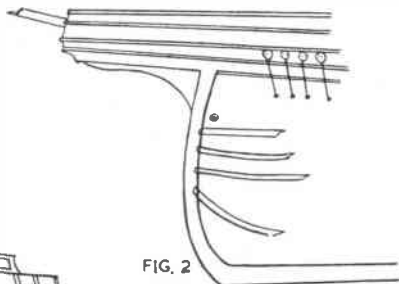
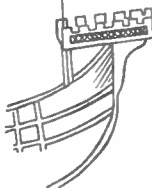

FIG. 2



FIG. 5



vessels and fitting them out as warships. During this period the galleon type began to be the main ship design, and in Fig. 7 we have illustrated two types of head from existing drawings of galleons of the period built in England.

Among our rivals for maritime supremacy the continental nations also

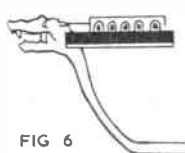

FIG. 6

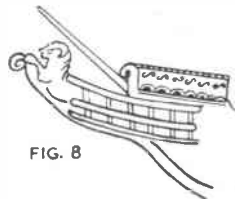

FIG. 8

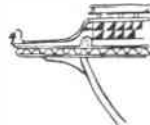

FIG. 7

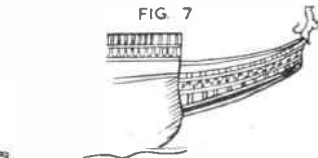

FIG. 9

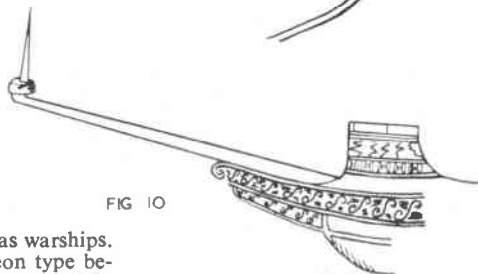
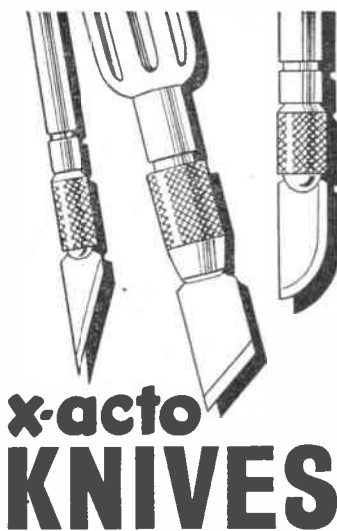

FIG. 10

loved by the French.

Fig. 10 is the bow of a Flemish galleon from an actual contemporary model. Notice the extremely elongated appearance of the galleon beak.



x-acto KNIVES

with the **BIG RANGE** of **INTERCHANGEABLE BLADES**

From Hobby Shops and ironmongers

Please write for illustrated brochure

DUFAY (B'HAM.) LTD.

X-ACTO DIVISION, 308 SUMMER LANE, BIRMINGHAM 19



X-acto Knives are made to develop your skill — with 3 different weights of handles, 25 interchangeable blades, gouges, routers, and punches — all in razor-sharp surgical steel.



what's
in
a
name?

When the name is CASCAMITE—CASCAMITE "One Shot"—there's a great deal in it—for woodworkers. Once it's been tried, CASCAMITE is the glue in which every woodworker swears undying faith!

CASCAMITE "One Shot" has the outstanding performance of a resin glue yet does not require a separate hardener to make it set. Each tin contains the resin powder and the hardener, blended together in exactly the right proportions. For use, only *one* operation is necessary—simply mix with cold water. And for woodworking jobs (furniture making, joinery, boat building, etc.), joints made with CASCAMITE will be as strong as the wood itself, stain-free, heat resistant and waterproof. Furthermore, joints can be successfully glued even when there are gaps between the surfaces of up to $\frac{1}{8}$ in. Test this unique glue for yourself on your next woodworking job. Packed in 3½, 7 & 18 oz. tins (2/6, 4/- & 8/6 respectively).



And for a professional finish to your woodworking jobs, be sure to use CASCO Wood Stopper for filling cracks and knots, covering nail and screw holes, etc. It sets rapidly giving a hard surface which takes stain, polish or paint. Packed in 8 oz., 2 lb. and 8 lb. tins (2/-, 4/- and 10/6 respectively) and available in white, cream and 8 wood colours.



112

Stocked by Ironmongers, Builders' Merchants, Handicraft Shops, etc.



SYNTHETIC RESIN & CASEIN GLUES

Manufactured by
LEICESTER, LOVELL & CO. LTD
NORTH BADDESLEY SOUTHAMPTON

APPARATUS & CHEMICALS

For your experiments. Let us help you equip a **HOME LABORATORY**

Beakers, Crucibles, Flasks, Funnels
Gas Jars, Test Tubes, etc.

Booklets:
(including postage)

'Experiments' 1/2
'Formulas' 1/2
'Home Chemistry' 2/10
New edition

Send 3d. Stamp for latest **PRICE LIST**

A. N. BECK & SONS (Dept. H.W.)
60 Stoke Newington High Street, London, N.16



HEAR ALL CONTINENTS With H.A.C. Short-Wave Receivers

Suppliers for over 18 years of Radio S-W Receivers of quality.

One-Valve Kit, Price 25/- Two-Valve Kit, Price 50/-
Improved designs with Denco coils. All kits complete with all components, accessories and full instructions. Before ordering, call and inspect a demonstration receiver, or send stamped addressed envelope for descriptive catalogue.

'H.A.C.' Short-Wave Products (Dept. 22), 11 Old Bond Street, London, W.1

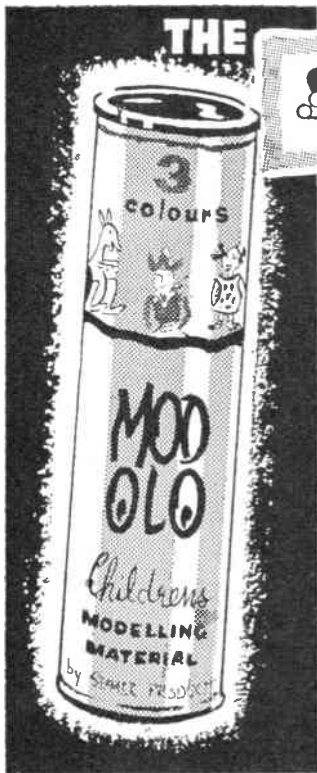

Sculptorcraft

people present!

'MODOLO'

Here's a fabulous new modelling hobby for children of every age. Even adults will find this fascinating, as with small pieces of wire life-like flowers can be made. There are three colours which will mould into all the colours of the spectrum.

'Rubbacraft'

These delightful figures are designed as squeaky toys for younger children. But they have sufficient merit to be hung as mascots.

- | | |
|--------------------------|--------------------------|
| 1. Dulcie Doll. | 4. Monty Monkey (illus.) |
| 2. Christopher Choirboy. | 5. Pete the Pied Piper. |
| 3. Clarence Clown. | 6. Terry Teddy Bear. |
| | 7. Gordon Golliwog. |

see us on T.V.

You saw us recently on the "Send for Saunders" programme. We shall be on T.V. again soon. Watch out for us.



SEAMER PRODUCTS (SCULPTORCRAFT) LTD
23/27 EASTBOURNE STREET, HULL

★ **LEARN** ★
RADIO & T/V
SERVICING
for your **OWN**
BUSINESS/HOBBY

● by a new exciting no-maths. system, using practical equipment, recently introduced to this country.

FREE Brochure from : —

RADIOSTRUCTOR
DEPT. G81, 46, MARKET PLACE,
READING, BERKS, 13,1

MAKE A MUSICAL BOX for as little as 19/9. New kits and tunes available. Movements 11/9. Please send 3d. stamp for free illustrated catalogue. — Swisscross Ltd., Dept. B, 202 Tulse Hill, London, S.W.2.

100 DIFFERENT stamps free! Request 1d. upwards discount approvals. — Bush, 53 Newlyn Way, Parkstone, Dorset.

WHEELS (Hardwood and Rubber Tyred Metal). Cot, Pram and Doll's House Fittings and Papers. Beads, Transfers, Prints and other accessories. Stamp for new lists. (Trade supplied.) New address — JOYDEN CO., 91 Pepins Way, Brookmans Park, Herts.

STAMPS FREE — Empire Packet including Spictorials and Victorians with approvals. — Robert J. Peck, 7A Kemp Road, Bournemouth.

Further reduced

Brand New
Slip into it — soft and comfy — enjoy restful sleep throughout night. No blankets, no sheets, everything in

one including special padding for a beautiful soft mattress effect. Light as a feather, it rolls up to a tiny lightweight size. 19/11, post 2/6. Even finished in heavy quality strong material. Really hardwearing. Not a blanket with outer, but genuinely quilted. **LISTS, WATCHES, etc.**



Sent for 10/-, bal. 18 fcnly. p y m t s. 7/6. Plus carr.

Water-proofed 1960 Tents of 8 oz. **WHITE DUCK**

1/2 PRICE OFFER! **SENT FOR 10/-**
The **FLIGHT LIEUTENANT** **Genuine NEW** Waterproofed 8 oz. **DUCK TENT**
CASH PRICE £5 17/6 CARD 6/-
Galeproof Brand new, surplus to export order. **DON'T CONFUSE** with Tents made from drab material never meant for tentage. This is real thing, withstands anything even in our climate. Approx. 7ft. 6in. x 6ft. x 6ft., 3ft. walls. Cash £5/17/6, carr. 6/- complete ready to erect, incl. valise. 'Willesden' Green 42/- extra. Ridge pole if req. 7/6. Flysheet available 37/6. Rubberised Groundsheet 19/6. These essentials sent on appro.

Headquarter & General Supplies Ltd.
(HOBW/97) 196-200 Coldharbour Lane Loughbore Junc., London S.E.5. Open Sat.

LEARN RADIO and ELECTRONICS the NEW practical way! Very latest system of experimenting with and building radio apparatus — 'as you learn'. **FREE** brochure from — Dept. HW 10, Radiostructor, 46 Market Place, Reading, Berks.

MODELS. You can make lasting stone-hard models with Sankey's Pyruma Plastic Cement. Supplied in tins by Ironmongers, Hardwaremen and Builders' Merchants. Ask for instruction leaflet.

BUILD YOUR OWN HI-FI at home! At last, for reasonable cost — the chance to make your own quality HI-FI audio equipment and to gain the knowledge to service and maintain it. **FREE** brochure from — Dept. HW 20, Radiostructor, 46 Market Place, Reading, Berks.

EXTRA cheques from writing. Send for 'Ideas for Writers' (free). Scores of suggestions for beginners and others. Typewriter unnecessary. — Writer's Ring (H.W.), 5 Edmund Street, Birmingham 3.

KUKLOS ANNUAL. Indispensable cyclist's handbook. Tours, resthouses, money-saving hints, 3/-, post free. — Burrow, Publishers, 2 Imperial House, Cheltenham.

CAN YOU DRAW OR PAINT — even if only beginner? Send for free booklet 'Make Art Pay', explaining how to develop your talent and sell to us. — Clun Valley Features (HW.), Clun, Shropshire.

WORKERS with sewing machines required for making cushion covers. Regular work guaranteed. Apply, enclosing S.A.E. — Dept. 28, Arnold Trading, 10 Shelley Road, Worthing, Sussex.

A HANDY BOX FOR BUTTONS

**MAKE IT FOR MOTHER
WITH YOUR FRESAW**

THIS handy little box for buttons is cut from $\frac{1}{4}$ in. and $\frac{3}{8}$ in. wood with a fretsaw. It will make a useful gift for mother, and can be made and painted in a few hours.

First of all the shapes must be drawn on to the wood. Pieces D and E, which are shown full size, may be traced and transferred by means of carbon paper.

Cut two pieces A ($\frac{1}{4}$ in.), one piece B ($\frac{1}{4}$ in.), two pieces C ($\frac{1}{4}$ in.), and two pieces D ($\frac{1}{4}$ in.). The overlay E should be $\frac{1}{8}$ in. thick. Assemble the pieces as shown in the sketch on the left of the page. Note that the lid consists of one piece A, and one piece B, glued together. A fancy knob of plastic or wood may be added. The 'buttons' overlay is glued on the front, and the whole box painted in bright colours. (M.p.)

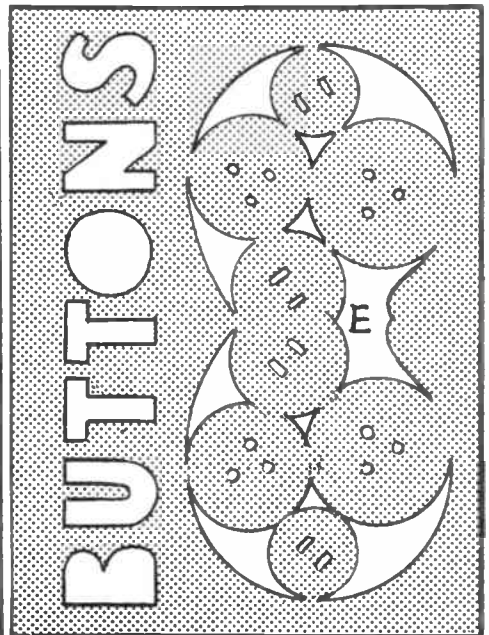
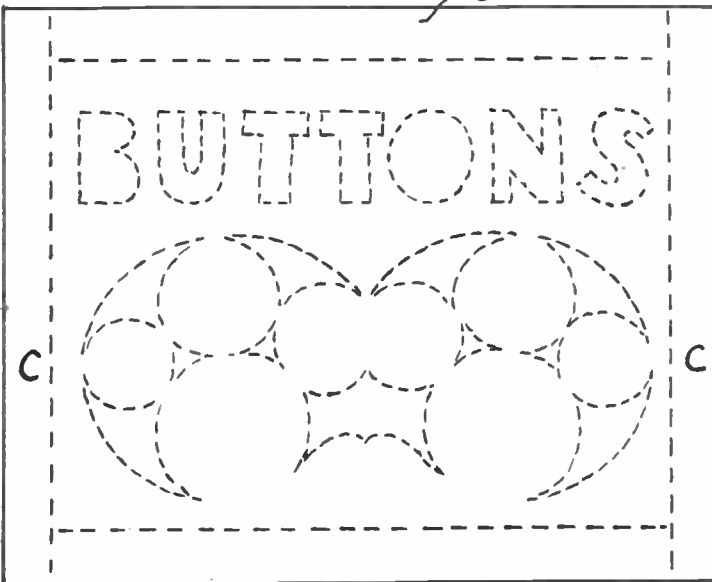
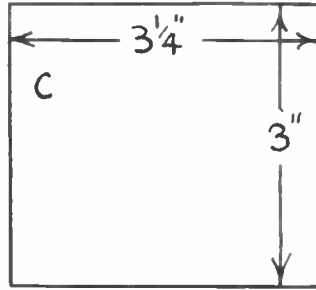
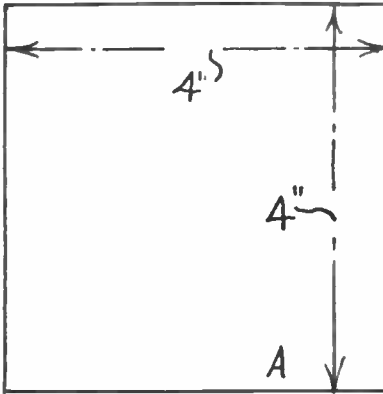
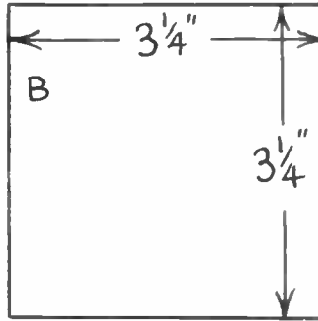
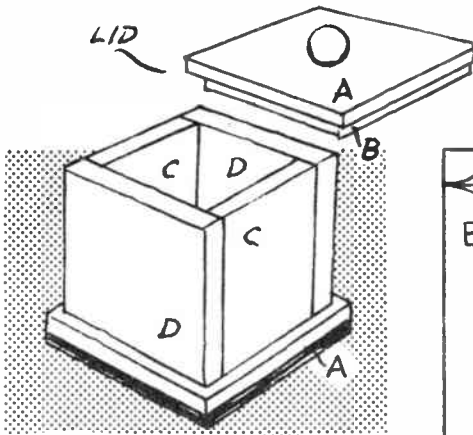

NOW—BRING IT TO LIFE

WITH THE HUMBROL TOUCH!

There's magic in the Humbrol touch! Humbrol is the supreme model builder's enamel, the 'professional' finish which makes so much difference. Equally effective on plastic, wood or metal it dries smoothly and without brushmarks. It gives a hard coating which will last for years and years. There are 34 highly accurate and consistent colours, glossy, matt and metallic. All are intermixable, enabling you to achieve the finest variations in tone. Humbrol is dry in an hour, a great advantage in speeding up model building.

Ask any expert—he'll have the Humbrol touch!

At all good hobby, handicraft and model shops, from $\frac{1}{2}$ oz. to $\frac{1}{2}$ pint tins.

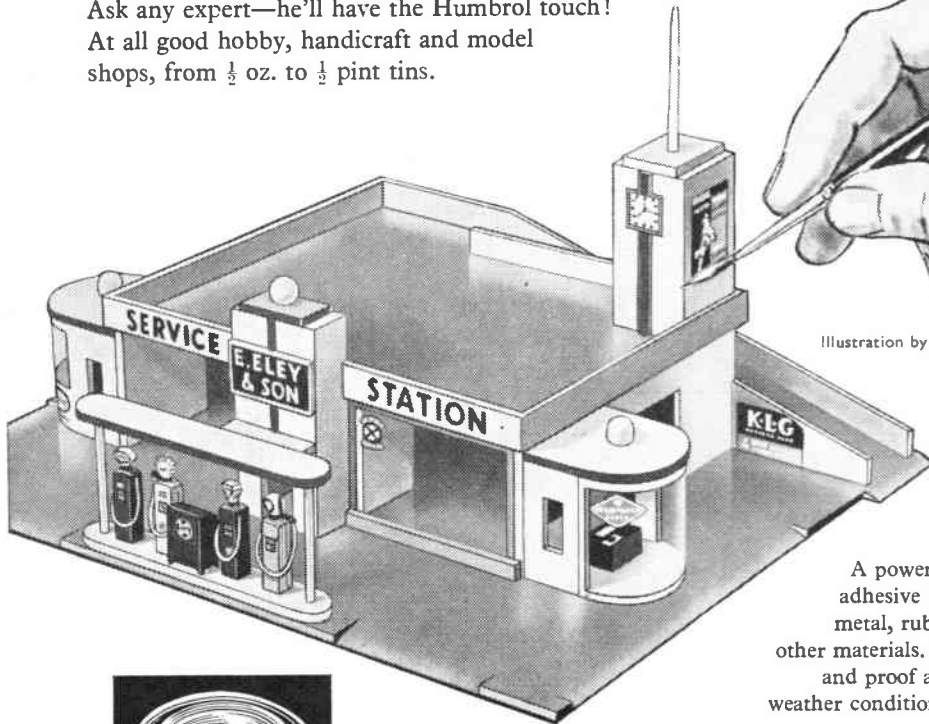

Illustration by courtesy of Hobbies Ltd.



Use Britfix 99 too!
A powerful general purpose adhesive that sticks wood, metal, rubber, glass and many other materials. Extremely durable and proof against water and weather conditions. Large tube 1/9.

HUMBROL

the art enamel that turns
models into masterpieces!

THE HUMBER OIL COMPANY LTD., PAINTS DIVISION, MARFLEET, HULL

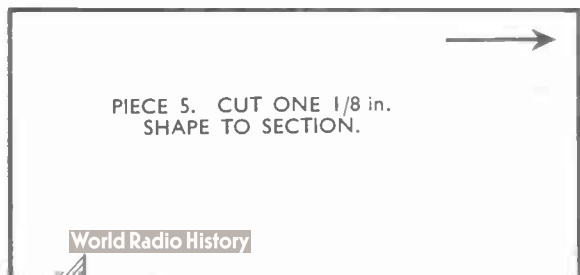
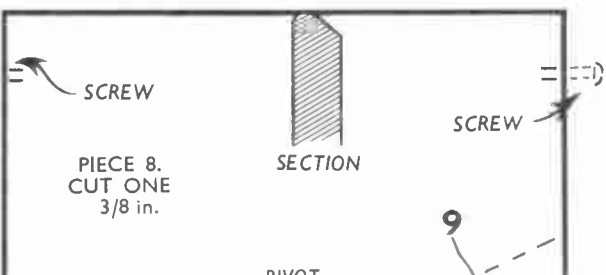
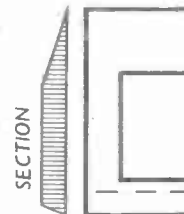
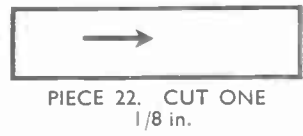
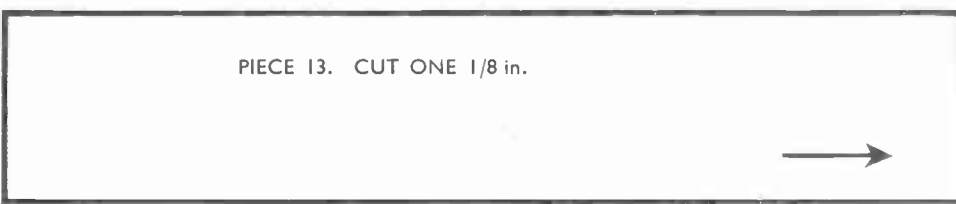
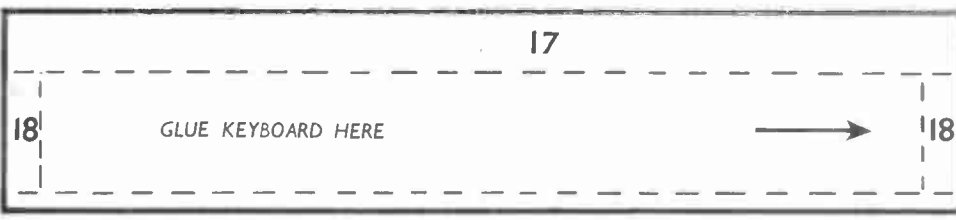
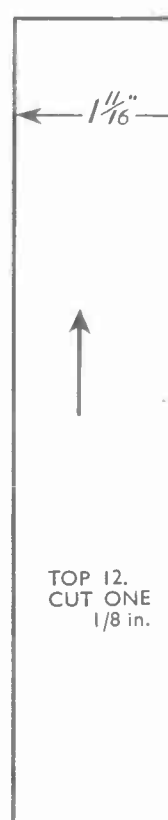
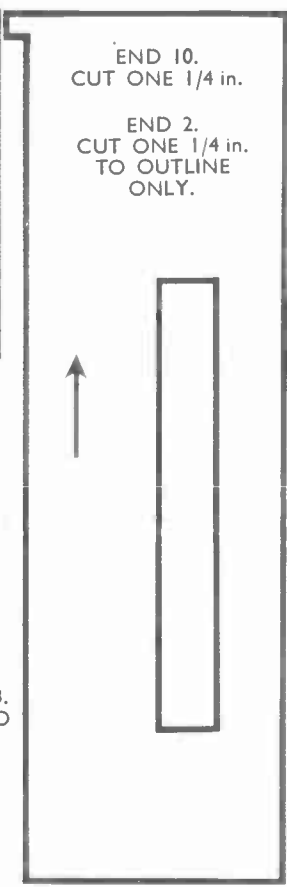
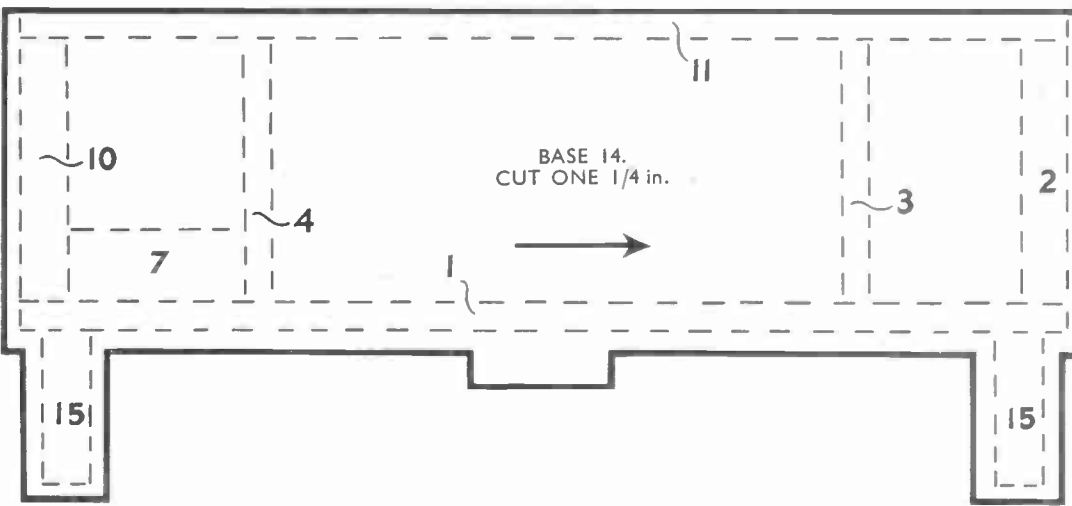
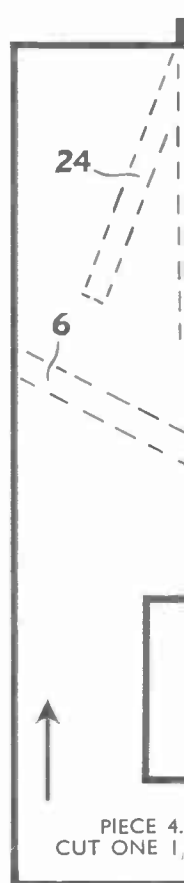
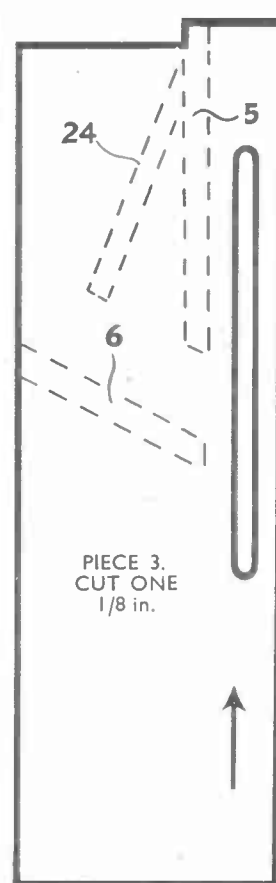
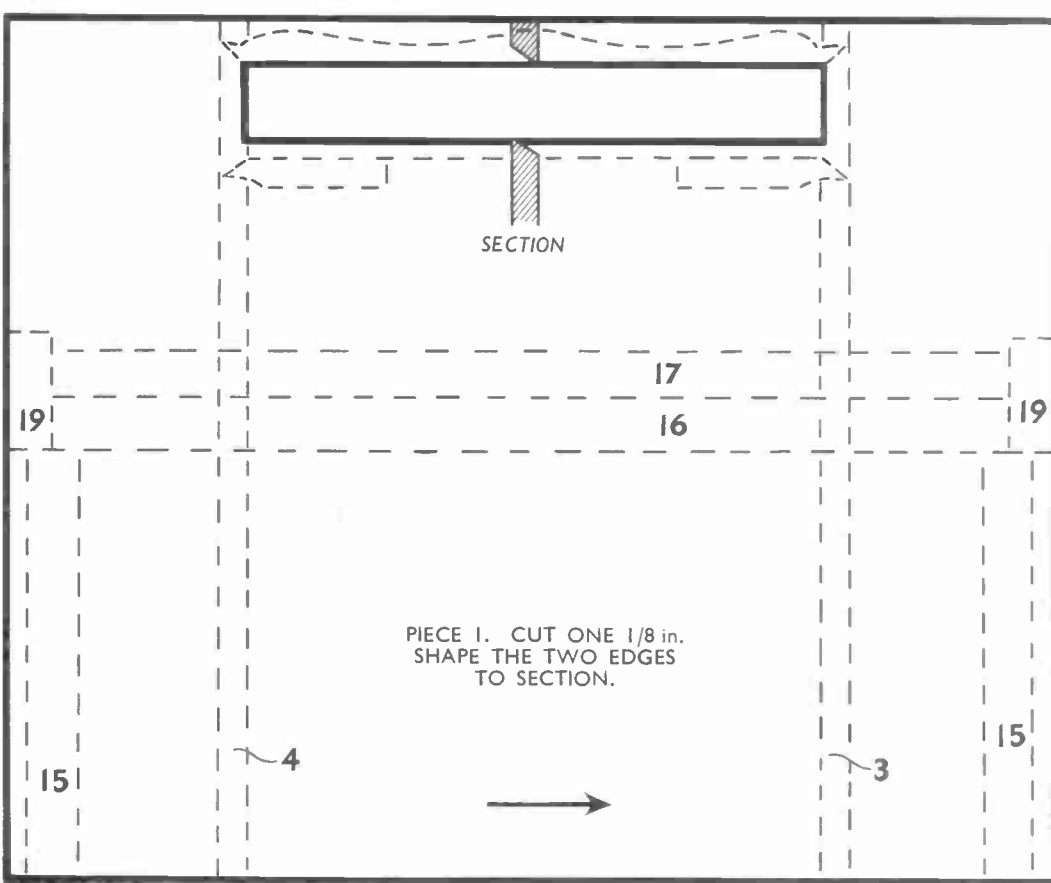



DESIGN

No. 3344

THE PIANO AUTOMATIC CIGARETTE BOX

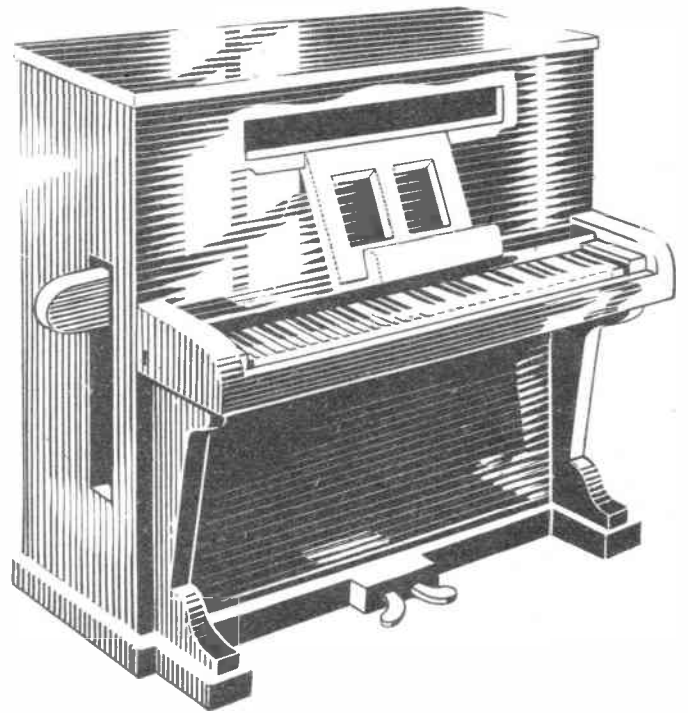

SIZE—6 ins. WIDE. 5 ins. HIGH.

A KIT OF MATERIALS FOR MAKING THIS DESIGN IS SUPPLIED BY HOBBIES LIMITED, DEREHAM, NORFOLK. PRICE ON APPLICATION.

THE ARROWS INDICATE DIRECTION OF GRAIN OF WOOD.

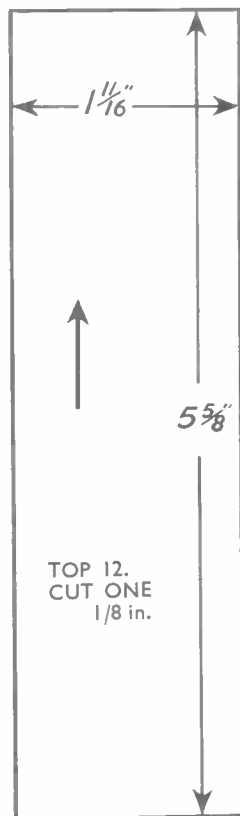
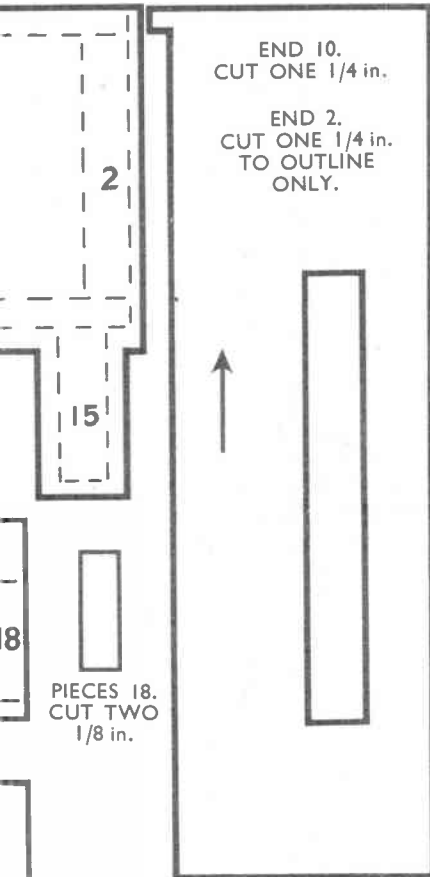
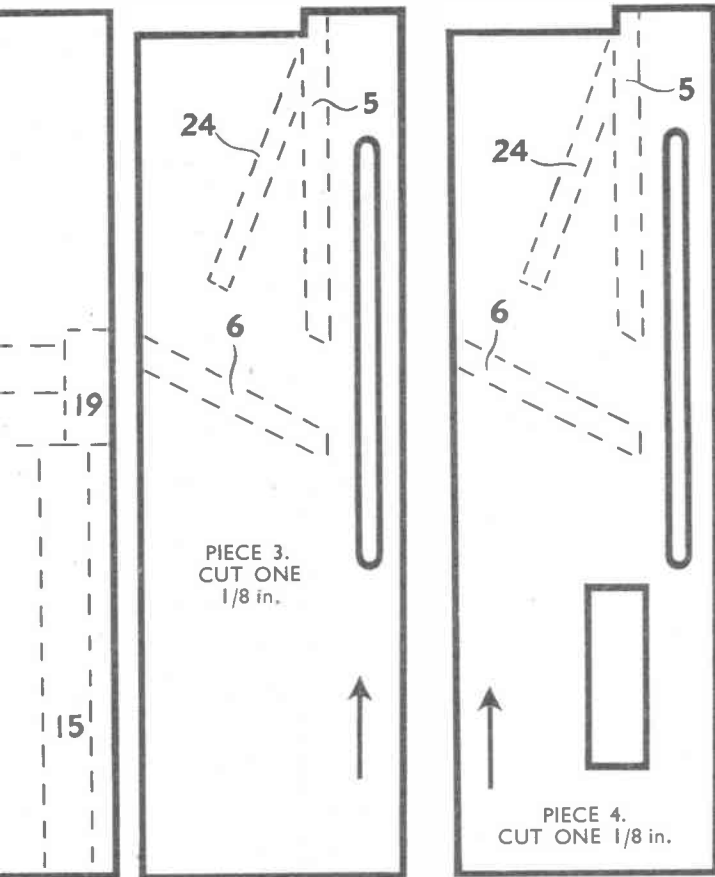

PIECES 20. CUT ONE OF EACH FROM COPPER OR BRASS.

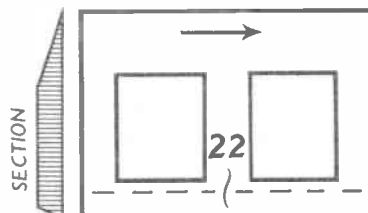
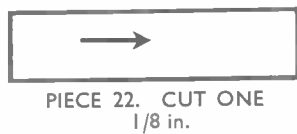

Use



Croid AERO

IT'S DESIGNED FOR THE JOB

This pure hot animal glue of great strength needs no mixing or preparation. The Home Outfit consists of 8 oz. tin Croid Aero Glue — Hot Water Container — Handy Brush — 4/- complete.

AVAILABLE FROM ALL BRANCHES OF HOBBIES LTD

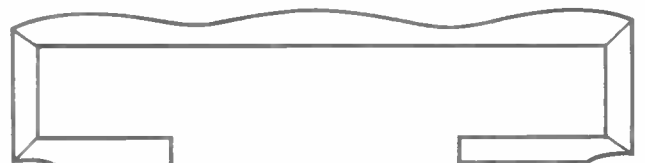

OVERLAYS ON FRONT. CUT ONE OF EACH 1/8 in.

1/8 in. ON.

PIECES 15. CUT TWO 1/4 in.

PIECE 1. CUT ONE 1/8 in.
SHAPE THE TWO EDGES
TO SECTION.

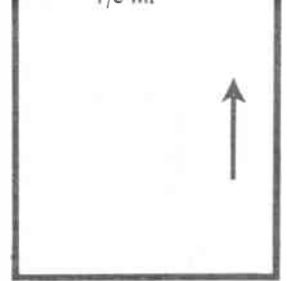
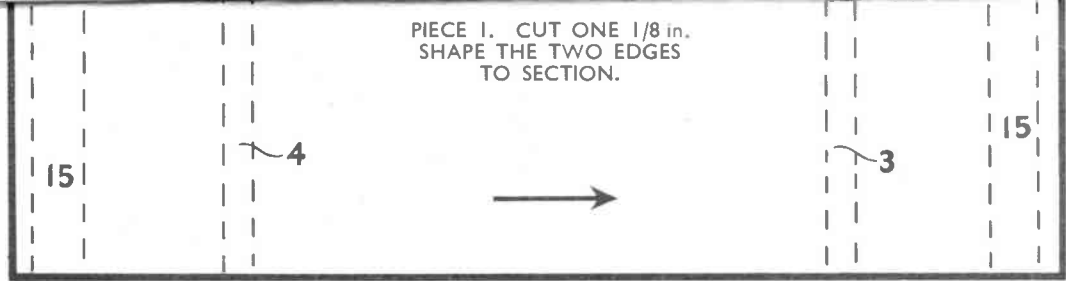

PIECE 4.
CUT ONE 1/8 in.

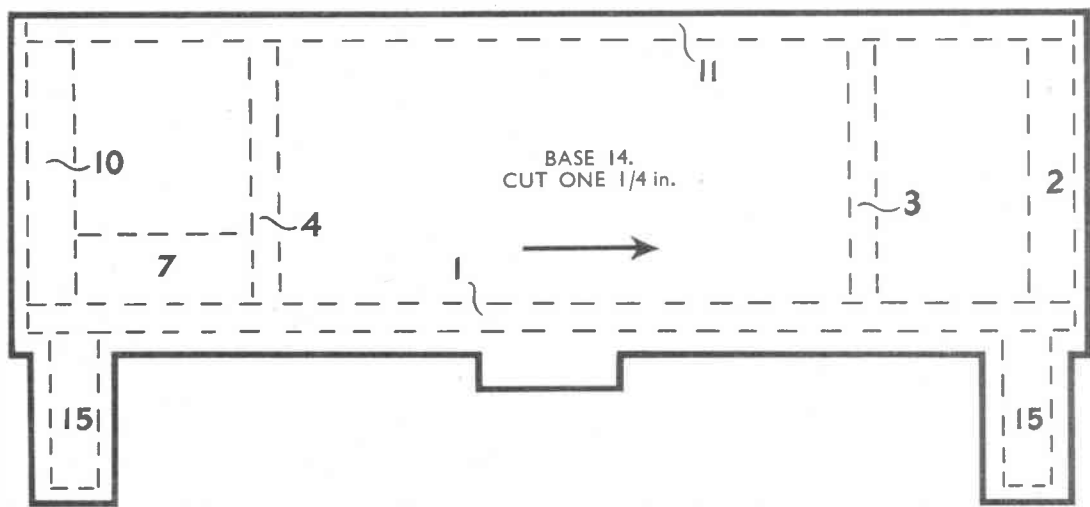

BASE 14.
CUT ONE 1/4 in.

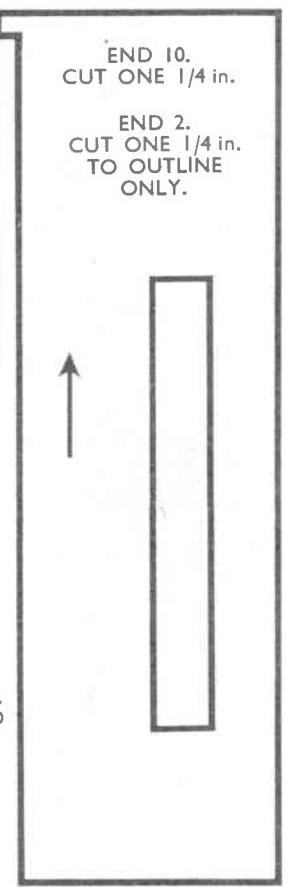

END 10.
CUT ONE 1/4 in.

END 2.
CUT ONE 1/4 in.
TO OUTLINE
ONLY.



TOP 12.
CUT ONE
1/8 in.

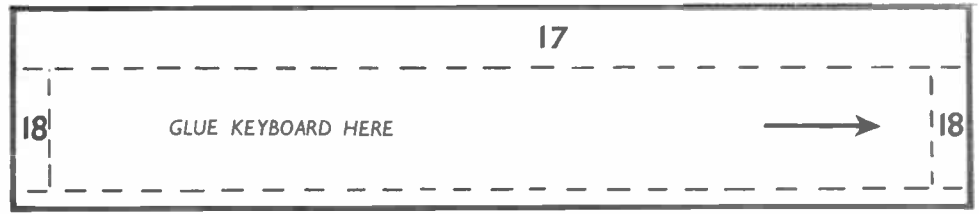

PIECE 16. CUT ONE 1/4 in.



PIECES 18.
CUT TWO
1/8 in.

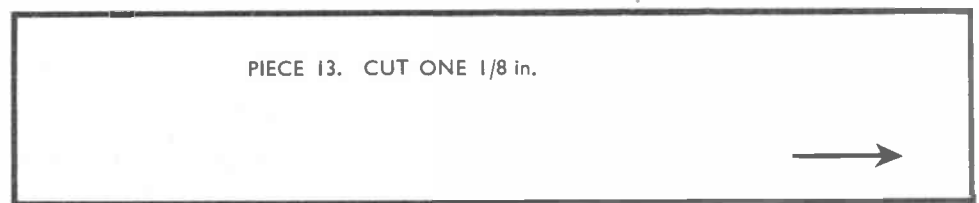

PIECE 13. CUT ONE 1/8 in.



PIECE 17. CUT ONE 1/4 in.

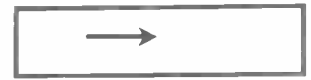

PIECE 22. CUT ONE
1/8 in.

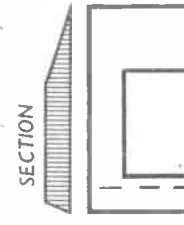

PIECE
1/8 in.

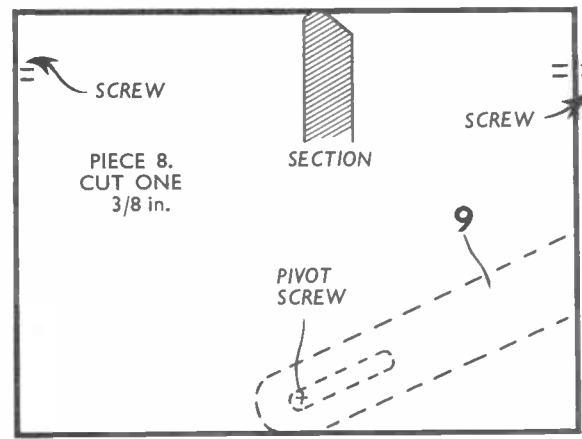

PIECE 8. CUT ONE
3/8 in.

SECTION

PIVOT
SCREW

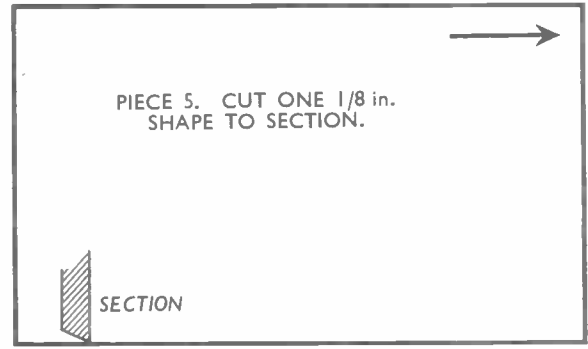

PIECE 5. CUT ONE 1/8 in.
SHAPE TO SECTION.

SECTION

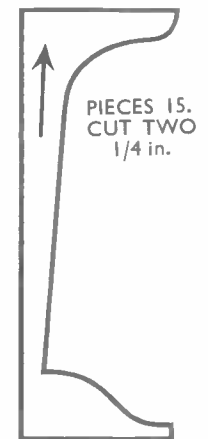

PIECES 15.
CUT TWO
1/4 in.



PIECE 23. CUT ONE 1/8 in.
CHAMFER TO SECTION.

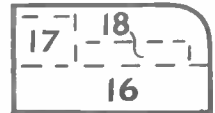

PIECES 19.
CUT TWO
1/4 in.

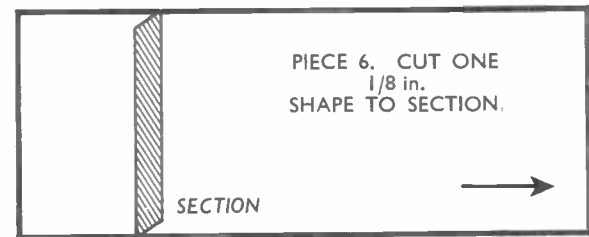

PIECE 6. CUT ONE
1/8 in.
SHAPE TO SECTION.

SECTION

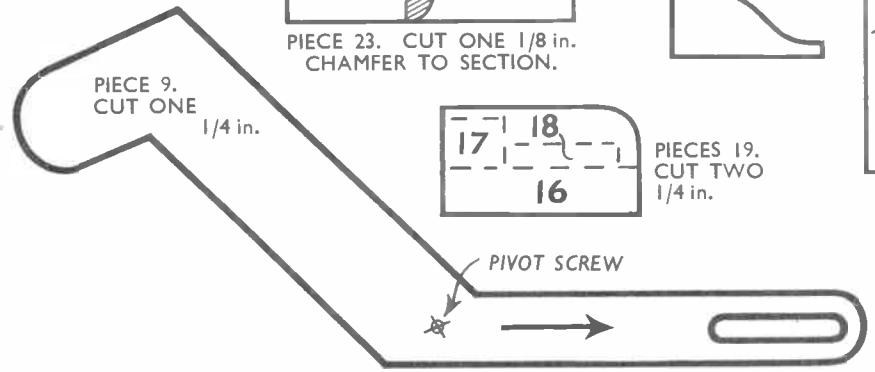

PIECE 9.
CUT ONE
1/4 in.

PIVOT
SCREW



PIECE 7.
ONE 3/8

PRINTED IN ENGLAND.

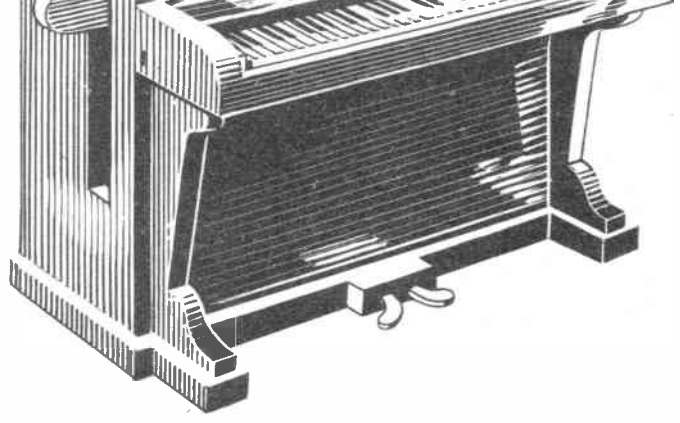
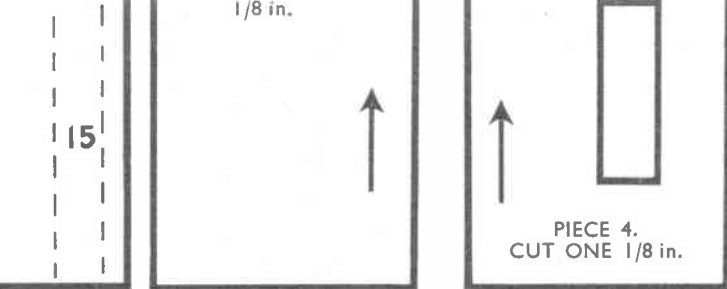

SIZE—6 ins. WIDE. 5 ins. HIGH.

A KIT OF MATERIALS FOR MAKING THIS DESIGN IS SUPPLIED BY HOBBIES LIMITED, DEREHAM, NORFOLK. PRICE ON APPLICATION.

THE ARROWS INDICATE DIRECTION OF GRAIN OF WOOD.

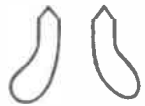
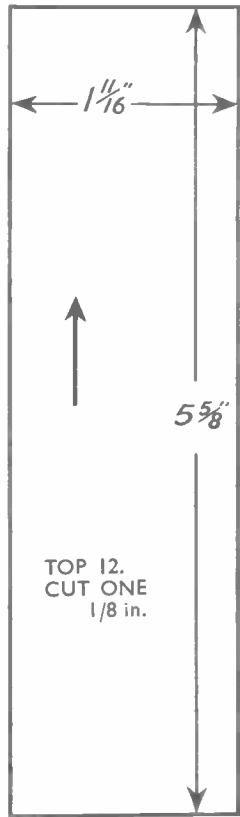
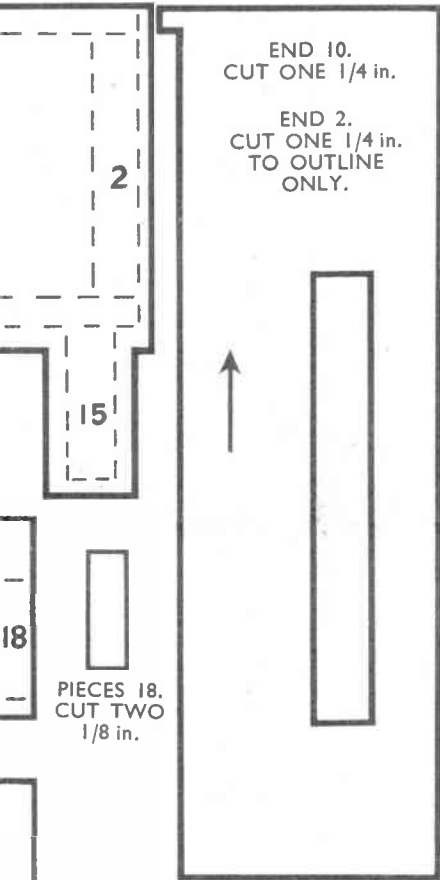

PIECES 20. CUT ONE OF EACH FROM COPPER OR BRASS.

Use

Croid AERO

IT'S DESIGNED FOR THE JOB

This pure hot animal glue of great strength needs no mixing or preparation. The Home Outfit consists of 8 oz. tin Croid Aero Glue — Hot Water Container — Handy Brush — 4/- complete.

AVAILABLE FROM ALL BRANCHES OF HOBBIES LTD

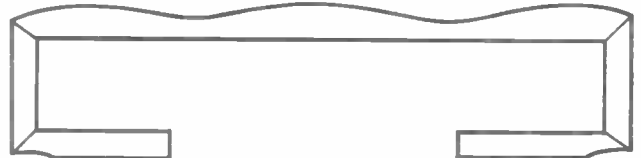
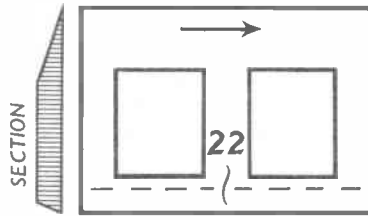
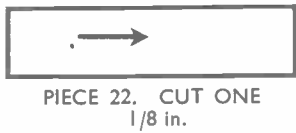

OVERLAYS ON FRONT. CUT ONE OF EACH 1/8 in.

