

4th MAY 1960

VOL. 130

NUMBER 3360

THE ORIGINAL
'DO-IT-YOURSELF'
MAGAZINE

HOBBIES *weekly*

FOR ALL
HOME CRAFTSMEN

★ *FREE Design Supplement*

Also in this issue:

CONTINUING THE
'HOBBY CRUISER'

AN EXPANDING
CLOTHES AIRER

COLLECTORS' CLUB

MAKING YOUR
OWN TRANSFERS

PATTERN-MAKING
HARMONOGRAPH

GARDENING HINTS

ETC. ETC.

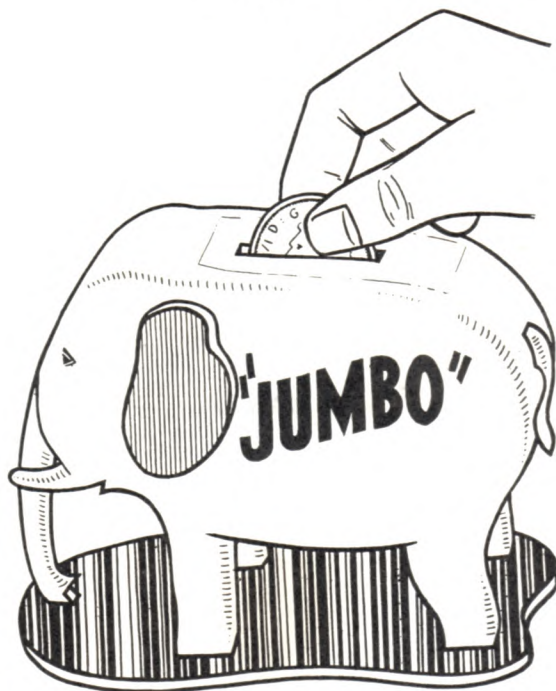

CHILDREN
WILL BE
INTRIGUED
WITH THE
SECRET
OPENING

SAVINGS BANK



Up-to-the-minute ideas

Practical designs

Pleasant and profitable things to make

5^D



FOR many years the Ind Coope Brewery at Burton-on-Trent has been brewing excellent beer, and expanding and developing throughout the world. The sign of the 'Red Hand' on the De Havilland Dove — the aircraft which the company uses for official business — is not merely an invitation to sample beer at its best, but also a reminder that Ind Coope, with feet based firmly on the ground, can rise to any occasion whenever circumstances demand.

IND COOPE'S—2

On our way to the airfield Mr R. L. Thompson (Public Relations Office) explained that when important negotiations are afoot, the company's directors have to travel great distances at short notice, and speed of travel is an essential feature of success. This called for a 'plane, in charge of which is Captain David Lancaster, a former fighter pilot, who had also flown on charter work.

I spent an exciting hour looking over the Dove, observing that it had twin engines, six armchair-type seats, and was painted in Double Diamond colours. It has an average airspeed of 175 miles an hour, is fitted with de-icing equipment, and has a Decca Navigator.

Before returning to the Brewery we drove down the runway. Ind Coope are

Canning plant at Burton

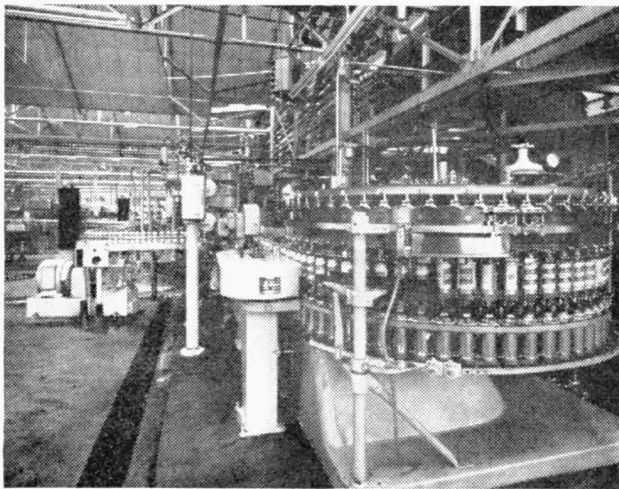

the only 'flying brewers' in the British Isles.

About 1930, a new trend in drinking was noted — the increasing demand for bottled beer.

Ind Coope's first bottled beers were bottled by hand machinery. Today, they are bottled with the aid of the most modern machinery available, and under the most hygienic conditions possible. The brewer's skill, borne of long experience, basically remains the same, but the application of that skill to produce the vast quantities of beer to satisfy the demands of an increasing population are

now developed through modern automatic machinery.

From the time top grade barley is taken out of freight cars by mechanical suction, and hops added in the great shiny coppers, to the moment the brewer gives his carefully tested approval to a batch of skol or Double Diamond, scientific skills as well as technical know-how play their important part in the brewing operation.

When the brew has satisfied the

brewer's rigorous tests, it passes to conditioning tanks to mature. During the entire production process the temperature is carefully controlled to ensure a pleasant tasting and stable brew. From huge storage tanks the beer is then pumped up by air pressure to the bottling plant, where it is automatically fed into bottles, which have been thoroughly cleaned and sterilized. These are then capped, and the contents pasteurized before passing through the labelling and packaging machines.

A million bottles and cans are filled and packed in this way every day to find their way into homes all over Britain.

Now some more notes.

China had its 'beer', called 'kiu', as early as 2,300 B.C., and beer in one form or another was known to nearly all peoples in ancient times. Wherever beer was introduced it became increasingly popular, the old Germanic tribes making their 'bior' from mashed germinated barley, this being the drink, sourish in taste, described by Tacitus. Later a much stronger brew, known in High German as 'alo', was produced; it, doubtless, gave its name to our English 'ale'.

If you need a pen friend from Burton, write to: David W. Acton, 33 Somerset Road, Stapen Hill, Burton-on-Trent, Staffs.



Two 90-barrel tankers

'JUMBO' SAVINGS BANK

A PART from being an interesting exercise in fretcutting, the Jumbo Savings Bank provides a novel model for a youngster, and an encouragement to save his pennies. To add to the interest, there is also a trick opening which will baffle anyone not in the know.

Actually, to get at the coins saved, it is necessary to remove one of the ears of the elephant, and this releases the coin con-

to the appropriate thicknesses of wood and then cut out as accurately as possible with the fretsaw. Take care in the cutting to ensure that all parts fit nicely so as to leave no ugly gaps, particularly where the coin container fits into the elephant's back.

The two outside pieces of the animal (pieces 1) are identical in shape. After cleaning up the parts thoroughly, make a start on the assembly by gluing the trunk section (5) in between two pieces 2. Similarly glue the tail section (6) between two pieces 3. These assemblies are then glued between the two pieces 1, a stage of which is shown in Fig. 1. Set aside this portion for the glue to dry thoroughly.

Continue by assembling the coin container (Fig. 2). This consists of pieces 4 glued on either side of piece 7, in which provision has been made for a slot for inserting the coins. When gluing these

A KIT FOR 6/4

All the planed panels of wood required for making the Jumbo Savings Bank are included with the dowelling in Hobbies Kit No. 3360, price 6/4. Obtainable from all branches, stockists, etc., or from Hobbies Ltd., Dereham, Norfolk (post 1/6 extra).

Illustration of completed project on front page

tainer, which can be lifted out for emptying. Measuring about $5\frac{1}{4}$ in. from tusks to tail, the model stands about 4 in. high on its base.

All parts which go towards its makeup are shown full size on the design sheet. They should be traced and transferred on

together, make sure that the holes in each piece are correctly aligned by temporarily inserting a spare piece of $\frac{3}{16}$ in. dowel rod through them while the glue is setting.

Fig. 3 shows the makeup of the secret opening release. This consists of the elephant's ear (piece 8) into which is

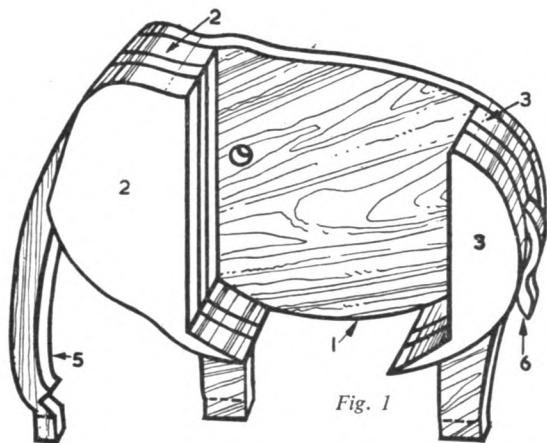

Fig. 1

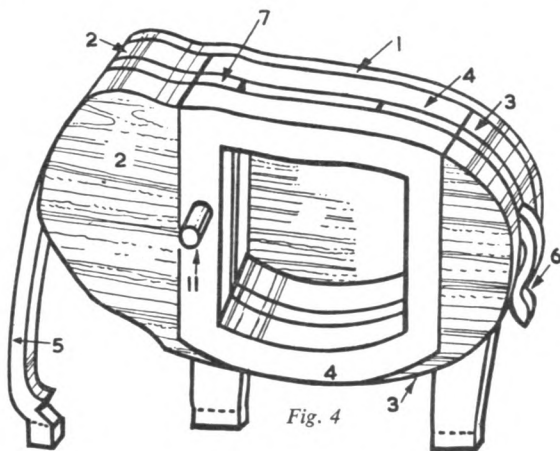

Fig. 4

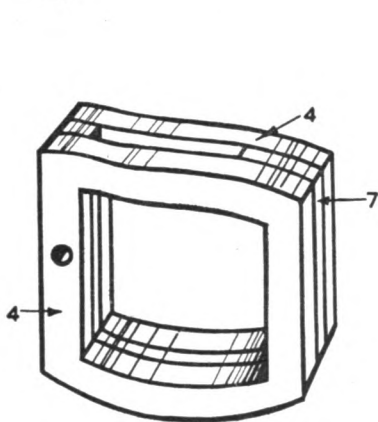

Fig. 2

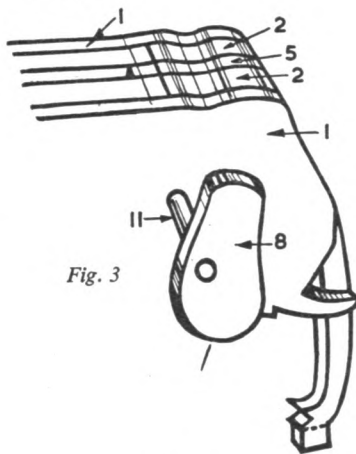

Fig. 3

glued a piece of $\frac{3}{16}$ in. round rod (piece 11). It will be seen from Fig. 4 that insertion of this dowel locks the coin container in position. When the dowel rod is removed by means of the ear, the coin container is freed and can be pushed up from below in order to empty the contents. The other ear (piece 9) is glued in a corresponding position on the opposite side of the animal's head.

The completed animal is now fixed to its base (piece 10) by gluing in the four feet and the trunk in the tenons provided.

Clean up thoroughly with glasspaper before painting. This can be in natural colours such as grey with black markings and white tusks, or as it is for a child, gay colours would be most attractive.

Continuing the HOBBY CRUISER

THE nose block (see Fig. 7) can be carved either from a piece of hard balsa $\frac{1}{2}$ in. thick or from a similar block made up of four pieces of $\frac{1}{8}$ in. thick balsa cemented together under pressure with their grains opposed to each other. Length and width of the rectangular piece should be a shade bigger than the overall depth and width of the fuselage at the nose. On what is to be the front face mark with a cross the exact position of the propeller shaft.

Cut a cartridge paper template of the noseblock in side view and paste it to the edge of the balsa. Trim round it carefully. Do exactly the same with the *plan view* shape of the block. Now cut a rectangle of $\frac{1}{8}$ in. hard balsa so that it fits neatly in the aperture at the front of the fuselage; this is the noseblock retaining spigot and is cemented to the back of the block. Before the cement has thoroughly set locate the block in the nose and make

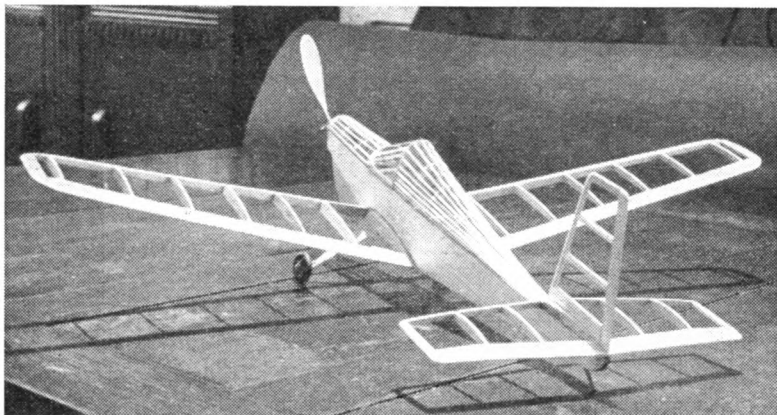

Fig. 6—The completed structure

to prevent it from eventually cutting into a tightly-wound rubber motor.

The one-piece wrap-round cockpit canopy is made from thin celluloid or, as in the original, thin clear plastic, with the addition of a 'fairing strip', cut from flexible cardboard or Bristol board — shown black on the detail development. Make a card or cartridge paper pattern of the canopy development, using the squares as a guide, and use this to cut the celluloid to shape. The shape of the fairing strip can be drawn direct on to cardboard and cut out.

Using impact adhesive, fix the strip to the celluloid in the position indicated. Balsa cement *can* be used for this if celluloid and not plastic is being used, but impact adhesive makes for a much cleaner job in this particular case. If the fuselage has been made accurately to the drawing you will find that the canopy

will fit neatly (Fig. 10) when bent round the rims of formers F4 and F5. However, the precise shape of the canopy in *your* particular model (if there have been any inconsistencies in the building of the fuselage) can be ascertained if you bend a piece of stiff tracing paper round F4 and F5 with the edge of the paper coinciding with the edge of F4 and then trace with a sharp pencil the required outline. Use impact adhesive to fix the canopy to F4 and F5 and to the straight portion of the balsa fuselage sides — applying it both to the rims of the formers and the fuselage edge and to the appropriate edges of the canopy.

Cut all the pieces for the fin and tailplane (Figs. 8 and 9) and assemble them with balsa cement. First it will be necessary to draw the components full size on paper; then the parts are fixed in place, *directly over the drawing*, between rows of pins. Rub a piece of candle over the drawing at all joint positions to prevent the balsa cement from sticking to the paper.

Having assembled the parts, round-off the leading edges and tips of each component and taper the trailing edge of the fin. Finish with fine glasspaper. Fill in the centre section of the tailplane with $\frac{1}{2}$ in. sheet balsa. Do not fix the fin to the tailplane until both components have been covered and finished.

The wing of the 'Hobby Cruiser' is identical with that designed for the 'Sprite', the jet-model described earlier in this series, with the exception of the centre section which is wider and incorporates the undercarriage, and the dihedral angle (the angle of the wings looking from the front) which is in-

By Gordon Allen

any necessary adjustment to align it with the fuselage; then mark the radius shapes of the fuselage nose on the back of it. Curve the block to its final shape, glass-paper it smooth and apply a thick coat of cement. Drill the block $\frac{3}{32}$ in. diameter (using the centre already marked) and fit a 20 s.w.g. screwed brass bush.

Bend the end of a length of 20 s.w.g. piano wire to the clutch shape shown on the drawing on the front of the propeller shaft, thread the wire through the 7 in. plastic propeller and the bush on the noseblock, and bend the motor hook with a pair of round-nose pliers. Cover the hook with a piece of valve rubber tubing

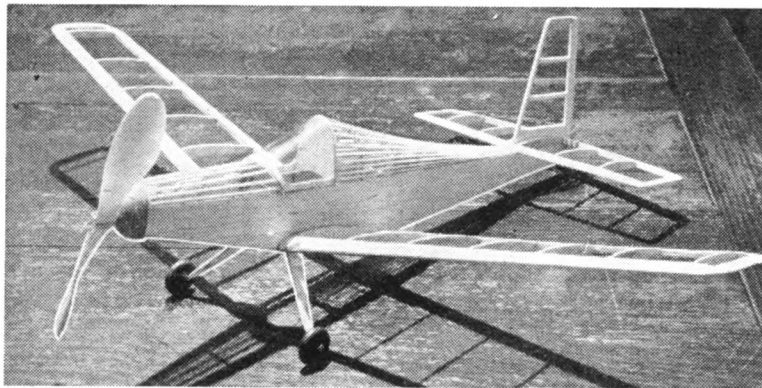

Fig. 7—Showing the nose block

creased. So if you have the drawings of the ribs and other pieces for the 'Sprite' wing all you have to do is increase the leading and trailing edge portions of the centre section.

Cut cartridge paper templates of the wing ribs, paste them temporarily to the

on the drawing. Mark this angle first in pencil and cut round the pencil marks with your modelling knife. Pin these pieces between rows of panel pins at the required distance apart and then cement the wing panels to them by butting them against the sloped ends of the pieces.

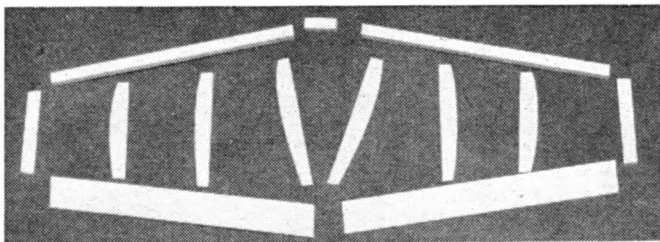

Fig. 9 — Tailplane components

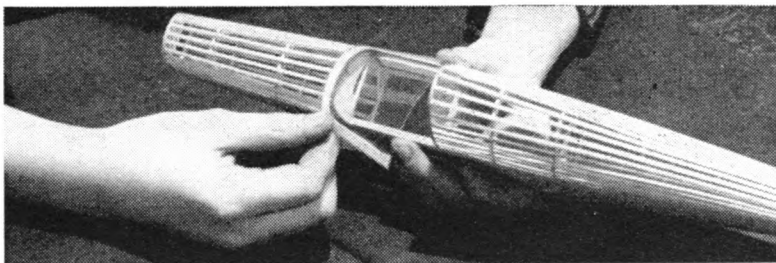

Fig. 10 — Fitting the canopy

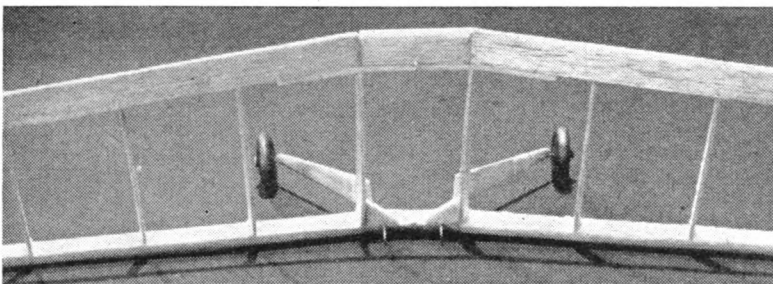

Fig. 11 — Attaching the leg fairings

$\frac{1}{16}$ in. sheet balsa, cut out the ribs and immediately remove the paper. Now cut the leading and trailing edges of the two main wing panels (i.e. neglecting the centre section) and the wing tips. Assemble these as you did the tailplane, directly over a full size outline of the wing. The leading edge, as shown on the drawing, tapers from $\frac{3}{8}$ in. square to $\frac{3}{8}$ in. by $\frac{3}{16}$ in.; this is cut with a fretsaw and glasspapered. The trailing edge is standard ready-shaped section $\frac{1}{2}$ in. by $\frac{3}{16}$ in. Make sure the ribs are kept upright during setting, then trim the leading edge and wing-tip to the shape indicated and finish with fine glasspaper.

To 'build in' the centre section, first cut the short leading and trailing edge piece and bevel the ends to the angle indicated

Place packing (books, boxes etc.) underneath each wing panel so that the wing-tips are each raised $2\frac{1}{2}$ in. and then allow the joints to set thoroughly.

Mark the shape of the 'dihedral-keeper' on to $\frac{1}{8}$ in. sheet hard balsa or thin plywood and cut it out. Now cut short pieces from the rear ends of the two innermost ribs to accommodate the 'keeper' and then cement it in place.

From a length of 20 s.w.g. piano wire bend the undercarriage to shape as shown on the main drawing. Here again it is best to draw the shape out full size and to use it as a guide. Make sure the two main 'legs' are level with each other and that the 'cranked' section at the top is flat when placed on a level surface. Also ensure that the legs have the correct

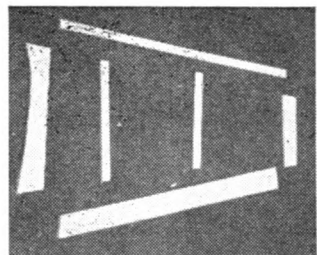

Fig. 8 — Parts for fin

amount of forward 'stagger'. Fix the balloon type plastic wheels in place on their stub axles by soldering a cup washer on the ends of the wire. Place a shield of thin card with a narrow slot in it between the washer and the wheels during soldering to prevent the wheels from becoming scorched and to provide the right amount of 'play' for their free rotation.

Cut the two leg fairings from $\frac{1}{8}$ in. sheet hard balsa, taper them towards their rear edges, using a blade and glasspaper, and then cement them to rear of the wire legs, making sure that they are parallel to the fuselage. When set, bind each leg with thread as indicated and coat the bindings with balsa cement.

Cement the whole unit to the leading edge of the centre section as shown (Fig. 11) and check, during the setting period, that it is in correct alignment in relation to the wing. Apply thread binding and coat it with cement.

Bend the four small wing-retaining hooks from straight pins or from 20 s.w.g. wire and cement them in the positions indicated; push the bent-over ends of each into the balsa. Finally, cut and cement in place the four $\frac{1}{8}$ in. sheet triangular gussets. This completes the entire structure of the Hobby Cruiser (Fig. 6).

In the next article we shall be dealing with the covering, finishing and flying of the model.

Next week's issue will show how to make a Play Sink for the young miss, in which she can wash her doll's dishes and clothes and splash away to her heart's content.

Make sure of your copy.

AN EXPANDING CLOTHES AIRER

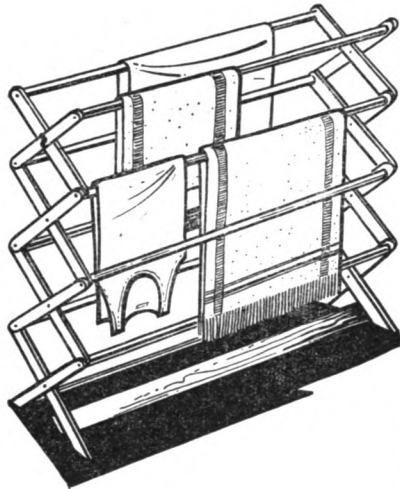

TO commence construction of this expanding clothes airer prepare sixteen strips of wood, cut to length as in Fig. 1. A cheap hardwood, such as beech, would do for these, or even deal, if of good quality. Plane the strips to a uniform thickness of $\frac{3}{8}$ in., and width of 1 in. Place side by side, as in Fig. 2, and at 1 in. from the ends at top and bottom, rule a straight line across.

A line should be drawn across the middle of the strips also. Set a gauge to $\frac{1}{2}$ in. and then gauge across the lines on each piece to mark the exact spots for the screws to enter to convert these strips to two latticed sides, as in the finished article.

It is desirable for the clothes airer to fold up quite flat, as in side view, Fig. 3, and to achieve this the screw holes must be bored exactly on the marks made on the strips. For the cross rods or bars, round wood rods could be employed, $\frac{3}{4}$ in. diameter, or as a good substitute, square strips of deal, planed to an octagonal shape. The latter, being of softer wood, might even be considered preferable. Suitable strips could be cut from a piece of board $\frac{7}{8}$ in. thick, and the corners planed off. This job can be expedited with the aid of a made-up gadget, as shown in Fig. 6, in which the unplanned square strips can be supported while their corner angles are planed off. These cross-rod can be of any length. For small family use a length of 30 in. to 36 in. will, in most cases, suffice.

Fitting together can now be undertaken. Screws of the round-headed type are employed, and a thin metal washer should be provided for each. The end holes are bored an easy fit that allows the screws to be pushed through the holes up to their heads with easy pressure of the thumb alone. Having bored these, the centre holes can be attended to. A differ-

ence in fitting is adopted here. In one strip a similar hole to those at the ends is bored, but in the strip to which it is subsequently attached, a smaller hole is made with a bradawl, just large enough to let the thread of the screw bite its way in. Detail A, in Fig. 5, explains this.

One exception to this is the screw holes in the two top sets of strips, where they cross each other, the easy-fitting holes being bored through both, and this time using a $\frac{1}{4}$ in. drill bit. These are joined together with screw bolts and wing nuts, as at B in Fig. 5, and being capable of adjustment for tightness, help to keep the clothes airer firm, when drawn out. Now screw the lattice sides to the cross-rod, commencing from the bottom upwards, as it will be found that the top rods, or one rod, at least, will have to be a trifle longer than the rest. In all cases where the screws are employed, slip a metal washer under their heads, as shown in Fig. 4.

Holes, made with a bradawl, must

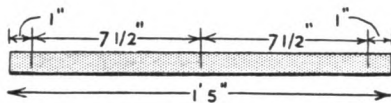

Fig. 1

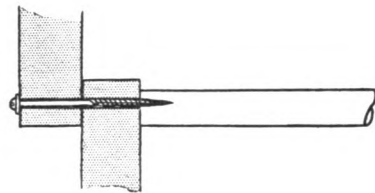

Fig. 4

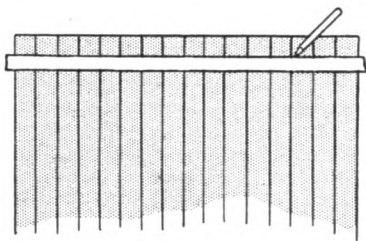

Fig. 2

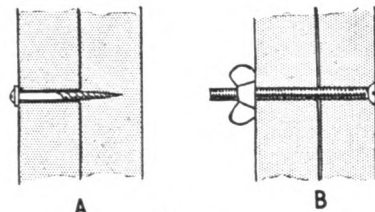

Fig. 5

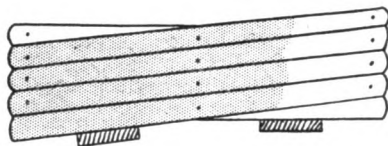

Fig. 3

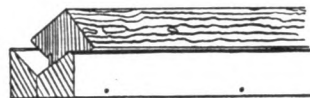
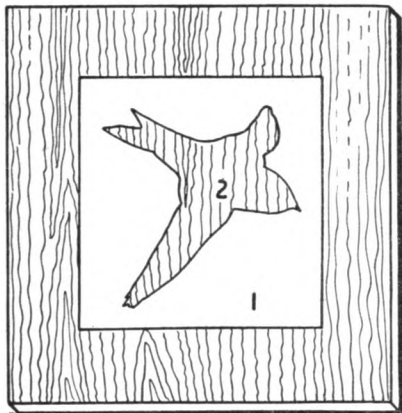

Fig. 6

APPLY YOUR OWN TRANSFERS

TRANSFERS which have a character and quality all their own can be made from coloured pictures taken from greeting cards, magazines, and catalogues. Beautiful results can be obtained by this simple and cheap method on such things as table mats, children's cots, boxes, trays, firescreens, brooches, and in fact anything which will benefit from the addition of a decorative print.

Briefly, the method is to transfer the colours of the print used on to the object to be decorated by eliminating the paper.



As the transfers are applied face downwards they will appear in reverse. Certain pictures, therefore, cannot be used, but an unlimited number of child, animal, flower and country studies, as well as decorative designs, are readily available for this application.

The following are the things needed; a small, fairly stiff brush; a softer brush; a packet of wallpaper stripper; waterproof glue; flour paste; sponge or soft rag; craft knife or penknife; clear matt

or gloss varnish, or glaze if the work is to withstand hard wear.

Now select your picture. Apply a thin even coat of waterproof glue to its face. For preference, use a glue that can be, if necessary, treated with a thinner. This glue must not be too thick or too rapid in setting. When the first coat is dry, add a second to the face of the picture. While this is tacky, press the picture firmly on to the article to be decorated, paying particular attention to the edges. Leave to harden.

In the case of larger pictures — that is over 5 in. by 5 in. — it is an advantage to apply waterproof glue to the wood also. Now waterproof glue, once it has hardened, is very difficult to remove from wood without damaging its surface. It follows then that this glue must be applied only to the area of wood which is to be covered by the transfer. The following method will ensure this being done. Say you are making a transfer of a picture from a magazine. Remove the page on which the picture is printed and carefully cut out the portion to be transferred. The rest of the page from which

1. Paper from which picture of bird has been cut. This paper is pasted first to the wood to be decorated
2. Shape of the bird seen on the wood
3. Cut-out picture, glued down at 2

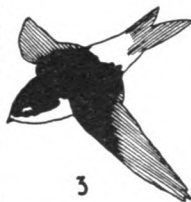

the picture is cut out, called the 'frame', should be fixed first with flour paste on to the article to be decorated. Its purpose is to prevent the waterproof glue from



spreading outside the area of wood covered by the transfer.

Having fixed this paper 'frame' in position, the outline shape of the picture will be seen on the wood, and this area can now be coated with waterproof glue, as previously mentioned. The transfer, of course, fits into this shape. Apply waterproof glue to the face of the picture which is to make the transfer, as previously mentioned, and fix it in position in the frame. Remember that two thin even coats of glue are better than a thick and uneven one. As the work proceeds, this paper 'frame', which serves only a temporary purpose, comes easily away from the wood, leaving only the transfer permanently in position.

The next stage is to prepare some of the wallpaper stripper. Apply this to the picture with the fairly stiff brush. Allow the solution to soak into the paper for a minute or so. Then firmly, but not harshly, begin to scrub with a circular motion and also in the direction of the grain of the wood. Unwanted paper starts peeling off. Clear this away with the wet sponge. Apply more of the paper-stripping solution and continue working with the brush and the sponge. Soon the picture (in reverse) will be visible. Use the softer brush at this stage, and also the knife to remove any obstinate flecks of paper. Do not use the point of the knife, and carefully work towards the nearest edge of the picture. You will be

Beautiful roses retain all their brilliant colours



Continued on page 81

MAKING A HARMONOGRAPH

THERE are many possible modifications in the designs of simple machines for the production of patterns entirely composed of curves. Some involve both a moving pen and a moving desk, but for the sake of simplicity and easier manufacture the harmonograph we describe has been designed with the basis of a twin ellipso-graph. This has a moving pattern desk, the pen being held above by an arm, but a further modification is suggested by way of the compound deflector pendulum.

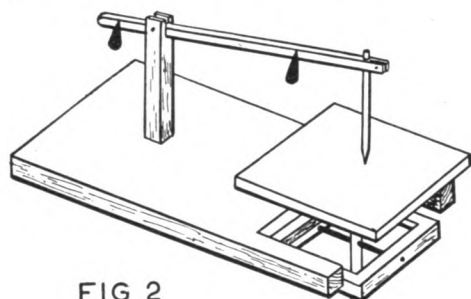

FIG 2

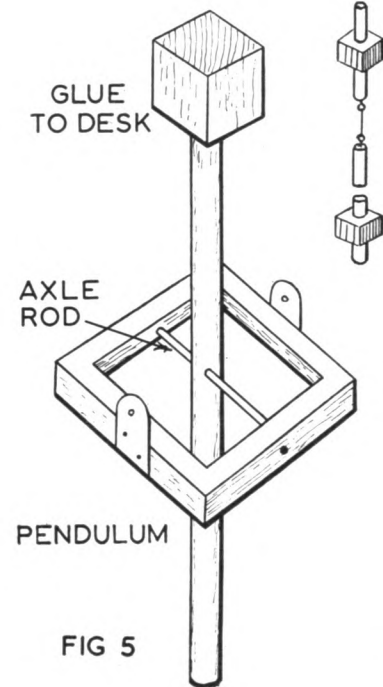

FIG 5

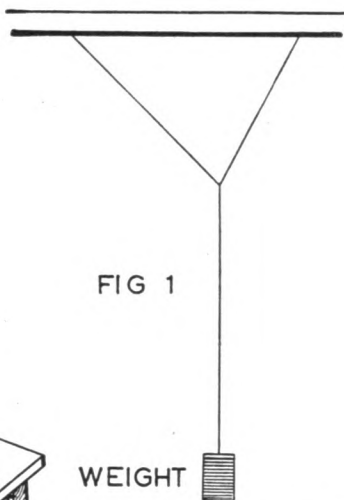

FIG 1

WEIGHT

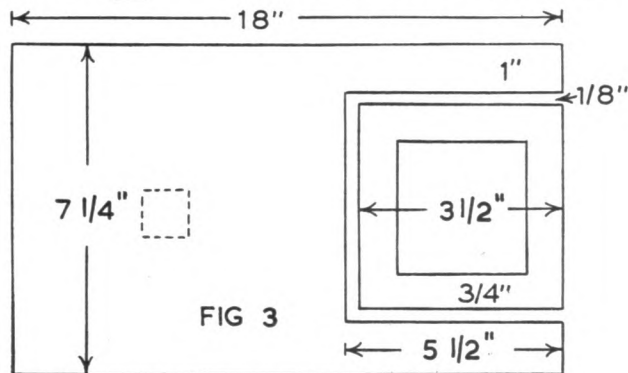

FIG 3

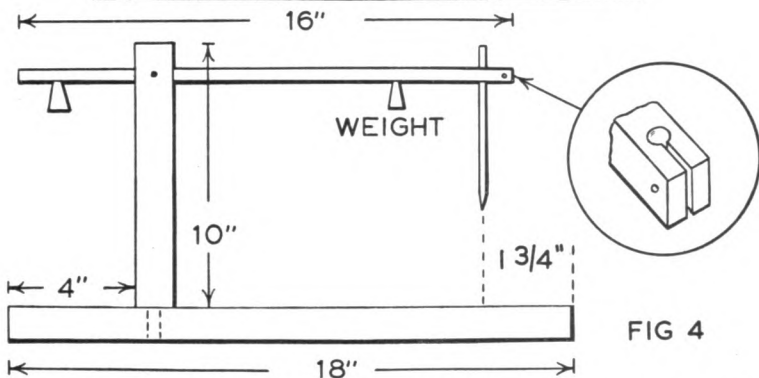

FIG 4

paper placed on the desk and consequently the continuous movements ultimately produce all manner of interlocking curved line patterns known as Lissajous figures. We find that a great variety of original patterns can be reproduced by using the swinging pendulum and when it is realized that further modifications can be achieved by altering the length of the pendulum or adding a second pendulum it will be seen that the combinations are almost limitless.

As stated, the simple pendulum forms the basis of these machines, in particular Blackburn's pendulum which takes the form of a letter Y. Two upper strings are attached to a beam as in Fig. 1, the lower string having a bob attached to keep the pendulum in a regular motion. If a pencil is fitted at the end it will trace a pattern on paper placed below. Alteration in the lengths of the two arms of the Y produces new effects,

The basis of all such machines is usually a pendulum which gives motion to the desk, which swings with the oscillations of the pendulum. A pen, or pencil, is held in a fixed position over the

so it should now be apparent that we can achieve the same object by altering the length of the pendulum in our machine.

Fig. 2 shows the harmonograph after completion and assembly. It will be seen

that the two pendulums have been fitted, each having a weight, but the lower is only attached to the upper by means of a piece of strong string, thus providing a secondary motion. The lower pendulum can be removed quite easily or added for more experiments. The suspension of the pendulum will be described in detail later.

First of all we require a piece of 1 in. shelving for a table measuring 18 in. by 7½ in., with a portion removed at one end. This is shown in Fig. 3, and little difficulty should be encountered in removing the waste material from the end where the pendulum assembly will be fitted. See that the sides of this aperture are well smoothed with glasspaper after cutting.

Fig. 4 shows the next stage of the table construction involving the fitting of an upright made from 1 in. square material and 10 in. long. This upright is slotted at the top to accept the pen-arm, which is made from ¾ in. square section. Cut the slot in the upright, smoothing the insides, and fix to the base by means of a dowel rod or screw from the underside. A hole should be drilled for inserting a small pin which acts as a pivot for the arm. The pen arm is drilled about 1 in. from one end with a hole large enough to accept a ball point pen and a sawcut is then made in the same end. If a screw is inserted the pen can be held quite firmly for writing on the moving desk. This fitting is shown in detail in the circle of Fig. 4. It will be seen that there is a small weight on the arm to provide constant contact between pen and paper, with another counterweight at the end of the arm. It is suggested that a series of small holes are drilled along the pen arm 1½ in. apart so that the weights may be adjusted as experience proves necessary.

We now arrive at the stage where the pendulum assembly is to be constructed and our design has overcome the making of difficult and precision knife edges. At the same time it is essential that the assembly moves freely, so all the holes and fittings must be accurate and free from burrs. In order to obtain freedom for a double movement it is necessary to provide for the pendulum to swing in two opposing directions. Reference to Fig. 5 will reveal how to use a small square frame made from ¾ in. square section. Construction is quite simple if half-joints are made at the corners, these being glued and pinned. Then attach a pair of small mirror plates — or metal brackets made from sheet brass — and ultimately this small square is attached by screws between and just below the two arms of the table as shown in Fig. 2. Note that this square must be so fixed that the edge nearest the body of the table does not foul the latter when tilted upwards. The frame should be made but not fitted at this stage.

It will be apparent that by attaching

the frame to the table we have provided one direction of swing and it now remains to provide for the other. Further reference to Fig. 5 will show that a rod is inserted through the opposite sides of the frame and subsequently through the dowel rod pendulum. Drill small holes in the sides of the frame for this rod, but the hole in the pendulum itself should only be determined after test. A bright steel rod — like a Meccano axle — will be ideal for this particular pivot.

We also need a desk for holding a piece of paper which takes the design when the pendulum has been set in motion. All that is required is a piece of substantial plywood 6in. square. This is ultimately glued to the cube fitted to the top of the dowel rod pendulum as shown in Fig. 5.

Prepare a 1 in. cube, drilling a ⅜ in. hole for the dowel rod pendulum, which should be at least 2 ft. long. Glue the rod into the prepared hole, fixing the desk on top of the cube. You will also note a further cube at the base of the rod which is for the addition of weights. A piece of lead weighing ½ lb. or 1 lb. may be shaped in the form of a split washer and fitted on the cube. It is suggested that the latter remains moveable — to shorten as desired — and several holes can be made in the rod for inserting pins in any desired position.

When the desk and pendulum have been completed the assembly may be attached to the table and arrangements made for fitting. Lower the pendulum through the frame, marking a drilling point for the axle, which will leave the desk at least 3 in. above the level of the table. Remove the pendulum, drill the hole and smooth, and the machine is

almost ready for use. Note that the pendulum must be correctly centred and balanced on the axle if this assembly is to perform its functions correctly.

It is necessary to clamp the table to a bench so that the pendulum can swing freely. Attach a piece of drawing paper to the desk by rubber bands. The pendulum must be started revolving in a circular motion and when the pen is lowered to the paper a pattern will be produced. Some preliminary tests will be advisable to determine the best weighting of the pen-arm and the pendulum.

Earlier we mentioned the introduction of another pendulum and the apparatus just described is the single main pendulum. A similarly made deflector pendulum, which will alter the oscillations considerably to produce a twin elliptic effect, can be suspended by means of a strong thread. Insert a screw eye in the end of the main pendulum and one in the end of the deflector pendulum, joining the two together by thread or a piece of wire about 2½ in. long. This deflector pendulum need only be 1½ ft. or 2 ft. long, but both pendulums must bear their own weights. With care the two pendulums can be set in motion, when they will combine to produce complex patterns.

It must be remembered that much depends on the correct weighting of the pen-arm to keep it in close contact with the paper as well as the maintenance of steady oscillations of the pendulums. See that the latter have a free action or the desk cannot move smoothly and freely. First attempts at making the fascinating Lissajous figures should be with the single pendulum, experimenting with the compound pendulum later. (S.H.L.)

● Continued from page 79

Apply your own Transfers

surprised how easily the unwanted paper comes away, leaving only the print transfer adhering to the wood in its full colours.

The paper 'frame' can now be taken off. Apply some of the stripping solution to it, allow this to soak in, and the frame will then come away quite easily.

After giving the picture a final sponge over with clear water, dry it by dabbing it with a cloth and holding it near to the fire for a moment or two. There is nothing in the whole process which will damage the wood or the transfer.

When dry, any slight cloudiness of the picture will disappear when the varnish is applied. Two coats are best. Work the first gently into the transfer. When the varnish has set the transfer is very tough, and may be sawn or trimmed, leaving absolutely smooth edges. By this method,

all the colours and highlights and even delicate tints are preserved.

Test your picture first by applying waterproof glue to a small area. If the ink does not smear (and in the majority of cases it will not), you can go ahead and produce a really fine transfer.

Practise first with small pictures on odd pieces of well-smoothed wood. You will speedily get the 'feel' of the method, and be able to do bigger things with success. Begin by making, say, a few brooches, for you can produce some really lovely ones by this method. If at the outset small pieces of the print lift, exposing the wood, you may work a matching oil colour over the spot, brushing it into the first coat of varnish. It will be an invisible repair. Wherever possible apply the transfer first, and do any staining or enamelling afterwards. (Ed.)



For good results sow wallflower seeds this month

Outside

LATE frosts can cause damage to tender bedding plants such as dahlias, geraniums, and begonias which are hardening off outside. Be ready with newspapers or cloches to provide protection if frost threatens. In the vegetable garden, potatoes should be covered with soil or newspaper. Strawberries may be protected with fine mesh fish netting erected on wood frames (see illustration). A light sprinkling of straw over the netting will usually prevent damage. Tender plants which are frozen, however, may sometimes be saved by spraying with cold water from a can, and by providing shade until the temperature rises. Usually the worst damage is caused by direct sunlight on frozen foliage.

Prepare for summer bedding by carefully lifting bulbs of hyacinths and tulips. Replant them in a trench, packed closely, to allow the foliage to die down. Daffodil and crocus bulbs should be left in, if possible. Polyanthus plants should be lifted, divided, and replanted in close rows in a shady position in the vegetable garden.

Bedding plants must be hardened off throughout the month, and planted during the last week if the weather is suitable. Do not be tempted to plant too soon. Sow biennials and perennials as the opportunity occurs. Spray roses for aphid, black spot, and mildew. Your seedsman will recommend suitable washes.

ROCK GARDEN — Continue to wage war on slugs and snails. Save ripening seed pods for immediate sowing. Sow seeds in boxes or pots, using J.I. compost and covering very lightly. Try taking cuttings of aubrietia at the end of the month.

FRUIT GARDEN — Pay attention to raspberries. Dust weekly with derris powder while flowers are opening, to control maggots. Thin out suckers. Obtain straw for placing round strawberry plants later. Remove unwanted runners as they form. Peg down as required for new plantation. Thin gooseberries, leaving enough fruit for eating as dessert.

VEGETABLE GARDEN — Transplant brassicas as ground becomes available. Sow beetroot and runner beans during

the second or third week. Plant celery late in the month. Earth up potatoes. Sow carrots, lettuce, radish, and turnips for succession. Pumpkins and gourds may be sown outside during the

1 1/2 IN. X 1 IN. WOOD

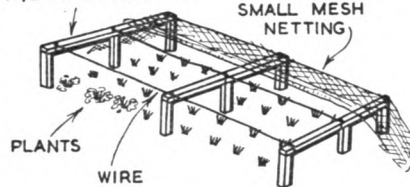

Protecting strawberries from slight frost.

last week. Outdoor tomatoes can be planted at the end of the month. Weeds should be composted while green.

Inside — warm house

SHADE during sunny periods and provide humidity by sprinkling floors with water. Sow primula seeds in variety. Sow cinerarias in boxes or pans for early flowering. Feed and pot on all subjects as required. Cuttings of fuchsias and begonias may be taken. Fumigate regularly against green and white fly, and red spider. Control cucumbers by stopping laterals.

THESE NOTES REFER CHIEFLY TO MIDLAND GARDENS. DUE ALLOWANCE SHOULD BE MADE FOR CHANGE OF LATITUDE.

Cool house

POT on chrysanthemums for the last time. Sow primula and cineraria. Stake and tie up flowering schizanthuses, fuchsias, pelargoniums, and calceolarias. Pot plants of perpetual flowering carnations into 7 in. pots for winter flowering. Give plenty of ventilation, and provide shade during bright periods.

Tomatoes and cucumbers may be planted early in the month. Increase water for cacti and succulents. As such as once or twice a week as needed. Conophytums should have NO WATER during May, June, and July. Small seedlings may be repotted and fresh seeds sown this month.

Cold house

SOW seeds of primula and cineraria. SPlant tomatoes during third or last week. Provide ventilation, especially during the day. Pot plants should now be treated as for cool house. Feed established plants, and fumigate regularly.

General

PAY attention to staking. Allow plants to grow round the stakes rather than stake at the last minute. Keep the hoe going. (M.h.)

An economical painting kit for the modeller

THE 'Humbrol' Mini-Kit of enamels is the ideal pack for small painting jobs. The phials are contained in a moulded plastic tray which is used as a six-compartment palette for mixing purposes.

Containing 'Humbrol' one-hour plastic enamels, the kit is made up of blue, yellow, red, green, black, and white, all high gloss.

Available from model and handicraft shops, including Hobbies branches, price only 2s., or from Hobbies Ltd, Dereham, Norfolk (post 6d. extra).



TOP MODELLERS USE BRITFIX 55

PVA ADHESIVE

A POSITIVE BOND · SO CLEAN TO USE · IN A HANDY SQUEEZE BOTTLE

BRITFIX 55 PVA White Adhesive... the result of careful research to provide the Top Modeller with the ideal adhesive.

Packed in a handy squeeze bottle for quick easy application, BRITFIX 55 PVA sticks Balsa, Paper, Card, Fabrics, firmly, cleanly... with a bond strength of over 3,000 lbs. per square inch... wipes easily off the fingers and keeps perfectly.

Take a tip, use BRITFIX 55 PVA, it's the new way to better modelling.

INDIVIDUALLY CARTONED
at 1/9d.



BRITFIX 66 Super Balsa Cement and BRITFIX 77 Polystyrene Cement complete the modellers' adhesive kit.

At prices from 6d. per tube. Available from Hobbies Shops everywhere.

BRITFIX

USED BY TOP MODELLERS EVERYWHERE

HUMBER OIL CO. LTD., (Adhesives Division), MARFLEET, HULL, ENGLAND.

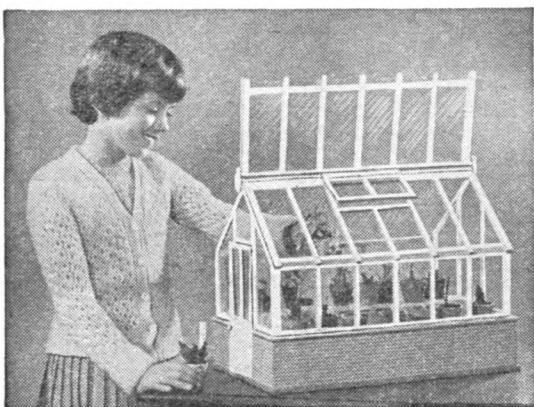

MINIATURE GREENHOUSE

A really practical model for the home

For growing cacti, succulents, miniature trees, seedlings, etc., and can be used as a propagating frame.

JUST LIKE DAD'S!

You can make this ideal showpiece from Hobbies Kit No. 3300, which contains all wood, materials, etc., and 12 sets of pots and saucers. Hinged roof, window, door. 18 in. x 12 in. x 13 in. high. Only a few simple tools needed in construction.

Kits from Hobbies branches, stockists or post free (see coupon). **39/6**

ALL-THE-YEAR-ROUND INTEREST

To HOBBIES LTD., Dept. 99, Dereham, Norfolk

Please send Kit No. 3300 for making Miniature Greenhouse
I enclose P.O. for 39/6

Name

Address

.....
.....
.....

LURE OF THE WAYSIDE INN

THE wayside inn is so alluring to the wayfarer. It is not merely shelter and refreshment; it is a beautiful image of contrast by which the least inviting inn becomes desirable, when, after a walk over hill and dale in the biting wind, one comes to the hospitable wayside inn. Most rambles and wayside lovers will agree with all that the writer of *The English Inn* implies:

'The inna lures us. It is not merely shelter and comfort. It is not merely shelter and refreshment; outside are snow, ice, fog, rain, and wind and mire. Inside, your imagination says, are glowing hearths, piquant odours, lights, drawn curtains, peace and order, and soothing chairs. It is grace after rancour! Of all descriptions of inns and inn scenes, both of the actual and the fiction world, that are recalled, almost all are set in winter. Indeed, most of our inns appear to have been designed with an eye to hard weather, their narrow passages, low ceilings, small rooms, huge fireplaces, and shuttered windows, all making for snugness.'

We who have a fondness for the open road, the wayside lane, the village, and the woodland by-pass, find the inn so truly inviting. It is the haven in which we drop anchor at the end of the day's trek, and we are especially attracted by its warm gay lights shimmering through hazy curtains, as we tramp down the miry country road when rain has set in to round off the winter afternoon. And if we fare no worse than the Pickwickians did at Towcester, we shall have little to complain of.

Snug anchorage

Hikers, who have been completing a long day's tramp, will probably recall the welcome appearance of some such inn. If you, for instance, have been tramping all day long, you will discover that, after you have dumped your knapsack, and have eventually sat down by a bright fire with a warm meal in front of you, that here you have the haven that affords the best shelter.

You may, afterwards, enjoy a homely chat in the parlour with the woodman, the gamekeeper, a shepherd or other real countryfolk. There is no anchorage so snug.

Mr. Thomas Burke, in his book *The English Inn* (a delightful companion for the knapsack) points out how for generations old inns have been given a place in the pages of books. 'All good novels are full of inns.' You must admit that they are well worth pursuing. What would 'Tom Jones', 'Joseph Andrews', Roderick Random', 'Pickwick',

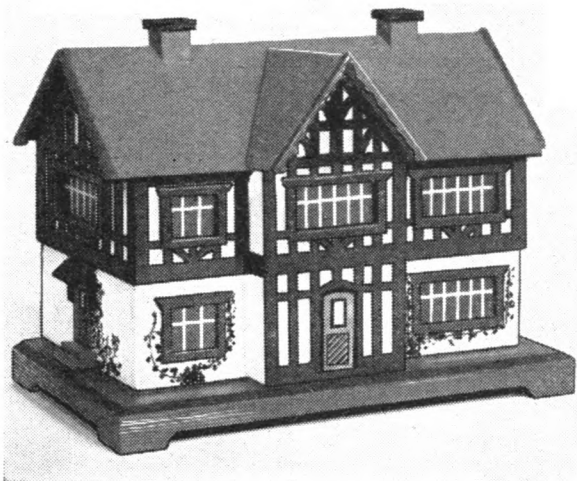

This fine model of a charming country tavern can be made from Hobbies Kit No 3222, costing 11/- (post 1/6). It is also designed to take a musical movement, which costs 16/- (post 6d.). Serving as a money box, the tune plays when a coin is dropped in a slot.

'Lavengro', etc., be without their inns. Much of their gusto would be gone, and without the inn the whole binding essence would be gone from that Pickwick of today. *The Flying Inn* is a book that should be in every self-respecting guest-room, along with *Biffin*, etc.

Dickens was very fond of roadside inns and taverns. No fewer than fifty-five are mentioned in 'Pickwick Papers' alone. Sir Walter Scott was also enamoured of inns. The first scene in 'Kenilworth' is laid at an inn; the most amusing scene in 'Rob Roy' takes place in the 'Clachau Inn' and poor misguided Jeanie Deans stayed at an inn when on her long pilgrimage to seek an interview with the king.

Washington, the author, was pleased to find himself snugly ensconced at an inn. There are associations of this great writer at the old 'Red Horse' at Stratford-on-Avon. Here you may see the room where Irving was inclined to style himself 'monarch of all he surveyed'. The chair he sat in, and his 'sceptre' — the homely poker — are still treasured.

But there, we could go on indefinitely singing the praises of the wayside inn and the taverns on the road. We shall have nothing to grumble at, let the weather be never so unkind, or the road never so long. If we never fail to see, as Dickens saw, the sign-board perched in a tree,

with golden letters winking in the sun, ogling the passer-by, especially if he is a hiker on a long tour.

English heritage

Have you ever pondered about these wayside inns, and thought of how much a part they are of England, almost as much a part as the wayside oaks, the old grey river bridge, and the ancient church.

Over many of the quaint old country inns there hangs the spark of romance. 'The inn on land and the ship on sea form a nucleus of all human adventure'. The author of *The charm of the English Village* writes: 'The signboard that swings outside the inn has many stories to tell as it creaks in the wind. Some are remarkable for their signs, and tell of the skill of the village blacksmiths of former days. The men who forged such beautiful specimens had the heart and mind of the true artist, though but simple village blacksmiths . . . of about one hundred and fifty years ago'.

One could go on indefinitely praising the virtues of the inn. Such inns have an attraction for all hikers and other road users. To quote an old writer: 'When I have earned a mug of ale — and when do you think that would be? After eight miles or ten? — there is no haven where I would sooner drop anchor than the inn'. (A.S.)

**DON'T LET SOLDERING
LEAD YOU A DANCE**



**use
FLUXITE**

Soldering ceases to be a knotty problem the moment you use FLUXITE. Solder flows on easily and smoothly—and stays on. For over half a century FLUXITE has been the choice of craftsman and engineer alike and, in this age, its reliability and speed has made FLUXITE even more in demand than ever.

**IT
SIMPLIFIES
ALL
SOLDERING**



FLUXITE LTD., Bermondsey St., London, S.E.1

GM 83

**MANY
MODELS
from
ONE TIN!**



Pyruma, plastic and ready to use from its tin, can be fashioned into the widest variety of models imaginable. Buildings for your model railway set, houses, ship models, animals and figures, ashtrays and plaques — all of which when set or baked to stone-hardness, can be finished in natural colours. Get the Pyruma Model Instruction book — see Coupon, and start making things like those shown below.

**SANKEY'S
PYRUMA
PLASTIC CEMENT**

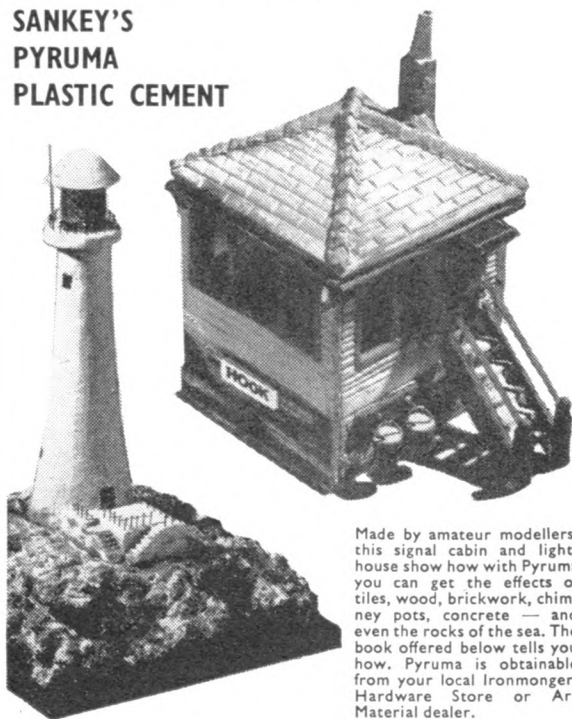

Made by amateur modellers, this signal cabin and lighthouse show how with Pyruma you can get the effects of tiles, wood, brickwork, chimney pots, concrete — and even the rocks of the sea. The book offered below tells you how. Pyruma is obtainable from your local Ironmonger, Hardware Store or Art Material dealer.

POST THIS BOOKLET COUPON TO-DAY

To **J. H. SANKEY & SON, LTD** (Dept. HW),
ILFORD, ESSEX

I enclose P.O. 6d. (not stamps) for a copy of Pyruma
Modelling Instruction Booklet, post free to:

NAME

ADDRESS

(BLOCK LETTERS PLEASE)

★ **LEARN** ★
RADIO & T/V
SERVICING
 for your **OWN**
BUSINESS/HOBBY

● by a new exciting no-maths. system, using practical equipment, recently introduced to this country.
FREE Brochure from:—
RADIOSTRUCTOR
 DEPT. G81, 46, MARKET PLACE,
 READING, BERKS. 4/5

ENJOY THE THRILL of Drawing or Painting. 'Make Art Pay' (free) explains remarkably, quick, easy method of improving mind, body and income. — Clun Valley Features (H.W.), Clun, Shropshire.

KUKLOS ANNUAL. Indispensable cyclist's handbook. Tours, resthouses, money-saving hints, 3/- post free. — Burrow, Publishers, 2 Imperial House, Cheltenham.

100 DIFFERENT stamps free! Request 1d. upwards discount approvals. — Bush, 53 Newlyn Way, Parkstone, Dorset.

Further reduced
 Brand
 New **LUXURIOUSLY QUILTED 'QUILTERFOAM'**
 Slip into it—soft and comfy—enjoy restful sleep throughout night. No blankets, no sheets, everything in one including special padding for a beautiful soft mattress effect. Light as a feather, it rolls up to a tiny lightweight size. 19/11, post 2/6. Even finished in heavy quality strong material. Really hardwearing. Not a blanket with outer, but genuinely quilted. Refund guaranteed.



Sent for 10/6, bal. 18 fortnightly payments 8 oz. 7/1. Plus DUCK, carr.

1/2 PRICE OFFER! SENT FOR 10/6
 The **FLIGHT LIEUTENANT** Genuine **NEW DUCK TENT**



Waterproofed 1960 Tents of 8 oz. **WHITE DUCK. Galeproof.** BRAND new surplus to export order. **DON'T CONFUSE** with Tents made from drab material never meant for tentage. This is real thing, withstands anything even in our climate. Approx. 7ft. 6in. x 6ft. x 6ft., 3ft. walls. Cash **£5/19/6**, carr. 6/- complete ready to erect, incl. valise. 'Willessden' Green 42/- ex. Ridge pole if req. 7/6 Fly-sheet 39/6 Rubberised Groundsheet 19/6. These essentials sent on appro. Refund guaranteed. **LISTS, TENTS**

Headquarter & General Supply Ltd.
 (HOBW/3) 196-200 Coldharbour Lane
 Loughboro Junc., London, S.E.5. Open Sat.

WHEELS (Hardwood and Rubber Tyred Metal). Cot, Pram and Doll's House Fittings and Papers. Beads, Transfers, Prints and other accessories. Stamp for new lists. (Trade supplied.) New address — **JOYDEN CO.**, 91 Peplins Way, Brookmans Park, Herts.

MODELS You can make lasting stone-hard models with Sankey's Pyrama Plastic Cement. Supplied in tins by Ironmongers, Hardwaremen, and Builders' Merchants. Ask for instruction leaflet.

PEN PROFIT. If you like writing send for 'Writers' Guide' (free). Thousands of words to interest beginner or experienced. Typewriter unnecessary under our system. — **Writer's Ring** (H.W.), 5 Edmund Street, Birmingham 3.

FREE stamp album and 20 stamps. Request Approvals, enclosing 6d. Additional gifts given. — **Beeze**, 8 Langland Villas, Mumbles, Swansea.

WORKERS with sewing machines required for making cushion covers. Regular work guaranteed. Apply enclosing s.a.e., Dept. 28. **Arnold Trading**, 10 Shelley Road, Worthing, Sussex.

CRYSTAL DIODE. instructions, etc., to build matchbox diode receiver, reception guaranteed. Send 4/- P.O. only to — **BCM/ALEXTONE**, London, W.C.1.

YIPEE·E·E·E·E·E·E

CERTOFIX
Really
FIXES

CERTOFIX liquid glue can cope with all general repairs. It unites wood, glass, metal and almost all substances. It is clean in use; its joints are stronger than the materials it unites.

Sold at all Woolworth Stores

CERTOFIX

APPARATUS & CHEMICALS
 For your experiments. Let us help you equip a **HOME LABORATORY**

Beakers, Crucibles, Flasks, Funnels, Gas Jars, Test Tubes, etc.
 Booklets:
 (including postage)
 'Experiments' 1/2
 'Formulas' 1/2
 'Home Chemistry' 2/10
 New edition

Send 3d. Stamp for latest **PRICE LIST**
A. N. BECK & SONS (Dept. H.W.)
 60 Stoke Newington High Street, London, N.16

HEAR ALL CONTINENTS
 With **H.A.C. Short-Wave Receivers**

Suppliers for over 18 years of radio S-W Receivers of quality.
 One-Valve Kit, Price **25/-** Two-Valve Kit, Price **50/-**
 Improved designs with Denco coils. All kits complete with all components, accessories and full instructions. Before ordering, call and inspect a demonstration receiver, or send stamped addressed envelope for descriptive catalogue.
 'H.A.C.' Short-Wave Products (Dept. 22), 11 Old Bond Street, London, W.1.

WOOD BENCH VICE

A strong hardwood vice which can be screwed to the work bench. A real serviceable tool, well made, and fitted with hardwood screws. 12 in. long.
 From branches or:
HOBBIES LTD.
 Dereham, Norfolk

Price 7/6 (Post 1/6)

A 'PENGUIN' THERMOMETER



THE basis of this thermometer is the 'Decorette' transfer sheet No. 4003. There are two different pictures on the sheet. Slide one of them on to a piece of $\frac{1}{4}$ in. wood, allowing room for the thermometer. Allow 24 hours to dry and then cut round the outline with a fretsaw. Give two coats of clear varnish. Another thermometer stand can be made with the other transfer.

Make a strut from waste wood to hold the picture upright. Pin the thermometer in position. The transfer sheet costs 2s. 3d., postage 3d., and the thermometer No. 5015 2s. 3d., postage 3d. Both are obtainable direct from Hobbies Ltd. Dereham, Norfolk, or from your nearest Hobbies branch or stockist. (M.p.).

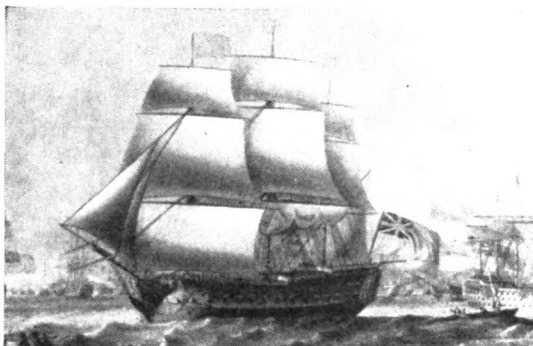

Illustration by permission of
National Maritime Museum

Just like the real thing!

Airfix kits are not just models — they're exact replicas, each series to a constant scale.

There are models galore in the Airfix range! Aircraft from fighters to bombers (*all to the same 1/72nd scale*), 00 gauge railway accessories, vintage cars, historical ships. Airfix value is *unbeatable* — ask your dealer for the latest list.

Nearly 100 kits from 2/- to 10/6d.

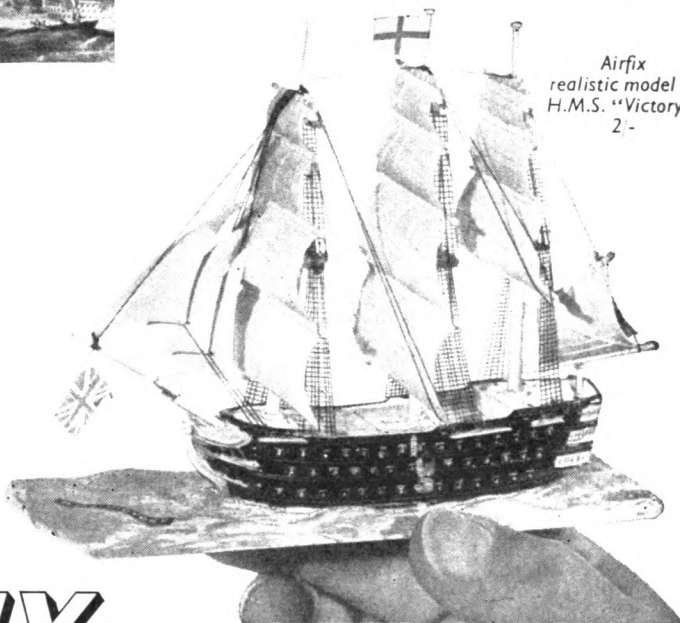

Airfix
realistic model of
H.M.S. "Victory"
2/-

AIRFIX

THE WORLD'S GREATEST VALUE
IN CONSTRUCTION KITS

From Model and Hobby Shops, Toy Shops and F. W. Woolworth

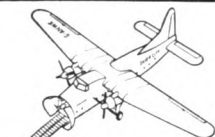

AIRCRAFT

Bristo Superfreighter 76d.

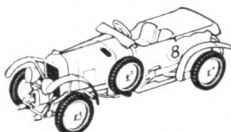

VINTAGE CARS

1930 Bentley 2l-

MODEL
FIGURES

Lifeguard
2/-

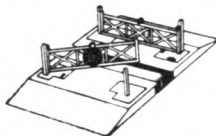

TRACKSIDE SERIES

Level Crossing 2/-

STOP PRESS!

Latest Airfix Production

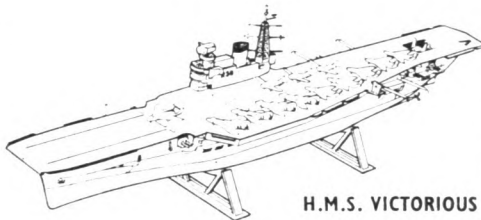

H.M.S. VICTORIOUS

The second kit in the new Airfix series of Famous Warships, this exciting model almost defies belief! It makes up from 94 separate parts into a magnificent model measuring 15½ inches long (constant scale 50 ft. : 1 inch). Attractively boxed, complete with Swift, Sea Venom and Gannet aircraft, cradles, marking transfers and cement—all for the remarkable price of only 6/-.

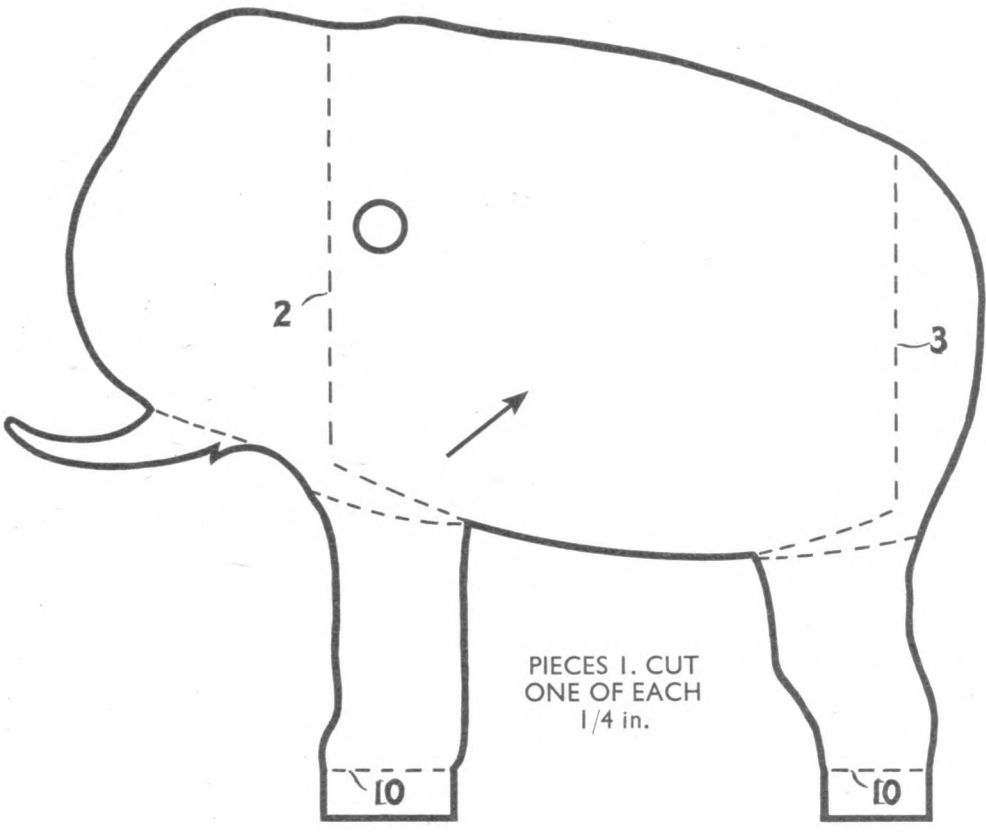

PIECES 1. CUT ONE OF EACH 1/4 in.

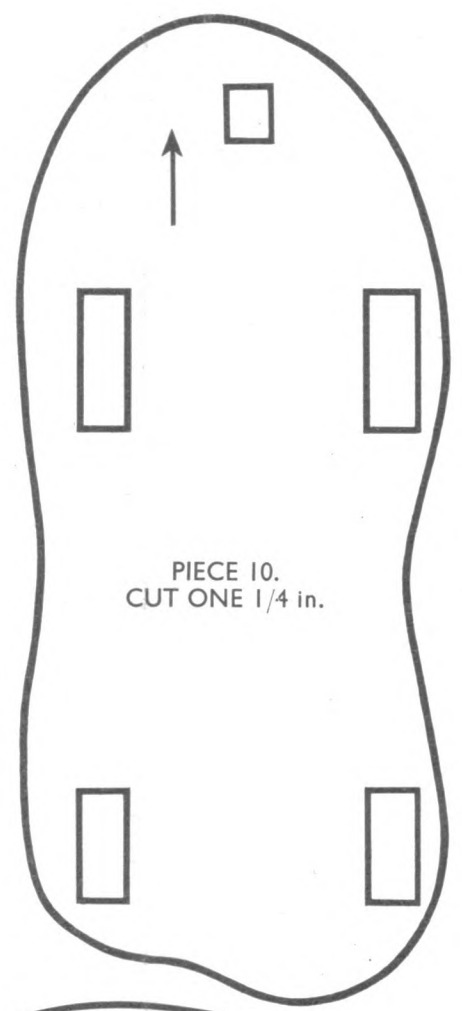

PIECE 10. CUT ONE 1/4 in.

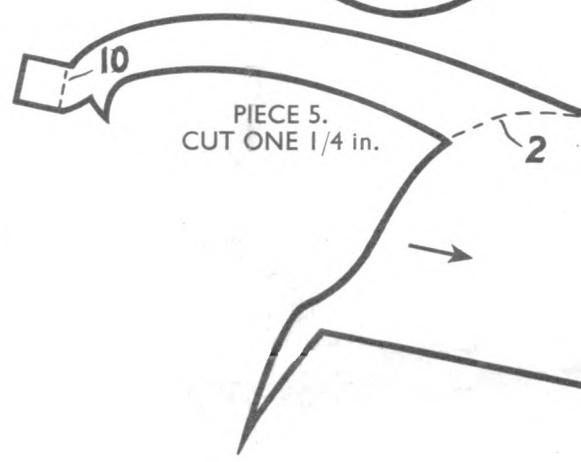
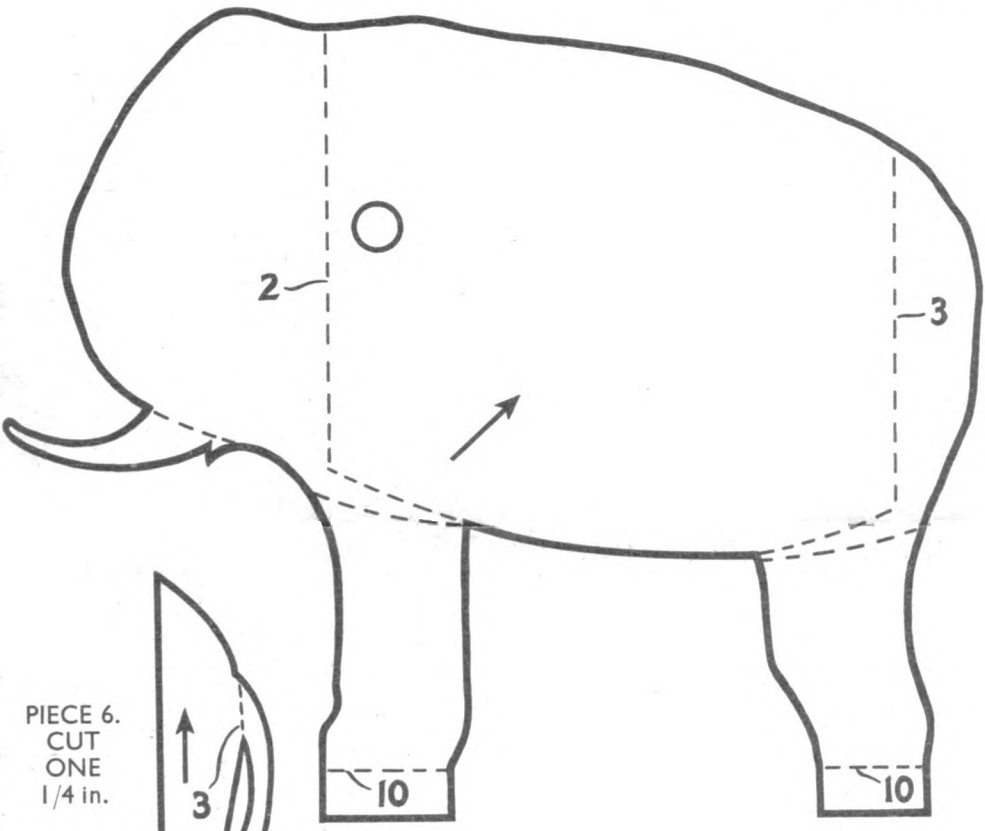

PIECE 5. CUT ONE 1/4 in.

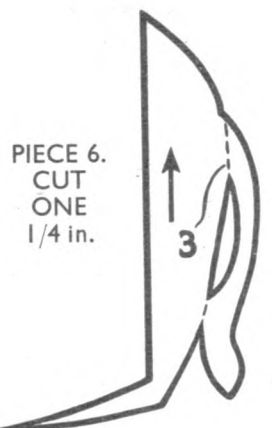

PIECE 6. CUT ONE 1/4 in.

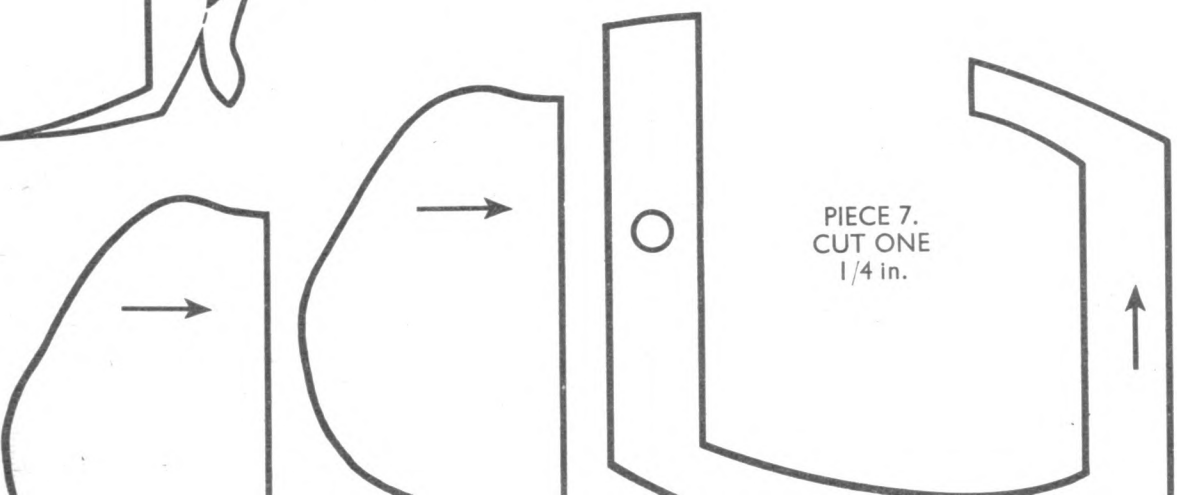

PIECE 7. CUT ONE 1/4 in.

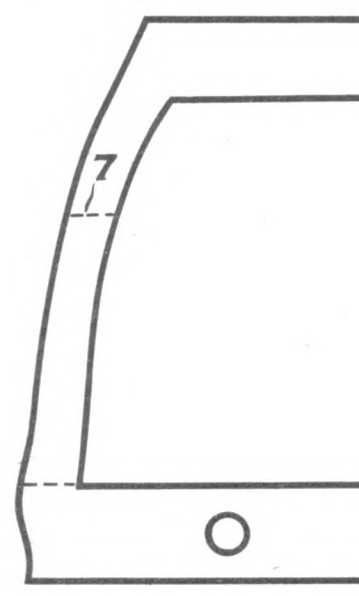



DESIGN

No. 3360

'JUMBO' SAVINGS BANK

SIZE: 5 1/4 in. x 2 1/4 in. x 4 1/4 in. HIGH

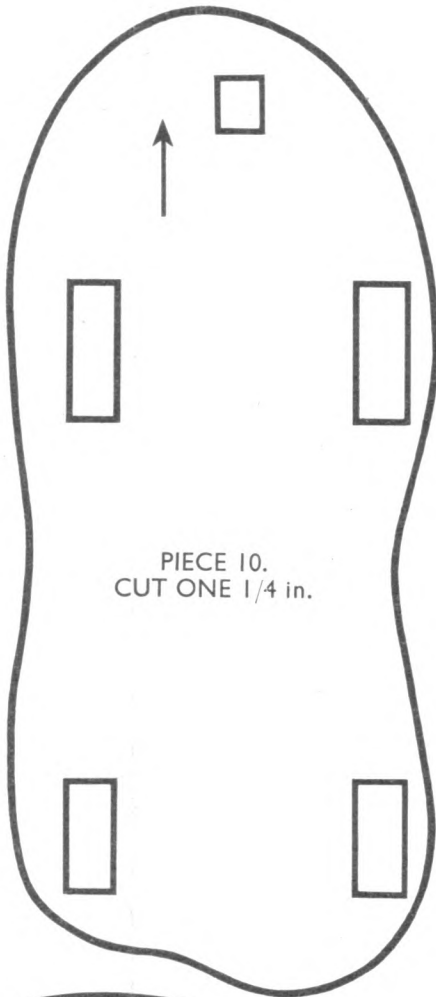

PIECE 10.
CUT ONE 1/4 in.

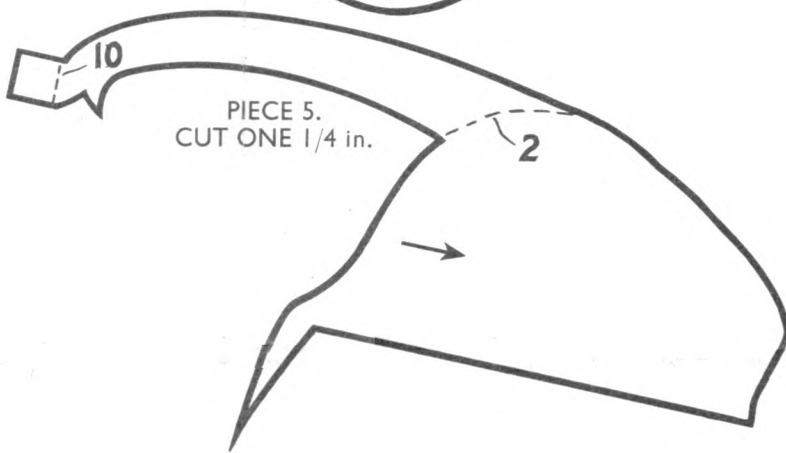
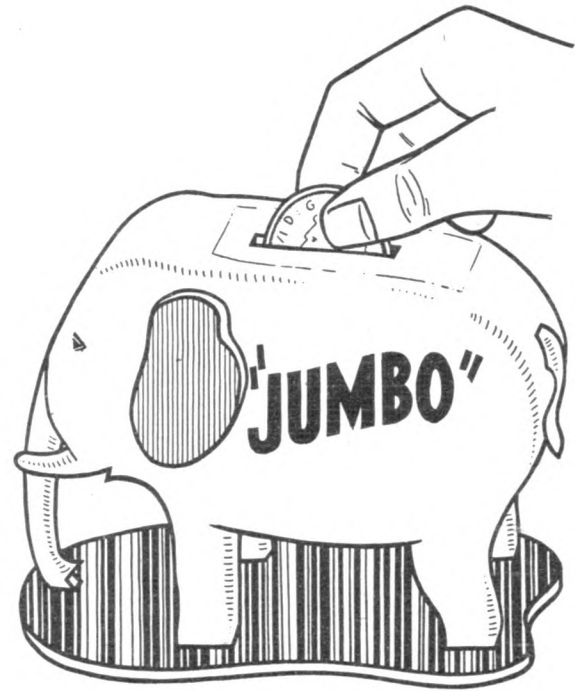

PIECE 5.
CUT ONE 1/4 in.

PANELS OF WOOD REQUIRED FOR THIS DESIGN
ONE H4 ONE G4 ONE ND8
A KIT OF MATERIALS FOR MAKING THIS DESIGN IS SUPPLIED BY HOBBIES LTD, DEREHAM, NORFOLK
PRICE ON APPLICATION.

A perfect finish every time

Humbrol Art Oil Enamel, the supreme model builder's finish. Available in tins from 1/2 oz. to 1/2 pint. A range of 34 colours available; glossy, matt and metallic. Humbrol Enamels dry in one hour.



FROM ALL BRANCHES OF HOBBIES LTD.

Don't spoil your model with an inferior paint...
always use **HUMBROL**

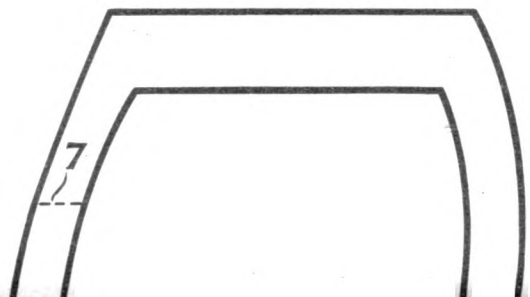
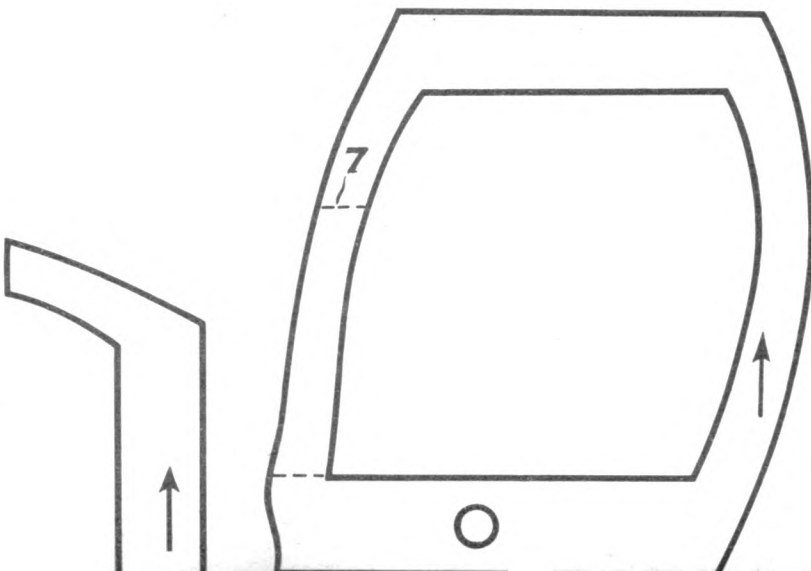

PIECES 1. CUT ONE OF EACH 1/4 in.



CUT ONE 1/4 in.

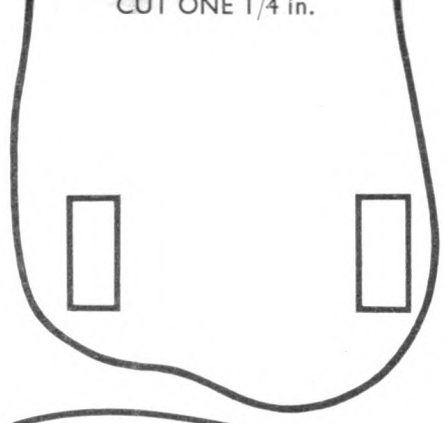

2

3

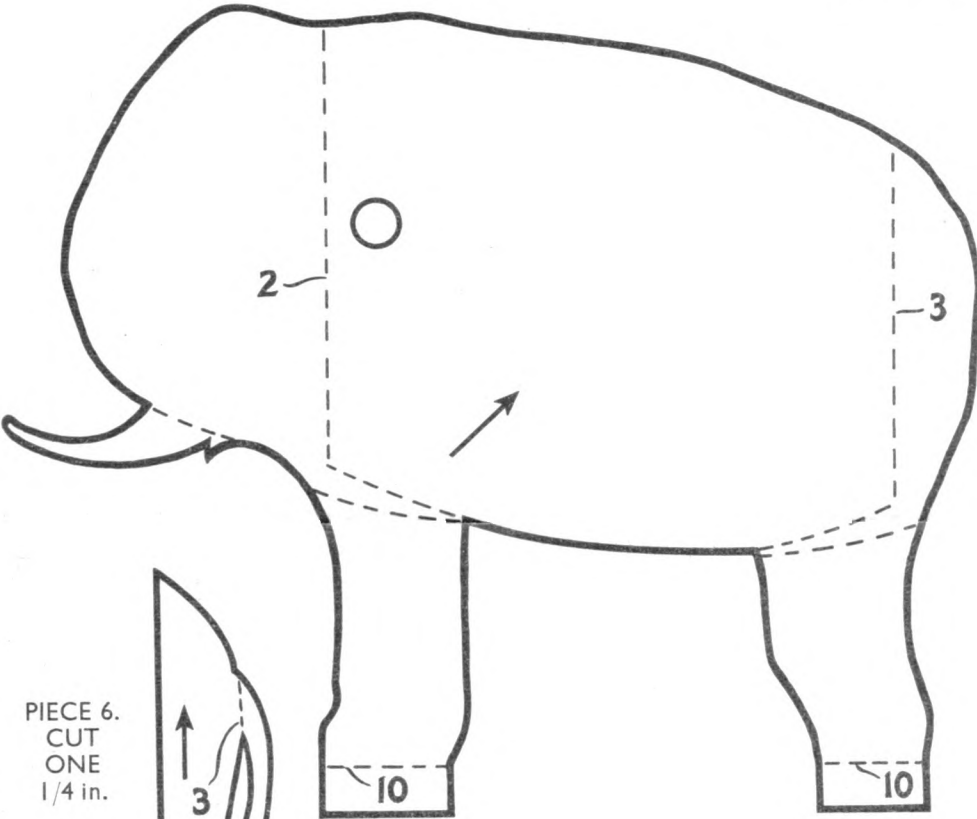

PIECE 5. CUT ONE 1/4 in.



PIECE 6. CUT ONE 1/4 in.

3

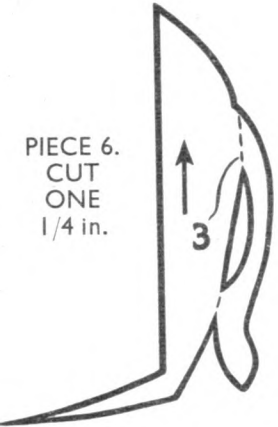

10

10

PIECE 7. CUT ONE 1/4 in.

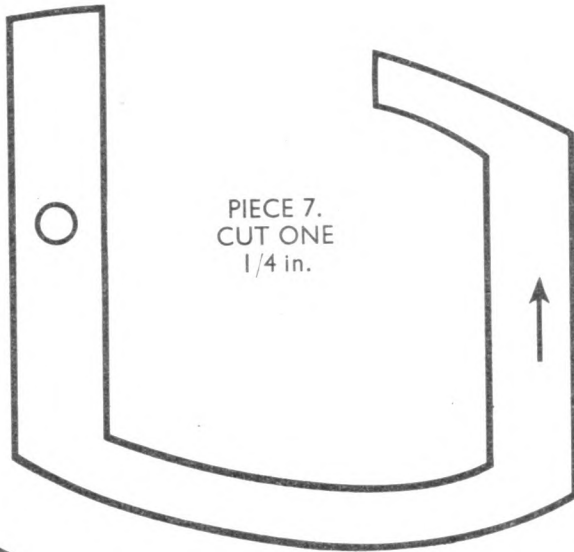

7

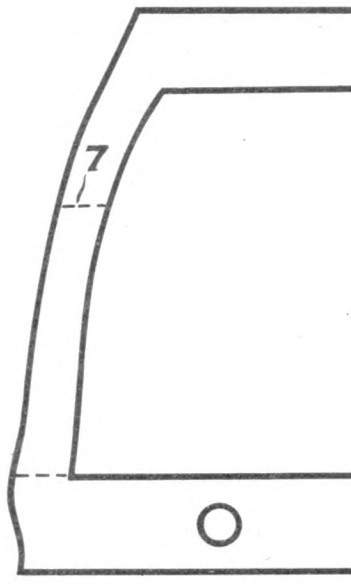

PIECES 2. CUT ONE OF EACH 1/2 in.

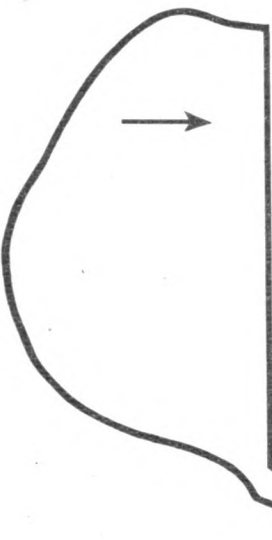

PIECE 8. CUT ONE 1/4 in.

PIECE 9. CUT ONE 1/4 in.

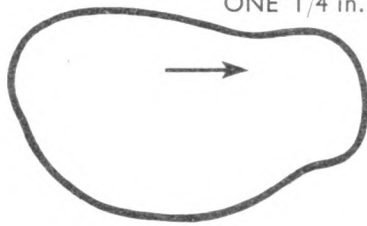

THE ARROWS INDICATE DIRECTION OF GRAIN OF WOOD

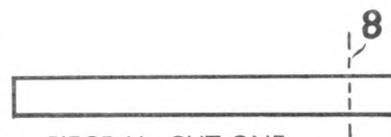

PIECE 11. CUT ONE FROM 3/16 in. DIA. ROUND ROD

PIECE 10.
CUT ONE 1/4 in.

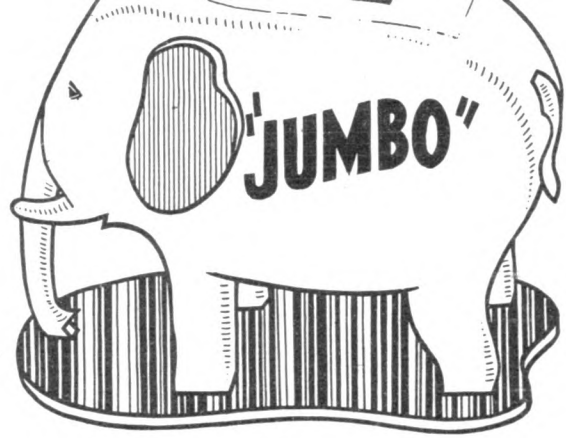
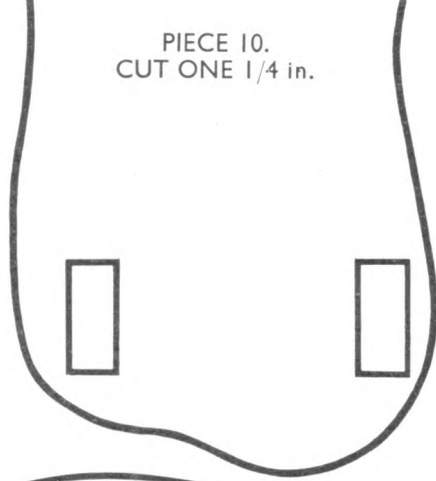

PIECE 5.
CUT ONE 1/4 in.

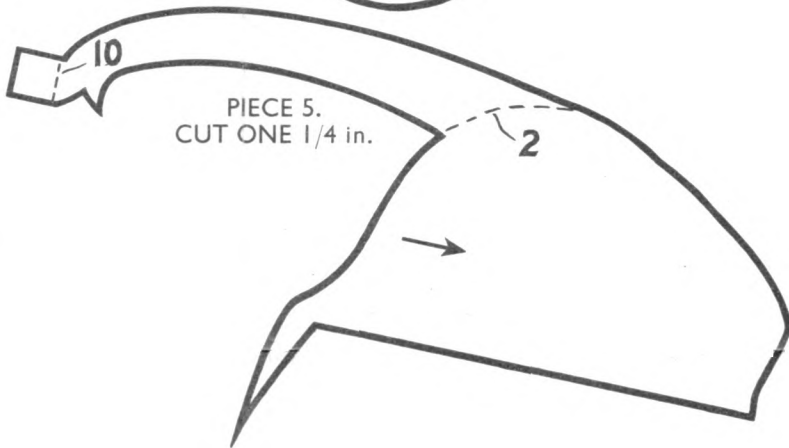

PANELS OF WOOD REQUIRED FOR THIS DESIGN

ONE H4 ONE G4 ONE ND8

A KIT OF MATERIALS FOR MAKING THIS DESIGN IS SUPPLIED BY HOBBIES LTD, DEREHAM, NORFOLK
PRICE ON APPLICATION.

A perfect finish every time

Humbrol Art Oil Enamel, the supreme model builder's finish. Available in tins from 1/2 oz. to 1/2 pint. A range of 34 colours available; glossy, matt and metallic. Humbrol Enamels dry in one hour.



FROM ALL BRANCHES OF HOBBIES LTD.

Don't spoil your model with an inferior paint...
always use **HUMBROL**

PIECES 4.
CUT ONE OF EACH
1/2 in.

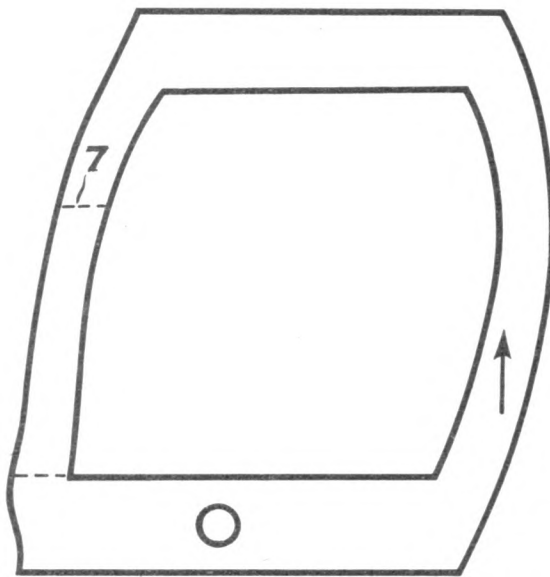

THE ARROWS INDICATE
DIRECTION OF GRAIN OF
WOOD

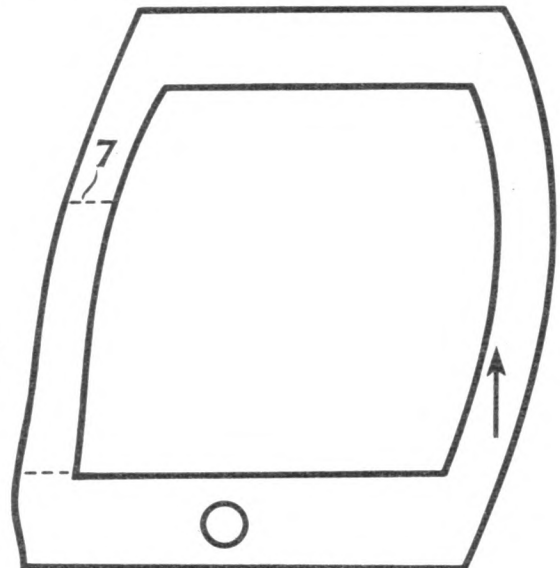

PIECE 3. CUT TWO 1/2 in.

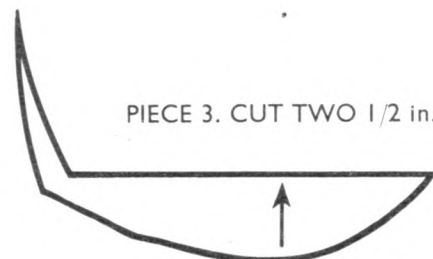

PIECE 11. CUT ONE
FROM 3/16 in. DIA.
ROUND ROD

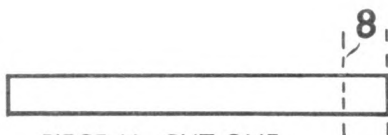

Animie the ANIMATED DUCK

A PULL ALONG

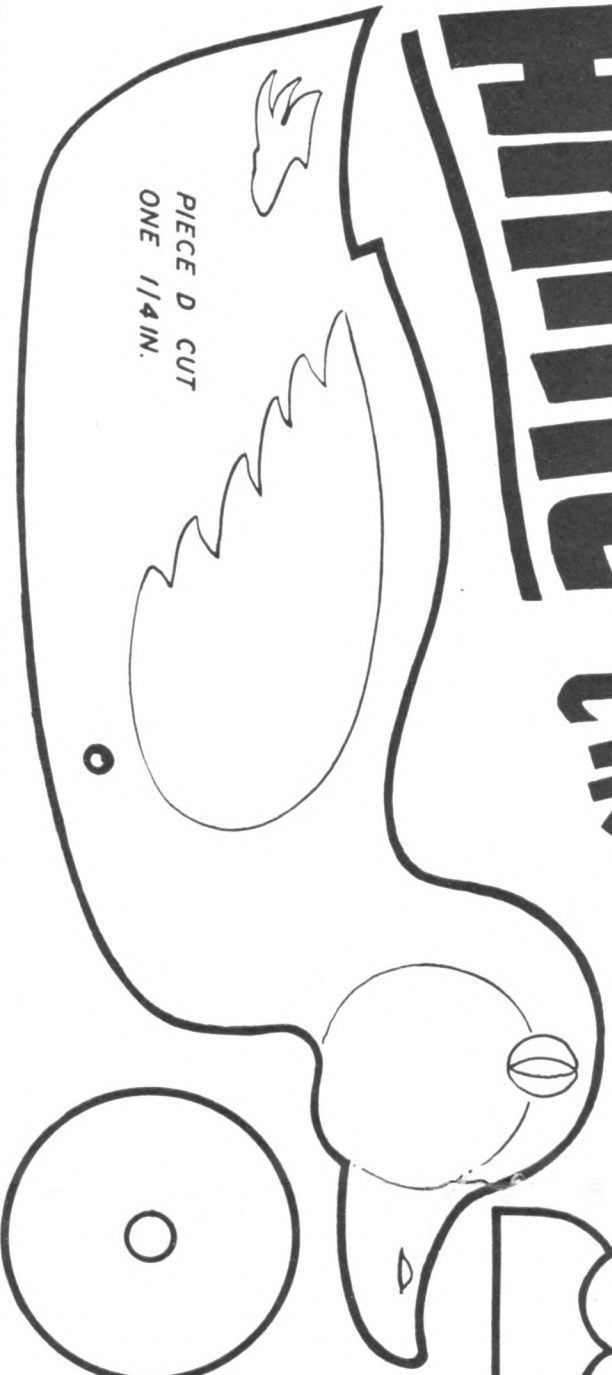

PIECE D CUT ONE 1/4 IN.

PIECES C CUT TWO 1/4 IN.

WHEELS E CUT FOUR 1/4 IN.

AXLE CUT ONE 1/4 IN. DIA. ROUND ROD

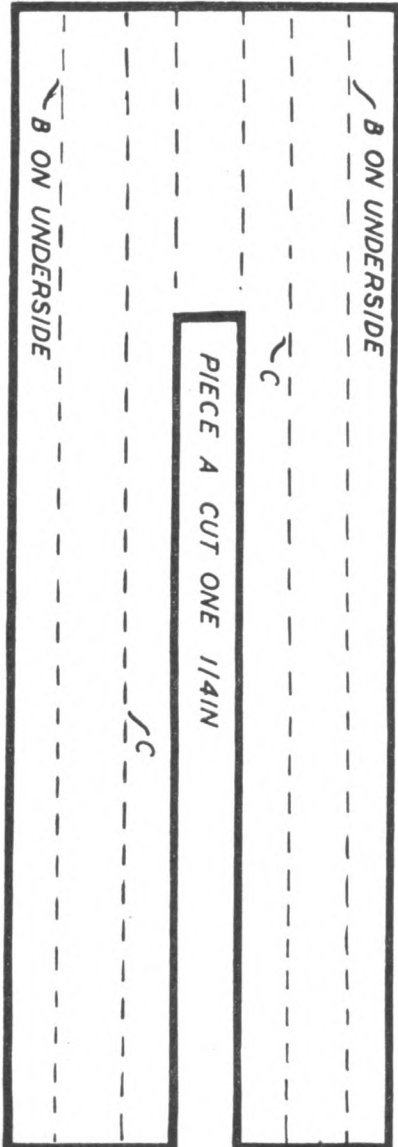
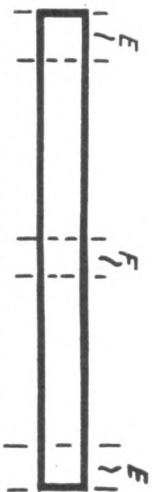

PIECE A CUT ONE 1/4 IN

B ON UNDERSIDE

B ON UNDERSIDE

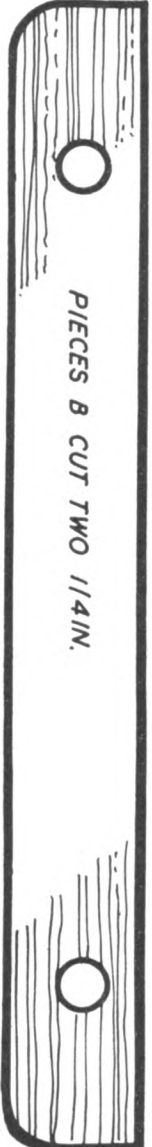

PIECES B CUT TWO 1/4 IN.



PIECE F CUT ONE 1/4 IN.

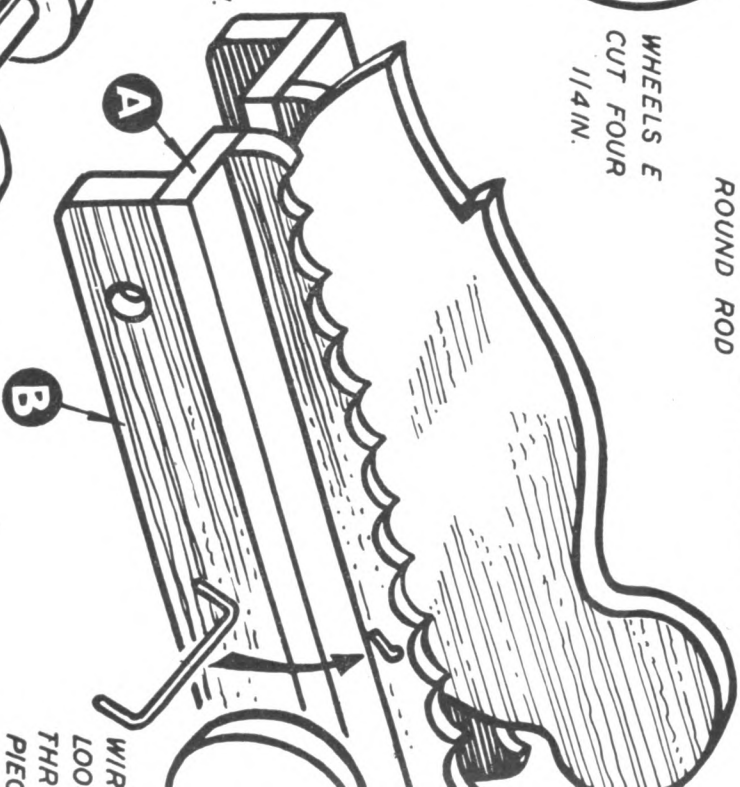

WIRE LOOP THRU PIECE

NOVEL FLORAL DECORATIONS

DAINTY floral decorations can be made by using a new plastic material which is easily home-processed. It is sold in the form of tiny crystals at large stores and handicraft shops under the proprietary name of Jiffy Bubbles. A jar of crystals costs 2/6.

Reference to our illustration will show the immediate result of an application of these decorative beads after processing, but if the twigs are allowed to remain in water, the leaves will ultimately emerge. You may also add the decorative berries to evergreen plants.

Collect some medium-sized twigs from trees or shrubs, either deciduous or evergreens as you choose, placing them in a large bowl, and rinsing thoroughly with clean cold water to remove any dirt or grime. This is most important if you live in an industrial area. Flowering Currant twigs or cuttings from Silver Birch Trees are ideal for this purpose. Surplus water should be shaken off, and the twigs allowed to dry.

The Jiffy Bubbles have the appearance of small clear crystals, not unlike sugar. Boil a small volume of water in a pan. While the water is boiling, a teaspoonful or so of the crystals is added to the water, and the lid placed on top of the pan. After a few moments the bubbles will expand into white beads, but you



must judge the correct size for yourself — normally about the size of small peas.

The bubbles are then placed in a strainer in order to drain off the surplus water, and allowed to dry.

This method will produce white berries, but the addition of red ink will change the colour to pink, and you may use other inks or dyes to make other shades. The berries will quickly dry if laid out on a sheet of old newspaper, and it is essential that they are thoroughly dry before proceeding.

Now take a clean dry twig, applying a good adhesive at various points. You will find that Copydex is ideal for this purpose of fixing the berries. Place the twig on newspaper, heaping the bubbles in the area of the adhesive, and they will adhere quite readily. This process is repeated until the twig is sufficiently decorated. Do not apply too much adhesive at a time, or it may dry out before adhesion occurs. When decorating evergreen twigs it is better to be a little more sparing, applying the adhesive here and there, and giving the final appearance of berries.

Surplus berries which have not adhered are shaken free on to a newspaper and used for another twig. If the twigs are allowed to stand in a vase containing water, the leaves will ultimately open, producing a really pretty decoration.

(S.H.L.)

A Target for your Toy Pistol

THIS novel 'aquaria tank' with performing 'frog' that leaps into the air when the striker rod is struck by a correctly-aimed missile, provides an effective target for use with the toy pistol described in our issue of April 13th.

The 'tank' consists of an assembled wood box to the dimensions given on the pattern page opposite. Cut the base, back, and end members from $\frac{3}{8}$ in. wood, and glue together. Clear plastic material is suggested for the front 'glass' panel, so that the frog, when positioned inside the tank, is visible to the marksman. Alternatively this panel can be of plywood, painted to represent a water tank with fish and other aquaria subjects, in which case the frog will be out of sight until released by pressure of the striker rod. Paint inside and outside of assembled tank, adding painted or cut-out fish, etc, to the inside surface of the back panel.

A hole is drilled about $\frac{1}{2}$ in. down from the top of each end panel nearest to the

edge of the front panel. Across the inside edge of the front panel stretch a length of rubber strip, knotting the ends securely through the holes. Transfer the full-size pattern of the frog on to plywood, and cut out with your fretsaw. Cut the central hole in the body, and glue in the round rod 'striker', as shown.

STUDY THE PATTERNS ON OPPOSITE PAGE

When the striker rod has set in place, glasspaper the cut-out frog then paint in bright shades of green, brown, and yellow, adding the eyes and mouth as realistically as possible. The target striker rod is painted bright red.

Mark a centre line from top to bottom of the front panel, and with the frog held in position behind the panel, mark the spot for the hole into which fits the striker rod. Drill this hole to the diameter of the rod. Test in place, and open out the hole or smooth down the rod to obtain a loose fit. The frog's feet should touch or just clear the base when mounted behind the panel, his eyes being about $\frac{1}{2}$ in. down from the top edge.

Glue or bind with adhesive cellulose tape the 'glass' panel to the front. A narrow strip of rubber for powering the target action can be cut from an old cycle inner tube. A less powerful but, nevertheless, effective 'catapult' can be obtained with garter elastic. When setting the target for shooting games, guide the striker rod over the elastic, suppressing the frog, and engaging the striker rod into the front panel hole.

The target should be accurately 'set', so that correctly aimed missiles cause the frog to jump sharply from the tank when the striker rod is hit. (T.S.R.)

LEAP-FROG TARGET

AMUSING TOAD TARGET FOR TOY PISTOL GAMES!

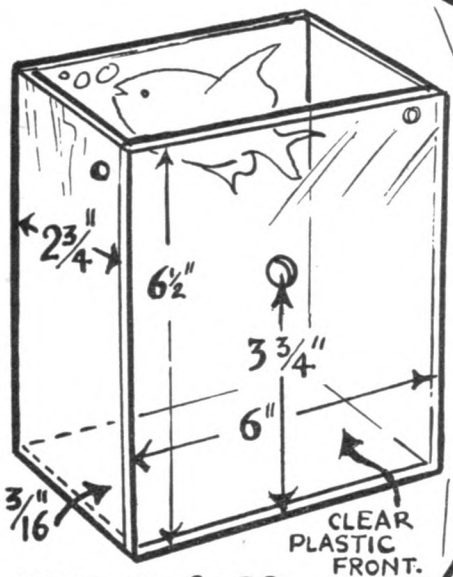

MAKE UP SIDES, BACK & BASE OF 'TANK' WITH PLY.

KNOT

STRIP RUBBER

KNOT

FROG PATTERN
CUT FROM ¹/₈" PLY.

PAINT OR GLUE
AQUARIA
PICTURES
INSIDE

DRILL OR CUT HOLE & GLUE IN ¹/₂" DIAM. STRIKER-ROD.

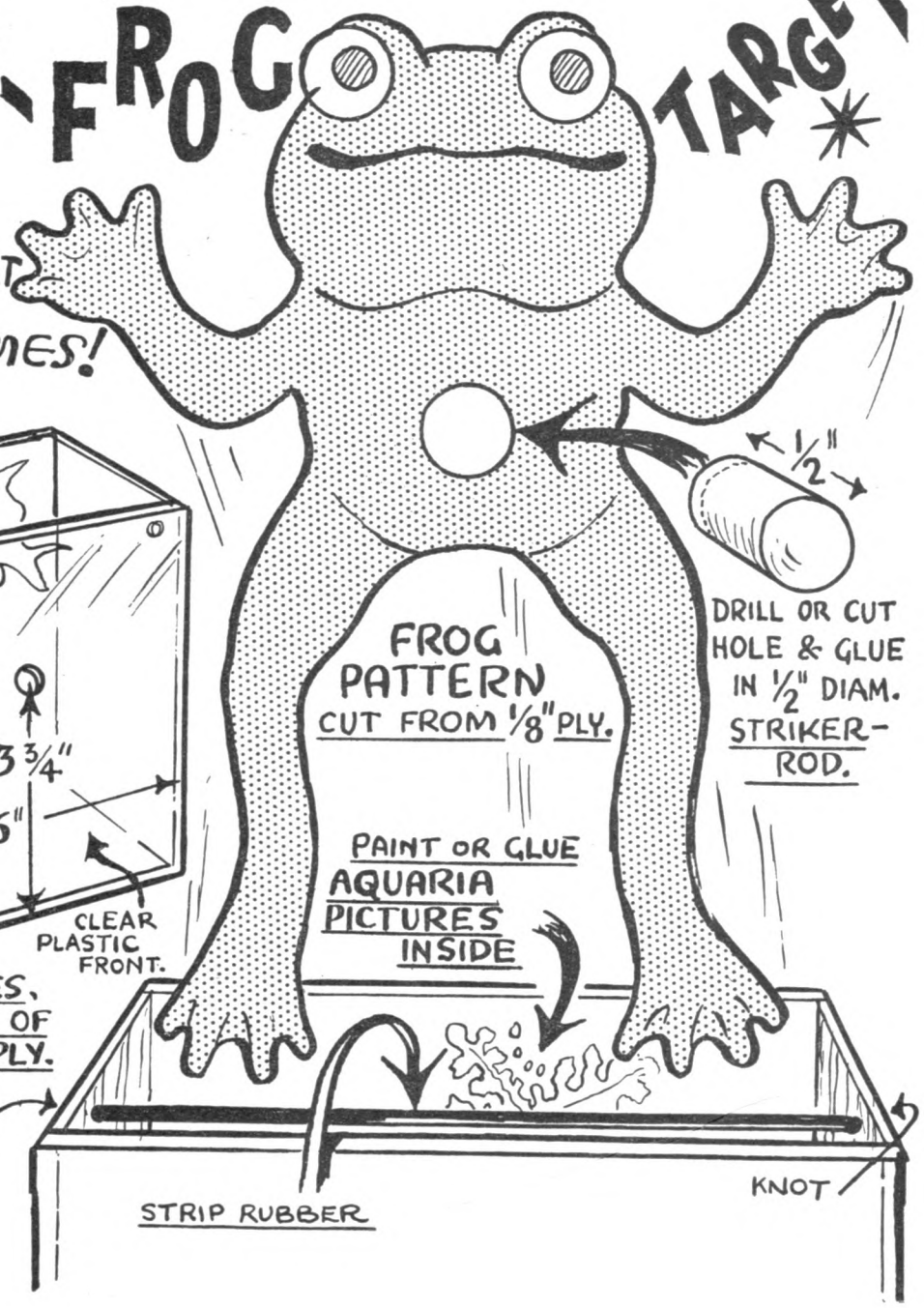

PHOTOGRAMS MEAN FUN

ABOUT one hundred years before photography was invented, a German professor named Dr J. H. Schulze discovered that silver salts were darkened by exposure to light. He used this discovery to copy manuscripts, and his early sensitized papers were very similar in many ways to those we use today. No camera was used, and the method merely consisted of arranging the manuscripts so that they were in close contact with the sensitive material.

This is the simplest form of photo-

efficient safelight if the whites are to be free from fogging. Moreover, whatever paper is selected you are advised to use a contrasting grade.

Cartoons and sketches form a good basis for humorous outline photograms, and you may assemble the various oddments in the ordinary roomlight before proceeding to the darkroom. When you are ready to proceed with the exposure, a sheet of paper should be fastened to a piece of board by means of pushpins to keep it perfectly flat. This does not apply

if you use netting, since it is better to lay same on the paper, covering both with a sheet of clean plate glass to ensure perfect contact.

When the oddments have been satisfactorily arranged according to your scheme, the paper is exposed to the white light. A 60 watt lamp may require about 5 seconds, although the paper speed will determine this, the light being held at a distance of 18 in. above the paper. The materials are removed, the paper developed, fixed and washed in the usual

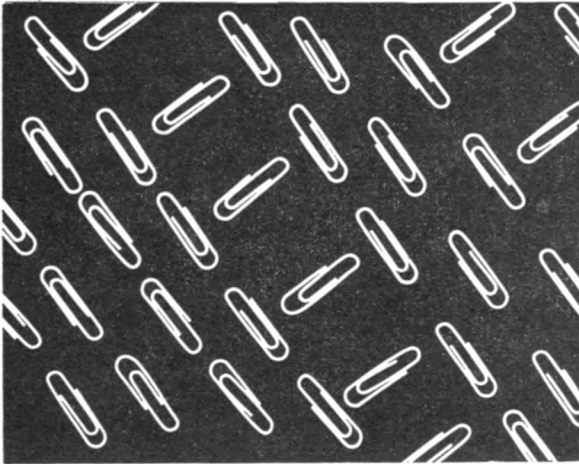

A simple example with paper clips

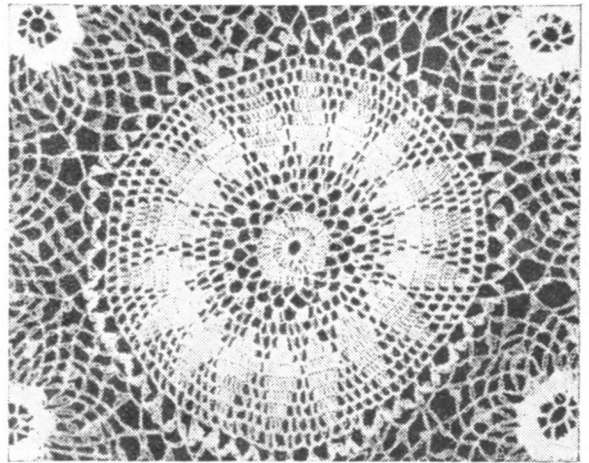

A lace mat made this pattern

graphy that can be imagined and the word itself really means 'writing with light', so we can use the same principle for making what we term photograms.

Our photograms are made within the confines of the darkroom with the aid of the usual safelight, and the only other apparatus required is some form of electric lamp controlled by a switch.

We could say that photograms are like silhouettes in reverse, an object being laid on the paper which is then exposed to the light and, after development, the picture is complete; no negative being required. And the fascinating part about this process is that, although everything is entirely under your control, one can never be certain of the result.

You may use any size of photographic paper, but it will be apparent that the best results are obtained on the larger sizes. While quarter-plate paper is quite convenient, and half-plate size allows much more scope; but it makes no difference whether you use contact printing paper or bromide paper normally used for enlargements. It should be noted however, that the latter demands a really

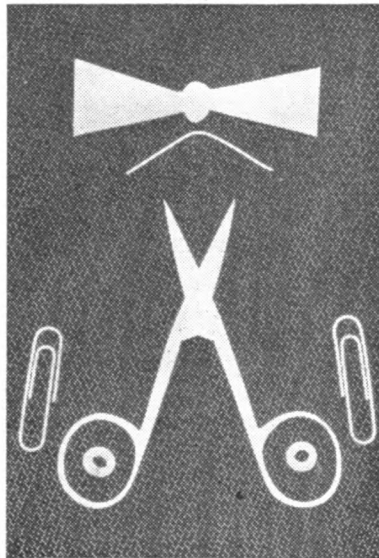

The objects were laid on glass which covered a piece of fine netting.

manner, and the photogram is complete.

It will be understood that the resulting prints are the originals and there is no negative available for further reproduction, so the process must be either repeated or a copy negative made.

It is quite possible that traces of dust may have settled on the sensitive paper during the processing, leaving white specks behind in the black background. The remedy for these is simple retouching. All you need is to charge a fine pen with Indian ink, touching the white spots.

The production of original photograms is almost limitless with a few simple materials. And combinations of various objects produce different effects. For example, you may lay a piece of perforated gauze or netting over the paper, placing other objects on top. The former will produce an all-over background, while the shapes of the other objects will print out normally. Scissors, pliers, nails, discs, paper clips, buttons and many other articles will help your designs. Why not try a few leaf patterns, or shapes cut from cartoons?

(S.H.L.)

SPOT ON with the **ILFORD Sporti 4**

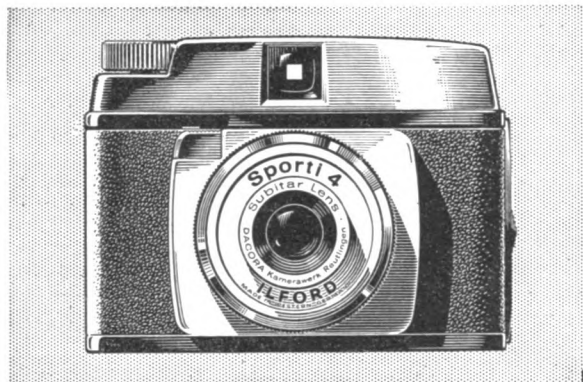

You'll get super pictures from this classy camera

ILFORD LIMITED · ILFORD · ESSEX

This new 'Sporti 4' is certainly some camera. A really smart job, strongly made, with a big eye-level viewfinder. Even if you've never had a camera before, you can't go wrong with the Ilford 'Sporti 4'. In daylight, set the aperture to **SUNNY** or **CLOUDY** and squeeze the button.

And you can easily take flash pictures, too, with the 'Sporti 4'. You get twelve pictures from every roll of 127 film. Spot-on—every time.

What a wonderful present the 'Sporti' would make! Or you could soon save your pocket money and buy it yourself—it'll give you a lifetime of fun, and it costs so little.

ILFORD SELOCHROME PAN

That's the film to ask for—whether you have a 'Sporti 4' or any other roll-film camera. Selochrome Pan is the all-purpose film made by Ilford, who also make the special films for nuclear research. So remember always to say "Ilford Selochrome Pan, please".

ONLY 49'8 EVER-READY
CASE 17/5



WENSUM DINGHY

Designed by P. W. Blandford. An excellent performer, with a good turn of speed under sail and suitable for racing. Overall length 11ft. Offered completely finished and ready for the water or in kit form to build yourself from full-size drawings and complete instructions.

COMPLETE DINGHY

(without sails)

£125

COMPLETE KIT

(without varnish and sails)

£74

SUIT OF SAILS (First-class Terylene)

All prices ex-works **£22.10.0** Quotations for delivery



HOBBIES LTD

(Dept. 99)

**DEREHAM
NORFOLK**

CHEMISTRY

AT HOME

BOOK bindings which have grown shabby can be restored by brushing with a special bookbinders' varnish. To make a small supply weigh out 4 grams of gum elemi, 4 grams of gum mastic, 6 grams of gum sandarac, and 3 grams of Venetian turpentine (NOT oil of turpentine). Owing to its sticky nature Venetian turpentine is best weighed on a watch glass. Put this into a small clean tin with a press-on lid, and pour on 30 c.c. of methylated spirit. When the spirit has dissolved the Venetian turpentine, remove the watch glass, and add the gums. Press home the lid, and leave the whole overnight. Then stir well, and if all is not in solution, stand the tin in hot water (no flame, because of the inflammability of the meths.), and stir until all is in solution. Coat the books thinly on spine and front cover, and leave to dry. Turn the books over and finish off the back cover.

Any varnish remaining should be stored, in a screw-capped jar fitted with an extra disc of rubber within the cap, so as to prevent evaporation.

SELF-RAISING FLOUR. — Should the lady of the house run out of self-raising flour and the shops be shut, a supply can be made quickly if one has at hand sodium bicarbonate, cream of tartar, and plain flour. Put 1½ pounds of plain flour into a large dry bowl. In a smaller dry vessel thoroughly mix ½ ounce of sodium bicarbonate and ounce of cream of tartar, and add it to the flour. Turn and stir with tumbling motion until you are satisfied an intimate mixture has been effected. Then sift the flour two or three times and stir up again.

WATERPROOF INKS FOR GLASS. — Such inks are often needed for use in the laboratory, home, and workshop. A simple formula consists of 10 grams of shellac, 4 grams of Venetian turpentine, 16 c.c. of oil of turpentine (NOT turpentine substitute), and 5 grams of indigo powder. Warm the oil of turpentine in a small tin standing in hot water, dissolve the Venetian turpentine in it, and then the shellac. Pour out when cool into a small screw-capped jar having an extra rubber disc. Stir in the indigo.

Another formula contains 10 grams of shellac, 5 grams of Venetian turpentine, 1.25 grams of gum sandarac, 15 c.c. of oil of turpentine, and 2.5 grams of either lampblack (for a black ink) or ultramarine in powder form (for a blue

ink). Dissolve as in the first formula, and then stir in the pigment.

TEMPORARY TRACING PAPER. — A useful ruse for tracing depends on the translucence given to ordinary writing or typing paper by benzine. This you may have noted if you have spilled cigarette lighter fuel on paper. Lay the paper over the matter to be traced, and brush well with benzine. The matter

USEFUL PRODUCTS YOU CAN MAKE

may then be reproduced by tracing with a pencil, using more benzine if evaporation occurs before the job is finished. The benzine soon evaporates and leaves the paper in its original state. Naturally, the operation should be conducted in absence of flames.

GRINDER DISC CEMENT. — Emery cloth or glasspaper can be satisfactorily cemented to discs on power tools by applying beeswax to the warmed disc, pressing on the cloth or paper, and allowing to set under pressure until cold. When worn, the cloth or paper is easily removed and replaced by warming.

RESISTANT CORKS. — By impregnating corks with rubber solution they can be made much more resistant to chemical solutions. Thin down ordinary rubber solution with benzene, and immerse the weighted corks therein for some hours. On removal and airing off, the rubber will be deposited in the pores. This treatment may also be used for waterproofing wood.

SCENTING TALCUM POWDERS. — A very special talcum powder is easily made to the perfume of your choice with the aid of the petals of any scented flower you may have. Other perfumed materials may also be used, such as cedar wood shavings or crushed cloves.

First make up the talcum base from 95 grams of purified talc, 2 grams of boric acid, and 3 grams of light magnesium carbonate. All these are available from a pharmacist. Mix thoroughly, and put a thin layer in a screw-topped jar, add a layer of the perfuming material and repeat the alternate layering until all the talcum base is used up. Screw on the lid and leave for two days. The talc

takes up the odour of the perfuming material during this period, and then may be sifted out. The operation may be repeated if the odour is not strong enough.

COPYING PAPER FOR LACE AND LEAVES. — For taking copies of lace, leaves, and similar flat objects, silver chloride impregnated paper should be prepared. The object appears pale on a dark ground. Unsurfaced paper is needed for the most even absorption of the chemicals. Dissolve 1.3 grams of sodium chloride (kitchen salt) in 28 c.c., or 1 fluid ounce of either distilled or filtered rain water, and pour the solution into a wide shallow vessel. Drop in the paper, and when thoroughly wetted lift, drain, press lightly between clean blotting or filter paper, and allow to dry.

Now make up a solution of 3.89 grams of silver nitrate in 28 c.c. of distilled or filtered rain water, and pour this into the shallow vessel which has been thoroughly rinsed free of salt solution with plain water. In a dim light, drop in the filter paper, and when soaked, lift, drain, and press as before, and allow it to dry in the dark. Keep the paper in the dark.

When required for use, place it between two sheets of glass, with the object to be copied uppermost, secure with rubber bands, and expose to light until the exposed part of the paper darkens no further. It must now be fixed by immersion in sodium thiosulphate solution ('hypo'). Dissolve 10 grams of sodium thiosulphate in 100 c.c. of water, and immerse the paper in it for fifteen minutes, keeping the paper on the move by rocking the vessel. Lift, drain, wash in running water for thirty minutes, lift and drain again, and allow to dry on a flat surface. (L.A.F.)

★ **KITS FOR CANOES, ★**
★ **DINGHY, AND A ★**
★ **CATAMARAN ★**

★ Hobbies Ltd. can now supply ★
★ canoes PBK 10 and 20 completely ★
★ made up and ready for the water. ★
★ Also available are kits for home ★
★ assembly. (See back page.) ★

★ Similarly, readers can obtain a ★
★ 'Wensum' Dinghy or kit of first- ★
★ class materials. (See page 103.) ★

★ A 16 ft. Catamaran is also on ★
★ the stocks. This twin-hulled 'Fly- ★
★ ing Cat' received an enthusiastic ★
★ write up from a daily newspaper ★
★ Yachting Correspondent after ★
★ trials on the Norfolk Broads. ★
★ Again, it will be available in kit ★
★ form or as a completed craft. ★

★ Further details of these craft ★
★ can be obtained from the Editor. ★

KITS FOR MODERN FURNITURE

from Dept. 99

HOBBIES LTD DEREHAM, NORFOLK

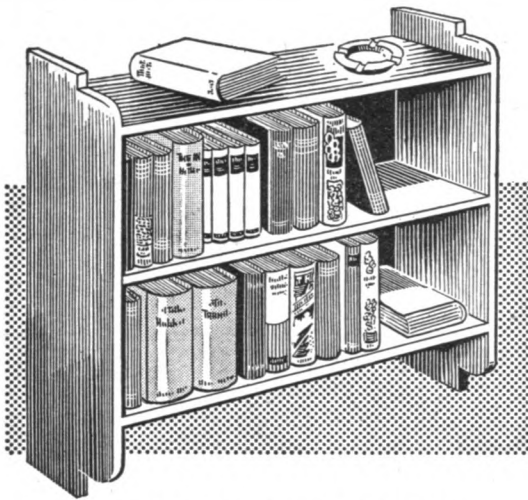

HANGING BOOKCASE

(DESIGN No. 3326)

36 ins. wide, 35 ins. high, 10 ins. deep

A space-saving unit to hang on the wall.
Kit of selected hardwood, plywood for back,
design sheet and instructions.

56/- (carr. paid)

SMALL CABINET

(KIT No. 3144)

Ideal as a bedside cabinet.

Size 27 ins. high, 18 ins. wide

Kit of selected planed wood,
dowel rod, hinges, handle,
design sheet and instructions
etc.

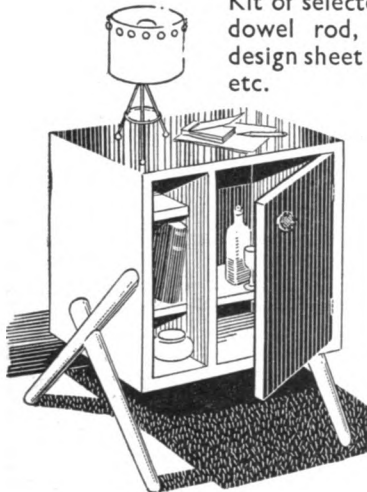

66/6 (carr. paid)

**THESE
KITS
SAVE
POUNDS**

CONTEMPORARY CABINET

(KIT No. 3114)

A really outstanding piece of work, of which any
handyman can be proud. As cocktail cabinet,
sideboard, etc.

Size 3 ft. long, 27 ins. high

Kit of selected planed wood, hinges, handles,
design sheet and instructions, etc.

102/6 (carr. paid)

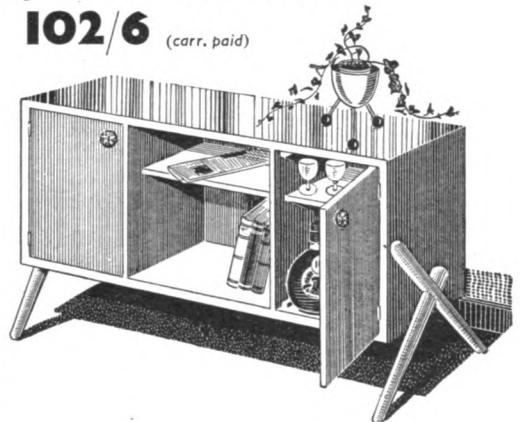

Kit No. 240
Special

ST. PAUL'S CATHEDRAL

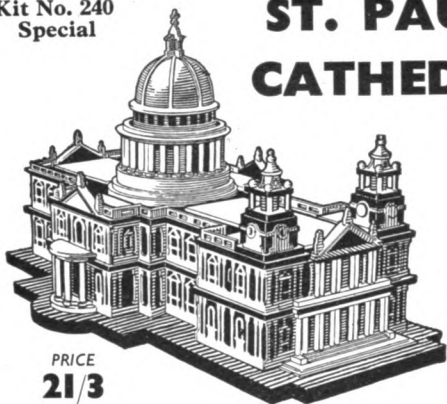

17 in. long
9½ in. high

PRICE
21/3

Craftsmen who want to make a really outstanding piece of work should try this fine model of St. Paul's Cathedral. Kit contains design, instructions, plywood, panels of wood, turned knobs, stripwood, etc.

Obtainable from Hobbies Branches or Stockists, price 21/3 or direct from Hobbies Ltd, (Dept. 99), Dereham, Norfolk (post 2/6 extra).

To HOBBIES LTD, Dept. 99, DEREHAM, NORFOLK.
Please send Kit No. 240 Special. P.O. for 23/9 (including postage) enclosed.

Name.....
Address.....

*The Pistol all your
chums will envy!*



- ★ High Accuracy and Hitting Power
- ★ Perfect Balance
- ★ Robust Construction

Send for catalogue

WEBLEY & SCOTT LTD

34 PARK LANE, HANDSWORTH, BIRMINGHAM 21. West Bromwich 2821

One of the Windsor Group of Companies

LET
★ **'Plasticine'**
HELP YOU DO-IT-YOURSELF Regd. Trade Mark
Harbutt's Plasticine Ltd, Bathampton, Bath

HOBBIES BRITISH FRETSAW BLADES

THE BEST YOU CAN BUY

YELLOW LABEL 1/2 per doz. 13/6 gross

BLUE LABEL 8d. per doz. 7/6 gross

From Hobbies Branches or by post (3d. extra)
from Hobbies Ltd., Dereham, Norfolk



★ LEARN ★ RADIO & T/V SERVICING for your OWN BUSINESS/HOBBY

● by a new exciting no-maths. system,
using practical equipment, recently intro-
duced to this country.

FREE Brochure from :—
RADIOSTRUCTOR
DEPT. G81, 46, MARKET PLACE,
READING, BERKS, 11/5

ENJOY THE THRILL of Drawing or Paint-
ing. 'Make Art Pay' (free) explains remark-
able, quick, easy method of improving mind, body
and income. — Clun Valley Features (H.W.),
Clun, Shropshire.

100 DIFFERENT stamps free! Request 1d.
upwards discount approvals. — Bush,
53 Newlyn Way, Parkstone, Dorset.

PEN PROFIT. If you like writing send for
'Writers' Guide' (free). Thousands of words to
interest beginner or experienced. Typewriter un-
necessary under our system. — Writers' Ring
(H.W.), 5 Edmund Street, Birmingham 3.

Further reduced
Brand
New

Slip into
it—soft
and
comfy—
— enjoy
restful

sleep throughout
night. No blankets, no
sheets, everything in
one including special padding for a beautiful
soft mattress effect. Light as a feather, it rolls up
to a tiny lightweight size. 19/11, post 2/6.
Even finished in heavy quality strong material.
Really hardwearing. Not a blanket with outer
but genuinely quilted. Refund guaranteed.

Sent for
10/-, bal.
18 fort-
nightly
pay-
ments
7/1. Plus
carr.

Waterproofed 1960
Tents of 8 oz. WHITE
Duck. Galeproof. Brand new,
surplus to export order. DON'T

CONFUSE with Tents made from drab material
never meant for tentage. This is real thing, with-
stands anything even in our climate. Approx. 7ft.
6in. x 6ft. x 6ft., 3ft. walls. Cash £5/19/6, carr. 6/-
complete ready to erect, incl. valise. 'Willessden'
Green 42/- ex. Ridge pole if req. 7/6 Fly-sheet 39/6.
Rubberised Groundsheet 19/6. These essentials
sent on approval Refund guaranteed. LISTS, TENTS.

Headquarter & General Supply Ltd.
(HOBW/4) 196-200 Coldharbour Lane
Loughboro Junc., London, S.E.5. Open Sat.



Completely new 54 page Edition
WHERE'S THAT CAR FROM?

Price 1/- (Postage 4d.)

Of all Booksellers

or

RALEIGH PRESS, Exmouth, Devon

WORKERS with sewing machines required
for making cushion covers. Regular work
guaranteed. Apply enclosing S.A.E., Dept. 28,
Arnold Trading, 10 Shelley Road, Worthing,
Sussex.

BUYING OR SELLING?

Classified advertisements on this page are
accepted at a cost of 6d. per word prepaid.
Use of a Box No. is 1/- extra. Send P.O. with
advertisement to *Hobbies Weekly*, Advert.
Dept., Dereham, Norfolk. Rates for display
advertising on application.

FOR MODEL MAKERS

THE 'MIGHTY MIDGET' electric motor,
T only 1¼ in. high. Runs at 10,000 R.P.M. from a
4½ V. torch battery. Minute current consump-
tion. Complete with pulley, price 10/6 postage 6d.
MODEL BOAT PROPELLER. 3 blades,
shaft, pulley, and 5½ in. long stern tube, to run off
above 'Mighty Midget'. Price 7/3, plus 6d. postage.
HOBBIES LTD. (Dept. 99), DEREHAM,
NORFOLK.

A SMALL CLOCK

(IDEAL FOR THE BEDROOM)

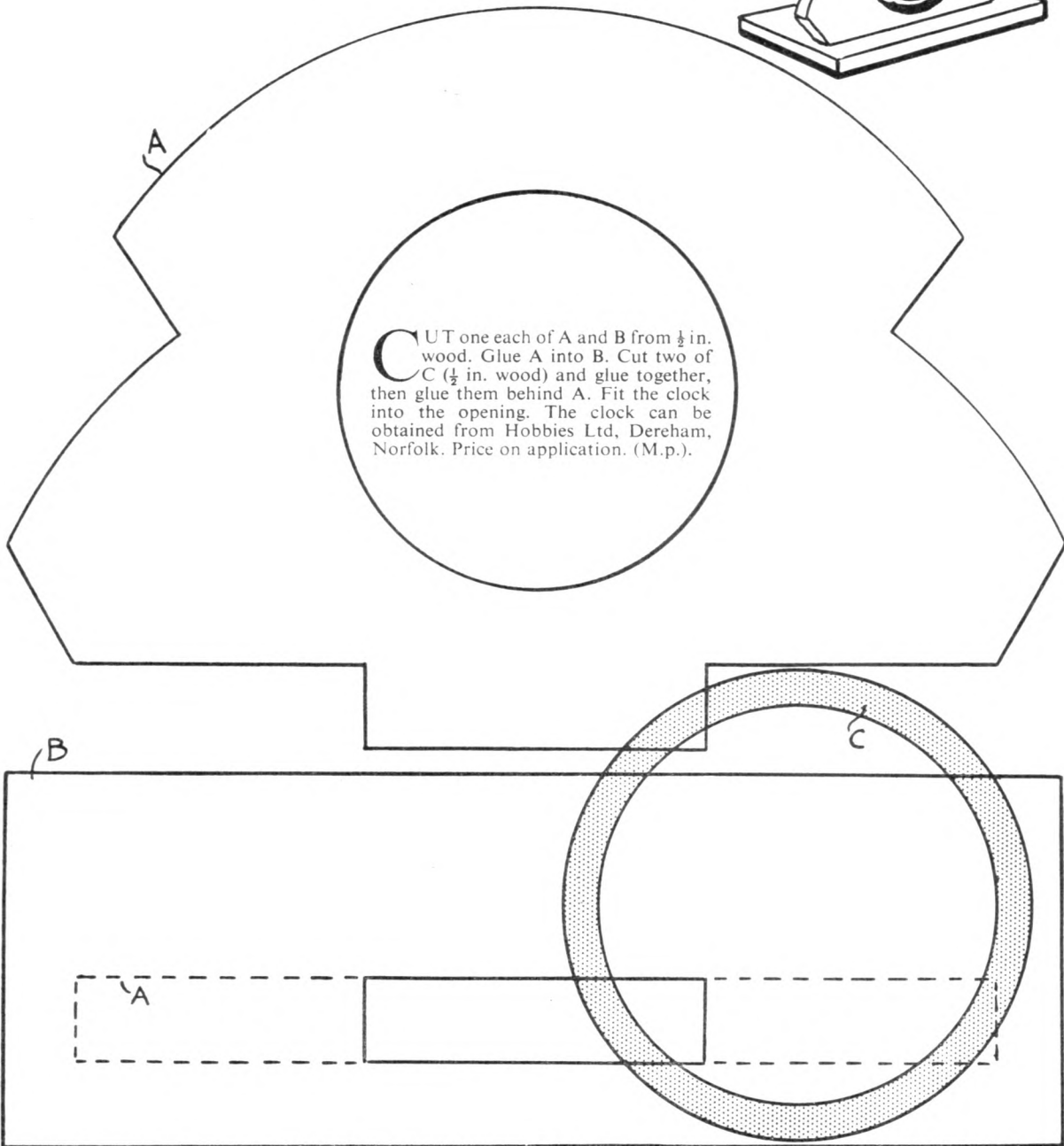

Single seat and two seat CANOES

COMPLETE AND READY
FOR THE WATER — OR
IN KIT FORM TO MAKE
YOURSELF

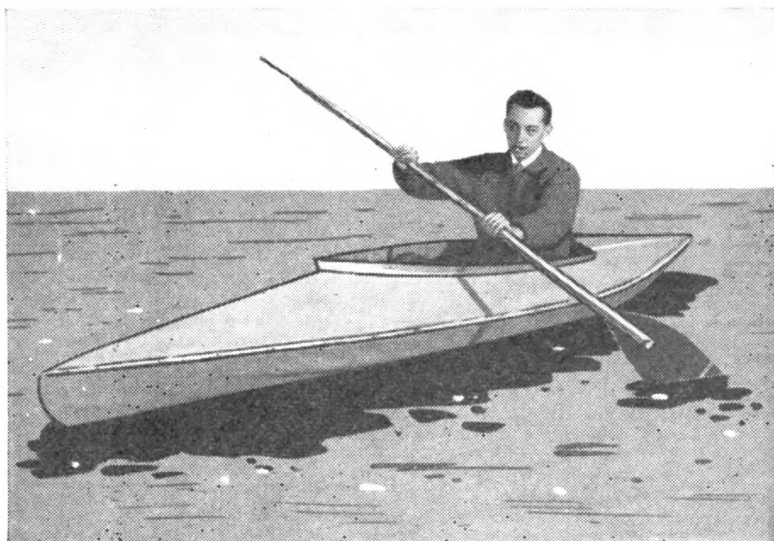

THE PBK 10 SINGLE SEATER

These popular craft are designed by that well-known authority, P. W. Blandford. With canvas skins, they are propelled by double-bladed paddles and are thoroughly at home on lake, river or canal—or even on the sea in experienced hands. They are offered as complete canoes, or as specially prepared kits, which include full building instructions.

PBK 10

Single seat—11ft. long
28in. beam—load 300lb.

COMPLETE CANOE **£24.5.0**
(without paddles) (Part p. & p. £2 extra)

COMPLETE KIT **£15.10.0**
(except paint and varnish
and without paddles) (Part p. & p. 15/- extra)

PBK 20

Two seater—15ft. long
32in. beam—load 700lb.

COMPLETE CANOE **£32.10.0**
(without paddles) (Part p. & p. £2.10.0 extra)

COMPLETE KIT **£22.5.0**
(except paint and varnish
and without paddles) (Part p. & p. 20/- extra)

DOUBLE-BLADED PADDLES, 47/6 Complete (Part p. & p. 2/6 extra)

DEREHAM

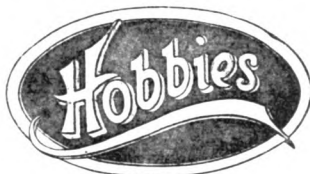

NORFOLK

11th MAY 1960

VOL. 130

NUMBER 3361

THE ORIGINAL
'DO-IT-YOURSELF'
MAGAZINE

HOBBIES *weekly*

FOR ALL
HOME CRAFTSMEN

Also in this issue:

HEARING AID
RADIO SET

ANIMATED TOY
FOR A CHILD

ELECTROSTATIC
NOVELTIES

COLLECTORS' CLUB

TARGET FOR TOY
PISTOL SHOOTING

PHOTOGRAM FUN

ETC. ETC.



FULL INSTRUCTIONS
FOR MAKING . . .

FOR THE
JUNIOR MISS

A PLAY SINK



Up-to-the-minute ideas

Practical designs

Pleasing and profitable things to make

5^D



THE men who began to build the Schlitz Brewery more than a century ago proved themselves true prophets when they chose the globe belted with the word 'Schlitz' as their trademark. Schlitz has carried the name and the fame of Milwaukee to the far corners of the earth.

In 1849, August Krug began a small brewery in Milwaukee, U.S.A., which was then a city of 17,000 inhabitants. In 1850 he was followed by his father, George Krug, and his nephew, August Uihlein, then a lad of eight.

After the death of August Krug in 1856, his widow married Joseph Schlitz, the book-keeper of the company. In 1875, Schlitz sailed for Europe on the S.S. *Friedrich Schiller*, to visit relatives. He

was lost at sea when the vessel foundered off Land's End. August Uihlein then assumed direction of the business, and was later joined by his brothers Henry, Edward, and Alfred.

LOOK FOR THESE INN SIGNS

The House of Schlitz has now become one of the world's largest breweries.

The illustrations show these many interesting signs.

'THE SILENT WOMAN' — You'll see this sign at Wareham, in Dorset. It depicts a woman with her head tucked underneath her arm!

'THE ROSE REVIVED' — Some people say this beer-drinking rose commemorates the Restoration. But it might be a hint from a thirsty sign-painter. Hogarth painted inn signs for drinks on the house.

'THE ADAM AND EVE' — This sign is in Paradise, Gloucestershire. Yet another *Adam and Eve* is in Norwich. It once had a landlord named Cain Abel.

'THE FIVE ALLS' — Many signs are satirical. The last figure depicts the man who 'pays for all' — John Bull.

'THE SHOULDER OF MUTTON AND CUCUMBERS' — Many signs feature famous regional dishes such as this. Others are: 'ROUND OF BEEF', 'CORNISH PASTIES', 'HAGGIS ARMS,' etc.

'THE WHY NOT?' — An invitation to a drink.

'THE CAT AND CUSTARD POT' — This curious name often crops up as a nickname for the 'RED LION'.

'THE WHITE HOUSE' — America's roots grow deep in Britain. Did you know that William Penn went to Oxford, and that Pocahontas once lived at Gravesend?

FEW Scottish coins are known prior to the 12th century. After that we have a truly national Scotch coinage, with pieces bearing the 'lion' and the 'thistle'.

COINAGE — 3

Under James I of England and VI of Scotland, the arms of Scotland and Ireland were quartered with those of England and France on English coins. The term 'Great Britain' was adopted for the United Kingdom, and on the reverse were the words 'Que Deus conjunxit nemo separat'.

Charles I improved the national coinage, both in design and execution. Cromwell discarded the royal arms from English coins, and substituted the simple cross of St. George with a palm and olive branch, and the legend, 'The Commonwealth of England'. On the Restoration, Charles II revived the old forms of his father's coinage.

At this time, the need for small change became so great that Charles II overcame his prejudice against coining the baser metals, and issued (A.D. 1672) a copper coinage, which was called 'Servant of Money'.

George I was the first to incorporate the title 'Defender of the Faith' on our coins. George III effected great improvements in them by his new coinage of 1817. The silver crown, with the Greek figures of St. George and the Dragon still on our sovereigns, now appeared, from a design by Pictrucci. The coinage

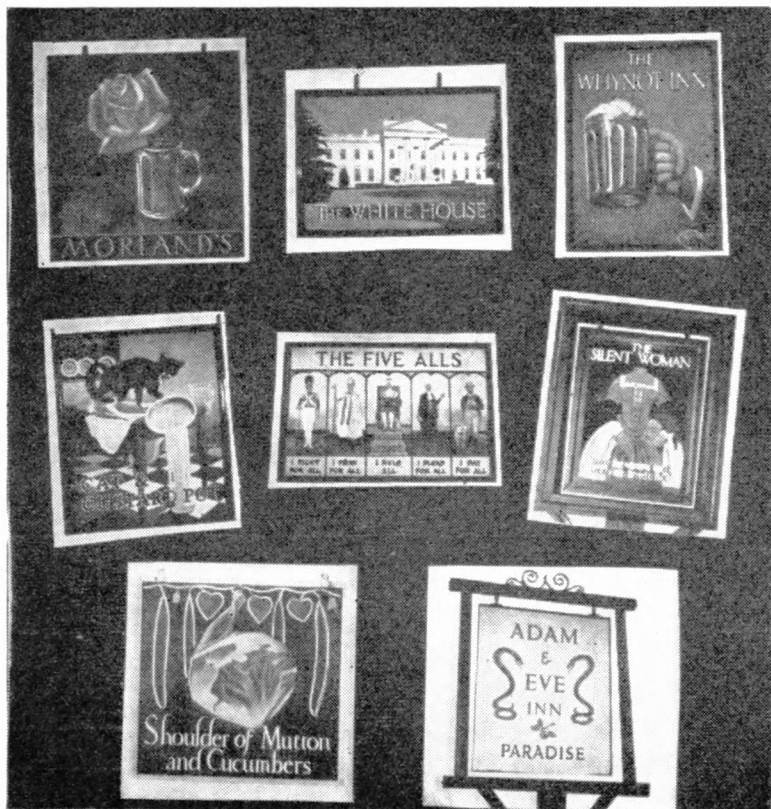

of George III gave our coins the form they now possess.

Queen Victoria, who began her reign in 1837, issued a series of coins having her likeness, executed by Wyon. The shillings were like those of the preceding reign, with the words 'One shilling' between oak and laurel branches. Large £5 pieces were also struck as medals, not for circulation. In 1860 the new bronze coinage replaced the older and weightier copper pieces. The Jubilee, or fiftieth year of her reign, was, as we all know, signalized by another new coinage in the form of a 'double florin', or four-shilling piece, in silver; as well as a £2 and a £5 piece, in gold.

C. T. Rathod, Vadi Pura H.87, Surendranagar, W.R., Bombay State, India, is an enthusiastic coin collector, philatelist, and fretworker. In a recent letter he said:

'I am a regular reader of *Hobbies Weekly*. I like writing to other readers from all over the world.'

Two friends from India

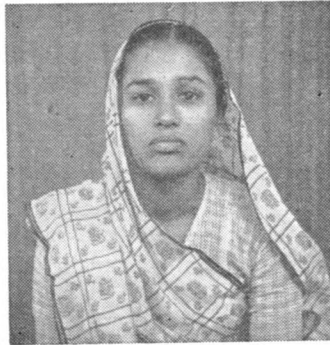

Mrs. Sarda C. Rathod

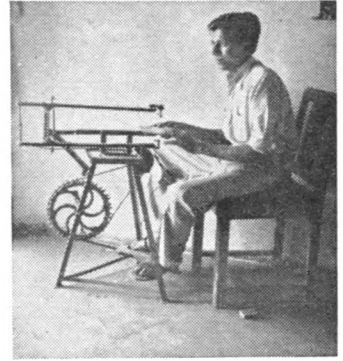

C. T. Rathod

Bourton's Village in Miniature

THE name 'Broadway' conjures up visions of the Great White Way in America, but in England it refers to a beautiful village, nestling at the foot of Fish Hill, bastion of the Cotswolds. Broadway is world famous as a typical 'Cotswold Stone' village, but not many miles away is Britain's Little Venice, Bourton-on-the-Water, famous alike for its seven miniature bridges spanning

the shallow and picturesque Windrush (which runs parallel with the main street) and its 'Model Village'.

Here, modern Cotswold craftsmen have made a village in miniature. The site is behind the village's New Inn, and building was started more or less as a hobby, some time in the 'thirties, by the landlord, aided by one or two local craftsmen.

In time they laid out the garden as a miniature of their own village, and as one walks round the narrow streets of this village, it is easy to pick out individual landmarks, and even shops. Many of the houses have curtains similar to those found in their real counterparts, and shops show nameboards and window displays. A miniature river Windrush enters the village by the old water mill and meanders through the site, while, in the church, the seats remind us of the invisible congregation, who at times sing well-known hymns, relayed from a control point by hidden speakers.

Trees and shrubs are all to scale, being carefully selected and pruned so as not to spoil the illusion.

The model of the inn itself is fascinating, for it shows the whole layout of the village, on even smaller scale, in the miniature Inn Garden, and to add final touches of accuracy the individual model on this 'ground plan' shows the layout, again to scale, so that one comes down to houses only a few inches across yet still identifiable.

This Lilliputian village has done Goliath work for charity, and many organizations benefit each year. It is a 'must' if visiting the Midlands of England, being well known to many American airmen, stationed at various times at nearby Cotswold airfields, as well as to thousands of visitors from other countries.



Bourton-on-the-Water's model village stables are perfect in every detail, yet even a rocking horse would be too big for them

Next week's free design will be for a charming Sundial Posy Ring. Make sure of your copy.

ELECTROSTATIC NOVELTIES

ROMAN ladies loved to wear necklaces of amber beads and sometimes they noticed that the yellow amber attracted little cloth threads. They believed that the amber had a 'spirit', which was responsible for its curious behaviour, but we know that the real explanation was that the amber became charged with static electricity when the beads rubbed against the ladies' clothes. Static electricity was responsible for the mysterious power of attraction. It is interesting to note that our word 'electricity' was derived from the Greek word 'elektron', which means amber.

When you rub a vulcanite fountain pen against your coat sleeve, or comb your hair, the comb or pen will become charged with electricity. We say that they have been given a negative charge, whilst your coat sleeve and hair have acquired positive charges of electricity. The charged objects will pick up torn fragments of blotting paper or little strands of wool, or cotton. However, these experiments will only work if everything you use is perfectly dry. On a damp day static charges will be conducted away by the moist air, even while they are being generated. Bearing the last points in mind you will be able to perform several unusual electrical experiments and construct a number of interesting electrostatic novelties.

Float a small toy plastic duck in a bowl of water and hold a charged comb or fountain pen near its beak. The toy will be attracted, and it will be possible for you to lead it all around the bowl without in any way touching it. Similarly, a 'ping pong' ball may be 'guided' around a table top by means of a charged comb or plastic rod.

A 'Hovering Butterfly' is a charming novelty. Merely fold in two a 1 in. by 2 in. piece of coloured tissue paper and carefully cut out the shape of a butterfly. Gum the butterfly to one end of a 4 in. length of cotton and fix the other end of the cotton to a cork. Stand the cork upon the table. Charge up an inflated rubber

balloon, by rubbing it several times upon your pullover, then hold it over the butterfly. The paper insect will be strongly attracted to the balloon and will 'hover' on the end of the thread, an inch or two underneath the surface of the balloon. Move the balloon back and forth and make the butterfly sway. The effect much resembles a miniature Indian Rope Trick. Avoid letting the balloon come in contact with the paper, otherwise the experiment will fail.

'Shock-Headed Pete' is an amusing puppet head made from a large cork, which is supported upon a little pedestal made from a piece of $\frac{1}{4}$ in. diameter dowel wedged into a cotton reel base.

Paint the head in a grotesque fashion. Finally, make a mop of hair by knotting together several dozen strands of white cotton and fix the hair on to the puppet by pressing the knot into a hole made in the centre of the head. Spread out the 'hair' realistically. Now, when you hold a charged balloon above the puppet, the hairs will stand on end and wave about in a fantastic manner as you move the balloon. Make sure that your apparatus is quite dry. Perhaps you will be able to complete your figure using genuine hair, which will give much better results.

A remarkable toy novelty of the last century was 'The Enchanted Table', or,

By A. E. Ward

'The Bewitched People'. Make one of these weird toys yourself, as follows: Line the bottom of a shallow cardboard or wooden box with aluminium foil, and obtain a thin sheet of perspex which will fit exactly over the top. A box measuring 2 in. by 6 in. by 12 in. will be quite suitable, or an old Christmas cracker box will do admirably if you can provide a piece of perspex large enough to cover it. Now, use your imagination while you cut out half a dozen human and insect shapes in coloured tissue paper. These must be half an inch less in height than the depth of the box. Place the paper figures inside the box and then fix on the perspex cover, using strips of Sellotape. When you rub the lid of the box, gently but firmly, with a piece of blanket, the figures will rise up and dance about, and will continue to do so for some moments after the rubbing is discontinued. The effect can be quite creepy and macabre, if you have made your toy on a large scale.

If you are unable to make the apparatus as described, place a sheet of aluminium foil beneath a little table formed by placing a sheet of glass across two books. Put your paper figures under the glass table and rub the glass energetically with a piece of blanket. The dance will proceed, as before.

Rubbing the perspex (or glass) will create a strong electric charge, which attracts the paper figures. As the figures touch the charged lid they too acquire a charge. Since these charges are all alike, they repel. When the figures rebound to the aluminium foil, their charges are neutralized and they may be attracted upwards again. This continues until the charge upon the perspex is exhausted.

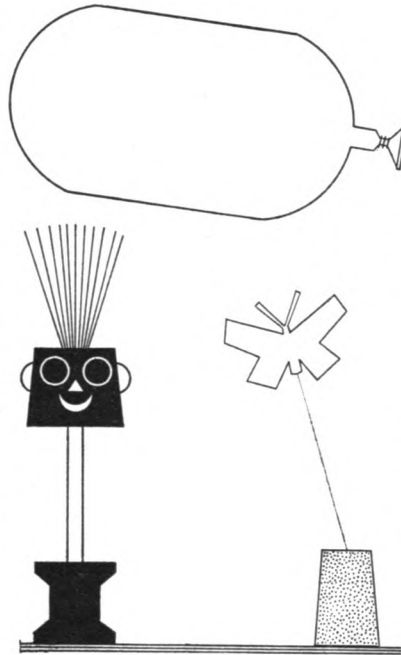

'Shock-Headed Pete' and 'The Hovering Butterfly'

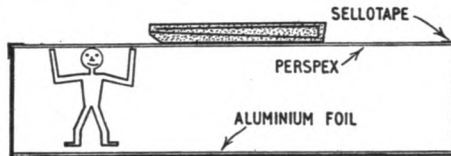
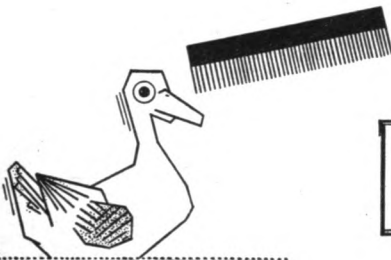

THE ENCHANTED TABLE

A HEARING AID RECEIVER

SURPLUS hearing aids, usually consisting of a 3-valve amplifier built from miniature valves and components, are available at quite low cost, and can be converted for radio reception. A midget receiver, running from tiny hearing aid batteries and giving headphone reception, is fairly easy to make from a surplus aid of this kind. The greatest difficulty, perhaps, is the extremely small and compact construction of the aid, which makes careful, rather delicate handling necessary.

The exact arrangement of parts, the size and shape of case, etc., will vary somewhat in different surplus aids. But very many use the same circuit, so that electrical details are the same. The aid usually has a small crystal microphone,

a tuned circuit with crystal diode replaces the microphone. The signal from the diode thus passes through the 3-valve amplifier to the earpiece.

To keep the receiver as compact as possible, a small compression trimmer is used for tuning. This has a fixing nut and adjusting screw, and can be secured to a

Satisfactory reception with the ferrite rod aerial depends on local conditions. For example, signals are better in an upstairs room than downstairs. Reception range is also only up to some 30 to 50 miles from a major BBC transmitter. If signal strength is insufficient, some type of extended aerial becomes necessary. This can be two or three yards of thin insulated wire, and it need not be out of doors except in a metal structure building. Local station reception will generally be possible with the ferrite rod aerial alone.

In areas where good reception of the Light Programme is possible on medium waves, the set can be made for medium waves only. This simplifies construction. But in some areas it is necessary to switch to long waves, for the Light Programme, and it is then best to make the aerial circuit cover both medium and long waves.

By 'Radio Mech'

small piece of metal or Paxolin, in the position originally occupied by the microphone. The diode can also be accommodated in this space. A small insulated terminal head or knob on the trimmer adjusting screw allows this to be

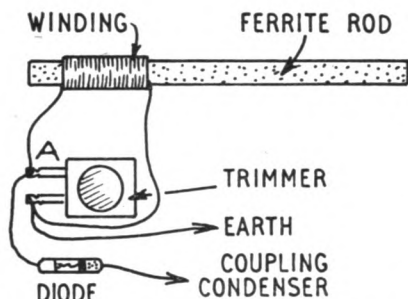

Fig. 1—Circuit for medium wave reception

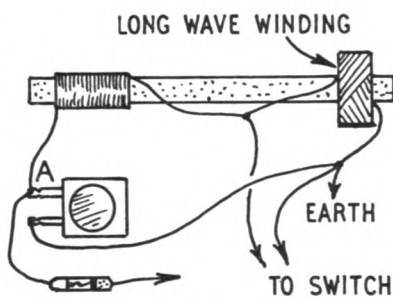

Fig. 2—Long and medium wave tuning

and a miniature earpiece. It should be in working order. That is, sounds picked up by the microphone should be heard, much amplified, in the earpiece. This shows that the 3-valve amplifier is working, and the whole of this part of the aid is left untouched.

To convert the aid for radio reception,

rotated by hand, for tuning.

Tuned circuit

If a ferrite rod is used as a core for the coil winding, this can give enough signal pick-up for listening to local stations. No external aerial and earth are then required.

Medium wave circuit

This is shown in Fig. 1. If the ferrite rod is about $\frac{3}{8}$ in. in diameter, the winding can be 80 turns of 32 S.W.G. enamelled or silk covered wire, turns side by side. Enamelled wire is best wound on a strip of paper placed round the rod. Adhesive or thread will hold the ends of the winding. With a 300pF trimmer, this will cover most of the medium wave band. But it should be noted that full wavelength coverage is impossible with this type of tuning trimmer. If it is particularly necessary to receive a station near the low wavelength end of the band (say 200 to 250 metres) a few turns should thus be removed from the winding. For the same reason, if there is particular need to reach high wavelengths, some turns should be added.

It is best to make experiments in this direction before finally wiring the aerial in, to make sure that the wavelength coverage will include the local stations.

If the winding is made with Litz wire, this will slightly increase efficiency. Litz of about 7/42 will do. That is, it will have seven strands of 42 S.W.G., each individually insulated from the others. At the ends, each strand must be cleaned, and all are soldered together. This type of wire is by no means essential.

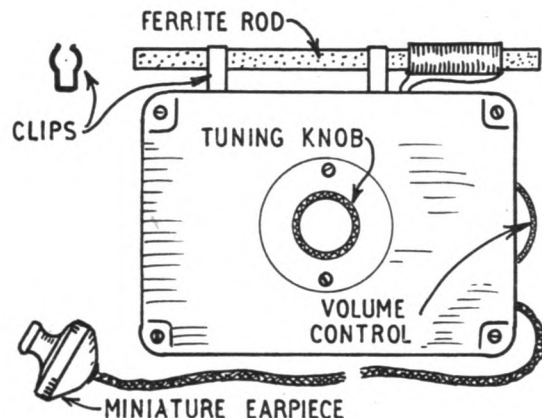

Fig. 3—Rod mounted on case, etc.

Dual-wave tuning

Connections for both long and medium wave reception are shown in Fig. 2. With some aids, a miniature microphone switch will be fitted, and can be used for wavechanging. If not, a switch can be made from a small strip of brass, pivoted

● Continued on page 95

IDENTIFYING BRITISH INSECTS

WHEN the amateur naturalist turns his attention to the subject of insects, he finds a bewildering number of different species. There are something like 20,000 species in this country, but many of these are small and inconspicuous, and a considerable amount of enjoyment can be had by getting to know a few of the larger and commoner ones.

The most conspicuous and probably best liked insects are the Butterflies, since these are associated with warm sunny days and bright flowers. A particularly handsome and easily identified butterfly is the Red Admiral. This is widely distributed but is usually not seen until late spring, when it is a frequent visitor to the garden. It is a striking butterfly, being basically black, but with scarlet stripes on the forewings and the edges of the hindwings. There are also white spots on the forewings, which are about 2½ in. across. The food plant of the caterpillar is the stinging nettle.

The Large Tortoiseshell is easily identified. Its colour is basically golden brown with spotted markings. Like many butterflies, the actual pattern is variable in different specimens. It is quite a large insect, about 2½ in. across.

The Small Tortoiseshell is rather similar to the Large, but about 1½ in. across, and perhaps even more attractive with its neat pattern. This butterfly may often be found hibernating indoors dur-

ing the winter, sometimes choosing a corner of the living room. It stays thus until the spring weather awakens it.

The Peacock is an unmistakable insect. It is a large butterfly with reddish brown wings and two definite 'peacock eyes' on each. It may be seen quite early in the year, often in March or April.

On chalky downs you will usually see a pretty little blue butterfly, the Chalkhill Blue. This is under 1½ in. across and of a beautiful pale blue colour; its wings being edged with black and white. The Common Blue is somewhat similar, but of a darker colour and is more widely distributed.

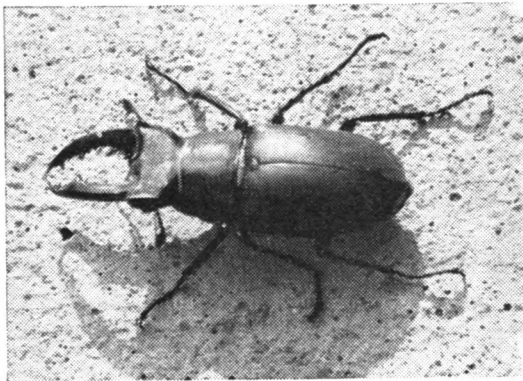

A male Stag Beetle

horn at the tail is black, and this is a distinguishing mark. The moth itself may be 3-4 in. across. Its wings are a fawn colour with dark brown markings and the body is similarly striped.

Another commonly seen moth is the Lime Hawk. This is a smaller insect, about 2½ in. across, and is somewhat variable in colour, usually being a lightish buff with dark wing spots. The caterpillar is particularly handsome and may usually be found on lime trees around the middle of May. It is of a clear green colour, sometimes with a red stripe on each side. The curved tail horn is usually pale blue. This bright colour is lost just before the caterpillar pupates, which it normally does in the earth at the base of the tree.

The well known 'Woolly Bear' caterpillars turn into the beautiful Tiger Moths. The most common of these is the Garden Tiger and is a fine insect with its yellow forewings and orange hindwings, both patterned with black spots. It is just over 2 in. across. The caterpillar of this species is the true 'Woolly Bear', with long black furry hairs; other Tiger Moth caterpillars are usually less hairy.

Although there are many more interesting insects in the Lepidoptera, as the butterflies and moths are called, we must leave them to consider some other insects.

Dragonflies are also very common, and familiar insects to be seen flitting over the surfaces of ponds upon large shimmering wings. There is a large number of different species of Dragonfly, and we cannot go into the differences between them here, so we shall consider a typical insect. Dragonflies have no chrysalis stage; the egg hatches into a water-living larva which preys upon other creatures and grows larger in stages, with a moult

By P. R. Chapman

The Painted Lady is not a native of this country, but an immigrant. It bears some resemblance to the Large Tortoiseshell, but with black and white on the front parts of the wings and lighter colour at the back, the basic colour being usually orangish.

The Meadow Brown is a somewhat drab insect found in meadows and fields, and is possibly our most common butterfly. It is nearly 2 in. across and of a dark greyish brown colour, with two small spots on the forewings. The female has in addition orange markings around the spots. The caterpillars feed upon grasses.

Moths may be distinguished from butterflies by the fact that the antennae are without the knobs that the latter possess. Some are plumed and some straight and hair-like. Also, of course, most but not all moths fly by night. The largest of the moths are the hawk moths. The caterpillars of these have a 'horn' or spike at the rear. One of the largest and commonest is the Privet Hawk Moth, and the caterpillars may be found on privet bushes about June. The

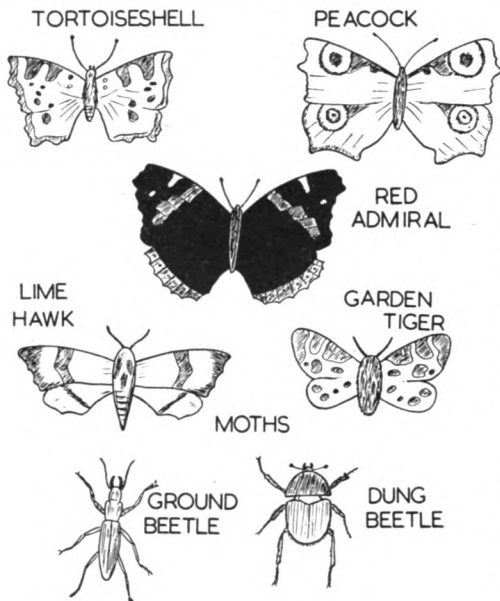

between each stage. It finally climbs a twig or reed out of the water, splits its skin, and the adult insect emerges. These are expert at flying and hunt other insects on the wing. Although living longer than one day as is sometimes supposed. Dragonflies have quite a short life as adults, probably living for about a month, although there is some uncertainty upon this point.

Grasshoppers are also insects associated with warm, lazy summer days. There are two main divisions of British Grasshoppers, the short and the long-horned. The 'horns' in this case refer to the antennae, and in the former group these are quite short, whilst members of the latter have long antennae, usually longer than the body.

Two of our commonest Grasshoppers belong to the short-horned group. These are the Two-coloured Grasshopper and the Meadow Grasshopper. Both are under an inch in length and are brownish in colour. The former has wings, which it sometimes uses, and makes a noise like 'tiss, tiss'. The Meadow Grasshopper is wingless, and the song of the male (female Grasshoppers do not sing) begins on a low note, rises and then fades away. These insects, in common with all their group, make the chirping song by rubbing their thighs against their wings.

They are vegetarians, and the Locusts belong to this group, but our own small species do no harm.

The Great Green Grasshopper belongs to the long-horned group who make their song by rubbing one wing across the other. This particular insect is unmistakable, being bright green in colour and up to two inches long.

The House Cricket, which is very closely related to the Grasshoppers, is often heard out of doors on summer evenings where it will make its presence known by its constant chirping. It is long-horned.

There are over 3,000 species of British beetles, and of these about 200 are large enough to be readily noticed. Naturally here we can only mention a very few of this vast number. The typical adult insect has characteristic wing cases or 'elytra', covering the folded wings. The largest of our beetles is the Stag Beetle, the jaws of the male being large and antler-like. In spite of its ferocious appearance, this insect is quite a gentle creature, feeding upon exudations from trees (in captivity it may be fed on honey). The female is smaller, and with smaller jaws, but these are more likely to give a nip than those of the male.

Two of our next largest beetles are aquatic, and may often be found in

ponds. The very large, actively swimming black insect is *Dytiscus*, the Carnivorous Water Beetle. This is a savage insect, and devours all it can overcome. The other is often called the Harmless Water Beetle, and although of about the same size, is purely vegetarian. It crawls underwater rather than swims.

A slender shining beetle, violet-black in colour, seen hurrying across the garden or field, is probably a Ground Beetle, of which there are several species, but the most common is the Violet Ground Beetle. This insect hunts mostly at night, attacking slugs, snails and other insects. Since it is carnivorous and has a voracious appetite it is of immense benefit in a garden, and should never be killed.

There are many different types of Dung Beetle, most of which are small. The commonest large one is the Dumble-Dor or Dor Beetle shown in the illustration. This sometimes blunders into rooms at night. These beetles dig holes under heaps of animal dung which they eat, and later lay their eggs in it. Since they bury far more than they consume, they are most useful insects in manuring the ground.

The Dor Beetle is extremely strong, as the searcher will discover if he tries to hold one in his closed hand; it is unlikely that he will succeed.

● Continued from page 93

Building a Hearing Aid Receiver

so that it can be swung over to rest upon a small bolt. The switch simply shorts out the long wave winding, when medium wave reception is needed.

The long wave winding needs to have about 200 turns of fine wire, such as 38 S.W.G. These may be held in place between two strong card washers. The medium wave and long wave sections of the aerial must be wound in the same direction. As the exact number of turns depends on the characteristics of the ferrite rod, it is wise to make a test, to see that the Light Programme transmitter can be tuned in properly with the trimmer about half closed.

It may be possible to use the long wave section from a ready wound coil. If this is Litz-wound, reception will be very slightly improved. It is possible to buy ready-wound medium wave, or medium and long wave ferrite rod aeri-als, but these cost much more than a home-wound rod.

Connections to amplifier

When the microphone is removed, together with any tone correction condensers or resistors wired to it, a lead from the coupling condenser of the first valve will be left free. The crystal diode

is taken to this, as in Fig. 1. The other lead from the tuned circuit, marked Earth, has to be taken to the earth line of the deaf aid amplifier. That is, the high tension or low tension negative circuit.

The miniature earpiece, already connected, can be used for listening. If it is preferred to use an ordinary set of phones, high impedance phones can be connected instead. Or two small terminals will allow phones or miniature earpiece to be connected as required.

Some aids have a miniature output transformer with low impedance secondary. For these, moving coil or low impedance phones, of about 50 ohms, can be wired to the secondary.

External aerial

When the miniature earpiece is retained, as may often be the case, it is important to remember that it is probably of crystal type, and can thus only work when the coupling choke or transformer in the aid is present. The choke or transformer in the aid must not be removed, for this reason. Nor can the earpiece be used with another receiver, unless a similar choke or transformer is added.

With the ferrite rod, volume from any

particular station will be best with the rod pointing in a certain direction, so it may be necessary to turn the set one way or the other. When the receiver is found to work properly, the rod can be fixed to the case by small brackets, as in Fig. 3.

If an extended aerial wire is used, this is taken to the tag marked 'A' in Figs. 1 and 2. A small terminal will allow this extra wire to be connected up any time it is needed.

Sometimes an earth is available. If so, it is taken to the earth circuit point described. A temporary connection to some earthed object can often be made. Quite often using the earth lead as aerial will give good results, no aerial being used.

It is important to use the batteries specified for the aid. These will often be a miniature 30V. for high tension, and a 1½V. cell or cells for filaments. In particular, the wrong filament voltage must never be used, the valves may be damaged.

Components required for the conversion are, a ferrite rod between about 3 in. and 6 in. long, and preferably not under ¾ in. in diameter. A 300pF postage stamp compression trimmer. Crystal diode in good condition, and coil windings as described.

Launching the 'Hobby Cruiser'

THE original Hobby Cruiser is covered entirely with white modelling tissue which is banana oiled, and is then finished with high-gloss cellulose coloured dopes; red for the wings and tailplane and white for the fuselage and fin. This is a pleasing combination but of course you can choose any of the wide range of first-grade model aircraft dopes available from your nearest branch of Hobbies Ltd.

Cover the wing with six pieces of tissue; one at the top and bottom of each outer wing panel and a piece on the top and one underneath the centre section. Use special tube tissue paste as an adhesive. Cover the top and bottom of the centre section first (starting with the bottom) measuring and cutting the tissue pieces accurately and leaving just sufficient overhang at front and rear to paste down finally. Small slits will have to be cut in the top piece to provide for the retaining hooks. The tissue should not overlap the ribs at the side by more than a 'fraction'.

In a similar manner cover the underside of the main wing panels. Cut pieces of tissue so that they overlap the structure all round by about $\frac{1}{8}$ in. Start by pasting one edge of the tissue neatly to the centre section rib and then work towards the wing-tip, pasting the tissue to each rib and to the leading and trailing edges as you proceed. Do not *pull* the tissue at the edges; merely lay it down on the structure and *smooth* it flat. Finally paste over the overlaps. Follow the same method for the top of the wings.

The fin and tailplane are covered in a similar way; three pieces being used for the tailplane (the underside is covered in one piece) and two for the fin.

Before attempting to cover the fuselage, glasspaper the balsa sides smooth, apply two coats of banana oil and glasspaper again between each coat. Cover the bottom of the fuselage at rear of the wing aperture with a single piece of tissue and paste down the $\frac{1}{8}$ in. 'overhangs' neatly. Make sure you apply paste to the crossbraces as well as the fuselage edges when you do this. The rest of the fuselage, excluding the balsa sides, is covered with separate strips of tissue, each tapering in shape, which are fixed to the stringers. Each piece should embrace no more than four stringers — to ensure that the tissue does not wrinkle. Start at F1 and work towards F4 when applying the tissue and then, for the rear of the fuselage, start at F5 and work towards F10. The underside of the nose is treated similarly. Trim away any tissue which overhangs the stringers with a razor blade.

When the paste has thoroughly set give the tissue on the fuselage and surfaces an even application of cold water; just sufficient to dampen it. When dry apply an even coat of thick banana oil with a very soft brush. Follow this with your coloured dopes which should not be too thick in consistency. If too thick, add special cellulose dope thinners (*not acetone*), until the dope has a fairly thin creamy 'texture'. Use a soft brush about

To provide small adjustments of trim during flying a small weight, made from a piece of solder hammered flat, is drilled and threaded on to a piece of thread and is suspended underneath the fuselage as indicated in the sketch. The elastic band, in tension, keeps the weight flush with the fuselage.

Hand-launch the model, preferably over long grass, facing into the wind — if any. A very calm day should be chosen

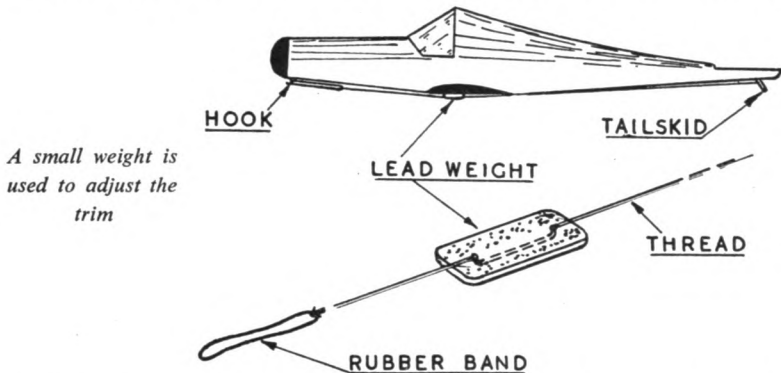

A small weight is used to adjust the trim

$\frac{3}{8}$ in. wide and apply the dope in long even strokes; never 'dab' when doing this job. If necessary apply a second coat of coloured dope when the first has dried completely.

Fix the fin to the middle of the tailplane with balsa cement and drill the motor-peg plates to take a 1 in. length of $\frac{1}{8}$ in. hard dowel rod. Fit the wing in place, via the retaining hooks, with $\frac{1}{2}$ in. rubber bands and clip the tailplane assembly in position with another, larger band. The end of this band can be retained over the tailskid or a short pin can be cemented into the fuselage for the purpose.

The 'Hobby Cruiser' is powered by four strands, that is two loops, of $\frac{1}{16}$ in. flat lubricated rubber 18 in. long, made up from one length and pre-tensioned, as described in an earlier article in this series. Use special rubber lubricant when the knot has been tied in the rubber. One end of the skein of rubber is retained by the dowel at the fuselage rear (a small panel of tissue is cut away underneath the fuselage to provide access to this anchorage) and the other end of the skein engages with the hook on the propeller shaft.

When the rubber motor is suspended freely in the fuselage the model should balance, slightly nose-down, when held on the fingertips, underneath the wing $1\frac{1}{4}$ in. from the leading edge, close to the fuselage.

to fly the 'Cruiser', for it is only a light-weight design. Employ a smooth, steady movement. Trim the model by placing thin pieces of balsa packing either under the leading or trailing edge of the tailplane, according to whether the model tends to stall or glide steeply.

Apply a few turns to the motor (it will take 500 maximum when the motor is stretched and the turns are applied with a handbrace fitted with a hook to engage the loop at the front of the propeller) and launch the model again. It should fly straight and level. Increase the turns gradually and correct any tendency for it to turn viciously to one side or the other by placing $\frac{1}{16}$ in. packing between the noseblock and fuselage *on the side to which the model turns*. It may also be necessary to place packing between the top of the noseblock and the fuselage if the model begins to stall again in spite of being all right on the glide.

During this procedure the trimming weight should be kept under the centre section of the wing and should be moved only to give very fine adjustment, and hence a very flat glide, when maximum turns have been applied to the motor and the model has climbed to altitude.

In the next article we shall be dealing with various methods of building streamlined fuselages which you can incorporate in your own designs.

Illustrated on front page

HOW TO MAKE A PLAY SINK

AFTER the tea party with dolls or friends it is fun for the youngsters to wash up the dishes, but no fun for mother, who may be busy at the sink. This easily constructed play sink is quickly knocked up from odd pieces of wood and hardboard. It can be made to take a small plastic bowl, and will provide hours of entertaining fun, besides being good training. It can be used outside or in the kitchen, and the shelves may be utilized for storing the doll's dishes.

The measurements shown in the diagrams will be useful for building, but the age and size of the child should be taken into consideration. Some saving on material may be effected if the sink is for a child under eight.

Study the diagrams before commencing work, and decide upon the finished size before cutting into any material. Note that the plastic bowl should not be wider than 15 in., or the width of the top will have to be increased.

The front view and plan in Fig. 1 show the general construction, with overall measurements. The four shelves are of $\frac{1}{8}$ in. or $\frac{1}{4}$ in. hardboard supported by rails, and the top, back, and ends are also of hardboard.

Commence work on the four small frames, as indicated in Fig. 2. Make them from 1 in. by 1 $\frac{1}{2}$ in. material, and nail

them together. Glue may also be used to give added strength.

Next make up the framework for the top as seen in Fig. 3. Space out the strengthening rails to leave room for the bowl. In the case of the top it would be best to use halving joints since this will give a more rigid construction.

Now assemble, as shown in Fig. 4. Nail the top frame in position, spacing the small frames 12 in. apart (outside measurement), as seen in Fig. 1. The small frames are further strengthened by cross rails at the back and front, as shown in Fig. 4. The shelves consist of pieces of hardboard cut to fit between the frames. Lightly tack the hardboard in position.

Now cover the ends and back with hardboard, allowing the back to project about 2 or 3 in. at the top. The corners may be rounded off to give a neater appearance. Lastly, the top is cut to size, and the position of the bowl marked. The circle is best cut with a keyhole saw. Make a start by boring a $\frac{3}{8}$ in. hole quite near the edge of the circle. Fix the top with panel pins, making sure that they are driven well home.

Clean up with glasspaper, and give one undercoat and one top coat of paint. (Mh.)

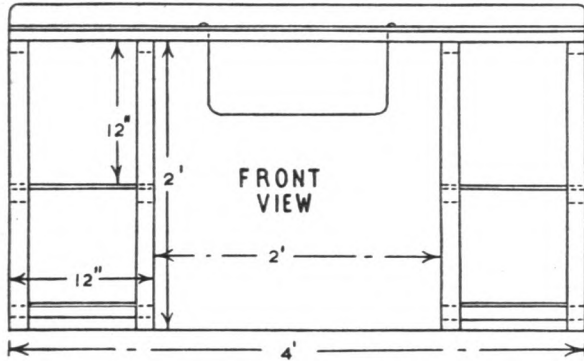

Fig. 1

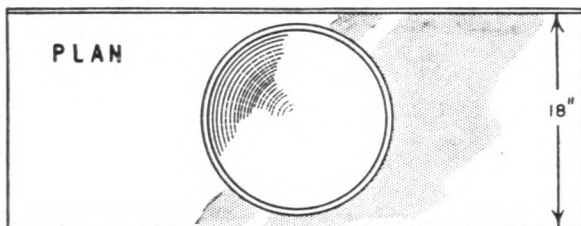
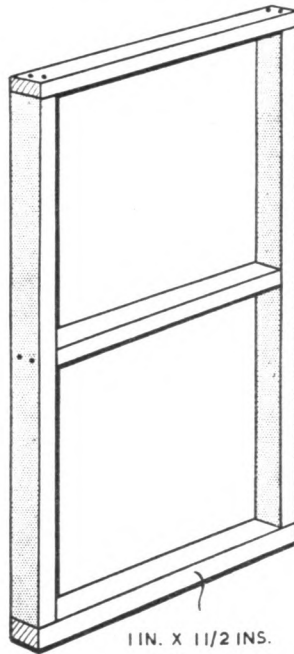

Fig. 2



1 1/2 IN. X 11 IN.

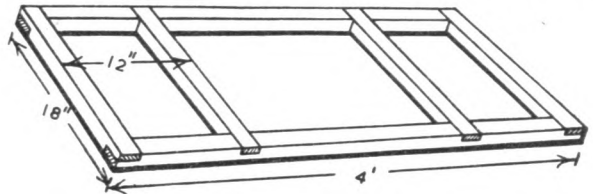

Fig. 3

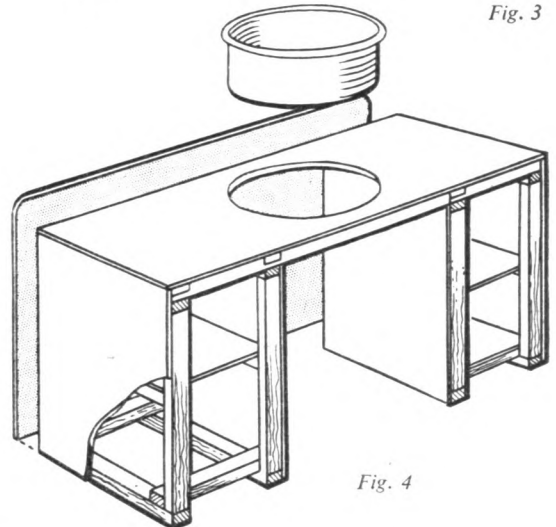

Fig. 4

Make the ANIMATED DUCK

A PULL ALONG TOY



PIECE D CUT ONE 1/4 IN.

PIECES C CUT TWO 1/4 IN.

WHEELS E CUT FOUR 1/4 IN.

AXLE CUT ONE 1/4 IN. DIA. ROUND ROD

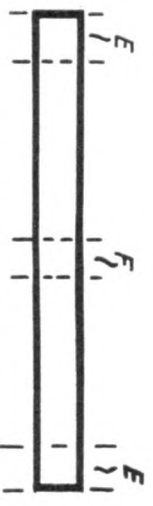

UNDERSIDE

C

PIECE A CUT ONE 1/4 IN.

C

UNDERSIDE

PIECES B CUT TWO 1/4 IN.



PIECE F CUT ONE 1/4 IN.

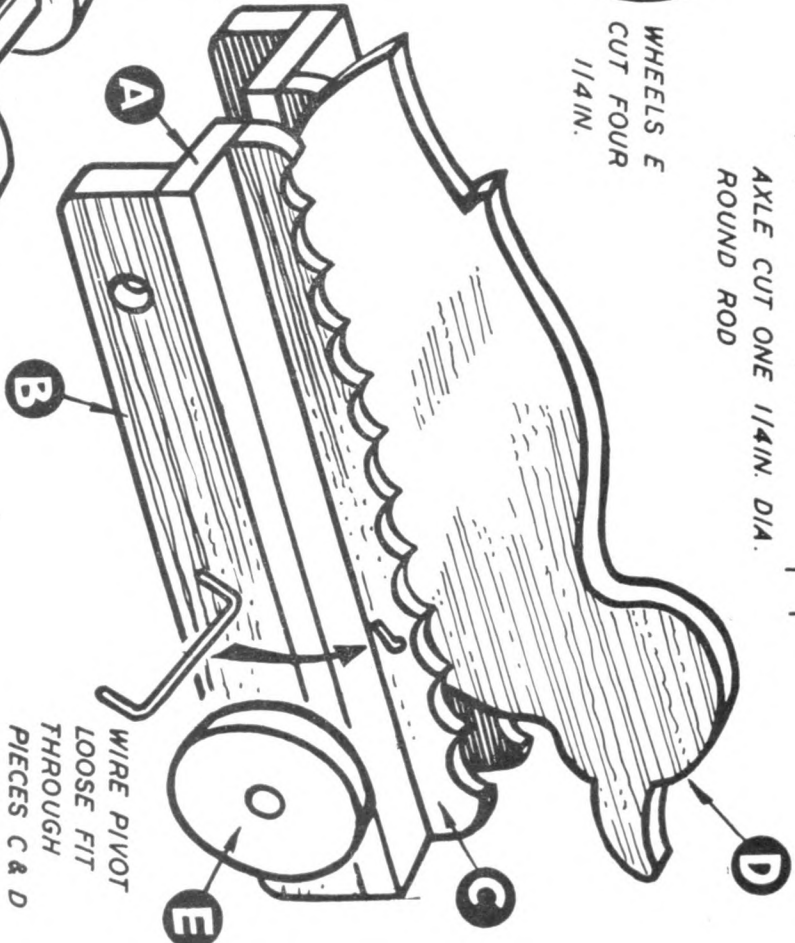
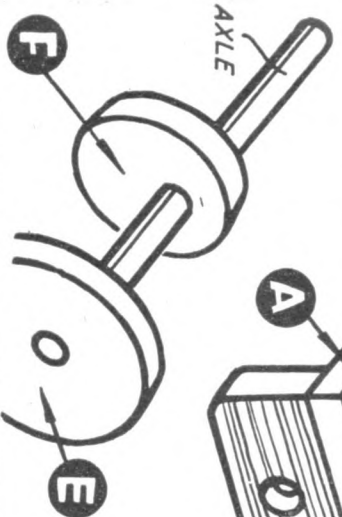
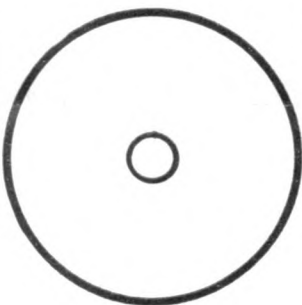

WIRE PIVOT LOOSE FIT THROUGH PIECES C & D

18th MAY 1960

VOL. 130

NUMBER 3362

THE ORIGINAL
'DO-IT-YOURSELF'
MAGAZINE

HOBBIES *weekly*

FOR ALL
HOME CRAFTSMEN

*FREE plan
inside for making . . .*

Also in this issue:

**MAKING A SHIP
IN A BOTTLE**

COLLECTORS' CLUB

**KITCHEN DROP
LEAF TABLE**

**A CRYSTAL SET
AND TUNER**

**BIRDS OF THE
COUNTRYSIDE**

**MODELLING AND
NOVELTY ITEMS**

ETC. ETC.

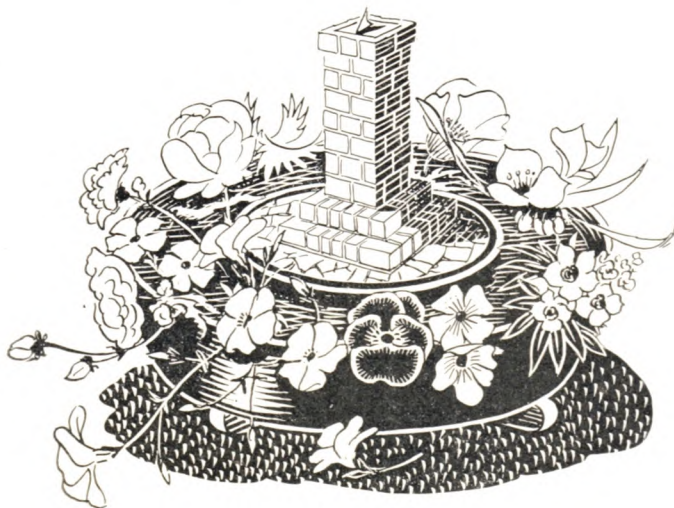

A 'SUNDIAL' POSY RING



Up-to-the-minute ideas

Practical designs

Pleasant and profitable things to make

5^D



A KNOWLEDGE of Heraldry is useful to the hobbyist, especially to the thematic collector of stamps, labels, etc. Heraldry is concerned with armorial bearings, the practice, art, or science of recording genealogies, the blazoning of arms or ensigns armorial, and all that relates to the marshalling of state ceremonies, processions, and cavalcades; the devising of suitable arms and badges for families, guilds, cities, and regiments.

Heraldry — 1

The antiquity of distinctive badges and ensigns dates from earliest times. The custom began in the East and soon spread to the West.

In the beginning only tribes or nations distinguished themselves collectively by some special emblem displayed on their banners; although certain princes and warriors adopted personal devices. Later, such distinctions were granted to families as hereditary honours in reward for chivalrous service rendered to their country. These special rewards meant far more than money or grants of land to those who often sacrificed life and limb, not for pecuniary gain, but purely from patriotic motives.

The Carians were the first to put crests upon their helmets and sculptured devices on their shields. These people inhabited a country in the south-west angle of Asia Minor, of which Halicarnassus was the capital and Miletus its rival — both famous cities of antiquity. Carian princes reigned under Persian protection, but the kingdom was annexed to Rome about 129 B.C.

The shields of Sophanes (Carian Warrior) bore an anchor. Eagles were popular Roman ensigns. Shields of Median kings bore a golden eagle.

The Greeks adopted Carian crests with flags adorned by images of animals or other devices bearing a distinctive relation to the cities to which they belonged.

The figure-heads on the prows of our ships owe their origin to the Phoenicians and Boetians. They used a figure of one of their gods, being thenceforth

the tutelary god and protector of the vessel.

Before our system of heraldry was organized, ancient British kings, Brute, Lud, Bladud, and others, all assumed their own insignia. Brute bore on a golden shield a 'lion rampant gules, charged on the neck and shoulder with three crowns in pale'. Camber, another British monarch, bore on a silver shield two lions passant gardant gules.

Descendants of the British Prince Cadogan-ap-Elystan still bear the arms of their warrior ancestors, 'Gules, a lion rampant regardant or', and combined with them the badge of the three Saxon chiefs (brothers), i.e. 'three boars' heads coupled sable, on a silver field' — which chiefs he slew in battle with his own hand.

Likewise the Saxons, who succeeded and partially exterminated our ancient British ancestors, are still memorialized by the badges of their thanes; and later on the Normans — so reputed in the annals of chivalry — were all individually distinguished by their armorial bearings.

As time went on, heraldry began to develop and be regulated by certain rules under State control, and the spirit of chivalry originating with the crusades, jousts and tournaments, may be credited with that development. English knights under Coeur de Lion, and the French under Philip Augustus, wore emblazoned shields. A collection of these shields arranged in proper order are kept in the Museum at Versailles.

During the twelfth century the science of medieval armory developed into a system. In the thirteenth century it gained popularity and favour — its uses being more fully recognized — under the reign of Henry III, when a regular system, classification and technical language of its own were devised and organized.

The earliest heraldic roll of arms still existing is dated at the time of Henry III. This is a copy of the original which was compiled between 1240 and 1249. Most of the principal terms in use in the present perfected state of the art are found on this roll. The right to bear arms was inaugurated at some time in or about the reign of Henry II.

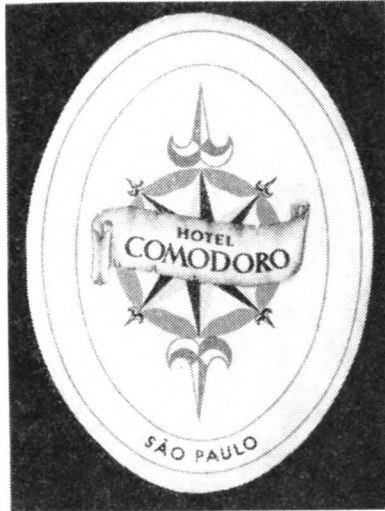

An heraldic hotel label

During the reign of Henry V, a registry of armorial bearings was inaugurated, rendered essential for the avoidance of confusion and the just settlement of disputations, but the incorporation of the officers of this College of Arms by royal charter was granted in 1483 by Richard III.

Cold Harbour was the name of the mansion allocated to the heralds as soon as it was incorporated into a college. It was erected between Blackfriars and St. Paul's Wharf by Sir John Poulteney, who was four times elected Lord Mayor of London.

This mansion was successively known as York Inn, Poulteney's Inn, and thirdly as Cold Harbour. In the reign of Mary I, the college was removed to Derby House, previously the palace of the Stanleys, and the Queen bestowed it on them by charter, Dethick being Garter King-of-Arms at that time.

This ancient building stood on St Benet's Hill, and was destroyed in the Great Fire of London, A.D. 1666. But the valuable records were all saved and conveyed to Whitehall, Charles II sending his private carriages for this purpose. Thither also the heralds removed and continued to reside until upon the original site the present college was erected. Sir Christopher Wren was the architect.

PICTORIALS 100 AIR MAILS
TRIANGULARS Different DIAMONDS
QUALITY · QUALITY · QUALITY
STAMPS FREE
Request attractive Approvals. Parent's permission
Send 3d. stamp only
CHILTON STAMP COMPANY (Dept. H)
41 ST CUTHBERTS ROAD · HOLY CROSS ·
WALLSEND · NORTHUMBERLAND

A KITCHEN TABLE WITH DROP LEAF

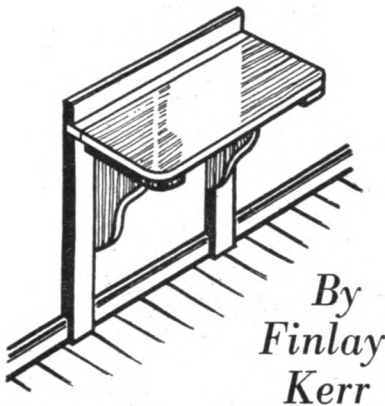

By
**Finlay
Kerr**

IT is understandable that every housewife should like to have plenty of table space in the kitchen. This, of course, is not always easy to obtain, particularly in small kitchens where every inch is valuable, and the provision of a solid table would be more of a nuisance than an asset.

In some cases, however, this problem can be solved by making a folding wall table like the one illustrated in Fig. 1, which when not in use can be easily folded flat against the wall. The design and construction of this project is very simple. There are no intricate joints to make, and it can confidently be tackled by the average home handyman, using only a few basic tools.

The illustration at Fig. 1 gives some suggestions for the dimensions for this table, but, of course, they may be

YOU WILL NEED	
Uprights.	2½ in. by ¾ in. 2 pieces 2 ft. 9 in. long.
Top hinging strip.	1½ in. by ¾ in. 1 piece 2 ft. 6 in. long.
Top cover strip.	2 in. by ½ in. 1 piece 2 ft. 6 in. long.
Brackets stops.	2½ in. by ½ in. 2 pieces 1 ft. 3 in. long.
Table flap.	¾ in. thick blockboard. 1 piece 2 ft. 6 in. by 1 ft. 4 in.
Brackets.	¾ in. thick blockboard. 1 piece 1 ft. 4 in. by 1 ft. 2 in.

altered to suit individual requirements. Make a start by plugging two 2½ in. by ¾ in. uprights to the wall. The uprights should be carried right down to the floor, so if there is a skirting board, then notch the uprights over it (Fig. 2). Secure a 1½ in. by ¾ in. piece of timber across the tops of the uprights to serve as a hinging strip for the table flap. A strip of ¾ in. thick blockboard may be used as a substitute. To give additional strength to this member it is advisable to insert a wood screw at the centre into a plug in the wall.

The next step is to make the two supporting brackets. These can be made up from pieces of 2 in. by ¾ in. timber, but a much better way is to use ¾ in. thick blockboard. The illustration at Fig. 3 shows how two brackets can be cut from a single piece of blockboard 16 in. by 14 in. Round and smooth off the sawn edges with glasspaper. Once the brackets have been made they should be hinged to the two uprights.

The thickness of the table flap should be ¾ in. to correspond with the thickness of the hinging strip. Once again ¾ in. thick blockboard is an ideal material for this purpose, and may be cut in one piece. Two 2½ in. by ½ in. pieces of timber should be attached to the ends of the flap to act as bracket stops. These should be screwed in position, and to give a more decorative finish to the table flap the outer corners should be slightly

rounded off. When this is done, attach the flap in position with a pair of brass butts. Steel butts are liable to rust with the condensation normally found in kitchens.

Although the top hinging strip should be fitted to the wall to give a neat join with the plaster, it is advisable to cover this join with a 2 in. by ½ in. moulded plate. This should be plugged to the wall.

Finally, paint or enamel the wood to suit the colour scheme of the kitchen, and cover the table top with plastic material.

A SPECIAL SPADE FOR GARDENERS

MANY a useful tip can often be gleaned by watching other gardeners at work. Seeing a friend spudding round a rose bush trying to find where the suckers were coming from led to the making of a cute little spade. It is necessary to remove some soil to get to the seat of the trouble, and calls for quite a small tool. To reach under the bushes without getting scratched demands a long handle, and here is just the tool for the job.

A visit to the shed brought to light an old coal shovel which didn't take long to alter. Most of the sides needed cutting off with a pair of shears or a hacksaw, so as to leave a nice flat surface (see dotted line).

Any roughness was removed with a file, and the bottom edge given similar treatment. A 3 ft. length of broom handle served as a handle.

A slightly rounded end to the shovel is probably best for all-round use, but a semi-circular one with a sharpened edge would be ideal for trimming the edges of the lawn. (A.F.T.)

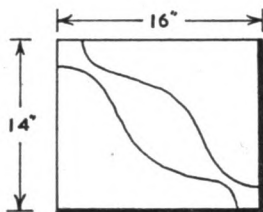
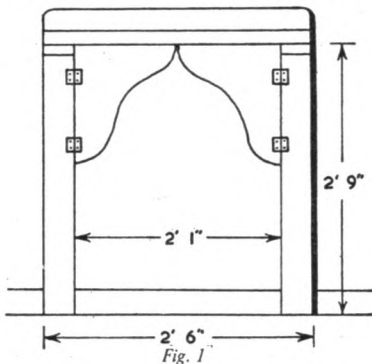

Fig. 3

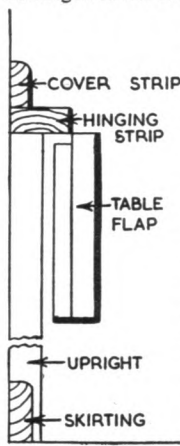
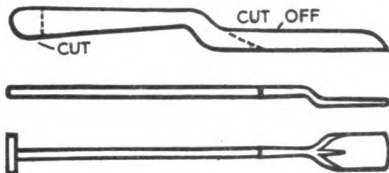

Fig. 2



CRYSTAL RECEIVER AND TUNER

THE crystal set described here can be used for headphone reception, and needs no battery or mains supplies. It may also be used as a 'tuner' in conjunction with a battery or mains amplifier. This allows the amplifier to be used for listening to local stations, and very good reproduction can be obtained in this way.

The receiver panel is 4 in. by 6 in., and it is screwed to a baseboard of $\frac{1}{2}$ in. wood of similar size. A hole is drilled for the tuning condenser. This item is best of air-spaced type, and is of $.0005\mu\text{F}$ capacity. The condenser shown is secured to the panel by short bolts.

Four small holes are also drilled in the panel, for aerial, earth, and phone leads. The type of detector given in the component list is held by two small brackets, and the holes drilled in the panel should be at such a distance apart that the detector is held tightly. If it is loose, crackling or intermittent reception may be caused.

Connections

Wiring up is very easy indeed, and all connections are shown in Fig. 1. Any kind of bare or insulated wire can be used. It will be seen that two terminals are joined together, for earth and phone connections, a lead passing from the earth terminal to the metal frame of the

tuning condenser. A connection is made from the aerial terminal, which holds one detector bracket, to the fixed plates of the tuning condenser.

The coil listed has two wire ends, and

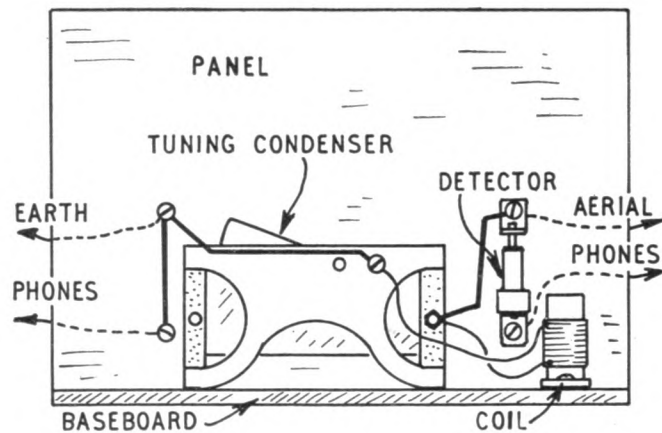
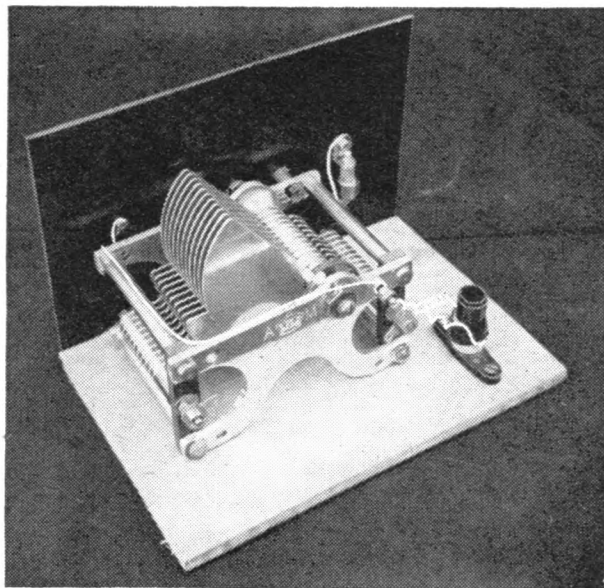

Fig. 1—
Complete
wiring plan

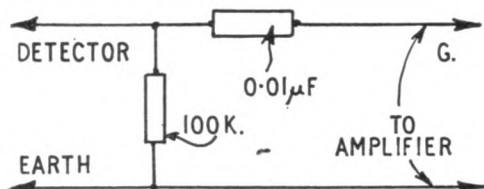

Fig. 2—Amplifier
coupling circuit

COMPONENT LIST

.0005 μF air spaced tuning condenser.	5s. 6d.
Pointer knob for same.	9d.
4 in. by 6 in. paxolin panel.	1s. 6d.
Dust cored M.W. tuning coil.	1s. 6d.
Crystal diode with brackets.	3s. 9d.
4 6BA cheese-headed $\frac{1}{2}$ in. bolts,	
4 6BA nuts, 4 terminal heads.	6d.
10 ft. copper insulated connecting wire.	6d.
For amplifier coupling; 0.01 μF condenser.	8d.
100K (100,000 ohm) resistor.	4d.

These parts may be obtained from Post Radio Supplies, 33 Bourne Gardens, London, E.4.

these are joined to the frame and fixed plates of the tuning condenser, as in Fig. 1. If a home wound coil is required, this can consist of 80 turns of 32 S.W.G. or similar enamelled wire, on an insulated former about 1 in. in diameter, turns lying evenly side by side. Small screws hold the coil to the baseboard.

Phone reception

Aerial, earth, and phones are connected to the four panel terminals, as shown in Fig. 2. Good quality phones, of medium or high impedance, will give best volume. The earth lead should go to a metal spike or other 'earth' actually in contact with the ground. A very long aerial is not usually needed. Indoor aerials will do in some localities, but if the aerial is fairly high, and clear of walls and earthed objects, better signal strength can be expected.

● Continued on page 113

An attractive Sundial Posy Ring

THIS sundial posy ring will make a charming centre piece for the table, and is also ideal for setting out on the sideboard or dressing table where its gay flowers will delight with colour and delicate perfume.

It consists of a plastic circular container which includes a well for the flowers, and this is placed on a wooden stand shaped to represent a sundial. It stands 4 in. high and the ring is $5\frac{3}{8}$ in. diameter. Short-stemmed flowers should be chosen to arrange delicately in the bowl.

MAKE IT FOR 5/-

Hobbies Kit No. 3362 for making this novel Sundial Posy Ring includes wood and the special plastic posy ring around which the model is constructed. Kits price 5/- from branches, etc., or by post from Hobbies Ltd., Dereham, Norfolk (post 1/6 extra).

The plastic ring is contained in Hobbies Kit No. 3362. All the parts needed for making the sundial and stand are shown full size on the design sheet. All pieces should be carefully traced, transferred to wood by means of carbon paper and cut out neatly with a fretsaw before cleaning up with glasspaper. Note that pieces 4, 5, 6, 7 and 8, which are assem-

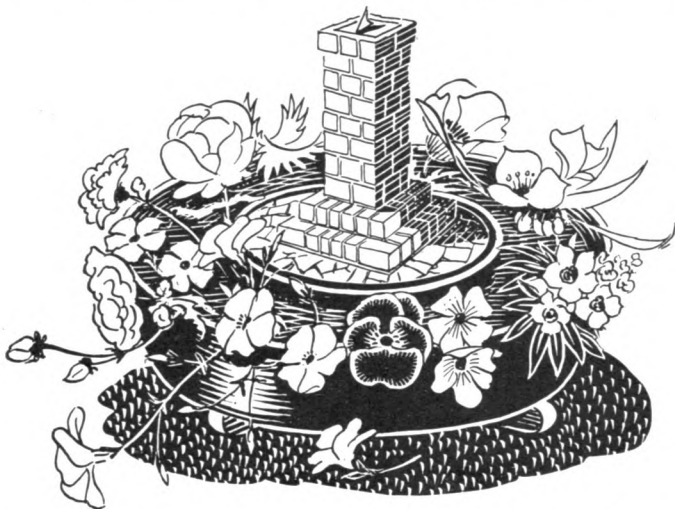

bled to simulate a brick sundial, are cut with a slightly irregular outline in order to give an appearance of rustic brickwork to the finished assembly.

It will also be seen that the plastic bowl goes over the round piece 3, which should be left a reasonably tight fit, that is, so as not to leave too untidy a gap. The brickwork is painted on, but this will be detailed later.

Commence assembly with the base, which consists of pieces 1 and 2 halved together. Glue should be used in all parts of the construction. Eventually the posy ring will rest on the extended arms

of pieces 1 and 2, as shown on the design sheet.

Continue the assembly by gluing the circular piece 3 on top of the base and then adding pieces 4, 5, 6, 7 and 8 in succession. The full detail of their assembly is shown on the design sheet.

The brickwork is represented by paint. Give all the woodwork an overall coat of buff and then paint in the bricks in a suitable shade of red, the crazy paving being marked with a brown line.

The gnomon on the top of the sundial can be represented by a piece of card or tin fixed to the centre of the dial.

● Continued from page 112

Receiver and Tuner

This type of detector does not have to be adjusted. Signals should be heard when the tuning condenser is rotated, and a pointer knob or simple dial can be fitted. With the dust cored type of coil, tuning is influenced by the position of the core, which should be well in towards the windings. This type of coil can normally be expected to give slightly sharper tuning than an air-cored coil. Crystal sets are never very selective. If necessary, to avoid interference from another station, tuning may be sharpened somewhat by shortening the aerial, or by including a condenser in the aerial lead to the receiver. This condenser

should be about $\cdot 0001\mu\text{F}$ to $\cdot 0003\mu\text{F}$.

As amplifier tuner

The receiver will provide a signal which can be fed into a mains or battery amplifier, so that the usual loudspeaker can be operated. When a mains amplifier is used, it should be of the type which is designed for A.C. mains, and has a transformer which isolates the amplifier circuits from the mains.

The receiver or tuner as it now becomes, is coupled to the amplifier, as shown in Fig. 2. The lead marked G must be taken to that pick-up socket, on the amplifier, which goes to the grid side of

the volume control. The leads to the tuner are taken to those terminals to which phones were connected, as shown. With a few small simple amplifiers there may be no volume control. In this case a $\frac{1}{2}$ megohm resistor should be wired across the two leads marked 'to amplifier' in Fig. 2.

The connections between tuner and amplifier should be quite short, and clear of mains and loudspeaker connections from the amplifier, or hum and howling may be caused. When the tuner is used with an aerial and earth which would give good phone volume, good speaker volume can be expected when the amplifier is connected.

A cabinet for the receiver can be built as a complete box, and the set can be inserted from the front, as no connections are needed at the back or elsewhere.

BIRDS OF THE COUNTRYSIDE

THE largest birds found in this country are the birds of prey. Some of them, such as the Golden Eagle, are rare, and found only in the remoter parts of the country. This bird is now confined to the Scottish Highlands.

One member of the hawk family

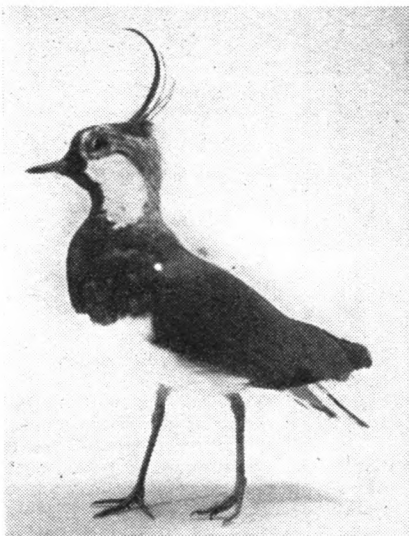

Lapwing

which is comparatively common is the Kestrel. This is a small bird, about the size of a pigeon, and at a distance appears to be brown. Close to, the plumage is a light brown with darker bars. It may be distinguished from other similar birds

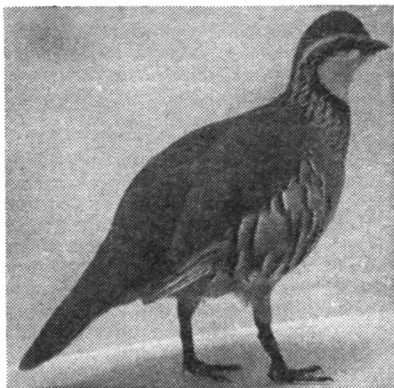

Red-Legged Partridge

by the way it hovers in the air whilst watching the ground for small animals to prey upon. When it sees one it plunges down to pounce on it. The Kestrel has very long wings and a blunt head.

Owls are probably our commonest birds of prey. Tawny Owls may be found in our large cities, where they hunt waste grounds and railway embankments for mice and voles. These are the owls that make the characteristic hooting noise, and sometimes a noise like 'ke-wick'. The Tawny Owl is a well-rounded bird with a mottled brown plumage and large dark eyes. Although hunting mainly by night, if you look carefully during the day, you may see a Tawny Owl roosting in a tree.

The very characteristic plumage of the Barn Owl makes it unmis-



Long-Eared Owl

ground. Two of the commonest are the Lapwing and the Partridge. The Lapwing's most noticeable feature is the long crest on its head. It has a beautiful dark green back. In size the bird is about

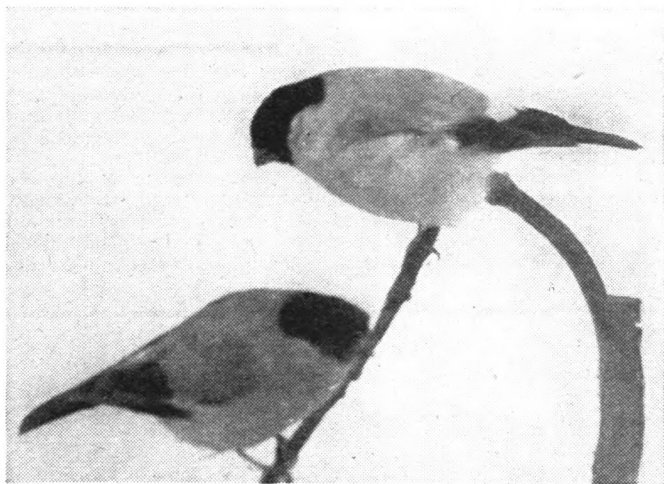

Bullfinches

takable, but it is more of a country bird, and not likely to be seen in towns. The feathers on the front of the bird are pure white, whilst the back is dark. This is also known as the Screech Owl, owing to the blood-curdling noise it makes.

The Long-Eared Owl is another bird that is very easy to identify. This bird has long ear tufts (but not ears) and black and buff plumage. Its eyes are yellow.

Some birds are characterized by the fact that they lay their eggs on the

as large as a pigeon, but it has very much longer wings.

The Partridge is, of course, a very popular game bird. One of the prettiest varieties is the Red-Legged Partridge. It has a brown back and white throat with a black outline; the sides are barred, chestnut and black on a greyish background.

The finch family is the most numerous family of birds. Every town dweller is

●Continued on page 115

GROWING CORKS FOR BOTTLES

DURING Christmas and other festive occasions it will be noticed that a large majority of bottles opened have been stoppered with a cork. When medicine has been prescribed, invariably the bottle has a cork plug. To stopper the bottles used for all these various liquids the cork used will be of the finest quality, for only the best is made into stoppers. The best can be expensive, too; for example, the cork used to stopper champagne bottles can cost around £300 a ton.

But bottle stoppers are only one of the many end-products of cork. Prior to the manufacture of any cork article, there has been much work, and many years of waiting. For cork is, in fact, a natural product, being the bark of an evergreen tree somewhat similar to our oak.

Although the tree grows from an acorn, as does our oak, it seldom grows very large. A normal height is between 20 and 30 ft. Most of these trees grow in Portugal, and so that country produces almost half of the world's annual cork production. The actual quantity produced world wide is just over 300,000 tons each year.

Once planted the trees are left alone for about 15 years. Then, during the dry summer months the bark is stripped by experts for the first time. The method is quite simple, an axe cut at the base of the tree, another at the top of the trunk, and the bark is peeled off, but it still needs the hand of an expert.

This first crop is not a high grade cork, and so is usually used for making charcoal. Nor is the second crop, which is taken about 10 years later. This crop is

Cork stripping is a delicate operation that requires a careful selection of the site for the axe, and great firmness in the strokes.



normally used for floats and buoys. The third crop, though, is normally of excellent quality and this, cut again after an interval of about 10 years, is the crop used to manufacture stoppers. At this and subsequent crops, each taken after a lapse of from 8 to 10 years, the bark removed is often up to 2 in. thick.

The bark of the cork tree is actually made up of very small cells of gas and

air, and it is these cells which give cork its lightness, buoyancy, elasticity, and insulating powers. Those qualities, together with that of being waterproof, mean that no cork is wasted. It enters the factory in large strips, and is used for manufacturing products until only small chips remain, and then these are used for making composition cork.

(J.A.C.)

●Continued from page 114

Birds of the Countryside

familiar with the Sparrow, and the Chaffinch is said to be the most numerous bird in this country. The latter is about the size of a Sparrow, and the cock bird has a bluish head and reddish coloured breast. The female, as is usual in the bird world, is a drab little thing, but both sexes have a small white patch on the front of each wing.

The cock Bullfinch is even more handsome with his unmistakable pinkish breast. In addition he has black wings and head and a grey back. The hen is just another little brown bird.

The cock Greenfinch is a pretty little green bird with yellow on the wings and tail. The hen looks rather like a sparrow, but on closer examination can be seen yellow markings on her wings and tail. The Yellow-hammer is also a member of the finch family. The cock bird is a beautiful yellow colour with a chestnut brown back. The hen is much browner but still has some yellow on her front.

The Blue Tit is a familiar little bird in the garden, even in towns. It has the unmistakable blue and yellow plumage which gives the bird its name. The Great Tit is a very conspicuous member of this family with its black and white head and yellow underparts. This bird has a characteristic song, if it can be called a song! It is rather like a saw being sharpened and is sometimes represented by the words "teecher, teecher". Tits have long tails for their tiny size and there is very little difference between male and female in plumage.

The Green Woodpecker may be seen on the trunks of trees, looking for insects. It has a characteristic undulating flight. The plumage is green with a yellow rump and a red head. The laughing call is loud and carries widely.

In conclusion we may mention the Skylark. This bird can be identified easily, since it is one of the few birds that sings on the wing.

(P.R.C.)



After being stripped, the cork is piled up, and awaits transportation to the factory,

E. Capper describes

MAKING A SHIP IN A BOTTLE

ALL you need to build a ship in a bottle is a very sharp penknife and lots of patience — oh! and a little wood and thread, a meat skewer, a few pins, a metal tube, and a spot of glue.

First select your bottle. Round or square will do, but best of all is a triangular whisky bottle if you can get one. Make sure the bottle is of clear glass.

The dimensions of your ship depend on the neck of the bottle. Fig. A shows the maximum width and depth of the hull and height allowable for bowsprit. The length of the ship should be in pro-

portion to this hull size. To find height of ship from hull bottom to mast-top, measure diameter or height of bottle itself, then deduct 1 in.

Use a close-grained wood for the hull, such as beech, and shape with a sharp penknife. Hollow out most of deck top to about $\frac{1}{2}$ in. depth, but leave stern and bow ends solid, as shown on plan Fig. D.

For masts and bowsprit, here again use close-grained wood, as the mast will not be much over $\frac{1}{8}$ in. diameter. Don't use matchsticks — they split. Taper off

wood towards top with penknife.

Drilling will be tedious, as holes must, necessarily, be small. Safest method is to make up a 'drill' by knocking the eye-end of a needle into a round piece of wood for handling, blunting the exposed pointed end of the needle, and burning the holes through the wood by heating the needle end over a gas flame.

You will need holes in the masts, bowsprit, deck-sides and cross-spars. Remember, you need not have as many lengths of rigging from masts to deck-sides as shown. Two will do, so drill

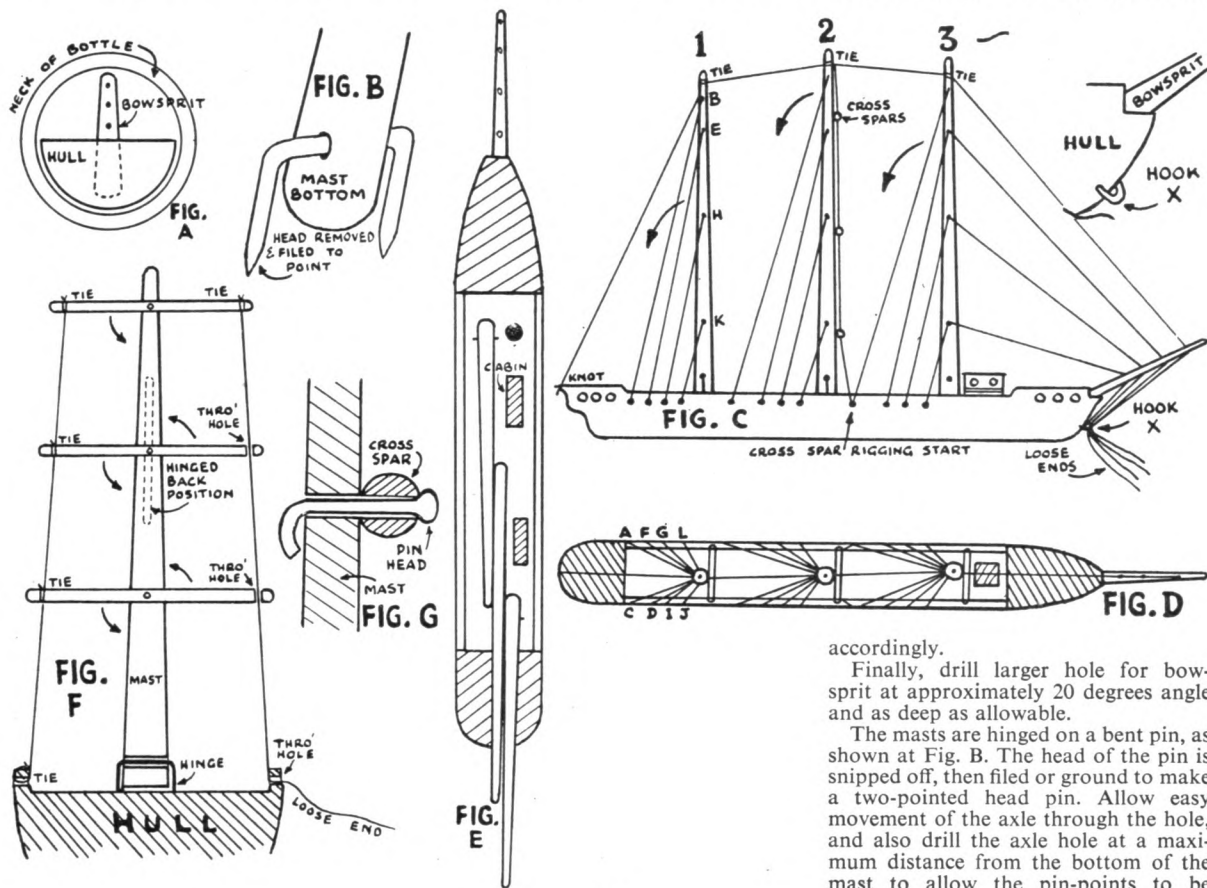
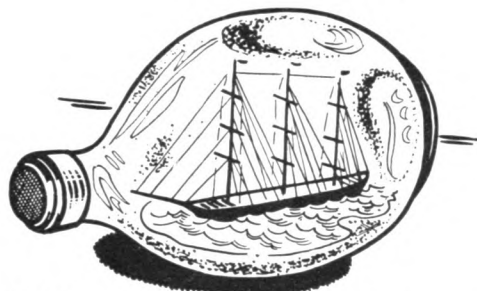

accordingly.

Finally, drill larger hole for bowsprit at approximately 20 degrees angle and as deep as allowable.

The masts are hinged on a bent pin, as shown at Fig. B. The head of the pin is snipped off, then filed or ground to make a two-pointed head pin. Allow easy movement of the axle through the hole, and also drill the axle hole at a maximum distance from the bottom of the mast to allow the pin-points to be

driven into the deck approximately $\frac{1}{8}$ in. when assembling.

The hinge for the cross-spars is also made from a bent pin except that the head is retained, the pin taken through the spar and mast holes, bent over at right angles and the surplus snapped off, G. Again allow easy movement.

One more bent pin is needed. Snip off the head, sharpen the point, bend to make a very small staple-shape, and drive it into the near-bottom of the hull under the bowsprit — see X in Fig. C.

Assembly

Hinge cross-spars to masts, and set the bowsprit with glue in the hole drilled.

As shown in Fig. E, the completed ship is able to slide endways through the bottle neck by the masts being lowered towards the stern end. If the masts were set in a straight line they would ride on top of one another, incline upwards instead of lying flat and prevent easy entry of the ship through the neck of the bottle. They must, therefore, be set in a staggered line, as shown on plan, Fig. D.

Rigging

Cut a small slit with a penknife at the centre of the stern end. Tie a knot in one end of a length of white thread, pull the thread through the slit so that the knot acts as a stop (see Fig. C). Now take the rigging to the top of mast 1 (Fig. C), tie to the mast, take to top of mast 2, tie again, then to top of mast 3, again tie, finally bringing it down to the top end of the bowsprit, keeping the thread reasonably taut. Here wind the thread around the bowsprit several times to hold it there temporarily, but leave at least 12 in. of loose thread before cutting off. The object of all this is to line-up the masts vertically, and also to assist and make easy the remaining rigging.

Now, using Figs. C and D in conjunction, start another length of thread by tying through the deck-side hole A. Take it through the topmost hole in mast B, then down to C, back up to D and so on, as shown. Finally secure with a knot through hole L, and repeat with masts 2 and 3.

Now, using separate lengths of thread approximately 15 in. long, tie thread

through the holes already being used on mast 3, and take the ends through the relative holes in the bowsprit (see Fig. C). Finally wind all loose ends through hook X.

You will now see that, by releasing the temporary hold (described in the rigging instructions) and threading the loose end through the topmost hole in the bowsprit, you are able to raise or lower the masts by controlling these loose ends.

The cross-spar rigging starts at deck-side hole (Figs. C and F), is tied around all left-hand ends of spars and top right-hand side, but from there travels down the right-hand side of spars through the drilled holes (Fig. F). Here, again, leave about 12 in. of loose end.

Minute blocks of wood can be added to represent cabins, but they must be placed so that they do not foul the lowered masts (Fig. E). Naturally, it is best to paint before assembling. Masts should be white, the hull dark shades, and the decks yellow or cream.

A concluding article will describe how to insert the ship in the bottle.

A Hammock from an old Barrel

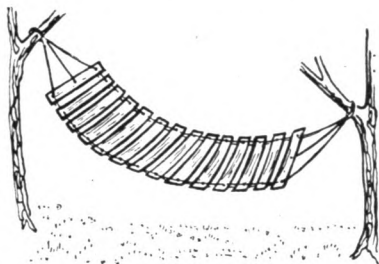

PERHAPS you have an old barrel which has outlived its usefulness — such as a water butt that leaks or has lost most of its hoops and is falling to pieces.

This is just the thing to make a really useful hammock to help you enjoy sunny days in the open air. It is very strong, quite comfortable, can be packed away in a small space, and will last a lifetime.

It should not be much trouble to knock off the remaining hoops and take the barrel to pieces, if it has not fallen into such a state already. If the barrel has been standing outside and is dirty, then give the staves a good scrub, and allow to dry thoroughly. After this, give the wood a good glasspapering, and well smooth all the edges to remove any roughness.

Drill a hole in both ends of each stave at a distance of $1\frac{3}{4}$ in. from the end. In order to take the two ropes which go through each hole, they will need to be

about $\frac{3}{4}$ in. in diameter. Do not make them so large that the stave will be weakened by so doing, and a tightish fit will be better so long as you can get the ropes threaded in.

It is a good idea to countersink both sides of each hole just a little, and finish it off with glasspaper to remove all roughness which might fray the rope.

The two ropes running down each side of the hammock are threaded through the holes, as shown at A. By this means, the staves will remain flat, and so add to the comfort of the hammock.

When the staves have been roped together, they should be spaced evenly along the line, and then secured so that they will not slide out of position. The two ropes between each stave are bound together with a strong twine, starting off as shown at B. Continue binding the twine round tightly, and finish off by putting the end through the loop, and then pulling the other end, as shown at C. This will draw the twine under the entire binding, and all you have to do is cut the end to finish off each section as at D.

To sling up the hammock, drill three holes in the end staves, fastening a stout rope in each, and hang between a pair of posts or tree trunks.

Treating the staves with linseed oil will help to preserve the oak, or if you like they may be given two coats of good oil paint in a gay colour. Either of these

finishes must, of course, be completed before the staves are roped together.

A light mattress or air bed will be needed to complete the comfort of the hammock. A folded blanket can be used, or a sheet of foam rubber would make an ideal material for the job.

(A.F.T.)

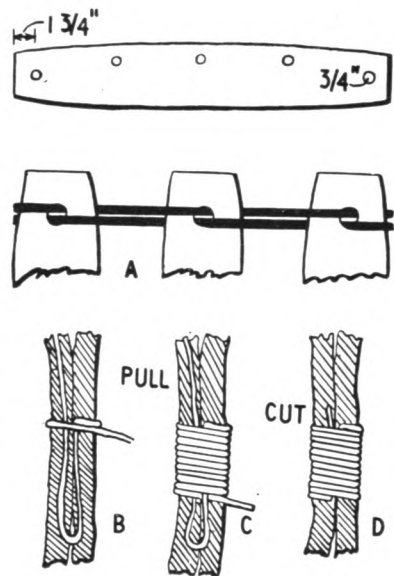

Mainly for Modellers

FOR some time now I have been working on designs for a series of miniature models of the many smaller coastal craft, fishing craft, etc., and will shortly be including details of some of these models to continue our *Miniature History Series*.

The designs will be to scale, and those of our readers who wish to make larger models of a particular vessel will be able to enlarge the design, either by the squares method or by a method I shall outline in the first of the series.

SOME NOTES ON SMALL CRAFT By 'Whipstaff'

This type of vessel affords the serious model maker the opportunity of making a really detailed model. At the scale of $\frac{1}{4}$ in. to the foot, used in most museum models, very fine detail can be shown on a model that is neither too large for the home, nor too large for the workshop space available to the average modeller.

On many of the larger types of sailing ships, the clippers and large windjammers of the latter part of the 19th century and the first decades of the 20th century, the wealth of detail is only possible in a small scale to expert professional model makers and very highly skilled amateur modellers, while to a scale that allows of fine detail, (even a scale of $\frac{1}{8}$ in. to the foot) results in a model far too large for most purposes.

As many of these vessels have disappeared from our waters and others are fast vanishing in the face of modern conditions, such a model, well made and detailed, has a real historical value. Models of these fine little ships are scarce and provide a worthwhile project for any model maker.

For examples, take the interesting Yorkshire Keels, Norfolk Wherries, trawlers and drifters that have sailed the waters around Ipswich, Lowestoft, Harwich and other places around the coasts of these islands. They provide scores of prototypes that are worthy subjects for the serious ship modeller.

The series contemplated will prove especially interesting to readers following our articles in wooden shipbuilding. They are all products of the shipwright's

trade in building in wood. Some are carvel built, some are clinker built; the types of rig being many.

In these types we will find vessels built for fishing close inshore; others for deep sea fishing. There are cutters and sloops built for the Navy and small coastal cargo carriers.

Different trades use different types of rig. Coal was carried in square rig craft, giving rise to the celebrated coal briggs. In carrying merchandise from the near East, a rig combining square and fore and aft was used. Heavier built vessels of the smack type were used for carrying corn and such produce.

Although steam brought an end to craft in the coal trade during the middle of the 19th century, the beautiful schooners used for fruit carrying became

very much in use around the 1850 period.

We shall be able in this series to consider such a wide variety of vessels as the early Herring Buss, the Yorkshire Keels, Crab boats, Pilchard fishing boats, Smacks, Sailing Barges, Luggers and many other types originating in places extending from the North of Scotland to Land's End.

It is also intended to include some models of vessels of unusual design from other countries, so that we shall, I am sure, provide each of our model makers with at least one little ship in which he will find pleasure.

For those who possess a home workshop that can be converted to a vertical drill, hollowing out hulls for miniature models or even small ships can be a simple job. Owing to the speed needed for using router bits for ordinary work, they are not suitable for use in the average drill, but I find small ones can be used with success.

The final finishing of the inside of the hull can be done with glasspaper, or if you have a flexible drive for your drill, a small grinding bob can be used.

Flower Pot Camouflage

A VERY large number of plants are available for growing indoors but unfortunately the flowerpots tend to become unsightly. Unless they are new or in good condition they need some form of camouflage.

Artistic containers into which the flowerpots can be placed are available in a variety of materials, but very often they are expensive or not the right size.

Here we show how to make at very low cost a most attractive fitment for a dirty flowerpot. The tube which slides over the pot is made from a strip of plastic material and stands on a wooden base. Odd scraps, which might otherwise be thrown away can be used, and if you have not got a strip long enough, several pieces may be joined together to make the necessary length.

There are very many types of plastic material which can be used, and in a large variety of attractive colours. Some are self-adhesive, some need the application of a special adhesive, but all are easy to join.

When measuring up the circumference of the flower pot, allow about $\frac{1}{8}$ in. for the join, and for a pot with a diameter of $4\frac{1}{2}$ in. you will need a strip 15 in. long and about 5 in. wide. The top edge may be left plain or may be ornamented in a variety of ways like the scalloped one shown.

It is a good idea to stick on a narrow strip of a contrasting colour at the top and this also helps to give added strength

and stiffness where it is most needed. The bottom of the tube, ornamented in a similar way, also helps in this respect.

A simple wood base to complete the job is easily made from a piece of hardwood about $\frac{1}{2}$ in. thick. Make it a little larger than the tube. It can be round with plain or bevelled edge or with, say, six or eight sides. Give it a coat of varnish or french polish to preserve it.

Stand the pot in a shallow tin of a size that will just fit inside the tube, to collect excess water.

(A.F.T.)

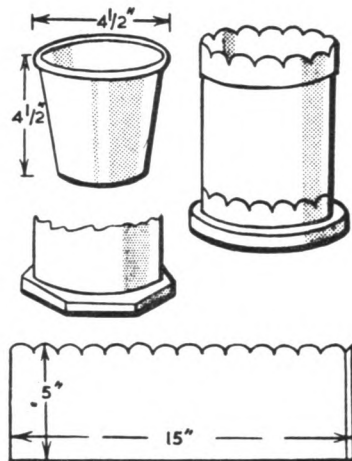

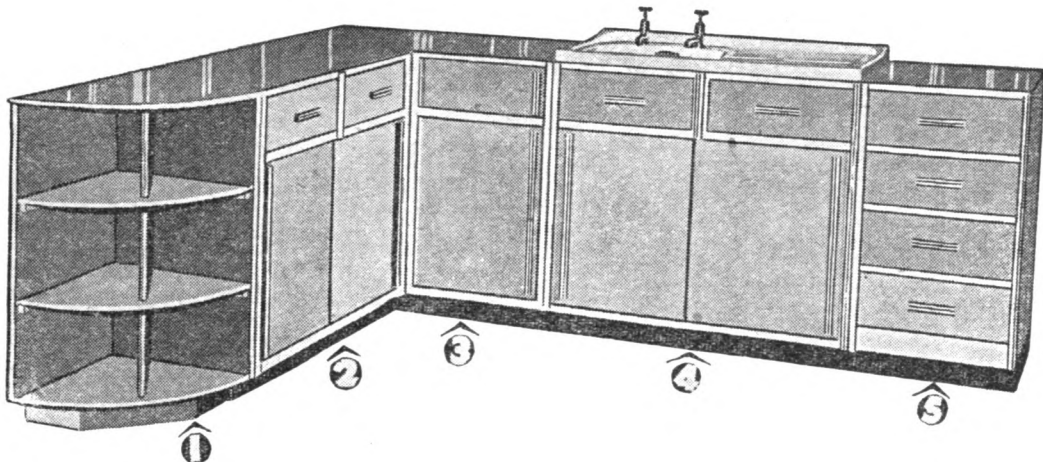

'DREAM KITCHEN' UNITS

AVAILABLE READY-MADE OR AS KITS

'Winsome' kitchen units are designed and produced by Hobbies Ltd., Dereham, Norfolk, and are available by post direct from Head Office or from all branches. Each unit can be used singly or in conjunction with others, according to size and shape of kitchen.

Designed to give maximum cupboard, drawer, and shelf space, they stand at a comfortable working height of 2 ft. 9 in. on recessed plinths. Sliding doors and durable plastic worktops are other compelling features.

Each unit is available completely finished (with choice of colour) or as a specially prepared kit in its natural state, ready to put together with a screwdriver and glue and finish to your own choice — a simple job.

1 END UNIT — No. 57

Complete £5 17s. 6d.
(part p & p 7/6 extra)

Kit £4 12s. 6d.
(part p & p 5/- extra)

2 CABINET UNIT — No. 51

Complete £8 15s. 0d.
(part p & p 10/6 extra)

Kit £6 19s. 6d.
(part p & p 7/- extra)

3 CORNER UNIT — No. 54

Complete £8 13s. 6d.
(part p & p 10/6 extra)

Kit £6 18s. 0d.
(part p & p 7/- extra)

4 SINK UNIT — No. 55 (without sink and taps)

Complete £6 15s. 0d.
(part p & p 10/6 extra)

Kit £5 10s. 0d.
(part p & p 7/- extra)

5 DRAWER UNIT — No. 52

Complete £8 14s. 6d.
(part p & p 10/6 extra)

Kit £6 19s. 0d.
(part p & p 7/- extra)

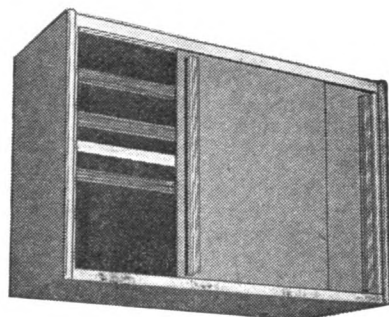

WALL UNIT (to match)

No. 53 (36" × 23" × 12")

Complete £4 10s. 0d. Kit £3 5s. 0d.

No. 56 (36" × 17" × 8")

Complete £3 12s. 6d. Kit £2 12s. 6d.

(part p & p unit 7/6, kit 5/-)

HOBBIES LTD

DEREHAM NORFOLK

For fascinating views

A MODEL CAMERA OBSCURA

HIGH upon the Bristol Downs, overlooking Brunel's famous suspension bridge at Clifton, you can still visit one of the few camera obscuras now remaining in England.

Though it is often wrongly ascribed to Leonardo da Vinci, the camera obscura,

draper will almost certainly be prepared to give you such a box. Also, you will need a 2 in. diameter convex lens with a fairly long focal length, and a lady's handbag mirror. Paint the entire inside of the box and lid jet black.

Cut a hole, slightly less in diameter

Mount the lens over the hole, securing it in place with strips of Sellotape.

Now prepare a strip of thin white cardboard to the exact dimensions of the cross-section of the box, allowing for $\frac{1}{2}$ in. wide end tabs. Bend the end tabs down at 90 degrees, and place the white strip inside the box, opposite the lens. In a poorly lit room, face the lens towards a brightly illuminated window, and move the white cardboard screen until a clear image of the window is projected upon it. The distance of the screen from the lens will be equivalent to the focal length of the lens. Glue the white screen exactly in this position within the box. Ideally the screen should be half-way down the box.

Make a 45 degree bracket, as long as the width of the hand mirror, from a strip of tin $1\frac{1}{2}$ in. wide. The two parts of the bracket should be $\frac{3}{4}$ in. wide. Bind the mirror to one 'arm' of the bracket, using Sellotape, and then use a second strip of Sellotape to secure the mirror in place, above the lens and facing towards the open side of the box. The diagram will make this arrangement quite clear.

Cut a rectangular hole in the lid of the box, in such a position that, when the lid is replaced, the hole will be on the right-hand side, about 1 in. above the level of the screen inside. Fix the lid in place with Sellotape.

Stand the completed camera obscura on end, and look through the little window, where you will see a naturally coloured image of whatever view is reflected and projected into the interior of the box. Take the box out of doors, and observe tiny panoramas of moving clouds, people, and foliage. You will be fascinated. (A.E.W.)

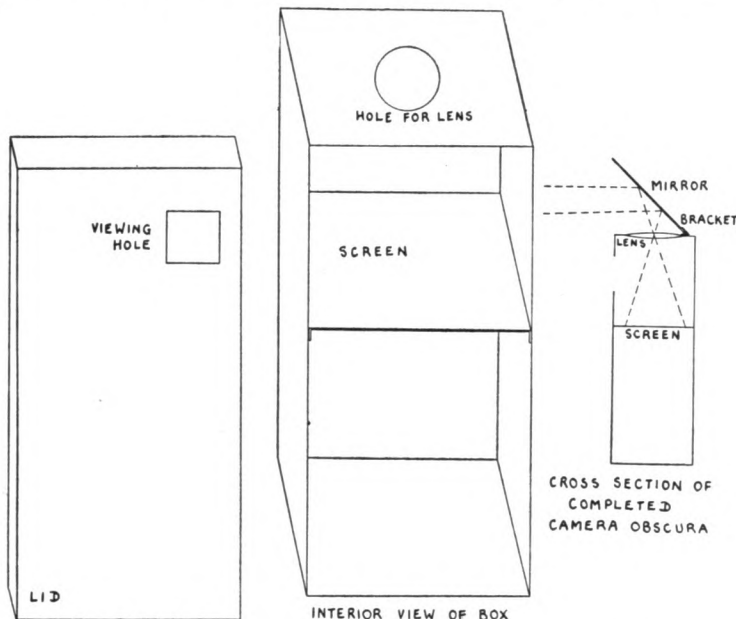

which was the ancestor of the modern camera, was invented a thousand years ago by an Arab called Alhazen. The Latin name means 'a dark room', and the device consists of a windowless vault, or tent, into which light is admitted through a pin-hole or convex lens, and allowed to fall upon a concave white screen. As occurs within the human eye, or camera, the projected image is upside down. This defect is usually corrected by means of a plane mirror. The projected view is a beautiful miniature, in full colour, of the outside world. Consequently, camera obscuras have always been popular for secretly observing the street or surrounding countryside. The artist Canaletto traced around views in a camera obscura in order to obtain the magnificent perspective for which his paintings are famous.

You can easily make a working model of a camera obscura, and experience its fascination for yourself. Obtain a large cardboard box with a lid, measuring approximately 20 in. by 10 in. by 6 in. A

than the lens, in the middle of one end of the box. This can be done by first marking out the size of the hole, using a ruler and compasses, and then cutting away the cardboard with a sharp penknife.

Screwdriver with a pistol grip

THE handle of the Steadfast ratchet screwdriver is shaped in a pistol grip fashion, thereby giving greater efficiency for turning power and speed. It is also a comfortable tool to handle. Made in translucent amber plastic, the handle is insulated and virtually un-

breakable. The 6 in. blades are chromium-plated and there is a robust and positive ratchet action. Price 10s. 6d. from tool dealers and ironmongers. Available from all branches or by post from Hobbies Ltd, Dereham, Norfolk (9d. extra).

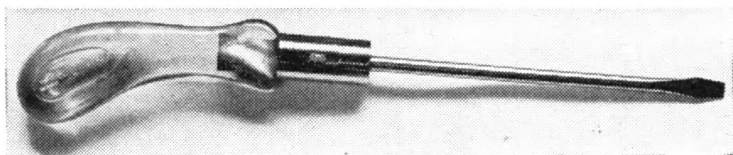

NEW Angles

on OLD favourites

from these Books bulging with BRIGHT IDEAS

Any volume in this most interesting range of books, each dealing with a different aspect of gummed paper-craft, will show you a wealth of ideas, the way to carry them out, and give hours of intense enjoyment.

Each is the key to an economical hobby that is rich in variety, ranging from the making of a charming picture to framing it delightfully — from three dimensional models to wall decorations, from paper sculpture to charming flower studies.



Other books by FREDERICK T. DAY

- Coloured Paper Decoration 7/6
- Coloured Papercraft for Schools .. 7/6
- Coloured Papercraft for Infants' Schools.. 6/-
- Lampshade and Parchment Craft .. 8/6
- Decorative Flower and Leafmaking .. 8/6
- Gummed Strip and Paper Modelling .. 7/6
- Paper Sculpture for Schools 7/6



8/6

All books obtainable from:
Newnes & Pearson Ltd.
Tower House, Southampton St., Strand, W.C.1.
Ask your stationer to show you the Butterfly range of
handicraft materials.

SAMUEL JONES & CO., LTD.

STATIONERY MILL, CAMBERWELL, LONDON, S.E.5. RODNEY: 5064



WENSUM DINGHY

Designed by P. W. Blandford. An excellent performer, with a good turn of speed under sail and suitable for racing. Overall length 11ft. Offered completely finished and ready for the water or in kit form to build yourself from full-size drawings and complete instructions.

COMPLETE DINGHY

(without sails)

£125

COMPLETE KIT

(without varnish and sails)

£74

SUIT OF SAILS (First-class Terylene)

All prices ex-works **£22.10.0** Quotations for delivery



HOBBIES LTD

(Dept. 99)

DEREHAM
NORFOLK

★ **LEARN** ★
RADIO & T/V
SERVICING
 for your OWN
BUSINESS/HOBBY

● by a new exciting no-maths. system, using practical equipment, recently introduced to this country.

FREE Brochure from :—
RADIOSTRUCTOR
 DEPT. G81, 46, MARKET PLACE
 READING, BERKS, 18/5

PEN PROFIT. If you like writing send for 'Writer's Guide' (free). Thousands of words to interest beginner or experienced. Typewriter unnecessary under our system. Writers' Ring (H.W.), 5 Edmund Street, Birmingham 3.

WORKERS with sewing machines required for making cushion covers. Regular work guaranteed. Apply enclosing s.a.e., Dept. 28, Arnold Trading, 10 Shelley Road, Worthing, Sussex.

WHEELS (Hardwood and Rubber Tyred Metal). Cot, Pram and Doll's House Fittings and Papers, Beads, Transfers, Prints and other accessories. Stamp for new lists. (Trade supplied.) New address — **JOYDEN CO.**, 91 Peplins Way, Brookmans Park, Herts.

Further reduced
 Brand New
LUXURIOUSLY QUILTED 'QUILTERFOAM'
SLEEPING BAGS ONLY 19/11
 POST ETC 2/6



Slip into it—soft and comfy—enjoy restful sleep throughout night. No blankets, no sheets, everything in one including special padding for a beautiful soft mattress effect. Light as a feather, it rolls up to a tiny lightweight size. 19/11, post 2/6. Even finished in heavy quality strong material. Really hardwearing. Not a blanket with outer, but genuinely quilted. Refund guaranteed.

Sent for 10/- bal. 18 fortnightly payments 8 oz. 7/1. Plus DUCK CARR.
1/2 PRICE OFFER! SENT FOR 10!
 The FLIGHT LIEUTENANT
 Genuine NEW
TENT



Waterproofed 1960 Tents of 8 oz. WHITE DUCK. Galeproof. Brand new surplus to export order. DON'T CONFUSE with Tents made from drab material never meant for tentage. This is real thing, withstands anything even in our climate. Approx. 7ft. 6in. x 6ft. x 6ft., 3ft. walls. Cash £5/19/6, carr. 6/- complete ready to erect, incl. valise. 'Willesden' Green 42/- ex. Ridge pole if req. 7/6 Fly-sheet 39/6 Rubberised Groundsheet 19/6. These essentials sent on appro. Refund guaranteed. LISTS, TENTS

Headquarter & General Supply Ltd.
 (HOBW/5) 196-200 Coldharbour Lane
 Loughboro Junc., London, S.E.5. Open Sat.

BRASS, COPPER, DURAL, ALUMINIUM, BRONZE
 ROD, BAR, SHEET, TUBE, STRIP, WIRE
 3,000 STANDARD STOCK SIZES
 No Quantity too small List on Application
H. ROLLET & Co. Ltd.
 6 CHESHAM PLACE, LONDON, S.W.1
 Also at
 Liverpool, Manchester, Leeds, Birmingham

CAMPING SITES in Britain — Full details of camping sites throughout the British Isles — 3/- from newsgagents and camping equipment dealers.

KUKLOS ANNUAL. Indispensable cyclist's handbook. Tours, resthouses, money-saving hints. 3/- post free. — Burrow, Publishers, 2 Imperial House, Cheltenham.

100 DIFFERENT stamps free! Request 4d. upwards discount approvals. — Bush, 53 Newlyn Way, Parkstone, Dorset.

MODELS. You can make lasting stone-hard models with Sankey's Pyruma Plastic Cement. Supplied in tins by Ironmongers, Hardwaremen and Builders' Merchants. Ask for instruction leaflet.

ENJOY THE THRILL of Drawing or Painting. 'Make Art Pay' (free) explains remarkable, quick, easy method of improving mind, body, and income. — Clun Valley Features (H.W.), Clun, Shropshire.

HEAR ALL CONTINENTS
 With **H.A.C. Short-Wave Receivers**

Suppliers for over 18 years of radio S-W Receivers of quality.
 One-Valve Kit, Price 25/- Two-Valve Kit, Price 50/-
 Improved designs with Denco coils. All kits complete with all components, accessories and full instructions. Before ordering, call and inspect a demonstration receiver, or send stamped addressed envelope for descriptive catalogue.
 H.A.C. Short-Wave Products (Dept. 22), 11 Old Bond Street, London, W.1

WOOD BENCH VICE

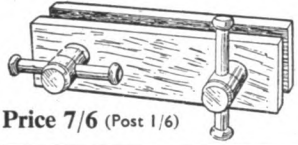

Price 7/6 (Post 1/6)

A strong hardwood vice which can be screwed to the work bench. A real serviceable tool, well made, and fitted with hardwood screws. 12 in. long.
 From branches or:
HOBBIES LTD., Dereham, Norfolk

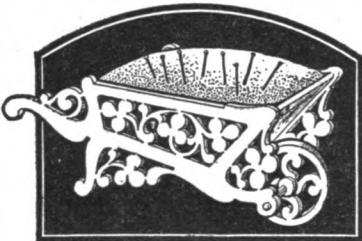

WHEEL BARROW PINCUSHION

An attractive and useful novelty which will give enjoyment to the craftsman in its making.

Kit No. 2122 contains selected wood, dowel rod for axle, design sheet with instructions, etc.
 Price 4/3, plus 1/- postage from
HOBBIES LTD. (Dept. 99), Dereham, Norfolk

TRINKET BOX

6 1/2 in. long

3 in. wide

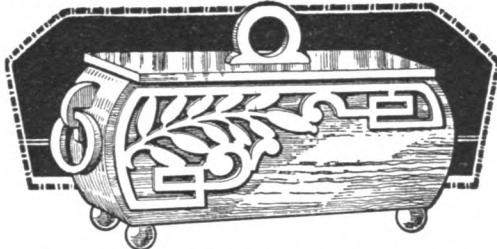

AN ATTRACTIVE AND USEFUL GIFT

Kit contains selected panels of wood, four ball feet, design sheet with instructions.

Price 7/4, plus 1/3 postage

To **HOBBIES LTD. (Dept. 99)**
DEREHAM, NORFOLK

Please send me Kit No. 2340.

Name

Address

P.O./Cheque for 8/7 enclosed.

MAKE THIS HANDY PIN TRAY

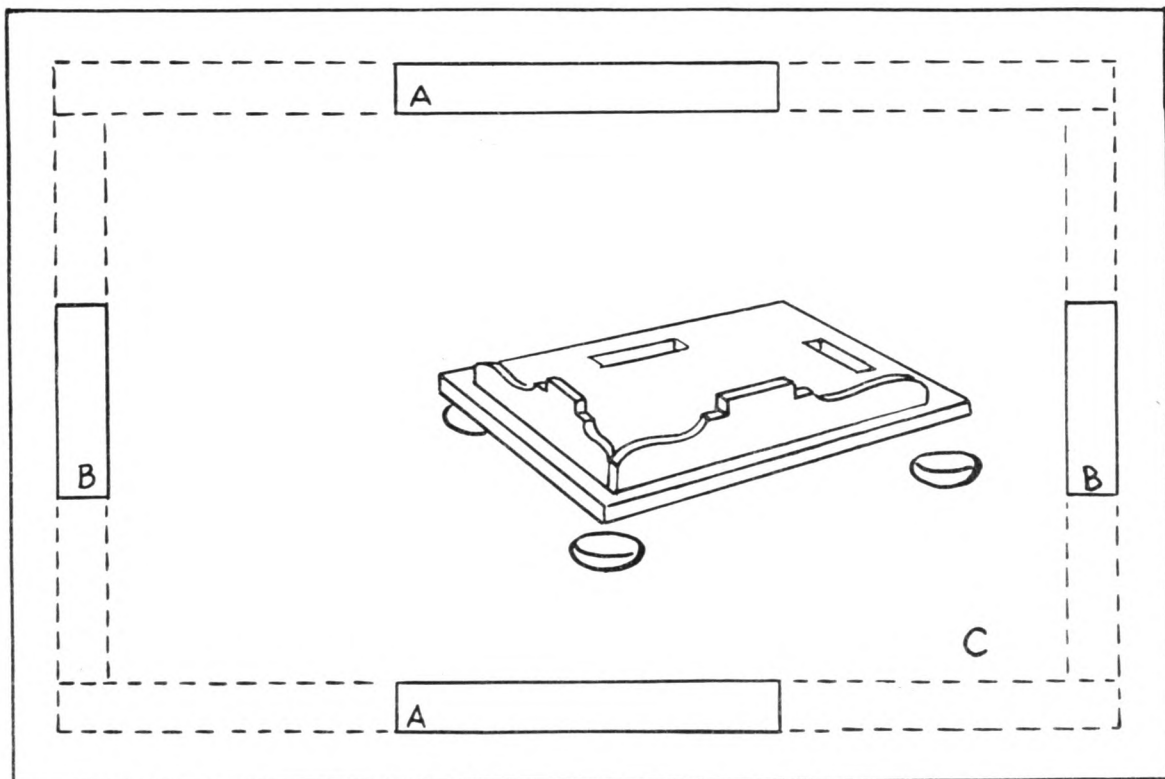

CUT one of C and two each of A and B from $\frac{1}{4}$ in. wood. Glue the sides A and the ends B in position, and clean up with glasspaper.

Glue four Hobbies No. 19 toes (price 1/- doz., postage 6d.) underneath.

Clean up and paint. Finish off by gluing a piece of green baize in the tray.

(M.p)

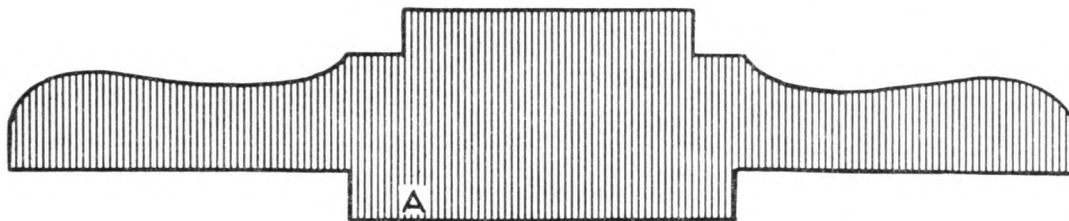
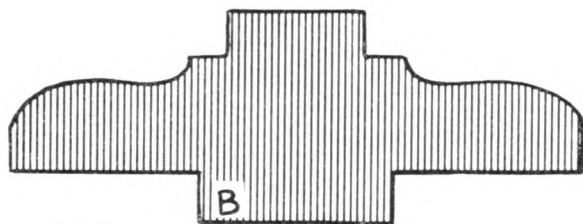

start a-

NEW

hobby with.....

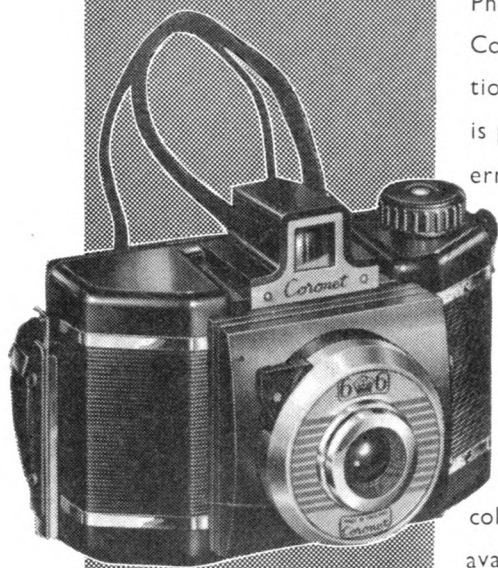

Photography is fun! And it's easy with the NEW Coronet 6x6 camera. No mathematical calculations; no range finding difficulties — everything is perfectly simple. With its brilliant ultra-modern styling and eye-level viewfinder the 6x6 is the last word in low priced cameras. What's more, it's fully synchronized for use with a Coronet flash gun.

The Coronet 6x6 takes twelve big album size pictures on easily obtainable 120 roll film. You can take black-and-white snaps by day or night: also pictures in colour. A handsome ever-ready carrying case is available, also a wallet containing a special close-up lens and lens hood.

PRICE **37/6**

the

NEW

coronet



**Send
this
NOW!**

Please send me a free illustrated leaflet
on the new Coronet 6x6 camera

NAME.....

ADDRESS.....

CORONET LTD., (DEPT. 72), SUMMER LANE, BIRMINGHAM 1

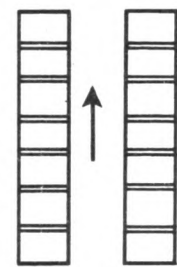
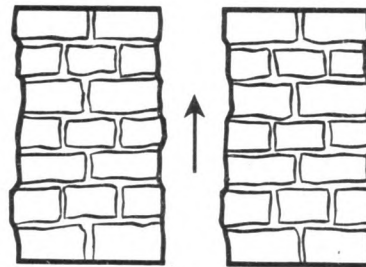
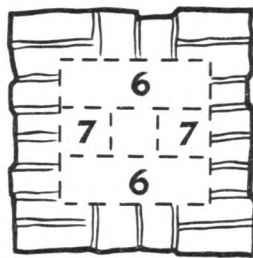
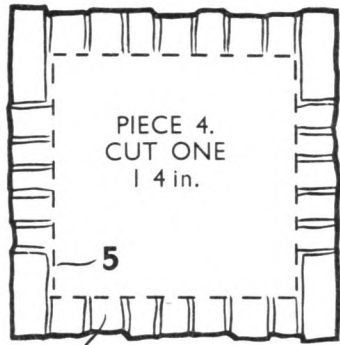
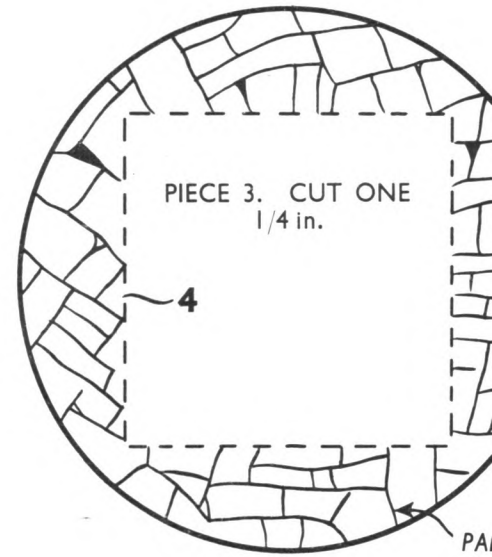
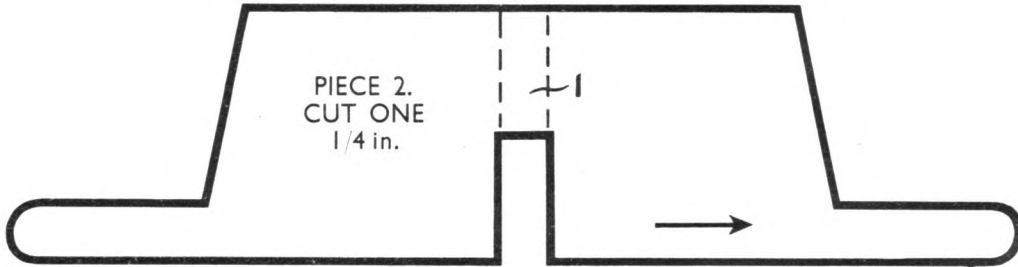
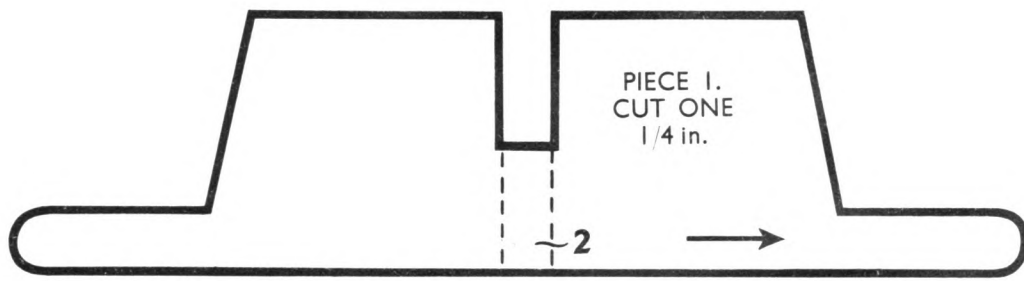

PAINT
ON

NOTE. CUT TO THE OUTSIDE OF
THICK LINES.

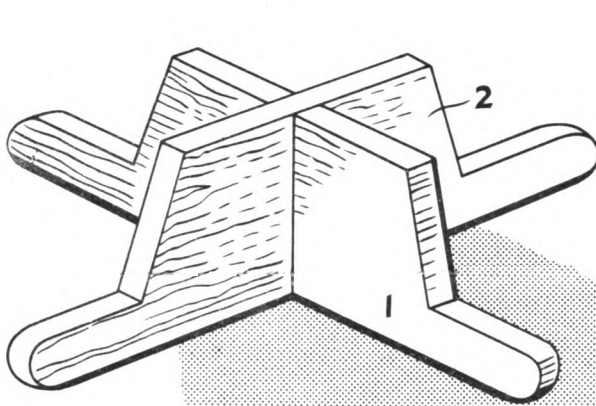

SHOWING HOW
PIECES 1 AND 2
ARE HALVED
TOGETHER.

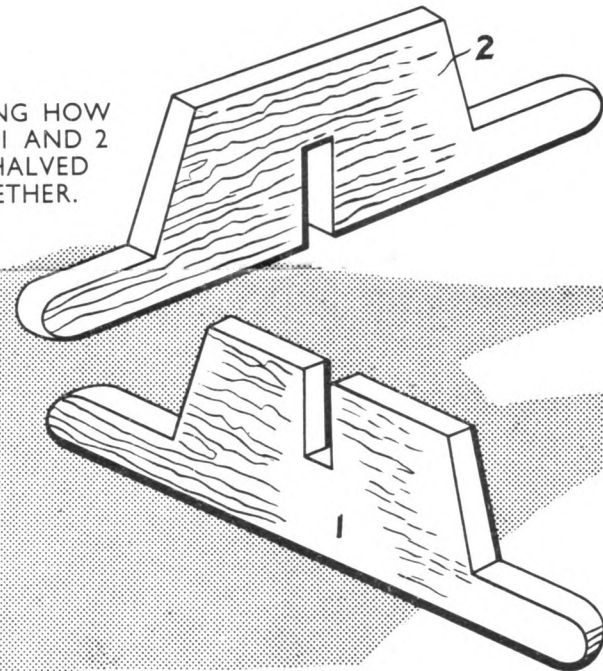

THE SUNDIAL POSY RING

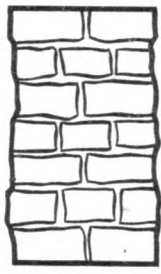
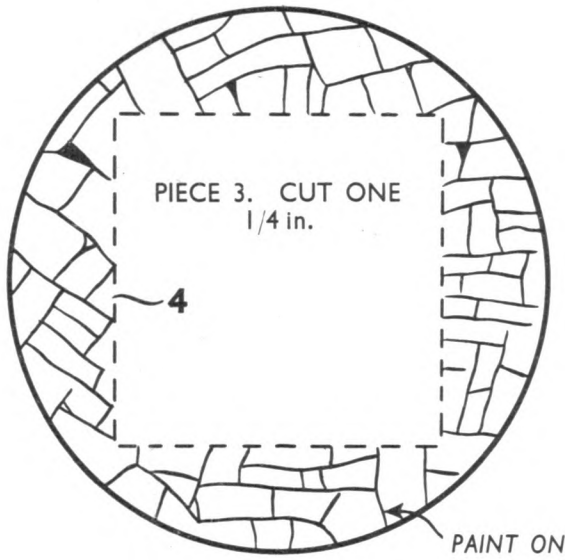

CUT ONE OF EACH 1/4 in.

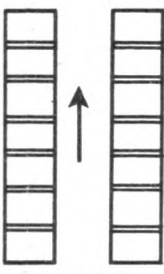

PIECES 7. CUT ONE OF EACH 1/4 in.

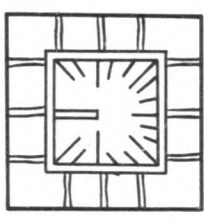

PIECE 8. CUT ONE 1/4 in.

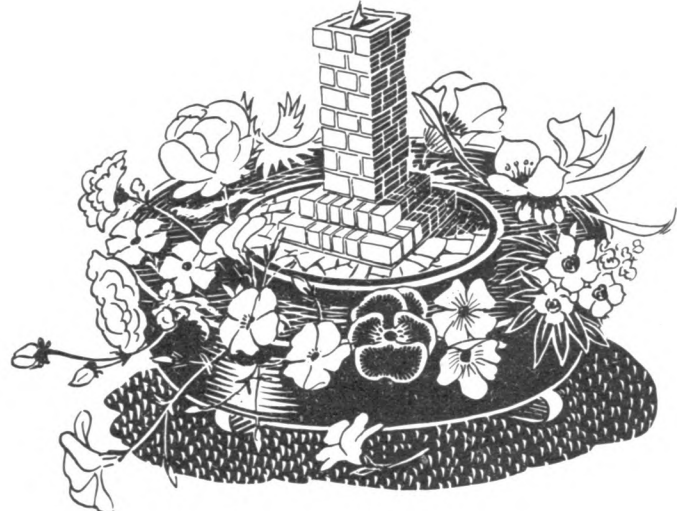

SIZE $5\frac{3}{8}$ in. DIAMETER.
4 in. HIGH.

SHOWING HOW PIECES 1 AND 2 ARE HALVED TOGETHER.

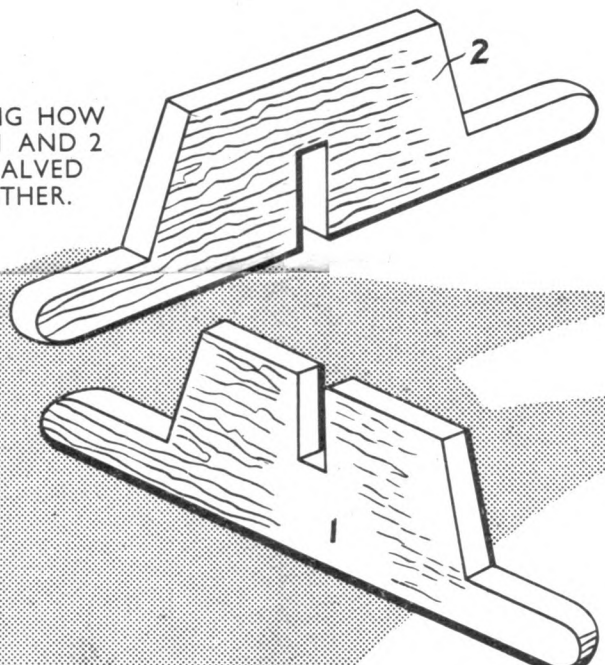

PANELS OF WOOD REQUIRED FOR MAKING THIS DESIGN

ONE Q4

A KIT OF MATERIALS FOR MAKING THIS DESIGN IS SUPPLIED BY HOBBIES LIMITED, DEREHAM, NORFOLK. PRICE ON APPLICATION.

A perfect finish every time

Humbrol Art Oil Enamel, the supreme model builder's finish. Available in tins from 1/2 oz. to 1/2 pint. A range of 34 colours available: glossy, matt and metallic. Humbrol Enamels dry in one hour.



FROM ALL BRANCHES OF HOBBIES LTD.

Don't spoil your model with an inferior paint... always use **HUMBROL**

NOTE. CUT TO THE OUTSIDE OF
THICK LINES.

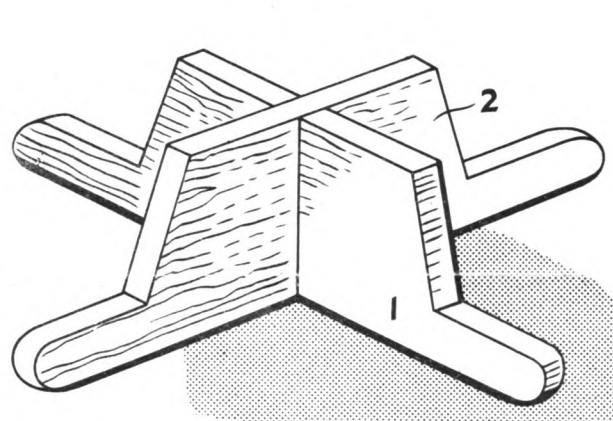

SHOWING HOW
PIECES 1 AND 2
ARE HALVED
TOGETHER.

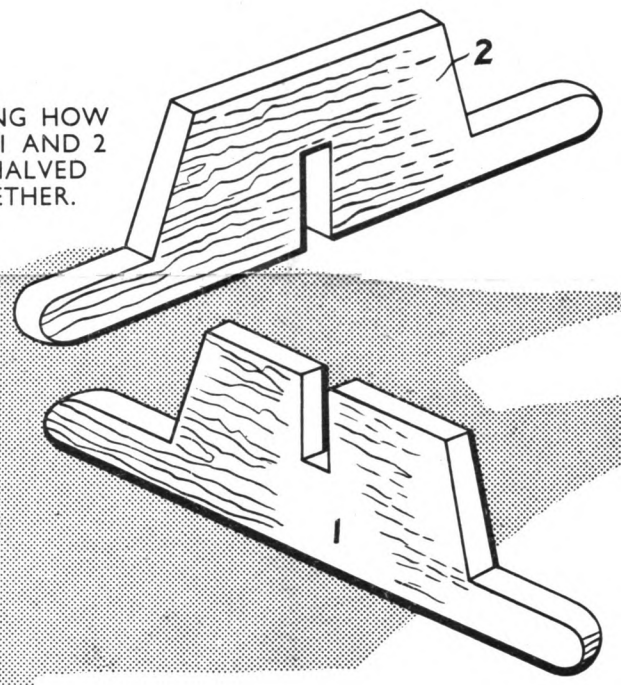

**USE A HOBBIES
FRETSAW
FOR
CUTTING OUT**

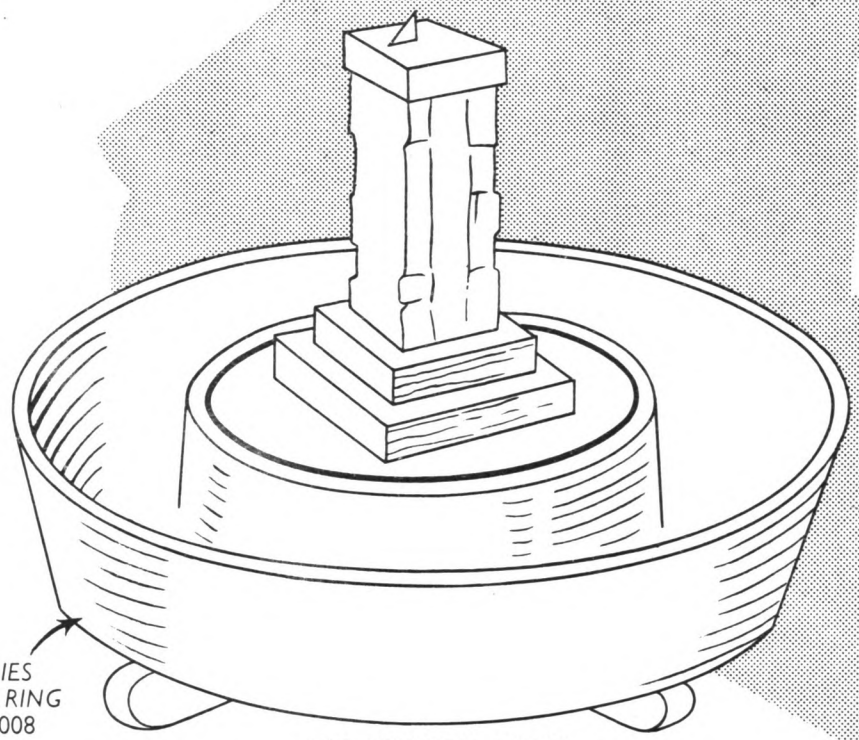

HOBBIES
POSY RING
No. 6008

THE SUNDIAL WITH
POSY RING IN POSITION.

1/4 in.
SIZE $5\frac{3}{8}$ in. DIAMETER.
4 in. HIGH.

SHOWING HOW
PIECES 1 AND 2
ARE HALVED
AND JOINED TOGETHER.

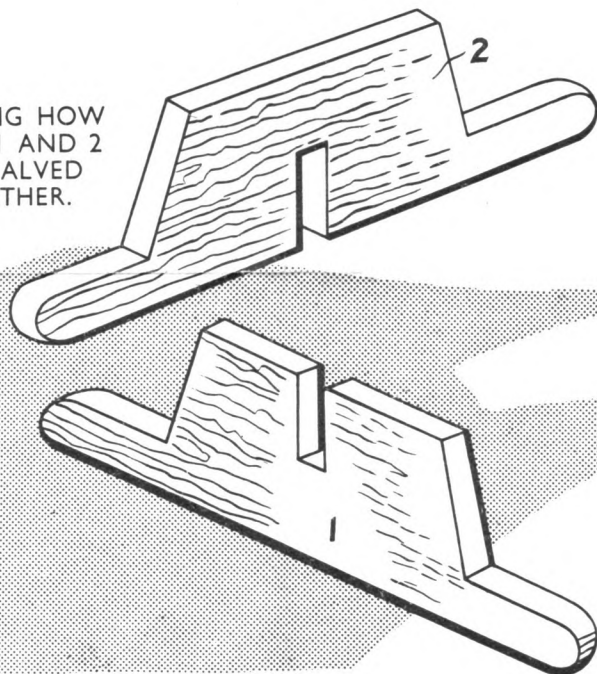

PANELS OF WOOD REQUIRED
FOR MAKING THIS DESIGN

ONE Q4

A KIT OF MATERIALS FOR MAKING THIS
DESIGN IS SUPPLIED BY
HOBBIES LIMITED, DEREHAM, NORFOLK.
PRICE ON APPLICATION.

A perfect finish every time

Humbrol Art Oil Enamel, the
supreme model builder's finish.
Available in tins from $\frac{1}{2}$ oz. to
 $\frac{1}{2}$ pint. A range of 34 colours
available: glossy, matt and
metallic. Humbrol Enamels dry
in one hour.



FROM ALL BRANCHES OF HOBBIES LTD.

Don't spoil your model with an inferior paint...
always use **HUMBROL**

USE A HOBBIES
FRETSAW
FOR
CUTTING OUT

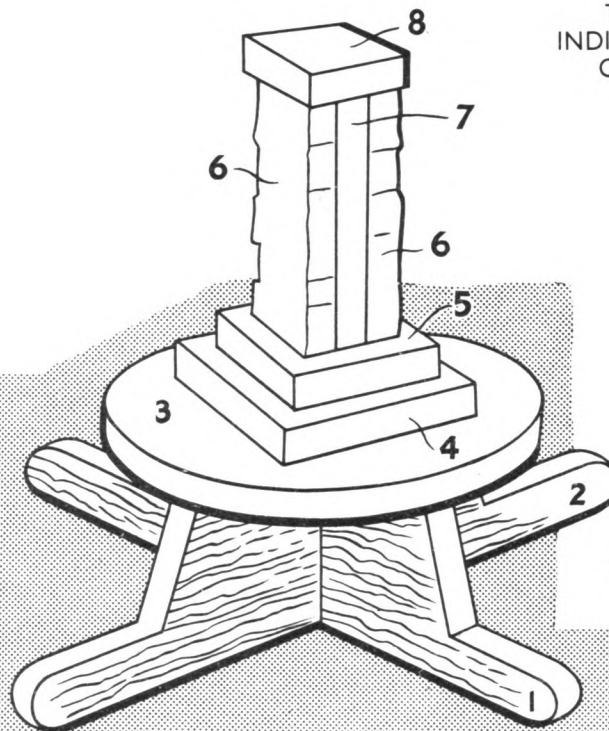

THE ARROWS
INDICATE DIRECTION
OF GRAIN OF
WOOD.

CONSTRUCTING
THE SUNDIAL.

25th MAY 1960

VOL. 130

NUMBER 3363

THE ORIGINAL
'DO-IT-YOURSELF'
MAGAZINE

HOBBIES *weekly*

FOR ALL
HOME CRAFTSMEN

Also in this issue:

MAKING INDOOR
RADIO AERIALS

COLLECTORS' CLUB

SET OF MODEL
MAKER'S DRAWERS

CHEMISTRY AND
NOVELTY ITEMS

PATTERNS FOR
FRETWORK PROJECTS

MASKING METHODS
IN PHOTOGRAPHY

ETC. ETC.

Instructions
for
making

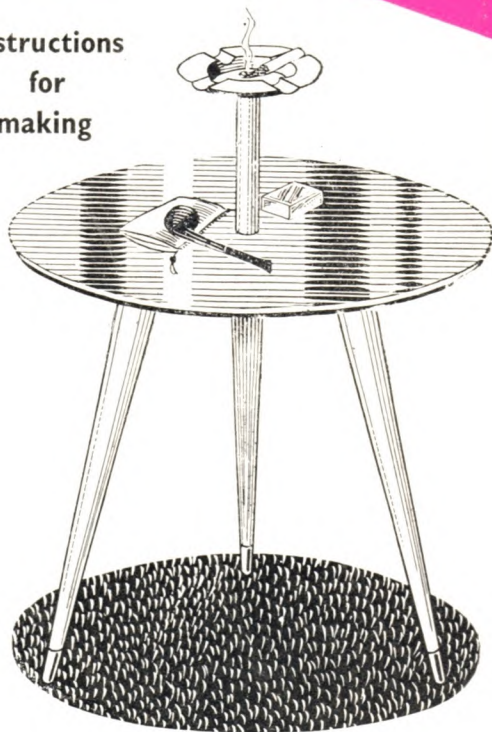

IN A NEAT
AND MODERN
STYLE

A SMOKER'S COMPANION



Up-to-the-minute ideas

Practical designs

Pleasing and profitable things to make

5^D



BEFORE discussing the 'Grammar of Heraldry', a few historical details explaining the *raison d'être* of this institution, and the rules whereby its distinctions are lawfully claimed, are due to those readers who may not be familiar with the subject.

Heraldry — 2

Under the old feudal system certain privileges were included with the granting of land to the 'gentry'. When a 'fief' (a parcel of land) was granted, say, for noble conduct, it carried with it the *status* of nobility, but not always an actual title. Thus, Wrotesley of Wrotesley, or Chisholm of Chisholm (chiefs for the last 700 years) were — and still are — equivalent to the 'Von' or 'Zu', and the 'leorde' of the German and French nobilities.

In feudal times all countries were divided into fiefs, and these again into arrière-fiefs. In Germany the holders of the first (fiefs) are styled Princes; in Spain, Grandees; in Hungary, Magnates. In England and France the grand vassals of the Crown corresponding to these were the Greater Barons (later called Peers).

Barons and Knights

The second order of nobles (recipients of arrière-fiefs) in Germany were styled Barons; in Spain, Hidalgos; in Hungary, Equites, and in France they were distinguished by the prefix 'de'. In England these gentry comprised Knights, Squires, and Gentleman, entitled to bear arms by right of their ancestral ownership of land (fiefs).

In all these countries the first and second orders are styled 'Noble'. Members of the first order are automatically members of the second, the difference being that to the latter special distinctions were awarded for noble actions in the service of King, country or the defence of the Christian Faith. Members of this group are popularly styled 'commoners'. This, however, is an illegal misnomer.

It is likewise illegal for a gentleman (in the heraldic sense) to be called 'spinster', for on the authority of Sir Edward Coke her correct designation is *Generosa*; the term 'generosity' being, in olden times, synonymous with 'nobility'.

The Hon. Sir Thomas Smith, Kt. (died 1577), and one of the principal secretaries to King Edward VI and Queen Elizabeth I, confirms the statements respecting the status of the gentlemen and women of England. 'The first part of gentlemen of England are called *Nobilitas Major*; the second sort of gentlemen be those which may be called *Nobilitas Minor*. Gentlemen be those whom their blood and race doth make noble, or known'.

Next in order came the yeomen tilling their own land (a rank equal in dignity to that of merchants and professional persons), and lastly the paid labourers, soldiers, sailors, and common people.

The designation 'yeoman' is derived from the Saxon *gemen*, and denotes one

that has some land of his own, a 'carn' of land or a 'plough land' (anciently of the yearly value of five nobles) to live upon. In law they were called *legales nomines*, or men fit to be called upon juries.

By a statute of 2nd Henry IV, cap.27, it is enacted that no yeoman should take, nor wear, any livery of any lord, upon pain of imprisonment, and to make fine at the king's will and pleasure.

With the enormous increase of the population many changes have taken place, and hereditary gentlemen and women are now engaged in trades and professions barred to them a century ago. Heraldry can with difficulty hold its own, and the title of 'esquire' or, in Germany, 'baron' does not necessarily describe the status of those who annex it. A *real* English Esquire holds the same rank as a genuine German Baron, and an English Baronet is equal in status to a genuine German Count.

Nobility and Peerage

Originally, the English nobles of the first (titled) class were all of the esquire or gentlemen class. But today this rule has been waived, and the conferring of a title does not make a man a 'gentleman' nor does it affect his hereditary descent.

Nobility (by rank, title or birth) should not be confused with peerage. A man who could not prove two descents would not be a 'gentleman' (*nobilitas*) in the true meaning of the term, even by the bestowal upon him of a dukedom, which in itself alone is only an honorary distinction.

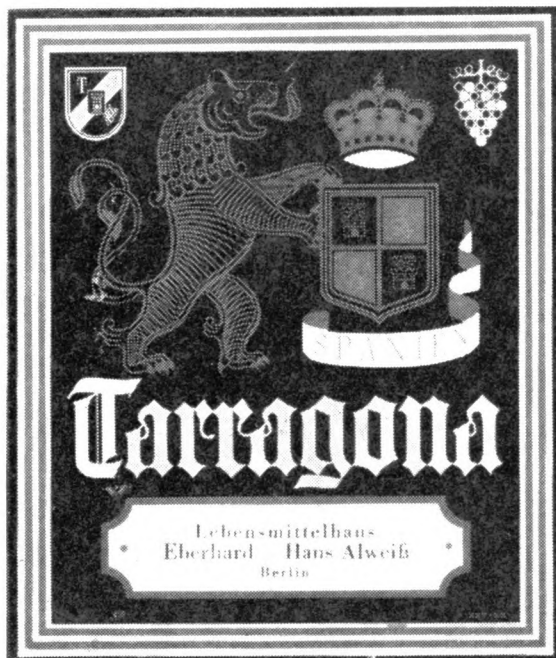

Heraldic wine label from Germany

Making the Smoker's Companion

THIS smoker's companion is an attractive piece of furniture and can be made in a few hours. It needs a minimum amount of work and there are no intricate joints to deter the less experienced worker.

The top should be a piece of faced plywood $\frac{1}{2}$ in. thick with the edges sanded to slope underneath as shown in Fig. 1. Make the top approximately 18 in. diameter. A 1 in. diameter hole is cut in the centre, using a fretsaw, and through this is pushed the column of 1 in. diameter round rod. The column should be about 6 in. to 9 in. long and should have a washer of $\frac{1}{2}$ in. wood glued and screwed to the end as seen in Fig. 1. Push the column through the centre hole from underneath, adding glue or screws as necessary.

The legs can be purchased ready-made from Hobbies Ltd, Dereham, Norfolk.

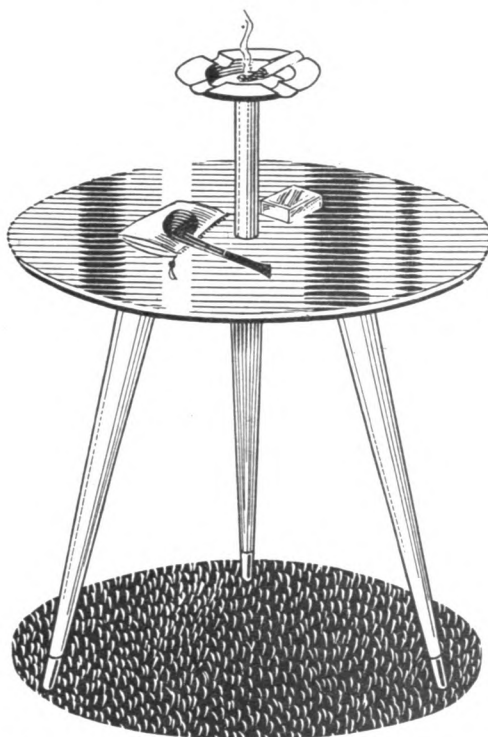
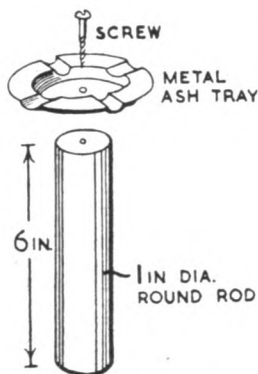
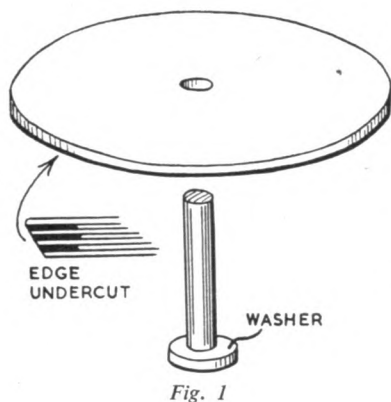

They should be 18 in. or 20 in. long, and are splayed as shown in Fig. 2. The blocks are screwed and glued underneath the top.

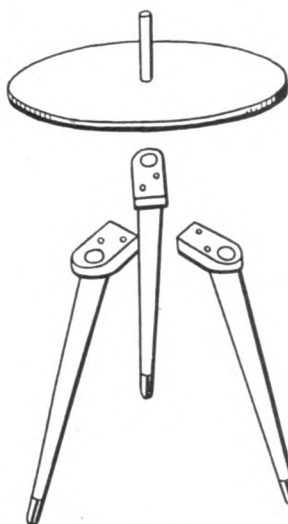

An ashtray is screwed to the top of the column as shown in Fig. 3. The ashtray may be purchased locally and it should be of metal.

The companion can be finished by staining and polishing or by staining and varnishing. Alternatively the whole thing may be painted and a plastic covering applied to the top.

The legs may be obtained in plain beech, ferruled beech, or ebonized ferruled beech as listed on page 141. (M.h.)

A new design for a Swiss Church Musical Box for cigarettes or trinkets, etc. will be given in next week's issue.

MAKE SURE OF YOUR COPY.

MAKING INDOOR AERIALS

IT is by no means always convenient to use a permanent outdoor aerial, and sometimes it is impossible to put up an aerial of this kind at all. Or a receiver may be wanted temporarily in another room, or is to be taken on holiday. In such cases some kind of indoor aerial will be needed, unless the receiver is a portable with its own internal aerial.

Indoor aerials of the type described here will give much more signal pick-up than the internal aerials in portables, and can thus be used with small valve or transistor sets. Quite often such indoor aerials can give enough volume with a crystal set.

It should be noted that indoor aerials are not satisfactory in a metal caravan, pre-fabricated house, or similar building.

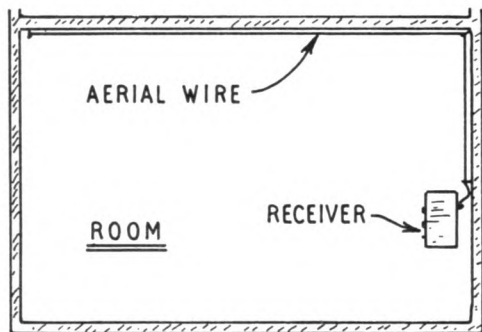

Fig. 1—A fixed indoor aerial

But they are often sufficient in any other type of building.

Fixed indoor aerial

When the set is kept in one position, an aerial of thin insulated wire can be taken along two walls of the room, as shown in Fig. 1. Single bell wire, either single strand or of the flexible type, will do well, and an inconspicuous colour can be chosen. The wire is one continuous piece right from the receiver.

A greater length of wire could be put up if it were taken along three walls, or even right round the room. But this is not recommended because for various reasons this may actually reduce volume.

The wire may be placed in the ledge of a picture rail. Or it can be stretched between small tacks or screws. Or adhesive tape can be used to hold it. No other insulation is needed, except that on the wire.

The aerial should be high near the ceiling, especially in downstairs rooms. Upstairs, it can give good signals, even if round the skirting board. In some cases mains wiring will be embedded in the

walls, or be near the aerial. If this may happen, it is often worth while trying a few alternative positions for the aerial, to find which gives the best results. This can be done by fixing it up temporarily with drawing pins. Having the aerial

By 'Radio Mech'

very near mains wiring may result in mains interference (crackling, clicks, etc) being heard in the receiver.

An extending aerial

When the receiver is not very powerful, so that a fairly long aerial is needed, and yet is often moved about, an aerial

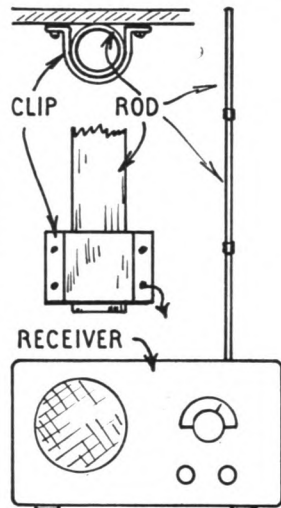

Fig. 3—A rod aerial

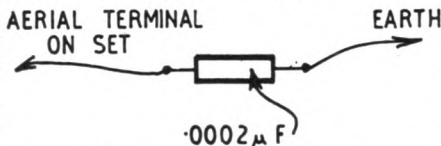

Fig. 4—Earthed aerial circuit

like that in Fig. 2 can be suitable. This consists of a spool carrying three or four yards of thin, insulated flex. The flex is unwound for use as an aerial. When the receiver is moved, the flex is wound back on to the spool, a small handle screwed or bolted on being provided for the purpose.

The spool is pivoted on a bolt, and a spring washer should be used to make firm contact between the metal spool and bolt. A lead from the strip or bracket

carrying the spool is then taken to the aerial terminal of the receiver.

This type of aerial can be extended as convenient. It may be looped up to a picture, hook, or other handy point. Or it may be laid along the floor, in upstairs rooms.

Rod aerial

With many small transistor and valve sets, a vertical aerial some 2 ft. to 4 ft. or so long will give good signals. Such an aerial is self-supporting, and can be made from surplus interlocking or extending aerial rods.

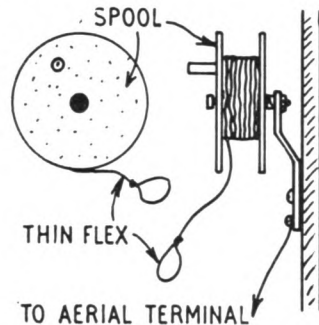

Fig. 2—Flex extending aerial

If rods are used, a clip can be made from metal and screwed or bolted to the receiver, as in Fig. 3. This clip should be a tight push fit for one aerial rod. Such rods are usually sold in 1 ft. sections, so three rods would make a 3 ft. aerial, and so on. The aerial can, of course, be taken apart in a few seconds, when not needed. It is thus useful for small receivers which are not sufficiently sensitive to work from an internal aerial, but which are used in various rooms.

Quite often the signal pick-up is good, because the rod aerial will be clear of walls, etc. The diameter of the rods or tubes, or the kind of metal used, is of no importance.

Earth as aerial

A fairly strong ground wave is often present, and this means that reasonably good signals will be received if an earth connection is used as an aerial. A condenser of about $0002\mu\text{F}$ (the exact value does not matter) should be included in the lead, as in Fig. 4. Some receivers will already have such a condenser inside, and an extra condenser is then not needed.

The earth used for this purpose can be almost any form which is available—connections to water pipes, an earth

● Continued on page 129

RENOVATING YOUR FENCES

EVEN the best quality wooden posts, though correctly treated, will rot in time, and it is usually an expensive job to replace them. The railings will have to be removed and are often damaged in the process. If the railings adjoin a public path they may be ready to collapse if anyone leans on them. It is possible that you may then

concrete.

If you examine the base of a weak post you will find it rotted away below ground level as shown in Fig. 1. You will usually find, too, that the post is quite sound above ground, sound enough in fact to take screws to hold iron strengthening stays similar to that shown in Fig. 2. The stays should be of 1½ in. by ¼ in.

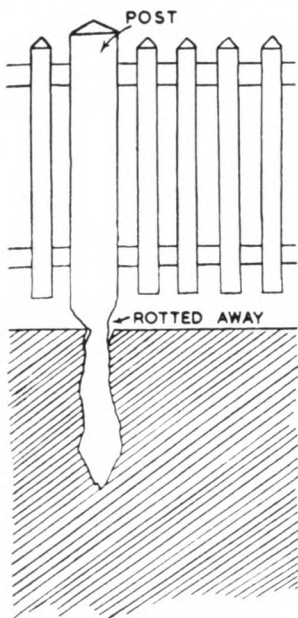

Fig. 1

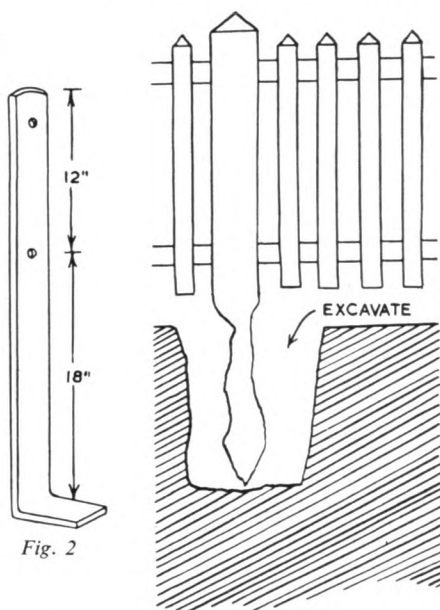

Fig. 2

Fig. 3

position all the time. Excavate round the post as shown in Fig. 3, throwing the soil well clear so that you have room to work comfortably. Next screw two stays in position, one on each side of the post.

A concrete filling is made up of a mixture of three parts sand and one of cement. Ram some rubble into the bottom of the hole and gradually fill with concrete, adding rubble as the hole is filled. Carry the concrete up 2 or 3 in. and smooth off nicely round the post as indicated in Fig. 4. Wet sacks should be

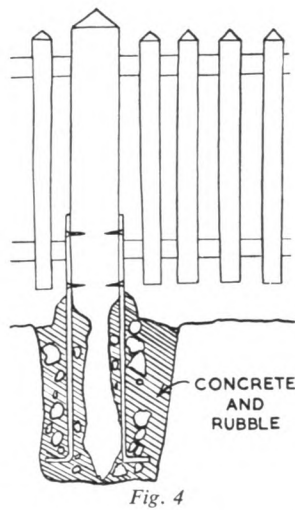

Fig. 4

be liable for damages if any injury is caused. Renovation, however, need not be an expensive job if the posts are left in position and strengthened with

mild steel, approximately 2 ft. 6 in. long. A local blacksmith or engineer will bend them, and they should be drilled to take 2 in. by 12 gauge screws. Paint them with black bituminous paint and allow to dry before using.

The posts should be treated alternately so that the fence may remain in

placed over the concrete for a few days until it is quite 'cured', then a little soil may be replaced. Keep the sacks moist if the weather is warm and dry.

In the case of corner posts the treatment should be similar, but the addition of one or two stays as shown in Fig. 5 will be an advantage. (M.h.)

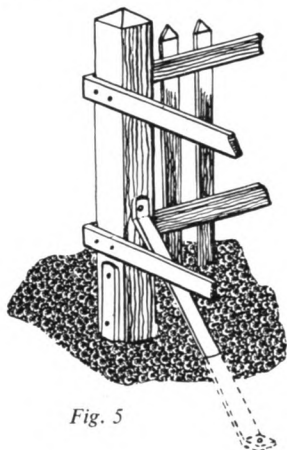

Fig. 5

● Continued from page 128

Making Indoor Aerials

spike, or other earthed metal objects. When using the earth in this way, no connection is made to the earth socket or terminal on the set.

The signal strength obtained with any particular aerial naturally depends on the type of receiver, and local conditions. Generally, any of the aerials mentioned will do for a valve or transistor receiver. With sensitive receivers, there may be little point in using an outdoor aerial, or longer wire, for ordinary listening.

With small, simple receivers, results will be better when the aerial gives reasonably good signals. This point is particularly important with crystal sets, which have no means of amplifying the signals. For a crystal set, the type of aerial shown in Fig. 1 is therefore recommended. An earth should be used as well, with a crystal set, but is very often unnecessary with a transistor or valve receiver.

A SET OF DRAWERS FOR MODEL MAKERS

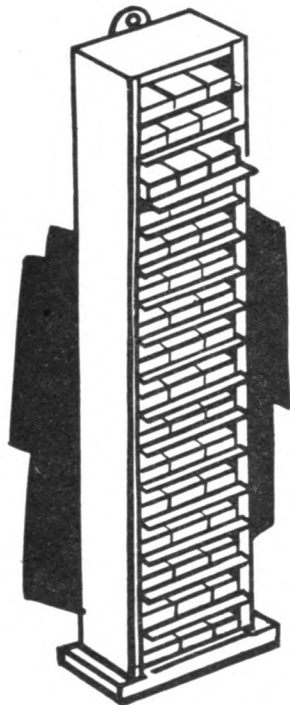

The frame can now be glued and screwed together, plain butt joints being quite satisfactory. A piece of hardboard $25\frac{1}{2}$ in. by $5\frac{1}{2}$ in. forms the back, and can next be tacked in place.

Hardboard shelves

The sixteen shelves are cut from $\frac{1}{8}$ in. hardboard; fifteen measure 3 in. by $4\frac{3}{8}$ in., and the bottom shelf is 3 in. by $4\frac{3}{8}$ in. The edges are lightly sanded to ensure that a nice sliding fit in the side grooves is obtained. The drawers from three matchboxes are glued centrally and to the back on each shelf. A $\frac{1}{2}$ in. of shelf will project from the front of the cabinet when they are pushed home. This provides a 'handle'. The gap between the top of the drawers and the next shelf enables the contents to be clearly seen, but labelling each drawer would also be advisable.

If desired, a small metal plate can be screwed to the back of the cabinet, as shown, to enable it to be hung on the wall.

It will be realized that the dimensions given can be altered to suit individual needs; for instance, the width could be doubled, enabling six-compartment drawers to be used.

As some matchboxes vary slightly in size it is advisable to check the ones used against the measurements given in case a slight adjustment is necessary. (C.A.G.)

DESIGNED to accommodate the various screws and small components collected by the modelmaker in the pursuance of his hobby, this set of matchbox drawers will prove a big asset, eliminating the need to rummage through the 'oddment box' every time a special type of screw is wanted. No less than forty-eight separate compartments are provided, yet only an area of some 7 in. by 3 in. of bench space is sacrificed for the fitment.

The sides and top are cut from $\frac{3}{16}$ in. plywood, $2\frac{1}{2}$ in. wide. The base is a 7 in. by 3 in. piece of heavier wood about $\frac{3}{4}$ in. thick.

Grooves or runners

Before assembling the frames, fifteen grooves are cut in the sides at $1\frac{1}{2}$ in. intervals for the sliding shelves of $\frac{1}{8}$ in. hardboard. If a small circular saw can be used for these it will be found that the width of cut is ideal without further trimming. An alternative method is to glue $\frac{1}{4}$ in. square strips of wood to the sides, forming runners for the shelves.

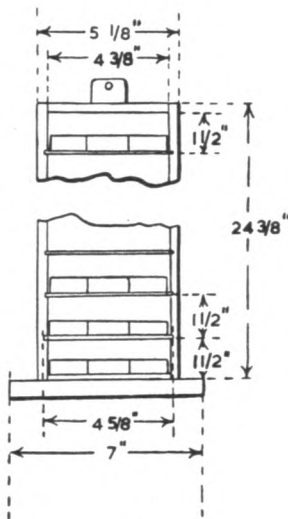

TWO MINUTE

QUIZ

by Ed Capper

ANSWERS ON PAGE 136

AN UNUSUAL
VIEW OF EVERYDAY
OCCURRENCE -



2. WHAT JOINT?

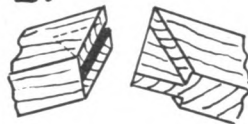

3. THIS
MORTAR TOOL
BEARS A
BOY'S
NAME -
WHAT IS IT?

4. NAME THE
PECULIAR NAIL



5. IF A BOUNDER IS
A CAD, WHAT
IS A BONDER?

New Croid Feature

A special plastic cap now fitted over the long nozzles of tubes of Croid Universal glue ensures that the glue does not 'cake' at the exit but is immediately available at a squeeze of the tube.

IDENTIFYING SEASIDE BIRDS

DURING the winter most of us are familiar with the flocks of gulls which descend on the countryside like snowflakes. These are the Black-headed Gulls, although actually when we see them inland the dark head is not noticeable. The dark brown feathers are shed after the breeding season. It may, however, be distinguished from the other gulls by its deep red legs and bill, which look so attractive against the white and grey plumage.

It may be difficult to realize that the dark-headed gull at the seaside, probably being bullied by its larger relatives, is the aggressive bullying bird with a *white* head that you saw on the local park pond in the winter! Actually a

England. The author once saw one on some mud flats near Hastings. These birds are very conspicuous with their black and white plumage, and red bills. Despite their name they are much more

white, and they are about the size of a pigeon. These small diving birds have large bills of an almost parrot-like appearance, and of a conspicuous red and blue colour.

The Guillemot is one of the most common of our diving sea birds. It has a dark back and head, and its underside is white. The beak is pointed, and the tail short; when upright the bird has almost the appearance of a penguin. It is widely distributed, particularly where there are high rocks for it to nest.

The Razorbill is somewhat similar to the Guillemot, but differs at its extremities, having a pointed tail and a thick bill. Although widely distributed it is less abundant than the Guillemot. It

By P. R. Chapman

likely to be seen eating small crustaceans on the shore than oysters.

The Puffins are regular summer visitors to our coasts, where they come to breed. Their plumage is black and

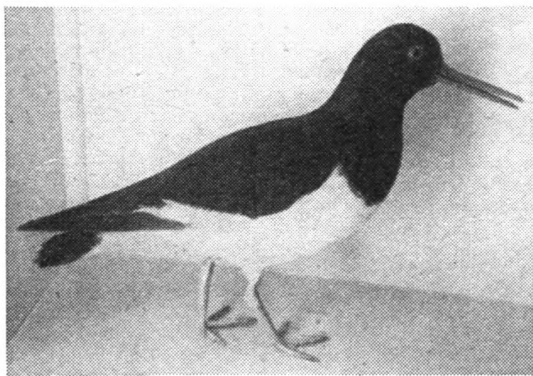

Oyster Catcher

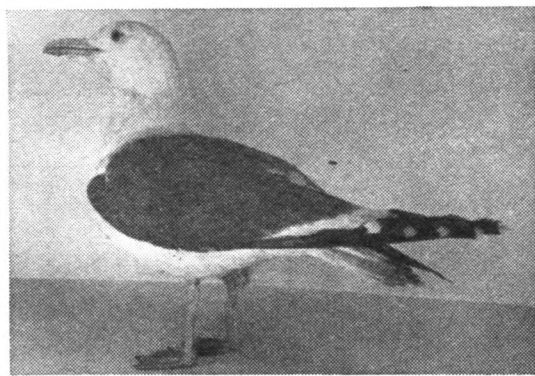

Lesser Black-backed Gull

number of Black-headed Gulls have taken up residence inland, owing to the easier life, and never see the sea.

The second most common gull in this country is the Herring Gull. This is the large voracious bird seen at our resorts. Although by no means the only gull to be seen at the coast, its pushing habits and general greediness tend to put all the other species in eclipse. It is a large bird, almost bigger than a duck when swimming. Recently it, too, has taken to wintering in the London parks, but may be distinguished from the Black-headed Gull by its large size and bill colour. This gull is grey and white in colouring, with light eyes, and a yellow bill.

The largest of all our gulls is the Great Black-backed Gull, but this is not so widespread as the others. However, it is a magnificent bird, although somewhat tyrannical in its behaviour. If you should see one you will probably recognize it by reason of its large size.

The Oyster Catcher is found chiefly in the North of Scotland and Ireland, but may be seen at times in the South of

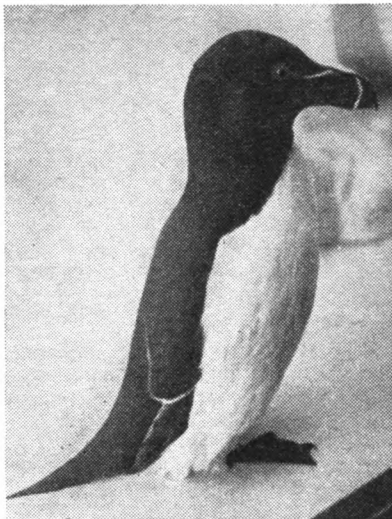

Razorbill. The Guillemot has a thinner beak

is the nearest relative to the famed extinct Great Auk.

If you are fortunate enough to be holidaymaking near one of the great bird colonies, such as the Farne Islands or Lundy Island, you will be able to see great numbers of these and other sea birds.

Summer holidays at the coast can be made much more enjoyable if the abundant bird life that surrounds our islands can be identified. These birds we have described will give a useful start; for the more ambitious there are many excellent books on the market.

AGENTS WANTED

Large private Christmas card Company has few vacancies for agents (spare time). Tremendous scope and excellent profits to be made by keen agents; wide range of best selling designs; reasonable prices. Write for further details without obligation to: GARRICK CARD CO. DEPT. 6, AVENHAM STREET, PRESTON, Lancs.

CHEMISTRY AT HOME

MANY important tests in chemical analysis depend on the formation of ferric compounds. A solution of a ferric salt, such as ferric chloride, added to the solution under test gives a characteristic colour or precipitate with many substances. With a salicylate or phenol a purple colour appears, with tannic acid a blue, with a thiocyanate an intense red, with a benzoate a buff precipitate and with formates and acetates a deepening of colour followed by coloured precipitates on boiling.

This is as far as the matter goes with most chemists — the carrying out of a small scale test in a test tube followed by rinsing the lot down the sink. These compounds have an interest beyond analysis and it is instructive to make isolation of some of them the basis of a series of experiments.

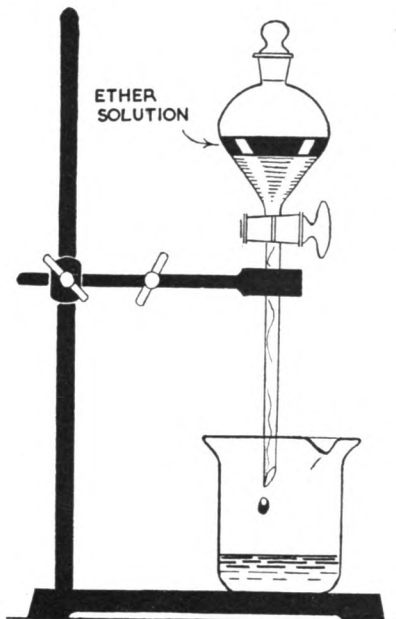

Fig. 1—Isolating ferric thiocyanate by extraction with ether

First try the reaction of ferric chloride and sodium benzoate. For this purpose dissolve (each in 100 c.c. of water) 4.5 grams of ferric chloride and 7.2 grams of sodium benzoate. Mix the two cold solutions, stirring well. A buff precipitate of basic ferric benzoate appears. Filter

this off and wash it well on the filter until one filtrate is free from the sodium chloride also formed in the reaction. This latter is ascertained by testing a few c.c. with a few drops of silver nitrate solution, when no curdy white precipitate should form.

Take a little of the sludge from the filter, put it on a watch glass and add a few drops of dilute hydrochloric acid. It whitens at once owing to the liberation of white benzoic acid. Dry the rest of the substance for your stock.

EXPERIMENTS WITH FERRIC COMPOUNDS

The formate and acetate detection tests are interesting. Try adding ferric chloride solution to sodium formate solution and sodium acetate solution in separate test tubes. The colour of the ferric chloride deepens to red. On boiling, an orange-brown precipitate is formed in the case of sodium formate and a red-brown with sodium acetate. Repeat the tests, progressively diluting the solutions before mixing. The test will be found to be very sensitive.

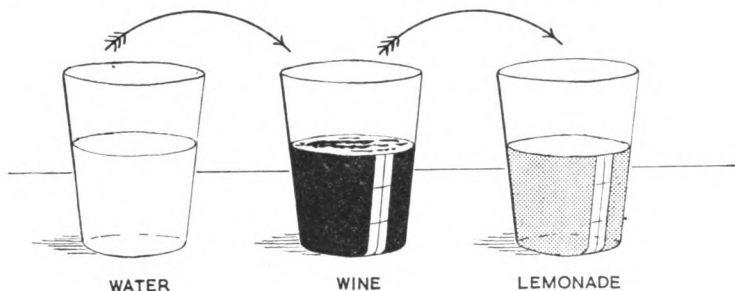

Fig. 2—Changing the beverage by pouring it into empty tumblers

To isolate the substances boiling solutions may be used. First, the formate. Dissolve 7 grams of sodium formate in 50 c.c. of boiling water and stir it into a boiling solution of 9 grams of ferric chloride in 50 c.c. of water. Continue boiling the mixture for a minute or two and then filter off the orange-brown precipitate. Wash well with water until silver nitrate solution shows one filtrate to be free of sodium chloride. Dry the precipi-

tate in a warm room. This is basic ferric formate.

Basic ferric acetate is formed similarly by mixing boiling solutions of 14 grams of sodium acetate in 50 c.c. of water and of 9 grams of ferric chloride in 50 c.c. of water. Filter and test the filtrates for freedom from sodium chloride as usual. The dried precipitate forms a rusty red-brown powder on grinding.

Tannic acid, or gallotannic acid as it is more precisely termed, forms an insoluble blue-black ferric gallotannate. It is the basis of common permanent blue-black writing ink. Its formation is interesting.

Dissolve 5 grams of tannic acid in 100 c.c. of warm water and let the solution cool. Add to it a solution of 2.2 grams of ferric chloride in 50 c.c. of water. A blue, then a black colouration appears, but if you draw up a little of the liquid into a pipette or into a short length of glass tubing you will observe hardly any insoluble ferric gallotannate suspended therein. One would expect a heavy precipitation. The reason for this curious phenomenon is that hydrochloric acid is liberated in the reaction and this partially dissolves the ferric gallotannate.

Now ferric gallotannate is not soluble in acetic acid, so if we add some sodium acetate, the hydrochloric acid will be removed as sodium chloride and acetic acid will take its place.

Dissolve 5.6 grams of sodium acetate in a small quantity of water and stir it into the first mixture. An immediate precipitate of ferric gallotannate now appears. Filter it off and wash it on the filter until one wash water is shown to be free of sodium chloride by the silver

nitrate test. Dry the ferric gallotannate in the oven. It forms an almost black mass.

This hydrochloric acid solubility of the compound is put to good use in modern inks. The old inks used to deposit the insoluble ferric gallotannate and clog inkwells and pens. Nowadays a controlled amount of hydrochloric acid is added to keep it in solution. The acid is removed by the dressing of the paper when one writes. The writing then darkens

and becomes insoluble, thus permanent. On mixing solutions of ordinary strength of ferric chloride and salicylic acid or a salicylate a purple colour appears, due to the formation of ferric salicylate. By using stronger solutions the salt will precipitate and this can be used as a means of preparing it. Dissolve (each in 20 c.c. of water) 2.7 grams of ferric chloride and 4.8 grams of sodium salicylate. Stir one solution into the other. The salt now appears as a purple-brown precipitate, which soon loses its brownish cast. As we have seen that it is somewhat soluble in water, ordinary filtration and washing will result in loss by its dissolving. Therefore filtration should be done under reduced pressure by means of a filter pump. When the mother liquor has run through, fill up the funnel with water and let it run through. Repeat this washing once more and then dry the substance on a porous tile. It forms a violet-black microcrystalline powder.

The preparation of ferric thiocyanate should not be neglected. Mix solutions of ferric chloride and ammonium thiocyanate. An intense red colour appears, due to the formation of soluble ferric thiocyanate. This may be separated from the ammonium chloride also formed by shaking with ether in a stoppered separating funnel, when the red colour of the lower aqueous layer is transferred to the upper ether layer (Fig. 1).

It is now a simple matter to separate the two by carefully opening the tap and letting the aqueous layer run out. The ether solution remaining in the funnel should now be poured out through the funnel neck into an evaporating basin.

Remember that ether is highly inflammable. No flames should be allowed in the vicinity and the operation should be conducted in the open air so as to allow the ether vapour to disperse harmlessly. As ether is very volatile it will evaporate fairly quickly. It may be speeded up if

desired by standing the basin on a water bath which has been filled with hot water. The ferric thiocyanate remains as a deep red solid in the basin.

The colour of this substance is removed by potassium sodium tartrate (Rochelle salt) and gives us the basis of a startling conjuring trick (Fig. 2).

Set out three tumblers. Dilute some ferric chloride solution until it is just colourless. Put this in tumbler number one. In the second put a few drops of ammonium thiocyanate solution and into the third a few drops of a strong solution of potassium sodium tartrate. These drops will be unnoticeable.

Tumbler number one contains what appears to be water, but on pouring it into tumbler number two 'wine' appears. Pour this into tumbler number three and it is changed to 'lemonade'! Though these chemicals are almost harmless, wash out the tumblers well with plain water before using them for drinking.

Interesting Locos — No. 23

London and North-Western Line

THIS Diamond Jubilee class 4-4-0 4-cylinder compound express locomotive was designed by Mr Webb for the London & North-Western Railway. In 1897, Mr Webb built two of these engines at Crewe, the first one being a 4-cylinder simple, with 15 in. diameter cylinders and 26 in. stroke, the second engine, 'Black Prince', being a 4-cylinder compound with all four cylinders in line under the smokebox.

These two engines were given a series of tests on the principal express duties on the main line, but after a while it was found that the boiler provided for the first engine was incapable of supplying sufficient steam for the four simple

cylinders, and the engine was subsequently altered to 4-cylinder compound to conform with the second engine.

The design apparently proved satisfactory and Mr Webb continued the construction of the class at Crewe. From 1897 to 1900, forty engines were built, being numbered in the L.N.W.R. list 1901 to 1940 inclusive. Number 1926, 'La France', built in 1900, was the 4,000th engine from Crewe, and was displayed at the Paris Exhibition in that year.

The subject of our drawing, No. 1914, 'Invincible', was built in June 1899, and was the 3,988th engine from Crewe. In 1920 it was renumbered 1257, when the number 1914 was given to the 4-6-0

Cloughton class engine 'Patriot', so named 'In Memory of the Fallen L. & N.W.R. Employees, 1914-1919.

The Jubilee compounds carried the following details: cylinders, 2 outside high pressure 15 in. by 24 in., 2 inside low pressure 19½ in. by 24 in., subsequently enlarged, however, to 20½ in. diameter; wheels, double radial truck, 3 ft. 9 in. diameter, driving, 7 ft. 1 in. diameter; boiler working pressure, 200 lb. per sq. in.; total weight of engine in working order 54 tons 8 cwt. Joy's valve gear was adopted and the total boiler heating surface was a nominal 1,401 sq. ft. (A.J.R.)

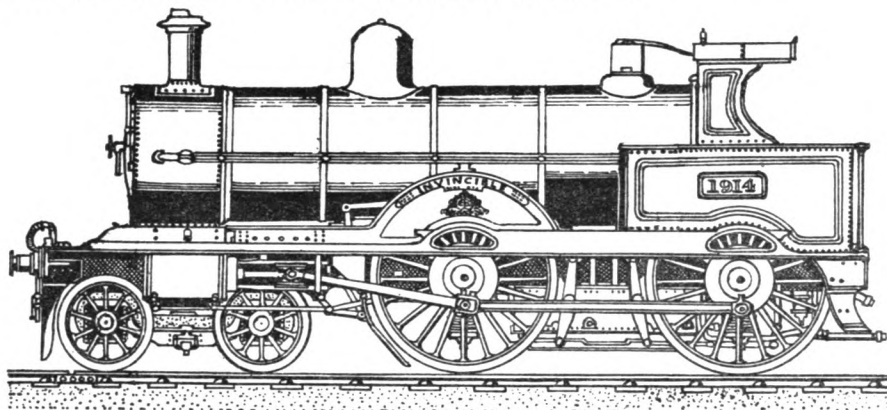

London and North-Western Railway 'Diamond Jubilee' Class 4-cylinder compound express locomotive No. 1914 'Invincible'. Built at Crewe—June 1899.

GENT'S TIE TIDY & STUD RACK

* WITH
COLOURFUL
TRANSFER

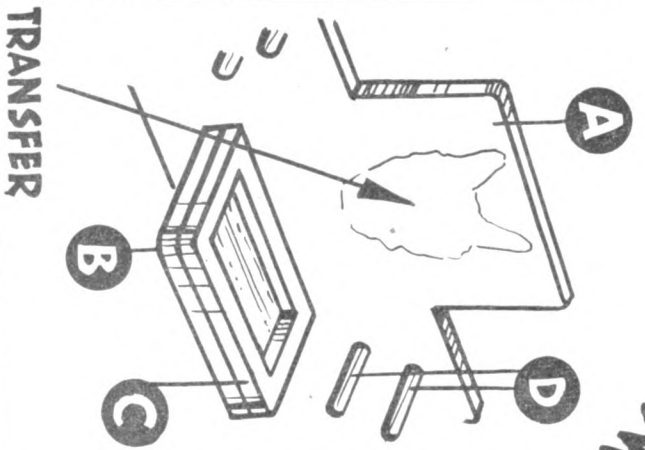
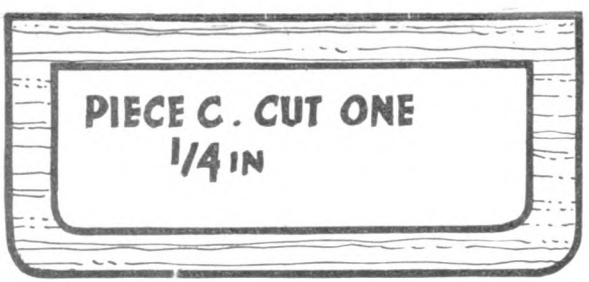
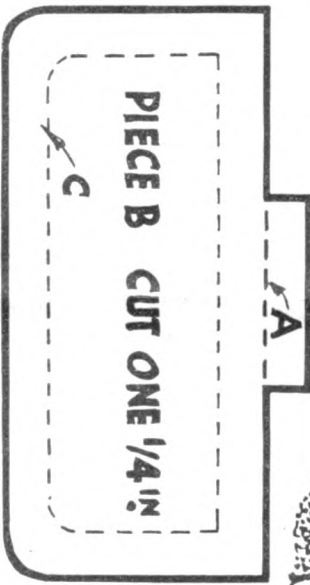
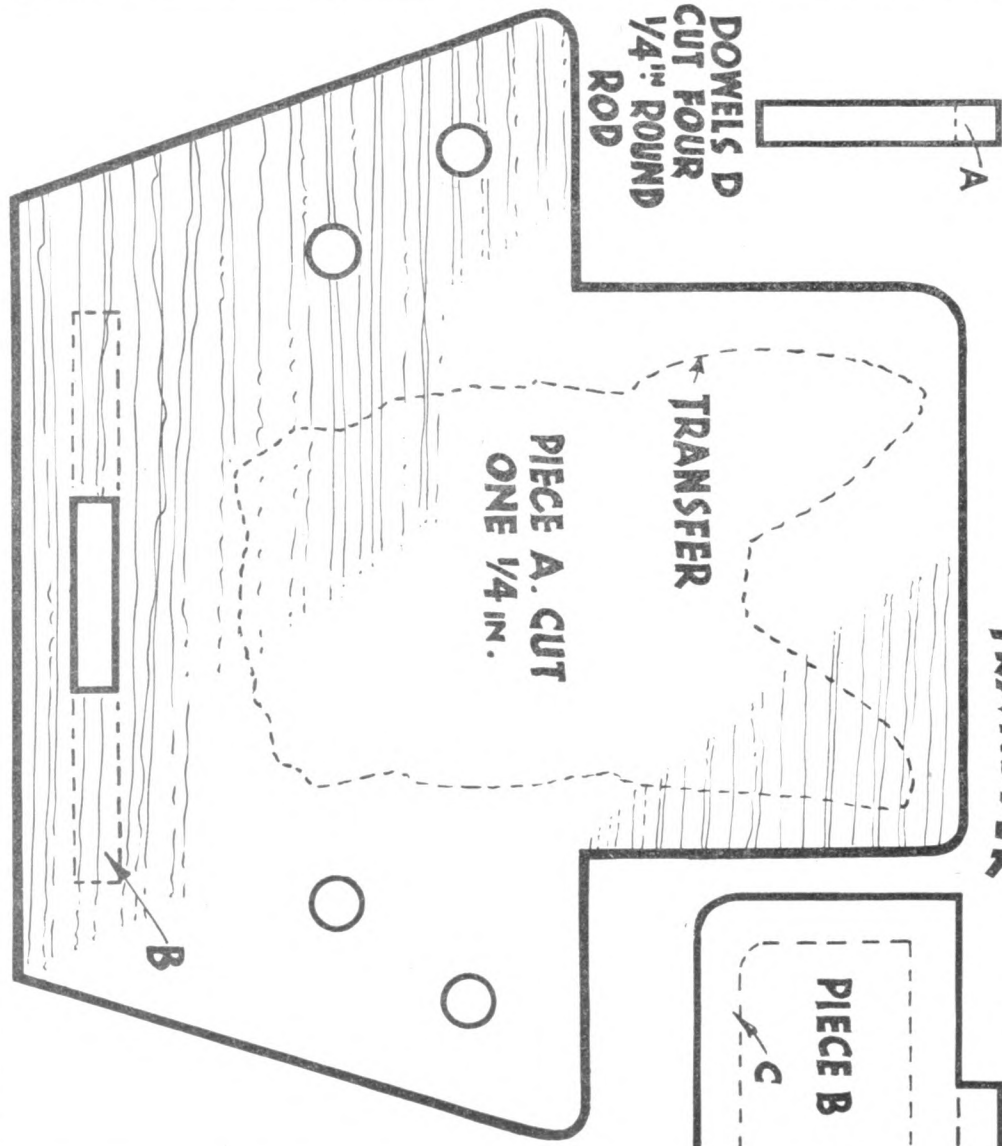

DECOR
DESIGN
FOUR
STUD
* ALSA
* POO
* COF
* LABR

ANOTI
EVEN
PROJ

WOMEN'S TIE TIDY

* WITH COLOURFUL TRANSFER

STUDY RACK

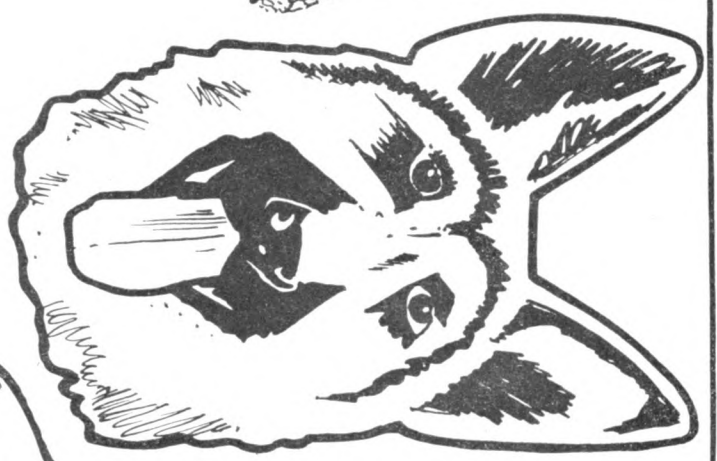
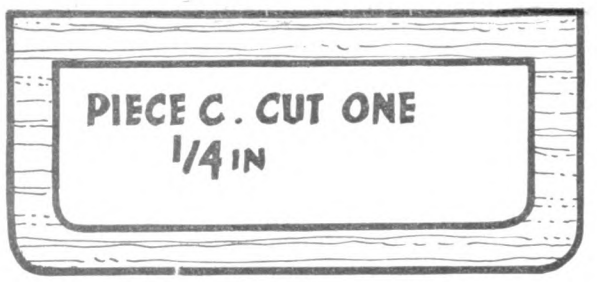
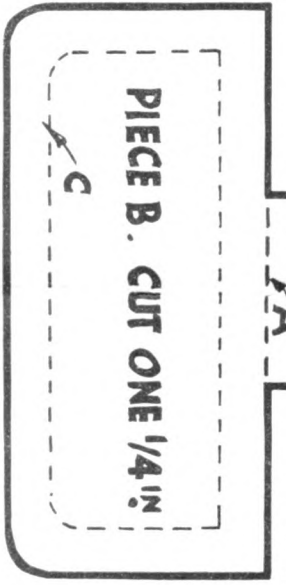
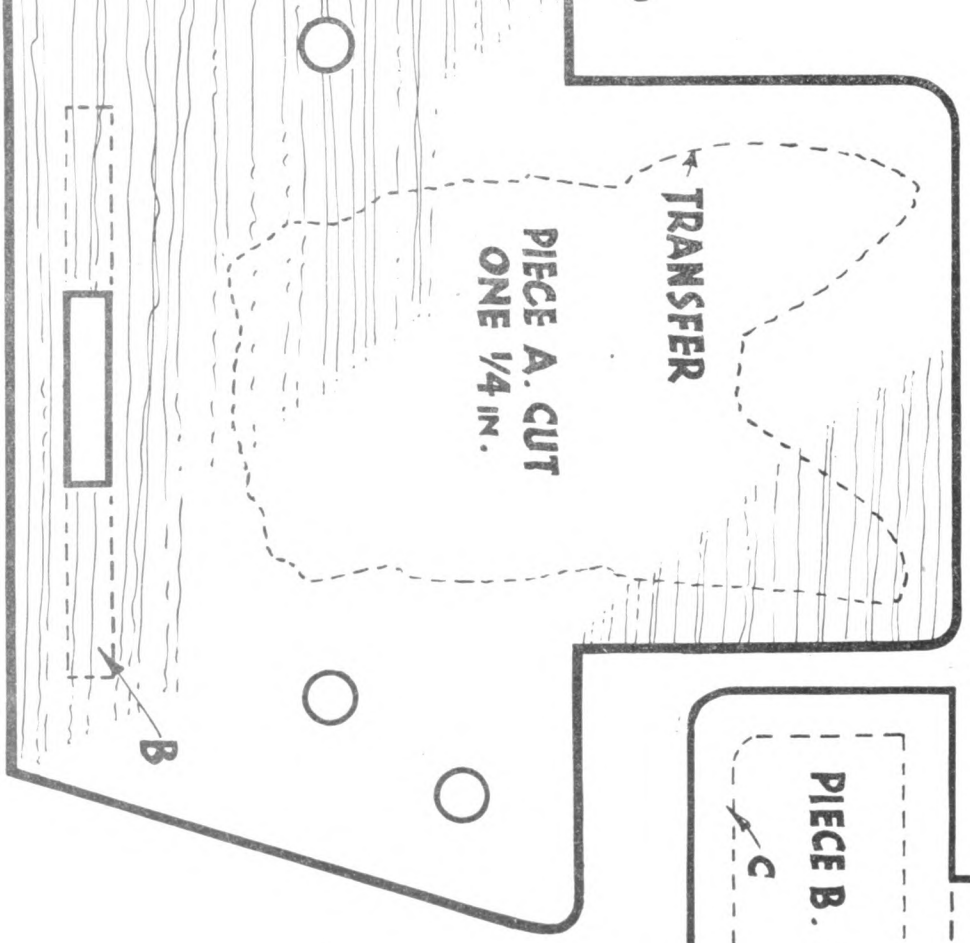

- DECORETTE
DESIGN No. 166.
- * FOUR DOG STUDIES
 - * ALSATIAN
 - * POODLE
 - * CORGI
 - * LABRADOR

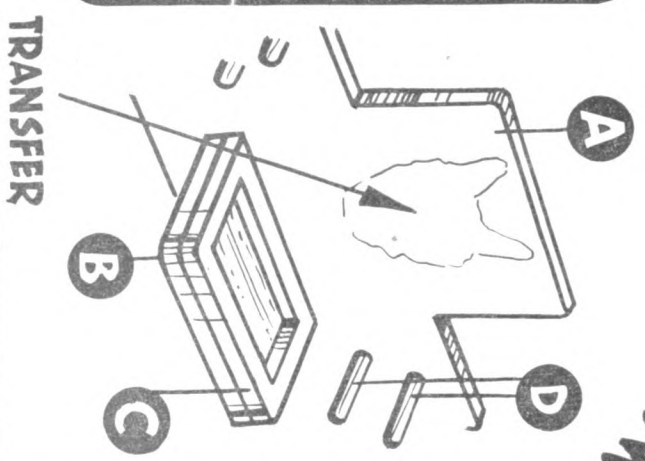

ANOTHER EVENING PROJECT

1

Making Fixtures in the Home

WHEN carrying out repairs and alterations about the house the home handyman is often required to make some kind of fixing to walls, ceilings and floors. If these fixings are to be made to wood then the procedure is quite simple with nails or screws. When, however, fixings have to be made to other materials which cannot be directly nailed or screwed, then some type of fixing device must be employed.

There are quite a lot of different fixing devices available and in order to achieve satisfactory results the home handyman should be familiar with the capabilities of each in order that they may be used to their best advantage.

For fixings to solid materials like brick, concrete and stone, the following methods are available.

Wood plugs

This is probably the oldest method of making fixings to a brick wall. The plugs consist of slips of dry, well-seasoned timber which are driven into holes made in the joints of the brickwork. To ensure a good fixing the plugs should have two opposite corners axed away in the manner shown in Fig. 1. By doing this the fibres of the timber will twist as the plug is driven into the wall and this will ensure a firmer grip for the fixing nail or screw. Don't use damp wood for making plugs because they will shrink as they dry out and become loose. To make the necessary holes in the brickwork joints to receive the plugs use a steel plugging chisel. Your local blacksmith will make you one for a shilling or two.

Rawlplugs

When a neat screw fixing is required to be made to a hard material the popular Rawlplug supersedes the wood plug. Where a wall is plastered, the use of wood plugs for a single fixing is not always suitable because they would be too large. Rawlplugs, on the other hand, require only a small neat hole. The material from which rawlplugs are made is jute. This is rot-proof and provides a fixing of remarkable strength. Rawlplug fixings should always be made right into the solid material. If a wall is plastered, the fixing screw should be long enough to penetrate a sufficient depth into the brickwork behind so that it does not rely on the plaster for any strength. When forming the holes use either a Rawlplug tool or a durium-tipped drill. The latter device is used when making fixings to a tiled wall. Rawlplugs are made in various sizes according to their diameter. It is essential when using a certain gauge of

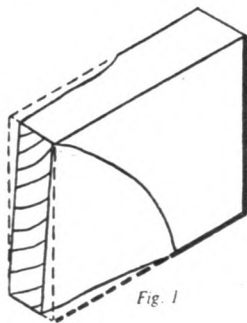

Fig. 1

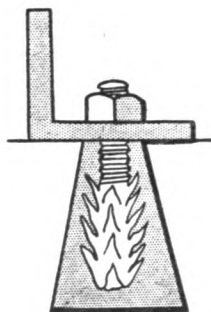

Fig. 2

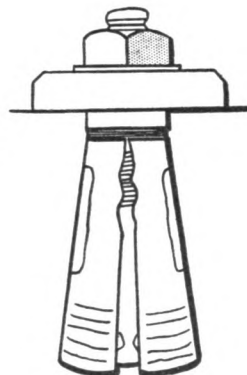

Fig. 3

screw to use the appropriate size of Rawlplug.

Rawlplastic

Another popular fixing device uses this asbestos fibre filling. This is in dry fibre form and is mixed with a little water until it becomes a plastic, pliable mass. Holes are bored in the wall as before and then a small portion of the mixed material is rolled in the palm of the hand to make a small plug. This is then pushed into the hole and rammed tightly 'home' with a special tool provided. Once the Rawlplastic fully occupies the hole in the wall a small hole is then made in the centre. To complete the fixing insert the screw into the filling and it will form its own threads in the material. This enables the screw to be removed and re-inserted any number of times without loosening its hold.

Ragbolts

Like the wood plug, the ragbolt is an 'old timer' and is used where it is necessary to make a strong fixing to, say, a concrete floor. The device consists of a strong bolt with a threaded portion at one end to receive a fixing nut and a barbed portion at the other end which is embedded into the concrete as illustrated in Fig. 2. When using ragbolts suitable holes must be made in the concrete and to ensure a strong fixture the holes should be slightly narrower at the top than at the bottom to form a dovetail. After this, the bolts are grouted into position with a fine concrete mix or with molten lead, which should afterwards be caulked with a blunt edged tool.

Rawlbolts

The use of Rawlbolts is far more efficient than ragbolts because they do not require large holes to be made, neither

do they require grouting up. The illustration at Fig. 3 shows a Rawlbolt which consists of a hollow steel casing. This expands as the central fixing nut is tightened. Only a small hole to allow the body of the Rawlbolt to enter into the concrete is required. Rawlbolts are capable of producing extremely strong fixings and are easy to remove when required.

(F.K.)

CONCRETE FOR THE HANDYMAN

EVERY home handyman has to do occasional work involving cement. But how many of us know what mixture to use for any particular job? Too coarse a mixture may be useless; too fine a mixture can be expensive.

A very handy booklet has been published by the Sand and Gravel Association of Great Britain which settles any such queries. It also carries some useful tips regarding the making of concrete slabs, pathways, concrete posts, etc.

This booklet is available from booksellers and bookstalls, and at the modest price of 9d. is well-worth seeking out.

ANSWERS TO QUIZ (see page 130)

1. Pincers removing a nail from a piece of wood; 2. Angle bridge joint with mitred shoulder; 3. A larry; 4. Wall plate nail. The curved lead portion is hammered down after nail is in place. Used for holding wire, etc. on wall; 5. A long stone running right through the thickness of a wall.

Masking methods for Photographs

As a change from the customary white-edged border of our prints we can make novel shapes of all kinds by using masks. These not only add an interesting touch to our albums, but also help to overcome 'difficult' negatives.

For example, the sky may be bald and devoid of interest; there may be some feature we would like to omit from the picture or there may be some defect in the negative itself, such as scratches. By cutting a suitable mask we can overcome all these difficulties, but we must not forget that there are times when an appropriate shape is most useful. At Christmas time we can cut out a mask in the shape of a holly leaf, enabling us to print novelty greetings cards.

In Fig. 1 we have used a simple leaf pattern, first cutting out an appropriate mask. The shape is drawn on thin opaque card, and neatly cut out with a sharp knife. When printing the picture, the leaf shaped mask is removed, leaving the counter-mask in close con-

Some interesting
and novel touches

described by

H. Mann

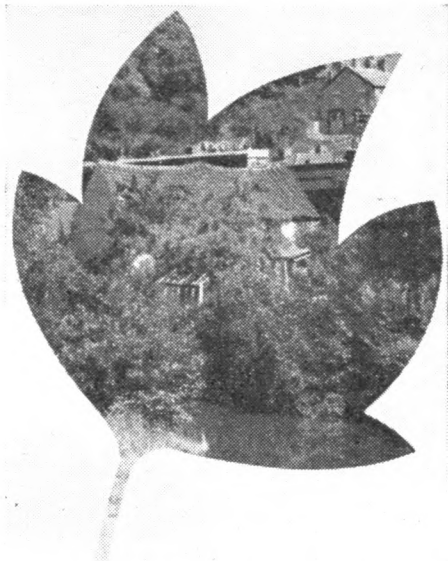

Fig. 1—The 'leaf' pattern

Fig. 2 is rather different in the treatment. We have made a window shape in exactly the same manner, but the procedure has to be modified. We first inspect the image with the counter-mask in position, shifting the paper about

on the exposed paper, the negative removed from the enlarger negative carrier, and an exposure made with white light for about two or three seconds. This has the ultimate effect of

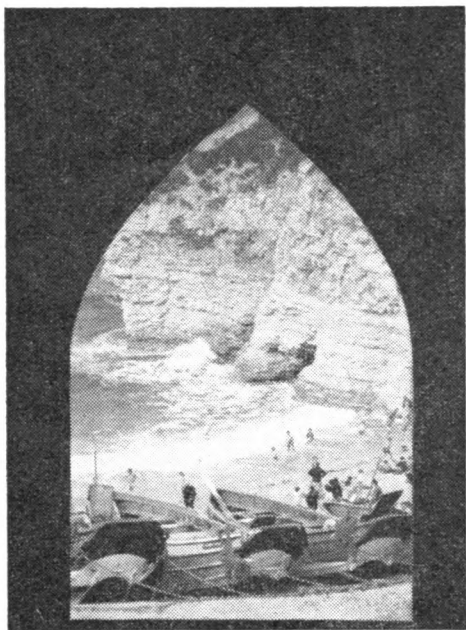

Fig. 2—A
'window'
shape

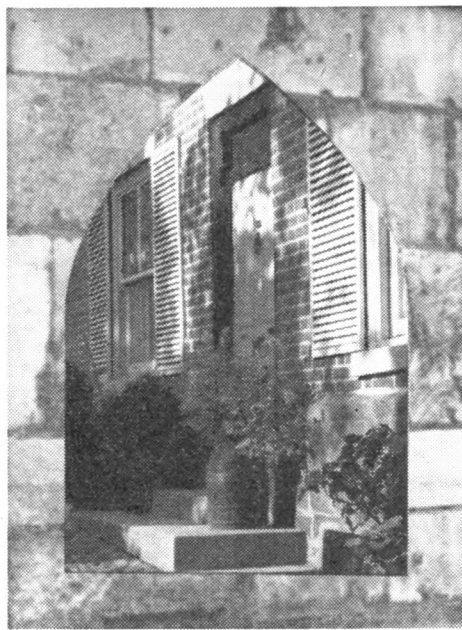

Fig. 3—
'Through
a window'
effect

tact with the sensitised paper, the exposure being made quite normally. The counter-mask protects the area surrounding the leaf pattern during the exposure, leaving a white background as shown.

until a suitable area for the 'window' picture is discovered. When this has been decided, the counter-mask is removed, and an exposure made on the whole piece of paper. The mask, that is the window shape, is now placed in position

making the area around the mask develop a full black as shown, giving the impression of a view seen through a window.

We can take this latter operation a stage further if we wish, and an example

★★★★★★★★★★★★★★
 ★
 ★ **IN QUIET WATERS** ★
 ★
 ★ **The popularity of canoeing** ★
 ★ **as a healthy and peaceful re-** ★
 ★ **creation is increasing tre-** ★
 ★ **mendously and thousands are** ★
 ★ **enjoying this inexpensive** ★
 ★ **pleasure. Why not join their** ★
 ★ **ranks by making your own** ★
 ★ **craft or purchase a super job** ★
 ★ **as shown on the back page** ★
 ★ **of this issue?** ★
 ★
 ★★★★★★★★★★★★★★

The foregoing gives a brief description of the use of masks for making novelty pictures, but it will be advisable to draw your attention to these further details.

It is best to use thin opaque card or strong black paper which is uncreased, and will lie quite flat on the sensitised paper. A sharp knife is essential for cutting the masks, and although it may be a little hard on the knife, a hard surface is best. You will find that a sheet of glass is an ideal surface for achieving a really clean cut. Moreover it is essential to see that the corners are sharp and free from any burr. A design can be sketched quite easily on a sheet of card equal in size to that of the paper you are to use for printing, and there will be no difficulty with curved lines if cups, saucers or plates are used in conjunction with a knife. Such domestic equipment was used for both the curved lines in the leaf pattern, and the arcs of the window shape.

Avoid 'fogging'

When the masks have been prepared, and are ready for the printing, note that it is essential that the two are in closest contact at the edges. If there is the slightest gap between the edge of the mask and the sensitised paper, the lines may be blurred, and there is a possibility of fogging. We cannot pin the masks down, unfortunately, for this would spoil the sensitised paper, but we can overcome this difficulty by placing small weights, such as pebbles, metal

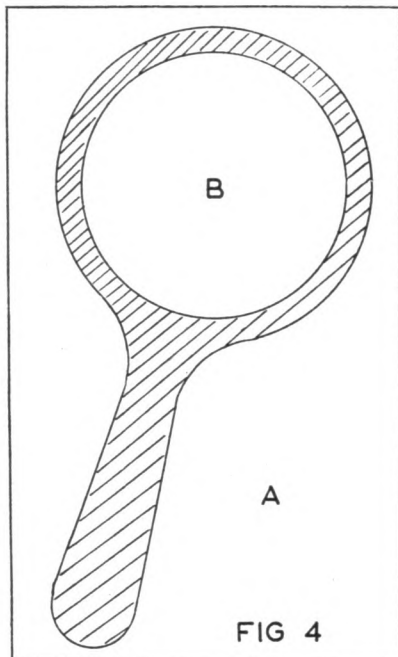

is shown in Fig. 3. The procedure is to select the area as before, but leaving the countermask in position while the first exposure is made. The window-shaped mask is now replaced in the aperture very carefully, so that the countermask is not disturbed, and will then cover the area already exposed. With the window mask in position, the surrounding countermask is carefully removed. We now exchange the original negative for another, making a second exposure. You will see that in Fig. 3 we have printed this outer area from an architectural negative, giving the impression of a view seen through a window.

nuts or washers, in suitable positions. This explains the necessity for using perfectly flat paper for the masks.

It goes without saying that test exposures are necessary in the first instance, but these become even more vital when two negatives, possibly of different densities, are to be used, as in Fig. 3. We might also mention that where two negatives are used in this fashion, the second should be quite simple, so that it does not compete in interest with the main subject.

Our illustrations only show two shapes but sufficient has been said to permit you to make all kinds of masks. Circles, oblongs, and odd shapes are quite simple to produce, but if you care to experiment a little further we suggest that the design of a hand mirror, as indicated in Fig. 4, would be suitable for a portrait. This mask actually consists of three parts, but the shaded portion is not used. Such a picture can be made by making an exposure with section A kept in position during the whole of the printing process. Section B is replaced after making an exposure of, say, a head and shoulders picture and secondly a further exposure made without the negative in the carrier to darken the remainder. This will have the effect of darkening the area lying between sections A and B, producing the shape of a mirror.

Triangles are important



To Youth Hostels Association (604HW), Trevelyan House, St Albans, Herts.

Please send me 'Going Places?' and details of membership

NAME

ADDRESS

Post this coupon today and get the right angle on holidays!

SPOT ON with the ILFORD Sporti 4

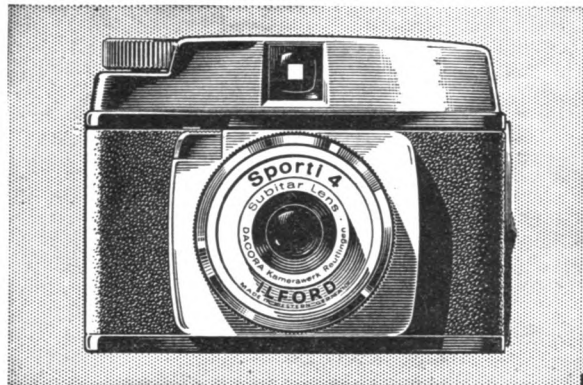

This new 'Sporti 4' is certainly some camera. A really smart job, strongly made, with a big eye-level viewfinder. Even if you've never had a camera before, you can't go wrong with the Ilford 'Sporti 4'. In daylight, set the aperture to SUNNY or CLOUDY and squeeze the button.

And you can easily take flash pictures, too, with the 'Sporti 4'. You get twelve pictures from every roll of 127 film. Spot-on—every time.

What a wonderful present the 'Sporti' would make! Or you could soon save your pocket money and buy it yourself—it'll give you a lifetime of fun, and it costs so little.

ILFORD SELOCHROME PAN

That's the film to ask for—whether you have a 'Sporti 4' or any other roll-film camera. Selochrome Pan is the all-purpose film made by Ilford, who also make the special films for nuclear research. So remember always to say "Ilford Selochrome Pan, please".

You'll get super pictures from this classy camera

ILFORD LIMITED · ILFORD · ESSEX

ONLY 49'8 EVER-READY CASE 17/5

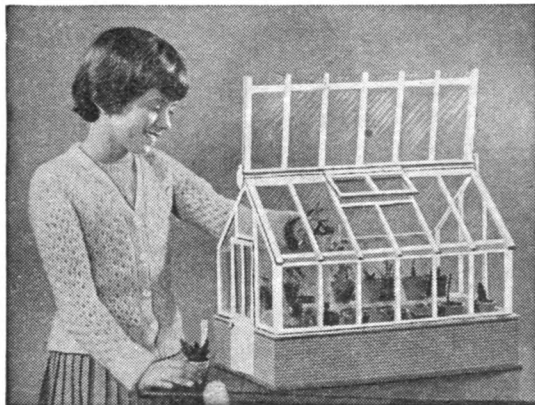

MINIATURE GREENHOUSE

A really practical model for the home

For growing cacti, succulents, miniature trees, seedlings, etc., and can be used as a propagating frame.

JUST LIKE DAD'S!

You can make this ideal showpiece from Hobbies Kit No. 3300, which contains all wood, materials, etc., and 12 sets of pots and saucers. Hinged roof, window, door. 18 in. x 12 in. x 13 in. high. Only a few simple tools needed in construction.

Kits from Hobbies branches, stockists or post free (see coupon).

39/6

ALL-THE-YEAR-ROUND INTEREST

To HOBBIES LTD., Dept. 99, Dereham, Norfolk

Please send Kit No. 3300 for making Miniature Greenhouse
I enclose P.O. for 39/6

Name

Address

.....
.....

HAVE FUN WITH STILTS

STILT walking can be a popular and healthy pastime. Here is how to make a pair which can be adjusted, and the height of the footrest altered, to suit your own progress.

When you start learning to walk on stilts the footrest will be at its lowest point, but as you progress it can gradually be raised until it is at its highest position.

The length of the uprights will vary according to your height. They are made from wood $1\frac{1}{2}$ in. square and between 4 ft. and 6 ft. in length. The top part must be rounded so as to form a comfortable grip handle, and a distance of 2 ft. will not be too much for this. When planed down or shaped by spokeshave, the wood should be well glass-papered to make the handles quite smooth and safe to use.

Illustrated are two methods of fixing the footrests on to the uprights. Both are

easy to make, equally secure, and are fixed to the uprights with bolts. That shown at A is a solid block of wood which rests in notches in the upright. The other footrest B has a strip of iron or similar metal screwed to the top of the wood block. The $\frac{1}{2}$ in. extension of the strip fits into slots in the upright and holds the footrest rigid, and on the other end the right-angled projection prevents the foot from falling off.

Both types of block are about the same size — 4 in. wide, 3 in. deep, and $1\frac{1}{2}$ in. thick. Allow an extra $\frac{1}{2}$ in. on the width of block A for shaping to fit the notches.

A $\frac{1}{4}$ in. bolt secures either type of footrest to the upright. Starting at about 6 in. from the bottom, the footrests can be raised by easy stages (4 in. to 6 in.).

If made of hardwood the stilts will not need any final finish, but a coat of paint will act as a preservative and also enhance the appearance. (A.F.T.)

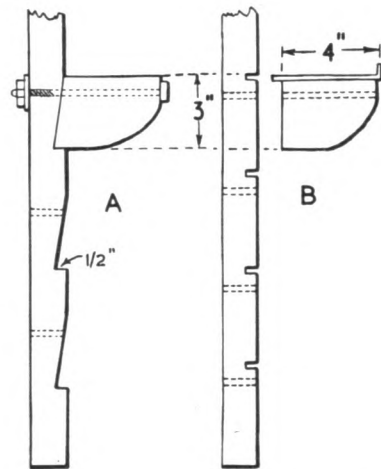

MODEL POWER STATION COVERS 200 SQUARE FEET

WHEN the President of Pakistan visited the vast new project of the Multan Power Station, he was shown an electrically operated model of the complete installation, which also included a district devoted to a housing colony.

This model was the work of M. Nawaz of Lahore, West Pakistan, and it took him eight months to complete. Covering an overall surface of approximately 200 sq. ft., the area devoted to the model Power Station measured 13 ft. by 9 ft., and the layout

detailed all the industrial buildings which went to the makeup of this great project, intended to supply electrical energy to the four corners of West Pakistan.

Mr Nawaz, who is an Exhibits Officer, obtained valuable assistance in his work from Hobbies Marvel fret-machine, which he says 'really worked wonders'. His Companion Lathe also came in quite useful, and he reports that Mighty Midget motors which were incorporated into the model were working very well. (Ed.)

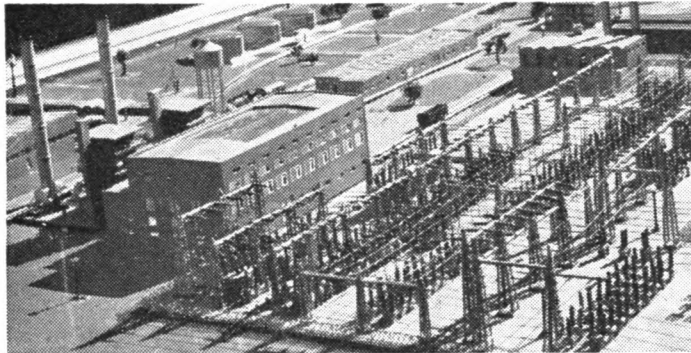

An idea of the intricate and detailed nature of the work can be gained from this section of the model showing the outdoor switchgear.

FLOWERS FROM COAL

A FEW of our readers have written to us about the article which appeared in our 2nd March issue under the above heading, and known under a variety of names such as 'coalflowers', 'heavenly flowers', and 'miners' trifles'. It would appear that the efforts of some of these readers have not been entirely successful.

Our contributor explains that results can be poor if a porous pot is used which has not had the 'fire' removed by being soaked in a bucket of water beforehand. Try a glass jar, such as a jam jar. The cloudy ammonia must not be of the synthetic type or have additives like detergents.

Here is another recipe for a chemical garden. Dissolve 1 dessert-spoonful of water-glass (as used for preserving eggs) in a pint of warm water, and pour into a jam jar. Then drop tiny crystals of some of the following chemicals, no bigger than a match-head, into the jar. These crystals will grow into fantastic coloured shapes: Epsom salts (white), manganese chloride (pink), cobalt nitrate (purple), copper chloride (green), iron chloride (brown), iron sulphate (grey).

Only a small quantity of the above should be bought, say $\frac{1}{2}$ oz. or 1 oz. at the most.

PHOTOGRAPHERS!

**DO YOUR OWN
DEVELOPING**



Here's a quick way to the mastery of developing photographic films. The Roto One tank is designed for easy loading. You have everything under control from the outset. Adjustable to take 120, 127 and 88 roll films or 20 exposure 35 mm. films. From Photographic Dealers, with full instructions, £1 10s. 0d.

IT'S EASY AND EXCITING WITH

JOHNSON Roto ONE

DEVELOPING TANK

JOHNSONS
OF HENDON LTD

★ LEARN ★ RADIO & T/V SERVICING for your OWN BUSINESS/HOBBY

● by a new exciting no-maths. system, using practical equipment, recently introduced to this country.

FREE Brochure from :—
RADIOSTRUCTOR
DEPT. G81, 46, MARKET PLACE,
READING, BERKS. 25/5

WORKERS with sewing machines required for making cushion covers. Regular work guaranteed. Apply enclosing s.a.c., Dept. 28, Arnold Trading, 10 Shelley Road, Worthing, Sussex.

ENJOY THE THRILL of Drawing or Painting. 'Make Art Pay' (free) explains remarkable, quick, easy method of improving mind, body, and income. — Clun Valley Features (H.W.), Clun Shropshire.

100 DIFFERENT stamps free! Request 3d. upwards discount approvals. — Bush, 53 Newlyn Way, Parkstone, Dorset.

Further reduced

Brand
New
Slip into
it—soft
and
comfy—
enjoy
restful

sleep throughout night. No blankets, no sheets, everything in one including special padding for a beautiful soft mattress effect. Light as a feather, it rolls up to a tiny lightweight size. 19/11, post 2/6. Even finished in heavy quality strong material. Really hardwearing. Not a blanket with outer but genuinely quilted. Refund guaranteed.

Sent for 10/-. bal. 18 fortnightly payments 7/1. Plus carr.

Waterproofed 1960 Tents of 8 oz. WHITE Duck. Galeproof. Brand new, surplus to export order. DON'T

CONFUSE with Tents made from drab material never meant for tentage. This is real thing, withstands anything even in our climate. Approx. 7ft. 6in. x 6ft. x 6ft., 3ft. walls. Cash £5/19/6, carr. 6/- complete ready to erect, incl. valise. 'Willesden' Green 42/- ex. Ridge pole if req. 7/6 Fly-sheet 39/6. Rubberised Groundsheet 19/6. These essentials sent on appro Refund guaranteed. LISTS, TENTS.

Headquarter & General Supply Ltd. (HOBW/6) 196-200 Coldharbour Lane Loughboro Junc., London, S.E.5. Open Sat.

LUXURIOUSLY QUILTED 'QUILTERFOAM'
SLEEPING BAGS
ONLY 19/11
POST ETC 2/6



1/2 PRICE OFFER!
The FLIGHT LIEUTENANT
Genuine NEW
Waterproofed
DUCK TENT
8 oz. WHITE
Duck. Galeproof. Brand new, surplus to export order. DON'T CONFUSE with Tents made from drab material never meant for tentage. This is real thing, withstands anything even in our climate. Approx. 7ft. 6in. x 6ft. x 6ft., 3ft. walls. Cash £5/19/6, carr. 6/- complete ready to erect, incl. valise. 'Willesden' Green 42/- ex. Ridge pole if req. 7/6 Fly-sheet 39/6. Rubberised Groundsheet 19/6. These essentials sent on appro Refund guaranteed. LISTS, TENTS.



TABLE TOPS

17/6 each

(post 2/-)

Two useful sizes:

20 x 20 in.
and
30 x 15 in.

Each size available in Oak, Sapele Mahogany or Walnut.

State which required

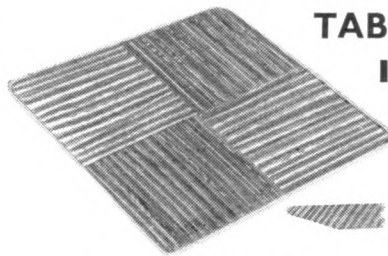

VENEERED BOTH SIDES

TABLE LEGS

PLAIN BEECH

No. 580 9 in. 2/- each
No. 581 15 in. 2/6 each
No. 582 18 in. 3/- each

FERRULED BEECH

No. 590 6 in. 2/9 each No. 593 15 in. 3/6
No. 591 9 in. 3/- each No. 594 18 in. 3/9
No. 592 12 in. 3/3 each No. 595 20 in. 4/-
Ferrules are of BRASS securely fitted

EBONISED FERRULED BEECH
No. 600

With metal block and brass ferrule.
One size only. 18 in. 5/3 each
(Postage: 3 or 4 Legs 1/6 extra)



From branches or by post

HOBBIES LTD DEREHAM NORFOLK

Completely new 54 page Edition
WHERE'S THAT CAR FROM?

Price 1/- (Postage 4d.)

Of all Booksellers

or

RALEIGH PRESS, Exmouth, Devon

CAMPING SITES in Britain — Full details of camping sites throughout the British Isles— 3/- from newsgents and camping equipment dealers.

PEN PROFIT. If you like writing send for 'Writers' Guide', (free). Thousands of words to interest beginner or experienced. Typewriter unnecessary under our system. — Writers' Ring (H.W.), 5 Edmund Street, Birmingham 3.

50 LARGE PICTORIALS 1/- catalogued over 10/-. Bargain offer as introduction to approvals. — P. E. Bentham, 40 Little Glen Road, Glen Parva, Leicester.

PICTORIALS **100** AIR MAILS
TRIANGULARS Different DIAMONDS

QUALITY • QUALITY • QUALITY
STAMPS FREE

Request attractive Approvals, Parent's permission
Send 2d. stamp only

CHILTON STAMP COMPANY (Dept. H)
41 ST CUTHBERTS ROAD · HOLY CROSS ·
WALLSEND · NORTHUMBERLAND

Inserting the Ship in a Bottle

IN last week's article we described the making and preparation of the model ship, and now comes the somewhat exciting task of inserting it in the bottle.

Obviously it will be impossible to clean thoroughly the inside of the bottle after the ship is in position, so make this the first job. It follows, therefore, that in inserting the putty 'sea' and the ship, extra care must be taken not to mark the inside of the bottle.

Approximately $\frac{1}{2}$ lb. of wood putty will be required for the sea. On to it pour dark blue paint and thoroughly knead together until the putty mass is completely coloured dark blue. Wait until the putty has lost its stickiness. This process can be hastened by laying it on some absorbent material, such as soft wood or cardboard.

Now roll the putty between the hands into long pencil-thick strands. Using a suitable metal tube, insert it into the neck of the bottle and slide the putty strands through the tube into the well of the bottle (see Fig. 1).

Take a steel meat skewer and insert the handle end into the bottle to reach the putty. Pound down the surface making it uneven to represent waves. Approximately a $\frac{1}{2}$ in. layer of 'sea' will be needed.

Using the metal tube again pour in two or three drops of green paint and knead it into the surface of the putty. Do the same with a few spots of white paint. If possible, manoeuvre the white to the crest of the waves. The finished result should really look like a stretch of sea.

In preparing the ship for entry into the bottle, swing the cross-spars around to a vertical central position on the masts; then lower the masts lengthways to deck

level and pointing towards the stern (Fig. 2).

Inserting ship

Pass a length of thread right round the centre of the ship and tie to the hook end of an ordinary meat skewer (see Fig. 3).

By E. Capper

Now insert the boat into the bottle, holding the pointed end of the skewer. Making sure the positioning of the ship is absolutely central, lower it on to the putty sea. Then with gentle pressure, push it into the putty so that only approximately $\frac{1}{2}$ in. of the deck-top of the hull is visible. The surplus lengths of rigging will trail back to the outside of the bottle as shown.

To release the skewer 'conveyor' first make up a cutter. Take a long thin stick, cut a slot one end, and insert a piece of broken razor blade into the slot so that only $\frac{1}{2}$ in. of the cutting edge is visible (Fig. 4). Bind around the slot with adhesive tape to keep the blade in place.

Now insert the cutter into the bottle alongside the skewer, and, using care, cut the thread holding the ship to the skewer as near as possible to the point where the thread disappears into the sea. Remove the skewer and the surplus thread will come away with it.

The ship must now be left for a day or

two until the putty sea is quite hard. Try it for hardness by occasionally prodding it with the skewer.

Having satisfied yourself that the putty is set hard, elevate the masts by pulling gently on the length of thread that travels from the bowsprit through the hook underneath in the hull (Fig. 5). Now bring the cross-spars to their correct horizontal position by gentle pulling on the other loose threads that control their movement.

When the masts and cross-spars are correctly aligned, hold all the loose thread ends in this position by wedging under some heavy weight, such as a flat-iron. Now carefully insert into the bottle a length of thin stick, on the end of which is a blob of glue. Place the glue on the point where the thread passes through the hook under the bowsprit and at the last points where the cross-spar rigging ends pass through the holes in the deck sides.

Leave in this position until the glue has set. If aero model cement is used this will only be a matter of ten minutes.

Now release the loose rigging ends from their wedge under the flat iron, and, taking the razor cutter, insert it into the bottle and cut off these surplus ends of thread as near as possible to their glued fixations.

Cut the cork to fit just below the rim of the bottle neck and fill in the shallow recess formed with sealing wax.

A simple wooden stand, comprised of two ends cut with a semi-circular seating for the bottle and held together by $\frac{1}{2}$ in. dowelling is shown at Fig. 6. A contemporary wire stand can be made from a single length of $\frac{3}{8}$ in. wire, formed as shown at Fig. 7. The free end is soldered to the left leg. A triangular bottle will, of course, require no stand.

If it is preferred to hang the bottle on the wall, suspend it with two loops of $\frac{1}{2}$ in. tarred rope.

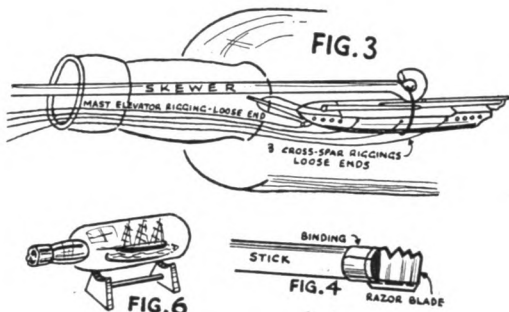
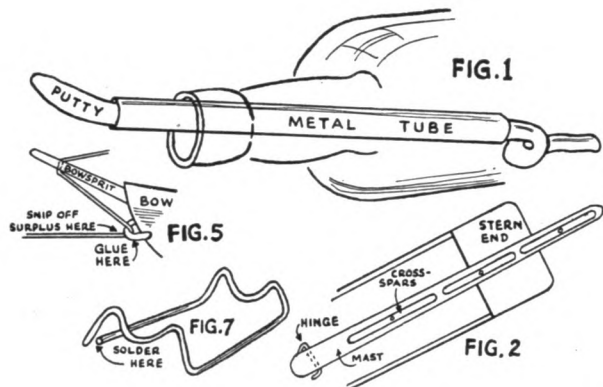

A DISTINCTIVE HALL SHADE

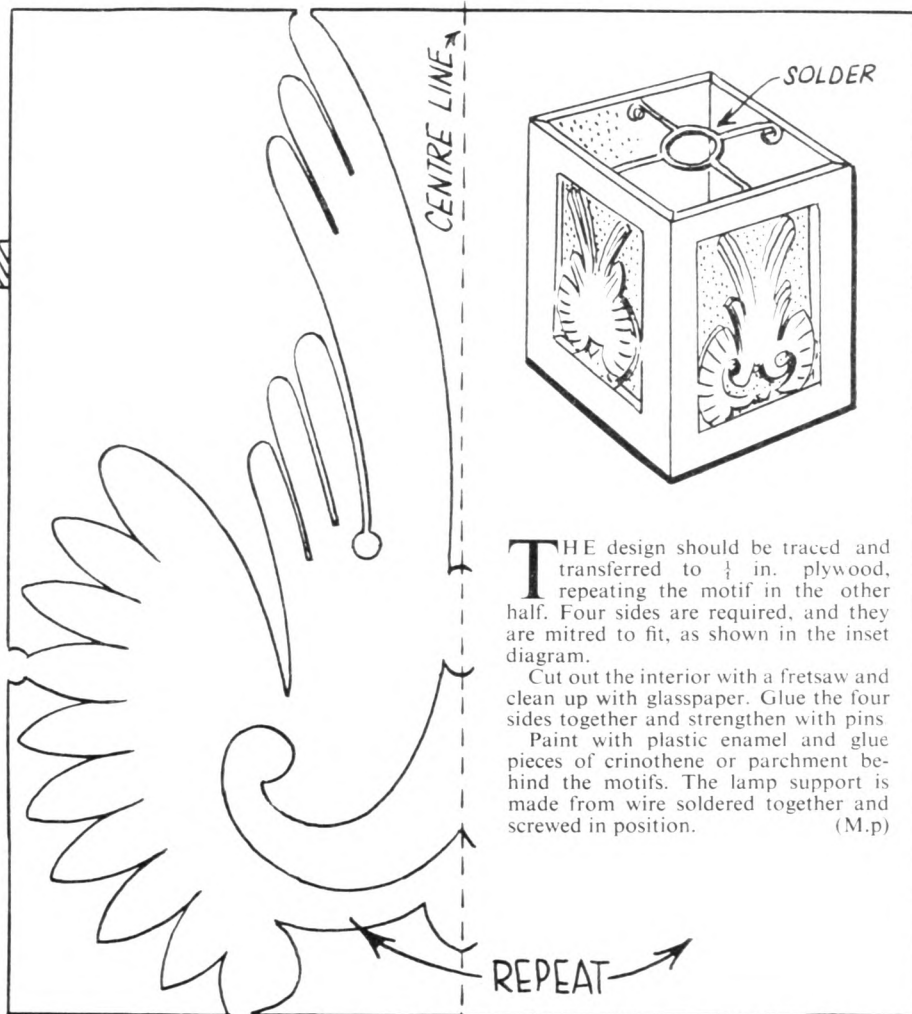

THE design should be traced and transferred to $\frac{1}{4}$ in. plywood, repeating the motif in the other half. Four sides are required, and they are mitred to fit, as shown in the inset diagram.

Cut out the interior with a fretsaw and clean up with glasspaper. Glue the four sides together and strengthen with pins.

Paint with plastic enamel and glue pieces of crinothene or parchment behind the motifs. The lamp support is made from wire soldered together and screwed in position. (M.p)

Single seat and two seat CANOES

COMPLETE AND READY
FOR THE WATER — OR
IN KIT FORM TO MAKE
YOURSELF

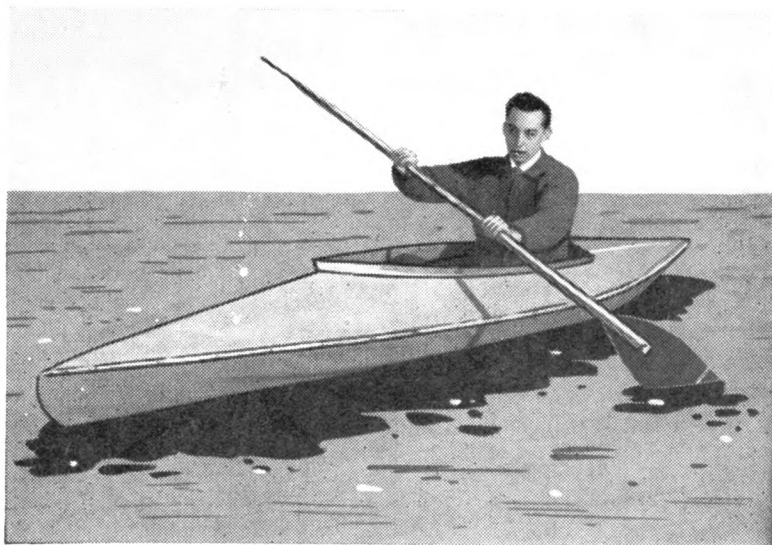

THE PBK 10 SINGLE SEATER

These popular craft are designed by that well-known authority, P. W. Blandford. With canvas skins, they are propelled by double-bladed paddles and are thoroughly at home on lake, river or canal—or even on the sea in experienced hands. They are offered as complete canoes, or as specially prepared kits, which include full building instructions.

PBK 10

Single seat—11ft. long
28in. beam—load 300lb.

COMPLETE CANOE **£24.5.0**
(without paddles) (Part p. & p. £2 extra)

COMPLETE KIT **£15.10.0**
(except paint and varnish
and without paddles) (Part p. & p. 15/- extra)

DOUBLE-BLADED PADDLES, 47/6 Complete (Part p. & p. 2/6 extra)

PBK 20

Two seater—15ft. long
32in. beam—load 700lb.

COMPLETE CANOE **£32.10.0**
(without paddles) (Part p. & p. £2.10.0 extra)

COMPLETE KIT **£22.5.0**
(except paint and varnish
and without paddles) (Part p. & p. 20/- extra)

DEREHAM



NORFOLK