

30th DECEMBER 1959

VOL. 129

NUMBER 3342

THE ORIGINAL
'DO-IT-YOURSELF'
MAGAZINE

HOBBIES *weekly*

FOR ALL
HOME CRAFTSMEN

★ FREE Design Supplement

Also in this Issue:

GARDENING HINTS
FOR JANUARY

PROJECTS FOR
THE LATHE

BOUNDARY SIGNS
ON FILM

MAKE YOUR OWN
TRANSPARENCIES

PATTERNS FOR A
'TUMBLING CLOWN'

PROJECTS FOR
THE HOME

ETC. ETC.

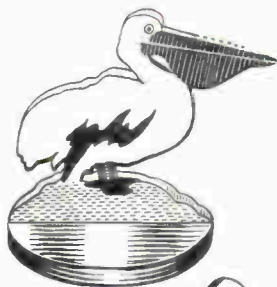
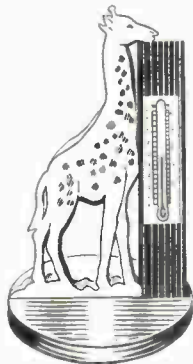

**MAKE THESE
INTERESTING
PROJECTS FOR
THE HOME**



THE TREBLE CHANCE



Up-to-the-minute ideas

Practical designs

Pleasing and profitable things to make

World Radio History

5^D



ON New Year's Eve it comes natural to think about years past, present and future.

It's a good idea to think of the year as a crown. The crown on New Year's Day is but a skeleton frame. On New Year's Eve it should be studded with gems, 365 bright, sparkling stones.

Just think of the many beautiful themes depictable in stamps and labels from this idea. The crown is an ever-popular design, being found in all forms on stamp and label issues.

NEW YEAR THEMES

Your notes could continue thus: each day is a rough, uncut stone. As each day passes it should be left behind bright and smooth, ready to be set. So every day has to be lived perfectly and completely, its duties worked out, no opportunities lost, no time wasted. Above all, the work on the stone should be begun and ended with prayer. Then week by week, month by month, the stones are set. On New Year's Eve the last one of all is put in its place.

What a beautiful crown if all the stones were worked and polished to perfection — what a beautiful 'New Year Album' yours would be!

New Year festivities must be given



their place. The illustrations show a few appropriate covers. These include India 1956 — Bell — 2d. mint. China 1957 — Pals — 2d. mint. Belgium 1957 — Lucky Four — 2d. mint. Meux's Brewery Co. Ltd — Horse-shoe.

Some interesting facts for your album.

Gloves were formerly customary New Year gifts. They were a more expensive article than they are today and occasionally a sum of money was given instead, which was called glove-money.

Presents were made to persons in authority to secure favour. Sir Thomas More, having, as Lord Chancellor, decided a cause in favour of a lady, on the following New Year's Day she sent him a pair of gloves with forty gold coins in them. Sir Thomas returned the gold with the following note:

'Mistress, since it were against good manners to refuse your New Year gift, I am content to take your gloves, but as for the "lining" I utterly refuse it.'

According to an old Scottish law, any Scotsman refusing an offer of marriage from a girl during Leap Year was liable to a fine.

Match labels: India 1956 — gold coins — 3d. mint. 1957 — ring — 2d. mint.

Some Friends 'Round the Globe'

PEN friend clubs originated in America, and it gives us great pleasure to introduce Virginia May Potter, secretary of 'Round the Globe' Club.

Virginia, who is well-known in hobby circles throughout the world, has thousands of friends. 'The club is one of the oldest and best in U.S.A.' she writes. 'I'm always anxious to exchange many things with anyone anywhere for new and old, used and mint stamps and first day covers, so write me, anyone who reads this, and let's get together.'

Let's meet some of Virginia's hobby friends, all of whom will be delighted to hear from regular readers of *Hobbies Weekly*.

Lester Richardson of New Hampshire, U.S.A., collects post cards. He has been interested in this hobby since he was a small boy, roughly 35 years. In those days he strung them together all over his room, cards from where he had

never been, and he always said when he grew up he was going to a lot of those places. Since those times, he has visited every State in the Union, and Canada, where he lived for some time.

Lester has been to Cuba. Friends found out he was collecting cards, so a great many were given to him. He is

now interested mostly in Indians, art, or covered bridges. He once had over five million cards, both new and used. He started a collection of Hugh Leighton cards but gave them up when he had 10,000 different. They went to a museum last year.

He spends an average of six hours a day on cards. He has nearly a million cards at present, and some 200 pen pals throughout the world.

Mr W. P. Ironmonger (25), 824 Hillworth Street, Lomita, California, U.S.A., collects stamps, coins, Christmas seals and cards. He has one complete set of Christmas seals from Denmark, 1904 to 1956.

The Duchess of Almazan from Madrid, Spain, collects hotel labels. She has over 14,000 in her collection.

Mr J. H. Herder, of Breda, Holland, (age 45), has 3,200 hotel labels. He is a teacher of dancing. His 9-year-old daughter also collects labels and stamps,



Virginia May Potter

Make these three novelties

THE TREBLE CHANCE

THE three projects to be made from our design sheet should prove most attractive to the fret-worker. They have been designed with a view to novelty and usefulness and are excellent examples of the kind of work that can be done with a fretsaw.

They should prove of particular attraction to youngsters who are now starting in this absorbing hobby, and will be found quite easy to cut. On the other hand, more experienced workers will find these novelties particularly suitable for making up as repetition subjects for use as gifts, or for sale in shops, and at bazaars, etc.

The LETTER RACK has as its motif an amusing penguin and consists of the back (piece 1), the base (piece 2), and the figure (piece 3), which is jointed with glue into the slot provided in the base. This is a most attractive novelty for placing on a hall table, sideboard, or mantelpiece.

For the PENCIL SHARPENER we have chosen the quaint bird, the pelican.



PENCIL SHARPENER



LETTER RACK

Here again the bird (piece 4), is jointed into the round base (piece 5). The fixing of the sharpener behind piece 4 is shown in detail on the design sheet, and will be sufficient to hold it securely in place. Here again this makes an attractive 'standing' novelty for child or grown-up.

The THERMOMETER STAND is designed in the shape of an elegant giraffe,

Hobbies Kit No. 3342 for making all three projects contains all wood and materials, including thermometer and pencil sharpener. Kits from branches, etc., price 5/11 or from Hobbies Ltd, Dereham, Norfolk (post 1/- extra).



THERMOMETER

piece 9 again being jointed into the base, piece 10. The thermometer is fixed in place by gluing, or by inserting screws, or small nails.

All parts for the three different projects are shown full size on the design sheet. They should be traced and transferred to their appropriate thicknesses of wood by means of carbon paper, and cut out accurately with the fretsaw. Clean up the pieces well with glasspaper before assembling, and adding the decorations. The edges can also be rounded off or left flat as desired. The Penguin Letter Rack, incidentally, would also look attractive in marquetry.

The colouring key for painting the three subjects is given on the design sheet, and is indicated thus: B = Black, O = Orange, W = White, BR = Brown, G = Green.

The 'Sir Brian Robertson'



AN interesting project' was how Mr S. R. Page of 24 St. Hilda Road, Cheriton, Folkestone, described the making of this electrically-driven model tug from Hobbies design No. 251 Special. A slight deviation was made by fitting a larger metal rudder, which gave better control in the water.

Mr Page, who works on British Railways, has named his model after the chairman of the British Transport Commission. Mr Page is very pleased with the model both as a showpiece and under working conditions. He made it from scrap pieces of wood, claiming it was 'fairly easy' and recommends this design to anyone who intends entering this sphere of modelling.

The kit for making the tug costs 47s. 6d. and includes motor and propeller unit.

A photographic hobby

'COLLECTING' BOUNDARY SIGNS



MANY villages, towns, and cities indicate their boundaries by means of a heraldic signpost at the side of the road. Collecting pictures of these armorial bearings is a fascinating hobby, revealing many strange stories and fables from the pages of history.

Wherever I go I always endeavour to take a photograph of the signpost, and if on holiday this makes a perfect start for the holiday album, acting as a cover picture. This is no difficult task, for all that is required is a snapshot. If you keep your camera steady and the light is reasonable, you will invariably get a good picture, but try to avoid distracting backgrounds. In this instance it does not matter if the verticals are a little out of true. It is also suggested that you ask any pen friends to supply you with similar pictures from their towns.

The taking of the photograph is only the first step in the hobby, for the interesting part is in the search for information showing how a particular sign was devised. Very often there are handbooks published by towns and resorts which supply all kinds of information, and these are normally available at the public libraries. If in doubt at all it is best to seek the assistance of the librarian, who will be able to obtain the details you require. Alternatively, a letter to the Town Clerk or Chief Librarian of a town requesting a brief history of the armorial bearings will almost certainly bring the information. On occasion I have not only received the

brief historical notes but also a specimen!

It should be remembered that in ancient times the love of heraldry was prevalent among all classes. There were attractive devices in brilliant colourings, usually employed to distinguish particular knights, cities and craft guilds, and there is little doubt they exercised a powerful influence on the people, creating an unswerving loyalty.

By S. H. Longbottom

Take, for example, the simple insignia of York. It is said that on Christmas Day 1251 King Henry III visited York to confer a knighthood on Alexander, the youthful monarch of the Scots. This took place in the Archbishop's palace near York Minster, and from the original order we learn that the Queen was dressed in a violet coloured brocade heraldically adorned with three leopards (or lions) on front of her dress.

The Mayor of York was present, and his banner bore 'The Five Lions of York'. Now the curious fact about the latter is that there is an unsupported fable that the insignia of the five lions upon a shield was granted by William the Conqueror to commemorate five brave defenders of the city when York was besieged and destroyed by his soldiers.

At the time when the design was produced there was a profound respect for

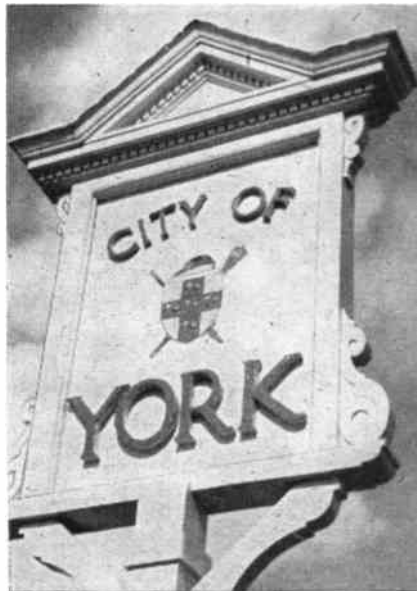

the ensign of St George, so this was undoubtedly adopted as the main charge on the shield, the latter being typical of the protective armour of the day. No doubt lions and tigers were intended to convey a power of strength to the opposing soldiers. The shield is crested with a Cap of Maintenance, which along with the sword and mace form emblems of the Lord Mayor's authority.

A more interesting story is connected with the coat of arms of the City of Bradford, which consists of a shield bearing three horns, supported by a ram and crested with a tongueless boar's head.

The story goes that some 500 years ago there was a ravenous wild boar of enormous size which lived in Cliffe Wood. It infested the town and neighbouring districts, giving fear to the inhabitants. It was made known that the Government would offer a reward for the destruction of this beast, and on St Martin's Day the King would present this to the deliverer.

A certain crafty woodsman hid himself in a tree to watch the habits of the boar, discovering that it frequented a particular well, today known as Boar's Well. In due course he shot the boar with his bow and arrow, but it was far too heavy for him to remove, so he cut out the tongue and placed it in his knapsack.

When our hero had departed another cunning young man came along, saw the

● **Continued on page 225**

USING A WHEEL ARBOR

A USEFUL attachment for the Hobbies Lathe is a wheel arbor, the use of which ensures that a finished wheel will have its axle-hole dead in the centre. This is of great help when making many models and toys.

EASY PAYMENTS FOR HOBBIES LATHES—SEE BACK PAGE

A $\frac{3}{8}$ in. Whitworth bolt is screwed into the headstock face. The length of the bolt does not matter, but for stability it should not exceed 2 in. Rotate the lathe to check that the bolt runs true, and if it does not, find a bolt that does. This is neces-

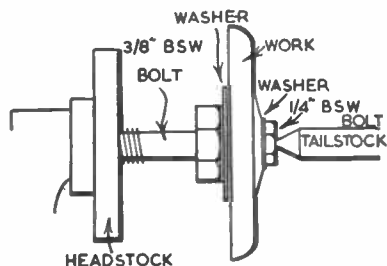
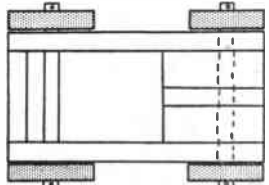
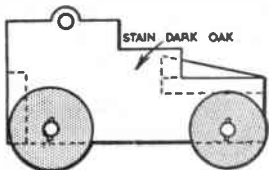
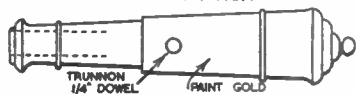

Fig. 1

sary for the basic accuracy of the device. Mark and centre-punch the centre of the head of the bolt and replace it in the headstock. The power of the lathe is now used to drill a hole down the centre of the bolt.

SHIPBORNE CANNON



Set the machine in motion and apply a hand drill, holding a $\frac{3}{8}$ in. drill to the centre-punch mark. Keep the drill perfectly horizontal whilst gripping the handle to prevent it turning, and the drill will make a neat hole. Withdraw the drill frequently and dip the tip into thin oil for cooling and lubrication, continuing until the hole is at least $\frac{1}{2}$ in. deep.

Remove the bolt, and tap the hole $\frac{1}{4}$ in. Whitworth. If you have no taps, your local cycle re-dairer will do this for you. Take in four $\frac{1}{4}$ in. Whitworth bolts, $\frac{1}{2}$ in., 1 in., 1 $\frac{1}{2}$ in., and 2 in. long, to cater for various thicknesses of wood, and centre-punch the centre of the tops of their heads. Drill a small countersunk crater on the punch mark. The arbor is now ready for use, and is set up as shown in Fig. 1.

The designs for a Shipborne Cannon and a Toy Locomotive give opportunity for the arbor to be tried.

A shipborne cannon makes a neat ornament. The barrel is a straightforward turning job, the trunnion hole and the bore being drilled after parting off. Try using an Abrafile for the detail work and for final parting. The carriage is made from $\frac{1}{4}$ in. wood. Cut the sides and clamp together whilst drilling axle and trunnion holes. Cut the cross-pieces

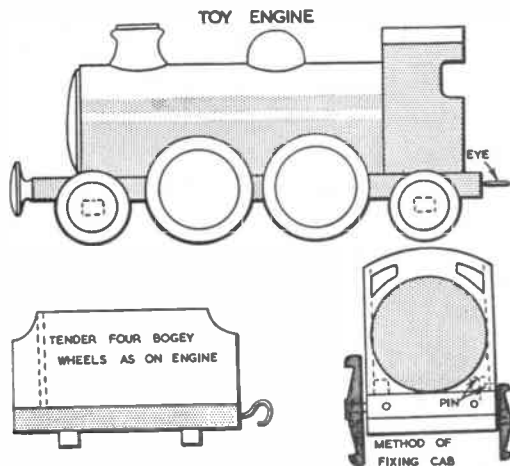

and assemble with panel pins. Mark out the wheels and cut, leaving a good $\frac{1}{8}$ in. surplus all round. Drill $\frac{1}{4}$ in. axle holes and clamp into the wheel arbor in pairs for turning to size, not forgetting that the front wheels are slightly larger than the rear ones. $\frac{1}{4}$ in. dowel is used for trunnion and axles. The barrel is painted gold and the carriage stained dark oak.

The chassis for a toy locomotive is made from $\frac{3}{8}$ in. wood, and the body, cab, funnel and dome are normal turning and fretsawing jobs, as is the tender body. The main components are held together by dowels and glue. The roof can be of thin ply. Wheels are cut oversize, drilled, and clamped in fours on the arbor for turning to outside diameter. They are then shaped individually, using a card template to give a good match. (R.N.T.B)

● Continued from page 224

'Collecting' Boundary Signs

boar lying defenceless, and conceived the idea of claiming the reward. Again the boar was too heavy to remove, so he cut off the head. Later the same day he claimed the reward, and was presented to the King. Closer inspection by the monarch revealed that the tongue had been removed, and this man could not provide a suitable reason.

Shortly afterwards the real hero presented himself, unfolded the riddle of the missing tongue, was duly recognized and given title to a portion of land (which is now named Hunt Yard). There was a further provision that he should attend the market place in Bradford each

St Martin's Day holding a hunting dog while three blasts were blown on a 'gelder's' horn.

This story reveals why the tongueless boar's head, the tree and the horns enter the design, the rams representing the staple wool industry of the city. We are not told, however, how the second man fared. He may have lost his head or been thrown into a dungeon for trying to cheat the Government!

The insignia of Filey indicates a seaside resort, and there is a gull holding a fish in its beak. This is said to denote the inshore fishing for which Filey is renowned.

BLACK & WHITE TRANSPARENCIES

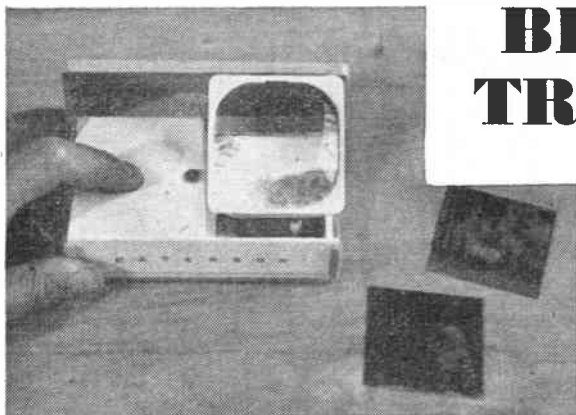

Popular type of pocket viewer used for colour transparencies, which can also be used for lantern slides. Two of the latter are shown on the right. The viewer holds two small batteries and lights up at the touch of the button switch.

YOU may have seen examples of the small coloured transparencies made from miniature films which are viewed through pocket accessories, and which can also be shown on a screen by means of a projector. You can make your own transparencies of black and white pictures to fit the same apparatus, and if desired, they can be coloured by hand. All you need for this process is a box of lantern slides measuring 2 in. by 2 in., the same size as the coloured transparencies when mounted in their cardboard holders. These slides cost 5/10 for a box of twelve.

appear as dark blotches when shown on a screen. The control of the image density is purely a matter of exposure and development.

On first examination of a lantern slide in its unexposed condition, you will probably experience some difficulty in detecting the emulsion side. The slides are normally packed face to face, groups of four being wrapped separately. If you cannot decide which is the face side, breathe on what is thought to be the glass side. A film of moisture will

always adjust exposure to the developer. For a first test it is, perhaps, best to expose one slide in strips of different times instead of cutting, develop for the standard time as set out by the manufacturer, then judging which is correct for that development time. We must emphasize that the density is most important when the ultimate object is projection on to a screen. If the projection lamp is weak it may not penetrate a dense slide, although this is not so important when using the hand viewer. Fortunately, these contact slides are quite slow, permitting development under a deep yellow safelight. Moreover, we can watch the development quite easily if the safelight is allowed to shine down on the dish. Any highlights in the slide — such as a sunlit wall or a white cloud — should have the appearance of being veiled over a little, and the safelight is quite sufficient for an inspection.

There is one other factor we should

By H. Mann

There is little doubt that a transparency is much more attractive than a paper print, and when shown on a screen by means of a projector, they become life-size or larger.

The slides are easy to make, similar to a contact print, and no enlarger is required unless you desire to elaborate on the process. They are manufactured in three different grades; slow contact which gives a blue-black image; warm tone, which is of medium contrast but moderately slow; and black tone which is rapid and comparable with bromide paper. The two latter are mostly used for making enlargements on to the slides, but the contact type will, perhaps, be found best for the beginner.

Of course, the slide cannot be any better than the original negative, so we must select those which are clear, free from fog, fairly transparent in the highlights and having clean shadows. In the slide itself the image should be clear, delicate, but having a complete range of gradations from the highlights to the shadows. And the latter must be transparent for opaque shadows would ap-

always remain momentarily on the glass side but not on the emulsion side.

The emulsion side of the original negative is placed in contact with the emulsion side of the slide, and both placed in an ordinary printing frame to ensure perfect contact between the two. Make certain that both the negative and the glass of the frame are free from dust specks. The exposure is then made as usual, but the exact time is difficult to state since much depends on the density of the negative. The plate maker's instructions will be a guide, but the writer finds that a normal negative at a distance of 1 ft. from a 60 watt lamp requires at least 1 minute exposure on an Ilford Contact slide. It is preferable that you should make tests on an average negative, and if necessary, it is quite easy to cut the thin glass with a glass cutter.

We can, however, advance the general rule of slide making, and that is to

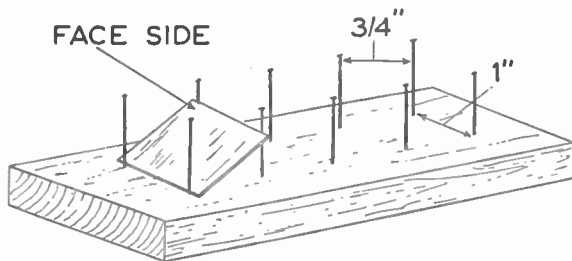

mention in connection with processing, and that concerns the fixing. It is desirable that a 'hardener' should be added to the fixing bath if the slides are to be subjected to the heat of a projector, or alternatively you may use an acid-hardening fixing bath.

We have already mentioned that the 2 in. by 2 in. size will fit the standard viewer and projectors available for colour transparencies, but some modification may become necessary for different negative sizes. With negatives larger than 2 in. by 2 in., it is often possible to transfer a proportion of same, selecting the most interesting feature. If the negative is almost the same size or smaller, any blank areas can be ultimately masked out. Where the whole of a larger negative is required, one can only resort to making a

● Continued on page 234

An attractive addition

CONTINENTAL HEADBOARD

IF you like cosy recesses, book shelves and built-in lighting to your bed headboard, then the Continental type is for you. Besides its functional value it takes to the contemporary scene like a duck to water.

It is quite easy to construct, being, in the main, a simple upright box shape. The most amateur of handymen can tackle it. When it is complete only the front shows — the back does not matter at all. Not that we are advising slap-happy work. The box shape is also most convenient for fitting lights, as the trailing flex can be completely hidden.

By E. Capper

The whole unit is made of a framework of 1 in. square battening, faced with $\frac{1}{2}$ in. hardboard or 3-ply. Sizes will vary with the bed to which it is to fit but as a guide, do not make the unit too high and thus give the impression of top-heaviness. Its length should be such that it extends beyond the width of the bed for at least 3 in. To accommodate bookshelves and recesses, its depth should be between 6 to 8 in.

As shown in the photograph the headboard can 'kill two birds with one stone' for besides its worth in the usual way, it can be fitted over an existing fireplace —

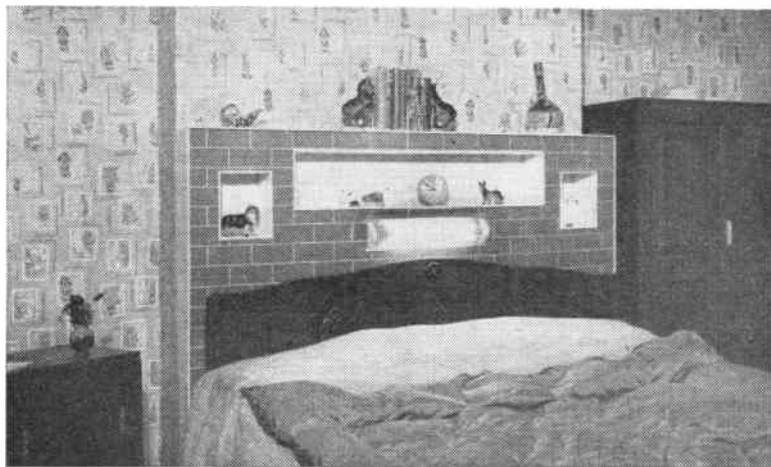

usually an eyesore in the modern bedroom. What is important is that if you do intend fitting the unit over the fireplace, it is not advisable to seal off completely the ventilation that would be afforded by the chimney flue — unless the room has also air-brick ventilation.

If it has not, keep the air supply in the room by cutting with a fretsaw, a 6 in. square from the front of the unit, near the bottom and in line with the chimney flue. Cover the hole with perforated zinc (as used for meat safes) and make a neat job of it by surrounding the zinc with a frame of half-round moulding.

An exploded view of the simple construction is shown in Fig. 1. The battening is held together with $1\frac{1}{2}$ in. oval-headed nails assisted by a spot of glue. Use a minimum of $\frac{1}{2}$ in. panel pins for affixing the headboard to the battening, for obviously you do not want nail heads or their depressions showing on the finished job. The front, top shelf and sides are, in any case, best held with glue.

The holes in the front piece into which the book shelf and side recesses fit must be cut out carefully and finished off with glasspaper. The book shelf and the recesses are made separately, and fitted into the cut holes. A pleasing effect is obtained by having the leading edges of these protruding in front of the unit by about $\frac{1}{4}$ in. This is easily done if, when making the book shelf and recesses, the battening is set back $\frac{1}{2}$ in. from the leading edges of the hardboard. Then, when the shelf is fitted, this $\frac{1}{2}$ in. is taken up by approximately $\frac{1}{4}$ in. thickness of the hardboard plus a protrusion of about $\frac{1}{4}$ in.

It will not normally be necessary to fit a back piece of hardboard to the unit itself although such a piece is advised for the book shelf and recesses. For the unit itself, the wall on to which it rests will serve the purpose of a back piece. To set the headboard permanently, use a small mirror-plate fixed to each side piece and into the wall via Rawplugged holes.

It is quite possible that the bottoms of the side pieces may have to be cut away to clear the profile of the skirting board. To ensure accuracy with the cut-away, make first a stiff-paper template of the profile of the skirting board and mark off same on the unit sides.

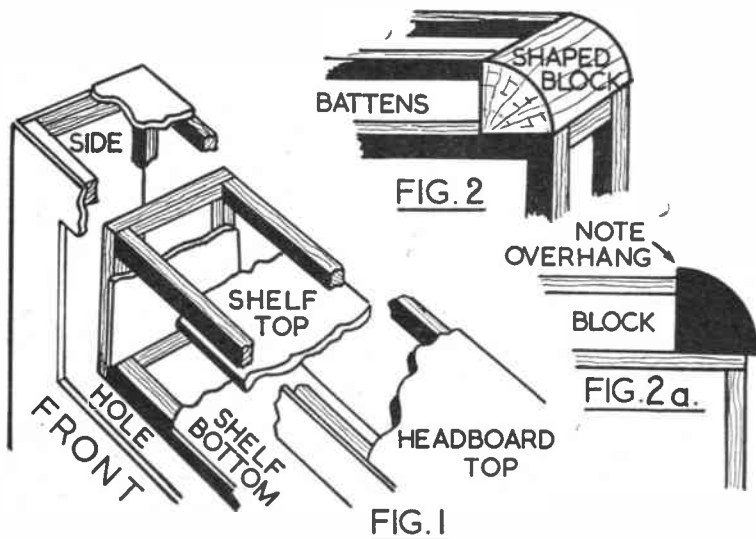

Naturally, it is easier to make square corners on the headboard as shown in the photograph. However, you may prefer softer rounded lines. The method employed is shown in Fig. 2. It involves the use of a block of wood shaped to a quadrant and fitted to the battening, as shown.

Care must be taken to ensure that a perfect quadrant is made. The surest method is to have it turned on a wood lathe, first into a circle; then cut the circle in half and finally into quadrants. If you do not possess a wood lathe it is worth while having the work done for you.

Note also, that the straight sides of the quadrant piece when fitted, must extend over the supporting battening to a distance equalling the thickness of the hardboard or 3-ply you are using for the facing (Fig. 2a). This is so that when the hardboard is fitted up to the rounded corner, no break or step is apparent at the join of the curve.

Fitting the lights

A single bed light can be fitted, or twin individual lights, whichever you prefer. Alternatively the two sides recesses can be used for lights. They can become concealed lighting by fitting shaped canopies or pelmets along the top edge of the recesses to hide the light bulb. This form of light however, would not be sufficient for the avid lay-in-bed reader, who needs really good illumination for his pleasure.

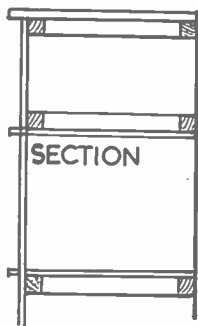

In the photograph, the light switch has been fitted on to the bed head. You may not prefer this arrangement. In that case, purchase a light fitting that incorporates a switch.

Fitting the light is simplicity itself, for all the trailing flex can be hidden inside the box-shape of the unit to emerge near the bottom corner of the headboard, convenient to the nearest socket supply.

For finishing the unit, almost any type of treatment can be employed. In the photograph, the sides, top shelf, book shelf and recesses have been enamelled in white whilst the main front is covered by imitation brickwork wallpaper.

It does not look well covered with the same wallpaper as used on the main wall of the bedroom. Anything gay and contrasty is much to be preferred. One

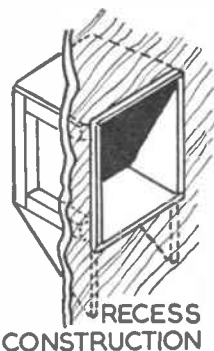

point to remember: do not paper the shelves as it will not stand up for long to the wear occasioned by books and ornaments.

If you can afford it, fluted hardboard for the front gives that sought-after contemporary effect. If you do use this material remember that it may be necessary for the front edges of the shelf and recesses to protrude more than $\frac{1}{4}$ in. in order to clear completely the bow fronts of the flutes.

Teenagers will probably prefer the front of their unit left plain so as to display stuck-on pictures of their pin-up boys, film stars, etc.

Whichever treatment you employ, make it gay; a loud splash of colour that is in distinct contrast to the rest of the room.



THE gay clown tumbles forward and backward along a special track in this attractive child's toy which is quite simple in construction. Full-size patterns for the cut-out figures are given on page 229.

To make the toy you will need: A, two 3 ft. lengths, $\frac{3}{8}$ in. round dowel. B, two $\frac{1}{2}$ in. pieces wood $2\frac{3}{4}$ in. by $1\frac{1}{2}$ in. C, two 2 in. lengths, $\frac{1}{4}$ in. rod. D, 6 in. by 6 in. panel plywood, $\frac{3}{8}$ in. or $\frac{1}{4}$ in. thick, E, two 6 in. by 6 in. panels plywood, and a table tennis or other similar-sized ball.

Trace the shape of the clown D on to paper, and transfer the full-size pattern to the wood with carbon paper. Repeat with the clown in the circle E, transfer

ring two of this pattern on to the panels. Cut out with a fretsaw. D has a centre hole to accept a $1\frac{1}{2}$ in. diameter ball. Check the size of ball available and make any correction to diameter before cutting the hole.

Glue and nail the dowels at their centres to the backs of the discs X. Drill two holes half-way through blocks B so that the glued-in dowels are $1\frac{1}{4}$ in. apart. Glue end rods C into centre holes drilled to a depth of $\frac{1}{2}$ in. for them. (See detail on pattern page.)

The heading illustration clearly shows the complete assembly of the toy. A piece of stripwood or rod may be fixed between the rockers E to stabilize the centre section of the runway, but clear-

ance should be allowed at this point for the passage of the revolving clown.

Clean up the cut-outs and draw in the detail of clown on reverse side of D. Paint both sides of D and one side of two pieces E, using bright enamels, and following the key to colouring provided on the pattern page. Complete the painting with bright colours to inside surfaces of rocker discs and the end blocks and rods. Finally, glue the ball into the hole of D.

The clown rolls along from one end of the track to the other by simply tilting the toy and the ends of the track. To keep the figure upright when not in motion, a screw or other form of weight can be fixed to one leg.

FULL-SIZE PATTERNS FOR THE CLOWN

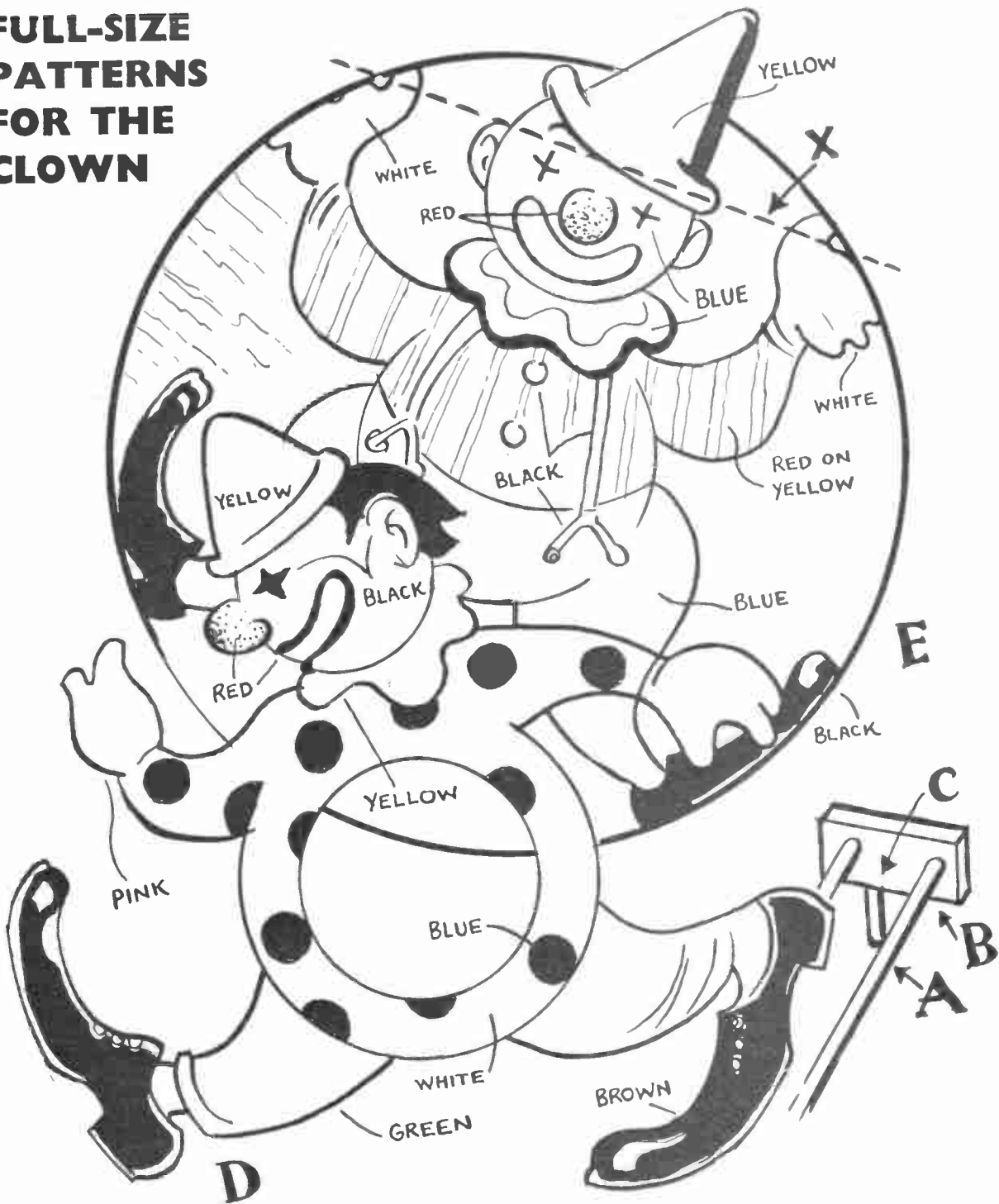

BUZZERS AND SHOCKING COILS

A NUMBER of interesting and useful pieces of apparatus such as buzzers, bells and shocking coils, which can easily be constructed, will be dealt with in this part of the series. It is worth noting that in most cases the exact dimensions of the various magnets or other parts are not important. For this reason, items already to hand can often be used.

By 'Modeller'

A flashlamp battery will provide enough current for any of the circuits described here, so the total cost involved will be very small.

Buzzers

An electric buzzer can be used as a warning device, or for Morse Code practice. The circuit for such a buzzer is shown in Fig. 27. The electro-magnet has a core of iron or similar metal, and this core fits in a bobbin wound with insulated wire. Current flows through this winding, to the armature, and back to the battery through the contact screw. The armature is thus attracted to the magnet core, but this breaks the circuit at the contact screw, so that the armature is released, springing back. Contact is then made again, and the sequence repeated, the armature buzzing rapidly backwards and forwards.

For a 3 volt to 6 volt battery, the bobbin can be wound with 26 SWG or similar wire. A small iron bolt will do well for the core, or a length of soft iron about 1 in. to 1½ in. long and ¼ in. in diameter. To form the bobbin, pieces of thin

wood, stout card, or Paxolin, about ¾ in. in diameter, are pushed tightly on to the core. A layer or two of brown paper, or insulating tape, is wound on the core, and the bobbin is then nearly filled with wire. There should be several hundred turns in all, the exact number being of no importance.

The armature is of iron or steel, about ¼ in. wide, ⅛ in. thick, and 1½ in. long. Tinplate (tinned iron) from a tin can will do, folded to give two or three thicknesses. The armature is bolted or soldered to a brass strip, which is fixed to a bracket, and bent out to meet the contact screw, as in Fig. 27. The strip from an exhausted 4½ volt battery will be the right size. The contact screw is fixed to

ally, as the buzzer described, a wire or thin strip, with hammer, being added to the armature. As the latter vibrates, the hammer strikes a gong or bell. To obtain a more powerful action, two electro-magnets are often used, as shown in Fig. 28, but one magnet is sufficient if a very loud ring is not wanted.

The magnets are made and wound as described for the buzzer. For proper results, the magnetic polarity at the ends near the armature must be opposite. This can be arranged by winding both magnets in the same direction, and joining together the inner ends of the windings. The windings are in series. Both magnets are fitted to a long iron bracket known as a yoke.

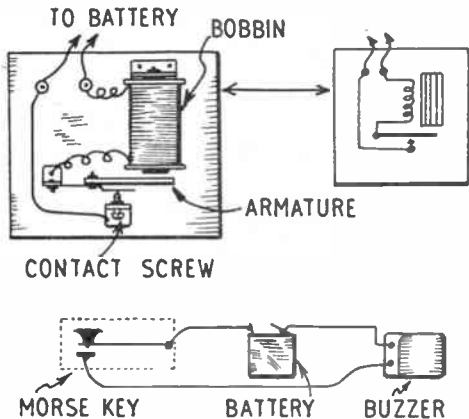

Fig. 27—Buzzer and circuit

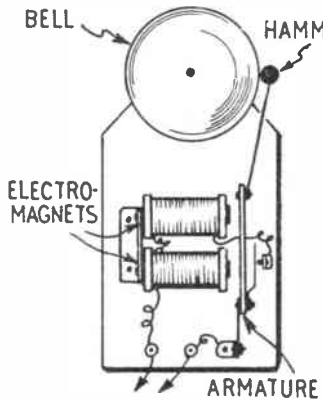

Fig. 28—How to make an electric bell

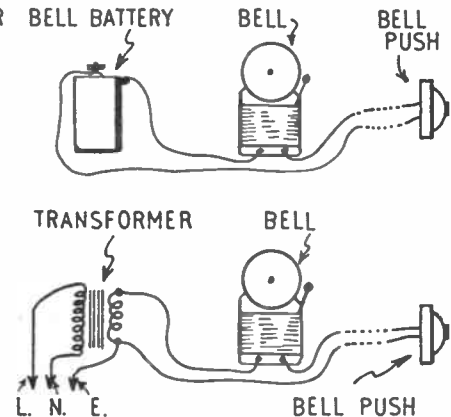

Fig. 29—Bell circuits for battery and A.C. mains

another small bracket.

The armature should be fairly near the magnet, and the contact screw bear firmly against the brass strip. The note of the buzzer can be adjusted by moving the contact screw, which can be set by means of locknuts, or by passing it through a nut soldered to the bracket.

Fig. 27 also shows a Morse circuit. The key can be made from a springy strip, with knob, pressed down to make contact with a flat strip screwed to the baseboard. For signalling two ways, as between separate rooms, two buzzers and keys can be used. For Morse practice, one person operates the key, while the other reads the message.

Bells are the same, electric-

The hammer can be made from a short, fairly heavy nut and bolt. Its best position can be found by bending the wire, after the armature has been adjusted so that it works well. The gong of an old cycle bell will be very useful when making up an electric bell of this kind.

Bell circuit

Fig. 29 shows how to use the bell, the bell push being fixed at the door, or where needed. If the leads to the bell push are very long, it may be necessary to increase the voltage of the battery. Or two batteries can be wired in series. Even small batteries will last a long time because current is only taken for a few seconds, when the push is depressed.

When a bell is permanently wired up, it is often run from a mains transformer, so that batteries do not have to be replaced. The circuit for this is also shown

● Continued on page 232



Kit No. 3308

Contemporary Plant Stand

27/6

(post 2/9)

Although simple in construction, this **Contemporary Plant Stand** makes an elegant showpiece in the modern home. Trough measures 30 in. by 7 in. Supported on 15 in. contemporary style legs, giving an overall height of 21 in. Kit contains design and instructions, panels of wood, and four 'screw-in' legs.



KITS FOR MODERN FURNITURE

Finest quality materials from which the handyman can make attractive contemporary furniture for the home, and save pounds!

Obtainable from all Hobbies Branches or Stockists, or by post from Dereham, Norfolk.

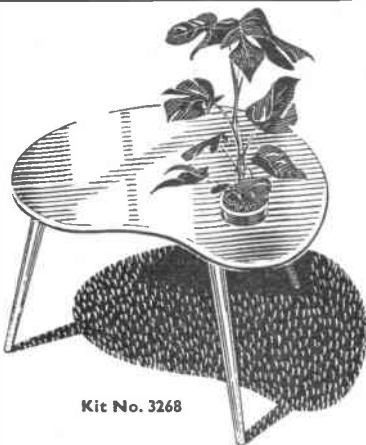

Kit No. 3268

Plant-Holder Table

This **Modern Table** with its intriguing little plant holder will appeal to all lovers of contemporary furniture. Size 24 in. by 18 in. by 20 in. high. Kit contains design with instructions, selected plywood and other wood, three 'screw-in' legs, and screws.

24/9

(post 2/9)

THESE KITS

Record Cabinet/Bookcase

Planned so that anyone who can handle simple woodwork tools can make a really good job of this **Record Cabinet and Bookcase**. A handsome cabinet 34 in. high, 20 in. wide and 13 in. deep to accommodate over 200 records and a quantity of books.

65/-

(post free)

Kit contains planed wood, plywood, four contemporary style 'screw-in' legs, hinges, beading, ball catches, cabinet stays, handles, etc.



Kit No. 3266



Kit No. 3278. This **Lady's Sewing Companion** is a really worthwhile job for the handyman. 30 in. wide, 17½ in. deep, 20 in. high. A handy table when closed. Kit contains selected planed wood, hardboard, beech rails, screws, corner plates, and four 'screw-in' contemporary legs.

65/-

(post free)

SAVE POUNDS

**Kit No. 3262
Marquetry
Firescreen**

This **Marquetry Firescreen** depicts a colourful bird with outstretched wings against a background of foliage. Overall size of the screen is 28 in. high by 18½ in. wide. Kit contains hardboard, planed wood, moulding, wood balls for feet, round rod, and selected veneers for marquetry picture.

15/-

(post 2/-)

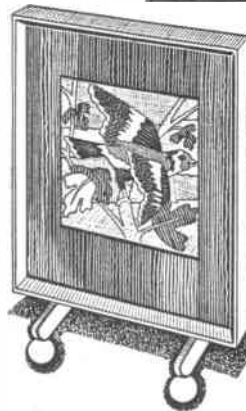

**To HOBBIES Ltd. (Dept. 99)
Dereham, Norfolk**

Please send me free booklet showing other kits available and

Kit No.

Name

Address

P.O. or Cheque for.....enclosed.

in Fig. 29. Bell transformers usually supply 3 volts to 8 volts.

Primary connections have to be made with mains-type cable, to a fused way on the distribution board. The primary is wired to the 'Live' and 'Neutral' power points. The secondary and core are wired to 'Earth'. This mains wiring must be

TO BATTERY

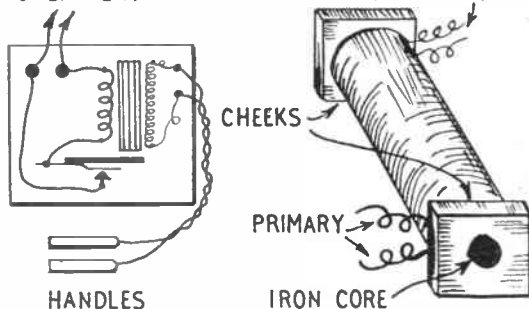

Fig. 30 — Shocking coil circuit and bobbin

carefully and properly done, the supply having been switched off first. If the user feels uncertain about being able to wire in the transformer safely, then it is recommended that a battery be used instead.

Connections to the bell and push can be of thin bell wire, fixed with insulated staples. These leads should be kept clear of all main house wiring.

Shocking coil

This also has a primary circuit exactly the same as that used with the buzzer. But there is also a secondary, as with a transformer, and having more turns than the primary. This steps up the primary (battery) voltage, giving a much higher voltage output. This is safe, because the current is small, but shocks should not be administered to anyone unexpectedly.

The buzzer part of the circuit is necessary because a transformer can only work with a fluctuating or interrupted current. If the battery were permanently connected to the primary, no output at all would be obtained from the secondary. This explains why transformers will work with A.C., but cannot be used with D.C.

To hold the windings, a core about 2½ in. long and ½ in. in diameter with cheeks 1 in. square will do well. The cheeks can be of thin wood, a tight fit on the core. The finished magnet can then be mounted on the baseboard by driving small screws up from below, or by gluing the cheeks down.

The primary can consist of two or three layers of 22 or 24 SWG wire, turns being wound evenly side by side.

The exact number of turns does not matter, but some 200 to 300 will be satisfactory. The whole primary circuit, with contact and armature, is exactly the same as that for the buzzer.

The primary is covered with a layer or so of brown paper or insulated tape, and the secondary is wound on top of this. About 2 oz. of 42 SWG silk-covered wire will be satisfactory. There is no need to try to keep the turns side by side, but they should be reasonably even.

The secondary is connected to two terminals. Lengths of insulated flex run from these terminals to the handles, which can be made by bending pieces of tin plate 1½ in. wide by 4 in. long into tubes.

A 1½ volt or 3 volt battery can be tried first, and the armature is adjusted to vibrate freely. If a stronger shock is wanted, the size of the battery can be increased, and the armature and contact screw so set that the coil buzzes more fiercely.

The strongest shock will be felt when the hands are damp. The coil can be used for amusement. For example, one lead may be connected to a bucket half filled with water, in which a coin is placed. Competitors try to pick the coin out of the water, while holding a metal handle connected to the other lead from the coil.

The remaining article in this series will deal with fuses and trips, charging accumulators, and electroplating.



Outside

PRESS on with digging — leave rough for frost to break up. Lift rhubarb crowns for forcing under glass. Apply winter spray (tar oil, etc) to fruit trees and bushes. (Ask your seedsman for information.) Continue pruning apples. Stake young trees. Tie in raspberry canes and mulch with old manure. Make up first hot bed. Set potatoes to sprout.

In the FLOWER GARDEN plants, such as delphiniums, peonies, fuchsias, etc., may be covered with sharp ashes and leaves to protect from slugs and frost. Trim laurels. Mulch peonies with old crumbly manure. Order flower and vegetable seeds. Make ready seed boxes and coat with green Cuprinol. In a hot bed, first sowings of carrot, lettuce, and radish may be made. Burn prunings

when ground is frozen hard to avoid trampling down soil. Spread bonfire ash on potato plot.

Inside — warm house

SOW gloxinias, begonias, coleus, Santirrhinums, petunias, perpetual and border carnations. Force rhubarb under staging. Give Christmas cactus (*Zygocactus truncatus*) water during mild weather while buds are forming. Fumigate when possible.

Cool house

THIS is the best month for taking cuttings of perpetual flowering carnations. Give a little bottom heat. Clean established carnation plants in pots. Take chrysanthemum cuttings. Bring in bulbs. Place annuals in pots as near glass as possible. Water sparingly and

JANUARY

THESE NOTES REFER CHIEFLY TO MIDLAND GARDENS — DUE ALLOWANCE SHOULD BE MADE FOR CHANGE OF LATITUDE.

carefully. Keep water off crowns of cyclamen. On mild, calm days, fumigate for green fly and white fly, at fortnightly intervals if possible.

Cold house

VENTILATE as much as possible. Pick decaying leaves off lettuces and chrysanthemums. Put down a little slug bait. If house is clear, scrub down paintwork and re-paint where necessary.

General

ARCHITECTURAL features such as paths, sundials, and pergolas may be planned and commenced this month. (M.h.)

Next week's issue will show how to make a novel and attractive Fruit Bowl, with 'rings' cut from one piece of plywood. 'Radio Mech' will also describe a Midget Battery 2-Valver and there will be full instructions for building a billiards table.

★ LEARN ★ RADIO & T/V SERVICING for your OWN BUSINESS/HOBBY

● by a new exciting no-maths. system, using practical equipment, recently introduced to this country.

FREE Brochure from :—

RADIOSTRUCTOR

DEPT. G81, 46, MARKET PLACE,
READING, BERKS. 30/12

BUILD your own Midget Transistor radio 28/6. With full instructions. Other kits from 8/6. Radio, Television books. S.A.E. details — Hamilton Radio (H), 237 Sedlescombe Road North, Hastings.

LEARN RADIO and ELECTRONICS the NEW practical way! Very latest system of experimenting with and building radio apparatus — 'as you learn'. FREE brochure from — Dept. HW 10, Radiostructor, 46 Market Place, Reading, Berks.

WHEELS (Hardwood and Rubber Tyred Metal). Cot, Pram and Doll's house Fittings and Papers, Beads, Transfers, Prints and other accessories. Stamp for new lists. (Trade supplied.) New address — JOYDEN CO., 91 Peplins Way, Brookmans Park, Herts.

MODELS. You can make lasting stone-hard models with Sankey's Pyrama Plastic Cement. Supplied in tins by Ironmongers, Hardwaremen and Builders' Merchants. Ask for instruction leaflet.

▼ Refund if not worth double! TV TABLE & EXTRA LARGE RECORD CABINET



Not only sand polished but also sprayed light or medium WAL-
NUT tone. NOTE—ROOMY BOOK CASES AT BOTH ENDS — one converts to Magazine Rack by insertion of sloping panel provided, as illustrated. Amazing offer — 59/6, carr. 6/6 or sent for £1. Balance 6 monthly payments 8/-, plus carr. A well-built contemporary piece of furniture to solve your record problem and also ideal as stand for TV, Radio or Record Player. 30" x 15" x 24" high, Modern sliding doors. Roomy interior, partitioned for classifications, holds up to 200 records (upright for perfect condition). Entirely of seasoned timber. Detachable legs. SEND quickly. LISTS, FURNITURE.

SEND FOR OUR FREE ILLUSTRATED CATALOGUES OF RADIOS, JEWELLERY, RINGS, BINOCULARS, FURNITURE, GUITARS, CLOTHING, ETC. ALL AVAILABLE ON THE EASIEST OF TERMS.

HEADQUARTER & GENERAL SUPPLIES LTD.

(HOBW/95) 196-200 Coldharbour Lane,
Loughboro Junc., London, S.E.5. Open Sat.

STAMPS FREE — Empire Packet including Pictorials and Victorians with approvals. — Robert J. Peck, 7A Kemp Road, Bournemouth.

100 DIFFERENT stamps free! Request 4d. upwards discount approvals. — Bush, 53 Newlyn Way, Parkstone, Dorset.

BUILD YOUR OWN HI-FI at home! At last, for reasonable cost — the chance to make your own quality HI-FI audio equipment and to gain the knowledge to service and maintain it. FREE brochure from — Dept. HW 20, Radiostructor, 46 Market Place, Reading, Berks.

There was a young man from Penzance — who hadn't a clue how to dance!

but he sent for our book — and in no time — just look!



—he's made an amazing advance!

Can't afford private lessons? Learn ballroom dancing at home. Send for exciting booklet *Dance Escort* — FREE to readers of *Hobbies* — which explains the dynamic SURE STEP system.
Just send name and address to:
ESCORT DANCE INSTRUCTORS
Studio H27, Harrogate
(or Rock 'n' Roll Course — send 4/6 P.O., or Old Time Course 8/6, or Cha-Cha Course 5/6)

EXTRA CHEQUES from writing. Send for 'Ideas for Writers' (free). Scores of suggestions for beginners and others. Typewriter unnecessary. — Writers' Ring (H.W.), 5 Edmund Street, Birmingham 3.

KUKLOS ANNUAL. Indispensable cyclists' handbook. Tours, resthouses, money-saving hints, 3/- post free. — Burrow, Publishers, 2 Imperial House, Cheltenham.

MAKE A MUSICAL BOX for as little as 19/9. New kits and tunes available. Movements 11/9. Please send 3d. stamp for free illustrated catalogue. Swisscross Ltd, Dept. B, 202 Tulse Hill, London, S.W.2.

DO IT YOURSELF Monster Kit of foreign stamps. Keep the kiddies quiet for hours. Send 2/6 only. Approx. 150 genuine foreign stamps on paper. — John Hemsworth, 12 Melbourne Ave., Bolton-on-Dearne, Rotherham.



BRANCHES: LONDON

78a New Oxford St., W.C.1
87 Old Broad Street, E.C.2
81 Streatham Hill, S.W.2
151 High St., Walthamstow, E.17

GLASGOW

326 Argyle Street

MANCHESTER

10 Piccadilly

Head Office & Factories—HOBBIES LTD, DEREHAM, Norfolk

BIRMINGHAM

100a Dale End, Birmingham 4

SHEFFIELD

4 St. Paul's Parade

LEEDS

10 Queen Victoria Street

HULL

179 Ferensway

SOUTHAMPTON

134 High St. (Below Bar)

BRISTOL

65 Fairfax Street

NEWCASTLE

42 Dean Street

GRIMSBY

88 Victoria Street



'Lighthouse' Electric Lamp

14 in. high. An ideal TV. or bedroom lamp. Kit No. 3252 complete with design and instructions, planed wood, plywood, balsa, switch, flex, lampholder, etc. 22s. 6d. (post 1s. 9d.)

USEFUL 'HOMELY' PROJECTS FOR THE HANDYMAN

Kits from branches or by post



Magazine Rack

Made of wood and plastic thonging. Size 19 in. wide, 8½ in. deep, 17 in. high. Complete Kit No. 3282 with design and instructions 12s. 0d. (post 2s. 3d.)

HEAR ALL CONTINENTS With H.A.C. Short-Wave Receivers

Suppliers for over 18 years of radio S-W Receivers of quality.
One-Valve Kit, Price 25/- Two-Valve Kit, Price 50/-
Improved designs with Denco coils. All kits complete with all components, accessories and full instructions. Before ordering, call and inspect a demonstration receiver, or send stamped addressed envelope for descriptive catalogue.
'H.A.C.' Short-Wave Products (Dept. 22), 11 Old Bond Street, London, W.1

HOBBIES LTD. (DEPT. 99), Dereham, Norfolk

THE TRAMP'S TELEGRAPH

THE last time I visited a friend of mine who lives in the country, he took me along to the end of his paling fence and showed me a squiggle chalked on it. He was very mystified.

We walked into the house, and I asked his wife if she had given a meal recently to a passing tramp. She admitted that she had, only the previous day. The hobo had leaned over the fence whilst she was hanging out the washing, said he had not eaten for days and could she spare him a meal.

'I don't suppose there was one word of truth in it, but he was a nice old chap, and I did really feel sorry for him', she continued.

I laughed. 'And now you can expect many more such callers', I replied. 'That tramp left a message in code for the next tramp who passed your way. The chalked squiggle he wrote means you are an easy type and, in short, someone who will fall for a tale of woe . . .'

Needless to say my friend's wife hurried to the fence with a damp cloth and removed the chalk marks.

Tramps have their own sign language. You might ask why they don't communicate to one another in the conventional way by word of mouth. A tramp, by the very nature of his calling, is an individualist. He makes his own way through life. Have you ever seen a pair of tramps walking together?

All the same they realize they are in a brotherhood; that they must endeavour to help each other. Hence the scrawled chalk marks left outside houses on which they have called. They act as a guide to the next tramp who calls.

The most used signs are shown in the illustration, and the key to their meaning is as follows:

1. Two interlocking circles. This represents a pair of handcuffs and means, in effect, that the local police do not look favourably on tramps and there is a danger of arrest.

2. A cross. As long as the tramp behaves himself he will not be bothered by anyone.

3. A pile of sawn logs. Tramps calling here will usually be able to get a meal or a few shillings, but they will have to work for it.

4. An open eye. The local authorities keep a sharp watch out for tramps and

at the least excuse will get them on the move.

5. A closed eye. Opposite to No. 4 and means that the authorities 'wink their eye' at tramps.

6. An inverted saucepan. Means the locality is 'dry'; there is either no pub around or if there is one, the landlord will not admit tramps.

7. A kind-hearted woman. It means the woman living in the house will always fall for a tale of woe. This was the sign my friend found on his fence!

8. A house with a line drawn through the open window or door. The house is well guarded by a large dog or a stern householder.

9. A stool with two circles. A safe camping site for the night.

10. Two diamonds. You will be perfectly safe in this area as long as you keep quiet.

11. A top hat. A kind-hearted man lives here.

12. A face and crossbones. A doctor lives here who does not charge or make annoying suggestions, such as referring the tramp to the local health authorities, and will treat the tramp free of charge.

Lastly, there is one sign which tramps avoid like the plague. It is the Cross of Lorraine inverted. It marks the home of a policeman!

(E.C.)

● Continued from page 226

Making Transparencies

reduction through the means of an enlarger.

Thorough washing of the slides is essential or stains may arise after some time, and if we are to ensure adequate protection of the face side — again necessary for projection — it is advisable to bind up with a cover glass of the same size. Cover glasses are inexpensive, very thin, of the same size, and bound by means of ready-cut strip binding like passepartout. The emulsion side of the slide is placed inside, so that it cannot be damaged, and the whole bound on the four sides to prevent the entry of dust. For those short of time, most photographic dealers sell slide holders, and there is a type of plastic sleeve, known as Arrowguards, which slip over the transparencies.

Since we cannot hang up our slides like a film, it is necessary to provide for their drying, but it is quite easy to improvise a suitable stand as shown in the diagram. All you need is a block of wood with a double row of nails. The

rows are made 1 in. apart, while the nails are knocked in $\frac{3}{4}$ in. apart down these rows. Insert the slides between the nails with the emulsion side face upwards, and the water will drain away.

The slides can be readily toned in many colours, and if you wish to pursue the idea further, it is quite possible to colour them with some of the transparent dyes used for colouring prints. Admitted, this is a tedious job requiring patience, but it was a regular practice before the advent of colour photography, and many of the advertisement slides shown in cinemas are hand coloured.

Whether or not you ultimately try colour photography, there is little doubt that the little transparencies made as described, will give you the utmost pleasure and create a new interest in your hobby, even if only seen through the miniature viewer. The writer now regularly makes these small slides to supplement colour slides where photography in that medium was not possible.

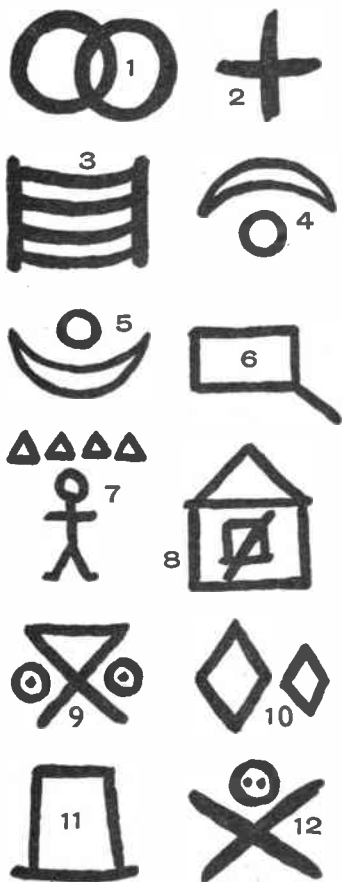

Full-size patterns for making A HANDY TOAST RACK

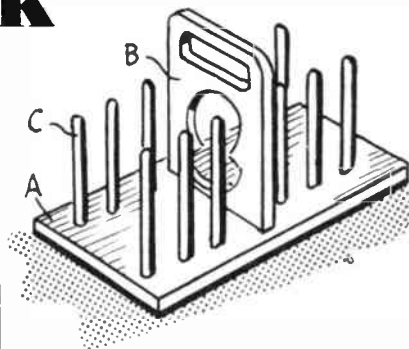
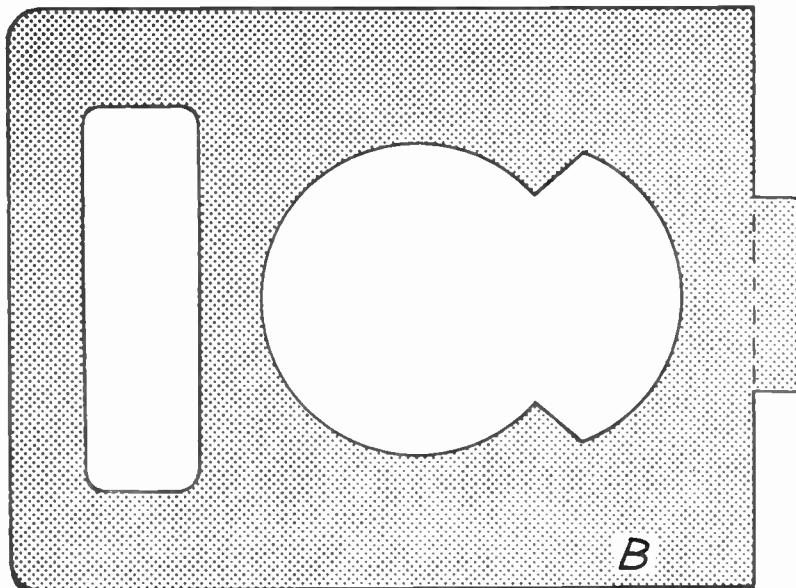

AN EASY JOB FOR THE FRETSAW

CUT one each of pieces A and B from $\frac{1}{4}$ in. wood. Piece B is glued into the slot in piece A. 3 in. lengths of $\frac{1}{4}$ in. diameter round rod are now glued into the holes in piece A. Clean up with glasspaper and paint with high-gloss enamel. (M.p.)

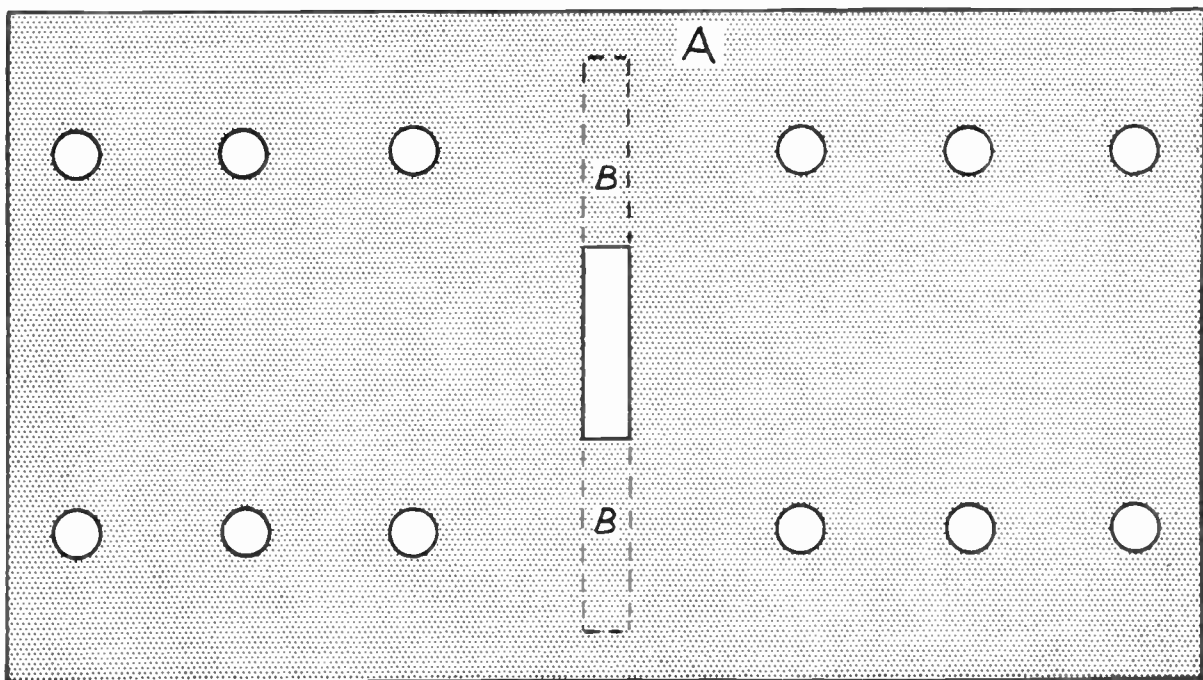



WOODWORKING LATHES FOR THE KEEN AMATEUR

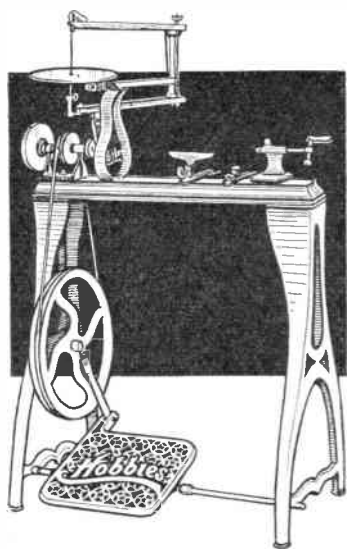

The 'Companion'

Handy Bench Lathe. This machine is similar to the 'Companion' Treadle Lathe but without the legs, treadle, etc. The headstock spindle has two small 'V' groove pulleys for drive by $\frac{3}{8}$ in. diameter round leather belt. The balance wheel is similarly grooved, so that three speeds are thus provided. An emery wheel, a spur centre and a screw centre are also included. Two centres obtainable.

Cash Price: (14 in. between centres) £5 10s. 0d.

Easy Payments: £1 down and 6 monthly payments of 16s. 5d.

20 in. between centres model, Cash Price: £5 17s. 6d. Or easy payments: £1 5s. 0d. down and 6 monthly payments of 16s. 11d.

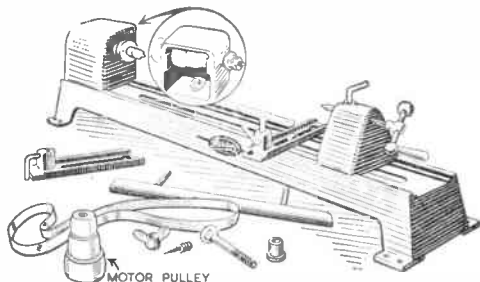

Mark II Bench Lathe

EASY PAYMENTS. A machine can be dispatched carriage paid after the initial down payment, and subject to the completion of a simple form of agreement. It is impossible for us to allow this system to apply in any part of Ireland, or anywhere outside Great Britain. Agreement forms are obtainable at any Hobbies branch, or you can do the business through the post with Head Office at Dereham, sending your instalments there.

The 'Companion' Treadle Lathe. A marvellous combination for the amateur. Obtainable with or without fretsaw attachment shown. The larger driving wheel has two grooves of varying depths to give a change of speed. The headstock is provided with a 2 in. faceplate, a spur centre, and a screw centre for turning cups. It has also a solid emery wheel. The tailstock has a screw feed centre. The lathe is 14 in. between centres and is provided with two rests, designs, saws, etc. The fretsawing attachment is secured to the lathe bed by one bolt, and can be put on or taken off as desired. It is fitted with 19 in. arms and an 8 in. diameter tilting table. A well illustrated book on Wood Turning is included with each lathe.

Cash Price: £13 10s. 0d. (as illustrated) or without fretsaw £10 0s. 0d.

Easy Payments: £2 15s. 0d. down, and ten monthly payments of £1 14s. 11d. Without fretsaw, £2 down and 8 monthly payments of £1 2s. 6d.

The 'Hobbies' Lathe. This lathe has similar features to the 'Companion' but is built for larger work. It stands 6 in. higher, and the distance between centres is 20 in.

Cash Price: £15 10s. 0d. complete. Without fretsaw £12 0s. 0d.

Easy Payments: £3 5s. 0d. down and 10 monthly payments of £1 8s. 5d.

Without fretsaw £2 10s. 0d. down and 9 monthly payments of £1 4s. 1d.

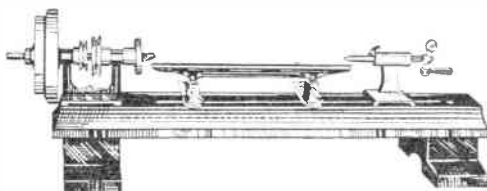

Handy Bench Lathe

On the **Mark II Bench Lathe** the keen handyman can turn his own stool legs, table lamps, wheels, and 101 things in wood. Unlike some 'cheap' lathes with bed made from steel rods or angle iron, the Mark II is built as a lathe should be built. It has a solid cast bed 32 in. long, machined its entire length. Specification: 22 in. between centres. Height of centres $2\frac{1}{2}$ in. A three-step pulley in conjunction with a similar three-step motor pulley gives speeds of 1,065, 1,420, and 1,890 R.P.M. Drive from motor (*motor not included*) is by $\frac{3}{4}$ in. flat belt provided.

Cash Price: £11 11s. 0d. Easy Payments: £2 5s. 0d. down and 9 monthly payments of £1 3s. 7d.

**HOBBIES LTD (DEPT.) DEREHAM
99 NORFOLK**

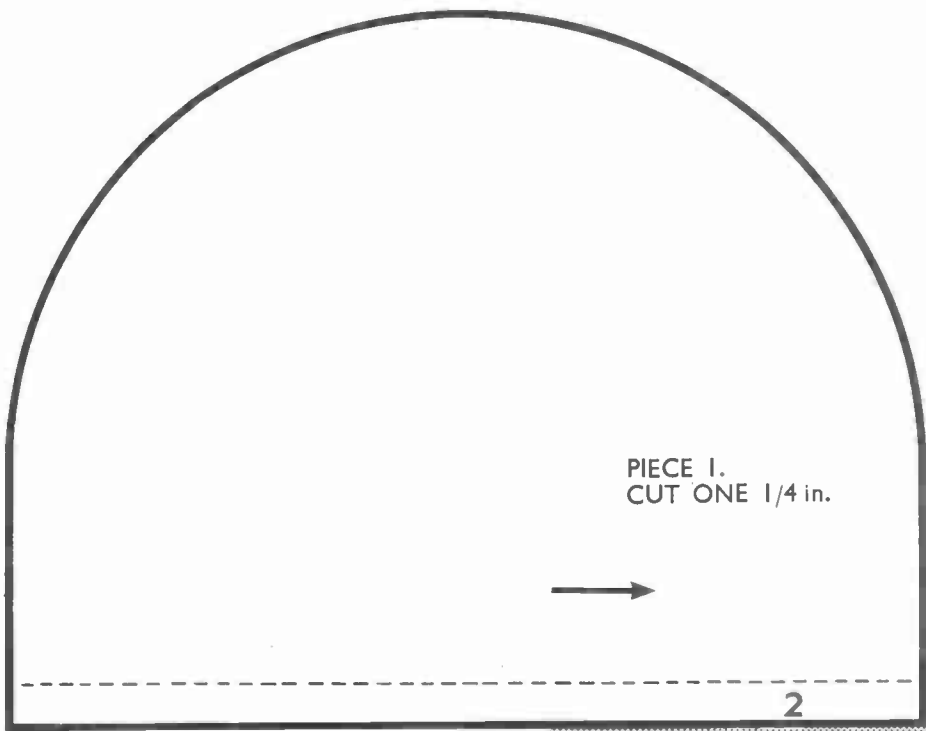

PIECE 1.
CUT ONE 1/4 in.

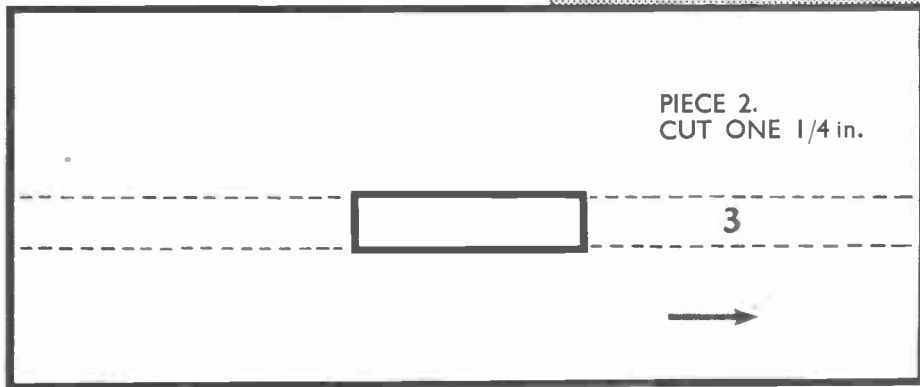
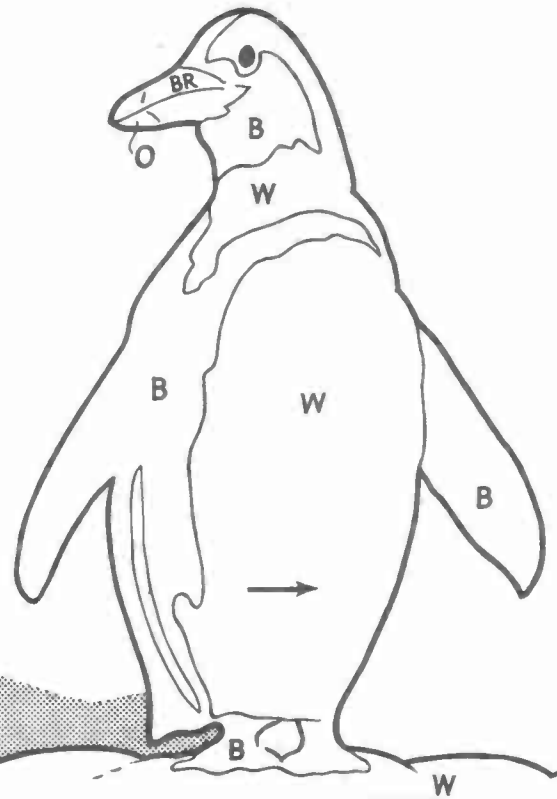

PIECE 2.
CUT ONE 1/4 in.



PIECE 3. CUT ONE

LETTER RACK

EASY TO MAKE WITH A FRETSAW

KEY TO COLOURS
 B = BLACK O = ORANGE W = WHITE
 BR = BROWN G = GREEN

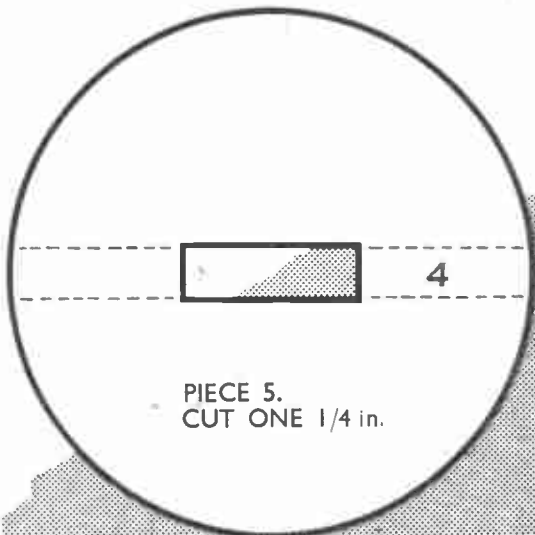

PIECE 5.
CUT ONE 1/4 in.



PIECES 6.
CUT TWO 1/4 in.
AND GLUE
TOGETHER.



PIECES 7.
CUT TWO 1/4 in.
AND GLUE
TOGETHER.

THE ARROWS
INDICATE DIRECTION
OF GRAIN
OF WOOD.

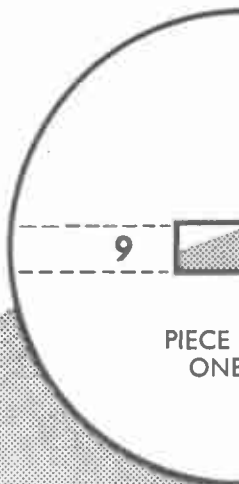

PIECE
ONE

PENCIL SHARPENER



BLACK LINE



DESIGN

No. 3342

THE TREBLE CHANCE

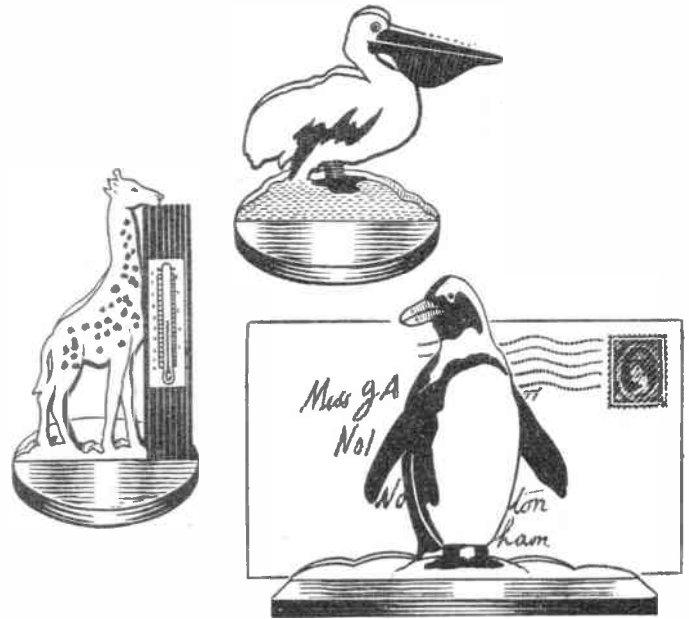
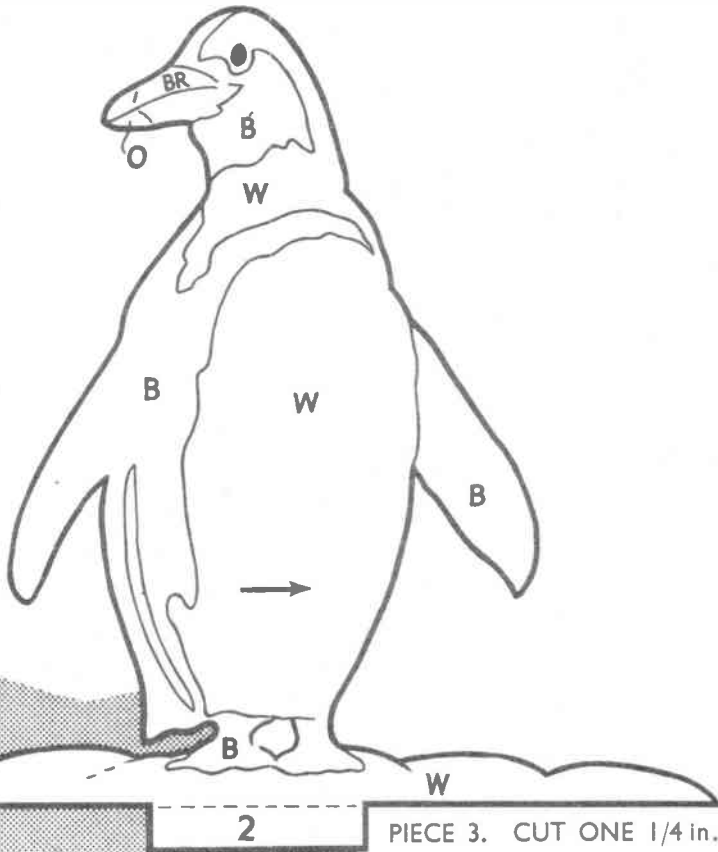

LETTER RACK

ALL PARTS ARE FULL SIZE.

A KIT OF MATERIALS FOR MAKING THIS DESIGN IS SUPPLIED BY HOBBIES LIMITED DEREHAM, NORFOLK. PRICE ON APPLICATION.

EASY TO MAKE WITH A FRETSAW



Use Croid POLYSTIK

IT'S DESIGNED FOR THE JOB
A cold liquid PVA adhesive combining instant grip with immense and lasting strength. Clean to use, non-staining. In polythene bottle with spreader 2/6.

AVAILABLE FROM ALL BRANCHES OF HOBBIES LTD.

THE ARROWS INDICATE DIRECTION OF GRAIN OF WOOD.

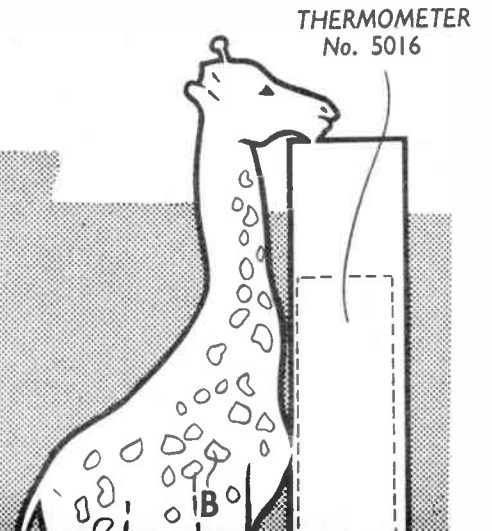
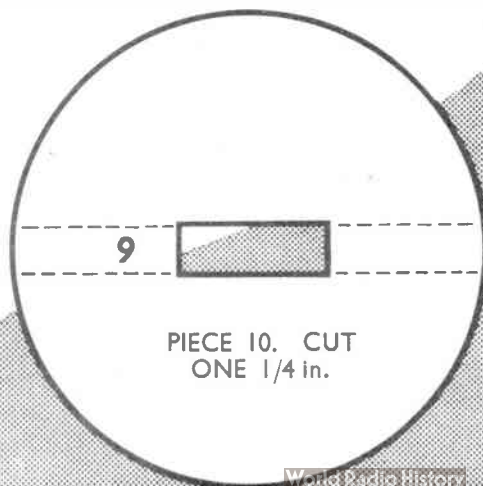

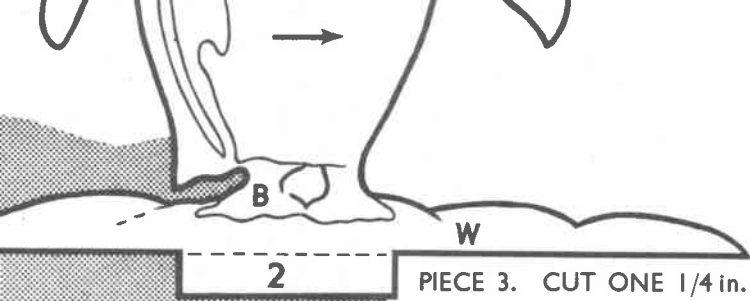

LETTER RACK

ALL PARTS ARE FULL SIZE.

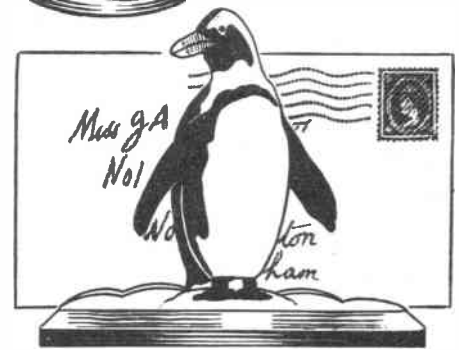

A KIT OF MATERIALS FOR MAKING THIS DESIGN IS SUPPLIED BY HOBBIES LIMITED DEREHAM, NORFOLK. PRICE ON APPLICATION.

EASY TO MAKE WITH A FRETSAW



Use **Croid** POLYSTIK

IT'S DESIGNED FOR THE JOB

A cold liquid PVA adhesive combining instant grip with immense and lasting strength. Clean to use, non-staining. In polythene bottle with spreader 2/6.

AVAILABLE FROM ALL BRANCHES OF HOBBIES LTD.

THE ARROWS INDICATE DIRECTION OF GRAIN OF WOOD.

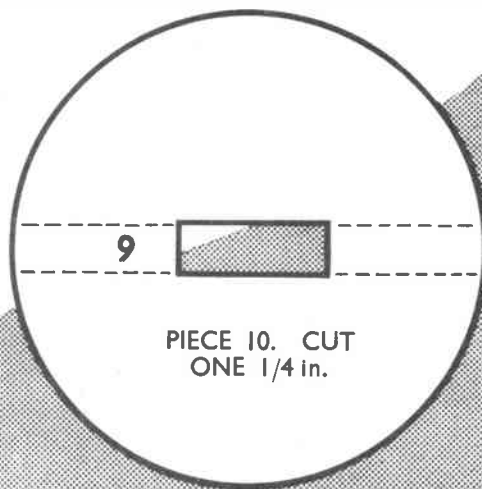

THERMOMETER



SHOWING FIXING OF SHARPENER BEHIND PIECE 4.

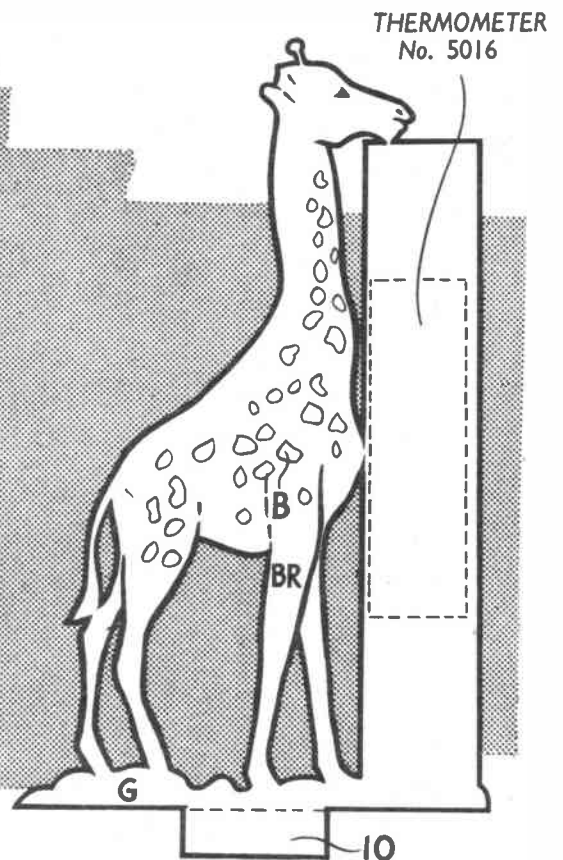

PIECE 9. CUT ONE 1/4 in.

PRINTED IN ENGLAND.