

25th NOVEMBER 1959

VOL. 129

NUMBER 3337

THE ORIGINAL
'DO-IT-YOURSELF'
MAGAZINE

HOBBIES *weekly*

FOR ALL
HOME CRAFTSMEN

*Fascinating for
the children*

Also in this issue:

MAKING THE
'HOBBY CLIPPER'

WHAT TO LOOK
FOR IN SPACE

COLLECTORS' CLUB

A 'STABLE-DOOR'
SERVING HATCH

CONTROLLING SPEED
OF MODELS

NOVELTY PROJECTS

ETC. ETC.

MAKE THIS . . .

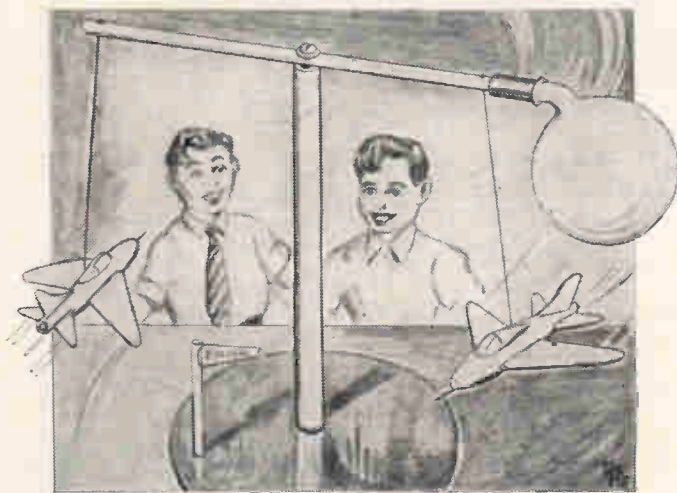

AERO-RACE GAME

Up-to-the-minute ideas

Practical designs

Pleasant and profitable things to make



5^p

'SMOKESTACK' Hardy of 615 N. Carrollton Ave., Baltimore 17, Maryland, U.S.A., has one of the largest collections of pictures and photographs of the apparatus that has been and now is used for fighting fires.

'I have been interested in the Fire Department all my life', he writes. 'I used to chase horse-drawn 'Steamers'. They were called "Smokestacks" — hence my name.

FIRE FAN

By R. L. Cantwell

'It is only in latter years that I have started collecting fire engine photographs. Most firemen are young, and missed the thrill of horse-drawn engines. Some have never seen one. That's where



my collection comes in. I have photographs of hand-drawn, horse-drawn, first motor types and the latest modern fire engines.'

Mr. Hardy was a part-time fireman during the war. He would like pen friends from any country.

The chief aim of the fire service is to get to a fire directly it breaks out, before it has had time to spread. Many large and serious fires might have been prevented had someone been on the spot with a bucket of water when the fire first broke out. Once a fire has got a firm hold of a building, especially if there is a wind blowing, there is little chance of saving it; all the firemen's efforts are then directed to preventing, if possible, the flames from spreading to adjoining houses.

It is on this account that elaborate arrangements are made for saving time at fire stations throughout the world. Every second lost can be of fatal consequence.

At one time, none but sailors were admitted into the London Fire Brigade; a certain Capt. Shaw asserting that they made the best firemen. A sailor is used to being called up at any hour of the night to face danger and his aptitude for climbing soon makes him at home on the fire-escape.



If you decide to become a 'fire fan' start off by collecting stamps, labels and post cards depicting fire engines, axes, badges, bells, belts, alarm boxes, gongs, helmets, hose, nozzles, etc.

Describe in your notes the old rigs and reels pulled by hand, advancing to the use of horses and then on to the modern automobile pumps and tenders, recording and illustrating the historical and scientific advance of the service.

might be lost in endeavouring to unlock the door, or whilst fumbling with the key you might drop it, and be unable to find it again in the smoke.

(3) Smoking in bed has been the origin of many serious fires, some of which have proved fatal.

(4) In case of fire, should you be unable to escape by the door, you must think of some other means of getting out of the house. The window naturally suggests itself as being the next best means of exit. Should there be no external means of descending to the ground safely, take the sheets off your bed and tear them into long strips. The ends should be knotted together by reef knots, which will not slip, for the greater the strain upon them, if properly tied, the more secure they become.

(5) If you should ever be forced to jump down into a sheet, remember to take a good long breath just before jumping, so as to fill your lungs with air; this will cause you to descend more lightly than if you were to jump with your lungs empty.

Many stamps and labels depict volcanoes, etc., which cause fire and havoc whenever they erupt.

And if you need a good pen friend don't forget 'Smokestack' Hardy.

Remember always the following fire precautions — depict them in stamps and labels:

- (1) Appliances for the extinction of fire should be always kept ready.
- (2) Bedroom doors should not be locked at night, as in case of fire valuable time

Schoolboy's Fine Model

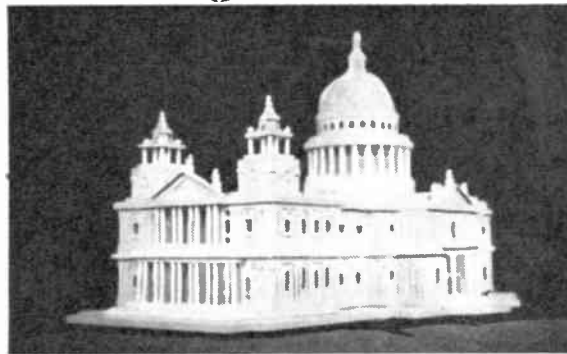

An instance of excellent work done by one of our younger readers is this model of St. Paul's Cathedral (240 Spl.), made by J. E. Morton, while still at school. Other designs which he has tackled successfully are the Royal Prince, Great Harry and Ha'penny Galleons, emphasising, as he says, that no-one should be deterred from attempting the seemingly difficult models. The Hobbies kit for making St. Paul's Cathedral, which is 17 in. long, costs 21/3 (postage 2/6 extra).

THE AERO-RACE GAME

MODEL planes are the suspended mobiles for this jet-powered aero-spinner unit, which provides an exciting 'guess-which-one-wins' game in which all the family can join.

Two aeroplane models — preferably of the 'jet' type, and identical in size and weight — are made in balsa-wood or assembled from light plastic construction kits.

YOU WILL NEED

1. 5 in. by 5 in., $\frac{1}{4}$ in. softwood.
2. 9 in. diameter disc, 3-ply wood.
3. 12 in. by $\frac{1}{4}$ in. diam. dowel rod.
4. 18 in. by $\frac{1}{4}$ in. diam. dowel rod.
5. 4 in. by $\frac{1}{4}$ in. diam. round rod.
6. Stiff paper, approx. 3 in. square.
7. Plastic or cardboard tube, $2\frac{1}{2}$ in. long, with inside diameter $\frac{1}{4}$ in.

Miscellaneous

Twin plastic or balsa-wood model aeroplanes (approx. wing span — 5 in.).
String, screws, washers, balloon.

When parts needed for the unit have been prepared, refer to the diagram for the simple method of assembly.

Disc 2 is nailed to top of base piece 1 and a central hole for the upright rod 3 is drilled to a suitable diameter and depth through both pieces. This column should preferably be a friction-tight fit, without glue, so the unit can be dismantled for compact storage when not in use.

Drill a hole at the exact centre

through the horizontal bar 4 for the screw, around which it must freely turn. Drill a small hole into the end of the column and, using washers as detailed, screw the units together.

About 1 in. from outside edge of the circular platform 2 drill a hole and glue in the 'winning post' rod. Form the 3 in. square piece of paper into the 'cone' 6 as shown, and glue on to top of the post.

Bore a small hole through each end of

the horizontal rod, and thread and knot the strings in place. Attach the hanging ends of the strings to pins in the model planes, so that they are suspended about 4 in. from base level.

Spinning the bar round with finger and thumb at the centre pivot will test the balance. The model is now ready for painting in gay enamel colours. Base is green, column red, and horizontal rod, blue. Add colour to the winning post and print in the wording 'Winner' or 'Finish'. If the aeroplanes are made especially for the model, then these will look well painted silver and number of plane added. Or they can each be a different colour.

To provide the power for propelling the unit, make up the jet tube and balloon assembly as shown. Prick a small hole halfway down the tube for the air outlet. This hole should be opened out gradually with a bradawl until the amount of air expelled is sufficient for propulsion without the air jet running out too quickly.

Blow up the balloon, while holding finger over air outlet hole, push the tube about $\frac{1}{4}$ in. on to one end of the horizontal rod, and release the air to set the models in motion.

Make sure that the jet hole is turned in correct direction necessary to obtain full propulsion. A large washer is slotted over each arm of the horizontal rod. By sliding one or both washers towards or away from the column, an adjustable counterpoise is provided for the unbalanced end, weighted by the 'jet' motor. (See details X and O in diagram.)

The plane which stops nearest to the finishing marker is the winner. (T.S.R.)

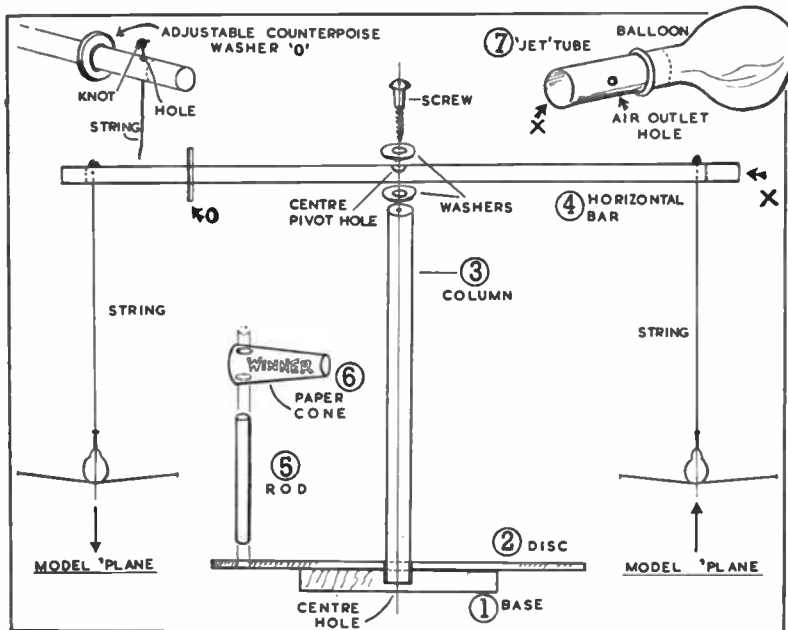
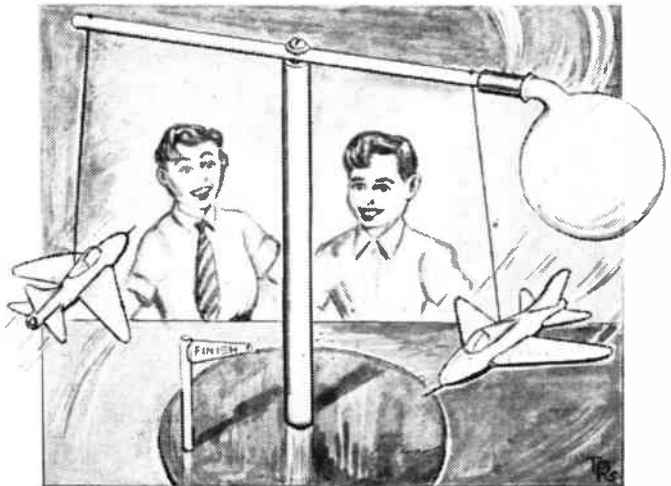

BUILD THE 'HOBBY CLIPPER'

YOU WILL NEED

- Sheet Balsa:**
2 pieces 36 in. by 3 in. by 36 in. by 1/16 in.
- Strip Balsa:**
4 pieces 36 in. by 1/16 in. by 1/16 in.
4 pieces 36 in. by 1/2 in. by 1/16 in.
1 piece 36 in. by 1/2 in. by 1/2 in. trailing edge section.
1 piece 36 in. by 1/2 in. by 3/16 in. trailing edge section.
1 piece 36 in. by 1/2 in. by 1/2 in. leading edge section.
1 piece 36 in. by 1/2 in. by 1/2 in. leading edge section.
- Miscellaneous:**
12 in. by 3 in. by 1/2 in. sheet; 18 gauge piano wire, cup washers, 18 gauge brass or aluminium tube, wheels, screwed brass bushes, tissue, paste, cement, dope, banana oil, 12 in. diameter medium-pitch balsa propeller, rubber, valve tubing, 1/2 in. dowel.



The completed 'Hobby Clipper'

AMONG the most interesting types of flying model aircraft are those which are powered by a tensioned skein of specially manufactured rubber strip. From the point of view of competitive flying in this field the 'duration' or 'endurance' type of model is an essential; while for sport-flying, which is another way of saying 'flying for just the fun of it', the rubber-driven semi-scale or scale model is ideal.

The 'Hobby Clipper', the construction and flying of which are described in this and two subsequent articles, falls into the 'competitive' class, but at the same time its extreme ruggedness makes it a very useful model for sport-flying by an inexperienced beginner. The method of constructing the fuselage has been specially devised for the beginner, who will find it quite simple to reproduce, and the finished component will withstand a great deal of rough treatment.

Begin by drawing out full-size, on

stiff drawing paper, the *outline* shape of the fuselage, using the dimensions and squares on the drawing (see centre page) as a guide. Also draw the vertical lines indicating the positions of the 1/2 in. square upright members, making quite sure that they are at right-angles to the top edge of the fuselage.

sharp pencil and ruler trace over the fuselage outline and over the lines representing uprights. Use a french curve or a piece of spring stripwood to help you draw the curve on the underside of the fuselage.

Remove the balsa and cut out the fuselage side with a razor blade or modelling knife. Use this balsa panel as a template to cut out another identical fuselage side from a second sheet of 1/16 in. balsa. On this second side mark with pencil lines the positions of the uprights but make sure that the sides 'pair', i.e., one left hand and one right hand.

Clip one side to your building board by driving panel pins (or stout straight pins) all round the edges of the balsa, about 1 1/2 in. apart. The pins must *just touch* the edges of the wood. Now run a thin line of balsa cement along one edge

By Gordon Allen

Now place your drawing directly over a 3 in. wide sheet of 1/8 in. thick hard balsa with sheets of carbon paper (carbon side against the wood) between the drawing and the balsa. Pin the drawing to the building board close to balsa to prevent movement and with a

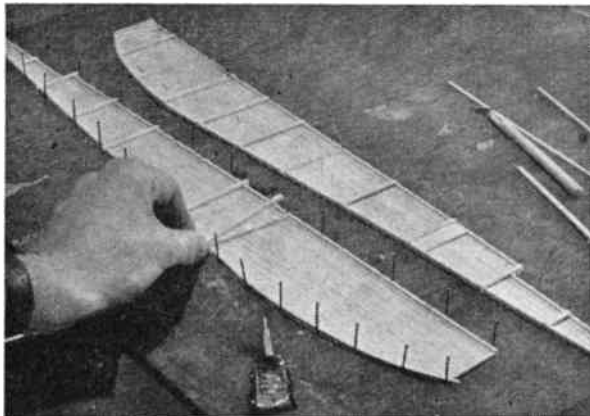

Fig. 1

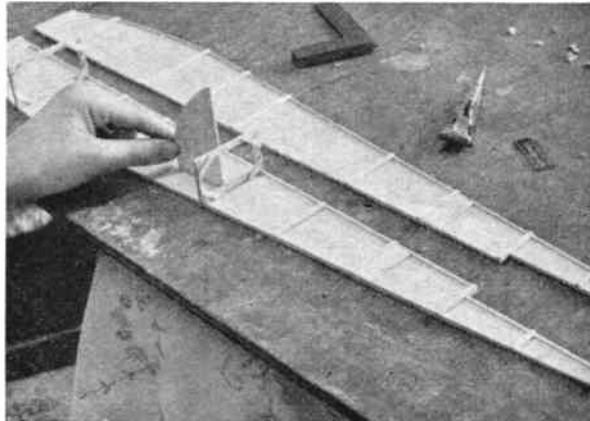

Fig. 2

of the balsa, on the upper surface, but do not apply the cement at the places where the upright members (denoted by the pencil lines) are to meet the edge. Press a strip of medium hard $\frac{1}{8}$ in. square balsa firmly on to the cemented edge and against the adjoining row of pins. Do

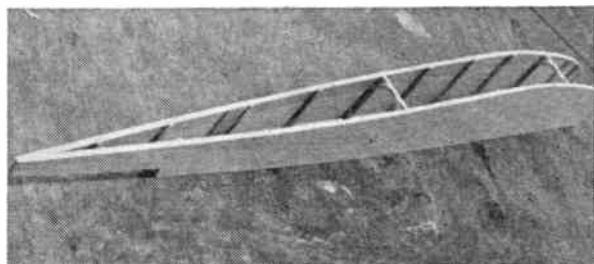

Fig. 3

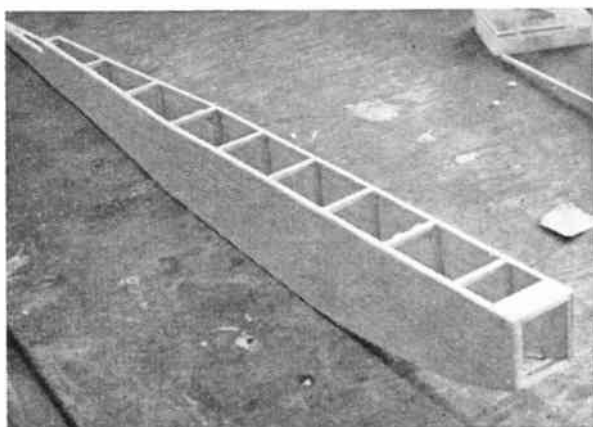

Fig. 4

the same on the opposite edge and along the 4 in. long 'step' at the tail-end.

When thoroughly set, cut $\frac{1}{8}$ in. wide gaps in this $\frac{1}{8}$ in. square 'beading' to allow the $\frac{1}{8}$ in. square uprights to be fitted, the ends of which are cut flush with the edges of the fuselage side after they have been fixed. Note that no uprights are fitted at the positions marked on the drawing; separate 'key' frames are fitted at these locations at a later stage (Fig. 1).

Cut two small pieces of $\frac{1}{8}$ in. hard balsa $\frac{1}{2}$ in. wide and trim one to fit snugly against the upright at the nose and between the $\frac{1}{8}$ in. square beading; trim the second piece to fit similarly near the rear of the fuselage side and then cement both pieces in place. Finally, fix a strip of $\frac{1}{8}$ in. square balsa between the beadings at the extreme rear of the component, and then remove the whole side. Treat the second side in exactly the same way.

Next, construct the two fuselage 'key' frames, the dimensions of which are given on the drawing. Clip the $\frac{1}{8}$ in. square top and bottom members between pins, cement in place the uprights, and check that the corners of the resulting rectangular shape are true right angles. Then add the diagonal braces, which are cut from $\frac{1}{8}$ in. by $\frac{1}{8}$ in. strip, and trim true.

Remove the frames and cement them in the appropriate places on one of the fuselage sides. To ensure that they are kept at right angles to the side, cut a small triangle of balsa which incorporates a perfect right angle and keep using this as a check on both frames until the cement has completely set (Fig. 2). Then cement the second fuselage side in position and place the assembly upside down with the straight edges of the fuselage top flat on the building board.

As shown in the plan view of the fuselage all the cross-braces of $\frac{1}{8}$ in. square balsa at the top and bottom of

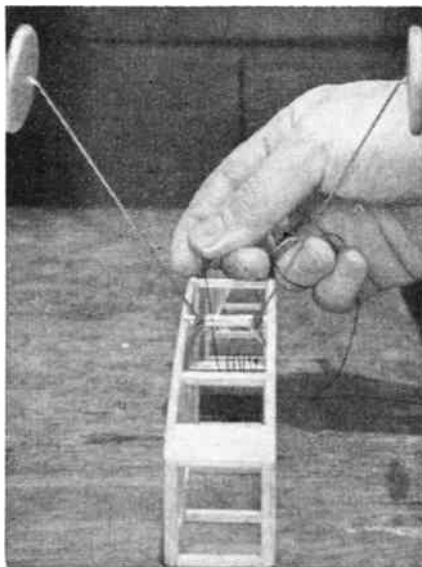

Fig. 5



Fig. 6

the fuselage are the same length up to points where the sides begin to taper towards the rear. Cut these each $1\frac{1}{2}$ in. long and cement them in place. Chamfer the $\frac{1}{8}$ in. square beading on the inside faces of the fuselage sides at the rear end, so that the sides join neatly as indicated on the drawing, and cement them together (Fig. 3). Cut the rest of the cross-braces, fit them in place, and fill in the nose at the top and bottom, immediately behind the front cross-braces with pieces of $\frac{1}{8}$ in. balsa $\frac{1}{2}$ in. wide. Glasspaper smooth and round-off the edges of the balsa sides (Fig. 4).

From a length of 18 gauge piano wire bend the undercarriage to the shape shown on the drawing. The $1\frac{1}{2}$ in. diameter wheels may be purchased ready-made and fixed in place by soldering cup-washers on to the ends of the protruding axles. Alternatively, hub-less streamlined wheels, as in the original, can be made from discs of $\frac{1}{8}$ in. sheet balsa as shown in the diagram and fixed in a similar way. Cement the undercarriage in the position shown, and add a further brace across (and inside) the fuselage against which the top of the undercarriage wire can rest. Cement and bind the wire to this and also bind the legs locally to the bottom cross-brace (Fig. 5).

Cover the top and bottom of the fuselage with tissue, water spray, and when dry, apply a coat of shrinking dope. Then cover over the top of this with a second layer of tissue, but this time use banana oil as an adhesive (Fig. 6). Glasspaper the sides of the fuselage and apply two or three coats of banana oil, glasspapering between each coat.

Finally cut the wing saddle-rails from hard $\frac{1}{8}$ in. sheet balsa and cement them in place.

In the next article we shall be dealing with the construction of the nose-assembly, the flying surfaces and the completion of the model.

CHEMISTRY AT HOME

INORGANIC lead salts offer a readily accessible and interesting field for the home chemist. The importance of some of them to everyday life is soon apparent in the course of one's experiments. White lead is unrivalled for cheapness and covering power, and it is the foundation stone of good paints. It consists of basic lead carbonate. Industrially, lead is placed in contact with spent tanning material and vinegar fumes. The lead is gradually converted into white lead. It can be made by a much quicker process, though its covering power is not so good as that produced by the slow corrosion process.

This quick process consists of double decomposition between solutions of a lead salt, such as lead acetate ('sugar of lead'), and sodium carbonate (washing soda). Make a solution of lead acetate in water and add sodium carbonate solution with constant stirring until a drop of the mixture is alkaline to litmus paper, that is, until red litmus paper is turned blue. This indicates a slight excess of sodium carbonate and hence rather more than enough for complete reaction.

A heavy white precipitate of basic lead carbonate will have formed during the addition, and this should now be purified from the soluble sodium acetate



AMMONIUM
SULPHIDE

Fig. 1—Changing a horse into a zebra

also formed in the reaction by thorough washing with water, either on the filter or by decantation. Dry the precipitate either on a tile or in the oven. Lead salts are, of course, poisonous if swallowed and so should be kept away from food.

Grind a little of the basic lead carbonate with linseed oil containing some

turpentine and try painting with it. A good finish results.

The disadvantage with lead based paints is their tendency to darken in the sulphur-laden air of towns. This is due to the formation of black lead sulphide. In the home laboratory this can be turned to account to mystify your friends. Draw a horse on a small piece of paper and cut out the figure. You are going to turn this into a zebra merely by placing it in a jam jar!

LEAD SALTS

Grind a little basic lead carbonate to a thin paste with water containing a little glycerine. Paint stripes on the horse and let the paint dry. Put a few drops of ammonium sulphide in the bottom of a jam jar provided with a cardboard disc cover or with a saucer (Fig. 1). Now admit your friends, remove the cover, put in the horse and replace the cover. The horse astonishingly develops the stripes of a zebra!

What happened is that the ammonium sulphide was giving off hydrogen sulphide which reacted with the lead carbonate to form lead sulphide.

Another lead salt useful in the world of colour is lead chromate. This is the chrome yellow of artists and decorators. Unlike white lead this pigment did not originate by chance observation of what happened when lead, vinegar and spent tan bark came together, but was born in a chemical laboratory. From being a scientific curiosity it went out into the world and reached every studio, paint shop and classroom.

With lead acetate and potassium dichromate to hand in even the smallest home laboratory we cannot let its preparation go undone. Double decomposition again is operative. To a solution of lead acetate, add potassium dichromate solution with stirring, until no more intensely yellow precipitate forms. The latter is, of course, the desired lead chromate. Purify it by treating it with several lots of water either on the filter or by decantation. Dry the lead chromate as you did the basic lead carbonate.

A little of this ground with weak gum water, and used as a water-colour, will indicate its intensity. Paler shades, such as lemon chrome, are produced by dilu-

tion with lead sulphate. The best way to effect this is by co-precipitation, for the admixture of the two is much more complete than by merely grinding the two together. If lead acetate solution be precipitated by a mixed solution of a soluble chromate and a sulphate, both lead chromate and sulphate come down together, their molecules evenly mingled.

Precipitation is improved by the addition of a little sodium carbonate to neutralize the dichromate to a chromate. A brilliant lemon-yellow shade of chrome yellow can be made thus, by dissolving all together in 200 c.c. of water 0.75 gram of potassium dichromate, 9.66 grams of sodium sulphate (Glauber's salt), and 0.72 gram of sodium carbonate. Stir this solution into one of 13.27 grams of lead acetate in 200 c.c. of water.

The precipitate which forms is much paler than the chrome yellow you first made. Wash thoroughly by decantation

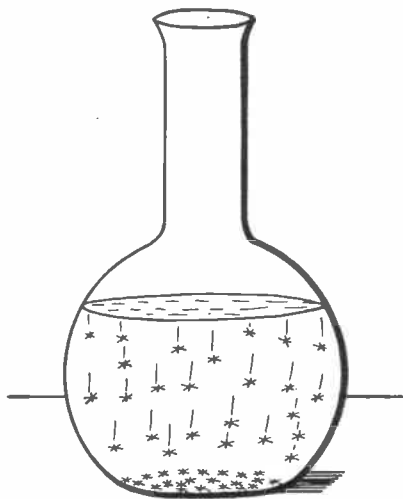

Fig. 2—The golden snowstorm

or on the filter. Dry the pigment either spontaneously or in the oven. The proportion of lead chromate to lead sulphate in this lemon shade is about one to seven. By varying the proportion of sodium sulphate, deeper or lighter shades may be produced.

● Continued on page 132

What to search for

LOOKING INTO SPACE

HAVING made the telescope and accessories described in previous articles, and had a general glance at the heavens, the amateur astronomer will feel the need to do more than just peer at random. To know where to find spectacular nebulae and star clusters in the depths of space presents no difficulty. Star maps and popular books on astronomy are plentiful second-hand, new, or in the public libraries.

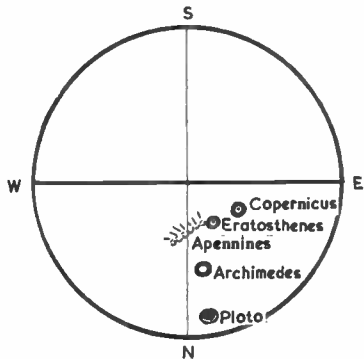
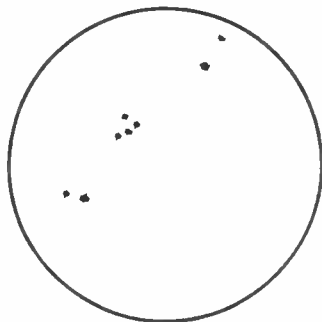
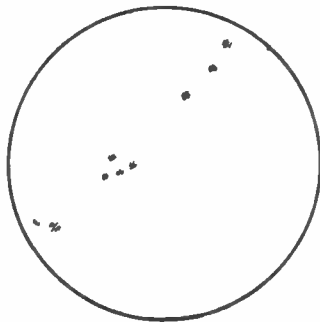

Fig. 1—Finding main lunar features by quadrant



FIRST DAY



THIRD DAY

Fig. 2—Sunspot changes in two days

Our nearest neighbour in space, the moon, is an easy object for the amateur's telescope, and every opportunity should be taken to see the various craters, mountain ranges and so-called 'seas'. At first sight the surface seems a confused, scarred jumble, and the identification of individuals a difficult task. A good moon map and a little systematic observation will surprisingly quickly restore confidence. A first-class guide to the moon's surface is to be found in *The Amateur Astronomer* by Patrick Moore (Lutterworth Press; 1957; 25s.). This consists of photographs side by side with

drawn maps naming the various features.

A further aid is to divide the moon's disc into quadrants, as shown in Fig. 1, and familiarize oneself with the larger features such as craters Copernicus, Archimedes and Plato in the N.E. quadrant. Once such as these are readily recognized, the smaller features in the quadrant are much easier to identify. It is soon possible to test out one's telescope for the smallest feature it will reveal. With the power of 80X recommended in the constructional article, crater Bessel in the Mare Serenitatis (Sea of Serenity) may be picked up in favourable conditions of illumination. This crater is about 12 miles in diameter. Remembering that the moon is getting on for a quarter of a million miles away, this is not a bad showing.

Incidentally, Fig. 1 may cause puzzlement in showing a reversal of south and north, but not of west and east. Teleoscopically, the last two are actually reversed, but astronomers prefer to retain them as shown. Consequently, all astronomical books show lunar compass points and quadrants in this way.

The best time for observation is when each crater is not fully illuminated, that

observations through the phases when craters seen clearly are difficult to make out a night or two later. As soon as the sun's rays are at a high angle, detail disappears.

Sunspots

With the aid of the sunspot charting attachment described in an earlier article a really interesting series of record charts can be compiled. Whenever possible, chart at the same hour of the day. With a clear run of sunny days the drift across the sun's disc changes in individual spot groups, and the appearance and disappearance of new spots at the sun's edges can be compared (Fig. 2).

By L. A. Fantozzi

The sun revolves on its axis every twenty-seven days. Spots pass out of sight round the invisible part of the disc. Fourteen days after the disappearance a watch can be kept for their possible reappearance. Should they not have cleared up during the period, any changes can be noted. Spot groups are often maintained for several revolutions of the sun. Each chart should be dated, and the time of observation inserted. As the sun is rarely without spots, there is nearly always something of interest to be recorded.

Though the planets are so much nearer to us than the stars, little can be seen with a power of 80X. Much higher powers are needed to show surface detail. Yet even 80X makes them worth while observing. The reddish colour of Mars is readily seen, the dazzling whiteness of Venus, the moons of Jupiter and the rings of Saturn. Star maps are useless for finding the planets, since the latter move about, whereas the stars remain in the same positions relative to each other.

Typical planets

For the amateur, the best aid to finding the planets is *Whitaker's Almanack* for the current year. Each month planetary notes are given and where in the heavens to look. A naked eye inspection of the indicated part of the sky will reveal what appears to be a star, yet with the difference that it does not twinkle, and often appears very bright. On now looking through the telescope it will be found that instead of the small brilliant point of light typical of a star there is seen a definite small disc. This

● Continued on page 132

disc appearance is typical of a planet.

Jupiter and Saturn will provide the most interest. Jupiter shows up as a comparatively large disc. On gazing steadily, at least four points of light should be seen close to it, rather like minute stars. These are some of its twelve moons. Saturn appears as a small oval at the present tilt of its axis. Steady gazing will reveal the central globe, a thin dark ring very close to it, and a larger light ring outermost.

The most spectacular objects to look for among the stars are star clusters and nebulae. The first requirement is to familiarize oneself with the constellations. These are groups of stars of which The Plough (also known as The Dipper, The Coach and Horses, The Great Bear and, to astronomers, as *Ursa Major*) is an example and which nearly everyone recognizes at sight. Not all are visible on any given evening. They are best identified one by one through the year as they come into favourable observing position in the eastern half of the sky. As the constellations rise in the east and wheel over to the west month by month, they soon become familiar and individual items can be sought out.

Star maps simplify the identification. To use The Plough as a comparative size and position guide clears up any doubts.

Seven Sisters

Some clusters are visible to the naked eye. An example is that of The Pleiades in the constellation Taurus (Fig. 3). This cluster is often called The Seven Sisters. The telescope reveals a great many more than seven, and a truly magnificent sight they are. The Pleiades is an open cluster. Another is readily seen with the telescope between Perseus and Cassiopeia. A magnificent globular cluster can be seen in Hercules, lying between this constellation and Corona Borealis (Fig. 4). Its stars are packed closely together like a ball, hence its designation as a globular cluster.

The two finest nebulae for the amateur's telescope are those in Orion (Fig. 5) and Andromeda (Fig. 6). A dark and clear night shows them to the best advantage, for then more of the misty patch of light of each is discernible. They are easily found. Star maps, particularly those given in *The Amateur Astronomer*, will indicate the position of many more, and as one progresses with one's observations, one realizes there always remains very much more to seek than one has already found.

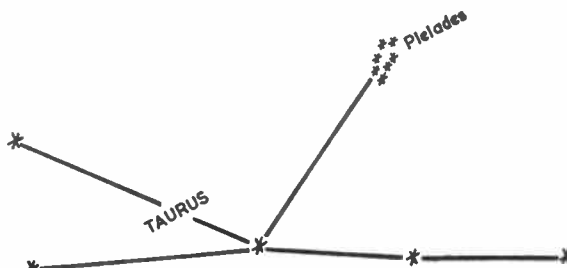

Fig. 3—The Pleiades cluster in Taurus

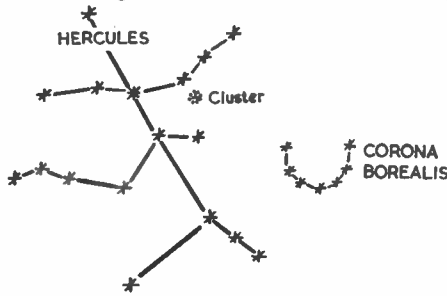

Fig. 4—The position of the globular cluster in Hercules

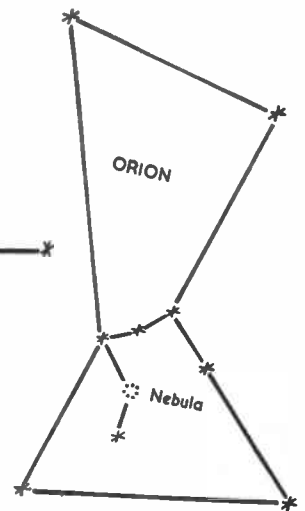

Fig. 5—The Great Nebula in Orion

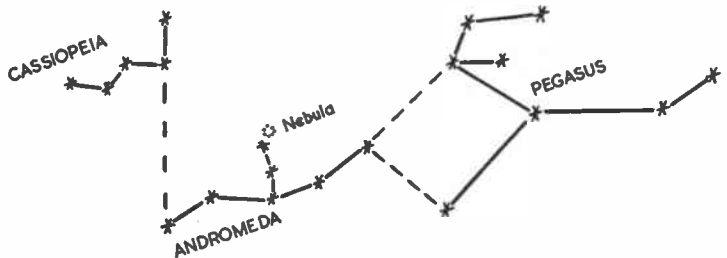

Fig. 6—How to find the Great Spiral Nebula in Andromeda

● Continued from page 130

Experiments with Lead Salts

Another highly coloured salt of lead is lead iodide. Dissolve about a gram of potassium iodide in water and add to it a solution of lead acetate. A yellow precipitate forms. Continue adding lead acetate solution until no more precipitate appears. This is best ascertained by filtering a little of the mixture from time to time and adding a few drops of lead acetate to the filtrate. When no precipitate appears in one-filtrate the reaction is complete. Filter off the lead iodide, preferably with the aid of the filter pump.

Lead iodide is slightly soluble in water, one part dissolving in 1235 parts of cold water. In hot water it is much more soluble, one part being soluble in 194 parts of the boiling solvent. This affords an interesting means of purification in that the crystallization from the cooling solution is a very beautiful sight.

Transfer the lead iodide to a 500 c.c. flask containing about 320 c.c. of boiling water. If all the lead iodide does not dissolve, add small further portions of water until it does. Note that the solution is colourless, not yellow as might be expected from the colour of the solid iodide.

If the sun is shining, the effect of the subsequent crystallization can be much enhanced by standing the flask in the sunshine. As the solution cools magnificent golden yellow spangles begin to appear, increasing as the temperature falls and looking like a shower of golden snow as they fall through the solution (Fig. 2).

When the solution is cold let it stand overnight for maximum crystallization to take place. Then filter off the iodide and let it dry. (L.A.F.)

Next week's free design is for making a 'Ship's Wheel' Perpetual Calendar.
MAKE SURE OF YOUR COPY

'STABLE-DOOR' SERVING HATCH

A SERVING hatch in the style of a stable door will be a novelty for the children and a definite boon to the housewife.

A stable door is a door cut in two halves, each half being hinged separately so that they can open independently of one another. They are often incorporated in caravans, and Londoners will have seen many in use in Mews converted into dwellings.

By E. Capper

Not everyone likes to tackle the building of a serving hatch. The mere thought of having to remove bricks from a wall, build framework and doors and re-plaster, scares all but the very keen handyman. With stable doors, a simple drop-on tray can be made in an evening, forming a combination that makes an ideal serving hatch.

The first job is to convert your present door into a stable door. Unhinge it and, using care, cut it exactly in half. If you have an old-fashioned door with sunken panels you may feel the time is opportune to cover it with $\frac{1}{2}$ in. thick hardboard to make it up-to-date. Use panel pins to fix the hardboard.

Next, re-hang the door portions. An extra hinge will have to be fitted on each half of the cut door. Matching hinges should not be difficult to obtain, and the fitting of the present hinges will be a good guide in fitting the extra hinges.

The existing door handle and lock, if any, will have to be removed, and any holes left should be filled in with a wood filler. Ball catches are then fitted, one to serve each half of the door.

The drop-on tray is simply made from a framing of 1 in. square planed battening with a surface of plywood or hardboard. Use oval nails and glue to fit the battening together. Round off the corners as shown in Fig. 1. A useful width is 14 in., whilst the length should be around 1 in. shorter than the door opening. Fit the hardboard surface with panel pins.

Four triangular brackets are made and screwed to the inside edges of the framing. The pairs are fitted about 3 in. in from the tray ends and should be spaced apart exactly the thickness of the door. This will allow the tray to fit firmly on the door edge without wobble — an essential when the tray is loaded.

Baize can be stuck on the edges of the brackets if desired, where they contact the door faces. If doing this, allow a little extra in the spacing of the brackets.



The surface of the tray can be covered with Fablon or Contact to allow easy wiping-down.

If you prefer, you can make a fixture of the tray, as shown in Fig. 2. First, screw 1 in. square planed battening along the two top edges of the lower half of the door. To these, fit two drop-flap pieces, made from 6 in. by 1 in. planed deal, by hinging with two pairs of brass butt hinges.

Two pairs of supporting hinged brackets are next fitted. Here again, make them from 6 in. by 1 in. planed deal, to the approximate proportions shown in Fig. 2 and hinged direct to the door face.

With the drop-on type of tray, you may care to use a suitable sized wooden tray instead of making one from batten framing and hardboard. Again, small steel angle brackets can be fitted instead of the triangular wooden ones.

If you find you have now made an unwelcome draught by cutting the door into two halves, tack on a strip of half-round moulding along the bottom edge of the top half of the door. Allow its edge to project for say, $\frac{1}{4}$ in., so that when the two halves of the door are closed, the projecting edge of the moulding covers up the gap between the two doors.

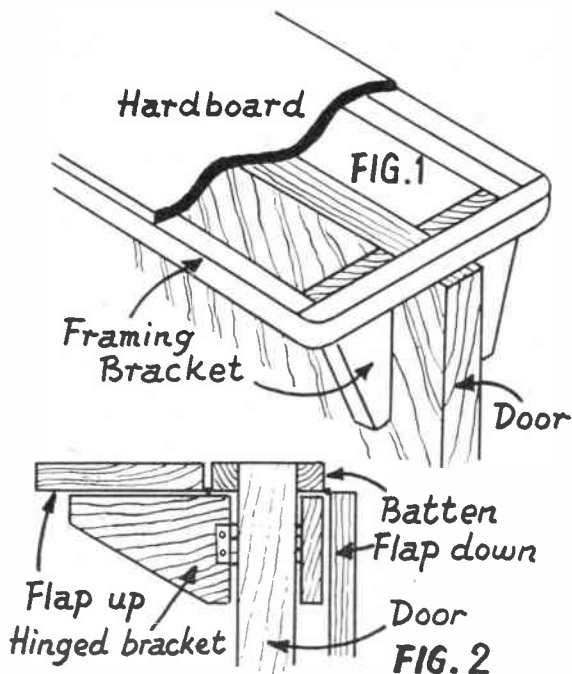

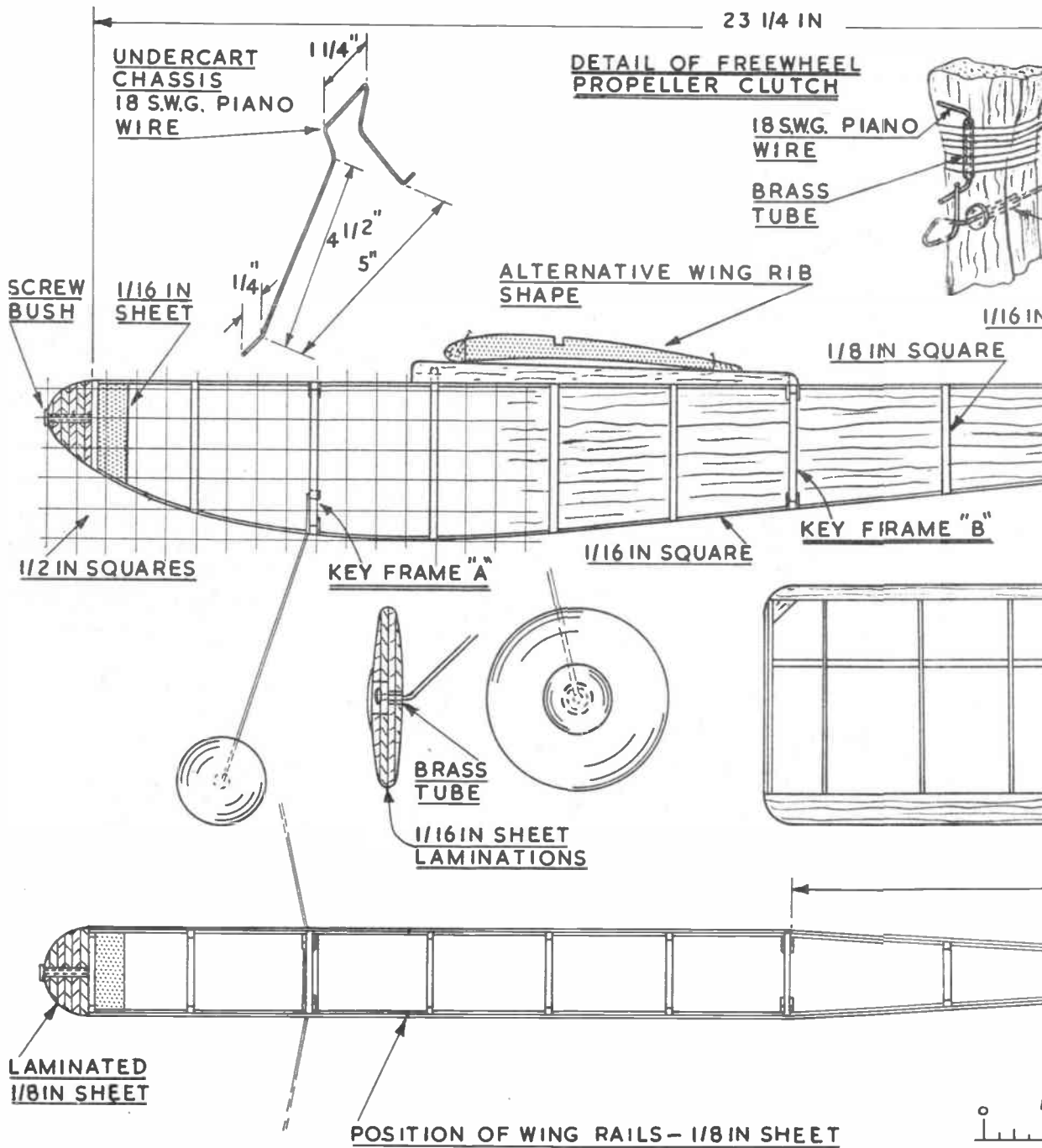

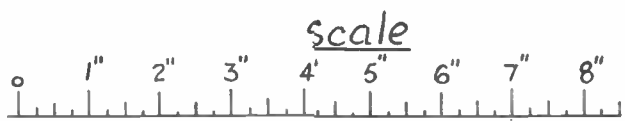
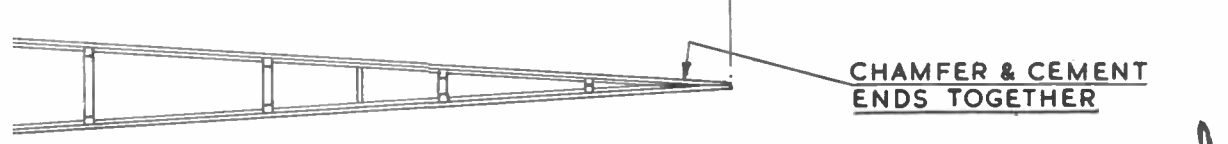
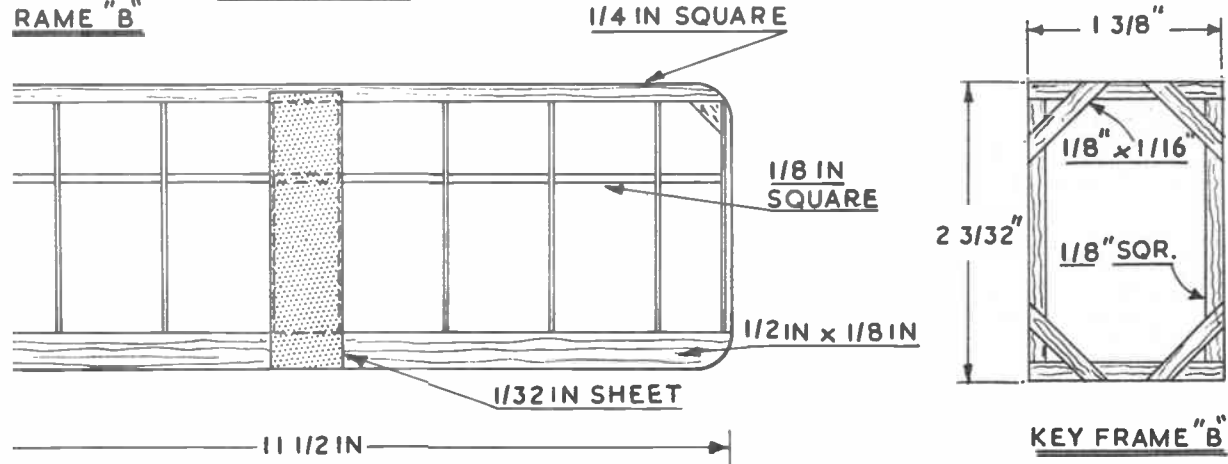
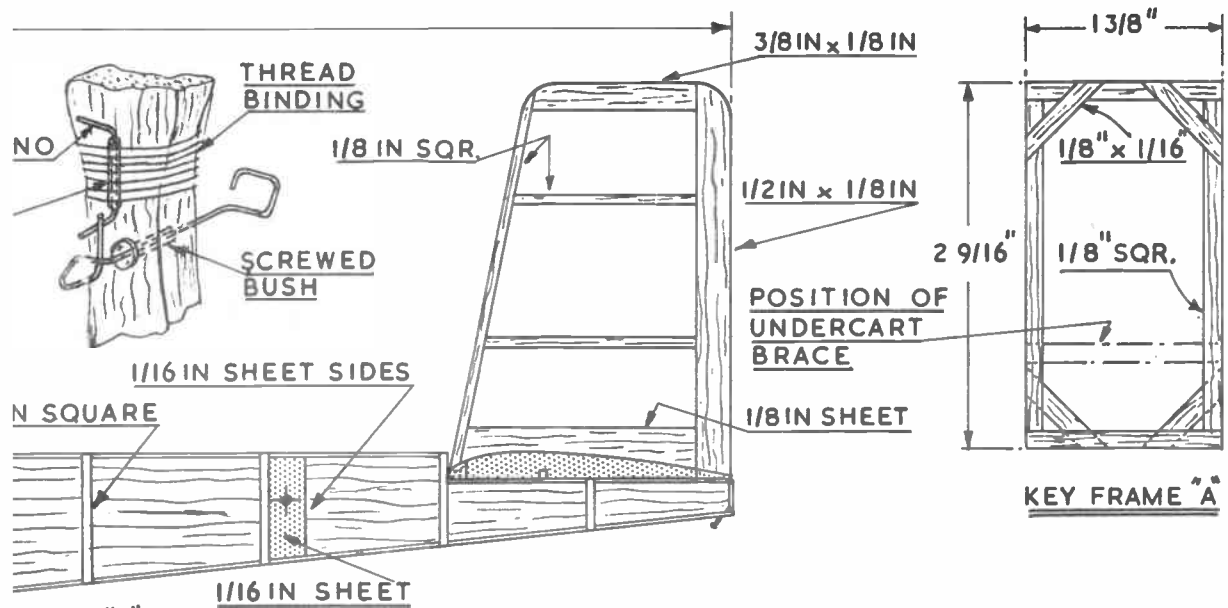

Hobby Blipped

MODEL SPEED CONTROLLER

THE speed at which an electric motor runs can be governed by means of a resistance control circuit, and this adds interest and realism to many models. Model boats may be fitted with a fully variable speed control, or with a stud controller or switch giving 'Full' and 'Half Speed' running. With trains, a variable controller is often used, so that the engine can be slowed down, but from time to time controlling speed in this way will be an advantage in almost any model.

A similar resistance controller can be used for dimming bulbs or lamps, for

By 'Modeller'

dissolving picture model viewers, or other purposes. The circuit is the same with either a motor or bulbs. The source from which current is obtained may also be a battery, accumulator, rectifier, or transformer. These points make no difference to the construction or method of using the resistance controller.

The circuit for adding a speed control or dimmer is shown in Fig. 11. The resistance is simply added in one lead to the motor or bulbs. A switch is often included as well, to enable the model to be switched off. But if the speed controller has an 'off' position where the circuit is

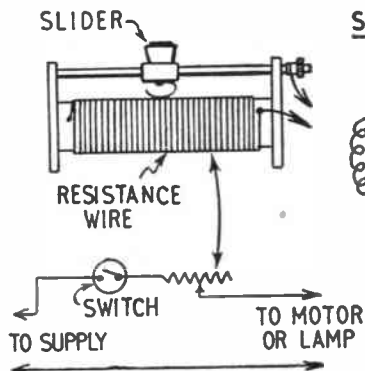

Fig. 11—Resistance control circuit

interrupted, a separate switch need not be used.

Making controllers

A resistance controller of the kind shown in Fig. 11 can easily be made up from wood. The slider moves along a metal rod, and has a curved metal contact which presses upon the turns of

resistance wire. With the slider fully to the right, little or no resistance is in circuit. As the slider is moved towards the left, more resistance is brought into circuit, thereby dimming the lamps or reducing the speed of the motor.

The resistance wire can be wound upon wooden dowel about $\frac{3}{4}$ in. or 1 in. in diameter, and about 3 in. long. Square pieces of wood screwed each end will hold the metal rod on which the slider moves. The slider may be fashioned from wood provided a flexible lead is taken directly from the screw securing the curved brass contact strip.

The thin iron wire sold for binding flowers is suitable for some motors. Or a few feet of alloy resistance wire can be bought. The gauge is not very important. For a small motor or bulb circuit, about 26 SWG will do, with about 22 SWG for the larger, powerful type of model motor.

To find how much of the particular wire used will be needed, hook up the motor and battery, with the resistance wire forming one connection, and slide the battery along, to bring more and more wire into circuit, until the motor is only just running. This length of wire is then cut off, and wound tightly on the wooden dowel, the turns being spaced out slightly. If the resistance is varnished, except where the slide passes, this will hold the turns secure.

If the resistance wire is rather thick, a

scrape away the enamel where the slider contact bears on the wire.

Rotary controllers

A stud controller can be made by fixing a ring of bolts or contact studs to a disc of paxolin or wood, and arranging a rotating arm so that it can bear upon any of the studs, as shown in Fig. 12. If one stud is not connected, this will provide an 'off' position for the arm.

Coils of resistance wire are secured between the studs, as shown, and the resistance in circuit drops as the arm is turned in the direction of the arrow. At the last stud, no resistance wire is in circuit. This gives full speed.

The resistance coils can be made by taking a few inches of wire for each coil, and winding it into a spiral on a pencil or similar object. These coils can be under the disc, or contained in a case, the contact studs being in a ring or arc on its front.

Single strands of very thin copper wire, wound into spirals, can be pressed into service if no resistance wire is available. But iron or resistance wire is stronger, because it does not need to be so thin. The small coils will grow quite hot, when in circuit, but this does not matter.

A rheostat is also shown in Fig. 12. Here, the resistance wire is wound on a curved strip of insulating material, and a rotating contact arm, worked by a knob and spindle, bears upon the wire. This

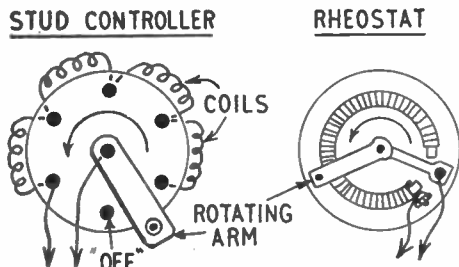

Fig. 12—Two further types of resistance controller

long piece (perhaps several feet) will be needed to slow the motor down. But if the wire is very thin, it will grow hot, and only a few inches will almost stop the motor. Very thick or very thin wire is thus rather awkward with this kind of controller.

If an 'off' position is wanted, leave enough free space for the slider contact to move completely off the resistance wire, when fully to the left. If enamelled resistance wire is obtained, carefully

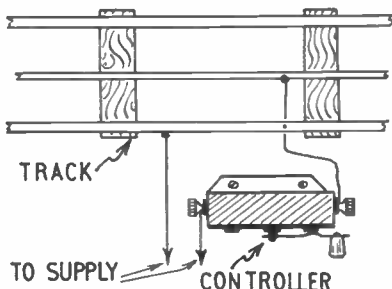

Fig. 13—Speed controller with model railway

kind of variable resistance is quite often available as surplus, and can be mounted in a small box, with on/off switch, to form a control unit.

In some models, such as boats, full and half-speed control may be sufficient. This can easily be arranged. A length of wire which will produce half-speed sailing should be found by trial, as explained, then coiled into a resistance spiral like those in Fig. 12. This coil is then included in series with the motor, with a

The world's knowledge

in ARTHUR MEE'S

CHILDREN'S ENCYCLOPEDIA

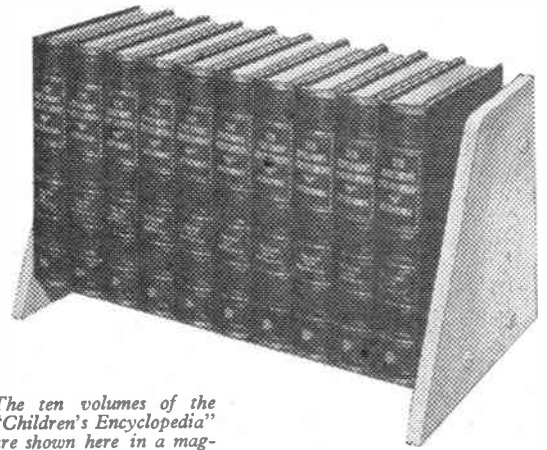

The ten volumes of the "Children's Encyclopedia" are shown here in a magnificent Solid Oak Bookcase which is presented FREE with every set.

In ten wonderful volumes the "Children's Encyclopedia" has all the information you need. Hundreds of different subjects from bridge building to railway working enable you to find out all you want to know about your favourite subjects. And the "Children's Encyclopedia" is a tremendous help with your lessons.

17,000 pictures make reading interesting

they help give a clarity to the subject matter which you will find very useful and interesting. These pictures include many in full colour to make it easier to understand and visualise what things look like in real life.

Ask your Mother or Father to fill in the coupon today and then to post it off, so that you can have all the information you need about the "Children's Encyclopedia".

**To: THE EDUCATIONAL BOOK CO. LTD.,
New Fleetway House, Farringdon Street, London, E.C.4.**

Please send me the FREE 28-page booklet which describes the "Children's Encyclopedia".

Name.....

Address.....

.....

HOBBIES 9A.

small on/off switch in parallel. When the switch is closed, the resistance coil is shorted out of circuit, so that the motor runs at usual speed. But when the switch is open, the coil comes into circuit. The two switch positions can thus be marked for 'Full' and 'Half Speed' running.

Wiring in

The resistance controller may be in either lead, and may be at any convenient point in the circuit, or near the motor or battery.

If used to control a train, it can be fitted in series with one rail, as in Fig. 13,

or it can be near the battery or transformer. If an on/off switch is included, this can also be at any handy spot, and in either lead, as convenient.

With some models the controller can be fitted in such a position that it represents the speed-control lever of the full-sized engine, boat, tram, or other prototype. But with a model train on a rail circuit, it is best to have the speed controller separate, near the track.

A speed controller is not a satisfactory substitute for the reduction drive or gearing which is generally required with a model electric motor. This reduction

drive should be present, as usual, because it allows the motor to generate more power, due to its relatively high speed. No difficulty will arise if the reduction drive is just the same as it would be if no speed controller were fitted.

Controllers like those described must not be wired directly to the mains. They are intended for low voltages, such as those obtained from dry batteries, an accumulator, or a mains transformer or rectifier.

The next article will describe
REVERSING MOTORS

Mainly for Modellers

IN ship modelling we find that although many tools are available in kits of tools such as X-acto, etc, we frequently are at a loss for one of a particular size.

Tools frequently wanted are small gouges, and these I make from pieces of umbrella ribs, mounted in a dowel handle as in Fig. 1; for larger gouges I

use hacksaw blades. These are made by heating the blade to a dull red to soften it and, after cooling, the teeth are filed off. A block of wood is rounded on one edge to make a shaping tool. With the blade resting on a slightly open vice, the shaping tool is placed on top and hammered into the blade to shape it (Fig. 2). Fitted to a suitable wood handle, the gouge has only to be sharpened and re-hardened.

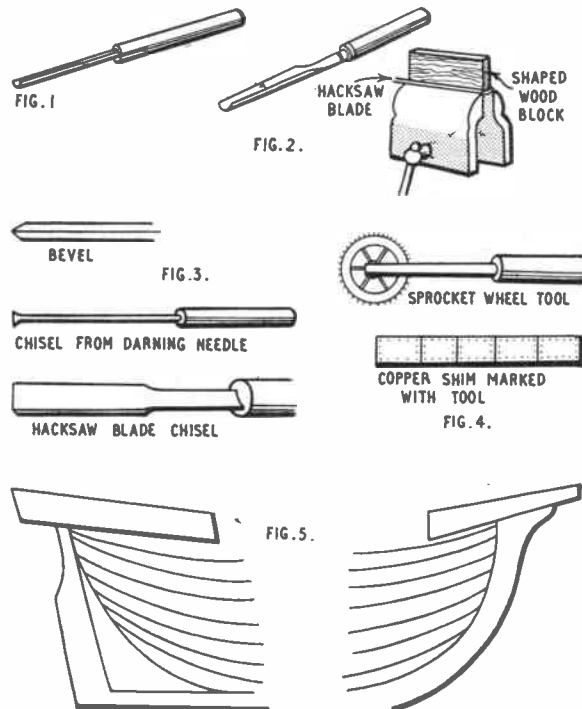

stone, afterwards mounting in a handle made from a piece of dowel rod.

Copper sheathing and plating

In many models of sailing ships up to the middle of the nineteenth century you will find that they were copper sheathed below the waterline as a protection against the boring beetles.

There are several ways of modelling this on your little ship. The easiest, and for small models undoubtedly, the best, is to use copper paint. Touches of green rubbed into the corners can suggest the presence of verdigris.

Copper shim can be used on larger models to make an actual sheathing; if you are a good miniature worker the plates can be cut and added separately as in actual practice. A method I follow on some models is to cut the shim into strips and, before gluing onto the hull, they are marked to represent plates. Mark the bolt heads with the tool shown in Fig. 4. This is made from a sprocket wheel from an old clock or watch (according to the scale of your model), mounted in a fork made from a piece of brass tube, and supplied with a wood handle.

The usual size of copper plates of this period were 3 ft. long by 1 ft. wide, so you can work out the size for your model.

Above the waterline the wood planking can be simulated by strips of veneer. To do this you must finish your hull smaller, by the thickness of the veneer to be used. Cut the veneer into thin strips of the width of your scale planks, and pin and glue in place, remembering to taper the planks where they reach the stem, sternpost and keel (Fig. 5).

Modern steel plate construction can be imitated by cutting the separate plates from drawing paper, spacing the fixing pins to represent the actual rivets.

For larger models, Bristol board can be used for the purpose. When either method is used, and the hull painted, the effect is that of actual plating.

Small chisels

The same method can be followed in making chisels from hacksaw blades. In this case we only use the shaping tool to shape the stem of the chisel, the front end being left flat; both tools need to be sharpened with a bevel on each side of the cutting edge (Fig. 3).

Very small chisels for use in carving the finer details on hulls of the Stuart and Jacobean periods can be made from needles, the darning needle being a particularly useful size. To make these, break off the eye sharply with a pair of pliers and shape the end on your oil-

Making toys, models and novelties is a paying pastime, and with a machine you can double your output right from the start. In fact you have a factory in the home.

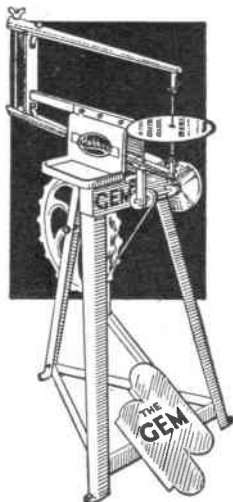
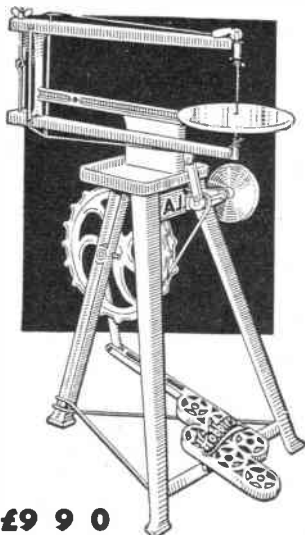

£9 9 0

THE 'GEM'
£5 17 6

'A.I.' TREADLE SAW

A sturdy machine with cast metal legs, metal table, wooden arms, special saw tension action, etc. Easy to treadle, smooth running and rigid. Provides a factory at home for the handyman — a machine for profit and pleasure.

A lighter machine with pressed metal legs, but easy running and a reliable worker. Sound value and a machine for all kinds of work. Spare blades, instructions, and designs are included with each.

THE 'MARVEL'
BENCH
MOTOR-
DRIVEN SAW

To meet modern needs. Just plug in and switch on from any house lighting point. For either A.C. or D.C. mains, with 230/250 volt motor, flex, switch, etc.

£12 5 0

Also a Bench Machine without motor for 97/6

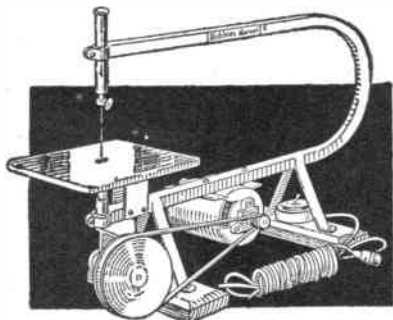

EASY PAYMENTS

A system is now in operation whereby a machine can be despatched carriage paid after the initial down payment, and subject to the completion of a simple form of Agreement. The slight additional cost over cash price is to cover extra clerical work, books, interest charges, etc. It is impossible for us to allow this system to apply in any part of Ireland, or anywhere outside Great Britain.

Agreement Forms are obtainable at any Hobbies Branch, where machines may be seen, and money paid each month. Or, you can do the business through Hobbies Head Office at Dereham, Norfolk, sending your instalments there.

GEM MACHINE

£1 5s. 0d. DOWN and 6 monthly payments of 16/11. (Cash Price £5 17s. 6d.)

A.I. MACHINE

£2 0s. 0d. DOWN and 8 monthly payments of £1 1s. 0d. (Cash Price £9 9s. 0d.)

MARVEL (without Motor)

£1 0s. 0d. DOWN and 6 monthly payments of 14/2. (Cash Price £4 17s. 6d.)

MARVEL (with Motor)

£2 10s. 0d. DOWN and 9 monthly payments of £1 4s. 9d. (Cash Price £12 5s. 0d.)

This model farm cost less than 2/6

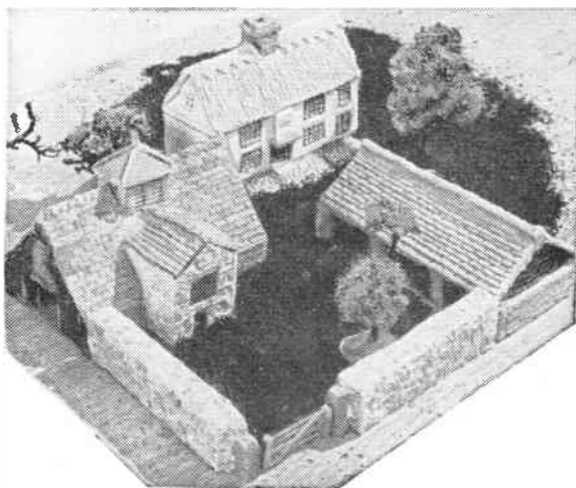

It was made from a half-crown tin of Sankey's PYRUMA — farmhouse, barn, implement shed, walls and gate — and there was still plenty of this grand modelling material left to build many more farm features, by simple methods described in the Instruction Book (see Coupon below). PYRUMA, plastic and ready-for-use, becomes stone hard after drying or baking, and can be painted in natural colours. For permanent modelling —

MAKE IT AND BAKE IT IN



Obtainable from your local Ironmonger or Hardwareman and many Art Material dealers. Ideal for making —

Model Railway Buildings and Accessories, Harbours, Ship Models, Airport Buildings and Features, Houses, Bookends, Ashtrays, Animals and Figures, Plaques, etc.

Post this Coupon today for your Instruction Book

J.H. SANKEY & SON, L^{TD}

Established over a century
Dept. H, ILFORD, ESSEX

Please send ILLUSTRATED INSTRUCTION BOOK with full colour pages on Pyruma Modelling.

Enclosed Postal Order value 6d. (not stamps)

NAME (Block letters).....

ADDRESS.....

MAKE YOUR OWN

FIRESIDE

CURBS

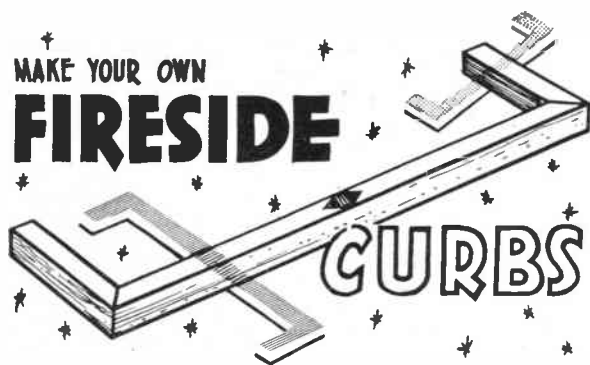

Described by S. H. Longbottom

A HANDSOME fireside curb can be made quite easily from ordinary 3in. by 2in. deal, half-jointed at the two corners, and finally covered on two sides with nicely grained oak or mahogany plywood.

Obviously, the curb should be made to fit your own fireplace but an average length is 52ins. with two pieces at the ends each 13ins. long. The two shorter pieces are half-jointed to the longer as shown in Fig. 1 and fastened together by glue and countersunk screws. Note that the joints must be trimmed clean after jointing.

As stated, this plain deal curb is covered with plywood on the top and at the front and we have two methods available. If one piece is made to fit the exact length and width of the top and one for the front we are obliged to fill in with a strip of quarter round section, as shown in Fig. 2A. Alternatively, we can make the top portion a little wider, that is by the thickness of the plywood itself, so that it covers the edge of the front plywood and is ultimately rounded off by glasspapering.

The method to use should be decided

before preparing the plywood which is subsequently mitred at the corners and glued to the deal base, and it should be noted that the front piece should extend beyond each end to its own thickness, so that it will hide the ends of the side strips of plywood. We should also mention that there is another method of saving material, and that is by preparing the top portion in two pieces and making a small square inlay with the grain running in the opposite direction. This is clearly shown in Fig. 3. After carefully preparing the square it is laid on one

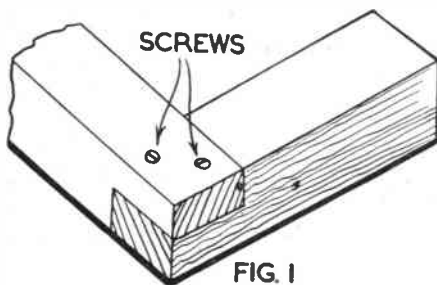

FIG. 1

QUARTER ROUND

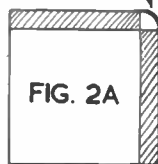

FIG. 2A

PLYWOOD

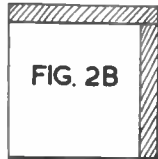

FIG. 2B

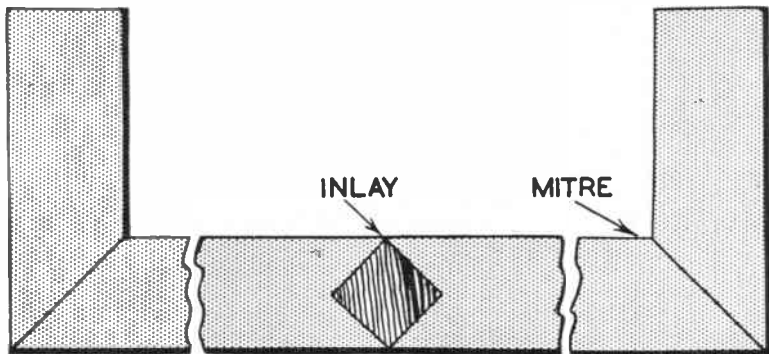

FIG. 3

half of the top and the perimeter scribed. After cutting out the resulting 'V' shape, fit the two parts together and mark out the other section. A fine saw must be used and the rough edges smoothed with glasspaper to make a perfect fit. We can also add moulded ornaments in the centre and at the ends if desired but these must be glued on after the plywood is fixed. Strong glue should be applied to the wood which is then placed in position and held firm with a waste piece of wood between cramps.

Constant close proximity to the fire will cause the wood of the curb to become very dry and it may easily ignite, so we must take additional precautions. Strips of thin sheet brass should be attached to the inside face of the curb. This material is easily obtainable from most sheet metal workers who will cut the strips to your size. All that is then required is the drilling of a few holes for screwing the brass guard to the inside of the curb. A final refinement is the addition of strips of baize on the bottom where it is in contact with tiles, linoleum or carpet.

The type of finishing depends entirely on the material used for making the curb. Oak-faced plywood should be stained and polished accordingly. Here you have the choice of french polish, a rubbed finish or a waxed finish, and similar

remarks apply to any wood you may select. We cannot overlook the fact that there are also many bonded plastics available which may be ideal for a kitchen curb and you may like to consider the suggestion before embarking on the project.

Although we have specified the use of 3ins. by 2ins. deal as being the basic size, it should be remembered that this is mainly for the lounge or dining room fireplace but where a small bedroom is involved it is wiser to reduce the size proportionately.

The Ideal Target Rifle
for the Young Shot

Webley



'JUNIOR' AIR RIFLE

Details on request
Semi-bead Foresight
14" Machine-cut Rifled barrel
Wheel adjustable Rear Sight

WEBLEY & SCOTT LTD., Established 1790
34 Park Lane, Handsworth, Birmingham 21

**YOU CAN BECOME A
HANDICRAFTS INSTRUCTOR**

EXPERIENCE NOT ESSENTIAL

Men who enjoy making things in wood or metal can turn their hobby into a permanent and interesting Career. Short hours, long holidays and security in a job you would really enjoy, can be yours if you become a Handicrafts instructor. Let us send details of the easiest and quickest way to get the necessary qualification.

We guarantee **"NO PASS—NO FEE"**

If you would like to know about our unique method of preparing you for one of these appointments, write today, and we will send you our informative 144 page Handbook—free and without obligation. Mark your letters "Handicrafts Instructor".

**BRITISH INSTITUTE OF
ENGINEERING TECHNOLOGY**

BIET

595 College House, Wright's Lane
Kensington, London, W.8

Watch & Clock Repair Outfit



The complete Outfit for cleaning and repairing. Comprises: Illustrated explanatory booklet, eye-glass, tweezers, screwdrivers, oil, dusting powder, oilers, also catalogue, tools and materials.

P. & P. 1/- extra. C.O.D. if required. **15/-**

The above with additional luminous compounds, jeweller's rouge, dial brush, jewels.

P. & P. 1/- extra. C.O.D. if required. **25/-**

Also available on request:
Illustrated Catalogue Swiss watches, Credit terms.
Illustrated Catalogue on Jewellery for Assembly.

BOLSTER INSTRUMENT CO. (Dept. H), Govett Avenue, Shepperton, Middlesex

STICK TO SECCOTINE

it sticks everything



1'3
PER TUBE

Sole Manufacturers—

McGAW, STEVENSON & ORR LTD., BELFAST 141

World Radio History

The making of a doll's house is a job well within the capabilities of any handyman. With a fretsaw, a few simple tools and one of Hobbies kits, he can make a lasting model of which he can be really proud, and one which is certain to please its small owner. For those who have suitable wood of their own, design sheets can be purchased separately. Metal windows, doors and fittings can also be obtained separately, and are listed in *Hobbies Annual*.

2 ft. wide
2 ft. high
16 in. deep

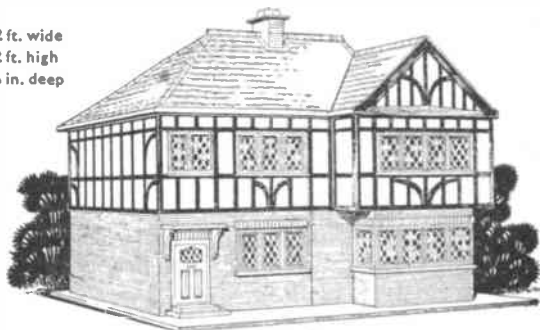

TUDOR DOLL'S HOUSE No. 237 Special

A large and attractive model of a typical half-timbered Tudor house, Double-hinged front. Metal windows, doors and fireplaces, and all necessary wood and fittings.

Price **92/6**



New low-priced **DOLL'S HOUSE. No. 254 Special**
Sturdy hardboard ensures rigid construction. Back opens to facilitate furnishing.

20 in. high Price **45/11**

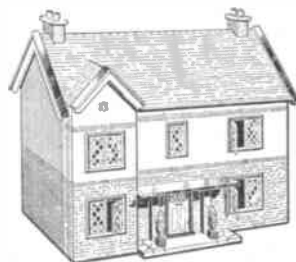

DOLL'S HOUSE. No. 2910
Another low-priced house. 17 in. wide. The front is hinged to reveal four rooms, a hall and landing.

Price **59/11**

DOLL'S HOUSE FURNITURE

Sets of designs for complete houses full of furniture are obtainable. For the smaller house (No. 2910) the set costs 2/-. The set for the larger houses (Nos. 237 Special and 254 Special) is 2/6. (Postage on each set 2d.) Complete kits containing a set of designs and all necessary wood are available price 8/11 (post 1/6) for the smaller house, and 19/3 (post 2/-) for the larger ones.

LIGHTING SET. Electrify your doll's house with a lighting set. Six bulb-holders, two switches, 6 yards flex and full wiring instructions.

(post 9d.) Set **7/11**

All supplies from branches, stockists, etc., or by post.

HOBBIES LTD DEREHAM NORFOLK

JAPANESE PYGMY TREES/MINIATURE GARDENS. Complete outfits of either 20/-, 100 varieties trees. Resale orders £4 for £3. **WREATH & BOUQUET MATERIALS,** Artificial Flowers, Everlastings. Dried & Dyed Grasses, Ferns & Foliage. Stamp all lists. — Station Nurseries (H.W.), Oakengates (Salop).

TRANSISTORS, Germanium Crystals, Head-phones, etc. Lists and diagrams free. Germanium Diodes with three crystal set circuits 1/-. Postage 3d. — P.R.S.(H), 33 Bourne Gardens, London, E.4.

★ LEARN ★ RADIO & T/V SERVICING for your OWN BUSINESS/HOBBY

● by a new exciting no-maths. system, using practical equipment, recently introduced to this country.

FREE Brochure from : —

RADIOSTRUCTOR

DEPT. G81, 46, MARKET PLACE,
READING, BERKS. 52/11

FREE gift of Korean Pictorials (cat. 15/-), and Guernsey Occupation Stamps to all who ask for Approvals. — Gibbons, The Close, Doyle Road, Guernsey.

GREAT FURNITURE SALE!
THREE-IN-ONE
★ **WRITING BUREAU**
★ **BOOKCASE**
★ **RECORD CABINET**



Sprayed Light or medium Walnut tone.

A really ultra modern space saving item of furniture for three essential purposes. Strongly constructed of seasoned timber, upper part consists of drop-front writing desk — closes when not in use — numerous compartments for documents etc. Spacious bookcase. Record Cabinet at base holds up to 200 records (upright for perfect condition). With modern sliding doors. Approx. 42" high x 24" wide. Only £3.19.6, carr. 11/6 or sent for £1. dep. bal. 18 ftly. pyts. 4/-, plus carr. Flat top takes radio cr gram, FREE LISTS, FURNITURE, RADIOS, GUITARS, CLOTHING, ETC. TERMS.

ONLY £3.19.6 CASH 11/6

H **E** **A** **D** **Q** **U** **A** **R** **T** **E** **R** **E** **R** **S** **E** **R** **S** **L** **I** **D** **S**

(HOBW/90) 196-200 Coldharbour Lane,
Loughboro Junc., London, S.E.5. Open Sat.

100 DIFFERENT stamps free! Request 1d. upwards discount approvals. — Bush, 53 Newlyn Way, Parkstone, Dorset.

STAMPS FREE — Empire Packet including Pictorials and Victorians with approvals. — Robert J. Peck, 7A Kemp Road, Bournemouth.

Completely new 54 page Edition

WHERE'S THAT CAR FROM?

Price 1/- (Postage 4d.)

Of all Booksellers

or

RALEIGH PRESS, EXMOUTH, DEVON

LEARN RADIO and ELECTRONICS the NEW practical way! Very latest system of experimenting with and building radio apparatus — 'as you learn'. FREE brochure from — Dept. HW10, Radiostructor, 46 Market Place, Reading, Berks.

MAKE A MUSICAL BOX for as little as 21/-. New kits and tunes available. Movements 13/- post free. Please send 3d. stamp for free illustrated catalogue. — The Swisscross Co., Dept. B, 202 Tulse Hill, London, S.W.2.

EXTRA CHEQUES from writing. Send for 'Ideas for Writers' (free). Scores of suggestions for beginners and others. Typewriter unnecessary. — Writers' Ring (H.W.), 5 Edmund Street, Birmingham 3.

GIFT for philatelists requesting Approvals. State interests. Postage please. — Jones, 46 Penallt Terrace, Llanelly.



Another "Musical" Winner! BALLERINA CIGARETTE BOX

Make it yourself

When the lid is lifted the gay Ballerina appears and "dances" to tuneful music in a ballet setting complete with a background of mirrors. Box holds 50 cigarettes.

Hobbies Kit No. 257 Special contains all materials for making the box, including paint, glue, mirrors, veneers, etc., and costs only 21/- (post 1/9 extra).

Post coupon for free booklet

Fit it with a musical movement, which incorporates the exquisitely dressed ballerina. Two tunes are available. Choose from:

B1 Swan Lake

B2 I could have danced all night

Price each 24/3
(post 9d. extra)

Many other outstanding novelties in Hobbies 1960 Annual. 168 pages, price only 2/- from newsagents, etc., or by post (6d. extra)



To HOBBIES LTD., Dept. 992, Dereham, Norfolk

Please send free 20-page booklet of kit details and items indicated.

- Ballerina Kit (21/- plus 1/9 post) 1960 Annual (2/6 post free)
 Musical Movement, state choice (24/3 plus 9d. post)

Name

Address

(Orders 30/- and over post free)

'SQUIRREL' LETTER RACK

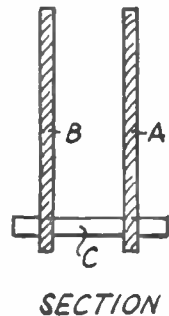
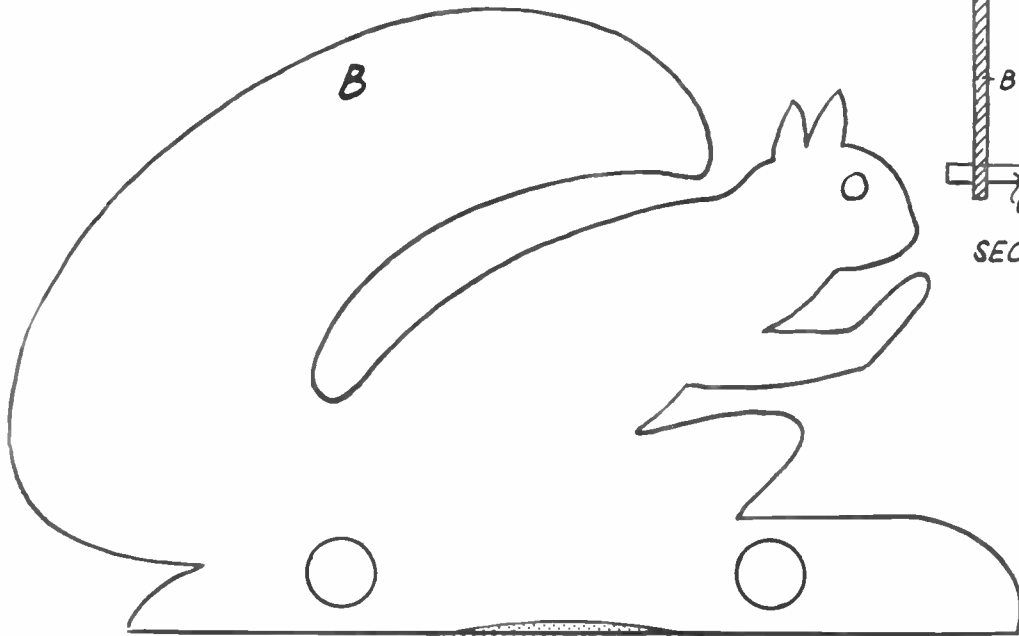

AN IDEAL JOB FOR THE FRETSAW

THIS easy-to-make letter rack is cut from $\frac{1}{4}$ in. wood with a fretsaw. Trace pieces A and B, and transfer them to the wood by means of carbon paper. After cutting, clean them up with glasspaper, making sure that the edges are smooth.

The two pieces are joined together by means of two pieces of $\frac{3}{8}$ in. round rod C 4 in. long, as indicated in the section. Finish off by painting in suitable colours. (M.p.)

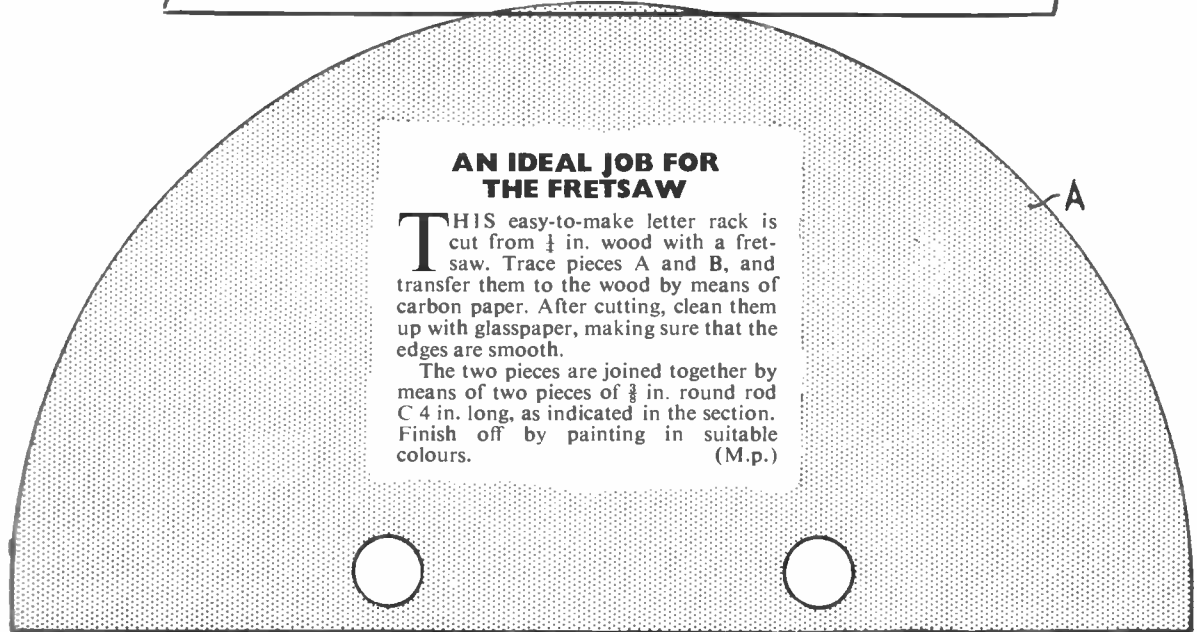

NOW build modern Style!
with REAL BRICKS AND MORTAR

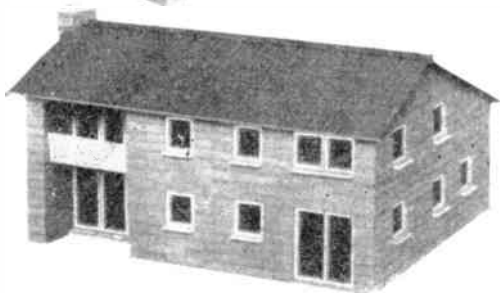
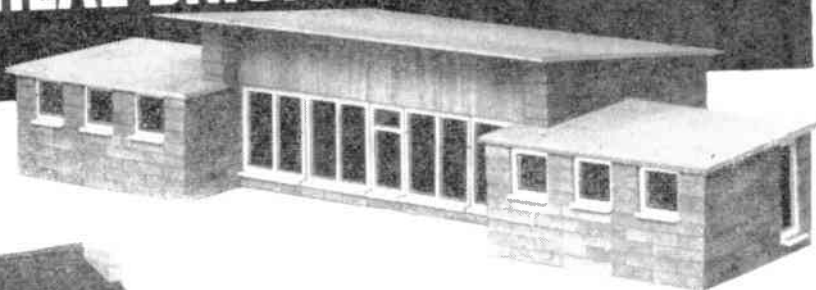

Exciting Contemporary Brickplayer enables you to *build modern!* It's the famous Brick and Mortar Building Kit brought bang up to date. New models are architect-designed to 'O' gauge scale. Kits include bricks in all required shapes, mortar, roofing, windows, doors; plans and instruction booklet. Models can be permanent or dismantled by merely soaking in water and bricks used again and again.

CONTEMPORARY BRICKPLAYER KITS :

"A" — 19 6; "B" — 26 9; "C" — 48 -

Extra bricks, roofing, cement, in low-priced packs; windows and doors obtainable singly.

TRADITIONAL BRICKPLAYER KITS also still

available - Kit 3—26/9; Kit 4—50 -; Farm Kit—61/6

At good toy shops,
hobby shops and de-
partmental stores. If
your dealer cannot
supply, please write
for leaflet and ad-
dress of nearest
sto-kist

CONTEMPORARY
BRICKPLAYER

J. W. SPEAR & SONS LTD., Dept. H.W., Enfield, Middlesex