

4th NOVEMBER 1959

VOL. 129

NUMBER 3334

THE ORIGINAL
'DO-IT-YOURSELF'
MAGAZINE

HOBBIES *weekly*

FOR ALL
HOME CRAFTSMEN

★ **FREE**
design supplement

Also in this issue:

FAIRY LIGHTS
FROM MAINS

A SPACE-SAVING
KITCHENETTE

COLLECTORS' CLUB

MAKING TOYS AND
NOVELTIES

'GUIDED MISSILE'
WALL BRACKET

ETC. ETC.

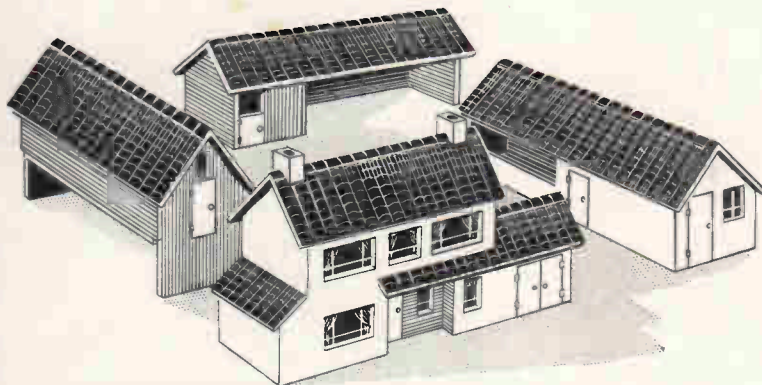

MODEL TOY FARM

How to make
**DAINTY
CACTI
BOWLS**



Up-to-the-minute ideas

Practical designs

Pleasing and profitable things to make

5^D

OUR articles on Meadophlogy have proved very popular. Hundreds of requests have come in for more informative features on breweries, public houses and signs, landlords and their hobbies, etc. One reader wrote:

'These articles are the most interesting I've read in years. It's good to read about our English pubs and the people who run them. It's a pity we have had to wait so long for such features — but let's hope you keep up the good work.'

I met Mr R. L. Thompson, Public Relations Officer of Ind Coope Limited, at the Brewery, Burton-on-Trent. 'So you want to write about us', he said. 'The Ind Coope Group is the largest in the British Isles and one of the largest in the world. We own over 5,000 properties, so you will have your work cut out. But I will help you all I can.'

THE IND COOPE STORY

It has always been part of Ind Coope policy to make every endeavour to ensure a happy and contented staff, and to make provision when misfortune occurs. This the company does, as well as taking every possible step to maintain a healthy working group of men and women. The welfare facilities available to all employees are as excellent as the safety record within the plant. The Medical Centre at Burton is a good example of what can be done in industrial plants.

It is a time-honoured tradition to give brewery employees 'allowance beer'.

'The men are allowed two pints a day', said Mr Thompson. 'Many enjoy a drink on duty, while others prefer to take their allowance home.'

In the afternoon I accompanied members of the Women's Section of The British Legion on a conducted tour of the brewery.

Mrs A. Smith, our hostess, introduced many of the officials, coopers, joiners, masons, painters, engineers and other trades who play a vital part in maintaining, at the highest level of efficiency, the many buildings, plant and equipment that constitute this vast brewery.

Founded in 1799

What of the history of Ind Coope? Here is what the company have to say of Mrs Ind, wife of Edward Ind, who founded the brewery at Romford in 1799, and of Mr O. E. Coope, who as a partner joined the firm, which then became Ind Coope in 1845.

'The Ind in Ind Coope has caused arguments in many a pub. Does it



rhyme with pined or pinned?'

'According to the archives, Mr and Mrs Edward Ind always pronounced it with a short 'I' as in India, and it was their fine brewing which started all the talk in 1799.'

phologist for about 18 years. His collection of over 40,000 labels from all parts is one of the largest in the world. Russian labels are never easily obtained, but Ian has many from Moscow and other breweries in Russia.



Their name, coupled with that of their partner, Mr O. E. Coope, was to become known all over the country. Their brewing skill, combined more recently with that of Allsopp's (founded in 1708), was to be passed on to men who would create such beers as Double Diamond, Long Life, John Bull and Graham's Lager, as well as a range of draught beers. Today, their small enterprise has grown into a world-famous brewery organization in Britain, with associations overseas in Eire, Kenya, Uganda, Trinidad and Canada.

Ian Tate is a brewer at the Wrexham brewery. He was a keen meado-

phologist for about 18 years. His collection of over 40,000 labels from all parts is one of the largest in the world. Russian labels are never easily obtained, but Ian has many from Moscow and other breweries in Russia.

Mr Simonds, landlord of the *Gloucester Arms*, Oxford, has been making hobby news lately. His collection of Double Diamond showcards on which the words 'Works Wonders' are printed in foreign languages is probably the only one of its kind. The most unusual sign in the collection is written in Pitman's shorthand.

No visitor can long be in Oxford without being aware of the many imposing and world-famous Inns and Hotels belonging to Ind Coope. For meadophologists, the city is the gateway to adventure.

(R.L.C.)

DAINTY BOWLS FOR CACTI

Described
by
S.H.L.

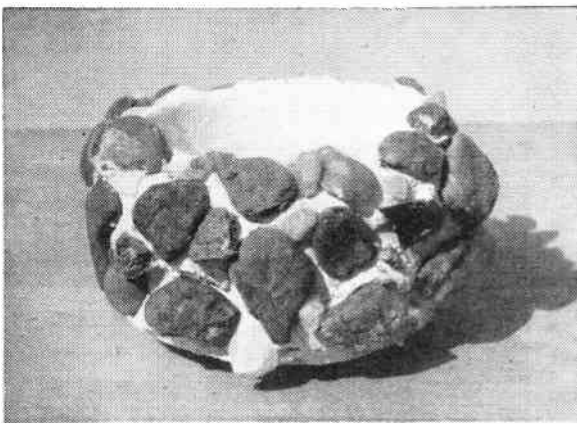

DAINTY cacti bowls as shown in our illustration, can be made without a potter's wheel or a kiln if parian cement or one of the modern crack fillers is used. Pebbles and shells can be used for ornamentation, or you may find suitable pieces of coloured stone.

Apart from the filler, we only require a few other accessories which help to form the circular pot; the main being an empty tin approximately 3 in. in diameter, a circular cardboard template $3\frac{1}{2}$ in. in diameter and three rubber 'feet'.

ball, then place on to the spare piece of oiled cardboard. Press the ball into a flat plate until it is about $\frac{3}{8}$ in. thick and the size of the template. Smooth the upper surface with an old knife, and trim any surplus while holding the tem-

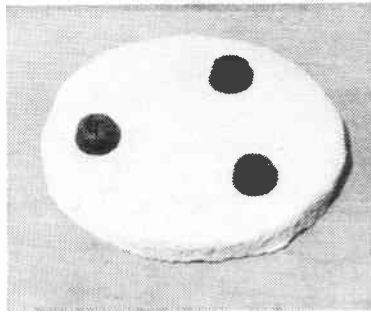

Fig. 2— Rubber buffers inserted

plate in position as shown in Fig. 1.

The three rubber 'feet' can be screwed in the plastic material as shown in Fig. 2 and the base should be laid aside until dry.

There are two stages in the building of the wall, the first comprising an inner shell, and the second a coating to hold the pebbles in position.

Reference to Fig. 3 reveals the first stage in placing the greased tin on the base. This tin is kept in position during the making of the inner shell for as long as necessary and then removed. It will now be realized that we have made provision for a wall about $\frac{3}{8}$ in. thick. Prepare the material (not too dry), but this time making a slab on the oiled cardboard about $\frac{1}{2}$ in. thick, and cut off strips approximately $\frac{1}{4}$ in. wide. Dampen the edge of the base with clean water, pressing on a length of the prepared strip around the greased tin. The same procedure is followed until the wall is about $2\frac{1}{2}$ in. high. The joins can be smoothed with a rubber roller.

The pot should be of even depth all the way round, and any surplus can be cut away with the knife while the material is still plastic. At this stage the pot may be laid aside until reasonably set, but

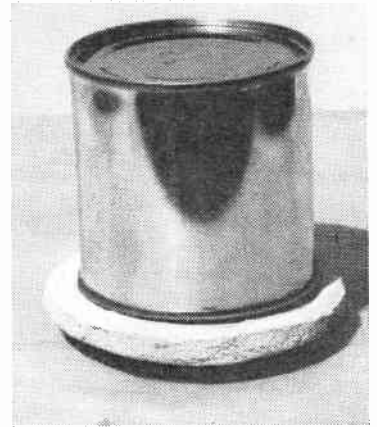

Fig. 3— Tin in position for moulding the wall

you must also give the tin a turn or so to ensure that it is quite 'free'.

We are now ready for the final stage of adding pebbles, shells, etc. for which another mixture of cement is prepared, but thinner consistency, for application with a brush. In this instance it is better to hold the pot sideways, applying a thickish coating of filler, and immediately placing the pebbles in position. Lay an inch or so of the mixture, apply the pebbles, and so on until the pot is entirely covered, leaving to dry thoroughly, when final trimming will complete.

The material will rasp or glasspaper quite easily. If you wish to colour the inside and top edge, use emulsion paint. Incidentally, it is quite a good plan to mix in some emulsion paint when preparing the filler.

AQUARIA PUTTY

MAKERS of aquaria will find this home-made putty most useful and reliable for attaching glass to iron or wood. Note that this putty hardens very quickly, so make only enough for the immediate purpose on hand.

Thicken some glycerine (to expel water), and to it add sufficient finely powdered litharge to form a thick paste. (M.H.G.)

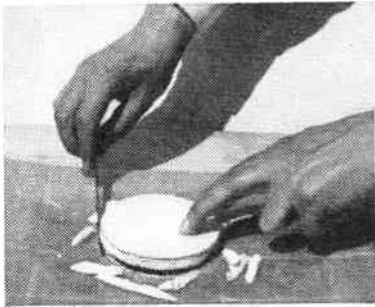

Fig. 1— Trimming the base to the size of the template

To prepare a circular base we require a cardboard template which is $\frac{1}{2}$ in. larger in diameter than the tin. This makes a difference of $\frac{3}{8}$ in. and allows for the thickness of the wall to be built on to the base. The cardboard should be either oiled or smeared with petroleum jelly to counteract any adhesion with the cement. A spare piece of oiled card is also required for laying the material.

A small volume of water is placed in a dish and the filler added slowly while being stirred. Sufficient powder should be added until the mixture is of putty-like consistency; neither too wet nor too dry. Take the material in the palms of the hands and after thorough mixing, roll into a

Instructions for making

THE TOY FARM

FROM a very early age, children love playing with models of real buildings, and this toy farm will give them hours and hours of pleasure, while affording plenty of scope for their vivid imaginations and play-acting.

The layout consists of four main farm buildings. They are the house with garage, a barn, a combined stable and

open cowshed, and a pigsty and dairy. These individual buildings can be moved around as required in order to give changes of layout, and to suit the needs of the child. With this farm there could be used many of the model figures and animals now available, and including all types of machines and equipment. A set of plastic animals is included in Hobbies kit. To give an idea of the size of the buildings, the frontage of the farmhouse extends to 11 in., and the others are in proportion.

Hinged doors optional

Hobbies kit contains all the plywood and hardboard necessary for making the buildings. Also the covering paper for the outside walls and roofs, and the windows, which are attractively printed on transparent acetate sheet.

The doors in all the buildings may be

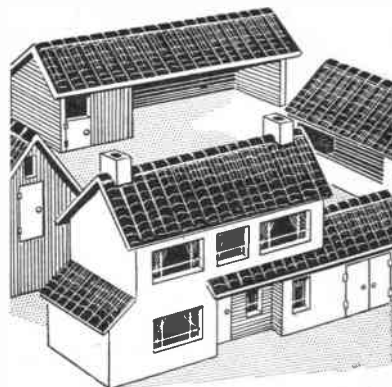

left as dummies or can be hinged to open by using strips of adhesive tape. Small round-headed screws will serve as knobs. The barn building is of the open type, which includes a high door for the purposes of loading and unloading straight from lorries.

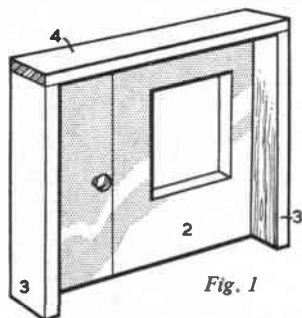

Fig. 1

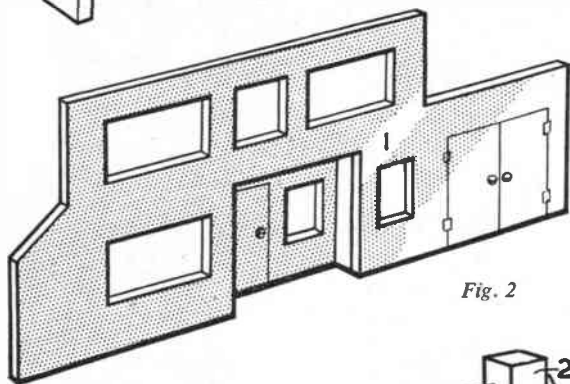

Fig. 2

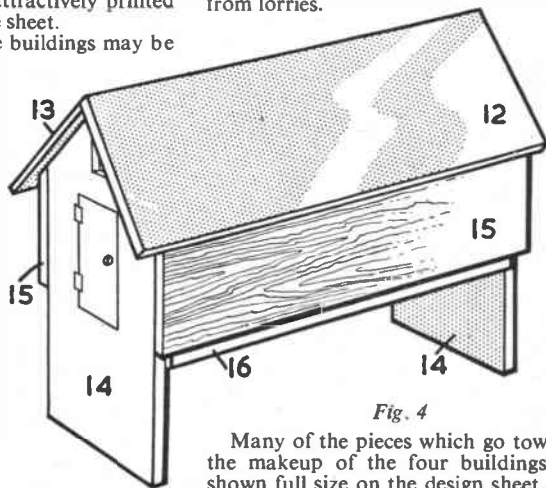

Fig. 4

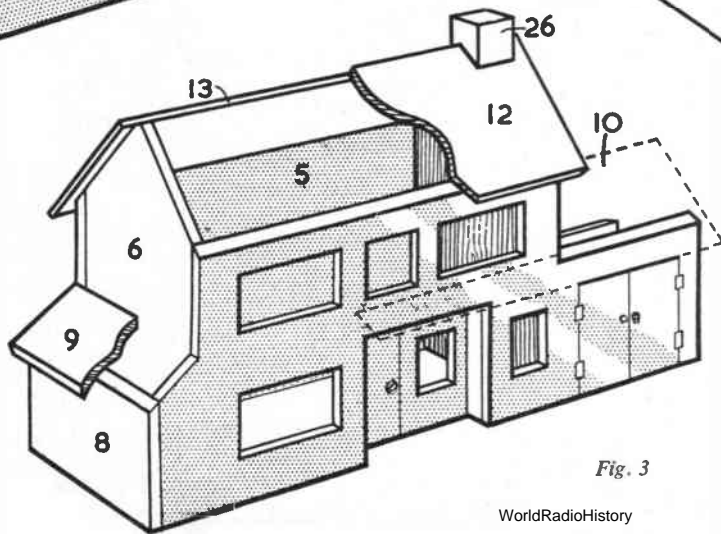

Fig. 3

Many of the pieces which go towards the makeup of the four buildings are shown full size on the design sheet, and for the other pieces appropriate measurements are clearly indicated. All the parts should be marked out or traced and transferred from the design sheet on to their appropriate thicknesses of wood or hardboard and cut out with the fretsaw. Clean them up well with glasspaper.

Recessed entrance

In assembling, which is completed throughout by gluing, make a start with the farmhouse. It will be noted that there is a recessed entrance and this is formed from piece 2, which is cut from the front, and pieces 3 and 4, as clearly shown in Fig. 1 and on the design sheet. When made up, the entrance is glued behind piece 1 as shown in Fig. 2.

Various other stages in the assembly of the farmhouse are shown in Fig. 3, but it should be mentioned that the addition of the chimneys can be left until after the

building has been papered. Note that the front roof of the garage extends along the front of the house over the entrance. The addition of the windows on all buildings is left until the last.

Fig. 4 shows the construction of the barn, Fig. 5 the pigsty and dairy, and Fig. 6 the open cowshed and stable. These illustrations will give a clear indication of how the various buildings are assembled. Note that the feeding

trough in the cowshed is formed by two pieces of stripwood $\frac{3}{8}$ in. by $\frac{1}{8}$ in. by $\frac{1}{4}$ in. When the shells of the buildings have been completed, the external decoration can be added. The walls should be

Painted white or cream, or papered to represent colour wash or natural stone. It may be preferred to paint the exteriors of some of the buildings to give a contrasting effect. Bright colours such as yellow or blue can be used to good effect on the doors and the edges of the window openings.

Tile pattern paper should be used for the roofs. The ridge tiles are formed by gluing along the ridge a $\frac{1}{2}$ in. strip of

KIT FOR 28/-

For making this fine Model Farm you can obtain a complete kit of materials, including printed windows. A set of plastic animals is also included. Ask for kit No 3334 from any Hobbies branch or by post (2/9 extra) from Hobbies Ltd, Dereham, Norfolk

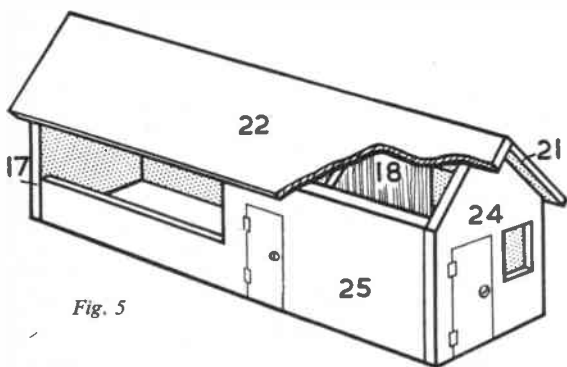

Fig. 5

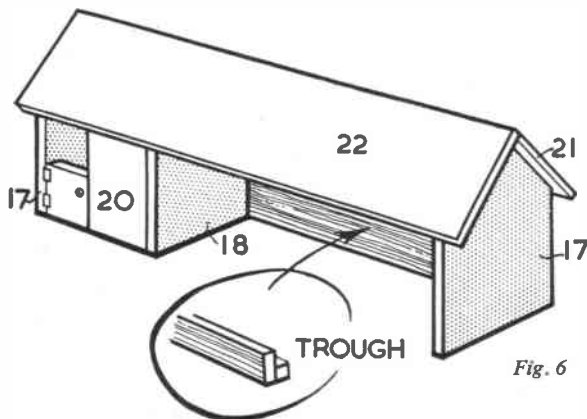

Fig. 6

trough in the cowshed is formed from two pieces of stripwood $\frac{3}{8}$ in. by $\frac{1}{8}$ in. by $\frac{1}{4}$ in.

When the shells of the buildings have been completed, the external decoration can be added. The walls should be

Painted white or cream, or papered to represent colour wash or natural stone. It may be preferred to paint the exteriors of some of the buildings to give a contrasting effect. Bright colours such as yellow or blue can be used to good effect on the doors and the edges of the window openings.

Tile pattern paper should be used for the roofs. The ridge tiles are formed by gluing along the ridge a $\frac{1}{2}$ in. strip of

windows, which are printed on acetate sheeting, should be glued behind their appropriate openings from the underside.

Protect your Plumbing this Winter

ARE you going to be troubled with burst pipes when the frosty weather comes? There is no reason why you should if you take a few simple precautionary steps to prevent this happening. Burst pipes are caused by the water inside freezing, and in doing so expanding slightly. Eventually this causes the pipes to fracture, and when the thaw arrives, the burst is then detected.

To prevent this happening, therefore, it is necessary to cover (or lag) the pipes with some insulated material such as canvas, felt, strips of carpeting, etc. This will keep the temperature of the water inside the pipes above freezing point. Incidentally, however, do you know where the stop cock is in your house for turning off the water supply? If not, then do find out as soon as possible, because in an emergency much damage can be prevented if the water is turned off quickly.

Vulnerable point

Another vulnerable point for frost attacks is the cold water supply tank which is normally situated in the roof

space. This tank is fitted with a ball-type valve, and in most cases is left uncovered. Sometimes the surface of the water in the tank freezes and prevents the ball valve functioning. To avoid

By K. Finlay

this happening, cover the tank with a wooden cover and then lay some odd pieces of carpeting, etc., on top. A better method, however, would be to box in the whole tank with one of the many insulation boards on the market nowadays. Do remember, however, that if there is an expansion pipe situated over the tank from your hot water system, then you must make provision for it by leaving a small hole in the covering.

During frosty spells it is a good plan to empty the water from the pipes when they are not in use; e.g., at night-time. This can be done by turning off the main stop-cock and turning on the various water taps until the pipes run dry.

Remember, you can't have burst pipes if there is no water in them.

Bad draughts should be avoided because they, too, can cause freeze-ups. Broken panes of glass in windows should be replaced and ill-fitting doors should be provided with suitable draught excluders.

It is also a good policy to place oil lamps near water pipes during frosty spells, particularly under the cistern of your W.C. You will find that the cost of keeping these lamps lit is small and will be well worth the expense.

Avoid dripping taps

Finally, don't forget that dripping water is a vulnerable point for freezing. Ensure, therefore, that all your taps function properly, and replace any worn washers with new ones, if necessary. Attend also to leaky joints in guttering and rainwater pipes whenever you see water trickling down the face of the walls.

If the foregoing points are observed, then there is no reason why you should require the services of a plumber when those icy cold days arrive.

FAIRY LIGHTS FROM MAINS

★★★★★★★★★★★★★★★★★★★★
 ★ In this first article in a new series ★
 ★ 'Modeller' deals with 200/250 volt ★
 ★ AC/DC mains operation of fairy ★
 ★ lights, 'flashers', adapters, switch- ★
 ★ ing, etc. Further articles will be as ★
 ★ follows, and the whole will form a ★
 ★ complete electrical guide for the ★
 ★ model maker. ★
 ★ 2. Low Voltage Fairy Lights. For ★
 ★ accumulator, or dry battery, when ★
 ★ no mains are available. Trans- ★
 ★ former running. Series and parallel. ★
 ★ Doll's house and model circuits. ★
 ★ 3. Batteries in Series and Parallel. ★
 ★ Switching. Controlling and running ★
 ★ a model. ★
 ★ 4. Speed Control and Dimming. Re- ★
 ★ sistance control for trains, boats, ★
 ★ lamps, etc. ★
 ★ 5. Reversing Motors. Reversing ★
 ★ D.C. 'permag' motors, and A.C. ★
 ★ type motors. ★
 ★ 6. Transformer Running of Lamps, ★
 ★ Motors. Running lamps and A.C. ★
 ★ motors from mains. Safety pre- ★
 ★ cautions. ★
 ★ 7. D.C. Models with A.C. Mains. ★
 ★ Rectifiers for trains, electroplating, ★
 ★ etc. ★
 ★ 8. D.C. Mains Models. Safety ★
 ★ circuits, voltage dropping and ★
 ★ rotary converters. ★
 ★ 9. Useful Equipment Circuits. Bells, ★
 ★ buzzers, fuses, trips, shocking coils, ★
 ★ charging and electroplating circuits. ★
 ★ ★
 ★★★★★★★★★★★★★★★★★★★★★

With bulbs in series in this way, current passes through each bulb in turn. As a result, if one bulb is defective, the whole string will fail to light. In such an event, a new spare bulb may be tried as a replacement in each holder in turn, until the whole string lights.

An alternative is to test each bulb in turn with a battery or transformer giving enough voltage to light the bulbs, if only dimly. This is handy with an old string of lights which may have several faulty. A 4½ volt dry battery will be sufficient for many bulbs of this kind, and the filament will glow if it is intact. But for some bulbs, especially those with deeply coloured glass, a higher voltage will be necessary.

.3 amp. Occasionally the wattage and voltage is marked. Lights of the same wattage and voltage will be suitable for use together.

If a check need be made to find how much current a bulb is passing, when the wattage and voltage are given, this can easily be done by dividing the wattage by the voltage. For example, suppose it is necessary to know what current a 7½ watt 25 volt bulb passes, As 7.5 divided by 25 = .3, the bulb passes .3 amp, and could thus be used in a .3 amp string.

Such decorative lights should be in their proper insulated holders, wired together with good quality insulated flex. If a longer flex lead is joined on, no bare joints must be left. There is then virtually no danger of shocks or fire. But it is wise to keep lamps clear of flimsy paper decorations.

Making up the voltage

When bulbs are wired in series, they may be of different voltages, if they pass the same current. This enables a small number of torch bulbs to be used in suitable models, and run from the mains by adding a household lamp in series, as

in Fig. 2. Torch bulbs pass about .3 amp (this is often marked) and a 60 watt lamp is then suitable.

This method is most suitable for an illuminated model or display which does not need to be touched, once set up. The large lamp may be used for general illumination. More than four torch bulbs can be used, if required.

This circuit should not be used with models for children, because the lamp and small bulbs are connected to the mains. In any model where bulbs or connections may be touched, a mains isolating transformer should therefore be fitted, as described later.

Flashing lights

Decorative lights are often made more effective by an automatic switching device and the simplest way of doing this is to use a thermo flasher of the kind shown in Fig. 3. This can be obtained with a socket one end, and an adaptor plug the other. It is then only necessary to insert the flasher in the lampholder from which current is drawn, and to plug the decorative lighting string into the flasher socket, visible at 'A'. 'B' shows how the device works. The bi-metal strip is fixed at one end, and has a

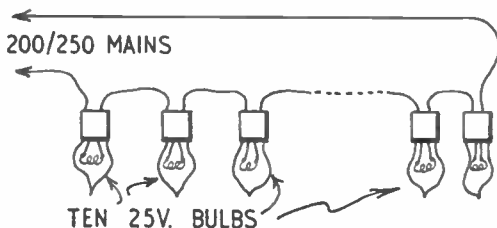

Fig. 1—Fairy lights wired in series

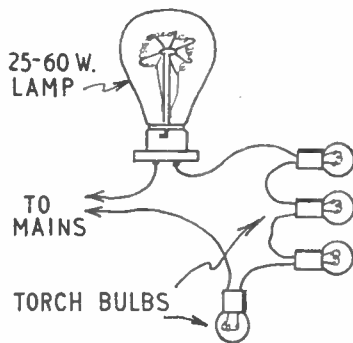

Fig. 2—Using a household lamp for voltage-dropping

THE most familiar type of decorative lighting is the string of fairy lights often used at Christmas, or for parties, and these are very attractive and usually appreciated by everyone. The bulbs may be of various colours and shapes, or fitted with coloured shades, and are placed on the Christmas tree, or with hangings and other decorations.

Such strings of bulbs are normally operated directly from the mains supply of 200 to 250 volts, either alternating or direct current mains being suitable. The combined consumption of such a string of lights is about the same as a single 60 watt house lamp, so running costs are low.

When small, low voltage lamps are to be run from a higher voltage, a number are wired in series, as shown in Fig. 1. Here, ten 25 volt bulbs are in series, for 250 volt mains. Such a string can be used with 200/250 volt mains, because the reduction of brightness with only 200 volts would not be important.

If a string fails to light after trying a new bulb in each holder in turn, more than one defective lamp is probably present. The whole string can only light when every holder contains a sound bulb.

When bulbs are wired in series in this way, all should be of the same current rating. With a new, complete set, or a proper replacement, this will always be so. Some makers mark the current rating on their bulbs, so that suitable new ones can be bought. World Radio History

contact the other end, which completes the circuit. When current flows, the heating coil causes the bi-metal strip to bend, separating the contacts. The lamps then

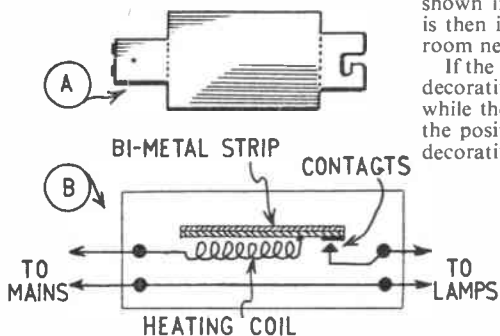

Fig. 3—A thermo-electric flasher

go out, and the strip cools until the contacts again meet, when the sequence is repeated.

Flashers of this kind should only be used with the strings of lights for which they are intended, because large house type bulbs would pass too large a current.

Mains connections

All mains connections must always be made by means of a proper mains plug or adaptor. With strings of decorative lights, current is usually drawn from a ceiling fitment. This is quite a good method, because the twin flex connections are then high and out of the way.

If the usual house bulb is removed to plug in the decorative lights this can be rather inconvenient, but a switched 2-way adaptor can easily be added, as shown in Fig. 4. The usual room bulb is then inserted in the adaptor, and the room need not be left in darkness.

If the adaptor is used as illustrated, the decorative lights can be switched off even while the main lamp is burning. Should the positions of the adaptor feeding the decorative lights and the main lamp be

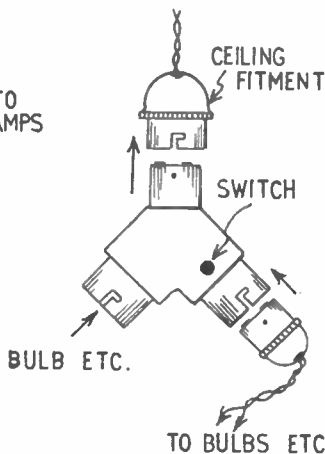

Fig. 4—Using a switched 2-way adaptor

reversed, then the main bulb can be switched off while the decorative lights remain on. The adaptor can be of such a shape that the large bulb hangs vertically

in almost its usual position.

Such an adaptor is very convenient for drawing current for any purpose when a 3-pin plug, with earth, is not required. But appliances intended to be run from a 3-pin plug must never be wired to an adaptor.

Connections carrying mains current should always be of good quality flex, with no bare joints or exposed ends. If a separate switch is wanted, it can be of the pear or lead-through type, and the flex is then cut and the switch connected in.

Before inspecting connections, etc., always withdraw the adaptor to disconnect the circuit. When making small changes, such as replacing lamps, always switch off with the main room switch, not with the switch in the adaptor. (The main room switch will be in the 'live' mains conductor, whereas the adaptor switch may by chance come in the 'neutral' conductor.)

Current for a string of lights can also be drawn from a 3-pin plug inserted in a wall socket. This is convenient when the flex can be kept out of the way, and will not be walked on, or otherwise damaged. With modern 13-amp (flat pin) plugs, the internal fuse can be replaced by one of quite low rating (say 2 amps) when lights are being run, and this will give good protection in the event of any short circuit arising in the leads.

Cracked, old flex, or broken adaptors and other parts must never be used with mains circuits. With a little care the whole will then be perfectly safe.

Next — Low voltage decorative lights.

Interesting Locomotives—No 21

PERHAPS the most remarkable express locomotives to run in this country around the period 1848-60 were the Crampton patent engines. The patentee — Thomas Russell Crampton — held the view that a steadier engine would result if the centre of gravity were situated on the same horizontal

line as the draw-bar. Several different types of Crampton engines were built, among the more noteworthy being the excellent specimens built by Tulk & Ley in 1849 for the South Eastern Railway. They were among the most successful of the Cramptons and remained in express service till 1873-75, whereas some other

railways having Crampton engines in service had withdrawn them after only some ten to twelve years' service. In all there were some 30 outside cylinder Crampton engines running in this country, the driving wheels varying between 7ft. and 8ft. diameter.

The drawing shows one of two Crampton engines built for the Midland Railway in 1848. These two engines had 7ft. driving wheels and 16in. by 22in. cylinders. A distinguishing feature was the deep double frames which had outside bearings for the leading and trailing axles, the middle axle having inside bearings only, as shown in the drawing. They were built by Messrs Kitson, Thompson & Hewitson of Leeds.

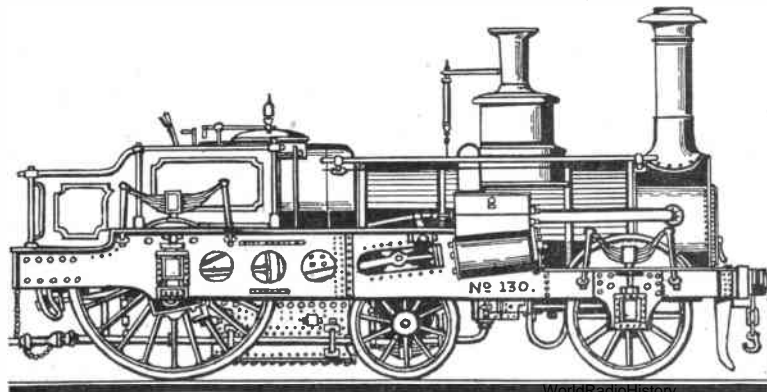

Next week's issue will contain patterns for doll's house furniture and among other interesting articles G. Allen will describe how to make a winch for model gliders.

MAKE SURE OF YOUR COPY

A SPACE-SAVING KITCHENETTE

9 in. in depth. There is nothing in its construction of a difficult nature, and most handymen could undertake the work quite easily.

A front elevation is shown in Fig. 1, divided by a vertical centre line. The left side shows the interior of the kitchenette with the doors, etc. omitted. At Fig. 2, a side section is given. The whole is built of good quality deal, $\frac{3}{8}$ in. thick, except where otherwise stated.

By W. J. Ellson

Cut the side to the given length, and where the horizontal divisions A, B and C appear cut grooves $\frac{1}{2}$ in. deep for their reception. A detail of construction is given in Fig. 3, to help make all plain and easy to follow. Across the top, bars of $1\frac{1}{2}$ in. by $\frac{3}{8}$ in. are nailed, to which the top of the kitchenette can subsequently be screwed. Cut divisions A and C the full depth of the sides. Division B is only 2 in. wide, the remainder of the grooves being filled up with 1 in. wide strips. These act as runners for the drawers. At D, screw fillets across, for a shelf to rest upon.

CUTTING LIST

Sides (2).	4 ft. 3 in. by 9 in. by $\frac{3}{8}$ in.
Divisions A, C.	2 ft. 0 $\frac{1}{2}$ in. by 9 in. by $\frac{3}{8}$ in.
Division B.	2 ft. 0 $\frac{1}{2}$ in. by 2 in. by $\frac{3}{8}$ in.
Top cross bars (2).	2 ft. by $1\frac{1}{2}$ in. by $\frac{3}{8}$ in.
Bottom bar (rear)	2 ft. by $1\frac{1}{2}$ in. by $\frac{3}{8}$ in.
Bottom bar (front)	2 ft. by 3 in. by $\frac{3}{8}$ in.
Kitchenette top.	2 ft. 2 $\frac{3}{4}$ in. by 9 $\frac{1}{2}$ in. by $\frac{3}{8}$ in.
Drawer front.	2 ft. by 4 in. by $\frac{3}{8}$ in.
Kitchenette back.	3 ft. 6 in. by 25 $\frac{1}{2}$ in. by $\frac{3}{8}$ in. ply.
Plywood panels (1).	1 ft. 10 in. by 1 ft. 7 in. by $\frac{3}{8}$ in.
Plywood panels (2).	1 ft. by 11 in. by $\frac{1}{2}$ in.
Plywood panels (drawer).	2 ft. by 9 in. $\frac{1}{2}$ in.
For shelving.	18 ft. of $\frac{3}{8}$ in. by 5 in. wood.
Drawer.	4 ft. of $\frac{3}{8}$ in. by 4 in.
Doors.	10 ft. of $\frac{3}{8}$ in. by 2 in. by $\frac{3}{8}$ in.
Flap.	8 ft. of $\frac{3}{8}$ in. by 3 in.

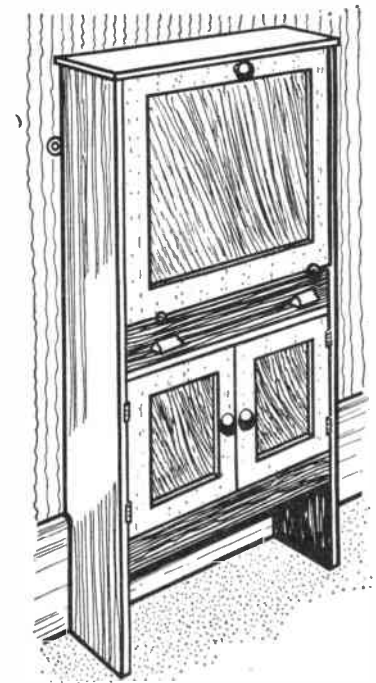

FOR small flats and single rooms, where space is so limited, this design for a kitchenette should be found invaluable. It is much shorter than the common pattern and only takes up

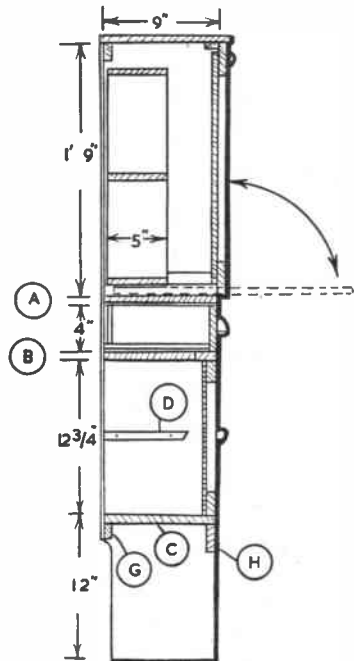

Fig. 2

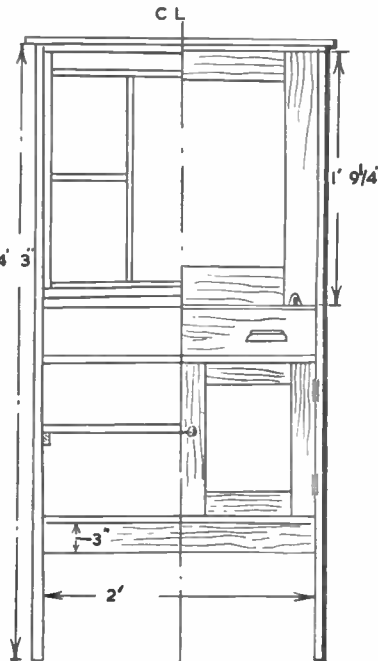

Fig. 1

WorldRadioHistory

As it is intended for the kitchenette to butt up against the wall of the room, where a wainscot is fitted, the lower portion of the sides should be cut away to fit over it. This will be seen in Fig. 2. Cut the top of the kitchenette to extend $\frac{3}{4}$ in. over each end and $\frac{3}{8}$ in. over the front. The parts can now be glued and nailed together to form the carcass of the work.

A lift-out flap covers the upper part. This slides inside and forms a table, indicated in Fig. 2 by dotted lines. On this the housewife can do her preparations for cooking. It is a frame of 3 in. by $\frac{3}{8}$ in. wood, joined together at the corners with a simple halved joint and covered on the inside face with a panel of $\frac{3}{8}$ in. thick plywood (see detail drawing Fig. 4). This panel is cut 1 in. less in dimensions all round.

The interior shelving, seen in the diagrams, is made up from $\frac{3}{8}$ in. wood. Make it as a frame, with added partitions to suit individual needs. It must be a close fit against the sides of the kitchenette, but a few inches short of the height inside, say about 1 ft. 5 in. Now slide in the flap to rest upon A, place the shelving on this, and fix it with screws to the sides. One each side may be enough. At the front, nail to each side part a strip of $\frac{3}{8}$ in. by $\frac{1}{2}$ in. wood, as in Fig. 3, E, to act as dust excluders when the flap is in place. Between these and the shelving, nail similar strips, as at F. These both rest upon the flap, when the latter is acting as a table.

● Continued on page 81

AN ATTRACTIVE GARDEN FEATURE

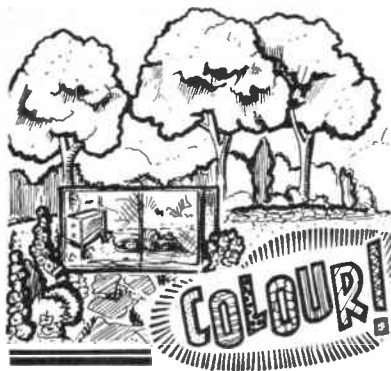

I SUPPOSE it may fairly be argued that whilst not all of us are gardening enthusiasts, nevertheless, the great majority of us have to 'follow' our gardens, if only to ensure they don't develop into near prairies or wildernesses. It therefore follows that where some of us are concerned, any novelty in the garden is to be sought after, since it tends to alleviate what is at best, a duty. Moreover, even where your true and enthusiastic gardener is concerned, certain tasteful novelties are bound to enhance the appearance of his 'little plot', will lift it out of the ordinary, and render it unique amongst its fellows. I saw such a novelty the other day, and so pleasing did it appear to the eye, and so reasonably easy to make, that I took detailed particulars.

In brief, the layout was an outdoor aviary and fishpool combined. It took up no great amount of room, and merged into the general garden scene to give a most delightful effect at the bottom of my friend's garden — just where his lawn finished. In fact, he had built it over and around a small rock garden between the lawn and a well kept shrubbery. From the house itself — no great distance away — it almost seemed that the birds (eight of them and all budgerigars) were in no way confined, as they disported themselves against the background of shrubs and flowering plants. Altogether, it was a most pleasing and colourful spectacle, and when one approached and stood near, there, between the larger stones and in the very centre of the rockery, was a cunningly contrived fishpool — with several plants growing therein and half a dozen small goldfish swimming contentedly around. In other words, colour on the ground and colour in the air — the whole blending wonderfully well into the overall scene.

Now to the technical details. The whole area (9 ft. wide by 18 ft. long by 6 ft. high) was wired in — so that no marauding cat could get anywhere near either the birds or the fish. The small

house for the birds themselves had been home-made, yet whilst it was small, it was adequate enough for their requirements. It measured 6 ft. wide, 2 ft. deep and 2 ft. high — and stood four feet from ground level on four stout wooden pillars driven a good foot into the ground. A sliding glass door in front enabled my friend to clean out and otherwise minister to his charges as and when necessary. The interior was fitted with several perches, four separate nest boxes, and the usual feeding and watering utensils to be seen in any birdcage. Four small 'popholes' at the side of the house (away from the prevailing winds), cut above a tiny 'landing platform' and protected from all draughts by a built over 'canopy', completed the house.

Eighteen timber posts (2 in. by 2 in. by 6 ft. and spaced at 3 ft. intervals) supported the fine mesh netting which encircled the whole area, and at one end, a 3 ft. wide door was built into the structure. Around the area of this door, two

more similar posts stood, supporting more wire, and carrying an outer door — into which, my friend went, closing this door behind him before entering the actual aviary. Wooden slats nailed across the top of all the posts carried the overhead netting, and completed the 'flight' area. One or two bush plants, inside the flight were supported by additional 'perches' in the shape of small tree branches rigidly fixed in position.

The fishpool was an old zinc bath-sunk to its very rim in the ground — after which, the rockery had been built all around it. The pool measured some 4 ft. 6 in. long by 2 ft. wide, and was 18 in. deep. Sand had been placed on the bottom, and certain plants were growing therein. Altogether, the whole arrangement was delightful, produced a very effective picture, and, as my friend declared, lured him into his garden — there to do other jobs — far more often than would otherwise have been the case.

(J.F.T.)

● Continued from page 80

Space-saving Kitchenette

The flap is held in place by notches, cut out at the bottom edge, to engage with the projecting screws driven in A, as depicted in Fig. 5. A cupboard

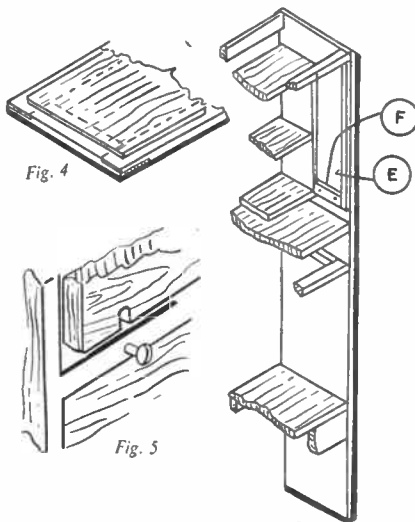

fastener or metal turnbutton is fitted at the top to hold it in place. Remember, when cutting the notches, to allow enough room at the top of the flap for it to be raised up enough to free itself. If the notches are cut $\frac{3}{8}$ in. long, and the screws driven into the division about midway of its thickness, this should suffice.

The drawer can be made in the usual manner and needs no further mention, except that it should slide in and out freely. Screw a pair of metal pulls to it. The doors covering the bottom cupboard portion are framed up from 2 in. wide wood, and covered on the inside faces with $\frac{1}{8}$ in. plywood. They are much the same in construction as the flap.

Hinge these with 2 in. brass butts and add the usual fastener and bolt. A shelf can be fitted inside the cupboard part as required. Cover the back of the kitchenette from top to division C, with plywood, $\frac{1}{4}$ in. thick. Space permitting, a 1½ in. strip of wood is fixed across at the rear, shown in Fig. 2, and a stiffener of 3 in. wide wood across at H. Fasten the kitchenette firmly to the wall with screws, through brass wall plates.

MAKING THERMA, THE HEAT IMP

THE familiar fact that air expands when heated and contracts when cooled is the working principle of Thermo The Heat Imp, an unusual and instructive scientific toy which can be made from easily obtained materials.

Begin by finding a 3in. tall bottle which has a fairly large neck, and obtain a cork which will fit the neck firmly. Bore a hole through the cork, in which to insert a 5in. length of glass tubing

By A. E. Ward

which should have an internal bore of at least one third of an inch in diameter. The tube must be pushed through the cork so that when the cork is fitted into the bottle the end of the tube will be about $\frac{1}{4}$ in. above the bottom of the bottle.

Make the imp from a small piece of thin bright red cardboard or stiff paper.

In order to cut a symmetrical figure first fold the cardboard in half. Cut out one side of the imp, using a small pair of sharp scissors. Unfold the resulting shape and you will have a whole, well balanced, figure.

Glue the tail of the imp to a $2\frac{1}{2}$ in. length of 10 amp. fuse wire and insert the other end of the wire into a $\frac{1}{8}$ in. long plug of cork which will slip without any difficulty into the glass tube.

Place about 1in. of cold water into the bottle and press in the cork with its glass tube. The water will probably rise an inch or more up the tube. Lower the cork plug into the tube and let the paper imp rest upon the top of the tube. Your apparatus will now resemble Fig. 1 and you will be ready to see if it works.

Stand the bottle in a cup of hot water and wait a few moments. The heated air inside the bottle will expand and push the water level higher up the tube. If you have followed the construction details carefully the cork float should be pushed up the tube and the imp forced upwards.

If you now cool the air inside the bottle by running cold water against the glass side, the air will contract and atmospheric pressure will drive down the water level in the tube. This should bring the imp back down to its original position.

It might be necessary to make a new cork float or to adjust the existing one by trimming with a razor blade, or adding a piece of lead shot. When you are satisfied with the performance of your imp make a cover to fit over the neck of the bottle.

Make the cover from a 5in. long tube of stiff black paper which can be fitted tightly over the neck of the bottle. Obtain a $\frac{1}{8}$ in. thick slice of cork with the same diameter as the paper tube. Cut a

disc of black paper which will overlap the edge of the cork and glue the disc on to the cork slice. Cut a 1in. diameter hole near the top of the tube and fit the cork slice into the tube to form a neat 'cap'. The completed cover should look like Fig. 2. Place the cover over the neck of the bottle.

The toy is now finished and can be made to work by placing it alternatively into cups of hot and cold water. When the air inside the bottle is heated the imp should rise up the black paper tube and appear in the little round window.

You might tell a story about Thermo The Imp who comes up from Hades whenever things below get too hot.

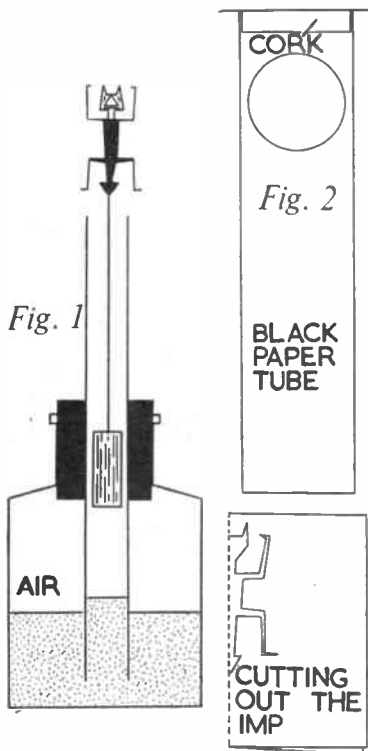
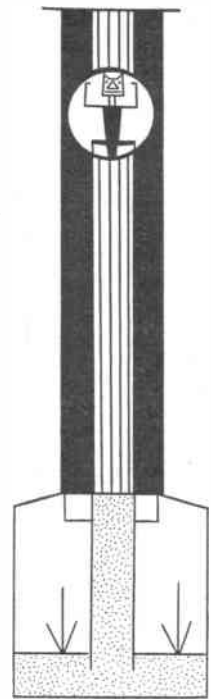

Sharpening a Countersink Bit

DRILL sharpening presents somewhat of a problem to some people, and the countersink bit even more so. Countersink bits do sometimes become blunt, and although it may seem a difficult job, they can be sharpened quite easily. No complicated equipment is necessary, and all you need is a block of hardwood and a little grinding compound.

The type of wood you use is not really important, but it is generally found that the hardest kind, and with a close grain, will give the best results. In this class boxwood is supreme, but beech or oak

are quite successful.

Carefully drill a hole with the countersink bit which you want to sharpen to the full depth of the bit. Then apply to the hole a paste made of emery flour and oil or valve grinding compound.

Now it is only necessary to rotate the bit in the countersink hole, *not* in the usual forward cutting motion, but anticlockwise — i.e., backwards. Keep the bit upright in the hole, and provided the bit is not too blunt, very little grinding should be necessary. A few turns occasionally should keep it in good order.

(A.F.T.)

MODELS FOR BOYS

No. 251 Spcl.
TUG 'CLIMAX'
16ins. long
47/6

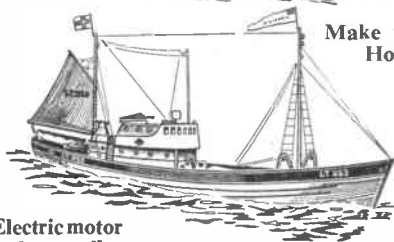

Make them with a
Hobbies Kit

No. 253 Spcl.
TRAWLER 'ANGLIAN'
18ins. long
49/11

Electric motor
and propeller
included

No. 3206
**'EMPRESS
OF
BRITAIN'**
24ins. long
56/5

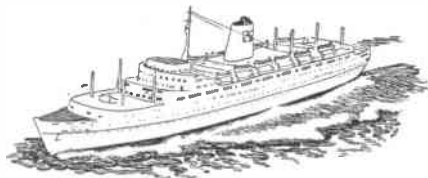

Hobbies Ltd, Dept. 99 Dereham, Norfolk

Learn to Draw

Direct from Paris

**UNDER
FAMOUS
FRENCH
ARTISTS**

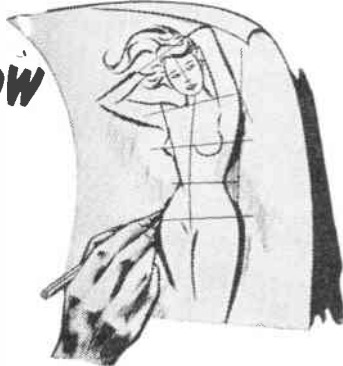

DON'T you wish you could draw and paint—Haven't you envied the pleasure of your friends who can—and the money some make?

Now you can learn to be a real artist in a few months, in your own home through the world-famous Paris A.B.C. School of Art.

The secret is you reap all the benefit of studying under famous French artists by post. Your lessons come (in English, of course) direct from Paris, your drawings go to Paris and your particular teacher in Paris sends his criticisms and suggestions direct to you.

You will be astonished how quickly you progress: how soon your amateur efforts take on the real professional touch.

Send this form today

FREE COUPON

The Paris A.B.C. School of Art
(Dept. 123), 211 Piccadilly, London, W.1

Please send free copy of your new illustrated
Brochure.

Mr., Mrs. or Miss.....

Address.....

You owe it to yourself to learn more about the wonderful training. Send this coupon with a 3d. stamp to the London Office or write for a free copy of its intensely interesting, profusely illustrated 32-page Brochure today!

ARCOY RABBETTER



Depth of
cutter adjust-
able from
0"—3/4"

Position of
cut from wood edge adjust-
able from 0"—1"

For use with any portable
drill

£1 . 19 . 6 COMPLETE WITH SAW



GREENHOUSES

USE THE

RABBETTER

To rebate for the glass



GARDEN SHEDS

USE THE

RABBETTER

To tongue and groove the
planks



DOORS

USE THE

RABBETTER

To rebate or slot for the panels



DRAWERS

USE THE

RABBETTER

To slot for the drawer bottom



LATHS

USE THE

RABBETTER

To make them from your surplus timber

From all good retailers or, direct from —

ARCOY PRODUCTS
KNOWSLEY ROAD, BOOTLE, LIVERPOOL 20

HOW TO TILE-IT-YOURSELF

FOR their general brightness and resistance to dirt, water and grease, ceramic tiles are unsurpassed. The initial cost may be higher than other decorating materials but the lasting satisfaction they give makes tiling your bathroom or kitchen well worth while.

Tiling has long been recognized as a specialist's job, but until thirty years ago, so was paperhanging! As with paperhanging, the advent of new adhesives has made tiling a job well within the capability of all handymen.

To encourage home decorators, the ceramic tile manufacturers have produced $4\frac{1}{2}$ in. by $4\frac{1}{2}$ in. tiles $5/32$ in. thick in a wide range of colours. This size and thickness have the quality of being easily and quickly fixed to almost any dry level surface; cement, plaster, wood, hardboard, and even old tiles if you wish to introduce a new colour scheme.

Start on small area

It is, perhaps, wise to spend a little time deciding how much you wish to tile. It is not necessary (if you have any doubts about your ability to fix tiles) to purchase the amount you would need to

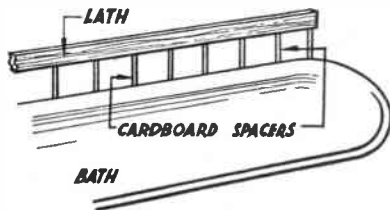

Fig. 1

even half tile your bathroom or kitchen. Start, if you wish, with just enough to provide a splash-back for the sink or bath because, when you have gained confidence you can add to the area at any time. This method will also make it easier on your pocket!

When you have decided the area to be tiled, measure it up and reduce your figure to square yards, as this is the usual standard measurement of quantity for flat tiles. Specially shaped tiles with one round edge are used for outside angles and the top row if you are only tiling part way up the wall. Tiles with two adjacent round edges are used on corners. These fittings, as they are called, are available in odd tiles only, if you do not require a yard. A point to remember is that there are thirty-six 6 in. by 6 in. tiles and seventy-two $4\frac{1}{2}$ in. by $4\frac{1}{2}$ in. tiles per square yard.

When buying any quantity of tiles, check them for nips, glaze specks and



shading from one batch to another.

Apart from the tiles themselves you will require a fixing agent (usually a black mastic solution), a spreader, tile cutter and a quantity of grouting powder or white-cement. A pint of adhesive will fix about sixty tiles and a pound of grouting powder will be enough for about one hundred tiles.

To simplify matters many of the tile manufacturers have made up sets for the home tile fixer, which contain thirty-six (half a square yard) $4\frac{1}{2}$ in. by $4\frac{1}{2}$ in. tiles, adhesive, spreader, cutter and grouting powder.

First ensure that the surface to be tiled is dry and even; any small indentations may be filled up with adhesive before proceeding.

If you are only attempting a splash-back, the edge of the bath or sink will provide a level on which to begin. For larger areas, nail a straight wooden lath horizontally (use a spirit level) about the width of a tile above the base of the area to be tiled. With the aid of a plumb line draw a vertical line on the wall to meet the lath at the left hand edge.

After stirring the adhesive, spread it on the tile with the spreader (or old table knife) to a thickness of about $\frac{1}{8}$ in.

Twisting motion

When using the mastic type of adhesives do *not* soak the tiles. Press the first tile firmly into position with a slight twisting motion, so that it is exactly in the angle formed by the base board and the vertical line you have drawn on the wall. The first horizontal row should then be completed, all tiles resting on the base and a gap of about $\frac{1}{8}$ in. left between each tile for grouting.

The second row should be started directly above the first tile you fixed, and at a distance of $\frac{1}{8}$ in. This spacing can be accurately achieved by placing small strips of cardboard between the tiles. (Fig. 1.)

When the main area has been completed, you may have to cut tiles to fill in any spaces around the edges. This may be done by scoring a line on the glaze with a glass cutter and tapping gently along the line until the tile breaks, or break away the unwanted portion with pincers.

The adhesive takes about 24 hours to dry at which time the lath and the cardboard separators may be removed. Any adhesive on the tiles may be removed by lightly rubbing with a paraffin or petrol soaked cloth.

Now you are ready for the final stage—'grouting'. Mix thoroughly 2 parts of grouting powder with 1 part of water. Allow this to stand for about 10 minutes, and then thin it down to a thick creamy paste.

Save time with a trowel

Fill in all the joints with this paste, using a small brush. Wipe off any surplus immediately.

Allow two hours for the grouting to harden, polish with a soft dry cloth, and the job is done!

If you are satisfied with the area you have done, it will be obvious to you that larger areas will have no further obstacles. When doing larger amounts it will save time if you spread the mastic on the wall with a plasterer's trowel. When the adhesive has become tacky—usually 30–40 minutes—press the tiles firmly into position with the same slight twisting action as before. (D.L.P.)

Remember



Poppy Day

YIPEE·E·E·E·E·E·E



CERTOFIX

Really
FIXES

CERTOFIX liquid glue can cope with all general repairs. It unites wood, glass, metal and almost all substances. It is clean in use; its joints are stronger than the materials it unites.

Sold at all Woolworth Stores

CERTOFIX

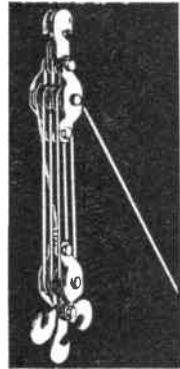

The HALTRAC MIDGET HOIST

Weighs 1 lb. Tested to lift 1,000 lbs.

PRICE **57/6**

will pull or lift anything. Self-lubricating solid nylon pulleys — 72 ft. nylon rope — rustless aluminium construction throughout. Standard equipment for the Motorist, Caravaner, Gardener, Workshop, etc. etc.

Available from all good Stores, Ironmongers, Halford Branches, Yacht Chandlers, etc., or from:

HALTRAC LTD. (Dept. HW. 9)

BOURNE WORKS, WEIMAR STREET, LONDON, S.W.15

Trade enquiries also invited

HEAR ALL CONTINENTS

With **H.A.C. Short-Wave Receivers**

Suppliers for over 18 years of radio S-W Receivers of quality.

One-Valve Kit, Price **25/-** Two-Valve Kit, Price **50/-**
Improved designs with Denco coils. All kits complete with all components, accessories and full instructions. Before ordering, call and inspect a demonstration receiver, or send stamped addressed envelope for descriptive catalogue.

'H.A.C.' Short-Wave Products (Dept. 22), 11 Old Bond Street, London, W.1.

WOOD BENCH VICE

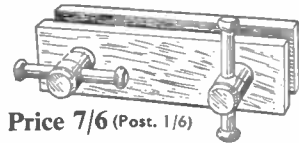

Price **7/6** (Post. 1/6)

A strong hardwood vice which can be screwed to the work bench. A real serviceable tool, well made, and fitted with hardwood screws. 12ins. long.

From branches or:

HOBBIES LTD.,
Dereham, Norfolk

When you ask
for a knife
- say **X-acto**

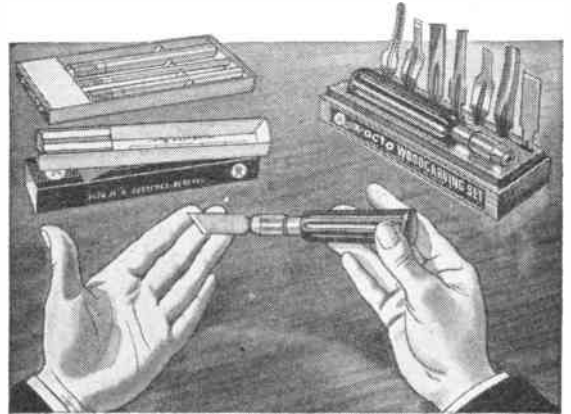

...they're made to
develop your skill!

A man knows that X-acto is *right* the moment he picks up one of these superb knives. X-acto have three different weights of perfectly balanced handle. 25 interchangeable blades, gouges, routers and punches—all in razor-sharp surgical steel.

X-acto's a precise tool. And an all-round tool—right for delicate modelling, right for handyman work around the house. When you ask for a knife—say X-acto.

From Hobby Shops and Ironmongers

And ask to see all the other tools
in the X-acto range



DUFAY (B'ham) LIMITED

(X-acto Products Division)

SUMMER LANE, BIRMINGHAM, 19

125 DIFFERENT STAMPS free to applicants for Junior approvals. Stamp to — Read, 19 Kelstern Close, Cinderhill, Nottingham.

BUILD AN EFFICIENT Crystal Receiver with our quality complete kit. Easy instructions. Soldering unnecessary. Good reception anywhere. Reduced price for short period 14/6 post free. Send P.O. NOW — Radio Components, Accessories, wonderful new Transistor Receiver Kits supplied. Send 3d. stamp for Bargain List. — **RADIOMATIC**, 26 Blackburne Drive, Hunts Cross, Liverpool.

MAKE A MUSICAL BOX for as little as £21/-. New kits and tunes available. Movements 13/- post free. Please send 3d. stamp for free illustrated catalogue. — The Swisscross Co., Dept. B, 202 Tulse Hill, London, S.W.2.

STAMPS FREE — Empire Packet including Pictorials and Victorians with approvals. — Robert J. Peck, 7A Kemp Road, Bournemouth.

EXTRA CHEQUES from writing. Send for Ideas for Writers' (free). Scores of suggestions for beginners and others. Typewriter unnecessary. — Writers' Ring (H.W.), 5 Edmund Street, Birmingham 3.

KUKLOS ANNUAL. Indispensable cyclists' handbook. Tours, resthouses, money-saving hints, 3/- post free. — Burrow, Publishers, 2 Imperial House, Cheltenham.

100 DIFFERENT stamps free! Request 4d. upwards discount approvals. — Bush, 53 Newlyn Way, Parkstone, Dorset.

Refund if not worth double!



TV TABLE & EXTRA LARGE RECORD CABINET

Not only sand polished but also sprayed light or medium WAL-

NOTE — ROOMY BOOK CASES AT BOTH ENDS — one converts to Magazine Rack by insertion of sloping panel provided, as illustrated. Amazing offer — 59/6, carr. 6/6 or sent for £1. Balance 6 monthly payments 8/-, plus carr. A well-built contemporary piece of furniture to solve your record problem and also ideal as stand for TV, Radio or Record Player. 30" x 15" x 24" high. Modern sliding doors. Roomy interior, partitioned for classifications, holds up to 200 records (upright for perfect condition). Entirely of seasoned timber. Detachable legs. SEND quickly. LISTS, FURNITURE.

SEND FOR OUR FREE ILLUSTRATED CATALOGUE OF BINOCULARS. EVERY KNOWN MAGNIFICATION. WATCHES, RADIOS, FURNITURE, ETC. ALL AVAILABLE ON THE EASIEST OF TERMS.

HEADQUARTER & GENERAL SUPPLIES LTD.

(HOBW/87) 196-200 Coldharbour Lane, Loughboro Junc., Loncon, S.E.5. Open Sat.

WHEELS (Hardwood and Rubber Tyred Metal). Cot, Pram and Doll's house Fittings and Papers, Beads, Transfers, Prints and other accessories. Stamp for new lists. (Trade supplied.) New address — JOYDEN CO., 91 Peplins Way, Brookmans Park, Herts.

MODELS. You can make lasting stone-hard models with Sankey's Pyruma Plastic Cement. Supplied in tins by Ironmongers, Hardwaremen and Builders' Merchants. Ask for instruction leaflet.

HOBBIES 1960 ANNUAL

Full supplies of HOBBIES 1960 ANNUAL are now available at branches, newsagents and stockists. This great value-for-money handbook costs only 2/- and readers are urged to obtain their copy straight away.

This edition is too good to miss, as apart from the normal features including many new projects, there are two free designs with each copy — for making a delightful Dancing Ballerina Cigarette Box and an up-to-date Service Station.

Postal copies can be obtained from Hobbies Ltd., Dept. 99, Dereham, Norfolk, price 2/6 post free (see coupon on this page).

FREE stamp album and 20 stamps. Request approvals, enclosing 6d. Additional gifts given. — Beeze, 8 Langland Villas, Mumbles, Swansea.

BUILD YOUR OWN HI-FI at home! At last for reasonable cost — the chance to make your own quality HI-FI audio equipment and to gain the knowledge to service and maintain it. FREE brochure from — Dept. HW 20, Radiostructor, 46 Market Place, Reading, Berks.

TRANSISTORS, Germanium Crystals, Head-phones, etc. Lists and diagrams free. Germanium Diodes with three crystal set circuits 1/-. Postage 3d. — P.R.S. (H), 33 Bourne Gardens, London, E.4.

LEARN RADIO and **ELECTRONICS** the NEW practical way! Very latest system of experimenting with and building radio apparatus — 'as you learn'. FREE brochure from — Dept. HW.10, Radiostructor, 46 Market Place, Reading, Berks.



Another "Musical" Winner!
BALLERINA CIGARETTE BOX

Make it yourself

When the lid is lifted the gay Ballerina appears and "dances" to tuneful music in a ballet setting complete with a background of mirrors. Box holds 50 cigarettes. Hobbies Kit No. 257 Special contains all materials for making the box, including paint, glue, mirrors, veneers, etc., and costs only 21/- (post 1/9 extra).

Post coupon for free booklet

Fit it with a musical movement, which incorporates the exquisitely dressed ballerina. Two tunes are available. Choose from:

- B1** Swan Lake
- B2** I could have danced all night

Price each 24/3 (post 9d. extra)

Many other outstanding novelties in Hobbies 1960 Annual. 168 pages, price only 2/- from newsagents, etc., or by post (6d. extra)



To HOBBIES LTD., Dept. 992, Dereham, Norfolk

Please send free 20-page booklet of kit details and items indicated.

- Ballerina Kit (21/- plus 1/9 post) 1960 Annual (2/6 post free)
- Musical Movement, state choice (24/3 plus 9d. post)

Name.....

Address.....

'MISSILE' WALL BRACKET

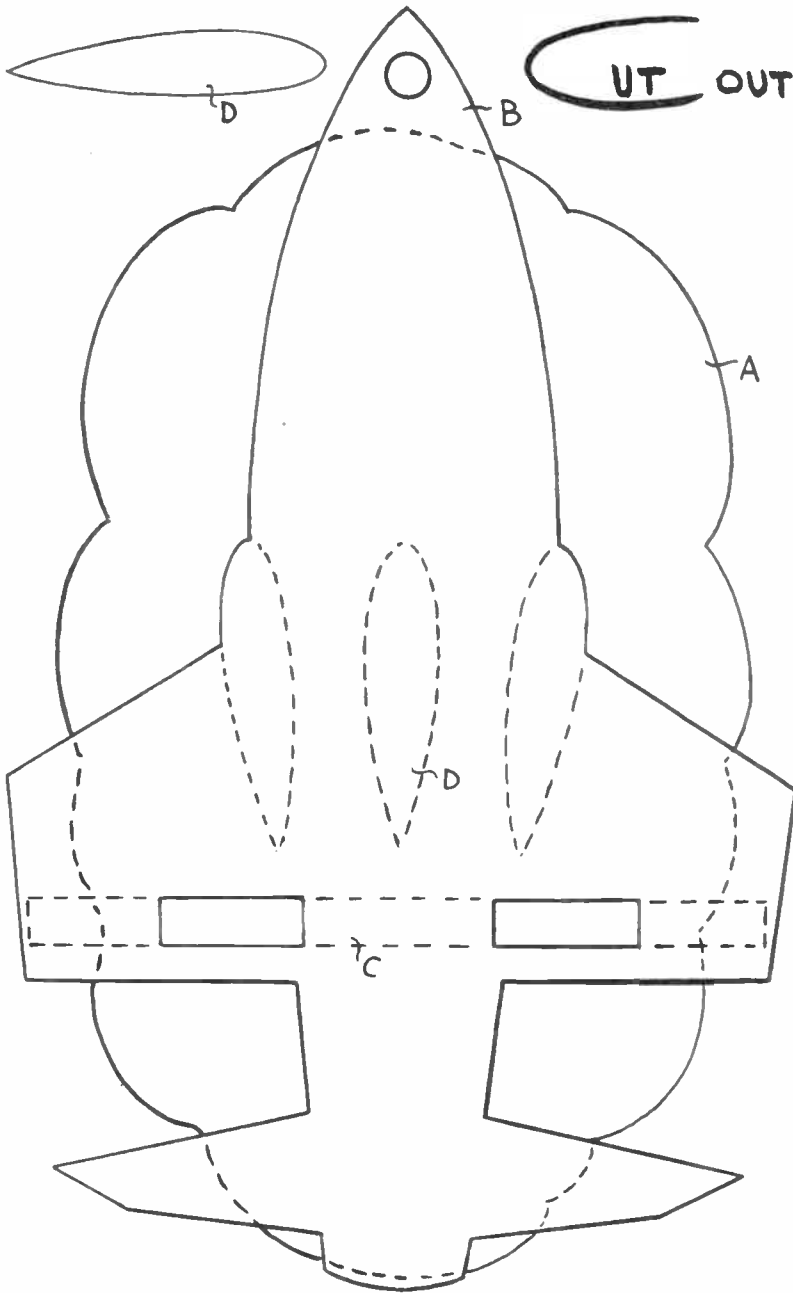

CUT OUT WITH A FRESAW

THIS small bracket with the outline of a guided missile, superimposed upon a background of cloud, makes a good subject for a first attempt at fretwork.

Cut one each of pieces A, B and C, and three of piece D from $\frac{1}{4}$ in. wood. Glue A to B and C to B. Note that the projecting pieces on C fit into similar slots in B.

The three pieces D are now rounded off slightly and glued to B in the positions indicated by the dotted lines.

Clean up with glasspaper and paint in suitable colours. (M.p.)

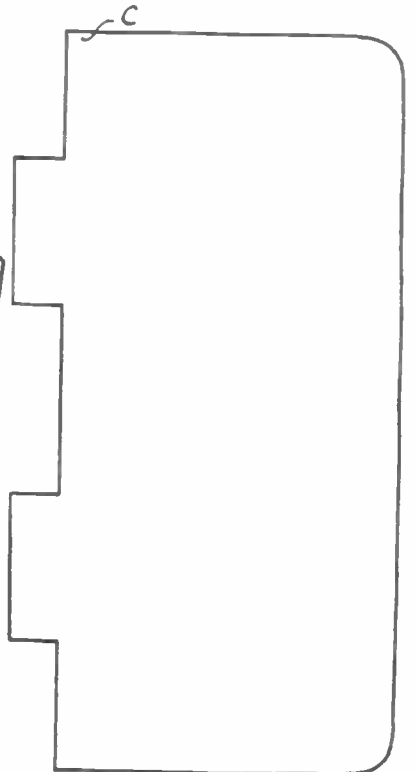

NOW build modern Style!
with **REAL BRICKS AND MORTAR**

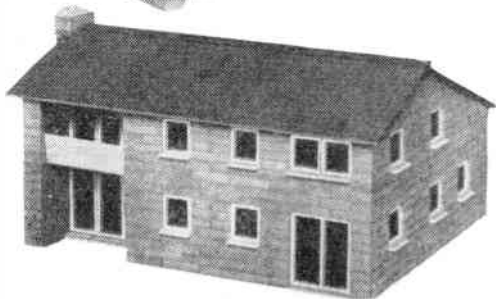
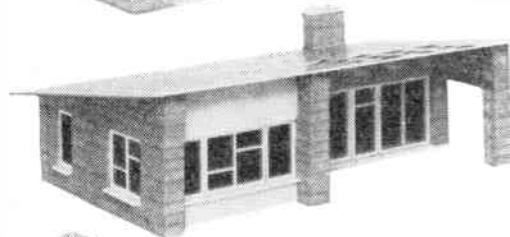
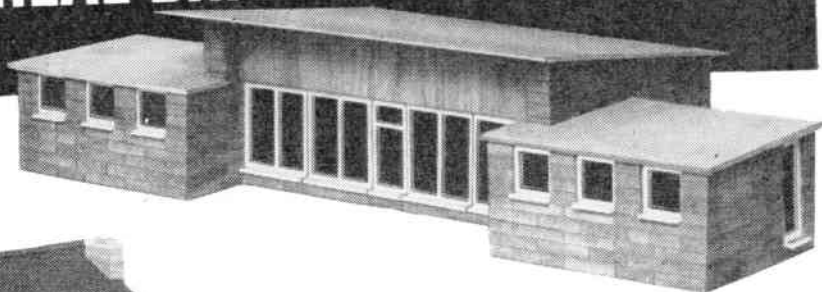

Exciting Contemporary Brickplayer enables you to *build modern!* It's the famous Brick and Mortar Building Kit brought bang up to date. New models are architect-designed to 'O' gauge scale. Kits include bricks in all required shapes, mortar, roofing, windows, doors; plans and instruction booklet. Models can be permanent or dismantled by merely soaking in water and bricks used again and again.

CONTEMPORARY BRICKPLAYER KITS :

"A" — 19/6; "B" — 26/9; "C" — 48/-

Extra bricks, roofing, cement, in low-priced packs: windows and doors obtainable singly.

TRADITIONAL BRICKPLAYER KITS also still

available - Kit 3—26/9; Kit 4—50/-; Farm Kit—61/6

At good toy shops,
hobby shops and de-
partmental stores. If
your dealer cannot
supply, please write
for leaflet and ad-
dress of nearest
stockist.

CONTEMPORARY
BRICKPLAYER

J. W. SPEAR & SONS LTD., Dept. H.W., Enfield, Middlesex

WorldRadioHistory



DESIGN No. 3334

TOY FARM

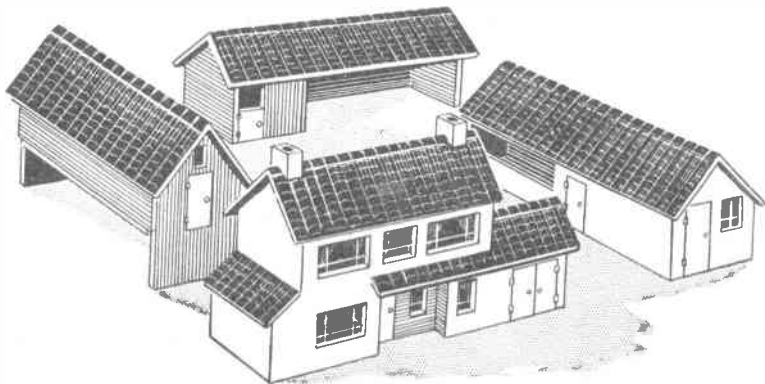

A KIT OF MATERIALS FOR MAKING THIS DESIGN
IS SUPPLIED BY HOBBIES LIMITED
DEREHAM, NORFOLK.
PRICE ON APPLICATION.

SIZE - Farmhouse is 11 in. wide,
with buildings in proportion.
Note - All $\frac{3}{16}$ in. pieces may be
cut from plywood.

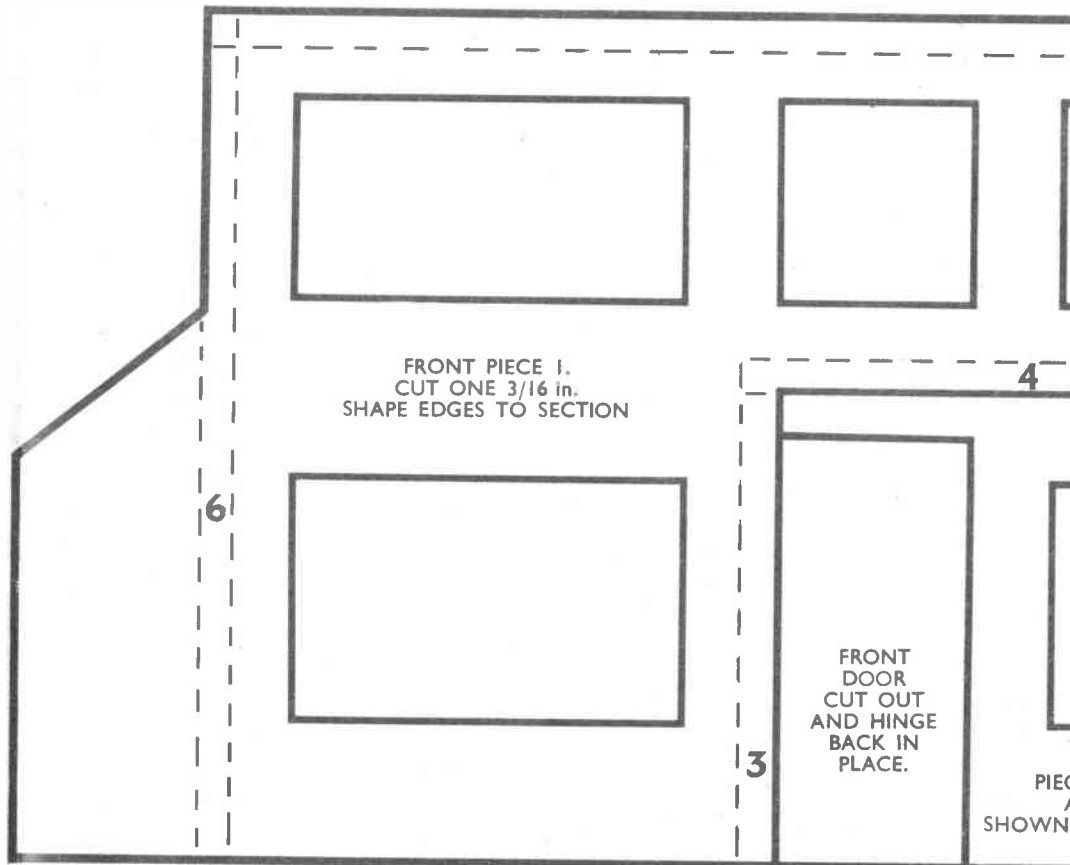

Use
Croid UNIVERSAL

IT'S DESIGNED FOR THE JOB

The popular general purpose liquid glue,
used cold for all making and mending



REAR ROOF 11
OF GARAGE.
CUT ONE
 $\frac{1}{8}$ in.
HARDBOARD.

5

END 24. CUT ONE $\frac{3}{16}$ in.

ENDS 17. CUT THREE $\frac{3}{16}$ in.
(TO OUTLINE ONLY)

STABLE DOOR
23
CUT ONE
 $\frac{3}{16}$ in.

CUT

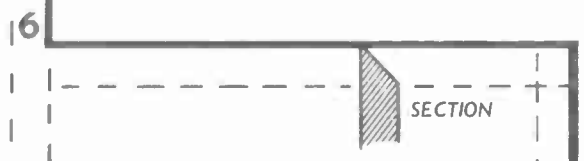
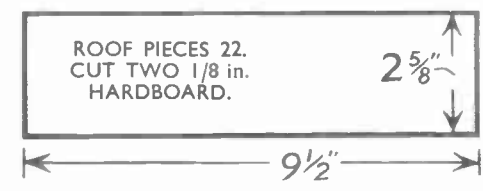
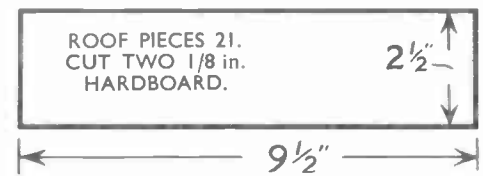
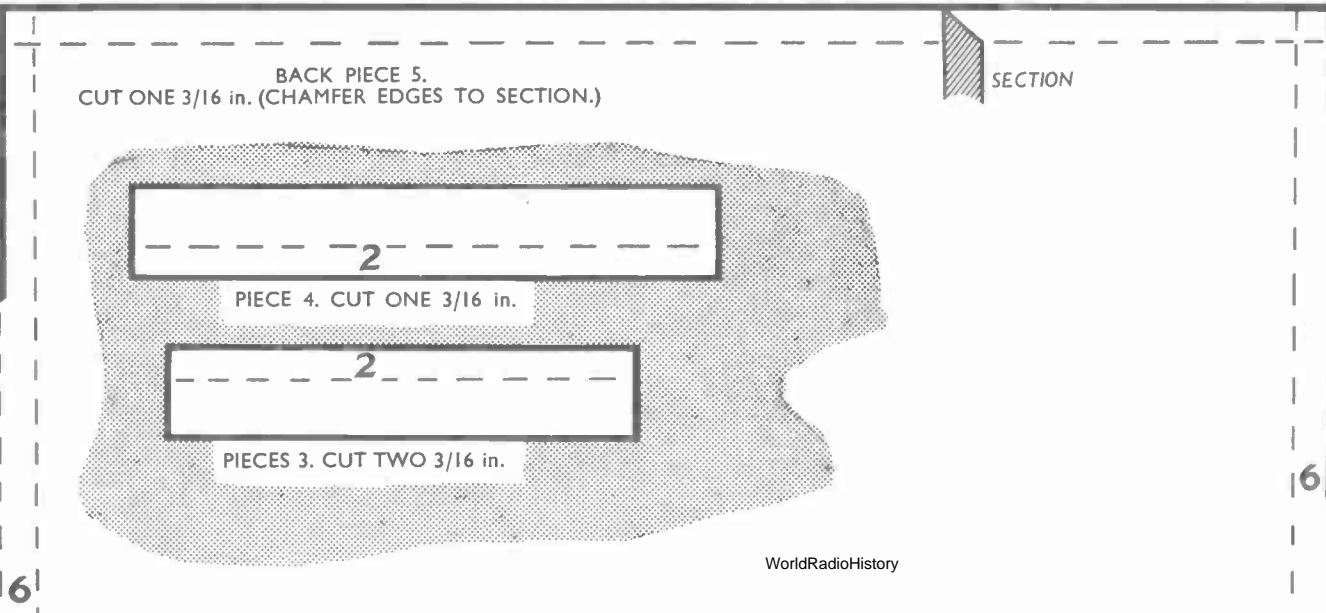
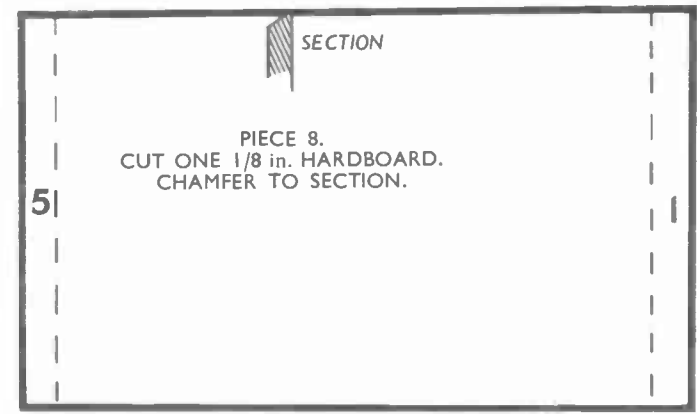
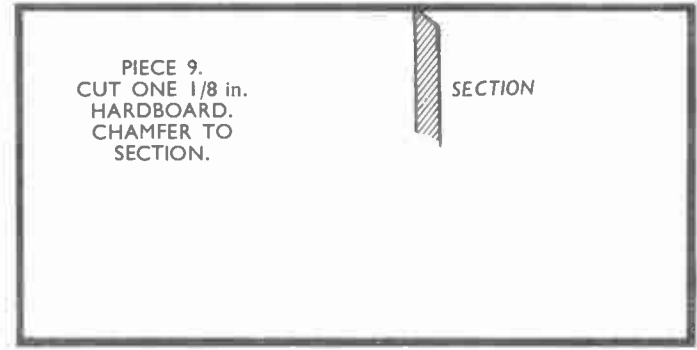
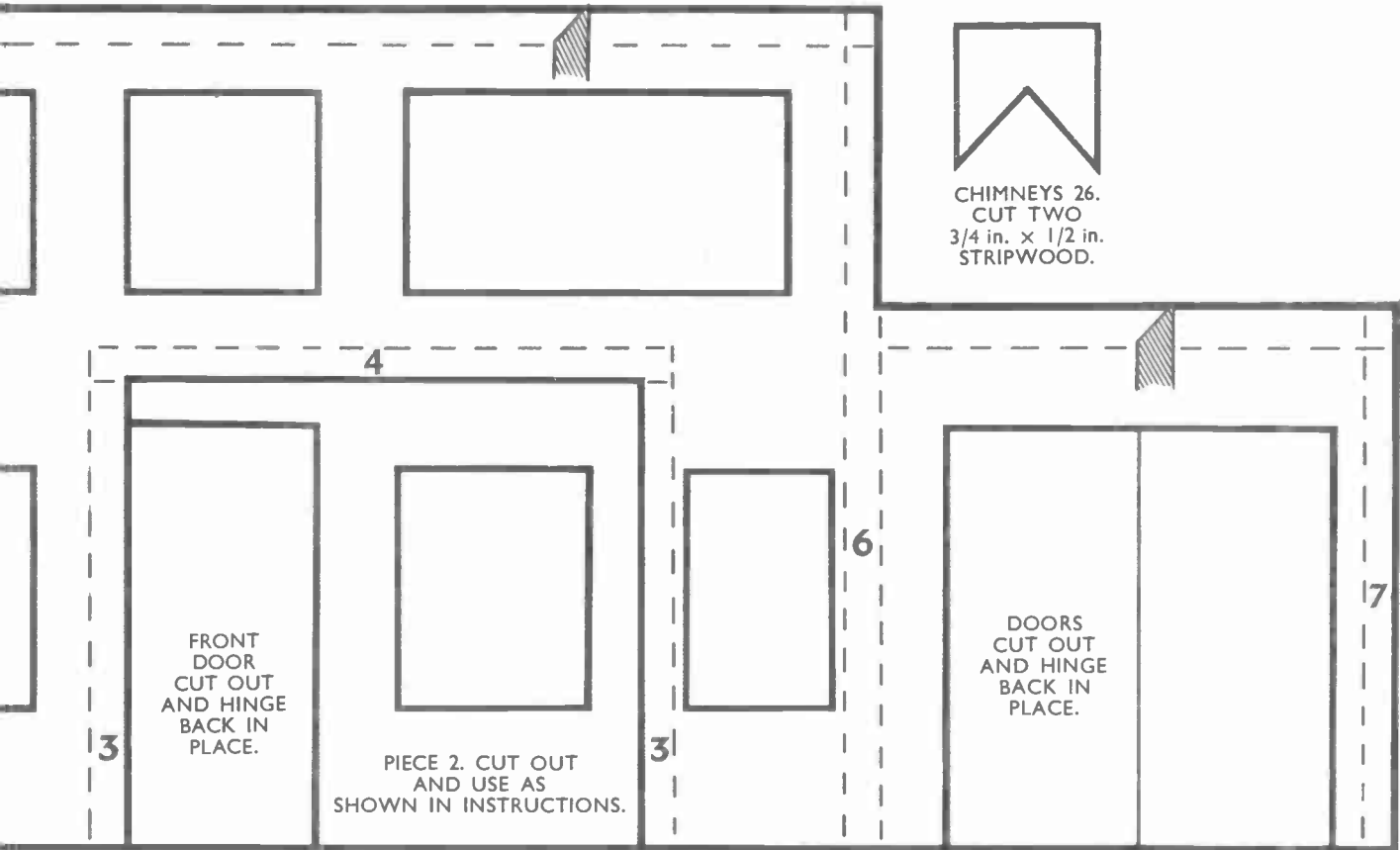

IT'S DESIGNED FOR THE JOB

The popular general purpose liquid glue, used cold for all making and mending with wood, leather, card, etc. The best glue for sticking laminated plastics. Large tube 1/2, 8 oz. tin 2/10, 16 oz. tin 4/6



AVAILABLE FROM ALL BRANCHES OF HOBBIES LTD

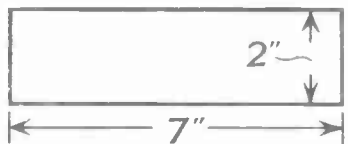
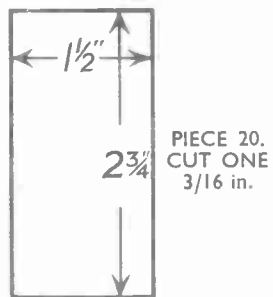
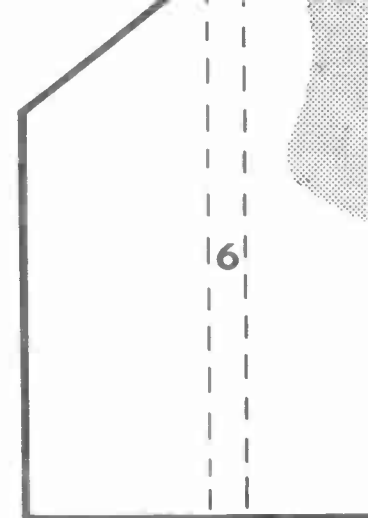
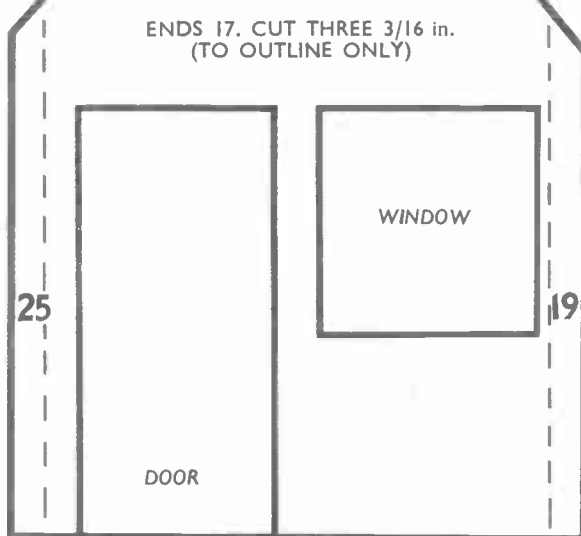
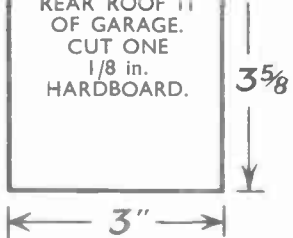

FRONT AND BACK OF BARN 15.
CUT ONE OF EACH 3/16 in.

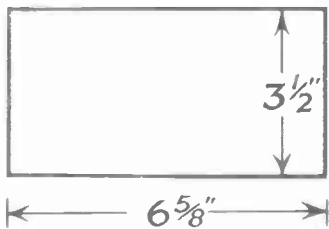

FLOOR OF BARN 16.
CUT ONE 3/16 in.

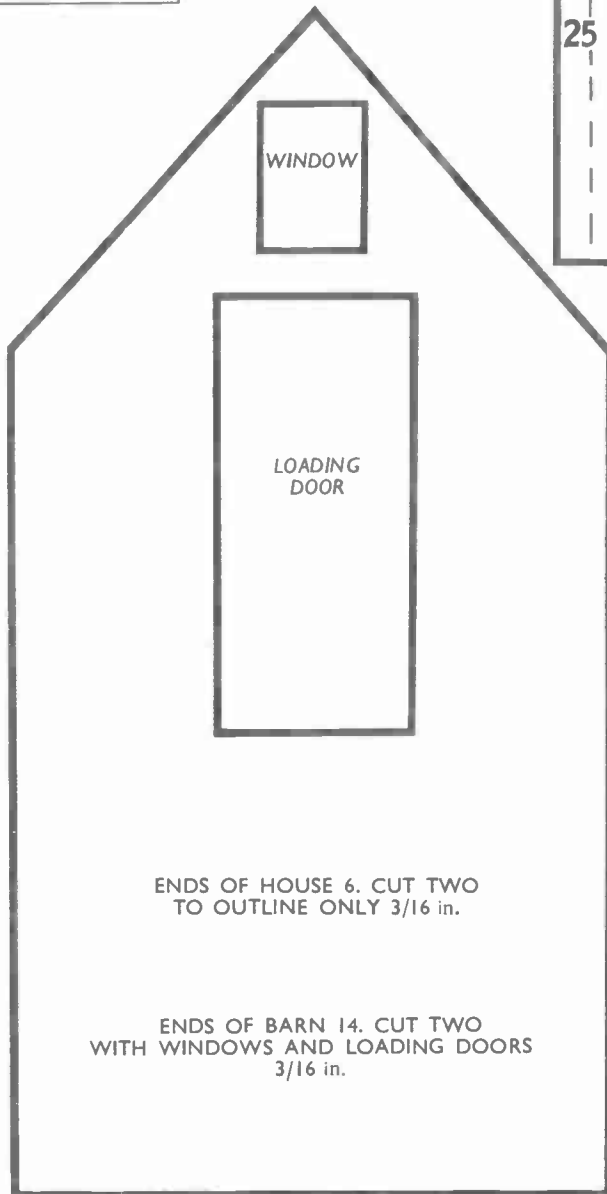

ENDS OF HOUSE 6. CUT TWO
TO OUTLINE ONLY 3/16 in.

ENDS OF BARN 14. CUT TWO
WITH WINDOWS AND LOADING DOORS
3/16 in.

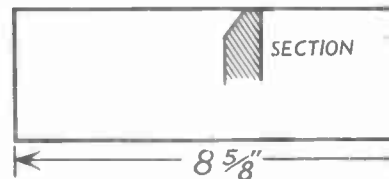
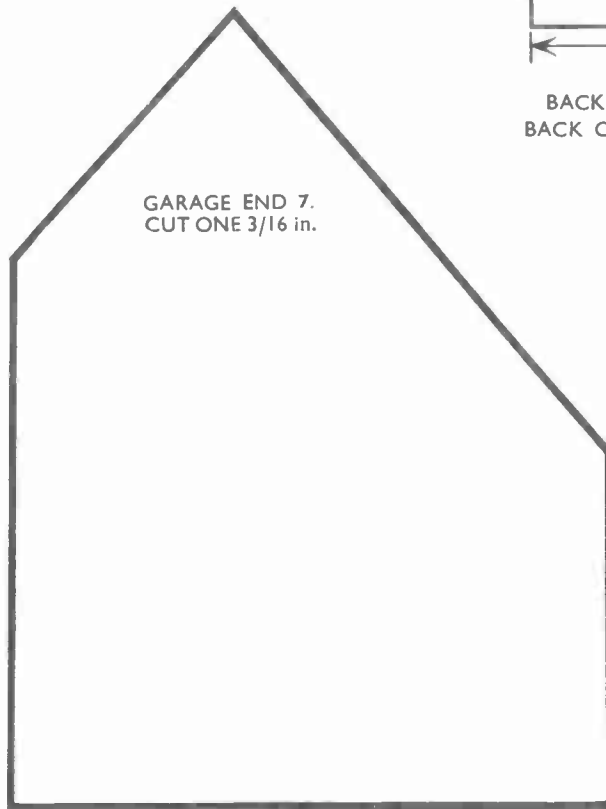

BACK OF PIGSTY 19 } CUT ON
BACK OF COWSHED 19 } EACH 3/16
CHAMFER TO SECTION.

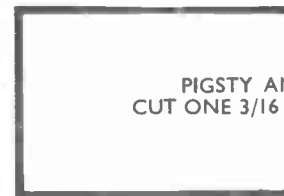
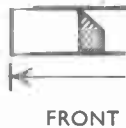

SECTION

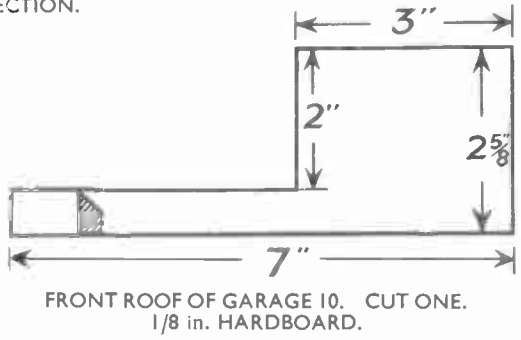
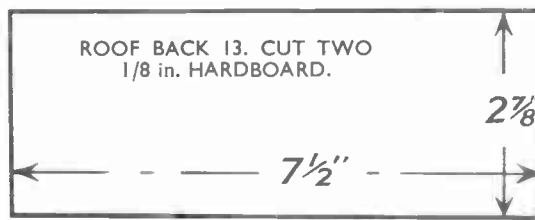
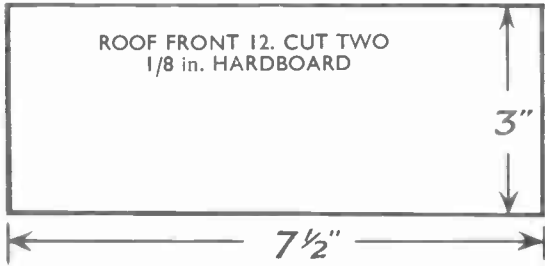
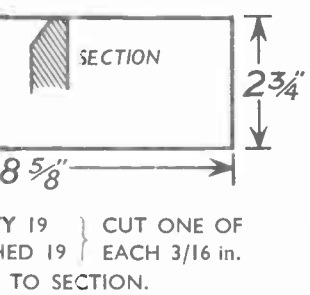

PIGSTY AND DAIRY FRONT 25.
CUT ONE 3/16 in. (EXTEND AS INDICATED)

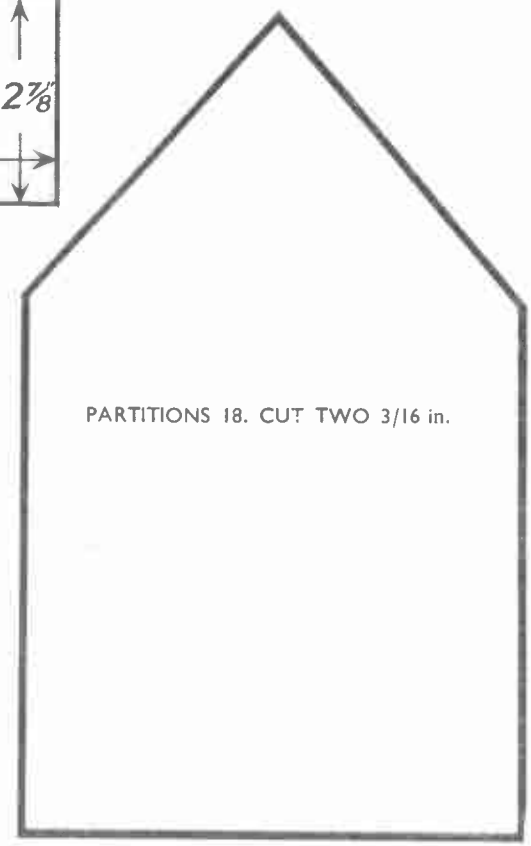
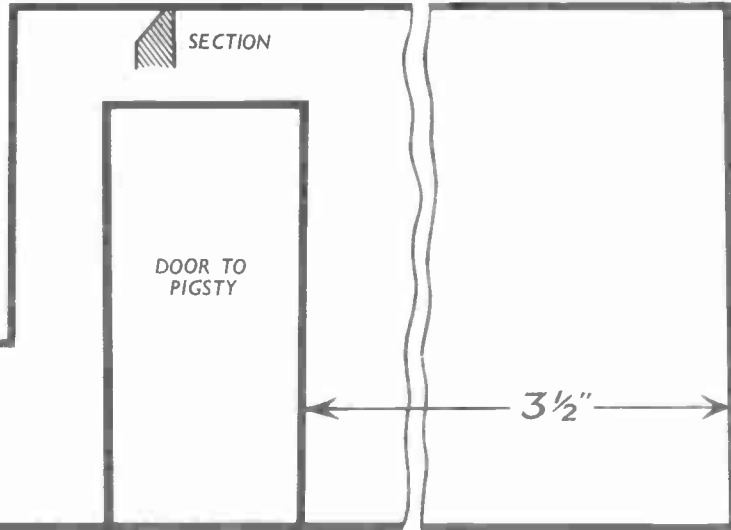

PRINTED IN ENGLAND.