

30th SEPTEMBER 1959

VOL. 128

NUMBER 3329

THE ORIGINAL  
'DO-IT-YOURSELF'  
MAGAZINE

# HOBBIES *weekly*

FOR ALL  
HOME CRAFTSMEN

Also in this issue :

BATTERY AND  
COIL TESTER

HATCHBOX TOYS

PLANS FOR THE  
HOBBY SOARER

GADGETS FOR  
WINE MAKING

COLLECTORS' CLUB

MODELS AND  
NOVELTIES

ETC. ETC.

## ELECTRIC CIGARETTE LIGHTER

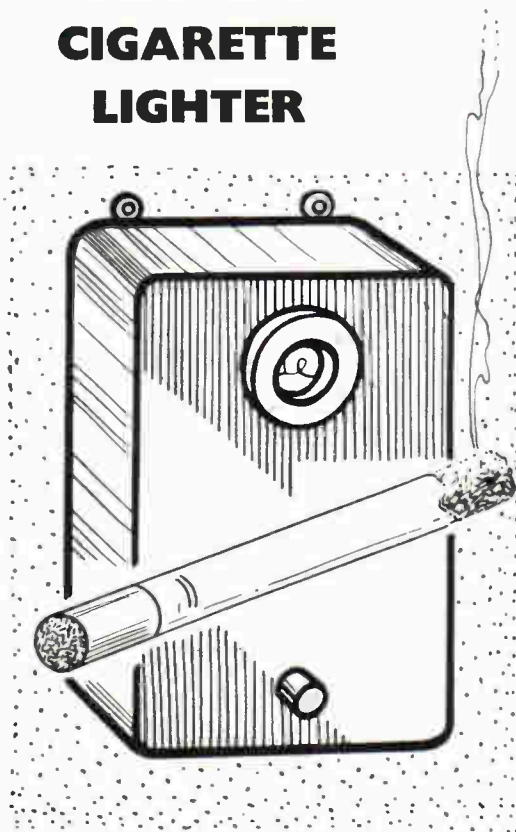

FULL  
INSTRUCTIONS  
FOR  
MAKING



*Up-to-the-minute ideas*

*Practical designs*

*Pleasant and profitable things to make*

World Radio History

5<sup>p</sup>

PARIS, the French capital, is Europe's most beautiful city. The gay night-life of Paris has a universal appeal. It is an unforgettable experience to walk along the Boulevards and mix with Parisians, who sail along as if they were the lords of creation; to visit the cafés with their billiard tables and people playing dominoes or dancing inside, or to go shopping.

I shall never forget a certain window filled with lovely dolls. They were dressed in the height of fashion and there were little trunks and boxes on either side containing a full wardrobe for fêtes, balls, morning calls, dinner parties, even a trousseau for Miss Dolly. No wonder that shop was called 'The Infants' Paradise'.

Notre Dame is the great cathedral of Paris. In the sacristy are many curious relics, including the bloodstained robes of three successive archbishops of Paris who were slain in revolutions.

## FRANCE — By R.L.C.

Marseilles, the first seaport town in the country, is a beautiful place. Upwards of 15,000 vessels enter its harbour yearly. In 1720, the city was visited by a plague; half the inhabitants died, 50,000 in all. A very ancient city, it was founded by the Greeks.

Bordeaux, on the Garonne, is another famous seaport town. It belonged to England for 300 years. It has magnificent quays, three miles long, on the banks of the river. A beautiful bridge, with seventeen arches, spans the Garonne, at that spot a quarter of a mile wide. The old town is most picturesque. Quaint houses, peaked gables, and hanging balconies are to be seen clustering around a grand Gothic cathedral. Our King Richard II was christened there. Some famous wines are made there.

Rouen possesses two noted churches, the Cathedral and St. Ouen. In the Place de la Pucelle, Joan of Arc was burnt alive. You cannot go down the streets of this town without coming, almost at every step, upon some relics of the past. It was from this part of France that the Norman conquerors of Britain came. The people are different from the rest of the French and have a

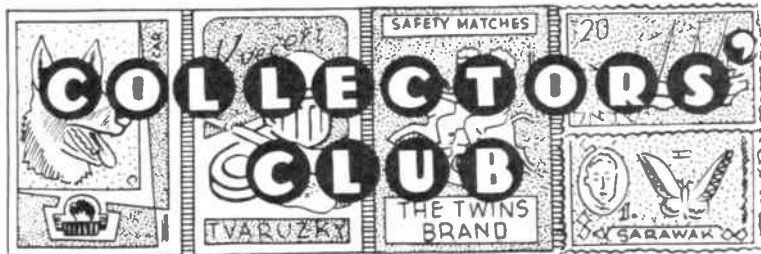

decidedly English look about them. Rouen is a busy place and is chiefly noted for its cotton manufactures.

At Crécy, in 1346, Edward III de-

feated the French. Edward the Black Prince won his spurs in this battle.

At Agincourt, in 1415, Henry V, with 10,000 English, routed 50,000 French, slaying as many as 10,000. Calais was taken by Edward III in 1347; it was recaptured by the French in the reign of Queen Mary, who was so distressed that she said when she died Calais would be found written on her heart.

Rheims has a beautiful Cathedral where the Kings of France were formerly crowned.

Nîmes has some interesting Roman remains. The Maison Carrée is a splendid Greek Temple. There is also a magnificent amphitheatre that used to hold 23,000 spectators.

Nice, a favourite seaside resort, is noted for its lovely scenery and soft climate.

The illustrations show a few of the thousands of stamps and labels which have been issued.

For French pen friends write to, M. J. Bachotet, 23 bis Rue de la Varenne, Saint Mauer, France. Claude P. Marchall, 10 Rue de Dantzig, Paris, France.



## Trip Round the World

MOST philatelists after realising the impossibility of completing a collection of world stamps decide to specialize. Some collect by country or country groups. Others study errors, forgeries, watermarks, postmarks, etc. But the majority collect thematics.

Apart from the usual themes many unusual subjects have been albumed and shown at exhibitions.

Thematics are also popular with philamenists and hotel label collectors.

There are hundreds of stamps and labels available depicting maps, transport, etc. which could well be used to illustrate a theme entitled 'Trip Round the World'.

Readers are reminded that all requests for information, etc., must be addressed to the Editor, 'Hobbies Weekly', Dereham, Norfolk, enclosing stamp for return and accompanied by the appropriate reply coupon (page 359).



# A DOLL'S DRESSER



**L**ITTLE girls love playing with tea sets and providing meals for their dolls. Here is a dresser which will accommodate all the little plastic cups and saucers etc. which go to make the set and will keep them all neat and tidy, thus acting as a lesson in housewifery for the young miss.

The dresser is of simple construction and can be made up by any handyman. Hardwood  $\frac{3}{8}$  in. thick is used throughout, except for the backing and working board which are of  $\frac{1}{8}$  in. plywood. The dresser is 16 in. high,  $5\frac{1}{2}$  in. deep at the bottom and  $2\frac{3}{4}$  in. deep at the shelves,

and is thus a handy size to accommodate the 'crockery'. A cupboard with two doors is provided at the bottom for pots and pans.

Start by cutting the two sides A, shelves B, and base C, assembling with glue and panel pins. Leave a 3 in. space between each shelf and fix the base  $\frac{3}{4}$  in. up from the bottom as shown by the dotted line at A.

Next cut the working board to the dimensions shown at D, smoothing and rounding off the two front corners before fixing to the sides A.

The cupboard front is cut from a piece 10 in. by  $4\frac{3}{4}$  in. as shown at E Measure  $\frac{3}{4}$  in. in on all sides and on each side from the centre line. The doors will be cut out with a fretsaw, drilling small holes in the corners for starting the cut. Reattach the doors to the frame by means of small hinges.

A piece of plywood 16 in. by  $10\frac{3}{4}$  in. by  $\frac{1}{8}$  in. forms the backing and the dresser is completed by the ornamental top shown at F, the design of which of course can be amended as thought suitable.

Four small cup-hooks are spaced 2 in. apart on each shelf and door knobs can be made from small lengths

of  $\frac{1}{4}$  in. dowel rod. Alternatively screw caps from toothpaste tubes make excellent knobs.

Ball catches for the doors can be added as a luxury.

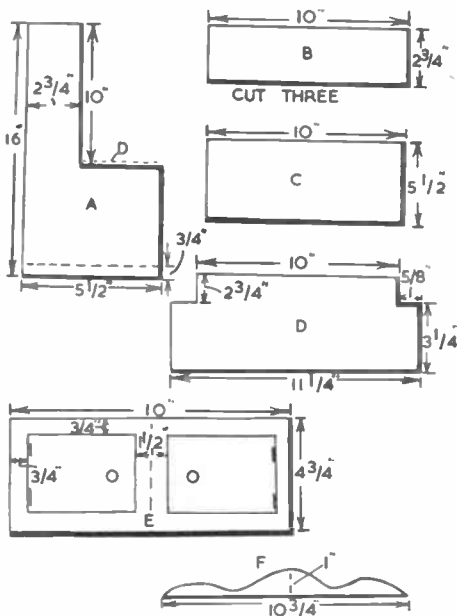

## Success Over Handicap

**O**UR picture shows a young man who has successfully overcome a physical handicap by grit and much perseverance. He is 13 year old Joseph Abbott of 2 Orchard Close, Weaverham, Cheshire, who was crippled by osteomyelitis some five years ago. Joseph, who is shown with his sister Mary, was in Warrington General Hospital for 18 months and on his return home it was suggested that a hobby might help him. With this end in view, Joseph's father bought him a fretwork set.

Ever ambitious, Joseph's first attempt was to make a Swiss chalet, and so pleased was he with his progress that he has now secured a Hobbies Companion Lathe and fretsaw for quicker working and greater output in order to meet the demands of friends and neighbours.

Fretwork and model-making is of course widely recommended as a hobby as a means of rehabilitation in the case of certain disabilities, and we are very pleased to record Joseph's success in this field.



Photo by courtesy of the 'Northwich Guardian'

# ELECTRIC CIGARETTE LIGHTER

Described by  
'Modeller'

**T**HIS cigarette lighter works in a similar way to an electric gas lighter, where a small wire element is made red hot by current from a dry battery. It is intended to hang on a wall at a suitable height for easy use, but could also be made as a standing lighter.

Using  $\frac{1}{4}$  in. wood, dimensions for the parts for the case will be seen from Fig. 1. Two sides are needed. Also two pieces as shown for the bottom, and a piece  $\frac{1}{2}$  in. by  $\frac{1}{2}$  in. by  $2\frac{1}{2}$  in. for the switch contact strip. The disc has a central hole about  $\frac{3}{8}$  in. in diameter.

## Wire element

This is shown in Fig. 2, and is fixed to a strip of thin wood or paxolin, which is afterwards fitted behind the cut-out in the front of the lighter. Two

A somewhat larger element can be made from .007 in., or 37 SWG wire, the coil consisting of 1 in. of wire. Other gauges can also be used, but if the wire is too thick the battery will not supply enough current to make the element bright red, and the lighter will not work.

The element can be tested by touching the leads from the bolts on the battery terminals. It will be found that very thin coils become hot almost immediately, especially if the length of wire is short. A few tests can easily be made to find the best length for the element, if the exact gauge of wire is not known.

## Push switch

The circuit is only completed for a few seconds, when the lighter is actually in use, the push switch being at the bottom of the case. It is made as shown in Fig. 2, and the brass strip can be taken from an old battery. One lead is secured under the strip, and another under a round-headed brass screw.

The push button is a short length of  $\frac{3}{8}$  in. diameter dowel, and is a smooth sliding fit in a hole drilled in the front of the lighter. The button is prevented from coming out by drilling a small traverse hole and inserting a tiny wooden peg.

The brass strip is bent out slightly, so that it only touches the screw when the button is pressed.

## Fitting together

Fig. 3 shows the completed lighter, as seen from behind. The front, top, sides

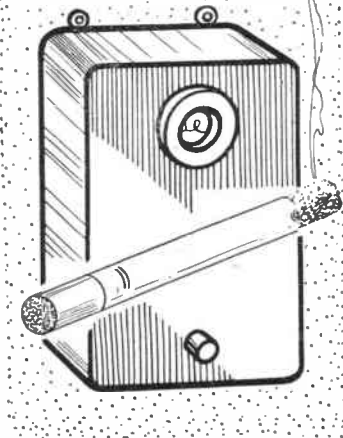

and bottom are assembled first. Glue is smeared on meeting surfaces, the parts being held together with small panel pins. When the glue has set, joints should be well sanded, and corners rubbed down to improve the appearance of the case.

The  $2\frac{1}{2}$  in. by  $\frac{1}{2}$  in. by  $\frac{1}{2}$  in. block, with strip, is then fixed in the bottom of the case, being flush with the back as in Fig. 2. The spare  $2\frac{1}{2}$  in. by 1 in. piece is then placed in position, the flex leads passing through a notch. Glue and panel pins will hold these parts.

A 3-cell  $4\frac{1}{2}$  V. battery, with brass contacts doubled over, is inserted in the case, and two small brackets, cut from brass, are screwed in the positions shown in Fig. 3. The battery strips are bent as necessary to make good contact with these brackets.

The completed element is now fitted in place, so that the coil and two bolt heads occupy the slot cut in the front of the case. Two small screws through the element strip hold it. The disc is then glued to the front of the case so that it covers the bolt heads but leaves the element coil exposed in the central hole.

The electrical connections are shown in Fig. 3, and should be really tight. The element coil should light a bright red as soon as the button is pressed, and the button must be released immediately a

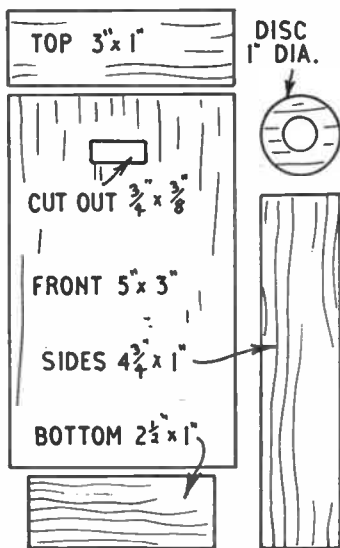

Fig. 1—Sizes to cut

small bolts (say 6BA) are fitted through holes  $\frac{3}{8}$  in. apart. Washers should be used under the bolt heads, to avoid breaking the element wire when they are tightened up. Two pieces of insulated flex are secured under the nuts, before tightening, to provide connections.

The element must be made from resistance wire. Thin copper wire is not satisfactory. For economical running from a  $4\frac{1}{2}$  V. dry battery, .0025 in. wire (that is, about 45 SWG) will be satisfactory. The actual coil is made by winding  $\frac{1}{2}$  in. of the wire round a small nail or stout needle, a little extra being left each end to loop round the bolts.

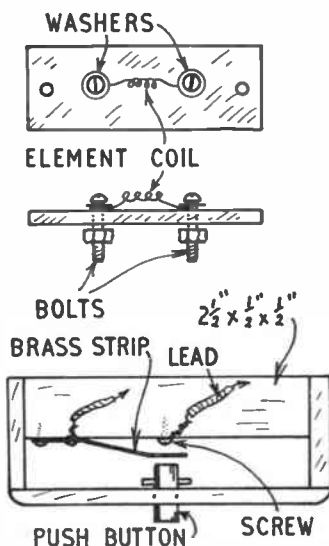
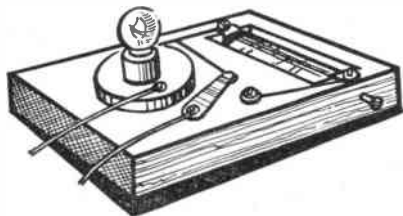

Fig. 2—Element and switch

● Continued on page 345

# COIL AND BATTERY TESTER



By W. J. Ellson

THE wireless amateur, who prefers to make his own set will find it necessary to test his coils, homemade or commercially produced. Other components may well be tested also for continuity, thus assuring that whatever may be amiss in the set, these at least are not to blame.

A very simple, useful and easy to construct tester is here described. A plan of it is given in Fig. 1, with a few additional details in Fig. 2 to help the constructor. For the base a piece of wood is cut to the dimensions given. This can be hard or softwood, and should be  $\frac{3}{8}$  in. or 1 in. thickness. If a piece of wood of such thickness is not available, the base can be built up from two or more pieces, glued together.

A second piece, of the same dimensions, will also be required to screw to the bottom of the base to form a floor to the battery compartment cut out of the base. This can be any thin wood to hand, even a bit of common box wood would serve. The battery compartment seen in Fig. 1, is chiselled out to dimensions, and is a simple job if the majority is removed first by boring out with a suitable centre bit.

### Brass contacts

Battery contacts are fixed to each end of the battery compartment. These can be  $1\frac{1}{4}$  in. lengths of thin springy brass, cut perhaps from the terminals of a worn out battery. They are bent at right-angles and fitted with screws. Bend the ends a little to ensure effective contact with the battery, a No. 8 size pattern (see Fig. 2A). At the centre in front of the battery, screw a lamp holder (any pattern will do) to hold a 2.5 volt torch bulb.

To the right of this a switch is fitted as seen. A simple home-made affair will give satisfaction. It is a  $1\frac{1}{2}$  in. length of springy brass, bored at one end to admit a  $\frac{1}{8}$  in. round-headed brass screw. Fig. 2B details the arrangement. The switch is screwed in place with a thick brass washer beneath it, and its free end bent upwards a little to provide a finger

grip for easy movement. The switch studs are just a pair of  $\frac{1}{8}$  in. round-headed brass screws, with thin metal washers beneath.

Connections to all points are indicated in Fig. 1 and should be quite plain, the circuit being a simple one. To one terminal of the lamp and to one side of the switch attach a length of flexible wire. These are the test leads.

To the free ends of these flexible leads a satisfactory form of terminal can be fixed by soldering a  $1\frac{1}{2}$  in. length of medium grade brass or copper wire to each. About  $\frac{3}{8}$  in. of the wire ends should

be bent at right angles as shown in Fig. 2c. Wind a few turns of adhesive tape round the soldered joint.

To operate the tester, put a 2.5 volt torch bulb in its holder and insert a No. 8 dry battery in its compartment. If the battery contacts are found to be unsatisfactory ensure better pressure by driving a 1 in. screw through the side of the compartment to press the metal contact against the contact of the battery. Having established firm and positive contact, connect the component under test to the two test leads and turn the switch strip to the right 'ON' position.

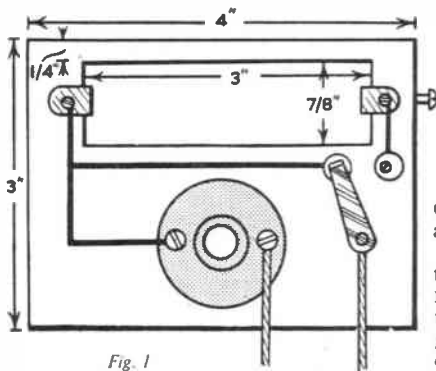

Fig. 1

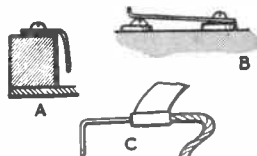

Fig. 2

Continuity in the component is immediately confirmed by the lamp lighting up.

With the switch turned to the left the tester can be used to keep check on the L.T. battery of the radio set. Just slip the terminal leads into the battery and get a reliable idea of the amount of current still available.

● Continued from page 344

## Electric Cigarette Lighter

light has been obtained. The battery will have a reasonable life because current is only drawn for a few seconds.

If the lighter is permanently fixed in a position where an A.C. mains supply is available, current may be drawn from a 4V. or 6V. transformer. A deeper case will be necessary, to accommodate the transformer.

The transformer primary is connected to a length of twin flex, fitted with a plug to insert in the mains socket. This circuit is left permanently connected, exactly as with a bell transformer, and no current will be taken when the lighter is not in use.

The transformer secondary is connected to the switch and element, exactly as when wiring in the battery. For a 4V. to 6V. transformer, the element can consist of about  $1\frac{1}{2}$  in. of 37 SWG or similar wire, with a little extra each end to loop round the bolts.

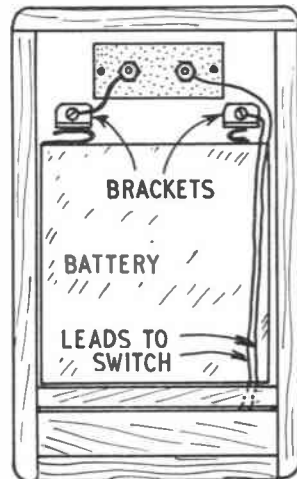

Fig. 3—Back of lighter

# THE AIM IS FOR 'DEPTH'

WHEN we admire a scene with our eyes we 'see' it in depth. It is not flat and without thickness — it stretches from foreground to far distance in receding planes. We have stereoscopic vision with two eyes spaced apart and transmitting different messages to the brain, and the brain translates the messages of our eyes. We know that a distant object the same size as a nearer one will appear smaller (just as we know it is the same size even though it 'looks' smaller). We know that haze and merging of tones to blue hazy distances means depth in vision.

The print you make, however, from the negative captured by your camera's single eye is, itself, a flat thing without depth. When we re-look at the original scene in print form we know it's a representation of something which had visual depth, and tend to 'see' it in that way again — but just as an artist, or the painter of stage scenery, uses skill to aid the visual effect of 'depth' on a flat surface, so the amateur snapper can put the 'feeling' of depth into his prints. It lies in selection and direction of the camera's single eye to aid an illusion of depth in a flat representation.

As usual, examples serve best to explain.



Placing near object close to camera and sharply focused — here a Crucifixion Cross — helps to add 'depth' to a shallow scene where main subject dwarfs foreground. The Norman Tower of Tewkesbury Abbey, Glos.

(1) Place some object much closer to the camera's eye than objects beyond. The near object will loom large in the print, those beyond smaller in com-

By E. G. Gaze

parison: we know they are further away, but now they LOOK further away in depth. The same applies if the near object is small compared to the main subject matter in the background. By being so much closer to the lens it looms large by comparison — just as a small



Line of fence tapering from foreground and figures for scale effect add 'depth'. Dore Abbey, Herefordshire

boy behind a tall man sees a distant building dwarfed by the man, though he knows the building is taller. Comparison gives distance, depth.

This is also useful when the main subject is large and will cover much of the print area with little or no chance of a foreground 'lead-in' — as often happens in confined spaces when trying to snap old buildings. Bulk is relative, distance is relative — and you don't want a print to look flat, without depth. Such a near object — lamp-post in a street scene, close figure, etc — must be sharply focused or it will blur and distract in the print. It is often the case that it is in shadow or not highlighted as is the main



Dore Abbey again, using gateway as frame from low-level viewpoint in conjunction with fence line. 'Depth' effect could be further accentuated by lightening tone of building

subject — it will print darker in tone than the main subject background which also adds to the 'feeling' of depth in the print. Our eyes tell us that tones tend to merge, become lighter in the distance, and contrast less. So often lighter tones in the distant parts of the scene accord with our own visual experience and add 'depth' to the print.

(2) Converging lines of roads, fences, telegraph poles, trees, etc., can be used in composing the picture before snapping to give a strong feeling of depth to the print by running from foreground right through to middle or far distance. They can be used in conjunction with figures for scale effect.

(3) A low level viewpoint, sometimes a high level one, will give scale and depth. The use of archways as frames to a scene to add visual interest pictorially to your print has been mentioned in previous articles — it also adds a feeling of 'depth' to the subject matter lying beyond. A frame such as this, combined with a low level viewpoint — to make sure of including the whole of a large main subject beyond the arch — can be very effective in giving an impression of

● Continued on page 347

Please youngsters with these

# SIMPLE MATCHBOX TOYS

IT is a fact that children are often excited by the simplest of toys, which can be manufactured in a few moments by a patient parent. Perhaps the young child is doubly pleased with

button or washer, a cotton reel, a length of cotton and a matchbox tray to make the radio. Tie one of the matchsticks to one end of the cotton, then thread the cotton through the cotton reel and

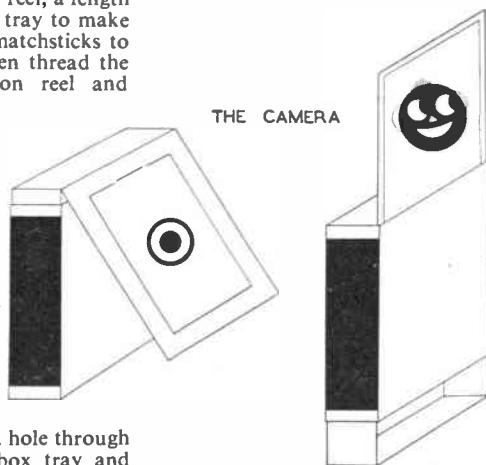
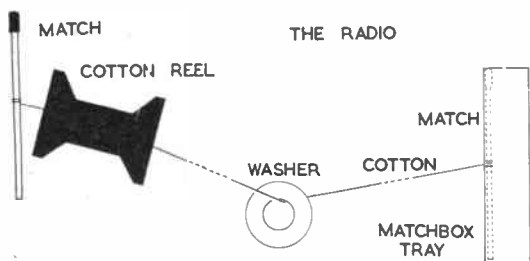

his plaything when he knows that he can duplicate the toy himself, should it be broken, and who can deny that to witness the creation of an object always increases its interest. Matchboxes comprise the main raw material for three quickly-constructed toys which will provide a child with much enjoyment.

To make the camera, remove the tray from an undamaged matchbox and cut along the sides and one end of the bottom using a sharp penknife, to form a long rectangular flap which is hinged to the tray at one end. Cut out a humorous portrait picture, measuring 1 in. by 1½ in. from a magazine or comic. Paste the picture on the inside of the flap, so that it will be right way up when the flap is raised. Draw a simple representation of the front of a camera upon the outside of the flap. Assemble the toy for action by inserting the tray in the cover, while letting the flap hang outside. The toy will thus bear a rough resemblance to a miniature camera. To operate, merely press the hinged end of the tray into the cover and let the resistance of the cover cause the 'front' to flip upwards, bringing the 'snapshot' into view.

By using the covers of matchboxes as blow guns and the trays as ammunition, a novel shooting game is possible. Characters cut from comics and pasted upon matchboxes will serve as targets. Number them by pasting on figures cut out from an old calendar. Set up the targets, well spaced out, upon a table, stand a reasonable distance away and 'shoot' matchbox trays at the various objectives. Alternatively, two young people can line up targets on opposite sides of the room and then shoot at one another's 'armies'.

You will need two matchsticks, a

washer respectively. Bore a hole through the middle of the matchbox tray and thread the cotton through the hole.

Tie the other matchstick on the end of the cotton, inside the tray.

Let a friend hold the matchbox tray 'receiver' against his ear, while you take hold of the cotton reel and the matchstick which keeps it in place. It will now be possible for you to make a variety of sound effects, which will be greatly amplified by the 'receiver'. Pull the cotton tight and slide the button back and forth, to produce a loud roaring sound. Pluck

the taut cotton to obtain a guitar effect. Slacken the cotton and spin the button, then pull the cotton tight for a sound like machinery or a motor-car engine. To make a noise like clapping hands, tauten the cotton and grate the thread around the rough edge of the hole in the cotton reel. The various sound effects can be made much more entertaining if you invent an amusing story to accompany them.

(A.E.W.)

● Continued from page 346

## The aim is for 'depth'

'depth' to the flat print — and this can be further accentuated if the main subject in the background is lighter in tone. Tone values are a matter of choice and in each case you must decide on your own.

(4) Differential focusing has often been mentioned in previous articles. Briefly, using a wide lens stop with critical focusing on a near object so that, while it is sharply rendered the background is thrown out of focus and completely blurred, will make the near object 'stand out'. If differential focusing is not so drastic the background, though falling out of focus as compared with the near object, still retains enough form to have definite shape and context to the near subject. It can be used to give a feeling of 'depth' — which is different from the effect of a near subject standing-out against a completely blurred background

(5) Make use of atmospheric haze, mist, etc. The drowsy haze of a hot day,

autumn mists shot with sunbeams, veiling fog — all, to a greater or lesser degree, tend to shroud the distances, hide detail and concentrate interest in masses. Haze, light mist with sun-light, and a foreground object clearly defined, give a great sense of 'depth' to a print. Don't use even a mild yellow filter as it tends to cut through haze and slight mist and destroys the effect of receding planes caused by the shrouding and merging of detail.

It is good policy to examine old prints and, if they lack this feeling of 'depth', to imagine how you could put it in next time. It is also easy to formulate rules for as many cases as you can find! Yet an approach with some of the above hints in mind may help to give your camera's single eye just that little extra power of pleasing you and others with your final print. It can't do any harm to experiment anyhow!

# BUILD THE HOBBY SOARER

## YOU WILL NEED

- Strip:**  
 36 in. by  $\frac{1}{2}$  in. by  $\frac{1}{4}$  in. Obechi — 2 lengths.  
 36 in. by  $\frac{1}{8}$  in. by  $\frac{1}{4}$  in. Hard Balsa leading edge — 1 length.  
 36 in. by  $\frac{1}{4}$  in. by  $\frac{1}{4}$  in. Hard Balsa trailing edge — 1 length.  
 18 in. by  $\frac{1}{2}$  in. by  $\frac{1}{4}$  in. Hard Balsa leading edge — 1 length.  
 18 in. by  $\frac{1}{8}$  in. by  $\frac{1}{4}$  in. Hard Balsa trailing edge — 1 length.  
 18 in. by  $\frac{1}{2}$  in. by  $\frac{1}{4}$  in. Hard Balsa for fin — 1 length.  
 6 in. by  $\frac{1}{2}$  in. by  $\frac{1}{4}$  in. Hard Balsa tailplane spar — 1 length.  
 18 in. by  $\frac{1}{8}$  in. by  $\frac{1}{4}$  in. Hard Balsa tailplane spar — 1 length.
- Sheet:**  
 36 in. by 3 in. by  $\frac{1}{16}$  in. Balsa — 2 lengths.  
 36 in. by 2 in. by  $\frac{1}{16}$  in. Balsa — 1 length.  
 8 in. by 3 in. by  $\frac{1}{4}$  in. Obechi — 1 length.  
 9 in. by 2 in. by  $\frac{1}{16}$  in. Plywood — 1 length.
- Miscellaneous:**  
 Scrap  $\frac{1}{16}$  in. sheet balsa,  $\frac{1}{8}$  in. sheet balsa, piano wire, balsa cement, banana oil, tissue, tissue paste.

**T**HIS 'stick' type glider is quite simple to construct, and combines ruggedness with a high performance. The first necessity for the builder of this model is a full-size drawing of the fuselage structure, and to aid you in making this the illustrations reproduced on pages 350 and 351 have been 'graphed' into squares at the nose where the outline of the fuselage is curved.

Draw the outline of the nose first on white cartridge paper, or even on the back of a spare piece of wallpaper, and complete the outline with straight lines, using the scale at the foot of the illustration for all measurements. Then draw the thickness of the longitudinal members ( $\frac{1}{8}$  in.), mark the positions of the vertical spacers and complete the shape of the wing-mount. Pin the completed drawing to a flat building board — preferably a thick piece of soft wood — and rub a piece of candle over the surface of the drawing paper at all joint positions

*The completed model, with Gordon Allan's son eager to fly it!*

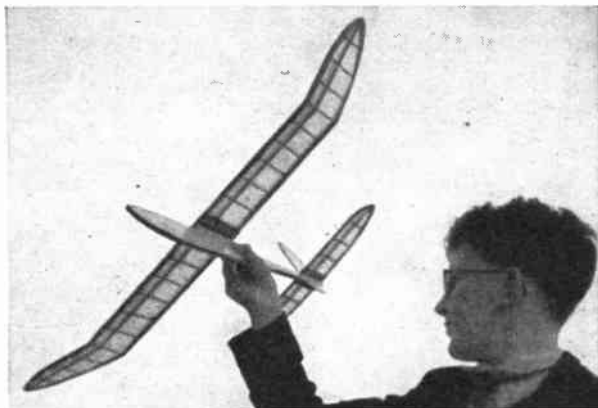

in the fuselage structure; this is to prevent surplus balsa glue from cementing the structure to the paper.

Drive straight pins or panel pins into the board along the lines of the drawing representing the longitudinal members

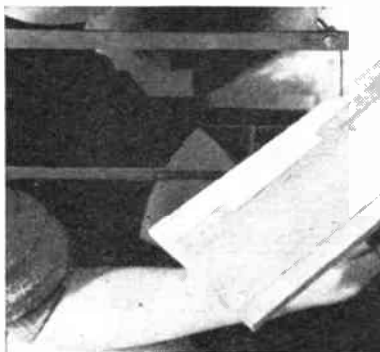

*Cutting the wing mount from obechi, using stiff paper pattern as guide*

(longerons), and space them at roughly  $1\frac{1}{2}$  in. intervals. Now slide a length of  $\frac{1}{4}$  in. by  $\frac{1}{4}$  in. obechi, on edge between each set of pins. Chamfer the ends of each piece to make a neat fit at the rear. Make sure that the strips are perfectly upright and do not lean. Join them at the back with balsa cement. Cut the spacers with a sharp modelling knife and try them for size. They should make a neat sliding fit. Smear balsa cement on the ends of each spacer, and at the spots on the longerons where they will fit. When completely dry, cement the spacers again, and fix them in position.

Draw out the shape of the nose-piece, incorporating the slot for ballast, on stiff paper, and cut it out. Paste this on to a piece of  $\frac{1}{4}$  in. obechi, and cut round it with a fretsaw. Trim the edges of the wood smooth with glasspaper, remove the paper pattern and cement the nose-piece in place. Then cut a slender triangle of obechi, and cement this in place at the rear of the fuselage frame.

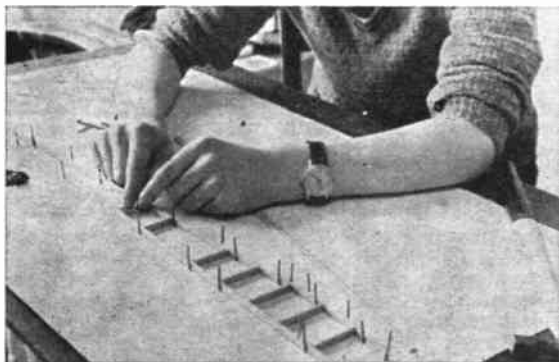

*Fitting obechi spacers in fuselage frame*

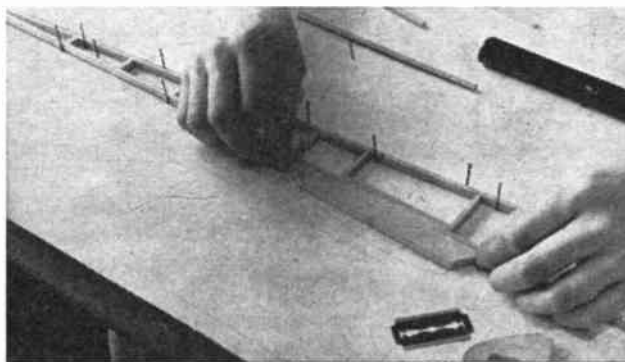

*Fit wing mount with balsa cement after cutting away part of framework to take it*



In a similar way trace the shape of the wing-mount, and cut it out from  $\frac{1}{4}$  in. thick obechi. Smooth with a file and glasspaper. The part of the fuselage frame underneath the wing-mount, which is shown chain-dotted on the drawing, is now cut away to make room for the mount. After this, remove the support pins locally, and cement the wing-mount in place. When completely dry, remove all the pins, so that the fuselage frame is free. Trim smooth with a file and glasspaper where required.

Cover one side of the frame with  $\frac{1}{8}$  in. sheet balsa. First apply a fairly liberal coat of balsa cement to one side of the fuselage frame, including the spacers, longerons, nose piece and wing-mount. Do this direct from the tube and spread it quickly. Place the frame on a 3 in. wide piece of balsa, and rest books

*After fixing tow hooks, cement second balsa side in position*

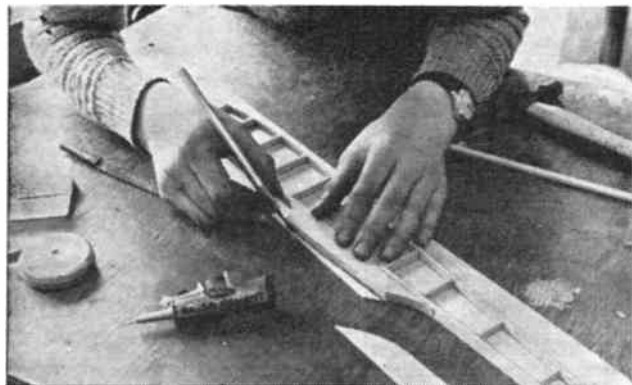
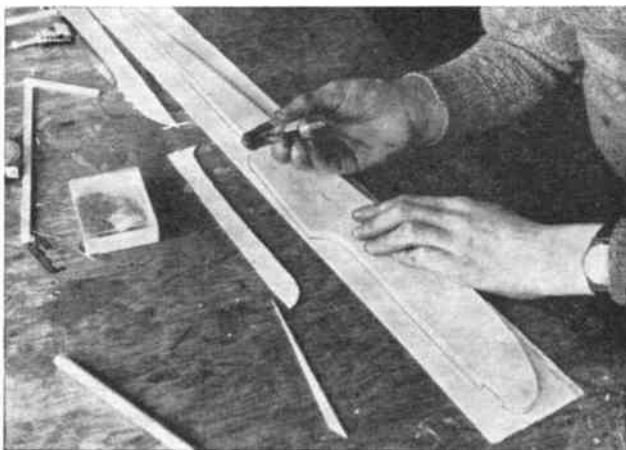

or similar weights on top of the frame along its whole length. Make sure the balsa is on a level surface free from small obstructions. Before the cement has completely set, scrape away any surplus which has been forced away on the

outside edge of the fuselage.

When set, trim away the unwanted balsa, and smooth the edges level with the frame. Before fixing the second side in precisely the same way, bend the two towhooks to shape from piano wire,

drill two tiny holes in the bottom longeron, slip the hooks in position and cement them in place. Then after cementing the second side in position, round off the edges of the balsa - with the exception of the two edges along the top of the wing-mount. Smooth the fuselage, and apply 3 or 4 coats of thick banana oil, glasspapering between each coat.

Cut the wing and tailplane platforms from  $\frac{1}{8}$  in. plywood to the sizes given on the drawing. Coat the middle of the platforms on one side of each with cement, and leave to dry. Then cement the wing platform in place, making sure it is absolutely at right angles to the fuselage. Run a fillet of cement at each side of the platform where it makes contact with the fuselage.

Recess the rear end of the fuselage at the top for  $\frac{1}{8}$  in. so that the tailplane lies flush. Cement in place as before.

In the next article we shall be completing the model ready for flying.

## A paper Drinking Cup

CAMPERS and picnickers will be sure to find a use for this quickly constructed paper cup. While it will be better to make your cup from waxed paper, other kinds of fairly stiff paper can be utilised in an emergency.

To make the cup, fold the paper square in half along one diagonal (Fig. 1). Then fold corner (B) to point (X) (Fig. 2), and fold corner (A) to point (Y) (Fig. 3).

The two flaps at point (C) should be folded forward and backward respectively (Fig. 4). Finally place your fingers in the space at the top, and open out the cup. It should appear as Fig. 5.

If you use paper cups on a picnic, do not leave them as litter. (A.E.W.)

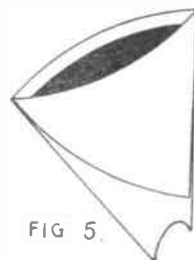
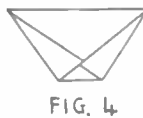
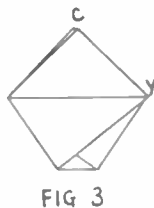
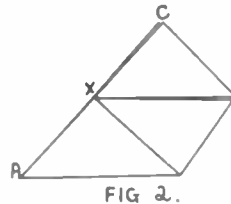
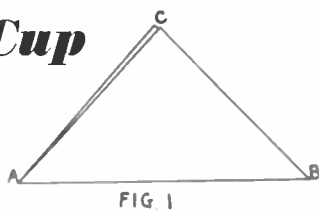

# HOBBY SOARER

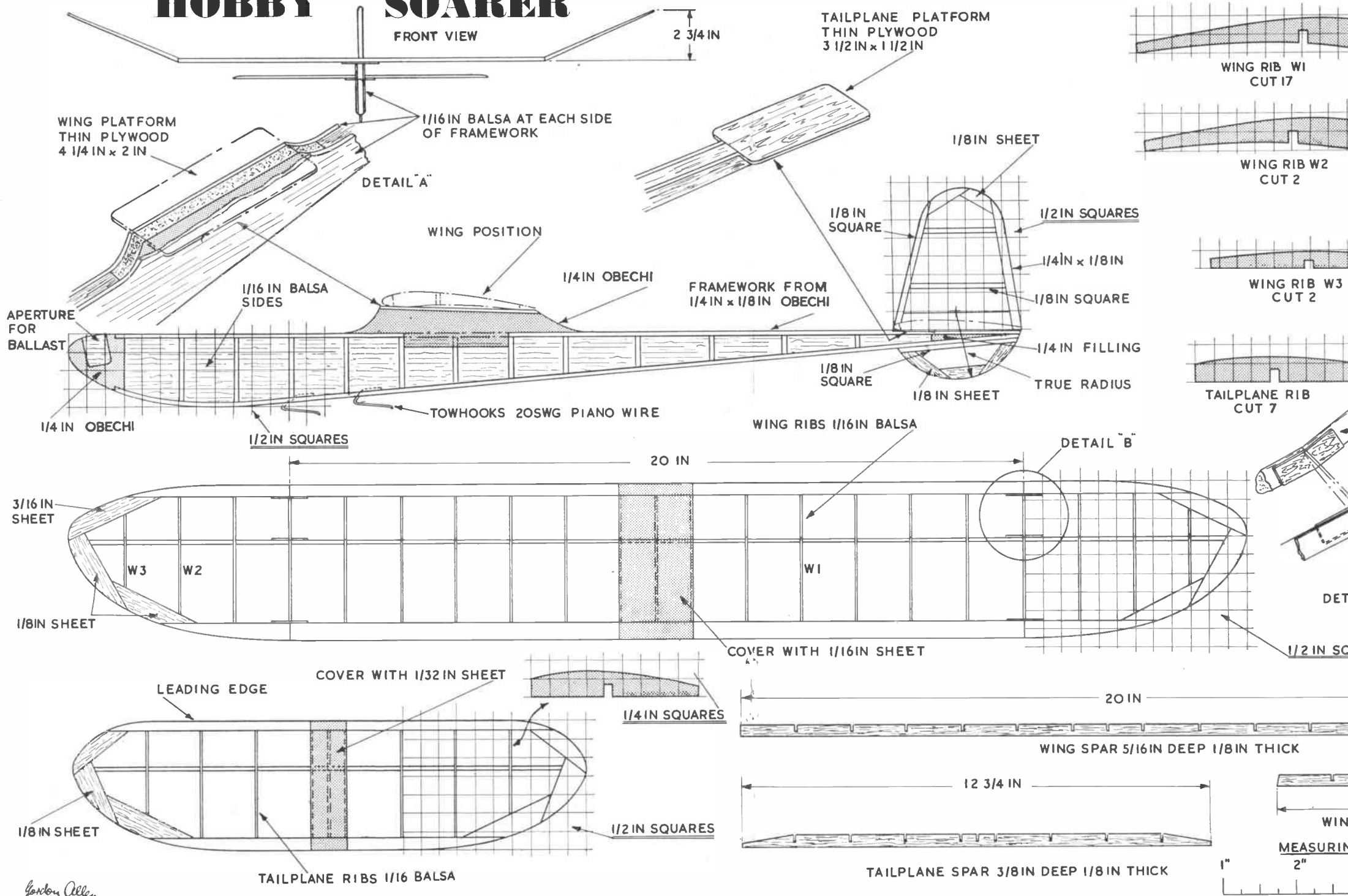

Gordon Allen

# HOBBY SOARER

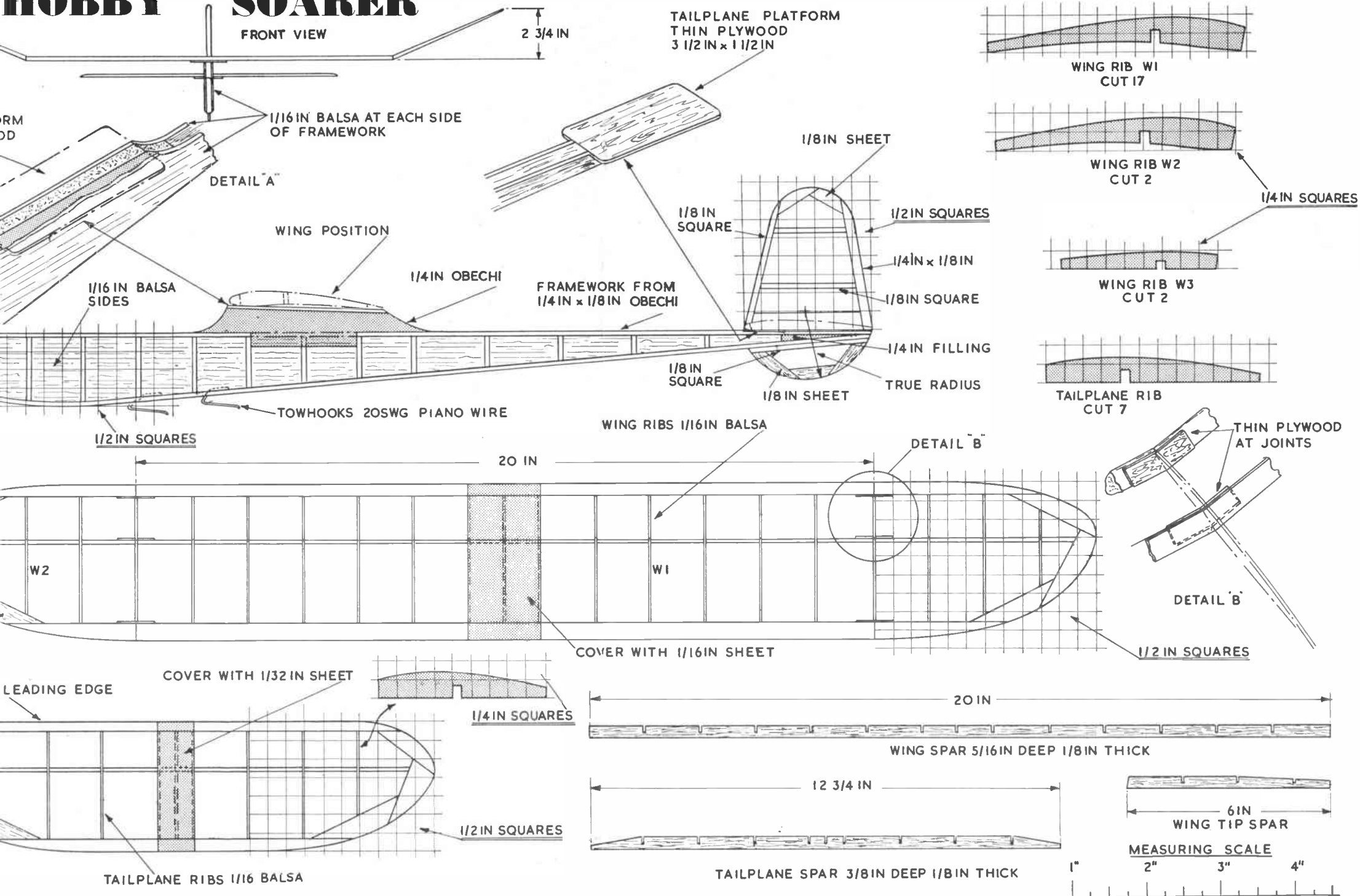

# Mainly for Modellers

**B**EFORE commencing our study of shipbuilding from the fourteenth century to the nineteenth century, the period that concerns most of our modellers and which covers most of our present kits, let us make a brief survey of the earliest ships built by man.

Undoubtedly, as far as our present knowledge of this vast subject goes, we must give the credit to the Ancient Egyptians for the first practical attempts at boat building; their first boats, shown in Fig. 1 were developed from their floats made from reeds.

Having developed a means of binding their reed bundles together they did so by binding them into graceful reed boats such as that in the sketch. This is copied from one found in the tomb of a noble of Thebes. The lines of this boat were later followed in shaping a dugout as shown by Fig. 2.

Wooden ships followed when the Pharaohs began to obtain supplies of wood, mostly cedar from Lebanon and Morocco. Then followed the invention of the sail.

The wood ships of Egypt were built of planks about 4ins. thick and edge to edge. The keel was a flat plank wider than any of the others. As in Fig. 3 the planks had dowels let into the edges to prevent movement, the planks forming the gunwale being laced together. The ends of the cross beams protruded through the hull, although actual frames or ribs do not appear to have been used. Instead of a deck, two walks extended down the length of the ship on either side of four upright posts and across these posts from stem to stern passed a strong rope cable. This was to prevent 'hogging', the term used when the ends of a wooden hull drop out of line due to strain.

Another early type of which we have some knowledge from classical writers and sculptors etc. is the Roman ship. In Fig. 4 we give details of a Roman merchant ship and in Fig. 5 we show the bow of a Roman war galley.

When we come to the Viking ships we have a form of hull that has persisted in various types of vessels up to the present time, it is so seaworthy and practical. Here we have the basis of later shipbuilding in frames built up on a keel and planked. Fig. 6 gives a section showing the type of framing used.

One of the earliest races to take up seafaring were the Phoenicians, their ships being built on Egyptian lines; in

fact one can trace close similarity between nearly all the early vessels to those of the Egyptians, even in the Chinese junk and canoes of Polynesia. The

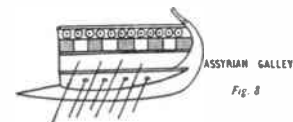
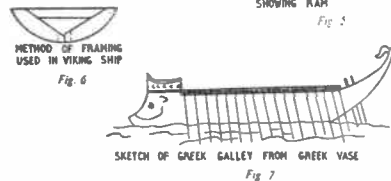
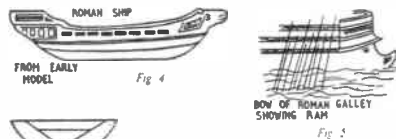
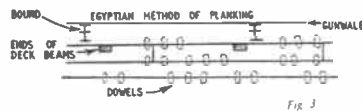
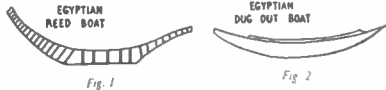

influence of Egyptian shipbuilding seems to have reached many lands the natives of Egypt never visited themselves.

To early Greece the art of boat-building was passed on by the Phoenicians and was soon improved on by them. In fig. 7 is pictured a reconstruction of a Greek war galley taken from an early vase.

Of Assyria and other early nations we do not possess detailed knowledge, but can only reconstruct from sculpture, pottery and early writings. In Fig. 8 we show such a reconstruction of an Assyrian vessel.

The earliest ships of war (by this I mean ships actually designed for fighting purposes) were the oared galleys. The

## WOODEN SHIP BUILDING - 2

### By 'Whipstaff'

Roman galley was inspired by those of Carthage, Rome's great rival, in fact the designing of war vessels by the Romans, based on those of Carthage, eventually meant the end of Carthage.

We have merely touched the fringe of the subject in this short survey, and in dealing with individual ships in later articles more details can be studied for the purpose of model building. In our next article we will commence our study of actual shipbuilding from Medieval times to the close of the nineteenth century.

*(In all these early sketches taken from pottery, sculpture, etc., proportions cannot be taken as exact, due to the artists having to conform to the material used.)*

## Electrolysis cleans the Silver

**C**LEANING silverware by electrolysis is much less arduous than laboriously scouring the items individually, and, since only harmless chemicals found in the kitchen are employed, the cost is virtually nothing. This method is, moreover, much kinder to the silver than scouring, which causes particles of the metal to be rubbed away.

Place the spoons or other small articles to be cleaned, in contact with the bottom of an aluminium dish or pan and cover them with about two pints of boiling water, to which one tablespoon each of common salt and baking powder have been added. Leave the articles in the solution for ten minutes, then re-

move them and rub them over with a dry cloth. The results will please you.

The process works because the items of silver in contact with the aluminium vessel act like electric cells, with the hot solution as an electrolyte. The tarnish of silver sulphide is dissolved, and the pure silver separated and redeposited, so that little is lost.

You can also use a handful of aluminium foil milk bottle caps in an earthenware bowl, instead of the metal pan, but remember to place the bottle caps in contact with the silverware, otherwise electrolysis will not occur. Unfortunately, this method is unsuitable for 'French finish' silverware. (A.E.W.)

# HELTER-SKELTER BALL RACE

— By T.S.R

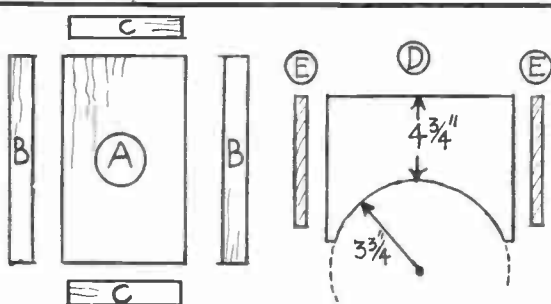

From  $\frac{1}{8}$ in. 3-ply cut A (base 12ins.  $\times$  8 $\frac{3}{4}$ ins.  $\times$  1ins.), B (sides 12ins.  $\times$  1ins.), C (ends 8ins.  $\times$  1ins.) and D (panel insert 8ins.  $\times$  7 $\frac{3}{4}$ ins.). Mark half-circle and cut out recess with fretsaw.

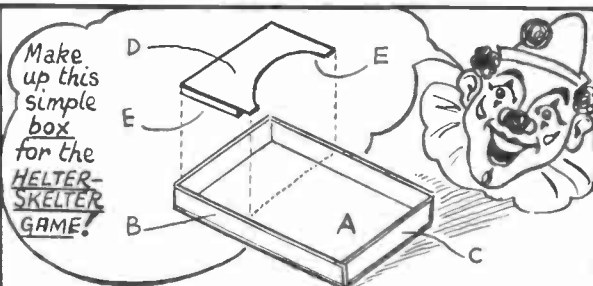

Make up this simple box for the HELTER-SKELTER GAME!

Cut two pieces E, 7in. length,  $\frac{1}{8}$ in.  $\times$   $\frac{1}{8}$ in. stripwood. Glue to underside edges of D. Glue ends between sides to base to form shallow frame. Fit panel D inside box. Do not glue down.

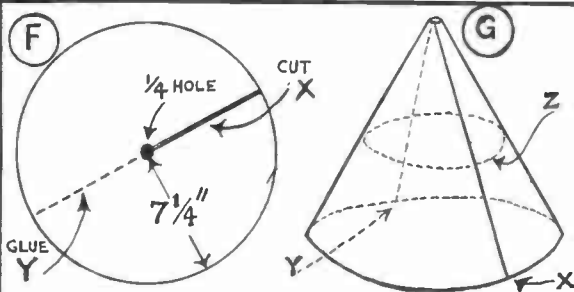

Mark out circle F with compasses, on to strong, flexible cardboard. Cut out disc and cut line X to centre hole. Secure X to Y with glue and staples to form cone. Cut line Z and glue overlap for dismantling and re-assembling if 'portable model' is desired (G).

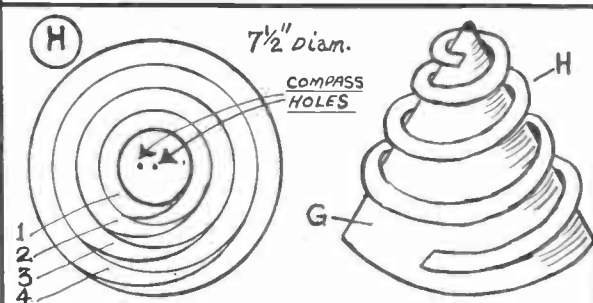

On stiff card, draw disc H and four  $\frac{3}{16}$ in. apart inner circles. Place compass point between centre hole and small circle, adjusting for each intersecting channel, 1 to 4. Cut disc and centre hole, then around line towards centre. Open out spiral and fit over cone.

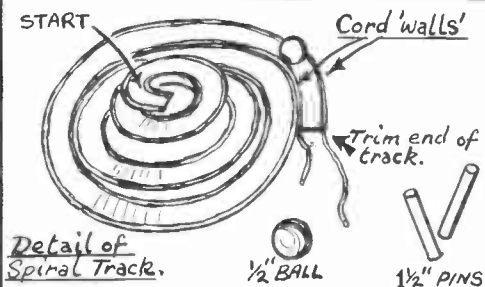

Glue picture cord around inner and outer edges of 'track'. Paint fair-ground target pictures on play-board. Drill score holes for balls and insert 'striker pins'. Fit assembly in recess. Spiral may be revolved on cone for directing glass marbles leaving track. Paint box and 'Helter-skelter' in gay colours.

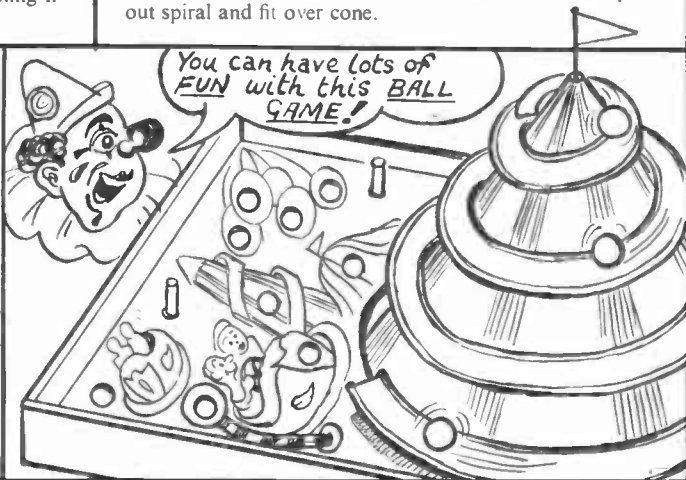

For your telescope

# SUNSPOT CHART ATTACHMENT

**M**ANY amateur astronomers who made the telescope detailed in a recent article will have been intrigued by the sunspots they were able to see with its aid. To keep a record of these and to watch their change of shape and drift across the sun's surface day by day is very interesting indeed.

To hold a sheet of paper steady in the image thrown by the instrument and to mark the relative positions of the spots is difficult. The obvious answer to this difficulty is a chart attachment to the telescope such as is shown in our illustration. Four metal struts hold a board bearing a sheet of paper, the whole being clipped to the telescope tube.

Having roughly sighted the telescope by squinting along the tube while wearing sunglasses (NEVER look through the telescope at the sun) the image thrown on the paper can be centred on a pre-drawn circle and the screen moved out or in until the image exactly fits the pre-drawn circle. After screwing tight the wing nuts at the clip the sunspots can be marked easily. As the image moves owing to the earth's rotation a slight side swing of the telescope will bring it into position again. Working thus, the spots can be accurately marked one by one.

By L. A. Fantozzi

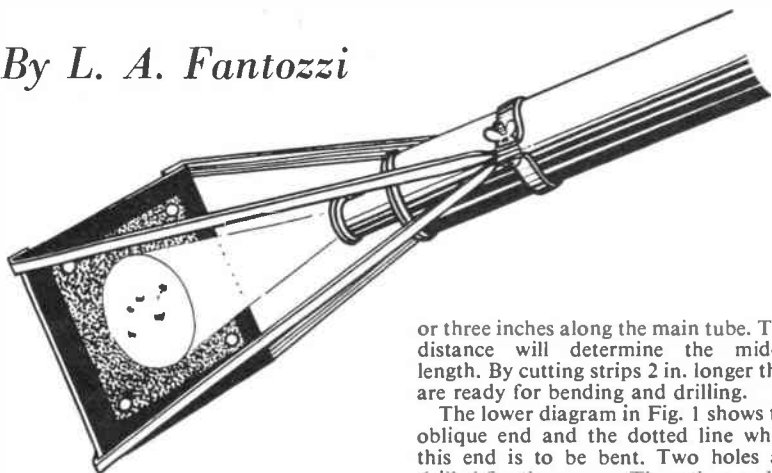

The size of the circle should be standard, a diameter of 4 in. being recommended. A sheet of cardboard placed on the top of the attachment will cut out glare from the inoperative part of the paper and make for comfortable working.

Lightness is an obvious advantage in the attachment, since this will throw less

or three inches along the main tube. This distance will determine the middle length. By cutting strips 2 in. longer they are ready for bending and drilling.

The lower diagram in Fig. 1 shows the oblique end and the dotted line where this end is to be bent. Two holes are drilled for the screws. The other end is twisted through a right angle and then brought down as shown. This, too, is drilled to accommodate the wing nut. The upper diagram shows the part plan of strut and screen board. The angle of the bend here will be determined by the diameter of your main telescope tube.

Fig. 2 gives details of the clip. Care should be taken in bending the clip strips that they are not made too long, or the clip will not grip the tube rigidly. It is better to cut slightly small and take up any slack with a washer dropped in with the strut ends if difficulty is found in attaining an exact fit. A little experiment, however, will generally produce a good fit without the need for a washer. The main aim should be rigidity. The ends of the struts are, of course, placed between the two clip flanges.

Finish is dictated by the glare of working in sunlight. Reflection from the bright metal strips and the screen board should be eliminated by painting dead black. The paper charts are fastened to the screen board with drawing pins.

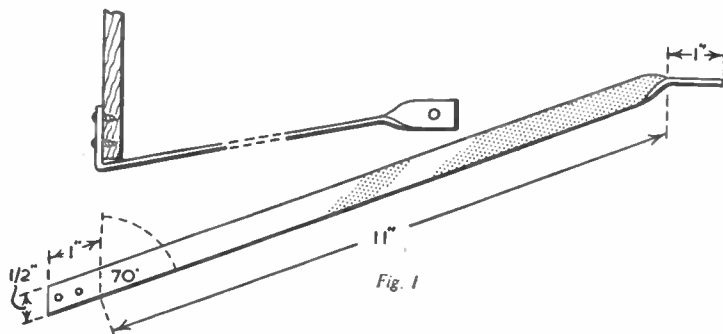

Fig. 1

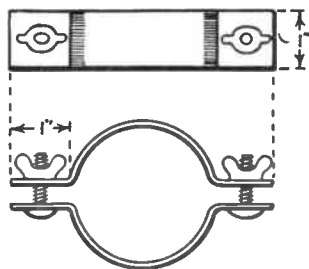

Fig. 2

strain on the telescope mounting. Balsa wood and aluminium strip are best. The screen board should be about 8 in. square and thick enough to bear screws or bolts to hold the struts in place.

The strut detail is shown in Fig. 1. The middle length of 11 in. is a guide, but a check should be made to suit the magnification of the telescope. This is done by drawing a 4 in. circle on paper, throwing the sun's image on the paper and moving the latter in or out until the image and circle coincide. Measure the distance from the paper to a point two

## 1960 COMPETITION

Next week's free Design will be the subject of our 1960 fretwork competition test piece in which prizes valued at over £200 will again be offered. It will be for a novel Pencil Holder.

This week's issue is the last in Vol. 128, which we regret because of the printing strike in July and August is six copies short. Oct. 4th will therefore be the start of Vol. 129.

# ARCOY RABBETTER

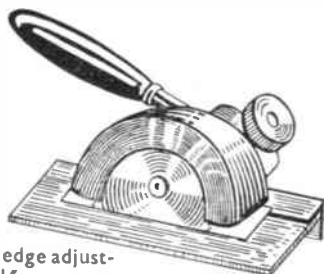

Depth of  
cutter adjust-  
able from  
0"–3/4"

Position of  
cut from wood edge adjust-  
able from 1/8"–1"

For use with any portable  
drill

**£1 . 19 . 6** COMPLETE WITH SAW



GREENHOUSES



GARDEN SHEDS



DOORS



DRAWERS



LATHS

USE THE  
**RABBETTER**

To rebate for the glass

USE THE  
**RABBETTER**

To tongue and groove the  
planks

USE THE  
**RABBETTER**

To rebate or slot for the panels

USE THE  
**RABBETTER**

To slot for the drawer bottom

USE THE  
**RABBETTER**

To make them from your surplus timber

**ARCOY PRODUCTS**  
KNOWSLEY ROAD, BOOTLE, LIVERPOOL 20

## It's Ready NOW!

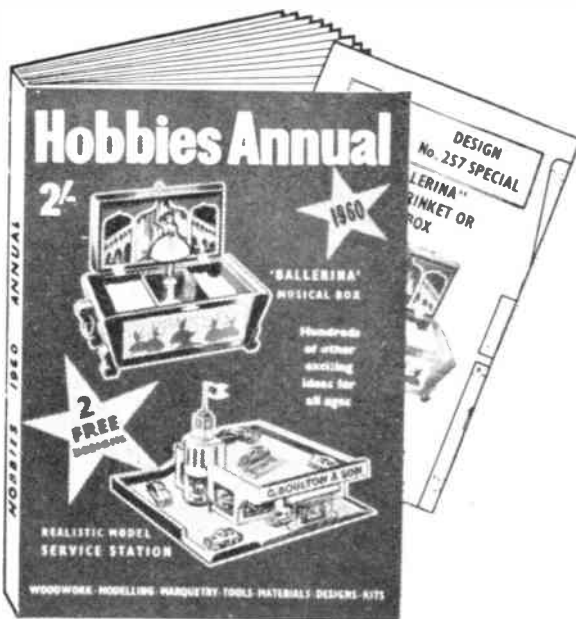

### The Annual You MUST Have

The big-value Handbook for the woodworker, handyman, modeller and handicraft worker. 168 pages full of interesting projects — and ONLY 2/-. TWO FREE DESIGNS WITH EACH COPY

Charming Ballerina Musical Box.  
Model Service Station for the modern lad.

Projects include:

- ★ Animated Toys
- ★ Trailer for Tricycle
- ★ Bathroom Drip Dryer
- ★ Blanket Chest
- ★ Coloured Marquetry Picture
- ★ Standard Lamp
- ★ Modern Clocks
- ★ Model, etc., etc.

From Hobbies branches, stockists, newsagents, bookstalls, etc. or send NOW for your copy by post (6d. extra).

To Hobbies Ltd., Dept. 99, Dereham, Norfolk.

Please send ..... copy/copies Hobbies 1960 Annual  
(2/6 each, post free). P.O. for ..... enclosed.

Name .....

Address.....

Simple and effective

# A PRESS FOR WINE-MAKING...



**I**N order to extract all the liquid from certain fruits or flowers when wine making, a press is often required. An efficient wine press can be an expensive and sometimes a cumbersome affair.

Quite a lot of liquid can be extracted from the fruit or flowers by placing them in a muslin bag and squeezing with the hands. With this method, however, much of the goodness is still left behind.

Much more pressure can be applied to the bag by using the little hand press described here. It can be likened to an outside nut-cracker, and of course, can be made in several sizes.

All we need to make the press are two pieces of hardwood and a cord to act as a hinge. A whitewood is to be preferred and sycamore is probably the best for the job, but if this is not obtainable there are many other types of hardwood quite suitable, preferably light in colour and close grained.

Do not make the press too large as this would be rather cumbersome and difficult to manipulate, while on the other hand a very small one cannot be expected to do the job in an efficient manner.

A good size for general work is 12ins. long, 3ins. wide and with a thickness of from  $\frac{3}{8}$ in. to  $\frac{1}{2}$ in. The handles are about 4ins. long and pared down to ensure a comfortable grip. Well smooth with

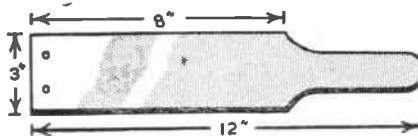

Make two, and hinge together.

glasspaper, paying particular attention to the edges so as to leave no sharp parts that could cut into the muslin bag.

Drill two holes in each piece  $\frac{1}{2}$ in. from the end and  $1\frac{1}{2}$ ins. apart. Connect the

---

By A. F. Taylor

---

two halves of the press together with a stout piece of cord or a leather thong, but do not tie them up tightly. Leave a space of say  $\frac{1}{4}$ in. between them.

It is not advisable to put too much material in the muslin bag at a time in order to get a satisfactory pressing. Suspend it at a convenient distance above the bowl and at such a height that the press can be manipulated with ease. Most of the flower wines will not need much pressure, but some of the harder fruits may be a trifle obstinate. Soaking in boiling water before they are pressed should, however, soften them sufficiently to make the job fairly easy. Some fruits can, of course, be cut up into small pieces to facilitate the process.

## ... and a Bottle-drying Rack

**A**NY gadget which will ease the work in the kitchen is always welcome. Bottle cleaning and drying, for instance, is one of those troublesome jobs which must be done thoroughly, especially if you are engaged in home-made wine making.

It is very important that wine should be put into a dry bottle, and the subject of this article will help to make this possible. Owing to the small size of the neck of the bottle it is practically impossible to stand it upside down to drain, unless the bottle is supported by some means.

Not only will this rack hold wine bottles in the correct position, but it can be used for almost any other kind of bottle, and also jam and preserving jars of various types.

The rack is very simple, is easy to make and is nothing more than a stout board into which are securely fixed a few dowels set at an angle of about 45°. Six pegs is a good number to have, but if you

have to cope with a larger quantity, the rack can easily be made longer, or by widening the board two rows can be incorporated.

### Provide a drip trough

To hold six bottles the board should be  $21\frac{1}{2}$ ins. long, 5ins. wide and about 1in. thick. The bottom edge is bevelled to enable the trough, which carries off the water, to be fixed at the correct angle. Quite a thin strip of wood will do for the trough, which goes the entire length of the rack, and is about 3ins. wide. This is glued and nailed securely to the lower edge.

Drill the holes for the dowel rods practically through the board at an angle of about 45°, and space them  $3\frac{1}{2}$ ins. apart. The dowels are 6ins. long and  $\frac{1}{2}$ in. diameter, and should fit tightly in the board. Finish off the rack by giving it two or three coats of a good quality paint, allowing each to dry well

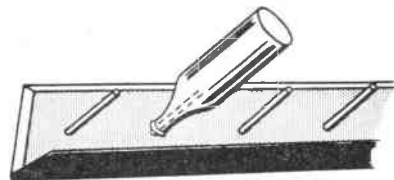

before applying the next.

Fixing the rack to the wall can be done in two ways, either by drilling a few holes in the board and screwing it up or by fixing two brass screw plates on to the back. This latter method has an added advantage, as it can be moved from one place to another. If not wanted for draining bottles over the sink, the rack may be used for hanging articles on in another part of the kitchen.

When used for bottle drying it must be raised about  $\frac{1}{2}$ in. at one end, so that there is a slight incline for the water to run off over the sink or into a container



# LADY'S SEWING 'COMPANION'

ALSO FOR  
USE AS  
A SMALL  
TABLE



MAKE IT FROM  
DESIGN No. 3278

A well-designed piece of furniture in contemporary style to hold all sewing and mending materials, etc. When closed it serves as a handy occasional table.

Today's value is in the region of £9 but a big saving can be made by working with Hobbies Kit No. 3278, price 65/-. This contains all planed wood panels, contemporary legs which are simple to fit, hinges, etc. Kits from all Hobbies branches, etc., or post free (see coupon).

Send for details of other furniture kits which will save you pounds.

To HOBBIES LTD., Dept. 99, DEREHAM, Norfolk

Please send details of furniture kits and Kit No. 3278 for Lady's Sewing Companion, price 65/-.

Name .....

Address .....

# This model farm cost less than 2/6

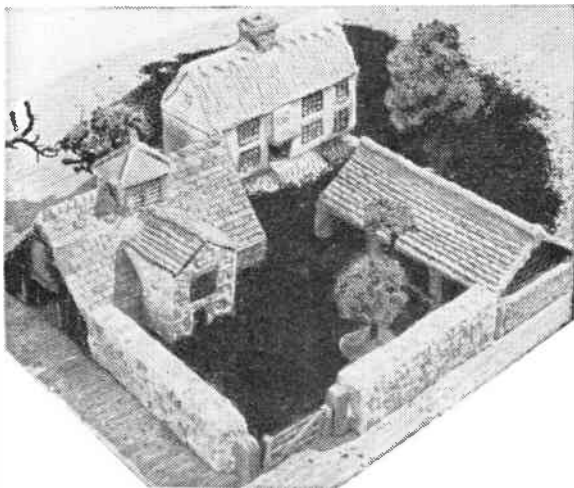

It was made from a half-crown tin of Sankey's PYRUMA — farmhouse, barn, implement shed, walls and gate — and there was still plenty of this grand modelling material left to build many more farm features, by simple methods described in the Instruction Book (see Coupon below).

PYRUMA, plastic and ready-for-use, becomes stone hard after drying or baking, and can be painted in natural colours. For permanent modelling —

MAKE IT AND BAKE IT IN



Obtainable from your local Ironmonger or Hardwareman and many Art Material dealers. Ideal for making —

**Model Railway Buildings and Accessories, Harbours, Ship Models, Airport Buildings and Features, Houses, Bookends, Ashtrays, Animals and Figures, Plaques, etc.**

Post this Coupon today for your Instruction Book

**J.H. SANKEY & SON, L<sup>TD</sup>**

Established over a century  
Dept. H, ILFORD, ESSEX

Please send ILLUSTRATED INSTRUCTION BOOK with full colour pages on Pyruma Modelling.

Enclosed Postal Order value 6d. (not stamps)

NAME (Block letters) .....

ADDRESS .....

**LEARN RADIO and ELECTRONICS** the NEW practical way! Very latest system of experimenting with and building radio apparatus — 'as you learn'. FREE brochure from — Dept. HW10, Radiostructor, 46 Market Place, Reading, Berks.

**BUILD YOUR OWN HI-FI** at home! At last, for reasonable cost — the chance to make your own quality HI-FI audio equipment and to gain the knowledge to service and maintain it. FREE brochure from — Dept. HW20, Radiostructor, 46 Market Place, Reading, Berks.

**INTRODUCTIONS** to new friends; home and overseas. — V.C.C., 34 Honeywell Road, S.W.11.

Completely new 54 page Edition

## WHERE'S THAT CAR FROM ?

Price 1/- (Postage 4d.)

Of all Bookellers

or

**RALEIGH PRESS, EXMOUTH, DEVON**

**100 DIFFERENT stamps free!** Request 4d. upwards discount approvals. — Bush, 53 Newlyn Way, Parkstone, Dorset.

**STAMPS FREE** — Empire Packet including Pictorials and Victorians with approvals. — Robert J. Peck, 7A Kemp Road, Bournemouth.

**MAKE A MUSICAL BOX** for as little as £21/-. New kits and tunes available. Movements 13/- post free. Please send 3d. stamp for free illustrated catalogue. — The Swisscross Co., Dept. B, 202 Tulse Hill, London, S.W.2.

**REFUND IF NOT WORTH DOUBLE!**

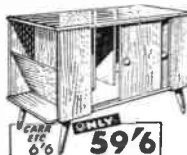

## TV TABLE & EXTRA LARGE RECORD CABINET

Not only sand polished but also sprayed light or medium WAL-

**NUT tone. NOTE—ROOMY BOOK CASES AT BOTH ENDS** — one converts to Magazine Rack by insertion of sloping panel provided, as illustrated. Amazing offer — 59/6, carr. 6/6 or sent for £1. Balance 6 monthly payments 8/-, plus carr. A well-built contemporary piece of furniture to solve your record problem and also ideal as stand for TV, Radio or Record Player. 30" x 15" x 24" high. Modern sliding doors. Roomy interior, partitioned for classifications, holds up to 200 records (upright for perfect condition). Entirely of seasoned timber. Detachable legs. SEND quickly. **LISTS, FURNITURE.**

SEND FOR OUR FREE ILLUSTRATED CATALOGUE OF NEARLY EVERY KNOWN MAGNIFICATION. BINOCULARS. TENTS, FURNITURE, ETC. ALL AVAILABLE ON THE EASIEST OF TERMS.

**HEADQUARTER & GENERAL SUPPLIES LTD.**

(HOBW/82) 196-200 Coldharbour Lane, Loughboro Junc., London, S.E.5. Open Sat.

**EXTRA CHEQUES** from writing. Send for Ideas for Writers' (free). Scores of suggestions for beginners and others. Typewriter unnecessary. — Writers' Ring (H.W.), 5 Edmund Street, Birmingham 3.

**TRANSISTORS**, Germanium Crystals, Headphones, etc. Lists and diagrams free. Germanium Diodes with three crystal set circuits 1/- Postage 3d. — P.R.S. (H), 33 Bourne Gardens, London, E.4.

**PERSONS** required to make new type fancy cushion covers. Apply, enclosing S.A.E. — Dept. 28, Arnold Trading, 10 Shelley Rd., Worthing, Sussex.

## HOBBIES 1960 ANNUAL

Regrettably, publication of **HOBBIES 1960 ANNUAL** had to be put back to September 12th because of the recent dispute in the printing industry.

Full supplies are, however, now available at branches, newsagents and stockists. This great value-for-money handbook costs only 2/- and readers are urged to obtain their copy straight away.

This edition is too good to miss, as apart from the normal features including many new projects, there are two free designs with each copy — for making a delightful Dancing Ballerina Cigarette Box and an up-to-date Service Station.

Postal copies can be obtained from Hobbies Ltd., Dept. 99, Dereham, Norfolk, price 2/6 post free (see coupon on page 355).

**THIRTEEN** Mint British Colonial Pictorials including Ghana Commemoratives, free with Approvals. — Hopper, 23 Houndsden Road, N.21.

**GIANTS**, Triangles, Pictorials, etc. — 100 Free. Request Approvals. Postage. — Salter, 42 North Rd., Rotherham.

# Webley

## AIR PISTOLS

High Accuracy  
and Hitting Power  
Perfect Balance  
Robust Construction



Send for Catalogue

**WEBLEY & SCOTT LTD.**

34 PARK LANE, HANDSWORTH, BIRMINGHAM 21

## WATCH AND CLOCK REPAIR OUTFIT



The complete Outfit for cleaning and repairing. Comprises: Illustrated explanatory booklet, eye-glass, tweezers, screwdrivers, oil, dusting powder, oilers, also catalogue, tools and materials. P. & P. 1/- extra. C.O.D. if required.

**15/-**

The above with additional luminous compounds, jeweller's rouge, dial brush, jewels. P. & P. 1/- extra. C.O.D. if required.

**25/-**

Also available on request:

Illustrated Catalogue of Swiss watches on Credit terms.

Illustrated Catalogue on Jewellery for Assembly.

**BOLSTER INSTRUMENT CO.** (Dept. H), Govett Avenue, Shepperton, Middx.

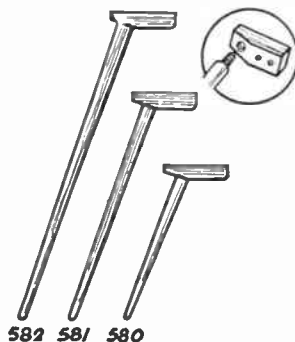

**You Can Make a Modern Table in One Evening with these legs**



A coffee table, TV table, footstool, etc. . . . all can be made in quick time with these Contemporary style legs. Beautifully turned in Scandinavian beech, they can be left in their natural colour, or stained. Each leg is threaded at one end to screw into a hardwood block (see inset) which, in turn, is screwed to the underside of a piece of plywood or suitable material which forms the table top. Simple . . . and a perfect job. The legs are obtainable in three sizes:—10 ins. 2/3 each, 15 ins. 2/6 each and 20 ins. 3/- each. Postage on 3 or 4 legs 1/6 extra. Legs from branches or:

**HOBBIES LTD, Dept 99, Dereham, Norfolk**

# DECORATIVE BELL FOR A BIRD CAGE

THE design shown here may be used as an ornamental miniature gong, a Budgie bell, or as a calendar. If used as the latter, the cut-out circle should be left solid and a small calendar pad glued in place.

Use your fretsaw to cut out the two pieces A and B from  $\frac{1}{4}$  in. wood. Note that only half of piece B is shown. Clean up with glasspaper and glue A into the holes in piece B. Finish off by staining and varnishing or by painting with high gloss enamels.

The bell may be obtained from Hobbies Ltd, Dereham, Norfolk, price 6d., postage 3d. It is hung in place by means of a short length of wire as shown. If used as a miniature gong a striker should be fashioned from a piece of waste wood. (M.p.)

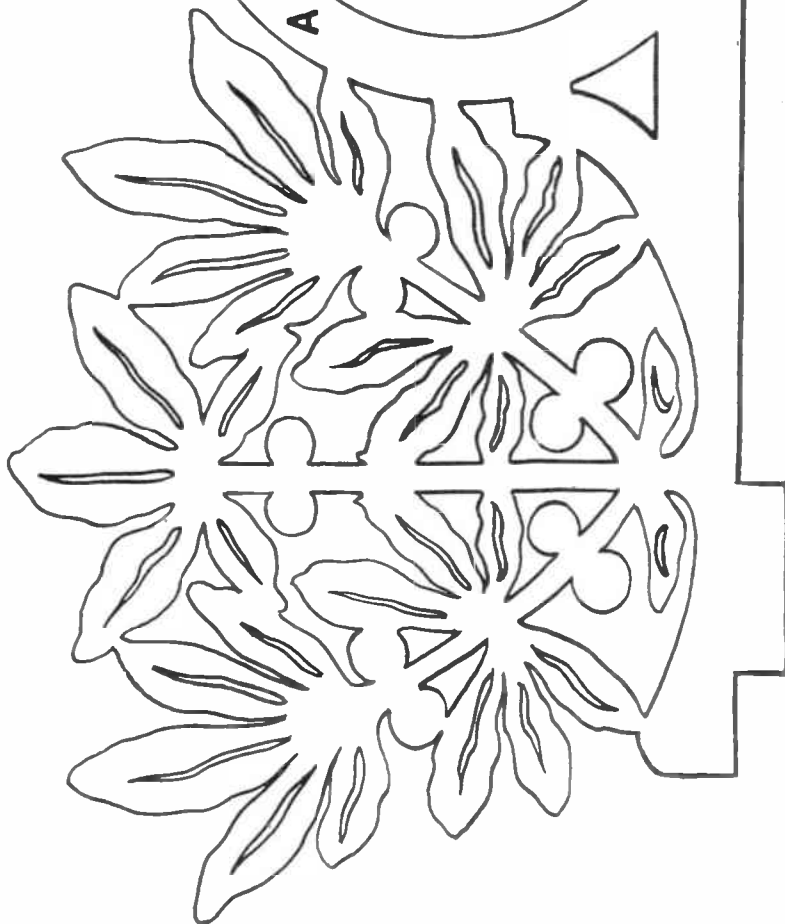
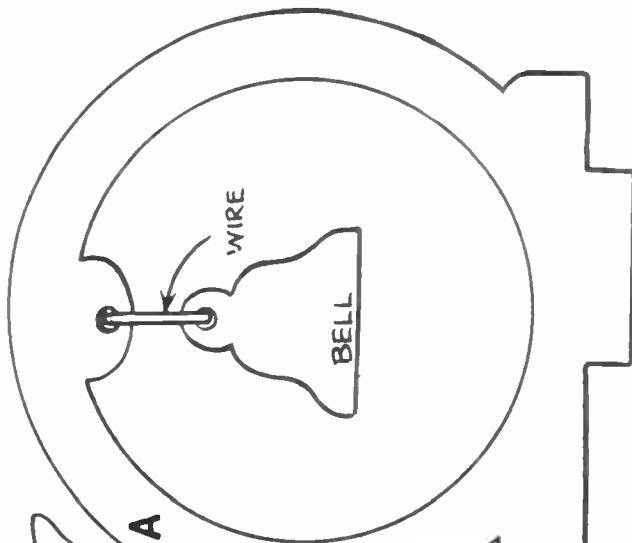
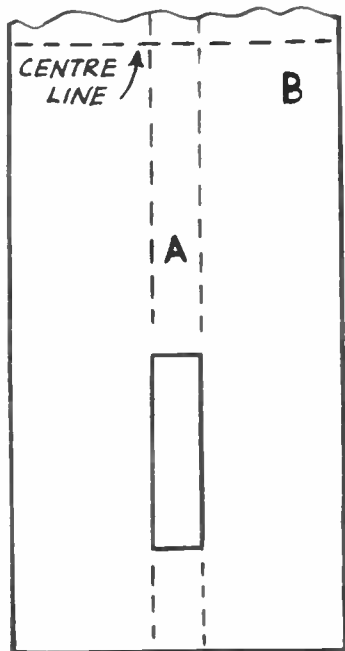

# OUT of the BLUE

## SUPER AIRCRAFT KITS

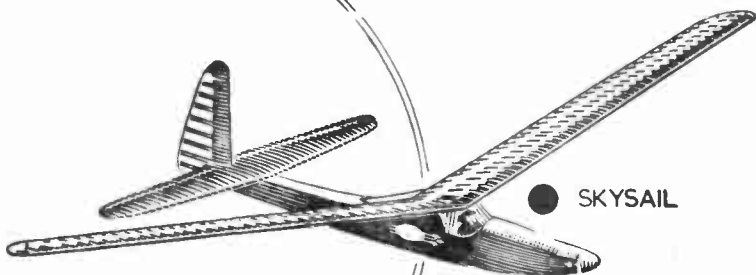

● SKYSAIL

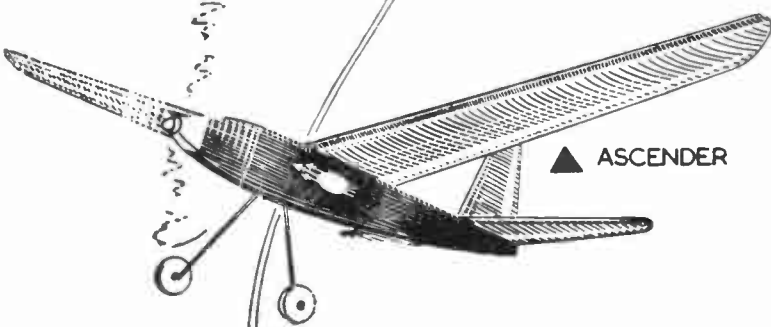

▲ ASCENDER

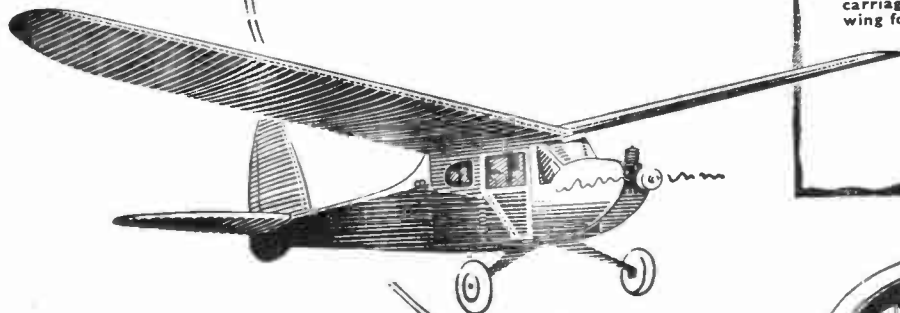

★ CHAMPION

### EXCLUSIVE FEATURES

These kits introduced by Hobbies have many important exclusive features. Designed to give top performance in their various classes. All sheet parts are die cut and there are super detail plans. Easy to build and fly.

● SKYSAIL — A 36in. wing span glider for tow launching. 'Wing-saver' tow hook—printed dummy pilot — anti-warp wing bracing — jig-lock fuselage alignment.

**6/3**

(post 9d.)

▲ ASCENDER — A 30in. wing span rubber duration model. Adjustable pitch propeller with replaceable blades — fixed tail surfaces for positive trimming — anti-torque automatic-action rudder.

**10/6**

(post 1/-)

★ CHAMPION — A 36in. wing span free flight power model. Suitable for 'S, '75, '8 and 1 c.c. motors. Opening cabin door and complete cabin details — scale type light alloy undercarriage — optional polyhedral wing for high power.

**17/6**

(post 1/6)

DESIGNED FOR  
THE NOVICE  
AND EXPERT



From all Hobbies branches and model shops, or

**HOBBIES LTD. (Dept. 99), DEREHAM, NORFOLK**