

16th SEPT 1959

VOL. 128

NUMBER 3327

THE ORIGINAL
'DO-IT-YOURSELF'
MAGAZINE

HOBBIES *weekly*

FOR ALL
HOME CRAFTSMEN

FULL INSTRUCTIONS FOR MAKING . . .

Also in this issue:

- TRIPOD FOR A
TELESCOPE
- COLLECTORS' CLUB
- BUILDING A
MODEL GLIDER
- ANGLING BAITS
- MICROPHONES
- LAUNCHING A
FIRE BALLOON
- MONOGRAMS
- STOCKING YOUR
GARDEN POOL
- ETC ETC

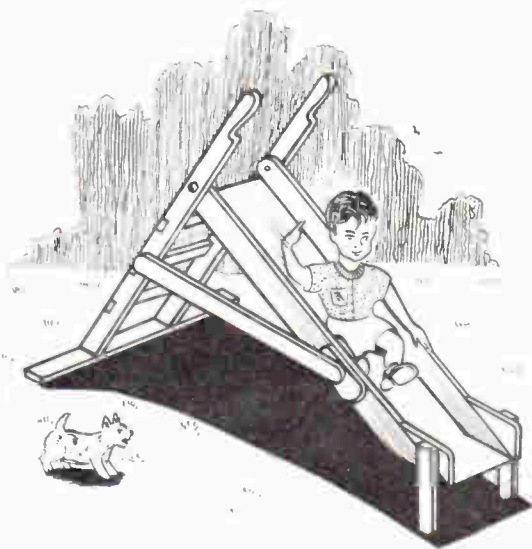

A SLIDE FOR YOUNGSTERS

Up-to-the-minute ideas

Practical designs

Pleasing and profitable things to make



5^D



tom right) are well worth attention, a full set being worth about £100.

A few weeks ago I bought a box of oddments at an auction sale and some good value oddments were included. Which shows how we must always be on the look out!

Many people think that stamp collecting is a costly hobby. This is not the case. The amount of money which may be spent upon it is practically unlimited.

THE first stamp issues of most countries are now very valuable. Many collectors never even see them. But in the present series we hope to discuss and illustrate many of the world's classics. For example, illustrations first left (below) depict the 1862 issue of Argentina — 15 cent blue, cat. at £16 single — the strip of 3 being worth about £60.

A pair, strip or block of stamps are more valuable than a single copy, therefore, never separate them or remove

THE WORLD'S CLASSIC STAMPS

them from their original cover. If you obtain a number of covers do not mount them in your album — use a special cover-folder which costs about 6/- from your local stationer.

The 1865 issues of Ecuador (illustrated second left) are now cat. at £12 mint, £9 used. The pair depicted are worth about £6.

Germany first issued stamps in 1872. The 1k. green (second right) is cat. at 75/- mint, 17/6 used.

The famous Suez Canal stamps of 1868 are rare. The 20 cent blue is listed at 30/- mint, £15 used. These stamps were withdrawn from sale Aug. 16th, 1868 and demonetised Aug. 31st, 1868.

The stamps of Queen Victoria issued at different times of her life are popular with all collectors. For important variants of the Queen's head we must go to our Colonies — as illustrated above.

The 3 cent Newfoundland stamp of 1880 (top left) depicts the Queen as a widow wearing a widow's cap. The



Canadian issue of 1898 (bottom left) is very similar, but the widow's cap is surmounted by a small crown.

Most Victorian stamp portraits were taken side face. In the Grenada stamp of 1875 (top centre) we have an example of three-quarter face. The 2 - Queensland stamp of 1882 (top right) is similar but shows more of the shoulders. This portrait of Queen Victoria was taken about 1850. The type was used on many Colonial stamps from 1d. to £1. most of which are valuable. In the St. Helena issue of 1861 (bottom centre) the hair is loosely coiled. This set is cat. at £9 mint.

Victorian issues of Hong Kong (bot-

On the other hand, one sees many interesting collections which represent the outlay of very little money. The specimens have been secured one or two at a time — some by exchange of duplicates, some contributed by friends.

(R.L.C.)

★★★★★★★★★★★★★★★★★★★★
 ★ Next week's free design will be for ★
 ★ an attractive electric lamp in the form ★
 ★ of an old-time galleon. Make sure of ★
 ★ your copy. ★
 ★★★★★★★★★★★★★★★★★★★★★



TRIPOD FOR A TELESCOPE

NO doubt many readers who constructed the telescope detailed in the recent articles on 'Making an Astronomical Telescope' find their skyline restricted in some quarter, owing to having a fixed stand. A portable tripod is the answer to this.

Essentially, as seen from our illustration, the tripod consists of a circular table, with a central hole to accommodate the lower disc of the telescope mounting, and three stout wooden legs, each of which bears a spike to prevent slipping. Metal brackets and nuts and bolts on the underside of the table allow for the opening and shutting of the legs. Fig. 1 makes this clear.

Height of legs

The legs should be made from $1\frac{1}{2}$ in. square timber. Their length will depend on your height. The table should be at about eye level when the legs are open to the extent of about 70 degrees with the ground — as they will be in the normal operating condition. To ensure this make the legs 4 in. longer than the distance between your eye level and the ground. Round off the top of each as shown in Figs. 1 and 2, and drill a $\frac{3}{8}$ in. hole centred $\frac{3}{4}$ in. from one end. The spike is made by inserting a 2 in. brass screw at the bottom end, and cutting off the head.

The table (Fig. 3) is cut from 1 in. wood, its radius $2\frac{1}{2}$ in. more than that of the bottom disc of the telescope mounting. The central hole is of the same diameter as the bottom disc. The brackets can be of steel or brass, but should be stout. A thickness of $\frac{1}{8}$ in. is recommended. Each is of the same width as the legs, that is, $1\frac{1}{2}$ in. The part screwed to the table is 1 in. long, and

that extending down the leg $1\frac{1}{2}$ in., this latter being drilled to accommodate the $\frac{3}{8}$ in. diameter bolt. Roundhead screws will hold the brackets to the table and holes should be accordingly drilled, each centred $\frac{1}{4}$ in. from the side of the bracket.

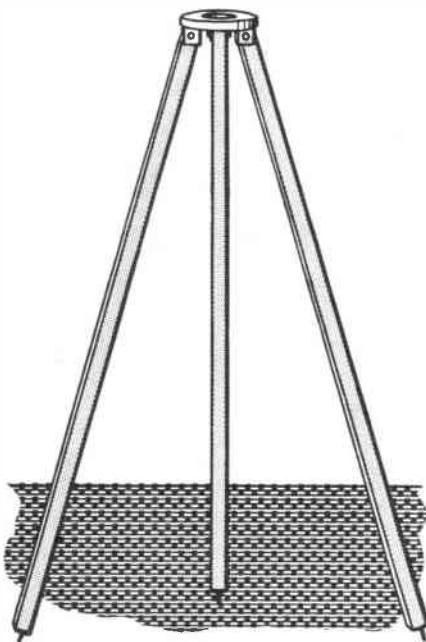

By L. A. Fantozzi

The positioning of the brackets is simplified by reference to Fig. 3. Marking out is, naturally, best done before the central hole is cut. Draw a line right through the centre. Put the lower end of the upright marking of a protractor accurately on the centre point, so that the two zero signs lie on the line. Mark off at 120 degrees on the outer edge of the table, and connect this point with the centre by drawing a line. Turn the protractor through 180 degrees, and repeat the operation. You will thus have lines A, B and C to guide the positioning of the brackets.

It only remains to draw lines at right angles, as, for example, line D, and to screw home the brackets along it $\frac{3}{4}$ in. on either side of the 120 degree lines, so as to give a space of $1\frac{1}{2}$ in. to accommodate the leg top.

A coat of paint to match the telescope and mounting and the tripod is ready for use. When setting up the tripod, the circular table should, of course, be made level by suitably adjusting the legs out or in. If this is not done, the telescope, especially if the tube is heavy, may tend to sideslip slightly, owing to the weight being unevenly distributed.

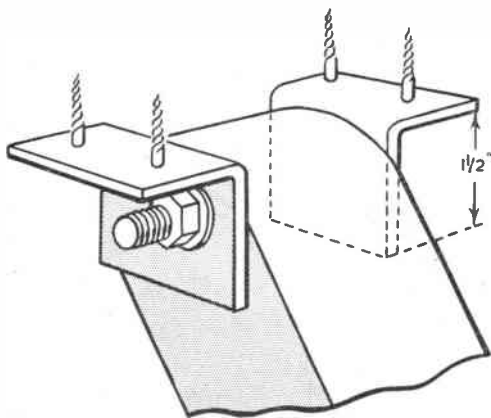

Fig. 1—The leg swivel fixing

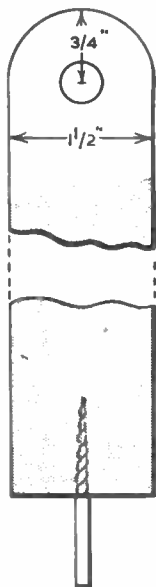

Fig. 2—Leg detail

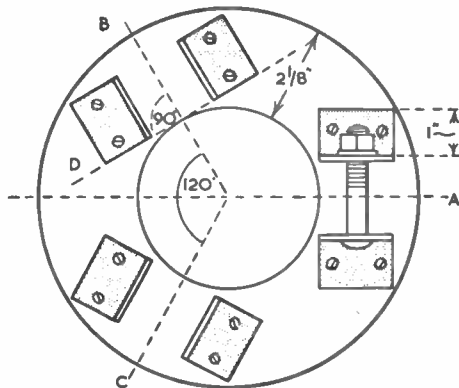

Fig. 3—Underside detail of table

A CATAPULT GLIDER

By Gordon Allen

In this series of articles we are going to deal with the construction of various types of flying models, starting with the design presented here for a small catapult-launched glider of all-wood construction, and which also provides an ideal model for 'chuck' launching.

Future articles and designs will cover tow-launched (or winch-launched) gliders, rubber-driven duration models, semi-scale models, models incorporating 'jet-packs' such as Jetex engines, and free-flight models powered by small compression-ignition engines — wrongly but popularly called 'diesel' engines.

All the designs and methods of construction will be simple but efficient, to appeal to the beginner who wishes to progress steadily from stage to stage in this fascinating and rewarding hobby.

Materials required will be clearly stated and all items are easily obtained at Hobbies branches throughout the country and all model shops.

LET us begin with the construction of the glider. On page 309 the fuselage is hatched into squares so that its shape can be reproduced on paper. Draw out these $\frac{1}{2}$ in. squares on

to stiff cartridge paper, using a ruler and set square. Then mark points on the vertical and horizontal lines where the fuselage shape intersects them. Join the points with a smooth line, using a thin piece of flexible wood as a guide for your pencil where the line is curved.

Cut out the shape, including the aperture for ballast, with a razor blade or modelling knife and paste it to the strip of $\frac{1}{8}$ in. obechi. Now cut the wood with a fine-tooth fretsaw almost flush with the paper pattern. Finish to the exact outline with glasspaper and then remove the pattern.

The thickness of the fuselage tapers to $\frac{1}{16}$ in. at the nose and at the tail for a distance of about $1\frac{1}{2}$ in. in each case. Incorporate this taper with the knife and

glasspaper. Smooth the sides and radius all edges with glasspaper *except the top edges on which the wing and tailplane fit.*

In a similar way mark out the shapes of the tailplane, fin and underfin, cut paper templates, paste them to the $\frac{1}{16}$ in. sheet balsa and cut out the shapes with a modelling knife. Smooth both surfaces of each component with a piece of glasspaper wrapped round a flat block of wood and radius the edges. Mark the positions of the tailplane flaps (elevators) and the fin flap (rudder). Cut away these pieces neatly, and note which way they can be refitted exactly.

The aluminium foil from the top of milk bottles is an excellent material for the flap hinges. Flatten this out and cut from it, using a knife, three pieces $\frac{1}{2}$ in.



Launching glider by catapult



Cutting hole in nose for ballast



Checking dihedral on wing tips

long, $\frac{1}{4}$ in. wide, each with four triangular prongs on the sides as indicated on the drawing. Bend the prongs at right angles. Place the flaps back in place (working on a flat surface), mark the position of the hinges by gently pressing the hinges into the balsa at their appropriate positions, and make $\frac{1}{4}$ in. long slits at the prong positions with a

RIGHT: *Fitting the balsa wing fillets*

BELOW: *Glasspapering wing to aerofoil shape*

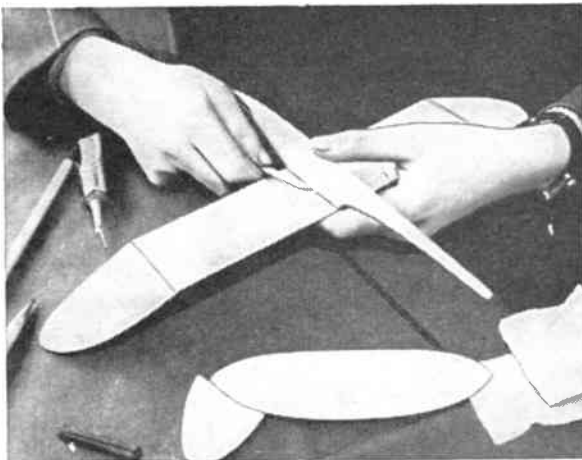
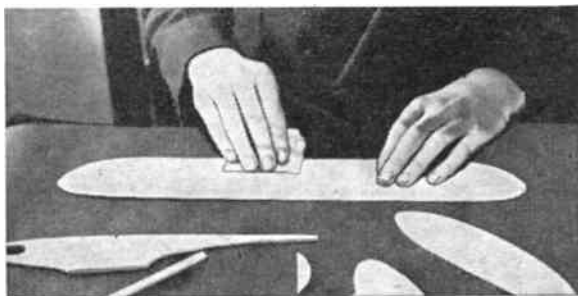

razor blade. Press the hinges in place and bend over the tips of the projecting prongs to secure the flaps.

Before fixing the tail surfaces in position with cement, give the fuselage several coats of banana oil — glasspapering between each coat when it has thoroughly set. Make sure that the tailplane and fins are at right angles to each

other when fixed to the fuselage, and that the fuselage and tailplane are also at right angles.

The wing is cut in one piece from $\frac{1}{8}$ in. balsa. Use the plotting method again to obtain the true shapes of the tips. Glasspaper the whole wing smooth while it is in its flat state, and during the smoothing, taper off the thickness of the

wing towards the trailing edge and towards the leading edge on the upper surface only, to form a slender 'aerofoil' section indicated in the side view of the fuselage drawing.

On the reverse side of the wing (ie on the under side) draw pencil lines across the wing indicating the joints of the wing tips — shown by full lines on the draw-

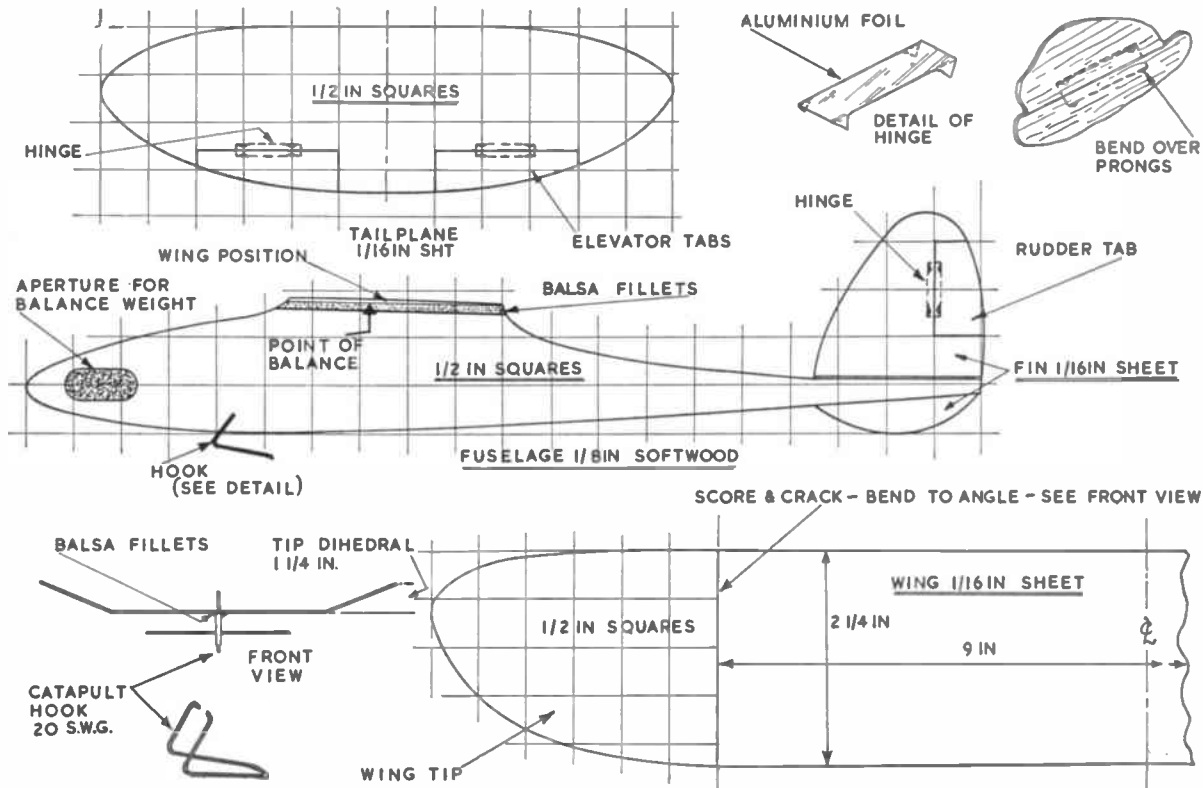

ing of the wing. Score across these lines with two or three strokes of a blade or knife. Then gently crack the wing at these joints, and bend the tips so that they are $1\frac{1}{2}$ in. above the rest of the wing (see front view). Run a liberal line of

cement along the cracks, place the wing on a flat surface and keep checking the wing-tip height until the cement has set.

Mount the completed wing on top of the fuselage, as indicated, using balsa cement. Check for squareness with the fuselage and then cement in place lengths of trailing edge to serve as strengthening fillets. Alternatively cut lengths of $\frac{1}{8}$ in. by $\frac{3}{8}$ in. balsa to a triangular section, and fix these in place. Round off the front and rear ends.

Balance the model at the point indicated by cementing thin pieces of lead or solder in the nose aperture. Then fill in the aperture with scrap pieces of $\frac{1}{8}$ in. sheet balsa, one at each side. Shave and glasspaper flush with the fuselage and apply banana oil.

Bend the catapult hook to shape and cement this firmly into grooves cut in the fuselage sides in the position shown.

Mark out the shape of the catapult frame direct on to the $\frac{1}{8}$ in. plywood, and cut it out with a fretsaw. Smooth it and drill two $\frac{1}{8}$ in. diameter holes one in each of the fork ends. Through the holes fix two stout elastic bands tied together,

YOU WILL NEED
Fuselage: 1 piece $\frac{1}{8}$ in. obechi 12 in. by $1\frac{1}{2}$ in.
Wing and Tail Surfaces: 1 piece $\frac{1}{8}$ in. hard balsa 24 in. by 3 in.
Wing Fillets: 6 in. length of $\frac{3}{8}$ in. wide trailing edge section.
Miscellaneous: Tube balsa cement, small piece piano wire, $\frac{1}{8}$ in. plywood 4 in. by 2 in., piece strip rubber or tough elastic bands, lead ballast, aluminium foil, banana oil, glasspaper.

or a piece of $\frac{1}{8}$ in. wide model aircraft rubber 6 in. long.

Trim the model first by hand-launching it with a fairly vigorous but smooth forward movement with the nose pointing slightly downwards. If the glide is very steep, bend the tailplane flaps slightly upwards; the opposite if the model tends to climb and then dive. Do this until a very flat glide results, and then you are ready to launch it with the catapult.

Next—The Hobby Soarer

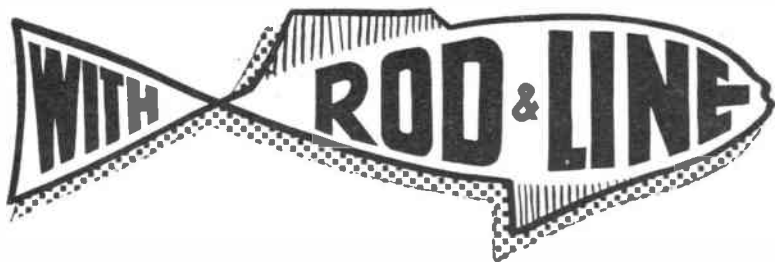
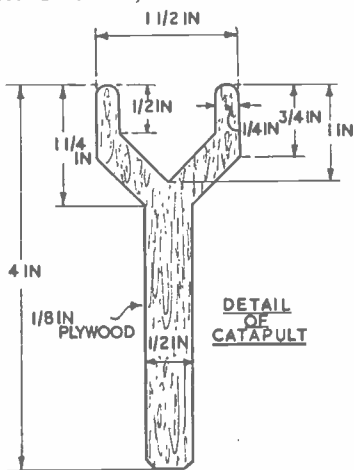

FISH of all freshwater species are, for the most part, omnivorous creatures, with the gift to feed readily enough on anything edible that comes floating down the river, or can be rooted up from the gravel and mud, or sucked from the straggling weed-growths.

It is, therefore, not surprising that fish may be caught on numerous kinds of baits. Fish have a liking for various baits, and we have been told of pike taking dead sparrows — the 'deader the better', that have fallen out of nests at the waterside. In ancient angling literature one finds references to the fondness of pike for rats, mice, voles, baby waterhens, waterside birds, nestlings mostly, and the young of rodents that live by rivers and lakes.

One curious pike bait that was often used with success in the past and is mentioned in ancient angling works, is the tip of a calf's tail, with a short length of bootlace attached. This peculiar device, attached to a simple

hook tackle, was said to be attractive to large pike.

Grasshoppers are 'good medicine' for trout, chub, and grayling, as well as other fishes. So are many kinds of beetles, grubs, and caterpillars. Snails, slugs, frogs and froglets, bluebottle flies, caddis flies, cockroaches, and many other insects the ordinary man would not attempt to fish with, will succeed when the more familiar baits as worms of all kinds, maggots, paste, creed-wheat and breadcrust have failed to attract. Fish can be very fastidious at times.

Cold Yorkshire pudding

Cold Yorkshire pudding, for instance, cut into tiny cubes once proved a very successful experiment when chub-fishing, and, doubtless, will do the trick again on occasion. Strips of raw beef will kill trout better than any bait you care to try. Macaroni is another titbit, chub above all other fish, often appreciate. Carp like a par-boiled potato, about the

size of a walnut. Boil the 'tater' in its skin, but peel it before you use it as bait. No better bait for a big old carp can be desired.

Cooked mussels and 'mussel-tongues' not long ago were recorded as catching fish as fast as they could be by an angler fishing for roach near the mussel cannery in Lincolnshire. He used cooked mussel for bait; he made good when other baits as maggots, wheat, hempseed, etc., would not coax a bite!

Baits to use

By A. Sharp

Immediately he decided to revert to the mussel bait, fish were caught as fast as he could rebait his hook.

Fruit is often a tempting bait. When elderberries are plentiful they will take roach, dace and chub at times. A strip cut from a mellow pear will prove attractive to chub, so too, will a bit of banana, at this time of year.

As to artificial lures, they are legion. In truth, baits that will catch fish are without end. Flies, for example, are limitless. The old angler was correct when he said: 'the trouble is not what to bait your hook with, but rather what *not* to use than what *could* be used!'

Fish will on occasions take anything that seems like being edible, and many strange baits tried as a last resource, have been highly successful.

USING MICROPHONES

VERY good microphones of the ex-service type may be bought cheaply at surplus stores, but it is not always understood that each of the various kinds of microphone requires to be used in a particular way. As a result, reproduction may be disappointing, or the microphone may seem to give no output at all. This usually arises because a suitable method of connecting up is not employed, and not from any defect in the microphone.

The following details should help overcome these difficulties, and may also enable some of the more popular ex-service microphone units to be identified, and properly used.

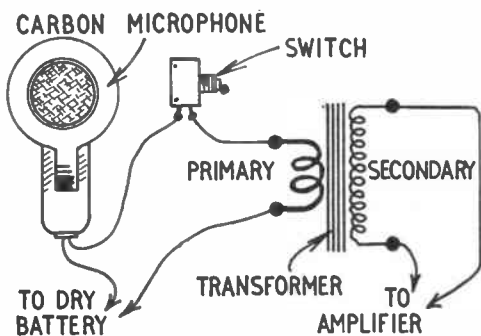

Fig. 1—Carbon microphone circuit

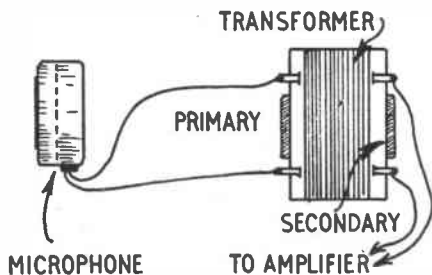

Fig. 3—Matching transformer with low resistance mike

Many surplus microphones are of carbon type. These do not generate any current themselves, but vary the strength of a current obtained from a battery. This current fluctuation is further increased by a transformer with a step-up ratio of 50:1, or 100:1. As a result, the signal obtained from such a microphone can be very powerful. This kind of mike is thus best for small amplifiers or radio sets which do not give much amplification, or for working a loudspeaker or phone type receiver direct.

Carbon microphones do not give the best quality of musical reproduction.

They are suitable for speech, however, or when a powerful output is more important than high musical quality.

Fig. 1 shows the usual circuit for this kind of microphone. Microphone transformers are made for the purpose, but

By 'Radio Mech'

if one is not to hand, a speaker matching transformer, with a fairly high ratio (say 35:1 or 50:1) will give quite good results. The thick, low-resistance winding must be used as primary, and the high-resistance winding is the secondary.

MICROPHONE OR EARPIECE

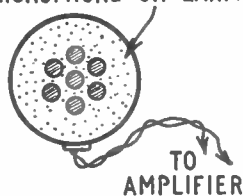

Fig. 2—Connections for high-resistance mike

Some surplus carbon type microphones include the following: handset No. 4A; handset mike No. 3 and No. 6; Tel-Rec. handset No. 9; carbon handset No. 8; Tannoy power mike insert YA2815, and all carbon mike buttons.

Some of the handsets have switches. The power mike is intended for operating a loudspeaker without an amplifier, but requires a 12V. accumulator to supply the heavy current necessary.

Sound powered units

If these are of high resistance, they can be wired directly to the pick-up sockets of an amplifier or radio. They give quite good musical reproduction, in addition to speech. The output is much less than that of a carbon mike, so that a fairly high amount of amplification is necessary, to obtain good volume.

Medium and high resistance earphones (500 to 4,000 ohms) will work in this manner. The circuit is in any case very simple, and is shown in Fig. 2. Various surplus earpieces are, in fact, sold as microphones, for use in this way.

Sound powered units may also be of low resistance, or moving coil type. These also generate their own output, needing no battery, but a step-up transformer has to be used between micro-

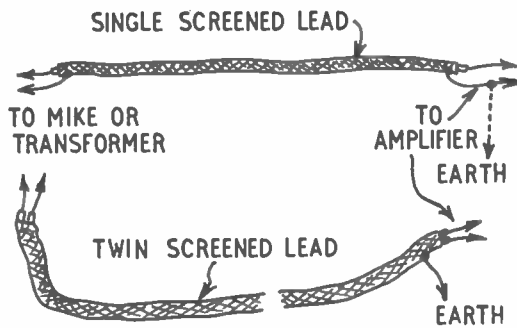

Fig. 4—How screened leads are connected

A dry battery is usually employed, and the best voltage can be found by trial. Too high a voltage will cause a noisy background, and about 3V. to 6V. will often do well. The switch interrupts the battery circuit to save current when the mike is not in use.

The exact form of construction of carbon microphones varies, but there are usually two carbon rods, discs or plates, with carbon granules between. The necessary transformer (without which the mike cannot work) is incorporated in the casing with a few models, but usually has to be added separately.

phone and radio or amplifier, as shown in Fig. 3.

Many such units are of about 50 ohms impedance. The ex-service ZC17602 is 40 ohms. Magnetic throat mikes, such as the No. 2 Mk.2 are often of lower resistance (this model is $7\frac{1}{2}$ ohms).

Results are best when the transformer primary matches the mike, or is of a similar impedance. If possible, the transformer should thus be purchased from the supplier of the microphone. If not, a multi-ratio transformer may be used instead, the best tapings being found by trial.

Crystal microphones are not often seen as surplus, but are wired directly to the radio or amplifier, needing no transformer or battery. They give very good results with speech and music.

Ribbon microphones give excellent musical reproduction, but have such a small output that a very sensitive amplifier is needed. A special matching transformer is also required. Condenser mikes also need more than average amplification to secure good volume. With these types, a pre-amplifier is often used to boost signal strength before feeding this to the main amplifier.

For loudest results with a simple amplifier, the carbon type is best. Crystal and moving coil mikes also give reasonable volume with average amplifiers. A small moving coil speaker, with its usual matching transformer, will act quite well as a microphone.

Connecting up

The correct circuits have been shown, but one or two points must be watched when wiring up. With mains equipment,

hum may spoil results if the microphone leads are near mains wiring. If the leads from the mike to the amplifier or receiver are long, whistling or howling noises may arise. These troubles can be reduced, or eliminated, by using a screened microphone lead, as shown in Fig. 4. The outer brading must be wired to the earth side of the radio or amplifier input. If this is not marked or known, the plugs should be changed over in the sockets, to find which is best.

Howling will also arise if sounds from the loudspeaker reach the microphone with sufficient volume. The mike should thus be kept at some distance from the radio set, or amplifier loudspeaker. If howling begins but ceases when a hand is placed over the mike, this shows that it is too near the loudspeaker. Keeping it away to the side of the loudspeaker, or screening it by means of an open door or other convenient object, may be sufficient to stop the howling. Such howling is most likely with a sensitive amplifier, and volume turned up towards maximum.

Some amplifiers, including those in tape recorders, have various microphone input sockets which may be marked for crystal mike, moving coil mike, etc. If so, use the appropriate input to suit the microphone. When a transformer would be required, as for a moving coil mike, this will often be fitted permanently in the amplifier, if sockets for moving coil microphones are present. Another transformer is not necessary.

Radio sets, and many popular amplifiers, simply have Pick-Up sockets. If so, the transformer must be connected externally for moving coil units, as explained. The signal from a microphone is smaller than that from most gram pick-up units, so that volume will have to be turned up somewhat.

For simple telephone circuits, similar pairs of moving coil or magnetic 'sound powered' units may be wired directly together, with no transformer or battery. Volume will not be very great, but is normally sufficient for 2-way conversation.

Stringing the Card

FROM time to time you may have seen a trick where some object or other is apparently pierced and ultimately appears on a ribbon or string, although the feat seems impossible. Here is a similar kind of trick you can do and only a little preparation is required.

As performer, you present an unsealed envelope to the audience, exhibiting it so that they can see there is nothing inside. You then pierce through the centre with a needle, ultimately passing through a piece of ribbon or string (see Fig. 1). You now take a piece of plain cardboard, pierce a hole in its centre, place inside the envelope and seal down the flap. A handkerchief covers the envelope, which is laid on the table with the ends of the string outstretched, and, after uttering a few magic words or a wave of the wand, you are ready for the conclusion of the trick. The envelope — still with the

string threaded through — is slit at one end and the card is slowly pulled out, when the audience will see that it is followed by the string which has somehow or other threaded itself through the centre while in the envelope!

So much for the brief explanation. Reference to Figs. 2A and 2B will indicate how this piece of trickery is contrived. First of all you take two identical envelopes as in Fig. 2A, sticking them face to face, so that the flaps are to the outside. Now refer to Fig. 2B, where you will see that a prepared card with a hole punched in the centre is slipped into one envelope and the flap sealed. After piercing the envelope the string appears to be passing through an empty packet, but you will now realise that it also passes through the additional envelope which contains the prepared card. So you must remember to conceal the back envelope

from the eyes of your audience, but this is not difficult. It is also advisable to make a tiny identification mark on one corner of that envelope which holds the card, so you know the correct one to slit open.

The string is passed through the combined envelopes in sight of the audience, and an identical piece of card placed in the empty envelope and sealed as already stated. When you are ready to reveal the card and string, the envelope should be turned so that it is endways to the audience and your scissors will hide the double thickness of paper. Slit open the end carefully, draw out the card slowly, and sure enough the string will follow. The covering handkerchief is merely subterfuge.

With this kind of trick there is always the possibility that someone may call for an inspection of the envelope, so you must be prepared for this eventuality. After cutting open the fake envelope it should be returned to the table and attention diverted to the card, which may be spun round a few times on the string. You may pass this out for examination if you wish—turn to the table to pick up the envelope, also for inspection, but the envelope you now pick up is a third, again specially prepared. This third envelope is a single one, sealed, pierced through the centre and slit down one end to give the appearance of the genuine thing, and it has been placed on the table before you commenced the trick.

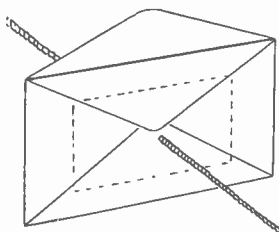

FIG 1

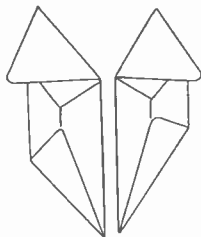

FIG 2A

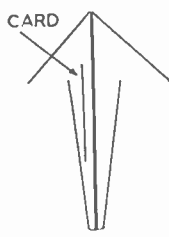

FIG 2B

HAPPY HOURS WITH A SLIDE

THE children will love the slide illustrated on the front page and will spend many enjoyable hours in its use. It is quite easy to make and there are no difficult joints to deter the amateur.

The steps and slide are made up as two separate units which are then bolted together and secured by the strut 8. When the slide is put away for the winter the bolts are removed to enable the parts to be packed flat.

Make a start by constructing the slide shown in Fig. 1A. The overall dimensions are shown in Fig. 2 and it will be obvious that the width must go between the sides of the steps 9.

The two pieces 1 are held together by three battens 2 spaced as shown in Fig. 1A. Pieces 1 are $\frac{1}{2}$ in. thick and the battens 2 are 1 in. by $\frac{3}{4}$ in. To provide a safe slide free from splinters a piece of linoleum is used. It is put between pieces 1 and the sides 3 so that it is held in

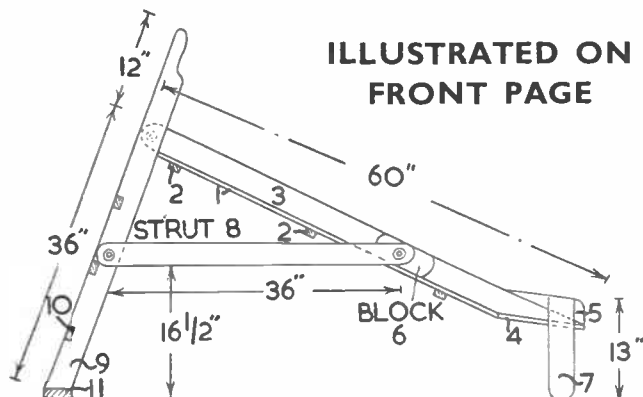
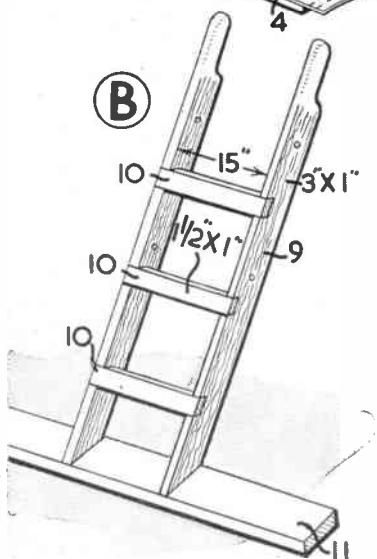
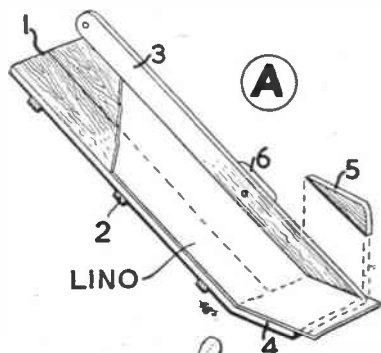

ILLUSTRATED ON FRONT PAGE

place when the pieces are nailed or screwed together. The sides 3 are $\frac{3}{4}$ in. thick and about 3 in. wide.

To give the correct slope at the lower end of the slide, piece 4 is nailed across as shown. The small pieces 5 and the legs 7 are now fixed to pieces 3.

Make up the steps as shown in Fig. 1B. Pieces 9 are shaped at the ends to form handles whilst the lower ends are screwed to piece 11 which should be about 4 ft. long. Piece 11 should be about $3\frac{1}{2}$ in. wide and $\frac{3}{4}$ in. thick.

The two portions are now bolted

together with $\frac{3}{8}$ in. diameter bolts and are held at the correct angle by means of the strut 8, which is 3 in. wide and $\frac{3}{4}$ in. thick. Since the strut comes on the outside of the steps it will be necessary to insert the blocks 6 in position between the struts 8 and the sides 3.

Clean up all round with fine glasspaper and give a coat of pink primer. Follow this with an undercoat and a top coat of outdoor quality paint. Allow to dry and then rub down with silicon carbide paper used wet. Give a final coat of paint to finish. (M.h.)

● Continued from page 318

Heat and Organic Salts

The oxalates of cobalt and nickel afford a ready means of making the respective metals in the laboratory. Heat some cobalt oxalate in a covered crucible until the latter is red hot and then remove the flame. When the glow has just gone from the crucible momentarily remove the lid with a pair of crucible tongs. A black powder will be seen which suddenly glows. At once replace the lid and let the whole grow cold.

The glow was caused by the oxygen of the air beginning to combine with the finely divided metal. So when making cobalt by this method be sure to keep the lid on until the whole is cold.

Tip out the black powder on to a sheet of paper and bring a magnet near to it. It is strongly attracted. Like iron, cobalt is magnetic.

By repeating this whole experiment with nickel oxalate instead of the cobalt salt you will obtain an olive-grey powder

of metallic nickel. This, too, is attracted by the magnet.

Both of these metals contain a small amount of carbon when made by these methods. For ordinary purposes this is of no consequence.

Lastly, another common laboratory salt, calcium benzoate, should be tested for its behaviour when heated. Put a little in a hard glass test tube and heat it. The water of crystallization of this salt is given off and then drops of a reddish liquid condense on the cooler parts of the tube. You will note this condensate has a peculiar smell. It consists mainly of an aromatic ketone called benzophenone, though smaller quantities of benzene and other substances are also present.

When the tube has been allowed to grow cold, try the acid and lime water test. Effervescence occurs and clouding of the lime water drop, thus showing that a residue of calcium carbonate is left.

*Decorative NO

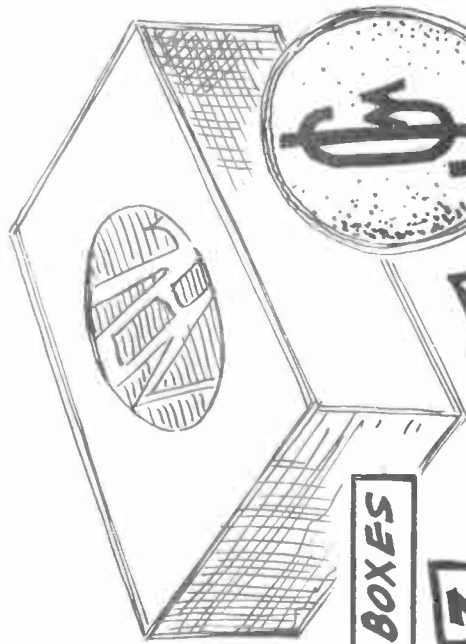

BOXES

3 SUGGESTED USES



BOOK JACKETS

PAPER KNIVES

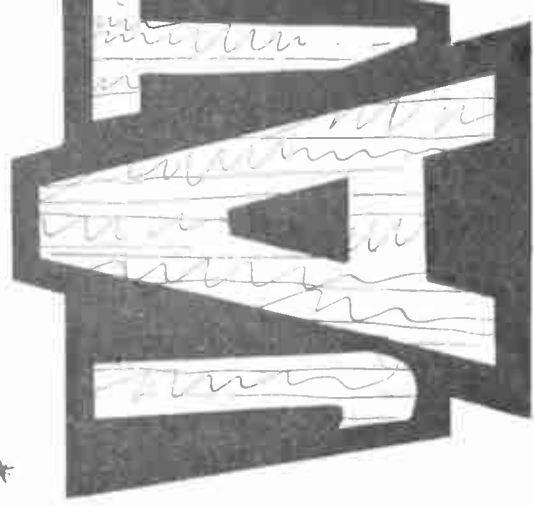

MARQUETRY

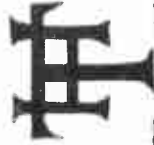
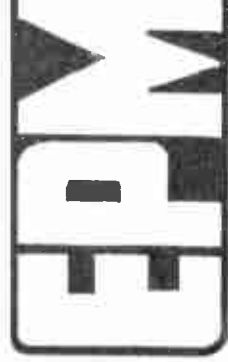

MONOGRAMS

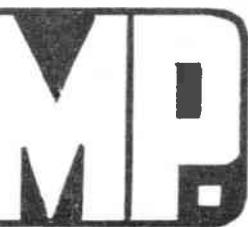
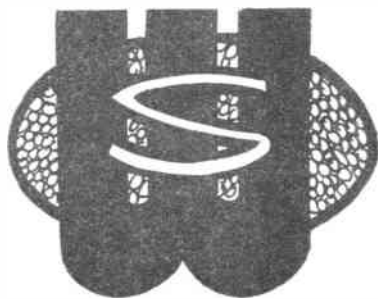
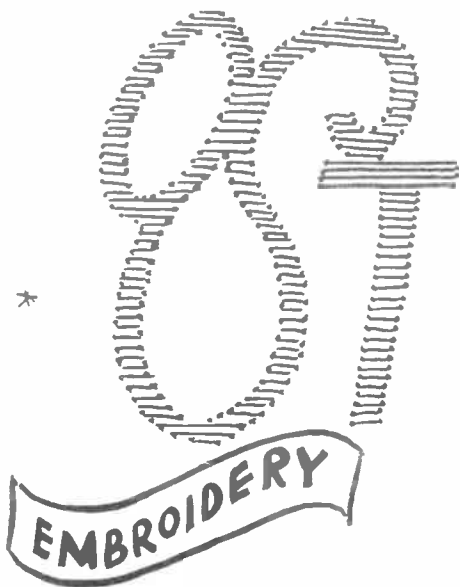

We have all — at one time or another — “doodled” on paper with the initials of our names, trying to design a balanced and pleasing personal monogram. These are of course used to good effect on such as blazer badges and the principle can be put to further use in other mediums.

Wood marquetry, for instance, lends itself particularly well for this use, and ideas can also be worked out in metal and paper of different colours. Such subjects as boxes, book jackets and paper knives, etc., can well be decorated with a personal monogram.

The main requirements are a good basic design with clean lettering, and it is suggested that other monograms should be studied so as to get a good idea of how different letters are pleasingly balanced.

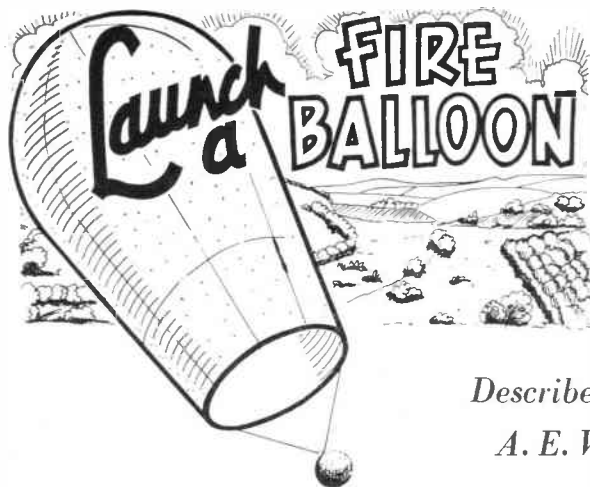

Described by
A. E. Ward

FOR thousands of years man envied the birds and yearned to fly. Many an intrepid aeronaut spread his home-made wings above lofty battlements, only to crash to a violent death as he attempted to copy the birds.

Not until 1783, was the conquest of the air successfully embarked upon, when Pilâtre de Rozier, together with a young nobleman, ascended from the Bois de Boulogne in Paris in a hot air balloon made by the brothers Joseph and Etienne Montgolfier. The balloon was 74ft. high and had a capacity of 60,000 cubic feet. It was made of linen, lined with paper and decorated in blue and gold with fleurs-de-lis, signs of the zodiac and the Cipher of Louis XVI. It is recorded that, 'the aerostat left the ground at 54 minutes past one o'clock, passed safely over some high trees and ascended calmly and majestically into the atmosphere'.

You can experience the thrill and pride of launching your own balloon for the modest cost of one shilling. The project described will be for a balloon 6ft. tall, with a maximum diameter of 4ft., but you will be able to make much larger balloons if you wish.

To begin with, you will need twenty-four sheets of good quality tissue paper, each measuring 20ins. by 30ins. These can be obtained from a stationer or at a bakery, and will cost about tenpence.

Paste the sheets of tissue paper together lengthways in eight sets of three, using a strong flour paste which must be applied as thinly as possible in order to conserve weight. Let all the rough surfaces face the same way and make the seams $\frac{1}{16}$ in. wide. Spread the paper lengths out to dry, then place them together in a pile on the floor, with all the smooth surfaces facing upwards. The pile of eight sheets must now be folded in half lengthways, and as this

operation must be performed accurately, it is advisable to obtain the help of someone in the careful folding of the pile (see Fig. 1).

Using a ruler and pencil, mark out one half of a side panel on to the top side of the folded heap (see Fig. 1).

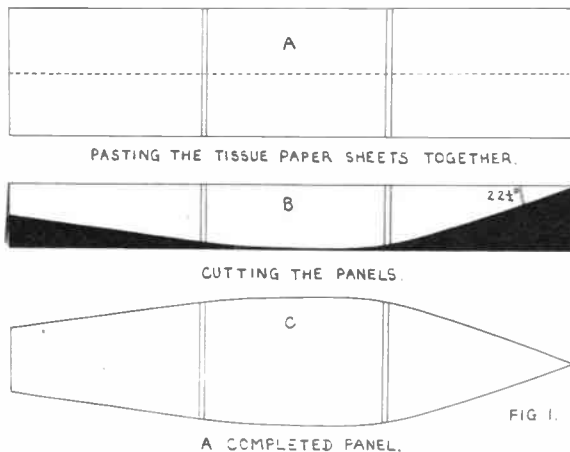

FIG. 1.

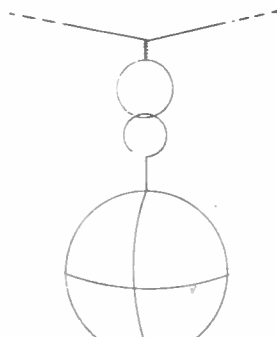

Fig. 2

Since the apices of the eight panels will have to meet one another exactly at the top of the balloon, the angles of the eight segments must total 360° . Thus the angle at the top of each panel must be 45° . Remember you are marking out half a panel, so begin by drawing in an angle of $22\frac{1}{2}^\circ$. A panel must broaden out to a maximum width about a third of the way down from the apex and then narrow to about half the broadest width at the bottom. Cut out the panels all together, using a large pair of sharp scissors, then open out the folds. You are now ready to commence pasting the panels together.

Lay panel one on the floor, with its smooth side downwards, and apply paste thinly along a $\frac{1}{16}$ in. margin down one edge of the panel, from apex to bottom. Carefully lay panel two over panel one, so that one edge of panel two rests over the pasted margin of panel one. Panel two must be smooth side upwards, since it is intended to make the balloon with its outer surface totally smooth. Gently press the edges together and finish the seam by again applying paste thinly along the margin, and folding over the pasted part. Press the seam gently all along.

Fold back the free edge of panel two, and paste along a $\frac{1}{16}$ in. margin from apex to bottom, as described for panel one. Attach panel three in the manner described for panel two. Continue to join the panels together until panel eight is pasted to panel one. While this is being done, care must be taken not to tear the paper or let the panels stick to the floor.

Now you must stiffen the neck of the balloon with wire. Obtain a piece of light wire, slightly greater in length than the circumference of the neck. Open out the balloon neck, and lay the two thicknesses of paper flat upon the floor. Lay one end of the wire along the

flattened edge and paste along a $\frac{1}{2}$ in. margin. Proceed to secure the wire in place by folding over the pasted edge and pressing it gently. Carefully turn the balloon over and fix the wire inside the rim of the other half of the neck. Twist the ends of the wire together, using a pair of pliers. Trim off any jagged ends of wire and make the join neat by covering it with a small piece of Sello-tape.

Adding the top

You will need the assistance of a friend when you paste the top on your balloon. Cut out a circle of tissue paper the size of a tea plate, and paste the rough side all over. Hand a dinner plate to your friend and lower the balloon completely over him while he stands quite still. Request him to hold the dinner plate above his head. Adjust the paper at the top of the balloon, so that the apices of the panels come together above the centre of the plate. Ask your helper to hold the plate steady while you

paste the circle right over the ends of the panels. Press it down firmly against the plate. Before releasing your assistant, open out the folds of your balloon and patch any holes which may be present in the envelope.

Fix a straight piece of stout wire across the neck of the balloon. Twist a little loop in the centre of the cross-piece. Before the balloon is launched a ball of cotton wool the size of a fist and soaked in methylated spirit will be bound with thin wire and hooked on to the loop (see Fig. 2).

Launch your balloon from a large open place on a *calm* day. Light a small fire of newspapers and have a friend to assist you to hold the neck of the balloon above the flames. The envelope will become inflated with hot air and will soon acquire a tendency to rise. When you are satisfied that the balloon is in an ascending condition, hook the cotton wool pad on to the cross-piece and ignite the methylated spirit. Tell your assistant to stand aside. As the

balloon pulls upwards, release it, and watch it rise high into the air. An ascent on a still night will be a ghostly and beautiful sight, and might inspire reports of Flying Saucers in the local Press!

Precautions

Your balloon rises owing to the fact that when air is heated it expands and becomes considerably lighter. Since the balloon is surrounded by denser cold air, it will tend to rise. Of course, for the best result you must ensure that the total weight of the materials used in construction is kept as low as possible.

The precaution of launching the balloon in calm conditions will be appreciated for two reasons. Primarily it is essential to ensure that the apparatus is not carried away by the wind to become a fire hazard to adjoining property, and your site should, therefore, be carefully chosen. You will also want to be able to retrieve the balloon on its descent to the ground.

Make this Hedge-trimming Gauge

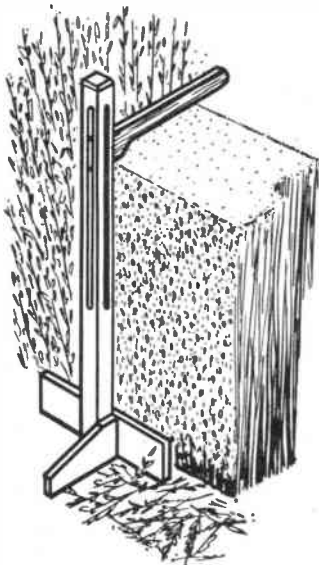

NOTHING looks more unsightly than to see a hedge which is wavy and uneven after being trimmed. Although many gardeners can trim a hedge perfectly straight and even with the eye, there are others who find this task rather difficult.

If you find yourself belonging to the latter group then why not make a simple hedge-trimming gauge like the one illustrated. This consists of a vertical

post suitably supported at the bottom and having an adjustable arm which can be raised or lowered to suit the height of your hedges. To operate this gadget successfully it will be appreciated that the hedge being trimmed must be next to a flat surface, such as a path or pavement.

By K. Finlay

The post consists of a piece of 2 in. by 2 in. timber which should be cut to suit the height of your tallest hedge. Two $\frac{3}{8}$ in. wide slots are next formed in the post at right angles to each other as shown in Fig. 1. One slot is to receive the adjustable arm and the other one is for the securing bolt. Chamfer off the top end a little for added appearance.

In order that the post may be able to stand erect by itself make a simple bracket arrangement at the base by nailing on two pieces of timber at right angles to each other.

Provides an 'angled' cut

The arm is made from a piece of $\frac{3}{8}$ in. thick timber or plywood and should be cut to the shape shown in Fig. 2. This should then be slipped into one of the slots in the post and a $\frac{3}{8}$ in. diameter bolt passed through complete with washers and wing nut. Once the nut is tightened

the arm should remain firmly in a fixed position at any height.

When in use, the gauge is set to the desired height and should always remain immediately behind the trimming shears. Note that if the top of the hedge is required to be made sloping then the gauge arm can also be made sloping to correspond with the desired angle.

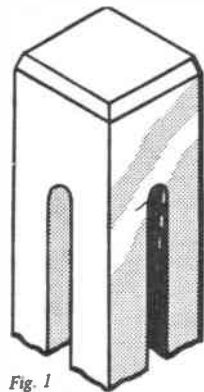

Fig. 1

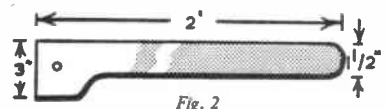

Fig. 2

CHEMISTRY

AT HOME

WHEN heated, salts of organic acids behave in an interesting manner, yielding a variety of volatile and non-volatile products. Many salts, particularly those of high molecular weight, undergo a complex decomposition. These are beyond the scope of the home laboratory. Certain salts, however, and which are among the average amateur's stock, lend themselves to a series of simple experiments.

Put a little sodium formate in an ignition tube and heat it at the tip of the flame. When hot, turn the tube mouth to the flame. A sharp pop will be heard and a momentary flame appears. This is due to the evolution of hydrogen. Let the tube cool, dissolve the residue in water and filter. Add some calcium

chloride solution. A white precipitate appears. Now add some sodium formate solution to some calcium chloride solution. No precipitate appears. A profound change has evidently occurred through the heating process. The sodium formate, in fact, broke down into hydrogen and sodium oxalate, the latter giving a white precipitate of calcium oxalate with calcium chloride.

Acetates, though so closely related to formates, react quite differently. Sodium acetate and calcium acetate will serve to show how. Both contain water of crystallization. This is best removed by spreading out the salts on tin lids and heating them with the flame about $\frac{1}{2}$ in. from the lid, stirring constantly and testing for complete removal of water by holding a watch glass close every so often. When

the glass no longer mists the dehydration is complete. Separately heat the salts in the apparatus shown in Fig. 1. When the salts are at a dull red heat, stop heating and filter the water, which now contains the volatile decomposition products. To portions of the filtrates add sodium hydroxide solution until alkaline, that is, until the liquid turns red litmus paper blue. Now add dropwise a solution of iodine in potassium iodide until a faint yellow colour persists. Clear this colouration with a drop or two of sodium hydroxide solution. A yellow solid separates. This is iodoform, whose odour reminds one of both iodine and apples.

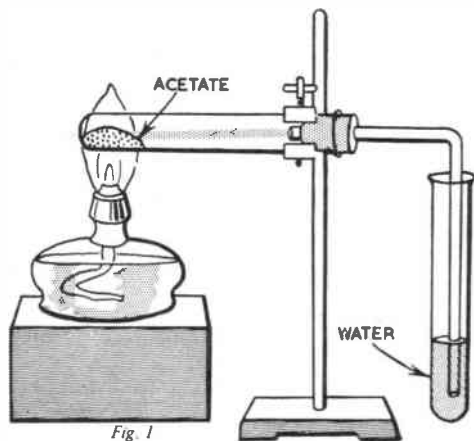

Fig. 1

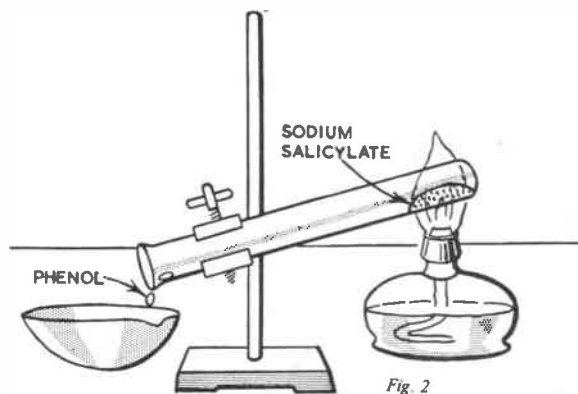

Fig. 2

The formation of iodoform was made possible by the presence in the water of acetone, which the acetates yielded on heating. If you test the residues in the heating tubes by adding a little dilute hydrochloric acid and holding a drop of lime water on a glass rod just above the mixture in each case, you will find the acetates have been converted into carbonates, for effervescence occurs and the lime water turns cloudy owing to the evolution of carbon dioxide.

Now try heating a little sodium tartrate in an ignition tube. The salt blackens and the vapours smell strongly of burnt sugar. Treat the residue with acid and lime water as you did with the acetates. Again carbon dioxide is given off with effervescence and clouding of the lime water, once more showing con-

version of the salt into a carbonate.

Sodium salicylate behaves interestingly, too. This should be heated in a slightly inclined test tube as shown in Fig. 2. This salt chars on heating and you will quickly notice a nice 'carbolic' smell. A drop or two of liquid condenses and falls into the evaporating basin. This liquid also has the 'carbolic' smell. It is, in fact, carbolic acid, or phenol as chemists know it.

To test the distillate for phenol, dilute it with a few c.c. of water. Pour half of the solution into a test tube and add a few drops of ferric chloride solution. A violet colouration appears.

HEAT APPLIED TO ORGANIC SALTS

To the other half of the phenol solution add bromine water. A white precipitate of tribromophenol appears.

Oxalates behave in various ways. Put a little calcium oxalate in an ignition tube and heat it. Hold a lighted taper or spill at the mouth of the tube. A blue flame appears due to carbon monoxide being given off. Let the tube cool and

add a little dilute hydrochloric acid. Effervescence occurs and if you hold a glass rod carrying a drop of lime water within the tube the drop will cloud showing that the effervescence is caused by the evolution of carbon dioxide and hence indicating a carbonate. Calcium oxalate, therefore, produces carbon monoxide and calcium carbonate on heating.

Repeat the experiment with copper oxalate, but in place of the lighted taper hold a drop of lime water on a rod within the tube. The copper oxalate blackens and the lime water clouds, indicating that carbon dioxide is being formed. When the tube is cold again shake out the residue on to a sheet of paper. You will find it is mostly metallic copper, the remainder being carbon.

● Continued on page 313

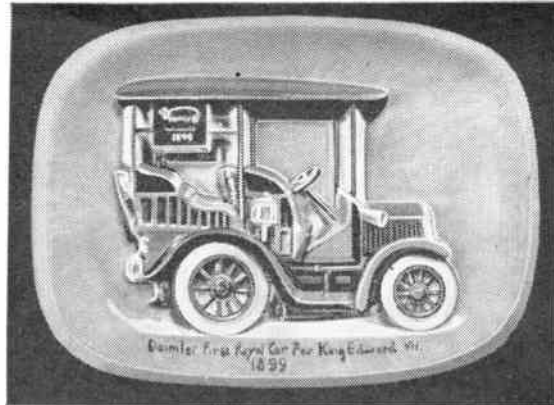
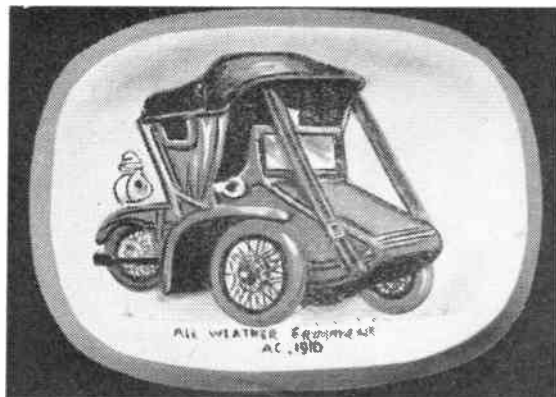

Veteran Car Plaques FOR THE ENTHUSIAST

Make a set of six wall plaques showing authentic replicas of Veteran cars. These are something new to the Sculptorcraft range of Plastic Moulds. They can be used many times over.

Write for illustrated leaflet, enclosing 3d. stamp



Sculptorcraft



SEAMER PRODUCTS (SCULPTORCRAFT) LTD, 23/27 EASTBOURNE STREET, HULL

A HANDY GLASSPAPER BLOCK

A wooden block with special handle which holds glasspaper taut and always in place. In two sizes, 3in., price 1/9 (post 6d.); 5in., price 3/- (post 9d.)

HOBBIES LTD., DEREHAM
Norfolk, and all Branches



LET
★ **'Plasticine'**

HELP YOU DO-IT-YOURSELF *Regd. Trade Mark*
Harbutt's Plasticine Ltd, Bathampton, Bath

ALL-STEEL CORNER CRAMP

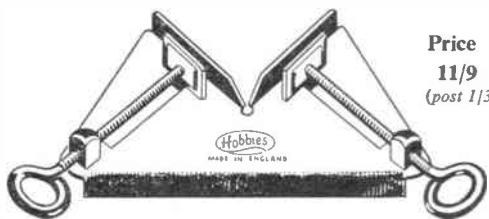

Price
11/9
(post 1/3)

A Picture Frame Cramp made from steel and practically unbreakable. It is well made and finished and will take work up to 2½ in. wide. For ordinary moulding it is a very serviceable article. From branches or:—

HOBBIES LTD, DEREHAM, NORFOLK



NEW DO-IT-YOURSELF PRINTING OUTFIT

£1·17·6

COMPLETE

Everything you need to print your own snaps. Combined safe light and exposing light. Three ½ plate dishes (orange, white and grey). Printing frame with masks. Two graduated measures. Two forceps. Thermometer with case. Con-Sol developer. Acid Fixing powder and full instructions.

JOHNSONS
OF HENDON LTD

FOR CONFIDENCE
IN PHOTOGRAPHY

WATER LILIES



THE GARDEN POOL

by
Ed. Capper

THE hardy water lilies (*Nymphaea*) range in size from strong growers with 10 in. blooms and leaves like dinner plates, down to dainty miniatures small enough to grow indoors in bowls. Their colours include white, many shades of pink, red and yellow. It is noteworthy that the reds are carmine, crimson or wine red, but do not include anything approaching scarlet. There are no blue lilies; this colour occurs only among the tender tropicals.

Lilies are perennial in habit. Growth ceases in the autumn and the plant dies back completely with the arrival of frost. The rhizome, with the protection of not less than 9 in. of water above it, is unharmed by winter cold, and begins to produce new foliage as soon as the warmth of spring arrives. New leaves appear by early May and flower buds by early June. Established plants flower continuously until well into September, fresh buds being produced steadily to replace the old flowers. These sink to the bottom to rot and become food to nourish the roots.

It is desirable to interrupt this natural cycle by removing the old flower heads or foliage. Neither will remain long on the surface after they have passed their best, but sink discreetly from sight to make room for young buds and leaves.

Water lilies are easy to grow provided the following essential conditions are adhered to:

SUNLIGHT. They should be grown where they will get sunshine for at least half of the day.

SOIL AND MANURE. A good turfy loam should always be used for their bed. Chopped lawn or orchard turves are ideal, but ordinary garden soil is quite suitable, preferably with the admixture of a handful of coarse bonemeal.

WATER DEPTH AND AREA. Only varieties appropriate to the water depth and surface area should be used.

PLANTING. Plant as described in the previous article. If you prefer to plant in wire baskets, the lilies will need replanting every three years. If a time comes when the foliage stands right out of the water in an overcrowded mass, the lily should be lifted and divided, one young offshoot from the main crown then being replanted.

SEASON. If necessary for spring-cleaning the pool, an established lily may be lifted as early as April. Young plants, however, will not have developed sufficient growth until late in May. Remember, therefore, not to touch young stock until this time has been reached.

Below is detailed some of the popular varieties:

WHITES.

Candida. A small plant with small starry flowers. Plant in 4-12 in. of water. Surface spread 1½-2 ft.

Pygmaea alba. Another miniature with flowers of 1½-2 in. across. Plant in same depth of water as *Candida*. It has the same surface spread.

Albatross. Large, pure white flowers with golden centres. Glossy foliage. Ideal for small pools. Likes 9-18 in. of water. Surface spread 2-3 ft.

Gonnere. Double flowers up to 9 in. across. Slow to flower, but worth waiting for. Plant in water 9-24 in. deep. Surface spread 3-4 ft.

Alba. The native white water lily. Will grow in moving water. Likes a water depth of up to 36 in., but will flourish in anything over 9 in. Surface spread up to 5 ft.

PINKS.

Laydekeri litacea. Rose-lilac flowers spotted with carmine and deepening with age. Flowers freely. Suitable for tubs or shallow pools. Water depth preferred 4-12 in. Surface spread 1½-2 ft.

Joanne Pring. Another miniature. Deep pink flowers, beautifully shaped. Likes water 9-18 in. deep. Surface spread 2-3 ft.

Firecrest. Clear pink flowers with red-tipped orange stamens. Plant in water 9-24 in. deep. Surface spread 3-4 ft.

Amabilis. Large pale salmon pink flowers deepening to soft rose and opening wide. Needs 9-36 in. of water depth. Surface spread 4-5 ft.

REDS.

Pygmaea rubis. A rare dwarf lily. The blooms open deep pink and deepen to a pomegranate red. Needs only 4-12 in. of water. Surface spread 1½-2 ft.

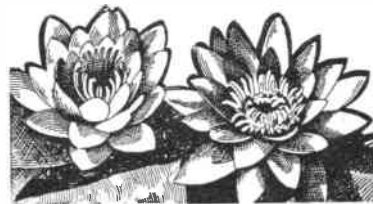

Ellisiana. A small lily. Glowing red flowers deepening to almost purple. Orange red stamens. Likes 9-18 in. of water depth. Surface spread 2-3 ft.

Gloriosa. An early and free blooming red flower. Moderate growth, ideal where space is limited. Plant in 9-24 in. of water. Surface spread 3-4 ft.

Chas. de Meurville. Large wine-red blooms flowering over long period. Set in 9-36 in. of water. Surface spread 4-5 ft.

YELLOWS AND ORANGES.

Pygmaea belvola. Dwarf plant with pale primrose flowers. Water depth required: 4-12 in. Surface spread 1½-2 ft.

Graziella. Orange yellow flowers with flush of coppery pink, flowering freely. Plant in 9-18 in. of water. Surface spread 2-3 ft.

Marliacea chromatella. Large, well-shaped primrose yellow flowers. Likes 9-24 in. of water depth. Surface spread 3-4 ft.

Col. Welch. Upstanding, narrow petalled canary yellow flowers. Lightly marbled foliage. Plant in 9-36 in. of water. Surface spread 4-5 ft.

This is only a very small selection of up to fifty varieties that can be obtained, and Messrs Stewarts Water Nurseries of Ferndown, Dorset, will gladly give any advice to those of you wishing a larger choice from which to select.

Cut blooms of water lilies make ideal table decoration. The flowers normally close up in the late afternoon, but if they are required for an evening function a few drops of paraffin wax or even candle grease, at the base of the petals and sepals will hold them firmly open.

Varieties suitable for this purpose are Gladstoniana, James Brydon, Escar-boucle, Masaniello and Chromatella. The *Marliacea rosea* makes an outstanding table centre.

Finally, in making a selection of water lilies it should be remembered that while the weaker growers will not stand deep water, the strong growers will flourish in shallow as well as deep water. About 85 per cent of lilies will flourish in 12-18 in. of water.

**DON'T LET SOLDERING
GET YOU DOWN**



**use
FLUXITE**

Soldering ceases to be a knotty problem the moment you use FLUXITE. Solder flows on easily and smoothly—and stays on. For over half a century FLUXITE has been the choice of craftsman and engineer alike and, in this age, its reliability and speed has made FLUXITE even more in demand than ever.

**IT
SIMPLIFIES
ALL
SOLDERING**



**FLUXITE LTD., Bermondsey St., London, S.E.1
GM.81**

**THE
FAMOUS
BENNETT
COLLEGE
can train your mind
to SUCCESS**

**WHAT CAREER
DO YOU WANT?**

Architecture
Building
Carpentry
Commercial Art
Diesel Engines
Draughtsmanship
Electrical Engineering
Electric Wiring
Mechanical Engineering
Motor Engineering
Plumbing
Quantity Surveying
Radio Engineering
Surveying
Telecommunications

Book-keeping
English
Geography
Journalism
Languages
Mathematics
Modern Business Methods
Police Subjects
Salesmanship
Shorthand
and many others

Or why not obtain a
Qualification?

A.M.I.C.E. A.A.C.C.A.
A.M.I. Mech. E. A.C.W.A.
A.R.I.B.A. A.C.I.S.
A.M.I. Struct. E. A.C.C.S.
A.M.J. Mun. E. A.R.I.C.S.
A.M.S.E. A.A.I.

GEN. CERT. of EDUCATION
& R.S.A. Exams.

**THROUGH PERSONAL
POSTAL TUITION**

A FREE book

vital to your career!

Read how the famous Bennett College can help you to success! Send now for this recently published FREE Book, "Train your mind to SUCCESS", which tells you about The Bennett College proven success in postal tuition ... and how it can help you to success in your career.

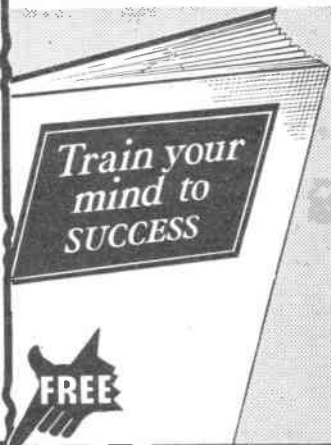

To THE BENNETT COLLEGE
(DEPT. J62N), SHEFFIELD
Please send me, without obligation, a free
copy of "Train your mind to SUCCESS" and
the College Prospectus on :

SUBJECT.....
NAME.....
ADDRESS

AGE (if under 21)..... *Please write in
Block Letters*

**THIS
COUPON
COULD BE YOUR
PERSONAL PASSPORT
TO SUCCESS.
Send it NOW!**

Completely new 54 page Edition

WHERE'S THAT CAR FROM?

Price 1/- (Postage 4d.)

Of all Booksellers

or

RALEIGH PRESS, EXMOUTH, DEVON

LEARN RADIO and ELECTRONICS the NEW practical way! Very latest system of experimenting with and building radio apparatus — 'as you learn'. FREE brochure from — Dept. HW.10, Radiostructor, 46 Market Place, Reading, Berks.

BUILD YOUR OWN HI-FI at home! At last, for reasonable cost — the chance to make your own quality HI-FI audio equipment and to gain the knowledge to service and maintain it. FREE brochure from — Dept. HW.20, Radiostructor, 46 Market Place, Reading, Berks.

INTRODUCTIONS to new friends; home and overseas. — V.C.C., 34 Honeywell Road, S.W.11.

100 DIFFERENT stamps free! Request 4d. upwards discount approvals. — Bush, 53 Newlyn Way, Parkstone, Dorset.

STAMPS FREE — Empire Packet including Pictorials and Victorians with approvals. — Robert J. Peck, 7A Kemp Road, Bournemouth.

REFUND IF NOT WORTH DOUBLE!



EXTRA LARGE RECORD CABINET & T/VTABLE
Not only sand polished but also polished light or medium WALNUT tone. NOTE — ROOMY BOOK CASES AT BOTH ENDS — one converts to Magazine Rack by insertion of sloping panel provided, as illustrated. Amazing offer — 59/6, carr. 6/6 or sent for £1. Balance 6 monthly payments 8/-, plus carriage. Magnificent cabinet built contemporary piece of furniture to solve your record problem and also ideal as stand for TV, Radio or Record Player. 30" x 15" x 24" high. Modern sliding doors. Roomy interior, partitioned for classifications, holds over 200 records (upright for perfect condition). Entirely of seasoned timber. Detachable legs. SEND quickly. LISTS, FURNITURE.



1500 TELESCOPE SIGHTING GUN SIGHTS
These new WAR DEPT. instruments fitted with genuine scientific hand-ground lenses are precision built and graticuled for dead-on sharp-shooting accuracy. Brand new and made for precise snipers' action, they represent an absolute bargain. Actual cost of production, without any profit, £8.10.0. OUR PRICE only 13/11, post etc., 2/1. If you want to get a precise bead on any thing this is the instrument to do the trick. Limited offer only, send quickly. FREE LISTS, TELESCOPES, BINOCULARS, TERMS. Headquarter & General Supplies Ltd. (HOBW/80 196-200 Coldharbour Lane, Loughboro Junc., London, S.E.5. Open Sat.

BRASS, COPPER, DURAL, ALUMINIUM, BRONZE

ROD, BAR, SHEET, TUBE, STRIP, WIRE
3,000 STANDARD STOCK SIZES
No Quantity too small List on Application
H. ROLLET & Co. Ltd.
6 CHESHAM PLACE, LONDON, S.W.1
Also at
Liverpool, Manchester, Leeds, Birmingham

APPARATUS & CHEMICALS — Gigantic Aprice reductions. Save pounds! Special offers. Catalogue free. New premises and better service. — Scientific and Technical Supplies (Notm.) Ltd., 286 Alfred Street Central, Nottingham.

MAKE A MUSICAL BOX for as little as 21/-. New kits and tunes available. Movements 13/- post free. Please send 3d. stamp for free illustrated catalogue. — The Swisscross Co., Dept. B, 202 Tulse Hill, London, S.W.2.

EXTRA CHEQUES from writing. Send for 'Ideas for Writers' (free). Scores of suggestions for beginners and others. Typewriter unnecessary. — Writers' Ring (H.W.), 5 Edmund Street, Birmingham 3.

PERSONS required to make new type fancy cushion covers. Apply, enclosing S.A.E. — Dept. 28, Arnold Trading, 10 Shelley Rd., Worthing, Sussex.

100 DIFFERENT FREE, from 35 countries Request Approvals — Lear, 106 Watleys End Road, Winterbourne, Bristol.

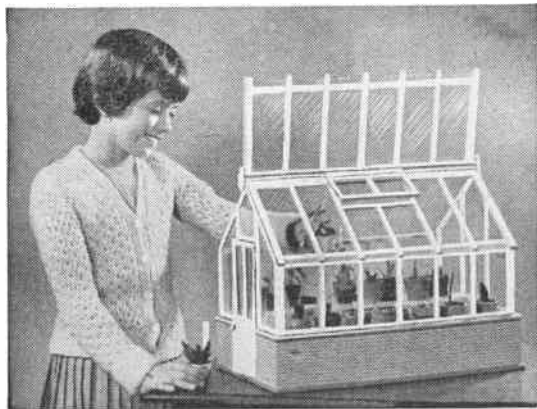

MINIATURE GREENHOUSE

A really practical model for the home

For growing cacti, succulents, miniature trees, seedlings, etc., and can be used as a propagating frame.

JUST LIKE DAD'S!

You can make this ideal showpiece from Hobbies Kit No. 3300, which contains all wood, materials, etc., and 12 sets of pots and saucers. Hinged roof, window, door. 18 ins. x 12 ins. x 13 ins. high. Only a few simple tools needed in construction.

Kits from Hobbies branches, stockists or post free (see coupon). **39/6**

ALL-THE-YEAR-ROUND INTEREST

To HOBBIES LTD., Dept. 99, Dereham, Norfolk

Please send Kit No. 3300 for making Miniature Greenhouse.
I enclose P.O. for 39/6.

Name

Address

.....
.....

When you ask
for a knife
-say **X-acto**

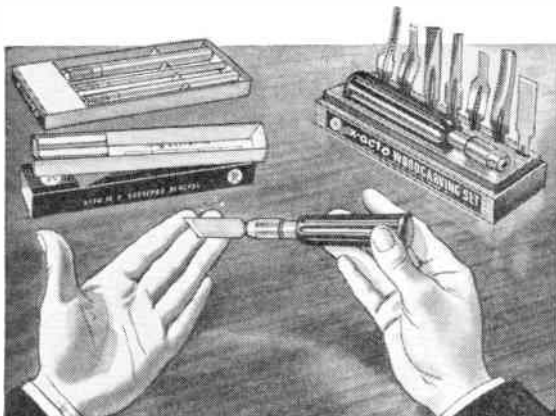

...they're made to
develop your skill!

A man knows that X-acto is *right* the moment he picks up one of these superb knives. X-acto have three different weights of perfectly balanced handle. 25 interchangeable blades, gouges, routers and punches—all in razor-sharp surgical steel.

X-acto's a precise tool. And an all-round tool—right for delicate modelling, right for handyman work around the house. When you ask for a knife—say X-acto.

From Hobby Shops and Ironmongers

And ask to see all the other tools
in the X-acto range



DUFAY (B'ham) LIMITED

(X-acto Products Division)

308 SUMMER LANE, BIRMINGHAM, 19

It's Ready NOW!

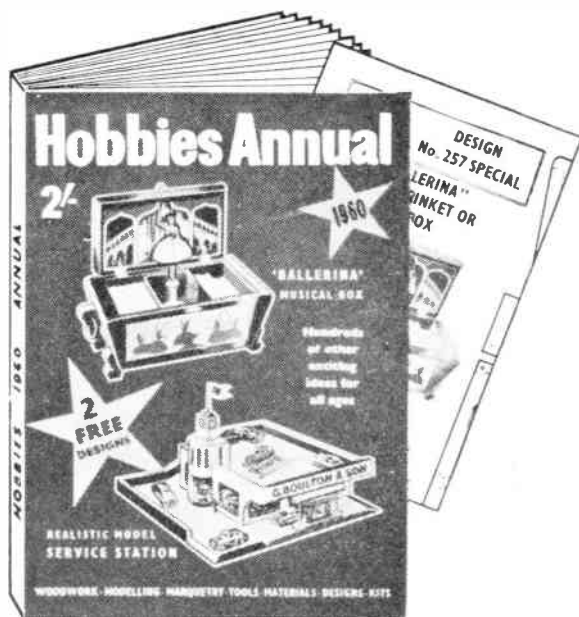

The Annual You MUST Have

The big-value Handbook for the woodworker, handyman, modeller and handicraft worker. 168 pages full of interesting projects — and ONLY 2/-. **TWO FREE DESIGNS WITH EACH COPY**

Charming Ballerina Musical Box.
Model Service Station for the modern lad.

Projects include:

- ★ Animated Toys
- ★ Trailer for Tricycle
- ★ Bathroom Drip Dryer
- ★ Blanket Chest
- ★ Coloured Marquetry Picture
- ★ Standard Lamp
- ★ Modern Clocks
- ★ Model, etc., etc.

From Hobbies branches, stockists, newsagents, bookstalls, etc. or send NOW for your copy by post (6d. extra).

To Hobbies Ltd., Dept. 99, Dereham, Norfolk.

Please send copy/copies Hobbies 1960 Annual (2/6 each, post free). P.O. for enclosed.

Name

Address

.....
.....