

24th JUNE 1959

VOL. 128

NUMBER 3321

THE ORIGINAL
'DO-IT-YOURSELF'
MAGAZINE

HOBBIES *weekly*

FOR ALL
HOME CRAFTSMEN

Also in this issue:

MARQUETRY IN
JEWELLERY

SAVING LIFE IN
THE WATER

BEGINNER'S
2-TRANSISTOR RADIO

COLLECTORS' CLUB

PATTERNS FOR
A PLANT HOLDER

CHEMISTRY AND
MODELLING

PROJECTS FOR
THE HOME

ETC. ETC.

Instructions to make

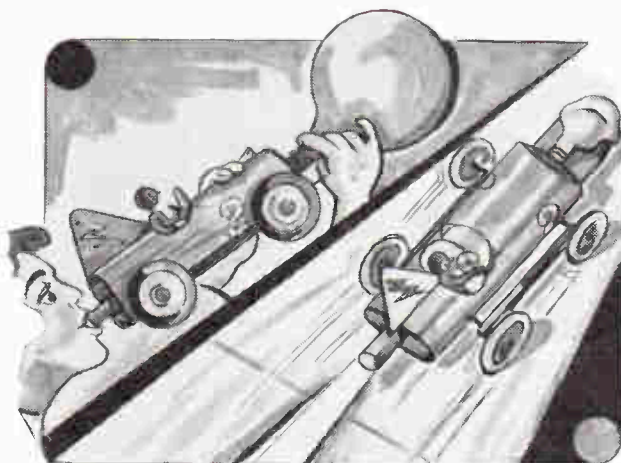

JET-POWERED RACING CARS



Up-to-the-minute ideas

Practical designs

Pleasant and profitable things to make

5^D.



THE story of Ansell's Brewery is one of industrial enterprise and reflects in all its forms the changing pattern of the onward-rushing twentieth century.

It all began in 1857 when Joseph Ansell, a typical early Victorian with a family of four sons, commenced modest production as a maltster. It is unlikely he visualized that his endeavours would

ANSELLS LABELS

result in the Ansell's Brewery of today with a £20,000,000 balance sheet and control of 1,500 houses.

In 1857 the stagecoach was giving way to the 'iron horse', the railway age was in full cry and already the country was served by over 5,000 miles of the new 'iron road'.

Joseph Ansell died in 1885 and was



The Theme of Work

PARENTS whose children collect stamps will find the thematic album an excellent pictorial aid to Christian teaching. For example: many forms of employment are depicted on a Hungarian set of 1950. The following talk could be given in conjunction with these stamps:

The man who is able to, but unwilling, to work leads an aimless life and usually becomes ill or a useless parasite.

The happy man with a 'healthy mind in a healthy body' has no time for idleness. There is no dull monotony for

him whose time and mind are occupied in honest productive work. For him 'life is real, life is earnest'; he applies the same zest and enthusiasm to his work as he does to his play and life in general.

No honest labour, however menial it may seem, is degrading. A doctor's work can be most unpleasant, yet he takes a great pride in it.

Should his work go wrong, the industrious man is not nettled or discouraged. He takes heart and instruction from past errors, and when improvements are made he is proud.

portrayed the progress in licensed premises. The Licensing (Consolidation) Act 1910 was a few years off, but already the progressive brewer had assumed responsibilities not envisaged in the Alehouse Act of 1828 or the abortive and quickly repealed provisions of the Beerhouse Act 1830.

In 1904 Edward Ansell became Chairman of the Company. He resigned in 1919 in favour of his eldest son, Mr. H. C. Ansell, only to resume office again in 1920 on the death of 'Mr. Harry'. He resigned again in 1923 and his death in 1929 at the age of 80 years broke the last link with the original founders of this now great brewery. (R.L.C.)



Instructions for making

JET-POWERED RACING CAR

YOUNG modellers can easily build this 'Balloonmobile' racer, which has super acceleration from a jet of air, powered by a rubber balloon!

The car body consists of (B) formed into 'tube'. About $\frac{1}{2}$ in. inside the ends are glued formers (F), and at the 'bonnet' end of oval-shaped body the balloon support (C) is fixed. This protrudes about $2\frac{1}{2}$ ins. Through holes in formers is slotted the blower tube (J)

YOU WILL NEED

(B) Thin card. 5 $\frac{1}{2}$ in. by 6 $\frac{1}{2}$ in. 1 $\frac{1}{2}$ in. by 1in. aperture cut 1 $\frac{1}{2}$ in. from end, and $\frac{1}{2}$ in. slot cut $\frac{1}{2}$ in. from end of 5 $\frac{1}{2}$ in. length of card.

(C) Stiff cardboard. 1 $\frac{1}{2}$ in. by 5in. Corners rounded one end.

(F) (2) 2 $\frac{1}{2}$ in. diameter circle on $\frac{1}{2}$ in. thick cardboard. Top and bottom reduced to form oval shape. Cut out, including hole (T) to accept tube (J).

(J) Plastic or cardboard blower tube 7in. long $\frac{1}{2}$ in. diameter.

(T.F.) $\frac{1}{2}$ in. thick cardboard. 2in. by 1 $\frac{1}{2}$ in. Cut to fin shape. $\frac{1}{2}$ in. long slot for jointing into slot in (B).

(A) (2) 4in. length, $\frac{1}{2}$ in. thick wire rod.

(S) (2) 2 $\frac{1}{2}$ in. diameter $\frac{1}{2}$ in. width rubber-band.

(W) (4) 1 $\frac{1}{2}$ in. diameter light-weight wheel of balsa, plastic or rubber.

(D) 3 $\frac{1}{2}$ in. length wire. (D2). Bead, approx. $\frac{1}{2}$ in. diameter, centre hole for threading on to wire. (D3) 1 $\frac{1}{2}$ in. by 2 $\frac{1}{2}$ in. thin card. Fold and cut to shape of figure.

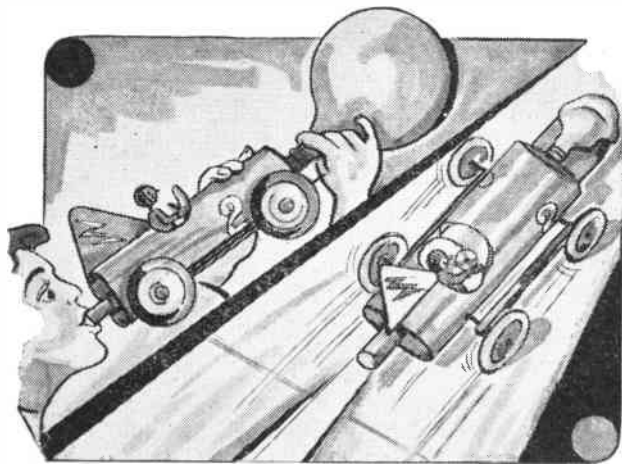

Described by T. S. Richmond

which passes through inside of body with the 'jet' protruding $\frac{3}{4}$ in. at the rear end. Elastic bands will hold the assembly together whilst the glued parts are setting.

Holes for inserting two axle rods (A)

should be correctly positioned in alignment, so that when pushed through body they run clear of the blower tube. The light-weight wheels (W) should revolve freely on the axles and are kept in place by bending up ends of axle rods with pliers. A rubber-band stretched from front to rear axles at each side of car prevents 'play' of wheels against car sides, as well as giving appearance of 'chassis springs'.

Make the little driver figure as shown and push wire into hole bored at bottom of body, so that the figure sits at either side of central blower tube: depending on whether 'left-hand' or 'right-hand' drive is preferred! Add driving wheel and windscreen, fashioned from bits of film, card and wire.

To provide the driving-power to your completed model, attach neck of small round balloon to blower tube in front of 'bonnet'. Support (C) prevents deflated balloon touching floor when car is in motion.

Inflate balloon by blowing into rear end mouth-piece of tube. Nip the neck of balloon whilst setting car down on smooth-surface floor or prepared 'track'. Release pressure and the sudden thrust of air from 'jet' tube will propel your racer along at great speed.

Plastic material is preferable to cardboard for blower tube, owing to moisture collecting within. Tube may be removed as required, and cheap toy balloons are easily replaced after a burst!

Finish model with poster paints. Build a team of these little balloon racing cars for exciting racing contests.

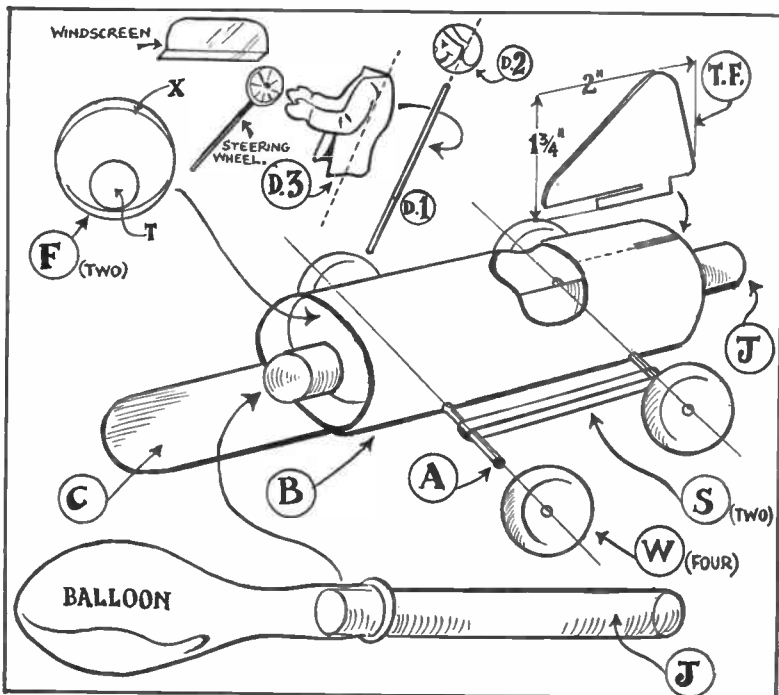

MARQUETRY IN JEWELLERY

MARQUETRY is used for decoration in many ways and, as such, it may vary from simple geometric designs for the reliefs of cigarette and trinket boxes to more complicated compositions in pictorial subjects. There is no reason why this art should not be used for personal adornment, the most obvious subject for this purpose being ear-rings.

By A. E. Haylock

In considering such tasks, one must either select a very simple design or condition oneself to some very intricate work in small areas. It may also be desirable to produce surfaces which are highly curved in two directions and, for these reasons, it is necessary to abandon the normal technique of applying the veneers flat upon a baseboard.

Use simple designs

The method described here can be used without regard to the size of the finished object and, within reason, there is no limit to the amount of detail which can be employed. One must bear in mind, however, that ear-rings will be viewed only from a distance and will be more or less constantly under movement. It is practical, therefore, to restrict one's activities to simple designs which will be all the more effective for their simplicity. The principle recommended is similar to that employed in rock making, wherein the letters 'go right through the stick.' This means, however, that the picture will be entirely produced from end and edge grain woods and must depend for its effectiveness upon colour rather than figuring.

Designs for this process are best prepared upon sectional or graph paper,



ruled sixteen squares to the inch. The thickness of veneers varies and must be taken into account in preparing the design or you may find the result distorted in one direction if they are much thicker or thinner than estimated.

The simplest form of ear-ring is the button type, consisting of a circular disc

about half to one inch in diameter, one face being flat and the other domed. For your first efforts, confine yourself to simple geometric designs as shown in Fig. 1. When you have mastered the technique, you can advance to monograms and, finally, develop simple motifs such as the sea-horse shown in Fig. 2.

Assembly by columns

Draw a circle on the graph paper approximately the size of the button you wish to make. This presumes that your veneers are all about $\frac{1}{8}$ in. thick. Should they be appreciably thinner or thicker, you must adjust your design accordingly. If for example they should prove to be $\frac{3}{16}$ in. thick only, the design should be twice the size of the finished product and so on. Within this circle, set out your design — you will find this easier if you use coloured pencils or crayons. Around the periphery of the circle, shade in the whole of each square cut by the circle. The excesses will be trimmed off in the finishing process.

When your design is complete, assemble it, column by column, from

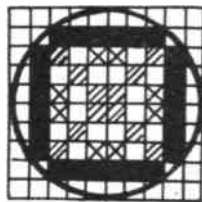

▣ MAHOG.

■ WALNUT.

⊠ OAK.

□ SYC.

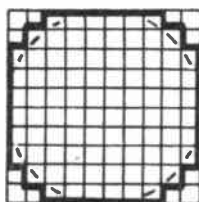

CROSS SECTION
BEFORE
FINISHING

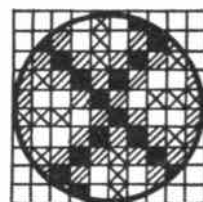

ALTERNATIVE
PATTERN

Fig. 1

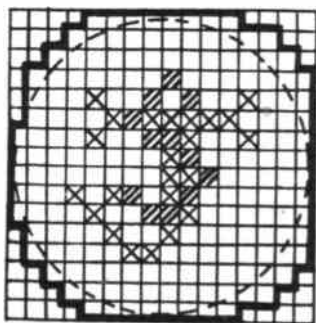

TYPICAL MONOGRAM

Fig. 2

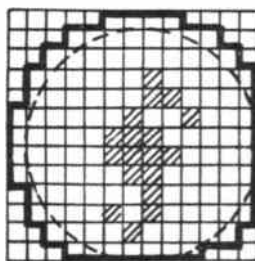

SIMPLE MOTIF

left to right. Taking the left hand column of the left hand design in Fig. 1, you will note from the key that it is to be executed entirely in sycamore and contains 6 squares. Cut from your bulk veneers a strip of sycamore 2 in. wide, with the grain running across it. From this strip cut a narrow one $\frac{1}{16}$ in. wide, cutting along the grain this time.

In the second column you will see a length of walnut the same size as the sycamore already cut. Prepare this and cement the two together with rapid setting marquetry cement, holding them firmly together with the fingers until set. A narrow strip of sycamore $\frac{1}{8}$ in. wide, on each end of the walnut, completes this column. Proceed in this manner,

assembling each column as you go and gluing it in place, until the whole is complete. It is advisable to put it aside now for 24 hours so that it may thoroughly harden.

Clip attachment

The rough cylinder (Fig. 1) should now be cleaned up with fine glasspaper and each end domed to taste (Fig. 3). A disc about $\frac{1}{4}$ in. thick can then be cut from each end with a fine tenon saw and given a coat of white french polish or clear lacquer and, apart from the attachment, the job is done. You should be able to cut two or three pairs of discs from the original cylinder.

This type of ear-ring is best fitted to a clip which has a small metal tongue to be pressed into the back of the disc and further secured with a liberal application of jewellery cement (Fig. 4).

Earrings can be made elliptical and even spherical in section. There are two methods of attachment — with a gold wire band or by means of a small eye inserted at the top after drilling (Fig. 5).

If the gold band is preferred, slightly groove the drop along the intended path of the band and very carefully bend a short length of gold wire around it,

CUT HERE



Fig. 3

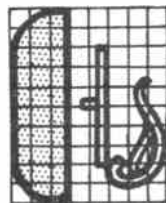

Fig. 4

securing the ends at the top by twisting them together with a pair of fine nosed pliers so that they finish in a loop. Alternatively, make a small eye of gold wire with a tail about $\frac{3}{8}$ in. long, drill the top of the drop, glue and insert the tail into it. In either case, the drop can be attached to a screw or hook earpiece by means of fine trace chain or jump rings to taste (Fig. 1).

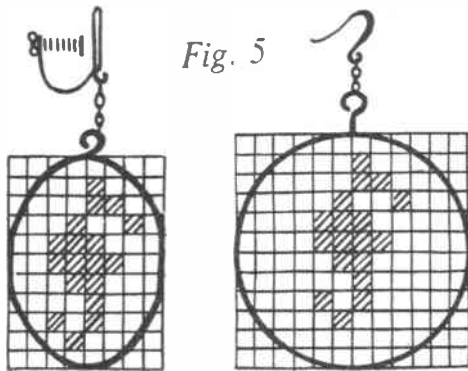

Fig. 5

INTERESTING LOCOS—No. 19

OUR illustration depicts one of the notable 4-4-0 express locomotives of the 'George the Fifth' class designed by Mr. C. J. Bowen Cooke the Chief Mechanical Engineer for the L. & N.W. Railway. The class originated with the first two engines Nos. 2663 'George the Fifth' and 2664 'Queen Mary', built at Crewe Works in July 1910. They were the 4970th and 4971st locomotives respectively to be erected at the famous works. They were in reality a development of Mr Whale's 4-4-0 'Precursor' class of 1904, except that the Schmidt superheater and 20in.

cylinders were adopted. Before finally deciding to adopt the Schmidt superheater for succeeding engines of the class. Mr. Bowen Cooke built ten engines of the 'Queen Mary' series without superheaters. After a series of trials however it was found that the superheated engines gave better results, both in performance and oil, coal and water consumption, and the 'Queen Marys' were later superheated, bringing them in line with the 'George the Fiftths'. A total of 90 engines of the class was built at Crewe between 1910 and 1915 and they were the most powerful 4-4-0 type to run on

the L. & N.W.R. The following were the principal dimensions. Cylinders 20in. by 26in. (some having 20 $\frac{1}{2}$ in. cylinders). Wheels diam., leading 3ft. 3ins., driving 6ft. 9ins. Heating surface = firebox 161.75 sq. ft. Tubes (1 $\frac{1}{2}$ in.) 1004.96 sq. ft. (5in.) 380.44 sq. ft. Superheater steam tubes 302.5 sq. ft. Total heating surface = 1849.65 sq. ft. Grate area 22.4 sq. ft. Working pressure 175 lbs. per sq. in. Maximum tractive force at 85% pressure = 20,066 lbs. The tenders ran on six wheels of 3ft. 9ins. diam. carrying 3000 gals. water and 6 $\frac{1}{2}$ tons coal. Weight of engine in working order was 59 tons 17 cwt, and with loaded tender attached 99 tons 2 cwt. A notable engine of the class was the 'Coronation,' the 5,000th engine built at the locomotive works — Crewe, — June 1911.' The illustration shows one of the last batch built in 1915 and named after holiday resorts served by the L.N.W.R. All the class were withdrawn from service in the 1940's. (A.J.R.)

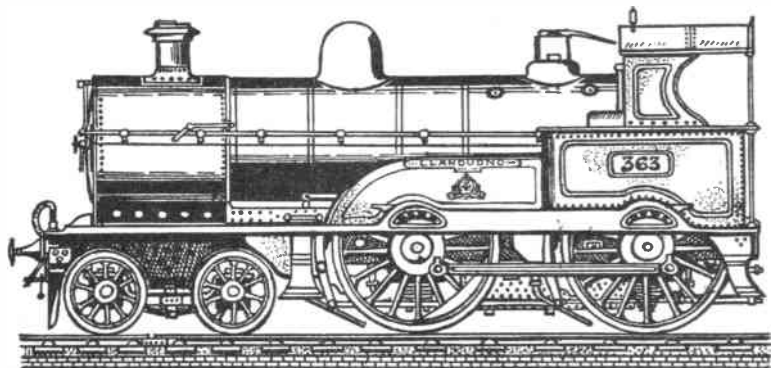

Note: In describing the G.W.R. Dean Tandem Compounds in No. 18 of our series, the engines were given as built to the 4-4-0 type. This, of course, should read 2-4-0.

SAVING LIFE IN THE WATER

EVERY year a number of people, many of whom are on holiday, meet a tragic death by drowning. For those of us who have learnt to swim, a knowledge of life-saving is invaluable, for even an accomplished swimmer may find himself in difficulties if he attempts a rescue without this knowledge. Even if one is never called upon to save a person from the water, the study of life-saving adds a zest and interest to the art of swimming and greatly increases one's confidence.

By P. R. Chapman

It is assumed that anyone considering life-saving is a competent swimmer, although the popular crawl stroke is not used at all, except for the purpose of reaching a drowning person as quickly as possible. The most important stroke is, undoubtedly, the life-saving back stroke, using legs only. Since when towing a person it is not possible to close the legs completely as in the ordinary back stroke leg kick, a modification is necessary. To get the idea of this, the best way is to support yourself on the rail of the bath at the shallow end, in the upwards floating position, open your legs and get a friend to stand between them. Keeping your thighs more or less horizontal, bend the legs at the knees, making rapid cir-



A happy place like this may quickly be transformed into a scene of tragedy where a life could depend upon a prompt rescue.

cular movements with the lower part of the legs.

When you can do this quite easily, try swimming in this way, remembering to keep your legs apart the whole time. Your hands should be clasped on your chest. This stroke must be practised continuously until you can keep it up for at least 150 yards, the distance stipulated by the Royal Life Saving Society. A common fault is just bending the legs backwards and forwards without the circular movement; this wastes energy and has little propulsive power. With practice, a powerful stroke can be developed.

You should be able to swim a similar distance using the ordinary breast stroke, and unless you are proficient in this, it must be practised also.

One of the most important things to learn in life-saving is to escape from the clutch of a drowning person (the release) and to get him under control, and although in practice this must, of course, precede any 'towing' methods or rescues, the latter will be described first, so that they may be practised and that when the releases are learnt later, they may be followed in the water by the appropriate rescue. There are four main methods of rescue, the actual one used in any particular case depending upon the condition of the victim.

If the person is quite calm or unconscious, the accepted method is to turn him on his back and place the palms of the hands over his ears, fingers pointing upwards. Your elbows should be bent so that his back rests on your forearms and his head is held underneath your chin. You then swim by using the life-saving back stroke already

learnt. Since the victim's legs will hang down between your own, the reason for learning without closing your legs will be apparent. If his legs tend to sink, as is quite likely, the 'drag' will increase and you will have to labour to pull him through the water. In this case you should push up his legs from time to time with your knee. You should practise this with a friend until you are able to keep it up for a distance of 20 yards.

When struggling

If the victim is not quiet but inclined to panic and struggle, in spite of reassurances, the second method of rescue is used. After turning him on his back as before, you should grasp his arms just above the elbows, your thumbs being uppermost, and pull back his arms so that his upper arms are at about right angles to his body. You should keep your own elbows tucked into your sides whilst towing and your partner's head should rest just below your chin or slightly on one shoulder. When held in this manner, struggling is much easier to control.

If the arms are injured, or are difficult to control or grasp, the third method of rescue is appropriate. Your arms should be passed under the victim's armpits and your hands spread apart and placed on his chest, with your thumbs in the hollow just above the collar-bone. Your arms should then be raised sideways so that the victim's arms are pulled out at right angles, and you should hold him firmly against your chest, swimming the back stroke as before.

Next: **The Tired Swimmer and Releases.**

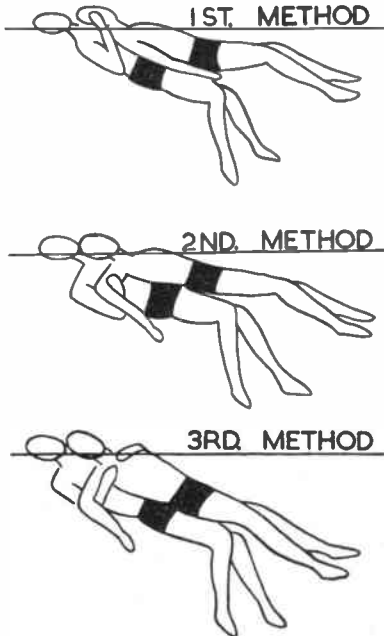

Suitable for Beginners

2-TRANSISTOR RADIO

THIS receiver is particularly suitable for beginners, because it can be built without soldering. This point can be quite important with transistors, which may be permanently damaged if the soldering iron is kept in contact with their leads for any length of time. Bolt connections increase the size of the receiver a little, but this extra space makes wiring up much easier. The completed set, with battery, is 2½ in. by 5½ in. by 1 in. deep (plus the projecting tuning knob and switch) so it is small enough to be carried in the pocket.

By F. G. Rayer

The circuit is shown in Fig. 1, and uses two transistors after the diode detector. This type of circuit is one of the most straightforward which can be relied upon to give good results with cheap surplus transistors. It is also easy to build the receiver with one transistor only, if a simpler circuit is wanted.

Reception conditions vary considerably, but some idea of the kind of results to expect will probably be of interest. The circuit is suitable for use with a ferrite rod aerial, a frame aerial, or an indoor or other extended aerial wire, and

the method which is most suitable for the purpose in view can be adopted, without any changes to the receiver circuit itself.

A ferrite rod aerial is some 5 ins. to 7 ins. or so long, about ¼ in. to ½ in. in diameter, and has a coil winding on it. Such rods may be purchased ready wound, or for winding. One, with winding, may be seen in the illustration of the panel of the receiver. The ferrite rod aerial has the advantage that the set is very compact. If it is no longer than the panel, the whole receiver will fit in a case 5½ ins. long.

Ferrite rod aerials do not provide much signal pick-up, but with this circuit reasonable headphone reception may be expected up to a distance of some thirty miles or so. In areas of good signal strength, the set is then completely portable, for listening to the local station. An indoor or outdoor aerial wire can be joined to the ferrite rod aerial winding, to increase volume or range.

COMPONENTS LIST	
1	megohm resistor (brown-black-green).
6-7K	(6,700 ohms) resistor (blue-violet-red).
200K	(200,000 ohm) resistor (red-black-yellow)
All	½-watt or similar.
·0003µF or ·0005µF	solid dielectric tuning condenser with knob.
On/off switch	with terminals.
Crystal diode	detector.
One doz.	¼ in. 8 B.A. bolts, with nuts.
All above available from Coventry Radio, 189 Dunstable Road, Luton, Beds.	
Two red spot transistors:	or one white spot and one red spot.
Two 8µF or similar	transistor coupling condensers.
Ready-wound ferrite rod	(if wanted).
Henry's Radio, Ltd., 5 Harrow Road, Paddington, W.2.	
Wire for home-wound coil or frame:	Post Radio Supplies, 33 Bourne Gardens, London E.4.
Miniature medium-wave or long-wave	dust-coated coils (if wanted):
Osmor Radio Products Ltd., 418 Brighton Road, South Croydon, Surrey.	

A frame aerial gives more volume than the ferrite rod aerial, but needs to

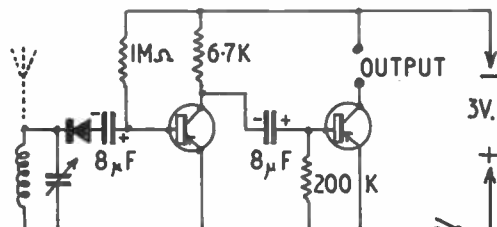

Fig. 1—Receiver circuit

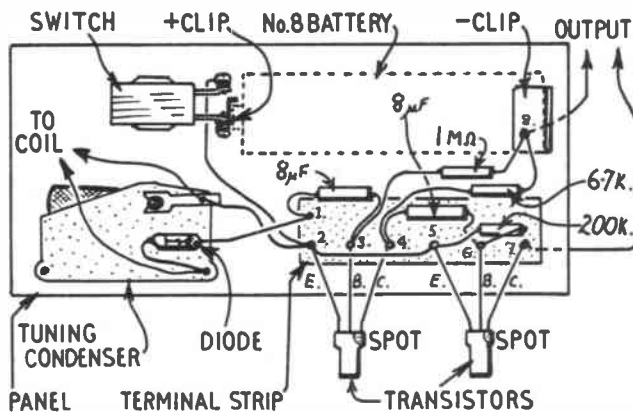

Fig. 2—Receiver wiring plan

be at least 6 ins. long each side for reasonable reception, so that a case 6 ins. by 6 ins. will be needed. If the frame aerial is larger, volume is improved. With such a frame aerial the set is portable, but not of pocket size. Using a frame aerial about 9 ins. along each side, volume was found to be much greater than with the 7 in. ferrite rod, and a powerful continental station such as Radio Luxembourg could be received well enough, after dark, for good headphone listening. An indoor or outdoor aerial can be added, as with the ferrite rod aerial, when available.

Best volume of all is obtained with an extended aerial wire.

2-Transistor set with ferrite rod aerial

This does not need to be very long. For example, about six feet of thin flex or other insulated wire may be used, extended as convenient. With a longer aerial, reasonably good loudspeaker reception is possible. When any kind of extended aerial wire is to be used, a small tuning coil may be fitted in the set. It is thus easily carried, but it is necessary to unwind the aerial wire, before use.

Details about aeriels and coils are given later. Meanwhile, the receiver itself is made up in exactly the same way, whatever type of aerial may be used.

Construction

Fig. 2 is a complete wiring plan of the set, built upon a paxolin or wooden panel $2\frac{1}{2}$ in. by $5\frac{1}{2}$ ins. Tuning condenser and switch are held by lock nuts. A small knob is fitted to the condenser, which can be $.0003\mu\text{F}$ if there is no need to tune to high wavelength stations around 500 to 550 metres, or $.0005\mu\text{F}$ if tuning to these high wavelengths is required.

Most of the parts are connected to 8 B.A. bolts on a $2\frac{1}{2}$ in. by $\frac{1}{2}$ in. paxolin terminal strip. If a Paxolin panel is used, and there is no objection to the bolt heads being visible, then the strip can be omitted, and holes drilled directly in the panel.

Looking at Fig. 2, bolt 1 joins the negative ends of the diode and $8\mu\text{F}$ condenser. No. 2 is joined to 5, and two short lengths of thin flex are also secured here, to go to the switch and moving plates tag or terminal of the tuning condenser.

Terminal 3 secures the positive end of the $8\mu\text{F}$ condenser, and one end of the 1 megohm resistor. No. 4 is for the negative end of the second $8\mu\text{F}$ condenser, and 6·7K resistor. Terminal 5 is joined to 2, as mentioned, and one end of the 200K resistor is also secured here. Terminal 6 holds the free ends of $8\mu\text{F}$ condenser and 200K resistor. Terminal 7 is turned the other way, so that it projects through the panel, forming one output terminal.

Small loops should be formed on the wire ends of the various parts, so that good connections can be made. The terminal strip can be completely wired up, except for terminal 7, before fixing it to the panel.

The transistors are now taken, and small loops are made at the ends of their leads, which should not be cut off short. With the first transistor, the emitter lead (E) goes to 2, the base lead (B) to 3, and the collector lead (C) to 4, as in Fig. 2. Either a white spot or red spot transistor can be used, the spot indicating the collector. With other types of transistor, follow the maker's instructions, which will show emitter, base and collector leads.

The second transistor has its emitter

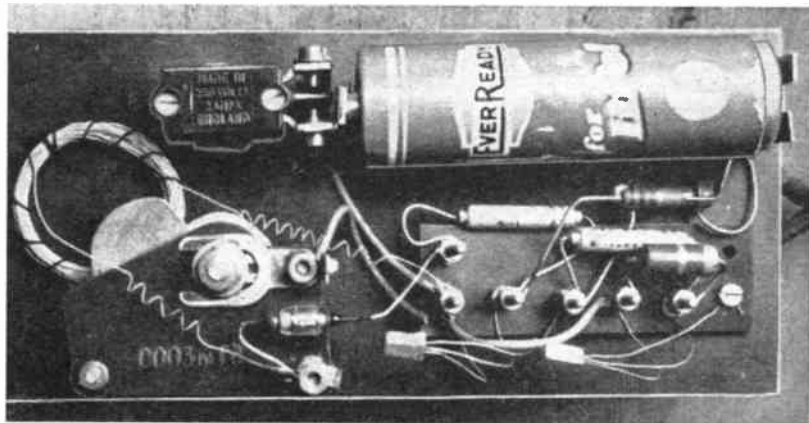

Behind panel of 2-Transistor set

(E) joined to terminal 5. The base (B) goes to 6, and the collector (C) to 7, which projects through the panel, as explained. A few extra nuts will be useful when making these connections. The transistors are then bent over so that they lie behind the panel, as shown in the illustration of the back of the receiver. A check should be made that leads do not touch each other, or other parts.

Battery clips

These are cut from scrap metal. One piece about $\frac{1}{2}$ in. wide and 1 in. long is bent like a bracket, and held by terminal 8. This terminal projects through the panel, as did No. 7, and also forms a junction point for the free ends of the 1 megohm and 6·7K resistors. The negative end of the 3-volt battery (zinc case) is in contact with this bracket. To obtain proper contact a little of the card casing should be cut off, or a small portion of the bracket bent in.

A small piece of metal about $\frac{1}{2}$ in. by $\frac{1}{2}$ in. forms the positive clip, and is drilled so that it can be held by one of the switch terminal screws. It is bent so that the battery fits quite firmly between the two brackets.

The battery is best left off until other wiring is finished, and it must always be inserted the proper way — that is, brass cap towards the switch.

Other connections

Terminal 2 is joined to the free terminal on the switch. The free end of the diode is taken to the fixed plates terminal of the tuning condenser. To assure good contact, the projecting soldering tag on the condenser can be bent over and held under the nut.

The tuning coil, ferrite rod coil, or frame aerial will have one end joined to the fixed plates terminal of the tuning

condenser. The other end goes to the moving plates, or terminal No. 2.

For listening, a single small phone, on a few feet of thin flex, may be used, or a twin headset can be used if preferred. Positive si taken to terminal 7, and negative to 8.i Miniature 'deaf aid' earpieces can also be used. Some of these require a coupling transformer, and cannot work without this.

If a speaker is used, it must have a matching transformer, as employed with valve sets. The transformer primary is taken to terminals 7 and 8, and the secondary goes to the speaker. Best results are secured when the transformer has a fairly low ratio.

If an earth should ever be used, it can be joined to terminal 2. When an extended aerial is employed, this is taken to the fixed plates terminal of the tuning condenser, where the diode is connected.

Ferrite aerial

If obtained ready wound, it should be for medium waves, and is simply connected to the tuning condenser, as described. If a rod is to be wound, about 50 turns of 32 S.W.G. silk covered or similar wire, in a compact pile, will be satisfactory. The exact number, to tune the medium wave band, depends on the size of the rod or slab. If it is remembered that adding turns will allow higher wavelengths to be tuned, while removing turns will enable lower wavelengths to be reached, then a suitable winding can easily be found.

Frame aerial

If this is about 6 ins. by 6 ins., about 20 turns of 28 S.W.G. or similar wire will do. For a frame a little smaller or larger, adjust the number of turns to use about the same length of wire; that is, 40 to

● Continued on page 205

WINDOW SILL EXTENSION

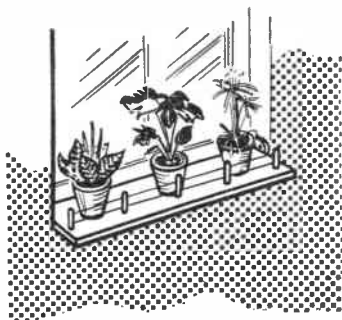

and have two holes bored in each, one near the top, and the other about half-way down. Through these holes a colourless plastic covered wire is threaded.

A side view of the board, in position on the window sill, is shown at Fig. 2. It will be seen that wood brackets are fitted to the underside of the board, to bear against the wall and give support.

These are cut from 4ins. square pieces of wood to the shape shown and glued and nailed in place. Note that a rightangled notch is cut out of the rear top corner of each to clear the projection of the window sill. Two brackets will be sufficient, placed a few inches in from each end, approximately where shown by dotted lines in Fig. 1.

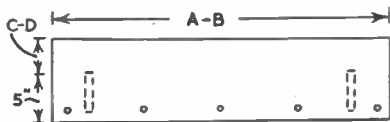

Fig. 1

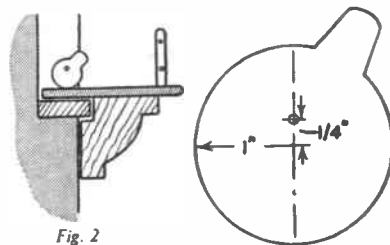

Fig. 2

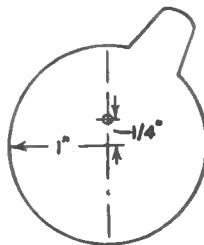

Fig. 3

Quick-release cam

To keep the board safely in position, and at the same time to allow for quick release, a cam is fitted at each end. Two can be cut from 1/2in. fretwood to the pattern given in Fig. 3. Strike the circle first, then, at 1/4in. from the centre of the circle drill a hole for a stout round-headed brass screw. Pencil in an extension one side of the circle for a finger grip when turning the cam, and cut out with a fretsaw.

With the board in position on the window sill, screw a cam each end to the window sash frame. Ensure that the finger grip is vertical, and the bottom edges of the cams are nearly touching the board. Moving the cam round a trifle will cause it to press on the board and keep it in place.

By W. J. Ellson

INTERIOR window sills are often too narrow to accommodate plant pots with safety. In such cases a very simple, but effective remedy, is to make an extension board to lay over the existing sill, and thus increase the depth.

An easily-made board is shown, which has the advantage of being quickly removed when necessary. The board can be cut from any suitable wood, but 1/2in. plywood is, perhaps, the best choice, on account of its lightness, and strength. Exact dimensions cannot, obviously, be given, as length and depth will largely depend on the window it is to be attached to. The length (A-B) in Fig. 1, will be the length of the window recess. That part of the depth shown (C-D) will be equal to the depth of the recess. An increase on this, to overhang, is shown as 5ins., but can be increased an inch or two if desired.

At about 1/2in. from the front edge bore a line of holes, as shown, into which 4ins. lengths of round wood rod can be glued. These are nicely rounded at top

★
★
★ The free design next week ★
★ is for making a matching pair ★
★ of useful household articles ★
★ consisting of an egg timer and ★
★ a thermometer, set in a novel ★
★ pelican bird motif. ★
★
★ MAKE SURE OF YOUR ★
★ COPY ★
★ ★

● Continued from page 204

Beginner's 2-Transistor Radio

45ft. This can easily be worked out. For example, the 6ins. by 6ins. frame has a perimeter of 2ft., so needs about 20 turns.

For a frame about 9ins. by 9ins., with 26 S.W.G. wire, about 18 turns will be necessary. The exact size of the frame is of no importance, and it need not be the same length each side. Frames of about 3ft. perimeter will need about 50ft., of wire, and frames of about 4ft. perimeter will require about 65ft.

A frame aerial, or ferrite rod, is directional, and gives best volume when pointing one particular way. The aerial can thus be turned for best results, when the station is tuned in.

Tuning coil

A small, dust-cored medium wave coil will give good results, and any make will be satisfactory. A simple coil can be made by winding about 65 turns of 32 S.W.G. enamelled or similar wire, on a 1/2in. diameter object, slipping off and binding with cotton, but results with this circuit will be slightly better with the dust-cored coil.

Space for a small coil can be found near the switch. If it is necessary to tune long waves, for the Light Programme,

then a long wave coil can be used for this.

No earth need be used. But occasionally an earth connection will be available and it can then be added. A wire clipped on to a tap, pipe, radiator or other earthed object is occasionally convenient, and may be found to improve volume considerably, or act as an aerial.

When the set has been made up with a tuning coil, the short 'throw out' aerial can be tried in various positions in the room, to see how this influences reception. If one end of the wire can be kept fairly high, this will usually give best signal pick up.

If the set should be used inside a metal vehicle, caravan, or building, then it is best to arrange an aerial outside, even if this is quite short, because signals inside may be very weak indeed.

One transistor

To make up as a single transistor set, omit the second 8µF condenser, 6.7K resistor, 200K resistor, and second transistor. Connect the phones in place of the 6.7K resistor. That is, from terminal 4 to terminal 8. Headphone volume will usually be good, with the one transistor only, if an extended aerial wire can be used.

"MUSICAL MOTIF"

WALL Plant POT HOLDER

STRIKES A HAPPY NOTE IN ANY HOME

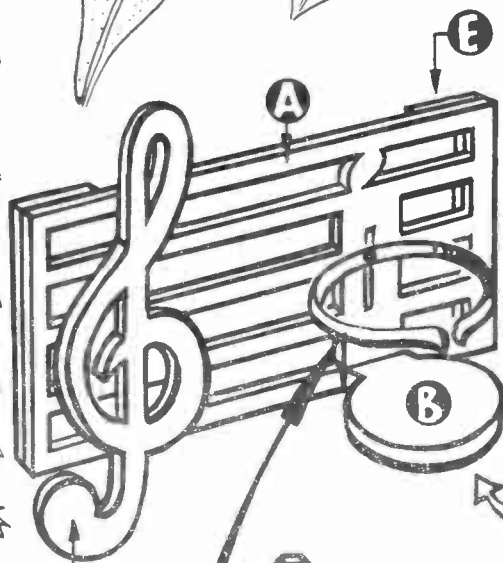
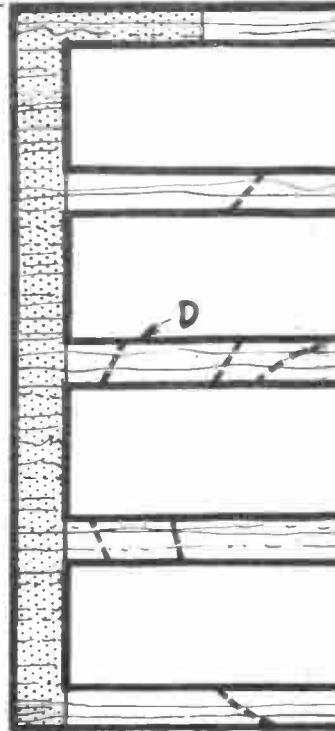

PIECE C
CUT ONE 3/16 IN.

BRACKET C
UNDERNEATH

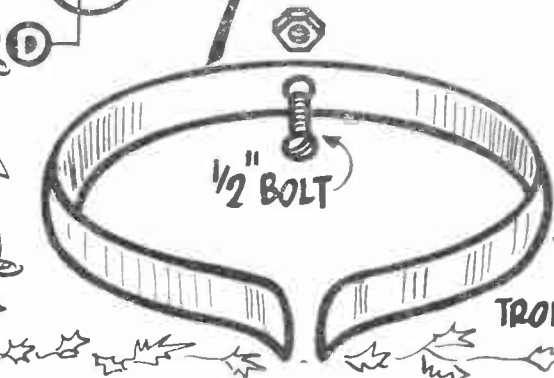

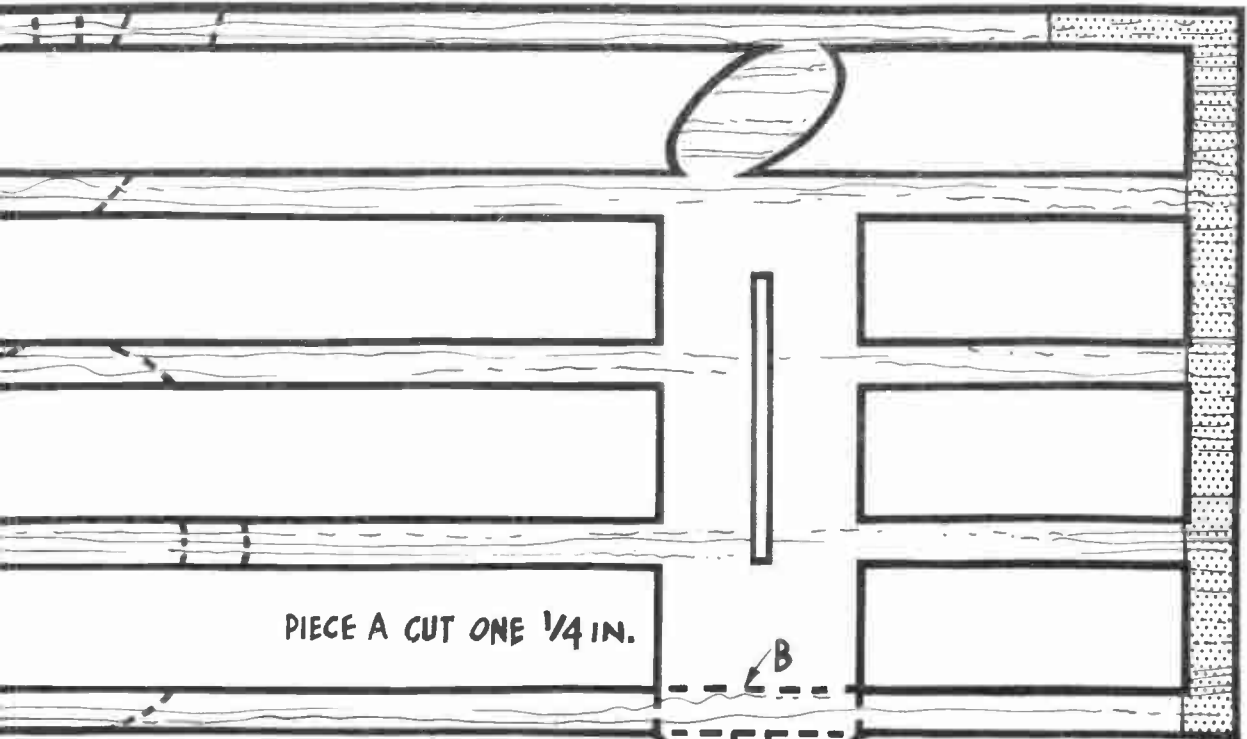

PIECE A CUT ONE 1/4 IN.

PIECES E SHOWN SHADED
CUT FROM 1/4 IN. GLUE BEHIND A

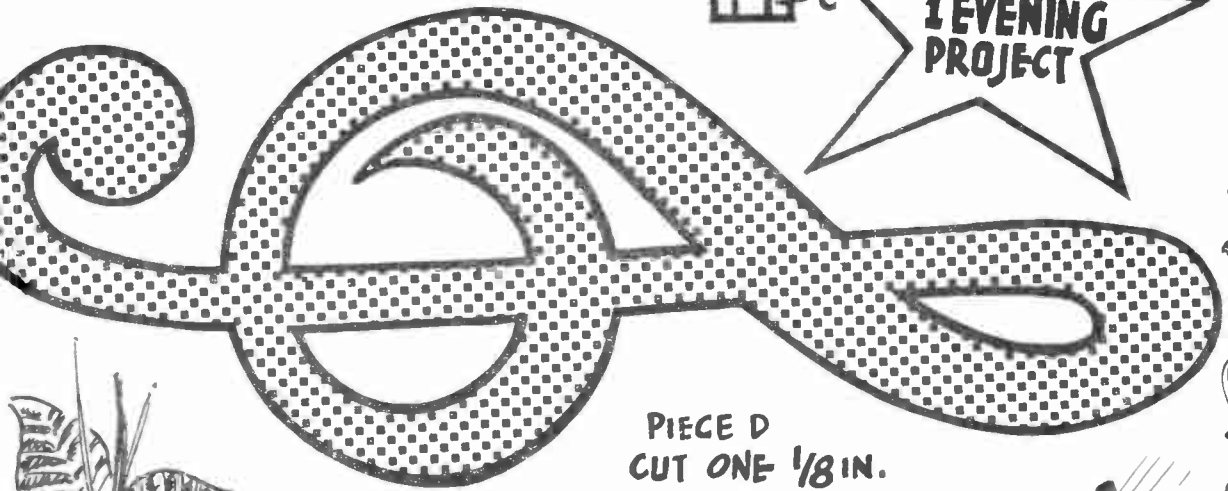

PIECE D
CUT ONE 1/8 IN.



CHEMISTRY AT HOME

CRACKED or broken laboratory glassware seldom need be consigned to the dustbin. A little time spent on it will result in repaired apparatus or its conversion into other useful items.

Broken test tubes, for instance, can be repaired or converted into semi-micro flasks, draught tubes or drying tubes. A broken condenser may be turned into a fractionating column or a dropping funnel.

Should a test tube have a broken rim, file a mark right round the tube just below the lowest point of the jagged edge and apply a hot glass rod. The glass will crack right round, the broken rim falling off and leaving an even end. This is now given a rim by heating in the bunsen

To repair a test tube with a broken bottom, hold the broken end in the flame until the glass softens, apply a glass rod similarly heated and continue heating until the two are well attached. Let the glass cool until it is rigid and then heat

REPAIRS TO APPARATUS

the test tube a short distance from the broken end until it is thoroughly soft. Using the glass rod as a handle pull off the end. The tail of glass left on the test tube can be gradually removed by touch-

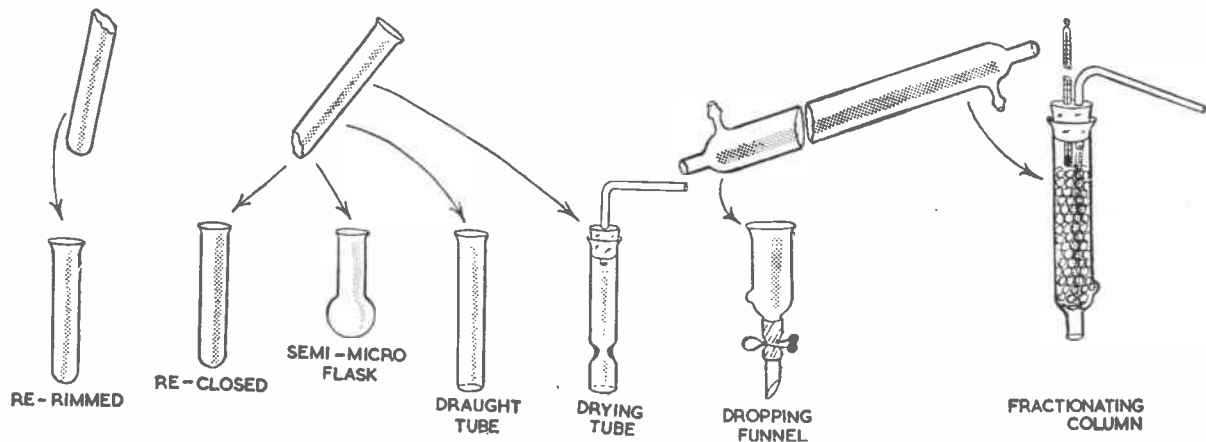

Repairing or converting broken test tubes

Conversions for a broken condenser jacket

flame until the glass softens, pressing in a corner of a charcoal block and turning tube and block. The glass folds over nicely. Shut off the air supply to the bunsen by closing the air hole and rotate the rimmed end of the tube in the luminous flame until it is blackened by soot. Then slowly raise the tube upward through the flame and out above it until it is a few inches from the tip of the flame. This anneals the rim and renders it less liable to crack by strains in the glass. Stand the test tube to cool with its rim free from contact with any solid body. The soot may then be washed off.

This operation can also be used to re-rim broken flasks and burettes. The annealing should finish all the other operations given in this article.

ing it with the stump and rod and drawing it away a little at a time. When the now closed end of the test tube has assumed a more or less pear-shaped form, continue heating in the flame, revolving slowly and occasionally putting the test tube mouth to your lips and blowing, so as to counteract the sinking-in of the hot end. Gradually the bottom of the tube will become round and well shaped. This heating and blowing also thickens the glass and restores its strength.

If you wish to make a semi-micro flask, continue heating and blowing until a bulb appears. Heat this again so that it begins to collapse, then blow it into shape again. By repeating this several times the bulb wall will thicken

to give it the necessary strength.

A draught tube is easily made by filing a mark all round the tube just above the jagged edge and applying a hot glass rod, when the end will crack off. Fire polish the rough edge by revolving it in the flame until it is smooth. Such a draught tube can be most useful for quickly oxidising small quantities of inorganic substances or for burning off organic matter. The substance is placed in the middle of the tube and the tube clamped in a slightly inclined position. On heating the middle of the tube, hot air rises and passes out of the tube while a fresh supply of air (and hence oxygen) rushes in from the lower end and reacts with the substance. A constant circulation of air over the substance is thus assured. Consequently, the combination with oxygen proceeds more rapidly than by the usual crucible heating.

To make a drying tube for gases, first make a draught tube. Now heat the glass an inch or so from the cut end, revolving constantly. The glass gradually thickens and sinks inward to form a constriction

which serves to hold the drying agent in position. This type of tube is convenient in that it can be inserted in the cork of the gas generating bottle and have a delivery tube leading off from the rimmed end.

When a condenser breaks it is usually the jacket which does so. With the type of Liebig condenser which has a loose jacket held to the inner tube by means of rubber tubing, the inner tube can be removed and used as an air condenser or a new jacket bought and fitted. The two halves of broken jacket should each have a file mark made right round the circumference just below the jagged edges and the waste glass removed by applying

● Continued on page 209

SHOE-CLEANING BOX

MAKE UP
THIS HANDY
FITMENT
Described

By
S.H.L.

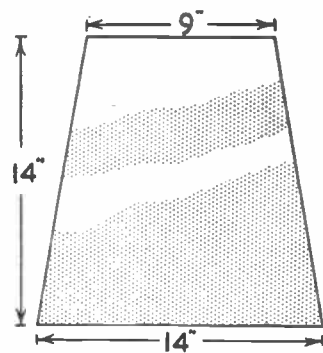
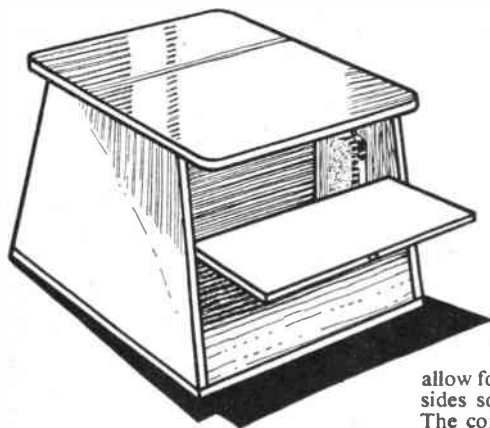

Fig. 1

A SHOE cleaning box which also takes the form of a handy stool is a useful accessory to the home. There are no difficult joints to prepare and the carcass may be constructed from $\frac{3}{4}$ in. material.

You will require two side pieces made from material measuring 14ins. by 14ins. and shaped as shown in Fig. 1 so that the end grain is at the top and bottom. The box has a central division made from hardboard and you may either make a suitable trench down the centre of both pieces or make a slot by fitting two strips of quarter round section which is glued and pinned. Fig. 2 shows how this may be done.

The bottom, measuring 12ins. by 14ins. and the top, measuring 11ins. by 14ins., are drilled and countersunk for screwing to the sidepieces, the holes later being filled with plastic wood or putty. Note that the hardboard partition must be slotted into position before fixing on the top. The measurements of the latter

allow for a one-inch overhang on all four sides so as to make lifting quite easy. The corners are rounded and the edges should also be rounded off. The width of the box, on the door side, is 12ins.

Both the front and rear of the box have small flap doors, and in each case the lower half is a fixture, while the other portion forms the door. Two pieces of wood are required, therefore, and the fixed half will need to be bevelled on the base edge to fit the angle where it meets the floor of the box. The upper half, composing the flap door, must be similarly treated for the top edge, where a ball catch should be fitted.

The lower half of this side should be fixed to the box by means of nails through the sidepieces, the holes being filled with plastic wood after punching in the nails. A pair of hinges fitted to both doors completes the woodwork.

You will require a small screw knob for each door. It is a good idea to furnish the top of the box with a piece of linoleum for durability.

You will find the division helpful in that brown polishes and materials may

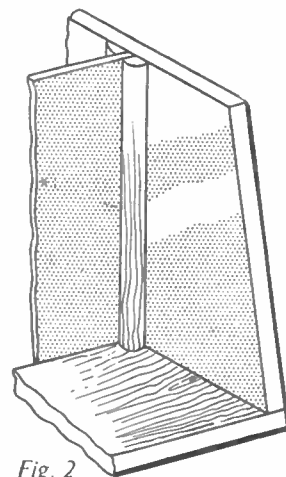

Fig. 2

be kept in a separate compartment from the black. Insert small screw-eyes into the ends of the brushes for hanging on small hooks inside the box.

● Continued from page 208

Chemistry Apparatus Repairs

a hot glass rod so as to make it crack off. Rim and anneal the cut.

The shorter of the two pieces of the jacket may be turned into a dropping funnel for use with liquids which do not affect rubber. The side tube should be sealed off as short as possible by softening the glass in the flame and drawing off with a heated glass rod. The stump of glass tube remaining should be blown slightly so as to prevent collapse by closing one end of jacket section with a finger and blowing into the other.

A short length of glass tubing, one end of which has been ground off at an angle on a well wetted grindstone, is then at-

tached to the narrow end of the jacket section by means of rubber tubing and a Mohr clip put in place.

An alternative to sealing off the side tube is to push on a short length of rubber tubing and to close this with a short glass rod.

The longer end of the broken jacket will serve to make the fractionating column. Seal off the side tube by either of the above methods, though drawing off is to be preferred since many liquids distilled through a column effect rubber. If the rubber tube and glass rod closure is adopted, this should be borne in mind when you are about to use the

column in an experiment.

A small disc of copper or brass gauze, or where the vapours attack these, a few small pieces of scrap glass, will serve to form a support on the narrowed end of the column. The column is then nearly filled with undrilled glass beads (these may be had from laboratory furnishers). Drilled beads may be used, but some loss of liquid will accrue through lodgment in the holes. A cork carrying thermometer and delivery tube is fitted in the wide end and the column is ready for use.

Finally, short 4in. to 5in. lengths of glass tubing offcuts need not be thrown away. By sealing off one end, blowing into shape and rimming the other end, they can be turned into ignition tubes.

INVARIABLY in our first attempts, and even in some of our later models, we use ready-made materials for our rigging — cord supplied in kits or purchased from a model shop, sewing thread, carpet thread, etc. But as we progress in our ability to model ships and to study the ships themselves, we realise that if our rigging is *not* to scale, no matter how excellent the actual model work, the model looks wrong. It does not satisfy our aesthetic taste because it does not look just quite right.

For models that are intended purely as an ornament for the house, ready-made materials are quite suitable provided we remember that the ratlines and running rigging are made with smaller cords than the shrouds and standing rigging.

A MACHINE FOR MAKING ROPES

By 'Whipstaff'

For such models I use either the Hobbies' rigging cord, dyed black, or heavy carpet thread for the standing rigging and No. 36 strong sewing thread in natural colour for the running rigging.

For miniature models in Hobbies series I use strong black button thread for shrouds and standing rigging and fine sewing thread (natural colour) for the running rigging.

For *scale* miniature work — by this I mean models of under 9ins. in overall length, say of a clipper ship or full rigged ship of any type — I cannot find any more suitable ready-made material than fine nylon fishing line for the standing rigging and nylon surgical thread for the running rigging. Nylon surgical thread can be had in numerous sizes down to a few thousandths of an inch.

Rope used in ships' cordage was made on a rope walk and for scale models we can use this method for making our own cords to scale size.

The most simple rope walk is merely your hand drill. In fact, for twisting wire ropes for scale models of the vessels of the late nineteenth, and twentieth, centuries one needs no more. But when making ships' cord from thread or Sylko the ends must be sealed with a spot of balsa cement otherwise they will untwist before use. In all cases the threads making up the cord must be cut a few inches longer than the required length of finished cord as the twisting together of the threads shortens the length.

For better scale modelling a miniature rope walk can be made. This will enable you to make all your model ropes correctly. These can be made in odd moments and set aside until required. For

Mainly for Modellers

making the ropes, fine sewing thread, 'Sylko', artificial silk and anglers' fly silk, and fine nylon thread can all be used.

For making the rope walk we need some gear wheels. Mine came from an old gramophone motor purchased for a couple of shillings. They can also be found in old clocks, or you could purchase Trix or Meccano gear wheels. For the metal worker, the upright plates can be made of metal, for the average model maker they can be made of hardwood. Mine, in the drawings, were made from very hard oak-faced plywood $\frac{1}{4}$ in. thick for the uprights, and $\frac{1}{2}$ in. thick for the bases, the wood 'top' was turned on a Hobbies lathe and grooved with a tenon saw.

The base of the rope walk was a $\frac{3}{4}$ in. plank — an old mantel shelf from a discarded fireplace, 4ft. 6ins. long. But any solid plank of wood, planed perfectly flat, can be used.

The head of the rope-making machine is fitted with three or four hooks, according to whether you will be making the heavier shroud laid ropes in authentic style, in which case a 'top' with four equidistant grooves is required. However, I find that for general modelling to the scales I use — $\frac{1}{4}$ in. to the foot and $\frac{1}{2}$ in. to the foot — the three-hook head is ample.

The tail of the rope walk is not a fixture. It slides along the baseboard as the cord is twisted; the runners are made of brass curtain rail, drilled and pinned to the base, the wood base of the tail being made of the thickness of wood that will allow of a sliding fit.

The tail base must be weighted, in order to keep tension on the cords

while twisting. This can be any heavy object or you could, as I did, use scrap lead melted and poured into a half-pound coffee or cocoa tin. The tin is first screwed to the base before filling with the molten lead.

The handle of the head, and the three hooks, are part of the axles of the gear wheels, and $\frac{1}{4}$ in. mild steel rod was used. This has a hook formed on the end and is cut off with sufficient shank to form the axle. The bearings are pieces of brass tube. The outside end of each axle can be pinched with pliers to flatten and prevent slip. The sketch shows the general construction of the walk.

To make the rope, fasten three strands, with the twist of each strand the same way, to the three hooks of the head and also to the single hook in the tail. Place the 'top' at the tail end with a thread in each groove. By winding the handle on the outside of the head the threads are twisted to form the rope. The 'top' ensures the thread twists evenly and slides along towards the head as the rope is formed. Again to be safe, if not using the cord immediately, secure each end with a spot of balsa cement.

The heavy ropes, cables, etc. can be made in the same way, but in this case we use not single threads, but threads we have already converted into three-strand rope.

As an example, say, on the *Ark Royal* model, we could use strong natural thread or artificial silk twisted to three-thread cord for running rigging, etc.; these in turn could be used to make our shroud and standing rigging cord, and the latter used to make up heavy anchor cables.

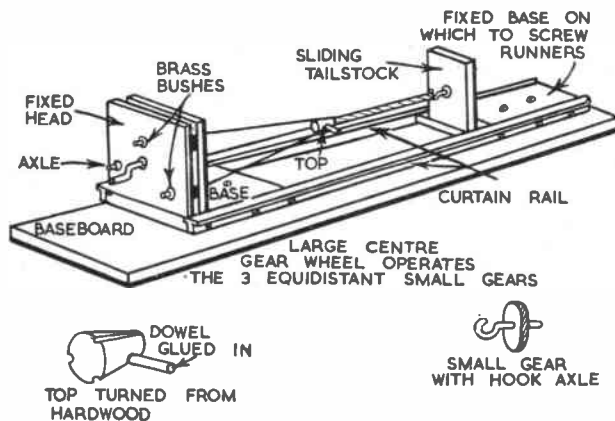

Whatever your speciality

You'll get a far better finish—far quicker—

with **NEW FORMULA**
HUMBROL
PLASTIC ENAMEL

NEW FORMULA
HUMBROL
PLASTIC ENAMEL

is available in 34 colours—
matt and gloss

½ oz tins 8d. Sizes up to ½ pint
Handy multiple painting kits 3/--12/11
from all good model shops and
hardware stores.



Specially formulated for the exacting standards of professional model makers, new formula Humbrol gives a superlatively fine finish to wood, metal, perspex, polystyrene, pottery, aircraft tissue and paper.

- *dual purpose: replaces colour dope*
- *dries in one hour*
- *lead free in most colours*
- *proof to diesel fuel*
- *brushes on easier*
- *consistently matching shades*
- *long lasting*

AIRCRAFT
SHIPS
GALLEONS
CARS
TRAINS
ARCHITECTURE
PUPPETS
MACHINERY
HANDICRAFTS

HUMBROL

A product of the paints division,
THE HUMBER OIL COMPANY LTD.

MARFLEET · HULL · ENGLAND

...ab evenly on the paper in...
 ...ht and hang to dry under...
 ...to know if you could...
 ...wish to make some play...
 ...mitter? (R.P. — Wolverhampton.)
 ...on the same...
 ...Channel 10 would

Replies to Readers

...result...
 ...safety is a brush potting...
 ...and 15V...
 ...more.)
 ...to charge a 12V. battery, as...
 ...board over a stou

Cleaning Brass

HAVE you a formula for a substance which will clean brass? It must not be an acid, as it is for cleaning old grandfather clocks. I wish just to dip the parts of the clocks in the substance and then rinse off with petrol. (K.H. — Newbury.)

An effective dip treatment for cleaning such brass parts can be made by shaking salt with vinegar in a bottle until no more will dissolve. Let the surplus salt settle and decant the clear liquid. Degrease the parts first by a petrol treatment and immerse in the cleaning fluid until they brighten. Remove, rinse with water and buff with a cloth. This method, though it is slightly acid from the vinegar, is so gentle that it eliminates the disadvantages of the customary treatment with the strong acids. You could treat badly corroded spots with another simple product. Dissolve 8 grams of soap in 80 c.c. of hot water, allow to cool, stir in 1 c.c. of ammonia of specific gravity 0.88 (obtainable from a dispensing chemist), pour into a bottle containing 16 grams of precipitated chalk and shake. Shake the mixture before use. It is used in the same way as the proprietary metal polishes and is gentle but effective.

* * *

Portable Reception

I RECENTLY constructed the 'Portable All-Dry Two' but up to now have had no success with it. I cannot get any volume at all, only a whistling sound. I have had the valves tested and O.K.'d, I retraced all the wiring from the plan, but to no avail. Could you please advise me what the trouble seems to be? (A.J.—Sheffield.)

THE circuit is in order and should be satisfactory. Possible causes of poor volume are as follows:—wrong resistor values due to wrong reading of the colour code, especially regarding the number of noughts; wrongly wired output transformer, or transformer and speaker not intended for use together. Reversed connections to reaction coil tags. Defective fixed condenser or other parts, or leaky coupling condenser. If all these points are in order, a better aerial may be required in your area. An aerial inside a building with metal fabric is not satisfactory. If you have phones, connect them from detector anode to H.T. positive. If normal

l-valve results are obtained, the tuned circuit detector and associated parts and wiring are correct, and the output stage (1S4), transformer and speaker must be suspected. With the transformer, the stout, low-resistance winding must be taken to the speaker. If, however, the above test does not give good phone reception, then coil, tuning condenser, wavechange switch and associated detector wiring should be checked.

* * *

Guitar Amplification

COULD you please send me details for making an electric pick-up for a guitar using throat microphones? (S.O. — Bedworth.)

A SINGLE microphone unit, mounted on or under the soundboard, should be satisfactory, the best position being found by trial. The microphones mentioned are usually carbon units, and require a 50:1 or similar microphone step-up transformer, and dry battery of about 3V. to 6V., the best voltage being found by trial. Connect the microphone to the primary of the transformer, with the battery in one lead. The transformer

secondary is wired to the input or pick-up sockets of a radio or amplifier. Disconnect the battery when the equipment is not in use, or fit a switch in one battery lead. Keep the microphone at some distance from the loudspeaker of the radio or amplifier, or howling may arise.

* * *

A Radio Wavetrap

I BELIEVE there is a device which can be added to a crystal set so as to tune out an unwanted station. I should be glad if you could send me details of how I can make one. (C.W.—Epping.)

A TROUBLESOME local station may be reduced in volume or cut out by using a wavetrap. This consists of a coil and variable or pre-set condenser wired in parallel and connected in the aerial

★★★★★★★★★★★★★★★★★★★★
 ★ Readers are reminded that all ★
 ★ requests for information should be ★
 ★ accompanied by a stamp for return ★
 ★ postage. Otherwise they may have ★
 ★ to wait weeks for a printed reply ★
 ★ in this column. ★

★★★★★★★★★★★★★★★★★★★★
 lead to the receiver. For the medium waveband use a medium wave coil; or 90 turns of 30 S.W.G. or similar wire on a 1in. diameter former will suffice. A .0005μF condenser is usual, but a smaller capacity will do for stations of low wavelength. Carefully adjust the condenser for minimum volume from the offending station.

OVERCOMING THE 'LOST GLUE' HAZARD



HOW often do you buy a tube of glue to do a small repair job, put the tube away, and when the next job comes along the adhesive just cannot be found anywhere? Leicester Lovell & Co. Ltd., manufacturers of Casco Synthetic Resin and Casein Glues have overcome this hazard in introducing Casco 'Contact' — a no-pressure impact adhesive which gives an excellent bond between a wide variety of materials, including glass, aluminium, leather, wood, cork, cloth, etc.

Casco 'Contact' is packed in two sizes costing 1/- and 1/9 each, in an appropriately sized 'pocket' container. This is the answer to the mislaid tube. The 'pocket' has a hole punched in it so that it can be hung up in a convenient place in the kitchen, the workshop or the garage — to be always on hand. Available from most ironmongers, hardware stores and Hobbies shops.

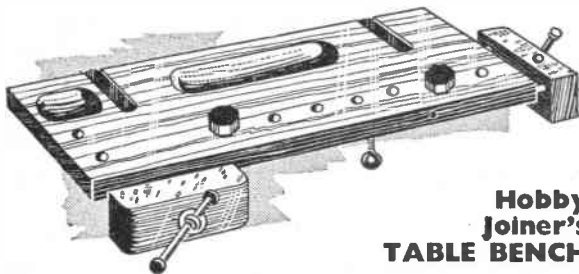

Hobby Joiner's TABLE BENCH

Cramps to kitchen table to provide an ideal working surface for cutting shaping and assembling small parts. The spaced holes and pegs permit work to be held for planing. Two sturdy vices, two metal cramps. Size 20 ins. long. Made of seasoned hardwood for years of service. **37/6**

HOBBIES LTD., Dept. 99, Dereham, Norfolk

YOU CAN BECOME A HANDICRAFTS INSTRUCTOR

EXPERIENCE NOT ESSENTIAL

Men who enjoy making things in wood or metal can turn their hobby into a permanent and interesting Career. Short hours, long holidays and security in a job you would really enjoy, can be yours if you become a Handicrafts instructor. Let us send details of the easiest and quickest way to get the necessary qualification.

We guarantee "NO PASS — NO FEE"

If you would like to know about our unique method of preparing you for one of these appointments, write today, and we will send you our informative 144 page Handbook—free and without obligation. Mark your letters "Handicrafts Instructor".

BRITISH INSTITUTE OF ENGINEERING TECHNOLOGY BIET
595 College House, Wright's Lane, Kensington, London, W.8

The 'WENSUM' Sailing Dinghy

by P. W. Blandford, A.I.N.A.

and The 'VENTURER' Outboard Motorboat now being manufactured by **PORTACON (PANGBOURNE) LTD.**

The Wharfe, Pangbourne, Berks. Telephone 567
Personal and Trade enquiries invited

The HALTRAC MIDGET HOIST

Weights 1 lb. Tested to lift 1,000 lbs.

PRICE 57/6

will pull or lift anything. Self-lubricating solid nylon pulleys — 72 ft. nylon rope — rustless aluminium construction throughout. Standard equipment for the Motorist, Caravaner, Gardener, Workshop, etc. etc.

Available from all good Stores, Ironmongers, Halford Branches, Yacht Chandlers, etc., or from:

HALTRAC LTD. (Dept. HW. 3)
BOURNE WORKS, WEIMAR STREET, LONDON, S.W.15

Trade enquiries also invited

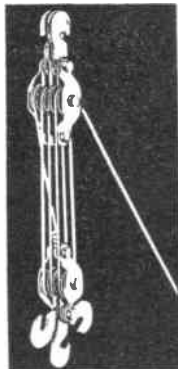

with



Hobbies kits for novel musical boxes are extremely popular for making up as gifts and for sale. Kits include materials and full instructions for making with a few simple tools. Musical movements are extra. Make your choice of tune from list below.

GET A KIT NOW!

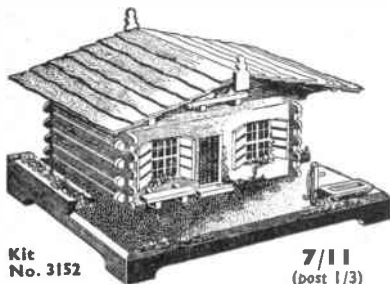

Kit No. 3152

7/11
(post 1/3)

SWISS CHALET. Lift the lid to offer a cigarette and it plays a tune. Fit with Musical Movement No. 1.



Kit No. 3222

11/6
(post 1/6)

MUSICAL TAVERN. A savings box which plays a tune when you insert a coin. Fit with Musical Movement No. 2.

- Fit your box with one of these tunes
- No. 1 Movement 15/6 (post 6d.)
 - F Harry Lime Theme
 - H Parade of the Wooden Soldiers
 - O Auf Wiedersehn
 - Z Gounod's Ave Maria
 - No. 2 Movement 16/9 (post 6d.)
 - R Happy Wanderer
 - S Teddy Bears' Picnic

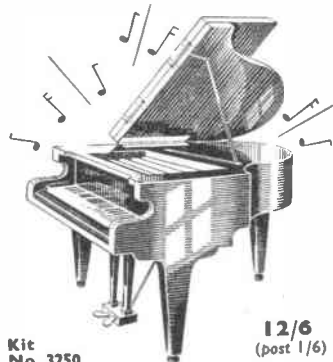

Kit No. 3250

12/6
(post 1/6)

GRAND PIANO. Kit includes printed keyboard. Fit with Musical Movement No. 1.

Other models detailed in free Booklet

To Hobbies Ltd., Dept. 99, Dereham, Norfolk. Please send free copy of 'Profitable Leisure' and items detailed.

Kit No.

Musical Movement.

Name

Address

P.O. for. enclosed

The Pride of any Boy

'JAPONICA'

A magnificent Sailing Cruiser with Auxiliary Motor

This fine model of a characteristic craft used on the Norfolk Broads is 20 ins. long. Extra mechanical power is provided by a Mighty Midget electric motor and propeller unit.

Make this magnificent craft with Hobbies Kit No. 3254 containing all wood, materials, motor, propeller, metal keel, etc., and easy-to-follow instructions. From branches, stockists, etc., or by post.



'JAPONICA' Kit No. 3254 65/-

FREE 20-page booklet 'Profitable Leisure' showing kits available for dozens of other exciting models (ships, aircraft, etc.)



GET A KIT TODAY

To **HOBBIES LTD.**
Dept. 99, Dereham, Norfolk

Please send free copy of 'Profitable Leisure' and 'Japonica' Kit No. 3254. P.O. for 65/- enclosed.

Name

Address

STOP SMOKING! Quick guaranteed remedy. Testing sample free!! — Triumph Remedies, (A16), Exeter.

LEARN RADIO and ELECTRONICS the NEW practical way! Very latest system of experimenting with and building radio apparatus — 'as you learn'. FREE brochure from — Dept. HW10 Radiostructor, Reading, Berks.

BUILD YOUR OWN HI-FI at home! At last, for reasonable cost — the choice to make your own quality HI-FI audio equipment and to gain the knowledge to service and maintain it. FREE brochure from — Dept. HW20 Radiostructor, Reading, Berks.

MAKE A MUSICAL BOX for as little as M21/- . New kits and tunes available. Movements 13/-, post free. Please send 3d. stamp for free illustrated catalogue. — The Swisscross Co., Dept. B, 202 Tulse Hill, London, S.W.2.

Sent for 10/-. bal. 18 fortnightly payments 7/6. Plus carriage.

1/2 PRICE OFFER! **SENT FOR 10/-**

The **FLIGHT LIEUTENANT** **Genuine NEW WATERPROOF DUCK TENT**

CASH PRICE £5-17-6 CARR 6/-

Waterproof 1959 Tents of real Box. WHITE Duck. Galeproof Brand new. Surplus to export order. DON'T CONFUSE with Tents made from drab material never meant for tentage. This is real thing, withstands anything even in our climate. Approx. 7ft. 6in. x 6ft. x 6ft., 3ft. walls. Cash £5/17/6, carr. 6/- complete ready to erect, incl. valise. 'Willesden' Green 42/- extra. Ridge pole if req. 7/6. Flysheet available 37/6. Rubberised Groundsheet 19/6. LISTS, TENTS, ETC. TERMS.

THE **1500 TELESCOPE SIGHTING** instruments fitted with genuine scientific hand-ground lenses are precision built and graticuled for dead-on sharp shooting accuracy. Made for precise sniper's action they represent an absolute bargain. Actual cost of production, without any profit, £8.10.0. OUR PRICE only 17/6., post, etc., 2/6. If you want to get a precise bead on anything, this is the instrument to do the trick. Limited offer only. Lists, Binoculars, Telescopes. Headquarter & General Supplies Ltd. (HOBW/68) 196-200 Coldharbour Lane, Loughboro Junc., London, S.E.5. Open Sat.

GUN SIGHTS 17/6 POST 2/6

STAMPS FREE — Empire Packet including Pictorials and Victorians with approvals. — Robert J. Peck, 7A Kemp Road, Bournemouth.

BUYING OR SELLING?

Classified advertisements on this page are accepted at a cost of 6d. per word prepaid. Use of a Box No. is 1/- extra. Send P.O. with advertisement to *Hobbies Weekly*, Advert. Dept., Dereham, Norfolk. Rates for display advertising on application.

INTRODUCTIONS to new friends; home and overseas — V.C.C., 34 Honeywell Road, S.W.11.

100 DIFFERENT stamps free! Request 4d. upwards discount approvals. — Bush, 53 Newlyn Way, Parkstone, Dorset.

EXTRA CHEQUES from writing. Send for 'Ideas for Writers' (free). Scores of suggestions for beginners and others. Typewriter unnecessary. — Writers' Ring (H.W.), 5 Edmund Street, Birmingham 3.

PERSONS required, to make new type fancy cushion covers. Apply, enclosing S.A.E. — Dept. 28, Arnold Trading, 10 Shelley Road, Worthing, Sussex.

450 COPIES HOBBIES WEEKLY 1942-54, 8 Handbooks, over 300 Designs. Offers — Box No. 36, Hobbies Weekly, Dereham, Norfolk.

Completely new 54 page Edition

WHERE'S THAT CAR FROM?

Price 1/- (Postage 4d.)

Of all Booksellers

or

RALEIGH PRESS, EXMOUTH, DEVON

HOBBIES BRANCHES

LONDON

78a New Oxford Street, W.C.1

(Phone MUSEum 2975)

87 Old Broad Street, E.C.2

(LONDON Wall 4375)

81 Streatham Hill, S.W.2

(TULse Hill 8796)

151 High St., Walthamstow, E.17

GLASGOW — 326 Argyle Street

MANCHESTER — 10 Piccadilly

BIRMINGHAM — 100a Dale End

SHEFFIELD — 4 St. Paul's Parade

LEEDS — 10 Queen Victoria Street

HULL — 179 Ferensway

SOUTHAMPTON — 134 High St.

BRISTOL — 65 Fairfax Street

NEWCASTLE — 42 Dean Street,

Newcastle-on-Tyne 1

GRIMSBY — 88 Victoria Street

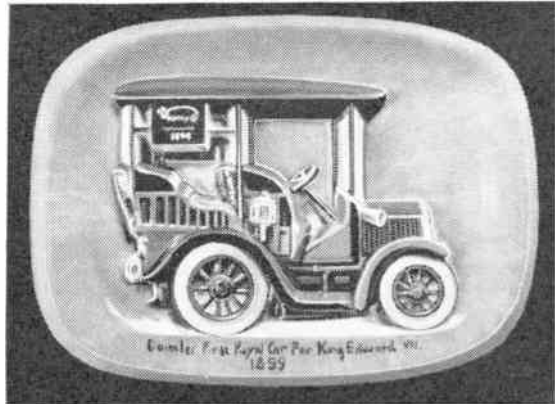
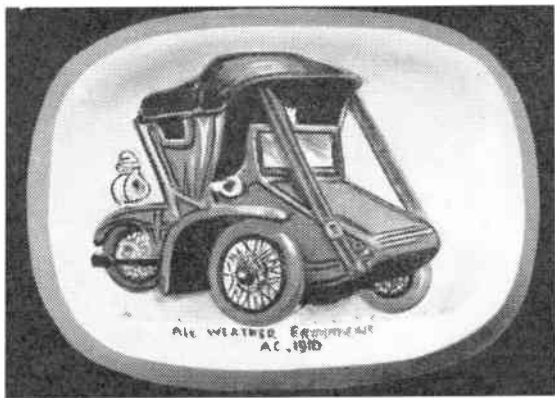

Veteran Car Plaques FOR THE ENTHUSIAST

Make a set of six wall plaques showing authentic replicas of Veteran cars. These are something new to the Sculptorcraft range of Plastic Moulds. They can be used many times over.

Write for illustrated leaflet, enclosing 3d. stamp



Sculptorcraft



SEAMER PRODUCTS (SCULPTORCRAFT) LTD, 23/27 EASTBOURNE STREET, HULL

For wood,
card,
plastic,
leather,
metal, etc.

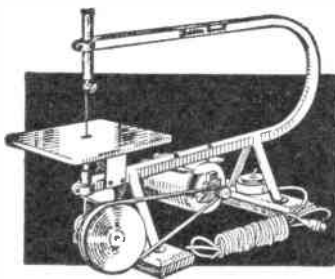

£12 - 5 - 0

TREADLE OR MOTOR FRETSAWS

Whatever the handyman or craftsman is cutting or making, one of Hobbies Fretmachines will help with the job. For toy making, fretwork, model making, it provides easy and speedy cutting in all kinds of material. A pleasure to use, a factory for output, a lifetime of service.

Obtainable at any Hobbies Branch or good class ironmonger or hardware stores. Or carriage paid U.K. from:

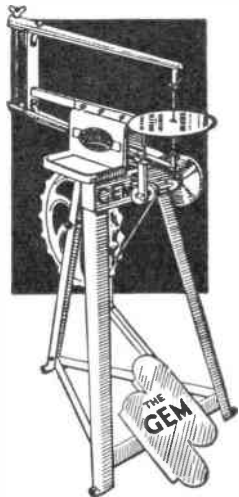

£5 - 17 - 6

HOBBIES LIMITED, DEREHAM, NORFOLK

READ THE RIGHT EXPOSURE.

WITH

JOHNSON EXPOSURE CALCULATORS



STANDARD DAYLIGHT
Just 'dial' subject, time, weather and film speed — and the correct exposure can be read off from the clearly printed scales. What could be simpler! Provision for filters. Price 3 - only.

COLOUR AND CINE CALCULATOR

For use in daylight with all types of still and cine colour reversal films. Just three movements of the dial — and there's the exact exposure for any weather, at any time of year. Price 4 6 only.

JOHNSONS
OF HENDON LTD

FOR CONFIDENCE
IN PHOTOGRAPHY