

10th JUNE 1959

VOL. 128

NUMBER 3319

THE ORIGINAL
'DO-IT-YOURSELF'
MAGAZINE

HOBBIES *weekly*

FOR ALL
HOME CRAFTSMEN

Also in this issue:

COLLECTORS' CLUB

RADIO CONTROL
OF VEHICLES, ETC.

MAKE CHEMICALS
FROM WASTE

WIND BREAK
FOR THE BEACH

PHOTOGRAPHY

PATTERNS AND
TOY NOVELTIES

ETC., ETC.

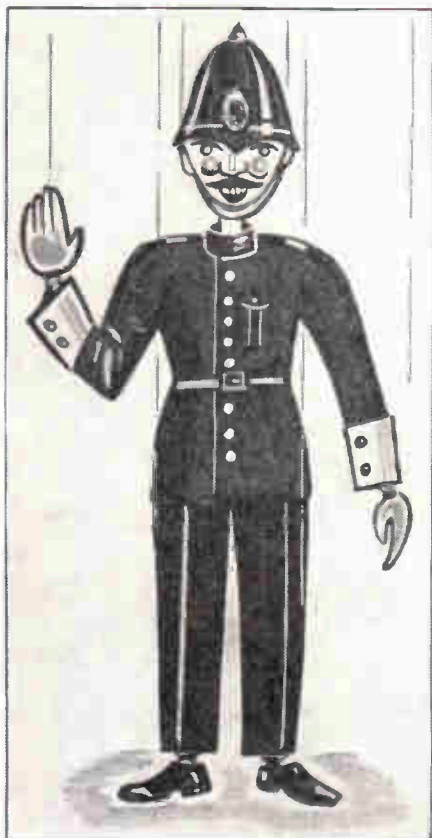

*Full details
for making
these
fascinating
fully-jointed*
**STRING
PUPPETS**



Up-to-the-minute ideas

Practical designs

Pleasant and profitable things to make

5^D



OUR pen friend service has become very popular. But would all readers please remember the following important points. *A*—Enclose a 3d. stamp for reply. *B*—Print (not write) your name, address and age clearly in top left-hand corner of paper. *C*—

MORE FRIENDS FOR YOU — *By R.L.C.*

Mention hobby interests and the country from which you desire friends.



Linda Rock



Ken Fowler



Keith Davies



William Armstrong



Glynn Taylor

Here are more suggestions. William Armstrong of Killypaddy, Lisnaskea, Enniskillen, Co. Fermanagh, N. Ireland, collects stamps, match labels and coins.

He said recently: 'I have been a regular reader now for many years and find Collectors' Club a great help to me.'

William is willing to exchange stamps and labels with readers throughout the world.

Ken Fowler of 57 Radford Place, Sheffield, 3, is 12 years of age. He collects stamps and wishes to exchange duplicates with other readers.

Glynn Taylor lives at 57 Boundary Road, Cheadle, Cheshire. He has a fine stamp collection and would like to exchange British Colonials with other readers.

Keith Davies of 10 Elgin Road, Sutton, Surrey, is well known to many of us. He collects all items of interest. Keith is training for hotel management at the Grosvenor Hotel, London. He is a free-lance journalist and would like pen friends from any country.

Many of our female readers have asked for pen friends. Here are some reliable hobbyists who have recently become regular readers of *Hobbies Weekly* and who are highly recommended: - Mrs. J. J. Burger, Happy Camp, California, U.S.A. — collects stamps, match labels and post cards; Betty Robinson, 45 Hartley Street, Cairns, North Queensland, Australia; Linda Rock, 33 Passmore Street, Westminster, London.

THE first thing to master in the pole jump is the take-off, so that the vaulter can give all his attention to the business of getting over the bar. While practising to get his distance, he should also be learning how to leave the ground.

The pole is planted firmly, the vaulter springs into the air, guiding his body by means of his arms and the pole. The legs must shoot up into the air and act as a sort of fulcrum to keep the chest clear of the bar.

When actually going over, the body must swing so that it faces the bar. The momentum of the run and the spring should have carried the feet into the air and given the body the required half turn. Just before the moment of clearance, the arms should lift, the back straighten, the legs drop down and the body drop over the bar.

THE POLE VAULT



The vault is somewhat of a gymnastic feat, requiring great strength in special muscles of the arms and shoulders. It must be remembered that in vaulting, as in similar field events, form often counts far more than natural ability. To succeed as a college or club athlete, perfection in form must be the first consideration.

MAKING STRINGED MARIONETTES

THE stringed marionette is, to both the artist and the craftsman, the highest form of puppetry. The heights of caricature and fantasy to which it can rise are far above those possible in other forms.

By C. Somerville

The marionette is a jointed figure controlled from above by strings, and may vary in size from a few inches to several feet. The puppet described here is 16ins. high and is made entirely in wood. Though puppets can be made from odds and ends with simple joints, these are rarely as effective as the fully-jointed wooden figure. This puppet has been so designed that, though requiring no specialised knowledge, it gives a high degree of satisfaction when carefully made.

A deterrent in the eyes of many would-be puppeteers is the skill neces-

sary in the carving and jointing of a marionette. This puppet requires no wood carving skill since the limbs and body are built up from shapes cut in either plywood or yellow pine planks. Balsa is not recommended since it is too light and makes for complication in jointing.

The completed marionette is shown at Fig. 1, and full-size patterns for body and limb components are shown on page 165.

The course to be adopted can be readily followed if the construction of one simple part, say the upper arm (C), is considered. Two sections of pattern (C1) are cut out in wood $\frac{3}{4}$ ins. thick, a fretsaw being used. Similarly, pattern (C2) is cut in $\frac{1}{4}$ in. wood. The three portions are glued, assembled and clamped as seen in Fig. 2. When the glue is thoroughly dry, the clamps are removed and the composite block is shaped using chisel, spokeshave, file or any shaping tool, and finally finished with glasspaper.

Similarly the lower arms (Fig. 2), and the legs (Fig. 3), are cut out, glued and shaped. The body pieces are treated in

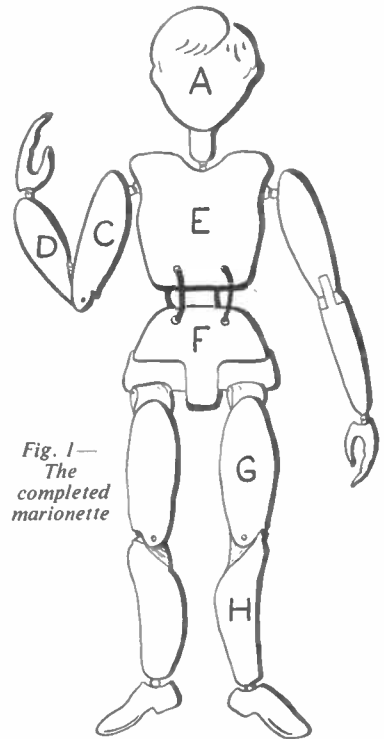

Fig. 1—
The
completed
marionette

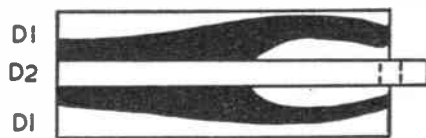

Fig. 2—Assembly of the arms

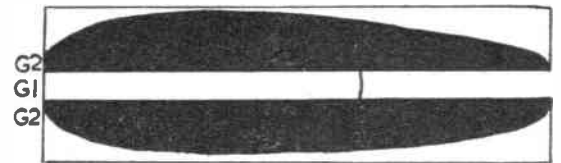

Fig. 3—Assembly of the legs

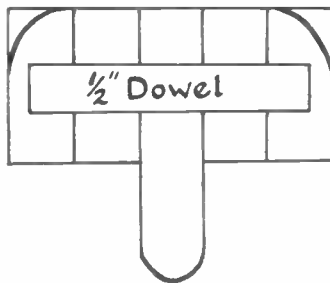
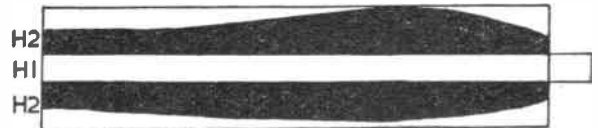
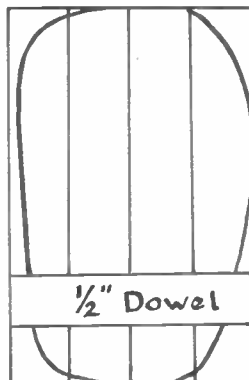

Fig. 4—Assembly of pelvis
and torso sections



exactly the same way, except that they are assembled on $\frac{1}{4}$ in. dowel (Fig. 4), to give added strength. The feet are made equally easily, the patterns being shown at Fig. 5. The hands should be individual to the character of the puppet, and the basic pattern (Fig. 6), may be adapted as wished. The outlines, one to four, are cut in $\frac{1}{4}$ in. plywood and each finger is rounded. Then the four slips are glued and clamped as shown. When dry the waste portions are cut away, and all square edges rounded off.

The torso (E) is joined to the pelvis (F) at the centre, by a cord, leather thong or bootlace. The legs are attached to the pelvis by a leather strip glued into saw-cuts in the upper leg (G) and suspended

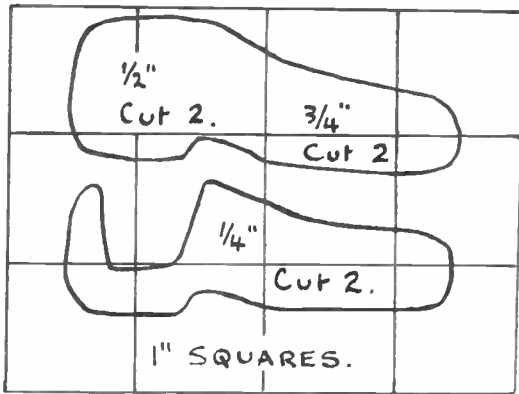

Fig. 5—Patterns for the feet

upon a wire running from each side and through the bottom projection of the pelvis (Fig. 8). The knee joint is a limited tongue and groove joint, pivoted on a panel pin. The ankle joint is a screw-eye, also pivoted on a panel pin in the slot in the foot.

The jointing for the arms is very simple, the shoulder (Fig. 7) and wrist joints being interlocked screw-eyes. The screw eyes to use are the very small brass ones used in rigging model boats. The elbow joint is merely a reversal of the knee joint.

The basic head shape, a sphere or egg

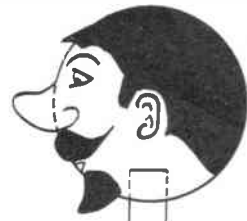

Fig. 7—Jointing of head, neck and shoulders.

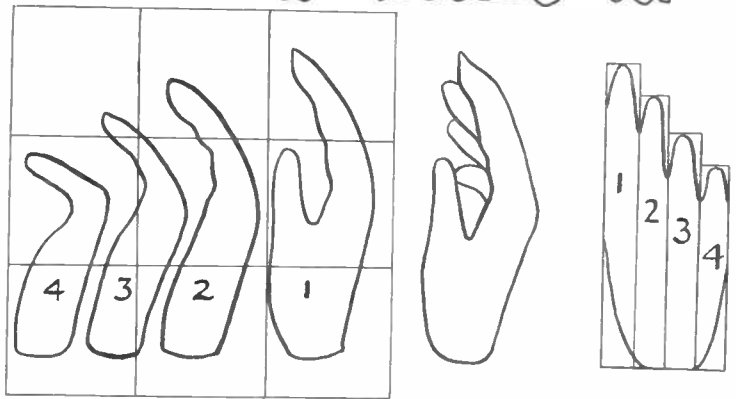

Fig. 6—Assembly of the hand

shape, is turned on a lathe from soft pine, redwood or any other moderately soft wood. The neck is 1 in. long and can be a dowel rod glued into the head later. Should you have no facilities for wood turning, there are various sizes of wooden balls available from any Hobbies branch or stockist, the 2½ in. diameter ones being ideal.

The nose and ears can be cut from wood and glued on, or they can be modelled in plastic wood or a mixture of sawdust and glue. Depressions for the eyes and some flattening of the cheeks can be easily done with a file and makes for better characterisation. Felt, wool or string makes excellent puppet hair, and can be glued on to the head, and then trimmed to style. Details of a typical head are illustrated at Fig. 7. Poster colours or oil paints are used for painting the head, which should be done boldly, using bright colours and avoiding small detail. Remember to paint the neck, for when you come to dress the puppet you

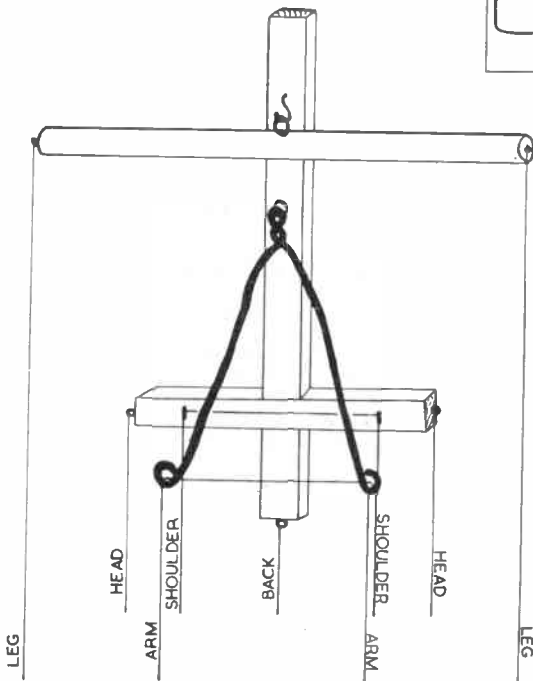

Fig. 9—The control

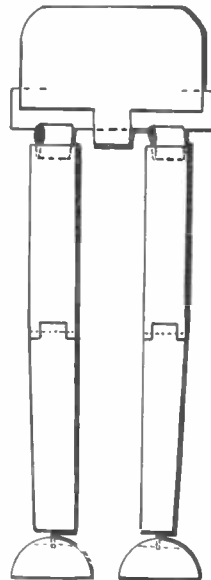
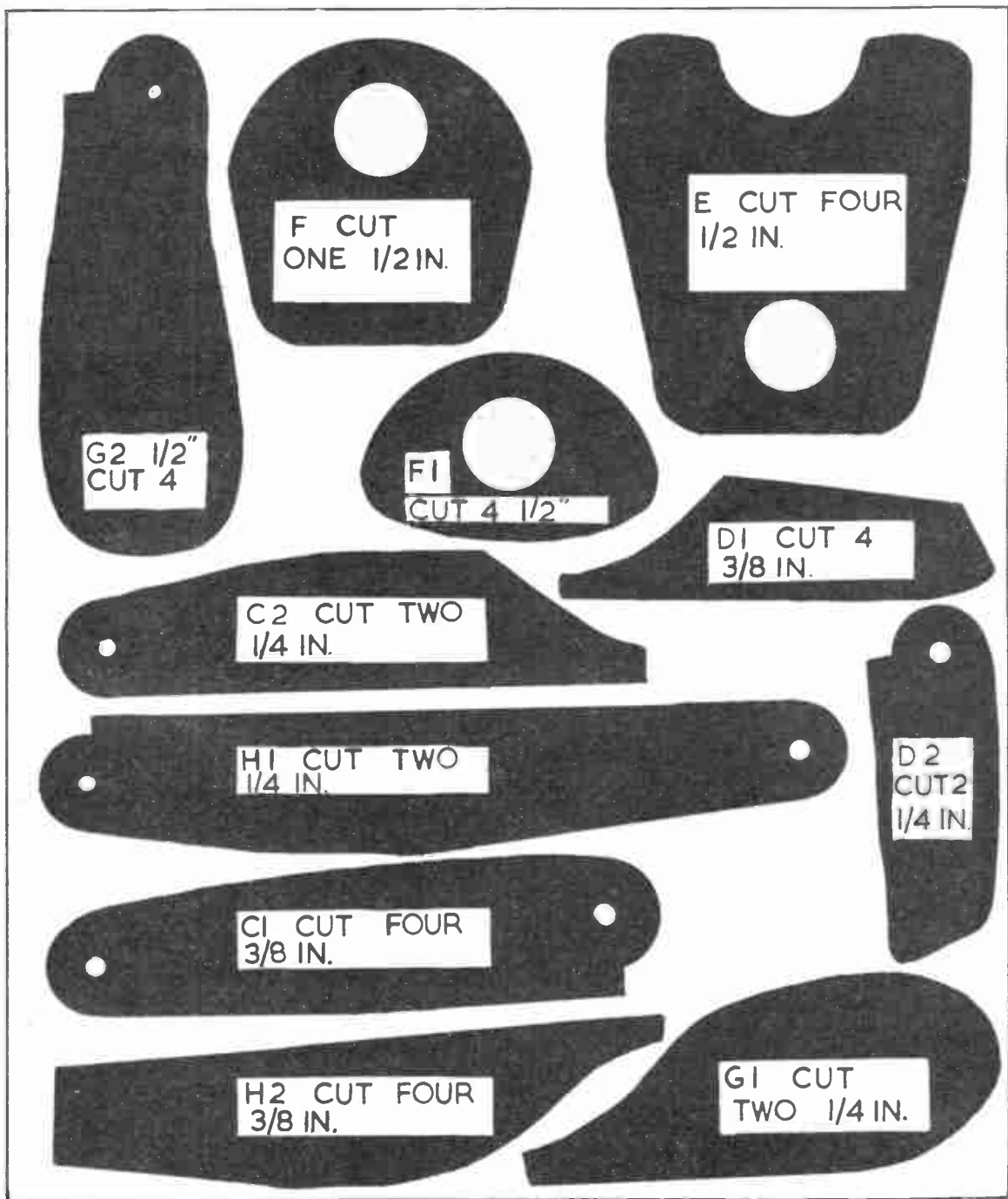

Fig. 8—Leg joints

● Continued on page 172

FULL-SIZE PATTERNS FOR A PUPPET



Transfer shapes by carbon paper to thickness of wood indicated and cut out with a fretsaw

VEHICLES AND AIRCRAFT

THE radio transmitters and receiver already described can be used to guide a model truck, armoured car, tank, or other vehicle, and this type of model may be preferred in some cases because it can be run indoors, or in the garden. The actual radio equipment will be very easy to operate in these circumstances, because the range will seldom exceed several yards. As a result, a low power transmitter can be used, and adjustment of the receiver and relay will be very easy indeed.

The same radio equipment (transmitter and receiver) may also be used to control a model plane. Radio control is sometimes used with large model gliders, but is most frequently fitted in a diesel model. Small model planes cannot carry the apparatus. As the model flies away the signal reaching the receiver grows weaker, and for this reason very careful adjustment of receiver and relay will be needed, or control of the model may be lost. The equipment should be tested on the ground, in advance, to discover the maximum safe range, and the plane should then be flown within this limit.

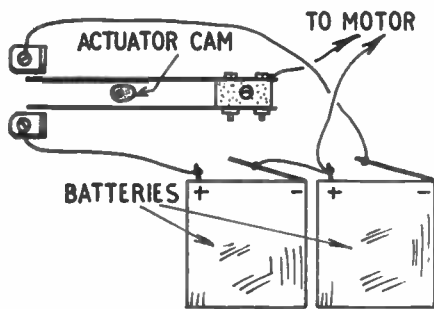

Fig. 1—Motor reversing with stop position

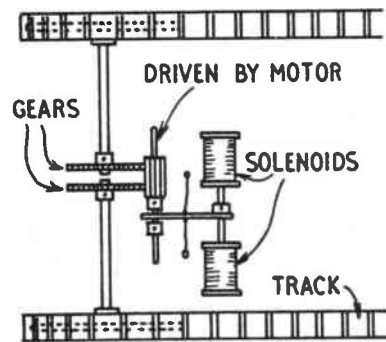

Fig. 3—Steering a model tank

Suitable guide devices for models of this kind can be made up as described here. With vehicles, Meccano worms, gears and other parts will prove extremely useful, but for a plane, the lightest possible items must be used.

Reversing from actuator

A control actuator has been described in which the actuator spindle could be made to take up any one of four positions, a cross-arm being released by a magnetic catch. This type of actuator can control a miniature electric motor of reversing type, which will steer the vehicle.

A small cam is a push fit on the actuator spindle, as explained for 'Off' switching in a model boat. Instead of using one contact only, two contact strips are fixed each side of the cam, as in Fig. 1. In two positions of the cam, these strips do not touch the brackets. In each of the other two positions, one strip is pressed into contact with its bracket.

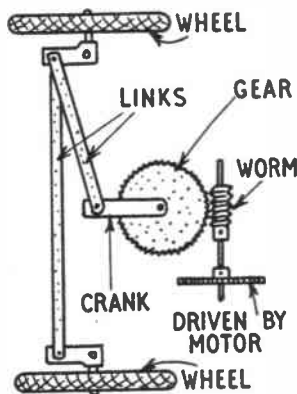

Fig. 2—Vehicle steering system

Two small batteries are used, wired in opposite polarity. When the actuator cam is in the position shown in Fig. 1, the steerage motor will not be running. One-quarter of a turn of the cam will make the motor run in one direction. A further quarter turn will stop the motor, while another quarter turn will reverse the motor. This sequence is repeated as often as required.

The thin contact strips can be bolted to a small insulated block. The contact brackets must be insulated from the body of the clockwork motor. There is, of course, no use now for the steerage wire fitted to the actuator crank, which originally controlled the boat rudder.

Vehicle steering can be arranged as shown in Fig. 2. A considerable reduction ratio is necessary between the motor and crank and this can be obtained by two stages of worm gearing, with large gears, or by using smaller gears and worms, and a gear or belt reduction drive from the motor.

The very small, midget type of motor will easily give enough turning power, if the reduction drive runs freely. Current is only taken while the wheels are being moved, for steering.

By 'Radio Mech'

The motor is wired to the contacts in Fig. 1, and the usual propulsion motor drives the model along. Keying the transmitter will give the following control positions for the actuator:

1. Steering motor off.
2. Steering motor turning model to right.
3. Steering motor off.
4. Steering motor turning model to left.

With positions 1 and 3, the wheels of the model may be straight, or set to give any required curve either way. Unrequired positions can be passed through before the model responds, as explained. It can thus be guided about in any manner required. A reduction drive which will turn the crank from a central position to one side in roughly 5 seconds will be convenient. Using batteries of smaller voltage, or adding a resistance in series with the motor, will cut down its speed, if necessary.

Exactly the same method may be used for steering a large boat, the crank working the rudder through a link.

Tracked models

When steering is provided in these, it is usually obtained by throwing one track out of gear. The model then begins to slew round, again running straight when both tracks are driving.

A satisfactory method of arranging this is shown in Fig. 3. When the model is running straight ahead, both gears are driven together by the pinion, which is fixed to a spindle driven by the propulsion motor. This drive, from motor to spindle, may consist of two stages of gears or belts, or a single worm drive, and the usual speed control resistance may be wired in series with the motor.

The actual steering system does not use another motor. Instead, the drive

pinion is held so that it engages both gears, this being done by a strip loose between pinion and a collar. This strip is held centrally by thin elastic, as shown. When one solenoid is energised, the strip moves the pinion out of engagement with one gear. If current flows in the other solenoid instead, the pinion is drawn the other way.

Only a very small movement (say $\frac{1}{4}$ in. in all, at the most) will be required, and the solenoids can take current from the main driving battery. For 6V., each magnet can have some 400 to 600 turns or so of 28 SWG or similar wire.

One magnet is connected to one of the contact brackets in Fig. 1, and the other magnet to the second bracket. Either solenoid can then be energized at will, or the circuit to both may be interrupted, for straight ahead running (both gears engaged).

As there is no real use for both 'off' positions of the actuator cam, one position can open contacts wired to the propulsion motor, as explained for a model boat. This will then stop the model so that it can be started up from rest, and halted, as desired.

Aircraft control

Because of the ease with which a model plane may be lost or damaged, great care should be given to see that all the control equipment works properly, and everything should be tested before each flight.

Control to make the model climb or descend is also needed, in addition to turning, and this makes the operation of the transmitter key more difficult. A really good flying model is also needed.

Fig. 4 shows a control unit with six positions, three for the rudder, and three for elevators. This would give turning each way, as well as straight flying, and descending, in addition to level flight.

The actuator or escapement disc has six teeth, and can thus be left in any one of six positions. Each time the transmitter is keyed, the escapement disc turns one tooth, or one-sixth of a revolution. A good length of twisted rubber will provide turning power, to keep weight down, and will allow quite a large number of operations, before re-winding is needed.

One disc on the same spindle controls the position of the rudder, a thread being attached to a thin metal strip bearing on the perimeter of the disc. When this strip rests against the section 'A' the rudder is straight. This will be so for three positions of the actuator. In a similar way, the second strip rests upon the edge of the elevator disc, and controls the elevators through a thread. Both threads are kept taut by light springs pulling rudder and elevators. When the portion 'B' of the elevator disc is against the strip, the elevators are adjusted for

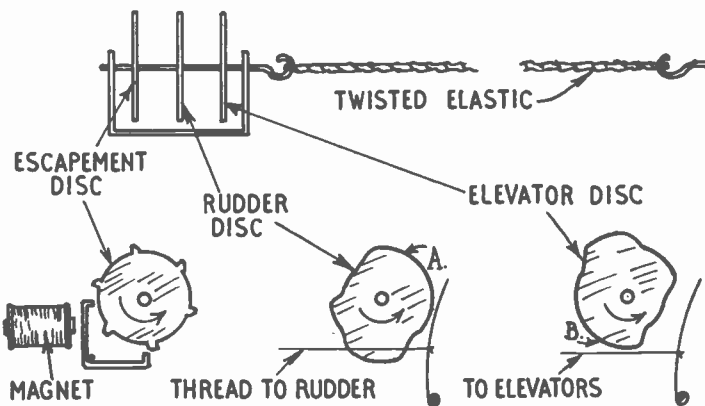

Fig. 4—Control unit for aircraft

level flight. This will be so for the three remaining positions of the actuator.

Both discs turn together, and this gives six positions, any of which can be selected by keying the transmitter. These give flying as follows:

1. Rudder straight, plane climbing.
2. Rudder straight, level flight.
3. Rudder straight, plane descending.
4. Level flight, rudder to left.
5. Level flight, rudder straight.
6. Level flight, rudder to right.

It will be seen that when the rudder is being controlled the plane is held in level flight by the portion 'B' of the elevator disc, which does not change in radius. Similarly, the portion 'A' of the rudder disc holds the craft in straight flight when the plane is climbing or descending. It is usual for simple diesel powered models to run until all the fuel is exhausted, and the engine stops. At this point, the plane should be turned into a

suitable position for landing, and should glide to a safe landing, in level flight, exactly as with a craft without radio control.

With the radio receiver switched off, and rudder and elevators positioned for straight, level flight, the plane should fly well, exactly as would an airworthy model having no radio control. The aerial may be stretched between rudder and mainplane. The control threads are best adjusted to give moderate degrees of climb and turn, as they can be altered to give sharper control afterwards, when it is found that the model responds well.

Next week, in the last article in this series on Model Control, 'Radio Mech' describes transistor and other circuits.

NEW FORMULA HUMBROL



A NEW formula Humbrol plastic enamel manufactured by The Humber Oil Company offers important advantages to the model maker and handyman. It gives a superb finish on metal, plastics, cardboard, glass, pottery, wood, and plaster models, and being lead free, is particularly recommended for children's toys. Packed in a wide range of sizes from miniature plastic capsules to the full gallon tins, it is extremely durable, and will withstand boiling water, petrol, etc.

It may also be used in lieu of colour dopes on flying model aircraft, is light in weight, and only takes an hour to dry.

The six intermixable colours in capsule form cost 1/3. Convenient kits, complete with brush and palettes are 3/- and 8/11, and $\frac{1}{2}$ oz. seamless tins cost 8d. (gold 1/-). Supplies are available from Hobbies branches, model stockists, etc.

CHEMISTRY AT HOME

THE residues remaining from the preparation of various gases are generally thrown away on finishing the experiment. This is wasteful, for they contain, or will yield, useful chemicals.

For instance, in the residue from hydrogen generation there is zinc sulphate. Similarly, the residue from the preparation of hydrogen sulphide contains ferrous chloride, which may be used for making ferric chloride. By working up residues future expenditure can be saved.

A series of bottles should therefore be kept, each appropriately labelled, and any residue obtained poured into its individual bottle. When fair amounts have accumulated they can be worked up to top up your stocks of basic reagents.

Before pouring off into its bottle the solution obtained from zinc and dilute sulphuric acid in your hydrogen generator, be sure that there is still some undissolved metal. If it has all dissolved, add more until some remains. This ensures that no free sulphuric acid is left. To obtain zinc sulphate, filter the solution and boil it to low bulk over wire gauze until the liquid is syrupy. After standing overnight for complete crystallisation to take place, remove the crystals to a porous brick to dry. Any liquid remaining in the evaporating basin can be returned to the residues bottle and worked up as part of the next batch.

Three-part process

Similarly, where hydrogen sulphide has been generated from ferrous sulphide and dilute hydrochloric acid some ferrous sulphide must remain undissolved before pouring the solution into its residues bottle. To work up this residue, first filter the solution. The filtrate is a solution of ferrous chloride. To obtain ferric chloride from this we adopt a simple three-part process, first converting it into ferrous carbonate, oxidising this by means of air to hydrated ferric oxide and then dissolving this in hydrochloric acid to form ferric chloride.

The ferrous chloride solution is strong and should be diluted with five or more volumes of water. To this add sodium carbonate solution until a drop of the filtered mixture gives an alkaline reaction, that is, until it turns red litmus paper blue. A dirty greenish precipitate of ferrous carbonate appears. Wash this by

decantation in a large bottle fitted with a siphon, as shown in the diagram, until one wash water gives no turbidity with silver nitrate solution.

The ferrous carbonate has now to be oxidised by means of air. This is done by filtering it off, transferring the sludge to a shallow dish and evaporating to dryness in a not too hot oven. The ferrous carbonate changes into brown hydrated ferric oxide.

The hydrated ferric oxide is then converted into ferric chloride by putting it in a flask heated in a water bath and adding dilute hydrochloric acid until only a little of the oxide remains undissolved. The filtered solution of ferric chloride so obtained may then either be kept as solution — whose strength, however, will be unknown — or better boiled to low bulk over wire gauze and then taken to dryness on a water bath.

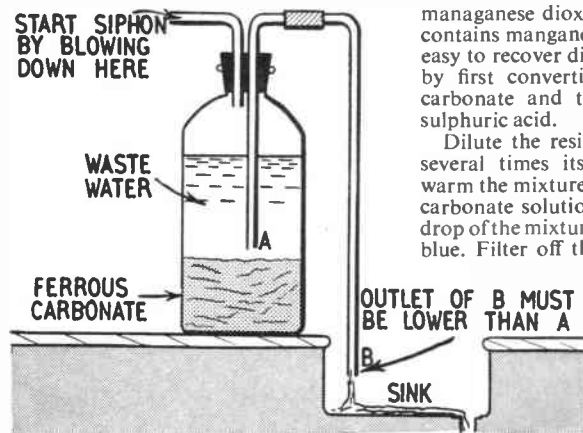

decantation while still warm, for it is deliquescent. It is preferable to aim for the dry substance, since you can then make up a solution of definite strength by dissolving a weighed amount in a definite volume of water.

When chlorine has been generated from manganese dioxide and hydrochloric acid, manganese chloride may be obtained from the residue. Filter off the excess of manganese dioxide and evaporate the filtrate to dryness. Manganese chloride remains. This should be pink. If it has a more or less brown shade

it contains iron, which is often present as an impurity in the original manganese dioxide. It may largely be removed by heating the product to low redness, cooling, dissolving, filtering and evaporating until crystals begin to appear on the surface of the hot liquid. On cooling and standing overnight pink crystals of manganese chloride separate and may be removed and dried on a porous brick.

'Oxygen mixture', consisting of potassium chlorate and manganese dioxide, is converted, during the heating which produces the oxygen, into potassium chloride. The manganese dioxide is there as a catalyst and is therefore unchanged at the end of the reaction. To obtain the potassium chloride, heat each 10

MAKE CHEMICALS FROM WASTE

grams of the residue with 30 c.c. of water, filter hot and allow to cool and stand a few hours. Filter from any deposit of unchanged potassium chlorate and evaporate the filtrate to dryness. White potassium chloride remains.

The residue from bromine preparation from a mixture of potassium bromide, manganese dioxide and sulphuric acid, contains manganese sulphate. This is not easy to recover direct, but it can be done by first converting it into manganese carbonate and then dissolving this in sulphuric acid.

Dilute the residue by pouring it into several times its bulk of cold water, warm the mixture and filter. Add sodium carbonate solution to the filtrate until a drop of the mixture turns red litmus paper blue. Filter off the precipitated manga-

nese carbonate and wash it by decantation until a few c.c. of one wash water no longer give a turbidity with strontium nitrate solution.

Filter off the manganese carbonate and dissolve the sludge in dilute sulphuric acid, while taking care that a little remains undissolved. Evaporate the filtered solution of manganese sulphate so obtained to dryness and then heat to low redness to decompose any iron present as an impurity.

Redissolve the cooled product in a
● Continued on page 169

A WIND BREAK BATHING TENT

SUNBATHE in comfort with this combined wind break and bathing tent. The screen illustrated is useful when on holiday or on weekend visits to the seaside. It is folded or rolled up when not in use and can be stowed

MAKE IT TO USE AT THE SEASIDE

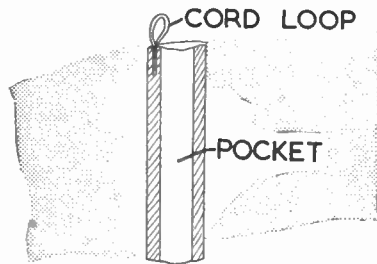
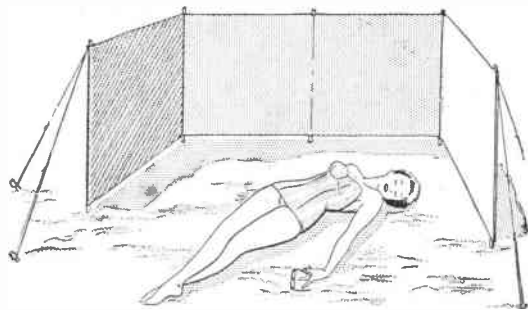

Fig. 1

away in quite a small space. It can be carried on a bicycle.

If the screen is carried by car it can be made of heavy, long lasting materials such as canvas, but otherwise a lighter material may be used. The kind of

The material should be about 54ins. to 60ins. wide and 16ft. long. Five pockets are made as indicated in Figs. 1 and 2 and a cord loop is provided at the top of each pocket. The posts are 6ft. long canes which slip right through the pockets and are pushed into the sand or ground. The loops in the material go over cup hooks, Fig. 3, in the tops of the canes and prevent the material from slipping down. The canes are pushed about 12ins. into the ground and further support is given by small stakes and guy ropes.

Adjustable clews and stakes may be made from wood as shown in Fig. 3. The guys are looped at the ends and are slipped over the tops of the canes, resting on the cup hooks.

The diagram in Fig. 4 shows how the screen and guys are arranged. For the wind break eight guys will be needed. To enter the tent, unhook two or three of the loops and lower the canvas sufficiently to step over. When the canvas is hooked back in position it gives adequate cover for changing.

Clews and stakes should be treated with wood preservative, otherwise the only precaution necessary is to see that the screen is not put away wet or damp. (M.h.)

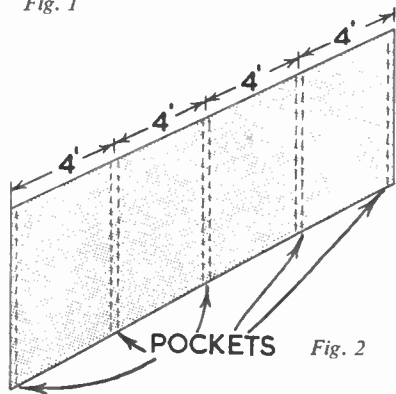

Fig. 2

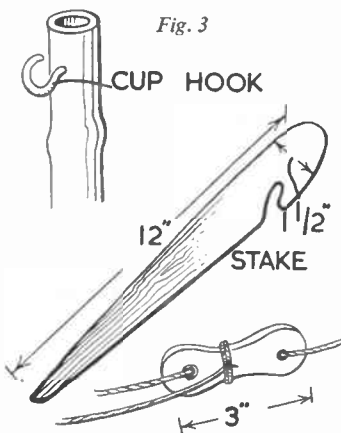

Fig. 3

material is not critical provided it gives protection from wind and at the same time forms an effective screen when changing.

● Continued from page 168

Chemicals from Waste

little water, filter and evaporate until a drop taken up on a cold glass rod crystallises at once. On then cooling and standing overnight crystals of manganese sulphate remain, which can be removed and dried on a porous brick.

Copper nitrate may be recovered from the residue from making nitric oxide from copper and nitric acid. Filter the blue solution from excess copper metal and evaporate to dryness on a water bath.

Lead nitrate heated to make nitrogen peroxide leaves a residue of lead monoxide. This may still contain undecomposed lead nitrate, but as this is soluble in water, whereas lead monoxide is not,

purification is easy. Simply heat the residue with water, pour off the liquid and again heat the oxide with more water. Finally, filter off the lead monoxide and dry it.

Though not a laboratory residue, rain water, of which we receive overgenerous supplies, can be put to good use. As it contains none of the calcium and magnesium salts which cause hardness in water, it makes a good substitute for distilled water and may be used for all ordinary purposes after it has been filtered from dust and grit. It contains small amounts of dissolved gases, but these are of no consequence in the laboratory. (L.A.F.)

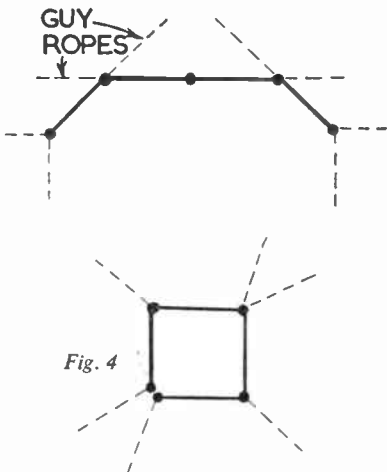
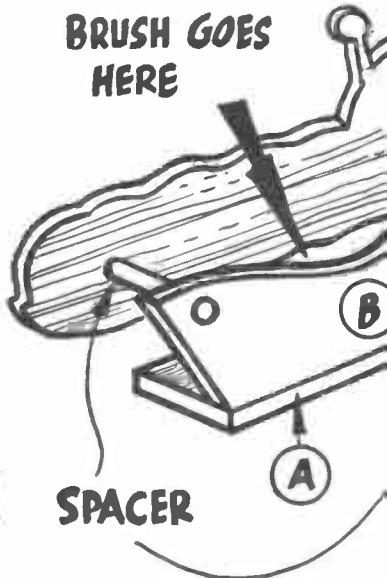
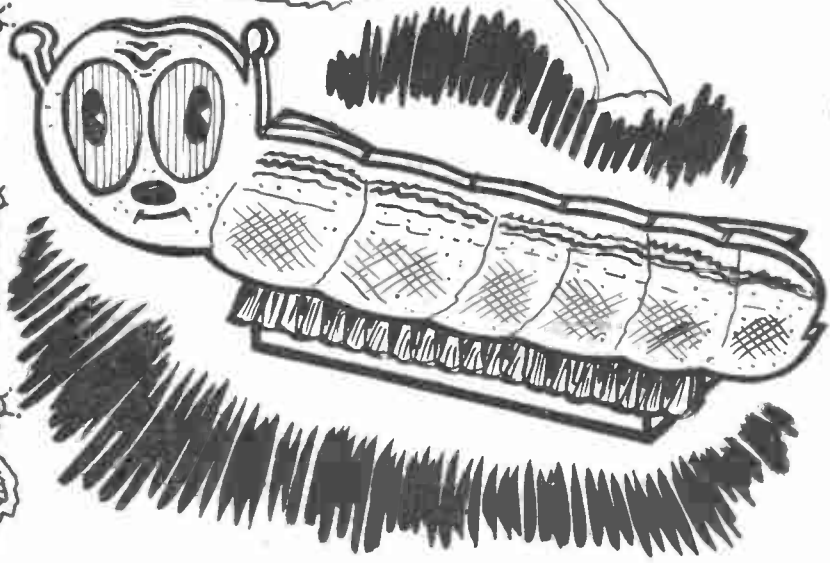

Fig. 4

CENTIPEDE SID

ONE PEST * * A

BRUSH GOES
HERE



SPACER



SPACERS ONE OF EACH 1/4" ROD

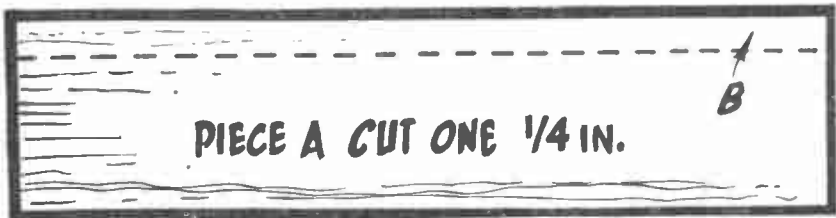

PIECE A CUT ONE 1/4 IN.

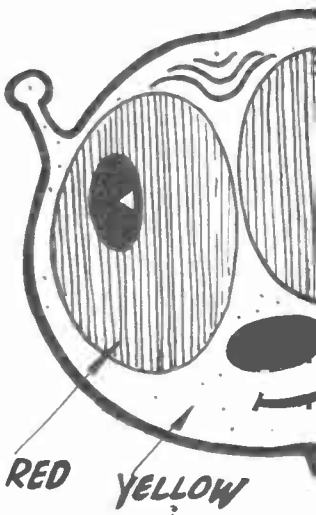

RED YELLOW

THAT DOESN'T NEED "BRUSH-OFF"

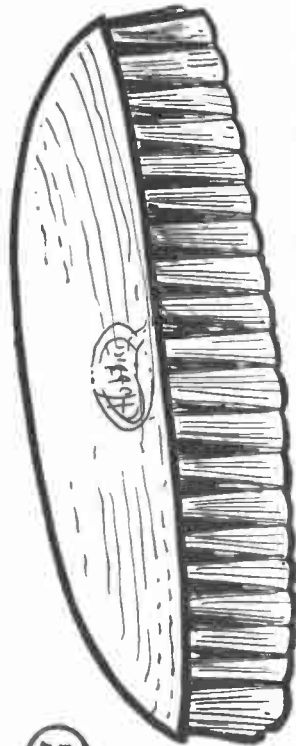

HOBBIES MINIATURE CLOTHES BRUSH
Price 2/5 PLUS POSTAGE.



BLACK

PIECE C. CUT ONE 1/4"



HANDYMAN'S PROJECT

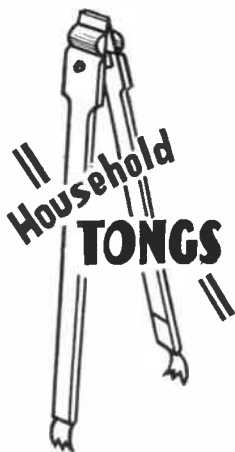

FOR keeping the hands clean when stoking up the living room fire, or lifting clothes from the boiler on wash days, a pair of tongs is indispensable. A simple pattern of tongs which can be made at home with items, mostly from the junk box, is described here.

Tongs need a spring to keep the jaws apart, and for this purpose use can be made of a spring paper clip of the common type, to be bought at any stationer's. For the tongs here mentioned, the clip measures 1 $\frac{3}{4}$ ins. long, but larger or smaller kinds would suit if the width of the legs were amended in proportion.

The legs (A) are cut to the dimensions given from hardwood, $\frac{3}{4}$ in. to $\frac{5}{8}$ in. thickness (Fig. 1). That portion of each leg, reduced to 1 in., should have its top side edges rounded off a little (not too much) for comfortable handling. If the tongs are required for lifting wet clothing from the wash boiler, the more usual metal claw jaws may be considered unsuitable, as liable to rust, and also to tear the clothes. Instead, therefore, wooden jaws are substituted. These are simply strips of the hardwood, $\frac{1}{2}$ in. wide, screwed at the bottom of the legs. Use brass screws and bevel off the strips, as at (A).

For handling coal, metal jaws are made. These are shown at (B), rear and side view. They are 1 in. by 2 $\frac{1}{2}$ in. strips of stout sheet metal, with teeth filed at one end, and bent inwards. These might be cut out from a disused strip hinge, if sheet metal is not available. Another method would be to utilize an old mild steel hinge (C), 2 $\frac{1}{2}$ ins. long. This should have its knuckle cut out, the two leaves left being screwed together side by side, and filed and bent as at (B). Drill for screw holes as necessary, and screw to the inside of the legs.

The legs are now fixed to the finger grips of the clip and there secured with

a screw bolt of suitable size. The length of these bolts should not exceed $\frac{3}{4}$ in. or they prove difficult to get in position. First, in each leg, bore a hole through for the bolt to pass. The position of the hole is important, as the edge of the leg must butt up against the spring, as at (D), in Fig. 2, to prevent it shifting sideways. The distance given for the hole will, in most cases, be about correct, but it would be as well to test by laying the leg in position on the finger grip, and run-

ning a pencil round the hole in the grip to mark its place on the leg.

To fix, first drop a small metal washer over the bolt, then pass it through the hole in finger grip, then through the leg to the outside. Thread a nut on, and twist it up tight. Treat both legs alike, when both should be firmly attached to the spring, with no tendency to move sideways. Fig. 2 (E), shows the inside face of one leg, and how the bolt is first secured through one of the finger grips of the paper clip. (W.J.E.)

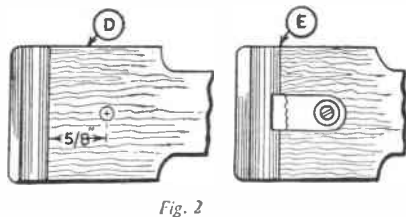
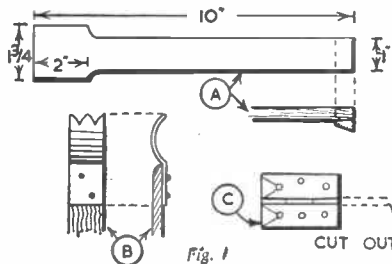

Continued from page 164

Marionette Control

may find it shows well above the collar.

Before dressing, put small brass screw-eyes just above each knee, one in the back, and one on each shoulder. These latter should be as wide apart as possible. These are to take the strings which will eventually support the puppet.

The great secret about dressing a marionette is to use easily flexible material, and to leave it loose round all joints. Drawing pins and glue are frequently used to hold the clothes in position, the former often being used for decorative purposes. Buttons can be made of small beads, nail heads or brass paper rivets. In cases where hemming is tricky it suffices to run a little of the now widely sold fabric glues along the edge of the material. One last point — use as little material as possible. If only a shirt front is to show beneath a coat, then do not make the complete shirt, make the front only and glue it on.

Almost every puppeteer has his own type of wooden control to which all the strings of the figure are attached. The English Upright control shown in Fig. 9 is very suitable for larger puppets. It consists of a wooden dowel about 8 or 9 ins. long and a crossbar fixed firmly on about 2 ins. from the bottom. The end of a wire hook projects slightly in front, and on this is suspended a detachable leg bar. Between the crossbar and leg bar, a large screw-eye is put in and through this runs a wire which is twisted

so that it cannot come out, yet is still free to swing. The two ends are bent into small loops through which the hand strings are threaded.

Hold the control upright between the hand wire and the leg bar. The hand wire rests on the middle finger, with which it can be moved. To make the figure bow tilt the control forward. The leg-bar should be taken off by the free hand for walking.

When stringing a puppet start with the head and then make all other strings just taut when the puppet is in a normal position. Use No. 18 carpet thread for the strings, either black, brown or dark green.

Small screw-eyes are set behind the ears for the head strings, and holes drilled for the hand strings. The screw-eyes under the clothes can be reached by a threaded needle. Leg strings are fitted about $\frac{1}{2}$ in. above the knee joint.

You will find walking the most difficult thing to make your puppet do, but that is a matter of practice. Practice will not make perfect, for one can continue improving one's manipulation after years of practice. You will find your puppet has a way of his own in doing things, and each different puppet you make will have its own individualities. One thing is certain, after only a little practice you can gain a reasonable skill and more than enough enjoyment to reward your efforts.

PROCESSING 'PAN' FILMS

DURING the last year or so photographic manufacturers appear to have ceased making the popular orthochromatic films widely used by amateurs, replacing them with the panchromatic variety. No doubt the latter reproduce all colours much more faithfully, but the amateur may be disturbed to find that development must be undertaken in total darkness, the ruby light being useless, and that he does not feel capable of such a task.

By S. H. Longbottom

This difficulty can be overcome by using a special safelight screen of dark green/blue supplied by dealers from size 7ins. by 5ins., a standard for most safelights. You should ask for an Ilford 908 GB (Green/Blue) screen, but note that when processing it is essential that the rays — which are, indeed, no more than a glow — do not shine directly on the film. In practice it will be found that the eyes very quickly accustom themselves to this restricted light, and after about ten minutes in the darkened room, it is easier to see the dishes, etc., even if in a shadowy form, than you may at first imagine.

As stated, the panchromatic film is sensitive to all colours, demanding a perfectly blacked-out darkroom to avoid any possibility of fogging and sometimes it is advisable to leave processing until nightfall. There is, however, no need to process in complete darkness, and the safelight mentioned may remain alight throughout, providing you remember to turn it away from the film. An investment in such a screen will be worthwhile if you like to process your own films, but for the occasional film it is possible to make a miniature safelight for use with a flashlamp bulb and battery. Obtain a small glass jar about 3ins. deep, with a screw-top lid, drilling a hole in the centre of the latter for a small bulb holder. Wires are led to the battery, a bulb inserted in the holder, and the glass base screwed into position. The latter should be covered with *very dark blue/green* material or painted on the outside in that colour.

The light penetrating such screens is very dim, but it can be said quite truthfully — and the writer has developed hundreds of films in this fashion — that after about ten minutes in a fully blackened room with only such a light, the eyes adjust themselves to the conditions, and can see the dishes quite plainly. This is something which

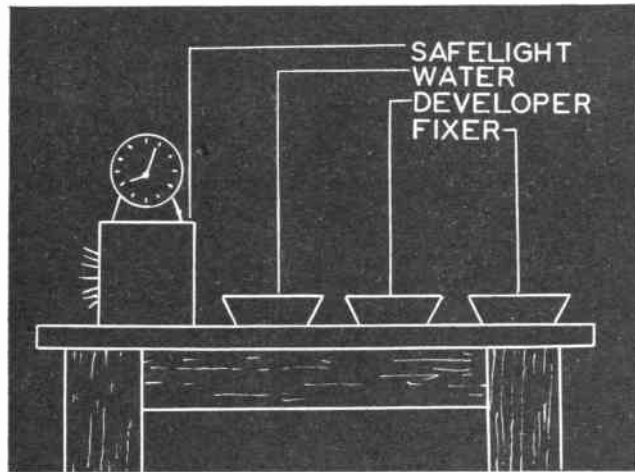

has to be experienced to appreciate, yet it is even possible to see the progress of the image building up on the film.

You are, therefore, recommended to prepare your workbench in normal light, arranging your dishes in a set order as shown in the diagram, and almost touching, so that the chemicals do not spill when working from one to the other. The safelight is directed *away* from the working area, and can be left alight during the processing without ill effect. You are also advised to arrange that a clock or watch, with a luminous dial, stands before you, and that you work to the time and temperature tables of development as indicated by the manufacturers. In this respect it must be emphasised that constant agitation of the solution by see-saw development is much quicker than the tank method, but often some allowance is made for this in the prescribed tables, for any over development will produce negatives which are much too contrasted for success.

Bench layout

Reference to the diagram will show the layout of the working bench. First a dish of water for pre-soaking and rinsing, a dish for the developing solution and a dish for the fixing solution, with a clock for timing. By standing centrally in front of the set of dishes you also enjoy the advantage of being able to feel the positions by mere touch.

The routine is quite simple and we will assume that the equipment is prepared, the dishes filled with their respective solutions, and the temperature has been verified. It is most important that the developing solution is at the

normal temperature of 68°; only a thermometer will verify this. If it is too cold, pour in a bottle and leave standing in a basin of hot water until the temperature rises sufficiently. In really cold weather the temperature can be maintained by placing the developing dish in another larger dish containing warm water.

The door has been closed and the windows sealed, so that we have only our tiny safelight, but, after waiting until the eyes have accustomed themselves we can break the seal of the film for processing. After unrolling the backing paper a short way we come across the free end of the film. Place a bulldog clip on this end immediately, after which the remainder of the film can be unrolled. You will discover that the other end of the film is stuck to the backing paper by means of a strip of adhesive tape. Tear off the film, fastening with a clip before it endeavours to tie itself into knots, which it will surely do if left to itself. We have to overcome this curling tendency before developing, so the remedy is to give a pre-soaking. If the film is now held with one end in each hand with the emulsion side downwards (this side has a natural tendency to curve inwards) and a little pressure applied to the back by the thumbs where it is held, the buckling will be obviated. The film should now be soaked in the clear water by running through in a see-saw fashion several times until it is pliable and in a manageable condition. Allow surplus water to drain, and you may proceed to the developing.

'See-saw' development

It is assumed that the temperature of the developing solution has been

checked and you are to use the time and temperature method of development. With your eye on the clock for the time of starting, one end of the film is immersed, emulsion side uppermost this time, in the liquid, and gradually pulled upwards as the other end descends. This is what we term see-saw development, a method used successfully long before the introduction of tanks. Many workers find it the most successful, not only because they can see the progress, but also because the solution is in constant, regular agitation and the chemicals do not sink to the bottom of the dish. A slow, steady action is required, for rapid up and down movements may cause bubbles to form in the developer which ultimately find their way to the surface of the film, preventing any chemical action should they remain.

When developing time is completed, the film is given a quick rinse in the plain water dish and then passed through the fixing bath until the creamy

appearance has vanished, leaving the film in its customary black and transparent state. It should be noted that when the film has been in the fixing solution a few minutes and the developer then neutralised it becomes possible to allow more illumination and you can work with the aid of ordinary ruby light.

The film is washed thoroughly after fixing in running water for at least thirty minutes and then hung up to dry in a warm — but not hot — dust free atmosphere.

Here we would like to mention some other aids you may find useful in attaining successful processing, first of which is what is termed a wetting agent. This is a special substance which reduces surface tension and permits even spreading of liquid on the surface to be treated. When you withdraw a film from plain water you will find it covered with patches of globules, but large areas remain unaffected. If you add a wetting agent to the water you will find that the

film is evenly wetted.

It is an obvious advantage to run the film through a bath of water containing a wetter which will speed the draining of the water from the film and avoid those tiny excesses in odd parts. A small bottle of this substance can be bought cheaply and is suitable for films and prints. Most photographic dealers will supply and a small bottle lasts a long while.

Scratch protection

We have only mentioned the fixing bath in brief terms, but remember you may use either plain hypo crystals, acid fixer or acid-hardening fixer. The latter hardens the film and not only permits drying at higher temperatures but also gives the emulsion added protection against scratching. Incidentally, it is possible to purchase chemicals for scratch proofing films if you wish to take this extra precaution, but in most instances the acid hardener fixer will be quite sufficient.

Amusing Jimmy, the Jumping Bean



THE elongated capsule with rounded ends, containing a free-to-move metal ball and commonly known as the Jumping Bean, is familiar to all. Young and old never fail to be intrigued by its antics as it somersaults down a tilted board in quite a lifelike manner. Schoolboys often manufacture Jumping Beans from scraps of metal foil, though most of the beans sold nowadays are made from plastic. Here is a grown-up version of the Jumping Bean which is well over sixty years old.

Jimmy is really a monster Jumping Bean made from a table tennis ball and a cardboard tube. Carefully cut a ball into two equal parts, using a razor blade to make the first incision and a small pair of scissors to complete the cut. Make a light cardboard tube $1\frac{1}{2}$ ins. long, with a circumference very slightly less than that of the half balls. Secure the tube with a strip of Sellotape. Fasten the

half balls on to the ends of the tube, using Sellotape, but place a heavy ball bearing into the capsule before you finally seal it up. You will now have an outsize Jumping Bean which must be dressed and disguised to resemble a little toy man.

Make a pair of trousers for the figure, but let the trousers legs be horizontally outwards. Cut two pieces of cloth to size, sew up carefully and turn the miniature garment inside out. Glue the trousers on to one end of the body. Feet and shoes can be made in coloured paper and glued just inside the trousers legs. Use coloured paper to make a jacket and upward pointing arms. Glue the jacket and arms in place. Finally, decorate the face with paper eyes, nose, mouth and ears, and add a bow and buttons to the jacket. When you have finished, Jimmy Jumping Bean will be the joy of any small child.

If you sit the figure on the top of a sloping board and then give it a slight push, it will somersault downwards in a most entertaining fashion, owing to the behaviour of the rolling weight inside. Jimmy will also stand upon his head with ease when on a level surface. (A.E.W.)

A GARAGE ON A MOTOR BIKE

EVERY year, the AA Road Patrol Service helps thousands of motorists who get into difficulty on the roads. The patrols are mounted on yellow motor Road Service Outfits, and their comprehensive equipment enables them to undertake all running repairs and to deal with any emergencies — in fact they're almost a garage on a motor cycle.

One of the latest Dinky Toys models is a grand miniature of these road patrols complete with driver in the distinctive khaki uniform. Die-cast in solid metal, with rubber tyres, and finished in lead-free black and yellow enamel, it is a model that will add interest and realism to all layouts. The length is $1\frac{3}{4}$ ins. and it costs 2/3.

Webley

AIR PISTOLS



Send
for
Catalogue

High Accuracy
and Hitting Power
Perfect Balance
Robust Construction

WEBLEY & SCOTT LTD.

34 PARK LANE, HANDSWORTH, BIRMINGHAM 21

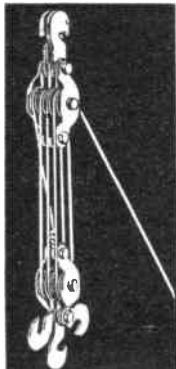

The HALTRAC MIDGET HOIST

Weights 1 lb. Tested to lift 1,000 lbs.

57/6 plus 1/6 p. & p.

will pull or lift anything. Self-lubricating solid nylon pulleys — 72 ft. nylon rope — rustless aluminium construction throughout. Standard equipment for the Motorist, Caravaner, Gardener, Workshop, etc, etc.

Send **NOW** to manufacturer
HALTRAC LTD. (Dept. HW.2)

**BOURNE WORKS, WEIMAR STREET,
LONDON, S.W.15**

Trade enquiries also invited

LET

★ 'Plasticine'

HELP YOU DO-IT-YOURSELF Regd. Trade Mark
Harbutt's Plasticine Ltd, Bathampton, Bath

The 'WENSUM' Sailing Dinghy

by P. W. Blandford, A.I.N.A.

and The 'VENTURER' Outboard Motor-boat now being manufactured by

PORTACON (PANGBOURNE) LTD.

The Wharf, Pangbourne, Berks. Telephone 567

Personal and Trade enquiries invited

'WENSUM' DINGHY KITS

Canoes and Dinghies, kits and finished craft. Marine Ply. Oars, Paddles and Materials.

Stamp for details

H. W. PALSER

1 Dean Road, Erdington, BIRMINGHAM 23 ERD 0870

LADY'S SEWING 'COMPANION'

ALSO FOR
USE AS
A SMALL
TABLE



MAKE IT FROM
DESIGN No. 3278

A well-designed piece of furniture in contemporary style to hold all sewing and mending materials, etc. When closed it serves as a handy occasional table.

Today's value is in the region of £9 but a big saving can be made by working with Hobbies Kit No. 3278, price 65/-. This contains all planed wood panels, contemporary legs which are simple to fit, hinges, etc. Kits from all Hobbies branches, etc., or post free (see coupon).

Send for details of other furniture kits which will save you pounds.

To HOBBIES LTD., Dept. 99, DEREHAM, Norfolk

Please send details of furniture kits and Kit No. 3278 for Lady's Sewing Companion, price 65/-.

Name

Address

HOW TO LAY ROOFING FELT

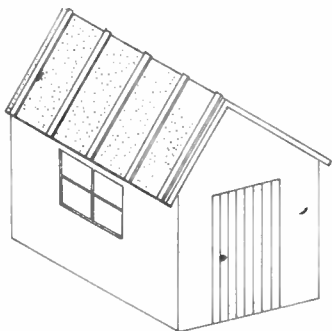

IF you have just constructed a garden shed, garage, out-building, etc., and wish to make the roof weatherproof by applying some roofing felt, then the following notes may be of some value. Felting a roof is quite a simple job to do, and when tackled properly and conscientiously it will remain serviceable for many years.

By Finlay Kerr

Roofing felt is obtainable in rolls 12yds. long by 1yd. wide. Generally speaking, felt is sold only in rolls, but some large stores cater for the 'small jobber' and will cut smaller pieces of felt to suit your own requirements. When buying roofing felt always get the medium or thick grades which will give you longer service. The thin cheaper types of felt tear very easily, and although their initial cost is less, they are uneconomical in the long run.

Like linoleum, roofing felt stretches a little once it is rolled out, so to avoid bulging after it is laid, it is advisable to open it out on the lawn or path for a few hours before fixing it in position. This will give it a chance to get accustomed to outdoor conditions.

Roofing felt is quite easy to cut. The best tool to use for this task is a lino knife; the hooked part being specially suitable for cutting material of this nature. Lay a wooden straight-edge along the line of cut, and draw the knife towards you, using the straight-edge as a guide.

The roof surface must also be carefully prepared. Ensure that the heads of all nails are punched below the surface and that the roof boards are reasonably flat. Protruding nails and uneven boards will only damage the felt once it is laid.

It is a good plan also to give the roof boards a good coat of creosote or some other preservative first.

Start by laying the first length of felt horizontally across the roof at the bottom (or eaves). The felt should be bent about 2ins. over the ends and eaves and tacked in place. Use galvanised clout nails, which are specially suitable for this job: don't attempt to use any other type of nail as a substitute. Nail the first length along the edges and ends of the roof boards at 2in. intervals. When this is done, repeat with another length of felt, lapping this one over the top of the first length by at least 3ins., as shown in Fig. 1. Nail along the lapped

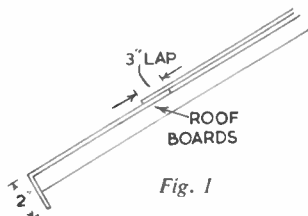

joint at 2in. intervals. Continue in this way until you arrive at the ridge.

The illustration at Fig. 2 shows the treatment at the ridge. Don't carry the top sheet over the ridge on to the other slope. Instead, cut a strip of felt 12ins. wide and cap this over the ridge; 6ins. on each slope. Insert the nails at the bottom edges of this capping piece and not through the top.

To give additional protection to the felt against the wind, 1½in. by ½in. battens should be fixed at 2ft. 6ins. intervals up each slope as shown in the main illustration. When fixing these battens in position remember to use wood screws. Nailing is not satisfactory because if the timber warps or twists, the nails are liable to get eased out slightly and allow rain to penetrate under the felt. Screws, on the other hand, offer a much greater holding power. It is advisable also to creosote the battens before fixing to make them more resistant against the weather.

A slightly different treatment is necessary when felting a 'lean-to' — a

single sloping roof built against a wall. The method of finishing off the top part where the roof meets the wall is to make a flashing from a strip of felt and tuck the upper edge into a joint in the brickwork, as shown in Fig. 3. Repoint the brickwork joint with a 1:3 cement/sand mortar filling.

Whenever possible, always try and avoid the use of vertical joints when laying roofing felt, because they can be rather troublesome. However, if you

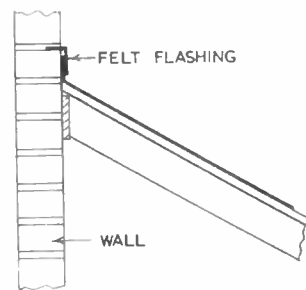
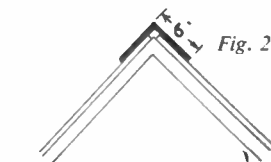

Fig. 3

find that you must make a vertical joint, then make it with at least a 9ins. overlap.

Finally, bear in mind that it is best to tackle your felting jobs on a dry calm day. Working with long lengths of felt during windy spells can be rather tricky, and in some cases dangerous.

Next week the free design will be for making a delightful Weather House in the form of a Swiss Chalet. Make sure of your copy.



**Introducing YOU to an
ABSORBING HOBBY with beautiful
really worthwhile RESULTS**

Some of the beautiful, interesting and useful items include fish tank models, sea shells and starfish; butterflies and moths; seasonal display flowers; model gardens and floating water lilies, etc.

All the models can be made from coloured paper and easily obtained materials of exceptionally low cost. The book is illustrated throughout with colour and monochrome photographs as well as many 'step-by-step' line diagrams.

An essentially practical book which will be tremendously useful for educational and therapy work.

- COLOURED PAPER DECORATION 7/6d.
- COLOURED PAPER CRAFT FOR SCHOOLS 7/6d.
- COLOURED PAPER CRAFT FOR INFANT SCHOOLS 6/0d.
- LAMP SHADE AND PARCHMENT CRAFT 8/6d.
- PASSE PARTOUT FOR SCHOOL AND HOME 8/6d.
- GUMMED STRIP AND PAPER MOELLING 7/6d.
- PAPER SCULPTURE FOR SCHOOLS 7/6d.

Other works
by **FREDERICK T. DAY**

All books obtainable from:
Newnes & Pearson Ltd.
Tower House, Southampton
Street, Strand, W.C.1
Ask your stationer to show you the
Butterfly range of handicraft
materials



8/6

SAMUEL JONES & CO. LTD.
STATIONERY MILL, CAMBERWELL, LONDON, S.E.5. RODNEY 5064

The Pride of any Boy

'JAPONICA'

A magnificent Sailing Cruiser with Auxiliary Motor

This fine model of a characteristic craft used on the Norfolk Broads is 20 ins. long. Extra mechanical power is provided by a Mighty Midget electric motor and propeller unit.

Make this magnificent craft with Hobbies Kit No. 3254 containing all wood, materials, motor, propeller, metal keel, etc., and easy-to-follow instructions. From branches, stockists, etc., or by post.



GET A KIT TODAY

To **HOBBIES LTD.**,
Dept. 99, Dereham, Norfolk

Please send free copy of 'Profitable Leisure' and 'Japonica' Kit No. 3254.
P.O. for 65/- enclosed.

Name

Address



'JAPONICA' Kit No. 3254 65/-

FREE 20-page booklet 'Profitable Leisure' showing kits available for dozens of other exciting models (ships, aircraft, etc.)

Make Your Own
MUSICAL CIGARETTE BOXES etc.

with

Hobbies
kits & outfits

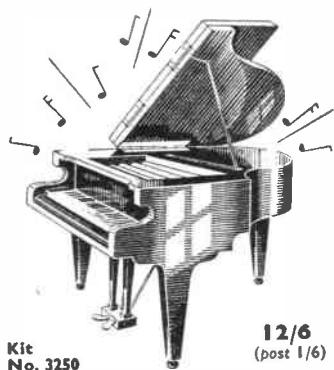

12/6
 (post 1/6)

Kit
 No. 3250

GRAND PIANO. Kit includes printed keyboard. Fit with Musical Movement No. 1.

Other models detailed in free Booklet

To Hobbies Ltd., Dept. 99, Dereham, Norfolk. Please send free copy of 'Profitable Leisure' and items detailed.

Kit No.
 Musical Movement.

Name
 Address
 P.O. for enclosed



11/6
 (post 1/6)

Kit
 No. 3222

MUSICAL TAVERN. A savings box which plays a tune when you insert a coin. Fit with Musical Movement No. 2.

- Fit your box with one of these tunes
- No. 1 Movement 15/6 (post 6d.)
 - F Harry Lime Theme
 - H Parade of the Wooden Soldiers
 - O Auf Wiederseh'n
 - Z Gounod's Ave Maria
 - No. 2 Movement 16/9 (post 6d.)
 - R Happy Wanderer
 - S Teddy Bears' Picnic

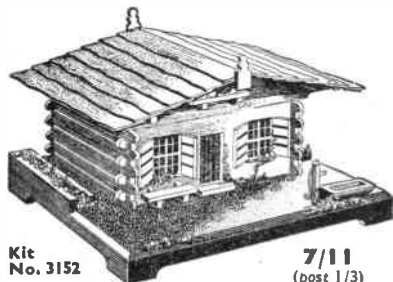

7/11
 (post 1/3)

Kit
 No. 3152

SWISS CHALET. Lift the lid to offer a cigarette and it plays a tune. Fit with Musical Movement No. 1.

BUYING OR SELLING?

Classified advertisements on this page are accepted at a cost of 6d. per word prepaid. Use of a Box No. is 1/- extra. Send P.O. with advertisement to *Hobbies Weekly*, Advert. Dept., Dereham, Norfolk. Rates for display advertising on application.

EXTRA CHEQUES from writing. Send for 'Ideas for Writers' (free). Scores of suggestions for beginners and others. Typewriter unnecessary. — Writers' Ring (H.W.), 5 Edmund Street, Birmingham 3.

PERSONS required, to make new type fancy cushion covers. Apply, enclosing S.A.E. — Dept. 28, Arnold Trading, 10 Shelley Rd., Worthing, Sx.

LEARN RADIO and ELECTRONICS the NEW practical way! Very latest system of experimenting with and building radio apparatus — 'as you learn'. FREE brochure from — Dept. HW10, Radiostructor, 46 Market Place, Reading, Berks.

BUILD YOUR OWN HI-FI at home! At last, for reasonable cost — the chance to make your own quality HI-FI audio equipment and to gain the knowledge to service and maintain it. FREE brochure from — Dept. HW20, Radiostructor, 46 Market Place, Reading, Berks.

FREE — Homeworkers' opportunity. S.A.E. — Esprey, 29 Newman's Grove, Rugeley, Staffs.

MAKE A MUSICAL BOX for as little as 21/-. New kits and tunes available. Movements 13/- post free. Please send 3d. stamp for free illustrated catalogue. — The Swisscross Co., Dept. B, 202 Tulse Hill, London, S.W.2.

Further Reduced

Brand New Slip into it—soft and comfy—enjoy restful sleep throughout night. No blankets, no sheets, everything in one including special padding for a beautiful soft mattress effect. Light as a feather, it rolls up to a tiny lightweight size. 19/11, post 2/6. Even finished in heavy quality strong material. Really hardwearing. Not a blanket with outer, but genuinely quilted. LISTS, WATCHES, etc. Sent for 10/-. bal. **1/2 PRICE OFFER!** **SENT FOR 10/-**



LUXURIOUSLY QUILTED 'QUILTERFOAM' SLEEPING BAGS ONLY 19/11 POST ETC 2/6

The **FLIGHT LIEUTENANT** **Genuine NEW WATERPROOF Box DUCK TENT** **SENT FOR 10/-**



Waterproof 1959 Tents of 8 oz. WHITE Duck. Galeproof Brand new, surplus to export order. **DON'T CONFUSE** with Tents made from drab material never meant for tentage. This is real thing, withstands anything even in our climate. Approx. 7ft. 6in. x 6ft. x 6ft., 3ft. walls. Cash £5/17/6, carr. 6/- complete ready to erect, incl. valise. 'Willesden' Green 42/- extra. Ridge pole if req. 7/6. Flysheet available 37/6. Rubberised Groundsheet 19/6. LISTS, TENTS, ETC. TERMS. **Headquarter & General Supplies Ltd. (HOBW/66) 196-200 Coldharbour Lane Loughboro' Junc., London, S.E.5. Open Sat.**

Completely new 54 page Edition
WHERE'S THAT CAR FROM ?

Price 1/- (Postage 4d.)

Of all Booksellers
 or

RALEIGH PRESS, Exmouth, Devon

100 DIFFERENT stamps free! Request 4d. upwards discount approvals. — Bush, 53 Newlyn Way, Parkstone, Dorset.

STAMPS FREE — Empire Packet including Pictorials and Victorians with approvals. — Robert J. Peck, 7A Kemp Road, Bournemouth.

STOP SMOKING! Quick guaranteed remedy. Testing sample free! — Triumph Remedies (A16) Exeter.

FREE — Albums, Accessories, if you buy my 4d. upwards approvals. Write for details. — B. E. Plumb, 32 Garfield Rd., Enfield, Middx.

"SUPER-STAMPS" — 25 stamps FREE, and S'good bonus on all purchases of our low-priced approvals. — "Super-Stamps", 4 Longmead, Tonedale, Wellington, Somerset.

EXCITING new "Pocket Cricket" Game and free gift of stamps (including Portuguese Indies set). Only 4d. stamp for quality approvals. Tereda Products, 155 Halton Road, Sutton Coldfield, Warwickshire.

THE 'LOCO' EGG TIMER

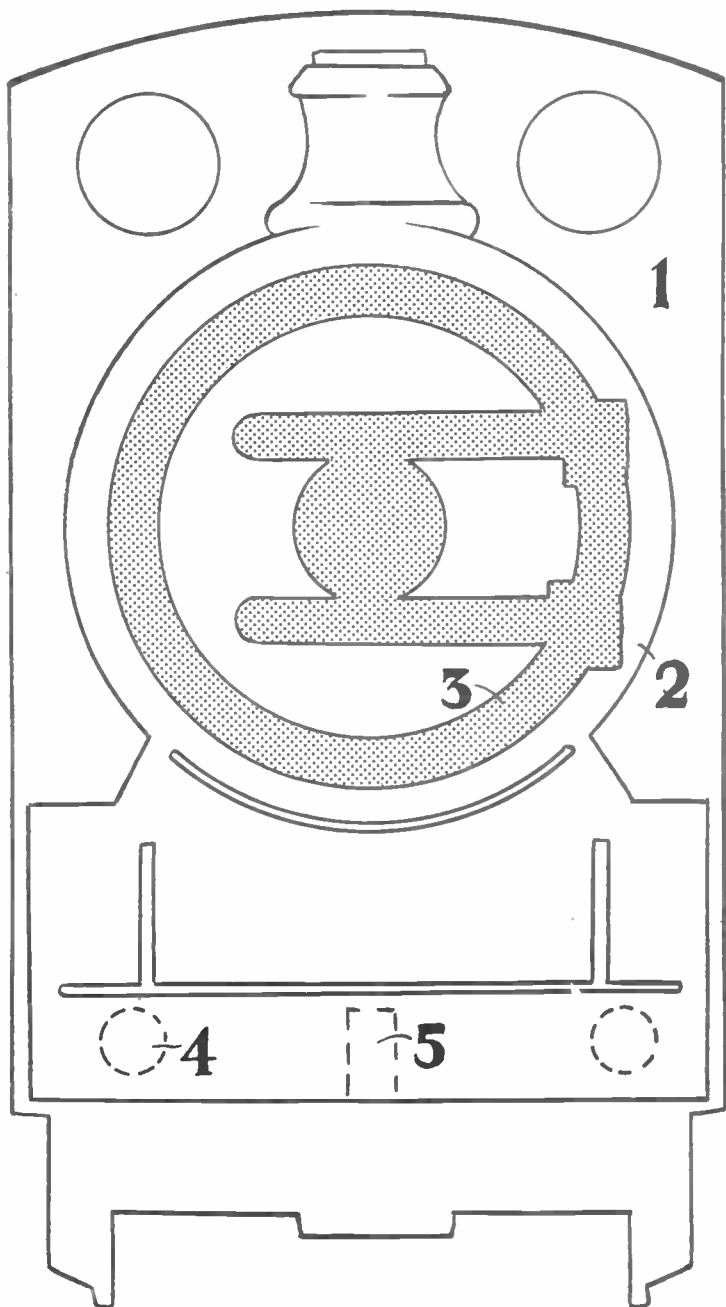

CUT one each of pieces 1, 2, 3 and 5, and two of piece 4, from $\frac{1}{4}$ in. wood. Glue piece 2 to piece 1, piece 3 to piece 2 and pieces 4 and 5 to piece 2. Paint with high gloss enamel and add the egg timer by means of the special clip illustrated. Screw a wall hanger on the back or add a strut from waste wood.

An egg timer and clip may be obtained from Hobbies Ltd., Dereham, Norfolk, price 1/1, postage 3d. (M.h.)

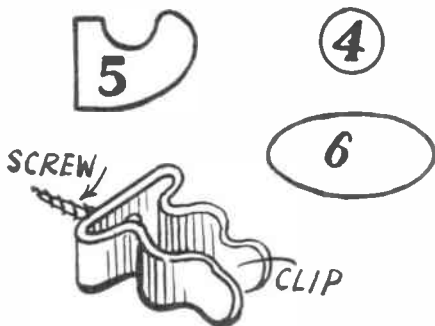

Add this new model to your

KITMASTER COLLECTION

A new model every month—that's Kitmaster!
And only Kitmaster gives you authentic models of the
world's most famous railway engines.

This month it's the Saddle Tank.

No.6 SADDLE TANK—4/6

First used on the Lancashire & Yorkshire
railway in 1891, this unique old dock
shunter has its water tank
saddled over the top of the boiler.

Add this interesting new model
to your collection.

In all good model
and toy shops *now*.

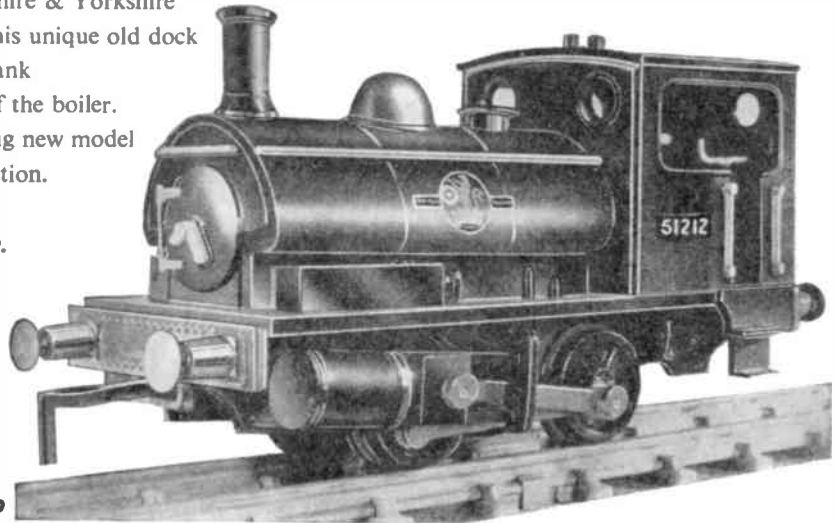

**HAVE YOU
MADE THESE
EARLIER MODELS?**



No.1 Stephenson's "Rocket" 4/6d.



No.2 Diesel Electric Shunter 4/6d.



No.3 Early American "General" 6/6d.



No.5 Schools Class "Harrow" 7/6d.



***Authentic models with
moving parts.***

***Can be used on OO
and HO gauge tracks***

A new model every month!

ROSEBUD KITMASTER LIMITED

KCM2