

29th APRIL 1959

VOL. 128

NUMBER 3313

THE ORIGINAL
'DO-IT-YOURSELF'
MAGAZINE

HOBBIES *weekly*

FOR ALL
HOME CRAFTSMEN

Also in this issue:

RADIO CONTROL
TRANSMITTER

AQUARIUM FOR
'TROPICAL' FISH

CHEMISTRY

WINE MAKING

PATTERNS FOR
FRETWORKERS

COLLECTORS' CLUB

PHOTOGRAPHY

ETC ETC

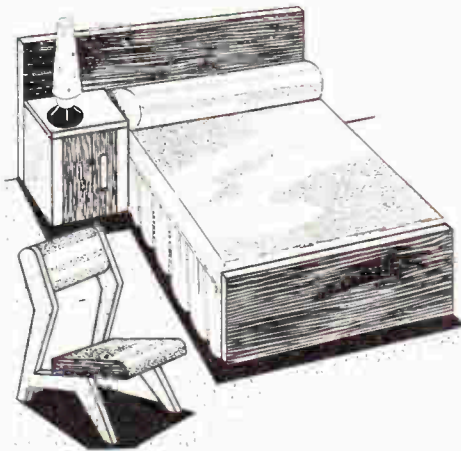

**PATTERNS FOR
DOLLS' HOUSE
FURNITURE**

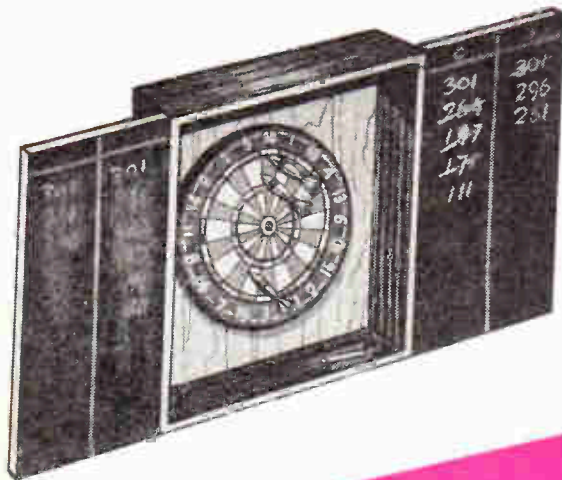

**MAKE A
DARTBOARD
CASE**



Up-to-the-minute ideas

Practical designs

Pleasant and profitable things to make

5^D

A 'TROPICAL' AQUARIUM

WE have already dealt with the keeping of cold water fish, and although these are eminently suitable for those who do not wish to arrange heating and thermostats, the scope is very limited.

The keeping of tropical fish is quite a popular hobby at the present time, and is not so expensive or difficult as many people imagine. When a tropical

By P. R. Chapman

aquarium has been installed, it is probably less trouble to maintain than a cold water one. The chief difficulty of the latter is the growth of green algae in the water and on the glass if too much daylight reaches the tank, and there is also the problem of overheating during hot weather. A tropical tank, on the other hand, is invariably illuminated with artificial light, which is far less prone to encourage algae, and, when maintained at 70-75°F, it is unlikely to become too hot even in summer.

We dealt with the construction of an

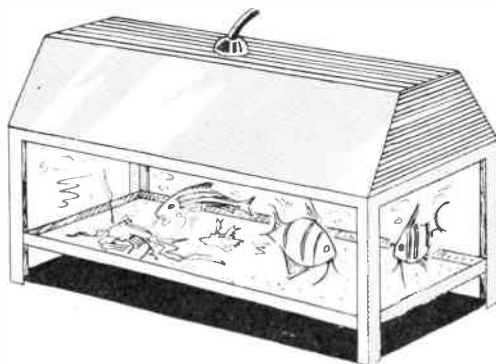

long life. The wattage of the heater must, of course, be sufficient to maintain the required temperature when the room temperature is at its minimum, and it is advisable to have a bit in hand. When correctly set the thermostat will cut out the heater at the required temperature, so that an excess of watts does not matter.

$$\begin{aligned} \text{Watts} &= \frac{75-50}{10} \times 11 \times 2\frac{1}{2} \\ &= \frac{25}{10} \times 11 \times 2\frac{1}{2} = 68\frac{1}{2} \end{aligned}$$

Thus a heater of 70-75 watts would be suitable under these conditions.

This is, of course, only an example,

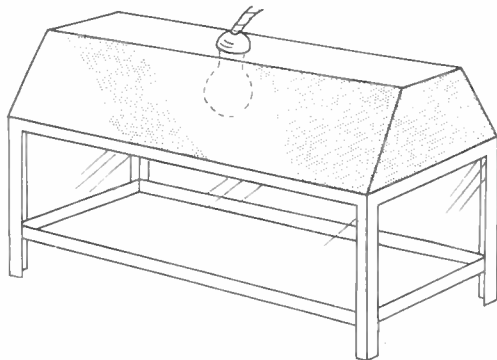

Position of the lamp

aquarium in the article on cold water fish, and a tropical aquarium can be exactly the same, except for the location. It is better to keep it away from a window, and it is most satisfactory and decorative in a darker corner of the room. It must, of course, be supported on a strong table or metal stand.

The temperature of the water in the tank will be anything from 70-85°F, according to the types of fish kept. This is easily produced and maintained to within a degree or two by means of a small immersion heater and a thermostat. These will cost about ten shillings each from most pet shops, and are an initial outlay only, for they both have a

The actual minimum wattage required can easily be calculated as follows:—

$$\text{Watts} = (\text{Tank temperature} - \text{room temperature}) \times \text{tank capacity in gallons} \times 2\frac{1}{2} \div 10$$

Naturally the figure taken for the room temperature must be the lowest one ever reached in the particular room, and will depend upon whether or not it is heated in winter. We will take an example, considering a tank 18ins. by 15ins. by 12ins. This has a capacity of about 11 gallons. If we assume it is to be kept at 75°F and that the room temperature is 50° (lower, of course, in an unheated room in winter), we have:—

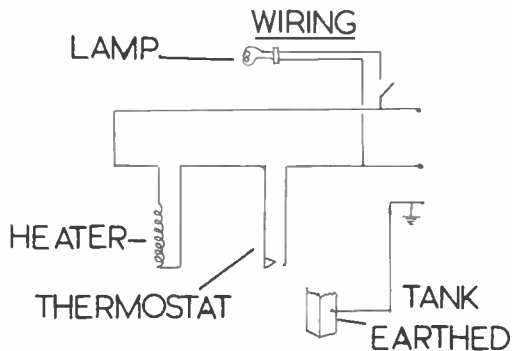

Circuit details

and the required figure for individual cases must be worked out in the same way. Since the amount of heat supplied to the water depends upon the thermostat setting, a higher wattage heater than necessary will not cost more to run.

Instructions for setting the thermostat should be included when the instrument is purchased; it is usually effected by immersing in water of the correct temperature and adjusting a screw until contact is just broken. The common types of heater and thermostat are enclosed in glass tubes and are intended to be completely immersed.

The only other addition to the aquarium described for cold water fish

is a lamp for the top, fixed in an elongated lamp holder made of tinplate or aluminium, which should, of course, be provided with air ventilation holes or vents. Details of this can be seen in the sketch, and also the circuit for the lamp, heater and thermostat. Although the fish will not be concerned about the construction of the lamp, if the whole set-up is to have decorative value, it should be as neat and well-made as possible. A 40-60 watt lamp should be sufficient, and it will probably be switched on during the evening when the room is occupied. To avoid any possibility of accident, the metal framework of the tank should be earthed.

Suitable fish

The filling of the tank, including gravel and stones, is exactly the same as previously described for the cold water aquarium. There is, however, a wider choice in suitable fish, most of which are much smaller and more brightly coloured than their cold water cousins. The great advantage of a tropical tank is that it can be stocked with tiny colourful fish at a price to suit most pockets. If you want to keep down the cost as much as possible, the common 'Guppy' is most suitable. These are very cheap (unless you go in for the fancy varieties), and fish keepers often find it difficult to dispose of their surplus stock. The males at any rate are quite colourful. These fish are in the class of 'live bearers', that is the tiny young are born alive and not hatched from eggs. There are several fish in this class, and they breed readily. Since they are also mostly 'live feeders', many of the tiny young get eaten, but, given sufficient plants in the water, enough will escape, by hiding away until too big to be eaten. If you really want to produce them in quantity, you will have to separate the female before the babies are born. Even she will eat them unless they can hide!

Most of these fish are comparatively cheap and easy to keep, individuals living about two years. 70°F is a suitable temperature. In addition to the Guppies may be mentioned the elegant green, red and yellow Swordtail, larger than the Guppy, with a long spike on the tail of the male, the dark green Platy, and the grey to black Mollie. The latter in particular should not be overcrowded, and they do not always mix well with other fish.

The vast majority of tropical fish are egg-laying, and, since breeding is more difficult, the fish are, naturally, more expensive. However, if you are prepared to spend a bit more on your hobby, a whole range of brightly coloured little fish awaits you. A visit to a well stocked fish fanciers' shop will indicate the variety and prices.

One of the brightest of these is the tiny Neon fish. As its name implies, it appears to be illuminated with a brilliant blue-green colour. These are fairly easy to keep, but difficult to breed. The Beacon fish have also glowing colours, and these breed fairly easily. The X-ray fish, or Enamel-fin is quite a novelty, appearing almost transparent.

The Carps and Bubble nesters

The tropical carps are slightly larger and amongst them we may mention the Zebra fish, which breed readily. The Bubble nesters, as their name implies, build a nest of bubbles at the surface (the males do this!), and they are also easy to breed. The well-known Siamese fighting fish are included amongst these, and males must not be kept together except when quite young, for they live up to their names! The Gouramis are also interesting types.

Larger fish

Lastly a few words about some of the most interesting of the tropical fish, and also the largest; the Cichlids. Many of these reach a length of 4-5ins., and so require more space. They also have a longer expectation of life than the smaller types, sometimes living to eight years, instead of about two. They will only take live food, such as Tubifex worms or surplus young Guppies. The elegant Angel fish are the most noteworthy of this group, but they are exceptional in being difficult to breed. The Egyptian mouth-breeder is another example, and breeds much more readily.

A few catfish are interesting to keep in the tank, and as they act as scavengers, they are useful. As in the cold water tank, some snails are advisable.

With the exception of the live-bearers, which require about 70°F, the most suitable water temperature is around 75°F. The tanks must not be overcrowded; about a dozen of the smaller types, or a lesser number larger ones, may be kept in an average sized aquarium.

In addition to the plants mentioned for the cold water tanks, a wider variety is available for the tropical fish keeper, some of them being very attractive. There are too many to list here, but, again, a visit to a good aquarist will be useful, and he will, undoubtedly, be pleased to advise.

TWO MINUTE

QUIZ

by Ed Capper

NAME
THE
JOINT

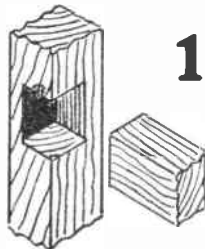

2 HOW MANY CHUFF
BRICKS ARE USED
IN BUILDING A HOUSE?

3

IN
MOSAIC
WORK EACH
CUBE IS
CALLED A - what?

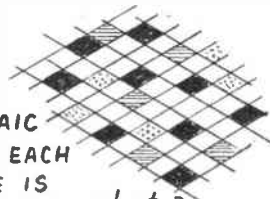

4



NAME THE RIVET HEADS

5

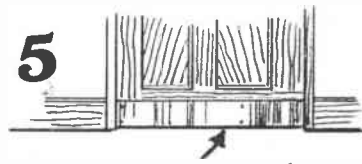

NAME THE METAL STRIP
FIXED TO DOOR BOTTOM

Next week's free design will be for a pull-along toy—an animated bunny rabbit which clangs a bell with a hammer. Make sure of your copy.

ANSWERS ON PAGE 68

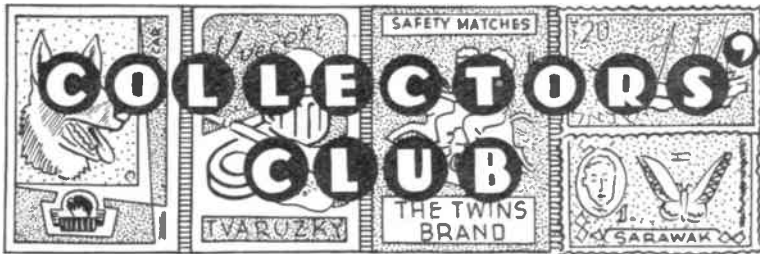

FREMLINS Brewery issue worthwhile labels. The Fremlin Elephant has an interesting origin. He is 396 years old. Born in 1563 as the crest of 'Gilbert Fremling of Newington and of Hartlip', he was incorporated with

FREMLINS ELEPHANT

the arms of 'Robert Fremling of Kensing' to form a trade mark for the brewery, founded in 1861 by four Fremlin brothers.

This original crest appears on a fine

DURING the past year, beer label collecting has become a major hobby. In 1957 collectors were few. Now they are found in every street.

DENMARK'S CARLSBERG

A letter to a brewery requesting labels should run something like this:

'As a collector of beer labels I feel that your covers deserve a place in my album. I appreciate the fact that you suffer from heavy pressure of business, and will esteem it a great favour if you can grant my request. I enclose return postage, apologizing for any inconvenience this letter may cause.'

Works of art, heraldry, languages and many other subjects appear on Carlsberg covers, a set of which will be sent free to all readers who send their request to the Editor, *Hobbies Weekly*, Dereham, Norfolk, enclosing stamp for return postage.



17th century Indian carpet in the Victoria and Albert Museum. Made for William Fremlin, who served the East India Company, the carpet was acquired for the museum by the National Art Collections' Fund with the aid of Mr. Frank Fremlin, last surviving founder of Fremlin Brothers.

A variation of this crest and arms granted in 1936 to the late Alfred Charles Leney, then chairman of Fremlins Limited, was also registered as a Fremlin trade mark.

Originally described in heraldry as 'an elephant statant Or, tusked Gules, wreathed round its neck Vert', the Fremlin Elephant began as one of those painted symbols of allegiance designed to rally men in battle, and has become a sign widely recognised among those who appreciate the finest products of the brewer's art.

All brewery trade marks have an absorbing history. This hobby has become so popular that it can now be termed a major pursuit of young and old. And the breweries are pleased to supply collectors with free labels. But when you write, please enclose return postage. (R.L.C.)

Medium Range Transmitter

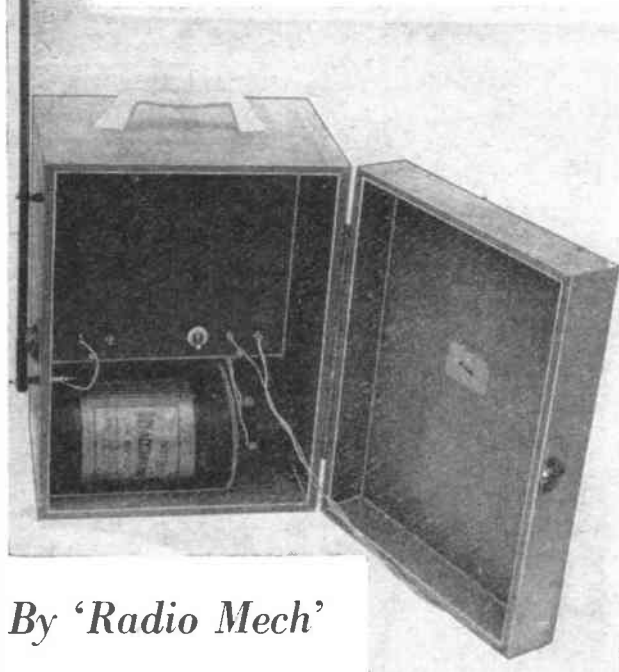

By 'Radio Mech'

A SINGLE valve will provide sufficient output for model control purposes when great range is not required. As a 1-valve unit of this type is extremely simple to build, it can be used with advantage for all such purposes, such as controlling boats on model sailing ponds and lakes, or for land models operated indoors or in the garden. In such circumstances, a range of over 50yds. is rarely required, and a single valve will easily be sufficient for this.

Quite apart from the economy of operation, a transmitter with a small output is useful when setting up and testing equipment, as it allows the receiver to be adjusted to a more sensitive condition than is possible when a very strong signal is used.

The circuit appears in Fig. 1, and is self-oscillating, for the 27 mc/s model control band. It will control any type of carrier-wave receiver, including ready-made equipment of this type. Few components are required. The 50pF condenser should have mica insulation. The fixed resistor (10K, or 10,000 ohms) is of ordinary 1-watt type. The $\cdot 1\mu\text{F}$ condenser can be of 250V. or 350V. working, and its value is not critical. For tuning, an air-spaced 30pF trimmer is

employed. The small, circular 'beehive' type allows a very compact layout, but any air-spaced trimmer or variable condenser of about this capacity will be satisfactory.

Almost any valve will function with this circuit. But for a fairly good output, a power type valve is required. This may be a triode, tetrode, or pentode, for 2-volt or 1.4-volt operation. If an accumulator is not desired, a 1.4V. valve, such as the 3D6 or 3Q5, is suggested. But if an accumulator is to hand, then the older type of power pentode, such as the 220HPT, PT2, etc., will give excellent results.

Coil winding

The coil has to be made with sufficient accuracy to ensure that the signal comes within the proper band. The former will need to be about 2ins. long. If of plain type, it should be 1in. in diameter. The ribbed type is very slightly more efficient, and needs to be 1½ins. in diameter, over the ribs.

The coil is wound with 20 S.W.G. copper wire, nine turns being used, as in Fig. 2. Turns are so spaced that this winding occupies 1½ins. on the former. The ends, (B) and (D) in Fig. 2, are made fast by passing them through pairs of

small holes in the tube. Turns should be as tight as possible, but the winding must not be painted, varnished or waxed to hold them secure. A few inches of wire should be soldered on to form the centre-tap C, which is 4½ turns from each end.

The coupling winding is now put on, consisting of two turns of insulated flex. These two turns are wound in the spaces adjoining the centre turn of the 9-turn winding, as shown by the dotted lines in Fig. 2. A touch of adhesive can be used to prevent the two turns coming loose.

Notes on wiring

Dimensions are unimportant, but a small baseboard about 4ins. by 6ins. will easily hold the parts. An insulated strip or panel is required at the front, to hold aerial and key tags or terminals, and switch, as shown in Fig. 3.

Referring to Figs. 2 and 3, (B) and (D) denote the beginning and end of the 9-turn winding, and go to the tags on the trimmer. (C) is the centre-tap, and is taken to the $\cdot 1\mu\text{F}$ condenser, and H.T. positive. The coupling winding goes to aerial and earth (L.T. negative) and is shown in the form of a single loop away from the coil, in Fig. 3, in the interests of clarity. The coil can be held in place by pushing it upon a cork or disc of wood screwed to the baseboard.

All connections must be fairly short and direct, especially in the tuned circuit. For battery leads, short pieces of flex may be used, provided with suitable plugs or clips, to fit the batteries. Torch cells, in parallel, may be used for the all-dry type of valve. Small circular clips on the brass top caps will do for the positive connection, with larger clips securely gripping the zinc cases for the negative connection. Or a 1½V. battery of the kind intended for portables may be used. (The 7½V. type of battery, or any battery over 1½V., must not be employed for the 1½V. circuit).

Valveholder wiring

There are only four leads to the valveholder — grid, anode, filament negative, and filament positive, as in Fig. 3. However, actual pin connections depend on the valve to be fitted. Fig. 4 gives pin connections for the 3Q5 and 3D6, viewing the valves from below. The remaining base is for any 2-volt pentode, tetrode, or triode, of the old 4-pin or 5-pin English type. (Triodes will not have the centre pin, but if this socket is wired, a pentode or tetrode can be inserted, instead of the triode, with-

out any changes to connections).

The valveholder is chosen to suit the valve, being octal or 5-pin. The leads can most easily be soldered on before the holder is finally secured in place. Some of the holder sockets require connecting to others, as in Fig. 4. When wiring is finished, the holder is held down by long screws and $\frac{1}{16}$ in. distance pieces, so that the sockets are just clear of the baseboard. It must be remembered that pin connections, for the octal-types, will not be correct if the valveholder is viewed from above.

Trimmer mounting

Most trimmers of the type mentioned have a projecting spindle which forms one connection, a tag providing the other connection. Such trimmers can be mounted by soldering a small bracket to the spindle, as in Fig. 5. This bracket is

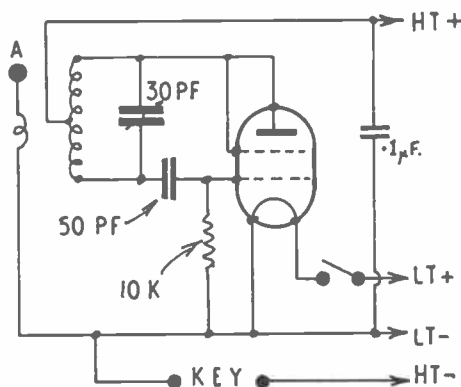

Fig. 1—Transmitter circuit

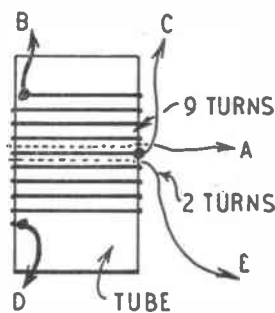

Fig. 2—Coil details

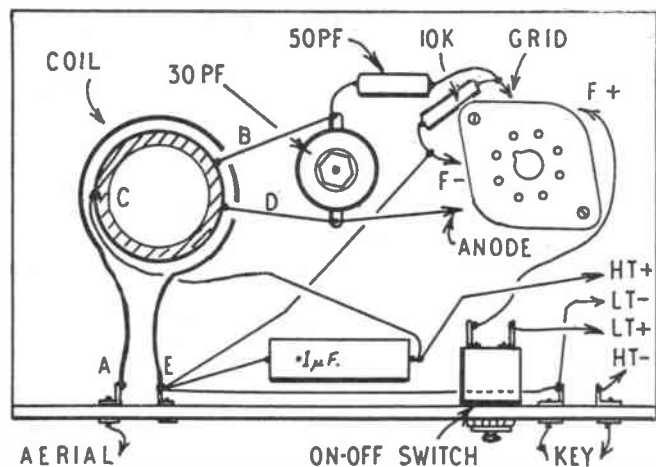

Fig. 3—Wiring plan

bolted to a small piece of ebonite or paxolin, to which a right-angle bracket is fixed. The angle bracket is screwed to the baseboard, so that the trimmer is held vertically.

A tool to adjust the trimmer should be made, preferably from ebonite rod or tube. One end is filed to engage with the trimmer, so that adjustments can be made without actually touching this component by hand. A tool with an insulated handle, but metal blade, is not satisfactory. For trimmers with a slotted shaft, the rod should be filed to resemble a screwdriver.

The bulb loop in Fig. 5 can also be made up, as it is very useful to check that the transmitter is operating. It consists of one or two turns of 20 S.W.G. wire, about 1 in. or so in diameter, with the ends soldered directly to the side and pip of a low-consumption bulb. Ordinary torch bulbs, which consume about .3 amp., are not satisfactory, as in-

sufficient power will be available to light them. The 6V. .06 amp. type of bulb used in the rear lights of cycle-dynamo sets may be used, or a .2V. .04 amp. battery receiver dial lamp, which will be most sensitive of all.

Oscillation test

The L.T. leads are taken to the appropriate battery ($1\frac{1}{2}$ V. or 2V. accumulator, according to valve). For H.T., a 90V. battery will be satisfactory. For low power, a 60V. battery will suffice. But for maximum power from the single valve, 135V. may be used with a 3D6, or 150V. with 2-volt output valves. Usually, however, a 120V. battery is employed with these valves, though 150V. may be obtained by wiring 90V. and 60V. batteries in series.

The tags, terminals, or leads marked 'key' in Fig. 3 should be shorted. No

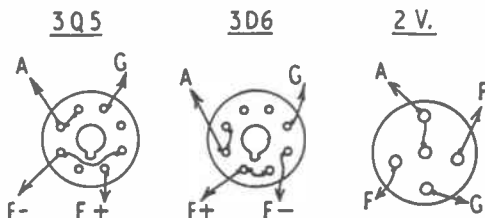

Fig. 4—Pin connections

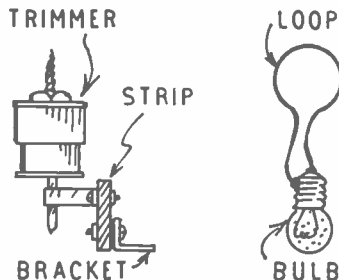

Fig. 5—Trimmer mounting and bulb loop

aerial should be connected, at this stage. The switch is then placed in the 'on' position, and the loop of the bulb tester is approached to the transmitter coil. The bulb should light, its brilliance increasing as the loop is taken nearer the coil. (With a powerful H.T. battery, avoid taking the loop so near that the bulb is fused). If the bulb does not light, this shows that no radio-frequency energy is being developed, and all connections, etc., should be checked.

Frequency adjustment

The 30pF trimmer is adjusted, with the insulated tool, until the transmitter signal comes within the 27 mc/s band. After this, no further adjustment is necessary, unless the transmitter or aerial is changed.

The correct wavelength may be found

● Continued on page 59

CASE FOR A DARTBOARD

Described
by
Finlay
Kerr

half-round moulding to the edge of the right hand door.

Attach two pull handles to the doors and four door fasteners; two at the top and two at the bottom of the doors. Secure the fitting to the wall at the

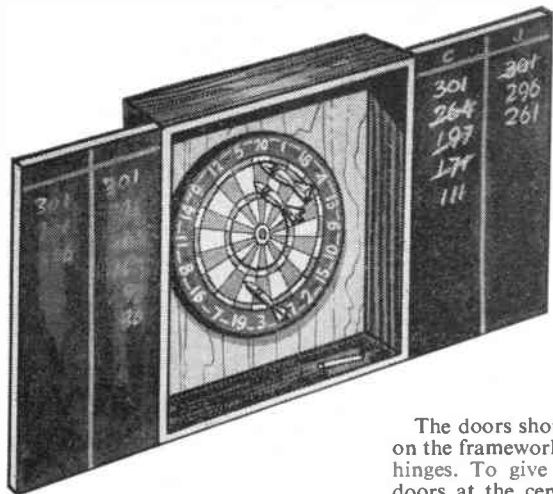

The doors should be hung in position on the framework with two pairs of butt hinges. To give a neater finish to the doors at the centre, nail on a strip of

IF you are a member of a local youth club, and the opportunity arises for small improvements and repairs to be done at your club premises, then don't be afraid to offer your services. The calling in of tradesmen to do simple jobs is expensive, so you will be doing your club a good turn if you can save the organisers a little money.

Take a good look round the club some night, and you'll soon discover that there are many jobs which could be done for the benefit of the club. For instance, is the dartboard left exposed on the wall when not in use? Why not offer to make a simple case, so that it can be neatly locked out of sight when not in use.

The illustration shows a suitable case in which the inner surfaces of the doors are used as blackboards for chalking up the scores. Only a few basic woodworking tools are required.

Start with the framework, which is made from 3ins. by $\frac{1}{2}$ in. timber. Plane all the surfaces smooth and cut two pieces 22ins. long and another two pieces $22\frac{1}{4}$ ins. long. Butt these four members together to make a frame 22ins. by 24ins., as shown in Fig. 1. Secure each joint with glue and one or two small nails. A sheet of plywood or hardboard cut 22ins. by 24ins. is next fixed to the back with $\frac{1}{2}$ in. panel pins.

The two doors can be made in two ways. Firstly, a frame can be constructed with 2ins. by $\frac{1}{2}$ in. framing halved together and then covered on both sides with hardboard or plywood to make a flush panelled door on both faces, as shown in Fig. 2. Alternatively, you can cut the two doors each 11ins. by 24ins. from a piece of $\frac{3}{4}$ in. thick blockboard. Blockboarding can be purchased from any wood supplier, and consists of a solid timber core faced on either side with a thin veneer.

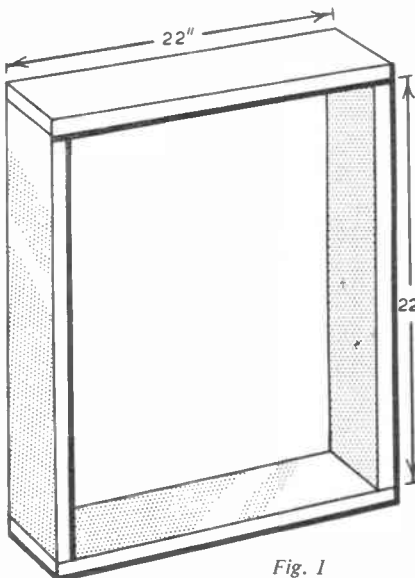

Fig. 1

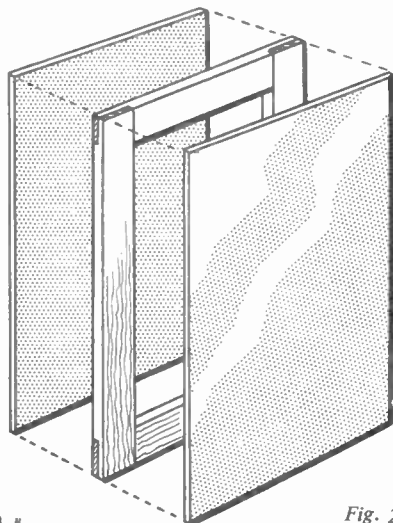

Fig. 2

desired height by attaching metal hangers to the frame.

Complete by applying two coats of blackboard paint to the inside faces of the doors. This is a special paint which is manufactured for providing a non-glossy black surface suitable for chalking and can be obtained from Hobbies Ltd., Dereham, Norfolk, price 1/3 (post 9d. extra). Apply one or two coats of ordinary paint to the remainder of the case or stain and varnish.

● Continued from page 58

Radio Control Transmitter

by means of a frequency meter or it may be adjusted to suit the output of a ready-made model control transmitter. If no frequency meter is available, and no ready-made transmitter can be borrowed, the wavelength can be ascertained from a crystal-frequency check oscillator. These methods, together with further details of aeriels, etc., will be dealt with later.

To control the model, a push switch or Morse type key is wired to the 'key' tags. This switch or key is operated in the manner required by the method of control fitted to the model. For example,

one pressure on the key may be required for 'turn left', two pressures, with a short interval between, for 'turn right', and so on. The 'pulse and space' method of control, which gives direct electromagnetic adjustment of the rudder position, can also be used if desired. It is hoped to deal with these methods of controlling the model in later articles.

Next week's article will describe a model control calibrator and full-power transmitter.

SPEED BEFORE THE CAMERA

THE beginner at photography soon learns the cardinal rule to hold his camera rock-steady at the moment of exposure to avoid blurring of the subject due to camera-shake.

He also learns, if he has the simpler type of box or folding camera with only one or two 'instantaneous' speeds (usually about 1/25 and 1/50 sec.), that

By E. G. Gaze

he is restricted to relatively slow-moving subjects. If his camera had a higher range of speeds — possibly up to 1/200 or 1/300 sec. — blurring due to camera-shake and subject movement can be reduced by the use of the faster shutter speeds.

But, in either case, it is helpful to bear in mind that movement of the subject itself affects the sharpness of image according to several factors which may operate singly or, more often, together.

Take a normal street scene. Pedestrians and slowly-moving traffic may be quite sharp when printed, in the far or middle distance — when close to camera blurring easily results when quite fast shutter speeds are used — especially if movement is across the lens axis or at a sharp angle to it, and less if movement is directly towards or away from the camera.

So movement of subject calls for

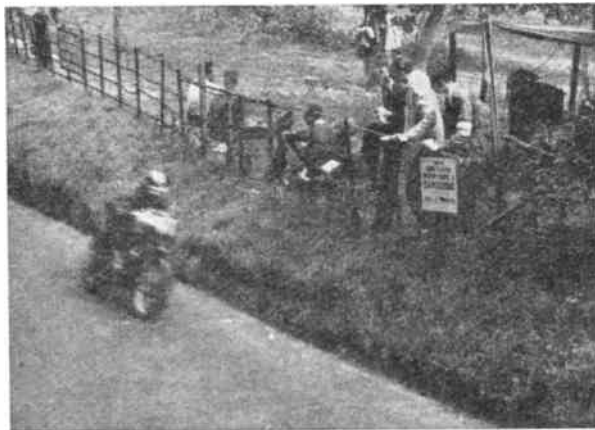

1
Conventional rock-steady grip on camera at time of exposure; use of highest available shutter speed unable to prevent blurring of fast moving bike and rider close to camera — background sharp and bike blurred, some impression of speed but main subject, bike, does not hold eye-interest in the print.

consideration of its distance from the camera and its direction relative to the lens axis — as well as consideration of its actual speed of travel.

An example: someone walking at 3 m.p.h. at a distance of 30 feet from the popular 2½ in. square camera (with the normal lens of approx. 75cm. focal length) can be rendered sharp at 1/25

sec. shutter speed if moving towards or away from the camera in a direct line. If walking *across* the lens axis then a shutter speed of 1/75 sec. is needed to stop movement. For holiday snapping: a sea wave running in to the beach at approx. 12 to 15 m.p.h., or a cyclist, will, with the same camera and at the same distance, require approx. 1/100 sec. shutter speed to stop movement; at an angle of 45 degrees to the camera will call for 1/150 sec.; and if moving across the lens axis will need 1/300 sec. to stop it effectively.

A car travelling at 40 m.p.h. at 30 ft. from the camera and directly towards or away from it will be rendered acceptably sharp with a shutter speed of 1/300 sec.; at an angle of 45 degrees to the lens axis the effective shutter speed needed will jump to some 1/450 or 1/500 sec.

The user of the simpler box camera, even the owner of a camera with a speed range up to 1/200 or 1/300 sec., may well feel then that objects moving faster than walking pace, or a normal pedal cyclist or a beach wave, are outside his scope unless considerably beyond a thirty-foot distance from him and not moving at a sharp angle to the lens axis. And obviously, if he is taking a moving object as his main subject, he will not want to have it too far away, to become relatively small on the negative image.

Fast-moving subjects, especially if close to the camera, seem 'out' for the box camera user — they may well be

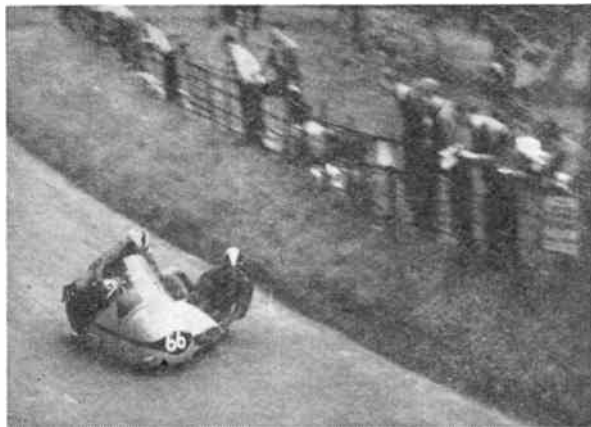

2
Camera was 'panned' with cycle-combination held centred in eye-level viewfinder. Background blurred due to camera movement, but combination sharp and distinct due to panning being used to off-set its movement across lens axis. A better impression of speed than No. 1—combination and crew also hold eye-interest in the print.

within the normal scope of the camera with a higher range of speeds, as some blurring often gives the impression of speed in the subject which may be more effective than actual 'stopping' of all movement by freezing it with an exceptionally high shutter speed.

But, fortunately for both types of camera, this is not necessarily so. Both types of camera users can narrow the difference between their types of camera, and increase the scope of their work, by making use of two hints — a moment of partial equilibrium that often occurs with a change of direction of movement, or, if that is not possible, by panning.

Swinging the camera

Panning has been mentioned in previous articles: so, briefly, it means keeping the moving subject centred in the viewfinder during its movement across the lens axis and thus off-setting its movement by the swing of the camera. An open frame viewfinder is best. A reflex screen or small 'brilliant' type of finder is difficult to use; it is necessary to pick up the subject before it reaches the pre-arranged snapping position and keep it in view all the time clearly. A simple wire-frame type of open viewfinder can be made easily and attached to the camera — it only needs care that its area of view is the same as that comprised within the normal finder fitted to the camera. And care must be taken that no halt or jerk occurs at the moment of pressing the shutter, that no halt is made in the swing of the camera — there must be an even follow-through movement up to and after pressing of shutter.

Sharp image

A little practice will soon give you the knack — remember, the follow-through movement, keeping the subject centred in the finder, is the real secret.

As by panning you cancel out the speed of the subject relative to the lens by the swing of the camera, any 'instantaneous' speed will give you a sharp image of the subject. If you have higher speeds their use will help to cancel out camera-shake or any slight jerk at the moment of exposure: but too high a shutter speed will tend to cancel out the blurring of the background and foreground, as mentioned in a moment — so here extra high speeds are not always best. Remember, it is the subject's forward speed you cancel out, not motion (such as a horse's legs or a car's wheels) in a different plane from the forward motion.

Panning, of course, means movement of camera at time of exposure and though it off-sets movement of main subject, all background and foreground will be blurred. This, too, will add to the impression of speed — probably more effective-

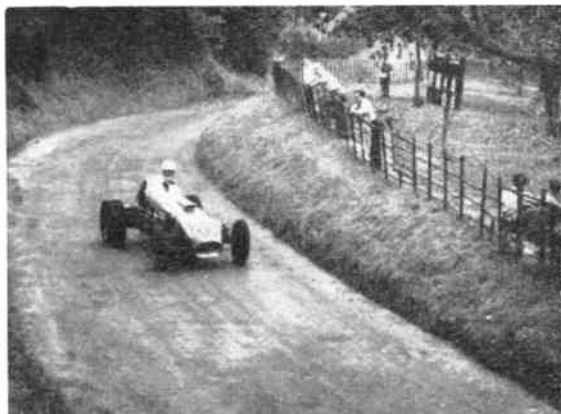

3

Car much further from camera than bikes in 1 and 2. Speed towards camera slowed by correction of speed skid—note direction of front wheels relative to body of car. Shutter speed used was same as in number 1—approx. 1/350 sec.

ly than a dead sharp surround to a blurred, fast-moving main subject. Compare illustrations 1 and 2 on this point.

A car travelling fast directly or almost directly towards the camera will often give no split moment of equilibrium when its motion is suspended — such as may be found by timing exposure of a breaking wave at the moment of climax just before it curls over, or a horse jumping, caught at the almost imperceptible pause at take-off or landing. But if a sharp corner forms your chosen snapping position the car may be braked temporarily with a sharp reduction in speed or caught at the very moment of coming out of a skid when relative motion is temporarily changed and forward motion reduced. See illustration number 3. Here there was no panning, but the car was further away from the camera position than in the other illustrations and at the final correction point of a speed slide — here a shutter speed of approx. 1/350 sec. has given an acceptably sharp rendering: whereas the same shutter speed in number 1, with the fast travelling motor-cycle considerably closer to the camera, has resulted in very definite blurring of the main subject.

So, if you have a simple camera with only one or two relatively low 'instan-

taneous' speeds, do not be afraid to have a shot at moving subjects, even quite close to for a large print image — learn the knack of panning. This is effective with subjects whose motion is almost all in the same plane — such as a car, motor-cycle, speed-boat, etc.: if movement is taking place at the same time in different planes there will still be blurring in those planes — e.g. the movement of a horse's legs at a fast gallop, the arms and legs of a running child.

If you have a higher range of shutter speeds then use of them during panning will also help to reduce blurring of movement out of the main plane of subject motion.

If the subject is moving directly towards or away from you then, obviously, panning cannot offset its motion: here the simpler camera user can only reduce the effect of blurring by snapping when the subject is a considerable way away. With higher speed ranges on the camera shutter the subject can be allowed to approach much closer before blurring becomes objectionable.

And you can decide for yourself when to pan and not, when to show speed by blurred surroundings or by blurring of subject against a sharp background: see Illustrations 1 and 2 again.

WORLD'S LARGEST CAMERA?

A CAMERA weighing 5 tons, measuring 30ft. long by almost 9ft. high, and capable of producing pictures up to 5ft. by 12ft., has just been built by Convair — the American aircraft manufacturers. Its purpose is to copy drawings which can eventually be turned into the metal plates that serve as patterns for the production of jet aircraft.

PHOTOGRAPHING THE MOON

THE promise of space travel has so caught the imagination of the American public that cameras are being sold to photograph the moon! The camera, which is attached to the photographer's own telescope, takes pictures on 2½ins. by 3½ins. film, has a German-made shutter with speeds of from one second to 1/200 second, and a four element lens. Cost—about £14.

PIECE A CUT ONE
1 1/4 IN.

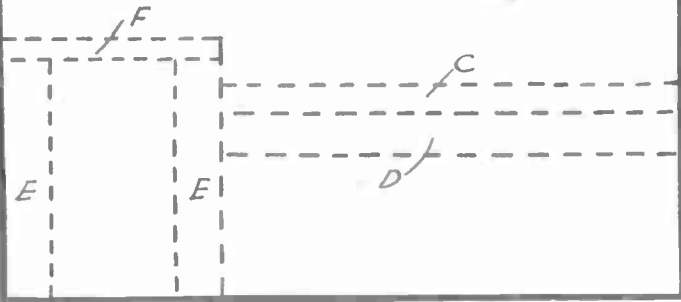

PIECE B CUT ONE
1 1/4 IN.

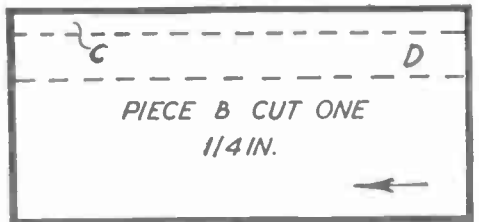

PIECES D CUT ONE OF EACH 1 1/4 IN.

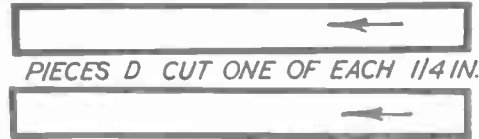

PIECE E
CUT ONE 1 1/4 IN.

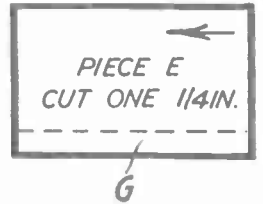

PIECE E
CUT ONE
1 1/4 IN.

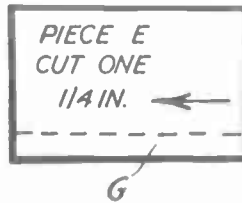

PIECE C CUT ONE 1 1/8 IN.

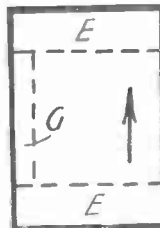
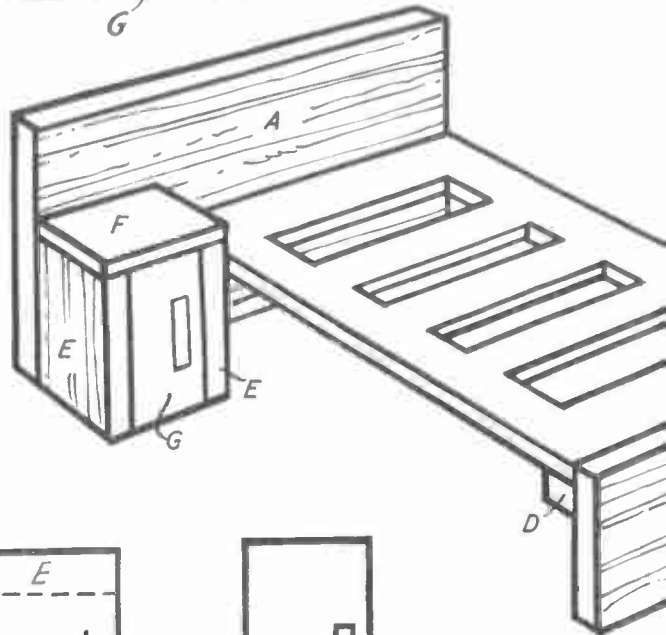
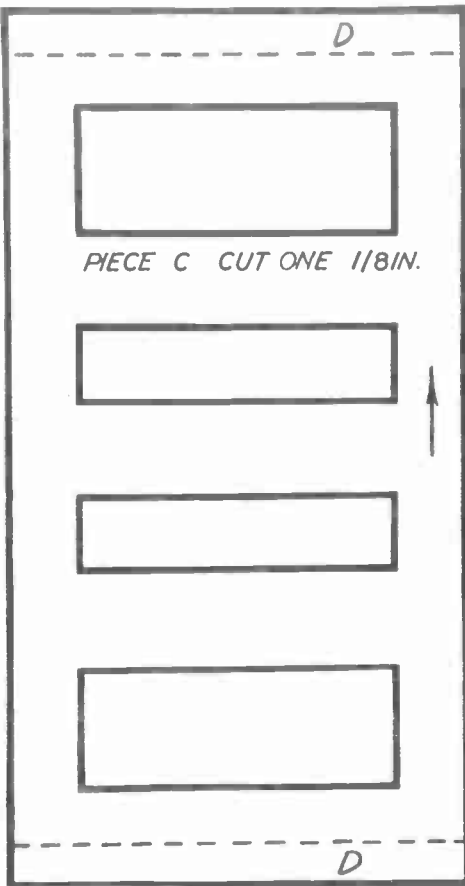

PIECE F CUT
ONE 1 1/8 IN.

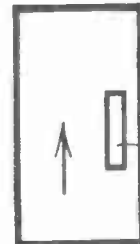

PIECE G CUT
ONE 1 1/8 IN.

PAINTED
ON

PRINTED IN ENGLAND

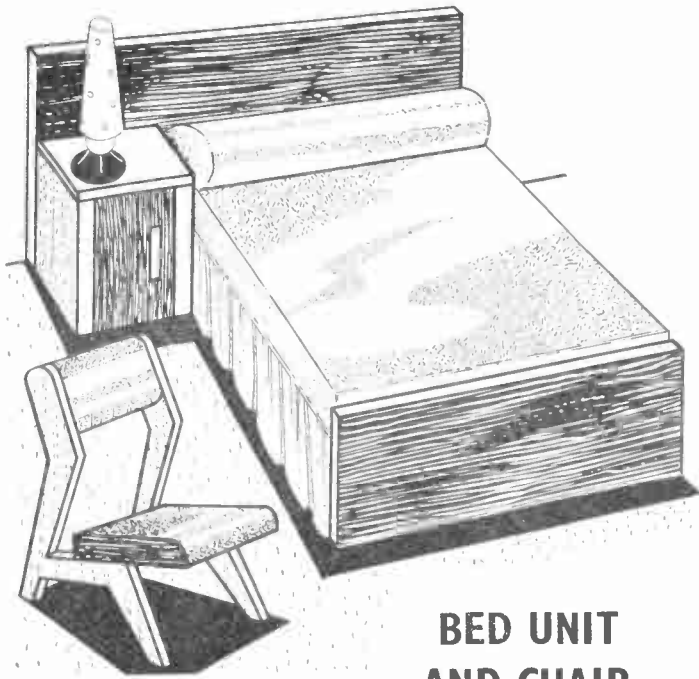

**BED UNIT
AND CHAIR**

THE ARROWS
INDICATE THE
DIRECTION OF
GRAIN OF WOOD

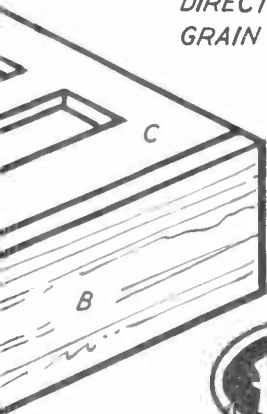

**DOLL'S HOUSE
FURNITURE
PATTERN**

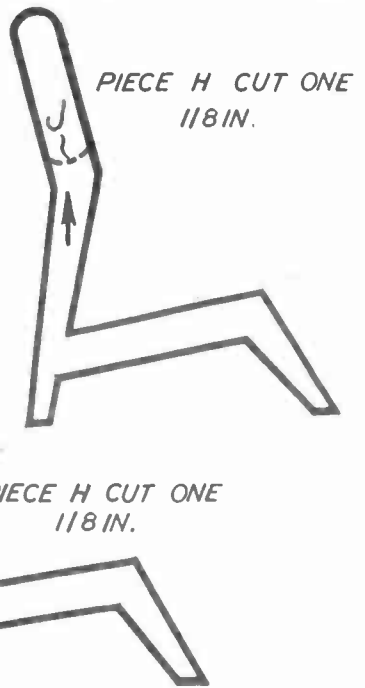
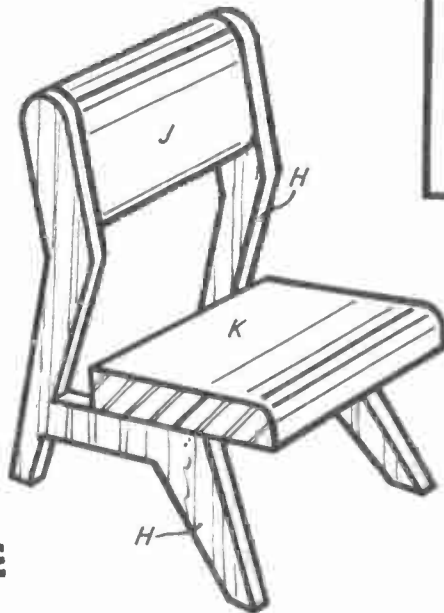

PIECE H CUT ONE
11/8 IN.

PIECE H CUT ONE
11/8 IN.



PIECE K CUT
ONE 11/4 IN.

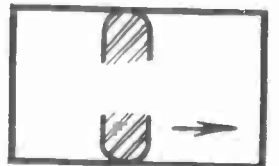

PIECE J CUT ONE
11/4 IN.

PANELS OF WOOD REQUIRED
ONE G4, ONE G2

CHEMISTRY AT HOME

THE name potassium ferricyanide sounds similar to potassium ferrocyanide. These are closely related in chemical composition, but in appearance and properties very different. The ferricyanide forms reddish crystals, gives an olive-brown colour with ferric chloride solution, and no precipitate with lead acetate solution. Potassium ferrocyanide, on the other hand, forms yellow crystals, gives a deep blue precipitate with ferric chloride and a white precipitate with lead acetate. There are many other differences in properties, but those given will amply suffice to differentiate the two.

Though potassium ferricyanide gives no precipitate with ferric chloride, it does so with ferrous sulphate and a splendid one, too. Dissolve some potassium ferricyanide in water and add ferric chloride solution. A gorgeous blue precipitate appears at once. This is Turnbull's Blue. To purify it, pour it on to a filter and let it drain well, then wash it two or three times by nearly filling the filter paper with water. Let it drain once more and then dry it in the oven.

Turnbull's Blue makes a good water colour. Grind some with gum mucilage to a smooth paste. The best way to do this is by the palette knife method, that is, by rubbing the two together on a stout sheet of glass with a pliable dinner knife (Fig. 1). Try painting with the product as you would with an ordinary water colour. A pleasing intense blue wash results.

The Turnbull's Blue reaction lends itself to the making of a secret ink. Simply write the message on paper with ferrous sulphate solution. Nothing can be seen when the solution has dried. Apply potassium ferricyanide solution by dabbing, brushing, spraying or even immersion and the writing appears in blue.

The parent acid of potassium ferricyanide is hydroferricyanic acid. It is unstable in the free state. Nevertheless, it is interesting to prepare a small specimen in order to see what it is like.

First make a saturated solution of potassium ferricyanide by adding small quantities of the solid salt to a little boiling water in a test tube until no more will dissolve. It is important to keep the solution boiling while adding the salt. Let the solution cool and pour it off the crystals which have separated out.

Take about 1 c.c. and add two or three times the volume of strong hydrochloric acid. Light brown hydroferri-

cyanic acid separates. Filter this off, but do not wash it, for it is soluble in pure water. Open out the filter and let the whole dry in the air. During the drying the filter turns bluish because of the absorbed hydroferricyanic acid. If kept, the acid itself sooner or later entirely decomposes into the blue substance.

Many ferricyanides are insoluble in water. Hence they can be prepared by double decomposition. That is, by adding a solution of potassium ferricyanide to solutions of metallic salts. These insoluble ferricyanides are seldom seen and it is interesting to prepare a range of specimens. As they are mostly coloured they have an extra interest for the home chemist.

When preparing specimens of this nature it is best to work with weighed

quantities, so as to be sure the reaction proceeds to completion and to obtain a suitable yield. If you have no balance and weights there is no need for disappointment, however. In this case, shake up the reactants separately with water, pour off from undissolved residue and add one to the other until no more precipitate forms. The reaction will thus proceed to completion, though the yield will be a matter for trial and error.

POTASSIUM FERRICYANIDE

As the home chemist well knows, most copper salts are blue. Copper ferricyanide is an exception. Dissolve 6.25 grams of copper sulphate in 50 c.c. of water and 5.45 grams of potassium ferricyanide in 30 c.c. of water. If the water is rather cold they will not dissolve readily. This may be put to rights by warming the water in each case. Mix the solutions while stirring rapidly.

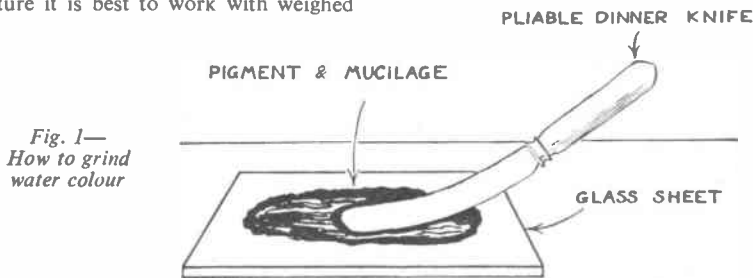

Fig. 1—
How to grind
water colour

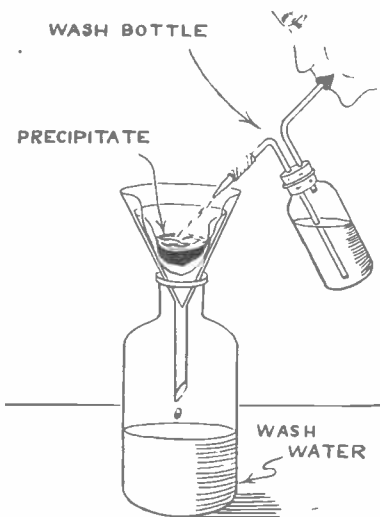

Fig. 2—Washing a soluble contaminant
out of a precipitate

An olive precipitate of copper ferricyanide appears at once. Filter it off. Since soluble potassium sulphate is also formed in the reaction this will contaminate the wet sludge of the copper ferricyanide on the filter. To remove it, wash the precipitate well with several changes of water from your wash bottle (Fig. 2), moving the jet around so as to stir up the sludge in the filter, until one filtrate no longer gives a white precipitate with strontium nitrate solution. Open out the filter paper on to a porous tile and dry the precipitate in the oven, or, though it is naturally slower, simply by leaving it exposed to the air.

Another striking colour difference is in the case of zinc. Zinc salts are usually white or colourless, according to their state of subdivision. Mix solutions of 8.61 grams of zinc sulphate in 70 c.c. of water and 6.58 grams of potassium ferricyanide in 50 c.c. of water. You will be surprised to see a dull yellow precipitate of zinc ferricyanide appear.

● Continued on page 66

THINKING OF YOUR HOME?

Any handyman can make a success of these projects for the home and save himself pounds. Hobbies kits contain all materials and full instructions for making.

GET YOUR KIT NOW!

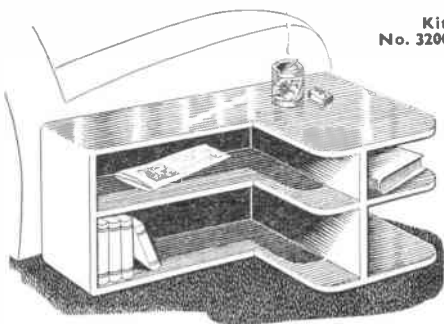

Kit No. 3200

FIRESIDE TABLE/BOOKCASE.
Kit of selected wood panels, etc.
68/9

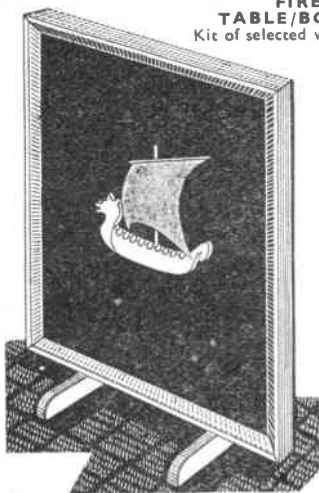

Kit No. 3208
VIKING FIRESCREEN. With ship model in semi-relief.
13/6 (post 2/-)



Kit No. 3174
BED TRAY/BOOK REST. A practical two-purpose job.
13/6 (post 2/6)

Kit No. 3268



CONTEMPORARY TABLE
Designed to hold a pot plant.
24/9 (post 2/9)

Please everybody with these charming pieces of furniture

★ ★ ★ ★ ★ ★ ★ ★ ★ ★ ★ ★ ★ ★ ★ ★
★ Dozens of similar money-saving kits in Hobbies ★
★ 1959 Annual. Only 2/- ★
★ from branches, news-agents, etc., or by post ★
★ 2/6. ★
★ ★ ★ ★ ★ ★ ★ ★ ★ ★ ★ ★ ★ ★ ★ ★

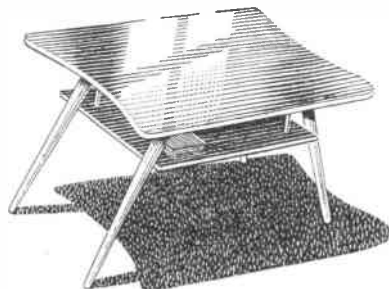

Kit No. 3212. **CONTEMPORARY TABLE.**
With shelf for books, etc. Made in an evening.
29/6 (post 3/3)



Kit No. 3266

RECORD CABINET AND BOOKCASE. Holds over 200 records, plus books.
65/-

SEND FOR FREE BOOKLET TODAY!

To Hobbies Ltd., Dept. 99, Dereham, Norfolk.
Please send free 20-page booklet 'Profitable Leisure', name of nearest Hobbies stockist and items marked x.

Hobbies 1959 Annual (2/6 post free)

Kit No.....

Name

Address

U.K. Orders totalling 30/- and over, post free

SCISSORS AND CARDS TRICK

FOR this trick you will require a pack of cards, a sheet of paper approximately 8ins. by 10ins. and a pair of scissors. The paper and scissors can be handed round for examination or shown to be without previous preparation, after which the paper is folded, a small section cut out and finally laid on the table with the scissors on top.

You now ask any member of the audience to name any number up to 52, and as an example we will imagine that

you may shuffle so long as the position of this card is not disturbed.

Whatever the number of cards is selected start counting from the top,

By 'Mystifier'

sliding each card on top of the previous one into the other hand. Here again a trial of this will quickly reveal that the

Another modification which will return the six of diamonds to the top, if preferred that way, is to make a show of recounting the cards when they will be returned to the other hand in the same order as starting. Incidentally, you may hear several numbers called and from an operational point of view it is always advisable to select low numbers.

After reading the secret of this trick it may have occurred to you that there are several modifications at your disposal.

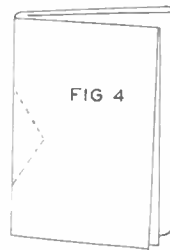
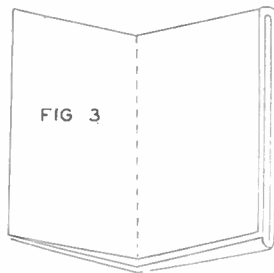
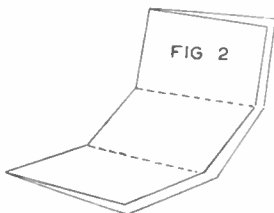
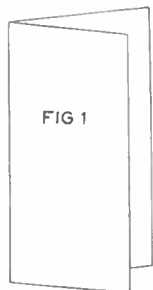

the figure 10 is chosen. The performer counts off ten cards from the top of the pack, holds it before the audience, when it is revealed as the six of diamonds, saying something after this fashion. 'I hope you are all quite satisfied that this card was chosen by our friend and we will now see whether the scissors have correctly forecast this choice.' On unfolding the paper and holding it before the audience you will see that there are actually six diamond-shaped pips cut out from the paper like a large playing card!

That in brief is the presentation of this trick but in order to perform it yourself we will now give the secret.

The paper and scissors are quite unprepared in any way, but it is most important that the paper is correctly folded and our diagrams show this simple task. Fig. 1 indicates the first folding down the centre, lengthways of the paper, and the doubled sheet is folded into thirds (Fig. 2) and then again in half as in Fig. 3. Fig. 4 shows how half of a diamond shape is cut out with the scissors — and this shape is selected in preference to clubs or hearts, or spades because of the ease of cutting — but you should first make a trial with some old newspaper. On opening out you will find that there are six diamond pips cut out.

You have also to make certain that the six of diamonds will be the card selected but there is no difficulty about this. Before embarking on the trick all you have to do is to place the six of diamonds at the top of the pack which

six of diamonds will be at the bottom of the new portion and this position will not be altered no matter how many cards are counted off.

Having counted off the correct number of cards calmly hold aloft the small pack revealing the six of diamonds. You need not even look at the cards for you may be quite sure that it will be this card.

For example, by folding the paper into quarters you will be able to produce a four spot, or if cut on another fold, the deuce, but you must always cut half of the particular shape and arrange for that card to be on top of the pack. With a little practice you will be able to cut out the other suits but of course you will not find this so easy as the diamonds.

● Continued from page 64

POTASSIUM FERRICYANIDE

Potassium sulphate is again also formed as a contaminant, so treat the precipitate in the same way as for copper ferricyanide, and then dry either in the air or in the oven.

Manganese salts generally are white or pink, but the ferricyanide is light brown. Manganese ferricyanide is easily made, too. Mix solutions of 6.7 grams of manganese sulphate in 60 c.c. of water and 6.6 grams of potassium ferricyanide in 50 c.c. of water. Filter off the brown precipitate of manganese ferricyanide and wash it free of the potassium sulphate (which is again formed in the reaction) in the same way as before. Dry the precipitate in the air or in the oven.

Cobalt ferricyanide, which is reddish-brown, can also be made by double decomposition, but needs a slight variation in the testing of the wash waters. First dissolve 7.14 grams of cobalt chloride in 70 c.c. of water and

then stir into it a solution of 6.6 grams of potassium ferricyanide in 50 c.c. of water. Filter off the precipitate of cobalt ferricyanide. This contains potassium chloride as contaminant and though it may be removed by washing, as was potassium sulphate from the other precipitates, we must test with a different reagent. Namely, silver nitrate solution, which gives a white precipitate with solutions of chlorides. When one wash water no longer gives this white precipitate, the cobalt ferricyanide is pure enough for your specimen collection, and may be dried in the air or the oven.

Although silver salts are, naturally, expensive to prepare on the usual scale, it will be no strain on your pocket to add a few drops of silver nitrate solution to some potassium ferricyanide solution on a watch glass, just to see the colour of the silver ferricyanide. It appears as an orange precipitate.

MODELS FOR BOYS

No. 251 Spl.
TUG 'CLIMAX'
16ins. long
53/6



Make them with a
Hobbies Kit

No. 253 Spl.
TRAWLER
'ANGLIAN'
18ins. long

54/6

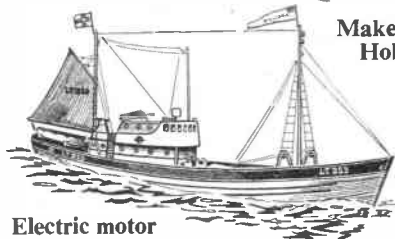

Electric motor
and propeller
included

No. 3206
'EMPRESS
OF
BRITAIN'
24ins. long
56/5

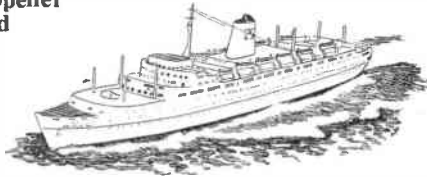

Hobbies Ltd, Dept. 99 Dereham, Norfolk



PRINTING YOUR OWN SNAPS IS EASY!

The JOHNSON JUNIOR PRINTING PACK is a photographic processing outfit containing all you want for making contact prints at home. No dark-room is required, and the instructions, plus a 16-page booklet on printing included with every pack, tell you clearly everything you need to know about making first-class prints from your own negatives.

Equipment provided includes a Johnson plastic printing frame, two 5x4 in. dishes, two print forcers, a set of masks, 25 sheets of contact paper and two packets each of Developing and Fixing chemicals. Ask your nearest photo-dealer for the Johnson Junior Printing Pack. It costs only 12/11.

AND POST CARDS TOO —

If contact prints are too small for your taste, you can, just as easily, make post card size enlargements of your snaps with the JOHNSON JUMBO ENLARGER. No special skill is necessary. There are two sizes: No. 1 for 2½x3½ in. negatives and No. 2 for 35 mm. negatives, each costing 53/6.

JOHNSONS OF HENDON LTD.



* GREAT CAMPING OFFER *



RIDGE TENT SENT FOR 4/-

BRAND NEW de luxe 'Safety' Tent. All colours. Complete. Ideal Cyclists, Campers. Length 7' 3" sleeping base x 4' 6" wide x 3' 6" high x 12" walls, all approx. Weight 3½ lbs. Cash 55/-, or 4/- deposit and 9 monthly payments 7/6. WITH FLYSHEET 83/6, or 9/- deposit and 8 monthly payments of 10/9. Both carriage 2/6. Wonderful value. FREE LISTS TENTS, MARQUEES, CAMPING EQUIPMENT, WATCHES, BINOCULARS, GUITARS, CABINETS, RINGS, JEWELLERY, ETC, TERMS.

These 1500 DEPT. instruments fitted with genuine scientific hand-ground lenses are precision built and graticuled for dead-on sharp shooting accuracy. Made for precise sniper's action they represent an absolute bargain. Actual cost of production, without any profit, £8.10.0. OUR PRICE only 17/6d., post, etc., 2/6. If you want to get a precise bead on anything, this is the instrument to do the trick. Limited offer only. Lists, Binoculars, Telescopes.

Headquarter & General Supplies Ltd. (HOBW)/60 196-200 Coldharbour Lane, Loughboro Junc., London, S.E.5. Open Sat.



BUYING OR SELLING?

Classified advertisements on this page are accepted at a cost of 6d. per word prepaid. Use of a Box No. is 1/- extra. Send P.O. with advertisement to *Hobbies Weekly*, Advert. Dept., Dereham, Norfolk. Rates for display advertising on application.

LEARN RADIO and ELECTRONICS the NEW, practical way! Very latest system of experimenting with and building radio apparatus — 'as you learn'. FREE brochure from — Dept. HW 10 Radiostructor, Reading, Berks.

BUILD YOUR OWN HI-FI at home! At last, for reasonable cost — the chance to make your own quality HI-FI audio equipment and to gain the knowledge to service and maintain it. FREE brochure from — Dept. HW 20 Radiostructor, Reading, Berks.

MAKE A MUSICAL BOX for as little as 21/-. New kits and tunes available. Movements 13/-, post free. Please send 3d. stamp for free illustrated catalogue. — The Success Co., Dept. B, 202 Tulse Hill, London, S.W.2.

STAMPS FREE — Empire Packet including Pictorials and Victorians with approvals. — Robert J. Peck, 7A Kemp Road, Bournemouth.

100 DIFFERENT stamps free! Request ½d. upwards discount approvals. — Bush, 53 Newlyn Way, Parkstone, Dorset.

FREE — Homeworkers' opportunity. S.A.E. — Esprey, 29 Newman's Grove, Rugeley, Staffs.

PHOTOGRAPHERS — Assemble your own photo-electric exposure meter. Kit of parts 30/-, Details S.A.E. — Lucas, 22 Hengrove Road, Bristol 4.

HOBBIES BRANCHES

LONDON
78a New Oxford Street, W.C.1
(Phone MUSEUM 7975)
87 Old Broad Street, E.C.2
(LONDON WALL 4375)
81 Streatham Hill, S.W.2
(TULSE HILL 8796)
151 High St., Walthamstow, E.17
GLASGOW — 326 Argyle Street
MANCHESTER — 10 Piccadilly
BIRMINGHAM — 100a Dale End
SHEFFIELD — 4 St. Paul's Parade
LEEDS — 10 Queen Victoria Street
HULL — 179 Ferensway
SOUTHAMPTON — 134 High St.
BRISTOL — 65 Fairfax Street
NEWCASTLE — 42 Dean Street,
Newcastle-on-Tyne 1
GRIMSBY — 88 Victoria Street

Completely new 54 page Edition

WHERE'S THAT CAR FROM?

Price 1/- (Postage 4d.)

Of all Booksellers

or

RALEIGH PRESS, EXMOUTH

APPARATUS AND CHEMICALS. Gigantic price reductions. Save pounds! Special offers. Catalogue free. New premises and better service. — Scientific and Technical Supplies (Notim) Ltd., 286 Alfred Street Central, Nottingham.

GLOSSY, Autographed Photographs — Film, Television, Radio and Recording Stars. Tremendous selection — list 3d. — Newdale (H), Thongsbridge, Huddersfield.

SUN TREATMENT FOR WINES

THE weather plays a far greater part in the making of home-made wine than most of us realize. Quite good wine can, of course, be made at any time, but it is far better if made during sunny weather.

Sunshine puts something into wine which it fails to collect under less favourable conditions. The south of France, Italy and Spain, all of them sunny districts, are famous for the excellence of their wines and this should be ample proof of the value of sunshine in its production.

By A. F. Taylor

The correct time to gather the flowers or fruit is the first important step in home-made wine making. Do it as early in the day as possible when the sun is up, but wait until any dew or moisture has disappeared. Material that is wet from either dew or rain may cause the wine to go mouldy or it may impart a mouldy or otherwise nasty taste.

The effect of sunshine on flowers and fruit when they are being gathered is to encourage the fermentation and improve the quality of the wine. After this initial 'sunning' it will help to do all the following preparations in sunshine, or at least during fine clear weather. This includes soaking the materials, adding sugar and yeast, and then putting it into jars, casks or bottles to ferment.

During the process of fermentation, the wine will benefit by being placed where the sun can shine on the containers for the greater part of the day. Clear glass bottles or jars are best for this purpose and besides giving added warmth the rays of the sun help to keep up a steady state of fermentation.

After a period of two or three weeks, and when the fermentation is slowing down or practically stopped, the wine is generally ready for its first racking. It is important that this is done only in clear, fine weather. Should there be a spell of dull, damp and cold weather then let it stand on the sediment until there is an improvement.

All future rackings are done in the same way, the second at about 3 months, another at 6 months and then, if necessary, at 1 year from the first racking. In some cases the wine may clear very quickly and not throw down much sediment. It will then not be necessary to rack more than twice.

Flowers are excellent wine makers.

Many of these wines retain the delicate fragrance of the blooms when carefully made, and the effect of sunlight on them is to increase this fragrance. Here are a few well tested recipes which are very suitable for the sunlight treatment. It must be remembered that most flower wines require added nourishment to ensure an effective fermentation. They are deficient in acid and this may be corrected by adding lemon juice, citric acid or sometimes other fruit juices. Raisins are often used as these are really dried grapes which also contain nutrients beneficial to the making of flower wines.

ELDERFLOWER WINE

This is probably the best known of all the flower wines, is easy to make and is really delicious.

- 1 pint elder flowers
- 1 gallon water
- 3½ lb. white sugar
- ½ lb. raisins
- 2 lemons
- ½ oz. yeast

There are two methods of preparing the flowers. One is to cut the blossoms from the stalks, leaving very little green. With the other method, which will produce a finer and more delicate brew, you must wait until the flowers are in full bloom and just ready to fall. Shake them into a bowl and measure off a pint, by pressing the blooms fairly tightly. Then add the sugar, chopped up raisins, thinly peeled rind of the lemons, and pour over a gallon of boiling water, stirring until the sugar is dissolved.

When it has cooled to 98°, mix the yeast with a little of the liquid and when this froths up (in about 15 minutes) add it to the wine together with the juice of the two lemons. Put it to work for about 14 days in jars or bottles, at the end of which it may be racked off for the first time.

MAYFLOWER WINE

What could be nicer than the scent from a mayflower bush on a sunny day? And equally nice is the wine which can be made from it. Mayflower (sometimes called may blossom) is perhaps better known as the hawthorn, and here is a good recipe to try.

- 2 pints mayflower blossoms
- 1 gallon water
- 3½ lb. sugar
- 2 lemons
- ½ oz. yeast

Boil the water, grated or thinly-peeled lemon rind and sugar until dissolved. Allow this to cool to 98° then add the yeast and lemon juice as in the previous recipe and put to work for 14 days.

CLOVER WINE

The flowers of the red clover do not get used for making wine as much as they deserve. It is indeed a very pleasant drink and quite cheap to make.

- 1 gallon clover blossoms
- 1 gallon water
- 2 oranges
- 2 lemons
- 3 lb. white sugar
- ½ oz. yeast

The blossoms can be used either as picked or they can be first dried in the sun. Put the blossoms into a pan with the water, grated peel of oranges and lemons and bring to the boil. Then simmer for half an hour and strain. Stir in the sugar until dissolved, add the juice of oranges and lemons and when cooled to 98° add the yeast and proceed as in the previous recipes.

CARNATION WINE

Many gardens have a large clump of old-fashioned pinks, and these sweet scented flowers will make an excellent wine. Not only the familiar white pink can be used, but any other type of carnation or dianthus that has a delightful scent.

- 2 quarts pinks
- 1 gallon water
- 3 lb. white sugar
- 1 orange
- 1 lemon
- ½ lb. raisins
- ½ oz. yeast

Pour boiling water over the petals, leave for three days, stirring several times a day and then place in a muslin bag and squeeze out all the liquid. Chop up the raisins, slice the orange and lemon thinly and add to the liquid together with the sugar and stir until dissolved. Mix the yeast with a small quantity of the wine which has been warmed to a temperature of 98° and add to the batch.

It will help the process of fermentation if the jar has been placed near a stove to warm it a bit before putting in the yeast. Allow to ferment for 21 days, then rack and bottle.

The recipes given here can be used to make other flower wines by just altering the type of blooms used. Try Marigold, Broom, Cowslip, Pansy, Coltsfoot, Daisy, Wallflower and Woodruff, and see how nice some of these can be.

ANSWERS TO QUIZ

(See page 55)

1. Rail joint; 2. None — for they are scrap bricks; 3. A tessera; 4. a-snap, b-ellipsoid, c-panhead, d-conical, e-round-ed counter-sunk; 5. Kicking plate.

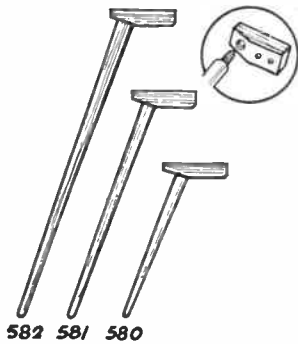

**You Can Make
a Modern
Table in
One Evening
with these legs**



**FOR ALL
CONTEMPORARY
FURNITURE**

A coffee table, TV table, footstool, etc. . . . all can be made in quick time with these Contemporary style legs. Beautifully turned in Scandinavian beech, they can be left in their natural colour, or stained. Each leg is threaded at one end to screw into a hardwood block (see inset) which, in turn, is screwed to the underside of a piece of plywood or suitable material which forms the table top. Simple . . . and a perfect job. The legs are obtainable in three sizes:—10 ins. 2/3 each, 15 ins. 2/6 each and 20 ins. 3/- each. Postage on 3 or 4 legs 1/6 extra. Legs from branches or:

HOBBIES LTD. Dept 99, Dereham, Norfolk

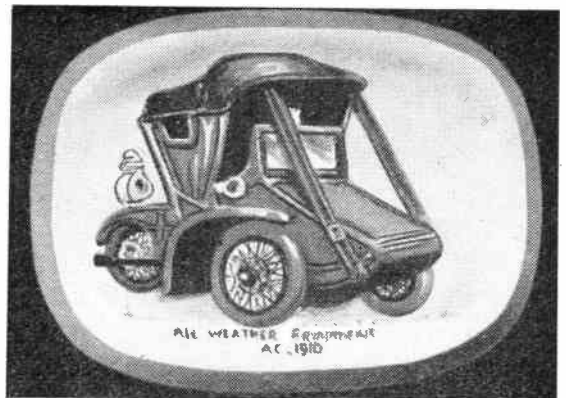

Veteran Car Plaques
FOR THE ENTHUSIAST

Make a set of six wall plaques showing authentic replicas of Veteran Cars. These are something new to the Sculptorcraft range of Plastic Moulds. They can be used many times over

Write for illustrated leaflet enclosing 3d. stamp



Sculptorcraft



SEAMER PRODUCTS (SCULPTORCRAFT) Ltd. 23/27 Eastbourne St., HULL

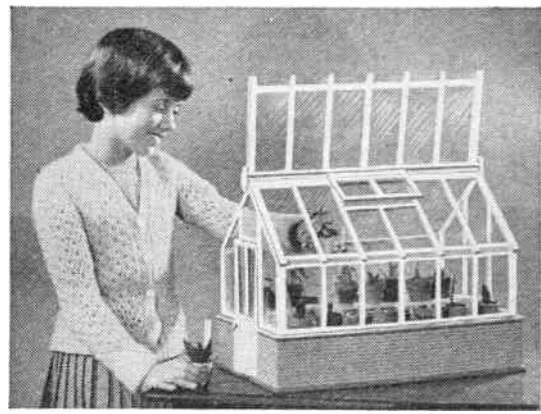

JUST LIKE DAD'S!

You can make this ideal showpiece from Hobbies Kit No. 3300, which contains all wood, materials, etc., and 12 sets of pots and saucers. Hinged roof, window, door. 18 ins. x 12 ins. x 13 ins. high. Only a few simple tools needed in construction.

Kits from Hobbies branches, stockists or post free (see coupon). **39/6**

ALL-THE-YEAR-ROUND INTEREST



**MINIATURE
GREENHOUSE**

*A really practical
model for the home*

For growing cacti, succulents, miniature trees, seedlings, etc., and can be used as a propagating frame.

To **HOBBIES LTD., Dept. 99, Dereham, Norfolk**

Please send Kit No. 3300 for making Miniature Greenhouse,
I enclose P.O. for 39/6.

Name

Address

.....
.....

Replies to Readers

Defective 2-valver

ON April 25th, 1956, you gave a diagram of a two-valve, all-dry portable radio; the two valves were 1.T.4 and 1.S.4. Having finally conquered it after a struggle, I find it operates, but not loud enough. It would be alright for earphones, but not for speaker. Could you please tell me the reason for this? If not, could I not add a third valve to this diagram? Or is it possible I have the wrong transformer and speaker? The only other reason I have is that the coil is not sufficient, as I have a Dual-range, not as you said, a Dual-Wave coil. (G.L. — Liverpool.)

POOR volume may be caused by almost any wrong connection, or unsuitable or faulty part. Speaker and transformer must be intended for use together and for a battery-type output valve. The dual-range coil would be suitable if intended for battery sets. If reaction can be increased by means of the reaction control, until oscillation arises, this usually shows that the detector stage is working properly. A better aerial would improve volume; so would adding a further valve. But if any fault is present in the set as it now stands, it is better to find this and correct it.

Insulating Lino from Damp

ABOUT eighteen months ago I covered the floor of my home with good quality inlaid lino which has given quite good service, but recently I noticed soft black spots appearing on the surface. On further examination I discovered that the adhesive which was used to stick the original floor covering (Marley tiles) had evidently seeped up through the joins and was rotting the linoleum. This is only one of three rooms I covered — the other two appear to be alright. Could you tell me whether this trouble is due to the fact that the one room is prone to dampness, or am I likely to have this trouble with all rooms? (R.H.—Gosport.)

WE have not heard of this trouble before, but as you say, it may be due to damp, although most tile adhesives are waterproof. It seems advisable to use a waterproof underlay beneath your lino. This could be waterproof wrapping paper — the type consisting of brown paper with a layer of bitumen. Polythene sheeting would be cheap and

satisfactory and either would satisfactorily insulate the lino from the old adhesive.

Cat Door

I UNDERSTAND it is possible to make some device which enables a cat to enter or leave its home at will. Can you please supply me with details? (J.B.—Baildon.)

I THINK what you have in mind can be seen from the illustration. An aperture is provided, and this is covered by a swivelled partition, the swivel being somewhat above centre so that the flap

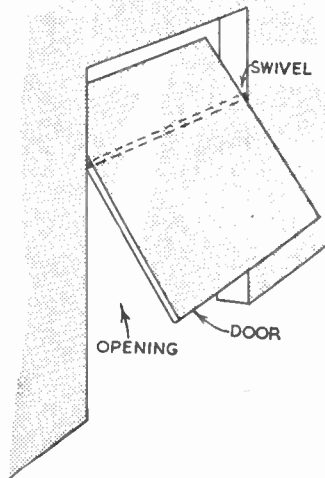

closes again when the cat has passed through. You will see that if the cat is trained to push on the bottom of the flap, it will open either way enabling the animal to pass in or out.

After-shave Lotion

I WOULD be much obliged if you could send me a formula for an 'after-shave' lotion. (G.E.—Rugeley.)

FIRST dissolve 0.06 gram of menthol in 100 c.c. of isopropyl alcohol. Then dissolve in this 1.25 grams of boric acid and 2.5 grams of glycerine. If desired, a

few drops of perfume oil, such as oil of lavender, may also be added. Finally, stir in 400 c.c. of water and filter if necessary. This gives a colourless lotion. If you prefer a tinted lotion, a trace of colour may be imparted by cautious addition of any cake icing colour.

Amplifying a Guitar

PLEASE tell me if the battery amplifier for a crystal set in 'Hobbies Weekly' December 5th 1956 would be alright for wiring up to an electric guitarette (one-stringed, reproduction by an earphone?) If so, please give wiring instructions and cost. (R.W.—Cricklewood.)

TO obtain really good volume, at least three valves would be needed, though a smaller amplifier would do for moderate volume for a small room. An ex-service two-valve amplifier for 2V. LT and 120V. H.T. may be obtained from Highstone Utilities, 58 New Wanstead, London, W.11, for 23/- post paid. If you are using an earphone as a microphone, this will not give such good volume as a proper microphone, and results will depend on the type of phone and how it is used. Volume should be best, with this method, if the bridge can be arranged to rest upon the edges of the phone diaphragm. Pressure from the string must not be exerted upon the centre of the diaphragm. Individual wiring instructions for ex-service equipment cannot be given because of the many different amplifiers, etc. produced. Take two leads from the 'phone to the input points of the amplifier, removing from circuit any low-impedance matching transformer which may be fitted.

Wiring Extension Speaker

I HAVE a radiogram with an extension speaker which is worked by the volume control on the set. I would like to know if it is possible to make the speaker independent of the set volume control, also could you please tell me how to switch the set-speaker off and still have the extension speaker going? (A.T.—Grimsby.)

TO silence the speaker in the radiogram, cut one lead from secondary of output transformer to receive speaker speech coil, and insert a switch in this lead. The speech coil leads usually go to two tags near the speaker cone. Be sure not to cut other leads in error. The ends of the cut lead may be lengthened to reach the switch. To control extension speaker volume separately, use a wire-wound potentiometer of about 25 ohms. Wire outer tags to leads from receiver. Connect one outer tag and slider tag to extension speaker. The control can be at the receiver end or extension speaker end of the extension line.

MAKE A NOVEL TRELLIS FOR INDOOR PLANTS

TRAILING plants such as ivy can be made to look even more attractive if trained to a trellis of wire as shown in the illustration. The two cut-out birds form a decorative base for the wire and may be painted in attractive colours.

Cut the two birds from $\frac{1}{4}$ in. wood and

glue them together. Sharpen the spear-shaped piece to a point. Bore holes as shown by the dotted lines to take the wire.

The cross pieces of the trellis are $\frac{1}{4}$ in. round rod drilled as shown in the detail. Paint the birds white with black eyes, orange beaks and grey neck and head.

(M.p.)

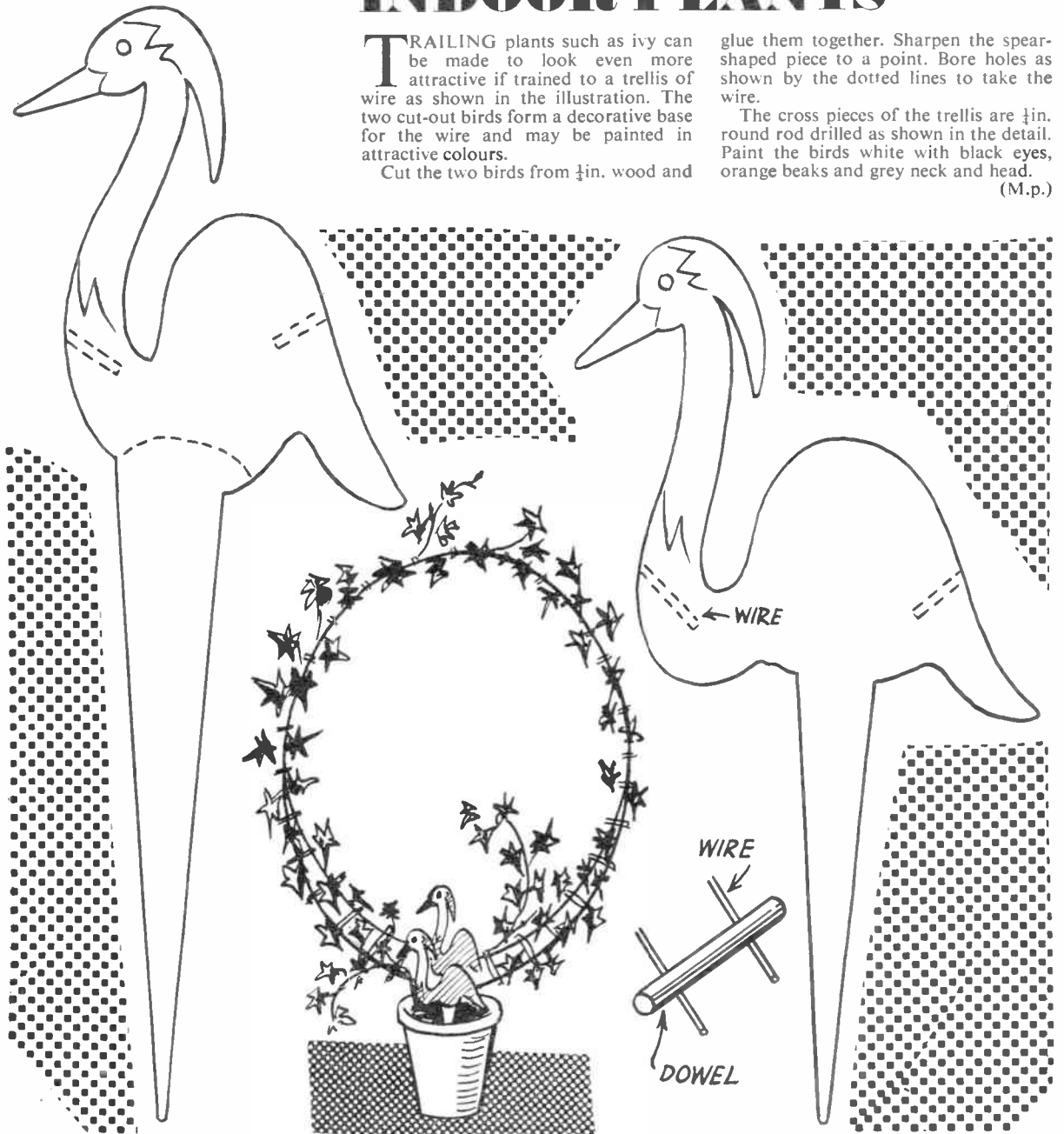

TWO SUPERB DESIGNS

For those who want
'something different'

The Swiss Church (right) and Willow Pattern Box (below) are two fine examples of exclusive designs introduced by Hobbies Ltd. They are intended for the worker who requires something more than just a plain 'musical box'.

Authentic in design and detail, the finished models provide ample reward for the care taken in execution, and can be put to a real practical use, such as for holding cigarettes or trinkets.

A list of tunes available which can be incorporated into these designs is given below. Kits and musical movements, which are sold separately, can be obtained from any Hobbies branch or stockist, or by post.



WILLOW PATTERN BOX
Design No. 3284

Scenes from the famous story in fine detail. Music plays when pagoda lid is raised. Kit of wood and materials for making box (post 1/6 extra) **9/3**

Fits with a movement from adjoining list



SWISS CHURCH
Design No. 256 Spcl.

Windows light up and music plays when the roof is raised. Kit of all materials and fittings, paint, glue, etc. (post 1/9 extra) **25/-**

Base 9ins. x 6½ins.,
12½ins. high.

MUSICAL MOVEMENTS
15/6 extra (see below)

CHOOSE FROM THESE TUNES

(A) Auld Lang Syne, (B) Limelight, (C) Swedish Rhapsody, (D) Silent Night, (E) Brahms' Lullaby, (F) Harry Lime Theme, (G) Blue Danube, (H) Parade of the Wooden Soldiers, (J) Bells of St. Mary's, (K) Moulin Rouge, (L) Vienna, City of My Dreams, (M) Jingle Bells, (N) Home Sweet Home, (O) Auf Wiedersehn, (P) Green-sleeves, (Q) O My Papa, (V) Merry Widow, (W) Tales from the Vienna Woods, (X) Irish Eyes are Smiling, (Z) Gounod's Ave Maria, or (I) Church Bells Air (specially for Swiss Church).
Each movement 15/6 (post 6d.).

Ask for details of other musical kits.

To Hobbies Ltd., Dept. 99, Dereham, Norfolk

Please send details of other Musical Box kits and items ticked.

- Swiss Church Kit 256 Spcl. 25/- (post 1/9)
- Willow Pattern Box Kit 3284. 9/3 (post 1/6)
- Musical Movement (A, B, C, etc.) 15/6 (post 6d.)

Name

Address

U.K. Orders 30/- and over post free