

9th DECEMBER 1959

VOL. 129

NUMBER 3339

THE ORIGINAL
'DO-IT-YOURSELF'
MAGAZINE

HOBBIES *weekly*

FOR ALL
HOME CRAFTSMEN

MAKE THIS WINDOW SILL BIRD TABLE

Also in this issue:

COLD WEATHER
PHOTOGRAPHY

COMPLETING THE
'HOBBY CLIPPER'

COLLECTORS' CLUB

MAKING A POT-
POURRI CASKET

PATTERNS FOR A
1946 FORD CAR

USING MODEL
TRANSFORMERS

A PICTURE IN
MARQUETRY

ETC. ETC.

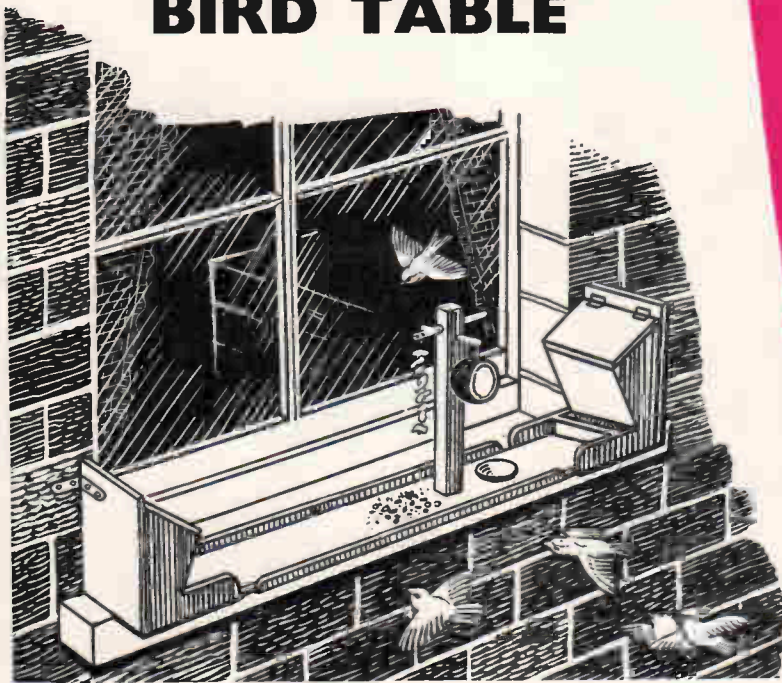

FOR YOUR FEATHERED FRIENDS



Up-to-the-minute ideas

Practical designs

Pleasant and profitable things to make

5^D

ABOUT 1,400 readers have joined the Society of Meadophiliats. Many members collect stamps and labels as well as beer, wine and spirit covers.

Gerard G. Divignat of 89 Flat, 2 Herrick Road, Saltley, Birmingham 8, is 17 years of age. He is a Roman Catholic and works for the Midland Electricity Board.

'I am a regular reader of *Hobbies Weekly*', he writes. 'My hobbies include meadophology, philately, physiology, correspondence, reading, short story writing, cinema and classical records.' He would like to hear from fellow members throughout the world.



'Your pen friend service is the best idea in years', he writes. 'I am a Welshman and was married to a Liverpool lady on June 28th, 1958. I have made 7 Swiss Musical chalets, a Swiss church, 8 forts and a garage for my nephew.'

Alan is an officer in the St. John Ambulance Brigade. He was involved in a serious car accident 11 years ago. 'I was in a terrible state', he says, 'never expected to live, but 5 minutes first aid saved my life and that is why I joined the Brigade.'

they proved to be a record of wages in kind, distributed to workers employed on the estate of a temple in the City of Lagash, about 4,500 years ago. These lists include issues of beer to the workers, also a kind of bread or cake of malted barley.

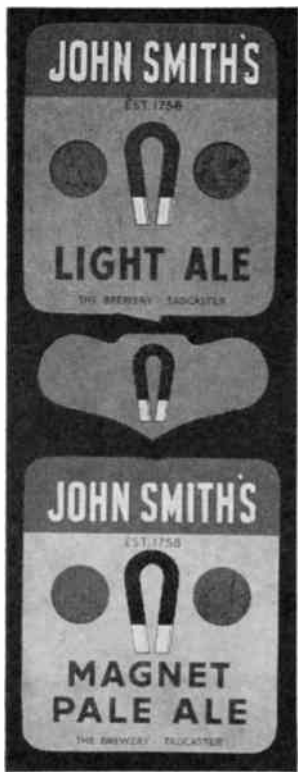

David Lowe (age 12) of 79 Oxford St., Cleethorpes, Lincs., attends Humberstone Grammar School. He would like pen friends about his own age.

Paul Mooney writes, 'I am 16 years of age and am at present attending the Technical Institute where I am doing a 3 year commercial course. I have heard from reader Clive Ramsbottom of South Africa and would like to have letters from other readers. My address is 40 Mulgrave St, Dun Laoghaire, Co. Dublin, Eire.'

Alan C. Stokes of 13 Borella Rd, West Derby, Liverpool 13, (age 33) has been making fretwork models since he left school.



G. G. Divignat

Alfred Kronegger of Graz-Eggenberg, Bayernstrasse 12, Austria, writes: 'Here in Graz we are a union of people collecting beer-mats. These are made of pasteboard and show pictures of the brewery. Please write to us if members of your club collect beer mats.'

The illustrations show labels issued by John Smith's Tadcaster Brewery.

Here are some interesting facts for your album: The old English name for barley was 'bere', and as barley malt has always been the principal constituent of beer it is not surprising that the name should have persisted as that of the liquor itself.

What is believed to be the earliest reference to the beverage is the inscription on a Babylonian clay tablet of 6,000 B.C., depicting the brewing of a crude type of beer for sacrificial purposes. Clay tablets were also discovered of a later date;



David Lowe



Paul Mooney

By 4,000 B.C. no less than 16 different kinds of beer were being brewed in Babylon, barley, spelt (wheat), and honey being the chief constituents. The addition of bittering plants, such as hops, had not at that time been tried and it was not until the 6th century B.C. that we had any definite record of the hop plant.

WINDOW SILL BIRD TABLE

IF you enjoy feeding the birds during the winter you will certainly want to make this window sill feeding table. During the severe weather birds will become quite tame. Once they find that they can feed undisturbed they will take little notice of movements within the room. The table may be cleaned and the hoppers refilled without the need for going outside.

Measurements of some of the pieces are given, but the overall width will, of course, depend upon the size of the window. The hoppers at each end should extend beyond the window so that angle plates may be fixed by means of Rawlplugs and screws. The approximate positions of the plates may be seen in Figs. 1 and 2.

All parts may be cut from $\frac{1}{2}$ in. wood and made up as shown in the diagrams. Fig. 1 shows the general layout and Fig. 2 shows the table fixed to the walls above the window sill.

Having decided upon the width of the table, cut out the various parts as indicated by Figs. 3 and 4. There is no need to be particular about the shape of pieces C, so long as they are all the same and agree with the sizes of B, D and F. The shaped pieces C should, of course, be cut out with a fretsaw. Screws and waterproof glue may be used throughout.

The dowels E are $\frac{1}{2}$ in. diameter and

SEE THE
ILLUSTRATION
OF FINISHED
PROJECT ON
FRONT PAGE

Fig. 1

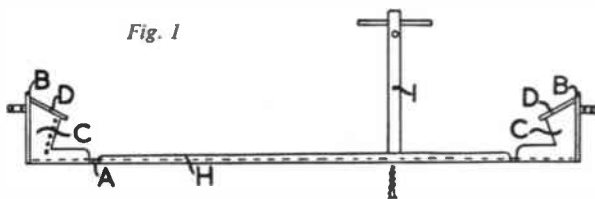
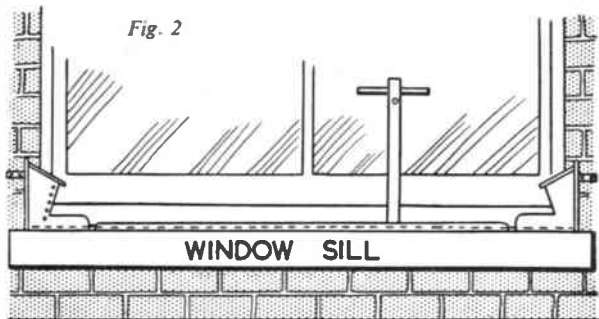

Fig. 2



are spaced equidistantly, the ends being painted before they are fixed in position. Secure the lids with light brass hinges and countersunk screws.

The upright I (Fig. 1) is 18 in. long and is cut from 1 in. square stripwood. Two cross-pieces of $\frac{1}{4}$ in. diameter round rod are tapped into holes drilled in the top and serve as arms from which to hang peanuts, etc., for the tits.

All pieces should now be cleaned with glasspaper and the grain filled before giving a coat of priming paint, following on with an undercoat and finishing coat of high gloss paint. Contrary to popular opinion the common birds will not worry about paint, especially if it is not too bright.

An alternative finish is to treat the wood with green Cuprinol, which will both colour and preserve the wood.

The hopper on the left is filled with crusts of bread, apples, pieces of fat, etc., whilst that on the right may be filled with grain of some description. Peanuts, pieces of coconut and lumps of suet may be hung from the upright. Do not forget that birds will appreciate a drink of water when the weather is frosty. (M.h.)

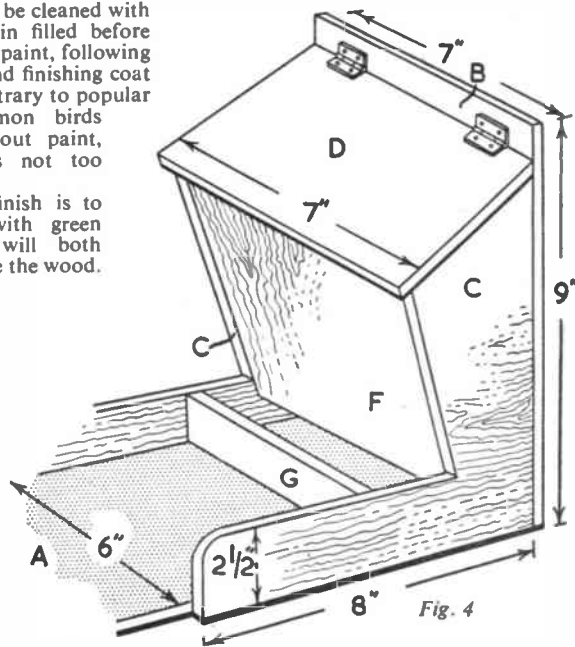
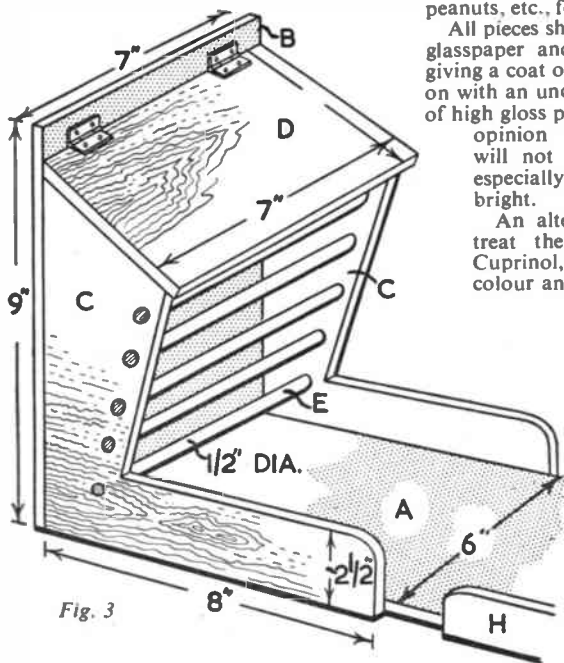

COLD WEATHER PHOTOGRAPHY

THE keen amateur photographer does not put away his camera in the winter months, even though holiday snaps may be over. He realizes that 'seasonal' weather has brought new picture possibilities right to his own door-step.

Trees are bare, presenting pictures of beauty against the sky in a way that trees in full leaf may not: a single tree on a hard-frosted morning will often make a picture in itself. Then there is the snow, the autumn and late winter mists giving new effect to well-known scenes with sunlight filtering through — the children playing in the snow, skating on the local pond, or on street 'slides'. No, the camera shouldn't be kept for summer holiday snapping only — it's an all-the-year-round tool.

This cold-weather photography also brings new problems, and the following hints may help to overcome them, and make the best of the weather.

Snapping hints

There is a great temptation in times of snow or hard frost to snap the mass of whiteness against the cold grey winter sky, but results often disappoint in a black and white print. Sunshine is needed to give sparkle, to add shadows which accentuate the sparkling highlights. A side light, or a shot against the light, will bring out the sparkle and give depth to the few shadows. A yellow filter will deepen the shadows, and thus accentuate the adjoining highlights, because the colour content of the shadows is mainly blue reflected from the sky. A yellow filter will also help to darken the more delicate blue of a winter sky, and so prevent that bald-sky effect: and a darker sky in a snow scene adds to the effect of 'coldness'. If a really deep-toned sky is required, then an orange filter will help, as with the frosted tree in the illustration.

On days of veiling mist, with sunlight filtering through, the beauty often lies in the very concealing effect of the mist which concentrates visual interest in the subject masses. To use a filter here, even a pale yellow one, will destroy this effect by 'cutting through' the mist. So mist scenes usually require no filter. And don't forget to allow for your filter exposure factor when using the filter.

Although winter light may not be nearly so intense as summer sunshine, do not forget that hard frost and snow reflect a great deal of available light. A sunlit snow scene may have a high

*Some
seasonal
tips by
E. Gaze*

A single tree on a hard-frosted morning will make a picture. Orange filter used to darken pale blue winter sky and so accentuate white of trees.



brilliance value. A glance at any exposure-table will confirm this point, and remember it if you rely on a meter reading for exposure. Shadows may be soft and few; you can base your exposure more on the highlights without worrying too much about the shadows. You want to avoid over-exposure which will destroy texture in the highlights and lose the sparkle.

Printing

In a snow or frost scene, even in sunlight, the accent is on 'coldness'. To use a warm-toned paper, or a cream-tinted one, will tend to destroy this 'brrr...' effect. Such scenes usually print to best effect on a normal bromide paper using a developer, such as an M.Q., to give cold blacks and cool shadows to contrast with the white highlights. A lustre or glossy surface will accentuate the sparkle.

Processing

Cold weather problems in processing boil down to one thing — having, and keeping, all solutions at the proper working temperature. The normal amateur usually isn't fortunate enough to have a separate darkroom complete with a system of room heating. He may have to make-do with the bathroom or

kitchen or the cupboard under the stairs, and the best way to ensure correct temperature of working solutions, and the most comfortable for the photographer, is to have room temperature at or a little above the normally recommended 65–70 degrees for most brands of solutions. If some method of room heating is out of the question, some way must be found to see that solutions are at correct working temperatures.

The actual mixing of developer and fixer presents no difficulty — a photographic thermometer, hot and cold water in necessary mixture. Mix fixing solution to correct working temperature, as well as developer. A too cold fixing solution is slower working and may result in prints being under-fixed if they are taken out at the normal time.

It is after the mixing of solutions to correct temperatures that the amateur without darkroom heating finds the snag — the small amount of solution in the dishes soon gets cold. And a cold developer works slowly, more softly, and can lead to trouble with poor print colour in the shadows.

To keep solutions at working temperature, there are electric dish-heaters on the market. They are quite expensive. A less expensive way is to use a small

● Continued on page 169

TWO CHRISTMAS NOVELTIES

GAY, original seasonal decorations are always welcome at Christmas and the two novelties we now describe can easily be made with the fretsaw.

For really substantial models we recommend the use of plywood, but you may use fairly stiff cardboard. Our design for the tree eliminates the need for a base of any description since the finished ornament will stand firmly on its lower branches.

In Fig. 1, each square represents half an inch and the design should be prepared on a piece of plywood measuring 7 in. by 5 in. Endeavour to make nice curves for all the branches, and in order to achieve a perfect balance of the two sides, it will be found better first to trace these out on a folded piece of stiff paper. Trace one half of the pattern with the fold in the centre and on opening you will have a correctly balanced template. It is then an easy matter to run a pencil

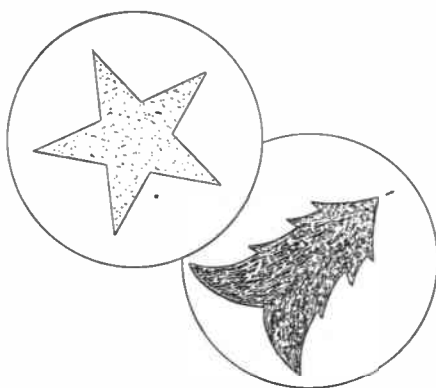

round the outline of the pattern, which is placed on the wood.

Two identical pieces are required for one tree, so clamp together the two, cutting out in one operation. If you care to make a few of these trees, either as gifts or for sale, you may be able to cut out several at the same time.

Now refer to the diagram, where you will see that there are dotted and shaded lines alongside the centre line. These are to indicate the method of fitting the two parts together. One of the pieces should be slotted from A to B and the other from B to C. The slots must be of the same width as the thickness of the plywood.

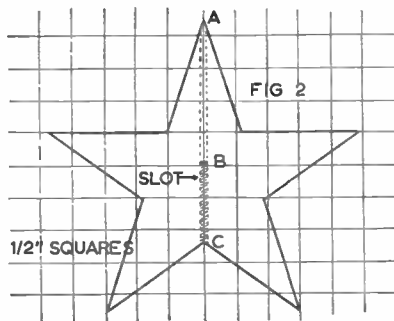
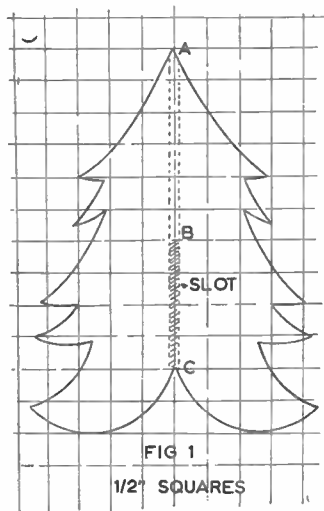

Having slotted the two parts together, the decorative tree should stand quite firmly, otherwise adjust by filing away and glasspapering.

For decoration, first treat the tree with dark green paint. This should be allowed to dry and if absorbed into the wood so that it looks patchy, a second one applied. Prepare a mixture of thin Alabastine filler in a saucer, to about the consistency of paint. Take an old toothbrush, or nailbrush and dip into the solution. The tree is now spattered with the mixture by drawing a thin stick across the bristles so that the material is sprayed on to the tree. Finish off by applying silver glitter.

If desired, a small silver star — again treated with the glitter — can be attached to the top of the tree.

A star may be made from the same material and here again we suggest that two pieces are made for fitting together. Since it is sometimes difficult to plan the five-pointed star we have drafted one out on squared paper (Fig. 2) and you may consider the squares as representing either half or whole inches. The star can either stand on a table or be suspended by means of a thread attached to the tip.

As a finish for the star it is suggested that a priming coat of white paint is first applied, followed by a coat of silver paint. Glitter can then be applied as before. (S.H.L.)

● Continued from page 168

Cold Weather Photography

immersion type heater — a small edition of the type which will boil a mug of shaving water, etc. These are also made for photographic use, and are obtainable from dealers. The dish-heaters can be obtained with a thermostat to maintain correct temperature. With the immersion type, a check must be kept with a thermometer, and the heater placed in the solution to bring it up when the temperature drops.

A cheaper and simpler method, which is just as effective for normal use, is to have a dish larger than the solution dish in it. Use the thermometer to keep a check on solution temperature, and a little experience will guide you as to how much hot water is needed in the larger dish and how often it will need renewing from the kettle.

The handyman can construct his own dish heater from a tin containing a small lamp, with effective light baffles. But take care that safe earthing is made of all

electric leads, and that the solution does not spill and cause a short.

A film developed in cold, damp weather may not dry as swiftly as a warm-weather developed one. Avoid the temptation to bring it into the living room, especially with a coal fire. Fire dust can cause trouble with innumerable spots on the soft gelatine. A wetting agent in the final washing rinse, and a rub down with a scrupulously clean photographic sponge, will aid drying even in a cold room, and help to avoid drying marks.

Finally: if your solution dishes have been put away after the summer holiday session, see that they are clean. The developer dish is especially prone to discolouration due to oxidation of old stale developer. This can be an unsuspected cause of uneven development of prints, especially if your dish is of the ridged-bottom type where the stains tend to concentrate. A mild scourer will remove most stains.

COMPLETING THE 'CLIPPER'

THE nosepiece, as shown on the drawing published in our issue of Nov. 25th, is carved from a block made by cementing together six pieces of $\frac{1}{8}$ in. sheet balsa each measuring $1\frac{1}{2}$ in. by $1\frac{1}{2}$ in. Oppose the grains of the pieces and hold them together under pressure, using a couple of bulldog clips, until the cement has set.

By G. Allen

On the front face of the block, mark with a cross the centre of the propeller shaft. The position of this is measured from the drawing. Now trace the shape of the noseblock in side view, cut it out, paste it to the edge of the block and cut round it with a small saw (Fig. 1). Trim with a file and glasspaper. In a similar manner make a pattern of the noseblock shape in *plan* view, paste it in place on the top curved edge of the block, then cut and trim to shape.

Cut a piece of $\frac{1}{8}$ in. sheet balsa measuring $1\frac{1}{2}$ in. square so that it makes a

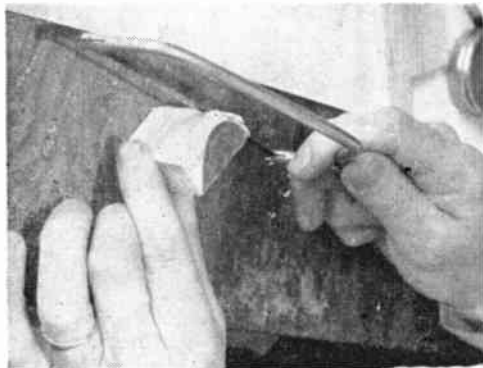

Fig. 1

snug fit in the aperture in the front of the fuselage. Cement this to the back of the noseblock and in the centre. When set, fix the entire block in the fuselage and with knife and glasspaper trim it to an accurate contour so that it lines out smoothly with the fuselage shape.

Drill the block with a $\frac{1}{8}$ in. drill and screw a flanged brass bush in place. The bush must have a bore suitable for a 18 swg piano wire shaft.

The balsa propeller used on the 'Hobby Clipper', is of 12 in. dia. with a medium pitch. You can buy this ready carved from Hobbies branches and it only needs two coats of banana oil —

The completed Clipper



glasspapering between coats. The propeller is already drilled at its hub but it will need opening out with a $\frac{1}{8}$ in. drill so that a screwed flanged bush can be fitted, similar to that used for the noseblock.

Cut a straight length of 18 gauge piano wire 5 in. long and with round-nosed pliers bend a loop so that the end of the loop extends for $\frac{3}{8}$ in., as shown in the drawing and on Fig. 2. Solder a cup

washer on the shaft just behind the loop. In conjunction with a piece of 18 swg brass or aluminium tubing $\frac{1}{2}$ in. long bend a Z-shaped pivot so that it will engage with the extended leg on the propeller shaft. Bind the pivot and tube to the front of the propeller as shown. Fit the shaft through the propeller, thread a ball-bearing washer or two cup washers on the shaft and then slide the noseblock in place. Finally

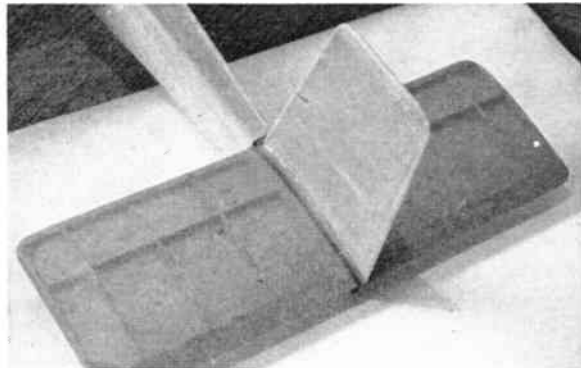

Fig. 3



Fig. 2

bend the diamond-shaped hook on the end of the shaft and slide a length of cycle valve rubber over it to afford protection for the rubber motor.

The nose assembly is held in place in the fuselage by pins and a small elastic band. Push four $\frac{1}{2}$ in. straight pins into the uprights at the four corners of the fuselage nose. Let them protrude $\frac{1}{8}$ in. Behind these stretch a small elastic band. This band is then stretched above and below the fuselage to pick up with two similar pins which are pushed into the noseblock, one at the top and one at the bottom.

Construction of the tail surfaces is

almost self-evident from the drawing and Fig. 3. Assemble the fin on a flat board after drawing it out full-size. After rounding off the leading edge and tapering the trailing edge to a wedge shape, cover each side with Japanese tissue. Water spray and when dry apply a single coat of banana oil.

Cut out the tailplane ribs and cement them to the $\frac{1}{8}$ in. square spar in the positions shown, again on a flat surface. Add the leading and trailing edges and

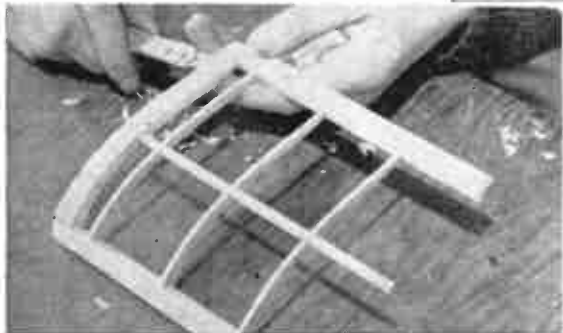
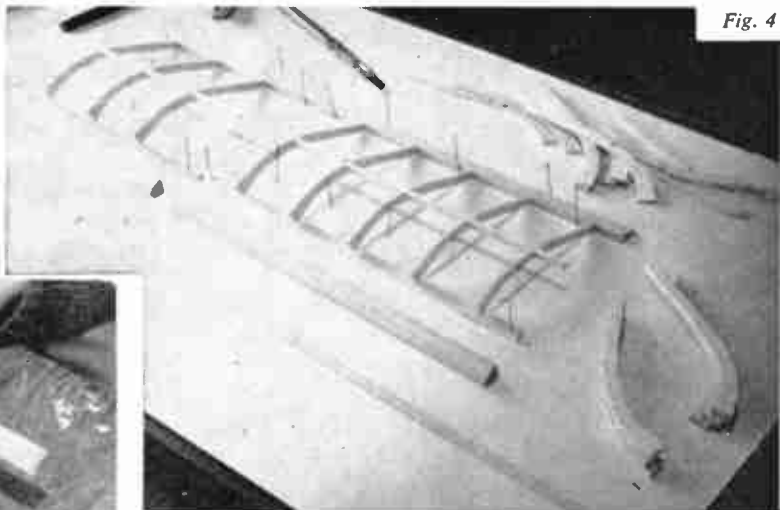

Fig. 5

the tailplane tips, each of which consists of two $\frac{1}{8}$ in. sheet ribs cemented together. Then round off the corners, and trim the whole structure with glass-paper. Cover the centre ribs with thin sheet balsa and smooth off the front and rear edges. Finally, cover each surface of the tailplane with tissue, applying paste to the ribs as well as the surrounding structure, water spray, and when dry apply an overall even coat of shrinking dope.

Cement the fin on top of the sheeting at the centre of the tailplane (Fig. 3) but

Fig. 6

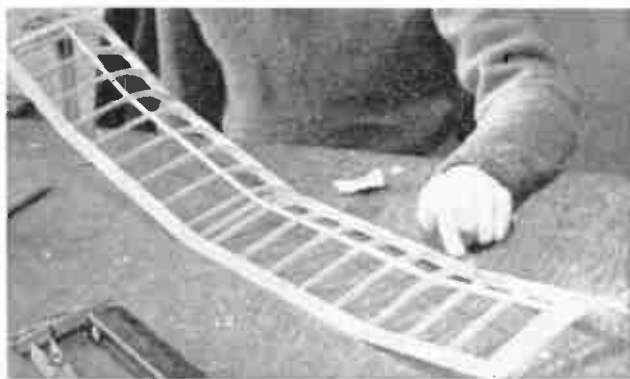
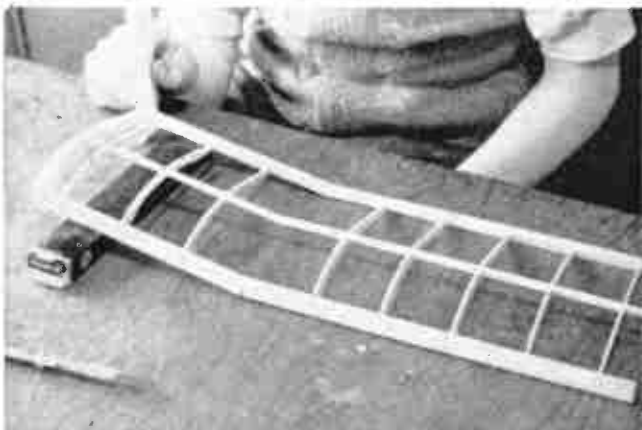

Fig. 7

angle it slightly so that the front corner of the fin is a little off-centre towards the left-hand tip of the tailplane. Fix the tailplane and fin assembly in place with a strong rubber band. This band is first placed round the fuselage in front of the tailplane, then stretched up and

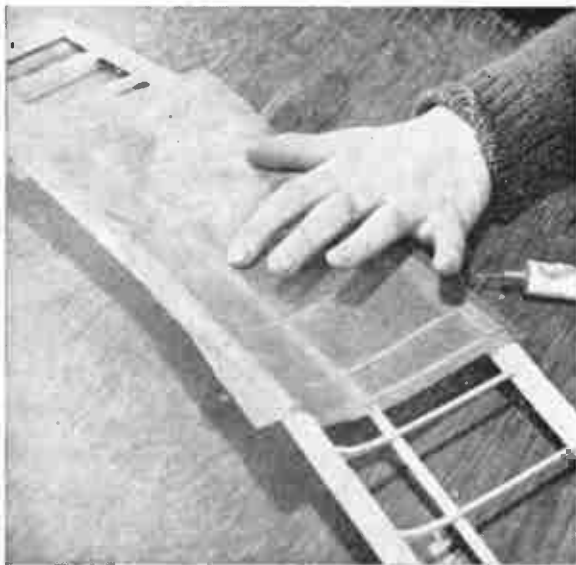
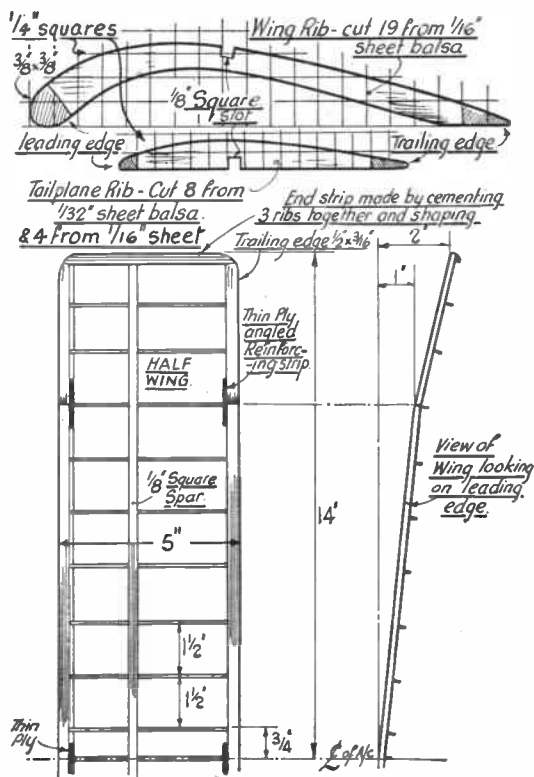

Fig. 8



over the fin and tailplane and fixed to the hook or bent pin underneath the fuselage at the rear.

Cut all the ribs for the wing including those which are to comprise the wing tips. There is a choice of wing-rib shape — the high-camber, high-lift type shown in the detail drawing of the wing or the more orthodox type shown on the fuselage drawing. Both are efficient, but the high-lift type requires more care during covering.

The wing is in four sections; two middle panels and two tip panels. Construct one of the middle panels first. Pin a length of $\frac{1}{2}$ in. by $\frac{3}{8}$ in. ready-formed trailing edge to your building board (Fig. 4) and cement the ribs to it, making sure they are kept vertical. To ensure a neat fit it will be necessary to place (temporarily) a strip of $\frac{1}{16}$ in. thick balsa

under the front of the ribs. Then cement the $\frac{1}{8}$ in. square spar in place, remove the structure from the board, and add the $\frac{3}{8}$ in. ready-formed leading edge. Trim to length and angle the ends of the members to accommodate the dihedral.

Build a wing-tip panel in a similar way and add the tip piece, which consists of three $\frac{1}{8}$ in. thick ribs cemented together, last of all. Trim the edges with a modelling knife (Fig. 5) and smooth.

Cement the tip panel to the center panel and check the dihedral (Fig. 6). Fix the millimetre plywood dihedral-keepers and add the rib at the joint.

Build the opposite side of the wing in a similar way, join the two sides together, add the dihedral-keepers at the middle and add the centre rib (Fig. 7).

Cover the underside of the wing first, using a separate piece of tissue for each panel. Apply the paste and the tissue to the *centre* of the ribs first (Fig. 8), then work your way towards the leading and trailing edges. Cover the top of the wing, starting at one tip and working your way to the opposite tip, covering a single panel at a time. Water spray and add a coat of shrinking dope.

Cement four thin dowel pegs or pins, two in the leading edge and two in the trailing edge at the centre section corners. To these are attached the ends of two rubber bands which serve to hold the wing to the fuselage.

Next — Making the rubber motor

Rustic Candlesticks

CANDLES give to a room that touch of charm and dignity which no other form of lighting seems able to provide. Even in these days of modern electric illumination many people still favour the restful light given by the humble candle.

In order to retain this old-world charm the holder or candlestick should not be too modern, and what could be nicer than wood in its natural state? Rustic woodwork is very easy to make, is very suitable for our purpose and the cost, if any, is extremely low.

The bark can be left on the wood, or if you object to the rough appearance it can be removed and the wood underneath, often quite beautiful, may be further enhanced with a coat of varnish or french polish.

As a centrepiece for the table we have a simple log A capable of holding two or more candles. It can be cut with square ends or at an angle as shown. Provide a flat base and drill the necessary number of holes in the top just large enough to receive the candles.

Smaller versions to take one candle would be very suitable to stand at the corners of a large table. As an alter-

native a slice about 1 in. thick cut off a log at an angle, as at B, would be quite effective. A smaller section to hold the candle may be fixed to the base C if this is not thick enough for the purpose.

Another good table centrepiece is made from a miniature tree 'trunk' having two or more branches sticking out as shown at D. Choose your section with the branches at different heights, as this gives a much more attractive appearance.

Quite good results can be obtained with a single twisting branch, and a pair of these would be suitable for adorning each end of a mantelpiece, especially if it is one of those old-world types with warm, mellow bricks.

In most cases it will only be necessary to drill holes in the wood to take the candles, but candle sconces can be obtained in various materials if you like something different, and are easy to fit.

There are many other finishes which can be tried. Gold or silver paint gives a very pleasing touch when applied to the rough bark in irregular splashes. Various coloured lacquers or enamels covering the entire job or in blobs is another useful method of adornment and quite effective. (A.F.T.)

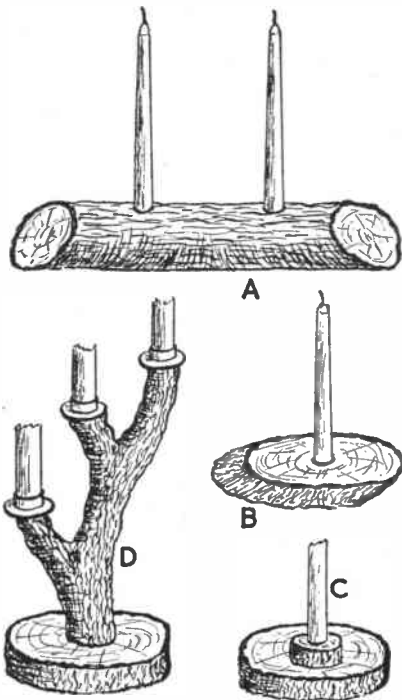



MOST OF US ENJOY THE DELIGHTFUL FRAGRANCE OF AN OLD ENGLISH GARDEN. BUT ALL TOO SOON THE WARM, SUNNY DAYS OF SUMMER HAVE DEPARTED, TAKING WITH THEM MEMORIES OF A THOUSAND AND ONE PERFUMES OF THE FLOWERS GROWN THERE. BY MAKING A POT-POURRI WITH THEIR SWEET-SMELLING BLOSSOMS, HOWEVER, WE CAN BRING A LITTLE RAY OF SUNSHINE INTO THE DULL WINTER DAYS

Says

A. F. Taylor

IN olden times pot-pourri was made in large quantities and stored in pots and jars with perforated lids so that the contents filled the room with their perfume, or in dainty sachets to put among the clothes and linen.

This article deals with an ideal container for your pot-pourri, together with some useful hints on making it. Besides having a well perforated lid the sides also have openings to enable the contents of the casket to perform their duty in a more effective manner.

There are endless varieties of wood which can be used, a hardwood probably being the best, but there is really no reason why a good plywood could not be used.

Each of the four sides (Fig. 1) can be cut from $\frac{3}{8}$ in. wood $5\frac{1}{2}$ in. long and 5 in. wide. The slots are made in the bottom halves of two sides and in the top part of the other two. If accurately made, these pieces will slide into each other and with a touch of glue will form a secure fastening. The fretted design can be similar to that shown or one of your own choice.

The bottom of the container, about $2\frac{3}{4}$ in. square, is cut with the edges slightly bevelled so that it fits snugly with a space of $\frac{1}{2}$ in. underneath. After glasspapering, cleaning up the frets, and gluing all the parts together the inside is lined with a thin material, such as muslin or silk, to keep the pot-pourri from spilling through, but allowing the perfume to escape. Glue it securely to the solid wood and avoid going too close to the frets. Four neat panels are easiest to

fix, the corners afterwards having a strip of $\frac{1}{2}$ in. wood glued down them. By taking this to within $\frac{1}{2}$ in. of the top it will also act as a stop for the lid. Thin strips may also be taken across the top to cover up the rough edges of the lining and also act as additional support for the lid.

Cut the lid (Fig. 2) from $\frac{1}{2}$ in. wood about $3\frac{5}{8}$ in. square and bevel the edges to fit loosely on top of the corner strips. A lining is not necessary for the lid but it would help to keep out dust.

The two pieces of wood for the handle (Fig. 3) are cut from wood 3 in. long and $1\frac{1}{2}$ in. wide with opposite slots in the centre. These are glued together and on to the top and complete the job.

Success in making pot-pourri lies in the careful drying of the flower petals

and leaves. The mixture will very soon go mouldy if there is any moisture present and it is absolutely essential to get every particle removed.

Drying in the sun is the best method, and all the petals should be spread out thinly on paper or a shallow tray.

Most sweet-smelling flowers retain their scent after being dried, but the violet, unfortunately, does not and therefore is not suitable. The good old-fashioned red roses are the best, and form the basis of most pot-pourri. Any other types of roses may be used if they possess a good scent.

Other useful flowers to dry are lavender, jasmine, honeysuckle, clove, carnation and heliotrope. The leaves of many herbs, too, can be used in small quantities and these include rosemary, lemon, thyme, marjoram, basil and sage, as well as sweet briar and geranium.

It is not necessary to dry everything at once. It may be done in small batches as the various flowers become available. When thoroughly dry they are put into a box and stored in a dry place.

Quite a good pot-pourri can be made with rose petals only, but a much better perfume is obtained by including a small quantity of other flowers and leaves. In order to fix the perfume, it is usual to add about one ounce of powdered orris root and perhaps a few tonquin beans pounded into small pieces. All these ingredients are well mixed and left for a few days, when they will be ready for use. If you like an extra rich perfume then a few spices can be added at this stage, but they must be used very sparingly. These can include cloves, cinnamon, cassia buds, vanilla beans, nutmegs and mixed spice. The grated rind of lemon or orange well dried can make a delightful change to the mixture.

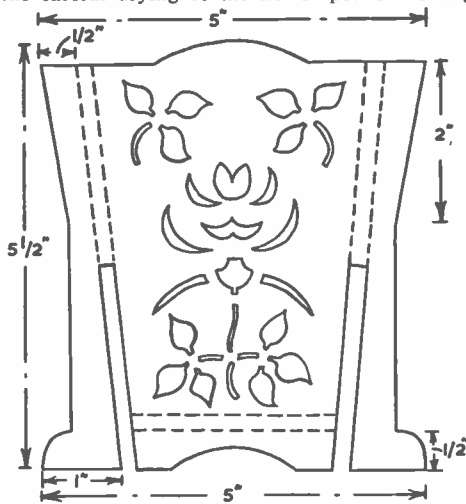

Fig. 1

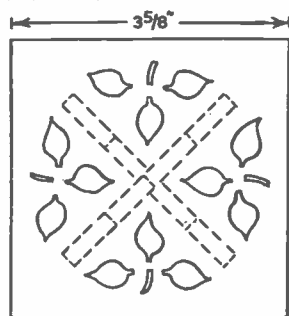

Fig. 2



Fig. 3

INTERESTED INVENEERING?
See page 181 for details of special offer to readers.

MODES OF TRANSPORT =

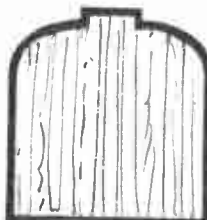
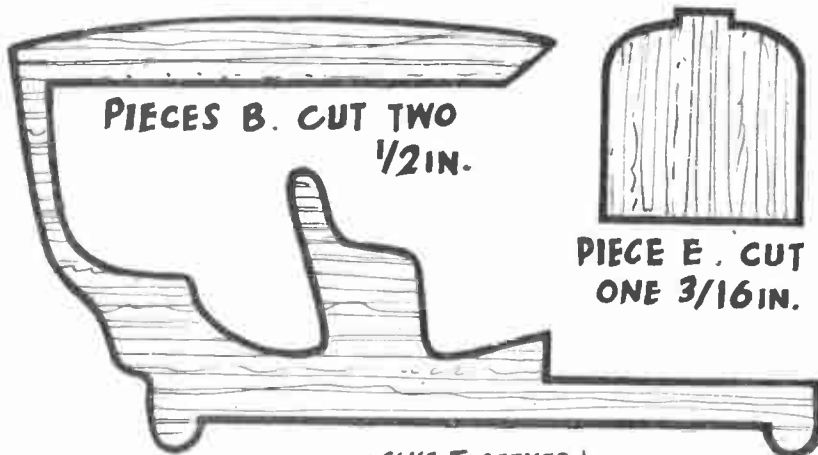
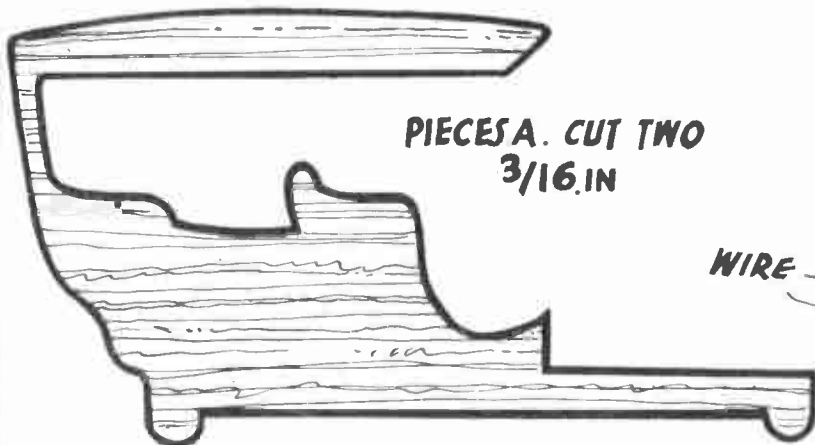

PIECES C. CUT TWO 1/2" (GLUE TOGETHER AND SHAPE +)

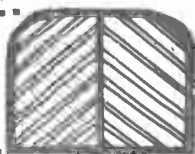
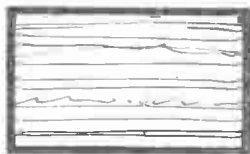

PIECE D. CUT ONE
3/16 IN.

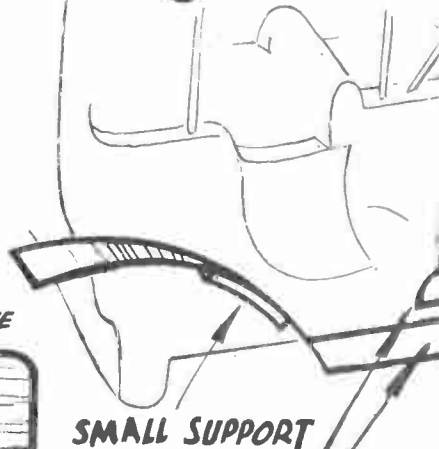
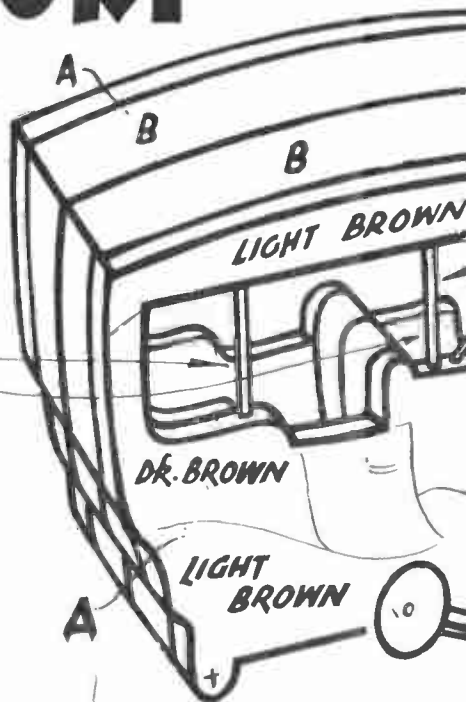

FURTHER DETAILS MAY BE OBTAINED FROM PHOTOGRAPHS,
OLD CATALOGUES & MAGAZINES.

1906 FORD

AUTOMOBILE

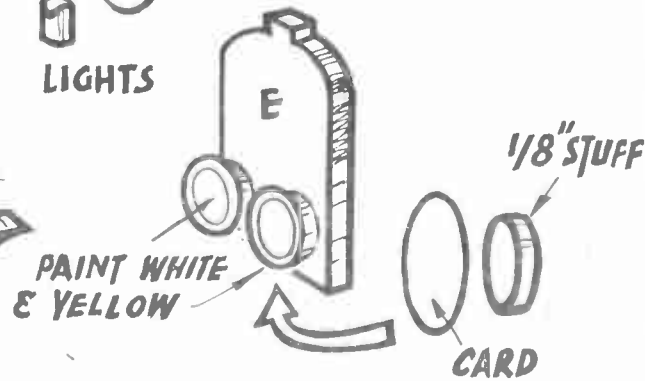
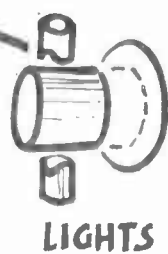
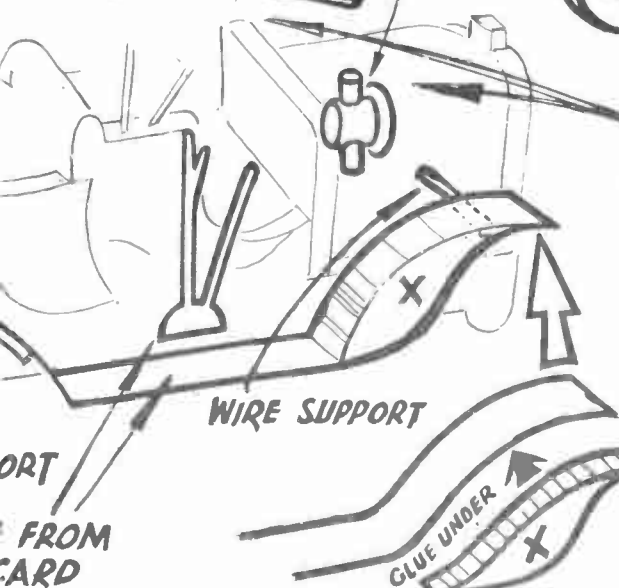
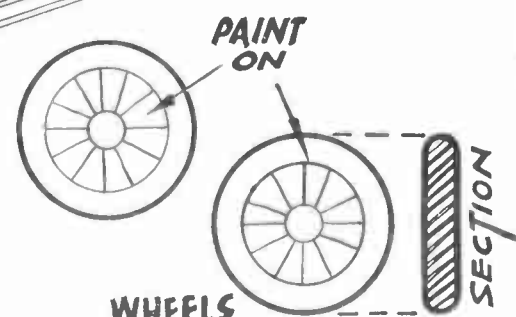
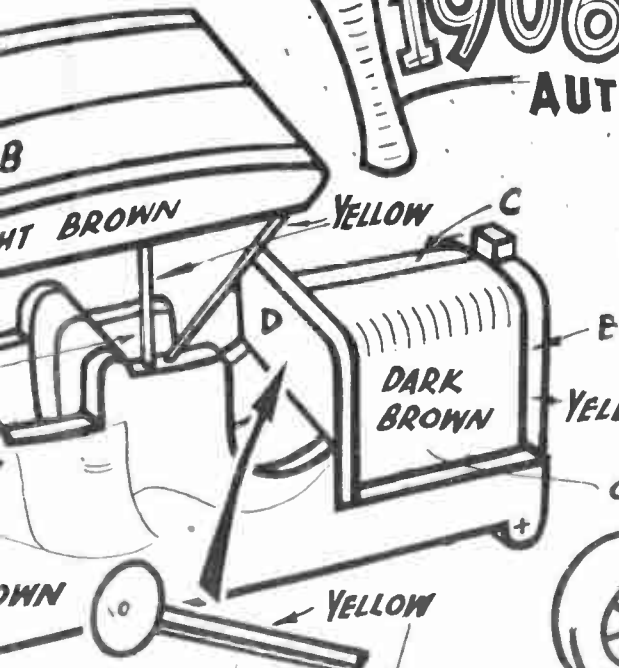

... Printed in England ...

THE USE OF TRANSFORMERS

WHEN A.C. mains are available, these provide a reliable and economical source of current for low-voltage lamps and motors. As the house supply is usually 200 to 250 volts, a transformer is used to reduce, or step down, this high voltage, and to isolate the model from actual contact with the mains circuit.

A transformer consists of an iron or alloy core, fitted with a bobbin in which primary and secondary windings are contained. The primary receives current from the mains, and has a large number

By 'Modeller'

of turns of wire. The secondary is insulated from the primary, and has fewer turns, so that a low voltage is obtained from it for the model.

As there is no actual electrical contact between primary (mains) and secondary (model) circuits, the model, and leads, connections, etc., are safe to touch. Running costs are extremely low, compared with the cost of batteries. It is also easy to obtain a larger current, if needed for a big model.

A transformer cannot be used with direct current mains. In most parts of the country A.C. mains are provided, however. In addition, the output obtained from the transformer will be A.C. This can be used to light bulbs, and to run motors with wound field magnets. But it cannot be used for purposes requiring D.C., such as electroplating, or running a permanent magnet motor, unless a rectifier is added. Ways of using a rectifier will be described in the next article in this series. Meanwhile, the transformer alone will provide current for illuminated models, A.C. type model motors, and any other purpose where low-voltage alternating current is suitable.

Simple transformer circuit

A very simple transformer circuit is shown in Fig. 18; and other circuits resemble this, though switches, etc., may be added. The primary is wired to the mains, and the secondary provides current for a small torch bulb. Such a circuit could be used in a mains-run Night Light, where the transformer could be concealed in the base, and the torch bulb mounted in a suitable shade or globe.

With mains transformers, the ratio is not indicated, but the output voltage and current are given. A bell transformer, for

example, might have an output of 5 volts. This means that with the primary fed from the house mains, a 5 volt supply is obtained from the secondary. The transformer could, of course, have a different voltage output, to suit the bulbs or motor.

The current rating of the transformer shows the maximum current which can be drawn, without the transformer overheating. For example, a 2 amp 6 volt transformer would give up to 2 amps at 6 volts. If 6 volt bulbs taking $\frac{1}{2}$ amp were run from it, up to eight bulbs could be connected. There is no need to take the full current, if it is not wanted, so such a transformer could run even a single bulb, if this were sufficient for the model, etc.

Quite often the actual current consumption of the model will not be known. There is no need to bother about this provided the transformer does not become hot after a period of running. If it does, then too much current is being

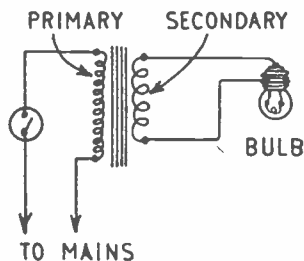

Fig. 18—Transformer with bulb

taken. With some motors the current required is mentioned in instructions. A transformer to suit can then be bought. Or one giving a little extra current can be chosen, if the model is to be illuminated as well.

Running bulbs in the way shown in Fig. 18 is extremely economical. If several bulbs are used, they can be all wired in parallel. Or bulbs may be combined in two's or three's, as was explained in the second article in this series, to suit an existing transformer.

Safety precautions

Mains voltages will be present in the transformer primary, so safety requirements which apply to all mains circuits must be observed here.

Good quality flex should be used, with a proper mains plug to suit the socket from which current is drawn. If the transformer has exposed primary tags, it should be enclosed in an insulated box, with small ventilation holes, so that

bare joints cannot be touched. If a switch is included in the primary circuit, as in Fig. 18, it should be of mains type.

When the primary circuit is soundly made and insulated, no shocks can arise from these connections. The only other possible source of danger lies in a breakdown in the transformer itself, so that primary and secondary windings come into contact. This is extremely unlikely in a soundly designed and well made transformer, but it is usual to add earthing, and a fuse, to provide extra protection. Even if the transformer breaks down, or short circuits arise, the model is then still safe. It is thus recommended that this precaution be taken with trains, and all similar models which are to be run from the mains, including illuminated models with bare bulb holders, low-voltage switches, etc.

In Fig. 19, a transformer with fuse and earthing is shown at 'A'. The transformer takes current from a 3-pin wall socket. The large pin on the plug is connected to the transformer core (and metal case, if present) and to the secondary. The connection 'L' goes to the 'Live' pin on the mains plug, which may be marked with a letter 'L' or a red dot. With flat pin 13 amp plugs, this is the pin to which the internal fuse is fitted. The connection 'N' goes to the 'Neutral' or 'earthed' side of the mains, marked with the letter 'N' or a black dot. 'E' is the Earth connection, to the large pin, already mentioned.

With 13 amp plugs with fuses, no additional fuse is needed. But with 15 amp plugs no provision for fitting a fuse is made, so the fuse can be included in a holder in the transformer box. It should be of low rating in either case — say 2 amps. This will blow much more rapidly than the heavy-duty fuses which would be present for electric fires, etc.

If the transformer should break down, or any short circuit arise so that mains voltages reach the secondary, a dangerous mains voltage cannot arise in the model, because the secondary circuit is earthed. In addition, the fuse blows at once, disconnecting the mains current.

If the fuse is in a separate holder, as mentioned, take care to include it in the 'Live' connection to the transformer, not in the 'Neutral' connection. With 3-core flex, red should be used for Live, black for Neutral, and green for Earth connections, to distinguish them.

Variable output

An adjustable output is useful for various models, and can be obtained by

● Continued on page 178

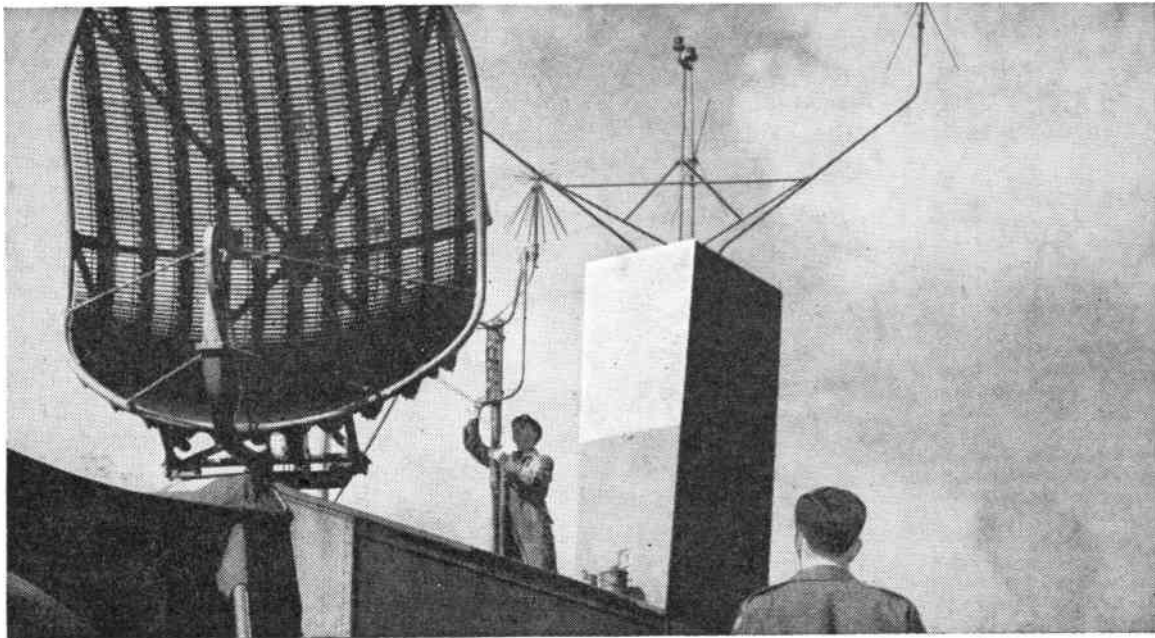

Ex-Apprentice fitters working on airfield radar equipment

How high are you aiming?

You're 15-17 and keen to get the most out of the world. All round you, you see it's the men with technical training who get the best jobs today. Good training means an apprenticeship. And a Royal Air Force Apprenticeship is the finest of all.

You'll go further in the Royal Air Force. A young man picked for an R.A.F. Apprenticeship is assured of getting the world's finest training for his chosen trade. He's paid while he learns, too—up to £6 a week, *all found*. And then? He'll join the closely-knit team of experts who maintain the air power of Great

Britain. He'll command the sort of money that a key technologist expects these days. Make no mistake, life in the Royal Air Force has everything—security, good living, and a dash of adventure too.

What's your line? There are two main classes of R.A.F. Apprenticeships. *Aircraft Apprentices* learn advanced radio, electrical and mechanical engineering. *Administrative Apprentices* are the future experts on the organisation side.

These Apprenticeships are not handed out to anybody. Competition is keen. To be considered, you must have done well at school, and be really eager to get on. There are vacancies in the trades listed on the coupon. Send it now for further details.

Post before 31st December 1959

To R.A.F. Central Recruiting Office (HS 39),
Victory House, Kingsway, London, W.C.2.

Please send me full details of R.A.F. Apprenticeships. I am particularly interested in:

Accountancy/Clerical	<input type="checkbox"/>	Supply Organisation	<input type="checkbox"/>
Aircraft Engineering	<input type="checkbox"/>	Electrical & Instrument Engineering	<input type="checkbox"/>
Armament Engineering	<input type="checkbox"/>	Radio Engineering	<input type="checkbox"/>

NAME

ADDRESS

..... DATE OF BIRTH



All Apprentices are urged to gain air experience. This Apprentice is off for a passenger flight in a Chipmunk.

including a variable resistor, or speed control, in one secondary connection, as shown at 'B'. The transformer should be able to give the highest voltage which will ever be needed (say 12 volts) and this can be reduced, for other models, by means of the resistance. Such resistances were described in No. 4 in this series.

A switch can be included in the secondary circuit, as at 'B', and can be the usual low-voltage type, exactly as if the model were run from a battery. The model can be switched on and off with this switch. But when the model will not be used for a period, the transformer itself should be disconnected, by pulling out the mains plug, or turning the main socket switch (if present) off.

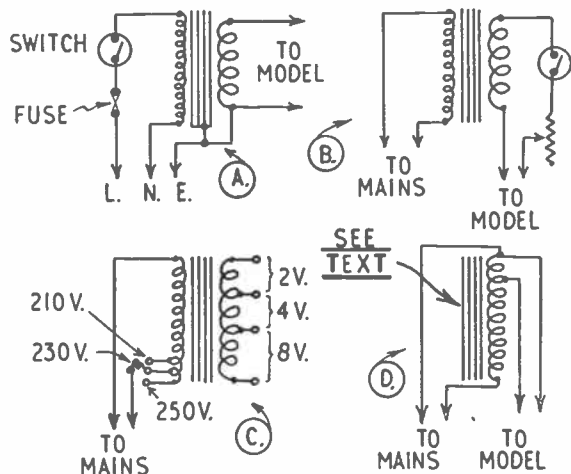

Fig. 19—Various transformer circuits. Circuit 'D' should never be used.

When the secondary circuit is interrupted (model switch 'off') practically no current at all will flow in the transformer primary. It is for this reason that bell transformers are permanently wired to the mains, the bell-push acting as an on/off switch in the secondary circuit.

Another method of obtaining various voltages is to use a tapped secondary, as shown at 'C'. Here, 2 volts can be had by connecting to the 1st and 2nd terminals. Connecting to the 2nd and 3rd terminals will provide 4 volts. If leads are taken to the 1st and 3rd terminals, 6 volts will be obtained. The 3rd and 4th terminals provide 8 volts, the 2nd and 4th terminals 12 volts, and 1st and 4th terminals 14 volts. An output of 2 volts, 4 volts,

6 volts, 8 volts, 12 volts or 14 volts can thus be selected at will. Such transformers are made for battery chargers and models, and are very useful.

Bell transformers frequently have three secondary terminals. The 1st and 2nd terminals provide 3 volts, and 2nd and 3rd terminals 5 volts, the total of 8 volts being obtained if leads are taken to 1st and 3rd terminals. The higher voltages are to compensate for the voltage drop in long wires to the bell or push.

At 'C' the primary is also tapped, for 210 volts, 230 volts or 250 volts mains. Some transformers have these tapings, so that the nearest voltage to the house mains can be chosen. Other transformers merely have two primary terminals or leads, for 200/250 volt mains.

With circuits 'B' and 'C' a fuse and safety earth return should be employed as shown at 'A'. These are not included in 'B' and 'C' because they have been explained already.

Surplus and special transformers known as 'auto-wound' or 'auto' transformers are occasionally seen. These provide a low voltage output, but there is only a single tapped winding, as shown at 'D' in Fig. 19. This means that the model would not be isolated from the mains at all.

Because of this, such auto-wound transformers should never be used for any model. They are designed for special electrical equipment, and are not intended to run models.

The correct type of transformers will have separate primary and secondary,

and there will be no actual electrical connection at all between the primary and the secondary.

As explained, the current rating of the secondary is the maximum which should be drawn. If it is desired to find out the total consumption of, say, a number of bulbs, add together the current taken by them all. For example, five .3 amp bulbs would take $1\frac{1}{2}$ amps in all.

The current taken by a motor varies according to its size, and the speed at which it is allowed to run. If the motor can only turn slowly, because the model is very heavy, or through insufficient gearing, the current rises. However, at least $\frac{1}{2}$ amp should be allowed for the smallest, most economical type of motor, such as can be run from small dry batteries. The larger type of permanent magnet motor may take 1 amp or so. Larger motors, with wound fields, will take some 2 to 3 amps, unless they are of the economical type designed for dry battery running, when the figure will be somewhat lower. The current will also be less for those motors which have a fairly high working voltage. For example, a 12 volt motor of given power would only require 1 amp, whereas a 6 volt motor of the same size and power would need 2 amps.

The most dangerous currents can, however, only arise when a short circuit is caused, as when a model train is derailed and the conductor rails are shorted. If allowed to persist, this heavy current will overheat and damage the transformer. To avoid this, a fuse can be inserted in the secondary circuit, between transformer and model. With a 2 amp transformer, a 2 amp fuse would do well. A short piece of fuse wire, between two small terminals, will do for the secondary circuit fuse.

This fuse, to protect the model and transformer secondary circuit, should not be confused with the mains primary fuse, shown at 'A' in Fig. 19, which should be retained.

Next — D.C. from A.C. mains

A Recipe for Marrow Rum

One marrow Demerara sugar
One orange $\frac{1}{2}$ oz. baker's yeast

THE marrow should be ripe and the skin tough and hard. Using a bread saw, cut the stalk end off and scoop out the pith and seeds. Pack the cavity with Demerara sugar. Mix $\frac{1}{2}$ oz. baker's yeast with 2 tablespoonfuls warm water, and the juice of the orange. Pour over the sugar in the marrow. Replace the top of the marrow, and seal it well with adhesive tape. Hang the marrow with the cut end uppermost in a muslin bag, and suspend it in a warm place.

Alternatively you can stand the marrow in a tall jug or earthenware vessel and cover with a thick cloth. After three weeks the liquid inside the marrow may show signs of leaking out. When this occurs, make a hole in the bottom of the marrow and allow the liquid to run out into a fermentation jar. Insert a fermentation trap or airtlock, and leave to perfect to a finish. You can if you wish add a few raisins to the liquid when you run it into the fermentation jar. The longer you can keep this 'rum' the better it will be.

Next week's free design will be for a delightful model Pixie House — a musical savings box.

MAKE SURE OF
YOUR COPY

This model farm cost less than 2/6

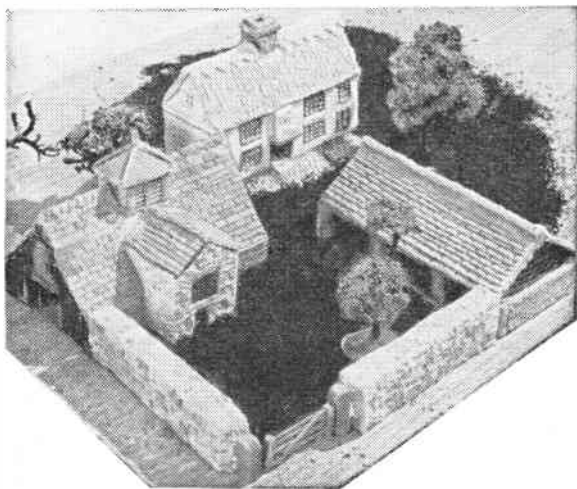

It was made from a half-crown tin of Sankey's PYRUMA — farmhouse, barn, implement shed, walls and gate — and there was still plenty of this grand modelling material left to build many more farm features, by simple methods described in the Instruction Book (see Coupon below). PYRUMA, plastic and ready-for-use, becomes stone hard after drying or baking, and can be painted in natural colours. For permanent modelling —

MAKE IT AND BAKE IT IN



Obtainable from your local Ironmonger or Hardwareman and many Art Material dealers. Ideal for making —

**Model Railway Buildings and Accessories,
Harbours, Ship Models, Airport Buildings
and Features, Houses, Bookends, Ashtrays,
Animals and Figures, Plaques, etc.**

Post this Coupon today for your Instruction Book

J.H. SANKEY & SON, L^{TD}

Established over a century
Dept. H, ILFORD, ESSEX

Please send ILLUSTRATED INSTRUCTION BOOK with full colour pages on Pyruma Modelling.

Enclosed Postal Order value 6d. (not stamps)

NAME (Block letters).....

ADDRESS.....

.....

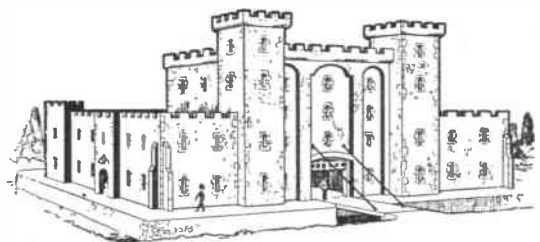

GIFTS

Kit No. 3274
GRAND MODEL FORT
Base 19ins. x 13ins.

27/6
(post 3/3)

FOR

Kit No. 2910
DOLL'S HOUSE
17ins. wide.
Four rooms, hall, landing.

59/11

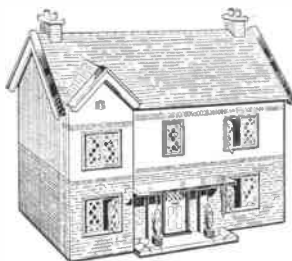

GIRLS

Kit No. 254 Spl.
DOLL'S HOUSE
Rigid hardboard construction.
Open back.

45/11



AND

BOYS

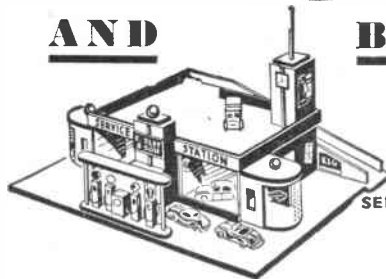

Kit No. 3129
SERVICE STATION
Very modern.
Base 24ins. x 18ins.

42/6

To Hobbies Ltd., Dept. 993, Dereham, Norfolk.
Please send free booklet illustrating kits available
and kit indicated here.

Kit No.....

Name

Address

P.O. for.....enclosed. (U.K. Orders value 30/-
and over, post free)

WATERSIDE FERNS



FERNS are particularly suitable for the cool, shady, moist spots around the pool where their delicate fresh green foliage makes a restful contrast with the more colourful plants.

Given a shady spot, most ferns will grow in quite poor soil, but they do appreciate humus; leaf-mould, therefore, should always be added to the soil. Shelter from the winds is necessary, whatever the position. Except where otherwise stated, the following ferns will flourish equally well in a limy or lime-free soil.

Adiantum pedatum. The Hardy Maiden-hair is the loveliest of the ferns. It has delicate fronds with glistening black stems and grows to 2 ft. in height. Its partner the Japonicum is an extremely rare and beautiful form with tender green fronds, tinted with pink.

Athyrium filix foemina. The Lady Fern is one of the prettiest native ferns with finely cut fronds. 3 ft.

Blechnum spicant. The Hard Fern is a very useful evergreen species, ideal for the shady part of a rock garden. It dislikes lime soil. 12 inches.

Dryopteris filix mas cristata. This handsome form of the Male Fern is a robust grower that makes a fine waterside specimen.

Osmunda regalis. The Royal Fern is most imposing. It likes to thrust its roots deep down into the water, and the fronds can grow as high as 6 ft.

Phyllitis hartstongue. A handsome evergreen species with shiny, strap-shaped fronds. Revels in the spray of a waterfall or fountain. Likes a limy soil. 12 inches.

Polypodium vulgare. The Adders Fern delights in damp, shady spots in well drained leafy soil, to which old mortar can be added. 12 inches.

Struthiopteris Germanica. The lovely Ostrich Feather Fern, with its circle of 3-4 ft. fronds leaning slightly outwards, looks like a beautiful, fresh green shuttlecock.

Remember, ferns cannot be moved at the same time as aquatics, and it is best to get advice from your dealer when purchasing.

Free-floating aquatics

These unique plants float freely on the water surface and do not require soil. They are unsuitable for running water and should also be excluded from lakes or very large pools.

By reducing the amount of light which enters the water, the floating aquatics help to discourage the growth of algae and blanket-weed. They also offer welcome shade to the fish.

Azolia caroliniana. Fairy Floating Moss. Makes a carpet of dainty, mossy texture, varying in colour from pale green to pink, bronze and crimson. Attractive and easily controllable in small pools, it gets out of hand in large sheets of water.

Hydrocharis morsus-ranae. Frog-bit. A

very pretty species with dark green leaves like water lily foliage in miniature. Small, white flowers, borne profusely in July and August.

Lemna. The common small Duckweed is an excellent food for fish and makes a carpet of bright green which can increase at a prodigious rate. Only introduce it, therefore, in pools where it can be controlled.

Stratiotes aloides. Water Soldier. A curious plant with spiny leaves which resemble the foliage of a pineapple. It winters on the pool bottom and rises to the surface in the summer to raise short-stalked white flowers above the surface, between June and August.

Utricularia vulgaris. The Bladderwort is an inconspicuous plant with interesting habits. It catches tiny, aquatic creatures in small bladders attached to its wiry underwater stems. After raising clusters of tiny, yellow flowers above the surface in July and August, it submerges.

Most of the floating aquatics have a very erratic sense of timing and in some cases do not appear at all until well into June.

'Airfix' model of the Rotodyne

AIRFIX'S new 1/72nd scale all-plastic model of the revolutionary Fairey Rotodyne has opening loading doors, a retractable undercarriage, fully detailed cockpit and a rotor diameter of 15 inches.

In January this year the Rotodyne set up a record 191 m.p.h. on a 100 kilometre closed circuit. This is 29 m.p.h. faster than the previous absolute speed record for helicopters.

The Airfix construction kit, containing 115 accurately-scaled pieces, costs 6s.

Other new Airfix Construction Kits are the 1/72nd scale Fiat G-91 NATO Strike Fighter aeroplane, the 1/32nd scale Morris Cowley 1923 'Bull Nose', and an attractive green platform canopy, an addition to the popular OO scale Trackside Series. These three kits cost 2s. 0d. each.

The Fiat G-91 is the first aircraft to be

produced to North Atlantic Treaty Organization specification and is now in service with the Italian, German and Austrian Air Forces. The 'Bull Nose' Morris Cowley originated in 1912. The 12 h.p. Cowley was introduced after the First World War and continued virtually unchanged until 1926, when the square radiator was adopted. The platform canopy will be specially welcomed by OO railway enthusiasts. The finished model is 6 in. long, 3½ in. wide, and just over 3¼ in. high.

All models are faithfully copied from originals, and are exact to scale.





NEW DO-IT-YOURSELF PRINTING OUTFIT

£1.17.6

COMPLETE

Everything you need to print your own snaps. Combined safe light and exposing light. Three 1/2 plate dishes (orange, white and grey). Printing frame with masks. Two graduated measures. Two forceps. Thermometer with case. Con-Sol developer. Acid Fixing powder and full instructions.

JOHNSONS
OF HENDON LTD

FOR CONFIDENCE
IN PHOTOGRAPHY

SPECIAL OFFER

TO READERS OF HOBBIES WEEKLY

6/-
VALUE
FOR ONLY

**BEAUTIFULLY MADE
VENEERING HAMMER**

**GENEROUS SAMPLE
OF CROID AERO
& INSTRUCTIONS**

4/-

(and the carton from a tube of Croid Universal)

Croid the strongest
glues in the world

15 KINGSWAY, LONDON, W.C.2

I enclose 4/- for the veneering hammer, instructions and tin of Croid Aero glue.

NAME

ADDRESS

Offer expires 31st January 1960. Applies U.K. only.

GRAND XMAS GIFTS

**FOR
THE
LAD**



**AND
HIS
DAD**

These fine presentation sets of Hobbies famous tools will prove ideal gifts throughout the year for any lad or adult interested in woodwork, modelling, etc.

Available from all Hobbies branches, stockists, etc., or send coupon today for immediate delivery.

Hobbies have other outfits costing up to 65/-, suitable for all occasions and all pockets.

YOU MUST HAVE HOBBIES 1960 ANNUAL 168 pages crammed with woodworking projects, toys, novelties, furniture, etc. Free designs for making Ballerina Musical Cigarette Box and Model Garage with each issue. Only 2/- from newsagents, etc., or by post 6d. extra.

FREE Ask for 20-page booklet of Hobbies tools and gift sets.

THE 'CROWN' With strong hand-frame, spare saws, cutting table, drill, instruction book, glasspaper block and design. **25/-** (post 1/9)



THE 'CHALLENGE' Represents real value. Contains 12 in. handframe, saw, steel cutting table, bradawl, spare saw blades, design and working instructions.

13/6 (post 1/6)



THE POPULAR 'A.1' The set most beginners demand. **38/6**



To Hobbies Ltd., Dept. 992, Dereham, Norfolk. Please send free 20-page booklet, name of stockist and items indicated.

- 'A.1' Outfit 38/6 (post free)
 'Crown' Outfit 25/- (post 1/9)
 'Challenge' Outfit 13/6 (post 1/6)
 Hobbies 1960 Annual 2/6 (post free)

Name

Address

MAKE YOUR OWN

GUITAR

Kit 3209

All wood (including partly shaped neck) full-size plan, sixstrings, etc.

57/6

(post free)



Overall Length 36½"

As shown on TV. Thousands of satisfied customers. Make your own first-class instrument.

From branches, etc., or by post

UKULELE

Kit No. 3260

Contains all wood, wire, strings, etc., for full-size instrument

23/9 Post 1/6



To Hobbies Ltd., Dept 993, Dereham, Norfolk. Please send Kit No.

P.O. for enclosed

Name

Address

★ LEARN ★ RADIO & T/V SERVICING for your OWN BUSINESS/HOBBY

● by a new exciting no-maths. system, using practical equipment, recently introduced to this country.

FREE Brochure from: —

RADIOSTRUCTOR

DEPT. G81, 46, MARKET PLACE, READING, BERKS. 9/12

LEARN RADIO and ELECTRONICS the NEW practical way! Very latest system of experimenting with and building radio apparatus — 'as you learn'. FREE brochure from — Dept. HW10, Radiostructor, 46 Market Place, Reading, Berks.

BUILD YOUR OWN HI-FI at home! At last, for reasonable cost — the chance to make your own quality HI-FI audio equipment and to gain the knowledge to service and maintain it. FREE brochure from — Dept. HW20, Radiostructor, 46 Market Place, Reading, Berks.

KITS for OLD TIME SHIPS

Hobbies range of Ship Models includes Elizabeth Jonas, Cutty Sark, Victory, Mayflower, etc. Complete kits of wood, sail material, guns, pulleys, cord, etc., with full-size patterns of parts and planed wood ready to cut out, shape and construct. A fascinating pastime.

Ask for free illustrated list at Hobbies Branches or from Hobbies Limited, Dept. 99, Dereham, Norfolk.

LET
★ **'Plasticine'**
HELP YOU DO-IT-YOURSELF Regd. Trade Mark
Harbutt's Plasticine Ltd, Bathampton, Bath

HOBBIES No. 2 CORNER CRAMP

Price

27/6

(Post 1/9)



This is the Corner Cramp favoured by many picture-frame makers. Made of cast iron, accurately machined, and fitted with steel screws. It takes mouldings up to 4 ins. wide. A good tool at a reasonable price. From branches or —

HOBBIES LTD., DEREHAM, NORFOLK

REFUND IF NOT WORTH 50% MORE.

Amazing Portable TRANSISTOR RADIO

ADVANCE 1961
SENSATION!



ONLY £6.19.6
MAGNIFICENT 2.100.00
OR SENT FOR 40%
BUILT BY PALM OF HAND.

Your personal set wherever you are. Genuine Transistor, only 6" x 4" x 1½", weight 15 ozs. Fits pocket yet has wonderful qualities reproduction & volume. Built-in Aerial & Speaker. Additional booster Aerial FREE! As pleasing as its big brothers. Finger tip control & selection of stations. Runs on 2 batteries obtainable everywhere 7d. each giving months normal use. Ultra modern case — delectful pastel shades. Guaranteed. £6.19.6 — 3/9 p & p, or 40/- dep. bal. 14 ftnly. ppts. 8/8 + p & p. Carrying case & Slings sent on appro. 12/6 ex. & Batteries 1/6 inc. post. LISTS GUITARS, RINGS, WATCHES, etc. Easy terms on most lines. STATE REQUIREMENTS.

HEADQUARTER & GENERAL SUPPLIES LTD.

(HOBW/ENG/92) 196-200 Coldharbour Lane, Loughboro Junc., London, S.E.5. Open Sat.

100 DIFFERENT stamps free! Request ½d. upwards discount approvals. — Bush, 53 Newlyn Way, Parkstone, Dorset.

STAMPS FREE — Empire Packet including Pictorials and Victorians with approvals. — Robert J. Peck, 7A Kemp Road, Bournemouth.

LOOK! 100 Free including loads of Pictorials, plus further gifts each time you request my cheap approvals. 3d. postage. — Salter, 42 North Road, Rotherham.

Completely new 54 page Edition

WHERE'S THAT CAR FROM?

Price 1/- (Postage 4d.)

Of all Booksellers

OR

RALEIGH PRESS, EXMOUTH, DEVON

MAKE A MUSICAL BOX for as little as 21/- New kits and tunes available. Movements 13/- post free. Please send 3d. stamp for free illustrated catalogue. — The Swisscross Co., Dept. B, 202 Tulse Hill, London, S.W.2.

EXTRA CHEQUES from writing. Send for 'Ideas for Writers' (free). Scores of suggestions for beginners and others. Typewriter unnecessary. — Writers' Ring (H.W.), 5 Edmund Street, Birmingham 3.

TRANSISTORS, Germanium Crystals, Headphones, etc. Lists and diagrams free. Germanium Diodes with three crystal set circuits 1/-. Postage 3d. — P.R.S. (H), 33 Bourne Gardens, London, E.4.

BUYING OR SELLING?

Classified advertisements on this page are accepted at a cost of 6d. per word prepaid. Use of a Box No. is 1/- extra. Send P.O. with advertisement to Hobbies Weekly, Advert. Dept., Dereham, Norfolk. Rates for display advertising on application.

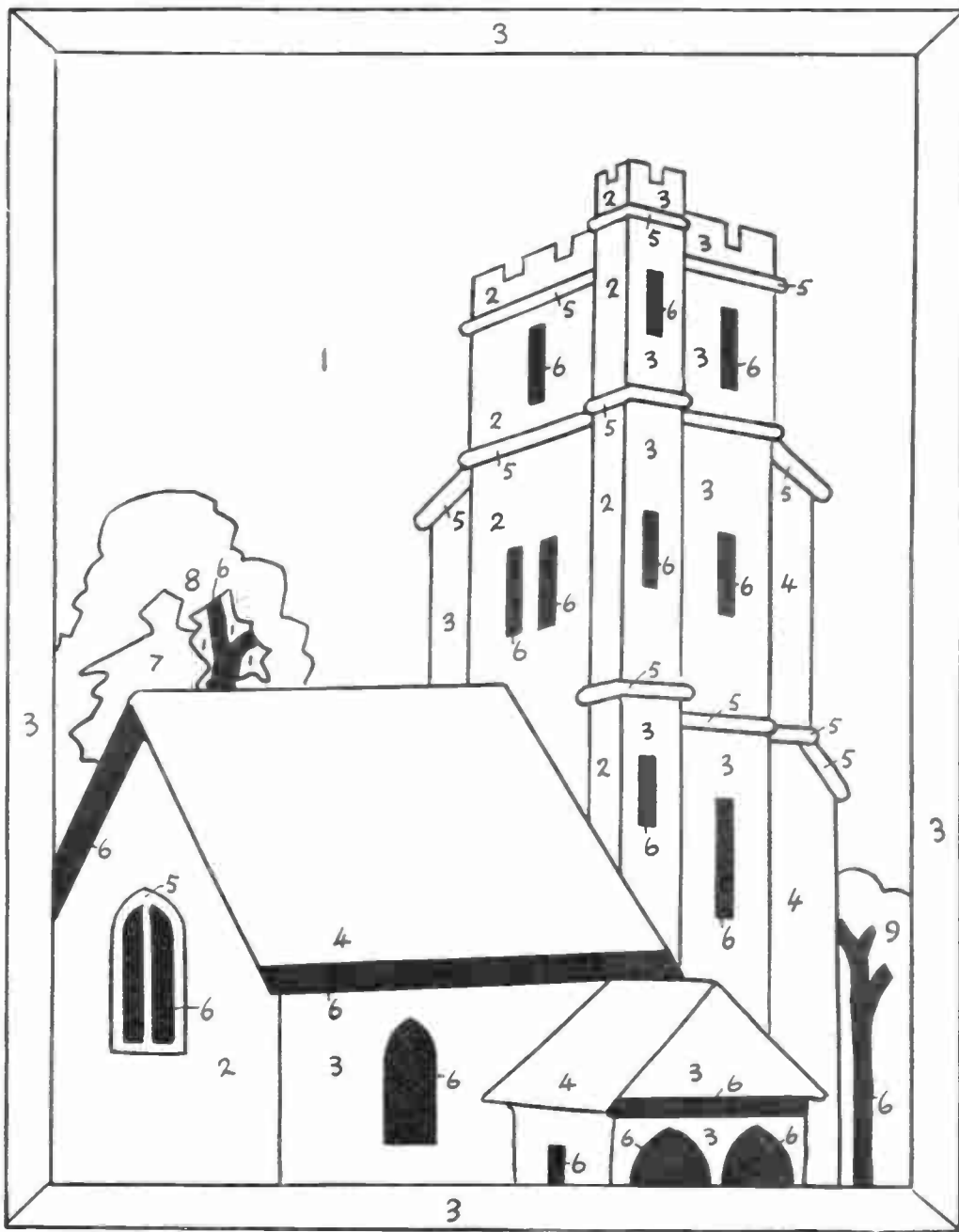

Suggestions for veneers to use:

- 1. Sycamore 2. Harewood 3. Walnut 4. Mahogany 5. Holly 6. Macassar Ebony 7. Walnut Burr 8. Elm Burr 9. Thuya Burr

build this!

Kitmaster's latest: 'Italian Tank' (No. 8) price 4/6



ROSEBUD KITMASTER LIMITED

It's a great day for model enthusiasts when a new 'Kitmaster' appears. Here's this month's —an authentic scale model of the Italian Tank locomotive, used for shunting duties by the Italian State Railways. Like all 'Kitmaster' models it's for use on OO and HO gauge tracks. Hurry to your nearest model or toy shop

KMC6

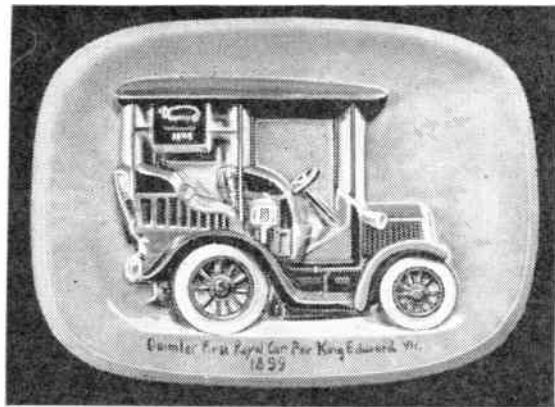
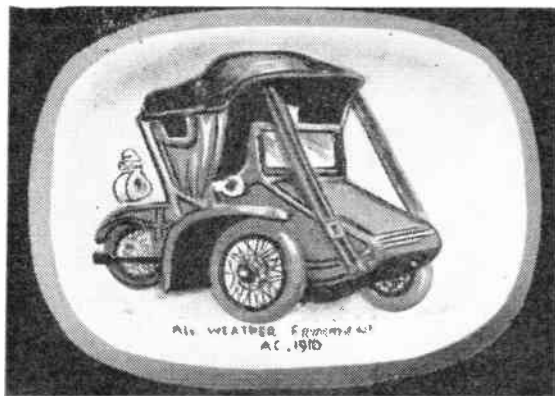

Veteran Car Plaques *FOR CHRISTMAS!*

Make a set of six wall plaques, showing authentic replicas of Veteran Cars. These make wonderful presents for Christmas. Use the moulds over and over again.

Write for illustrated leaflet, enclosing 3d. stamp



Sculptorcraft



SEAMER PRODUCTS (SCULPTORCRAFT) LTD, 23/27 EASTBOURNE STREET, HULL