

# HOBBIES WEEKLY

APRIL 9th 1958

VOL. 126

NUMBER 3258

IN THIS ISSUE

	Page
Windvane and Bird Scarer -	1
Chemistry in the Home -	4
Selecting and Masking -	5
A Child's Safety Gate -	6
Collectors' Club -	7
Improved Scissors Sharpener -	8
Store Under the Stairs -	8
The 'Satellite' Ball Game -	9
'Loitering' in the Vale of Belvoir -	10
Mainly for Modellers -	12
A Model Destroyer -	12
Draughtboard Puzzles -	14
Patterns for a Model Destroyer -	15



All correspondence should be addressed to the Editor, Hobbies Weekly, Dereham, Norfolk

★ *FREE design inside*  
*for this*  
*novelty*

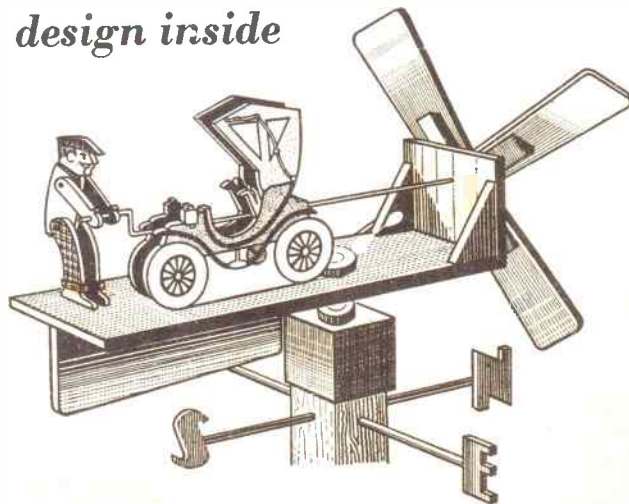

## WINDVANE AND

FOR its eye-catching novelty and practical use, this mechanical windvane and bird scarer should have a very popular appeal. As a garden ornament it will amuse and interest, as a seed preserver it will please — and it also correctly indicates the wind direction.

When the blades of the vane are stirred by the wind, a metal spring working on a ratchet arrangement emits a

crackling noise calculated to keep the birds away from your freshly sown seeds and growing seedlings. At the same time the motorist will be actively engaged in cranking his ancient vehicle, the strength of his actions being governed

★★★★★★★★★★★★★★★  
★ This is the first issue of a new ★  
★ volume. Readers who wish to pre- ★  
★ serve their copies for permanent ★  
★ reference should obtain an 'Easi- ★  
★ oinder' which holds two volumes (52 ★  
★ copies) available from Hobbies Ltd, ★  
★ Dereham, Norfolk. Price 8/6 each. ★  
★ ★★★★★★★★★★★★★★★★

by the force of the wind. On a lazy summer's day with but a faint suggestion of a breeze, he takes things very easily. But on a gusty day just watch his feverish attempts to get his circulation flowing and bring a spark of life into his veteran model!

The car, incidentally, is a model of a 1903 Studebaker. The shapes for this and the motorist are shown full size on the design sheet, and should be traced on to their appropriate thicknesses of wood. Measurements of other pieces are given on the design sheet and in the accompanying Fig. details. All parts should be measured out on the wood and cut out neatly with a fretsaw.

Make a start in assembly with the vane

## BIRD SCARER

itself. Pin and glue pieces 2 and 3 at the end of the platform (1). It should be noted that, as this model will be used outside and be in continual contact with the elements, a waterproof glue should be used throughout construction.

FOR ALL HOME CRAFTSMEN  
Over 60 years of 'Do-it-Yourself'

World Radio History

4  $\frac{1}{2}$  D

Next make up the car (Fig. 1) and motorist (Fig. 2). In Fig. 1 the two blocks (pieces 5) are glued in between the sides (pieces 4) and a length of wire will be inserted later through holes in these blocks. The car assembly can now be glued into the base (1) ensuring that it faces the correct way, of course!

The legs and arms of the man (Fig. 2.) are made to pivot freely on the body, and are secured by screws or sturdy wire nails. The legs (pieces 8) are likewise tenoned into the base.

The sails must be marked out properly so that the blades have the proper twist. We have shown these in detail in Fig. 3. Procure two pieces of lin. square wood 9ins. long (15 and 16) and mark them

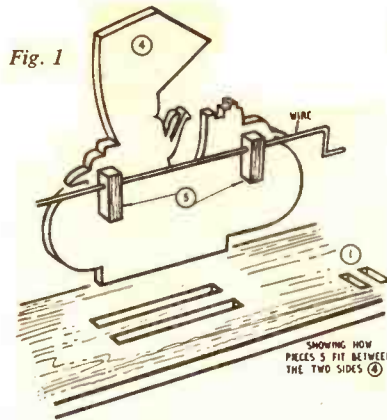

Fig. 1

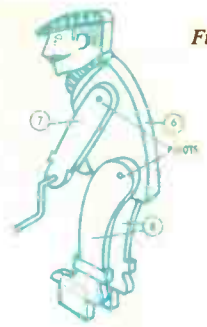

Fig. 2

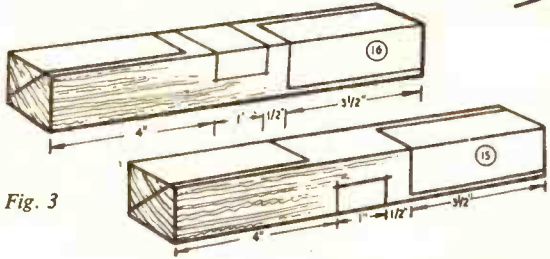

Fig. 3

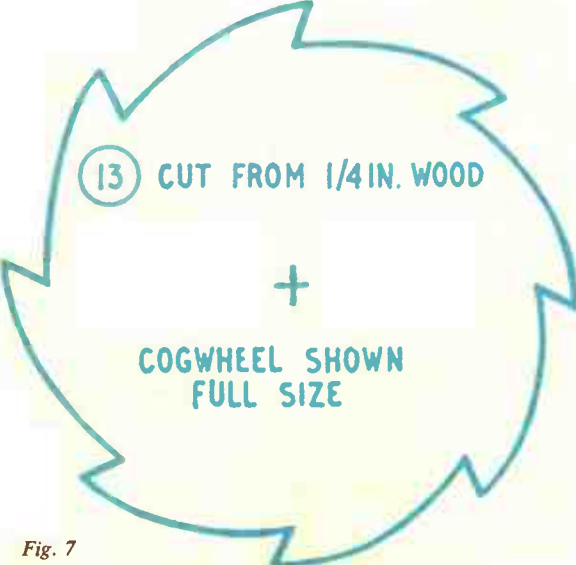

Fig. 7

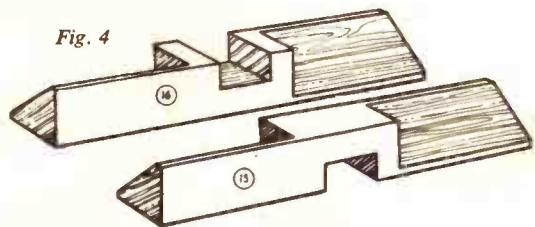

Fig. 4

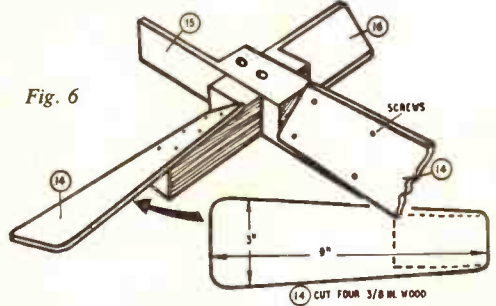

Fig. 6

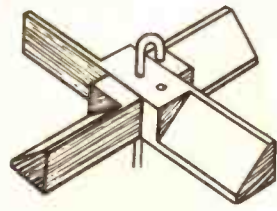

Fig. 5

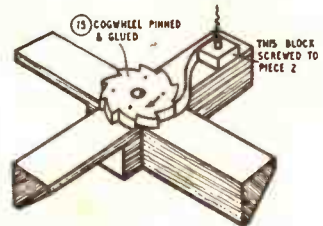

Fig. 8

out as shown. These are identical except for the pieces which are cut out at the centre where they are halved together. Fig. 4 shows clearly the wood that has been cut away. The waste wood is removed by first cutting with a tenon saw and then paring away with a broad chisel.

There are two holes shown slightly enlarged in Fig. 5. The centre one takes the wire and the other takes the end of

the wire after it has been bent round. The diameter of the holes should be slightly smaller than the wire so that it is secure when the bent portion is pushed home. The wire should preferably be galvanised.

To make the blades, cut out four pieces (14) to the approximate shape shown in Fig. 6. The material should be 3/8 in. thick. Fix securely to the sails by means of small screws.

Turn your attention now to the ratchet (13) that produces the noise. Cut this to shape as shown full size in Fig. 7 from 1/4 in. wood. Fig. 8 shows the spring just about to drop off the end of a cog. A piece of springy metal is fixed to a small block by means of a screw. The block is in turn screwed to piece 2.

Now make up the box (Fig. 9) to fit over the top of the post on which the model is to be erected (pieces 9, 10 and

11). This box is designed to fit over a 2½ in. square post. A larger post will, of course, have to be sawn down to size at the top section in order to take the box.

Figs. 9 and 10 show how the vane rotates through a spindle (piece 17) which consists of a 6 in. length of 1 in. diam. round rod. The spindle is an easy fit in the hole in piece 1 without being too sloppy. After inserting in the hole, a washer (12) is glued to the top of the spindle. A second washer is glued to the spindle underneath the platform (piece 1) so as to ensure fairly easy play. This can be chamfered to reduce friction. The bottom two washers are similarly fixed to the spindle as shown in Fig. 10 and they can also be glued to the top and underside of piece 9. The fixing box is

Fig. 9

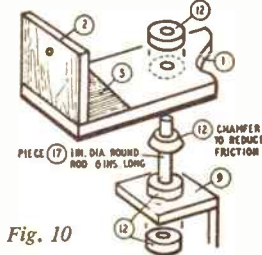
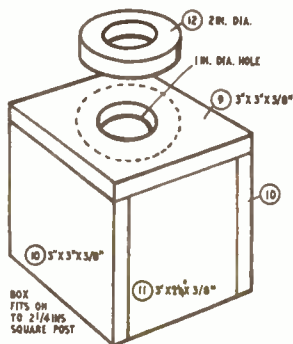
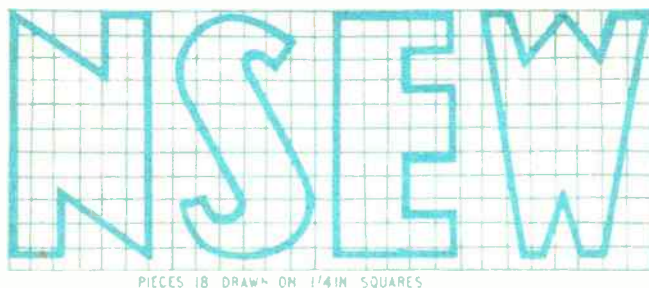

Fig. 10

Fig. 12



now ready to be placed over the post and fixed by screwing from the sides.

The wire drive can now be inserted. Make a start by bending at the sail end as seen in Fig. 5. The wire proceeds through piece 2 then through the two blocks (5) in the centre of the car. The handle end is bent as shown in the finished illustration, and is finally inserted through the arms (pieces 7) of the motorist. Note that the wire should have easy movement in all these holes, and fashion it so as to make the movement as frictionless as possible. Adjust the metal strip to the ratchet (piece 13) so that it makes good contact with the cogs.

Piece 19 is pinned and glued underneath piece 1, and acts as a wind catcher

to swing the vane into the wind (Fig. 11).

The wind direction arms are made up from pieces 18 and ¼ in. round rod. The outlines of the letters N.S.E.W. (pieces 18) are shown in Fig. 12. These have to be enlarged on ¼ in. squares to give a final height of 2½ ins. each. Their fixing to the ends of the dowel rods is shown in Fig. 13. The dowels are then glued into four holes in the post underneath the fixing box. Fix the points by compass readings.

To withstand the weather, the model should be well preserved with several coats of paint. Suggestions for colours are given on the design sheet and the car and figure can with advantage be painted first, before fixing to the platform.

Fig. 13

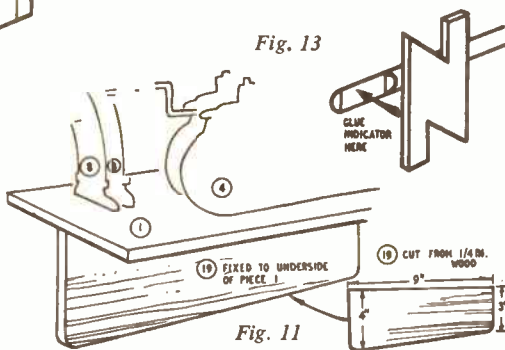

Fig. 11

### KIT FOR 16/-

Kit No. 3258 contains panels of wood, wire, strip steel, etc. for making the Windvane. Kits obtainable from branches or Hobbies Ltd., Dereham, Norfolk, price 16/- (post free).

Continued from page 4

## Making Double Salts

resistance to oxidation by the air.

Nickel ammonium sulphate, another double salt, has industrial importance. It is used in nickel plating baths. It forms splendid green crystals, especially if the solution is allowed to cool slowly. Dissolve 29 grammes of nickel sulphate in 30 c.c. of hot water and stir into this a solution of 12.5 grammes of ammonium sulphate in 17.5 c.c. of hot water. On cooling, the crystals of the double salt deposit and may be removed and dried on a porous tile.

And now how about using this to make a good nickel plating powder which will operate without electricity? It works well on copper and brass articles and, though not of such thickness as the electrolytically deposited metal, it is surprisingly durable and stands much handling.

To make it, powder finely some of the dry nickel ammonium sulphate. Weigh out 6 grammes of it and thoroughly mix it with 0.3 grammes of magnesium powder and 3 grammes of precipitated

calcium carbonate. This should be kept in a well closed jar, for it is affected by damp air.

When you wish to plate copper or brass, put a little of the powder on a tin lid, dip a moistened cloth into it and rub on to the metal. A dull film of nickel appears. When the metal is evenly covered, change your cloth for a soft clean dry one and buff up. A bright plating of nickel results. If the original metal was very tarnished it is as well to clean it first with ordinary metal polish and then to swab with petrol. This powder is an excellent preparation to know. Cheap and easy to make, easy to use, it can transform worn plated articles.

(L.A.F.)

# CHEMISTRY IN THE HOME

**W**HAT are double salts? They are crystalline compounds of two salts in definite proportions. They are generally formed by mixing solutions of the two salts and then crystallizing. If there is an excess of one salt over the other, the double salt is formed, but the excess of the other salt crystallizes separately, thus showing that double salts really are made up of definite proportions. Double salts are generally less soluble in water than their components, so that on mixing strong solutions of the latter the double salts usually crystallize out at once. It will be seen from this that their preparation is often easy.

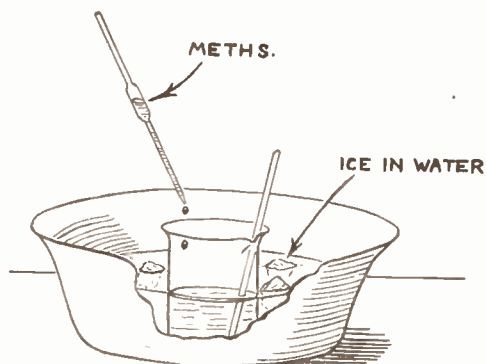

Fig. 1—Making chrome alum

The commonest example of a double salt is alum. Chemically it is potassium aluminium sulphate. Its preparation gives us a typical method. Separately dissolve in the smallest possible quantity of lukewarm water 1.74 grammes of potassium sulphate and 6.66 grammes of aluminium sulphate. Mix the solutions and allow to cool. Alum separates. Pour off the mother liquid and dry the crystalline alum on a tile. A further amount may be had by evaporating the mother liquor somewhat and letting it cool, when it crystallizes out.

Similarly, chrome alum (potassium chromium sulphate) may be made from potassium sulphate and chromium sulphate, but a more convenient way is to reduce an acidified solution of potassium dichromate.

Dissolve 3 grammes of potassium dichromate in 12 c.c. of water in a beaker and stir in slowly 2.2 c.c. of strong

sulphuric acid. Stand the beaker in cold water, and, if you can obtain it, put a piece of ice in the surrounding water to keep the temperature down (Fig. 1) during the subsequent reaction. Now add methylated spirit a few drops at a time from a pipette, stirring thoroughly and pausing a minute or two between each addition. These pauses are necessary, since the reaction causes a temperature increase and if this rises too high the final product will contain an uncrystallizable form of chrome alum and lower the yield.

The orange colour of the solution gradually darkens and finally passes to green. At this point stop adding meths

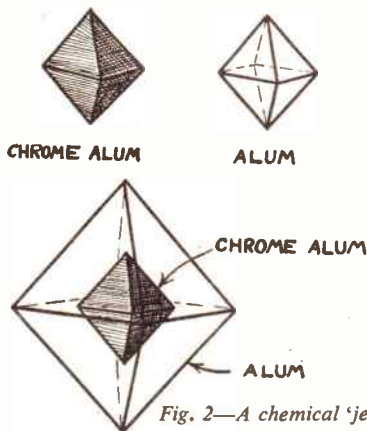

Fig. 2—A chemical 'jewel'

and let the whole stand overnight. A lilac crystalline powder of chrome alum separates. Filter this off, preferably with the filter pump, wash with a little cold water and dry it on a porous tile.

Ordinary alum and chrome alum crystallize in the same form. A most striking chemical 'jewel' can be made by using this property. Warm two portions of water to 40°C., but no higher. In one dissolve alum and in the other chrome alum to saturation. Pour off from undissolved solids and let the solutions cool overnight. Crystals separate. Pour off the clear upper liquids and keep the alum solution in a bottle for the time being. The solution of chrome alum should be kept in a warm place of even temperature, such as a mantelpiece, until crystals deposit. When you note a good shaped crystal rather

## MAKING DOUBLE SALTS

like that shown in Fig. 2, remove it and the clear upper liquid to another beaker and replace the whole in the warm place. Repeat this process until you have a fair sized crystal, rejecting all other crystals which happen to form.

This violet diamond-shaped crystal will now serve as a nucleus for a colourless alum layer, a crystal within a crystal. Put it in a beaker with the alum solution which you bottled and proceed as you did with the chrome alum solution. By repeated treatments quite a large crystal may be formed. There is an element of luck with crystal growing in this homely way and your crystal may not have the perfect shape shown in

Fig. 2, but the sight of a violet centre in even a badly shaped colourless crystal is most intriguing. As alum becomes opaque on long exposure to air, the crystal should be protected with a thin coat of clear cellulose varnish.

You may have kept a solution of ferrous sulphate on hand and noted that it gradually became brown and deposited a rusty solid. This is caused by oxidation and passage to ferric sulphate. By using a double salt of ferrous sulphate this difficulty can be avoided. Ferrous ammonium sulphate, the double salt, oxidizes very slowly

indeed, and reacts like ferrous sulphate in ordinary tests. Consequently, it is a more desirable laboratory reagent.

It is easily made on the principle that double salts are usually less soluble in water than their components. Add one drop of strong sulphuric acid to 30 c.c. of cold water. Bring the water nearly to the boil and dissolve in it 17.5 grammes of ferrous sulphate. Add to this a solution of 12 grammes of ammonium sulphate in 15 c.c. of hot water, stir well and let the liquid cool overnight. Green crystals of the double salt will be found in the beaker. Remove these and let them dry on a porous tile. You will note that they are of a much paler green than ferrous sulphate. The double salt is much used in volumetric analysis because of its

● Continued on page 3

## Enlarging (3)—by 'Photographer'

# SELECTING AND MASKING

**E**NLARGING not only allows a bigger picture to be obtained, but allows the subject matter to be selected to give a more pleasing result. It is very unusual for the whole of a negative to be enlarged, as a better print is usually obtained by leaving out some sections — usually those round edges.

A little care given to selecting the part of the negative actually used is always worth while. The use of a masking device, to hold the paper flat and provide a white border, is also recommended.

### Choosing the picture

An examination of the negative will often give a good idea of the part which can best be enlarged. For example, if a person has been photographed against a background of hedges, trees, or other un-

interesting material, it will be best to concentrate upon the person, making a finished print of this area only.

Another method is to insert the negative in the enlarger, and focus it upon a piece of white paper on the enlarger baseboard. Two wide masks, of stout black card, are then used to cut off unwanted parts of the picture. These can be overlapped, as in Fig. 1, so that the area to form the actual print may be of any size, and forming either a vertical or horizontal picture. When a portion giving the best and most interesting appearance has been selected, this can be made to fit the paper which will be employed, by moving the enlarger head up or down as required. In this way a very good idea of the appearance of the finished print can be obtained.

tive can be enlarged to fill the whole of the paper selected. An enlargement can thus always have a much more satisfactory appearance than a contact print. Crookedness, due to tilting the camera, can also be eliminated when enlarging.

The limitation to enlargement is imposed by the detail in the negative. If the camera was held perfectly still at the moment of exposure, and was focused correctly, almost any modern equipment can give half- and whole-plate prints of sufficient sharpness. But if a poor lens, or faulty operation, has given a fuzzy negative, this defect will become more and more visible as the degree of enlargement is increased. With high degrees of enlargement, the individual grains in the film emulsion can also become visible, resulting in a grainy print. Size

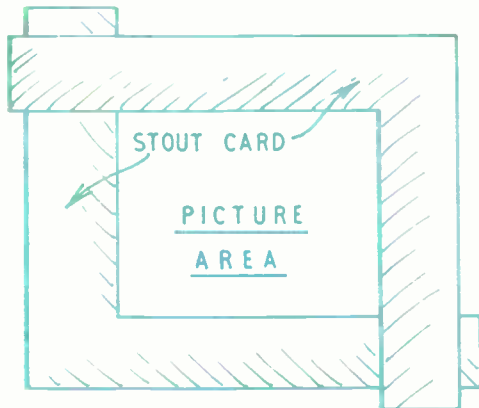

Fig. 1—Pair of card masks

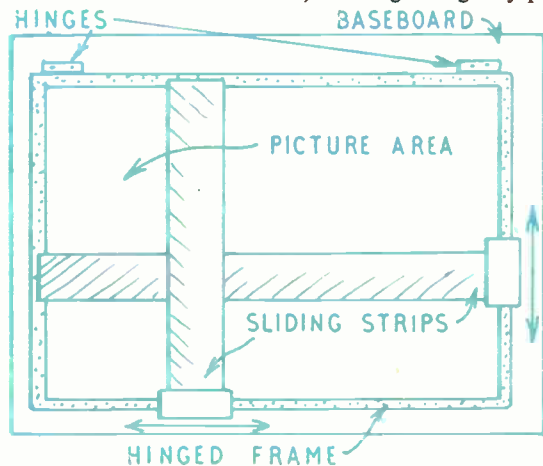
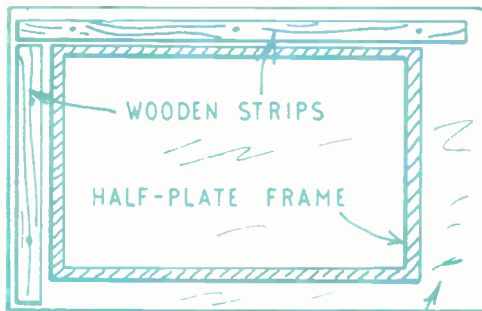

Fig. 2—Adjustable masking frame



BASE-BOARD  
Fig. 3 —  
Frame for  
uniform sizes

### Sizes

The most popular sizes, for average albums, are as follows:

Quarter-plate, or  $3\frac{1}{2}$  ins. by  $4\frac{1}{4}$  ins.

Postcard, or  $3\frac{1}{2}$  ins. by  $5\frac{1}{2}$  ins.

Half-plate, or  $4\frac{1}{2}$  ins. by  $6\frac{1}{2}$  ins.

Whole-plate, or  $6\frac{1}{2}$  ins. by  $8\frac{1}{2}$  ins.

Even larger papers are available, but become rather expensive, so that postcards and half-plates, with an occasional whole-plate print of outstanding objects, are most popular.

Within limitations, the selected part of the nega-

alone should thus never be put first. Instead, the degree of enlargement should be chosen to give the most pleasing appearance.

### Masking

Adjustable masking frames may be obtained, and one is shown in Fig. 2. The sliding strips can be moved along, so that the picture area can be of any required size or shape, exactly as with the card masks in Fig. 1.

When the best picture has been selected, the enlarger is switched off, and the hinged frame is lifted. A piece of bromide paper is then placed on the masking frame baseboard, being kept up towards the hinges, and to the left. The frame is then lowered, and holds the paper, at the same time covering its edges from the enlarger light, so that a white

border is obtained. It is possible to construct such an adjustable mask, though this is not easy.

A simpler type of mask is shown in Fig. 3 and is much more easy to construct. Some workers prefer it, because it always gives prints in uniform size, whereas the adjustable mask tends to result in prints of very many different sizes and shapes.

The bromide paper is kept back and to the left, against the wooden strips, and the appropriate masking frame is placed upon it, also being pressed against the strips. Several masking frames can, of course, be used, to obtain uniform prints in a number of sizes.

The edge of each frame can conveniently be  $\frac{3}{8}$  in. or  $\frac{1}{2}$  in. wide. With  $\frac{1}{2}$  in. borders, the postcard mask would thus be  $3\frac{1}{2}$  ins. by  $5\frac{1}{2}$  ins. overall, with an aperture 3 ins. by 5 ins. The half-plate mask would be  $4\frac{1}{2}$  ins. by  $6\frac{1}{2}$  ins., with an opening  $4\frac{1}{2}$  ins. by 6 ins.

The frames or masks are best cut

carefully from 3-ply, the edges being made true by rubbing with a glasspaper block. It is also possible to make them from  $\frac{1}{8}$  in. or  $\frac{1}{4}$  in. strips, jointed and glued at the corners. When completed, the frames should be painted black.

#### Other methods

The white border obtained with a masking frame often improves the appearance of a print. However, occasional prints without this border help to provide a variety in an album.

If no border whatever is wanted, the paper may be held flat by placing a sheet of perfectly clean glass upon it. Plate glass is best, but not essential. The glass must be free from flaws, and can be of any reasonable size larger than the print. The enlarger is adjusted so that the print contains subject matter right up to the edges.

Another method of holding the paper flat is to place a small object upon each corner, only slightly overlapping the

paper itself. This results in white triangular corners.

It is also feasible to use long loops of elastic, passed right round the enlarger baseboard, or round a flat board placed upon the baseboard. The use of a separate board simplifies placing the paper under the elastic. The elastic is adjusted to run parallel with top and bottom of the paper (or the sides), and will leave narrow white lines here.

Yet another method is to insert drawing pins in a piece of flat board, so spaced that the bromide paper can be slid under their heads. The drawing pins need not be removed to withdraw the paper, and will hold even thick, curly types of paper down. When bromide paper is placed with its sensitive surface upwards, as it must be, it is always the edges which curl upwards. This is worth remembering when dealing with glossy papers of such a type that it is otherwise difficult to distinguish the emulsion side from the plain side.

## A CHILD'S SAFETY GATE

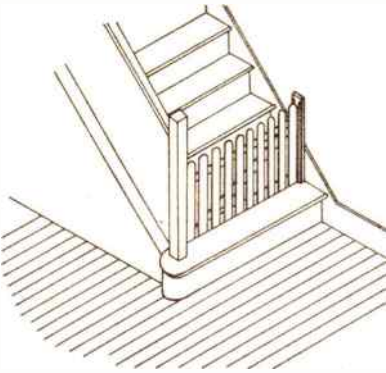

By Finlay Kerr

THE illustration shows how a stair can be blocked off by means of a safety gate to prevent toddlers climbing up and possibly falling down causing injury to themselves. The gate can also be used at the top of the stairs when the child is in an upper room or on a landing. The construction is very simple and the whole job does not take very long to do.

The material used for making the gate is  $2\frac{1}{2}$  ins. by  $\frac{3}{4}$  in. softwood, planed smooth on all four sides. The size of the gate will, of course, vary according to

individual requirements but a suitable height is 2ft. Cut two horizontal ledges to the required width of the gate and then cut the required number of uprights, allowing a space of 1 in. between each upright. Once cut, the tops of the uprights should be rounded off to give a neater appearance. After this, nail them to the ledges as shown in Fig. 1. To make the gate more rigid, cut a diagonal brace and nail between the two ledges. Note from Fig. 1 that the ends of the ledges should project a distance of 1 in. beyond the uprights.

The method of holding the gate in position is shown in Fig. 2. Two 1 in. by  $\frac{3}{4}$  in. laths are secured at either end and the gate is slipped down between them. On one side, the laths can be nailed

directly on to the newel post of the stairs but on the other side it is most probable that a 3 ins. by 1 in. post must first be plugged to the wall. It is not essential to make these laths the full height of the gate. If desired, they can be made about 6 ins. long and nailed at a height to suit the projecting parts of the ledges.

Once the constructional part of the job has been completed, give all the surfaces a good rub over with glasspaper and remove all sharp corners and edges. Finish off by staining and varnishing or by applying one or two coats of paint.

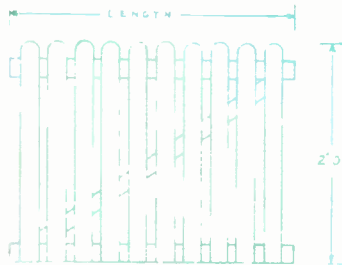

Fig. 1

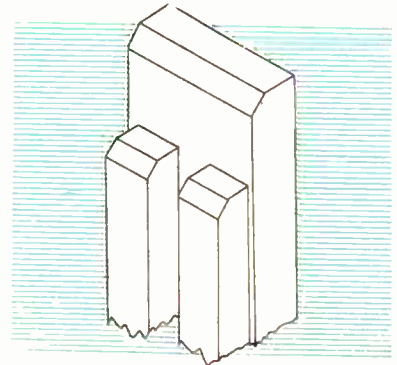

Fig. 2



**E**VER since the public began traveling by air the Air Baggage Label has been popular. Later, when business houses, manufacturing concerns, etc., realised the advantages of shipping their wares by air, Air Cargo Labels began to be seen more and more. Air baggage labels are more widely used than most other air labels. They are the most colourful. Pan American World Airways have issued many handsome covers depicting some of the countries visited along their routes.

## AIR TRANSPORT LABELS—By R.L.C.

British European Airways, who for a short time have been operating a Helicopter Service, have one very interesting item. It consists of the word HELICOPTER overprinted in yellow on their regular round baggage label.

British Overseas Airways have issued several attractive labels advertising their round the world services.

Air baggage labels are now produced in many different sizes and shapes. There are the round ones of K.L.M. Royal Dutch Airlines, British European Airways, Aer Lingus, American Airlines, Qantas Empire Airways, Air Nolis, Air India International, Alitalia, Canadian Pacific Airlines, etc.; the triangular ones of Scandinavian Airlines, Misrair, Line Aerea Italiana; the oval ones of Cyprus Airways, American Overseas Airlines, Australian National Airways, Swissair, Linca Aeropostal Venezolana, and the diamond labels of Tasman Empire Airways, East African Airways Corp., Aden Airways, Malayan Airways. We can find many odd shapes from such companies as Ethiopian Airlines, Scandinavian Airlines System, Iberia Spanish Airlines and Aero O/Y of Finland.

A complete list of the various Air Lines operating at present can be found in such

air guides as Bradshaws A.B.C. or American Aviation.

Cargo labels serve many purposes. Included in this class are labels designating packages, parcels and crates to be carried by either air express or air freight.

The majority of cargo labels are destination labels and usually bear the names of the towns served by the particular Air Line concerned. Some, in addition to the names, have spaces for other details such as weight of consignment, consignment note number and name and address of consignee.

Those seeking hobby adventure will find air transport labels exciting. A thematic collection could be based on the aircraft portrayed on the various issues. A small collection could be formed of one label from every Air Line. A complete collection could become valuable.

If any members of the League of Hobbyists would like to take up this hobby I shall be pleased to help in every way possible — and if there is sufficient interest — will open a department for air transport label collectors.

**I**F you are a 'collecting' enthusiast you should join the League of Hobbyists. Post coupon to: Raymond Cantwell, Hon. Secretary, 'League of Hobbyists', 48 Fourth Avenue, Slade Park, Headington, Oxford, England. Please enclose a stamp for return postage.

**LEAGUE OF HOBBYISTS**

**APPLICATION FOR ENROLMENT**

Full Name.....

Address.....

.....

.....

Age.....

I am interested in the following departments (Please tick)

Stamps ..	Hotel Labels ..
Match Labels ..	Cigar Bands ..
Cheese Labels ..	Buttons ..
Cigarette Cards ..	Coins ..

I also collect.....

Any other remarks/suggestions.....

.....

I am a regular reader of 'Hobbies Weekly'

Name of Newsagent.....

Address.....

.....

(Subscriber-readers should indicate)

I hereby apply for Enrolment as a Member of The League of Hobbyists.

(Signed).....



Simple to make

# Improved Scissors Sharpener

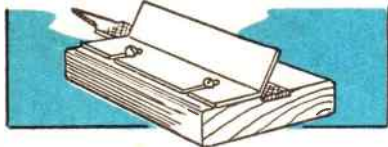

**T**HE scissors sharpener illustrated, is a very useful article to have about the house, and will quickly put an edge on scissors blunted, perhaps, by cutting unsuitable materials. The improvement lies in the fence, against which the blades of the scissors are pressed during the sharpening action. It permits adjustment over the whole cutting surface of the file and prolongs its usefulness.

The gadget is quite simple to make and needs only a small piece of wood, preferably a hardwood about  $\frac{1}{2}$  in. thick, and a piece of sheet brass, fairly stout gauge, supplied with a pair of stout brass round-headed screws. The file, which is the sharpening agent, should be medium-cut, and some  $\frac{1}{2}$  in. wide and say 4 to 5 ins. in length. Provided it is long enough, a broken file in reasonably good cutting condition, would suit quite well and continue to perform valuable service.

Cut a wood block to the dimensions given in Fig. 1 and down the centre saw and chisel out a groove, a tight fit for the file to be used. The depth should permit the file to be flush with the surface of the block. It must not project above it as the angle of the fence, with reference to the

cutting surface of the file, would be altered and that would not be good for the scissors edges.

Fit the file in and tap down gently until level. An end view of the fence, fitted over the file, is given at Fig. 2 and shows the angle of it. Cut a piece of fairly stout gauge brass sheet to size given at Fig. 3 and scribe a line down where shown by the dotted line. Now cut two slots, about  $\frac{1}{4}$  in. wide and  $\frac{1}{2}$  in. long, at the places indicated. The easiest method here is to drill a  $\frac{1}{4}$  in. hole at  $\frac{1}{4}$  in. from the dotted line for each slot and cut from each to

test against a pencilled angle drawn on a piece of paper until satisfied. Fix the fence to the block, and position it to partially cover the file to help keep the latter from shifting during the sharpening operations. The two screws should do this effectually, but should there be any tendency for the file to ride backwards owing to the pressure of the scissors blades, a third screw could be driven in opposite the fence, its head just pressing against the other side of the file to keep it flat and firm.

The sharp edges of the block might

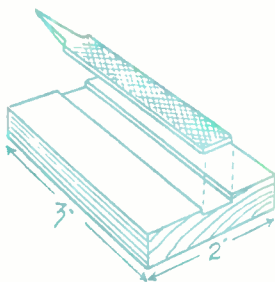

Fig. 1

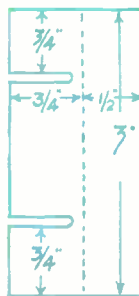

Fig. 3



Fig. 2

the edge of the fence with a metal-cutting fretsaw blade. This is easily done, but saw gently and don't let the blade get too hot or it may snap.

Place the fence in a vice and bend along the line to the angle given. Bend as accurately as possible and frequently

well be rounded off a little to make it comfortable to hold in the hand. Usually a few strokes of each scissors blade in turn on the file will resharpen it fit for use, but take care to keep the flat side of the blade pressed against the fence as it is moved over the file. (W.J.E.)

## Store Under the Stairs

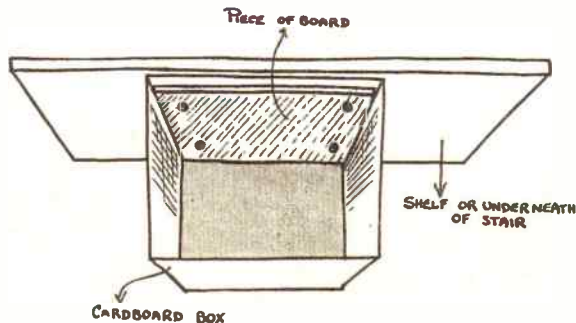

**T**HE storing of that useful material, old newspaper, is often something of a problem. If the shelves of the cupboard under the stairs are full, then is the time to think of the underneaths of them, or the underneath part of a stair. A stout cardboard box (of the margarine variety) four screws and a board (to fit roughly inside the larger side of the box) will quickly provide good storage space.

Bore holes in the four corners of the piece of wood, slip under the 'roof' of the box and insert the screws through to the underneath of the shelf or stair.

The same effect can be obtained by using a wooden box, but the cardboard is easy to obtain, and 'gives' better if bumped in the dark! (W.J.S.)



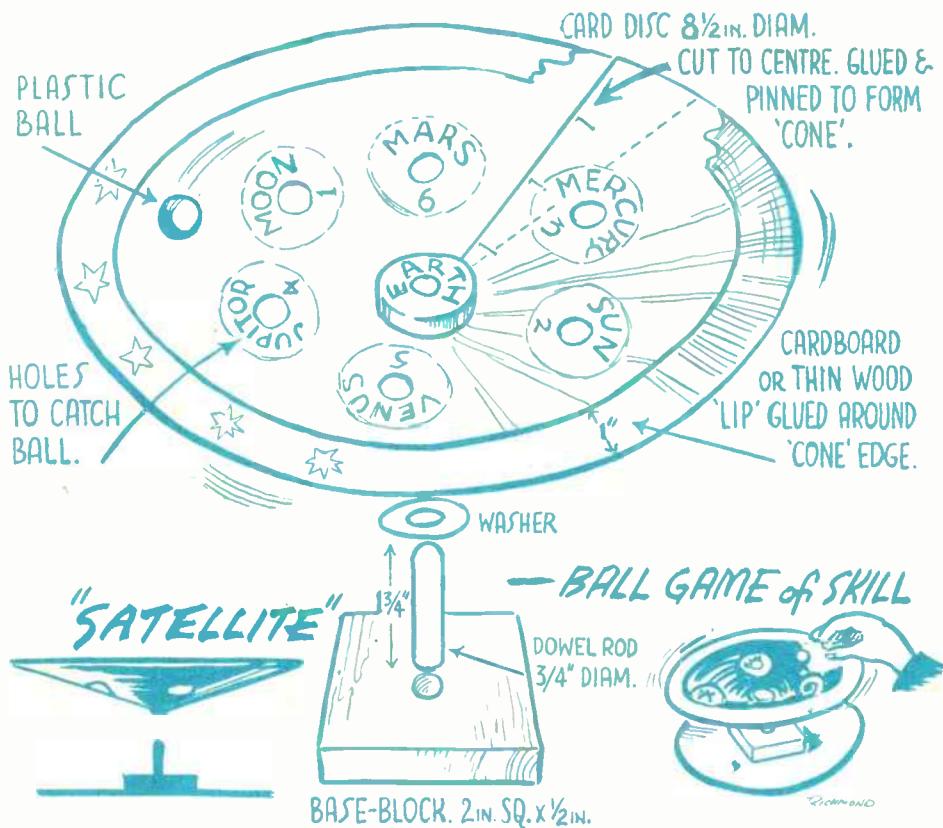

## THE 'SATELLITE' BALL GAME

**S** PIN the 'Saucer', drop in the 'Satellite' ball, see it shoot round, stop, and — if you are lucky — land in one of the 'Planet' score holes. This little 'Outer Space' ball game is quickly made from cardboard with the addition of a block of wood and short length of round rod. The spinning saucer can be inverted on the spindle for easy storage.

The 2in. square base block has a centre hole into which is glued the dowel rod spindle. From fairly stiff cardboard cut out the  $8\frac{1}{2}$ in. diameter disc. Pierce a centre hole and cut towards this as shown. Draw the cone to form a shallow cone, gluing the overlapping edges together.

From  $\frac{1}{2}$ in. thick wood cut the  $1\frac{1}{2}$ in. diameter disc which will be used as the knob for spinning the saucer. Before cutting out, however, drill the centre hole, to avoid wood splitting. Glue this knob to the centre of the cone, and when set, file out the hole so that the unit may

fit over and spin freely around the spindle.

Slip a washer or two on the spindle rod, allowing the rod to protrude a little above the handle disc. Cut out a series of holes around the saucer into which the ball used in play can fit without it actually passing right through.

With your compass draw a set of rings on thin card or paper, and print on each in indian ink the name of a planet

and a number for scoring, as shown in the sketch. Cut them out and glue one around each hole. To keep the ball within the saucer a cardboard ring is made to fit around the outside edges of the cone, and held secure with glue and adhesive tape. Paint cardboard cone with poster paints and varnish. Use bright enamel or cellulose paint for the wood components. (T.S.R.)

Next week F. G. Rayer will start a series of radio articles specially written for the beginner to this worthwhile hobby. There will also be fretwork and marquetry patterns, while gardeners will be pleased with the delightful suggestions for making decorative boxes for plants. MAKE SURE OF YOUR COPY.



*The castle at Newark-on-Trent*

# ‘LOITERING’ IN THE VALE OF BELVOIR

By  
*A. Sharp*

**L**OITERING, yes. For when exploring a charming corner of the countryside, the cyclist, out for pleasure only, has no desire to speed. Indeed, to enjoy the nooks and hidden beauties of our land, so well endowed with pleasant scenery and delightful villages, it is no penance to go slowly, absorbing the many things of interest as one lingers here and there.

In the Vale of Belvoir the cyclist finds himself in a region of beautiful green fields and woods, fair to look upon. The borders of Lincolnshire and Leicestershire link up with Nottinghamshire in this corner of the Midlands.

Tucked away from the busy highways, and approached only by quiet by-roads, many villages lying in this beautiful vale have retained much of the old world charm so redolent of the picturesque country life of days gone by — days of peace and serenity, when time passed leisurely, in contrast to all the hectic speed and hustle of the world today.

Cyclists touring the Midlands might do worse than include this short stretch of country in their itinerary; and for those who reside in such towns as Nottingham, Lincoln, and Grantham, what can surpass, within an easy run out from home, a day's exploration hereabouts?

Standing sentinel over this tract of pastoral country are the round towers of Belvoir Castle, rising among the trees at the top of a high hill. From this hill the cyclist or other traveller, gets a wonderful panorama lying before his eyes — the wide fields, fertile and level, of the Lincolnshire and Leicestershire countryside.

Of the castle there still remains a little of the original Norman keep; but about 1800 the then Duke of Rutland proceeded to build Belvoir in the Modern Gothic style, and much of the older work was removed. The ill-fated King Charles I visited Belvoir on his last ride from Newark to Oxford in 1645.

When loitering at Belvoir we may be reminded that this castle has a close link with Staunton Hall, about seven miles distant — a place described as ‘an oasis of quiet beauty and historic interest’, for at Belvoir is the Staunton Tower, the golden key of which is presented by the head of the Staunton family on the occasion of the Sovereign paying a State visit to the castle. This key with a peacock under a crown and a bell-rope, keep alive the long associations of Belvoir with Staunton. The bell-rope had to be provided and given to Bottesford Church nearby, in order that, when Belvoir Castle was threatened, aid might be summoned from the inhabitants of the Vale.

## Link with Scott

Staunton Hall was looted by the Roundheads — and bullet holes are still to be seen in the fine old door. Staunton, by the way, dates from the Norman Conquest, and is mentioned in Domesday Book. There is a link between Staunton and the famous author, Sir Walter Scott, for it is the ‘Willingham’ of his well-known novel ‘Heart of Midlothian’. The place lies at a point where Nottinghamshire, Leicestershire, and Lincolnshire meet.

An interesting tour of this little Vale of Belvoir that we have enjoyed more

than once is from Nottingham down to Bottesford, right through the heart of it, following the course of the Grantham Canal. The route is: Nottingham to Cotgrave, Cropwell Bishop, Kinoulton, Hickling, Harby, Plungar, Redmiler Belvoir, Knipton to Bottesford, or through Denton from Knipton, to Grantham, cutting out Bottesford. But it would, perhaps, be a pity to do so, for Bottesford, lying at the end of the Vale, is a charming spot, with a very fine church containing some magnificent alabaster tombs where rest many members of the Rutland family. The church stands in all its great beauty of architecture by the side of a small stream amid lovely trees. In the village are the remains of an ancient cross, with stocks, and whipping post.

## Farming Country — and historical

The Vale is farming country, with few industries, and some of the villages lying in these fertile lands claim their historical associations. Aslockton, which lies on the edge of the Vale, has connections with the Cranmers, and it was here that the great church reformer, scholar, and martyr, Thomas Cranmer, was born in 1489.

Wiverton claims historical links, for here came Prince Rupert with 400 of the flower of the royal troops. From Wiverton Rupert addressed a letter to the Parliament, asking for a pass for himself, his brother, and other noblemen and gentry to leave the kingdom, consequent upon his exciting interview with King Charles I at Newark. On November 4th, 1645, Wiverton was surrendered to the Parliamentarians under Major-General Poyntz.

For cyclists who desire a short trip through quiet places away from the rush and rattle of the busy main roads, the Belvoir country will be appreciated, for it is never over-crowded. Most of the motor traffic takes the Great North Road or the Fosse Road, and lying, as it were, between those two great lanes of noise and dust, the Vale is by contrast a sequestered tract of country, dreaming in an old-world atmosphere, with the castle perched high on its wooded hill overlooking the flat cultivated lands spread out below.

# Two new Dinky Toys just out!



**VANWALL RACING CAR** Dinky Toys No. 239

Here she comes . . . whooo-oo-sh . . . there she goes . . . the Vanwall—the racing car that's making and breaking records all over the world. This model has all the sleek lines and powerful appearance of the real thing—it's a perfect job. Length 3½"

Price 3/6. (inc. Tax)



**AUSTIN A.105 SALOON** Dinky Toys No. 176

Look at this model Austin A.105 for luxury de luxe! Now there's a car that anyone would be proud to own. Get this superb model for your collection now—it has transparent windscreen and windows.

Price 3/3 (inc. Tax) Length 4"

Keep on collecting **DINKY TOYS** - they're the best in the world

Made by MECCANO LTD. LIVERPOOL

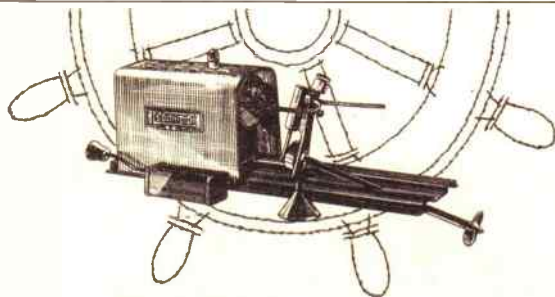

## a model **STEAM** marine engine

**OF HIGHEST QUALITY, AND PERFORMANCE**

This latest addition to the famous range of "Mamod" model steam engines is the ideal power unit for model boats, with a length of 20" and over. An extremely lively unit with many refinements including chromium plated windshield, heat insulation and a complete lubrication system. Price 45/- including P.T.



# A GUITAR

## for only 65/11

OVERALL  
LENGTH  
36½ ins.



MAKE IT  
WITH A  
KIT FROM



Everything needed to make a first class job. Easily constructed with a few simple tools. Thousands in use. Shown on TV.

All wood (including partly shaped neck) materials, fittings, full size plan, six strings, tutor, etc.

From branches, stockists or direct

To HOBBIES LTD., Dept. 99, Dereham, Norfolk.  
Please send Guitar Kit No. 3209. P.O. for.....enclosed.

Name .....

Address .....

.....

# MAINLY *for* MODELLERS

I AM frequently asked by modellers to suggest the best finish for some small part, either in metal or wood. As these requests come from ship model makers of many interests I feel that some of the methods used will be of help to our readers, whether building galleons, warships, liners, or working models.

In regard to actual paintwork although many writers, particularly those who write instructions for kits, suggest poster colours for galleon models, I myself always prefer to use artists' oil colours for such models. Apart from the liability of poster colours, even when varnished, to flake off in time, in my opinion they are too bright. The old ships would be painted in colours mixed in oil, therefore the texture of the finished job would be quite different from the texture of poster colour. One has only to compare an oil painting by any of the well known artists with a poster or showcard done in poster paints to realise the vast difference in the finish so I would suggest to modellers of old time ships that they try this medium for themselves. They will use no other afterwards for this particular type of model and will be surprised how easy these colours are to use. For the purpose of model painting I thin these colours with distilled turpentine only, not the usual mixture used for painting pictures.

## For modern vessels

For modern vessels, liners, etc, Messrs Reeves have now made again available their range of paints for shipmodellers. These paints are capable of being applied in thin coats that have more than ordinary covering power and thus do not make small parts look out of scale, a fault that ordinary paints and enamels certainly have. A very small deck fitting that has to be painted can easily look out of scale and clumsy when given a coat of paint. Reeves' special paints avoid this, even in miniature work.

In painting your hull the best results will be obtained if two or three coats of white are given and each one allowed to harden, rubbing down between each coat with very fine glasspaper. Another method I have found to give a superior finish is to apply one or two coats of shellac and then rub down with dental pumice powder. The powder is placed in a piece of cloth, the cloth twisted to form a ball or rubber. It is then dipped in a saucer of clean water to dampen it and applied with a circular motion as with

french polishing. If you use the latter method, do make sure that the hull carving is as perfect as you can get it. This method not only gives the wood a very smooth finish but leaves it polished and every little defect in carving and shaping will show as the light touches it.

## The water-line

To obtain a perfect water-line between the lower hull and upper works colours usually presents a difficulty to those of us who are not adept with a brush. This can be overcome by using decorators masking tape. Draw the waterline in at the proper height, lay a strip of masking tape above this, following the curve and paint the lower colour up to this, when dry remove tape, place another piece below and exactly meeting the upper edge of the paint already applied and proceed to apply the colour to the upper part of the hull; when dry remove the tape and you will have a perfect water-line between the two colours.

For metal fittings modelled in wood, that is fittings that on the actual vessel would be made of metal, but in our model will be made in wood, I suggest using boxwood. Boxwood can be given a metallic finish by painting with a black brushing cellulose enamel, dusting with a suitable bronzing powder and slightly daubing with a brush.

## FINISHING FITTINGS

By 'Whipstaff'

Deck parts and fittings of metal were usually black in early ships, so were chains, the metal parts of anchors and some of the guns. For those of us who do model these parts in metal, brass or copper can be used. It is easy to work and can be blackened by dipping in a solution of liver of sulphur.

A method that is now finding favour for the colouring of flags is, for the average modeller, something of a boon. Instead of painting the small designs, some of which are quite small and delicate, they are drawn on in the new coloured indelible pencils, sharpened to a fine point they will simplify the drawing of even the finest lines. If you use them on paper flags it will be necessary to use a fine brush and water to blend the strokes together. This is not necessary with flags of fabric, silk, etc. Finish by spraying or gently brushing on a coat of artists' fixative. This and the pencils can be obtained from any artists' supply shop.

For those of our readers who are gifted in the use of a paint brush there are available special paints for painting on fabric.

## A MODEL DESTROYER



### FULL-SIZE PATTERNS ON PAGE 15

THE use of a Hobbies fretsaw makes it easy to construct this model destroyer. It is simplified so that even a beginner can make an attempt, but at the same time the parts are shaped to give a most realistic effect.

Cut pieces (A), (B), (C), (E) and (F) from  $\frac{1}{4}$ in. wood, and pieces (D), (G) and (H) from  $\frac{1}{8}$ in. The side view shows how the parts are shaped and assembled. They are simply glued one on the top of the other.

The funnel is cut from  $\frac{3}{8}$ in. round rod, whilst the guns and mast are cut from medium gauge wire. Drill  $\frac{1}{16}$ in. holes in which to insert the wire.

The model should be mounted on a base of  $\frac{1}{4}$ in. wood which is painted green and blue to represent waves, etc. A good effect can be obtained by using plastic wood which is moulded with the fingers to give the wave effect. The destroyer should be painted medium grey all over. (M.p.)

**10,000 FORMULAS.** Trade secrets, recipes, processes. Remarkable 900 page book. Only few available. Money back guarantee. 27/6 p. pd. — S. P. Ltd., 28(H.B.) Dean Road, London, N.W.2.

**100 DIFFERENT stamps free!** Request 4d. upwards discount approvals. — Bush, 53 Newlyn Way, Parkstone, Dorset.

**WHEELS** (Hardwood and Rubber Tyred Metal), Cot, Pram and Doll's House Fittings and Papers, Beads, Transfers, Prints and other accessories. Stamp for new lists. (Trade supplied.) New address — **JOYDEN CO.**, 91 Peplins Way, Brookmans Park, Herts.

**'PAINTSPRAYING' HANDBOOK.** Covers Car, Industrial & Flock Spraying, 3/6, post 4d. Catalogue of our Cellulose and Paints and all Allied Sundries 3d. — Leonard Brooks Ltd., 81 Oak Road, Harold Wood, Essex.

**MODELS.** You can make lasting stone-hard models with Sankey's Pyrama Plastic Cement. Supplied in tins by Ironmongers, Hardwaremen and Builders' Merchants. Ask for instruction leaflet.

**LEARN** it as you do it — we provide practical equipment combined with instruction in Radio, Television, Electricity, Mechanics, Chemistry, Photography, etc. — Write for full details to E.M.I. Institutes, Dept. HW47, London, W.4.

**MAKE** a MUSICAL BOX for as little as 21/6. New kits and tunes available. Movements 14/9 post free. Please send 3d. stamp for free illustrated catalogue. — The Swisscross Co., Dept. B, 202 Tulse Hill, London, S.W.2.

**\* GREAT CAMPING OFFER \***



**RIDGE TENT** SENT FOR 4/-

**BRAND NEW** de luxe 'Safety' Tent. All colours. Complete. Ideal cyclists, campers. Length 7' 3" sleeping base x 4' 6" wide x 3' 6" high x 12" walls, all approx. Weight 3½ lb. Cash 55/-, or 4/- deposit and 9 monthly payts. of 6/-. 1 of 2/6. WITH FLYSHEET 83/6, or 9/3 deposit and 8 monthly payts. of 9/9. 1 of 4/9. Both carriage 2/6. LISTS OTHER EQUIPMENT.



**Lonnie Donegan**

**'KING OF SKIFFLE' RECOMMENDS**

**GUITAR** at £17-9-6 CASH PRICE SENT BY 7 DAYS FREE TRIAL FOR 5/- POST & P.K.G. 3/4

Balance payable 22 fortnightly payments 7/3.

Abso- lutely free with the Guitar — Col- oured Skiffle Sash and Easy Playing System — Stru- m

immediately! Electric Pick-up £2 extra. Lonnie Donegan really knows how to play. 1,000 only special full size plectrum models. Rock 'n' roll, Calypso, etc. Handsomely polished or two-tone. Super treble and bass, warm responses. Solo or Band. Impossible to describe — play it! Professional Italian. 6-string model, not 4-strings. Make every session fabulous, be the "most" and ever popular.

Headquarter & General Supplies Ltd. (HOBWGGX/6) 196-200 Coldharbour La. Loughboro Junc., London, S.E.5 Open Sat.

**KUKLOS ANNUAL.** Indispensable cyclists' handbook. Tours, resthouses, money-saving hints, 3/- post free. — Burrow, Publishers, 2 Imperial House, Cheltenham

**BECOME** trained chiropodist. Quick postal, Bpractical. **GRADUATE SCHOOLS**, 48a Abbey Street, Accrington.

**STAMPS FREE** — Empire Packet including Pictorials and Victorians with approvals. — Robert J. Peck, 7A Kemp Road, Bournemouth.

**CHEMICALS AND APPARATUS.** Free booklet of 100 experiments with orders over 15/-. Send 3d. stamp for catalogue and details of special offers. — Scientific & Technical Supplies (Nottm.) Ltd., Dept. H, 9 Wellington Circus, Nottingham.

**MATCHBOX** crystal receiver parts and instructions, 3/6. Reception guaranteed. — Write BCM/ALEXTONE, London, W.C.1.

**STAMPS** on approval. Good value. — John Goodwin, 189 Vaughan Road, Harrow, Middx.

**110 DIFFERENT stamps free!** Request approvals, enclosing postage. — Banks, 62 Avonlea Road, Sale, Cheshire.

**10 CANADA** (Cat. 3/11) 1/6; 10 Australia (Cat. 3/1) 1/-; 20 U.S.A. 2/-; all commemoratives. Super mixture 5/-. Post 3d. extra. — A. J. McKenna, 19 Mount Rd., Fleetwood.

**HOW TO STOP SMOKING**

and permanently overcome that ceaseless craving for tobacco. Save money, safeguard health. Send stamp for details of the world-famous inexpensive Stanley Treatment for tobacco habit.

**THE STANLEY INSTITUTE LTD Dept. 30**

12 Bridewell Place, London E.C.4

**Hobbies**

**BIRMINGHAM** 100a Dale End, Birmingham 4  
**SHEFFIELD** 4 St. Paul's Parade  
**LEEDS** 10 Queen Victoria Street  
**HULL** 10 Paragon Square  
**SOUTHAMPTON** 134 High St. (Below Bar)  
**BRISTOL** 65 Fairfax Street  
**NEWCASTLE** 42 Dean Street  
**GRIMSBY** 88 Victoria Street

**BRANCHES: LONDON**  
 78a New Oxford St., W.C.1 (Phone MUSEum 2975)  
 87 Old Broad Street, E.C.2  
 81 Streatcham Hill, S.W.2

**GLASGOW**  
 326 Argyle Street

**MANCHESTER**  
 10 Piccadilly

Head Office & Factories — **HOBBIES LTD, DEREHAM, NORFOLK**

**HEAR ALL CONTINENTS With H.A.C. Short-Wave Receivers**

Suppliers for over 18 years of radio S-W Receivers of quality. One-Valve Kit, Price 25/- Two-Valve Kit, Price 50/- Improved designs with Denco coils. All kits complete with all components, accessories and full instructions. Before ordering, call and inspect a demonstration receiver, or send stamped addressed envelope for descriptive catalogue. 'H.A.C.' Short-Wave Products (Dept. 22), 11 Old Bond Street, London, W.1.

**HARDHITTING ACCURATE**

**Webley AIR PISTOLS**

**AIR RIFLES · ACCESSORIES**

Write for Catalogue  
**WEBLEY & SCOTT Ltd., 166 WEAMAN ST., BIRMINGHAM, ENGLAND**

**For wood, card, plastic, leather, metal, etc.**

**£12 - 5 - 0**

**TREADLE OR MOTOR FRETSAWS**

Whatever the handyman or craftsman is cutting or making, one of Hobbies Fretmachines will help with the job. For toy making, fretwork, model making, it provides easy and speedy cutting in all kinds of material. A pleasure to use, a factory for output, a lifetime of service.

Obtainable at any Hobbies Branch or good class ironmonger or hardware stores. Or carriage paid U.K. from:

**£5 - 17 - 6**

**HOBBIES LIMITED, DEREHAM, NORFOLK**

To set you thinking

# DRAUGHTBOARD PUZZLES

**D**RAUGHTS and draughtboards have been used in the past as a basis for puzzles and the following may be considered as some of the world's best teasers in this category. Two concern the division of a draught-

cutting as shown to prove this for yourself, but there is an answer.

Puzzles with draughts were designed not only for amusement but also for instruction, skill, and, as a trial of patience, and the two which follow are, undoubtedly, the best of their kind.

In about the year 1884 a man named Tait is said to have evolved a clever puzzle with eight draughts, four black and four white laid alternately in a row as shown in Fig. 5. You may use plastic

white draughts are together and all the black ones in an unbroken row. You are not permitted to reverse the order of any pair when moving them into a new position, or to make any adjustments between the moves.

Remember that there are only four moves, that you may move an adjoining pair at each move and that after the four correct moves the two colours should be separated.

Next we have the 'Leap Frog' puzzle, where four black draughts and three white ones are arranged as shown in

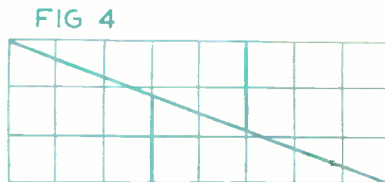
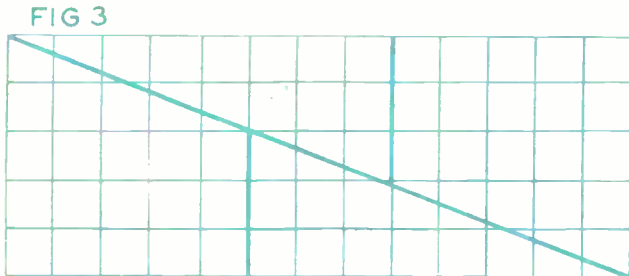
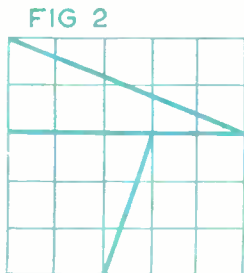
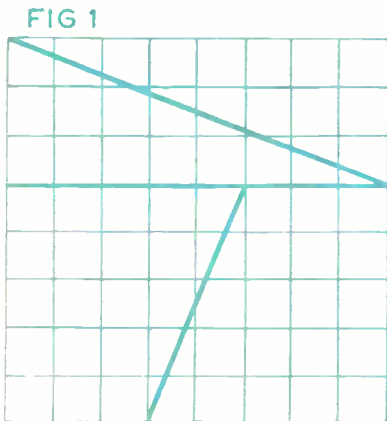

board, but, of course, while they are so named it will, perhaps, be best to rule out some 1in. squares on paper and make a checkerboard for these puzzles.

Reference to Fig. 1 will reveal a checkerboard of 64 small squares, cut into four divisions as shown by the thicker lines and producing two triangles and two odd shapes. Fig. 2 shows a similar division, but here only 25 squares are used.

The amazing feature about these two divisions is that when they are fitted together again in the form of an oblong as shown in Figs. 3 and 4 the former appears to have now 65 squares, gaining one, while the latter has only 24. The puzzle is to account for the odd squares either acquired or lost. You will have to square out a piece of paper as suggested,

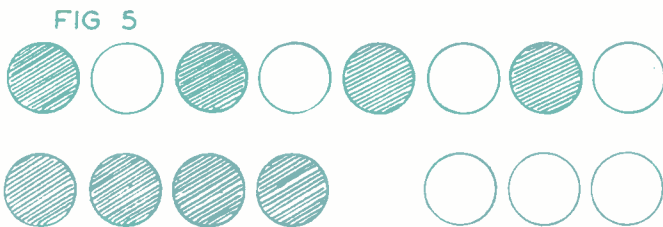

FIG 6

cutters, or halfpennies and shillings if you wish, so long as the colours used are quite distinctive.

The problem is to make four moves, moving two adjoining draughts at the same time, so that eventually all the

beyond is vacant — just as in the game of draughts itself.

Both these puzzles will try your patience and in order to let you enjoy the fun we are holding the answers over until our next issue.

~~~~~  
By S. H. Longbottom  
~~~~~

Fig. 6 on a checkerboard. Here the puzzle is to make the draughts change sides, so that the white ones are on the left and the black ones on the right. The black draughts may only be moved to the right and the white ones may only be moved to the left, but any draught may be allowed to leap-frog over a neighbour if of opposite colour and the square

# A MODEL DESTROYER

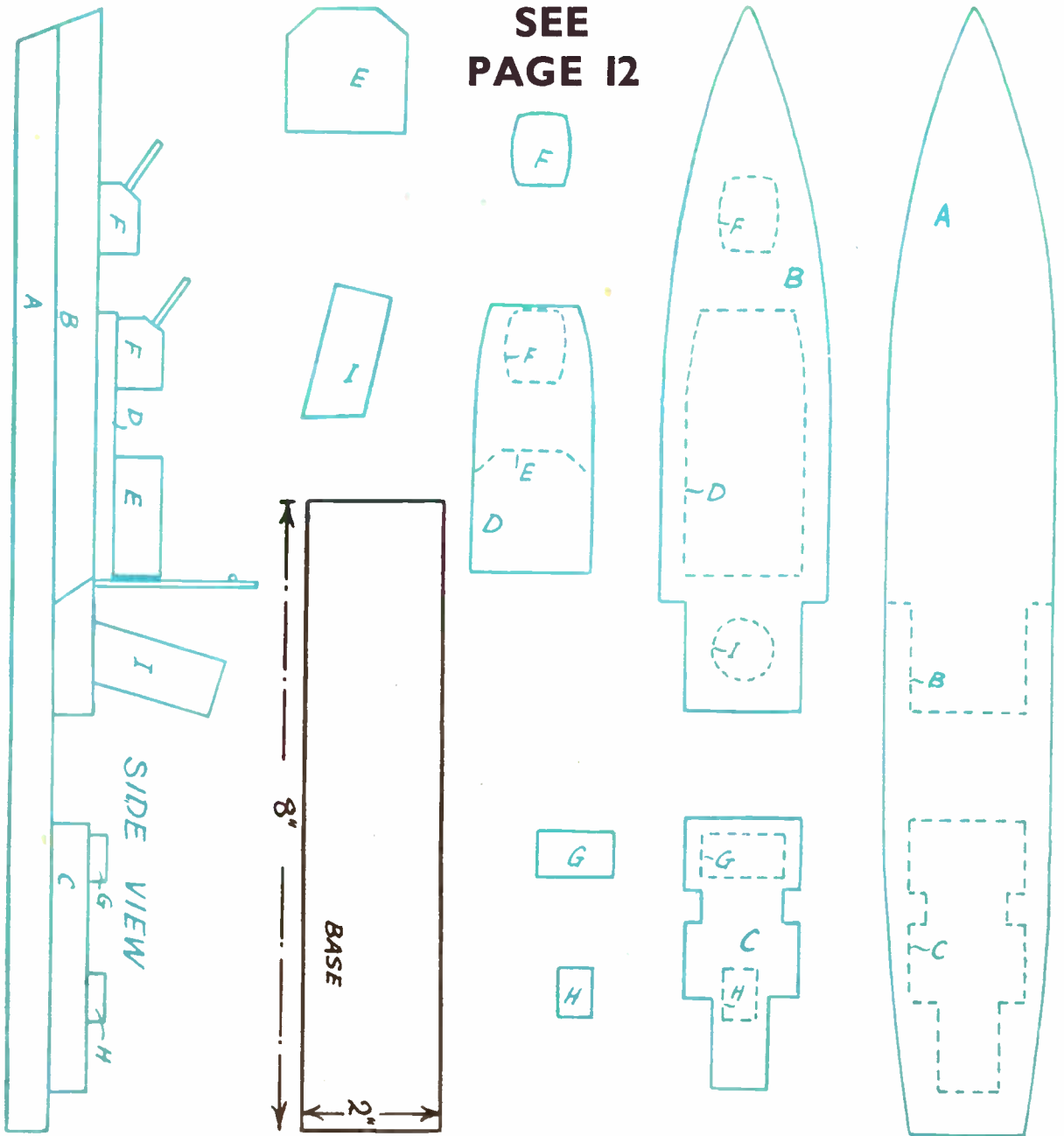



YIPEE·E·E·E·E·E·E·E

**CERTOFIX**

*Really*  
**FIXES**

CERTOFIX liquid glue can cope with all general repairs. It unites wood, glass, metal and almost all substances. It is clean in use; its joints are stronger than the materials it unites.

Sold at all Woolworth Stores

**CERTOFIX**

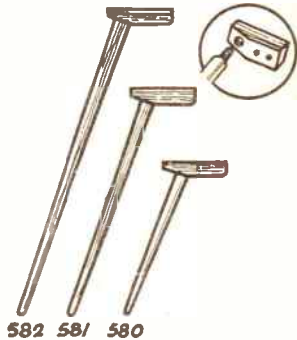

**You Can Make a Modern Table in One Evening with these legs**



**FOR ALL CONTEMPORARY FURNITURE**

A coffee table, TV table, footstool, etc. . . . all can be made in quick time with these Contemporary style legs. Beautifully turned in Scandinavian beech, they can be left in their natural colour, or stained. Each leg is threaded at one end to screw into a hardwood block (see inset) which, in turn, is screwed to the underside of a piece of plywood or suitable material which forms the table top. Simple . . . and a perfect job. The legs are obtainable in three sizes:—10 ins. 2/3 each, 15 ins. 2/6 each and 20 ins. 3/- each. Postage on 3 or 4 legs 1/6 extra. Legs from branches or:

**HOBBIES LTD., Dept 99, Dereham, Norfolk**

**Yours for only 8/6d.**

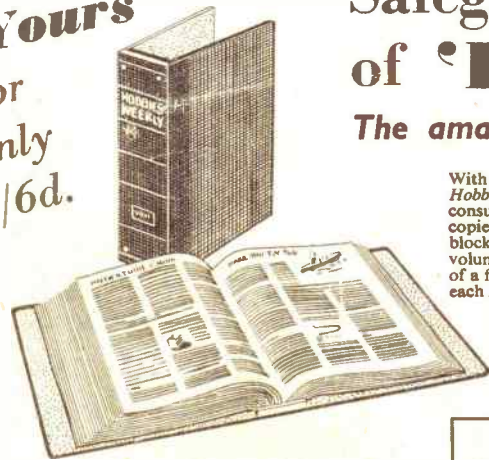

**Safeguard your copies of 'HOBBIES WEEKLY'**

**The amazing 'EASIBINDER' (Pat.) makes it simple**

With the new *EASIBINDER*, specially prepared for Hobbies, you can bind each copy of *Hobbies Weekly* as you get it, turning your favourite magazine into a permanent, easily-consulted library of immense value, and avoiding the delay and despair occasioned when copies are accidentally mislaid or destroyed. Carefully finished in black leather-cloth and gold-blocked on the spine, each binder is strong, serviceable and neat. It will hold two complete volumes (52 copies) and costs only 8/6. Each copy of the magazine is quickly inserted by means of a flexible steel wire, and can easily be removed if necessary. Easy-to-follow instructions with each *EASIBINDER*. Get one today and take care of your copies of *Hobbies Weekly*.

**NOTE** From the issue April 10th, 1957, there is a slight difference in the size of the magazine, and two sizes of *Easibinders* are available. Type A is for binding issues published before April 10th and Type B is for those printed subsequently. To avoid confusion, when ordering, please indicate clearly the type of *Easibinder* required. Indices for each completed volume 1/- each post free.

- ☆ One 'EASIBINDER' holds two volumes (52 copies)
- ☆ Easy to use

**Post today**



To: **HOBBIES LTD., Dept. 99, Dereham, Norfolk.**  
**PLEASE SUPPLY . . . . . EASIBINDERS**  
 (Type . . . . . ) at 8/6 each.

NAME . . . . .  
 ADDRESS . . . . .  
 P.O. for . . . . .  
 enclosed . . . . .