

# HOBBIES WEEKLY

DECEMBER 4th 1957

VOL. 125

NUMBER 3240

## IN THIS ISSUE

	Page
Two Working Toys - . . . . .	161
Home-made Crackers are Exciting	162
Make your own Greeting Cards -	163
Aircraft Spotting - . . . . .	164
A 'Frying Pan' Clock - . . . . .	165
A Holder for Fretsaws - . . . . .	166
Make this simple Tie Stretcher -	166
Try These New Wines - . . . . .	167
Developing your Films - . . . . .	168
Is This Your Problem? - . . . . .	170
With Rod and Line - . . . . .	172
Patterns for Animal Cut-outs -	175



All correspondence should be addressed to the Editor, Hobbies Weekly, Dereham, Norfolk

\*\*\*\*\*  
 \* Kit No. 3240 contains wood, \*  
 \* wheels, fittings etc., for making \*  
 \* these Two Working Toys. Kits \*  
 \* obtainable from branches or from \*  
 \* Hobbies Ltd., Dereham, Norfolk. \*  
 \* Price 6/9 post free. \*  
 \* \*\*\*\*\*



**T**HE rotating clowns and walking policeman toys make excellent ideas as gifts for young children. The clown toy consists of two figures which revolve on the tops of the wheels of the lorry as the toy is pulled along by a youngster. It will be seen that two other clowns can also be made so as to fill up the four posts on the toy.

The policeman consists of an ordinary 'walking' toy which is pushed along by means of a stick.

The makeup of both is clearly explained on the design sheet, where it will be noted that the reverse sides of the figures are shown for the purposes of painting.

Note, too, that the wheel of the policeman (piece 7) has to be glasspapered down slightly so as to ensure an easy movement between pieces 5 and 8. The wheel is pivoted with a fret pin.

## TWO WORKING

*Make them for  
young children  
from*

## TOYS

*FREE design inside*

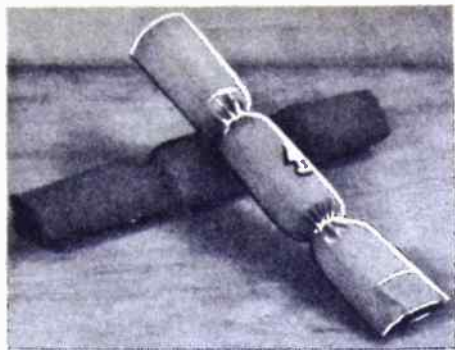

# HOME-MADE CRACKERS ARE EXCITING

Says  
S. H. L.

**C**HRISTMAS crackers add a seasonable touch of gaiety to every party table, but they can be much more exciting when made by yourself. Novelties, puzzles, toys, games and traditional mottoes can be of your own selection, and probably far more appropriate than those contained in the commercial product.

Again, you may make crackers of any size, omitting the snaps if intended for tiny children who may fear the bang.

Obtain some crepe paper for the outer cases, cutting into oblongs measuring 5½ ins. by 10 ins. It is nice to have a variety of colours, but if this will prove too expensive it is suggested that red crepe paper looks gay and attractive. Each end of these oblongs may be fringed with the scissors, or cut in saw tooth fashion, although the ones shown in the top illustration have been left untreated.

We next require some sheets of white

tissue paper and novelties. Lay a sheet of tissue paper on the table in a vertical position with a stiffener on top, with the tools close together on top of both. Bring the tissue paper to the tools, rolling round until the tube is formed. Remove the tools, tucking in the tissue at one end.

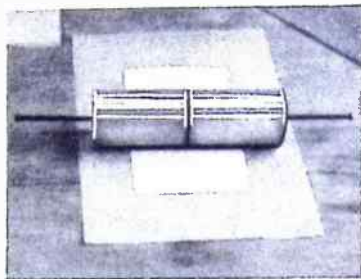

Fig. 1 Making the tube for the carrier

either side. You are advised to apply a touch of gum to the top of the crepe to hold the cracker firm during the next stage. Roll the cracker into shape a few times with the aid of the tools, when it will become quite firm.

The cracker now requires that distinctive crimping at the waist on either side of the carrier, achieved by looping a length of string round the cracker, and drawing tight as shown in Fig. 3. First withdraw the tool on the right hand side about a quarter of an inch, making a gap between the end of the carrier and the tool. Ease the cracker from the table so that a double loop of thin string can be passed round at this point, then pull tightly until the paper crimps. Remove the string, pushing the tool back to the original position while holding the cracker with the left hand in order to produce a neat shoulder and a nicely crimped waist. The other end is now treated in exactly the same manner when both tools may be removed and the cracker is almost complete. All that remains to be done to give that professional appearance is the addition of a coloured scrap attached with a touch of gum.

Crepe paper, tissue paper and thin

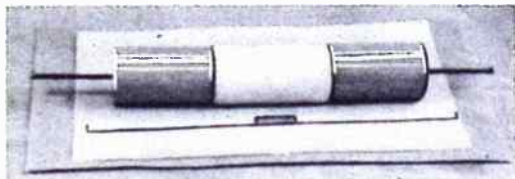

Fig. 2 Ready to roll the cracker

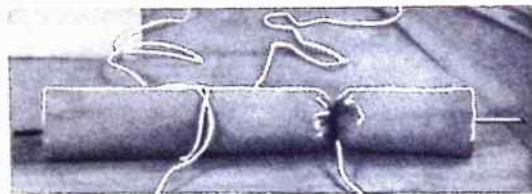

Fig. 3 Making the crimped waist

tissue paper, two for each cracker, measuring 5 ins. by 8½ ins., and stiffeners made from thin, white card measuring 2½ ins. by 5 ins. In addition a pair of 'tools' is required. These are merely two pieces of round wood, e.g. an old brush handle, 1½ ins. in diameter and 2 ins. long. It will be appreciated that these tools form the basic diameter for average sized crackers and it will be necessary to make modifications if smaller sizes are to be made. The tools are completed by fitting handles in the form of 2 in. nails knocked into the centre of one end of each roller.

The first step is shown in Fig. 1 where a tubular container is being made to hold

A hat, puzzle, gift, motto, or what you will is placed in the tube and the tissue folded in to seal the contents. The motto is one of those tiny scraps of paper bearing a joke or conundrum, often the cause of much amusement. No cracker is complete without one of these and perhaps you may be able to invent some original quips, packing into the tabular container.

Fig. 2. shows the next stage of rolling the cracker into shape. Lay a piece of crepe paper horizontally on the table, a sheet of tissue on top, the cracker snap — which must not be forgotten — and the filled tube centrally with a tool at

card are all obtainable at most stationer's shops, and cracker snaps, mottoes and scraps can usually be bought at handicrafts shops or toyshops. Paper hats are normally sold ready rolled and there are hosts of small wire puzzles, charms or novelties available.

It may also be mentioned that it is possible to buy specially prepared cracker paper bearing gay printed borders down each edge and which is ideal for this work. And it should be remembered that the chief advantage of making your own crackers is that you can often include a really pleasant surprise in the novelty filling.



**G**REETINGS cards made from your own negatives are easy to produce, and being printed on double weight sensitised card no special mounts are required. All you need is a suitable mask to shield the white portions

## Make your own Greetings Cards

Fig. 1 shows how a piece of cardboard is prepared with an aperture made for the picture. It will be noticed that the fold is arranged exactly in the centre with allowance for a narrow border at the sides, top and bottom. This mask is then hinged by paper gumstrip to another piece of card of equal size. When preparing the greetings cards a piece of sensitised paper is placed between the two boards and the exposure made.

After processing it is essential that the cards be left under pressure for some time until they are perfectly flat, scoring on the outside where they are to be folded. Note that matt surfaced papers are the most suitable for this type of work and that you have the choice of white or ivory based papers.

The wording is made during the ex-

underneath the negative. The writing must be fine and smaller than usual when enlargements are intended. An old piece of film will be found useful if soaked in domestic bleach to remove the emulsion, rinsed in water and dried.

When making the prints the written 'negative' is placed on top of the ordinary negative in the enlarger carrier. Where contact prints are to be made the ordinary negative is in contact with the sensitised paper and the written one on top. In the latter instance it will be advisable to lay a piece of glass over the negatives to give close contact with the paper. Moreover, the writing may be much larger — almost normal — than when processing with the enlarger.

One of the main advantages of producing your own greetings cards is that

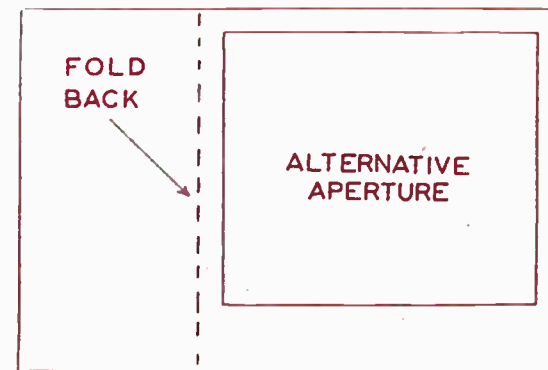
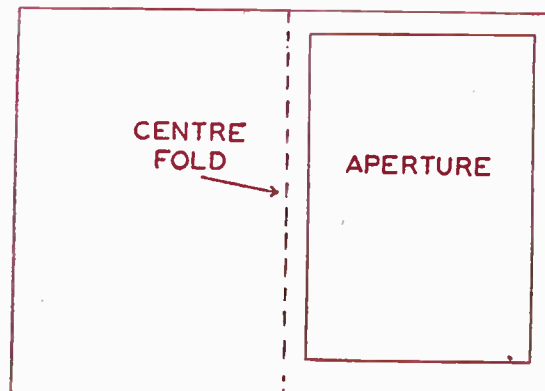

of the card during exposure and a piece of celluloid for inscribing the wording.

It is advisable to use half plate size paper measuring 4½ ins. by 6½ ins., but the size of the actual picture can be modified according to your choice. The card may be folded in the centre, but you may make a larger picture occupying two thirds of the paper with the remainder folding back (see Fig. 2.) Alternatively, you may print a long narrow picture with the paper either vertical or horizontal, a novelty shape which is rapidly gaining popularity.

posure, only requiring the preparation of a special 'negative'. You may use any wording you like to convey the seasonal message, but it must be remembered that if the white lettering is to stand out boldly it must be arranged so that it will be on a normally dark part of the picture as illustrated.

Place a piece of clear celluloid over the selected negative, writing in the wording in indian ink with a fine steel pen. The writing should be made over a thin part of the negative and it will be easiest by placing a piece of white card

a really personal note may be introduced, quite apart from the fact that you may make as many as you like. Pictorial scenes or happy snapshots may be used just as you desire and there is something about this type of personal greetings card which makes it far superior to the commercial product.

The picture size, as already stated, can be planned to suit your negative, the folding portion being merely for support in the usual manner. Any other message you wish to add, along with your signature, may be written inside. (S.H.L.)

# TWO WORKING TOYS



SIZE—  
POLICEMAN  
5 ins. HIGH.

CLOWN CART—  
6 ins. LONG.  
6 ins. HIGH.

PANELS OF WOOD  
REQUIRED FOR THIS DESIGN  
**ONE GDI2 ONE Q4**  
A KIT OF MATERIALS MAY BE  
OBTAINED FROM HOBBIES LIMITED  
DEREHAM, NORFOLK.  
PRICE ON APPLICATION.

**Use Croid POLYSTIK**  
IT'S DESIGNED FOR THE JOB  
A cold-liquid PVA adhesive combining  
instant grip with immense and lasting  
strength. Clean to use, non-staining. In  
polythene bottle with spreader 2/6.  
AVAILABLE FROM ALL BRANCHES OF HOBBIES LTD.

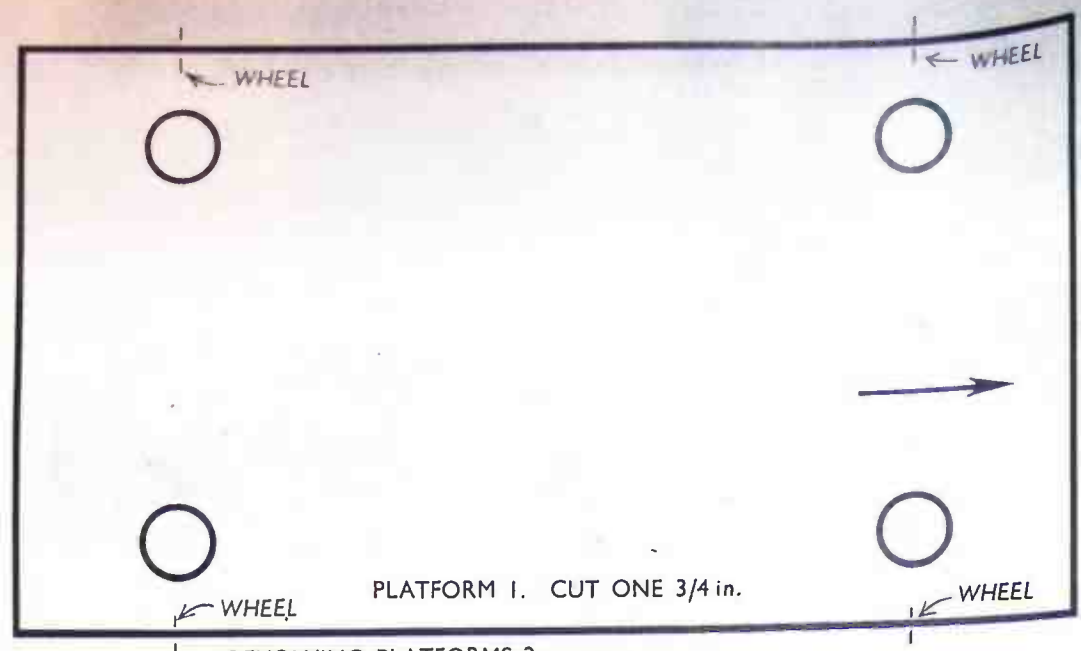

PLATFORM 1. CUT ONE 3/4 in.

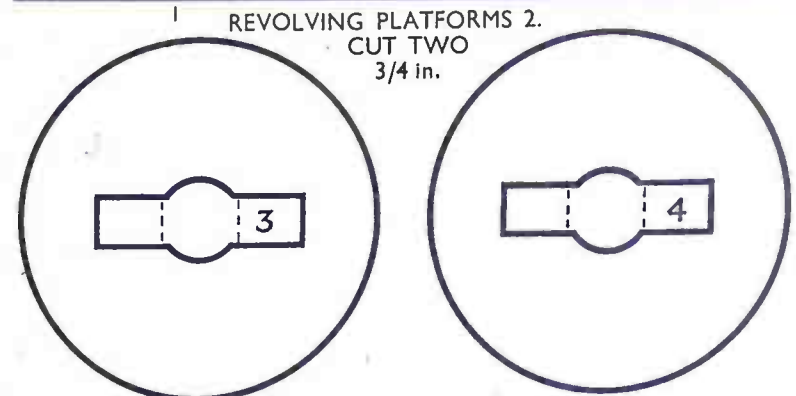

POSTS.  
CUT FOUR  
FROM 3/8 in.  
DIA. ROUND  
ROD.

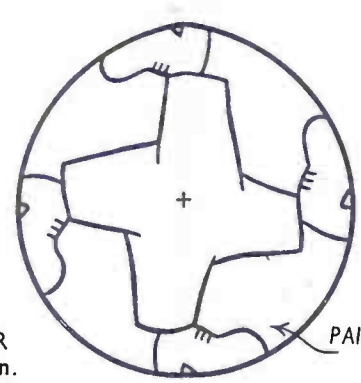

REVERSE  
SIDE.

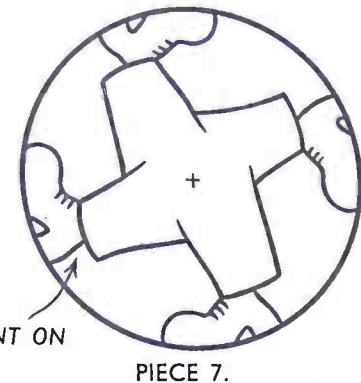

PIECE 7.  
CUT ONE 1/4 in.

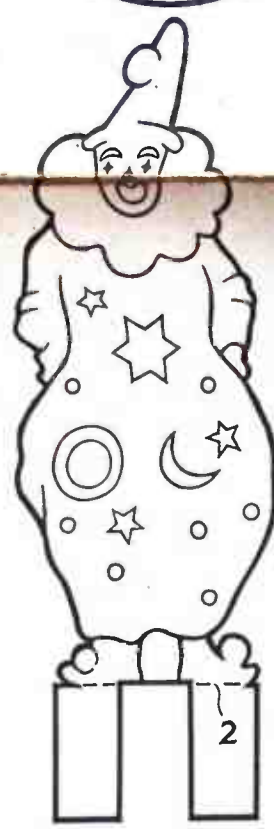

CLOWN 3.  
CUT ONE 1/4 in.

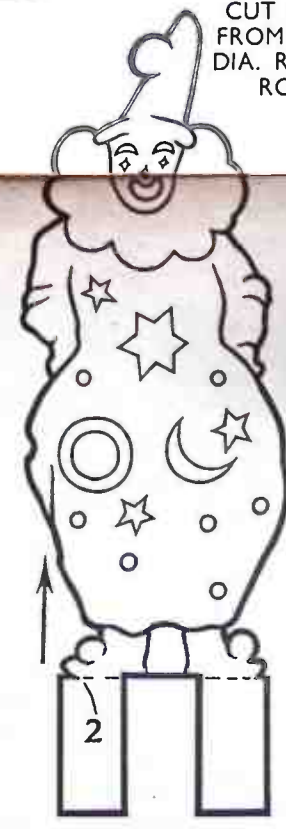

CLOWN 4.  
CUT ONE 1/4 in.

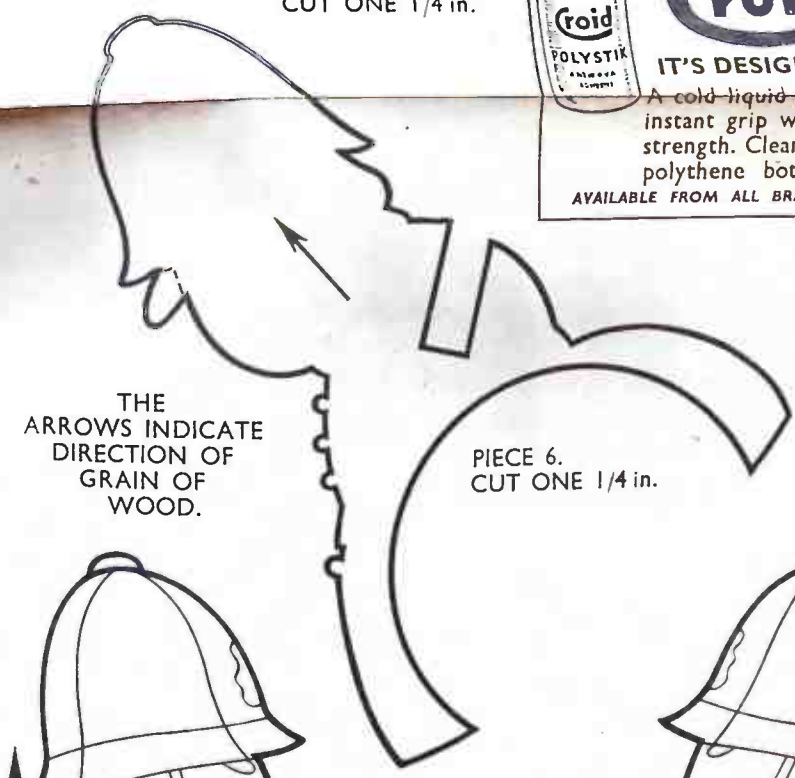

PIECE 6.  
CUT ONE 1/4 in.

HANDLE 9.  
CUT ONE  
FROM 1/4 in.  
ROUND  
ROD.



PIECE 5.  
CUT ONE  
1/4 in.

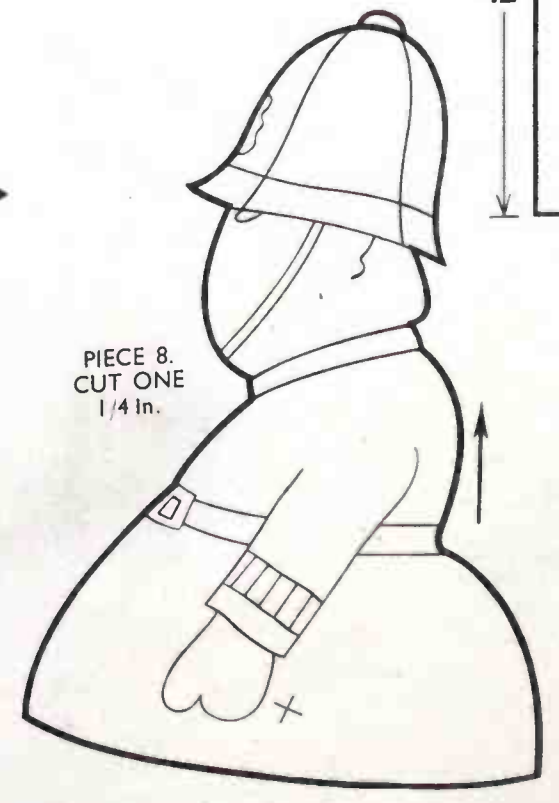

PIECE 8.  
CUT ONE  
1/4 in.

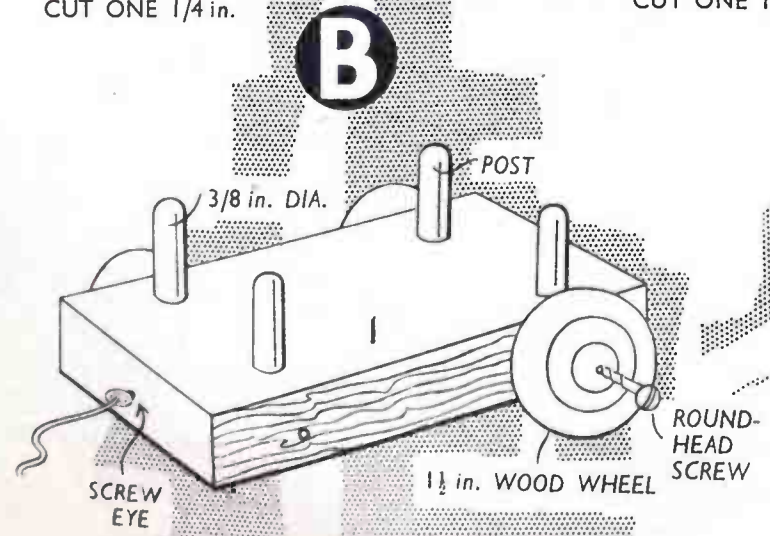

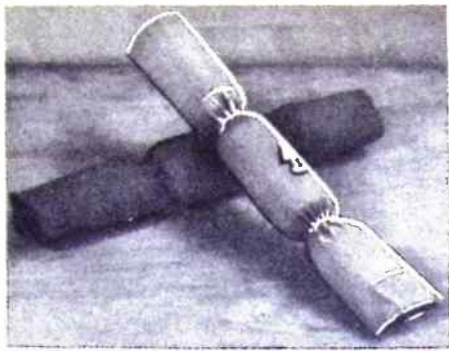

# HOME-MADE CRACKERS ARE EXCITING

Says  
S. H. L.

CHRISTMAS crackers add a seasonable touch of gaiety to every party table, but they can be much more exciting when made by yourself. Novelties, puzzles, toys, games and traditional mottoes can be of your own selection, and probably far more appropriate than those contained in the commercial product.

Again, you may make crackers of any size, omitting the snaps if intended for tiny children who may fear the bang.

Obtain some crepe paper for the outer cases, cutting into oblongs measuring 5½ ins. by 10 ins. It is nice to have a variety of colours, but if this will prove too expensive it is suggested that red crepe paper looks gay and attractive. Each end of these oblongs may be fringed with the scissors a little, or cut in saw tooth fashion, although the ones shown in the top illustration have been left untreated.

We next require some sheets of white

tissue paper on the table in a vertical position with a stiffener on top, with the tools close together on top of both. Bring the tissue paper to the tools, rolling round until the tube is formed. Remove the tools, tucking in the tissue at one end.

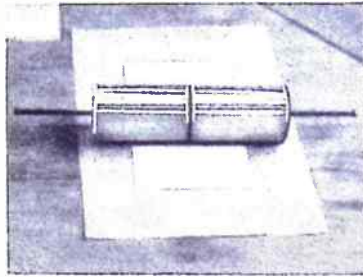

Fig. 1 Making the tube for the carrier

either side. You are advised to apply a touch of gum to the top of the crepe to hold the cracker firm during the next stage. Roll the cracker into shape a few times with the aid of the tools, when it will become quite firm.

The cracker now requires that distinctive crimping at the waist on either side of the carrier, achieved by looping a length of string round the cracker, and drawing tight as shown in Fig. 3. First withdraw the tool on the right hand side about a quarter of an inch, making a gap between the end of the carrier and the tool. Ease the cracker from the table so that a double loop of thin string can be passed round at this point, then pull tightly until the paper crimps. Remove the string, pushing the tool back to the original position while holding the cracker with the left hand in order to produce a neat shoulder and a nicely crimped waist. The other end is now treated in exactly the same manner when both tools may be removed and the cracker is almost complete. All that remains to be done to give that professional appearance is the addition of a coloured scrap attached with a touch of gum.

Crepe paper, tissue paper and thin

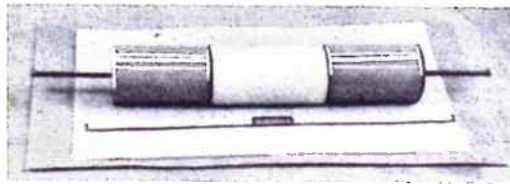

Fig. 2 Ready to roll the cracker

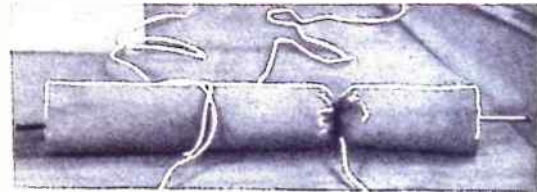

Fig. 3 Making the crimped waist

tissue paper, two for each cracker, measuring 5 ins. by 8½ ins., and stiffeners made from thin, white card measuring 2½ ins. by 5 ins. In addition a pair of 'tools' is required. These are merely two pieces of round wood, e.g. an old brush handle, 1½ ins. in diameter and 2 ins. long. It will be appreciated that these tools form the basic diameter for average sized crackers and it will be necessary to make modifications if smaller sizes are to be made. Fig. 2. shows the next stage of rolling the cracker into shape. Lay a piece of crepe paper horizontally on the table, a sheet of tissue on top, the cracker snap — which must not be forgotten — and the filled tube centrally with a tool at

A hat, puzzle, gift, motto, or what you will is placed in the tube and the tissue folded in to seal the contents. The motto is one of those tiny scraps of paper bearing a joke or conundrum, often the cause of much amusement. No cracker is complete without one of these and perhaps you may be able to invent some original quips, packing into the tabular container.

Fig. 2. shows the next stage of rolling the cracker into shape. Lay a piece of crepe paper horizontally on the table, a sheet of tissue on top, the cracker snap — which must not be forgotten — and the filled tube centrally with a tool at

card are all obtainable at most stationer's shops, and cracker snaps, mottoes and scraps can usually be bought at handicrafts shops or toyshops. Paper hats are normally sold ready rolled and there are hosts of small wire puzzles, charms or novelties available.

It may also be mentioned that it is possible to buy specially prepared cracker paper bearing gay printed borders down each edge and which is ideal for this work. And it should be remembered that the chief advantage of making your own crackers is that you can often include a really pleasant surprise in the novelty filling.



GREETINGS cards made from your own negatives are easy to produce, and being printed on double weight sensitised card no special mounts are required. All you need is a suitable mask to shield the white portions

## Make your own Greetings Cards

Fig. 1 shows how a piece of cardboard is prepared with an aperture made for the picture. It will be noticed that the fold is arranged exactly in the centre with allowance for a narrow border at the sides, top and bottom. This mask is then hinged by paper gumstrip to another piece of card of equal size. When preparing the greetings cards a piece of sensitised paper is placed between the two boards and the exposure made.

After processing it is essential that the cards be left under pressure for some time until they are perfectly flat, scoring on the outside where they are to be folded. Note that matt surfaced papers are the most suitable for this type of work and that you have the choice of white or ivory based papers.

The wording is made during the ex-

underneath the negative. The writing must be fine and smaller than usual when enlargements are intended. An old piece of film will be found useful if soaked in domestic bleach to remove the emulsion, rinsed in water and dried.

When making the prints the written 'negative' is placed on top of the ordinary negative in the enlarger carrier. Where contact prints are to be made the ordinary negative is in contact with the sensitised paper and the written one on top. In the latter instance it will be advisable to lay a piece of glass over the negatives to give close contact with the paper. Moreover, the writing may be much larger — almost normal — than when processing with the enlarger.

One of the main advantages of producing your own greetings cards is that

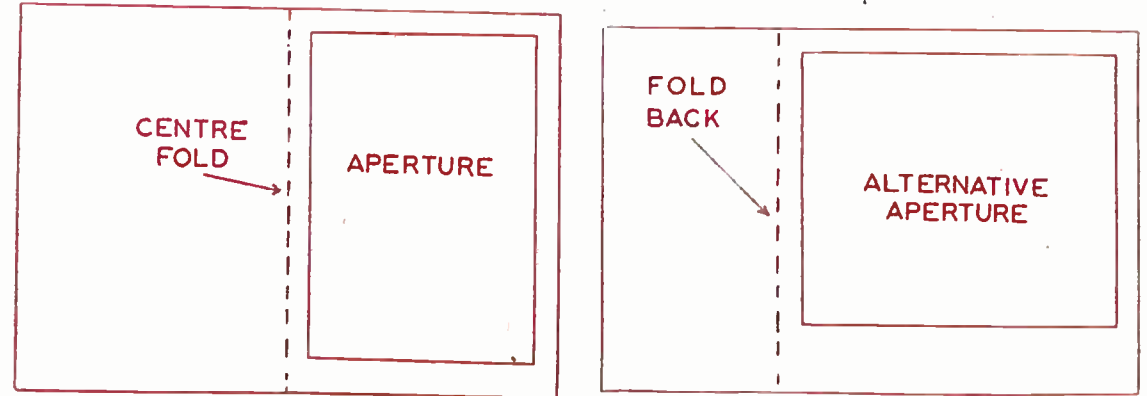

of the card during exposure and a piece of celluloid for inscribing the wording.

It is advisable to use half plate size paper measuring 4½ ins. by 6½ ins., but the size of the actual picture can be modified according to your choice. The card may be folded in the centre, but you may make a larger picture occupying two thirds of the paper with the remainder folding back (see Fig. 2.) Alternatively, you may print a long narrow picture with the paper either vertical or horizontal, a novelty shape which is rapidly gaining popularity.

posure, only requiring the preparation of a special 'negative'. You may use any wording you like to convey the seasonal message, but it must be remembered that if the white lettering is to stand out boldly it must be arranged so that it will be on a normally dark part of the picture as illustrated.

Place a piece of clear celluloid over the selected negative, writing in the wording in indian ink with a fine steel pen. The writing should be made over a thin part of the negative and it will be easiest by placing a piece of white card

a really personal note may be introduced, quite apart from the fact that you may make as many as you like. Pictorial scenes or happy snapshots may be used just as you desire and there is something about this type of personal greetings card which makes it far superior to the commercial product.

The picture size, as already stated, can be planned to suit your negative, the folding portion being merely for support in the usual manner. Any other message you wish to add, along with your signature, may be written inside. (S.H.L.)

# AIRCRAFT SPOTTING

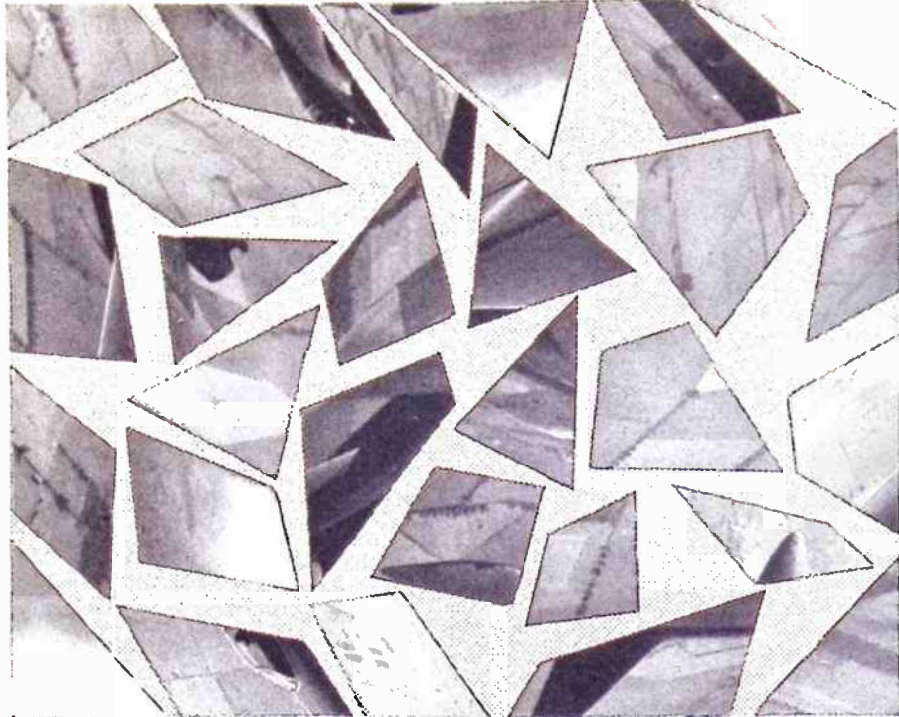

**M**OUNT the picture on stiff card or thin plywood, cut out the pieces with a modelling knife or fretsaw and join them together, jig-saw fashion, to complete a picture of the world's first and only *lightweight jet fighter*.

It is a British machine and behind its design lies an interesting story. In 1951 Mr. W. E. Petter, designer and director of the company which manufactured the aeroplane, reasoned that a *standard fighter* was too costly to manufacture and maintain, too big and too heavy. These factors strained our own resources and often proved prohibitive where possible foreign markets were concerned.

\*\*\*\*\*  
 \* Next week's issue will contain \*  
 \* more suggestions in preparation \*  
 \* for the coming festive season; \*  
 \* also the usual features \*  
 \*\*\*\*\*

A study of the big conventional fighters showed that much of the equipment they carried was necessary to their operation *because* they were big machines. Also, it was argued because

~~~~~  
*By G. Allen*  
 ~~~~~

of their large size, heavy engines were required. If these were reduced in size the airframe could be lightened, some of the usual equipment would not be necessary, less fuel would be needed, and a machine with a performance equal to a standard fighter would still be the result. One important factor was armament — this would have to be reduced in weight but not in effectiveness. Two 30 mm. Aden quick-firing cannons compact and extremely powerful, provided the answer. All this would mean that a fighter could be built weighing one third that of a standard fighter at little more than a

third of the cost. Moreover, it could be built without the use of large and costly machine tools.

So work started on the design of a private-venture light fighter — a venture where hundreds of thousands of pounds of private money was at stake.

Just as the project was gaining momentum, the manufacture of the small powerful turbojet round which the design was based was abandoned! But to gain flight experience an aircraft very similar in layout was designed round a lower-powered engine — the Armstrong Siddeley Viper — and proved highly successful. Then the Bristol Orpheus engine came on the market, an engine powerful enough for the *original* conception of the fighter. So another machine was built, a picture of which forms the basis for our Quiz.

With a span of only 22ft. 2ins. the aircraft is capable of high sub-sonic speeds, and later versions will fly faster than sound in level flights. Foreign air forces are now being equipped with the fighters. Can you solve the puzzle?

Answer next week.

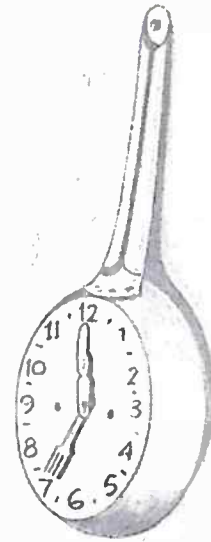

**H**AVE a look at the wife's frying-pan. Is it old? Is it time it was scrapped?

And that old alarm clock on the shelf. Are you prepared to give it a 'new look'?

Finally, can you do a somewhat finicky job but one that's really worth the trouble? If these three factors apply, you can make yourself this novel frying-pan clock, which will grace any wall.

First thing to do is to give the frying-pan a good clean, especially on the undersides. File and emery away any carbon crustations. Get it really clean.

Now, the clock face. An elementary knowledge of geometry is all you need. First, find the diameter of the pan bottom (see (A) in Fig. 1). Measure across with a rule. The greatest distance will be the diameter.

On a sheet of plain paper, scribe a circle of this diameter. Set your compasses at half the diameter or radius.

### Marking the face

Now, still using the radius setting, scribe six equal marks around the circumference of the circle (see (B) Fig. 1). You now need six other marks to make up the twelve marks for the clock face. With a rule, measure carefully the distance between two of the marks on the circumference (see (C) Fig. 1).

Now, starting from the exact centre of the distance (C), start to scribe off another six equal marks around the circumference. These marks will come exactly between the first set of six marks and complete the twelve points needed for the clock face.

# A 'FRYING PAN' CLOCK

You can if you wish, now measure off the distance between each of the twelve marks to give you five equal marks for minutes, but this is not strictly necessary.

With scissors, cut out the paper circle and stick it on to the pan bottom with adhesive tape. The clock will hang from a hook through the hole in the frying-pan handle and for this reason the '12' on the clock face must be in a direct straight vertical line with this hole. Be careful with this.

With a sharp point, pierce the paper to mark the twelve hour marks and the centre mark through on to the pan bottom underneath.

Dismantle the old alarm clock mechanism from its case. To do this you will first have to remove the hands. You will see that they are held by a firm push-fit over the central bearings. Each hand will have its own bearing.

Prise them off carefully. Invariably, the clock mechanism is fixed to the clock face by a nut and bolt or a nut locating over a threaded portion of the frame of the mechanism. Usually there are two or more of these fixtures and these same holds are to be used to fix the mechanism to the pan bottom (see (A) in Fig. 2).

First, drill a hole through the pan bottom at the centre marking you have made on the clock face. Make it of a size sufficient to take the larger of the hand bearings (see (B) in Fig. 2).

With the hand bearings through this hole, mark the points where the nut and bolt holds (A) will be, and drill holes to take them.

When the mechanism is fixed it is almost certain that the case of the old alarm clock will slip back into place. At the most, however, only a very little adjustment will be needed. Naturally, this case must be used to keep the clock dust-free.

As shown in Fig. 3, the minute hand is in the shape of a knife, and is slightly larger than the hour hand, which is in the form of a fork. Naturally, you need not make these coverings to the existing hands, but it gives your clock that extra novel touch.

Fig. 4 shows how the knife and fork

hands are fitted over the existing hands — the tags shown at Fig. 3 being bent back to hold the old hand and its new face together.

Use thin sheet metal for the knife and fork. A cocoa tin, cut up, is ideal. Then you can use ordinary scissors for making the rather tricky cuts.

Push the hands back firmly on to their bearings. You may have to tap them on using a thin piece of tubing, the hole of which does not greatly exceed the diameter of the hand bearings. Be careful to set the hands correctly, with

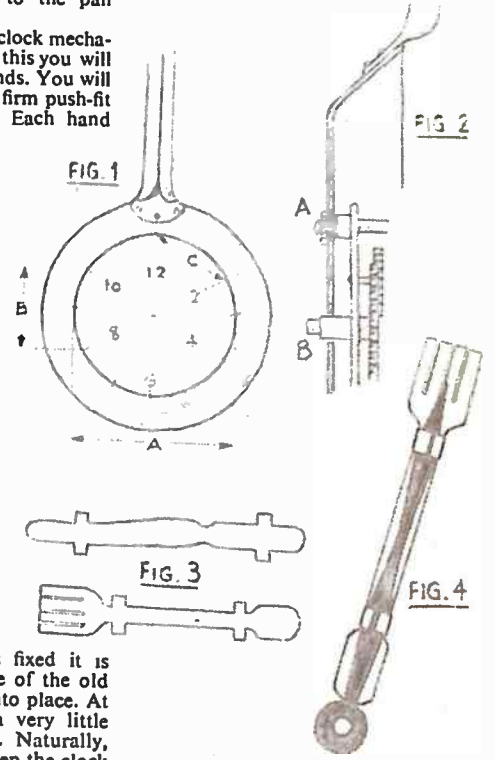

the minute hand exactly at '12' and the hour hand exactly at one of the hours.

Paint the clock with high-gloss enamel, preferably light green. Paint the hours black. If, however, numbering is not your strong point, cut out suitably sized figures from an old calendar, and with tube-glue, stick them around the clock face. (E.C.)

Keep them handy

## A Holder for Fretsaws

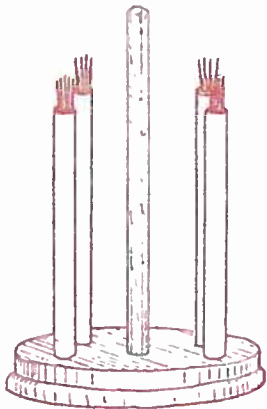

By W. J. Ellson

**A** VERY convenient holder for fretsaws can easily be made with a few short pieces of tubing, mounted on a wooden base.

A search in the junk box will probably provide the tubing, which can be of any material, and should be in about 4in. lengths. Plastic tubing is suitable and should the reader have a few used ball point pens, here is a useful ending for

them. There is now on the market a pattern of pen, costing only a shilling. Such pens do not take a refill although they give some months service. The writer, having an accumulation of four, utilised them for the fretsaw holder illustrated.

With ordinary tubing, it is only necessary to cut short lengths and bore holes in a wood base to make a tight fit for them. If you use old ball point pens, however, twist the top and pull out the interior, leaving only the case. Saw off the tapering lower end, and a piece of tubing, just suitable for fretsaws will be left.

A sketch plan and section of the base is given. The base is made up of two pieces of wood — thicknesses unimportant — glued together. The upper one is cut circular and centred. With the radius given, strike on the disc a circle, divide into four, or as many parts as tubes desired, and drill holes through, suitable in size for the tubing. In the centre bore a hole to admit as a tight fit a 6ins. length of wood dowel rod, to act as a convenient handle. Glue this in, then fix the tubes in with a suitable adhesive.

The bottom disc is cut 3ins. in diameter. Its edge is quarter rounded, then it is glued to the top disc to complete the work.

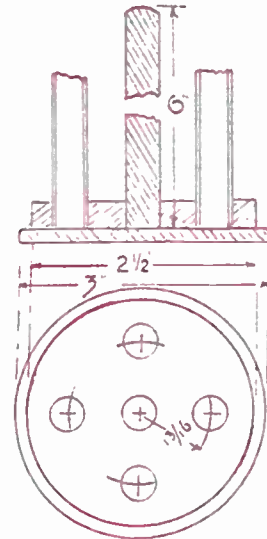

For fretworkers employing several grades of blades, it is a great help to label the grade number on each tube.

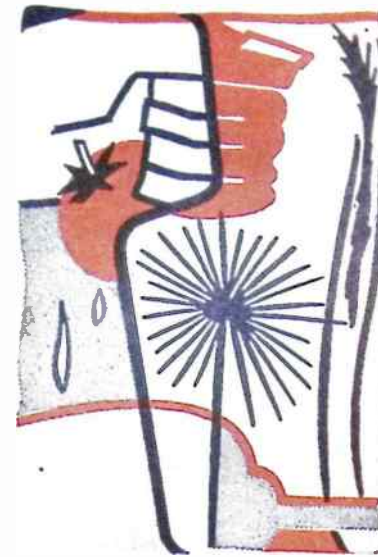

## TRY THESE NEW WINES

flavour slightly —  $\frac{1}{4}$  lb. of each is about right. Another variation is to use brown sugar instead of white which will considerably alter the flavour.

### Banana Wine

Bananas which have gone black and soft need not be thrown out, but turned instead into a very nice wine. You can of course use fresh ones just the same. Here is the recipe:

$\frac{1}{2}$  lb. Bananas  
 $\frac{1}{2}$  lb. Raisins  
 2 lbs. Sugar  
 4 pints Water  
 $\frac{1}{2}$  oz. Yeast

Cut up the bananas without the peel and also the raisins and boil for about fifteen minutes. Strain, add the sugar and yeast when cool and put into bottles to work for fourteen days. If raisins are difficult to get, sultanas may be used instead, also  $\frac{1}{2}$  lb. dates can be chopped up and used instead of the raisins or both used together.

ever tried dandelion leaf wine? This is a health wine which is quite as good as that made from the flowers, and you can make it practically all the year round. It is a good idea to grow a few plants in the garden for wine making — they take up little room and are of much better quality than when growing wild. Here is a good recipe:

12 ozs. Dandelion leaves  
 $1\frac{1}{2}$  lbs. Sugar  
 2 ozs. Rice  
 4 pints Water  
 $\frac{1}{2}$  oz. Yeast

Boil the leaves and rice in the water for  $\frac{1}{2}$  hour, strain, and when cool, add the sugar and yeast and put into bottles to work for fourteen days. This recipe may be varied by the addition of 6 ozs. horseradish leaves. As a change  $\frac{1}{2}$  lb. prunes or 1 orange may be used. Horseradish leaves may also be used instead of the dandelion leaves in the same proportion.

### Tomato Wine

Ripe tomatoes provide a really wholesome food and when made into wine it is a most delicious drink besides being a good tonic.

5 lbs. Ripe Tomatoes  
 4 pints Water  
 $1\frac{1}{2}$  lbs. Sugar  
 1 teaspoonful Salt  
 $\frac{1}{2}$  oz. Ginger  
 $\frac{1}{2}$  oz. Yeast

Bruise the ginger with a hammer and boil with the tomatoes, salt and water for thirty minutes. Strain through several thicknesses of butter muslin, add the sugar, stirring until dissolved, and lastly add the yeast. Put into bottles and allow to work for about eighteen to twenty-one days.

The recipe can be varied slightly by omitting the ginger and using some other spice instead, but be careful not to overdo this and it is better to keep on the low side.

### Yarrow Wine

Many of the herbs of the countryside can be made into excellent wines and yarrow is a good example of this. It is found by the roadside and on waste

● Continued on page 169

## Make this simple Tie Stretcher

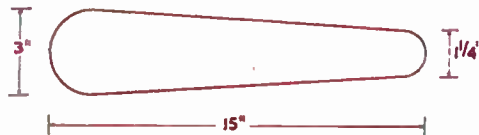

**T**IE stretchers are becoming very popular nowadays no doubt because they are effective and easy to use. The gadget consists of a piece of thin material shaped to fit the inside of a neck-tie and when in use the stretcher is inserted inside the tie and pushed firmly 'home'. This keeps the tie in good condition and removes any creases. Tie stretchers can be obtained from most large stores and these are normally

made of plastic but why not make your own? They are very simple to make and the cost is low.

To make, obtain a few pieces of  $\frac{1}{4}$ in. thick wood, preferably a hardwood to avoid splinters, and cut them to the size and shape shown in the diagrams with your fretsaw. Once cut, smooth off the sawn edges with a rub of glasspaper and remove all sharp corners. It is essential that no rough parts remain for these may

damage your ties when the stretchers are used.

If desired, the stretchers can be finished off by applying a coat of hard wearing lacquer. (F.K.)

### PAPER SIZE

**T**HE following formula may be used to prepare a solution for 'sizing' ordinary photographic prints prior to painting with water colours. This size reduces the paper surface to a neutral state which will take normal water colours satisfactorily.

oxgall (pure)	15 grams
methylated spirit	1 oz.
distilled water	4 ozs.
	(R.H.W.)

### Tea Wine

Tea wine does not sound very exciting but once you have tried it you will want to make some more. It is easy to make as well as being cheap and can be made at any time of the year.

4 pints Tea  
 2 lbs. Sugar  
 2 Lemons  
 4 ozs. Raisins  
 $\frac{1}{2}$  oz. Yeast

Save all the tea left over from the teapot which would otherwise be thrown away, and put it in a jug or container of some sort until you have sufficient according to the recipe. Then thoroughly mix with the sugar until dissolved, add the juice of the lemons and grated peel together with the raisins chopped up small. Finally add the yeast which has been previously dissolved in a little of the sweetened tea and put into bottles to work for about two weeks.

Prunes may be used instead of the raisins or you may add both to alter the

### Celery Wine

Although celery is rarely turned into wine it makes a really excellent drink and is reputed to possess medicinal properties. Either the sticks can be used or the leaves alone in which case you only need half the quantity. This recipe may be varied by including  $\frac{1}{2}$  lb. to  $\frac{1}{4}$  lb. rice.

4 lbs. Celery  
 3 lbs. Sugar  
 1 gallon Water  
 $\frac{1}{2}$  oz. Yeast

Cut up the celery into small pieces and boil for about thirty minutes until tender. Then strain, add the sugar and yeast when cool and allow it to ferment in bottles for fifteen days, when it can be decanted and bottled and lightly corked. If you are using the leaves only it is not necessary to boil quite so long — about fifteen to twenty minutes is usually sufficient.

### Dandelion Leaf Wine

Dandelion wine made from the flowers is probably one of the most popular home made wines but it can only be made while the flowers are at their prime. Have you

# Developing your Films

DEVELOPING is no longer a difficult, skilled task, because modern developers are so reliable that it is only necessary to time the period for which the film or plate is immersed. Results equal to those obtained professionally can easily be achieved, but at less cost, and without the delay involved in sending a film away to be developed. Few chemicals are required, and there is no reason whatever why the very first film should not be a complete success. If contact prints are also made at home, as will be described later, the finished pictures can be available quickly.

By F. G. Rayer

Developers can be obtained in liquid or powder form, or as tablets to be dissolved in water. Some developers are for films only, but others can also be used for the contact prints, so that no further developer need be obtained. An example of the latter is Tabloid 'Rytol', available at any photographic chemist. Whatever the developer chosen, it is wise to keep to the same type for some time, as frequent changes are only liable to cause confusion, and possible errors in timing development.

The only other chemical required is a 'fixer' to prevent the film deteriorating when exposed to daylight. An acid fixer is usually employed, and Johnson's Acid Fixing Salts is an example. This will also do well for both films and contact prints.

### Dish or tank

The film may be developed and fixed in a dish containing the chemical, or in a daylight tank. The dish is cheapest, and a clean basin may be used with success. The film is passed continually through the developer, by holding it in a long loop, as shown in Fig. 1, so that it is kept wet. For panchromatic films, this has to be done in complete darkness. With ortho films, a weak red safelight can be used.

Dish development is not much used at home, as a completely dark room is required. It is worth trying, however, if a start is to be made with a minimum of expense. Stray light must on no account reach the film, or it will be fogged, or become black all over.

The daylight tank, as its name suggests, allows processing to be carried out

by ordinary light. The simpler type of tank has a spiral into which the film is inserted, and this has to be done in darkness. A light-proof lid is then fitted on, a central hole allowing the chemicals to be poured in. More expensive tanks can also be loaded in daylight. However, the simpler type of tank is recommended, as it is easier to use. It is generally possible to find a suitable spot or time to load the film into the tank. For example, at night, during darkness. Or by entering some large cupboard or other dark recess which could not very well be used as a darkroom for dish development.

With reasonable care, such a tank will be almost everlasting. It also helps to protect the film during processing, avoiding scratches, etc., which may arise with dish development.

### Mixing the chemicals

Instructions for mixing the developer will be given with the packet or bottle. For example, the Rytol tablets are provided in pairs. For dish development,

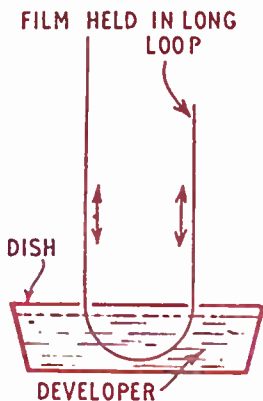

Fig. 1—Developing film in a dish

4 ozs. of developer will be required. One pair of tablets is thus dissolved in 4 ozs. of water. For tank development, about 10 ozs. of developer will usually be required, to fill the tank. (Large tanks may require more). One pair of tablets should thus be dissolved in 10 ozs. of water, for this purpose. A photographic measure is very useful for measuring out fluid ozs. Failing this, 10 ozs. of water will be half a pint.

The developer is mixed just before the film is to be done, and is thrown away after use. It can be mixed in a clean jar or jug, ready for pouring into the tank.

The strength of the fixer is not important, but eight heaped teaspoonfuls of the fixing salts mentioned, in one pint of water, will be suitable. If a measure is available, 2 ozs. of powder in 15 ozs. of water can be used. The water should be warm, to assist mixing. A clean bottle will be handy to keep the fixer in, as it can be stored after use, and employed again, for a number of films. It is also best to mix more than the exact quantity required for the tank, as sediment can then be left undisturbed in the bottle.

### Developing the film

When the developer has been made up correctly, as explained, development is by 'time and temperature'. As an example, Selochrome film is developed for the following time, according to the temperature given, with one pair of Rytol tablets in 10 ozs.

Temperature	Development Time
60°F.	30 minutes
65°F.	24 minutes
70°F.	20 minutes

If the film is developed in a dish, the

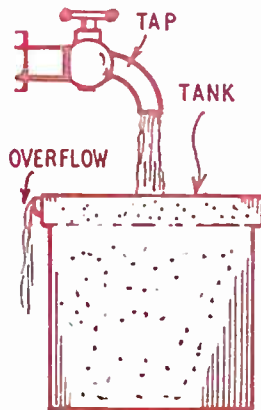

Fig. 2—Tank washing roll films

solution is more concentrated, and kept more in motion, so that shorter times are used, as follows:—

Temperature	Development Time
60°F.	9½ minutes
65°F.	8 minutes
70°F.	6½ minutes

The mixed developer can be made up at the correct temperature by adding hot or cold water, as required. It is then poured into the tank, and the time noted. The tank is 'agitated' at occasional intervals by turning the stirring rod provided for this purpose. With a dish, timing is from the moment the film

begins to pass through the developer. During very cold weather it is best to stand the tank in a vessel of water, kept at the required temperature by adding a little fresh hot water as necessary. This will prevent the developer cooling down, which would hinder proper development.

### Rinsing and fixing

When the correct period has elapsed, the developer is poured out of the tank, the lid being kept on. Clean water is then poured in, the stirring rod revolved a few times, and the water is emptied away. This helps to wash out remaining developer, and can be done again. The clean water only needs to remain in the tank a few seconds.

With dish development, the film is lifted out of the dish, and dipped once or twice into a large jug or other vessel filled with clean water.

The ready mixed fixer is now poured into the tank, and the stirring rod agitated a few times. Or, for dish development, the film is deposited in a further vessel containing the fixer, care being taken that it does not coil up, overlapping so that the solution cannot reach some areas.

The fixer should never be cold — say, not under 60°F. After about 5 minutes, it is safe to look at the film by ordinary light. All creaminess should have gone. If not, the fixer is rather cold, weak, or exhausted. The film should remain in

the fixer, with occasional agitation, for at least twice as long as required to clear away all creaminess. No harm will be done if the film is left in the solution much longer.

Processing is now completed, except that chemicals have to be washed out of the emulsion, so that the film will not deteriorate. Once fixed, the film can be studied by daylight. If it is pulled out of the tank spiral, it will be necessary to hold the whole spiral submerged in water, as a wet film cannot otherwise be pushed in easily. If it is not desired to look at the film, immediately after fixing, then it can, of course, be left undisturbed in the spiral, to await washing.

### Final washing

If the film is in the tank spiral, washing is easily accomplished by allowing a tap to run clean water into the central opening, as shown in Fig. 2. Only a moderate stream of water is required. The film should be left in this position for about half an hour. It is a good plan to empty the tank out a few times during this period, to assure no diluted fixer accumulates at the bottom.

Loose films, removed from a spiral or developed in a dish, can be washed in a bowl or large basin, having at least thirty minutes under a running tap. Longer washing will do no harm, the purpose merely being to clear away all chemicals.

If no running water is available,

immerse the film in clean water, and leave for about five minutes. Then change the water completely, and repeat, until the film has had twelve changes of clean water during about an hour in all. This is a little troublesome, but running water is usually available, and washing is then very easy.

### Drying and storing

The film is most easily left to dry naturally, by hanging it up by one end somewhere free from dust. Drying will take place more rapidly if excess moisture is gently wiped away with a photographic sponge, or soft fluffless cloth. If the film can be hung up and left overnight, this is ideal. Holes can be pierced through the film, at each end — one for hanging, and the other for a small wire hook, with weight, to keep the film extended.

Quite rapid drying is also possible by gentle heat, but care is required, or the film will become distorted, or stained by droplets, which dry more slowly than the rest of the emulsion area.

Transparent negative envelopes are an excellent means of storing, the film being cut up into separate negatives. With these, the negative can be seen without removing it. Or ordinary envelopes can be used. If so, it is best to mark the contents on the outside. A simple method is an indication of the date, and subjects, so that there is no need to take out each negative for investigation.

Continued from page 167

## Try making these New Wines

ground almost anywhere, and on account of its medicinal properties should be used more than it is. The small white or pinkish flowers are at their best in July but you can use them at any time while they are in bloom.

- 2 pints Yarrow flowers
- 2 lbs. Sugar
- 4 pints Boiling water
- 1 Lemon
- 1 Orange
- ½ oz. Yeast

Allow the flowers to soak in the boiling water for three to four days, stirring each day. Strain through muslin and lightly boil for fifteen minutes with the grated rind of orange and lemon, and yeast while still warm. Stir until dissolved and put into bottles to work for fifteen days.

### Clove Cordial

With the exception of ginger the other

spices do not appear to be used to any extent for wine making although they are excellent for the purpose. Besides being used to add flavour to many fruit and flowers wines, cloves will produce a pleasant warming drink which is very acceptable during the winter months.

- ½ oz. Whole Cloves
- 1 Orange
- 4 pints Water
- ½ oz. Whole Ginger
- 1½ lbs. Sugar
- ½ oz. Yeast

Gently boil for about ½ hour the grated rind of orange and lemon with the cloves and ginger which should be well bruised with a hammer. Then add the juice and pulp of orange and lemon and allow to cool, when it is ready for straining through butter muslin. Before it is cold add the sugar and yeast and stir until dissolved. Put into bottles and allow to ferment for fourteen days when

it can again be strained and bottled up but do not put the corks in too tight to start with.

These are only a few of the unusual types of wine which can be made, others include pea pod wine, nut wine, date and fig wine. Perhaps you would like to try making some of the more unusual kinds — you will find it most interesting and maybe something really outstanding will be the result. (A.F.T.)

★ ★ ★ ★ ★ ★ ★ ★ ★ ★ ★ ★ ★ ★ ★ ★

### OCTOBER CROSSWORD WINNERS

- ★ No competitor submitted an all-correct solution to our prize Crossword Puzzle published in the issue of October 2nd. Winner of the senior watch was L. Catt, 32 Upper Bevendean Avenue, Brighton 7, Sussex. The junior winner was ★ Colin Stone, 2 Greenhithe Close, Sidcup, Kent. Ball point pens were ★ sent to readers of the six next best entries in each section. ★

★ ★ ★ ★ ★ ★ ★ ★ ★ ★ ★ ★ ★ ★ ★ ★

# Replies to Readers Is this YOUR Problem?

## Preservative for Aviary

I AM erecting a small aviary for budgies, etc. and propose to treat all wood exposed to the elements with Green Cuprinol; will this in any way affect the birds? (A.N.—Middlesbro')

ALL preservatives are poisonous in their liquid state, but once dry, Cuprinol should not affect your birds. It takes some time to dry completely, and you should wait until the final oiliness has gone before introducing the birds.

## Plaster Sealer

I WOULD like to know if there is a cheap, efficient plaster sealer for plaster ornaments prior to painting them; the one I have in mind is a white matt sealer. (A.G.—Sandown.)

THE cheapest sealers for the purpose can be made from size or gelatine. These should be dissolved in hot water in amount sufficient to produce a very thin syrupy solution, whitening or precipitated chalk stirred in to give the white effect, and the plaster brushed with the hot solution. Such sealers will have to be made up just prior to use. More convenient, although slightly more expensive, would be a water-based shellac sealer. Its advantage lies in that it can be bottled and kept for use at any time. To make it, dissolve one ounce of bleached shellac in a warm solution of half ounce of borax in 6 fluid ounces of water, and stir in enough whitening or precipitated chalk to give a white film when brushed. Use the solution cold. The plaster objects must be allowed to dry thoroughly before applying paint over the sealer.

## Discoloured Celluloid

DO you know of a chemical which will remove the yellowness on white celluloid mudguards? (H.B.—Warrington.)

THE yellowness on white celluloid mudguards is often due to absorption at the surface of oil. It will yield to cleaning first with a paste of Vim-type scouring powder made with water and applied with a wetted rag, followed by rinsing, allowing to dry and then working all over with steel wool. Rinse again, and if much gloss has been lost, restore it by polishing with a paste of whitening and water. Yellowness caused by light is due to chemical change and is much more difficult to remove —

often impossible. If the first treatment has failed, chemical bleaching may be tried. Half a cup of Parazone in  $\frac{1}{2}$  bucketful of water should first be mixed. The mudguards will have to be immersed in this for half an hour and the difficulties owing to the shape are obvious. We suggest a shallow vessel where the mudguards can be treated portionwise by turning through the full arc, one half hour being allowed for each portion, of course. After each treatment rinse with warm water and dry. This treatment may affect the metal fittings, and where these are not removable they should be relacquered.

## \*\*\*\* Sawing Veneers \*\*\*\*

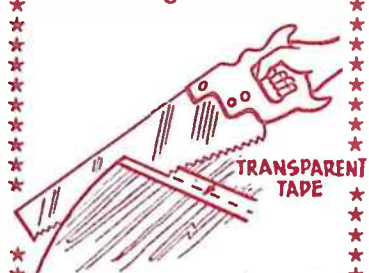

Old veneered wood, which it is intended to use again for some other project, can more safely be cut if a length of 'Sellotape' is stuck along the sawing line. The veneer is then less liable to lift and splinter at the cut edges.

## Photographing TV Items

I HAVE a box camera and would like to get good pictures from our TV; I have tried, but the films are returned blank. Is there a way to overcome this? (R.S.—Trumpington.)

A BOX camera lens aperture is small so that a short time exposure will be necessary. Darken the room and set the TV so that the picture is as bright as possible, with strong blacks and whites. Use a very fast film such as HPS. Set the shutter control to B or T for brief time exposures. (Follow your instructions or check the setting with camera open and no film in.) Support the camera on a tripod or table, using a close-up lens so as to get a sharp image on the film. Ensure the camera is level, correctly positioned,

and measure the distance between camera and TV screen, to suit the figure given for the close-up lens used. You will have to choose moments when there is little or no movement on the screen. Exact exposures vary widely, according to the TV set and lens aperture, but as a first trial,  $\frac{1}{2}$  to one second should do well. If the negatives are found to be thin, increase this to 2 to 4 seconds. If the negatives are dense, try less than  $\frac{1}{2}$  second. Do not use slow or ortho films.

**ROCK 'N' ROLL** Craze of Century. They'll crowd round when you strum. **ELVIS PRESLEY**, great U.S.A. Rock 'n' Roll Star, has his name on every one. Easy to play, simple Tutor supplied free, including carrying box. Fitted Nylon strings give good old Rock 'n' Roll and Calypso effect. Made of Styrene for strength. Send 24/6, plus 2/6 post. **ELVIS PRESLEY UKETTE**, self-playing apparatus incorporated. 10/11. Post etc. 2/-.

**AMAZING GOVERNMENT SURPLUS NEW TELEPHONE INTERCOM MOBILE OR STATIC** COMPLETE ONLY 12/11 POST ETC. 2/-

Complete transmitting and receiving apparatus for two persons. From a few yards to a mile. Normal telephone strength. No batteries or electricity — it just works! Send 12/11, post 2/1. Ready for use in 5 mins. Lists, Binoculars, Watches, Tents, Terms. Headquarter & General Supplies Ltd. (HOBW/88) 196-208 Coldharbour Lane Loughboro Junc., London, S.E.5 Open Sat.

**GOVERNMENT SURPLUS BARGAINS.** Inter-room Telephones, comprising 2 self-energised microphone/receivers and approx. 6yds. flex (may be extended if desired). No Batteries needed. Nothing to wear out. Complete 9/6, post 6d. Motors, Transformers, Switches, etc. 3d. stamps for illustrated list. Milligan's, 24 Harford Street, Liverpool, 3. Money Back Guarantee.

**EVERY CAR THAT PASSES—YOU WILL FIND THE INDEX MARK ALPHABETICALLY ARRANGED IN 'WHERE'S THAT CAR FROM?'** Price 9d. from all Booksellers or from the Publishers (2d. postage) **RALEIGH PRESS, EXMOUTH**

**STOP SMOKING** in 3 days or money back. Safe, pleasant, permanent. The only scientific way. No Will Power necessary. 'Conquered the habit in 24 days'.—F.C. 'Within 2 days I was free from the tobacco habit'.—W.G. 'Was a smoker for 2 years and broke the habit in 2 days'.—F.N. 'I used to smoke 20 a day... now I have no desire to smoke'.—J.M. Recommended by 'Health and Efficiency Magazine'. Complete course 7/6 (or \$1.00 bill). Details 2d. stamp. Sent under plain cover. **NATURE REMEDIES, 28 (H/174) Dean Road, London, N.W.2.** (Established 1928)

# Your boy... an Engineer in the making

Mobile Crane made with Meccano Outfit No. 3

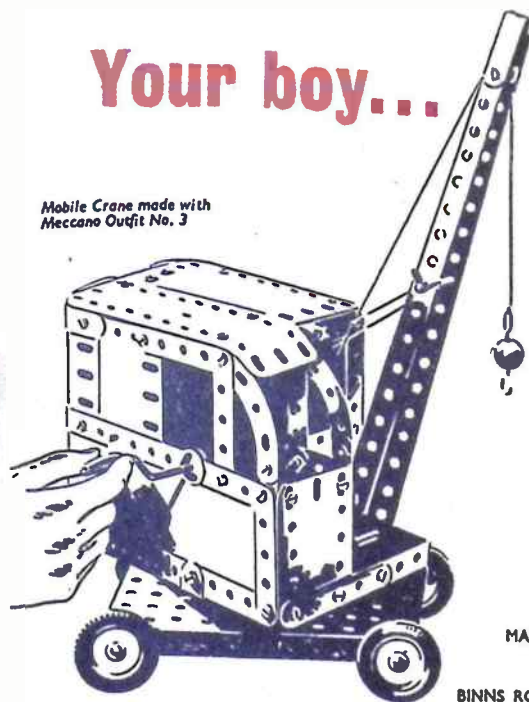

MADE IN ENGLAND BY  
MECCANO LIMITED  
BINNS ROAD, LIVERPOOL 13.

**MECCANO**

## NEW! THE PRACTICAL WAY of learning RADIO · TELEVISION · ELECTRONICS

**NEW**—Experimental outfits and lesson manuals sent on enrolment remain the student's property. Tutor allotted to each student for personal tuition throughout the course. In radio and television courses, specially prepared components are supplied which teach the basic electronic circuits (amplifiers, oscillators, detectors, etc.) and lead by easy stages, to the complete design and servicing of modern radio and TV equipment. THESE PRACTICAL COURSES ARE IDEAL AND MAY BE YOURS FOR MODERATE COST

Fill in the coupon to-day for a free Brochure. There is no obligation whatsoever. Courses with equipment enable you to design, construct and service 2-stage radio equipment 2-stage T.R.F. circuits · Television equipment · Workshop Test Panel Oscilloscope · 5 valve 3-waveband superhet circuit



**SUBJECTS INCLUDE:—** Radio · Electronics · Television Equipment Mechanics · Chemistry · Photography · Electricity · Woodwork Electrical Wiring · Draughtsmanship · Art · Short Wave Radio Oscilloscope · also many other Home Study Courses without equipment.

**EMI INSTITUTES** COURSES FROM 15/- PER MONTH

E.M.I. INSTITUTES, Dept. 31X, London W.4

NAME \_\_\_\_\_

ADDRESS \_\_\_\_\_

Subject of Interest \_\_\_\_\_ AGE \_\_\_\_\_ (if under 21)

(We shall not worry you with callers) 4/12/57 ICBS

## GAMAGES LONDON'S HEADQUARTERS FOR HOBBIES

including an extensive show of 'Hobbies' Fretwork Outfits and Machines. Easy Terms available.

### BANDSAW MACHINES



Cuts wood up to 2in. thick. Height 22in., width 12in., depth of throat 6 1/2in., table 7in. sq. 7in. rubber tyred internal wheels. Full length hinged door. Oil impregnated bearings. Table graduated in degrees. 4in., 5in. and 6in. 3 step cone pulleys. Sheffield steel saw blades. Requires 1/2 h.p. motor to drive at 700/900 r.p.m. Original List Price £15.

BARGAIN PRICE **£8/12/6** Or 9 Monthly Payments of **20/8**

Carr. & Pkg. 7/3 Gt. Britain. 1/2 H.P. 230/250v. A.C. Electric Motor. Pulley and Belt £8/9/3 extra. Carr. 8/6. Fully Motorised Unit £16/17/6. Carr. 12/-.

### COMBINED PLANER & SAW BENCH

PLANER. Circular cutter block with two steel blades mounted in ball-bearings. Tables independently adjustable by screw for rise and fall on inclined ways. Adjustable fence. 4in. cutters. Length 15in.

SAW BENCH ATTACHMENT. 7in. saw blade fits on extension of cutter block. Table 11in. x 9in. fits over planer, with provision for tilt, rise and fall. 2in. cut. Two-step vee pulley, approx. 1 1/2in., 2 1/2in. diam.

BARGAIN PRICE **13 GNS.** 32/6 COMPLETE

Years for 9 Monthly Payments of Carr. & Pkg. outside our van area. 7/3 Gt. Britain. Planer only, £9/10.



GAMAGES · HOLBORN · LONDON · E.C.1 HOLBORN 8484





**A**MONG the various fishes that give good sport during the winter the chub is high on the list. It is a lusty hard-fighting fish in prime condition in December until March.

There are rivers well attractive to chub-anglers, streams that seem adaptable to the chub's habits. They thrive and grow fat under favourable conditions. Some rivers are famed for their specimen fish. We have the Hampshire Avon, for instance, in which the record chub was taken weighing 8 lbs. 4 ozs. Many specimens of 5 lbs. have also been recorded. The Thames is another good chub river, which has yielded fish up to 7 lbs. The Kennet, Severn, Wye, Dorset Stour, Great Ouse, and the Trent, to mention but a few rivers, are noted for their chub. Indeed, the angler has not far to travel in any direction where 'coarse' fishing streams abound, in order to find a bit of interesting 'chubbing'.

Why winter for catching these fish? For one thing they haunt the deeper parts of a stream, though not all the time. But it is not unusual to find chub in 4ft. to 6ft. of water. Sometimes in winter you need to fish at a depth of 12ft. to 14ft. and more when chub are lying in a deep hole.

#### Tackle and baits

Best spots for chub include hollow banks, near willow-trees whose roots grow in the water; in eddies and slacks; in back-waters; near bridges; at the confluence of a tributary stream if there is a deepish eddy at the end of a 'scour'; also weir-pools are good places, and in stretches bordered by alders and willows. In such spots chub collect in small shoals; for they are 'homing' fish. Sometimes you will find them in compact companies in a nose-to-tail queue, the bigger fish at the head of the shoal, and the lesser to the rear.

For tackle you need a three-joint light cane rod of from 10ft. to 12ft. long, with greenheart top, bridge rings and the usual reel fittings, a 'Nottingham' reel or similar type, an undressed silk line and a 6in. quill float. The cast can be of nylon 3x strength, and the hook a No. 8 crystal. The cast is shotted, so that

only the tip of the float shows above the surface. Plumb the depth and permit the bait to swim about two-thirds or so of the depth of the hole you intend to fish.

Baits for winter include maggots, a knob of old cheese or cheese paste, live minnows, red worms, and when the river is high and coloured by rain, the tail-end of a lobworm is worth trying.

Let your line travel freely down the 'swim' with no drag or stoppages; you can do this direct from the reel, or you can pay out the line with your left hand, checking the float gently as it rides along, so that the baited hook is gradually in front of the float. This affords a better chance of getting the hook home into



the fish's mouth, when the time comes.

Let the bait reach a point as distant as is convenient to control, then gently withdraw it and recast until all the available water has been fished. It may take a dozen or more 'swims' to do this; but by such methods you will, doubtless, find the place where the fish are located. Then continue to exploit the area, ground-baiting a little all the time. If worm is used as bait, a few small worms thrown in from time to time will keep chub roving around on the watch for more, and so attract them to your baited hook.

#### Ledgering

A likely ground-bait also consists of stale bread well soaked, with mashed potatoes, all well kneaded together and moulded into small balls, which are cast into the 'swim' from time to time, one or two being ample at a time.

Besides float-fishing, ledgering is often successful for taking chub. The tackle

## GOOD SPORT WITH CHUB

By A. Sharp

consists of a 1yd. length of gut or nylon of medium strength, with a running lead nipped on the line some 20ins. above the No. 8 hook. To maintain this lead or bullet in position, a split-shot may be pinched on the line on either side of it; these shots to be about 9ins. apart.

#### Identification

During winter, baits need not be as varied and numerous as in summer, when such tempting tit-bits as fruits, grubs, bluebottle flies, wasp grubs, live insects as crane flies, etc., may be used with effect. In winter stick to maggot, worms, cheese, small live minnows, and small spinners. Chub are fond of such

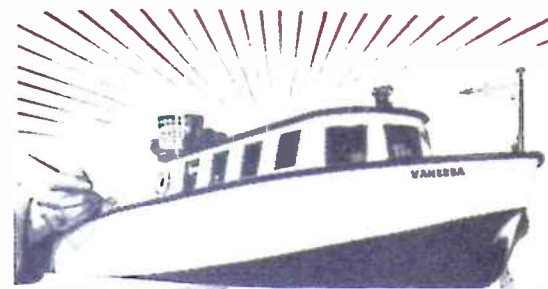

Top class modelmakers choose  
**VALSPAR**  
2-4 Hour  
LACQUER · VARNISH · WOODSTAIN



The model illustrated above obtained two first prizes in our recent Exhibition at Huddersfield due mainly to the finish which is Valspar Lacquer...

it's easy to see the reason why

They put the finishing touches to your hours of patience providing a brilliant smooth finish on any surface.

Valspar Lacquer requires no knotting, priming or undercoating and one coat gives an excellent result on a smooth non-absorbent surface.

\* PROOF AGAINST BOILING WATER, PETROL, OIL, ALCOHOL, ETC. \* DRIES IN 2-4 HOURS

GOODLASS, WALL & CO. LTD.  
179/185 (AC12) Gt. Portland St. London W.1  
Please send me a free copy of the Valspar Handbook giving full details of how to use Valspar paints

NAME .....  
BLOCK CAPITALS  
ADDRESS .....

## 3 important questions

for technically-minded boys under 17

New R.A.F. missiles now in production! A Jetliner fighter carrying Firestreak air-to-air missiles—fitted with infra-red homing system.



Where can I land a really interesting job?"

A technician's career in the Royal Air Force puts you right at the forefront of scientific developments. Missiles, electronics and radar, as well as jet aircraft, are all top priority in to-day's R.A.F.

"What about prospects—and pay?"

This obvious importance of the R.A.F.'s technical side means big new opportunities for Ground Staff. If you're keen, promotion comes quickly. Pay is good—and more of your money stays in your pocket, because you haven't the living expenses of 'civvy street'.

"How do I start?" By joining the R.A.F. now between 15 and 17, as an Aircraft Apprentice. And if you're not technically minded, you have equally good prospects as an Administrative Apprentice. Send the coupon for details! AIRCRAFT APPRENTICES for Aircraft, Armament, Radio or Electrical & Instrument Engineering. ADMINISTRATIVE APPRENTICES for Supply or Accounting & Secretarial duties.

### R.A.F. Apprentice Scheme

for boys 15 to 17

To: R.A.F. (H.S. 74), VICTORY HOUSE, LONDON, W.C.2. Form not over 17. Please send me full details of the Apprenticeship Scheme.

NAME .....

ADDRESS .....

Date of Birth .....

(Applicants from British Isles only)

Post this before Dec. 31—or you may be too late for the next entry —If you're too young for the R.A.F.—join the Air Training Corps!—

# Clean as a whistle!

**TRIX**  
**x-acto**

**HANDICRAFT KNIVES with interchangeable blades**

From wood to paper, from plastic sheeting to lino—Trix X-acto knives, gouges and routers cut through them as clean as a whistle. Knives cost 1/6 to 7/- Extra blades from 6d each. Fill in coupon for free leaflet.

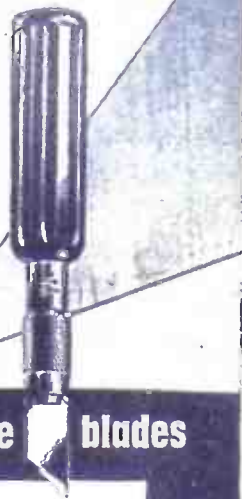

Please send me free copy of leaflet illustrating Trix X-acto Knives and Tools.

NAME \_\_\_\_\_

ADDRESS \_\_\_\_\_

H3/12

TRIX LTD., 5 Conduit Street, London W.1.  
One of the Ewart Holdings Group of Companies

Tib. 40

**GENUINE Swiss Musical Movements.** The best and largest selection of tunes in the country; lowest prices 16/3 each. Genuine Thorens Movements, 22/9 each. All guaranteed. P & P 9d. extra on all orders.—Richardson & Forder, H.W., 5 Chapel Place, White Hart Lane, London, N.17.

**STAMPS FREE** — Empire Packet including Pictorials and Victorians with approvals. — Robert J. Peck, 7A Kemp Road, Bournemouth.

**100 DIFFERENT stamps free!** Request 1d. upwards discount approvals. — Bush, 53 Newlyn Way, Parkstone, Dorset.

**MAKE A MUSICAL BOX** for as little as 12/6. New kits and tunes available. Movements 14/9 post free. Please send 3d. stamp for free illustrated catalogue. — The Swisscross Co., Dept. B., 116 Winifred Road, Coulsdon, Surrey.

**WHEELS** (Hardwood and Rubber Tyred Metal). Cot, Pram and Doll's House Fittings and Papers. Beads, Transfers, Prints and other accessories. Stamp for new lists. (Trade supplied.) New address — JOYDEN CO., 91 Peplins Way, Brookmans Park, Herts.

**LEARN** it as you do it — we provide practical equipment combined with instruction in Radio, Television, Electricity, Mechanics, Chemistry, Photography, etc. — Write for full details to E.M.I. Institutes, Dept. HW47, London, W.4.

**MODELS.** You can make lasting stone-hard models with Sankey's Pyruma Plastic Cement. Supplied in tins by Ironmongers, Hardwaremen and Builders' Merchants. Ask for instruction leaflet.

**FREE stamp album and 20 stamps.** Request approvals, enclosing 4d. Additional gifts given. — Beeze, 8 Langland Villas, Mumbles, Swansea.

**BECOME** trained chiropodist. Quick postal practical. — GRADUATE SCHOOLS, 48a Abbey Street, Accrington.

**'PAINTSPRAYING' HANDBOOK.** Covers Car, Industrial & Flock Spraying. 3/6, post 4d. Catalogue of our Cellulose and Paints and all Allied Sundries 3d. — Leonard Brooks Ltd., 81 Oak Road, Harold Wood, Essex.

**KUKLOS ANNUAL.** Indispensable cyclist's handbook. Tours, resthouses, money-saving hints, 3/-, post free. — Burrow, Publishers, 2 Imperial House, Cheltenham.

**15/6 CRYSTAL RADIO kit.** Easy-to-build with only a screwdriver and pliers. Post free — send 15/6 P.O. ALSO — 1 and 2 valve kits, headphones, etc. — send stamped addressed envelope for complete list to — Blanchard's Radio, Dept. HC7, 13 Gainford Gardens, Manchester, 10.

**110 STAMPS FREE,** valued 10/-. Request approvals. — Westlake, West Park, Clavton, Holsworthy, Devon.

**NEW CZECHOSLOVAKIA Sports Set.** All large fascinating pictorials. Smashing free gift for approval applicants enclosing 3d. postage. — Yulwontmor Stamps (Dept. H6), 29 Layton Avenue, Mansfield, Notts.

**WE DISPLAY** for sale all hand-made arts and crafts. S.A.E. please. — Box No. 32, *Hobbies Weekly*, Dereham, Norfolk.

**The GLOW BOW**  
Sensational Novelty!  
Plus 9d. **6/6**  
Post. Pkg.  
Bow lights up from concealed on/off switch. All Wires concealed, works from battery obtainable anywhere  
**MONTROSE PRODUCTS** (Dept. H.W.3) 623/7 Holloway Road, London, N.19

**REAL RADIO**  
de luxe Crystal Set  
Without phones **20/-**  
Inc. phones 31/-  
Real Radio Reception — Not a Toy!  
Phones essential. Ideal Bedrooms, Invalids, Private listening. No Electricity, No Batteries. Works anywhere 4" x 2" x 4". + 2/- P.P. C.O.D. ex.

**HEAR ALL CONTINENTS**  
With **H.A.C. Short-Wave Receivers**  
Suppliers for over 18 years of Radio S-W Receivers of quality.  
**One-Valve Kit, Price 25/-** **Two-Valve Kit, Price 50/-**  
Improved designs with Denco coils. All kits complete with all components, accessories and full instructions. Before ordering, call and inspect a demonstration receiver, or send stamped addressed envelope for descriptive catalogue.  
**'H.A.C.' Short-Wave Products** (Dept. 22), 11 Old Bond Street, London, W.1

Exercises for the fretsaw

## ANIMAL CUT-OUTS

**I**N TENDED primarily for decorating various boxes for trinkets, cigarettes, studs, collars or handkerchiefs, these cut-outs are also useful for beginners as an exercise in fret-cutting.

The shapes should be traced and transferred to wood by means of carbon paper. The wood should be 1/4 in. plywood or fretwood.

The interior frets are drilled with a fretwork drill and cut out first. The outlines are then carefully cut and cleaned up.

The animals such as the horse and dog can be made to stand up as toys if they are inserted in Hobbies No. 48 1/4 in. grooved moulding.

The cut-outs may be painted in natural colours or left as plain silhouettes. (M.p.)

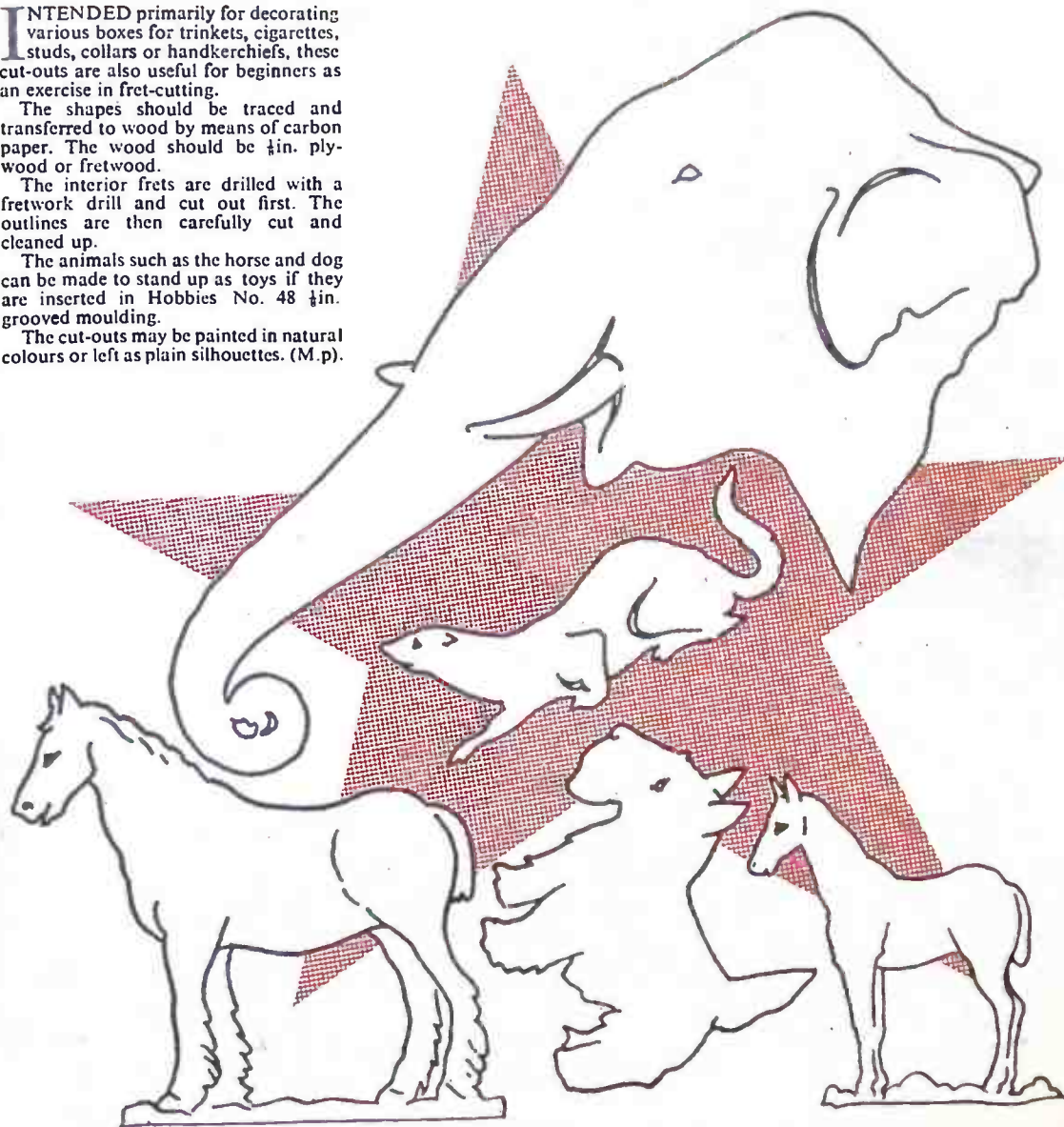

175

Printed by **BALDING & MANSSELL, LTD.**, London and Wisbech, and Published for the Proprietors, **HOBBIES LTD.**, by **HORACE MARSHALL & SON, LTD.**, Temple House, Tallis Street, E.C.4. Sole Agents for Australia and New Zealand: **Gordon & Gotch (A'asia) Ltd.** For South Africa: **Central News Agency Ltd.** Registered for transmission by Canadian Magazine Post.



# makes you an expert... *easily!*

It's not difficult to be an expert with the BRITFIX/HUMBROL combination... tried to the qualities which the Handyman needs... tested to the requirements of the do-it-yourself man. And—more than ever—produced to give that 'professional' look... That's the way with H.O.C.—you can see-it-yourself when you do-it-yourself!

## FOR WORKING IN WOOD OR PLASTICS . . . .

**Humbrol Art Oil Enamel,** a 4-hour lacquer enamel which dries with a brilliant finish. Is most suitable for the handyman about the house, being ideal for touching up all decorative household and workshop utensils.



**BRITFIX TISSUE PASTE.** A specially prepared paste for aeroplane tissue providing exceptional adhesion and non-staining qualities.



**BRITFIX CEMENT.** The finest all-purpose adhesive made. Transparent, water and heat proof, BRITFIX CEMENT combines rapid drying with the utmost tenacity.

**BRITFIX PLASTIC POLYSTYRENE CEMENT.** A high quality polystyrene adhesive, combining quick drying with excellent adhesion. An ideal companion to Enamel



**BRITFIX COLOUR DOPES,** fast drying, clean and bright, smooth and easy to work with.



**HUMBROL INTERMIXABLE PAINTING KIT.** Humbrol Art Oil Enamel Kit-6 intermixable colours in capsule form. An economical method of application for the Handicraft Worker.



# *the choice of the expert!*

Send to-day for FREE Humbrol Colour Card.

THE HUMBER OIL CO. LTD., MARFLEET, HULL.