

# HOBBIES WEEKLY

IN THIS ISSUE

	Page
Drummer Electric Lamp . . . . .	417
'Phoney' Photographs and Competition . . . . .	419
A Tea-cloth Tidy . . . . .	420
Settee Side Table . . . . .	420
Chemistry in the Home . . . . .	421
Securing Maximum Volume . . . . .	422
Finishing 'Sesqui' . . . . .	424
Storing Your Negatives . . . . .	426
Figure Drawing Made Easy . . . . .	428
Patterns for Tea-cloth Tidy . . . . .	431



MARCH 27th 1957

VOL. 123

NUMBER 3204

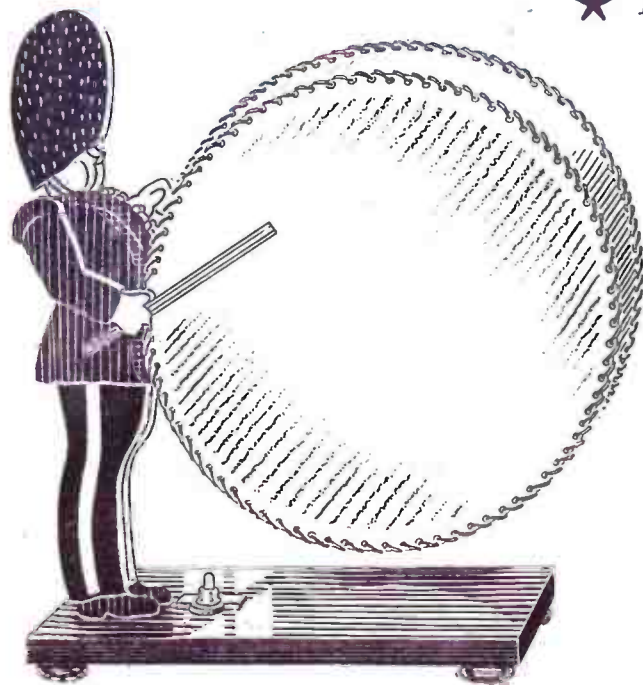

A NOVEL AND APPEALING DESIGN WHICH  
ADDS CHARM TO ANY SETTING IN THE HOME

## ★ FREE Design to make **DRUMMER ELECTRIC LAMP**

**T**HIS electric lamp in the shape of a guardsman drummer in which illumination comes through the big bass drum makes a very novel design and is particularly suitable for televiewing or for the bedroom. Children will certainly appreciate its guardsman theme. The woodwork is quite easily cut out with a fretsaw and assembled, and women members of the household could help with the thonging for the lamp shade, which is of Crinoline and gives an excellent subdued light. It is not advisable to use a bulb larger than 40 watts.

Hobbies kit includes all the necessary materials for making, including Crinoline, and all the electrical equipment, which provides for an on-off switch.

Make a start by tracing off the parts from the design sheet and transferring them to the various thicknesses of wood by means of carbon paper. Cut out all parts with a fretsaw and clean them up thoroughly with glasspaper.

All correspondence should be addressed to The Editor, Hobbies Weekly, Dereham, Norfolk

For Modellers, Fretworkers  
and Home Craftsmen

World Radio History

4½<sup>D</sup>

PAGE 417

The first step in the assembly is with the pieces forming the drummer. The front view in Fig. 1 shows the relative positions of the numbered pieces. It will be seen that the centre pieces 2 and 3 are shaped and positioned so as to leave a space between them through which the electric flex goes. Glue pieces 2 and 3 to piece 1 in the positions indicated by dotted lines. Next glue pieces 7 on either side of the face and pieces 8 on either side of the busby, as seen in Figs. 1 and 2. To complete the as-

sembly of the guardsman, glue piece 4 to pieces 2 and 3 as shown in Fig. 3. Figs. 4 and 5 show the construction of the piece to which the bulb holder is fixed. Note that the nipple of the bulb holder is screwed to piece 10. Fig. 3 shows how this assembly is fixed to the drummer by gluing and screwing. Now leave the figure and make up the shade. Use plastic-covered wire for the framework, taking the dimensions from Fig. 6. First make one complete circle of wire of 9ins. diameter, overlapping the

ends and binding with thread. The other piece of framing is almost a circle less the 2ins. gap as indicated. The ends are bent across to the other circle and the two are bound together.

### GET A HOBBIES KIT

Kit No. 3204 contains all the materials necessary for making this charming 'Drummer' Electric Light, including wood, electrical equipment, Crinothene, wire, thonging, etc. Obtainable from branches or post free from Hobbies Ltd., Dereham, Norfolk, price 24/1.

Three pieces of Crinothene are needed — two circles of 9ins. diameter and a 6ins. wide strip about 28ins. long to go almost round the circumference of the frame, leaving off at the gap. Punch equidistant holes all round the Crinothene edges with a leather punch if available, and lace the plastic thonging as shown in Fig. 6, making sure that the thonging goes under the wire each time. If no leather punch is available, a bodkin can be used quite effectively for the lacing. The ends of the thonging are knotted off. The space now left in the strip of Crinothene is for insertion of the lamp holder.

Place the lampshade over the bulb and holder and secure it at the back in piece 10 by means of a small roundhead screw. This screw is removable when the shade has to be taken off in order to change the bulb and for wiring up.

Now bore the hand of piece 6 to take the 1/4in. drumstick, and glue both arms in position on the drummer.

If it is thought necessary to shape the drummer, the shade will have to be removed, but the figure will look quite satisfactory if left in sharp silhouette outline. At this stage the drummer and stand can be painted with colours of individual choice.

When the paint is completely dry, glue the guardsman in the slot provided in the base, and complete the wiring. Note from the wiring diagram in Fig. 7 that one lead is broken at the switch and continues from there to the bulb holder. Remove the cap from the switch and place piece 14 in position. After replacing the cap, the body of the switch is placed in the hole provided in the base and piece 14 is glued and screwed to the top of the base. After fixing the ends to the lamp holder, bind the two leads securely together under the base and fix them by a staple, so as to allow no movement on the lead. This will prevent a direct pull on the switch connections. Throughout the wiring, of course, no bare wires should be left exposed.

To finish off, glue toes under each corner of the base.

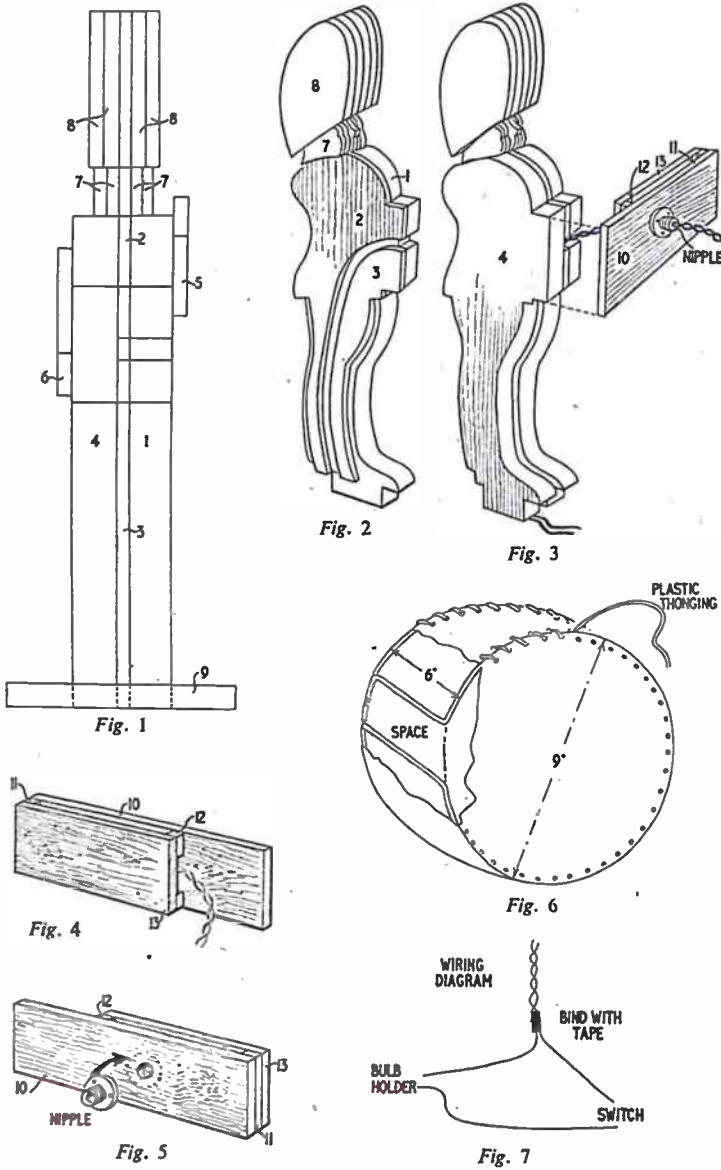

## Our competition subject

# 'PHONEY' PHOTOGRAPHS

**T**HE camera cannot lie. Once upon a time this statement may have been correct, but now the camera certainly can lie, and misrepresent.

One popular form of misrepresentation is that known as 'table-top' photography. In this, small objects are arranged on a table top to represent their larger counterparts when photographed. Possibly the reason for its popularity is because the result does not solely depend upon camera skill. The building and arrangement of scenes has to be carefully thought out.

\*\*\*\*\*  
 \* March 29th is the last day for receiving entries in our February \*  
 \* competition. There will be another \*  
 \* prize competition next month. \*  
 \*\*\*\*\*

While the scenes can be either comical or serious, the sizes of the objects used must be taken into account. In comic scenes, for example a mouse chasing a cat, out of scale animals could improve the required effect. But for serious scenes, such as cars crashing over cliffs

or army displays, then all the objects must be to scale.

Toys are ideal subjects around which to build a scene. Cuddly toys, toy animals, toy vehicles, farmyard animals and equipment, small china ornaments and, perhaps, the favourite — army equipment, can all be used to a good effect.

Much of the background material need not be faked. This includes when used, earth, twigs, rocks and water. Many of the requirements needed to complete the scene though need a deal of thought. So, salt can be used for snow and towelling for grass. Seeking these substitutes and experimenting with them provides a lot of the interest to be found in this type of photography.

Lighting, too, needs careful study. A spotlight is useful, but a torch beam will give a similar result. Floodlights and the ordinary domestic bulb again produce all the different shadows as required. Candle-lighting is often difficult, but well worth trying.

Quite often a background cloth can be dispensed with, but when needed, a painted cloth, sheet of cardboard or hardboard will always achieve the proper effect.

## Watches and Pens as Prizes

**T**HE competition this month is to submit a 'table-top' photograph. Any objects may be used and the originality and skill of subject arrangement will be taken into account by the judges when making their final decision. Lightly print on the back of the photograph all materials and objects that have been used.

There are two sections — one for Seniors (16 and over) and one for Juniors (15 and under). A watch, as in previous competitions, will be awarded to the winner of each section and ball-point pens will be awarded for the six next best entries in each section.

### RULES

1. Entries must be received by the Competition Editor, *Hobbies Weekly*, Dereham, Norfolk, by April 30th and cannot be returned.
2. Winners will be notified and prizes despatched by May 15th. Details will be published in a subsequent issue of *Hobbies Weekly*, and we reserve the right to publish any entry.
3. The name, address and age of the competitor must accompany the entry.
4. An entry must be the unaided effort of the competitor. All entries for the Junior Section *must* be accompanied by the certificate below, or a similar declaration on plain paper, signed by a parent, otherwise the work cannot be considered.
5. Because of Customs regulations and the necessity to adhere to a definite closing date, entries are confined to those from Great Britain and Northern Ireland.
6. The judges' decision is final and no correspondence can be entered into.

## A Tea-cloth Tidy

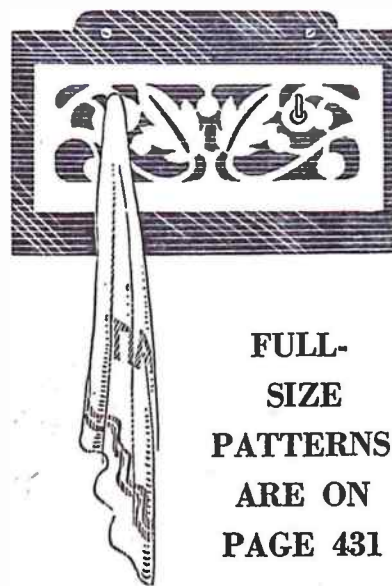

**M**OTHER will be pleased if you make her this neat and attractive tidy for her tea-cloths. Just two pieces of fretwood are sufficient and it only takes a short time to cut them out and glue them together.

Mother will be pleased with this decorative fitment for the kitchen

FULL-SIZE PATTERNS ARE ON PAGE 431

Piece (A) is 1/4in. thick and piece (B) 1/2in. Drill the openings in piece (B) and cut them out first, then cut round the outline. Clean up with glasspaper and glue the two pieces together. Do not use too much glue or it will squeeze out round the edges. Give two or three coats of brush polish. If you like you can lightly glasspaper between coats. This treatment will give an attractive golden finish. Two cup hooks are screwed in place to hold the tea-cloths, and the rack itself is screwed to the wall using Rawl-plugs if necessary. (M.p.)

### CERTIFICATE (for Juniors)

The entry is the unaided work of \_\_\_\_\_ aged \_\_\_\_\_  
 Signed \_\_\_\_\_  
 Relationship \_\_\_\_\_  
 Address \_\_\_\_\_



# SETTEE SIDE-TABLE

THIS is an unusual design for a small table to stand beside the arm of a settee. Its shape conveys the impression that it is part of the settee rather than an independent item. Overall form of the finished table is quite simple — Fig. 1. The well rounded 'feet' carry legs at one end only. Adequate support for the table top is given

(1in. by ½in. strip). The former is to be preferred from the point of view of appearance. The top braces are cut from ½in. ply and fasten directly to the top of the legs. The feet, of ½in. ply or solid stock (preferred) can be marked out from the pattern given in Fig. 3.

The method of assembly differs according to whether round or rectangular section legs are used. In the case of rectangular section legs the braces and feet are attached to the inside of each leg, as shown in Fig. 4. Fasten with woodscrews inserted from the inside. These joints should also be glued for rigidity. The dowel rail is glued

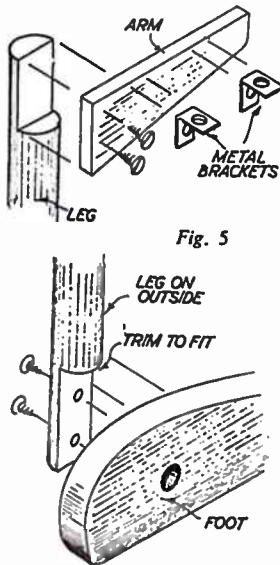
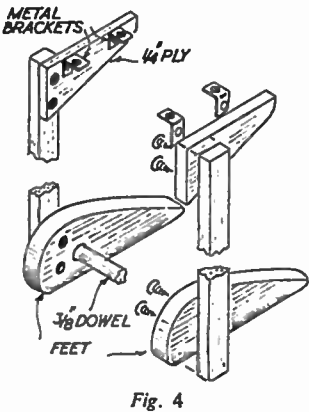
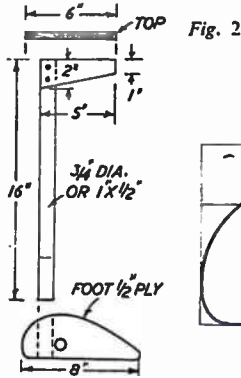
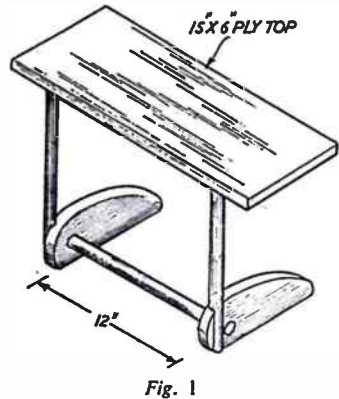

by braces, these being largely hidden from view. The size of the table — both width and height — can be adjusted to match individual settees, so check first that the dimensions given do fit your requirements. If not, adjust them accordingly.

The top is a rectangular panel cut from ½in. ply, with the edges slightly rounded by glasspapering and finished perfectly smooth all over. The leg assembly is shown in Fig. 2. The leg itself can be circular in section (½in. diameter dowel stock) or rectangular

between the feet to give rigidity to the bottom of the assembly.

With circular section legs, top and bottom lengths of each leg must be half lapped, as shown in Fig. 5. These half laps are first cut square and then trimmed — at the top to take the

By R. H. Warring

bottom taper of the brace and at the bottom to match the rounding of the foot. Aim for a perfect joint line. When satisfied, attach brace and foot to each leg with screws as before. Again, the leg should come on the outside.

Metal brackets are attached to the braces with woodscrews. Meccano brackets are ideal, or similar brackets can readily be drilled and bent from thin sheet metal. These brackets enable

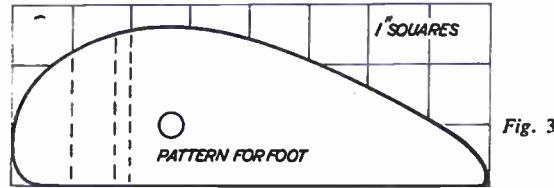

the top to be attached to the rest of the assembly with woodscrews from the underside, thus leaving the top surface of the table entirely unmarked. This is particularly helpful in getting a perfect finished appearance when veneer faced ply is used for the top. For a painted table the top could be screwed through directly to the braces (when no brackets are needed), the holes filled and covered with the paint finish. An interesting alternative form of construction is to use metal (e.g., duralumin) tubes for the legs which can then be reduced to ½in. diameter. Support the walls of the tubing at the half lap joints with carved blocks of wood of semi-circular section and fit brace and foot to each leg with screws, as before. Metal legs, if used, should be highly polished.

## A FORMULA FOR POLYVINYL GLUE

Ingredients are:—methylated spirit and two or more ounces of polyvinyl acetate. Warm the meths. by standing the vessel in hot water and dissolve the polyvinyl acetate therein. If intended for flexible joints, the addition of ½ ounce of tricresyl phosphate is advantageous.

# CHEMISTRY IN THE HOME

TO embark on a series of experiments with silver nitrate may sound an expensive proposition. This is not so. By using about 1 gram for each experiment the cost will turn out no more than by using the larger quantities worked with in the case of other chemicals. Further, the solution of silver nitrate stocked by laboratory furnishers catering for students is sold at very moderate rates, and this may be used for some of the experiments.

Foreign silver coins afford another cheap source of silver nitrate. If you have any of these, you may like to prepare the substance for yourself. First dilute some strong nitric acid by stirring it into an equal volume of water. Take care with the strong acid. If you get any on your hands, wash it off at once with water. Place the coins in a beaker and pour on some of the acid.

## Beware of fumes

Effervescence starts and brown fumes are given off. These are injurious if breathed in any quantity, so place the beaker in the open air in a safe place. Copper will almost certainly be alloyed with the silver to give it hardness. Accordingly, instead of obtaining, as the coin dissolves, a colourless solution of silver nitrate, we have a blue solution containing both copper and silver nitrates. We shall see how to separate the copper from the silver presently.

In the meantime, take note when the effervescence stops. If there is still undissolved metal in the liquid, add more acid. Repeat this until the metal has all dissolved. Then filter the solution.

To separate the silver from the copper, add table salt (sodium chloride) solution. A white precipitate of silver chloride appears. Copper chloride, being soluble, remains in solution. When further addition of table salt solution gives no increase of the precipitate, filter off the silver chloride and wash it well with hot water in the filter.

Put the sludge of silver chloride in a beaker, add a little dilute sulphuric acid and drop in a piece of sheet zinc. The silver chloride immediately starts to blacken near the zinc, being converted into metallic silver. Soon the entire mass is black.

Remove the zinc and wash the silver by decantation with several lots of hot water, until one wash water is no longer acid — proved by its not causing blue litmus paper to become red.

This silver powder may now be converted into silver nitrate by putting it in a beaker and adding small quantities of strong nitric-acid diluted with an equal bulk of water. When the metal has dissolved, filter the solution from any black flocks (which consist of impurities from the zinc) and boil the solution to dryness in an evaporating basin, when you will obtain a white mass of silver nitrate.

If you left your silver chloride exposed to light for long, you will have noticed that it began to turn a lavender shade, then darkened still further. So silver chloride is sensitive to light — as are many other silver salts. Here we have the principle of photography. Starting with just the chemicals in your own

## Silver Nitrate Experiments Part 1

piece of black lace serves very well. Working in candle-light still, place this on the treated surface of the paper and put the whole in a printing frame or between two sheets of glass held together with rubber bands, as shown in the diagram. Bring the whole into daylight and leave exposed until the parts of the paper which are not covered by the lace darken no more.

Again working in candle-light, remove the paper. You will see a perfect reproduction of the lace in white on a near-black background. The white area contains unaltered silver chloride. If the picture is to be permanent it must be removed. Otherwise, exposure to daylight will cause it to assume the same dark colour of the background.

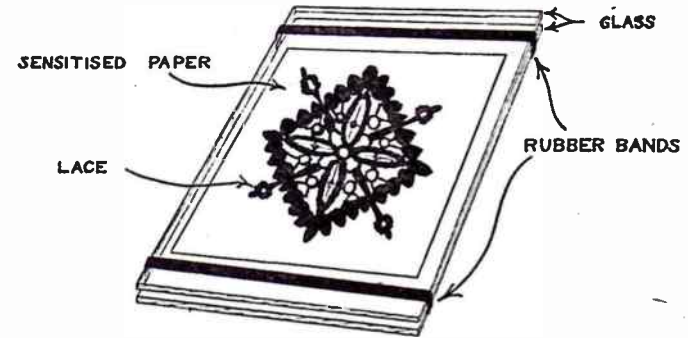

An impromptu printing frame

laboratory, it is most interesting to go farther into this principle. You do not need a camera.

First you will need to prepare some sensitised paper. This is quite simple. Pour into a plate a solution of 1 gram of ammonium chloride in 50 c.c. of water. Onto this carefully lower a piece of drawing paper, centre first, corners last, so as to avoid trapping air bubbles. Let the paper float for about five minutes. then pin it up to dry.

## Photographic image

The next stage must be done in very dim light, preferably in candle-light. Float the paper — its ammonium chloride treated surface undermost — on a solution of 2 grams of silver nitrate in 25 c.c. of water for three minutes. Then pin up the paper to dry in the dark.

Now to take a photographic image. A

Silver chloride is soluble in sodium thiosulphate solution ('hypo'). Therefore by washing the paper with this solution, we can make the image permanent. Dip the paper in plain water first, and then soak it in a solution of 20 grams of sodium thiosulphate in 100 c.c. of water for ten minutes. As no toning process has been used, the dark area will become reddish-brown, but this is of no consequence for our purpose.

Remove the paper and leave it in running water for an hour, or soak it in several changes of water. The photograph may then be pinned up to dry. This simple process can, of course, be used also for many interesting purposes. For example, taking prints of leaves, silhouettes, insect wings, and so forth.

Silver is not the only metal to give a white precipitate when a soluble chloride

Continued on page 423



# Securing Maximum Volume

CRYSTAL receivers are built and used in quite large numbers, their popularity, doubtless, depending upon low cost, and the fact that no mains or battery supplies are required. Some constructors are very satisfied with results, while others are somewhat disappointed because volume is too low for comfortable listening. In view of this it is worth while considering here how loud results may be achieved, and what errors may cause weak reception.

Though a crystal set is an extremely simple piece of apparatus, every component plays an important part. Crystal sets cannot amplify (as valve sets do), so it is essential to make the most efficient use of the signal, and to secure as powerful a signal as possible, in the first place. A poor crystal set, in difficult circumstances, may be so weak that listening with it is a strain. On the other hand, a good crystal set, properly used,

the station sounded, as against noting down a meter reading.

## Aerials

Though enough volume may be had from a good indoor wire, an outdoor aerial will always give louder results. Fig. 2 shows a typical aerial and earth system, and will help to clarify the points mentioned.

By F. G. Rayer

With a given length of aerial, signals will be loudest when the wire is as high as possible, well insulated at suspension points, and as far as can be arranged from roofs, trees and other earthed objects. It is often possible to extend the aerial over the lawn or garden, perhaps, using a tree, etc., to support the distant

and tied, so that both aerial and down lead are in one piece. The use of wire between the insulators and house or mast is not recommended, as cord is better.

If the down lead is kept well away from the building, it will pick up more signals, instead of losing some of the signal obtained from the aerial. The top of the lead should be at least 2ft. from the wall if possible. To avoid losses, the lead-in should be well insulated, a lead-in tube being best.

## Earth Connection

A good earth greatly helps reception, and the earth lead should not be unnecessarily long. If the set is near a window, the earth lead can go straight through this outside, this will do well.

The earth itself is some metal object actually in contact with the ground, preferably in a damp spot. Spikes may be purchased to drive into the ground.

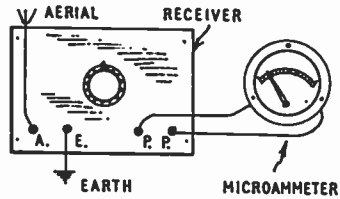

Fig. 1—Measuring the signal strength

can give such an output that every word is clearly audible with the phones lain on the table, or even the other side of the room.

## Output Testing

When careful tests are being made, to obtain maximum possible volume, it is very helpful to measure the output from the crystal set. The signal obtained is of such a nature that this can be done by means of a sensitive moving-coil meter wired to the phone terminals as shown in Fig. 1, the phones being disconnected. Any improvement to aerial, earth, or receiver will then be shown by the pointer of the meter moving farther across the scale. The best type of meter is that requiring about 100 to 250 microamps for full-scale reading. These are occasionally obtainable at low cost from ex-service stores, being used in some aircraft instruments.

If this method is not to be employed, then the various steps necessary to obtain best volume may be taken, and the improvement noted by the louder signals heard. The main difficulty here is that of trying to remember how loud

end. At the house, the simplest method is to put a cord out of the top of a bedroom window. If a staple or hook can be fitted up by the eaves, or to a chimney, so much the better. The aerial need not be horizontal, the aim being to get it well clear of all other objects.

The usual wire consisting of 7 strands of 22 S.W.G. (7/22) is very good for both aerial and earth leads. The length will usually depend upon circumstances, and between about 40ft. and 75ft. for aerial and down lead will be satisfactory. The longer the aerial, the stronger the signal received.

One or two aerial insulators are used at suspension points. To avoid joints, a single length of wire (say, a 60ft. coil) can be threaded through one insulator,

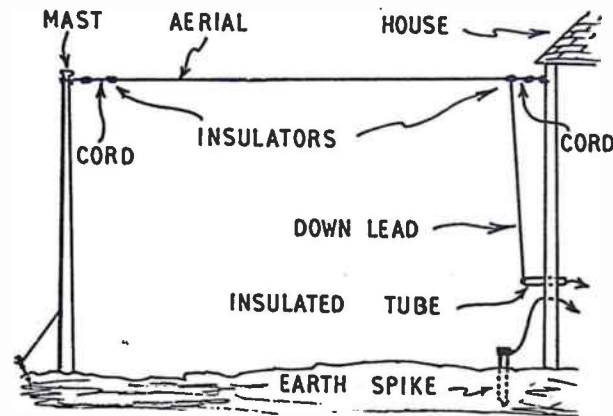

Fig. 2—Aerial and earth system

Or the lead may be soldered to a fairly large piece of metal sheet or netting, buried in the soil. With the latter method, metals which soon rust away are best avoided.

Sometimes a descending main water pipe can be used. The connection should be secured to the pipe by means of an earthing clip. Gas pipes should not be used, nor hot water pipes or other pipes only reaching earth by a roundabout route.

When circumstances permit, a length of copper wire may be buried 1ft. to 2ft. deep, for earth. With a lawn, the wire can be put 6ins. to 12ins. deep, in wet weather, by cutting a vertical slit with a spade, not removing any turf, and pushing the wire down into it.

Assuming a good signal has been obtained, proper use must be made of it. First, this requires an efficient tuning system. An air-spaced variable condenser is best, the solid dielectric type being avoided unless space is important.

The coil also needs to be efficient. This means that it must not be wound with very thin wire, and the former or tube should have good insulation. The various coverings do not much affect results, except that enamelled wire is best if damp is likely, as it does not absorb moisture like cotton. The windings should not be varnished, painted or waxed, as this reduces insulation. Nor should there be shorted turns, which absorb energy.

The efficiency of various coils will be easily seen if they are connected up, a station tuned in, and the meter reading noted. The meter indicates the rectified radio-frequency wave, and is not influenced by the audio signal being carried. This avoids any possible confusion if spoken items are followed by loud music, or so on.

The most efficient coils of all are wound with Litz wire, which has many strands of thin wire forming the single conductor. When they are of good design, the modern type of coil with a dust iron core is also very satisfactory.

## The Detector

The signal developed across the tuning coil has to be changed into an audible signal, and the detector accomplishes this. Its efficiency considerably influences volume. It may be a fixed 'crystal diode', or have adjustable crystals, or a crystal and cat's whisker. All these give similar results when in good order.

The bare type of crystal should not be handled with the fingers. If dusty or greasy, a new surface can be found by cracking the crystal with pincers. Crystal diodes should not be heated by soldering. Old ex-service detectors or manufacturers' rejects are also best avoided, as likely to give weak reception.

With adjustable detectors, the whisker or smaller crystal should be withdrawn, the arm moved, and the whisker or crystal gently placed into contact with the main crystal. Moving the search arm at random is likely to damage the crystals, so that no sensitive spots remain. The type of detector with two crystals is particularly likely to be spoiled by moving the smaller crystal about without first lifting it by pulling out the plunger or arm.

If volume is poor, and no other fault is suspected, it is often worth while trying a detector known to be in proper working order.

## Headphones

With a given signal coming from the receiver, the volume will depend upon the efficiency of the headphones. A sig-

nal amply loud with good phones may be a mere whisper with poor phones.

Most to be avoided are the low-impedance ex-service phones which are really intended for other purposes. These were made to give powerful results from valve amplifiers and receivers, and are often very poor performers with the relatively weak signals from a crystal set.

☆☆☆☆☆☆☆☆☆☆☆☆☆☆☆☆  
 ☆ Next week, F. G. Rayer will de-☆  
 ☆ scribe a simple and efficient crystal☆  
 ☆ set which can be accommodated in☆  
 ☆ a matchbox. There will also be a☆  
 ☆ large pattern showing how to make☆  
 ☆ Easter novelties for children and☆  
 ☆ many other interesting projects. ☆  
 ☆☆☆☆☆☆☆☆☆☆☆☆☆☆☆☆☆

If such low-impedance phones are in hand, they can be used with fair success if the correct impedance matching transformer is added in circuit. But even then, volume will not equal that obtained with phones of more suitable type. There is also the difficulty that so many low impedances exist, each requiring its special transformer, that the transformer obtained may not be the best one. Unfortunately several suppliers of items for crystal sets provide such phones, and they are best avoided when maximum volume is wanted.

The correct type of headphone has a resistance of between 500 and 4,000 ohms, the diaphragm being very near the magnet poles.

● Continued from page 421

# Silver Nitrate Experiments

is added to a solution of one of its salts. Mercury and lead do so. Consequently, it is useful to know a simple way of distinguishing them from each other.

Take three test tubes. In one, put a few drops of silver nitrate solution; in the second, mercurous nitrate solution (caution, this is poisonous); and in the third, lead acetate solution. Note that all these salts are white in the solid state, and hence cannot be distinguished from each other by appearance.

Now add to each test tube a few drops of sodium chloride solution. A white precipitate forms in each case. Now add some ammonium hydroxide to each. The silver chloride dissolves to a colourless solution, the mercurous chloride blackens, but the lead chloride is unchanged.

An interesting compound of silver to prepare is silver oxide, for, oddly, this can be made to yield oxygen. Dissolve 1 gram of silver nitrate in about 5 c.c. of water. Add sodium hydroxide solution.

A characteristic of such phones is the fact that the very small magnetic gap (which causes their sensitivity) allows insufficient diaphragm movement with valve set equipment, so that a peculiar rattle develops. This will be absent from phones made for valve equipment, with a large gap. High-class phones designed for crystal sets should not, in fact, be used with valve equipment, without precautions, or they may be damaged.

Balanced armature and moving coil phones must also be mentioned, as they are often found among ex-service stock. Moving coil phones require a matching transformer. This may be difficult to obtain, as the transformer employed with moving-coil speakers is not very satisfactory.

The balanced armature types do not require a transformer, and can give quite good results when the windings are of fairly high impedance.

## Range

The power and distance of stations tuned in will also greatly influence volume. As a rough guide, really loud signals should be obtained up to 40 to 50 miles from a major B.B.C. station. Good volume is usually possible up to 100 miles or more, which means that there are few areas where satisfactory reception is impossible.

A person nearer a station will often find an indoor aerial sufficient. But the type of aerial described is best for longer distances, and some overseas stations should normally be audible after dark, with such an out-door wire.

A brown precipitate of silver oxide appears. When the further addition of sodium hydroxide produces no more precipitate, filter off the oxide and wash it well with hot water in the filter. By testing each wash water with red litmus paper you will note that however long you wash the oxide the water still reacts alkaline by turning the paper blue. This is not due to adhering sodium hydroxide still being washed out of the oxide, but to the fact that silver oxide is slightly soluble in water and then acts as if it were silver hydroxide, which, being a base, behaves like an alkali and blues red litmus paper.

Dry the oxide in the oven and then put a little of the brown powder in a small dry test tube. Heat this and insert a glowing wood spill so that the glowing end is near the heated oxide. The spill will burst into flame, showing the evolution of oxygen. When no more oxygen is given off a residue of silver powder remains.



# FINISHING 'SESQUI'



With the back rest in the single-seat position, the canoe becomes a comfortable single-seater which is easily controlled and paddled by one.

FIX canvas with  $\frac{1}{2}$  in. copper tacks. Support the framework upside-down and lay the hull canvas centrally over it. Drive two or three tacks into the bottom of one end post, then go to the other end and stretch well before tacking in the same way there. A good tension along the centre line is essential if the skin is to fit smoothly all over. Put more tacks at about 12 ins. intervals along the centre line, then turn the canoe the right way up.

Start near the middle and turn the canvas over the gunwale, then tack inside (Fig. 4). Pull tightly at right-angles to the keel always. Do about 1 ft. at each side in turn, tacking at

about 2 ins. intervals. Cut away over the frames and trim off the surplus as you go, working outwards towards the ends. If there is any tendency to pucker, pull hard up the centre of the crease. If the canvas is not wide enough to turn over the gunwales at the widest part of the canoe, it may be tacked outside the gunwales, and taken over as soon as the hull narrows sufficiently.

Towards the ends there will not be sufficient room to swing a hammer inside, and the tacks may be driven by squeezing with large pliers. At the ends the canvas has to be cut and wrapped around the end posts. Hold one side

against the end post and mark its shape with chalk, then cut about  $1\frac{1}{2}$  ins. outside it. Make darts in the edge so that the canvas will wrap without creasing (Fig. 5). Roughen the wood by scraping with a saw, then coat the wood and

☆☆☆☆☆☆☆☆☆☆☆☆☆☆☆☆☆☆☆☆  
 ☆ P. W. Blandford concludes instruc- ☆  
 ☆ tions for building PBK14, Mk2 which ☆  
 ☆ started in last week's issue. Copies ☆  
 ☆ available from the Editor (6d. post ☆  
 ☆ free). ☆  
 ☆☆☆☆☆☆☆☆☆☆☆☆☆☆☆☆☆☆☆☆☆

canvas with Bostik C or 252. Allow this about thirty minutes to dry, then press the parts together. Wrap the other side over in the same way.

Make the end caps from waste canvas. Shape the two sides to overlap on the end and leave sufficient at the top to go over the deck later. Fix the end caps, but leave the tops loose at this stage. Use tacks in the end overlap if necessary.

Taper the ends of the keel (H) and make the length sufficient to overlap the end caps. Paint the meeting surfaces of keel and canvas and screw the keel on while the paint is wet, using screws at about 12 ins. centres driven from inside. At the extreme ends screws will have to be driven from outside. A pair of bilge keels (I) should be made in a similar way and fixed to the next stringers out from the keel. They should be about the same length as the cockpit. If the canoe is likely to be used much in shallow water or dragged over pebbles, two more shorter bilge keels (J) should be fixed to the next stringers.

The deck canvas is stretched over, tacked at the ends and a few points around the gunwales, then at about 2 ins. intervals all round. The cockpit opening is cut out and the edge tacked to the coaming frames (Fig. 4). Stick down the ends and close over the end caps. Cover the canvas joint around the gunwale with a rubbing strip (K) screwed at about 6 ins. intervals.

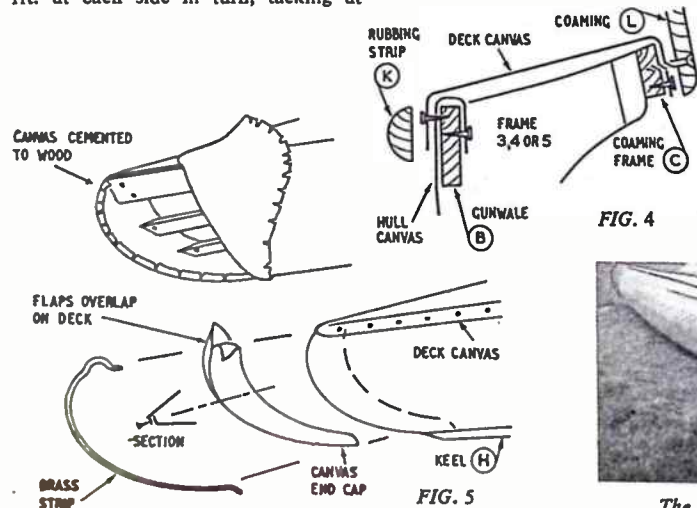
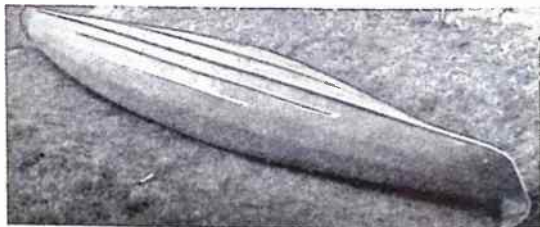

FIG. 4

FIG. 5



The keel and bilge keels fitted, viewed from aft.

Taper the coaming sides (L) from about 3 ins. forward to 2 ins. aft and round the top edge of the cockpit back. The coaming looks smartest if the point is cut to slope forward. Round all the exposed edges and screw to the coaming frames.

Back rests should be made to swing and should be shaped to fit the small of the back. The most comfortable type has two ash slats (Fig. 6) which have been given a slight curve. This is possible with ash. Soak the wood in boiling water for about ten minutes, then squeeze to shape in a vice and leave over night.

Make the two crossbars with wedges to hold the slats. For two-seater work the front back rest should be over frame 4, although it may be a little further forward for a light crew. For single-seater work it should be moved back to frame 5. Make the crossbar a suitable length for both positions. The back rests should be removable for ease in stowing kit. The rear back rest pivots on two stout screws, which have their heads cut off after driving. The brackets are drilled and bent from strip brass. The supports in both positions for the front crossbar are flat brass pieces

slotted to take the screw necks and held out from the coaming by wood packings.

Beginners will find it best to sit on the bottom boards, but after a little experience a seat up to 3 ins. high will be found to give a better paddling position.

Varnish the coaming and backrests. Paint the hull. Two coats of a marine or good household paint will do. A proofed canvas deck may be unpainted.

The paddles should be double-bladed 8 ft. long. It is difficult to make spoon-bladed paddles and professionally-made ones should be bought if possible. However, quite satisfactory straight-bladed ones may be made with ordinary hand tools (Fig. 7). Spruce is the best wood. Do not use a heavy wood. The paddle may be made in one piece, or jointed with a pair of telescopic brass tubes at left the centre.

Use  $1\frac{1}{2}$  ins. square wood and glue on pieces to make up the blade. Cut the

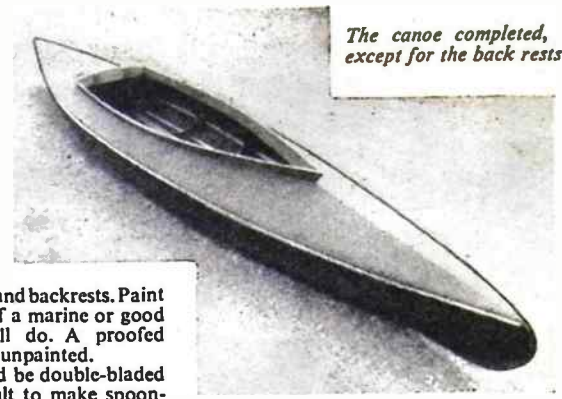

The canoe completed, except for the back rests.

outline with a coping saw and draw a centre line around the edge. Use this as a guide and taper the blade to about  $\frac{1}{4}$  in. thick with a ridge at the middle. Plane off the corners of the square loom and work it to round with glasspaper. The tip of the blade should be protected with thin copper folded over and tacked on. Give the paddle several coats of varnish.

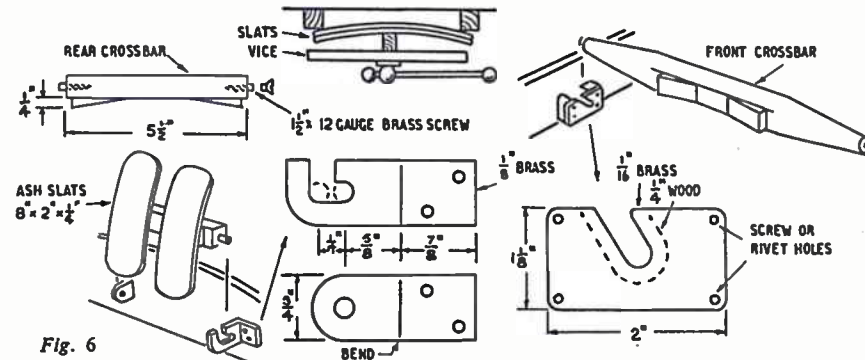

Fig. 6

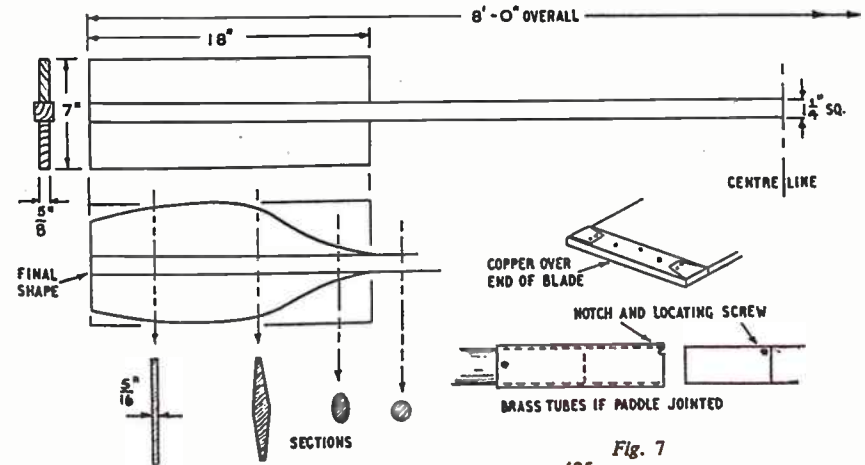

Fig. 7

## SESQUI (PBK14, Mk 2) FULL-SIZE DRAWINGS

The designer is the owner of the copyright in this canoe. Readers may build craft to this design for their own or club use, but anyone wishing to build for sale should first communicate with the designer.

Instructions given in this article are complete, but the work will be simplified if a set of plans is bought from Hobbies Ltd., Dereham, Norfolk; price 12s. 6d. These include full-size drawings of the frames and other shaped parts, etc., together with all other drawings and instructions, as well as instructions for making accessories, including sailing gear, trolley and spray covers.



An easy but efficient method

# STORING YOUR NEGATIVES

NEGATIVE storing is something of a problem to the amateur photographer. Putting together in a large envelope is bad, as they soon develop abrasion marks, and stored this way whole bundles have to be handled to find any given one.

Here, however, is a simply-made folder that at once satisfies most of the conditions of good storing (and filing). The negatives in it are well protected and each has a compartment to itself. Furthermore, any one can be selected straight from its division without

Now remove the negatives and with some care fold the sheet twice along its length as Fig. 2, so that a single negative will lie comfortably between the creases and the edges of the folded strips come higher than the centre point (Fig. 3). This means that more paper must be turned up at the bottom than is turned down at the top. Some care is needed in the folding, as it is harder than it might seem to crease accurately a length of paper, the lines of bending having a tendency to form a slight curve.

Next, with a discarded negative in

clearly seen. This labelling is useful when a number of folders are stored in a box or on a shelf, book fashion.

### Box for holding

A holding box is made up of two end pieces (A) Fig. 5, 4½ins. by 2½ins. by ¼in., side pieces (B) 8ins. by 2½ins. of ¼in. plywood and a base (C) 7½ins. by 4½ins. by ¼in. These are secured together with the ends overlapping the base and sides overlapping ends and base. Short screws are used, ¼in. (small gauge) for the ends and base, ½in. for the sides — two to

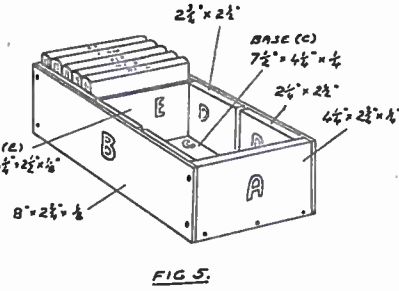
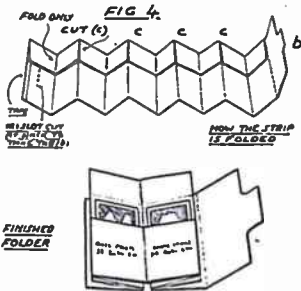
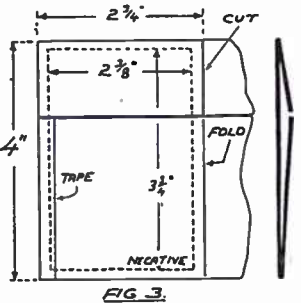
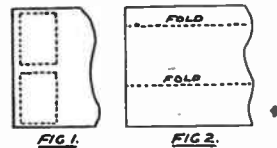

position to give the necessary width, fold across the strip as Fig. 3. Then fold again, but this time in the reverse direction. Continue so to the end of the piece which will leave it zig-zagged as in Fig. 4.

In the front fold make the slot (a) with a sharp blade and then trim the further end to a tab (b). This must be of such a shape and length that it will slip nicely into the slot and hold everything together in the same way that seaside sets of views are kept closed.

With the scissors still in hand, slit along every other fold on the upper turn-down as (c) and all is completed, bar giving the folder a good pressing under some heavy weight.

The negatives are inserted as indicated in the picture of the finished folder, one to each partition. Data can be written to go with each negative on the lower turn-up. As will be seen, the folder automatically opens in divisions which each reveal two negatives. When opened flat at any division the top strip of paper is turned up to extract the desired negative. After re-inserting, the flap is turned down again, thus eliminating all danger of the films slipping out or working too far up.

When the folder is closed and the tab in the far side slot, it will be found that sufficient thickness is produced on the upper edges to allow a few words describing the contents to be put on and

each seam. On the inner face of the side are the pieces (D), the outer being 2½ins. by 2½ins. and the middle ones 2½ins. by 2½ins. These are glued in position, leaving the ¼in. vertical channels between, as shown, in which the partition (E) 4½ins. by 2½ins. by ¼in. can be slipped for handiness in dealing with the folders. No lid is required for the box, as the negatives are already protected. (H.A.R.)

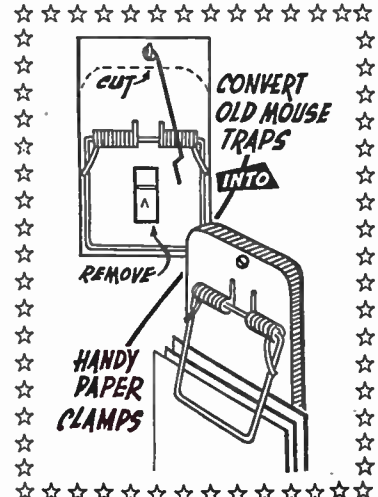

previous handling or having to handle any of the others. Space, too, is given in each compartment for recording the subject, exposure, type of material and other relevant details. Moreover, when the folder is opened, the tops of the negatives can be seen, which is a distinct advantage.

To make a folder for the 3½ins. by 2½ins. size to hold eight negatives, a strip of smooth drawing paper 8ins. by 22ins. is required — longer for more divisions. Any paper really will do, provided it is fairly thin and of a fine texture, so as not to present any roughness to the contents. The paper chosen should also be fairly tough and not easily torn or cracked.

Lay a piece out on a flat surface and if making for a negative size other than that mentioned, place two negatives in position as Fig. 1 to get the width of paper required. In all cases the width must be a little more than two negatives end to end.

# POPULAR KITS...

No. 3188

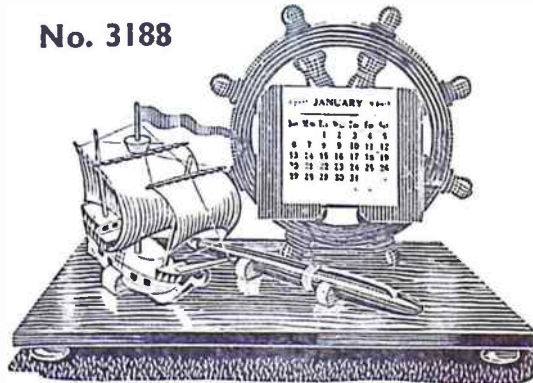

'Galleon' Perpetual Calendar with pen rack. Ideal for a desk. Kit includes wood, parchment, perpetual calendar set ... 5/- ...with novel appeal

No. 3184

## WEATHER HOUSE

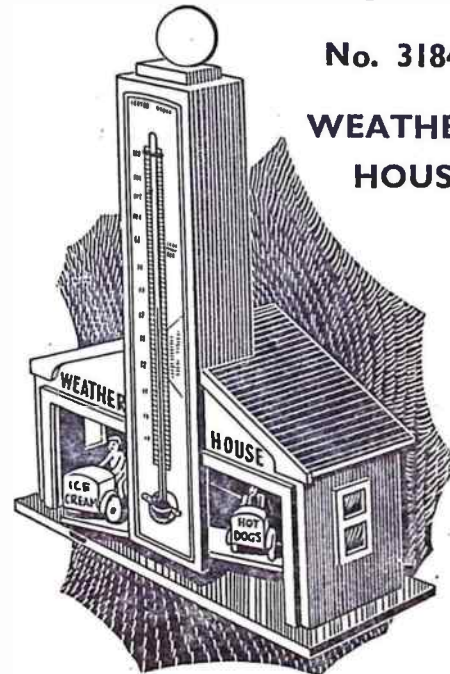

Foretells the weather ahead. Kit includes wood, gut, thermometer etc. ... 8/1  
Kits from branches or  
**HOBBIES LTD** (Dept) Dereham  
99 Norfolk

BUILD YOUR OWN FURNITURE WITH OUTFITS BY

*Wren Craft*

SAVE FIFTY POUNDS!!!

The WREN Contemporary Bedroom Suite of six pieces for

£52-15-0

AVERAGE SHOP PRICE £103-16-0

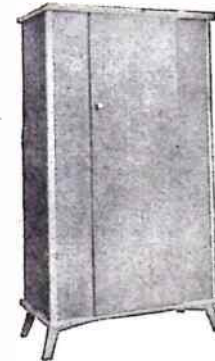

ALL THE PARTS ARE FULLY MACHINED WITH SATIN-SMOOTH FINISH, YOU ONLY HAVE TO USE THE GLUE THAT COMES WITH THE OUTFIT AND PRESS TOGETHER

we announce A NEW RANGE

- BOOKCASES with sliding glass doors or open front
- CORNER WRITING BUREAU
- END UNITS

All the pieces of this new range are designed for adapting to your own scheme or for use as free-standing pieces

FREE CATALOGUE

Post the coupon, or send a post card for the catalogue of 60 articles you can assemble

WREN CRAFT FURNITURE LTD  
Wellington Crescent, New Malden, Surrey  
Please send me FREE copy of catalogue

Name \_\_\_\_\_  
Address \_\_\_\_\_



For young artists

# Figure Drawing Made Easy

**D**RAWING is one of the most fascinating of all hobbies and almost everyone has tried his hand at it in some form or another. Many aspiring artists have expressed a desire to work on the human figure, but have soon given it up on account of the difficulty of the subject.

Have you not often wished that you could draw the human figure in action? Well, here is your chance to make a start, for this article has been devised for those who would like to explore that branch of art and it forms a most appropriate introduction to figure drawing. Because these skeleton drawings are spontaneous creations, they are full of action, and it is this fact that makes them so interesting.

We do not have to look far for subjects to sketch — they are around us every day and everywhere. We pass them in the street and meet them at work and play, and we can practise the art wherever we are.

The materials needed are few, quite cheap and easily obtainable; in fact drawing is one of the least expensive of all hobbies. For quick action sketches a B or 2B pencil will be found best, but this will depend to a certain extent on the type of paper used. The soft texture of the B range will flow over the paper in easy graceful lines which is the secret of good true-to-life figures. Try to obtain a free flowing action from the start and not a hard disjointed effect.

We have a wide range of paper to choose from and it is best to experiment with several kinds until you find one to suit your particular style. A sketching block or pad of paper is, undoubtedly, the most convenient form and these can be obtained from any good class art stores in a variety of sizes.

You may, however, prefer to make up the blocks yourself, and this is a very good idea, as you have a wider choice of paper and size. Good quality quarto typewriter paper is excellent, and if this is cut in half or even quarters, a very handy pad can be made. Put two or three dozen sheets of paper on to a stout piece of card fastening them at the top with a spring paper clip, or you can bind them together with two wire book staples pushed through and turned over on the back.

A pad of quarter size typewriter paper can be easily held in the hand and used for quick sketches in almost any place. Excellent scope is provided, for instance, at a football match or at a sports meeting where the human figure can be studied in an endless variety of poses. With a small pad you will generally be

able to work without much interruption from passers by.

At home these quick studies may be transferred to more permanent form by copying them in an album of good quality paper with a pen and ink. This can be a job for a rainy day or the long winter evenings.

Armed with paper and pencil we are ready to sally forth and try our hand at action sketches and by studying the illustrations on this page, you will form a good idea how to produce them. First then it is important even with these rough sketches to draw the figure in its proper proportions. Only in cartoon is it permissible to exaggerate certain features, but then it should not be overdone.

of the world with a light stride, (G) is tired and weary, and the absence of sharp angles adds to this impression.

More practice will, no doubt, be needed in sketching running figures like (H), as so little time is available in which to study the movements, but it pays to persevere with it. It will help if you copy the studies on the sports page of newspapers.

You will have plenty of time to draw grandpa (I) with his bent back and this contrasts greatly with youth (F).

Living near to the frock coated or legal area will bring you in touch with the gent with top hat and brief case (J), but these characters are becoming rarer each day. Likewise the immaculate youth meeting fair maid (K) is almost a

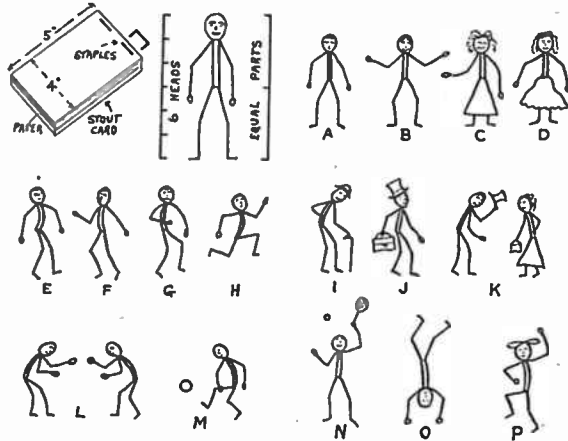

The human figure is  $5\frac{1}{2}$  to 6 heads high, and this varies slightly between male and female. There is, of course, a little difference between the various members of the race, as no two people are the same, but these figures are a fair average and will help you greatly. The length of the legs generally equals the length of body and head together, while the arms are a little shorter than the legs.

Several ordinary standing figures are given in (A) to (D), in which the female is depicted by adding a skirt and, perhaps, a wisp or two of hair. Quite a surprising amount of expression can be shown by just a few simple strokes, and a golden rule here is in the economy of line, keeping them down to a minimum.

Everyone walks in a different manner, and there is scope here for a lot of experimenting. While (F) seems on top

thing of the past, but they make excellent studies if you have the good luck to see them.

The many kinds of sport give us ample opportunity to sketch these quick action studies — boxing, football and tennis (L), (M) and (N) to mention only a few.

After a little preliminary experimenting you will find these skeleton sketches quite easy to do. They are extremely valuable in helping to develop your skill in figure drawing. Try adding flesh to the skeleton, then dress it up, and besides the practical help of this method, you will find it very amusing.

If you are unable to get out to obtain subjects to draw, here is a tip to help. By standing in front of a long mirror you can pose in almost any position, study the pose a few moments and then copy it from memory. (A.F.T.)

For wood, card, plastic, leather, metal, etc.

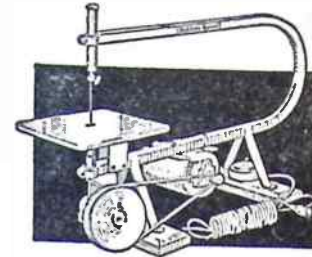

£12 - 5 - 0

## TREADLE OR MOTOR FRETSAWS

Whatever the handyman or craftsman is cutting or making, one of Hobbies Fretmachines will help with the job. For toy making, fretwork, model making, it provides easy and speedy cutting in all kinds of material. A pleasure to use, a factory for output, a lifetime of service.

Obtainable at any Hobbies Branch or good class ironmonger or hardware stores. Or carriage paid U.K. from:

£5 - 17 - 6

HOBBIES LTD., (Dept. 99), DEREHAM, NORFOLK

## NEW! THE PRACTICAL WAY of learning RADIO · TELEVISION · ELECTRONICS

AMATEURS · S.W. RADIO · MECHANICS · PHOTOGRAPHY · CARPENTRY, etc., etc.

**NEW**—Experimental outfits and lesson manuals sent on enrolment remain the student's property. Tutor allotted to each student for personal tuition throughout the course.

In radio and television courses, specially prepared components are supplied which teach the basic electronic circuits (amplifiers, oscillators, detectors, etc.) and lead by easy stages, to the complete design and servicing of modern radio and T.V. equipment.

**THESE PRACTICAL COURSES ARE IDEAL AND MAY BE YOURS FOR MODERATE COST**

Fill in the coupon to-day for a free Brochure. There is no obligation whatsoever.

Courses with equipment enable you to design, construct and service  
2-stage radio equipment  
3-stage T.R.F. circuits · Television equipment · Workshop Test Panel  
Oscilloscope · 5 valve 3-waveband superhet circuit

**SUBJECTS INCLUDE:—** Radio · Electronics · Television Equipment  
Mechanics · Chemistry · Photography · Electricity · Woodwork  
Electrical Wiring · Draughtsmanship · Art · Short Wave Radio  
Oscilloscope · also many other Home Study Courses without equipment.

<b>EMI INSTITUTES</b> <small>Associated with H.M.V., Marconi-phonos, etc., etc. The only Home Study College run by a World-wide industrial organisation.</small>	<b>COURSES FROM 15/- PER MONTH</b>	
	E.M.I. INSTITUTES, Dept. 31X, London W.4	
	NAME <input type="text"/>	
	ADDRESS <input type="text"/>	
Subject of interest <input type="text"/>		AGE <input type="text"/>
		(if under 21)
(We shall not worry you with callers) 27/3/57 1C85		

# There's an outfit or a mould in the

## Sculptorcraft

# range to brighten your home!

In the 17 complete outfits and 300 individual moulds which Sculptorcraft offers, there's a mould to enhance your own home surroundings. A Toby Jug... An Ash Tray... A Pirate Jug or maybe a Wall Plaque, all of which will blend in with your furnishings. Send stamped addressed envelope and complete the coupon below for full details.

Please send me, without obligation, your price list of moulds and outfits

Name

Address

SEAMER PRODUCTS (Sculptorcraft) LTD.  
23/27 EASTBOURNE STREET, HULL



Classified advertisements are accepted at a cost of 6d. per word prepaid. Send P.O. with advertisement to Advertisement Dept., Hobbies Weekly, Dereham, Norfolk

**GENUINE Swiss Musical Movements.** The best and largest selection of tunes in the country, lowest prices 16/3 each. Genuine Thorens Movements, 22/9 each. All guaranteed. P & P. 9d. extra on all orders. — Richardson & Forder, HW, 5 Chapel Place, White Hart Lane, London, N.17.

**WHEELS** (Hardwood and Rubber Tyred Metal), Cot, Pram and Doll's House Fittings and Papers, Beads, Transfers, Prints and other accessories. Stamp for new lists. (Trade supplied.) New address — JOYDEN CO., 91 Peplins Way, Brookmans Park, Herts.

To stamp collectors —  
**100 FLAGS (FREE)**

Printed in full colours, gummed and perforated just like stamps, these are ideal for illustrating your stamp album. Complete sheet of 100 different will be sent to you quite free if you enclose 2½d. stamp and ask for a selection of stamps on approval (without approval — 9d.)

Don't delay, rush your order to —  
G.E. MOAT (Dept. HF) 133 Beedell Ave., WESTCLIFF, Essex

**100 DIFFERENT stamps free!** Request 1d. upwards discount approvals. — Bush, 53 Newlyn Way, Parkstone, Dorset

**SWISS MUSICAL MOVEMENTS.** Before you buy send 3d. stamp for our illustrated brochure — Metwood Accessories (Dept. HW) Church St., Wolverton, Bucks. (Trade enquiries invited.)

**STAMPS FREE** — Empire Packet including Spictorials and Victorians with approvals. Robert J. Peck, 7A Kemp Road, Bournemouth.

**STOP SMOKING!!** Quick guaranteed remedy. Free testing sample!! — Triumph Remedies (H), Exeter.

**\* GREAT CAMPING OFFER \*  
RIDGE TENT SENT FOR 4/-**

**BRAND NEW de luxe 'Safety' Tent.** All colours Complete. Ideal cyclists, campers. Length 7' 3" sleeping base x 4' 6" w/de x 3' 6" high x 12" walls, all approx. Weight 3½ lb. Cash 55/-, or 4/- deposit and 6/- monthly, WITH FLYSHEET 83/6, or 9/3 deposit and 9/9 monthly. Both carriage 2/6. **LISTS OTHER EQUIPMENT, TENTS, CLOTHING, WATCHES, ETC., TERMS.**

**\* R.A.F. NEW WATERPROOF BACK PACKS \***  
One large FULLY ZIPPED Compartment. One ditto same size back to back, 4 Buttoned off separate side by side super imposed Pockets, 2 strong adjustable webbing backstraps with easy release press studs. Made of genuine R.A.F. 100 per cent. waterproof material, all brand new. Ideal for Motor Cyclists, Hikers, Fishermen and a 100 other uses. 4/11 only, post etc. 1/1. A fraction of original cost. Send immediately.

**HEADQUARTER & GENERAL SUPPLIES LTD.**  
(HOBW/52), 196-200 Coldharbour Lane Loughboro Junction, London, S.E.5  
Open all day Saturday. 1 p.m. Wednesday.

**MODELS.** You can make lasting stone-hard models with Sankey's Pyruma Plastic Cement. Supplied in tins by Ironmongers, Hardwaremen and Builders' Merchants. Ask for instruction leaflet.

**EARN** it as you do it — we provide practical equipment combined with instruction in Radio, Television, Electricity, Mechanics, Chemistry, Photography, etc. — Write for full details to E.M.I. Institutes, Dept. HW47, London, W.4.

**'PAINTSPRAYING' HANDBOOK.** Covers Car, Industrial & Flock Spraying. 3/6, post 4d. Catalogue of our Cellulose and Paints and all Allied Sundries 2½d. — Leonard Brooks Ltd., 81 Oak Road, Harold Wood, Essex.

**● DON'T MISS IT!**

The superb, novelty-packed  
**1957 GADGETS ANNUAL**  
**HOW TO MAKE** over 350 of the latest and cleverest gadgets and devices for home . . garden . . hobbies . . garage . . tools . . gifts . . puzzles . . novel inventions With patent spiral binding, and fully illust. The huge 1957 GADGETS ANNUAL only costs 10/- from POSTLIB PUBLICATIONS, Kingsbury, London NW 9

**KUKLOS ANNUAL.** Indispensable cyclist's handbook. Tours, resthouses, money-saving hints, 2/10, post free. — Burrow, Publishers, 2 Imperial House, Cheltenham.

**AMERICAN DELTAGRAM PUBLICATIONS.** Things to make on your 'Lathe', 'Band Saw', 'Scroll Saw', 'Circular Saw and Jointer', set of four books 10/- inc. postage. Year's subscription 'Deltagram' 12/6. Send for complete catalogue. — Wilton Ltd. (Dept. 57), 9 Drapers' Gardens, London, E.C.2.

**SMASHING FREE GIFT** — Czechoslovakia 1956 Trains Set to approval applicants enclosing postage. — Yulwontmor Stamps, (Dept. H5), 29 Layton Avenue, Mansfield.

**CHOOSE FREE STAMPS** from our modern approvals. Fine stamps — fair prices — MacStamps, 19 Crowell Road, Cowley, Oxford.

**Chemistry Experiments in your own laboratory**



WE CAN SUPPLY A WIDE RANGE OF **APPARATUS AND CHEMICALS**

Send 3d. Stamp for **PRICE LIST**

'EXPERIMENTS IN CHEMISTRY' 1/2 (post free)

**A. N. BECK & SONS** (Dept. H),

60 STOKE NEWINGTON HIGH STREET, LONDON, N.16

**WATCH AND CLOCK REPAIR OUTFIT**



The complete Outfit for cleaning and repairing. Comprises: illustrated explanatory booklet, eye-glass, tweezers, screwdrivers, oil, dusting powder, oilers, also illustrated catalogue, tools and materials.

**12/9**

Plus P. & P. 1/- extra. C.O.D. if required.

**21/-**

The above with additional luminous compounds, jewellers' rouge, dial brush, jewels. Plus P. & P. 1/- extra. C.O.D. if required.

**ASSEMBLE YOUR OWN JEWELLERY**

Selection of unset earrings, pendants, rings, brooches and stones, etc. at fraction of cost. Send S.A.E. now for big illustrated free catalogue. Money back guarantee.

**THE BOLSTER INSTRUMENT CO.** (Dept. HD7) GOVETT AVENUE, SHEPPERTON, MDDX.

**MAKE A RADIO**

**NO SOLDERING**—Only a screwdriver and pliers required. All kits complete with easy to follow building instructions.

**WINNER** crystal set, 12/6 post free.

**CONQUEROR** 1-valve set, 22/6; valve and batteries 15/6 extra.

**FREE!** Send stamped addressed envelope for complete list of 10 kits

**BLANCHARD'S RADIO**

(Dept. H6), 13 GAINFORD GARDENS, MANCHESTER, 10

**HEAR ALL CONTINENTS With H.A.C. Short-Wave Receivers**

Suppliers for over 18 years of Radio S-W Receivers of quality.

One-Valve Kit, Price 25/-

Two-Valve Kit, Price 50/-

Improved designs with Denco coils. All kits complete with all components, accessories and full instructions. Before ordering, call and inspect a demonstration receiver, or send stamped addressed envelope for descriptive catalogue.

H.A.C.' Short-Wave Products (Dept. 22), 11 Old Bend Street, London, W.1

**Is This Saw in Your Kit?**

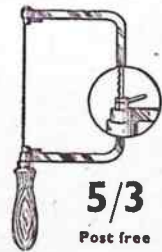

**5/3**

Post free

You can cut almost anything in wood with this Coping Saw. The blade is 6½ins. long and can be turned to cut at any angle. No tool-kit is complete without one. Get yours NOW.

Buy from any Hobbies Branch or post free from Hobbies Ltd., Dept. 99, Dereham, Norfolk

See page 419

**Patterns for Tea-cloth Tidy**

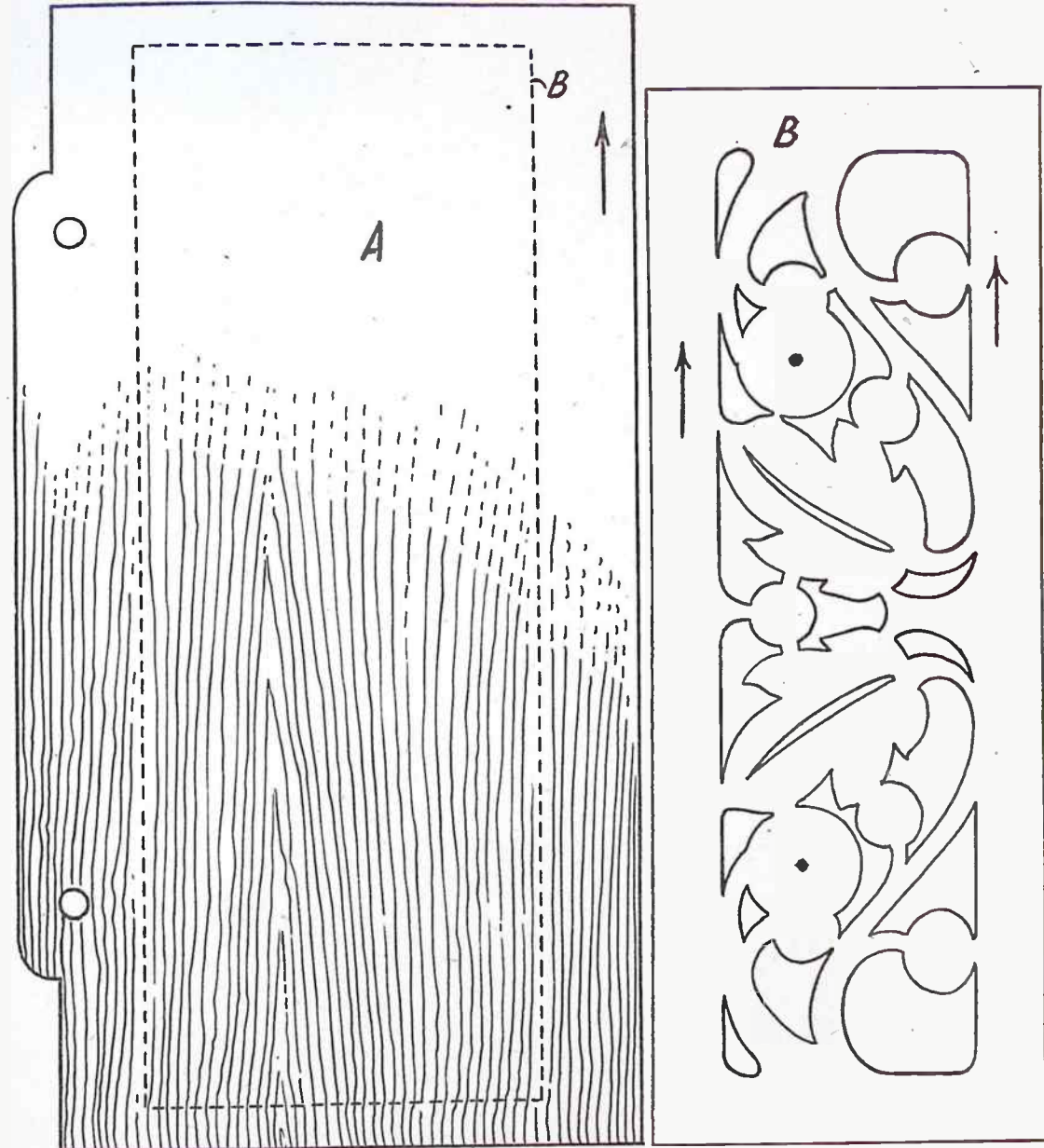

**AN INTERESTING PROJECT FOR FRETWORKERS**



# MADE THESE YET?

Kits from branches or  
**HOBBIES LTD. (Dept 99)**  
**DEREHAM, NORFOLK**

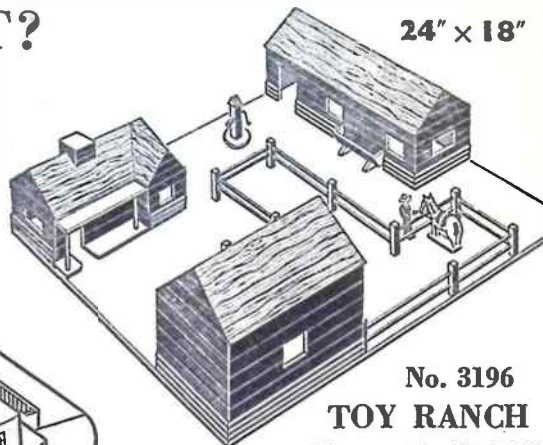
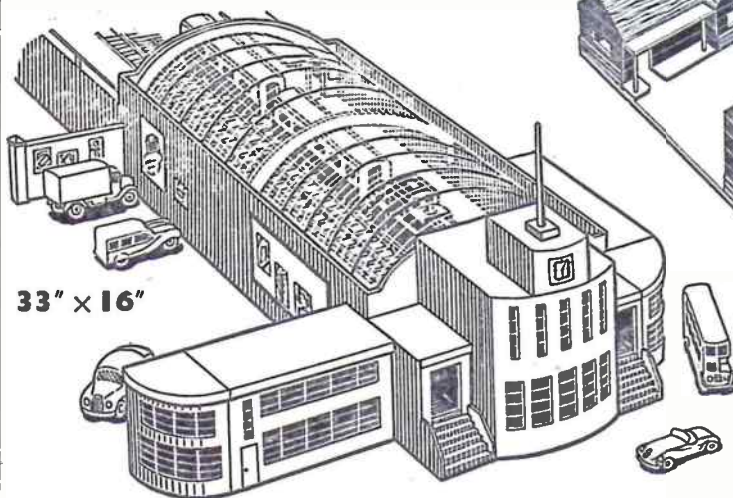

**No. 3196**  
**TOY RANCH**

All materials, Kit 13/6

\*\*\*\*\*  
 \* IT'S MUCH EASIER \*  
 \* WITH A KIT \*  
 \*\*\*\*\*

**No. 3190**  
**'OO' GAUGE STATION**

All wood, transparent material,  
 posters, etc. Kit 17/6

## BED-TRAY or BOOK-REST

Kit contains all  
 wood and fittings.

From branches:

- LONDON  
 78a New Oxford Street, W.C.1.  
 (Phone MUSEum 2975)
- 87 Old Broad Street, E.C.2  
 (LONDON Wall 4375)
- 81 Streatcham Hill, S.W.2  
 (TULse Hill 8794)
- GLASGOW—326 Argyle Street  
 (Phone CENtral 5042)
- MANCHESTER—10 Piccadilly  
 (Phone CENtral 1787)
- BIRMINGHAM—100a Dale End

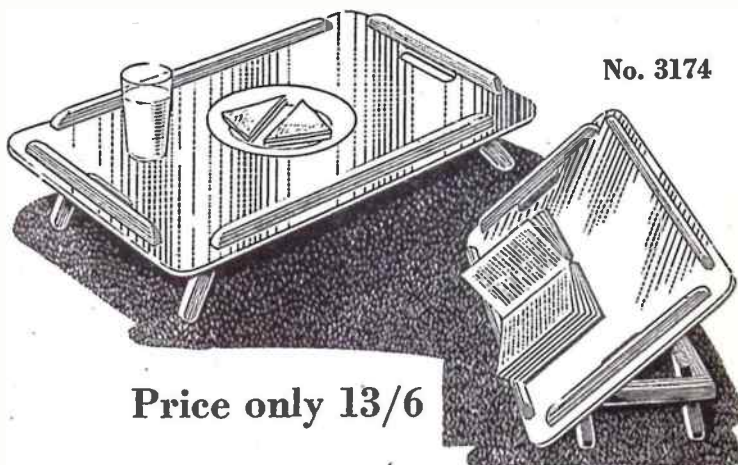

Price only 13/6

- SHEFFIELD—4 St. Paul's Parade  
 (Phone 26071)
- LEEDS—10 Queen Victoria Street  
 (Phone 28439)
- HULL—10 Paragon Square  
 (Phone 32959)

- SOUTHAMPTON—134 High St.  
 (Below Bar) Phone 25947
- BRISTOL—30 Narrow Wine Street  
 (Phone 23744)
- NEWCASTLE—42 Dean Street  
 Newcastle 1

or direct (post free)

**HOBBIES LTD (Dept 99) Dereham, Norfolk**



# THE DRUM ELECTRIC LAMP

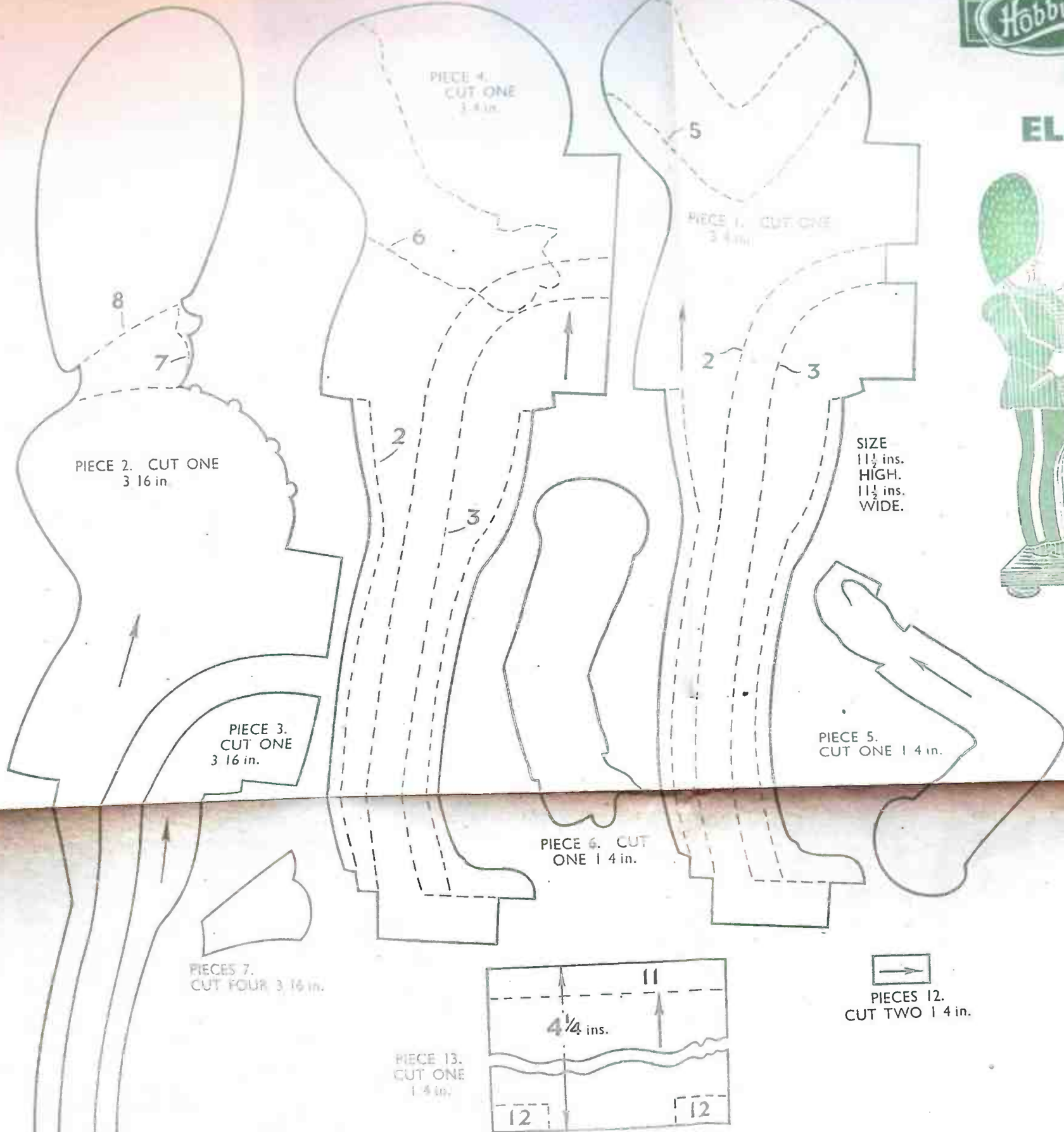

SIZE  
11 1/2 ins.  
HIGH.  
11 1/2 ins.  
WIDE.

A KIT OF MATERIALS FOR MAKING THIS DESIGN IS SUPPLIED BY HOBBIES LIMITED, DEREHAM, NORFOLK. PRICE ON APPLICATION.

*The Handy Paint in Tubes*

Starlon is perfect for touch-ups and small painting jobs. Quick drying. No brush marks. Brilliant finish. No waste—you squeeze out only the quantity required.

**Starlon**  
PLASTIC ENAMEL PAINT

Obtainable at Hobbies and other hobby shops.  
STARLINE · SOUTHEND · ESSEX

1/- PER TUBE

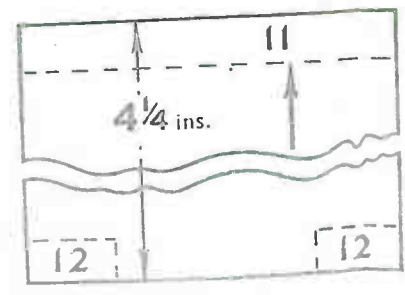

PIECES 12.  
CUT TWO 1 4 in.

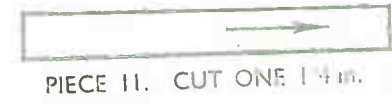

THE ARROWS INDICATE DIRECTION OF GRAIN OF WOOD.

BASE 9. CUT TO THIN LINE.  
CUT ONE 3 8 in.

PIECE 10. CUT TO THICK LINE.  
CUT ONE 1 4 in.

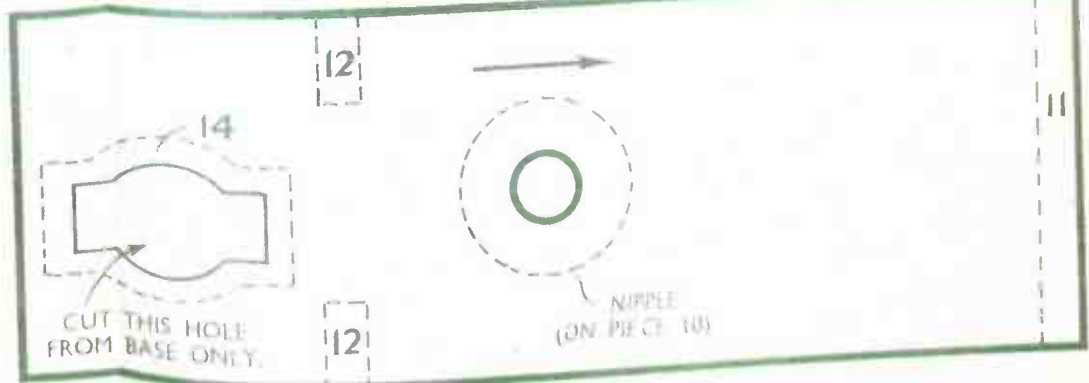
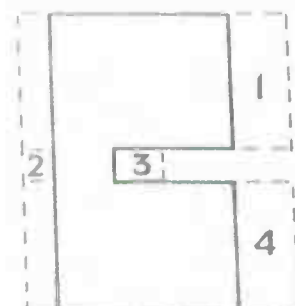

PIECES 8.  
CUT FOUR  
1 4 in.

