

HOBBIES WEEKLY

IN THIS ISSUE

	Page
Toboggan and Sledge	209
A Press for Wine Making	211
Mainly for Modellers	212
Make Your Batteries	213
Seven Woods in a Racket	213
Through Station Layouts	214
A Tidy for Gardeners	215
Original Jigsaw Puzzles	216
Hints on Keeping an Aquarium	217
Your Lens Apertures	218
The Chub is Worth Seeking	220
Dace are in Their Prime	220
Your Chance to Help the Birds	222
Patterns for An Adjustable Bevel	223



DECEMBER 26th 1956

VOL. 123

NUMBER 3191

Be ready
for revels
in the snow!

IT is no use waiting for snow to fall before you think of making a toboggan. By the time you have collected wood and materials and found time to start construction, the snow may have gone. It is wiser to be prepared, so that winter fun can be enjoyed when the opportunity arises.

A rough and ready construction might serve to give a certain amount of fun, but a toboggan or sledge properly constructed will be much faster and easier to manoeuvre. It will also last for many years if cleaned and painted before putting away at the end of the season.

Instructions to make TOBOGGAN

The choice of wood depends upon what is available. Much, too, depends on whether or not you have metal runners fitted. In the latter case the whole thing may be constructed from deal. In the absence of metal runners, however, it is advisable to make the sides from hardwood such as beech or oak. These woods will stand up to wear better than deal.

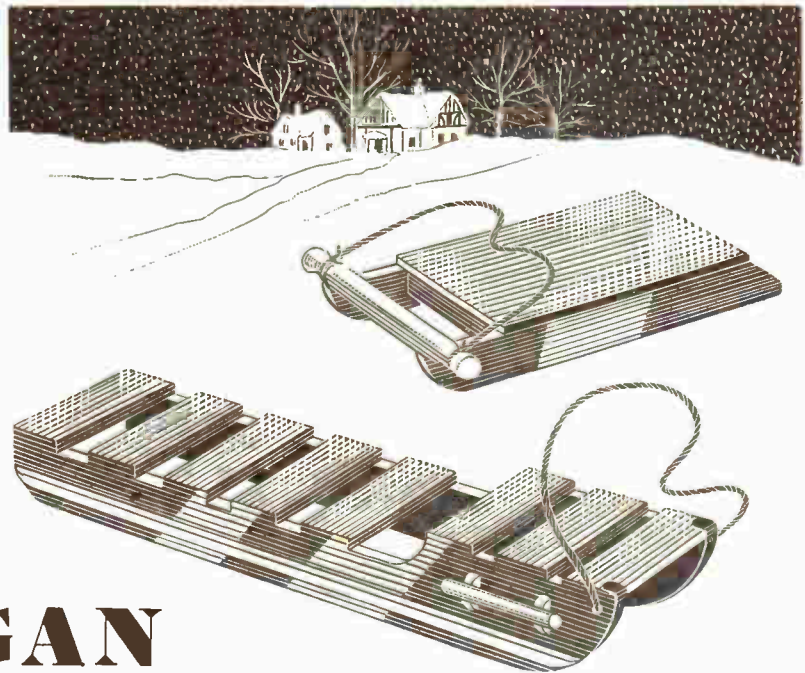

AND SLEDGE

We show two models in the illustration; one is large enough to take two or three adults sitting, and the other suitable for a single rider. The larger one has handgrips, at the front, which are

used when lying full length. Ropes are fitted on both models.

The construction of the larger one will be dealt with first. A side view is

● Continued on page 210

All correspondence should be addressed to The Editor, Hobbies Weekly, Dereham, Norfolk

For Modellers, Fretworkers
and Home Craftsmen

World Radio History

4 1/2^D

PAGE 209

DETAILS FOR MAKING THE TOBOGGAN

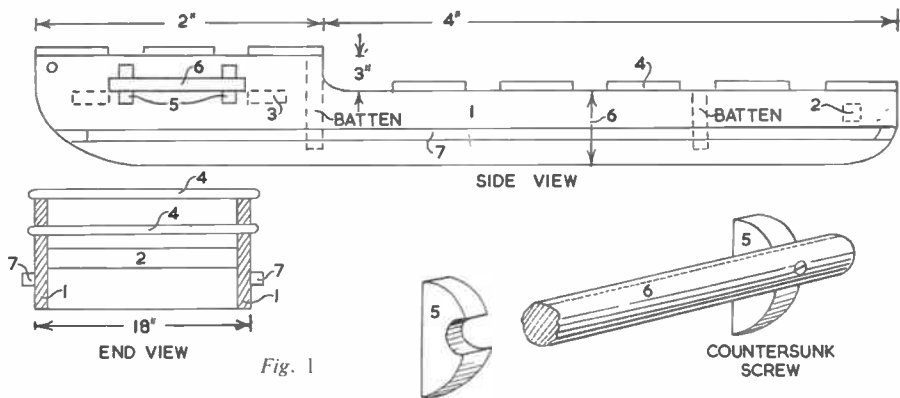

Fig. 1

shown in Fig. 1, and all necessary measurements are given. The two side pieces (1) are cut from 1in. thick wood and are joined together by piece 2 (1in. square wood) and two pieces 3 (3ins. by 1in. wood). Pieces 2 and 3 are 16ins. long. These pieces should be screwed to the sides using countersunk screws.

Seating consists of a number of boards (4) screwed in place as shown; they should be about 3ins. apart. Battens of wood to strengthen the sides about 1in. by ½in. may be screwed along the insides as shown by the dotted lines.

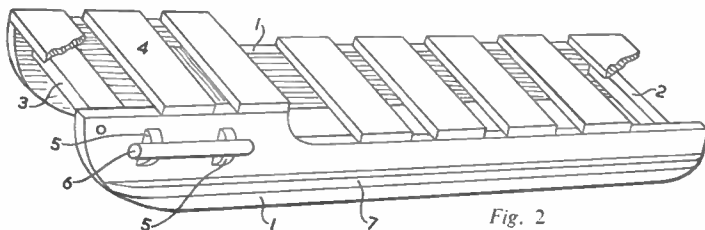

Fig. 2

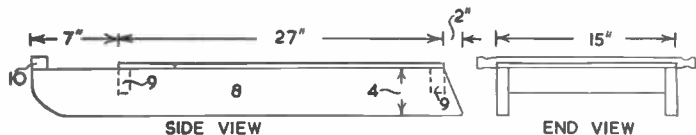

Fig. 3

SLEDGE

Fix a long strake (7) of 1in. square wood on the outside of each side, securing it with nails or screws. These strakes can act as footrests if necessary.

The handgrips are made from pieces of 1in. wood (5) and 12in. lengths of 1in. diameter round rod (6) as shown in the detail in Fig. 1. A cut-away diagram, Fig. 2, shows the general construction.

The whole toboggan is now painted, giving two or three coats if necessary. Pay particular attention to the end grain, where the paint soaks in quite a lot.

The last job is to fit the metal runners,

using ½in. by ½in. metal strip. It is not difficult to bend this cold, and to fit round the curves. Secure them by means of countersunk screws.

The smaller model is shown in Fig. 3. The side and end views give the main dimensions, while the other drawing shows the construction.

The sides (8) and braces (9) are cut from 1in. wood. Pieces 9 are 13ins. by 2ins., and the positions are shown by the dotted lines on the side view. The shaped piece (10) at the front is 19ins. long by 1in. square. It is cut away at the ends to receive the rope which is simply tied in position.

The seat consists of ½in. boards nailed to the sides (8) and the crosspieces (9). Finish off by painting and fitting metal runners as before. (M.h.)

★ Readers in Northumberland and the North-East will be pleased ★
★ to know that a HOBBIES BRANCH has been opened at ★
★ 42 DEAN STREET, NEWCASTLE 1 ★
★ All Hobbies tools, kits, designs, materials, etc. available. ★
★ Also large stocks of other well-known kit ranges for the ★
★ modeller and handyman. ★

★ A BRANCH OF HOBBIES LTD., DEREHAM ★
★ *****

A PRESS FOR WINE MAKING

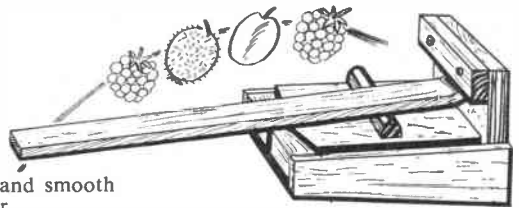

THERE are many methods of extracting the juice of fruit when preparing home-made wines, all of which have their good points. Some people pour boiling water over the fruit and let it stand for a time, while others prefer to boil the fruit and water together.

Pressing the juice out of the fruit, however, is the method which has been used for hundreds of years by a large number of wine producing countries, the grape being the fruit mostly employed.

By A. F. Taylor

On account of expense, grapes are not used much by the home-made wine producer, but there are many other fruits which may have their juice extracted with a press. All the soft kinds such as currants, gooseberries, blackberries, raspberries, plums and damsons are suitable. It is advisable, however, to cut the plums and damsons in half and remove the stones before pressing them.

Apples, pears and rhubarb, which are somewhat harder, should be cut up into small pieces before putting into the press.

For small quantities

The wine press described in this article has been designed to fulfil the requirements of the home wine maker who only makes up small quantities at a time. By keeping the dimensions down to a workable minimum, not only will it be more efficient but the pressure needed to extract the juice will also be quite low.

Good quality hardwood should be chosen for the job, and sycamore, being a clean white wood, is very suitable, although almost any clean close grained hardwood may be used. Cut the base first and build the press up around this board. In order that the juice may drain away, the board slopes from back to front, a difference of $\frac{1}{2}$ in. being quite sufficient.

A level baseboard may be used by putting a block under one end to tilt it, but it is much better to cut the base from a single block having the necessary slope. Make it 9 $\frac{1}{2}$ ins. long, 5ins. wide and 1 $\frac{1}{2}$ ins. thick at one end, tapering off to 1in. at the other.

It should not be difficult to cut this wedge shaped piece off with a saw,

afterwards planing it level and smooth and finishing with glasspaper.

Next cut and fit the end block, and as it holds the lever in position while pressure is applied, it must be robust and securely fixed. A piece 7ins. long, 5ins. wide and 1in. thick should be strong enough and is fixed with two long stout screws into the baseboard. If you use

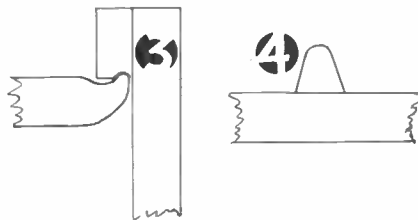
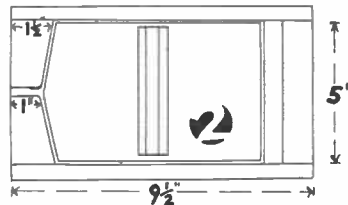
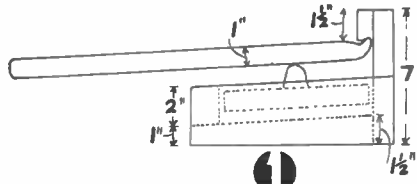

glue for extra security, it must be of the waterproof type.

Fixed along the top edge of this end block is a strip of wood which holds the lever end and is shown in detail in Fig. 3. It is 5ins. long, 1 $\frac{1}{2}$ ins. wide and $\frac{3}{4}$ in. thick, and needs two or three screws to fix it securely. A shallow groove is cut along the lower edge to hold the lever in position, and this need not be more than $\frac{3}{4}$ in. deep.

Further strength is given by the two side pieces which project 2ins. above the baseboard, but their real purpose is to form a tray to hold the fruit while it is being pressed. A thickness of $\frac{1}{2}$ in. should be sufficient, while the length is 10 $\frac{1}{2}$ ins. and the width 3 $\frac{1}{2}$ ins. at the back, tapering to 3ins. at the front.

To complete the tray two wedge shaped blocks are secured to the front of the base, leaving a gap of about $\frac{1}{2}$ in. for the juice to flow through. Fig. 2 shows

the shape and position, and they should be made the same height as the side pieces project above the base. Tapering from 1 $\frac{1}{2}$ ins. to 1in. at the centre will prevent the juice from collecting at the sides and enable it to drain away completely.

Make these to fit snugly at the sides and the same applies to the other end, so that there are no cracks for the juice to seep through.

The lid is just a flat block of wood 1in. thick cut to fit neatly inside the press, leaving a margin of not more than $\frac{1}{8}$ in. round the sides. The fulcrum is fixed across the centre (see Fig. 4), and this also acts as a handle for lifting out the block. Cut a length of 1in. square wood 4 $\frac{1}{2}$ ins. long, taper and round off the top as in Fig. 4, and fix in position with two brass screws. If the screws are inserted from underneath they must be filed off flush, but it is better, however, to fix them from the top.

The pressure lever is made from wood 1 $\frac{1}{2}$ ins. wide and 1in. thick, with its head shaped off as in Fig. 3. The length is determined by the amount of power needed to work the press. About 18ins. is a good length, but this may be increased to 21ins. or 24ins. It is not advisable to exceed this unless the entire press is made of somewhat thicker wood to withstand the extra power which will be applied.

Provided the press has been made of a good white hardwood, very little finishing will be needed after it has been well smoothed with glasspaper. It is an advantage, however, to give it either a light coat of varnish or of brush polish to help preserve it.

Some fruits may be used for making wine without adding any water. It is only the very juicy fruits which are best for this purpose, otherwise you will need such a large quantity that the cost will be much beyond the value of the wine produced. The finished produce, however, is a much superior drink, and it is a good idea to make a small quantity for special occasions.

In order to obtain the greatest amount of juice some fruits may be passed through the press twice or even three times. Well wash the press immediately after use, and well dry before putting it away, otherwise a mould is likely to form, and this might seriously affect the flavour of any future wines.

MAINLY *for* MODELLERS

IN making ship models much interest and pleasure can be had by adding details that may not be shown in our actual design. Many authentic details can be added because most kits are to a more or less degree made with simplified details, enabling even the beginner to make a good model. As we progress we feel the desire to improve on the details and, from this, we go on obtaining increased pleasure in our hobby and in the necessary research work to obtain these improvements.

One of the details that adds to the interest of our modelling and assists greatly when we come to the rigging, if added, are correct fife rails and fittings.

Fife rails are placed at the foot of the masts. They are about waist high, supported by strong stanchions and drilled to take belaying pins, to which the ropes from some of the rigging are belayed.

These fife rails differ in size and position, as it depends upon the particular mast and its rigging. A foremast and a mainmast may have fife rails extending around three sides, while the mizzen usually has only two short ones, either running fore and aft, or running across the ship and placed fore and aft.

Boxwood is ideal

For scale models boxwood is the ideal material, detail depending upon the scale of our model. Rails are glued into mortices in the uprights, after being drilled for the belaying pins. For tiny models bamboo is the material to use, as even when drilled it is quite strong in small items.

If the model is of sufficient size to allow of detailed rigging we must ensure that our fife rails will stand the pull of the rigging ropes when belayed. In heavy rails it is possible to drill through at an angle and reinforce the glued joint by driving pins through the deck. In small models extra length can be allowed and fashioned into a dowel or tenon to fit into a hole drilled in the deck, or in the case of a tenon, into a mortice cut into the deck.

Pin rails are flat ledges of wood set edgewise to the timberheads on the inside of the bulwarks, holes being drilled to take the belaying pins. These pin rails are placed at all shroud sections of the bulwarks.

Belaying pins can be made from ordinary pins, the heads flattened lengthways to represent the handles, for larger models they can be made from bamboo with paper strips glued on to make the handles. In large true scale models they can be turned from box-

wood, holly or brass wire or rod, depending on the scale size (see sketch).

Details of the fife rails on your particular model will be shown on your design or plan. If not, the sketches made below show some of the various types, and I will be ready to advise on the correct type for a particular vessel.

Turned stanchions are a feature of many vessels of all periods, and to those with a small lathe they represent no difficulty. If you have no lathe they can be filed to shape from good quality stripwood, or a hand drill can be held in the bench vice and used as a lathe, small files being used to shape the stanchions.

In the finishing of square stanchions,

MAKING FIFE RAILS

By 'Whipstaff'

such as we find in sailing vessels of most periods, including the present day, do not forget the little detail of chamfering the corners as in the sketch. It makes such a difference to the appearance of the finished model.

In the attached sketches we have most of the types of fife rails you will come across, and these short notes should enable you to add the appropriate type to your model.

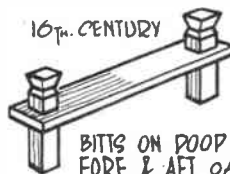

16TH. CENTURY

BITTS ON POOP FORE & AFT OF FORE & MAIN MASTS

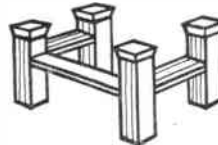

16TH. CENTURY 3 SIDED BITTS & RAILS

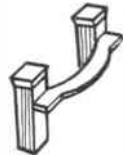

ANOTHER EARLY TYPE

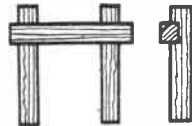

CABLE BITTS VARIOUS PERIODS ON SMALL VESSELS

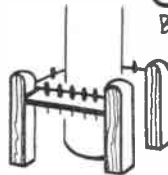

SHROUD DEAD EYES

3 SIDED 18TH. & 19TH. CENTURY



BELAYING PIN



HORSESHOE TYPE OF FORE FIFE RAIL



HEAD OF PIN FLATTENED



BAMBOO PAPER

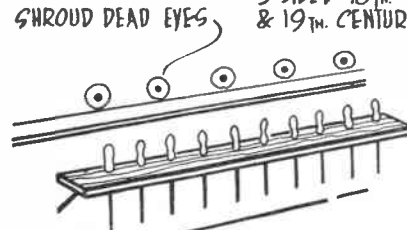

BULWARK PIN RAILS

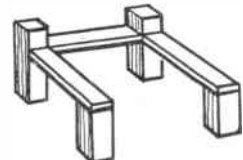

ONE 19TH. CENTURY TYPE



18TH. CENTURY TURNED FIFE RAIL STANCHIONS



CHAMFERED CORNERS SHARP CORNERS AVOIDED PARTICULARLY ON SAILING SHIPS. LESSEN DANGER TO CREW WHEN THROWN BY ROUGH SEAS OR WIND.

Particularly suitable for one-valvers

MAKE YOUR BATTERIES

says
**F. G.
Rayer**

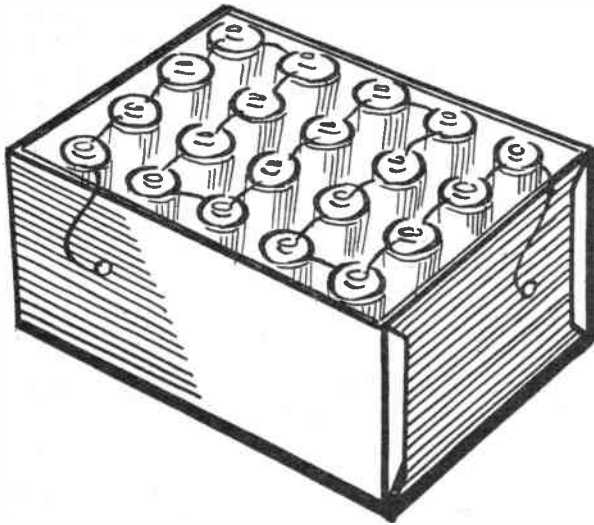

IT may be wondered why anyone should make a high tension battery when they may easily be purchased ready for use. The answer lies in the fact that small batteries suitable for 1-valvers are not easy to obtain. If miniature 'deaf aid' batteries are employed, they do not have a very long life, because of their very small size.

Some manufacturers still produce 45 V and 60 V H.T. batteries with normal sized cells, but there is so little demand for these that few shops stock them. The solution is to make up a small battery with torch-battery cells, and this will have a much longer life than the miniature 'deaf aid' battery.

Use popular type

One valve sets (or 2-valves used with phones) will normally operate satisfactorily on about 30 V, and this can be obtained from ten 3-volt torch batteries. Assuming that the constructor can solder, the whole battery can be made up in quite a short time. There is no advantage in using miniature or pen-torch cells, so the slightly larger, most popular type will be best. Each 3 V battery contains two separate $1\frac{1}{2}$ V cells, and the 20 cells will fit in a cardboard container of the size shown in Fig. 1. It is, of course, possible to make up a battery of any desired voltage, by using a suitable number of cells.

Each card cylinder in which the cells are fitted should be cut through, leaving half the cylinder on each cell, for insulation purposes. A short length of thin wire (about 24 S.W.G.) is then soldered to each zinc case, and left standing vertically. These wires only need to be tin. or so long.

A touch of glue is then applied to each card case, and the batteries put together in rows, as shown, an elastic band or string holding all together. At

this stage the container can be made from a sheet of card.

Each projecting wire is then bent over to the top of the next cell, clipped to the correct length, and fixed to the brass cap by a touch of solder. When finished, all the cells will be in series, as in the diagram. A short length of red flex, soldered to the final brass cap, forms the positive connection. A black lead from the zinc case of the cell at the other end of the battery forms negative, as shown. If bare wire is used in the battery, it must not touch any points, except where soldered.

If there is any danger of components, etc., in the receiver touching the cells, then a sheet of card can be placed over the top of the finished battery, so that

only the two flex leads come out for connecting up.

If no previous attempt at soldering has been made, then constructing such a battery will be excellent practice. The brass caps and zinc cases must be perfectly bright and clean at the point where connections are to be soldered. The wire must also be perfectly clean. Cored solder, such as is obtained in 6d. cartons, is suitable. The soldering iron should be really hot (but *not* red-hot) and is used to melt the solder directly upon the point to be soldered, so that the core of flux will help to make a strong joint possible.

With normal use the battery will last at least six months.

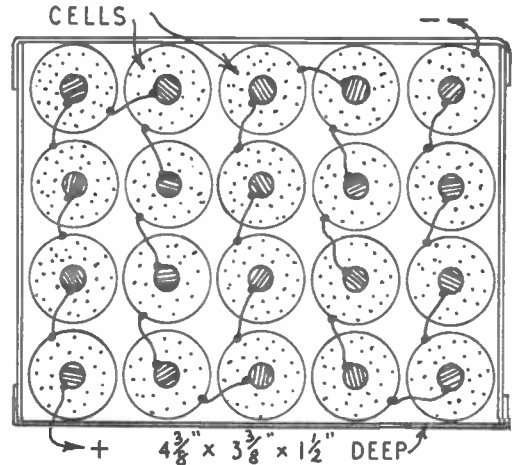

Seven Woods in a Racket

NO fewer than seven woods go to the making of a tennis racket: for the main frame and handle, English ash and beech, Canadian birch and American hickory; for the 'throat' of the frame, light West African mahogany or English sycamore; for the 'shoulders', ash, beech or hickory; and the four handle pieces are of mahogany or the Nigerian wood, obeche.

The preparation of these different woods for their eventual roles is interestingly narrated in a new educational booklet, 'Making a Tennis Racket', produced by Dunlop. The

shaping of the throat wedge, for example, is done with tools at 24,000 revolutions a minute. Another machine drills the 64 holes for the strings 32 at a time. Synthetic resin glues now reduce from two days to half-an-hour the time which animal glues took to stick the woods together; and today they stand up to three-quarters of a ton stress before they fracture.

Readers who would like a copy of the booklet may have one free on application to: Dunlop Information Officer, St. James's House, St. James's Street, S.W.1, mentioning *Hobbies Weekly*.

THROUGH STATION LAYOUTS

By E. F. Carter

THE double-road passing station, in one form or another, represents fully 75 per cent of British prototype stations, and its design is much simpler in many respects than the single-line passing stations we have already considered, though the ever-present problem of platform length often presents a very real difficulty in model form.

There are many different types of double-road through-station, of which the basic form could be said to be represented by Fig. 1, wherein the track layout is of the simplest character. The 'down' sidings are shown in full line, but are also represented on the 'up' side by dotted lines; and it should be noted that the entry into them in either case is against the direction of main line traffic — a proviso which is an absolute

'must' on the real railway. In actual practice also, the length of the shunting spur (shown very much shortened at S) must be made equal to the maximum length of the trains brought into the goods yard.

Another type of station is depicted in Fig. 2, in which the layout is arranged to allow for a stopping train at the platforms (from either direction) to be passed — in the station — by a 'fast' through-train. A further modification of this type of station is shown in Fig. 3, where additional provision is made for main-line trains also to have platform accommodation, the platform nearest the station buildings allowing easy

access to the 'down' local trains by reason of the 'down' local line being platformed on each side. Such intermediate platforms make for ease of passenger transfer from main-line to local trains and vice versa.

Such a station as that shown in Fig. 2 makes an excellent basis for an exchange station if it is situated in the position shown in Fig. 3, where the distance (X-X) and (Y-Y) should be increased to allow of the 'down' local line passing under the main lines at not too steep a gradient. In this respect it may be well to remember that at least 4½ ins. in 'O' gauge, and 2½ ins. in 'OO' scale must be allowed as headroom between the baseboard surface of the lower track and the underside of the bridge or tunnel carrying the upper road. To get

● Continued on page 215

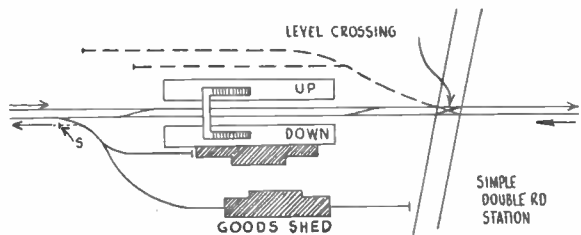

Fig. 1

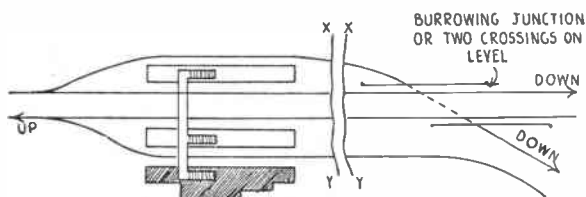

Fig. 3

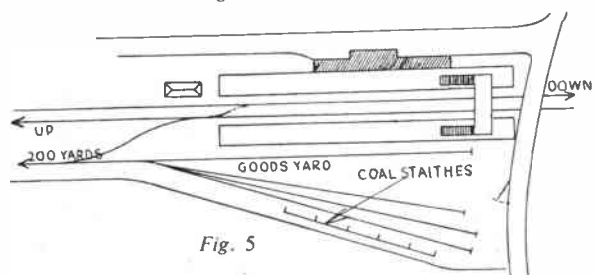

Fig. 5

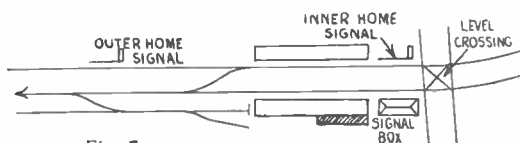

Fig. 7

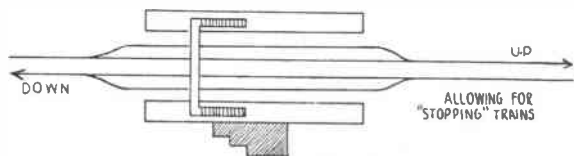

Fig. 2

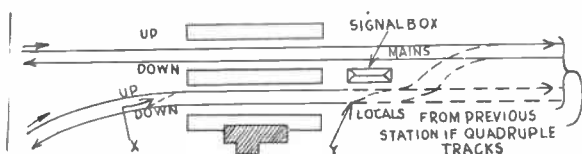

Fig. 4

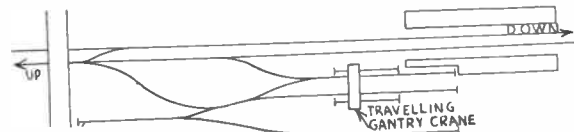

Fig. 6

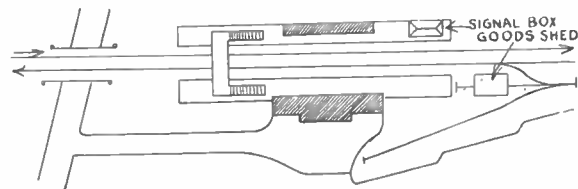
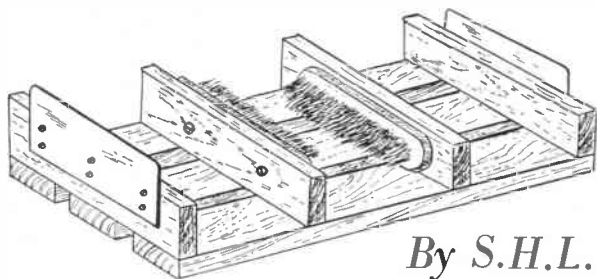

Fig. 8



A 'TIDY' FOR GARDENERS

By S.H.L.

EVERY gardener knows how soil will persist in clinging to his footwear during digging operations, and the displeasure of the proud housewife if these accumulations happen to be brought indoors. And then there are youthful footballers, returning home from muddy playing fields, forgetting to clean their shoes and thereby incurring mother's wrath. So if this gadget is termed a gardener's friend, it will really prove a blessing to the entire family.

Brushes are provided for cleaning the shoe sides, while scrapers will remove the bulk of unwanted mud from the soles.

The material used throughout is 2ins. by 1in. wood. Three pieces, each 2ft. long form the base, with four pieces 8ins. long for the crosspieces. Prepare the wood, drilling holes and countersinking, in the long pieces for screwing the crosspieces. The two end pieces may be attached first by screwing from the underside. Two cheap brushes, with stiff bristles, are fixed to the other two pieces before securing to the base. The two parts with brushes attached are fixed in the centre, 8ins. apart and 6ins. from the end piece.

You may also consider the possibility of attaching additional brushes to the base for brushing the shoe soles after scraping.

At this stage, it is best to apply a generous coating of creosote, for the 'friend' will, doubtless, be kept outside the house and exposed to all weathers, demanding an efficient preservative.

The scrapers fastened to each end are fashioned from galvanised sheet steel, each measuring 1½ins. by 7ins. Round off at the corners and attach by screws to the end, so that the steel projects above the upper face edge of the batten for ½in. If you have no such material handy, most sheet metal workers will cut out suitable pieces for a few coppers.

The user stands with one foot on the base to keep the device firmly in position, while the other foot follows the necessary action for freeing the shoe from mud, first by using the scraper and then the brushes. Most of the soil is removed by the scrapers, but the brushes will remove any clinging to the shoe sides. As previously mentioned, the addition of more brushes, screwed to the base, will ensure clean shoes before entering the house.

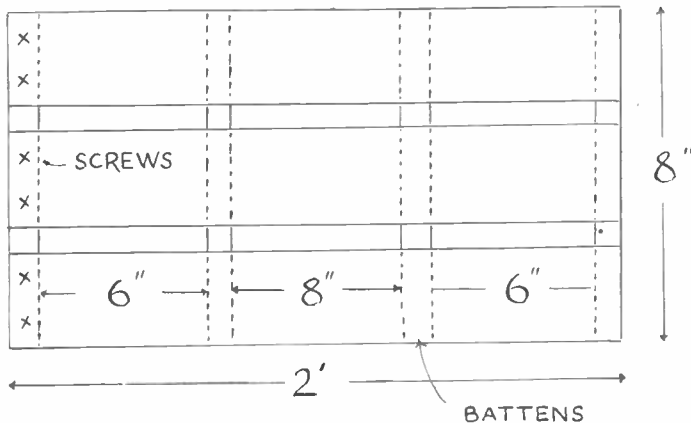

● Continued from page 214

Through Station Layouts

this clearance, a run of, at the very least 25ft. in 'O' gauge or 14ft. 6ins. in 'OO' scale will be needed to give a workable gradient of 1 in 70; though, of course, if the lower line dips as much as the upper one rises, and at the same rate, then half the aforementioned distances will suffice, the difference in level being shared equally between the two tracks.

If parallel tracks are run in quadruple form (a very rare occurrence in model form) as shown in Fig. 4, it is obvious that branch-line stopping trains are held clear of the actual junction without the use of either a burrowing junction or a fly-over junction; though branch-line trains can arrive at the station platforms to be reversed and run back if cross-overs for engine round are duly provided at (X) and (Y).

Close study of Figs. 5, 6, 7 and 8 will give some idea of the great variety to be seen in the arrangements of prototype double-track through-stations, each having its own goods-yard and facilities to suit the class of traffic for which it caters. Thus the layout of Fig. 5 specially caters for coal traffic; Fig. 6 for heavy machinery, being equipped with a travelling gantry crane; whilst Figs. 7 and 8 show simple variants of Fig. 1,

suited for places on a layout where space is cramped.

It will be realised that it is impossible to state which is the 'best' station layout for a double-track railway, because so much depends upon available space and the amount of cash which can be spent on trackwork. Points and crossings are expensive to purchase and are not quickly made — especially by the beginner, so in many cases, one's station layouts must be determined by unalterable factors, and hence the proverbial 'coat' must be cut to suit the 'cloth'; which is a great pity, but none the less true.

It must not be thought that the mere multiplication of complicated point-work will necessarily increase the joy of running a model railway. On the contrary, more often than not, the greatest pleasure can be derived from the skilful manoeuvring of a small amount of rolling-stock on a layout of very limited size and simplicity. In truth, it all depends upon what angle of the model railway hobby most appeals to the reader, but a neat little railway, well built and run in a really railway-like manner is far to be desired to a rambling affair upon which realistic operation is a sheer impossibility by reason of its size.

EASY TO MAKE WITH A FRETSAW

ORIGINAL JIGSAW PUZZLES

THIS kind of puzzle actually owes its name to the type of saw used in the making, in other words, a jigsaw — the power version of our faithful friend the fret saw. While jigsaw puzzles are not a new invention, they remain as

foreign pen friends may like to send a puzzle picture made from their own portrait. If one wants to do a good deed, he may make puzzles for both children and adults confined to the hospitals, or for those members of our Forces serving on ships or lonely outposts. He may be sure they will be greatly appreciated.

perhaps, a photograph taken by oneself can be used. As an alternative to pictures there are other ideas. A page of humorous cartoons may suit some hospital patients; or how about a piece of music for a pianist friend? There are cigarette cards, labels, used greetings cards, and anything it is considered will make an interesting and original puzzle.



The picture has been divided into major portions according to the shape of the subject. Note the provision for interlocking. The dotted lines in section 1 show how the subdivisions will be made.

fascinating to make as to solve, for both juveniles and adults. There are many variations at one's disposal for really up-to-date puzzles.

It will be well known that the most intricate puzzles are those consisting of hundreds of pieces, but when making a puzzle it is best to keep in mind the recipient. A puzzle made for a young child should only be cut into a few simple shapes. The puzzle to tease your friends' patience may be larger, the intricate pattern being cut into as many pieces as possible without interfering with the picture. These points must be remembered if it is proposed to make some puzzles for gifts.

Exchange your puzzles

Before proceeding to the actual making of these puzzles it may be mentioned that it is a good plan for a group of friends to each make one, then starting a little exchange club, when all share the pleasures of each other's handiwork. Moreover, those with

Our familiar puzzle takes the form of a picture, cut up into a number of shapes, but we have many variations to make our puzzles original. For a change, use a map of any country, cut along the borders of the provinces, or counties, then sub-divide to form the puzzle pieces. This should be very good for one's geography!

A surplus of foreign stamps — even a little damaged and unfit for the collection — can form the basis of some very intricate puzzles, depending on the manner of mounting. Using a piece of hardboard or plywood for the base, stamps may be pasted on side by side in perfectly straight rows, but the puzzle will be much more teasing if stamps of all sizes are stuck on at random, some overlapping the others. When using stamps, it is preferable to make the puzzles from either all colonials or all foreign, but not a mixture of both.

When dealing with the ordinary picture, the procedure is to cut out the principal portions first, again sub-dividing as when dealing with maps. The accompanying photograph shows

Mount on a base

The first step is the mounting of the material on to a suitable base. Use hardboard or plywood lightly spread with paste. The picture is carefully laid on and smoothed down to eliminate air bubbles, then kept under heavy pressure until dry. It is important that the paste has thoroughly dried out before starting to saw. And this applies equally to stamps, maps or photographs.

Where stamps are to be mounted in random fashion, it will be appreciated that it is not sufficient to coat the board, for each overlapping stamp will require its own coating of paste. The quickest way is to damp a small pad with paste, or smear a saucer with a thin coating, dabbing the stamps on in turn before transferring to the board.

If it is desired to give the puzzle an attractive finish, a coating of crystal paper varnish may be applied. This will also be protective, allowing the puzzle to be wiped with a damp cloth occasionally for cleaning purposes.

No one who has used a fret saw should be afraid of tackling the cutting out. Keep the work firm and flat, with the saw quite vertical throughout the cutting process. Fortunately one is not obliged to keep to any rigid line, and any irregularities do not matter. Start with the major portions as mentioned, and then subdivide again and again, but always remembering those little pro-

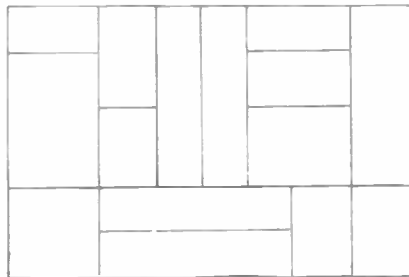

A simple pattern

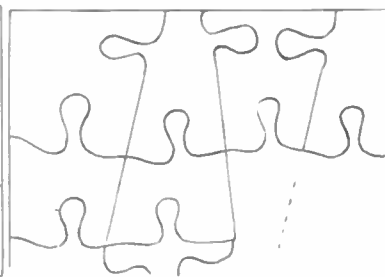

Interlocking pattern

how various areas are cut out to the shape of the objects, with provision for interlocking of these major pieces. Any coloured picture from a magazine, or

jections which make the pieces lock together. This may sound an unnecessary precaution, but be careful to

● Continued on page 217

Hints on Keeping an Aquarium

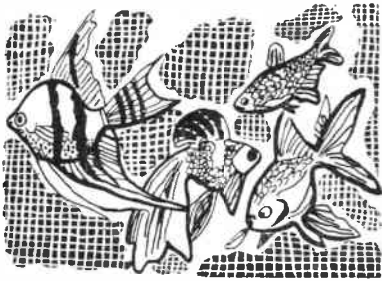

AQUARIUM tanks, for the beginner who takes up this most interesting hobby, may be of three main types. There is the bell jar, the metal frame tank with glass sides and a base of slate, and the home-made affair made out of a strong wooden box with a glass front. Bell or round glass jars or globes are not altogether suited to aquaria purposes, as they admit too much light and the curved sides focus heat rays towards the water, which is not good for the fish.

The metal-framed tank is the best of the trio, for the glass sides can be easily replaced if accidentally broken. The rectangular aquaria, as sold by dealers, is useful in that brown paper can be pasted over one or two of the sides, enabling the fish to find a shady corner when they need it. A handy size of aquarium for the beginner is about 18ins. long by 12ins. wide by 18ins. deep. Some advocate a slate tank with a glass window let in one side only.

Whatever sized tank is selected, you must remember that the total water surface exposed to the air determines the number of fish that may be kept in it. 'An inch of fish to a gallon of water' is an old maxim, and generally a sound one when first stocking your aquaria. Allow at least 6 cubic inches of water for each fish.

Stocking and Management

In most cases the position of the aquarium will be not by choice but by necessity. It is advisable to have it in a place where it gets direct light from above, but in the average room a window will be suitable, where the tank does not receive too much strong light.

Place a layer of clean sand at the bottom of the tank; river sand or shingle is best. Having done so, insert suitable plants, including *Vallisneria*, *Elodia*, *Ludwigia*, *Myriophyllum*, etc., for cold water tanks. Tropical varieties are best for tropical aquaria. Fish require water in which plants suitable for them are kept.

Place the aquarium where it will get light but not too much sun, a couple of hours' sunshine a day are enough.

Aerate the water daily by laddling out a jugful and returning it from a little height.

Change the water when you observe the fish congregating near the surface. If the fish are of kinds needing well-aerated water, one of the aerators worked by electricity may be employed.

Always let tap water, when used for replenishing the tank, stand for some time first.

Feed your fish 'a little and often' and do not allow them to have a good feast followed by a fast. 'Ant eggs', or better still, one of the prepared foods supplied by aquarium dealers; dried *Daphnia*, small earthworms cut up in tiny pieces, bloodworms, etc., are suitable. All fish benefit from a mixed diet. You can usually get supplies of food for your fishes from most dealers in aquaria.

Do not overcrowd your aquarium with fish. They require oxygen like all other animals, and if too crowded they will suffer. When starting your aquarium in the first place, be sure you buy *healthy* fish only.

All surplus and uneaten food left at the bottom of the tank should be syphoned out periodically. A few water snails in the tank will help in keeping it clean, by acting as scavengers.

Cold Water Fish

The would-be aquarist will carefully select his fish for the tank. Small specimens, up to 2½ins. in length, will be better for his purpose than bigger species, if he intends to keep an ordinary aquarium.

Choose fish without blemish. Accept none but those with unsplit fins, and make certain that no scales are missing. Do not buy fish with signs of fungus on

body, fins, or mouth. Dull eyes in a fish are not a good sign. Accept no fish for your tank that is flat-sided, thin and lanky.

Goldfish are the most popular of aquarium fish. Do not forget there are many varieties. There is the common kind, reddish-gold in colour, though sometimes with patches of black or white. Of the many varieties we may mention the 'Veil-tail', the 'Fan-tail', the 'Comet', and other fancy strains. Next in favour we have the Golden or Red Japanese Carp, the Golden Orfe, the Golden Tench, Prussian Carp, Mirror Carp, the Common Tench, Rudd, Roach, Bream (silver), Minnow, Gudgeon, Catfish, Dace, Perch, Miller's Thumb, Stone Loach, etc.

Tropical Tank

Keeping a tropical aquarium is a very entertaining hobby. Most of the kinds of fish for the purpose are exceedingly pretty and brightly coloured. The same type of tank as already mentioned can be used, but the temperature of the water should be higher than for cold-water fish, generally varying from 70°F. to 80°F. To regulate the water temperature, use an electric thermostat, which can be supplied by the dealer.

Popular tropical species include Cichlids of several varieties, Siamese Fighting Fish, Gouramis, Zebra Fish, Harlequin Fish, Barbs, Characins, Live-bearing Cyprinodonts, Mollies, Moon Fish, Sword-tails, and Angel Fish, etc.

The beginner is advised to confine his earlier attention to goldfish and the hardier cold-water types. Choose small rather than large specimens. As he becomes more experienced he will discover just how many fish he can keep in a given tank. A handy book for the tyro is 'Keep an Aquarium' by E. G. Boulenger (Ward, Lock & Co., Ltd.). (A.S.)

● Continued from page 216

Original Jigsaw Puzzles

place each piece in a bag or box once it has been cut out for reasons of safety. There is nothing more annoying than to finish the whole of the cutting out to find that one piece is missing. Should this happen here is a tip. Place the existing pieces together around the area of the missing piece, placing on a piece of board of exactly the same gauge as the rest of the puzzle. Hold the pieces firmly in position while carefully pencilling the shape of the empty space on the board. Cut out this piece accurately and with water colour paints or coloured

pencils fill in some of the missing detail, matching the colours as near as possible. The same method is useful for replacing missing pieces of any existing puzzles.

Puzzles are best kept in a box or small linen bag which can be tied at the neck. If you have a duplicate picture it will help solving the puzzle and can be pasted on to the lid of a box. Remember that hardboard and plywood mounts will give the best service in the long run. The puzzle shown in the illustration was made from a picture mounted on ¼in. plywood and is very substantial. (S.H.L.)

YOUR LENS APERTURES

SOME photographers are quite needlessly puzzled about the exact meaning of the 'f' numbers, or apertures, which are marked on all but the very simplest cameras. In actual fact these numbers serve a very useful purpose, since they show how much light is passed by the lens. They are also arranged in such a way that they are by no means difficult to understand.

Apertures are expressed by the letter 'f' followed by a number. For example: f8, f11, and so on. These numbers show how large is the hole, or aperture, through which light passes. The photographer can thus adjust his exposure accordingly, or choose an aperture to suit the light. In poor light, a large aperture would be wanted, to secure enough exposure. But with good, bright light, this might give over-exposure, so a smaller aperture is used.

The actual figures give the diameter of the aperture, as a fraction of the lens focal length. For example, if the lens has a focal length of 4ins., then f8 would be an aperture $\frac{1}{2}$ in. in diameter, while f16 would be an aperture $\frac{1}{4}$ in. in diameter. It will thus be seen that the *higher* the 'f' number, the *smaller* is the light passed by the lens.

The normal series of 'f' numbers used today is as follows:—2, 2.8, 4, 5.6, 8, 11, 16, 22, 32. This may seem peculiar, but the series is used because each 'f' number is one-half the aperture of the previous number. For example, f4 only passes half the light of f2.8. Similarly, f11 passes half the light of f8, or twice the light of f16.

Referring to the diagram will help to make this quite clear. Here, a variable iris diaphragm is shown. Set at f4.5, the lens is almost fully open, passing a large amount of light. Closed down to f5.6, only about one-half the light passes. When closed as far as f11, the opening is quite small, so that even less light can pass. Apertures such as f16 and f22 will be even smaller.

Some very simple cameras do not have a variable iris, but a metal plate with a number of holes of different diameter, which can be brought before the lens. The effect of using these is exactly the same as with the iris.

Why 'Stop Down'?

Using a smaller aperture is called 'stopping down'. Each movement of one stop means a reduction in aperture to the next figure in the series. For example, from f16 to f22, or from f4 to f5.6.

There are several reasons for stopping down, instead of using the lens at its widest aperture all the time.

First, it may be necessary to reduce the light passing, as explained. Apertures of f4 to f8 do well for dull days, but when bright sunshine is available it is necessary to stop down to f16 or even f22, with normal exposures of 1/50th second.

In addition to this, definition is improved — the negative is more sharp, especially towards the edges. This arises even with expensive cameras. Looking at the diagram, it will be seen that when the lens is stopped down well, light rays

f3.5 lenses are similarly found, letting pass a little more light than f4. Some cameras also have f6.3 lenses, and it is usually safe to employ this exactly as if it were f5.6.

All these various lenses (unless very old) will have the f8, f11 and f16 numbers given, whatever the maximum aperture is. No difficulty arises in using them, therefore.

Only expensive cameras have apertures as large as f2.8 or f2, as these lenses are of very large diameter, and

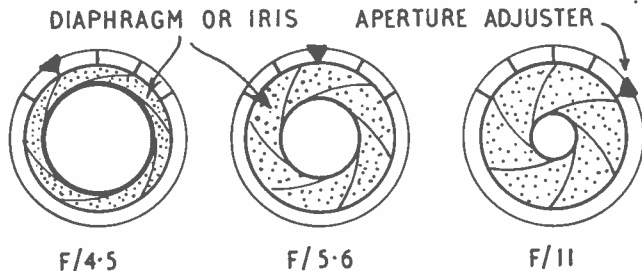

only pass through the centre. This gives better definition than when light is also passing through the outer parts, or edge, of the lens.

Another advantage of stopping down lies in the increased 'depth of field' obtained. This term, like others used in photography, is simple to understand. It merely indicates the extent to which objects at various distances from the camera are sharp on the negative. Once again, an example will clarify this. Suppose the camera is focused upon an object at 10ft., and the lens at f4.5. The depth of field will then extend from about 9ft. to 11ft. Objects nearer than 9ft. or farther than about 11ft., will be badly out of focus, and thus appear blurred in the picture. But suppose the lens is stopped down to f22. The depth of field then extends from 6ft. to 20ft., the camera still being focused at 10ft.

There is no need to remember actual figures, but it will have been realised that the depth of field increases each time a smaller aperture is used. Focusing thus becomes less important or critical. Again, in street views or scenes with objects at a wide range of distances, a small aperture (f16 to f22) becomes necessary, if there is to be enough depth of field to cover this.

Very often the widest lens aperture is not any of the figures given. A f4.5 lens is an example of this. The maker has not used a lens quite large enough to be f4, but in terms of exposure it will be safe to use the f4.5 setting exactly as if it were f4.

Most cameras of other than very simple type begin with a largest aperture of f4.5.

Actual Exposures

It is hoped that there will not remain any mystery about 'f' numbers after the foregoing explanation. So that the knowledge gained can be put to good use, it is worth while to consider some typical exposures. Assuming that a film such as Selochrome (30° Scheiner) is to be used, with the shutter set at 1/25th second, the following apertures would be suitable for landscape scenes:— Bright Sunshine, f22. Trifle Overcast, f16. Dull, f11. Very Dull, f8.

For near views of figures, houses, trees, etc., it is necessary to open up one stop. This gives:— Bright Sunshine, f16. Trifle Overcast, f11. Dull, f8. Very Dull, f5.6.

As each number in the series given is one-half the previous number, in terms of exposure, it is easy to adjust the aperture for other shutter speeds. If 1/50th second were to be used, instead of 1/25th, the aperture has to be opened one stop. For example, f16 would be used instead of f22.

Very simple, cheap cameras have no means of adjusting the aperture. With these, it is safe to assume that the lens is set at f16. This explains why such cameras are not suitable for dull light. They will, however, give good pictures in bright daylight, or sunshine, where the aperture of f16 allows enough light to pass to expose the film. (F.G.R.)

TRY FRETSAW INLAY

Marquetry the EASY Way!

If you like marquetry work, you MUST try Fretsaw Inlay. It has many advantages over knife inlay work with veneers, and is easier, yet the results are equal to the finest marquetry work! Using a fretsaw, all the pieces are cut at once—and must fit perfectly. You get THREE good pictures from four pieces of wood—quite a consideration when you are making pictures for sale—and all are cut at the same time. There's no mess and no bother with Fretsaw Inlay. The kits illustrated are complete with four selected $\frac{1}{8}$ in. panels of different

coloured woods, $\frac{1}{2}$ in. backing board and strip-wood for border. The overall size of a finished picture as illustrated is 14ins. x 10ins. There are also kits for trays inlaid in the same way and using larger panels of wood. Get Hobbies free pamphlet and learn more about Fretsaw Inlay. You'll be surprised how easy it is to create masterpieces in wood!

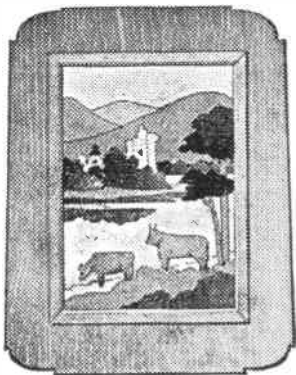

'Kilchurn Castle' (Kit No. 3008)
New designs for Fretsaw Inlay are published from time to time in this magazine. Make sure not to miss them.

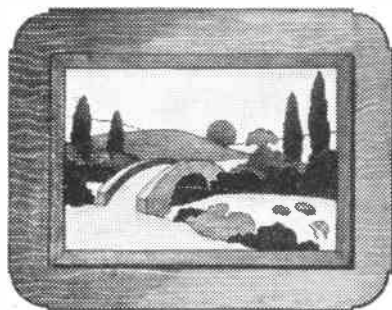

'The Bridge' (Kit No. 3016)



To **HOBBIES LTD.**, Dept. 99, Dereham, Norfolk

Please send me the items I have marked thus X.

FREE copy of
Pictures in Wood*

KIT 3008
9/6, post free

KIT 3016
9/6, post free

I enclose
P.O. for

NAME

ADDRESS



**YOU CAN PRINT
16 SNAPS IN
ONE EVENING
AT HOME**

with the

JOHNSON PRINT-A-SNAP PACK

It's much more satisfying, and so convenient, to print your own photographs at home. There's no waiting for results—you get them on the spot, and it's amazingly easy when you use the Johnson Print-a-Snap Pack. This little kit costs only 3/6, and you can make sixteen $2\frac{1}{2}$ x $3\frac{1}{2}$ in. prints or twenty-four $2\frac{1}{2}$ x $2\frac{1}{2}$ in. prints depending on the size of the negatives you are using. (You must state the negative size when ordering.) Any dimly-lit room will do to work in, and no special equipment is necessary. If you want to take up photography as a hobby this is the simplest and most interesting way to start.

Ask your local photographic dealer for the Johnson Print-a-Snap pack.

It contains one packet of developer; one packet of fixing powder; one packet of the new Johnson Contact Paper; a cardboard printing frame and a sturdy wallet to keep your prints in after you have made them, together with full instructions.

ALL THIS FOR ONLY 3/6

NEW!

**THE PRACTICAL WAY
of learning RADIO
TELEVISION · ELECTRONICS**

- Beginners Radio Course ●
- Advanced Radio ●
- Short Wave Technique ●
- Lesson Manuals ●

Experimental work includes construction of Basic Oscillators, Amplifiers, Deflectors, Power Units, 1, 2 and Multivalve TRF and Superhet receivers.



COMPLETE EXPERIMENTAL COURSES IN RADIO ENGINEERING and SERVICING

An entirely new series of courses designed to teach Radio, Television and Electronics more quickly and thoroughly than any other method. Specially prepared sets of radio parts are supplied and with these we teach you, in your own home, the working of fundamental electronic circuits and bring you easily to the point when you can construct and service radio receivers, etc. Whether you are a student for an examination; starting a new hobby; intent upon a career in industry; or running your own business—these Practical Courses are ideal and may be yours at very moderate cost. With these outfits, which you receive upon enrolment and which remain your property, you are instructed how to build basic Electronic Circuits (Amplifiers, Oscillators, Power Units, etc.) leading to designing, testing and servicing of complete Radio and Television Receivers.

COURSES FROM 15/- PER MONTH

POST THIS COUPON TODAY

To E.M.I. Institutes,
Dept. 31, Grove Park Road, London, W.4.
Please send me your FREE book on Practical Courses

NAME

ADDRESS

26 Dec.....IC74

**EMI
INSTITUTES**

associated with
"His Master's Voice,"
Marconi House,
Columbia, etc.

Holiday angling

The Chub is Worth Seeking

CHUB are often classed as vermin that cause much tribulation for trout fishers in summer, when they — the chub — establish themselves in streams sacred to the game mottled fish. That may be so; but your winter chub, round and about the Yuletide holidays, is a different creature. In December, a chub, if of passable size, say, 3 lbs. to 5 lbs., is no mean opponent. Neither is such a specimen ill-looking or ungainly. Rather is it a singularly handsome fish, silvery-green and shiny of mail; or, as the late Sir Herbert Maxwell described it, 'firm and bright as a salmon-trout'.

The 'Loggerhead'

That assertion from an eminent authority may appear very flattering, but other experts of the angling world praise in no mean terms the 'logger-headed' fish. The late H. T. Sheringham (and no one would entertain disputing his testimony), has a good word for him in his book — 'the most satisfactory quarry of the winter angler'. In another place he refers to the chub as 'a really excellent fighter, especially if hooked near a bed of weeds or the roots of a tree'. True enough, for if there is one haunt chub love more than another, it is under a willow. They do not scorn other waterside trees, but a willow for some reason is easily first, and should the roots stick out a foot or more under the water, and the current has washed away the bank, causing the tree to lean over a pool with some of its lower boughs awash, better still.

Probably no 'coarse' fish provides a greater thrill than does a chub racing away at a headlong pace towards a tangle of old rods. It is a case of touch and go. You may turn him from his objective — more likely the quarry will gain sanctuary, and leave the angler trembling in cold despair.

Habits differ

The habits of chub differ somewhat during winter from their summertime ways when you see them dimpling under the trees overhanging the stream. In the winter days you stand little chance of spotting them by eye as in summer, but they are to be found in almost the same haunts. The ideal chub river is rather placid and clean, but by no means innocent of snags and roots. Hollows under bush-hung banks, 'pockets' between bushes where the current is slack, eddies at bends and elbows are all likely spots. Chub have the homing instinct and they will generally be found lurking in a favourite swim year after year. Once

a chub-hole, always a chub-hole, unless floods of heavy nature drastically alter the character of the banks.

Probably the modern trend to pull up trees and straighten banks, and to 'canalise' stretches of once winding, shady streams has done much to spoil some once grand chub waters, and frequently it is a long walk between one worth-while hole and another. In any case, there is seldom room for more than one angler to fish any chub haunt at one time. In a well-fished river chub take a lot of catching, even in the winter days when the water is more or less coloured. In such streams, where angling is now pursued by the multitude, success demands intimate knowledge.

It is a good idea to try out all places likely to be tenanted, then, if chub are present and in feeding mood, they will soon let you know it, always provided the angler plies his art with intelligence and circumspection, bearing in mind the character of a wary and shy quarry. Once you locate chub be prepared to stay thereabouts for a while. Though chub do not consort in big shoals like roach, they do assemble in small companies, often with two or three good-sized ones in the lead with lesser fish strung out behind. If the angler goes about his task with discretion he may extract a few nice fish from the 'swim'

ere the rest sense that something untoward is happening. Let them catch glimpse of him and they just melt away into the deeps or under the rooty banks.

Tickle its appetite

Whereas in summer chub take artificial flies, natural insects, grubs, caterpillars, grasshoppers, and what not, including fruits of various kinds, much of this sort of food is not available during winter, when the angler can cut down his list of baits considerably. It is doubtful if there is a better bait at this season than a bright and lively red worm, which has been 'scoured' in damp moss for some days before use. The tail-end of a medium lob fished on leger tackle frequently provides reward, particularly if previous to starting, the hole has been suitably ground-baited, with a mixture of boiled rice and potatoes, soaked bread and bran, to which concoction a few small worms have been added. Another mixture favoured by old-timers consisted of soaked greaves and clay, made into suitable balls. Years ago pith and brains were all the go, but seem to have gone out of favour, though the difficulty of obtaining such from the butchers during ration times may have had a lot to do with this once famous chub bait, becoming scarce. (A.S.)

Dace are in Their Prime

AFISH well worth catching in winter is the lively dace. A good dace hooked on fine tackle at this period of the year, is one of the best, for, in common with chub, roach, and grayling, they are in their prime now.

We like the dace, it is such a beautiful fish, built on symmetrical lines and elegant in shape and of spruce appearance. He is prettier and more slender than the roach, but lacks the carmine with which the latter's fins are dyed. Silvery with dark olive back, the dace is really a fish to be admired, both for looks and sporting qualities.

There are three excellent baits for winter use when after dace — red worms, maggots, and small cubes of bread-crust. If the water is coloured by rain causing soil-washings, the worm is the best. Dace are often met with in roach swims, and prefer the deeper runs at this period. Tackle should be fine, and the hook No. 14 crystal. Dace, being gregarious, travel in small shoals, and, as when roach fishing, it is advisable to

attract them by ground-baiting with the usual mixture of soaked bread and bran, or any similar concoction proved useful in keeping fish together in the swim.

'Swimming the stream' for dace is a pleasant method of winter fishing, especially if you pick your day. If chub also are present in the stretch, you are fishing, all the better — you may enjoy a bit of fun. We should be inclined to choose a mild day with not too much wind, and with the river in its normal winter flow. Mid-day and early afternoon, is the time for fishing during frosty conditions, for then the water will have lost a little of its icy sting. Yet it is possible to catch fish during the last hour of daylight, in mild winter weather.

* Next week's free design will be *
* for making 2 Modern Trays, con- *
* taining delightful marquetry inlay *
* pictures of wild geese or a Scottie *
* dog. *

STAMPS FREE — Empire Packet including Spectatorials and Victorians with approvals. — Robert J. Peck, 7A Kemp Road, Bournemouth.

MAGIC catalogue. T. and Donkey Puzzle 1/- DeHempsey, 363 Sandycombe, Kew, Surrey.

Classified advertisements are accepted at a cost of 6d. per word prepaid. Send P.O. with advertisement to Advertisement Dept., Hobbies Weekly, Dereham, Norfolk

GENUINE Swiss Musical Movements. The best and largest selection of tunes in the country, lowest prices 16/3 each. Genuine Thorens Movements, 22/9 each. All guaranteed. P & P, 9d. extra on all orders. — Richardson & Forder, HW. 5 Chapel Place, White Hart Lane, London, N. 17.

SWISS MUSICAL MOVEMENTS. Before you buy send 2d. stamp for our illustrated brochure. — Metwood Accessories (Dept. HW), Church St., Wolverton, Bucks. (Trade enquiries invited).

● I MUST GET

... the **EXTRAORDINARY** Home-made **GADGETS MAGAZINE** EVERY MONTH it fully describes **OVER FIFTY** ingenious gadgets, devices and novelties I **CAN MAKE.** ● I'll get it at W. H. Smith's etc., or send 1/3 direct to:—

Home-Made GADGETS MAGAZINE
(26) Kingsbury, London, N.W.9

● 10/- buys the **HUGE 1957 Gadgets Annual** ●

STICK TO



PER TUBE KEEP A TUBE IN THE HOME
Sole Manufacturers: McCaw, Stevenson & Orr Ltd., Belfast

100 DIFFERENT stamps free! Request 1d. upwards discount approvals. — Bush, 53 Newlyn Way, Parkstone, Dorset.

'PAINTSPRAYING' HANDBOOK. Covers Car, Industrial & Flock Spraying, 3/6, post 4d. Catalogue of our Cellulose and Paints and all Allied Sundries 2/6. — Leonard Brooks Ltd., 81 Oak Road, Harold Wood, Essex.

1700 MARVELLOUS TRICKS, half-quarter price, five different Bargain catalogues. Send 2/- (returnable). — Orlestones, Riverside Road, Shoreham-by-Sea.

TATTOO materials; postal tuition. Tattoo mark remover. S.A.E. — 61 Stanley Ave., Dagenham.

MUSICAL BOX MOVEMENTS

Only 14/9 post free, Swiss made. Everything for making a complete box, movement included, 21/9.

S.A.E. for tunes, etc.

The Swisscross Co., Dept. B,
116 Winifred Road, Coulsdon, Surrey

Dress in a 'near to life' D a v y Crockett Hat, Jacket, and Leg

BOYS! Be a real DAVY CROCKETT

COMPLETE 4-PIECE OUTFIT *NO DEPOSIT! includes FREE HAT



all with fringes and adjustable belt. **WATERPROOFED.** Hat is real Fur Fabric. Send 2/6 for post, etc. If satis. 5 monthly payts. 4/6. Cash 19/11 complete. Ages 4 to 9 & 10 to 13. **STATE AGE, DAVY CROCKETT TENTS 21/-, post, etc. 1/6. LISTS, TERMS.**



THE Tom-Tom WIGWAM TENT
SUPERB "TOM-TOM" COTTON PROOFED FABRIC, NOT NYLON. 4' 3" x 4' 3", height 5' 6". With collapsible poles, dismantle swiftly & transport elsewhere. No centre pole. Erected anywhere. A real waterproofed Tent. Holds 4/5 children. SEND 2/6 DEP., then 4 monthly payts. 5/9. Cash 21/-, Post 2/6. Waterproof Groundsheet 10/6 if req. Lists, Terms, Open Sat. 1 p.m. Wed. Headquarter & General Supplies Ltd. (HOBW/40), 196-200 Coldharbour Lane Loughboro Junction, London, S.E.5

LEARN it as you do it — we provide practical equipment combined with instruction in Radio, Television, Electricity, Mechanics, Chemistry, Photography, etc. — Write for full details to E.M.I. Institutes, Dept. HW47, London, W.4.

Yours for only 8/6d.

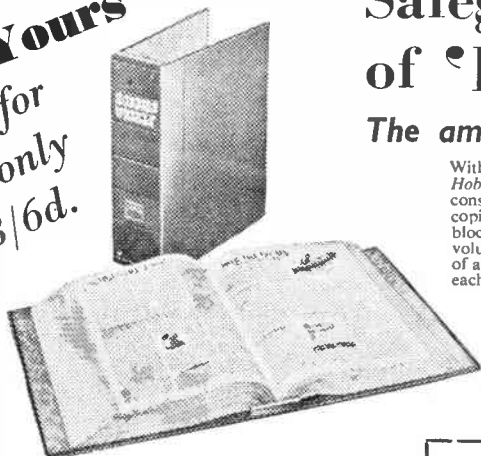

Safeguard your copies of 'HOBBIES WEEKLY'
The amazing 'EASIBINDER' (Pat.) makes it simple

With the new **EASIBINDER**, specially prepared for Hobbies, you can bind each copy of *Hobbies Weekly* as you get it, turning your favourite magazine into a permanent, easily-consulted library of immense value, and avoiding the delay and despair occasioned when copies are accidentally mislaid or destroyed. Carefully finished in black leather-cloth and gold-blocked on the spine, each binder is strong, serviceable and neat. It will hold two complete volumes (52 copies) and costs only 8/6. Each copy of the magazine is quickly inserted by means of a flexible steel wire, and can easily be removed if necessary. Easy-to-follow instructions with each **EASIBINDER**. Get one today and take care of your copies of *Hobbies Weekly*.

NOTE! For those who prefer to bind each volume (26 copies) in the orthodox way, the familiar red binding cases are still available, price 4/6 each, and indexes are published for each completed volume and cost 1/- each. To avoid confusion, however, these items should be ordered separately. **USE THE COUPON ONLY TO ORDER EASIBINDERS.**

October 3rd (No. 3179) was the start of a new volume

☆ **One 'EASIBINDER' holds two volumes (52 copies)**

☆ **Easy to use**

Post today



To: HOBBIES LTD., Dept. 993, Dereham, Norfolk.

PLEASE SUPPLY EASIBINDERS at 8/6 each. P.O. for is enclosed.

NAME
ADDRESS

YOUR CHANCE TO HELP THE BIRDS

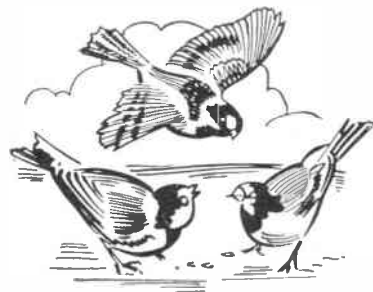

ONE of the pleasantest duties of the bird-lover at this winter period is to see that all the feathered creatures that come to the garden and the back-door may rely upon his bounty and his help. Remember that when at times the countryside is bound up by frost and snow, many thousands of birds die through sheer hunger and thirst. Therefore, place food and water in ample supplies each day such weather conditions prevail, always in convenient spots, but where Tabby or Smut cannot climb or otherwise reach.

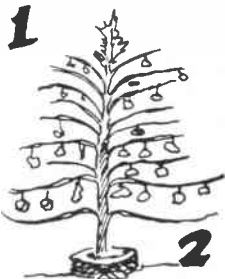

What is more picturesque and welcome to the bird-lover — and most of us come into that category — than the sight of wild birds in the garden or back-yard? The frost and snow will have brought crowds of feathered guests to your premises, and there is no better time in which to study their ways and feeding habits. To the vicinity of human dwellings they will flock in order to forage for a few scraps and bits of food. To help them and to make the most of your opportunity it is advisable to make your garden an attractive 'guest house' by catering liberally for the different species that will surely visit your hospitable table.

When fixing up a bird table or other contrivance, place it at some height from the ground or in any open situation. Cats will not then be able to

ambush or spring on your guests unawares. Get all food receptacles ready for use before hard and severe wintry weather sets in.

A bird table can be easily made out of a box lid secured to a piece of timber by a screw through the centre. An old sweeping brush handle will do nicely or a few feet cut from a clothes prop. Any handy fellow can make a more elaborate table if he has the necessary tools.

The table should be spread with a handful of breakfast porridge oats, pieces of fat, bread crumbs, scraps of cake and old buns, etc., the wastage from your own table and kitchen.

Coconut holders

A divided coconut slung from the boughs of an apple or other fruit tree is an old device, but, nevertheless, a good one. When the white nut has been picked off by the birds, smear the inner side of the nut with suet, mutton fat, dripping, or lard. Another use for a suspended coconut is to half fill it with food scraps, seeds, etc., which the finches will enjoy as well as the tits and others.

An excellent device is to get a short bough or piece of wood suitable for the purpose, cut and trim it, and afterwards bore or chisel a number of holes about 1½ ins. diameter and about 2 ins. deep, allowing about four of such holes to the foot at equal distances apart. A bough 2ft. in length will furnish eight holes. Fill them with fatty foods and fix the bough well up in a suitable handy tree in the garden. Replenish daily in hard weather. The tits of all kinds will gather fussily around to fill their tummies. (See Fig. 1.)

When you have finished with your Christmas Tree (Fig. 2) do not throw it away, but set it in the centre of your lawn, patch of grass, or garden. On its branches hang bits of suet, strings of monkey nuts, pieces of coconut, bones that have shreds of meat attached to them, bacon rind, fruit like apples, and bread crusts. At the foot of the Christmas tree spread a little crushed hemp

By A. Sharp

seed, which will be welcomed by the seed-eating birds such as the finches.

A most important thing is water. In frosty weather repeat the supply when ice forms on the surface. Place outdoors two or three shallow dishes or pans of water for the birds' use. Do not fail to look at it periodically on days when the wind is freezing, and break any ice that has formed.

Never throw out food for the birds on to ground covered with deep snow where it will sink out of sight. Sweep or shovel a clear patch and put your offerings in the centre of it. Renew, if further snow follows.

It is very interesting to watch the feathered visitors, whose ways are always worth noting. Sad it is, however, to notice that your guests are very rude to each other, and behave badly at the bird table. They chase each other away from the food, bully each other, and even snatch the best titbits out of each other's beaks. Starlings bully their own kind unmercifully; but they are not alone in bullying tactics, for the black-birds are equally as bad. The sparrows are sneaking foragers, always slipping in under the beaks of their friends and snatching the best titbits.

Robins are pugnacious, devoting themselves mainly to the pursuit of all robins and others, except the tits, who are seldom put off their feeding places for many seconds. Thus our feathered guests carry on, bullying and chasing each other, and generally making every effort to get the most there is, before some other bird wins it. Provided you place out plenty of different scraps of food there will be something for all wherewith to fend off hunger during hard times of winter.

MAKE A RADIO SET!

NO SOLDERING—only a screwdriver and pliers required. Kits from 8/6, 10 kits to choose from. Send S.A.E. for complete list or a 3/6 P.O. brings you easy to follow building instructions for all 10 sets. Send to:—

BLANCHARD'S RADIO

(Dept. H1), 13 GAINFORD GARDENS, MANCHESTER, 10



HOBBIES BRITISH FRETSAW BLADES

THE BEST YOU CAN BUY

YELLOW LABEL 1/2 per doz. 13/6 gross
BLUE LABEL 8d. per doz. 7/6 gross

From Hobbies Branches or by post (2½d. extra) from Hobbies Ltd., Dereham, Norfolk

For greater accuracy

AN ADJUSTABLE BEVEL

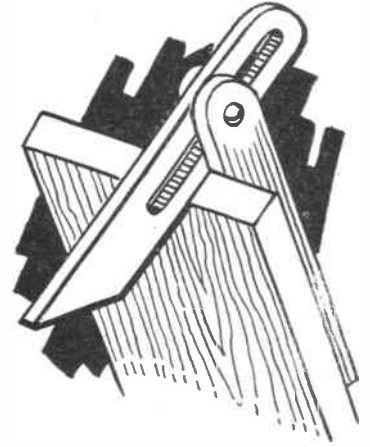
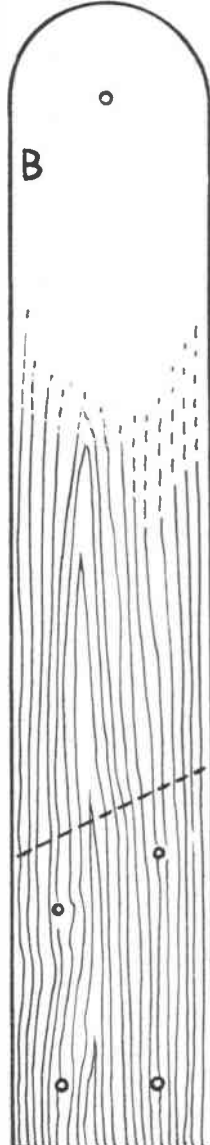
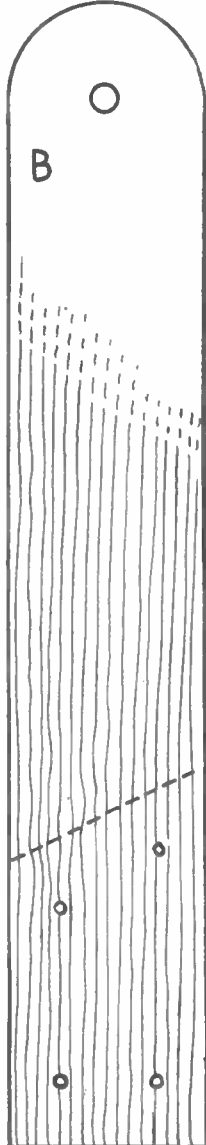
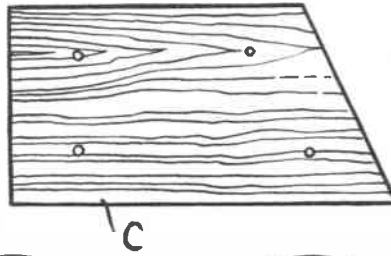
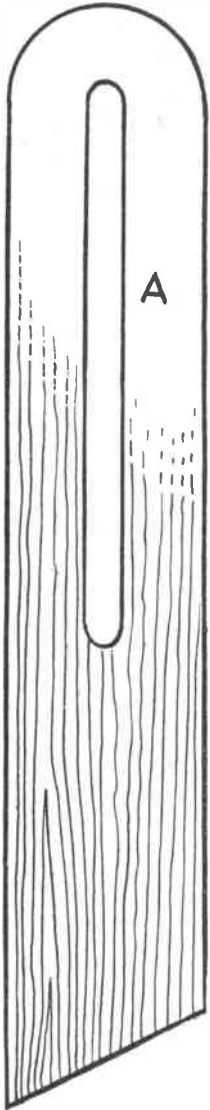

USEFUL GADGET FOR FRETWORKERS

THE adjustable bevel is particularly useful to fretworkers and model makers where chamfering has to be done. It ensures that the chamfer is correct along all its length.

Cut the pieces (A), (B,B) and (C) from $\frac{1}{4}$ in. hardwood and glue pieces (B,B) and (C) together as shown in the diagram below. This can be strengthened by the addition of pins or small screws, and forms the stock or handle. The blade is inserted and held in place by a round-head screw which can be tightened to hold the blade in any position. A small bolt and wing nut could be used in place of the screw. Finish off by giving three or four coats of brush polish. (M.p.)

MAKE
IN
ONE
EVENING

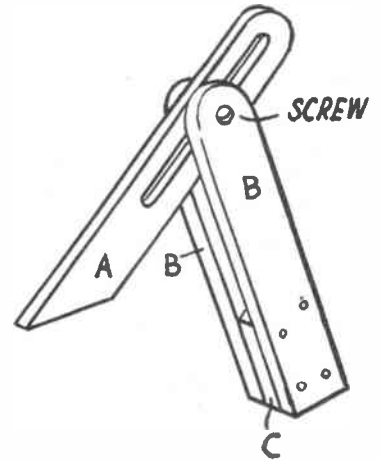

**YOU CANNOT
GO WRONG
WITH A . . .**



**FRETWORK
OUTFIT OR
MACHINE**

AS A REALLY PRACTICAL, LASTING GIFT

The most popular fretwork machines and outfits in the world. Made in Hobbies' own factory in Norfolk, and all fully guaranteed. A Fretsaw can be used for almost any kind of cutting in wood, composition board, plastic, sheet metal, leather, card, etc. Any outfit or machine will ensure a lasting and useful hobby.



'CROWN' OUTFIT

With useful small hand frame, spare saws, cutting table, drill, instruction book, glasspaper block and design. A very popular outfit.

22/6

'A.1' OUTFIT

The set most beginners demand. Contains a Hobbies lever hand-frame, with special saw tensioning device, wide range of tools, designs and instruction handbook. In deep box, 15in. square.

37/6



**THESE ARE TESTED TOOLS
GUARANTEED
TO GIVE
EXCELLENT SERVICE**

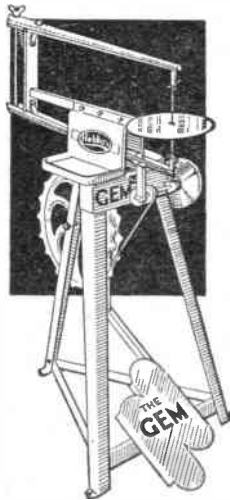

**THE 'CHALLENGE'
OUTFIT**

Real value for the beginner. It contains all the tools necessary to make a start.

13/6



'NATIONAL' OUTFIT

Containing a special comfortable grip hand-frame, spare saws, cutting table, drill, glasspaper and holder, designs and instruction book. A really sound outfit.

30/-

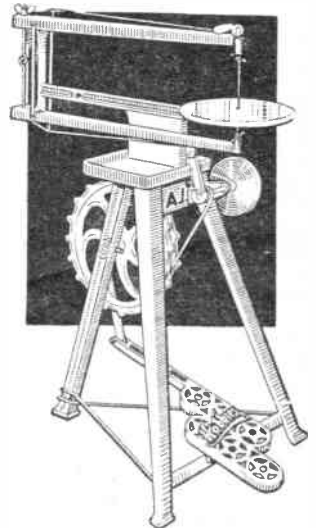

THE 'A.1' MACHINE

A sturdy machine with cast-metal legs. Easy to treadle, smooth running and rigid. Provides a factory at home for the handyman.

9gns.

THE 'GEM' MACHINE

An easy running and reliable machine, for all kinds of work. With pressed metal legs it is lighter than the A.1, but of robust construction.

£5/17/6

**ALL HOBBIES TOOLS FROM BRANCHES, STOCKISTS OR DIRECT
HOBBIES LTD, DEREHAM, NORFOLK**

Printed by BALDING & MANSELL, LTD., London and Wisbech, and Published for the Proprietors, HOBBIES LTD., by HORACE MARSHALL & SON, LTD., Temple House, Tallis Street, E.C.4. Sole Agents for Australia and New Zealand: Gordon & Gotch (A'sia) Ltd. For South Africa: Central News Agency Ltd. Registered for transmission by Canadian Magazine Post.