

# HOBBIES WEEKLY

IN THIS ISSUE

	Page
A Working Model Pleasure Cruiser	17
Make Scale Garages for Model Cars	20
A Bookcase to Fit a Corner	21
Experiments with Lactic Acid	22
Stamp Collector's Corner	23
Miniature Pictures	24
The Magic Bat	24
A 'Meter' Money Box	25
Replies of Interest	26
Ideas for Drawer Fronts	28
A Birthday Card in Wood	31



APRIL 11th 1956

VOL. 122

NUMBER 3154

## Introducing 'CRUSADER'

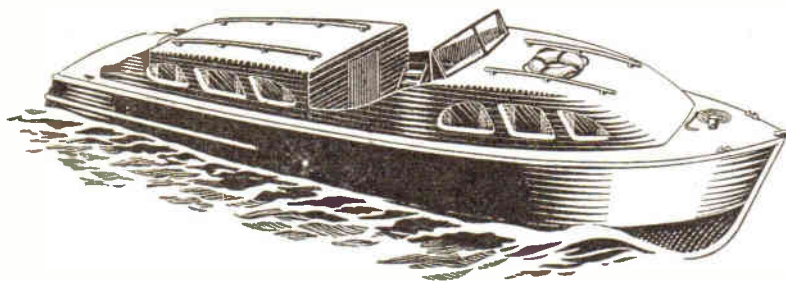

*Make it  
from this  
week's  
FREE  
Design*

## A WORKING MODEL PLEASURE CRUISER

**F**OLLOWING the success our readers had with the working model motor launch 'Patricia', we have much pleasure in presenting 'Crusader', which is a model on similar lines excepting for the addition of cabins. It is a type used on inland waters by thousands of holiday-makers, and there is accommodation normally for about six adults. The scale of our model is  $\frac{1}{2}$  in. to 1 ft. and the overall measurements are a length of 19 ins. and a beam of  $4\frac{3}{8}$  ins.

It is constructed on the hard chine principle, using formers and stringers in a similar manner to that in model aircraft making. Powered with the Mighty

Midget motor, it is guaranteed to give a speedy performance with which is allied the benefit of low battery consumption, making it very economical to run. The power is obtained from a 4.5 battery, and the movement is suitably geared down by pulleys to the propeller shaft which allows the motor to run at high revolutions, on which the Mighty Midget thrives.

Before undertaking this project, the worker is urged to study the design sheet and instructions very carefully to get a complete idea of the method of assembly. It will be noticed that some pieces, such as 16, 17 and 18, are cut to fit, and not shown on the design sheet.

All the other pieces are numbered as near as possible in the order of assembly.

When you have gone through the design and understood it thoroughly, trace the parts and transfer them to their correct thicknesses of wood. The first portion to be assembled is the keel (pieces 1 and 2). Glue the two parts of piece 2 at X and then to piece 1 at A as shown in Fig. 1. Pieces 3 and 4, which comprise the after-ends of the keel, are then glued together as shown in Fig. 2. It should be noted that for those who are using their own material, the keel assembly as shown in Fig. 1 can be made in one piece.

All correspondence should be addressed to The Editor, Hobbies Weekly, Dereham, Norfolk

*For Modellers, Fretworkers  
and Home Craftsmen*

**4  $\frac{1}{2}$  <sup>D</sup>**

PAGE 17

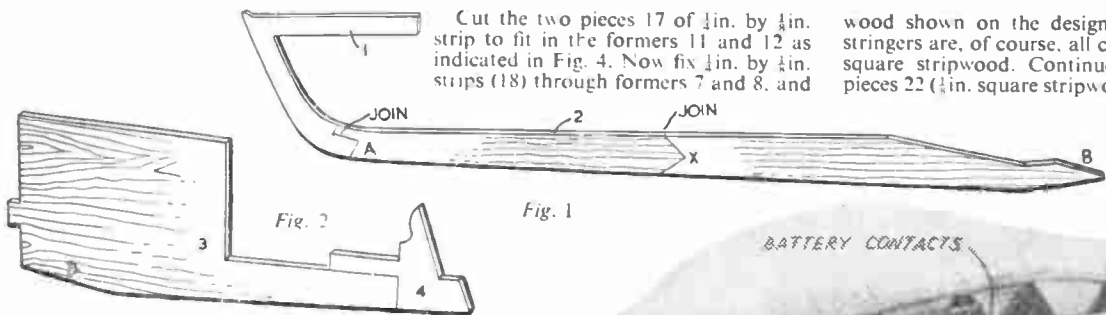

Cut the two pieces 17 of  $\frac{1}{4}$  in. by  $\frac{1}{4}$  in. strip to fit in the formers 11 and 12 as indicated in Fig. 4. Now fix  $\frac{1}{4}$  in. by  $\frac{1}{4}$  in. strips (18) through formers 7 and 8, and

wood shown on the design sheet. The stringers are, of course, all cut from  $\frac{1}{4}$  in. square stripwood. Continue by gluing pieces 22 ( $\frac{1}{4}$  in. square stripwood) up each

The next stage is to cut out the formers consisting of numbers 5 to 11 inclusive. Insert two  $\frac{1}{4}$  in. by 3 in. round head screws in former 7, the positions being shown on the design. The heads are for the battery contacts which when assembled will be facing the stern. At the same time, attach two pieces of covered wire of 8 in. and 10 in. lengths to these screws. The shorter length goes to the switch as indicated in Fig. 3, and the longer eventually leads to the motor.

Glue formers 5, 6, 7, 8 and 9 to the front portion of the keel, at the same time gluing in pieces 14 and 15 between formers 7 and 8 (Fig. 4). Waterproof glue or Balsa cement should be used throughout for the assembly.

Formers 10 and 11 and transom 12 are next glued to the rear portion of the keel (Fig. 4). The spacing of the formers is indicated by dotted lines on the actual pieces on the design sheet. Take note of

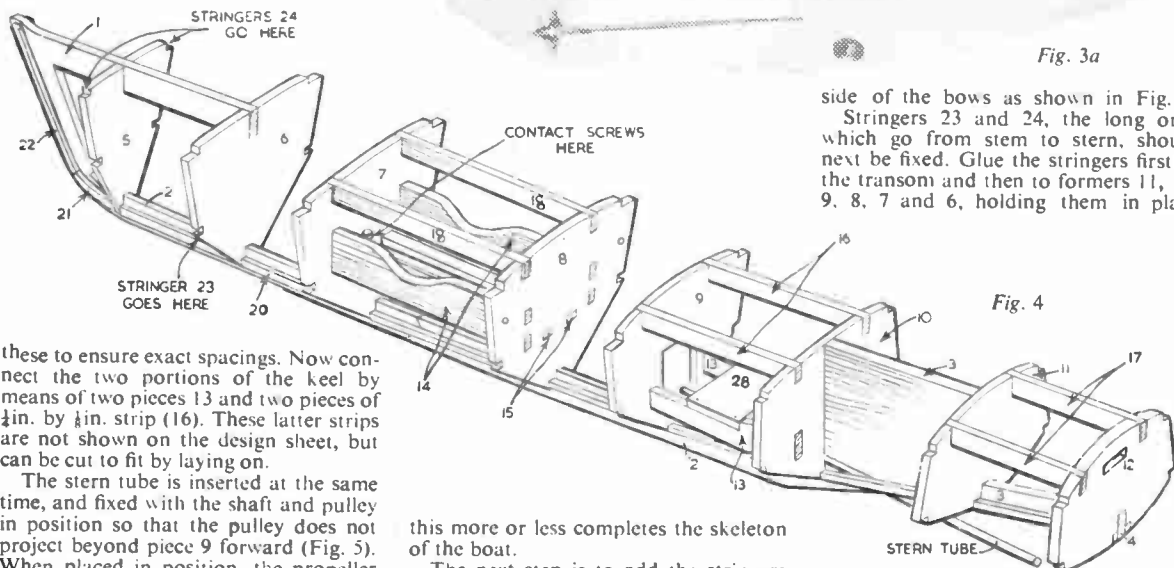
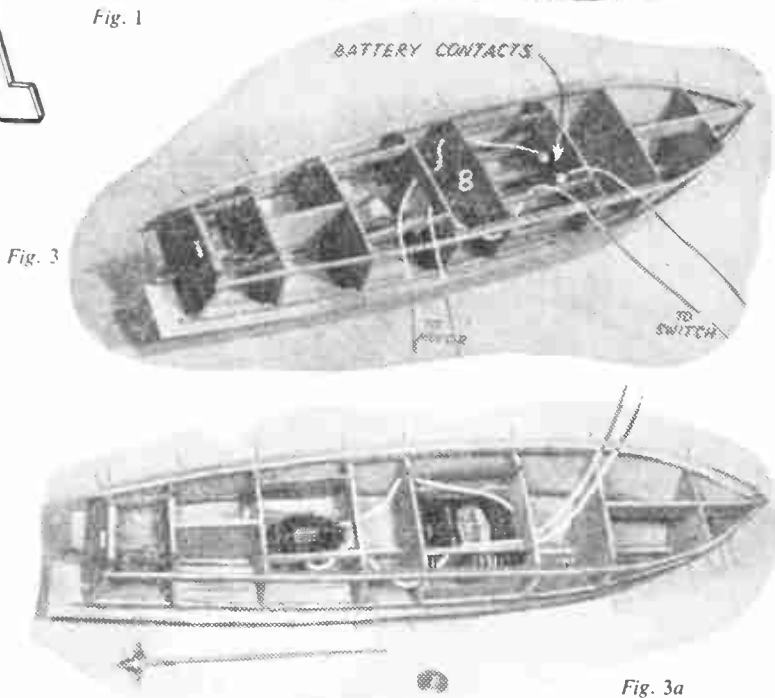

these to ensure exact spacings. Now connect the two portions of the keel by means of two pieces 13 and two pieces of  $\frac{1}{4}$  in. by  $\frac{1}{4}$  in. strip (16). These latter strips are not shown on the design sheet, but can be cut to fit by laying on.

The stern tube is inserted at the same time, and fixed with the shaft and pulley in position so that the pulley does not project beyond piece 9 forward (Fig. 5). When placed in position, the propeller should be able to revolve freely and without touching the keel of the boat. Allow a clearance of at least  $\frac{1}{8}$  in. between the keel and the outside edges of the propeller blades. The stern tube goes between the two pieces of keel at B.

this more or less completes the skeleton of the boat.

The next step is to add the stringers and skin the hull and sides. Fix short stringers (19) along formers 6, 7, 8 and 9 as in Fig. 6. Then glue the long stringers (20) along the keel as in Fig. 4. Notice that pieces 21 which are a continuation of 20, are small shaped pieces of  $\frac{1}{4}$  in.

side of the bows as shown in Fig. 4.

Stringers 23 and 24, the long ones which go from the stern to stem, should next be fixed. Glue the stringers first to the transom and then to formers 11, 10, 9, 8, 7 and 6, holding them in place

until the glue is dry by ordinary household pins. Then steam the bow end of the stringers if necessary, and when pliable fix to former 5 and stem. (Note — to facilitate the curving of the stripwood, hold it in the steam of a fast boiling

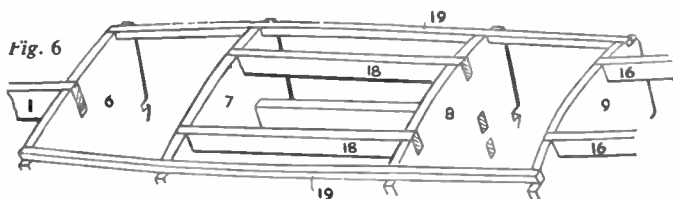
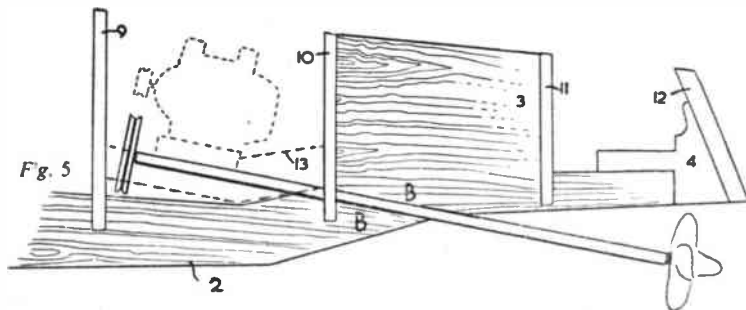

kettle and form the curve when the wood becomes pliable)

In the kit is an extra piece of  $\frac{1}{4}$  in. square stripwood to be used in place of any which has inadvertently been broken in bending. To join two pieces, glue and bind as in Fig. 7 and remove the thread when the glue is set.

The motor wire already fixed to the contact screw can now be threaded through former 8, and the wire which connects the motor and switch will also be seen to go through former 8 (Fig. 3). Both switch wires are led through the hole in former 7 into the compartment between 7 and 6 (Fig. 3A).

Now clean up all work thoroughly with glasspaper and remove excess glue with a knife. It will be noticed that stringers and formers must be shaped slightly so that the plywood skin will go on flat.

The skin of the hull can now be added, using  $\frac{1}{32}$  in. plywood. Cut a piece of card to the approximate size for a rough fit, in order to use it as a template for

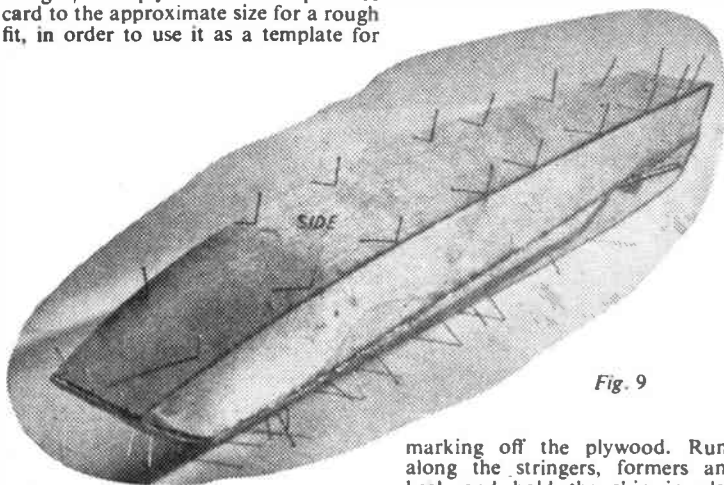
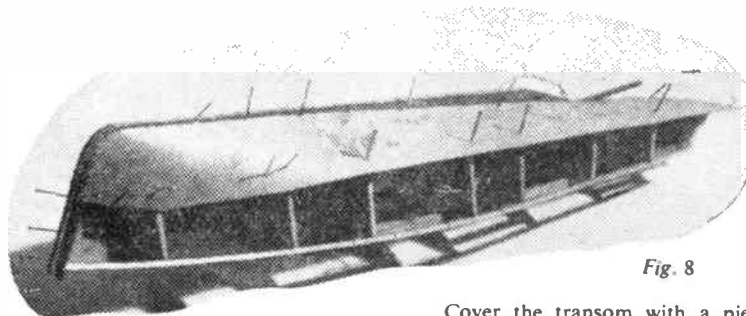
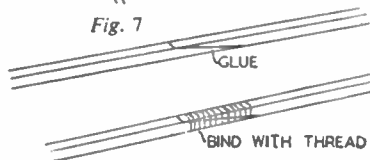

marking off the plywood. Run glue along the stringers, formers and the keel, and hold the skin in place by

Fig. 9

## Make it Easy

Hobbies Kit No. 3154 contains all the necessary wood and materials, including a Mighty Midget motor and propeller unit, needed for this grand cruiser. Kits obtainable from branches and stockists or post free from Hobbies Ltd., Dereham, Norfolk, price 45/-.

## Buy a Kit

gently tapping in ordinary household pins. It should not be necessary to use steam in order to get the curve for the bow. If the plywood has been cut slightly oversize (which is advisable), you can now trim off the excess. The pinning for this section is shown in Fig. 8.

When the skin has been applied to both sides of the hull, the sides themselves can be dealt with in the same manner, but before starting, trim the excess plywood on the hull back to the stringers (23). Now glue and pin the sides (Fig. 9). When the glue is set hard, the sides can be trimmed and cleaned up with glasspaper.

Cover the transom with a piece of thin plywood, covering the ends of the stringers and keel, but leaving a hole through which the rudder bar will protrude.

The rudder (27) is cut from  $\frac{1}{8}$  in. wood and shaped to section, and the rudder bar (26) is shaped from medium gauge wire. Details of these can be seen on the design sheet. The rudder must be drilled as shown by the dotted lines. Prise open two small screweyes far enough to take the rudder bar. Screw them into the transom, insert the rudder bar and rudder complete, and then close the screweyes with pliers. The small piece of valve rubber is intended to fit tightly in the opening so that the rudder will remain in the position as pre-set.

**This article will be concluded in next week's issue. Make sure of your copy.**



# MAKE SCALE GARAGES FOR MODEL CARS

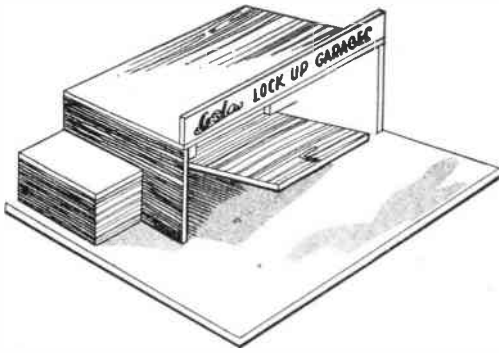

By R. H. Warring

THESE model 'lock-ups' are proportioned to house 1/18th scale model cars. The original was actually made to accommodate two of the electric-powered plastic scale models hence the 'store' attached to the end served a special purpose — to hold spare batteries. It can, of course, be omitted on your model, but it will be found very useful for holding 'spares', such as keys for clockwork motors, etc..

The proportions of the garage can be adjusted to suit models of other scales. Simply decide on the maximum length of car you wish to accommodate and divide this by 9. This will give you a factor by which all other dimensions should be multiplied to arrive at the new proportions (except for material thicknesses, which should remain the same except for very small models.)

## Basic assembly

An exploded view of the basic assembly is shown in Fig. 1. The baseboard itself can be hardboard or ply, and can, if you wish, be larger than the dimensions given. Sizes for the roof and back wall are also given on this diagram. Note that the back has two window cut outs, spaced to come in the middle of each garage. Roof and sides can be hardboard or ply.

The other walls are cut from  $\frac{3}{8}$  in. thick material, such as ply or obeche. You will probably be unable to obtain obeche sheet in 5 inch widths, but two standard width sheets are readily joined with cellulose cement, or a synthetic resin glue. The walls are marked out as in Fig. 2. Note the slot cut near the top of the deepest edge. This should be  $\frac{1}{8}$  inch wide and is best cut with a warding file, or an abrafile. Position the slot accurately and do not cut too deeply. Three walls are required off this pattern, but only one has a window cut-out.

The tops of the walls are braced with  $\frac{3}{8}$  in. square strip, glued in place (and pinned as well if you prefer). Fit these braces over length and then trim down

flush after mounting. The three walls and the back can then be assembled permanently on to the base, using glue and pins for all joints.

## Adding the store

If you wish to include the store, this is built up next as detailed in Fig. 3. Obeche sheet of  $\frac{1}{8}$  in. thickness is a satisfactory material and joints only require gluing. The top consists of two separate pieces, glued together. It is a plug fit in the frame. Assemble the store right on the baseboard and glue against one wall.

The windows can be 'glazed' and framed next. The glazing is done by cementing thin celluloid or acetate sheet to the inside, using balsa cement. The frames are then built up to fit from  $\frac{1}{8}$  x  $\frac{1}{8}$  hardwood strip, glued in place on to the celluloid — Fig. 4. Do not use excess cement in making the joints as otherwise this will ooze out over the celluloid and spoil the appearance. The hardwood strip is best cut with a fine blade fretsaw, making all joint lines as neat as possible.

The doors are fitted next. Proportions are shown in Fig. 5. The thickness

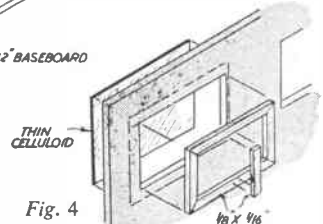
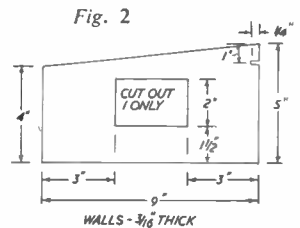
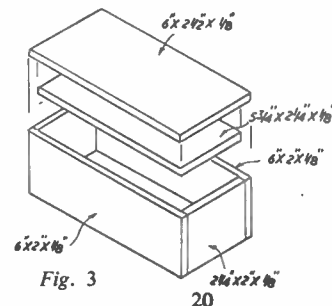
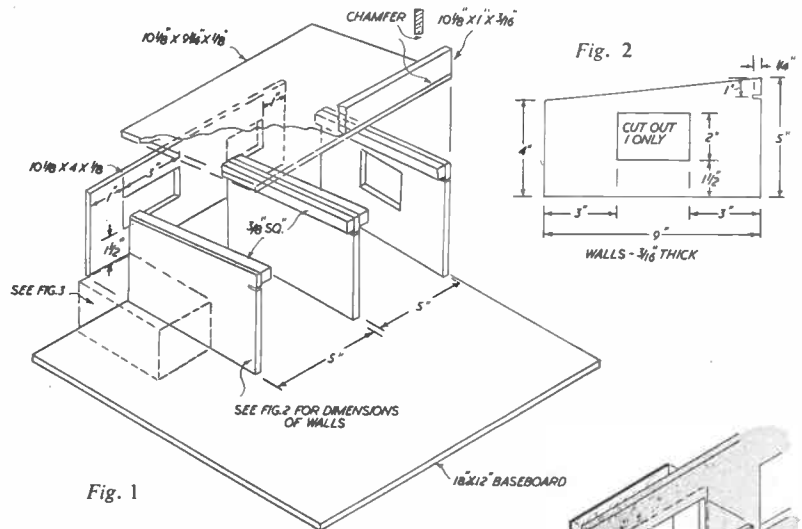

of the material is  $\frac{1}{4}$  inch and it should be solid stock, i.e. not plywood. Each door should be an accurate fit with the square cut-outs at the top corners just giving the right clearance to avoid binding on the braces. Score the front face of each door with horizontal lines to represent panelling, and then force in shotr

lengths of 18 s.w.g. wire, as shown, to act as hinge pins. The doors are mounted simply by locating these hinge pins in the slots cut in the walls.

To keep the doors from falling out a light rubber band is then fitted, as shown in Fig. 6, running between small screw eyes or bent pins fastened to the back top edge of the door, and the back wall, near roof height. Adjust the rubber band tension so that it is sufficient to hold the door open in a horizontal position but without giving too vicious a 'spring'.

To hold the door in the close position a simple lock must be fitted, consisting of an L-shaped piece of 18 s.w.g. wire anchored with two small staples. Drill a corresponding hole in the base so that the wire can be pushed down into it to keep the door closed, acting like a tiny bolt. If the wire is kinked between the staples this will prevent the bolt working

loose and being lost, but make sure that you have enough vertical movement left. Alternatively, of course, the doors can be mounted on conventional hinges, in which case it would probably be neater to cut back the bracing strips across the top of the walls and so avoid the corner cut-outs in the doors.

Once satisfied with the working of the doors, chamfer off the top edge of the back panel and fit the roof, gluing and pinning down securely. The facing strip of  $1" \times \frac{3}{8}"$  hardwood is chamfered along its bottom edge to rest truly vertical and is glued down to complete the job.

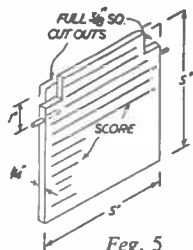

Fig. 5

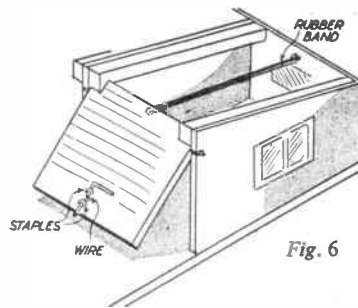

Fig. 6

Paint the garage buildings in any suitable colour, and add any other details which may appear appropriate. The baseboard is best painted matt grey, and, when dry, can be lined out freehand with a small brush and black paint to represent stone paving; or you can dust on sand whilst the paint is still wet and blow and dust off surplus later.

## A Bookcase to Fit a Corner

By J. MacIntyre

FOR a room with a very limited space the corner bookshelf solves some of the problems. It is also useful for small knick-knacks, and ornaments, etc., and provides a handy spot for the table lamp.

Half inch or  $\frac{3}{4}$  in. plywood is used throughout in making the fitment. The shelves should be cut first. This is easily accomplished by drawing a plan from the squared 2 ins. plan (Fig 1) on to the plywood.

Once the shelves have been cut to their proper sizes clean down all the edges with glasspaper. On the top shelf a small groove running right round

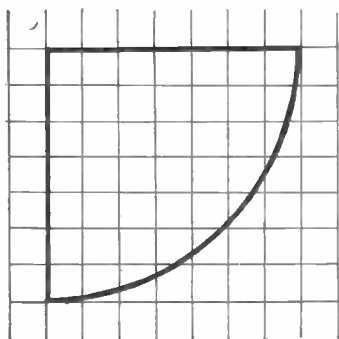

2" SQUARES

Fig. 1

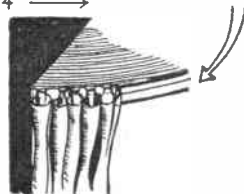
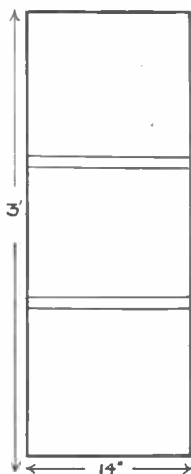

Fig. 2



should be cut to take the curtain wire. These wires are specially sprung and when stretched will hold the curtains securely in position.

### For extra strength

Then the end pieces are carefully chiselled in four places (two on each side) to support the shelves. (Fig 2) These end pieces should have three holes drilled for each shelf to take wood screws as extra strengtheners. Before assembling, glue the shelves into position. When the whole article has been completed it should be well cleaned down with glasspaper. Next, a good coat of flat white paint should be brushed on as a base for a finishing coat. Finish and colour will of course depend on the choice of the worker.

# Experiments with Lactic Acid

THE number of chemicals we unwittingly meet in everyday life is surprising. The subject of this article is a case in point. Every time we decide the milk is "off" we have bumped into lactic acid. Minute organisms present in the air (if you want to make the family sit up, tell them the organisms are called *Bacillus acidii lactici*) have got into the milk and are busily at work breaking up the milk sugar into this acid which makes the milk taste sour.

Not much lactic acid is ever formed in sour milk, because as the acid strength approaches a certain point the organisms begin to find life uncongenial and die. They can only live in not too acid surroundings. It has also been discovered that they will break down other sugars besides milk sugar into lactic acid.

Though these organisms are normally a nuisance, now that we know what makes them tick we can get our own back for once by setting them to work to prepare enough lactic acid for us to isolate a specimen for the laboratory shelves.

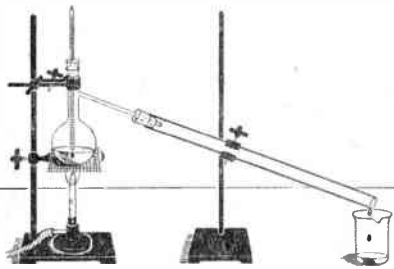

Fig. 1.—The apparatus for heating Lactic Acid

There is not much milk sugar in milk — only about 4 per cent — so we cannot expect much lactic acid from that. What we will do is to supplement it by adding ordinary cane sugar. By adding calcium carbonate in the form of precipitated chalk to combine with the acid as it is formed, we can keep the liquid neutral and so favour the activity of the organisms. By the addition, too, of a little nitrogenous matter in the form of rotten cheese we can give the organisms extra food to keep them fighting fit.

So dissolve 40 grams sugar, in 215 c.c. water, add 66 c.c. milk, 2 grams rotten cheese and 25 grams precipitated chalk. A two pound jam jar will do to contain the mixture. Tie a circle of thin cotton over the mouth to keep out dust and place the jar in a warm place, such as the top of the domestic oven.

Stir the mixture every day. Any diminution of the original volume by

evaporation must be rectified by small additions of water.

In a week or so the mixture will have formed a very stiff paste, due to the chalk reacting with the lactic acid to form calcium lactate. We now have to separate the latter. Squeeze out the mixture through cotton cloth. Extract the residue in the cloth with several lots of boiling water until no more appears to dissolve.

## Separation

Filter the united extracts through cloth, boil down to small bulk and let the liquid stand overnight. Solid calcium lactate separates out. Remove this and dry it by draining on a porous brick. Keep a portion for your chemical stock. By dissolving the rest in water and adding oxalic acid, calcium oxalate will be precipitated and lactic acid left in solution.

Each 10 grams calcium lactate (dissolved in 100 c.c. cold water) will require 4.09 grams oxalic acid (dissolved in 50 c.c. warm water). Mix the two solutions, stir well and then filter off the white calcium oxalate. The filtrate consists of a dilute solution of lactic acid. Concentrate this on the water-bath until it is slightly syrupy and then bottle it for your specimen collection.

The calcium oxalate can be washed on the filter for your specimens, too. When one wash water is no longer acid to litmus paper — that is, until a drop does not cause blue litmus paper to become red — dry filter paper and calcium oxalate in the oven. Remove the calcium oxalate to a dry bottle.

For the rest of your experiments you will find it more convenient to use bought lactic acid. You will note it is a colourless syrupy liquid and if you dilute some with water and test with blue litmus paper the paper will be fully reddened, indicating it has a strong acid reaction. It forms salts with metals easily. Later in the article we will see how some of these are prepared, but first let us see the action of heat on lactic acid.

## Heating the acid

Pour 20 c.c. lactic acid into a distillation flask fitted with a thermometer whose bulb dips into the acid. Connect up to a wide tube (to act as an air condenser) and place a beaker at the exit. Fig. 1 shows the fully rigged apparatus.

Heat the flask. Up to 210 degrees Centigrade a colourless liquid distills. This contains water and acetone. Change the receiver at 210 degrees and raise the bulb of the thermometer out of the acid. Continue heating. The distillate now

obtained will contain oily drops. When the white vapours which appear in the condenser begin to turn yellow, stop the distillation. Only about 2 c.c. of residue remains in the flask. If any crystals form in the condenser, apply the flame cautiously. They will melt and run out.

Let the second distillate stand a couple of hours. The oily drops solidify to an off-white crystalline mush. Add 70 c.c. cold water, stir well, filter off the crystals, and dry them in the filter paper on a porous tile. They can be purified by dissolving them in 12 c.c. of boiling methylated spirit, using the reflux apparatus shown in Fig. 2. On allowing the solution to cool white crystals separate, which can be dried on a porous tile for your stock. These consist of a compound called lactide.

We see from this experiment that lactic acid cannot be distilled without decomposition, for it decomposes mainly into water, acetone and lactide.

Now for the salts. Zinc lactate is a

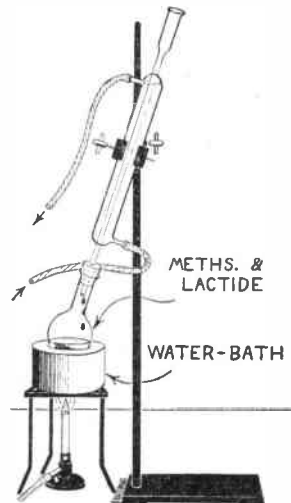

Fig. 2.—Purifying Lactide

typical salt of lactic acid. It has been used in medicine. To prepare a specimen, dilute 18 c.c. lactic acid with 60 c.c. water and boil the solution. To this add 10 grams zinc oxide, previously ground to a cream with a little water. Most of the zinc oxide will dissolve. When no more appears to do so, filter the liquid hot and set the filtrate aside to cool overnight. Crystals, in the form of small white prisms, separate. Filter these off and dry them on a porous tile. A further crop of crystals may be obtained by boiling down the original liquor and

● Continued on page 23





## THE STORY OF RICE

By L. P. V. Veale

ONE of the most important grains in the world economy is rice, and the number of stamps both foreign and from the British Empire, which have pictures that are connected with rice and its cultivation is a very fair reflection of its value.

About the earliest issue of stamps that showed anything of rice growing was the 1912 issue from Kedah, part of the Federation of Malaya. The lower values, from 1c to 8c show a sheaf of rice, and the values 10c to 50c have a view of a Malay ploughing with two water buffaloes. The next year China issued her very long set of 19 stamps.

Having discussed the commodity, and something about the conditions that are necessary for its growth, let us look at the ground in which it grows. We are very fortunate in having an excellent picture to look at for this, the illustration which appears on the 26c of the 1935 issue from U.S.A. for the Philippine Islands. There is another on the 24c of the 1932 issue. Both of these stamps show the rice terraces, the making of which convert the sides of the mountains, which otherwise would be useless, into valuable producing areas. Moreover it means that the water which would rush down the mountain side carrying the

was used again in 1943. In the case of the occupation of the Philippine Islands by the Japanese there was a very nice issue of a rice planter, showing the ways in which the plants after coming from a nursery bed are taken and planted by hand into a water covered plot.

The 1948 issue of the Republic of the Philippine Islands has a design showing the threshing of rice. This was issued in connection with the United Nations Food and Agricultural Organisation Conference which was held at Baguio. British Guiana which has always had a picture of ploughing a rice field, has a much more up to date picture on the 6c



What rice looks like

Preparing the soil

Rice terraces

Harvesting

Storing

This was the London printing and was followed by a printing from Peking with the same values and the same designs. In 1923 the designs were re-drawn and this time there were 22 values with six of them showing a Chinese coolie cutting rice. It is really rather surprising that there are not more stamp pictures from China showing something to do with rice, because this area produces far more of this crop than anywhere else in the world.

It would be possible to take a catalogue, copy down the issues on which rice is featured and mention them in order according to the date of issue, but such a method would be neither profitable nor very interesting. Instead of that we propose to take the designs irrespective of the date of issue and use them to give some idea of the growing of the crop.

In order that rice may be cultivated it is necessary to have a high temperature in summer and also that the fields in which it is being grown can be flooded. While the seedlings are in the early stages two inches of water are sufficient but as they get older then the water must be much deeper. It grows very rapidly, — as much as nine inches in twenty four hours. Two rice harvests in the year are usual in Bengal.

earth with it and causing serious soil erosion will be kept in check and only allowed to flow down from one terrace to another after it has done the work of assisting the rice to grow.

One danger must be emphasised and that is of taking for granted that a country produces a lot of a commodity simply because it shows a picture of that commodity on its stamps. One such example is Sierra Leone. If you examine the stamps from this area you see there is a picture of a rice field, and on the later stamps a picture of the cutting of rice and a native carrying it. Some rice is produced there but not sufficient to warrant one thinking that it should be called one of the production areas.

The illustration of the stamp from Burma gives a clear picture of the ploughing. Notice that it is overprinted 'Mily Admn'. If you can obtain the stamp without the overprint then you have the best of the lower values of the 1938 set; It is of the same value as the 1 rupee, but if it has the overprint 'Mily Admn' then the value is changed from 10/- to 6d. Although Burma is the area which has most rice available for export yet there are few designs showing the production. During the Japanese occupation a stamp was issued in 1942 showing ploughing and the same design

of the Queen Elizabeth issue. In this case the usual cutting by knife gives place to the rice combine-harvester. Sarawak completes the story of rice by having a picture of a rice barn on the 20c of the 1950 issue.

● Continued from page 22

### Experiments with Lactic Acid

setting it aside once more to crystallise.

A specimen of magnesium lactate is easy to prepare, too. Dilute 6 c.c. lactic acid with 60 c.c. water and warm the solution in a 250 c.c. beaker. Stir in a little at a time 3 grams magnesium carbonate. Carbon dioxide is given off with effervescence. When the reaction is over, filter the solution hot, evaporate the filtrate at the boil until minute crystals appear on the surface and then set it aside overnight. White crystals of magnesium lactate form and may be drained and dried on a porous tile.

In medicine the acid and some of its salts have long been used. Dyers employ it in some mordanting processes and it has been found to give a fine soft handle to wool. It has also proved valuable in the calico printing and tanning industries.

From normal negatives make

# MINIATURE PICTURES

**A**TTRACTIVE miniature pictures can be made by direct contact printing from your own negatives merely by using a larger size of paper and the preparation of a suitable mask.

Using quarter plate size printing paper (3½ ins. by 4½ ins.) as a basis, a mask is made to suit the size of the picture space. For 3½ ins. by 2½ ins. negatives an opening 3 ins. by 2 ins. must be cut out from the centre of a piece of black paper measuring 3½ ins. by 4½ ins., leaving a uniform border of ¼ in. all the way round. For the 2½ ins. by 2½ ins. size it is better to make a difference between the top and bottom borders as shown below with a 1 in. border at top and a 1½ ins. border at the bottom, but with ¼ in. at the sides.

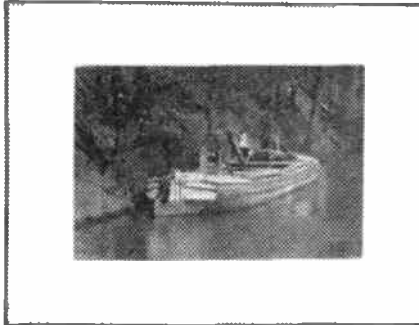

By S. H. Longbottom

square shaped mask may often be used to advantage in conjunction with the larger negative, since uninteresting features may be omitted and interest will centre in the subject.

When preparing the masks, use a set square to produce accurate corners, with a sharp knife for clean cuts. A quarter plate printing frame is also required. The mask is laid on the glass in the printing frame, the negative placed over the opening — emulsion side upwards — and then a piece of quarter plate printing paper. When making your purchase of paper, ask for double-weight variety. This is stiffer than ordinary paper, approaching the thickness of postcards. A variety of surfaces

are also available and if you have no facilities for glazing glossy paper you will find semi-matt or fine lustre a very nice surface.

Pictures of this size may be glazed and bound with passe partout either for hanging on the wall, or with a leg glued on made suitable for standing on a table.

If you wish to give your prints a real difference with the addition of a deckle edge, all you need is a ruler and two pieces of thin card the same size as the prints. The edge produced by the following method is similar to that of hand-made deckle edged papers and cards, and superior to the normal commercial product which is usually machine cut. Stack the prints together between the two pieces of card, looping a couple of rubber bands round, in one direction, to keep in place. Hold the pack firmly together on a table top, striking the uppermost sides with the edge of a ruler.

The distance between the deckles should be about ¼ in. but is unnecessary to attempt to make them equal; indeed the attraction is in the unevenness. When one side has been treated the pack is reversed and the same procedure followed. The rubber bands are then adjusted over the treated sides to allow the deckling of the other two remaining sides. With care and a little practice you will find that this simple process will enhance the look of your miniature pictures.

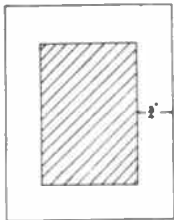

3½" × 2½" prints

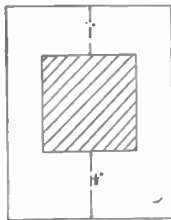

2½" sq. prints

Note that the former mask allows for making either upright or vertical prints while the same difficulty does not arise with square pictures, where the opening should be 2 ins. square. Incidentally the

## THE MAGIC BAT — By R. W. Wood

**H**ERE is a neat little trick that anyone can make from a spare piece of wood in less than half an hour. It is a miniature cricket bat having three small holes bored through it. There is also a thin wooden peg that fits tightly into any of the holes.

The performer shows the bat on both sides and pushes the peg through the top hole. He again shows both sides so that it is obvious there is no deception. Presently he passes his left hand over the bat and it is seen that the peg has jumped from one hole to the next!

The bat is again shown on both sides, then the peg is withdrawn. On being placed in the middle hole it jumps to the bottom hole of the three. The bat is always clearly shown on both sides, yet the peg jumps from hole to hole in a most mysterious manner.

To make the trick take a piece of clean white wood about ¾ ins. wide, 3½ ins. long and ¼ in. thick. It is im-

portant that both faces of the wood when smoothed and finished must appear identical in grain.

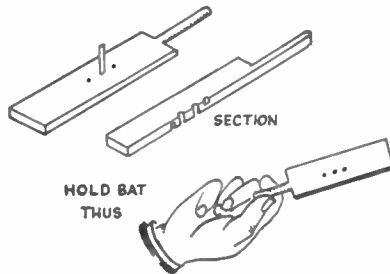

The sectional view shows how the holes are made. Two go right through the bat and two go only half way, one "blind" hole being on each side. It will now be seen that the peg will appear to be in different holes according to the side which is shown.

The actual deception lies as much in the handling of the bat as in its construction. With the peg in one hole it is held between the thumb and forefinger of the right hand in the way illustrated. The hand is now turned over to show the other side of the bat, but in turning it the bat is rolled between the finger and thumb so that the same side is shown! Thus the peg appears to be through the same hole in the bat when viewed from both sides.

To cause it to jump, pass the left hand over the bat and roll it as before, bringing the under side uppermost. Now go through the movement of apparently showing both sides, thus completing the deception.

There is a knack in handling the gadget, and a little practice will teach you the movements more easily than a host of instructions. Once the knack has been acquired you can show the trick to anyone, anywhere at any odd moment.



Save your coins in . . .

# A 'Meter' Money Box

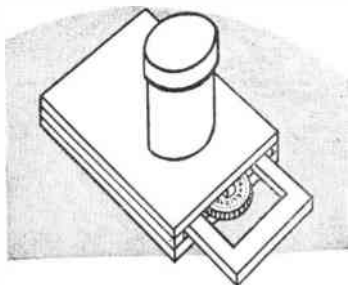

$\frac{7}{8}$  in. diameter, has first to be removed (Fig. 3). Glue over this hole a  $1\frac{1}{4}$  in. length of cardboard tubing. The tubing,  $1\frac{1}{4}$  in. diameter, on which "Cellophane" paper is wrapped, is suitable for this purpose. However, the opening will

money-box in the left hand, gently pull out the drawer, and a sixpence will fall into your hand. If the drawer is tight, then you will need to raise each side slightly.

When you are satisfied with the

*By F. Gilson*

smooth working of the drawer, stick down each side with gummed paper. Then carefully cover all the outside of the cardboard with black passe partout; but do not attempt to cover the drawer inside.

There is room for twenty sixpences. If your meter takes a shilling, then the

**H**OW exasperating it is, not to be able to use the gas stove, because you cannot find a coin for the meter!

But, if you make this simple money-box and keep it filled with suitable coins there will always be one to hand. All you

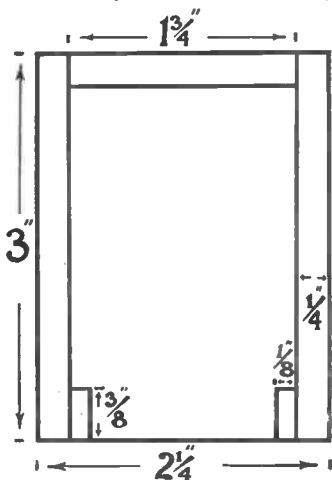

Fig. 1.—The frame

will need to do is to pull out the drawer, and one will fall out. The money-box is easy to make, and cardboard can be used for its construction for the sake of cheapness.

For the base a piece of cardboard, 3 in.  $\times$  2  $\frac{1}{4}$  in. is required. It should be at least  $\frac{1}{8}$  in. thick. On top of this base, at the sides, glue two  $\frac{1}{4}$  in. wide strips, 3 in. long. Then glue two pieces,  $\frac{1}{2}$  in. wide and  $\frac{3}{8}$  in. long, at the front ends of each strip (Fig. 1). At the back, between the side pieces, glue a strip  $1\frac{1}{4}$  in.  $\times$   $\frac{1}{4}$  in. This forms the frame.

The drawer should be made next, and for this you will need cardboard a little thicker than a sixpence, measuring 3 in.  $\times$   $1\frac{1}{8}$  in. Cut away two pieces at the sides, and the centre oblong, as in Fig. 2.

Over the base and drawer, place another piece of  $\frac{1}{8}$  in. cardboard, 3 in.  $\times$  2  $\frac{1}{4}$  in. But a round portion,

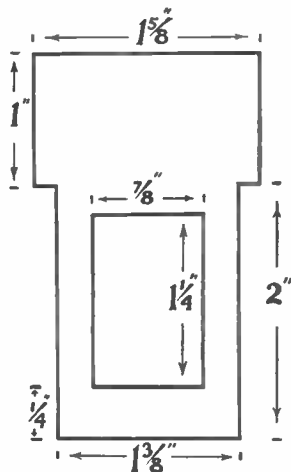

Fig. 2

need to be reduced to  $\frac{1}{4}$  in. diameter. This can easily be done, by sticking around inside a  $1\frac{1}{8}$  in. wide strip from a postcard. Push it down, so that it is level with the top of the tube.

The cap is made from a round piece of cardboard, slightly larger than  $1\frac{1}{8}$  in. diameter. Around it glue a strip from a postcard,  $\frac{3}{8}$  in. wide and 4  $\frac{1}{4}$  in. long. Remove the lid, and place some sixpences in the tube. Then, holding the

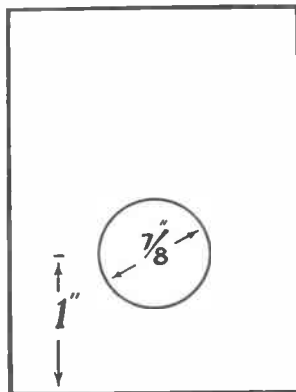

Fig. 3

hole in the tube will need to be larger, and the side pieces will have to be thicker.

## In Great Demand



The following is contained in a letter from Mr. J. G. S. Wiggill, P.O. Box 48, Welkom, O.F.S. South Africa.

'I would like to tell how delighted I am with my Model Tug Climax, for which I was lucky enough to obtain a kit in Johannesburg. Apart from its wonderful sailing qualities it makes an excellent addition, on its stand, for the dining room, so

much so that my wife has laid claim to full ownership, and I have to seek permission to sail it now and again!

'Then it only remains to tell you what pleasure Hobbies have given me, which has been profitable as well'

This tribute is one of many received concerning Design No. 251 Special kit for which costs 52/6 and can be obtained from branches and stockists etc., or post free from Hobbies Ltd, Dereham, Norfolk.



Kit No. 3096 (39/6), for the motor launch 'Patricia' is also propelled by a Mighty Midget electric motor and has also proved very popular.

# Replies to Readers

## Is this YOUR Problem?

### T.V. Suppressor

**CAN** you give me details of a simple TV suppressor gadget for a Trix permanent magnet motor driven by a 4½ volt battery? (J.D. — Glasgow).

**SPARKING** at the brushes is doubtless responsible for the trouble you mention, and may be in part due to worn, dirty, or poorly-adjusted brushes, or dirty commutator. The motor should not cause significant interference if it is as far as practicable from the receiver and aerial lead-in. If suppression is required, two condensers of about 1µF may be wired from each brush to the opposite battery circuit, on the motor. If the trouble is slight it may be sufficient to use one condenser, wired in parallel with the brushes. In very bad cases it may be necessary to earth the frame of the motor, and wire the suppressor condensers from each brush to the frame, but this would not normally be necessary with a model motor, unless very near the receiver or aerial lead-in. Short battery leads may help in reducing interference radiation.

\* \* \*

### A Cement Floor

**I WISH** to cover the rough cement floor of an outhouse about 7½ square yards. Is there a suitable liquid plastic I could use? (G.H. — Wallsend).

**IF** the floor is so rough as to present an uneven surface, it would be as well to dampen it, then render with a

½ in. thick layer of concrete, two parts sand to one of cement. For a liquid to prevent dust rising, we suggest a coat or two of POSSH which eliminates the dust where the outer surface of the floor has worn. This liquid can be bought direct from Devon Paints Ltd. Church Lane, Barnstaple, Devon. A 5/9 tin will cover 20 sq. ft. allowing for two coats.

\* \* \*

### Re-Staining Furniture

**I HAD** a light wardrobe and dressing table which I wished to darken. I used a dark oak varnish stain but it turned out to be patchy. What can I do to get the furniture back to a nice dark oak? (G.B. — Kidderminster.)

**YOU** will have to first remove the whole of the polish, and this can most conveniently be done by the use of a proprietary brand of polish remover such as you can obtain from most oil-shops and ironmongers. Lightly glass-paper over, and then apply a spirit oak stain of the desired shade. If the wood is already darkened, it would be best to dilute the stain and apply two or more coats as may be necessary to get the right tinge of oak finish desired. You can french polish over this, or apply a coat of brown hard spirit varnish as preferred.

### ☆☆☆ WORTH KNOWING ☆☆☆

☆☆☆ **Smoothing Glass Edges** ☆☆☆  
 ☆☆☆ **T**O smooth down the sharp edges of glass rub them with a paste composed of powdered carborundum and water applied with a hardwood rubber. Follow this by using a fine grade emery powder, and finish by polishing with rottenstone and water. ☆☆☆

### Tape recordings on Discs

**I HAVE** a tape recorder and wonder if it is possible to make recordings of weddings etc. and then get them on to records. I have a record player also; could this be made to turn the records while being recorded on? (O.W. — Burton-on-Trent).

**D**ISC records are made by the blank being turned by a powerful motor, a cutting head being drawn across by screw mechanism, and being fed from a powerful amplifier. The ordinary turntable motor used for playing records is not powerful enough, while a jewel cutting stylus is usually employed. If you wish to read up the subject to see what is required, books on disc recording may be obtained from large technical book shops. It is now almost impossible to buy blanks in other than large quantities, since the popularity of tape recording. Such records can only be played back a limited number of times, with fibre needles, as they deteriorate. Aluminium blanks are often used. Firms exist who will make disc recordings from a tape recording, and one may be found locally since some large musical shops include this among a recording service for local performers. The charge is usually around 15/- for one side.

## Miscellaneous Advertisements

**MODELS.** You can make lasting stone-hard models with Sankey's Pyrama Plastic Cement. Supplied in tins by Ironmongers, Hardwaremen and Builders' Merchants. Ask for instruction leaflet.

**AMERICAN MAGAZINES.** One year's A'Popular Mechanics' 32/-; 'Homecraftsman' 16/6; 'Homecraft' 18/-. Full list from Willen Ltd. (Dept. 57), 101 Fleet Street, London, E.C.4.

**KUKLOS ANNUAL.** Indispensable cyclist's handbook. Tours, resthouses, money-saving hints, 2/10, post free. — Burrow, Publishers, 2 Imperial House, Cheltenham.

**DO-IT-YOURSELF BOOKS.** List free. — S.P. Ltd., 28(H) Dean Road, London, N.W.2.

**PAINTSPRAYING' HANDBOOK** (1954 Ed.). Covers Car, Industrial & Flock Spraying. 3/6, post free, including catalogue of our Cellulose and Synthetic Paints and all Allied Sundries and Plant Hire. — Leonard Brooks Ltd., 81 Oak Road, Harold Wood, Essex.

**ACID-SHARPENED FILES.** One dozen assorted specially sharpened files, all types and cuts; ideal for modelmakers, etc. 12/6 post free. — Phoenix File Co., 22 East Union St., Manchester.

**SWISS MUSICAL Mechanism** for cigarette Sboxes, etc., 18/- post free. S.A.E. for illustration and list of tunes available. — Dept. HW., Metwood Accessories, Church St., Wolverton, Bucks. (Trade supplied.)

**GENUINE Swiss Musical Movements.** The best and largest selection of tunes in the country, lowest prices 16/3 each. Genuine Thorens Movements 21/- each. All Guaranteed. P. & P. 9d. extra on all orders. — Richardson & Forder, H.W., 5 Chapel Place, White Hart Lane, London, N.17.

**EARN** it as you do it — we provide practical equipment combined with instruction in Radio, Television, Electricity Mechanics, Chemistry, Photography, etc. — Write for full details to E.M.I. Institutes, Dept. HW., 47 London, W.4.

**STAMPS FREE** — Empire Packet including Pictorials and Victorians with approvals. — Robert J. Peck, 7A Kemp Road, Bournemouth.

**WHEELS** (Hardwood and Rubber Tyred Metal). Cot, Pram and Doll's House Fittings and Papers. Beads, Transfers, Prints and other accessories. Stamp for new lists. (Trade supplied). New address — JOYDEN CO. 91 Peplins Way, Brookmans Park, Herts.

**100 DIFFERENT** stamps free! Request ¼d. upwards discount approvals. — Bush, 53 Newlyn Way, Parkstone, Dorset.

**CONJURING Catalogue** and Gravity glass trick. 1/- — DeHempsey, 363 Sandycroft, Kew, Surrey.

**PLYWOOD;** large sizes, 14 lbs. 10/- delivered (Express) C.W.O. — H. Leader (1920), Gosford St., Middlesbrough.

**'MONEY AT HOME'** — the new monthly magazine full of money-making schemes and profitable ideas for spare-time workers, is now on sale at all newsagents. 12 issues 13/6 post free from — Dept. H., Project News Ltd., 12 Meer Street, Stratford-upon-Avon.

**154 HOBBIES** (1930's), £2. Volumes 1-5, 8, 25, £2. — Lambert, 347 Gertrude Road, Norwich.

**STAMPS** — choose some FREE from our approval books of colonials, modern sports, trains, animals and many others you need. Send today — MacStamps, 19 Crowell Rd., Cowley, Oxford.

**SWISS Musical Movements**, 15/-. Artistic Clock Supply Co., 17a New Oxford St., London, W.C.1

# Accessories by **CARBORUNDUM**

FOR YOUR HOME-WORKSHOP POWER TOOLS

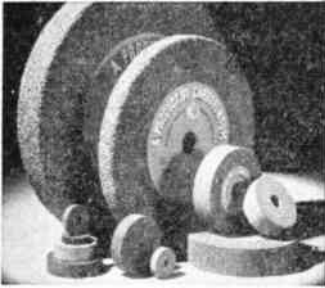

## SMALL GRINDING WHEELS

Coarse and fine wheels to fit all standard home-workshop machines are provided in a range of different grits and bonds for grinding all kinds of materials, including plastics and high-tensile steel.

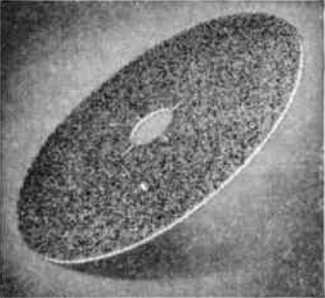

## 5" ABRASIVE DISCS

Our 5" coated-paper discs have been specially designed for home use on handyman's small-power tools. ALOXITE abrasives are provided for light metal finishing operations, and garnet abrasives for woodwork.





**MOUNTED WHEELS AND POINTS**  
*For use with high-speed tools*

CARBORUNDUM offer a complete range of mounted wheels and points in standard shapes and sizes. They find a thousand and one uses for small grinding work and for finishing operations in a wide variety of metals and other materials, ranging from hard steel to plastics.

**ALL THESE ACCESSORIES SHOULD BE AVAILABLE WHEREVER SMALL POWER TOOLS ARE SOLD FOR HOME USE. IF YOU HAVE ANY TROUBLE IN GETTING THEM PLEASE WRITE TO:**

**THE CARBORUNDUM COMPANY LIMITED, TRAFFORD PARK, MANCHESTER 17**

PHONE: TRAFFORD PARK 2381



## Abrasive products by **CARBORUNDUM**



## Finishing the job

# IDEAS FOR DRAWER FRONTS

THE instructions given here are mainly concerned with covering the fronts of drawers and not so much with drawer construction. The illustrations do not necessarily show the orthodox methods used in carpentry and joinery, but are designed to help the amateur to make a workmanlike job with the limited tools at his disposal.

Assuming that you do not wish to make a dovetail joint and have resorted to the simple method of butting the sides and front together you will need to add screws or nails for strength as shown in Fig. 1. A sectional view of this joint is shown at A in Fig. 2.

### A dust proof drawer

To form a dust proof drawer, the front can be covered entirely with  $\frac{1}{2}$  in. wood as shown by the diagram B in Fig. 2. Note that the covering projects  $\frac{1}{4}$  in. all round to form a moulding which can be shaped as desired. It can be chamfered to form a flat sloping edge or can be rounded as shown in the illustration.

shown in C. For small drawers the moulding can be reversed and allowed to project all round, forming a dust proof edging as at D. Many types of moulding are suitable for this purpose, and the one we have shown is Hobbies No. 24 moulding. This particular one is suitable for small work since it is only  $\frac{7}{8}$  in. wide.

Continuing on the same principle as at C and D it is quite in order to mitre a shaped piece of wood round as shown at E. It should be about 1 in. wide or less according to the size of drawer and should project  $\frac{1}{4}$  in. all round. Here again the outside edge may be chamfered or rounded as suggested in the previous example at B. A step further in this direction is to use Hobbies fillet moulding No. 307 mitred around the inside as indicated at F.

### Cutting the mitres

When cutting the mitres it is best to use a mitre cutting tool or a mitre block. The mitres should be accurately

saw steady therefore and keep it in the same position for each cut.

Where cheap or poor quality wood is used it can be covered with veneer and a moulding run round the outside as shown in G. In this case however the thickness of the front should be increased by  $\frac{1}{8}$  in. to  $\frac{1}{4}$  in. to allow for the thickness of the moulding. Unfortunately this method is only practicable where a suitable plane is available for making the rebate. The front must be quite flat and smooth before the veneer is glued in place.

The ideas suggested apply particularly to ordinary wood and not to plywood. In the latter case the top edge of the drawer should be covered by a strip of  $\frac{1}{4}$  in. wood. Fig. 3 shows a dovetail joint for use with  $\frac{3}{4}$  in. plywood and Fig. 4 shows the method of covering the front and top edge. Note that the front should be lower than the sides to the depth of the covering strip used.

With drawers for kitchen cabinets the method of construction shown in Fig. 5

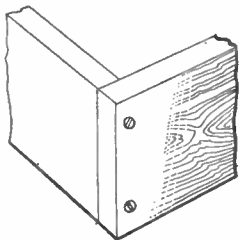

Fig. 1

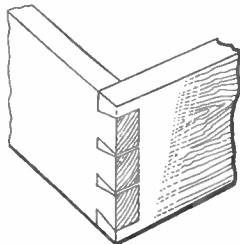

Fig. 3

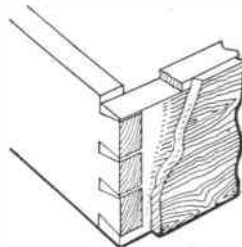

Fig. 4

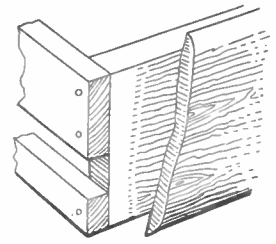
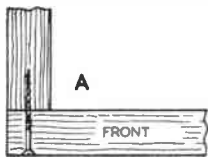
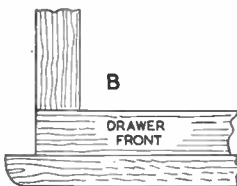

Fig. 5



A



B

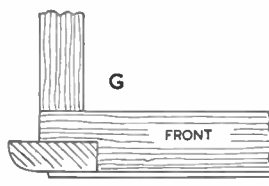

G

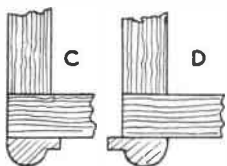

C

D

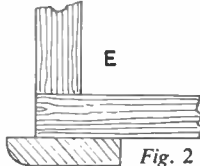

E

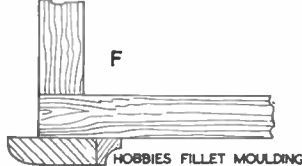

F

Fig. 2

HOBBIES FILLET MOULDING NO. 307

The shaping can be done with a small plane such as the "All steel" or Hobbies "No. 1". Finish off by using glasspaper on a large size block.

It is not essential to cover the whole of the drawer front. In many cases it will be sufficient to mitre a moulding round as

marked before cutting and it is advisable to make a trial cut before starting work. Keep the saw level and upright and try not to cut the mitre block itself. It is sometimes possible to move the saw about in the block and this can cause inaccuracies in cutting. Hold the

can be used. The side members are spaced to allow the runner to go between them. The front is then covered by a piece of wood overlapping all round to form the dust proof edging. In the case of kitchen furniture nails may be used wherever required. The heads can be punched just below the surface and the holes filled with putty or plastic wood before painting.

### Fixing the covering pieces

So far we have said nothing about the method of fixing the covering pieces to the drawers. This can usually be done with glue, but the parts must be cramped up while the glue is drying. Alternatively suitable weights such as heavy books can be used to keep the wood from warping while the glue is hardening. Where the cover piece is of sufficient thickness it is often possible to add screws from the inside of the drawer to give added strength to the glue. (M.h.)

## Make model buildings —

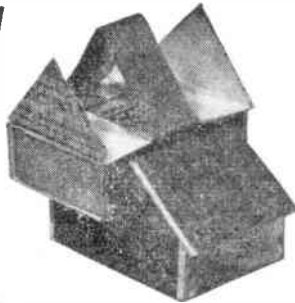
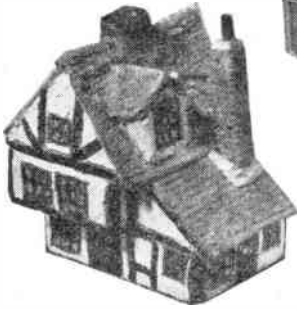

**as simply  
as this!**

**A** new method—described in a new book on Pyruma Modelling. This shows how to turn empty match boxes into model buildings, by Pyruma 'Plasticraft'. It is one of the *many* methods of modelling in plastic Pyruma, shown in black and white and full colour pages, which enable you to build and finish in natural colours:—

**MODEL FARMS, RAILWAY STATIONS, SIGNAL CABINS,  
AIRPORT BUILDINGS, DOCKS. SHIPS, FIGURES, ANIMALS,  
ASHTRAYS, BOOKENDS, DOLL'S FURNITURE, PLAQUES,  
RELIEF MAPS, ETC.**



is a ready-to-use material, cheap to buy locally, and easy to work by following the Instruction Book offered below. Pyruma dries or can be baked to stone-hard permanence, then painted in natural colours. Sold by local Ironmongers and Hardwaremen, Hobbies shops and Art material Dealers, in airtight tins from 1/6 upwards.

Send Coupon and 6d. P.O. (not stamps) for this NEW Book of instructions to:—

**J.H. SANKEY & SON, LTD.**

Estd. 1857  
Dept. H, ILFORD, ESSEX

Enclosed 6d. P.O. (not stamps) for PYRUMA MODELLING INSTRUCTION BOOK addressed to:—

NAME .....

ADDRESS .....

.....



*Saves you £'s*

**VALSPAR**

**2-4 HOUR LACQUER**

**VARNISH • WOOD STAIN**

Paint, Stain or Varnish whitewood furniture with Valspar which produces a brilliant, smooth finish — proof against boiling water, alcohol, petrol, oil and grease.

No knotting, priming or undercoating required — easily applied coat-over-coat. Dries in 2-4 hours.

See all the VALSPAR range of paints at the Ideal Home Exhibition, Stand No. 248 Grand Hall Gallery.



GOODGLASS, WALL & CO., LTD. 179/185 .CD4 Great Portland Street, London, W.1

Please send me a free copy of the Valspar Handbook giving full details of all Valspar Paints.

NAME .....

BLOCK CAPITALS .....

ADDRESS .....

.....

# Wolf Cub

## ELECTRIC DRILL AT ONLY £5.9.6

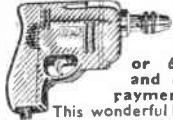

or 6/- deposit and 6 monthly payments of 19/6d.

This wonderful Electric Drill is also the power unit for ALL Cub equipment. Drilling capacity: Mild Steel, 1/2"; Hard Wood, 3/4"; with 210 watts input on full load. Complete with 1/4" three-jaw chuck and Allen key and 5ft. of cable. TV Suppressed. State Voltage. ALSO Sanding & Polishing Kit (drill, discs, etc.). Cash Price: £6.10. 6 or 19/- deposit and 6 monthly payments of 21/-

Send for Illustrated Brochure  
**BARGAIN DISTRIBUTORS** (Dept 124), 5 Silver Street, Luton

# ELECTRIC PAINT SPRAYER

## 4/- deposit



and 6 monthly payments of 13/6  
 Cash Price 75/-

Paint easily, evenly, twice as fast with the Burgess Electric Sprayer. Sprays paint, varnish, etc. Complete with sturdy glass container, flex, nozzles for ceiling spraying and extra nozzle discs for different liquids. A.C. mains—state your actual voltage. Fully guaranteed. 96-page booklet supplied FREE with Sprayer. Also Horvell Electric Paint Stripper 30/- cash, or 4/- deposit and 3 monthly payments of 10/-.

Leaflets free.

# RUBBER MOULDS FOR PLASTER WORK

From 1/6 each. Figures, dogs, cats, flights of birds, etc. Moulding Compound for Mould Making, 8/6 per lb. Moulds for Metal Soldiers from 3/- each. Lists supplied.

F. W. NUTHALL,  
 69, ST. MARKS RD., HANWELL, LONDON, W.7

# HEAR ALL CONTINENTS With H.A.C. Short-Wave Receivers

Suppliers for over 18 years of Radio S-W Receivers of quality. One-Valve Kit, Price 25/- Two-Valve Kit, Price 50/- Improved designs with Denco coils. All kits complete with all components, accessories and full instructions. Before ordering, call and inspect a demonstration receiver, or send stamped addressed envelope for descriptive catalogue. H.A.C.' Short-Wave Products (Dept. 22), 11 Old Bond Street, London, W.1

# MAKE A RADIO SET

**NO SOLDERING**—only a screwdriver and pliers needed. FULL-SIZE plans and building instructions for 8 sets, 2/6 post free. **CRYSTAL RADIO KITS:** "Varicoil", coil tuned, 10/6; "Popular", condenser tuned, 17/6; "Twin", very selective, 21/-; "Major", works well anywhere, 21/-.

**EXPERIMENTAL KIT No. 1**, builds all 4 crystal sets above, 27/6.

**"BASIC"**, a very simple 1 valve set, 35/- with valve and batteries.

**"NEW ECONOMY 1"**, receives scores of stations, 52/6 with valve and batteries.

**"NEW ECONOMY 2"**, works with loud-speaker, 82/6 with valves and batteries.

**"PERFECT" 1-VALVE LOUDSPEAKER set**, £3 with mains type valve and batteries.

Prices include postage and packing  
 Send S.A.E. for list—or send 2/6 P.O. for easy to follow building instructions for all sets.

**BLANCHARD'S DEPT. RH,**  
 13 Gainford Gardens, Manchester, 10

# THE 'ROYAL CHARLES'

is the latest design in Hobbies wide range of models of famous old-time galleons. Obtain your design FREE with

**HOBBIES 1956 HANDBOOK**  
 Now on sale (2/-) at newsgents, etc., or 2/3 post free from  
 Hobbies Ltd., Dept. 99, Dereham, Norfolk

# \* GREAT CAMPING OFFER \* RIDGE TENT SENT FOR 4/-



BRAND NEW de luxe "Safety" Tent. All colours, Complete. Ideal Cyclists.

Campers. Length 7 ft. 3 in. sleeping base x 4 ft. 6 in. wide x 3 ft. 6 in. high x 12 in. walls, all approx. Weight 3 1/2 lb. Cash 42/- or 4/- deposit and 6-monthly With fly-sheet 70/- or 9/3 deposit and 9/9 monthly. Both carr. 2/- Don't delay, send now.

# GERMAN PRISMEX BINOCULARS

**6 LENSES x 40 mm COATED LENSES.** Popular Squat Model  
**No Deposit CASH PRICE 69/6**



For wide field viewing, finest value for German Prismex Binoculars. 5 1/2 x 4 1/2", Bending Bar for eye adjustment, centre focus. Splendid magnification, 3D viewing. Clear Bloomed lenses, wide angle. Sports and holiday use, day and night lenses. Lightweight model. With case lanyard and leather straps. Send 2/6 for pack. & reg., etc. 7 days approx., if satis. send 4/6, then 8 pavs. 9/- in 8 months. CASH 69/6. LISTS, TERMS

**HEADQUARTER & GENERAL SUPPLIES LTD.**

1 HOBW X(3), 196-200 Goldharbour Lane. Loughboro Junc., London, S.E.5. Open Sat.



*Build the real thing—*

# with BRICKPLAYER

- |   |          |
|---|----------|
| Brickplayer Kit 3                                     | 26s. 0d. |
| Brickplayer Kit 4                                     | 48s. 9d. |
| Kit 3A converting Kit 3 into Kit 4                    | 26s. 0d. |
| Brickplayer Farm Kit                                  | 58s. 3d. |
| 2000 Bricks Box                                       | 55s. 0d. |
| Extra Bricks, Roofing and Cement in low-priced packs. |          |
| Windows and Doors obtainable singly.                  |          |

# BRICK AND MORTAR BUILDING KIT AND ACCESSORIES

The Brickplayer Kit contains miniature bricks in all required shapes, mortar, roofing, plastic windows and doors, plans and instruction booklet. All models are architect designed to 'O' gauge scale.

Buildings can be permanent or dismantled by merely soaking in water and the bricks used again and again. Obtainable from good toy shops and departmental stores.

If your dealer cannot supply, write for leaflet and address of nearest stockist to:

**J. W. SPEAR & SONS LIMITED**  
 Dept. 'HW', Enfield, Middlesex

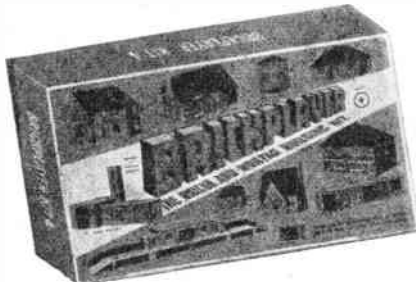



Make it 'permanent' with

# A Birthday Card in Wood

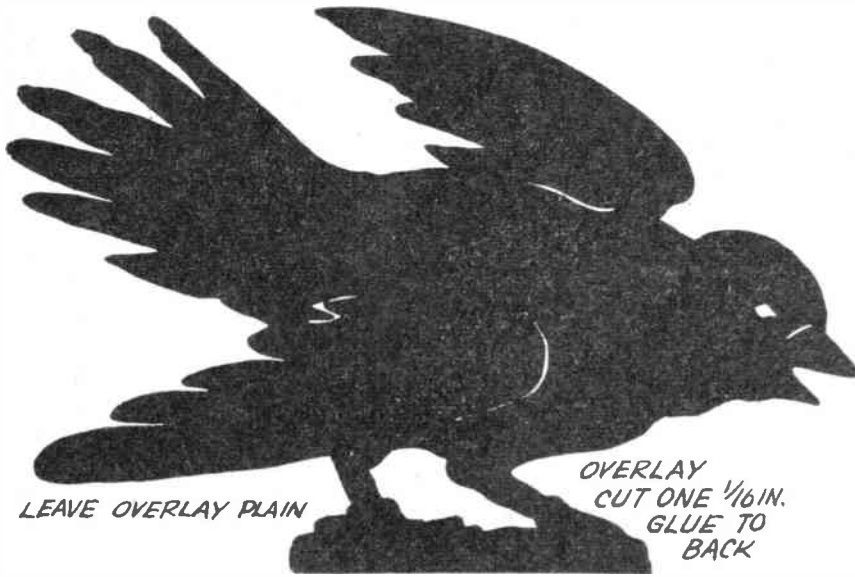

LEAVE OVERLAY PLAIN

OVERLAY  
CUT ONE  $\frac{1}{16}$  IN.  
GLUE TO  
BACK



A BIRTHDAY card in wood is an attractive gift and one which will really be appreciated.

Use your fretsaw to cut out the parts and glue them together as shown. The black background should be painted before assembling.

The greeting can be painted on or scribed in poker work. (M.p.)

STRUT. CUT ONE  
 $\frac{1}{8}$  IN. HINGE  
BEHIND BACK

BACK. CUT ONE  $\frac{1}{8}$  IN.  
PAINT BLACK

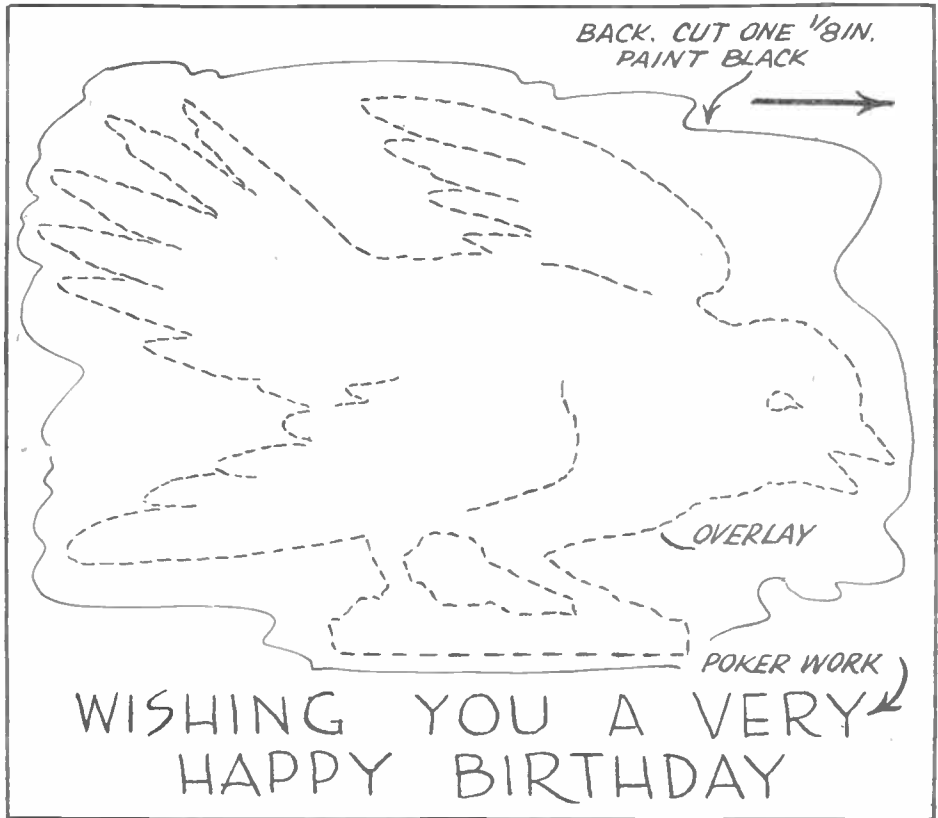
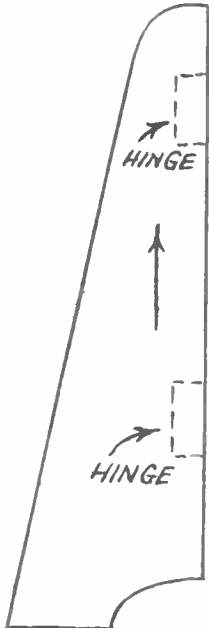

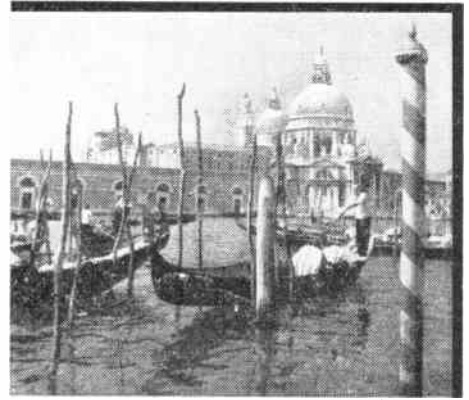

Venice, Italy.

# ILFORD FILMS

*the best*  
for <sup>1</sup>faces  
and places

ILFORD FILMS in black-and-white in all popular sizes. In 35mm. colour, too!

## NEW!

### THE PRACTICAL WAY of learning RADIO TELEVISION · ELECTRONICS

- Beginners Radio Course
- Advanced Radio
- Short Wave Technique
- Lesson Manuals

Experimental work includes construction of Basic Oscillators, Amplifiers, Deflectors, Power Units, 1, 2 and Multivalve TRF and Superhet receivers.



### COMPLETE EXPERIMENTAL COURSES IN RADIO ENGINEERING and SERVICING

An entirely new series of courses designed to teach Radio, Television and Electronics more quickly and thoroughly than any other method. Specially prepared sets of radio parts are supplied and with these we teach you, in your own home, the working of fundamental electronic circuits and bring you easily to the point when you can construct and service radio receivers, etc. Whether you are a student for an examination; starting a new hobby; intent upon a career in industry; or running your own business — these Practical Courses are ideal and may be yours at very moderate cost.

With these outfits, which you receive upon enrolment and which remain your property, you are instructed how to build basic Electronic Circuits (Amplifiers, Oscillators, Power Units, etc.) leading to designing, testing and servicing of complete Radio and Television Receivers.

COURSES FROM 15/- PER MONTH

#### POST THIS COUPON TODAY

To E.M.I. Institutes,  
Dept. 31X, Grove Park Road, London, W.4.  
Please send me your FREE book on Practical Courses

NAME .....

ADDRESS .....

April II ..... 1974

## EMI INSTITUTES

associated with  
"His Master's Voice,"  
Marconiphone,  
Columbo, etc.

## A Professional Finish at your Finger-tips!

With easy to use Robbialac Lacquer you can give your own handwork a flawless finish. You will enjoy using this quick-drying versatile Lacquer which covers perfectly in one coat, leaves no brush marks and dries to tack-free in 2-4 hours. Overnight it sets to a hard glass-like gloss that resists steam and hard wear.

Sold in a range of 24 brilliant colours plus black, white and silver, Robbialac Lacquer is available from all good paint shops, cycle shops, ironmongers and hardware dealers in handy ½, ¼, ⅛ and 1-pt. tins.



## ROBBIALAC LACQUER

FREE: Put a 'factory finish' on your handiwork. For free Instructional Leaflet send 1½d. stamp to: Dept 6L4 Jenson & Nicholson Ltd., Carpenters Road, London, E15.

Printed by BALDING & MANSELL, LTD., London and Wisbech, and Published for the Proprietors, HOBBIES LTD., by HORACE MARSHALL & SON, LTD. Temple House, Tallis Street, E.C.4. Sole Agents for Australia and New Zealand: Gordon & Gotch (A'sia) Ltd. For South Africa: Central News Agency Ltd. Registered for transmission by Canadian Magazine Post.