

HOBBIES WEEKLY

IN THIS ISSUE

	Page
The Cruiser 'Superb'	289
Canework Basketry	290
A Toy Fortress	291
An Extending Table	292
The Syrian Heart Wire Puzzle	293
A Portable Bookcase	294
Better Short-wave Listening	295
Patterns for Pen Rack and Ink Stand	296
An Electric Extension Lead	298
Protect Fish from Fungus	298
Make a Seed Drill	300
The Snap Puzzle	303



FEBRUARY 15th 1956

VOL. 121

NUMBER 3146

★ *Make it from FREE design inside*

*Waterline Model
of a
British Warship*

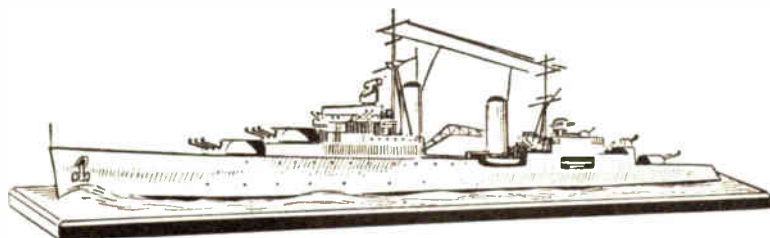

THE CRUISER 'SUPERB'

MANY of our readers have shown a keen interest in waterline models of famous ships, and we are pleased in response to requests to introduce this new model cruiser, the *Superb*, which is one of the latest of Britain's warships. Carrying a crew of 867, the *Superb* is 555ft. long, and has a beam of 64ft. Our model is to a scale of approximately 1in. equals 45ft., and makes up to 13ins. long. It will make a pleasing addition to the collections of all ship modellers.

To commence, trace the parts from the design sheet on to their appropriate thicknesses of wood as indicated, and cut them out with a fretsaw. Take particular note of the shaping of piece 2,

which gives a downward sweep towards the centre of the ship, and also the scooped-out sections in this piece, in which the small boats will be situated. Clean up all parts ready for assembly.

FOR ONLY 6/11

All the wood, wire, and card, etc., necessary for building this fine model ship are included in Kit No. 3146, which costs only 6/11 from Hobbies branches etc., or post free from Hobbies Ltd., Dereham, Norfolk.

GET A KIT NOW

This should be started by gluing piece 2 to piece 1. Continue building up the superstructure on piece 2 by adding pieces 4, 5 and 6 and so on, as indicated by the dotted lines on the various pieces on the design sheet.

Continue this step by step, building up on the stern of the ship, starting with piece 3 on which pieces 26, 27, 28, etc., are placed. A study of the numbering in Fig. 1 in conjunction with the diagrams on the design sheet will give a clear indication of how the superstructure is built up.

Next the large guns consisting of pieces 15 and 16 should be finished. Glue these in position on pieces 14, two

● **Continued on page 291**

All correspondence should be addressed to The Editor, Hobbies Weekly, Dereham, Norfolk

*For Modellers, Fretworkers
and Home Craftsmen*



A fascinating hobby

CANEWORK BASKETRY

BASKETRY is one of the oldest of man's handicrafts, but only a few people practised it until recently, as it was thought that it needed a high standard of skill. However, a system of weaving on to plywood bases has been introduced. While the true basketry 'strokes' and basic methods are still used, the craft has been greatly simplified, and the making of such items as wastepaper baskets, lampshades and flower baskets in cane can now be done by any keen hobbyist.

Tools Needed

First, a word about the tools and necessary materials. The tools required are few and sufficiently common to be in every craftworker's kit. They include a really sharp knife, a ruler and Bradawl. A pair of round-nosed pliers for kinking cane will be invaluable, while to make the cutting of cane on the inside of

could well be home-made it will probably be more satisfactory if these, too, are purchased. They are of $\frac{3}{8}$ in. or $\frac{1}{2}$ in. ply of birch, alder, and similar light-

~~~~~  
*By Christopher Allan*  
~~~~~

coloured woods, and carry a series of holes drilled through the face at a short distance from the edges, these holes being intended for upright stakes. They can be obtained in oblong, square, circular and oval shapes, in a wide variety of sizes. Thus, square bases can be obtained with sides 3ins. to 14ins. or 16ins. long, and ovals and oblongs of all sizes up to a maximum of 12ins. by 18ins., suitable for trays, etc., are similarly obtainable.

The price of these bases will vary

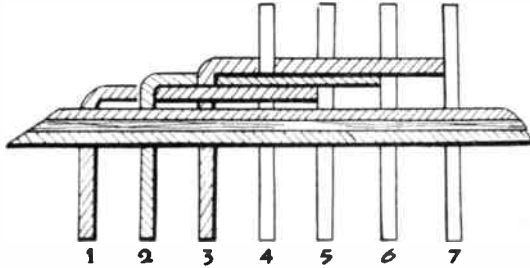

finished work easier, a pair of side-cutting pliers will be found useful.

Cane is usually sold in hanks of $\frac{1}{2}$ lb. weight, though many firms supply the material in smaller hanks at a correspondingly cheaper price. This cane is white in colour and comes from China, the Netherlands East Indies and neighbouring regions, being the core of the rattan palm. Very long lengths are obtainable (a $\frac{1}{2}$ lb. hank may consist of only a few strands), it is of circular shape, and its size is indicated by a number such as 'No. 3 cane', 'No. 8 cane', and so on. This is an easier system of describing cane than by its diameter, which may range from 2mm. for size 3 cane up to 4 $\frac{1}{2}$ mm. for size 16 cane.

In addition to the round centre cane an oval-shaped 'lapping cane' can be purchased by the foot, and can be obtained in various colours such as pink, red, cream, green and yellow. It is used for wrapping around the handles of baskets or to add a touch of colour to the work. Lapping cane is not used to any great extent by the beginner, who will find that centre cane of sizes 3, 5 and 6 are the most commonly used.

Although the necessary plywood bases

according to size. Some makers' stocks are rather cheaper than others, but prices of from 5d. to 5/- represent the average range for bases of, say, 3ins. to 16ins. diameter. Usually such bases have one completely defect-free face, so that it may be stained, painted, polished, etc., as desired, and it is also possible to buy bases having a plastic or similar decorative surface. These, however, are rather expensive and are not recommended for beginners' use.

Practise the Strokes

Before seriously attempting any canework it is advisable to practise the various weaving strokes. This can best be done by drilling a series of holes $\frac{1}{2}$ in. apart on a strip of plywood and using this as a practice board. The holes should be about $\frac{1}{2}$ in. in diameter. A supply of sizes 3 and 5 cane will be needed, and this is not necessarily wasted, as it can be resoaked and used afresh.

Centre cane must be made pliable before it can be worked satisfactorily. To do this it must be soaked in a bucket of water for ten minutes, and as it has a tendency to float, it must be anchored down, so that it gets thoroughly wet.

After removal from the bucket it should be warped in a damp cloth for a further twenty minutes before being used. It is also important to note that once weaving has started the cane must never be allowed to dry out, or it may tend to break rather than kink, and will not weave easily. When it becomes dry, therefore, it should be damped with a wet cloth.

With the material in a pliable condition, cut off a suitable number of 12ins. lengths of No. 5 cane, and thread each through a hole in the plywood, allowing each to project about 3ins. through the bottom.

The first attempt at weaving should be a 'foot trac', which is a type of border used to secure the upright stakes and to raise the base. The border is shown in Fig. 1.

To make the explanation easier to follow, the uprights have been numbered 1, 2, 3, and so on. The plywood is turned upside down, and where the stakes pass through the base, they are nipped with the round-nosed pliers, so that they will kink more easily.

Follow this Order

Stake No. 1 is bent down behind No. 2, passes in front of Nos. 3 and 4, and is then left inside No. 5. Similarly, stake No. 2 is bent behind No. 3, passes in front of 4 and 5, and is then left inside No. 6. When the border is woven as far as possible, spare ends of the stakes inside the border may be cut off with the side-cutting pliers.

The making of a continuous trac border and some other weaving strokes will be considered in the next article in this series.

FOR YOUNG FRETWORKERS

On pages 296 and 297 will be found the first of a series of fretwork patterns which will be published to assist newcomers to "get the feel" of this fascinating hobby. Experienced fretworkers will also find the projects well worth making up.

It is suggested that the complete centre page should be carefully withdrawn by lifting the wire binding staples to facilitate tracing the various parts. The pages can later be replaced to keep your copy of *Hobbies Weekly* intact.

Made from Strawboard

A TOY FORTRESS

Described

by

James

MacIntyre

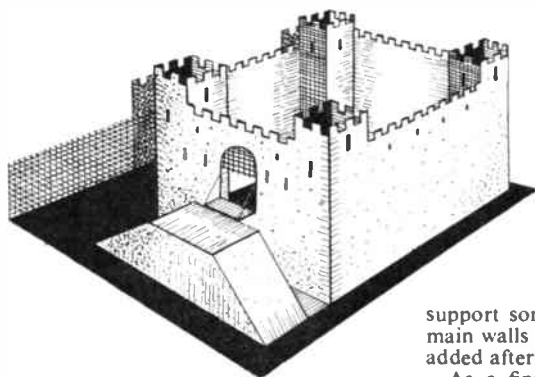

THE toy soldier fortress illustrated is made from strawboard, a heavy type of cardboard. One big advantage of using this material is that it can be easily cut with a sharp knife. Strawboard is sold by shops which stock artist's materials and one sheet measuring 34ins. by 24ins. costs approximately 2/-.

All the various pieces of the fort are held together by pieces of gummed paper which has great strength when two pieces are gummed over each other. Experience has taught the use of a finger dipped in a glass of water as a moistener when wetting the gummed paper.

From the diagrams illustrated, the various pieces are marked out on the strawboard, then carefully slit apart

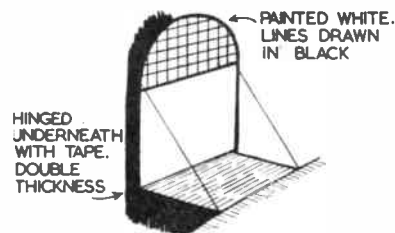

The drawbridge

with a keen bladed knife. The fort components are built on a base measuring 12ins. by 22ins., being securely held together by strips of gummed paper. For further strength add one or two extra strips at the corners.

The drawbridge is also hinged with strip paper and two pieces of cord are added to help the appearance of authenticity. The portcullis is painted by using a water-colour brush and Indian ink. Windows in the towers and sides of the fortress are also applied with the same brush.

When constructing the towers a platform could be added roughly 1½ins. from the top of the walls. This is to

support some of the lead soldiers. The main walls are built first and the towers added afterwards.

As a finish for the fortress a good strong glue is boiled up and carefully applied section by section. While each section is still tacky scatter sawdust over it to form a rough surface. When the whole fortress has been covered in this manner it should be left to dry. After the glue has set hard it is painted a 'camouflage' design of green and brown, the windows being picked out in black. The moat could be painted blue.

More walls and towers, a moat surrounding the whole fortress or, perhaps, a miniature platform around the walls, could be added. Or again, if photographs of famous castles and fortresses are available there is nothing to prevent the reader from constructing exact replicas.

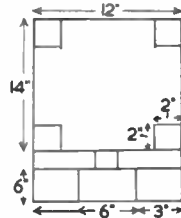

Plan Dimensions

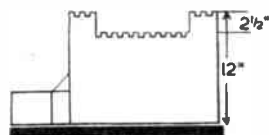

Side view

Continued from page 289

British Cruiser 'Superb'

at the forward end and one aft. Continue by assembling and fixing the small guns, torpedo tubes, boats and other equipment. Note the positioning of the crane (22) behind the forward funnel.

The masts should now be assembled from wire and card. The sections can be soldered together or bound with thread and glued. Holes should be drilled in the appropriate positions on the decks to receive the legs of the masts, and a touch of glue applied.

At this stage, fix the completed assembly to the base which is cut from stripwood and ½in. fretwood to the dimensions given on the design sheet. Secure the ship by screwing from underneath the base with ¼in. screws. Alternatively, the *Superb* can be glued to its base.

The model should now be painted all over, preferably a battleship grey with a matt finish such as is obtained with poster paint or a flat undercoat.

Readers may have their own ideas on the simulation of the sea which is painted on the base. A good effect can be obtained, however, by the following method. First paint the top of the wood base blue, allow to dry and then coat with glue. Lay on this a covering of thin Cellophane and before the glue sets,

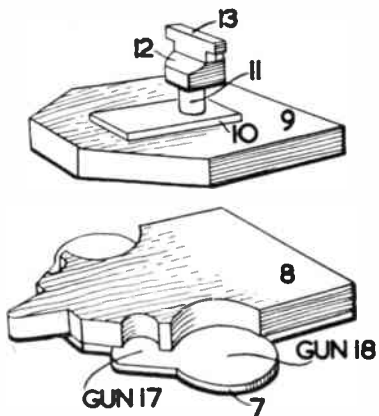

Fig. 1

this can be pushed and manipulated to form wrinkles which make realistic scale-sized ripples. Paint the top of these ripples white round the ship and in her wake. An imitation sea can also be made with Plasticine, glue and sawdust or plasticine suitably painted. There should, of course, be a slight bow wave and a stern wash.

For your home

AN EXTENDING TABLE

DESIGNED on more simple principles than the commercial pattern of extending table, the one illustrated is easier to make, and quite within the scope of the average woodworker. It extends from its normal length of 3ft. to double, providing extra space on party occasions.

By *W. J. Ellson*

A side section of the table is shown in Fig. 1, and an end elevation in Fig. 2. As the area dimensions are the same, the table being a square, measurements not found in Fig. 2, can be gained from Fig. 1. For construction, beech is suggested for the legs and oak or other suitable hardwood, which will take a stain to imitate it, are recommended for the rails and slides of the extending parts of the table top. For the tops, both extending and fixed, deal will serve for the frames, with a covering of $\frac{1}{4}$ in. plywood, thus avoiding the rather troublesome business of gluing boards together, edge to edge.

Take the legs, and at 6ins. down from the tops, chamfer their corners to 4ins. short of the bottom ends. The actual ends are bevelled off, as seen in the drawings. Cut the rails to length, plus tenons. At detail (A) the tenons are reduced to $\frac{1}{2}$ in. thick at the tenon ends, a $\frac{1}{4}$ in. slice of the wood being sawn off each side. Set out the mortises for these tenons on the legs, positioning them for the rails to be exactly central in their width. As the tenons of adjacent rails will meet in the mortises, as at (B), they must be bevelled off to 45 degrees.

Slots for sides

At one end of the table, shown in Fig. 2, a couple of slots are cut for the passage of the slides (to be dealt with later). Similar slots are cut for the same purpose in the opposite end, but as the slides working through these will be inside those of the opposite end, the position of the slots must be at distances of 4ins. from the legs, as will be fairly obvious. Glue all together, and knock the joints well home. Leave for a while for the glue to set hard. Metal plates, shown by dotted outline (G) could use-

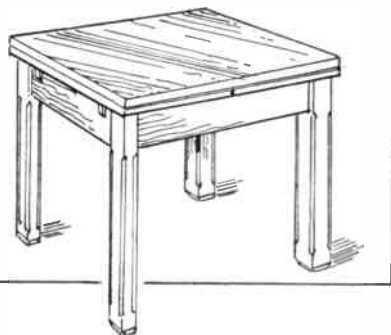

fully be screwed to the rails, inside, to prevent the wood splitting between the slots.

The frames for the table tops can now be made up. The one for the fixed top,

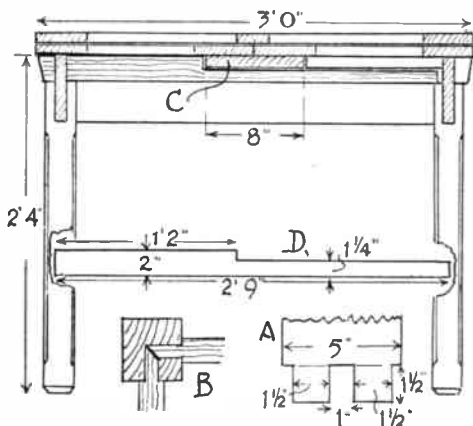

Fig. 1

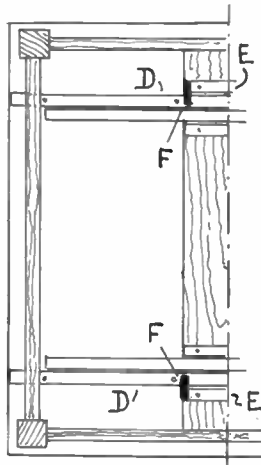

Fig. 3

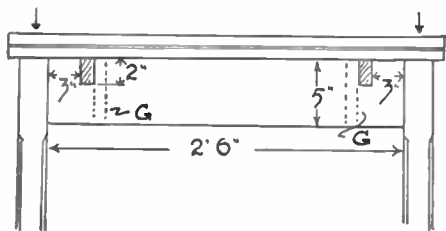

Fig. 2

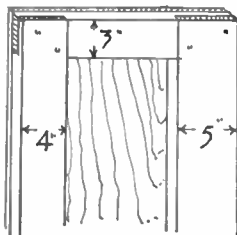

Fig. 4

CUTTING LIST	
Legs.	(4). 2ft. 4ins. by 2½ins. by 2½ins.
Rails.	(4). 2ft. 9ins. by 5ins. by 1in.
Bar. (C).	2ft. 7½ins. by 8ins. by ½in.
Slides.	(4). 2ft. 9ins. by 2ins. by 1in.
Extending tops.	(2). 2ft. 11½ins. by 4ins. by ½in.
Extending tops.	(4). 1ft. 5½ins. by 3ins. by ½in.
Extending tops.	(2). 2ft. 11½ins. by 5ins. by ½in.
Fixed top.	(2). 2ft. 11½ins. by 4ins. by ½in.
Fixed top.	(2). 2ft. 11½ins. by 3ins. by ½in.
Fixed top.	(1). 2ft. 6ins. by 3ins. by ½in.
Edging strips.	22ft. run of ½in. by ½in. wood.
Panels of plywood.	1—2ft. 11½ins. sq. and 2—2ft. 11½ins. by 1ft. 5½ins.
	½in. dowel rod, 6ins. 4 metal plates (G) ½in. by 5ins.

as we can describe it, is 2ft. 11½ins. square, with a central bar notched in. Deal of 4ins. width for the ends, with 3ins. wide stuff for sides and middle bar. For the extending parts, two frames of length 1ft. 5½ins. by width of 2ft. 11½ins. will be needed. The timbers for these are detailed in Fig. 4. Note here that the 5ins. sized ends of these are to meet together, when in position on the table, under the fixed top, and the corner joints of all just halved together and glued. The slides are screwed to these to permit of their being drawn apart far enough for the fixed top to fit between, and thus extend the length of the table.

Cover all three frames with plywood, glued and pinned over, then hide the edges with strips of $\frac{1}{4}$ in. fretwood $\frac{1}{4}$ in. wide. The meeting edges of the extend-

● Continued on page 293

Make—and solve

The Syrian Heart Wire Puzzle

PEOPLE of all ages are interested in wire puzzles and will generally 'have a go' in order to try and prove their skill. Some puzzles are easy to make, and when you know how, are equally easy to solve.

Being small and compact, wire puzzles can be carried about quite easily, and are ready to use on your friends on all occasions. With 'time on your hands' on a bus or train journey, or when waiting in a queue, a puzzle of this type can be an ideal companion and help to relieve what might otherwise be a monotonous period.

The Syrian Heart is an excellent example of a wire puzzle which can be made from a length of wire in a short time. A pair of ordinary pliers will do the job, but a neater finish will be achieved if the loops are made with round-nosed pliers.

Iron wire of 16 or 18 S.W.G. is probably the best type to use, and will not be difficult to bend to the correct shape. Either of these gauges will retain their shape reasonably well, the 16 S.W.G., being the stoutest, of course.

The puzzle consists of three parts (A), (B) and (C), the bar (C) being permanently fixed through the two loops of (B). The object of the puzzle is to remove the heart-shaped wire (A) from the other pieces without bending

the wires or forcing them in any way.

Apart from the measurements mentioned below, considerable variation is possible without affecting the working of the puzzle. However, the loop in the heart-shaped piece (A) must not be any wider or any shorter than in the drawing, and the rings in (B) and (C) must be exactly as given.

By A. F. Taylor

The complete puzzle is shown in Fig. (D), with the heart-shaped piece (A) hanging on loop (B). In the next three drawings the solution is given in detail. Starting with (E) the loop of the heart piece (A) is just entering one of the rings in piece (B) with the large ring (C) lying flat on the heart loop.

Continue sliding the ring (B) until it reaches the end of loop (A) as shown at (F). It is now only necessary to give the large loop in (C) a quarter turn as in Fig. (G), pass it through loop (A) and slide (B) off. Replacement is just as easy.

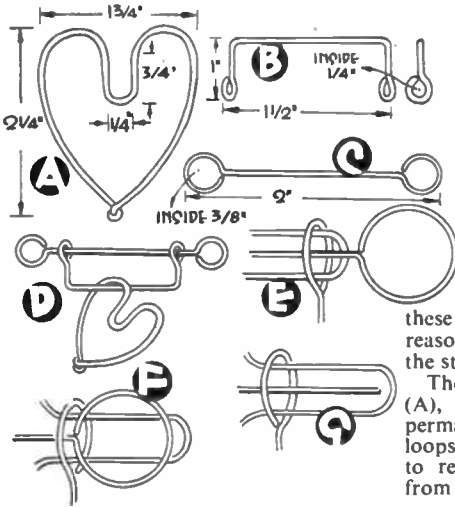

Continued from page 292

An Extending Table

ing frames are not so covered, it not being necessary. As a concession to neatness, mitre the ends of these covering strips. Place all three tops aside for the moment and proceed with the cutting of the slides.

Firstly, across the rails of the table fit an 8ins. wide board of deal, exactly at the middle. This is shown in Fig. 1 at (C) and can be notched into the rails, or screwed to wood fillets, nailed and glued to the rails beforehand at the correct distance down for (C), when fixed to them, to be just level with the top edges of the rails. The slides, lettered (D) in Fig. 1, four of which will be needed (two to each extending frame) are cut to the shape shown.

A half plan of the underside of the table is given in Fig. 3, showing the position of the slides. Place the extending frames of the table upside down on a bench, and then position the table, also upside down, upon them. See the tops extend an equal amount over the table. Place the slides in their respective slots, as in the diagram, and taking particular care to see they are truly parallel

in pairs, screw them to the underside of the frames, two screws to each slide.

To guide them in their travel, nail fillets of wood against them, as at (E), these being not so close as to impede the free passage of the slides. The fillets are nailed to middle bar (C). Bring the table right side up, draw the extending frames aside, and try the fixed top between. All being well, remove fixed top, close extensions together, then replace the fixed top above them.

Keep all three in their correct respective positions, either with hand cramps, or the assistance of a friend, then at each corner of the fixed top, and in a position directly over the centre of the legs beneath, drill 1/2in. holes through and about 1/2in. into the legs as well. Cut four pieces of 1/2in. dowel rod, about 1 1/2ins. long each, and glue these into the corner holes in the fixed top, to extend beneath about 1/2in. or a trifle less and form pins, which will keep the fixed top in its place, table extended or normal.

It would be as well, to prevent the extending frames being drawn too far out, to fit a metal stop to each slide.

This is quite a simple job. Cut four strips of metal 1/2in. wide and 2ins. long, and screw one to each of the fillets (E) in the position indicated at (F) in Fig. 3. These cover the slides. Draw the slides apart, enough to let in the fixed top between, then drive a nail or screw into each slide to butt up against these stops and so prevent further movement outwards. It will be noticed in Fig. 3, that only two such stops are shown, but the diagram is a half plan. The stops for the other two slides would be screwed to the fillets at the ends not in view.

One final point. If, when closing the extending table to normal, the meeting ends of the slides tend to catch, just bevel off a trifle at their ends. They will then glide past each other quite freely. Finish the table by staining and polishing, or varnishing, to the tone preferred.

ACCESSORIES

Telephone Handset Mouldings—P.O. Type—12/6 per set.

Single Pin, 2-way plugs—4/6 each.

Set of Transmitter Parts—10/6.

Set of Receiver Parts—10/6 each.

Tinsel Flexible Cords—tagged each end, 4ft. 6ins. long—8d. each.

Various type Relays; Induction Coils; Choke Coils; Condensers, etc.—Price on application with stamped addressed envelope.

'ONILY' COMPONENTS LTD.,
Llanerch-y-Mor, Holywell, Flintshire

A PORTABLE BOOKCASE

By F. Gilson

THIS useful bookcase can be packed into a parcel measuring 34ins. by 6½ins. by 2½ins. Consequently it is easy to transport, and to store until required. Strong and firm, the shelves are deep enough to hold many large books. To assemble takes only a few minutes. Students, especially, will find it most serviceable, on account of its convenient size and easy portability.

It is made throughout of ½in. thick wood, and consists of seven lengths (4 shelves, 2 sides, and 1 locking piece on the top shelf). Eight wooden pegs are also required for keeping the shelves firm.

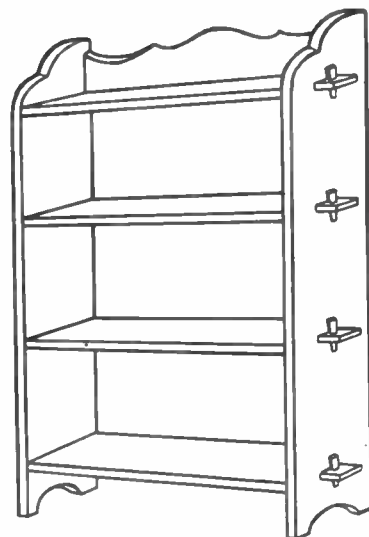

Fig. 1 The Bookcase assembled

Fit all the pieces carefully together, and push the eight pegs into the holes. Then, having tested the bookcase for rigidity, take it apart. Stain and varnish each of the seven pieces, including the pegs. When dry reassemble.

Make the sides first (Fig. 2). Two pieces of wood are needed, each 34ins. by 6½ins. Shape the top as indicated in Fig. 3, and the bottom as Fig. 4. In each of the sides make four slots, 2½ins. wide and ½in. deep (Fig. 2).

For each of the four shelves, take the ½in. wood, 28ins. by 6½ins., and cut it as in Fig. 5. The holes (A) and (B) are to receive wooden pegs. Each peg should be cut from a piece of the ½in. wood, and measures 3ins. by ¼in. Taper gradually to ¼in., so that the peg can be inserted half way in the hole (Fig. 6).

The top locking portion is cut from wood, 25½ins. by 5ins. Shape according to Fig. 7. To receive this, a slot ¼in. deep, and 2½ins. long, needs to be cut in each of the side pieces.

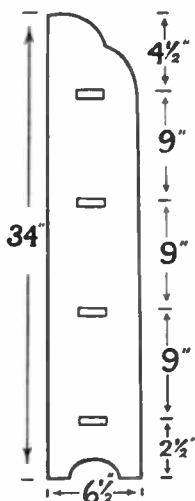

Fig. 2 Side

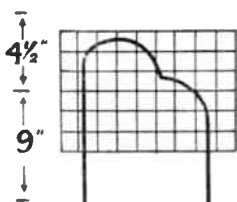

Fig. 3 Top of Side

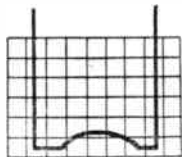

Fig. 4 Bottom of Side. Squares represent 1 in.

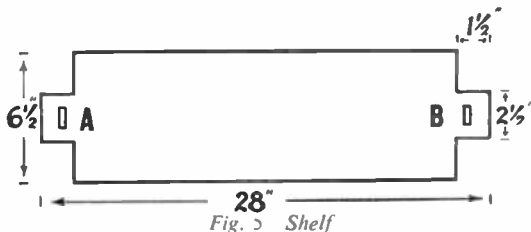

Fig. 5 Shelf

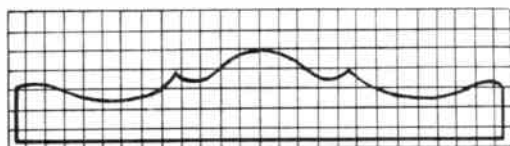

Fig. 7 Locking Piece

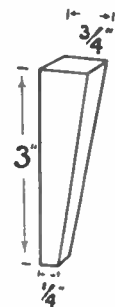
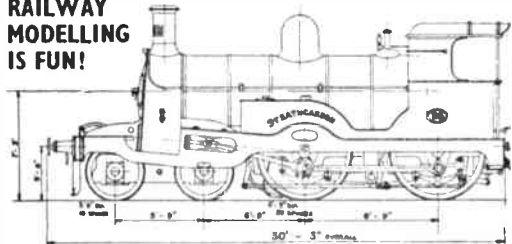

Fig. 6 Peg

RAILWAY MODELLING IS FUN!



Read The **RAILWAY MODELLER**

Monthly 1/6

Packed full of plans, pictures and articles to help you with your hobby

1/8 post paid

Dept. HW, Pecoway, Seaton, Devon

HEAR ALL CONTINENTS With H.A.C. Short-Wave Receivers.

Suppliers for over 18 years of Radio S-W Receivers of quality.

One-Valve Kit, Price 25/- Two-Valve Kit, Price 50/-

Improved designs with Denco coils. All kits complete with all components, accessories and full instructions. Before ordering, call and inspect a demonstration receiver, or send stamped addressed envelope for descriptive catalogue.

H.A.C. Short-Wave Products (Dept. 22), 11 Old Bond Street, London, W.1.

BETALLER

in 12 days or money back. New gland and spinal discovery increases height 2 to 5 inches. 'I have gained 4½ inches in height. My weight increased from 9-stone 4-lb. to 10-stone 3½-lb.'—P.D. 'Increased 3 inches'.—H.G. Guaranteed harmless. Full course 10/- (or \$1.50). Air Mail 16/3. Details 1½d. Sent under plain cover. J. H. MORLEY, 28 (H/153) Dean Rd. London, N.W.2. Practical Courses, all subjects. List free.

Better Short-Wave Listening

MOST present-day receivers have a short wave range, yet few people make much use of this. They may try it when the set is purchased, but soon decide that it is not worth bothering with. There is, however, actually much of interest on the S.W. band, and it is hoped that a few notes will help listeners to obtain more enjoyment from it, no matter whether they have a commercially-made receiver, or a special or home constructed S.W. set.

Reception Differs

Reception on the S.W. bands is very different from that on the Medium and Long Wave bands. First, S.W. signals travel much greater distances, so that world-wide reception is possible. Secondly, the various 'bands' come into use at certain periods of the day. Finally, tuning is very critical, due to the small separation of stations. For example, on the Medium Wave band of 200 to 550 metres several metres are usually allowed between stations. But with S.W. stations this is not so. Between 25 M. and 26 M., for example, in a space of only *one* metre, there are over *two hundred* transmitters, any of which could be picked up in this country when conditions are favourable.

Aerial System

Powerful stations in U.S.A., Africa, etc., will generally be audible with even a poor inefficient aerial. But much better results will be had from a good outdoor aerial, which will give a stronger signal, especially from weak stations.

Fig. 1 shows a simple S.W. aerial of good type. It should be as high as possible, and the down-lead must be as far from walls, etc., as can be arranged. A distance of less than 2ft. from the house should be avoided. Signal pick-up in the down-lead will then be good, and the horizontal portion may be omitted altogether, if circumstances make this necessary. For the one shown (known as an Inverted L) a length of 7/22 or similar wire (that is, having 7 strands of 22 S.W.G.) is best, and the whole can be 45 to 60ft. The wire is uncut right from the receiver, forming one uninterrupted length. The farther it is from trees, walls, chimneys and gutters the better, and two insulators should be used at each point of suspension. It will also give very good M.W. and L.W. reception.

S.W. 'Bands'

Stations do not appear all round the S.W. tuning scale, as they do round the M.W. scale. Instead, most are congregated into 'bands' of only a metre or so,

blank spaces (or Morse stations) arising between.

The more important bands are as follows:—

Wavelength	Usual Name
13.8 to 14 metres	13 metre band.
16.7 to 17 metres	16 metre band.
19.1 to 20 metres	19 metre band.
24.5 to 26 metres	25 metre band.
29.5 to 32.5 metres	31 metre band.
40 to 43 metres	41 metre band.
47.5 to 51 metres	49 metre band.

There are also amateur transmitter bands, those most used being the 20 M. and 40 M. bands, corresponding to actual wavelengths of around 21 M. and 42 M.

Other stations will, naturally, be found outside these bands, but they are relatively few.

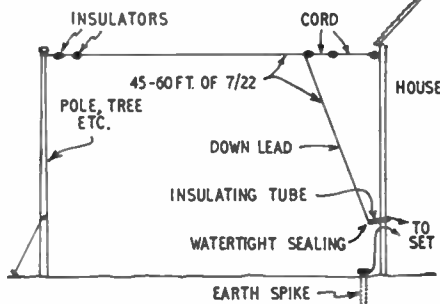

Fig. 1—Aerial for all-wave reception

As darkness moves round the Earth, the propagation of S.W. signals varies. Because of this various bands come into use, then sink into disuse, every 24 hours. The hemisphere from which signals come best also depends on the time of day. For example, in the early morning strong signals may be received from Australia, on the 25 M. band, yet none from U.S.A., while Australia may be inaudible during the evening, but the band crowded with U.S.A. and other 'local' stations. In general, the following results will most often be obtained on the various bands.

13 M. band. Afternoon, Far East (Japan, China, Philippines).

19 M. band. Morning, European. Afternoon, Far East, Near East and Africa. Evening, U.S.A.

25 M. band. Morning, Australia and European. Afternoon, Asia. Evening, Europe, Africa, Americas.

31 M. band. Early morning, Australia. Evening and Night, Asia and Americas.

41 M. band. Early evening, Asia and Africa. Night, U.S.A., Asia and Africa.

49 M. band. Afternoon, Europe. Night, U.S.A. and Africa.

Conditions vary—some days a remote station may be loud, and another it may be unheard. 'Local' stations such as those in Germany, France, Italy and Russia will usually be audible on almost any band at any time, but the above gives a good indication of the manner in which more distant stations usually grow audible. Hundreds of stations announce in English, or give English programmes. When these are heard, they may be noted down, with the time, for reference.

Careful Tuning

Even very powerful S.W. stations require to be tuned in very accurately. With weak stations, *very slow* tuning is essential—otherwise it is possible to tune right through a station without hearing it. Almost at once various European and U.S.A. stations will be

By F. G. Rayer

heard. Radio Moscow also radiates at great power. But for really distant reception these powerful signals should be ignored, and a search made for weak stations.

More than anything else, long-distance S.W. reception depends on the user. Patient, slow tuning is required. If one band seems dead, attention may be given to another. During winter evenings most bands are worth attention.

Some Stations

So many S.W. transmitters exist it is impossible to list them all, and such lists may be purchased. Below are given some of the more easily-received stations, which anyone should be able to tune in after a few days practice. These have English programmes.

Rome. 13.91 M. 16.85 M. 19.58 M. 25.2 M. 30.67 M.

Moscow. 100 stations in 19, 25, 31, 41 and 49 M. bands.

Ankara. 16.84 M. 19.79 M. 25.51 M. Switzerland. 19.84 M. 25.28 M. 31.43 M.

U.S.A. 13.88 M. 16.78 M. 19.57 M. 25.21 M.

Australia. 16.82 M. 25.21 M. 30.99 M.

Conversion into metres

Many stations give frequencies instead of wavelengths. These are in megacycles, and may be converted into metres by dividing into 300. E.g., 31.25 M. is 9.6 megacycles, etc. Some stations use the same wavelength as others, but operate at different hours.



FRETWORK PATTERN

P
PANELS
DESIGN
PANELS
BE OBT
HOBBIE
NORFO

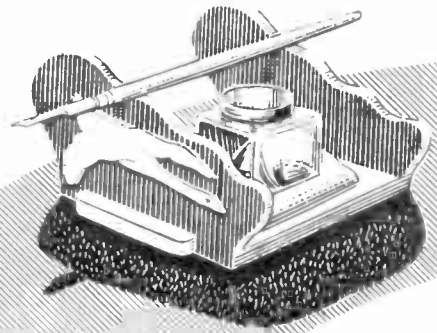
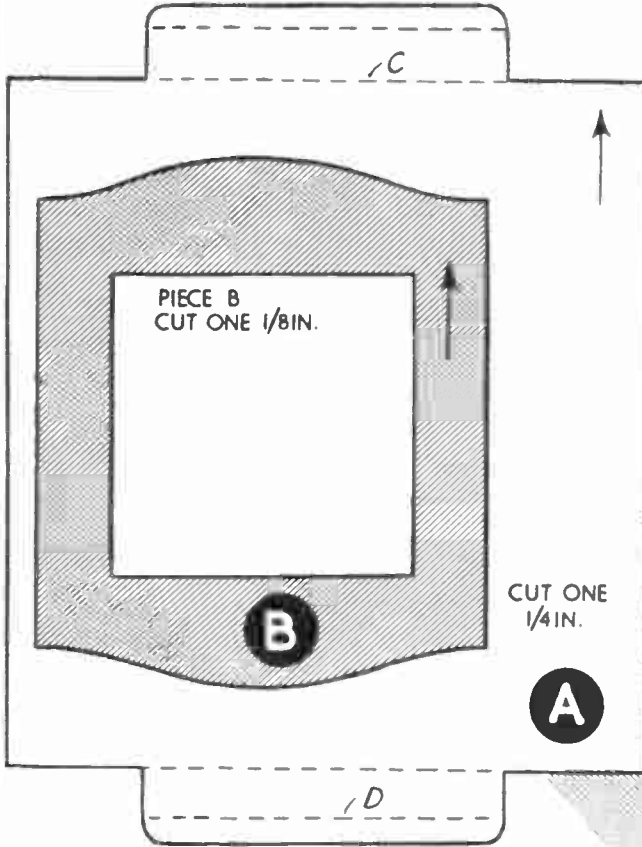

ALTERNATIVE
OVERLAYS
CUT TWO 1/8IN.

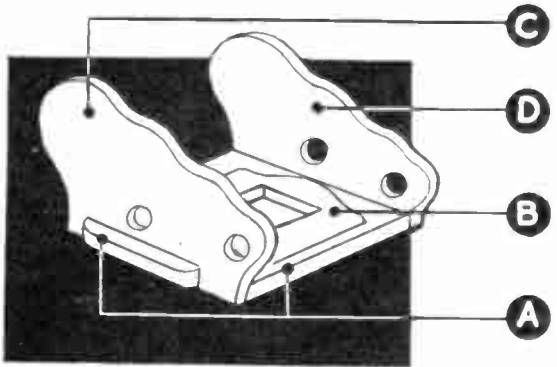
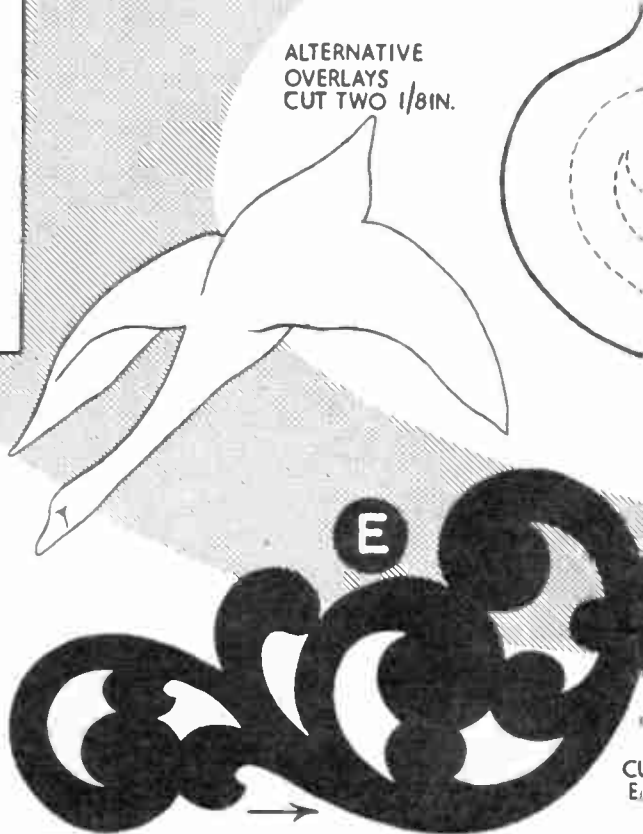

PEN RACK and INK STAND

PLAYS OF WOOD REQUIRED FOR EACH
 PEN. ONE Q4, ONE Q2.
 GLASS AND GLASS INKWELL CAN
 OBTAINED FROM
 WOODWORKING SUPPLIES LTD. DEREHAM,
 NORFOLK. PRICE ON
 APPLICATION

THE ARROWS INDICATE
 DIRECTION OF
 GRAIN OF
 WOOD

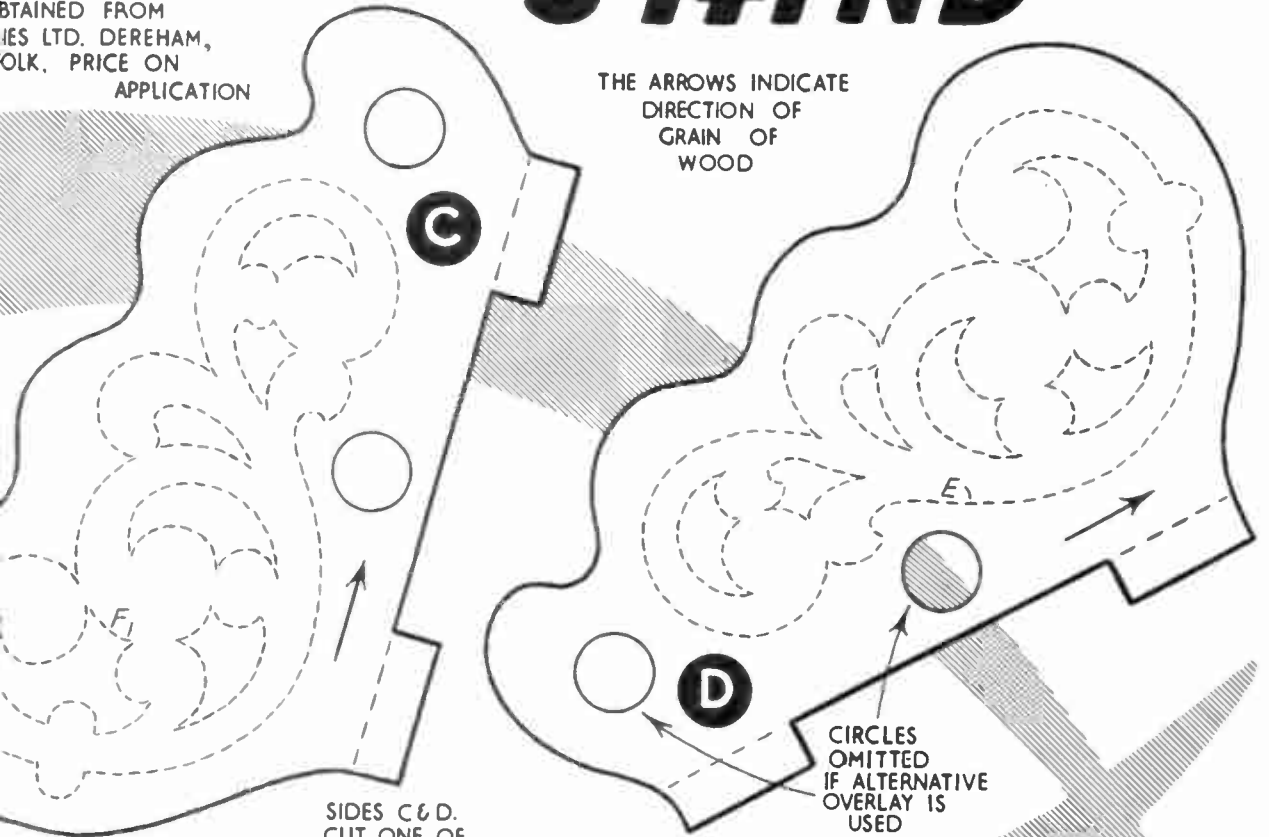

SIDES C & D.
 CUT ONE OF
 EACH 1/4 IN.

CIRCLES
 OMITTED
 IF ALTERNATIVE
 OVERLAY IS
 USED

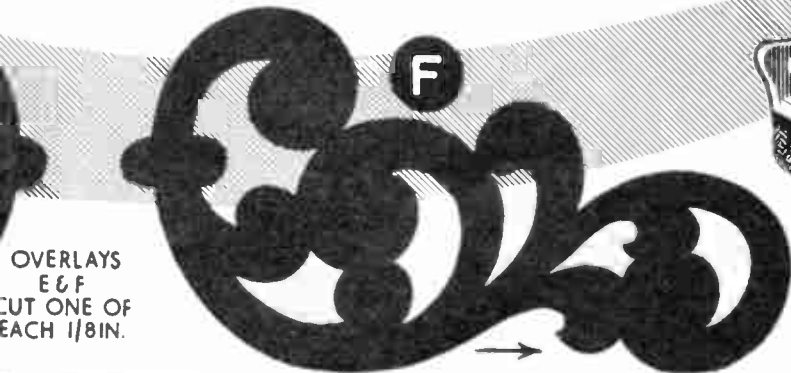

OVERLAYS
 E & F
 CUT ONE OF
 EACH 1/8 IN.

An Electric Extension Lead

FOR owners of the various types of portable electric drills, this extension lead will prove a very useful item.

First cut the plywood to fit the base of the switch block and drill it with four countersunk holes for screwing on. In the centre of one side of the block drill a hole of sufficient size to allow the cable to pass through. Remove any sharp

edges each side of the hole.

The 3-pin socket is now fitted to the block. This is done by removing the cover, placing it in the centre of the block and marking through the fixing holes. Three holes about $\frac{1}{8}$ in. diameter should be made for the wires to the socket. These can be marked through in the same way as for the fixing screws. Screw the socket into position.

The cable is now passed through the hole in the side of the block and the ends stripped back for connecting to the appropriate sockets.

To prevent the wire from pulling out it is cleated as shown in Fig. 1. This cleat is made from 20 S.W.G. copper wire and twisted up tight with pliers.

Now connect the leads as follows:— Red to 'L' terminal, Black to 'N' and Green to 'E'. At the other end of the lead the 3-pin plug is fitted in a similar manner.

Finally fit the plywood base to the block with small brass countersunk screws. (J.A.H.)

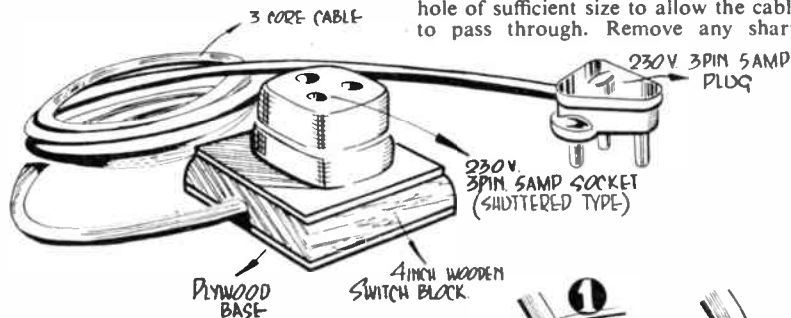

You will need a length of 3-core rubber-covered flexible cable (about 20ft.), a standard 230 volts, 3-pin 5 amp plug and socket, a wooden switch block (4ins. square) and a piece of 3 ply to suit.



Protect Fish from Fungus

ONE of the commonest diseases to which fish are prone is fungus, attacking as it does both wild fish, especially the game species as salmon and trout, and also aquarium and pond varieties. Fish confined in tanks are peculiarly susceptible to its ravages.

Fungus (*Saprolegnia ferax*) is a growth that affects any part of the body of a fish, occurring, in its earlier stages, chiefly in small patches. Injured fish are liable to the disease, which also attack weakly fish and those in poor condition following a strenuous spawning experience. In this latter category we have 'kelt' salmon, many succumbing to it after the spawning season.

The ailment is easily recognised; it is a growth appearing in the form of white or greyish threads protruding in clusters from the body of a fish. In its early stages it may be rubbed off with your fingers, and many fish so treated have ultimately recovered. Fungus is rooted in the skin, and often affects the underlying muscles; if it gets into the gills it is beyond remedy, causing in time the death of the affected fish. Otherwise there is a chance of saving the victim.

As wounded and injured fish are more liable to develop fungus than healthy ones, it cannot be too strongly urged

upon all who handle live fish from time to time to exercise greatest care when doing so, being particular not to injure the scales.

Fungus is thought to menace all kinds of freshwater fishes, and on occasions the disease has caused high mortality in various waters. In the hatcheries where thousands of fish are confined, lack of cleanliness, and the neglect of clearing out any deceased fish, and also uneaten food decomposing at the bottom of tanks and ponds may well predispose the fish to contract fungus. Attention to these details will help to minimise the trouble.

Placing affected fish in a bath of salt and water, or in a solution of permanganate of potash, is recommended as a likely cure. In *River Management* (Lonsdale Library) by H. E. Towner Coston, the following treatment is said to be satisfactory: 'Put the affected fish into a 3 per cent solution of common salt and leave them there until they show signs of distress. Slightly affected fish need only one bath, but if the disease has taken a firm hold, successive baths may be needed. Another method consists of dipping the fish into a bath of one part copper sulphate per 2,000 parts of distilled water, for one minute.'

Fungus has been described as the

'aquarist's enemy' and it certainly is a troublesome thing. An important matter is to detect it in good time, before it can become deep-seated. As soon as the disease is seen and identified, get the salt bath going. An easy way of measuring the strength of the solution is in the ratio of one ounce of salt to one gallon of water.

Be sure and have your tank emptied of its contents and thoroughly sterilise it before returning the fish after treatment. It is as well to retain the unaffected fish in a suitable receptacle for a few days until you feel sure that none of them have developed signs of the fungus. Do not put back the affected fish until you are sure they are quite cured. Spratts Patent, Ltd., supply a good steriliser, Spratt's Germicide, for purifying the aquarist's tank or aquarium. This can be obtained from most dealers of aquarium supplies.

You can help to avoid your fish contracting this disease by stocking your tank with only healthy fish in the first place. Then, when introducing additional new stock, keep the same in a separate vessel for a little time, two or three days, to ensure there is nothing wrong with them. One affected fish put into your aquarium among your stock can do considerable harm. Do not overcrowd your fish. Keep the tank clear of decomposing food, etc., as much as you can, and see that the water is well aerated. (A.S.)



Leaves no Brushmarks!

Here is a paint that provides a smooth professional finish at the touch of a brush, an easy to use quick-drying finish that covers perfectly in one coat and leaves no brushmarks. Just ask for Robbialac Lacquer, the gloss finish that is available in 24 brilliant colours plus black, white and silver and which provides a hard wearing surface that resists weather, water, steam and chemical atmosphere. Robbialac Lacquer comes in handy $\frac{1}{2}$, $\frac{1}{4}$ and 1 pint tins and is sold by all good paint shops, cycle shops, ironmongers and hardware dealers.

ROBBIALAC LACQUER

FREE: Put a 'factory finish' on your handiwork. For free Instructional Leaflet send 1½d. stamp to: Dept. 612

JENSON & NICHOLSON LTD., CARPENTERS RD., E. 15

Perfect models & ornaments so simple to make!



Profitable modelling for all the family. The Sculptorcraft range of moulding outfits includes over 200 different moulds and an extensive range of complete kits. The enthusiast can turn this pleasant hobby into a profitable one!

Illustrated is the traditional Toby Jug, Blue Bird Wall Plaques and the Highlander—only 3 in the wonderful range, all of which can be painted in the glorious colours supplied, to give an everlasting effect.



Send stamped addressed envelope for full details and illustrated literature of the complete Sculptorcraft range to Dept. HW56/1

Wolf Cub ELECTRIC DRILL AT ONLY £5.9.6

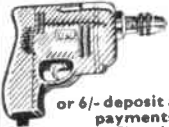

or 6/- deposit and 6 monthly payments of 19 6d.

This wonderful Electric Drill is also the power unit for ALL Cub equipment. Drilling capacity: Mild Steel, 1/4"; Hard Wood, 1/2"; with 210 watts in put on full load. Complete with 1/4" three-jaw chuck and Allen key and 5ft. of cable. TV Suppressed. State Voltage. ALSO Sanding & Polishing Kit (drill, discs, etc.). Cash Price: £6. 10. 6 or 19/- deposit and 6 monthly payments of 21/- Send for Illustrated Brochure

ELECTRIC PAINT SPRAYER 4/- deposit and 6 monthly payments of 13/6



Cash Price 75/- Paint easily, evenly, twice as fast with the Burgess Electric Sprayer. Sprays paint, varnish, etc. Complete with sturdy glass container, flex, nozzles for ceiling spraying and extra nozzle discs for different liquids. A.C. mains—state your actual voltage. Fully guaranteed. Also Horvell Electric Paint Stripper 30/- cash, or 4/- deposit and 3 monthly payments of 10/- Leaflets free.

THE MOST VERSATILE TOOL EVER!

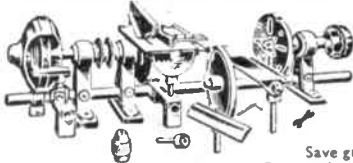

PICADOR PUP

ONLY £6.15.0 OR 25/- deposit and 6 monthly paym'ts of £1

Save ground space with this modern multi-purpose tool. PICADOR PUP comprises a wood turning lathe, a rise and fall, fully tilting circular saw, a hooded grindstone with drill sharpening attachment, together with sanding and drilling attachments also. It GRINDS, including Twist Drill Grinding, TURNS, SAVS wood, plastics or soft metals. SANDS and DRILLS. PICADOR PUP is small, compact, handy and motor driven. Only £6.15.0 cash or 25/- deposit and six monthly payments of £1. Extra cradle providing for drive by 1/4" drill. Price 23/- 3" four-jaw Chuck suitable for the above £3 cash or 16/- deposit and three monthly payments of 16/6. ALSO Picador Rotosaw, Price 33/-. Spare blades available, 8/6 each. Send 4d. for Illustrated Brochure. BARGAIN DISTRIBUTORS (Dept 124), 5 Silver Street, Luton

Sculptorcraft

SEAMER PRODUCTS (SCULPTORCRAFT) LIMITED
23/27 EASTBOURNE STREET, HULL

MAKE A SEED DRILL

WITH the days growing longer gardeners are already looking forward to the time when they can get to work on their plots, sowing the seeds for future beauty. In the meantime the implement described here can easily be made in preparation for sowing the first drill.

With it seeds can be sown the correct depth. The V-point of the tool opens out just the right shaped drill for most kinds of seeds that are sown in the open. No need to improvise with a hoe when you can make a proper tool for the job.

The fretsaw is used to make the head of the tool, which is cut from 1in. thick wood. Use hardwood, preferably oak, and choose a piece which is free from knots and shakes. You will need a piece just over 9ins. by 6ins.

And be ready to start the first sowing of the season

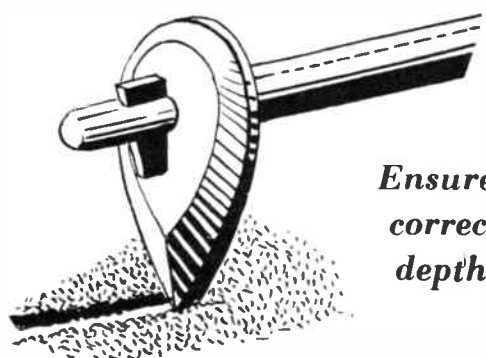

Ensures correct depth

Mark out the shape shown in Fig. 1, using compasses and rule where possible. Note that the 3ins. and 2½ins. circles must be scribed before cutting out the central hole. Cut round the outline and then chisel away the sides to make a chamfer all round. The angle of the chamfer varies as you can see from the side view. When most of the wood has been chiselled away, you can finish off with a rasp or wood file and then with coarse glasspaper. Finally rub down with fine grade glasspaper and give two or three coats of brush polish.

The back of the head can be marked out with depths from ½in. to 2ins. or even 4ins., as shown in Fig. 2. Paint a strip about 1in. wide with white paint or

enamel, giving two or three coats in order to obtain a really durable finish. The markings can be made with black paint, using a fine-pointed water-colour brush.

Next make the shaft, using a hoe or pitchfork handle. Cut it about 5ft. 4ins. overall and shape one end with a shoulder as shown in Fig. 3. The slot is for the wedge which holds the head in place. Cut the slot 1½ins. long as shown in Fig. 4. It should be just over ½in. wide to take ½in. wood.

The wedge is shown full size in Fig. 5. It is cut from ½in. oak or other hard wood and cleaned up ready for inserting in the handle. Fig. 6 shows how the wedge is inserted to hold the head in place. It must be given a gentle tap to fix it securely and prevent it falling out when the tool is in use.

After a final rub down with glasspaper, the tool can be given two or three coats of brush polish and a coat of varnish. Allow to dry for at least three or four days before attempting to use in the garden. (M.h.)

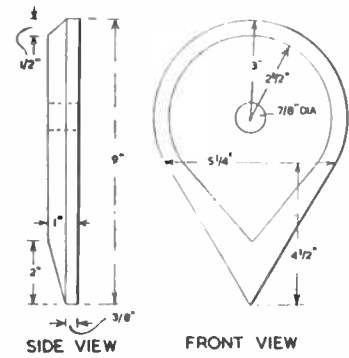

Fig. 1

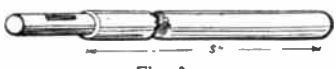

Fig. 3

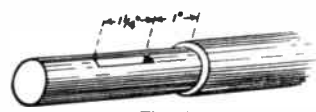

Fig. 4

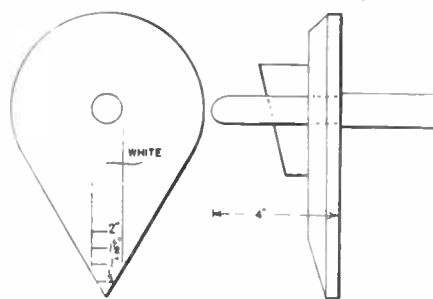

Fig. 2

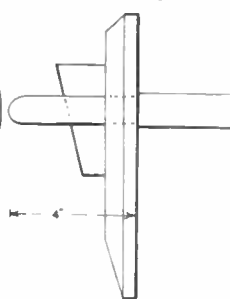

Fig. 6

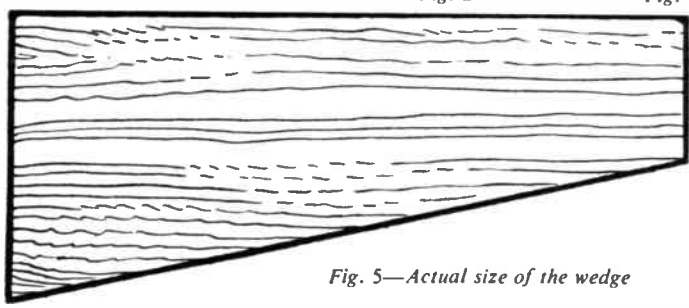

Fig. 5—Actual size of the wedge

A Book to Read

A Steam Locomotive for 'O' Gauge
by N. Dewhurst

THIS design of a model steam locomotive for 'O' gauge which can be built to scale proportions with modest equipment, and without special castings, is described here. In order that it may be attractive to a beginner in model steam locomotive construction, the functional parts are simplified and reduced to a minimum consistent with satisfactory working. A mild criticism is that some of the measurements given on the designs are hardly clear enough for the complete beginner to follow with ease.

Published by Percival Marshall & Co. Ltd., 19-20 Noel Street, London, W.1—Price 5/-.

NEW!

EXPERIMENTAL KITS

LEARN THE PRACTICAL WAY

Here is home study of the most effective kind under expert tutors. There is no better way of studying for an examination for a career in industry or starting a new hobby. Our Practical courses comprise the most modern methods of postal tuition, combined with a practical kit of parts (which is supplied upon enrolment and remains your property).

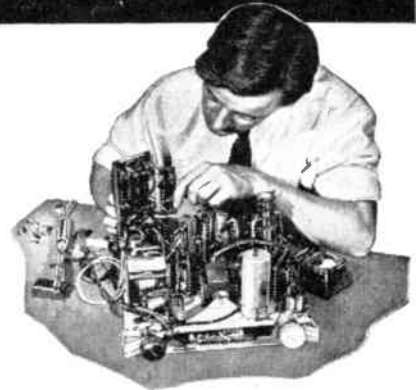

COURSES FROM 15/- A MONTH

COURSES WITH KITS INCLUDE : Radio, Television, Mechanics, Electricity, Chemistry, Photography, Carpentry; also Draughtsmanship, Commercial Art, Amateur S.W. Radio, Languages, etc.

POST THIS COUPON TODAY

E.M.I. INSTITUTES, Dept. 31X, Grove Park Road, London, W.4. Please send me your free book.

Subject(s) of Interest

NAME

ADDRESS

15/2/56 IC.51

EMI INSTITUTES

The only Postal College which is part of a world-wide Industrial Organisation.

HOME DECORATION & CARPENTRY

New ideas in the lounge? Fitted cupboards in the kitchen? This is the opportunity to do those jobs you've always THOUGHT you could do. Here is a special reprint for the Spring of these well-known and popular books. They sell fast! Do not miss this chance to get your set NOW.

All the information you need at your finger tips

Numerous illustrations and plans given at every stage for all types of work

HOME DECORATION Part I deals with outside work—order of procedure, safety precautions, tools and equipment—preparing and repairing cement, brick, stone and glass—rubbing and scrubbing paint and varnish—undercoating and finishing doors, gutters, windows, pipes and other features. Part II fully covers interior decorating. Separately deals with Ceilings, Walls, Woodwork and Floors—their cleaning and preparation, best materials and methods—suggests schemes for different rooms—tackles individual problems. Instructions all through for estimating materials needed and for mixing and matching colour.

CARPENTRY Forgotten how to do a dovetail joint? First remind yourself of the basic practices and then follow this book through the house and out into the garden and garage. Full chapters on tools—woodworking and finishing—all kinds of joints—how to make carcasses, frames, drawers, how to fit hinges—glue—veneers. Chapters on furniture and fittings throughout the house together with instructions for smaller articles. Garden 'fittings' are also dealt with. Cutting lists are given for ordering and there are sketches and plans for every stage.

FREE EXAMINATION FORM

To the New Era Publishing Co. Ltd.,
45 New Oxford Street, London, W.C.1

Please send me, carriage paid, for my inspection **Home Decoration and Carpentry** in two volumes. I understand that I am under no obligation to purchase, provided the books are returned within seven days. If I keep the books I agree to remit to your address 5/- within eight days of receipt of books, five monthly payments of 5/- and a final payment of 7/6 (completing the subscription price of £1 17s. 6d.). Cash price within eight days £1 15s. 0d.

Surname

Name
(Block letters please)

Residence

WILL BE SENT ON SEVEN DAYS' APPROVAL FREE OF COST OR OBLIGATION TO PURCHASE—COMPLETE & POST COUPON TODAY

Date..... Age (if under 21).....
HO890.



SAVE MONEY!

WITH WOLF
ELECTRIC TOOLS,
YOURS
FOR ONLY **5/- dep.**

and 7 monthly payments of 17/6. Cash £5.96
The Wolf Cub 3/4 in. drill is the most compact and powerful fully guaranteed electric drill ever marketed at a popular price. A tool with a thousand uses.

WOODTURNING LATHE

Consists of Wolf Cub 3/4 in. Drill, Bench clamp, Drill-stand Base Set, Drill-Stand, Pillar Set, Lathe Set, Woodworking Tool Set. Send for Complete Price Lists.

FOR ONLY

£1.0.0 deposit and 9 mchly. payments of £1.5.0.
Cash Price £10.10.6

FREE OFFER. Purchasers of Lathe Kit will receive FREE a parcel of offcuts consisting of two 12mm, 9-ply boards 12in. x 17in. and one obeche board 7 1/2 in. x 9in. x 3/4 in. WORTH 10/-.

THE TOOL YOU HAVE BEEN WAITING FOR



Use it for forming, smoothing, shaping. The tool with 1,001 uses. 500 razor-sharp teeth. NO SKILL NEEDED but a craftsman's finish every time.

TERMS:
PLANE
only
5/- dep. and 3 mchly. pay. of 5/- p. & p. 1/-
"FILE"
type only
5/- dep. & 2 mchly. pay. of 5/- p. & p. 9d.

Cash Price:
PLANE 17/6
1/- P. & P.
FILE 12/6
9d. P. & P.
Replacement
Blades 3/6.

ALL ITEMS POST FREE.

JOHN RYSDALE (Dept. H7), COLYTON, DEVON

PLYWOOD BARGAINS

9-PLY OFFCUTS (12mm) at less than Cost Price (BIRCH FACED).

Ideal for Modellers, Handymen, Handicraft Workers.

NO BOARD less than 17in. x 12in. Make fine pastry or drawing boards.

2 boards, 8/6 4 boards, 16/-
6 boards, 23/6 8 boards, 30/-
10 boards, 37/6

2 1/2 d. stamp for sample. Quotations for large quantities on request.

Quick delivery.



WATCH AND CLOCK REPAIR OUTFIT



The complete Outfit for cleaning and repairing. Comprises: Illustrated explanatory booklet, eye-glass, tweezers, screwdrivers, oil, dusting powder, oilers, also illustrated catalogue, tools and materials.
Plus P. & P. 6d. extra.
C.O.D. if required.

12/9

The above with additional Luminous compounds, jewellers' rouge, dial brush, jewels.

21/-

Plus P. & P. 6d. extra. C.O.D. if required.

ASSEMBLE YOUR OWN JEWELLERY

Selection of unset earrings, pendants, rings, brooches and stones, etc. at fraction of cost.

Send S.A.E. now for big illustrated free catalogue.

Money back guarantee.

THE BOLSTER INSTRUMENT CO. (Dept. HB51)
GOVETT AVENUE, SHEPPERTON, MDDX.

SPECIAL OFFER

12 Assorted Acid-Sharpended Files from 4" to 14", all shapes (including at least one Millenicut or Dreadnought File) for 12/6d. post free.

These files have been specially sharpened by a chemical process for use on Wood, Brass, Alloys, Leather, etc., and are indispensable to the Modelmaker, Handyman, Leatherworker, etc.

PHOENIX FILE CO.

22 EAST UNION STREET, OLD TRAFFORD, MANCHESTER 16

MODELS. You can make lasting stone-hard models with Sankey's Pyrama Plastic Cement. Supplied in tins by Ironmongers, Hardwaremen and Builders' Merchants. Ask for instruction leaflet.

AMERICAN MAGAZINES. One year's 'Popular Mechanics' 30/-; 'Homecraftsman' 16/6; 'Homecraft' 18/-. Full list from Willen Ltd. (Dept. 57), 101 Fleet Street, London, E.C.4.

KUKLOS ANNUAL. Indispensable cyclist's handbook. Tours, resthouses, money-saving hints, 2/10, post free.—Burrow, Publishers, 2 Imperial House, Cheltenham.

TOY CASTING MOULDS. Soldiers, sailors, airmen, etc. 1,000 varieties from 3/- each. Rubber moulding compound for flexible moulds, granulated ready for use, 8/6 per lb. Aluminium moulds for plaster work. S.A.E. for list. Catalogue 9d.—F. W. Nuthall, 69 St. Mark's Road, Hanwell, London, W.7.

SWISS MUSICAL Mechanism for cigarette boxes, etc., 18/- post free. S.A.E. for illustration and list of tunes available.—Dept HW., Metwood Accessories, Church St., Wolverton, Bucks. (Trade supplied.)

PAINTSPRAYING' HANDBOOK (1954 Ed.). Covers Car, Industrial & Flock Spraying. 3/6, post free, including catalogue of our Cellulose and Synthetic Paints and all Allied Sundries and Plant Hire.—Leonard Brooks Ltd., 81 Oak Road, Harold Wood, Essex.

STAMPS FREE—Empire Packet including Pictorials and Victorians with approvals.—Robert J. Peck, 7A Kemp Road, Bournemouth.

ATTRACTIVE stamps on approval, suitable beginners, medium collectors. Satisfaction guaranteed.—Sidney Herbert, 383, Commercial Road, Portsmouth, Hants.

* GREAT CAMPING OFFER *



RIDGE TENT SENT FOR 4/-

BRAND NEW de luxe 'Safety' Tent. All colours. Complete. Ideal Cyclists,

Campers. Length 7 ft. 3 in sleeping base x 4 ft. 6 in. wide x 3 ft. 6 in. high x 12 in. walls, all approx. Weight 3 1/2 lb. £2 15s. or 4/- deposit and 6/- monthly. Wich fly-sheet £4 2s. 6d. or 10/- deposit and 9/9 monthly Both carr. 1/6. Don't delay, send now.

REAL GOLD PLATED

GENTLEMAN'S COCKTAIL WATCH

ALSO LADY'S WATCH

NO DEPOSIT

Long running mainspring. Real Gold Plated Gentleman's Cocktail Watch (with stainless back) fitted with the popular bevelled crystal glass that really puts this watch into a different field. Aircraft shock resisting lever escapement. Crocodile grained leather strap. Lady's with cocktail strap. Expanding Bracelet 12/6 extra with either model. Full guarantee. Send only 2/6 for packing and registration. 7 days approval. If satisfactory send 7/6, then pay 8 payments 10/- within 8 months. Cash price £3.19.6. Luminous model! 6/6 extra. LISTS, TERMS.



HEADQUARTERS & GENERAL SUPPLIES LTD.

(HOBW/93), 196-200 Coldharbour Lane, Loughboro Junc., London, S.E.5. Open Sats.

GENUINE Swiss Musical Movements. The best and largest selection of tunes in the country, lowest prices 16/3 each. Genuine Thorens Movements, 21/- each. All guaranteed. P. & P. 9d. on all orders.—Richardson & Forder, H.W., 5 Chapel Place, White Hart Lane, London, N.17.

DO-IT-YOURSELF BOOKS. List free—D.S.P. Ltd., 28(H) Dean Road, London, N.W.2.

ACID-SHARPENDED FILES. One dozen assorted specially sharpened files, all types and cuts; ideal for modelmakers, etc. 12/6 post free. Phoenix File Co., 22 East Union St., Manchester.

LEARN it as you do it — we provide practical equipment combined with instruction in Radio, Television, Electricity, Mechanics, Chemistry, Photography, etc.—Write for full details to E.M.I Institutes, Dept. H.W. 47, London, W.4.

PEOPLE interested in light clean work, (not canvassing), can receive generous rates of payment by sending S.A.E. for details to—Dept. GB/1, Castle Manufacturing Company, Savoy Chambers, Middlegate, Newark, Notts.

100 DIFFERENT stamps free! Request 1d. upwards discount approvals.—Bush, 53 Newlyn Way, Parkstone, Dorset.

BOYS—make yourself a crystal set; no soldering, all parts supplied, including screwdriver, for 13/6.—Park Electric, 39a Park Street, Leamington Spa.

ALL components with instructions for slide-coil crystal set. Tunes 200-550 metres; 3/9 post free.—Bailey, 44 Stanley St., C. Oldham.

GOVERNMENT SURPLUS BARGAINS.

Inter-room Telephones, comprising 2 self-energised microphone/receivers and approx. 6yds. flex (may be extended if desired). No Batteries needed. Nothing to wear out. Complete 9/6, post 6d. Motors, Transformers, Switches, etc. 3d. stamps for illustrated list. Milligan's, 24 Harford Street, Liverpool, 3. Money Back Guarantee.

Mystify your friends with

THE SNAP PUZZLE

THIS little wooden puzzle will completely mystify your friends. They will try for hours to hook the elusive elastic.

The diagrams show all the construction. The plunger is provided with a notch, and you are supposed to hook the 'elastic loop' inside the barrel. Tell your friends to hook the loop, and watch their antics.

As will be seen in the diagrams (A) and (B) there is no loop inside at all. It is camouflage, the two ends of elastic giving the appearance of a loop inside. When showing your friends how to 'hook the elastic' you put the plunger in as far as it will go, twist it round, first in one, then in the other direction. After a few 'false' tries you pull it out gently for about 1 in., then snap it back. The 'snap' is caused by squeezing the handle between the finger and thumb. If the handle is smooth you can make it snap back just as if you had in fact hooked the 'loop of elastic'. (M.p.)

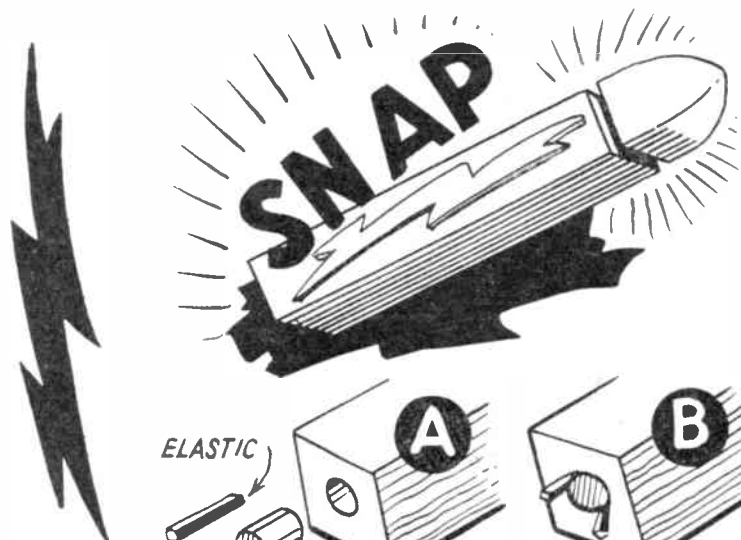

OVERLAYS.
CUT TWO $\frac{1}{8}$ IN.

ELASTIC

DOWEL

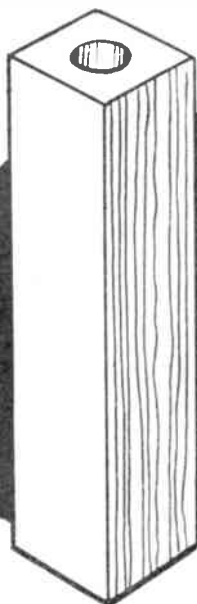
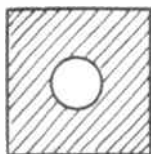

FINISHED
BARREL

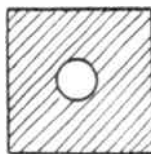
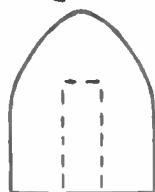

SECTION

THE HANDLE.
CUT ONE FROM
 $\frac{3}{4}$ IN. SQUARE
STRIPWOOD

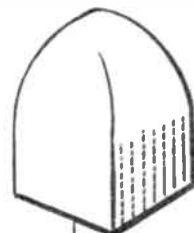

THE
FINISHED
PLUNGER

NOTCH

BARREL. CUT
FROM $\frac{3}{4}$ IN. SQUARE
STRIPWOOD

PLUNGER.
CUT ONE
FROM $\frac{3}{16}$ IN. DIA.
ROUND ROD



Do-it-yourself

with a Spear & Jackson saw

Fine saws priced to suit all pockets. They're manufactured by the makers of the craftsman's first choice—world-famous 'Spearior' Handsaw.

'Aetna' General Purpose Saw.

'Sovereign' The Amateur Craftsman's Saw.

'Cockerill' Household Saw.

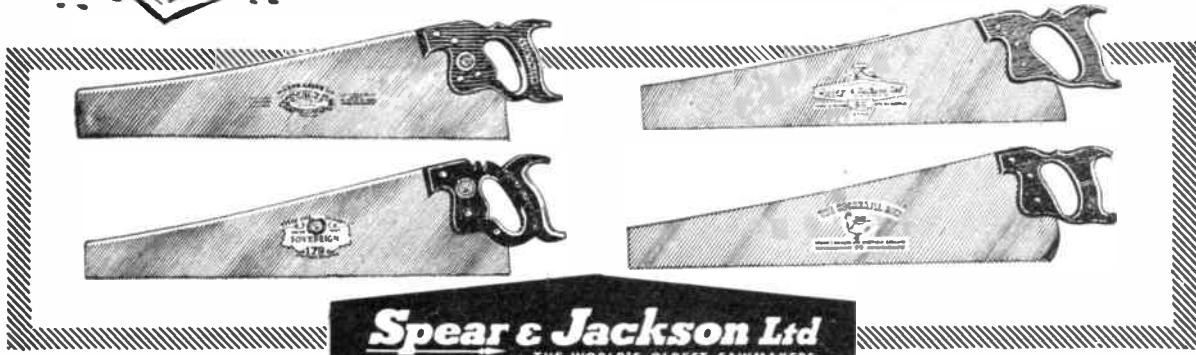

Spear & Jackson Ltd
THE WORLD'S OLDEST SAWMAKERS

HSI.

AETNA WORKS, SHEFFIELD 4

SAVE POUNDS AND POUNDS

on Furnishing with

Wren Craft

HOME ASSEMBLED FURNITURE

Just fit the ready-made parts together!



LOOK at the lovely chandelier we made for only 47/- (without shades)

⁴ plus carr. & pkg 2/9



FREE! THE WREN CRAFT BOOK OF FURNISHING - POST COUPON NOW!



... a lavish, beautifully illustrated book ... yours NOW, without obligation.

Only 73/- for a bedstead ... or 50/3 for a coffee table ... or 218/6 for a wardrobe! Yes, you save pounds when you furnish the Wren Craft way. And assembly is so very, very simple. Every outfit contains perfectly fitting, precision-cut parts, screws, pins and special glue. Simply follow the step-by-step instructions to

make your own top-quality furniture. The timber is top-quality too — OAK, WALNUT, MAHOGANY, BEECH, and the finish is smooth as satin. There's a wonderful range of Wren Craft furniture just waiting for you to assemble. All at a fraction of shop prices and on easy terms if you wish.

MAKERS GUARANTEE 100% SATISFACTION — OR MONEY BACK IN FULL!

Please send me — free — a copy of the WREN CRAFT BOOK OF FURNITURE

NAME _____

ADDRESS _____

WREN CRAFT FURNITURE LTD., KINGSTON ROAD, NEW MALDEN, SURREY H.7

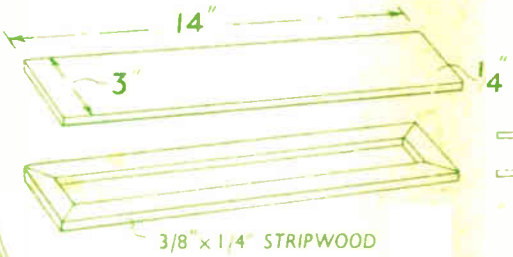
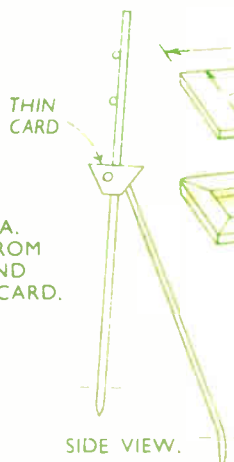
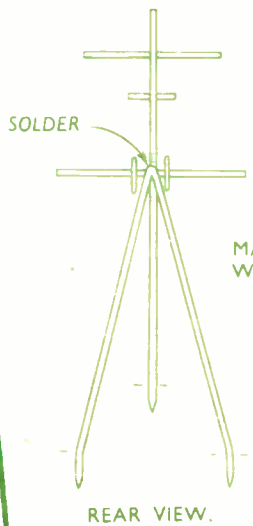
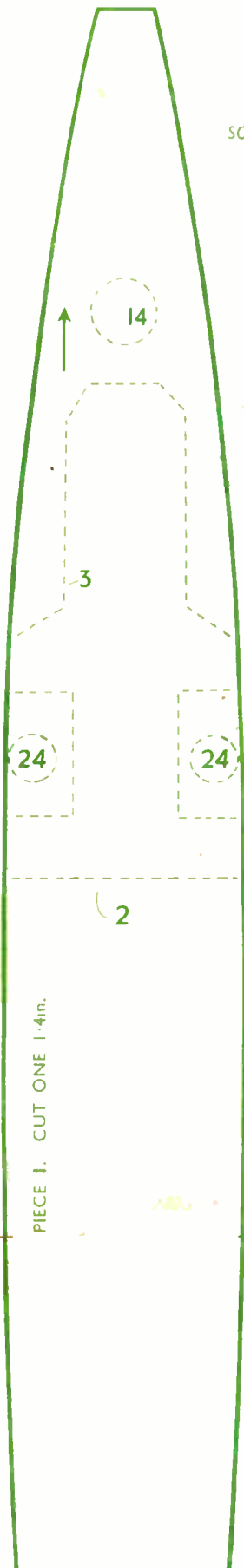

SHOWING HOW THE BASE IS MADE UP.

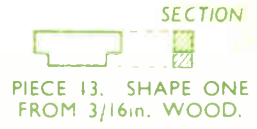

PIECE 10. CUT ONE FROM THIN CARD.

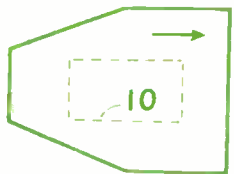

PIECE 9. CUT ONE 3/16 in.



PIECE 8. CUT ONE 3/16 in.

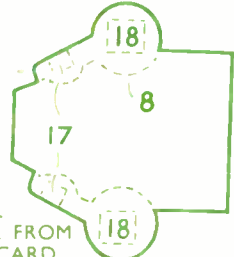

PIECE 7. CUT ONE FROM THIN CARD.

PIECES 25. CUT SIX FROM MEDIUM GAUGE WIRE.



PIECES 24. CUT TWO 3/16 in.

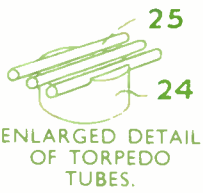

MEDIUM GAUGE WIRE



CUT THREE 3/16 in. MAKE UP INTO UNITS (19) AS SHOWN ABOVE.



GUNS 17. SHAPE SEVEN FROM WASTE WOOD AND THIN WIRE.

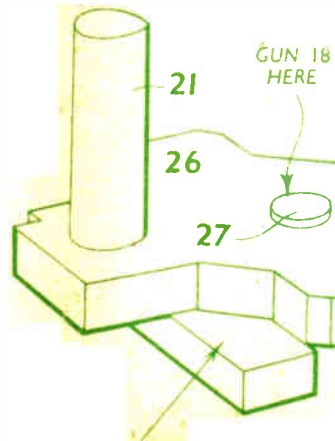

18 HERE



MAST B. MAKE FROM W AND CARD

SOLDER

FRONT VIEW.

SIDE VIEW.

MODEL CRUISER ('SUPERB')

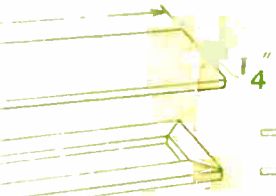

1/4" STRIPWOOD
HOW THE
MADE UP.



SECTION
SHAPE ONE
1/16in. WOOD.

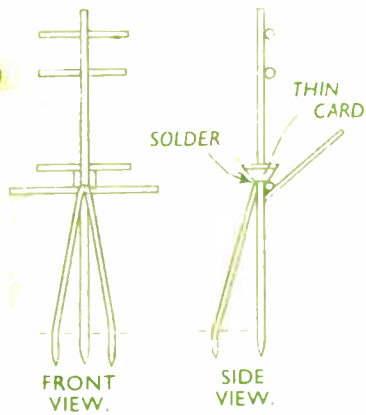

MAST B.
MAKE FROM WIRE
AND CARD.



SIZE
12 1/2 ins.
LONG.

PANELS OF WOOD
REQUIRED FOR THIS DESIGN

ONE H4 . ONE GD6 . ONE G3

*A complete kit of the above materials can be obtained from
HOBBIES LTD., DEREHAM, NORFOLK*

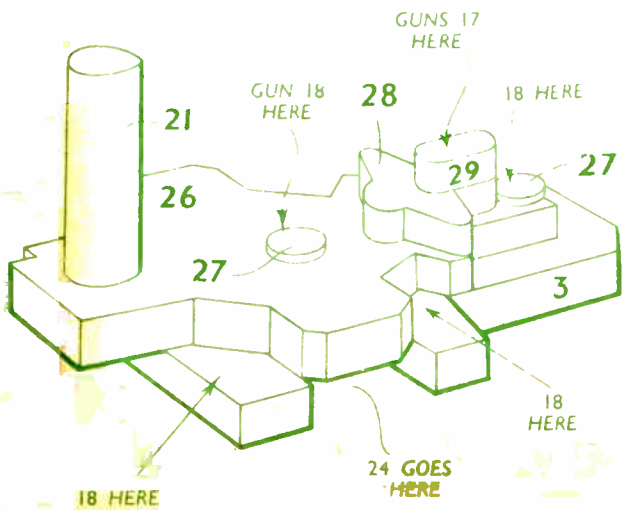

Glue it with **Croid**

LIQUID GLUES OF QUALITY

UNIVERSAL GLUE for use cold straight from the Tube 1-oz. or Tin 2-oz.

AERO GLUE for quicker setting, in the Home Outfit 4-oz. or in Tins from 1-oz. each.

POLYSTIK PYA ADHESIVE a new adhesive in Polythene bottle at 2-oz.

The world's strongest glue is available from all branches of Hobbies Ltd



PIECE 7 GOES

PIECE 1. CUT

ROUND ROD
SIDE VIEW. FULL SIZE.
19

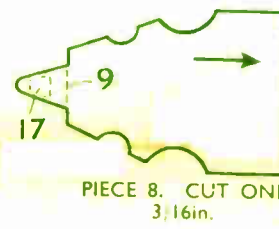

CUT THREE 3/16in. MAKE UP INTO UNITS (19) AS SHOWN ABOVE.

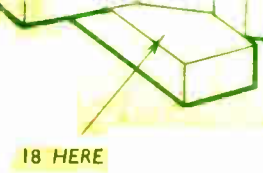

GUNS 18. SHAPE NINE FROM WASTE WOOD AND THIN WIRE.

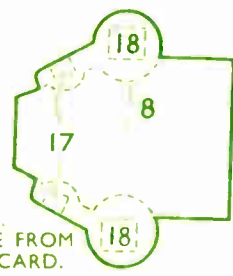

GUNS 17. SHAPE SEVEN FROM WASTE WOOD AND THIN WIRE.

PIECE 7. CUT ONE FROM THIN CARD.



GUNS 16. CUT NINE MEDIUM GAUGE WIRE.

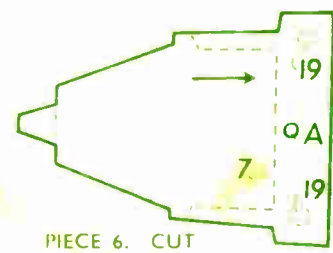

PIECE 15. CUT THREE 3/16in.

SECTION FUNNEL 20. CUT SHAPE TO SECTION. ONE 3/8in.



PIECES 14. CUT SIX FROM THIN CARD. GLUE TOGETHER IN PAIRS.

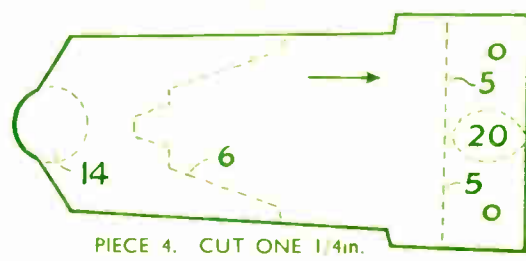

PIECES 5. CUT ONE OF EACH FROM THIN CARD.



PIECE 2. CUT ONE 3/8in. SHAPE TO SECTION.

