

# HOBBIES WEEKLY

IN THIS ISSUE

	Page
An Inlaid Picture . . . . .	305
Building-Blocks from Stripwood . . . . .	307
Cotton-Reel Chessmen . . . . .	307
A Neat Side Table . . . . .	308
A Book to Read . . . . .	308
Replies of Interest . . . . .	309
Attractive Stand for Cacti Plants- Make this Novel Production Box . . . . .	310
A Set of Miniature Garden Tools . . . . .	311
How to Renovate a Wicker Chair . . . . .	311
A Lady's Workbox . . . . .	312
Interesting Experiments for Beginners . . . . .	313
Practical Hints on Dowelling . . . . .	314
A Portable Tool Box for the Handyman . . . . .	316
Details of the Cacti Stand . . . . .	319



FEBRUARY 16th 1955

VOL. 119

NUMBER 3094

## ★ This week's FREE DESIGN ★

**T**HOUSANDS of holiday-makers each year have a happy time on the famous Norfolk Broads, travelling the pleasant waterway on cruisers and yachts, and stopping at will for a cooling swim, or to indulge in a quiet spot of fishing.

To many of these, the subject of our design for an inlaid picture, taken from an old print of the Ferry Inn at Horning, will be very familiar, and will recall pleasant memories of halts for refreshment. It is also of interest to note that this inn has recently been reconstructed, and, therefore, presents a different appearance from our reproduction.

The subject particularly lends itself to the making of an inlaid picture, and with careful working the finished effort



*'The Ferry Inn'*

# AN INLAID PICTURE

will grace the wall of any home. If desired, of course, it could also be used for knife marquetry.

For the inlaid picture, a specially prepared kit can be purchased. It includes a panel of  $\frac{1}{2}$  in. wood to make the frame, four selected  $\frac{1}{8}$  in. inlaid panels of contrasting colours, and

sufficient stripwood to make the overlay border.

### Trace the Outline

The frame should be made first. It is cut to the outline shown on the design sheet, and it will be noticed that for space reasons only the top half is shown

in detail and workers will complete the whole, of course, by reversing the design and carrying on from the centre lines. The outline should be traced on to the wood and when it has been cut, a small hole should be drilled in one corner and the whole of the centre of the frame removed as accurately as possible.

All correspondence should be addressed to The Editor, Hobbies Weekly, Dereham, Norfolk

**For Modellers, Fretworkers  
and Home Craftsmen**

**4<sup>D</sup>**

The reason for this is that the panel will later be used as a backing piece for the inlaid picture itself, and will eventually be put back into the frame as the finished work.

#### Inlay Cutting

To cut the inlays, pin the four pieces of wood together with the whitewood uppermost. Be sure that the pins are outside the area of the picture. Now trace the design carefully on to the whitewood. Another method is to paste the design down, but this is not generally recommended in view of the tendency to warp and the fact that the design has eventually to be cleaned off, thus necessitating extra work.

It is suggested that the first pieces to be cut should be the small insets in the foliage of the trees. Drill a very fine hole at the edge of them, just sufficient to take a fine sawblade (No. OO or O), when working on these sections.

Following this, start removing the pieces of the pattern one after the other until all is completed. Slight deviation from the lines of the pattern will not matter unduly, as the pieces being cut will be exactly the same and must, therefore, fit when making up. This, of course, assumes that you have followed an essential in this type of work—that is, to keep the saw upright when cutting. Otherwise it will be seen that if the saw is used at an angle, the bottom sections will be of a different size and fit from the top ones.

#### Matching Up

When all the pieces have been cut, choose the ones which match those shown on the design referring, of course, to the key, and glue them piece by piece to the backing board. This, you will remember, is the piece cut from the centre of the frame. See that the pieces fit together tightly, and do not be in a hurry. Let the glue squeeze up between the pieces so that the whole is well filled. Now place a piece of paper over the picture and put the work under weights. When it has dried thoroughly, clean off the paper with a suitable scraper such as a Skarsten (a piece of glass will serve if you have no proper tool), and finally clean up with a piece of very fine glasspaper.

You may possibly find that there are gaps in the surface which require filling in. To remedy this, a good method is to use a mixture of white glue—Durofix or similar—and sawdust of the colour required. The mixture should be principally sawdust with just enough glue to make the whole adhere. Rub this mixture well into the places to be filled, and leave to dry before levelling off.

This completes the main work, and you should now provide a suitable finish for the picture. Apply white wax

polish as used for furniture, and polish briskly with a soft duster. A proved method is to apply the polish with the fingertips, gently rubbing it in. Then glasspaper very gently over the surface and apply polish again by the fingertip method. To get a perfect result, do not hesitate to make up to as many as six applications of the polish, each followed by gentle smoothing with glasspaper and a final polish. This will give the picture depth and also make it shine.

### YOU CAN GET A KIT

For making this picture you can obtain a kit (No. 3094) containing all necessary materials, including four selected  $\frac{1}{4}$  in. panels of inlay wood, from any Hobbies Branch, or post free from Hobbies Ltd., Dereham, Norfolk, price 8/4.

Polishing from time to time, after the picture has been hung, will keep it in excellent condition. Now prepare the stripwood border. This should be mitred and chamfered as shown on the design sheet, and glued into place on the frame. A word of warning here—take special care with the mitres, as badly cut joints will depreciate from the look of the finished picture.

The whole of the frame is now cleaned up, and either stained and polished or wax polished only, as desired. You might possibly like to make the mitred border lighter or darker than the actual frame for contrast. It will depend on the colour and quality of the actual wood, but whatever the finish chosen, the whole of the frame should serve to draw attention to the inlaid picture and not away from it.

The inlaid picture is now placed in position from the back of the frame, and secured by pasting a piece of stiff

brown paper over it and the frame, in much the same way as when mounting a photograph. The backing piece holding the inlay picture stands proud of the frame by some  $\frac{1}{8}$  in., of course, but this does not matter, as it is not seen.

Prepare the picture for hanging with two screw eyes and a length of cord. If the picture is to be hung from a rail, a fairly long length of cord will be required, but if it is to be suspended from some lower wall fitting, then it is preferable to stretch a shorter length of cord fairly tightly between the two screw eyes, so that when the picture is hung on the fitting, the cord is not seen.

#### Extra Pictures

You will have noticed that apart from the picture already made, there are also sufficient parts to make three others. Although the colours are not the same as those in the original, you will be able to match up two of the three and make quite reasonable pictures. The rest will probably have to be discarded because the colourings are not suitable. For instance, one of the sky pieces of the four inlay panels cut will be of dark wood and would look out of place in the normal picture.

For the two extra pictures you are able to make, find pieces of plywood or other suitable backing wood and glue the pictures down as before. Then give them a framing of ordinary picture frame moulding which is quite cheap to buy, and you have another two passable pictures. These would make nice gifts for friends.

As an alternative to making extra pictures from the additional pieces, they can be used as an inlay decoration on other articles you may be making. For instance, they could form parts of trays, firescreens, and trinket boxes or articles of furniture. Often quite small parts of a design can be used to enhance larger furniture such as cabinets and bookcases.

## Build a Canoe for under £6

Canoeing enthusiasts will be pleased to learn that we shall soon be publishing details for another single-seat canoe, PBK10. Designed by P. W. Blandford, it has faster lines and is even easier to build than the very successful PBK11, first published in 'Hobbies Weekly' four years ago. PBK10 has been constructed for a total cost of under £6.

### WATCH FOR FURTHER DETAILS

You can make these

# Building-Blocks from Stripwood

THESE are intended as a first exercise in woodworking for a beginner, and are suitable as a gift for a child of up to about 8 years of age. The main difficulty in obtaining blocks having sufficiently uniform thickness is overcome by using Hobbies stripwood. For the blocks described, two 3ft. lengths of  $\frac{1}{4}$  in. by  $\frac{1}{4}$  in. stripwood are required, and one 3ft. length of  $\frac{1}{4}$  in. by  $1\frac{1}{2}$  in. stripwood.

The  $\frac{1}{4}$  in. by  $\frac{1}{4}$  in. stripwood is marked out to provide the following: four pieces 6ins. long, eight pieces 3ins. long, four pieces 2ins. long, and ten pieces 1ins. long. These lengths are multiples of  $\frac{1}{4}$  in., so that the blocks will fit in many ways.

The 3ft. length of  $\frac{1}{4}$  in. by  $1\frac{1}{2}$  in. stripwood is cut as follows: two pieces 6ins. long and eight pieces 3ins. long. Two of the 3ins. pieces are marked out as shown at (A) in Fig. 1, a 45 degree set-square being used. A further 3in. piece is marked as at (B).

Marking out should be as accurate as possible, and on two sides of the wood.

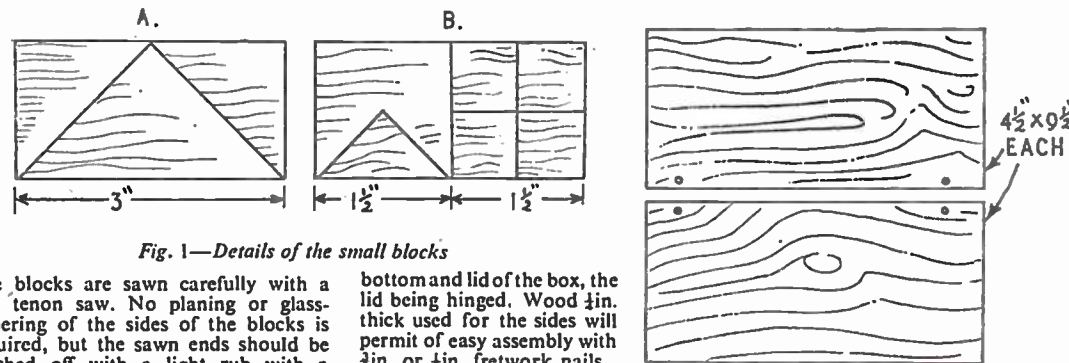
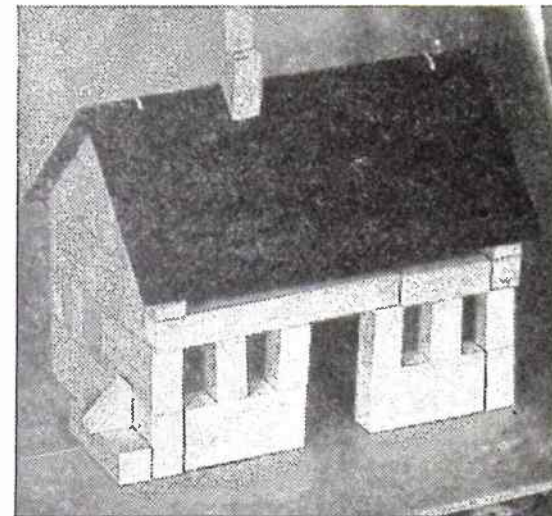

Fig. 1—Details of the small blocks

The blocks are sawn carefully with a fine tenon saw. No planing or glasspapering of the sides of the blocks is required, but the sawn ends should be finished off with a light rub with a glasspaper block, to remove any rough edges which would prevent the blocks standing squarely on end.

#### 3-ply Roof

The roof is made from 3-ply, as shown in Fig. 2, thin string loops through the holes illustrated holding the pieces together. This roof may be used in the normal way, or flat, as a platform, or as a flat roof in models of this kind.

The photograph shows a model built with the blocks as described. Among other models may be listed towers, churches, bridges, pavilions and garages, etc.

The wooden box to hold the blocks will require to be 6ins. by 9ins. by 1ins. inside. Ply may be used for the

bottom and lid of the box, the lid being hinged. Wood  $\frac{1}{4}$  in. thick used for the sides will permit of easy assembly with  $\frac{1}{4}$  in. or  $\frac{1}{8}$  in. fretwork nails. (F.G.R.)

Fig. 2—The Roof

## Cotton-reel Chessmen

AN employee at Brechin Castle, Scotland, Mr. G. H. Tait, has the unusual hobby of carving sets of chessmen from discarded cotton reels. He selects thirty-two empty reels of uniform size and with the aid of a small saw, a penknife and a few files he carves handsome chess figures, staining half the set red or black. During the recent war he spent most of his spare time making game sets for disabled Servicemen who were in hospitals, and one of his best sets of chessmen was so highly

prized by the Red Cross Organisation that they had it exhibited all over Britain. He has made over 10,000 different chess or draughts pieces. For a change, he turns to draughtsmen, and makes three pieces from an ordinary-sized reel, while from the unwanted ends of his reels he makes stands for tiny dresses for dainty Victorian dolls. When these dresses are removed from their stands they become miniature spinning tops.

(D.G.)

# A Neat Side Table



Fig. 1

THE small table shown in Fig. 1 would look well if made from mahogany and finished by french polishing.

The top of the table is 18ins. square and stands on four tapered legs 29½ins. long and 1½ins. square. The legs are lightened in appearance by chamfering slightly to the measurement given, being ¾in. square at the bottom. The four rails (A) connecting the legs at the top are 13½ins. by 1in. by ¾in. in section. The shelf (B) is 14ins. square by ¾in. or 1in. thick. The rails (C) are ¾in. square in section and two horizontal rails 12½ins. long and four measuring 9½ins. will be wanted.

The table top may have a wide chamfer carried round on all four sides as shown in Fig. 2 and in the detail (Fig. 3). A plain side-view of the table with dimensions is given in Fig. 2, and Fig. 4 shows the method of framing the parts together. In Fig. 5 is given a cross-section of the joint between the legs and the top rails. A second detail showing the haunched top of the joint is given in Fig. 4.

Fig. 6 shows how the small rails (C) are coggled together at their intersections. The tenons are level with the outer faces of the cross-rails. They are ¾in. wide and are haunched down ¼in. from the top edges. The mortises are set

45 degrees as shown in Fig. 5. The shelf (B) should be framed into the legs, first notched over them and tenoned into them as shown in the detail at the lower end of Fig. 4. Care must be taken to arrange the small tenons on rails (C) so that they line up

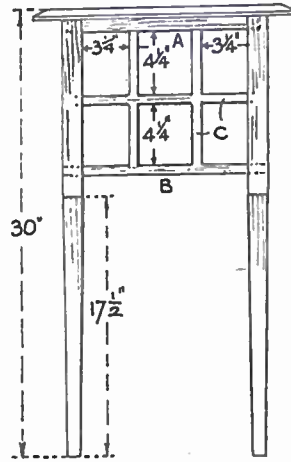

Fig. 2

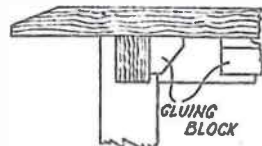

Fig. 3

in ¾in. from the outer faces of the legs, and are cut to correspond with the tenons. The mortises are cut from each face of the legs until they meet, the ends of the tenons being cut to an angle of

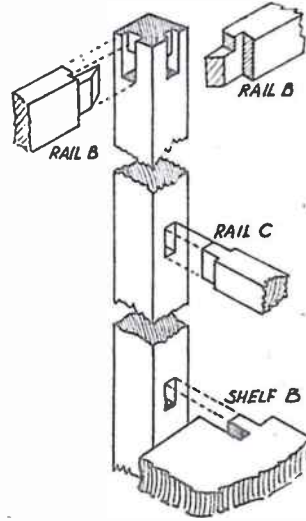

Fig. 4

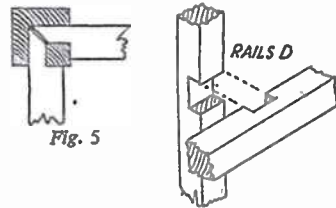

Fig. 5

Fig. 6

accurately with the several mortises in shelf (B) and top rails (A). The rails (C) may be simply housed full-section ¾in. in depth, or they may have small tenons cut on their ends as shown in the detail Fig. 4.

All the woodwork should be cleaned up ready for assembling and gluing together. First fix the rails (C) together, and then fix them into the shelf and top cross-rails. The whole is then fixed into the legs, care being taken not to use too much glue. Next add the table top and fix it to the rails by means of glued angle blocks as seen in Fig. 3. (S.W.C.)



## Electric Motor Query

I HAVE a 3-phase electric motor (fractional h.p.) and wish to work this from single phase. I believe there is a way in which this can be done. Any details or suggestions will be appreciated. (G.W.—Congleton.)

IT is sometimes possible to run a 3-phase motor from standard A.C. mains, a condenser being used to obtain phase shift. To do this, one A.C. lead should be wired to one 3-phase input terminal, and the other to a second 3-phase input terminal. The condenser is wired between the remaining 3-phase input terminal and one A.C. mains lead. Experiment should be made to find the best method of connection, and the direction of running may usually be reversed by changing the condenser connection from one A.C. lead to the other. The condenser should be of 500 V working rating, and will usually require to be of 1 to 2 mfd. This depends upon the current drawn by the motor. A condenser with a fairly high power-factor rating may be required, or it will overheat and possibly break down as a result.

## Pointing a Wall

PLEASE advise me as to what materials and tools are necessary to 'point' walls, and also the easiest method of doing so. I should also like to know what to buy to make the mortar and the proportions needed in the mixing. (F.S.—South Shields.)

FOR pointing a wall you will require a brick rake, for scraping out the old mortar, a pointing trowel, and a straight-edged strip of wood. Remove the old mortar with the rake, dust and damp, and trowel in the new mortar. After each line, place the straight-edge above and below the mortar and draw the trowel along, to leave a neat mortared line. Trowel the mortar in so that its surface is slightly behind the edge of the bricks at the top and a little in front of them at the bottom, to throw the water off. A mortar for repointing the wall can consist of 1 part cement to 2 parts of fine sand, measured in bulk. If a whiter mortar would be preferred, substitute lime for the cement. Do not mix too much at a time if you are a beginner at the work.

## Indelible Pencil Marks

PLEASE tell me how to remove indelible pencil marks from a kitbag. (C.C.—Liverpool.)

PROVIDED there has been no reaction between the proofing and the pencil dye, methylated spirit alone will remove the marks. Soak the part in a saucer containing meths., pressing and squeezing the cloth. Renew the meths. if the marks are heavy enough to stain the liquid deeply. If any stain remains, dry the kitbag and apply a poultice of equal parts of chloride of lime (bleaching powder) and whiting made into a paste with water. Leave for about a quarter of an hour, wash off and soak the part in vinegar for a few minutes, then rinse well in water. This latter treatment, if needed, should counteract any combination with the proofing.

## Metallizing Non-Metals

I SHOULD like to know something on the subject of metallizing non-metals, such as leather, glass, wood, plastic, etc. (M.M.—Dunedin.)

THE principle of metallizing non-metallic materials is dealt with in full technical detail in the British publication *How to Metallize Baby Shoes*, price 3/- from D. C. Williams, 16 Newton Rd., Southampton. The methods given should be applicable to materials other than leather, for these rely on the application of a simple non-conducting coating, followed by brushing on a film of a good conductor. Plating is then done in the usual way. The scheme seems a big improvement over the old graphite coating method. The chemicals needed can be had from any laboratory furnisher—some from a pharmacist. The electrical equipment, too, is not elaborate, and readily obtainable.

## Cleaning a Brass Clockcase

PLEASE tell me the best way to clean a brass-cast clock case, and how to treat it afterwards to keep its colour. (A.C.—Finchley.)

NORMAL tarnishing can be removed with clear household ammonia. If possible, remove the movement from the case, for it may be affected by the fumes. Dip a rag in neat

ammonia and rub on the brass. When bright, remove surplus ammonia and loosened tarnish with successive rags wetted with plain water. A toothbrush may be used if the case has casting crevices. For heavy tarnishing, treat first with ammonia, then with nitric acid diluted with three times its volume of water. Very thoroughly remove the latter with wetted rags and keep it off the skin. After drying, buff up with a good metal polish, swab with a rag wetted with benzene and apply a protective lacquer consisting of Durofix thinned down to brushing consistency with amyl acetate.

## Heating an Aviary

I WISH to make a heater for my budgerigar aviary. If possible I should like one where no electricity is involved because my aviary is in such a position that it would be impossible to get electricity to it. (W.E.—Luton.)

PROVIDING your aviary is well built and sited in a sheltered spot and is dry and draught-proof, no heater is required, as the budgerigar does not require artificial heat, except, perhaps, in extremely severe wintry spells, and then it is only necessary to maintain the temperature of your birdroom above 40 degrees. The danger from heating apparatus—apart from electrical—is in smoke and fumes. You would have a difficult job in making a 'foolproof' aviary heater yourself, but there are firms which supply fumeless heaters for aviaries in various sizes. We would recommend you to write to D. Ross & Sons (Dept. C.B.2), St. Leonard's Works, Forres, for particulars. For smaller birdroom, an oil-burning heater is sold by P. J. Bryant, Forest Rd., Fishponds, Bristol. Actually, rather than run risks of losing valuable budgies, it is better not to use heat at all where there is no electricity supply, for if an oil heater is left unattended for some unavoidable reason for long periods, there is danger from fumes, smoke and fire.

## Limed Oak Finish

I WISH to know the various ways and methods of getting: (1) the limed oak finish on furniture, (2) any finish on oak to retain its natural shade (after glass-papering), as applying button polish tends to make it yellow, and eggshell varnish makes it immediately darker in tone. (C.G.—Paisley.)

FOR the limed oak finish desired, employ Romany limed oak filler, applied after staining and partial polishing. For a natural oak finish, use white polish or a brush-on clear cellulose varnish, as preferred.

# A Book to Read

## Making Pottery Figures

by Marjorie Drawbell

THIS book has now been published for a little over a year, but we were prevented from mentioning it at the time of its publication, and feel that it is of sufficient interest to warrant review now, despite the time lapse. The modelling of pottery figures has always been a satisfying craft, and whether the figures are made in unique pieces or for

duplicating, there is much expert advice in this book on achieving successful results. Miss Drawbell is a regular exhibitor at the Royal Academy, and her book will prove invaluable to the student and craftsman. The illustrations are particularly clear and the step-by-step photographs provide a course in themselves. Published by The Studio Ltd., 66 Chandos Place, London, W.C.2—Price 15/-.

You can make this

## Attractive Stand for Cacti Plants

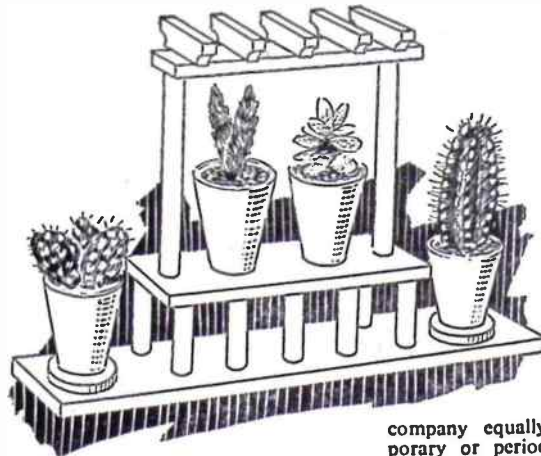

More Details are on page 319

the seven columns of  $\frac{1}{2}$ in. diameter round rod are then glued in place. On top of these is another platform to take two pots. Two tall columns and cross-pieces make a miniature pergola, as shown.

Two rings are cut out with a fretsaw, and glued to the base. Clean up all the parts with glasspaper and give two or three coats of white or stone colour enamel. Place the pots as shown in the illustration.

Remember to buy cacti in small thumb pots or alternatively increase the size of the stand to suit large pots. (M.p.)

company equally well with contemporary or period furniture and with two or three cacti in pots, makes an ideal gift.

All parts may be cut from odd wood and round rod. The base is cut first and

THIS stand is specially designed for cacti in small pots. The very nature of the stand enhances the appearance of the plants. It keeps

HERE'S MAGIC FOR YOU!

## Make this Novel Production Box

MAGIC is a fascinating hobby, and when the amateur magician is handy with tools he can make some really excellent tricks—tricks that would be expensive to buy at a magic depot.

Here are the instructions for making and working a clever production box. The box may be shown convincingly empty, yet suddenly it yields flowers, handkerchiefs, streamers and the usual collapsible goods of the conjurer.

### The Secret

The sketch shows that the box has a base and two sides, while the back and front slide in and out on runners of stripwood. Behind the back of the box, unseen by the audience, is a smaller box glued firmly in place. This carries the articles which will later be produced.

In presenting the trick, the front of the box is slid right out, showing the inside quite empty. The back is then slid out, and the audience can see right through, proving the absence of mirrors.

Now the original front piece is slid into the back while the back piece goes into the front. This simple move conveys the hidden articles secretly into the box. The box is now turned round and shown on all sides. It has been shown inside and out, apparently quite free from any faking.



After a wave of his hand the magician reaches into the box and artistically produces the contents. Suitable items for bringing forth can be obtained at magic depots. It is possible to obtain a set of baby alarm clocks which nest

together and may be produced one by one.

The base of the box is a piece of  $\frac{1}{2}$ in. plywood, 7ins. square. The fixed sides are two pieces of  $\frac{1}{2}$ in. plywood, 7ins. by 8ins. high. The sides are fixed to the base with six cup-head chrome screws and a touch of glue. The back and front are  $\frac{1}{2}$ in. plywood, 7ins. by 7 $\frac{1}{2}$ ins. high to allow for standing on the base and coming flush with the top. The secret box to hold the articles is 5ins. square and 3ins. deep. It is fixed together with panel pins and glue, then it is glued in place 1in. from the top of the back. The runners in which the back and front slide are of  $\frac{1}{4}$ in. stripwood. They are glued in place, the outer ones being flush with the edges. A larger box can, of course, be made from which to produce livestock.

### Bright Colours

The job should be finished in bright art enamel. It adds to the decorative effect if a few imitation Chinese characters are painted on the sides and sliding panels. These should be in a strong contrasting colour. The backs of the sliding panels should be painted or stained a deep black, the inside of the box being similarly treated. If desired a set of four small wooden knobs can be fixed under the base to act as feet. (R.W.W.)

AN IDEAL GIFT FOR A FRIEND

## A Set of Miniature Garden Tools

GOOD work cannot be expected by using inferior tools and this applies especially to the craft of gardening. Some people possess what is known as 'green fingers' and can get anything to grow, but even to them much depends on the tools they use.

The manner in which young plants raised from seed are transplanted can either make or mar their future success. It is for work such as this that a set of quite small garden tools can be extremely useful. Now that miniature or Japanese gardens are becoming so popular it is really essential to possess tools which are in relation to the size of the work to be done. Ordinary garden tools would be out of all proportion and could do much damage to the tiny plants.

To make a set of miniature garden tools is not a difficult task and will repay the time spent. Many people use a tiny forked stick for transplanting but this is only a makeshift and is easily broken.

If you are not a gardener yourself but enjoy making things, a set of these tools would make an ideal present for a friend, or quite a profitable little business could be started by making them for sale.

Sheet iron is the best material for most of the tools, although brass is quite serviceable and somewhat easier to work with. The thickness will depend on their size and for the smallest the metal from a good quality tin should be about right.

The general layout of a trowel complete with handle is given at (A),

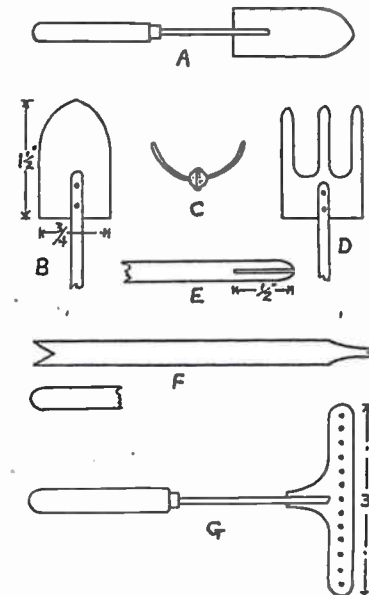

while (B) shows all the measurements for the smallest size and (C) the shape it will have when bent. For larger sizes the measurements must be increased in proportion.

The point of the trowel can assume many different shapes, from square or curved to pointed, but that shown will be most useful for our purpose. The blade is fastened into a piece of brass or

iron rod which is slotted to a distance of about  $\frac{1}{4}$ in. The end is tapered off as shown at (E) and it can be fixed either with solder or one or two rivets. The rod should be about 4ins. long, and this in turn is fixed into a suitable wooden handle. For getting into awkward places the rod may be somewhat longer and it is often an advantage to make it curved.

For the fork (D) all the parts are cut the same size as for the trowel, but the sheet metal is kept flat and three or four prongs cut out with a fretsaw. Transplanting young seedlings is made quite easy with the tool (F), which is just a strip of any sheet metal about 6ins. long and  $\frac{1}{2}$ in. wide. The 'V'-shape ends are made in different sizes to suit different plants, or one end may be just rounded off and used to make the hole and firm the soil round the seedling when planted.

A miniature rake shown at (G) is very useful and will complete our set of tools. It is used with great advantage when making up a seed box, giving a good surface to the soil. Sheet metal 3ins. long and about  $\frac{1}{2}$ in. wide has a projection on one side to fasten to the handle in a similar manner to the other tools.

Drill a series of holes and solder in a row of panel pins. The number of holes and the size of the pins will govern the fineness of the soil and must be left to your individual requirements.

A coat of paint on the handles and all or part of the metal work will improve the appearance as well as helping to preserve the tools. (A.F.T.)

## How to Renovate a Wicker Chair

DISCOLOURED and grimy wicker chairs can spoil the appearance of an otherwise neat and tidy room.

Therefore, to give such a chair a thorough cleaning and overhaul is always well worth the trouble.

Dust it all over thoroughly and brush out as much dirt as possible from the crevices. Then scrub the chair well with a stiff brush and a good cleansing agent. Rinse it afterwards with clean water but avoid dousing it. When it is really dry, peel off any loose wicker to the point where it is securely attached to the chair. Do not, however, take off more than is absolutely necessary.

Next, brush the exposed frame with

animal glue. Ordinary glue will serve the purpose but animal glue is preferable for a good job. Prepared 'cements' should not be used in this connection.

Stout packing twine can be used to repair the damaged parts of the chair if it is not possible to obtain the proper matching wicker. It should be wound round and round the frame, over the wet glue, and the ends secured firmly. Excess glue must be wiped off.

When quite dry again, glue size should be brushed on to seal the twine and hold it together. This will also form a good base for painting, if it has been decided to complete the job in as near a professional manner as possible.

In this event, brush on a priming

coat. It is advisable to use a white undercoat tinted with the colour of the selected final coat to achieve a good finish.

For the application of the final coat it is a good plan to procure an inexpensive insect-spray gun, as this makes an economical speedy job, and will ensure an even distribution if carefully used. A good brand of enamel thinned with turpentine should be used for this final coat.

In selecting the colour, pay attention to the predominating colours of the room to avoid any 'clashing'. If the chair is to be used outdoors, bear in mind the colouring of any other garden furniture. (E.M.B.)

# A Lady's Workbox

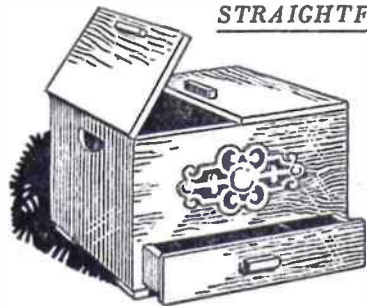

Fig. 1

THE attractive workbox shown here would make an ideal gift for a woman. It has good interior space with two lift-up lids, a convenient drawer for reels of cotton, silk, etc., and, if desired, a tray may be made for various other articles necessary to the seamstress.

Any good hardwood may be used for the box, oak or mahogany being specially recommended. The construction is reasonably simple, and Figs. 2

CUTTING LIST		
(A)	2	9 1/2 ins. by 10 1/2 ins. by 1/2 in.
(B)	1	14 ins. by 9 1/2 ins. by 1/2 in.
(C)	1	14 ins. by 7 1/2 ins. by 1/2 in.
(D)	1	14 ins. by 11 ins. by 1/2 in.
(E)	1	13 1/2 ins. by 10 1/2 ins. by 1/2 in. ply
(F)	2	4 ins. by 1 1/2 ins. by 1/2 in.
(G)	2	11 ins. by 7 1/2 ins. by 1/2 in.
(H)	2	13 ins. by 2 ins. by 1/2 in.
(I)	1	14 ins. by 10 1/2 ins. by 1/2 in. ply
(J)	1	13 1/2 ins. by 2 1/2 ins. by 1/2 in.
(K)	2	9 1/2 ins. by 2 ins. by 1/2 in.
(L)	4	2 ins. by 2 ins. by 1/2 in.
(M)	1	7 1/2 ins. by 4 ins. by 1/2 in.

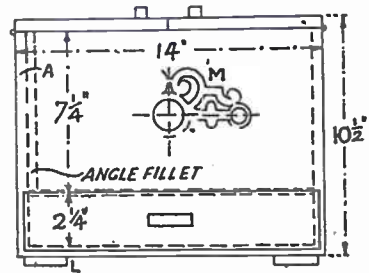

Fig. 2

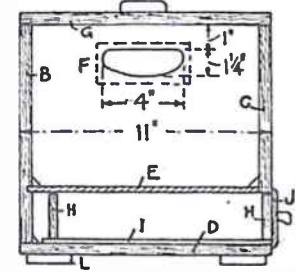

Fig. 3

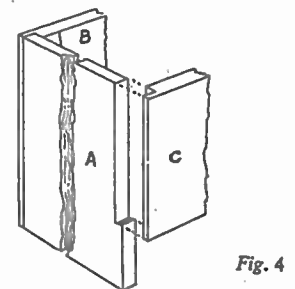

Fig. 4

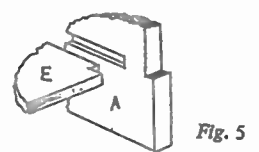

Fig. 5

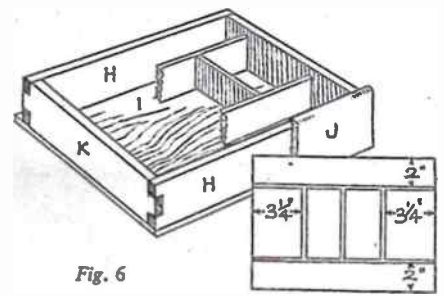

Fig. 6

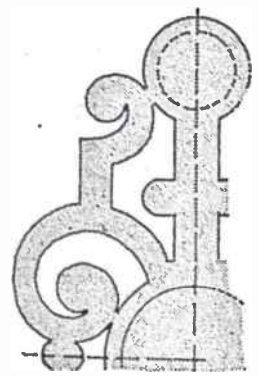

Fig. 7

which closes flush against the floor (D) and to the front (C) of the box. The floor is grooved into the back and further strengthened by glued angle fillets. This floor (E) must be fitted in while the sides of the box are being assembled. Note here that hand-holes are suggested in the ends (A) for the purpose of lifting the box, these holes being lined inside by gluing on thin wood, as shown in Fig. 3. The main floor (D) is screwed to the ends (A) and to the back (B). Four toe blocks are

floor (I) is countersunk screwed to the edges of the frame, and the partitions are arranged as the little plan in Fig. 6 shows. The ends of the short cross-partitions may be single-tenoned into the long ones, this work being done with a fretsaw.

When setting out the parts of the drawer, first take careful measurements of the actual opening. The sides of the completed drawer can then be glass-papered down to make an accurate fit. Round off all sharp edges before

glued and screwed to the floor as shown. The lids must be made from well-seasoned wood to hold flat and to keep their shape. They are fixed by brass hinges to the ends of the box, and each lid should have a brass or chromium knuckle stay.

The drawer may be made as suggested in Fig. 6, the frame rails (H) and (K) being pin-jointed and glued together, and the front (J) afterwards glued on and screwed from inside. The

putting any finish on the wood. The ornamental overlay on the front is optional. This overlay, if added, will, of course, be glued and pinned on after the box has been stained or otherwise finished.

The pattern of the overlay can be prepared for cutting by using the diagram (Fig. 7). This, being a quarter of the whole pattern, can be transferred to the wood by setting out the two centre lines shown dotted on to the wood and then using carbon paper for pencilling in each quarter section round the dotted lines.

(S.W.C.)

# Interesting Experiments for Beginners

THE terms element, mixture and compound turn up constantly in chemistry and it is necessary to be quite clear what we mean by them.

An element consists of only one substance. Iron contains nothing but iron. Therefore, it is an element. Copper, zinc, sulphur and carbon are other everyday examples of elements.

sulphur into a dry test tube. Lay the tube flat and bring a magnet near. The tube will be attracted and may be drawn along the bench by moving the

magnet. Now heat the tube until it is red hot and let it cool. Again test it with a magnet and try to draw it along the bench. You will be unable to do so. Something has happened to the iron. Break the tube and a black button will be found. Crush it and examine it with a lens. Neither iron nor sulphur will be seen. Shake some with water. Only black particles will sink and no sulphur will be floating. Mechanical means have failed to separate the iron and sulphur. The iron and the sulphur are still there, but in another form. They have combined together to form iron sulphide—a compound.

### Same Proportion

Each distinct compound always contains the same elements in the same proportions. In mixtures we can vary the proportions at will and still have a mixture. One mixture which is essential to us is air. It contains the gases oxygen and nitrogen, together with minute amounts of other gases. It is the oxygen we need. Without it, no fire would burn. Aeroplane and car engines would be at a standstill.

A simple experiment will show this. The requirements are shown in Fig. 2—a large jam jar or deep, wide bottle and a candle stuck on a bent wire passing through a tin lid. Make the hole in the lid gas tight by pressing a little Plasticine round the wire. Lower the lighted candle into the jar and seal the edge of the lid with Plasticine, too. The candle will burn for a time and then dim and go out. The wax of the candle is combined with all the oxygen of the air in the jar. No oxygen being left, it cannot continue to burn.

### Life-giving

The body, too, needs oxygen to combine with its waste materials. Without it we, too, would 'go out'.

Probably an appalling thought has struck you. With all these aeroplanes, cars, ships and trains racing about the world gobbling up oxygen, millions of people breathing it and fires squandering it, we shall sooner or later be left in the same state as the candle in the jar!

There is no cause for alarm, however. Nature has balanced things very nicely for us. In burning and breathing, oxygen combines with carbon to form the compound carbon dioxide, which is a gas. This is poured out into the air. Plants and trees breathe in this gas through their leaves, remove the carbon which they need for their growth and turn out oxygen into the air.

Continued on page 316

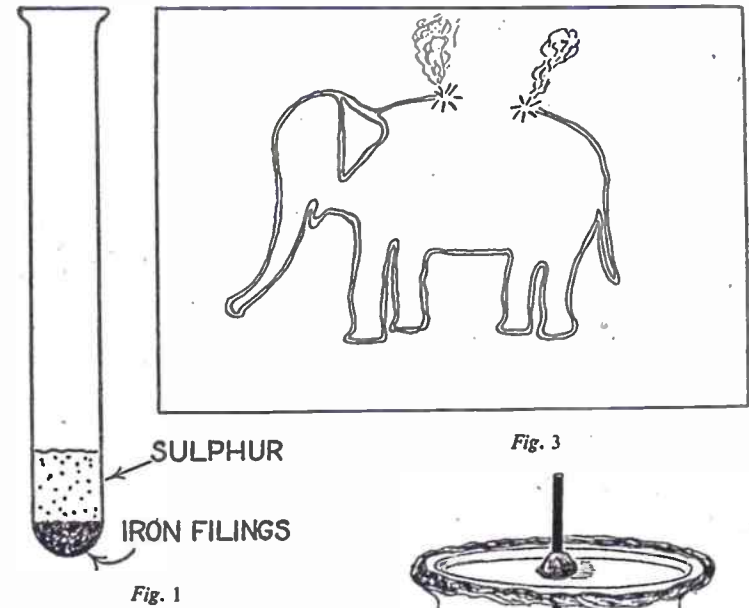

Fig. 1

Fig. 2

A mixture consists of two or more substances lying side by side, and those substances can easily be separated by mechanical means. Grind together salt and coal. Though the mixture looks an even grey, a lens will show the salt and coal particles lying side by side. Stir the mixture with water and filter. The coal alone will remain on the filter. Pour the clear liquid which passes through the filter into a saucer and let it dry. The salt will remain behind.

Fill the end of a dry test tube with iron filings to the depth shown in Fig. 1, and then add sulphur to a total depth of 1/2 in. Empty out the powders and mix well. A lens will reveal iron and sulphur particles. Shake a portion of the powder with water in a test tube. The iron will sink and much of the sulphur will float about in the water. This, too, is a mixture.

A compound consists of two or more elements combined together into something quite different from the elements in it. Put another mixture of iron and

Fig. 2

# Practical Hints on Dowelling

By W. J. Ellson

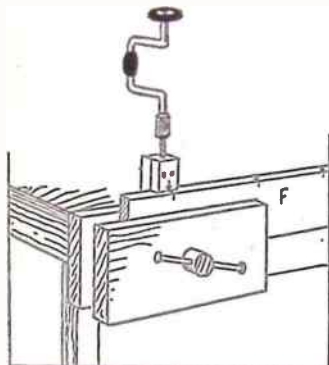

to be dealt with, and other sizes of dowels, too, though  $\frac{1}{4}$  in. and  $\frac{1}{2}$  in. ones will usually suffice for most jobs. Remembering that the point of the bit must come exactly in the middle of the edge of the board to be dowelled, it is a simple matter to substitute suitable slips of wood for part (B), of the required thickness to ensure this. They could be made as occasion arises, and kept handy in a bag or box. The back part (A) will be common to all.

To use the gadget for dowelling two boards together, edge to edge, first lay the boards together, as at (C) in Fig. 2, and pencil across both where the dowels are subsequently to come. Square these lines across the edges, as at (D), and

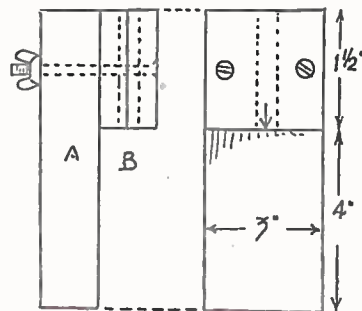

Fig. 1

mark the face sides of each board with an (F) in pencil. This is important. Place the gadget against the boards (one at a time, of course) and clamp up in the vice. Tap gadget at its side until the arrow comes exactly over the pencilled guide mark on the board. See the board is placed with its face side towards you. Place the drill bit in the hole in gadget, and then bore deep enough for half the dowel to enter. This operation is shown in the general view.

Used correctly, all holes will be in alignment, and truly square with the face side of the boards. Side the dowels are a shade less in length than the combined length of the holes, then glue them in and clamp up. If home-made dowels are employed, cut a narrow notch down each to allow air to escape as the dowels are tapped home.

Another job where a dowelled joint is often used is shown at Fig. 3, where the rails of a stool or table are so fixed to the legs. A good and easy method here is to cut a piece of stiff paper of a size to fit the top portion of the legs where the

dowels are to come, as at (E) and (F). Mark the position of the dowels with centre and cross lines, place on the legs, and prick through with an awl.

To use the gadget on this part of the job, cut a piece of wood, as at (H) in Fig. 2, of suitable thickness and interpose between parts (A) and (B). Its thickness will be determined by the distance required between (A) and the point of the drill bit, this distance being obviously the same as the distance between the side of the legs and the dowel points. As a further guide, draw pencil lines across the leg over the dowel guide points already made. The holes can then be bored with the aid of the gadget, as described.

To mark accurately the holes for the dowels on the ends of the rail, draw two

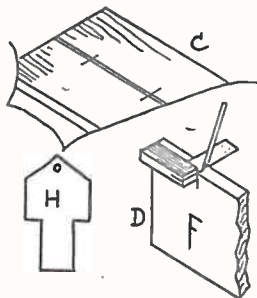

Fig. 2

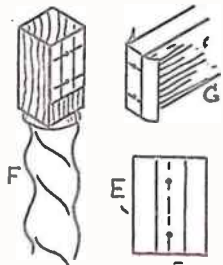

Fig. 3

lines down the paper guide (E) the thickness of the wood apart, with the dowel spots down the centre. Fold the paper on the lines drawn, and place on the end edges of the rails, as shown in detail (G). Prick through on the spots, and pencil line across each. Then the holes can be bored, as already described, with the bit, working through the guide hole in the gadget.

To save subsequent work, keep the thickening pieces, made as necessity demands, with the gadget in a box. They may come in useful later on.

**NEW!**

# EXPERIMENTAL KITS

## LEARN THE PRACTICAL WAY

Here is home study of the most effective kind under expert tutors. There is no better way of studying for an examination for a career in industry or starting a new hobby. Our Practical courses comprise the most modern methods of postal tuition, combined with a practical kit of parts (which is supplied upon enrolment and remains your property).

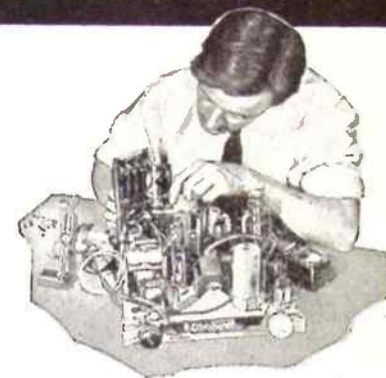

### COURSES FROM 15/- A MONTH

COURSES WITH KITS INCLUDE: Radio, Television, Mechanics, Electricity, Chemistry, Photography, Carpentry; also Draughtsmanship, Commercial Art, Amateur S.W. Radio, Languages, etc.

**EMI INSTITUTES**  
The only Postal College which is part of a world-wide Industrial Organisation.

### POST THIS COUPON TODAY

E.M.I. INSTITUTES, Dept. 31X, Grove Park Road, London, W.4. Please send me your free book.

Subject(s) of Interest \_\_\_\_\_

NAME \_\_\_\_\_

ADDRESS \_\_\_\_\_

16/2/55 \_\_\_\_\_ IC. 51

The Ideal HOBBY for any age!

SCULPTORCRAFT MOULDING AND PAINTING OUTFITS... FASCINATING... PROFITABLE.



THE 'Sculptorcrafs' range of moulding outfits includes over 200 different moulds and an extensive range of complete kits... the enthusiast can turn this pleasant hobby into a profitable one! Illustrated are 3 models... Blue Bird Wall Plaques; Traditional Toby Jug and the Rustic Ash Tray—all of which can be painted in glorious colours.

**Sculptorcrafs**

BY SEAMER PRODUCTS

Send 2½d. stamp for Free Catalogue to Dept. H.W.2, Seamer Products, 23-27 Eastbourne St., Hull. Tel. 37011



## Leaves no Brushmarks!

Here is a paint that provides a smooth professional finish at the touch of a brush, an easy to use quick-drying finish that covers perfectly in one coat and leaves no brushmarks. Just ask for Robbialac Lacquer, the gloss finish that is available in 24 brilliant colours plus black, white and silver and which provides a hard wearing surface that resists weather, water, steam and chemical atmosphere. Robbialac Lacquer comes in handy  $\frac{1}{4}$ ,  $\frac{1}{2}$ ,  $\frac{3}{4}$  and 1 pint tins and is sold by all good paint shops, cycle shops, ironmongers and hardware dealers.

## ROBBIALAC LACQUER

FREE: Put a 'factory finish on your handiwork. For free Instructional Leaflet send 1½d. stamp to: Dept. 6L2.

JENSON & NICHOLSON LTD., CARPENTERS RD., E.15

# A Portable Tool Box for the Handyman

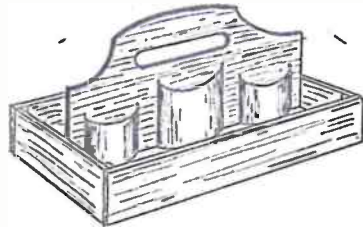

wood, and the corners can be reinforced with triangular strips if this is thought necessary. Cut the base of the tray first, then the sides can be built around it. For most general purposes a piece 14ins. long and 11½ins. wide will be sufficient, but this may be increased

DOING innumerable jobs about the house means carrying tools and materials from place to place and often at very short notice. A washer may be needed on a tap, a sash cord for a window, lino may need tacking down or a hinge need oiling.

All these varied tasks call for an assortment of tools, nails, screws, nuts and bolts, etc. When you start on a job you probably do not know your actual requirements, and to save a lot of running about it is nice to have as much as possible in a handy place for use on the spot.

This article deals with a compact container for tools and materials that can be easily carried about from place to place and is always ready for any repairs that may be needed. Although quite light in weight it is comparatively strong and is easy to make.

The entire framework is of ½in. ply-

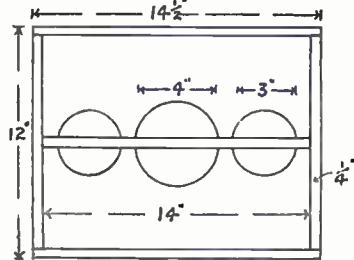

if necessary to house a wider range of tools and material.

The sides are built around the base-board and they need not be very deep—2½ins. to 3ins. will be enough. Two pieces 14½ins. for the long sides and two pieces 11½ins. for the short sides. Glue and tack these firmly in place and fix the corner pieces for strength if thought necessary.

The circular containers for screws, nails, etc., are cut from old tins and the centre ply panel which divides these in half also acts as a handle for carrying the tray around. The centre tin is larger than the two outside ones, being about 4ins. diameter, while the others are 3ins. each.

### Smooth Edges

Neatly cut the tops off the tins and file and emery paper the edges quite smooth. If you do not mind spending a little extra time on the job an ideal finish is to solder a piece of wire round the outside of the tin tops. When done neatly this makes a smooth edge and avoids cutting the hands.

To hold the tins in place the centre ply panel is cut and slotted as shown and then slipped over all the tins and glued and tacked in position. Cut this centre panel from ½in. ply 14ins. long and 7ins. wide.

The slot for carrying is about 5ins. long and 1½ins. wide and the edges well rounded off with glasspaper. It would, perhaps, be an advantage to fit triangular corner pieces to the ends of the handle for strengthening where it is glued to the sides of the tray.

Give the tray a coat of paint to preserve it and make it fit to be seen anywhere about the house.

(A.F.T.)

Continued from page 313

## Home Chemistry

Burning and breathing both work on a similar principle, because both involve combination with oxygen. In the body, carbon-containing waste matter in the blood is turned into carbon dioxide which is got rid of by breathing out. Sometimes in serious illnesses the oxygen of the air is not concentrated enough to do the job and more has to be supplied to the patient.

An intriguing experiment will show what a help this is. Half fill a test tube with hydrogen peroxide and drop in manganese dioxide little by little until bubbles rise in the liquid. The bubbles contain oxygen and, bursting at the surface, fill the empty part of the tube. Light a spill and blow it out. The glowing end—like the patient—will soon go out, if some help is not given.

Plunge the glowing end into the oxygen in the upper part of the test tube. With a slight pop the spill will burst into

flame again. This glowing spill test is always used to find out when a chemical is giving off oxygen.

### Spectacular Trick

Oxygen can be made from many other chemicals besides hydrogen peroxide and manganese dioxide. These other chemicals all contain a lot of oxygen and part with it easily. Heat a little potassium permanganate in a dry test tube and plunge in a glowing spill. It takes fire, showing that the chemical is giving off oxygen. This chemical will even provide enough of the gas to set fire to glycerine. The experiment makes a most spectacular trick—no less than making fire without a match!

Powder some potassium permanganate and heap it into a cone on a tin lid—about as much as would heap up on a shilling. Make a little hollow in the top and let one or two drops of glycerine

fall into this. In a few moments smoke will appear. Suddenly the glycerine will burst into a fierce lilac flame and the mass round it will glow red hot.

Another trick makes use of potassium nitrate (saltpetre, or nitre), for this, too, provides extra oxygen. In a quarter test tube of water dissolve as much potassium nitrate as you can by warming over a flame. With this solution draw the outline of, say, an elephant on porous white paper. See that the outline has no breaks. Make a small pencil mark at one point and let the paper dry. The drawing will be unnoticeable. On touching the pencil mark with the glowing end of a bit of burning string, a spark will appear, separate into two and run all round the outline of the elephant (Fig. 3).

While you have the potassium nitrate solution you might like to make a fuse. Simply soak a length of soft white string in it for about a quarter of an hour. After removing it and letting it dry, it will fizz and burn quickly on applying a light.

(L.A.F.)



**ELECTRIC PAINT STRIPPER**

4/- DEPOSIT  
3 monthly payments of 10/-  
Cash price 30/-

Old paint peels off like magic with the Marvell electric paint stripper. Easy, even strokes remove paint, varnish, etc. Four-sided blade for angles and corners. A.C./D.C. mains—state voltage.

P. & P. 1/- Send for leaflet



**ELECTRIC PAINT SPRAYER**

For 5/- deposit

Cash 75/- Or 5/- deposit and 6 monthly payments of 13/6

Paint easily, evenly, twice as fast with the Burgess Electric Sprayer. Sprays paint, varnish, etc. Complete with sturdy glass container, flex, nozzles for ceiling spraying and extra nozzle discs for different liquids. A.C. mains only—state voltage. Fully guaranteed. Illustrated leaflet free



**SANDER POLISHER** (ELECTRIC)

5/- DEPOSIT

The I. & G. Electric Sander Polisher does the job ten times faster than by hand with no effort. Sands wood, furniture, burnishes metal, polishes cars, furniture, silver, A.C. only 220 250v. Cash 75/- Or send 5/- deposit and 6 monthly payments of 13/6

Send for complete list of Tools



**UNIVERSAL SAW**

8/- DEPOSIT  
6 monthly payments of 6/-  
Cash price 49/6

The I. & G. Universal Saw fits any electric hand drill. Saws much faster than by hand. 3 blades with saw, one for 1½" timber, one for metal, one for plastic etc. Simple, robust. Send for leaflet.

**BARGAIN DISTRIBUTORS**  
(DEPT. 124) 5 SILVER STREET, LUTON



*A really superior finish!*  
... FOR 101 JOBS

Easy to apply and quick to dry, these inexpensive lacquers have many uses. They will impart a rich and lustrous finish to models, picture frames, lamp standards, wicker chairs, work baskets, those unsightly water or gas pipes, etc. Fine for dance shoes too! Be sure to ask by name for

**CROWN SILVER LACQUER AND GUINEA GOLD LACQUER**

FINEST QUALITY  
RICH & LUSTROUS  
BRITISH MADE

OBTAINABLE ONLY FROM  
**WOOLWORTHS**

1/- TINS

## MORE FUN FROM YOUR RAILWAY!

Get the most from your railway by reading, each month, the leading magazine for the Average Enthusiast, large, lavishly illustrated, and packed full of practical articles on all aspects of the hobby.

**With The RAILWAY MODELLER**

1/6 Monthly      1/8 post paid      Dept. H.W.  
Layout Plans No. 1 1/3 No. 2 1/3      Pecoway  
Scenic Modelling      1/9      Station Rd.  
The Railway Modeller Model Railway 6d.      Seaton, Devon

### A MODEL-MAKER'S 'MUST'!



The 'BRITINOL' Sprit Blowlamp Gives a 3-4 inch flame from methylated spirit, is ideal for all soldering jobs, and heats a small iron rapidly. Completely automatic in action, no pumping necessary. Price 7/- from Hobbies or Halfords shops, or in case of difficulty, from:

**BI-METALS (Britinol) LTD.,**  
St. Mary's Works, Bridge Road  
London, N.9

**MAGIC** Jumping Card and wonderful Catalogue 1/-.—DeHempsey, 363 Sandycombe, Kew Gardens, Surrey.

**TOY CASTING MOULDS.** Soldiers, sailors, fairmen, etc. 1,000 varieties from 3/- each. Rubber moulding compound for flexible moulds, granulated ready for use. 8/6 per lb. Aluminium moulds for plaster work. S.A.E. for list. Catalogue 9d.—F. W. Nuthall, 69 St. Mark's Road, Hanwell, London, W.7.

**NEW AND USED** Correspondence Courses for sale. List.—Courses, 28 Dean Road, London, N.W.2.

**RUBBER MOULDS** for plaster casting, Sample 3/11. Trade supplied. S.A.E.—Burlleigh Supplies, 13 Burlleigh Street, Hull.

**SWISS MUSICAL** Mechanisms for cigarette boxes, etc., 18/- post free. S.A.E. for illustration and list of tunes available.—Dept. HW, Metwood Accessories, Church St., Wotterton, Bucks. (Trade supplied.)

**A GRAND BOOK FOR ALL THE FAMILY.** The "Kaylee Year Book of Bright Ideas". A really helpful guide to home planning, decoration, Hobbies, toys, etc. Showing famous Kaylee Transfers in brilliant colours, and most effective uses. From "Hobbies" stockists 1/- or direct. **KAYLEE TRANSFERS LTD.,** (HW) Long Eaton, Nottingham Postage 3d.

**GOVT. SURPLUS BARGAINS.** Electric Motors, 3-6V D.C. Dimensions 1" dia. x 1½" long. Low consumption, good torque. Ideal small models, etc., etc. Our price only 4/6, post 4d. Hundreds of other bargains. 3d. stamp for illustrated list of Motors Transfers, Switches, etc. **MILLIGAN'S,** 24 HARFORD STREET, LIVERPOOL, 3. Money Back Guarantee.

The amazing  
**'ABRAFILE'**  
ROUND FILES

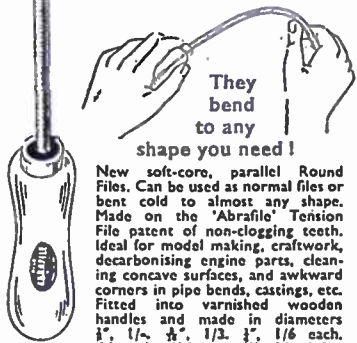

They bend to any shape you need!

New soft-core, parallel Round Files. Can be used as normal files or bent cold to almost any shape. Made on the 'Abrafile' Tension File patent of non-clogging teeth. Ideal for model making, craftwork, decarbonising engine parts, cleaning concave surfaces, and awkward corners in pipe bends, castings, etc. Fitted into varnished wooden handles and made in diameters 1/8", 1/4", 3/8", 1/2", 3/4", 1" each. Also the 'Mousetail'—ideal for small work. Price 4½d. each. From all leading hobby shops and ironmongers, or send 1½d. stamp for illustrated leaflet to:

**ABRASIVE TOOLS LTD.**  
162 GRAY'S INN ROAD, LONDON, W.C.1

**'PAINTSPRAYING' HANDBOOK** (1954 Ed.). Covers Car, Industrial & Flock Spraying. 3/6, post free, including catalogue of our Cellulose and Synthetic Paints and all Allied Sundries and Plant Hire.—Leonard Brooks Ltd., 81 Oak Road, Harold Wood, Essex.

**AMERICAN MAGAZINE** Subscriptions. One Year Popular Mechanics 32/-; Popular Science 28/6; Homcraftsman 16/6; Homcraft 18/-; Deltagram 10/6. Free booklet quoting others.—Willen Ltd. (Dept. 57), 101 Fleet St., London, E.C.4.

**STAMPS FREE!!** Twenty unused (2½d.).—S.G. H. Barnatt, Limington, Somerset.

**Micromodels**  
MODELLING IN CARD

**GIANT SHOVEL EXCAVATOR**  
SET TO, II

**HAMPTON COURT**

SET ARC XXI

Send stamped addressed envelope for Illustrated List of 100 Models, Historic, Architectural, Mechanical, Railway, Maritime, Aero, etc. etc.

**MICROMODELS LTD.**  
3 (H) Racquet Court  
Fleet Street London E.C.4

**LEARN** it as you do it—we provide practical equipment combined with instruction in Radio, Television, Electricity, Mechanics, Chemistry, Photography, etc. Write for full details to—E.M.I. Institutes, Dept. HW.47, London, W.4.

**DOLL'S HOUSE** fittings and papers. Send S.A.E. for list. Doll's House plan, special, send 2/6. Trade supplied.—Zimplan, 88 Ware Road, Hoddesdon.

**STAMPS FREE**—Empire Packet including Pictorials and Victorians with approvals.—Robert J. Peck, 7A Kemp Road, Bournemouth.

**STOP SMOKING!!** Quick guaranteed remedy. Free Testing Sample!!—Triumph Remedies (11.2), Exeter.

**MODELS.** You can make lasting stone-hard models with Sankey's Pyram Plastic Cement. Supplied in tins by Ironmongers, Hardwaremen and Builders' Merchants. Ask for instruction leaflet.

**PLYWOOD—HARDBOARD**—at amazing low prices. Send S.A.E. for samples and prices to—N. Gerver, 10 Mare Street, Hackney, London, E.8.

**THIS IS IT!**

**THIS** is the very book "The Sunday Dispatch" said, "Tells everything!"

**THIS** is the very book the Press said, "is packed with every Gadget-Making Instruction—is invaluable."

**THIS** is the very book from which 3 great National papers are printing extracts in their own columns!

**THE DE-LUXE 10/- ONLY 1955 GADGETS ANNUAL**

Massively printed on solid card throughout with full cloth binding and concealed spiral hinges for easy reference and elegant appearance.

Packed from cover to cover with Over 350 of the very latest and most ingenious ideas in easily made gadgets and devices for every purpose including home—Garden—Workshop—Car and Garage—Hobbies—Tools and Implements—Saleable Inventions—Miscellaneous Novelties—Charming Gifts—Amusing Puzzles—and a Host of Other Fascinating Devices. Every one can be made from wood and scrap materials.

Over 250 Illustrations and Diagrams

What a Wonderful Gift this Grand Book Will Make

Return post service—send 10/- only and ask for the "De-Luxe 1955 Gadgets Annual" to:—The Home-Made Gadgets Magazine, 24 Swan House, Kingsbury, London, N.W.9.

**LEARN TO WEAVE.** Diploma Correspondence Course, also 'Make Your Own Loom Plan'. Write—"Homcrafts" Magazine, 29, Canterbury.

**FREE!** Bi-coloured car and motor-cycle stamps (catalogued 3/11), to approval applicants enclosing postage.—R. Cater, 280 Tuddenham Rd., Ipswich.

**STAMP Collectors**—what's your line? 100 Australia, 6/-; Canada, 4/6; Egypt, 6/-; India, 3/-; Iraq, 6/9; New Zealand or South Africa, 8/6; 1,000 World, 9/6; 500 Empire, 14/-; 11b. unsorted stamps on paper, 12/-; all post free.—E. Faircloth, 1 Keep Hill Drive, High Wycombe, Bucks.

**100 DIFFERENT** stamps free 1½d. upwards approvals.—Bush, 53 Newlyn Way, Parkstone, Dorset.

**\* GREAT CAMPING OFFER \***

**RIDGE TENT** SENT FOR 4/-  
BRAND NEW de luxe Para. Tent. All colours. Complete. Ideal Cyclists, Campers. Length 7 ft. 3 in., sleeping base x 4 ft. 6 in. wide x 3 ft. 6 in. high x 12 in. walls, all approx. Weight 3½ lb. £215s. or 4/- deposit and 6-monthly. With fly-sheet £42s. 6d. or 10/- deposit and 9-9 monthly. Both carr. 1/6. Lists of other models. Terms. Send now for this really wonderful offer.

**TELESCOPE** QUICK ACTION!  
See this telescope in action. Up in a flash with special single draw that cuts down focusing time. You have the object you wish to view at close quarters, in a split second. Boy Scouts, Hikers, Cyclists, etc., like this useful telescope because let into the body there is an accurate compass which gives you bearing of view. The price of this absolutely super bumper bargain 2/6 only plus 6d. post, etc. NO MORE TO PAY. Black grained body with nickel finish. FREE LISTS WATCHES, BINOCULARS, TENTS, TARPAULINS, MARQUEES, TERMS. Open Sat. 1 p.m. Wed. Headquarter & General Supplies Ltd. (Dept. HOBW/39), 196/200 Coldharbour Lane, Loughboro Junction, London, S.E.5

**MAGNETIC COMPASS**  
WITH INSET  
2/6 6 POST ETC.

**ABOUT** time that you, too, sent for my 14 approvals. There's always something!—Triggs (Approvals), 9 Princes St., Deal, Kent.

**PRINTING** Machine—Small Gammeter, Model 60 printing machine. Complete with many banks of type; ideally suitable for Clubs or Societies for printing circulars, programmes, announcements, etc. Inspection and offers invited. Birmingham.—Box No. 16, Hobbies Weekly, Dereham, Norfolk.

**45 STAMPS** free. Send 2½d. requesting attractive approvals.—C. Rogers, 31 St. Leonard's Ave., Hove, Sussex.

**SUPER** free offer—Mini 1954 Spanish Morocco Set; request approvals, enclosing 2½d. stamp.—Foster, 37 The Worthing, Birmingham, 30.

**AMERICAN MAGAZINES.** Yearly subscriptions:—Model Railroader 39/-; Model Trains 28/6; Popular Mechanics 32/-; Popular Science 31/-; Profitable Hobbies 28/6. Specimens 3/6 each.—Hobson, 79 Southbrook Road, Exeter.

**SEA SHELLS** for all types of shellcraft. Large for small quantities. Send now for latest price list, post free, to—Sea Shell Supplies, Bray Rd., Alderney, C.I.

**10/6!** CRYSTAL Radio Kit. Send 5d. for building instructions.—Blanchard's (H6), 13 Gainford Gardens, Manchester, 10.

**FREE** stamps—50 different, plus 10 San Marino Pictorials, on application for my approvals.—P. E. Bentham, 40 Little Glen Rd., Blaby, Leicester.

**FASCINATING** steel tracing machines for copying and enlarging from newspaper and magazine drawings, sketches; interesting; 5/- post free.—Clayton, 16 Westminster Road, Bradford, Yorks.

**100 STAMPS** and perforation gauge, free to all approval applicants enclosing 2½d. stamp.—Cliffe West (N), 61 Wynyard Road, Sheffield, 6.

**MATCHBOX** size crystal sets. All parts, crystals, instructions, complete, 3/3. Efficiency guaranteed. Folio of four crystal and crystal diode designs by F. G. Rayer (all-wave, miniature, etc.), 1/1½ post free.—Bailey's, 44 Stanley St., C. Oldham.

**TRANSFER** Graining Paper—Oaks, Walnuts, Samples, 1/-. Complete range, 3/-.—Roll, 16/10.—H. Decano Co., 20 Clarendon Rd., Jersey.

SEE PAGE 310

**DETAILS OF THE CACTI STAND**

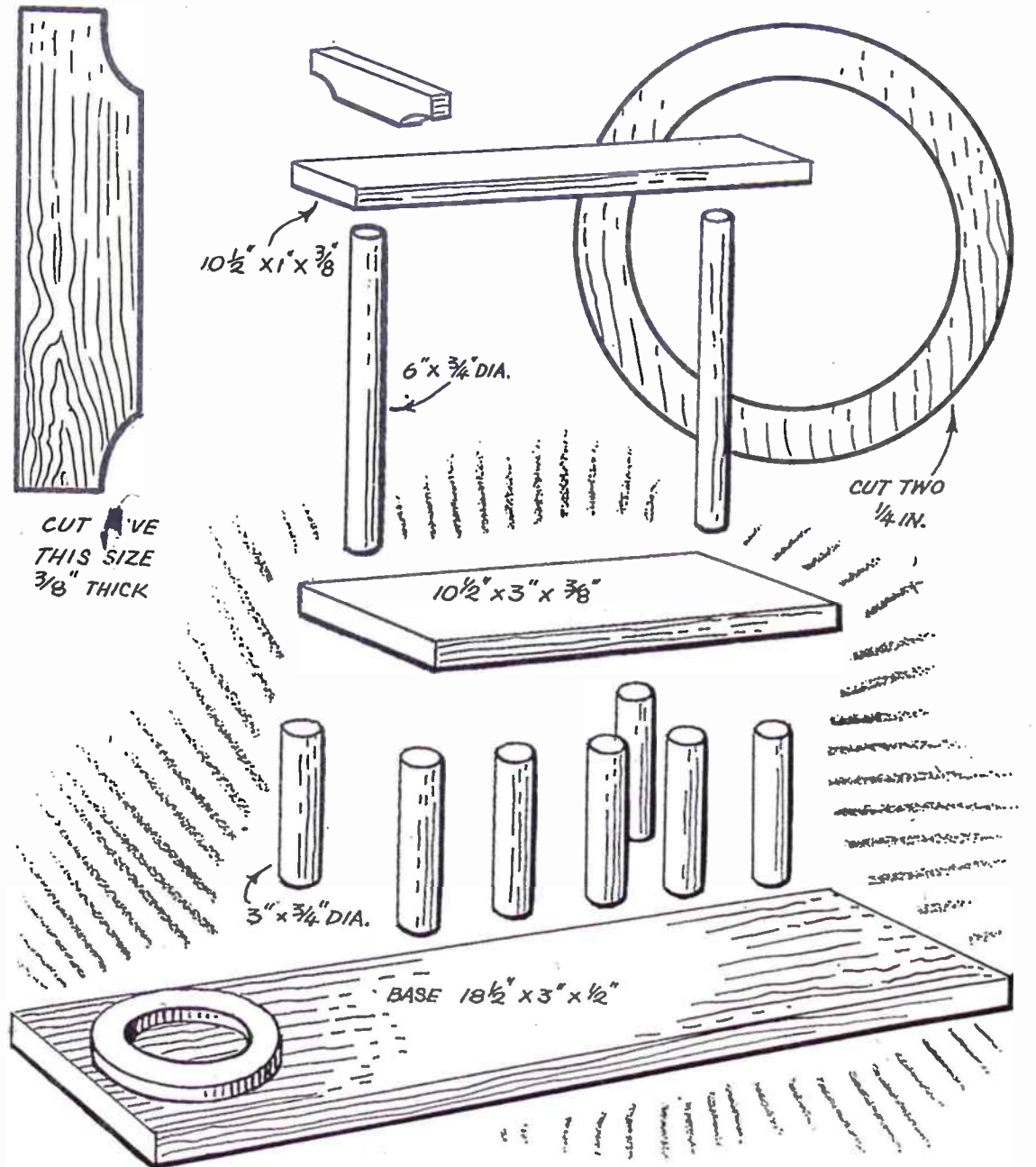



# WHATEVER YOUR PASTIME!

## HANDICRAFT ANNUAL

WILL SHOW YOU HOW TO  
MAKE MANY THINGS AT  
HOME IN YOUR SPARE TIME  
INCLUDING:—

BOOKCASE TABLE · CHILD'S COT  
BOOKCASE UNIT · CHILD'S DESK  
WARDROBE · HOUSEHOLD ARTICLES  
PLASTER-CASTS · LEADED LIGHTS  
GARDEN SHED · NEW DOORS FOR OLD  
PICTURE FRAMES · DOLL'S HOUSES  
AND MANY OTHER THINGS  
TO BE MADE FOR PLEASURE AND PROFIT

## HANDICRAFT ANNUAL

1955 EDITION

REPRINT NOW  
READY

OBTAIN YOUR COPY  
FROM YOUR  
NEWSAGENT

OR DIRECT FROM  
HANDICRAFTS LTD.  
PETERBOROUGH

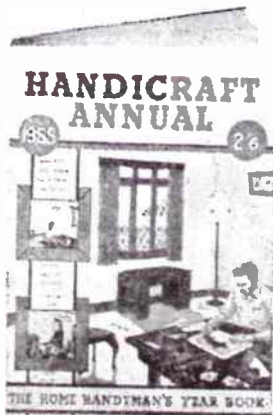

2/9 Inc. POSTAGE

THE "FLUXITE QUINS" AT WORK

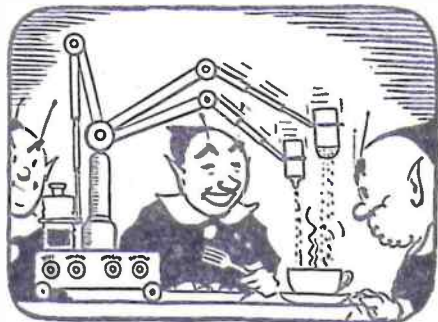

"Our new Auto-Cruet," grinned EE,  
"And all made, with FLUXITE, by me.  
Just press button A."

"I did!" shouted EH,  
"And got pepper and salt in my tea!"

# FLUXITE

## SOLDERING FLUID



and its famous equal  
**THE**  
SOLDERING PASTE

*Simplify all  
Soldering!*

The standard sizes of  
FLUXITE FLUID are:

4 Fluid Ounces	8 Fluid Ounces
20 Fluid Ounces	1/2 & 1 Gallon Cans

FLUXITE LTD BERMONDSEY ST·LONDON S·E·1

GM.7

Telephone: HOP 2632  
EXPORT ENQUIRIES INVITED

Printed by BALDING & MANSELL, LTD., London and Wisbech, and Published for the Proprietors, HOBBIES LTD., by HORACE MARSHALL & SON, LTD., Temple House, Tallis Street, E.C.4. Sole Agents for Australia and New Zealand: Gordon & Gotch (A'sia) Ltd. For South Africa: Central News Agency Ltd. Registered for transmission by Canadian Magazine Post.



FRAME. CUT ONE 1/4 in.

CENTRE LINE

BORDER STRIP

CENTRE LINE

SIZE  
14ins. BY  
10 1/2 ins.

Glue it with **Croid**  
 Universal Glue for use cold straight from the tube or tin from 1/- each.  
**Aero Glue** in the Home Outfit or in tins from 1/3 each for quicker setting.  
 Available from all branches of Hobbies Ltd.

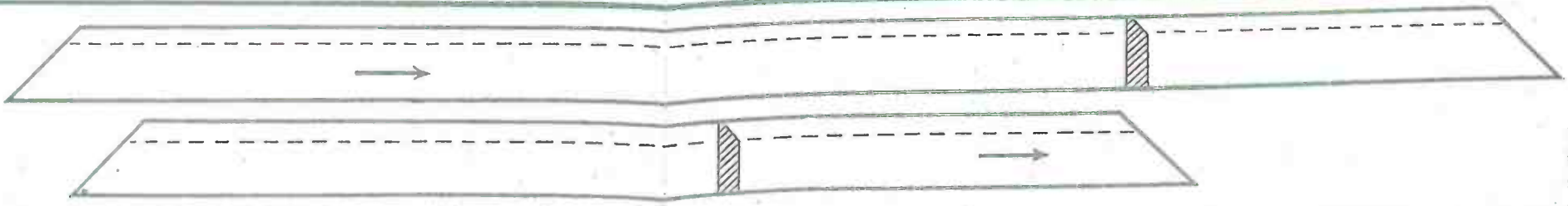
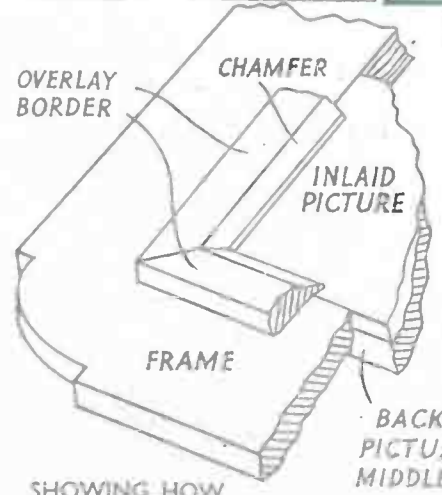

OVERLAY BORDER STRIPS ROUND PICTURE. CUT TWO OF EACH FROM 1/2 in. BY 1/2 in. STRIPWOOD

SHOWING HOW THE PICTURE IS FRAMED. A PORTION ONLY OF ONE CORNER OF THE FRAME AND PICTURE IS GIVEN

THE ARROWS INDICATE THE DIRECTION OF GRAIN OF WOOD

PRINTED IN ENGLAND

KEY TO INLAY PICTURE.

	LIGHT		MEDIUM DARK
	MEDIUM LIGHT		DARK

Materials required for this design  
**WOOD** One J4. Four No. 1 Inlay Panels (contrasting colours).  
 A complete kit of the above materials can be obtained from  
**HOBBIES LTD., DEREHAM, NORFOLK**  
 Price on application



**AN INLAID PICTURE**  
**THE FERRY INN**

**Hobbies DESIGN**  
 No. 3094