

Hobbies

WEEKLY

CONTENTS

	Page
How to make an Episcopo	401
Boot Guards for the Spade	402
Novelty Fountain	403
Making a Chain Wrench	404
Useful Clip	404
A Main Line Saloon Coach	405
Simple Compass	406
Three Easy Novel Ics	406
Rustic Fences & Pergolas	407
Coconut Novelities	408
Multi-Purpose Money Box	409
Replies of Interest	410
A Magic Frame	411
Shipmodeller's Corner	412

March 26th, 1952

Price Fourpence

Vol. 113 No. 2943

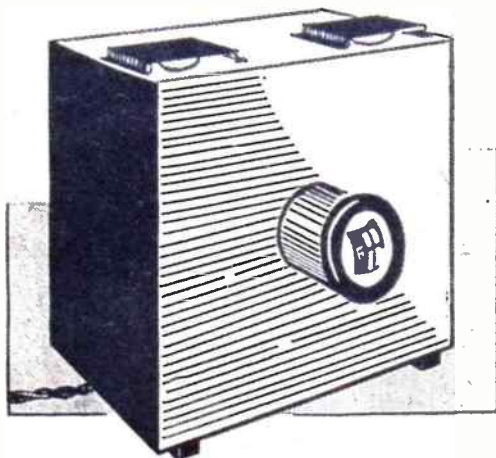

THIS very popular instrument will project on to a screen any photo or picture within its limits. It is of easy construction, and will furnish hours of amusement and instruction. A plan view, minus top, is given in Fig. 1, to show the interior arrangement. From this, it will be seen that a pair (or one) of lamps are employed to illuminate the picture, which is placed opposite the lens. The latter is contained in a metal tube, and capable of an in and out motion for focusing purposes. The whole presents no difficulties whatever, and is quite simple to operate.

Making the Box

The box can be made of wood $\frac{1}{2}$ in. thick, though tinplate would be better if the reader has the skill, and tools to use it. Dimensions are given in the drawing, and these should be adhered to, so if a

thicker wood is used, these dimensions should be increased in proportion. The bottom and the top of the box could be made of good quality cemented plywood $\frac{1}{2}$ in. thick. In the front of the box, cut out a hole for the lens tube (to be mentioned further on) and in the back saw out a door $6\frac{1}{2}$ in. square. If a fine blade is used for sawing out, the piece left can be used as the door, and not wasted. The top and bottom are screwed on, for removal when adjustments are necessary to the lamps. Round the door, on the inside, glue $\frac{1}{2}$ in. thick strips of wood, as in the drawing, letting

them overlap $\frac{1}{4}$ in. in the opening, to trap the light from escaping, and act as a stop for the door.

Hinge the door at its bottom edge, and fit a small metal button above to keep it shut. Now remove the bottom of the box for fitting the lamp holders in position. These can be of the batten type, and are screwed where shown in the plan. Near the back edges of the bottom, bore a line of $\frac{1}{8}$ in. holes for ventilation, a very necessary precaution, as the heat from the lamps in such a confined space must have an outlet. In the top of the box, bore a pair of $1\frac{1}{2}$ in. holes as outlets for the hot air to escape. These should be directly above the lamp holders.

The Light Traps

Pieces of tin should be bent to the shape shown in the view of the finished episcopo, and be screwed over these outlets to trap the light. Behind the lamps, a reflector is to be fitted. These can be made from empty tins. Just cut the bottoms of the tins away, and cut out the vertical seam. Leave enough of the tin at the bottom to form a small tab, which can be bent outwards, and punched for a screw, by means of which it can be fixed to the bottom of the box,

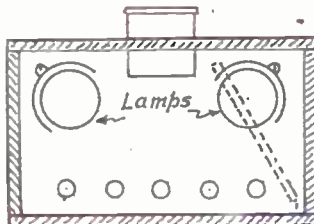

Fig. 1

All correspondence should be addressed to The Editor, Hobbies Weekly, Dereham, Norfolk.

behind the lamps. Bend the reflectors to a semi-circle suitable to the diameter of the lamps.

It is quite practical to employ only one lamp, if powerful enough, and to fit a mirror across the opposite corner, where shown in Fig. 1, by the dotted lines. With two lamps, however, of the household type, and, say, of 60 watts, an

even illumination is secured, without too much heat, such as a high powered projection lamp can produce. To complete the inside arrangement, glue to the bottom a couple of strips of wood, $\frac{1}{4}$ in. square section, to raise the episcope above the table and allow a current of air to circulate beneath.

At this stage, the inside of the box

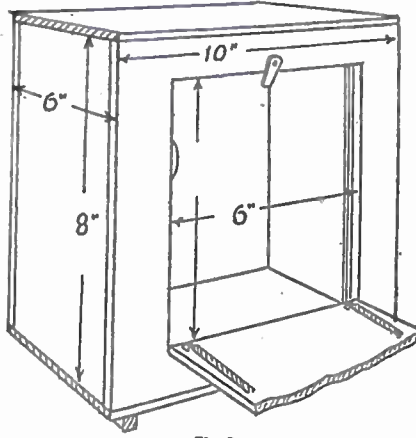

Fig. 2

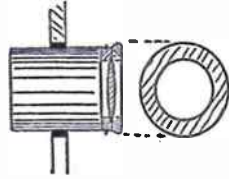

Fig. 3

should be painted white. Connect the lamps in parallel, and attach a sufficient length of flex to reach the nearest light point. Thread the flex through one of the ventilation holes in the bottom of the box, and rescrew the bottom in place. A switch can be added if considered necessary, but is quite optional, as the plug can be inserted where the episcope is to be used, without a switch at all.

For the lens a cheap magnifying glass will serve, about 2 ins. to 2½ ins. diameter and with a focal length of 6 ins. to 7 ins. If more, the tube it is mounted in can be increased proportionately. For the lens mentioned a tube 2 ins. long will be enough. The tube can be cut from an empty tin, and should be about $\frac{1}{4}$ in. more in diameter than the lens. There are several methods of mounting the lens in the tube, and some readers may have their own. One method is illustrated in Fig. 3, and shows the lens sandwiched between two wood rings, the inner ring fitting tightly in the tube, and the outer ring, which is glued to it, a little larger than the tin.

Neat Finish

If these rings are stained black, and the outer one varnished, a neat effect will result. Cut a hole in the front of the box, a trifle larger than the tube, and line it with a strip of cloth, so that the tube can slide freely in and out. To the inside of the door fit clips of springy metal, as shown in Fig. 2, to hold the photo or picture to be projected. Finish the completed instrument with a coat of black varnish or enamel. (330)

Experimenters can make this NOVELTY FOUNTAIN

THIS novelty item is modelled on Hero's fountain—a fountain which works apparently without applied power. Fill the upper basin with water and a spray of water shoots out of the central tube projecting above the water. The fountain will continue as long as there is water in the upper basin.

The principle of operation can be followed by reference to Fig. 1 and Fig. 2. Under the basin are actually two tanks, interconnected with a pipe (B). From tank 1 rises pipe (C), which is the pipe from which the spray or fountain

filled. Both (D) and (E) must be plugged airtight before the fountain will work again—otherwise air transferred from tank 2 into tank 1 would simply escape through (D) and (E), instead of ejecting water through tube (C).

Basic construction of the model is shown in Fig. 3. The basin is a tin lid or a cut-down tin can of suitable diameter. This rests on a rectangular pedestal made from $\frac{1}{4}$ in. stock. Small tin lugs soldered to the underside of the basin form an attachment point for screwing to the wood pedestal. The tank system must be installed before adding the front of the

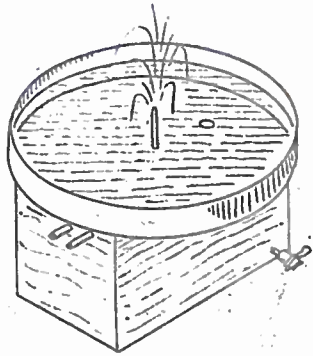

Fig. 4

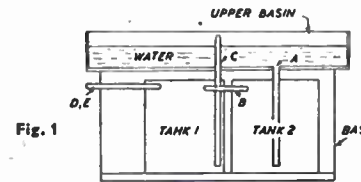

Fig. 1

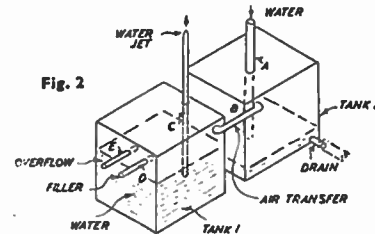

Fig. 2

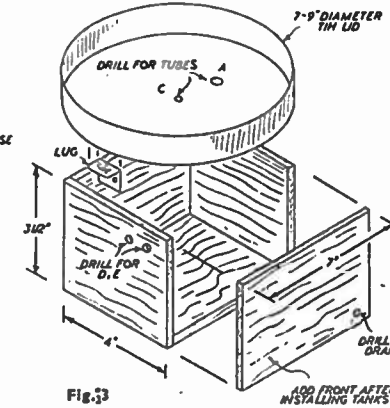

Fig. 3

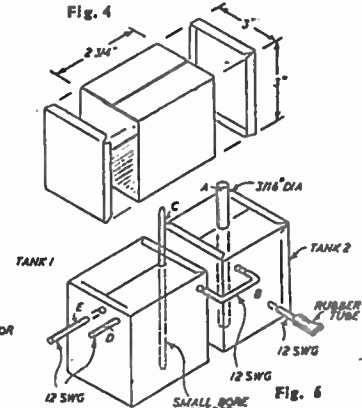

Fig. 6

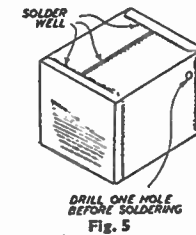

Fig. 5

jets. Leading from the basin to tank 2 is another, wider pipe (A).

Water flows from the basin through pipe (A) into tank 2. As tank 2 fills up it displaces air into tank 1. Tank 1 is initially filled with water and under the action of the air pressure from tank 2, the water from tank 1 must escape. It can only do this through the pipe (C)—hence the jet or spray from the top of this pipe, the spray being achieved by using a small bore pipe and drawing out the end.

Pipes (D) and (E) are simply used for filling. After a complete operation, tank 1 will be almost empty of water, whilst tank 2 will be full. A drain pipe is fitted to empty tank 2, whilst tank 1 is refilled through tube (D). Tube (E) is an overflow to indicate when tank 1 is

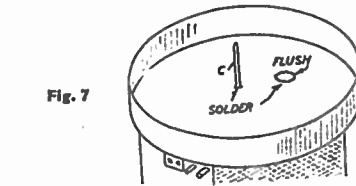

Fig. 7

pedestal. The tanks are simply made from tinfoil, soldered together—Fig. 4. Bend accurately so that the ends are initially a close press fit over the body and it is not necessary to rely entirely on the solder to obtain a watertight assembly. Also drill at least one hole in the tank before completing the soldering—Fig. 5. If this is not done it will be nearly impossible to solder all the seams properly due to the heated air inside the tank tending to blow out.

The piping assembly is then shown in Fig. 6. Use a fairly thick pipe for tube (A) and a narrow bore copper pipe for (C).

The remainder of the piping is 12 S.W.G. brass or copper tubing. Draw out the end of tube (C) into a finer point and then solder all the pipes in place. There is no objection, of course, to soldering the two tanks together also.

Assemble the tanks inside the pedestal, passing pipes (A) and (C) up through suitable holes drilled in the basin. Pipes (D) and (E) and the drain pipe for tank 2 protrude through the sides and front of the pedestal, respectively. Solder pipes (A) and (C) in place and finish off pipe (A) flush with the bottom of the basin. Your model is now complete.

The drain pipe is normally closed by a simple valve of rubber tubing. A clip squashes the end of the tubing flat. Remove the clip or slip the rubber tubing off to open the drain. Tapered pegs, or a similar type of closure can be used to block pipes (D) and (E) after the filling operation. The strength and type of fountain spray can be adjusted by altering the shape of the fine nozzle at the end of pipe (C). (337)

TIPS FOR THE GARDENER

BOOT GUARDS FOR THE SPADE

If there is a criticism I would make of some spades it is that they tend to play havoc with the boots of the gardener by cutting through the instep. This is a serious disadvantage to those who, like myself, are guilty of gardening without bothering to change into gardening boots.

Some spades have integral guard plates, which prevent the blade from cutting the boot. Where these are not fitted the deficiency can easily be remedied.

Two Schemes

One method of overcoming the trouble is to obtain a piece of small-bore pipe, from which two short lengths of about 3 ins. are cut. These are put in the vice, and a saw-cut made in each, as shown in the sketch, Fig. 1. With the blade passing through these saw-cuts, the pipes are driven on with hammer blows. A disadvantage in this method is that the guards may become slack and tend to come off, as they are not tied together.

For my own spade I have made the sheet-metal type shown in Fig. 2, and it is so light and effective that I think it superior to a built-on foot-guard.

A piece of sheet-steel $\frac{1}{8}$ in. thick is cut to the shape shown. The sizes given are

for a blade of 8 ins. width and the lengths would need modification for blades of different width. The metal is bent as shown in the second view. It is then fitted in position on the spade and the end lugs hammered around the blade sides sufficiently to form supports under the top flanges. The spade is now ready for use and is only 4 ozs. heavier than

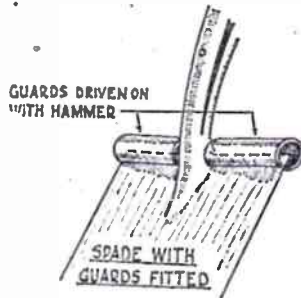

Fig. 1

before. Minimum weight is a very important consideration.

The guard I have fitted has shown no sign of becoming loose, or bending out of shape, yet it can be slipped off at any time for cleaning or greasing. (294)

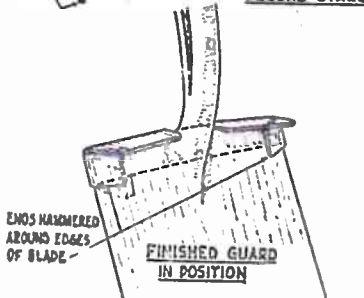
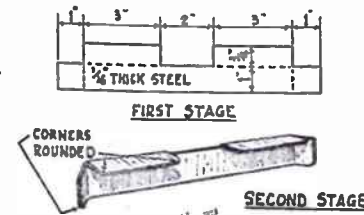

Fig. 2

MAKING A CHAIN WRENCH

THE home handyman is frequently called upon to unloosen screw caps that have stuck fast. The contents of the tins or bottles have got on to the threads of the cap and have glued or cemented it on to the neck.

A useful device to have about the workshop is a chain wrench of the type shown in Fig. 1 (or a similar pattern)—chiefly used for removing free-wheel sprockets on cycles. Fig. 2 shows the shape of the head, the whole job being made of $\frac{1}{2}$ in. tool steel about 8 ins. long overall, with a length of cycle chain riveted one end. At *a* we see the chain free. At *b* we see it wound round a screw cap *c*. It may be an advantage to keep the thumb on point *d*. Such a wrench can also be used for screwing on caps extra tightly.

Such tools, it is believed, are not generally sold to the public, being reserved for the cycle-repair trade, and whilst a fair number of our readers may be able to tackle a light engineering job such as this, if a home-made tool is required, others will appreciate a simpler method—one equally effective. This is demonstrated in Fig. 3, where an obstinate metal screw cap of a preserve jar is being taken off.

Needed: a 12 in. length of $\frac{1}{2}$ in. gas pipe or similar. At one end, two slots are sawn, starting, possibly, as in Fig. 5 and then filling open. Fig. 4 shows the two slots, that farthest from us being comparatively small—just large enough to allow the chain to pass (the chain being held with a pin riveted in) whilst

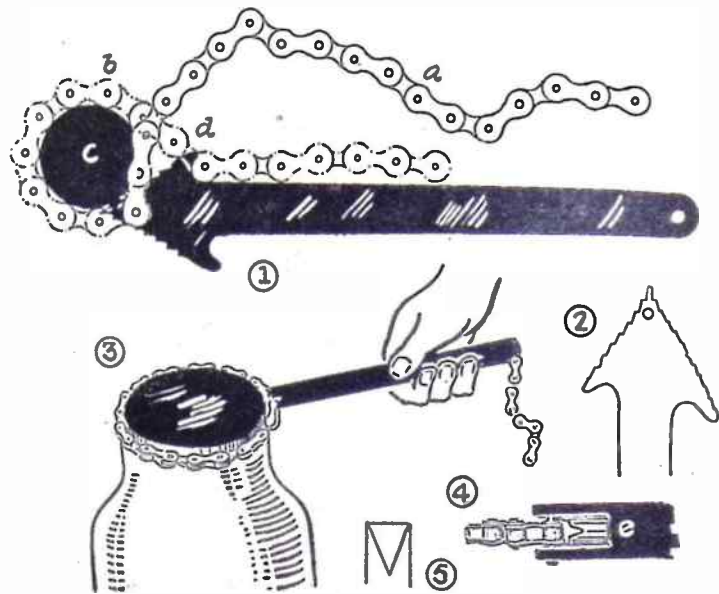

the other slot is a little larger, with a square end. The chain is formed in a loop and the free end passed down the tube. In use, the chain bears against edge *e* and thus leverage is obtained.

Quite optionally, another large slot can be cut at the far end of the tube and a second leverage point obtained, the free end of the chain being held in the same hand that holds the tube.

This device cannot well be used on plastic caps as they so easily break. A good way of loosening such caps is to place the bottles, etc., upside down in a shallow pan of cold water, so that the caps are just covered, and slowly warm up the water. This treatment will almost invariably loosen the caps long before the water boils. Never place the necks in boiling water, as the glass will crack. (310)

means of the cable release, and in such a case the time shutter, which on some models requires both an up and down movement of the trigger, cannot be used. (176)

gauge brass, 1 $\frac{1}{2}$ ins. by $\frac{1}{2}$ in. A slot $\frac{1}{2}$ in. long and $\frac{1}{4}$ in. wide is cut at one end, the corners rounded off, and the whole bent up, as shown. Such a clip can easily be slipped on the cable when required, and takes up a very small space in the photographer's gear. Cable releases do not vary much in size, but it is as well to check up the foregoing measurements (taken from the writer's own release) before making one's own.

Even photographers with a time shutter on their cameras will find the clip useful. It is often advantageous to manipulate the shutter at a distance by

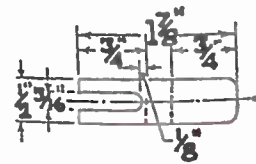

Details of the clip and how it works



A Main Line Saloon Coach

FOR THE TOY RAILWAY

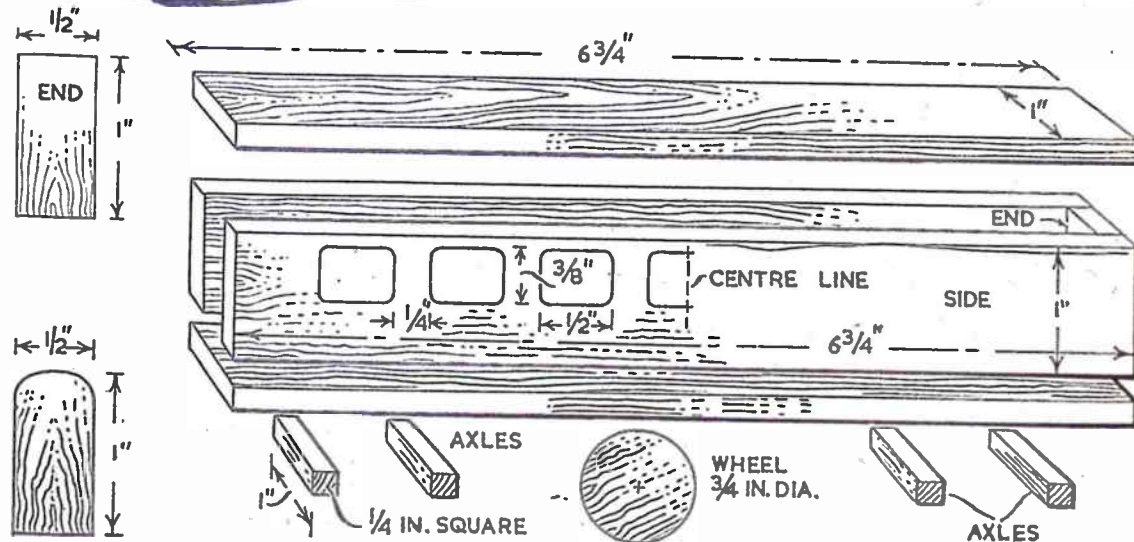
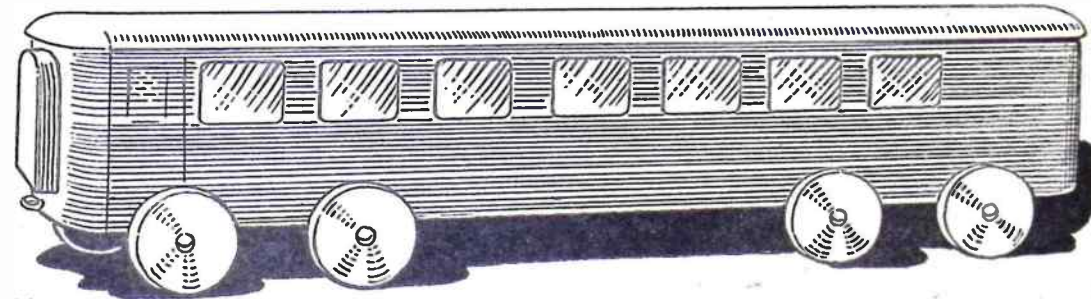

CONTINUING our Toy Train Series we give this week details of a saloon type railway carriage. As in the previous articles the wheels are carried on fixed axles on the outside of the coach and not on bogies underneath as in actual practice. This considerably simplifies the construction and assembly. The main outline of the coach conforms as near as possible to the actual thing.

Construction

The main dimensions are shown on the diagrams and each part should be cut from $\frac{1}{2}$ in. wood. The sides, roof and floor are all identical in overall size, but the sides will have openings cut to represent windows. There should be about seven of these on each side, but the exact number is not important so

long as both sides are alike. The easiest way to draw these in is to start from the centre line, keeping to the measurements shown. Work from each side of the centre line like this and you will have an equal space remaining at the ends. Note that the windows may be painted on instead of cut out. Now glue the sides on the floor, and the ends between the sides as shown. Assuming the windows to be cut out, you must now paint the inside of the coach red. This applies also to the underside of the roof. Leave a margin in this case for gluing. Round off the ends of the coach and then glue the roof in place. This must also be rounded off to conform to the shape of the coach. The edges will also be rounded off as shown in the illustration. Glue the rounded block on one end to represent the corridor extension.

The axles are cut from $\frac{1}{4}$ in. square stripwood and glued to the floor. The centre of the first one is $\frac{1}{2}$ in. from the end and the next is 1 $\frac{1}{2}$ ins. away, centre to centre. Cut the wheels from $\frac{1}{2}$ in. round rod, in $\frac{1}{2}$ in. or $\frac{3}{4}$ in. lengths and drill through the centre ready for screwing to the axles.

Paint the coach blue or maroon and the top white or cream. The windows, if painted, will be jet black. Paint the corridor extension black and the wheels black or grey. Screw the wheels in place and insert a screw eye at each end of the coach as described for the other toys in this series.

To complete a train you will need to make two or three coaches, keeping them all the same colour and painting the name, such as 'The Norfolkman' on the sides. (339)

For the photographer — A USEFUL CLIP

CERTAIN cameras have only a bulb setting on the shutter, and not one for time, so that for long exposures the plunger of the cable release must be kept down. This is particularly awkward when taking flashlight photographs, as it means that the hands are not free to attend to the light, etc. The makers often recommend wedging the trigger with a piece of matchstick—a clumsy expedient.

The attached diagram shows how a clip to hold down the plunger may easily be made from a scrap of stout

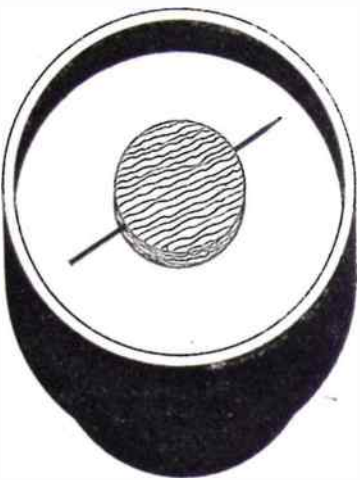

The compass ready for use

You can make this SIMPLE COMPASS

MAGNETISM has fascinated men from time immemorial. The beginning of its history is lost in antiquity. Even before the coming of the Ancient Greeks something was known of a strange stone with the power to attract iron.

Moreover, as was the case with so many of the forces of nature, man first regarded magnetism with superstitious awe. For many thousands of years, in fact, he gave credence to such fantastic stories as the one about magnetic mountains with the power to sink ships. This they were said to do by extracting the nails from vessels entering their orbit.

It was not until the potentialities of this great new force manifested themselves to a few of the more enlightened

that man set about harnessing its direction-finding properties. But we have no idea what the first compasses were like. The most we can do is hazard a guess that they were simple bar magnets set in wood or cork and floated on water.

A compass such as men probably used to steer their ships by for centuries is shown in the accompanying illustration. All you have to do to possess one quite as good is to acquire a bowl—preferably wooden, so that you can mark the compass points along the inner rim—and fill it two thirds with water.

Magnetise a length of wire pointed at one end by stroking it towards the point twenty or thirty times with the South pole of a magnet. Insert this centrally across the diameter of a round flat cork and set afloat. (184)

pieces and then give them to your friend and see how long they take to arrange them in the form of the complete letter 'L' again!

For a more permanent job, the 'L' could be cut from fretwood. (484)

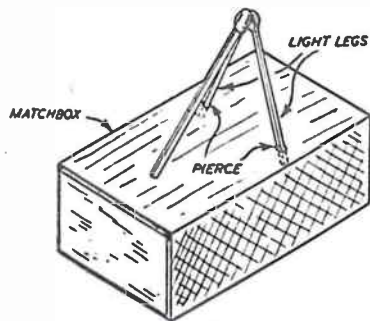

TELL your friends you can make a matchstick obey your commands! Without touching it, you say, you can make a match curl up like the horse's tail in the song.

The secret is this. Make two small holes in the top of a matchbox and push two matches into this to form an inverted 'V'. Lay a third match against this, making a sort of tripod. All the heads of the matches are resting against each other.

Light the legs of the two matches forming the 'V'. As the flames reach the top the heads of the matches will flare up and the third match will start to burn. As this burns down the bottom will leave the matchbox where it was resting and curl right up! (488)

Three Easy Novelties

YOU have probably had one of those party puzzles often found in crackers where you have a number of little pieces which you have to put together to make a square or a letter. Here is how to make one.

Draw out a letter 'L' as shown, on a postcard. Make the upright part of the 'L' about 3ins. and the foot about 2ins. long. Draw in the other lines shown lightly in pencil

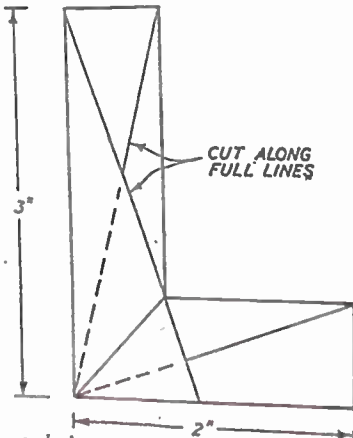

and then cut out the six pieces with scissors. Rub any pencil marks off the

406

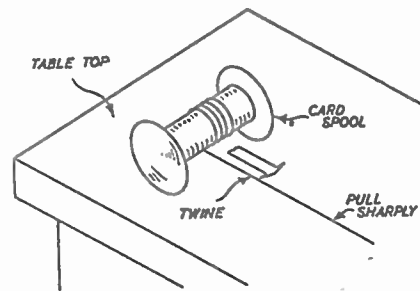

HERE is a little novelty which flies without wings! You need a short piece of card tubing to which is glued two larger circles of card to form a spool. On this spool wind a length of string or twine. Rest on the table and then give the twine a sharp pull so that the twine comes free and gives the spool a spinning motion.

The Ceiling's the Limit

If you wind the twine on as shown in the sketch, the spool will fly forwards and upwards. With a little practice you can make it reach the ceiling. If you wind the twine on the other way, however, so that the spool is set spinning in the opposite direction, the spool will run to the edge of the table and then dive to the floor.

(111)

Enrich your garden with

RUSTIC FENCES and PERGOLAS

MANY gardeners, on occasion, have small quantities of hedge timber for which they can find no use, except burning. Those who have not, can often obtain it fairly easily. An excellent use for this kind of timber, or for small apple branches obtained when thinning overgrown orchard trees, is in the construction of rustic fences and pergolas.

To those who prefer the informal, rather than the formal, in the garden, rustic work is a much more satisfying proposition than trellis, which, unless of special hardwoods and costly in price, is likely to be short-lived. There is, of course, no reason why rustic work should not be used in a formal garden, but it should then be constructed of straight poles, preferably of pine.

The rustic fence or pergola is a thing of pleasure—providing pleasure in its construction and lasting pleasure in its appearance, especially when festooned with the subjects which love to climb it.

If you can restrain your impatience, soak the tips in creosote for a day or two, after pointing them with a hook. Drive these into the ground with a heavy mallet and use a small, but heavy object on a string to check for vertical. It is best to be generous with these uprights, for on them the strength of the fence or pergola will largely depend. You will be able to check the alignment of the verticals by looking along them.

Fascinating

The construction of a rustic fence is quite a fascinating job, once the uprights are in position. Branch by branch the remaining sticks are threaded between them, and arranged, where possible, so that they pass in close proximity to each other. A nail should be inserted at each point of contact, and where there is near-contact, a nail will bring the two pieces together. Nails should also be inserted where the horizontal members happen to cross each other. For satisfactory nailing, two hammers, or one

be neatly sawn off, but this should be done after nailing, as a nail close to an end is likely to cause a split.

You will notice that as the work proceeds the fence becomes increasingly rigid, especially if the horizontal members are fairly strong, and can be intertwined among the uprights. When it is finished you should be able to watch your children climb it (as they will) without fears for their safety, or for that of the fence.

A very pleasant background to a flower or vegetable plot can be effected by the construction of a shallow fence of this type on the top of a low hedge or bank. The fence can form the support for a variety of climbing subjects and will itself provide a useful and effective wind-break.

Properly constructed and adorned, a pergola can transform any garden of reasonable size. The same freedom as used in rustic fencing should not be indulged, and only sufficient members as are necessary for strength should be

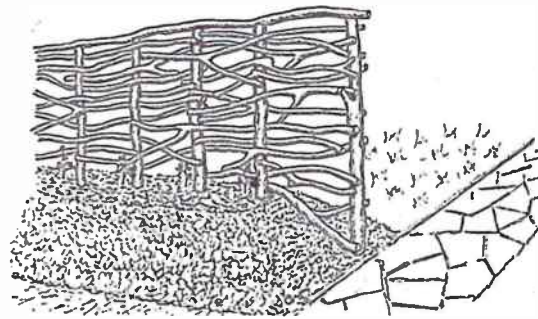

A well made rustic fence

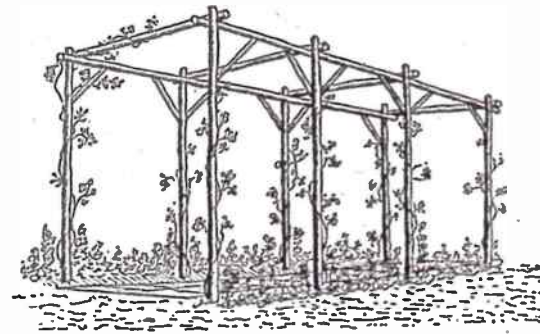

An example of pergola work

Assuming there is a supply of small timber, a site which needs a fence or which a pergola would beautify, the first step is to sort the wood into its varying sizes, trimming out any awkward side branches and ruthlessly eliminating all the smaller pieces, which are not of sufficient diameter to take a nail without splitting.

New Nails

If you have a box of assorted nails as collected by most gardeners, do not produce them for this job. They are too bent and too rusty. Instead, obtain a good supply of new nails of different sizes—preferably galvanised.

The largest and straightest branches should be selected for the uprights, and

hammer and one heavy object will be required. The supplementary hammer should be held firmly against the side opposite the hammer-blow.

Many people spoil the whole appearance of a rustic fence by leaving stray ends of stick poking out in various directions, by using branches down to mere twigs or, worse still, by breaking these off haphazardly and leaving the jagged ends. All projecting ends should

used. Besides the vertical posts, longitudinal ties and cross ties, diagonal bracings might be used at the intersections to give strength.

Peeled or unpeeled timbers may be used, as preferred, but the fact that unpeeled timbers will soon harbour insects and woodlice should not be overlooked. The bark will be shed in stages, in any event. (336)

MASTS FOR SMALL MODEL SHIPS

When making very small model ships, it will often be found convenient to use needles for the masts. Besides being stronger than wood, needles are recommended because the 'eyes' come in useful when rigging the vessel, for you are able to thread the cottons, or whatever you are using, through them from one end of the ship to the other. With certain types of craft the after-mast is placed on part of the superstructure or upper deck, and in these cases different sized needles are used for each mast so that, when fixed, the tops of both are level.

407



"Aunt Dinah"

How to make COCONUT NOVELTIES

eyes are dots of white paint. The mouth is outlined with bright red. A string of toy beads completes this amusing novelty.

'Uncle Tom' might also be attempted, though, admittedly, Aunt Dinah is the easier on account of her hair being hidden, mostly, by the scarf, and the ear-rings suggesting ears that, in actuality, do not exist on the model. Still, Uncle Tom might have cotton-wool white hair, steel-rimmed spectacles (made from wire) and, of course, a corn-cob pipe (for which an acorn might be used). Ears can be cut from cardboard and stuck on. Aunt Dinah does not really require a nose specially made, but Uncle Tom's nose can be of plastic wood. The sketch (Fig. 2) shows the idea, but readers will surely want to introduce their own original 'twists'.

If you want a really practical use for the 'Aunt Dinah' novelty, however, try mounting the top half to the front of a box and using the whole affair as a twine holder, as illustrated (Fig. 3).

There are plenty of other uses for coconut shells, however. The strict

utilitarian can use the inverted half shells (arranged in a suitable rack) to hold small machine parts in the workshop (Fig. 9). The bowl-like arrangement enables the parts to be picked up easily. For fancy work, however, the bowls shown in Figs. 5, 7 and 8 can be attempted. These show bowls made respectively with half, three-quarter and a whole coconut. The nuts can be quite easily cut with a hacksaw and trimmed with a file. Decoration can be by means of paint or poker work. Fig. 4 shows how the base for Fig. 5 (and also for Fig. 7) is cut from fretwood. The handles for Fig. 5 are, of course, made separately, as are the peg-like legs in Fig. 8.

Even the pieces cut away in the making of, say, Fig. 7 can be utilized for making, among other things, buttons. It may be objected that even in these expensive times, buttons are cheap enough to buy. So they are—the mass produced ones. But buttons of novel shape and material are well worth the making, and a few typical designs are shown in Figs. 6, 10 and 11. (306)

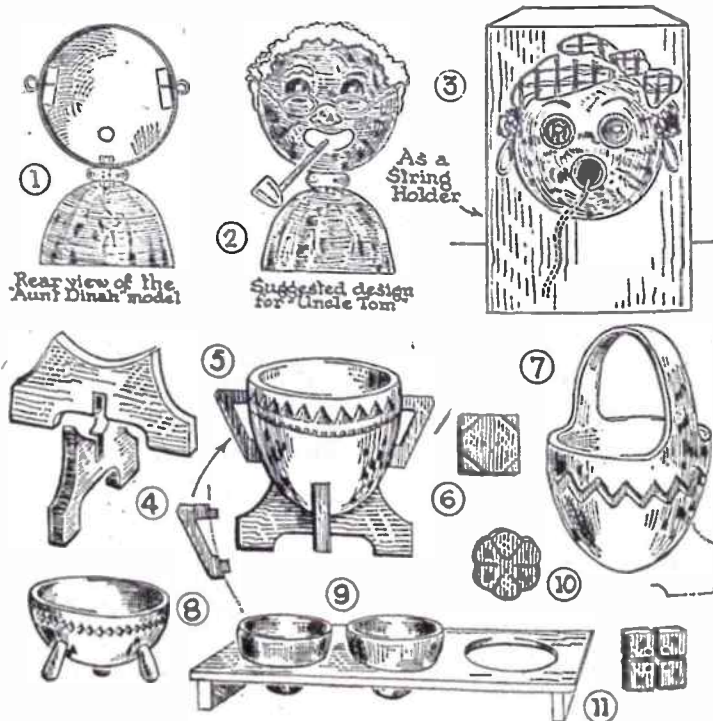

Prepare for the tradesmen with this MULTI-PURPOSE MONEY BOX

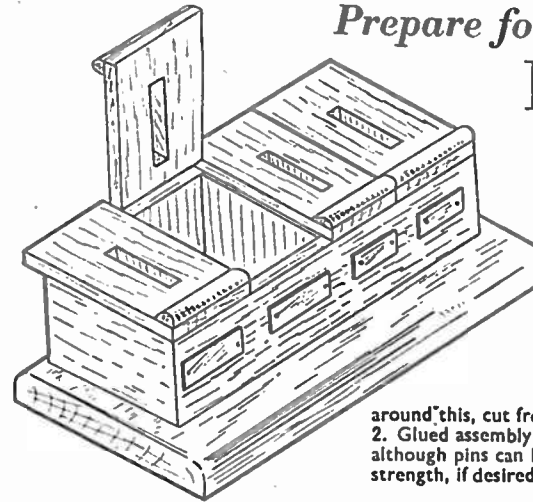

can be made quite an attractive ornament.

The base should be cut from a piece of $\frac{1}{2}$ in. or $\frac{3}{4}$ in. material—Fig. 1. The box frame is then built up around this, cut from $\frac{1}{2}$ in. material—Fig. 2. Glued assembly should be sufficient, although pins can be used for additional strength, if desired.

The Joints

THIS money box is divided into four separate compartments and was designed to meet 'family' needs. One compartment can be allocated to the 'baker', another to the 'milkman', and so on. If filled regularly there will never again be that frantic searching around for change, or the few odd sixpences and coppers to pay the weekly bills. The money box itself, too,

Instead of the simple butt joints for the box, corners may be dovetailed, as in Fig. 3. This calls for accurate workmanship, but is effective if well done. If dovetail jointing is used, then the side panels should be made from wood other than ply.

With the sides assembled on the base, the three partitions can be glued in place. These are simply 2 in. squares of $\frac{1}{2}$ in. or $\frac{3}{4}$ in. material—Fig. 4. Make sure

that the assembly is true and all the partitions are flush with the top of the sides.

The lid is cut next. This overlaps the sides in width and is cut from $\frac{1}{2}$ in. material. After the rectangular shape has been cut out accurately, part off into four separate panels, each 2 in. wide—Fig. 5. Re-assemble the lid by gluing a length of half-round stock along one edge. This will hold all the pieces together for the next stage of assembly. Each lid compartment, incidentally, can be cut with a slot for the insertion of coins, if desired. If slots are to be incorporated, cut them before parting the lid into its four separate pieces.

The lid is then hinged to the main assembly as indicated in Fig. 6. One hinge is required for each lid panel—four hinges in all, screwed to both the lid and side. Once assembled correctly, cut through the half-round dowelling at

(Continued on page 410)

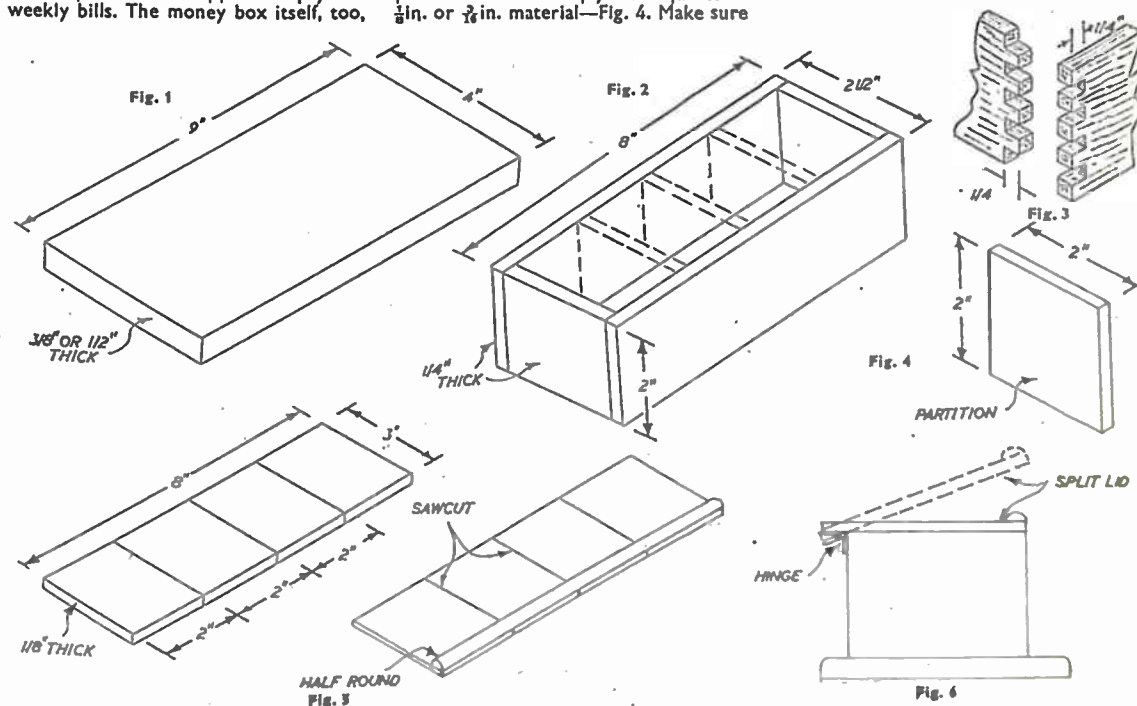



Weather House

PLEASE tell me how to rig the actuating element in an humidity-operated weather house in order to make the old man or old woman appear at their doors in the expectation of wet or fine weather. (C.D.—Evesham).

ALTHOUGH the weather house scheme does work on occasion, it is by no means an infallible device. It is, in any case very sensitive and easily deranged. Almost any kind of gut and many kinds of linen thread which stretch and shrink under changes of humidity, will give the effect. Tension on the gut is very important; it should be adjusted on a day when the atmospheric conditions are very decided, e.g. very dry or very wet. The positioning of the strands should be arranged at the same time so that the desired figure protrudes.

Pick-up Volume

MY radio has no pick-up sockets, so I fitted mine as instructed in a back issue, but now find the volume too loud even when turned right down. As the volume-control works the set O.K., could I fit another volume-control on to the pick-up cabinet? (G.K.—Larkhall).

APPARENTLY your receiver volume control is so fitted that it works on 'Radio' only. However, a control for the pick-up can be added as follows:—fit a .5 megohm volume-control potentiometer at some convenient point near the pick-up. This control will have three tags. Take leads from the pick-up to the two outside tags. Two further leads are then taken from the control to your pick-up sockets, one going from one outside tag, and the other from the centre tag on the control. It will then be possible to adjust volume from maximum to zero, using this control, which should be fitted with a suitable knob.

MULTI-PURPOSE MONEY BOX

(Continued from page 409)

each panel line to separate the lid panels once more. Each lid panel should open independently without fouling its neighbour. The overhang of the lid permits each section to be opened up to

a vertical position.

Finish the money box by glasspapering down perfectly smooth, rounding off the corners of the base. A strip of baize can be glued to the underside of the



Static Electricity

I HAVE been told it is possible to generate electricity from a piece of glass and a rubber. Could you tell me how this can be done? Also how could I wire an ordinary flashlamp bulb to be lit from above source? (J.M.—Londonderry).

THE electricity mentioned is known as 'static electricity' and cannot be used for lighting bulbs, or anything of that nature. It may be generated by rubbing an ebonite rod or similar object with flannel (negative polarity), or glass with silk (positive). The materials must be absolutely dry. It is manifested by the ability of the charged materials to attract small pieces of paper or other light objects. Small sparks, audible as a 'crack' may be produced by discharging to the knuckle or other earthed object. Such electrical charges may be produced in a variety of ways, such as by combing hair or fur, brushing brown paper vigorously, and other frictional methods.

THIS IS WHAT YOU LOOK FOR NEXT WEEK



Here's a preview of next week's issue No. 2944, just to show you what to look for when you call at your newsagents. The new cover coincides with the first issue of a new volume, and is attractively colour-

ed in orange and black on white. As with all issues of "Hobbies Weekly," you'll find it the best fourpennyworth that money can buy. Apart from the

complete instructions for building a grand two-seater canoe, and a free Design Sheet for a large toy Doll's Shop, it contains plenty of other "how-to-make" and "how-to-do" articles.

Make sure your newsagent has your copy reserved!

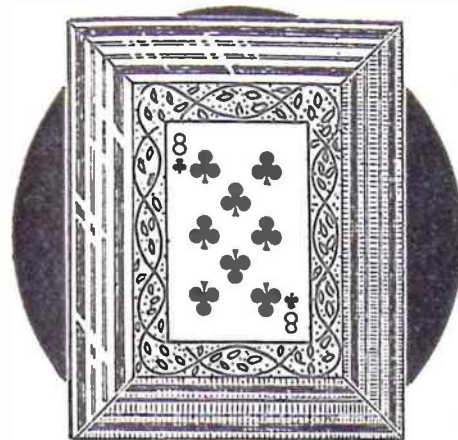

For the amateur conjurer — A MAGIC FRAME

leave an opening 3 1/2 ins. by 2 1/2 ins. From an ordinary used postcard, cut a piece 3 1/2 ins. wide and 2 1/2 ins. long. Glue this to the two pieces of glass in the manner shown in Fig. 8, i.e. with a 1/2 in. wide glued band, the attachment being done on the inside of the glass. When quite dry, take a strip of wood of 1/2 in. by 1/2 in. section (the length is immaterial) and round over the edges slightly. Lay this (G) in the middle of the card strip (F) and bend over, so that the tops of the glass pieces touch. (This can more neatly be done if lines are first neatly scored on the card.

To keep the whole unit flat and to provide as much space in the reservoir as possible, a 'shoulder' will be formed on part (F) as shown in Fig. 1.

On the inner side of part (D), glue 1/2 in. wide strips of card—about equal, in thickness, to three playing cards—on three sides only. Note the bevel in sketches (1), (5) and (8).

Still keeping strip (G) in position until the last minute, bind the two pieces of glass together with passe-partout, at least, all round except, temporarily, for portion (Z) on Fig. 5. Into this opening pour carefully, some very fine sand. Builders' sand is useless. The best, perhaps, is the very fine silver sand sold in pet shops for bird cages, etc. It must be perfectly dry and 'pour' perfectly. Detail (X) shows how the sand comes up to the top of the lower line of fancy paper, or just a trifle below. When the sand is introduced (one or two trials may be needed) opening (Z) can be sealed up. When this unit is reversed, the sand should run down freely and cleanly and completely fill the plain glass opening. Likewise it should run smoothly back to its reservoir when the unit is again reversed, and be quite hidden.

It will be realised that the opening where the card appears (and has to be covered with sand) is 3 1/2 ins. by 2 1/2 ins., which is a little over 8 sq. ins., whilst

(Continued on page 413)

A PIECE of apparatus of the greatest possible utility to the conjurer is that known, among magicians, as the 'Sand Frame', though it should not be thus described to laymen, as the word 'sand' might hint at the secret.

Let us call it a plain 'Card Frame', though we might mention from the very beginning that the frame can be proportioned to hold postcards, and instead of tricks involving the appearance or enshimment of a playing card, a photograph of, say, a film star or politician can be used, or of some member of the family, when performing at home.

The frame consists of the usual wooden surround of picture-frame moulding, with an inner decorative border, as seen in the illustration. The frame is glazed with glass and one can see right through to the back, which is hinged, so that one can insert or remove a card. This flap is shown in Fig. 6 and is held shut with a tiny turn-button. A card placed in the frame, however, vanishes or a card can be made to appear in a presumably empty frame.

The Secret

The secret lies in the fact that the glass is double. At the bottom of the frame is a 'reservoir' (F) containing some fine sand. When the frame is reversed, the sand runs down and hides the card placed behind it. The inside of the rear flap is covered with a sandy-toned paper and spectators imagine that they are looking right through the glass to the back.

Start by cutting two pieces of window glass (which is thicker than picture glass) 5 ins. by 3 1/2 ins. Obtain some fancy paper and cut into 1/2 in. wide strips. Gum the face side evenly and thinly and stick the strips to one piece of glass (C) so that the design will appear through the glass when viewed from the front and

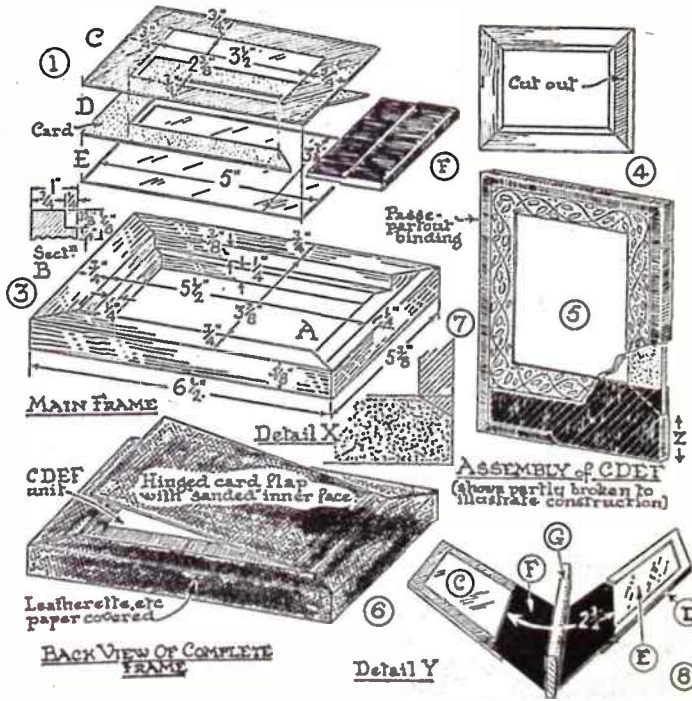

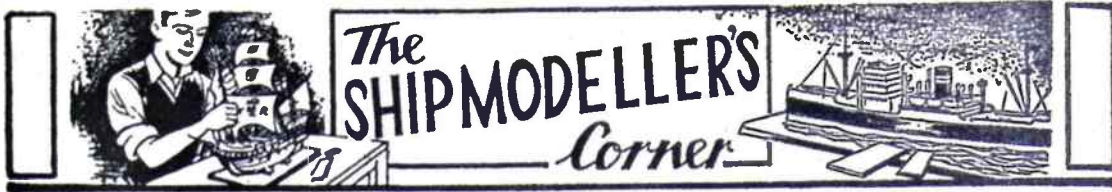

PART 3
Standing and Running Rigging (I)
WE will now prepare the mast and yard assemblies, and we can then proceed with the interesting work of rigging our model.

Before completing the mast assemblies as directed in the kit instructions, however, we will add the wooding to the fore and main masts. This was used in early days to prevent the masts from splitting, and was later replaced by mast bands of iron.

The most effective method of doing this work is to bind the masts with strong thread, making each wooding 1/4 in. wide and spacing them about 1 1/2 ins. apart; this method is in line with the correct nautical manner used.

A second method, which I have seen used with effect on small models, is to paint gummum paper black, cut into strips 1/4 in. wide with a razor blade and roll and gum these in position around the mast (see Fig. 1).

Next, prepare the yards by fitting them with the necessary blocks to take the rigging cords. On each end of both the fore lower yard and main lower yard attach a sister block (see my previous article on blocks), and along the length of each yard attach single blocks, as in Fig. 2.

This sketch also shows the blocks for the remaining yards. Yards can be glued, pinned and bound in position, or they can be attached, in the case of the lower yards and mizzen yard, in true nautical fashion by means of parrels; this will add to your interest in modelling and add to the historical accuracy of the model. Fig. 3 shows details of parrels and their use in attaching the yards to the masts.

Position your yards across the ship as shown in my article early this year on 'Rigging the Royal Sovereign'.

It must now be decided whether to use the commercial one-hole deadeyes supplied with kits or whether to use the authentic heart-shaped deadeye of the period. If you decide to use the authentic shape you will need to make a quantity of these, 1/4 in. and 3/8 in. in size, and details of several methods of producing them will be found in my article on deadeyes in the issue of November 29th, 1950.

Having completed the mast assemblies in accordance with kit instructions and prepared our yards, we

Building The 'ARK ROYAL' from Kit No. 211 sp. By 'Whipstaff'

are now ready to commence the actual setting up of the rigging.

Step bowsprit and masts in position on the model, and avoid the excessive rake given the masts of so many shop models.

While waiting for the glue to set and secure the masts firmly, proceed to set up the deadeyes in the channels, and in the after end of each channel to main and fore masts, set in two eye-bolts made from lill pins. It is advisable to allow for these by cutting the channels slightly longer at the after ends than shown on the design.

Turn to Fig. 4 and proceed by setting up first the main-stay, using your heaviest cord for this, the main rope in the ship.

Take a length of cord and seize a deadeye in one end. Take the other end forward through the hole cut in the beam to accommodate the bowsprit gammoning, up and back on the

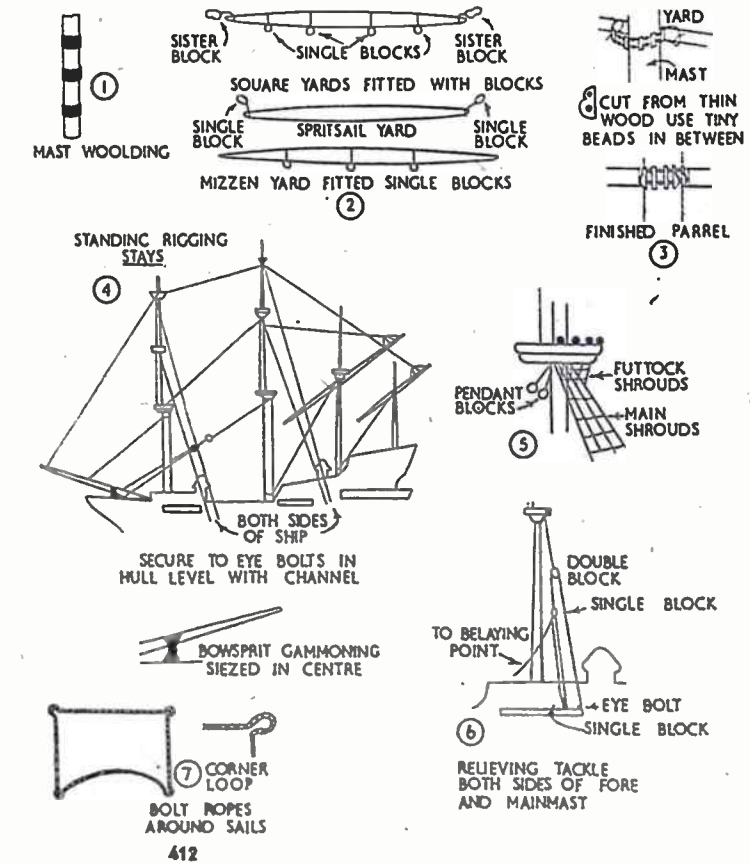

opposite side of the fore-mast and seize to the other end by the deadeye, thus making a double stay passing each side of the foremast.

Now take a short length of the same cord, seize a deadeye in one end and secure the other end to the main mast below the top; pass a lanyard through both deadeyes and reeve taut. Be careful not to draw too tightly or you will pull the mast out of alignment.

Follow this with fore stay and mizzen stay, both single cords, and then the bowsprit gammoning. This latter must be drawn taut by seizing in the centre with fine thread as in the sketch.

Whether you set your shrouds up on a jig away from the model or build them on the actual model direct is a matter of choice, but now is the time to erect the shrouds to fore, main and mizzen masts, leaving the topmast shrouds until later.

They can be built by gluing the ratlines across or in true nautical fashion by tying across the shrouds with clove-hitches, a much more workmanlike and authentic method. Both methods were described in my recent article on shrouds.

In a model of this size it is not as difficult as it may seem to adopt the correct method of adding the ratlines. Space them 3/8 in. apart, and, of course, use finer cord than that used for the shrouds themselves.

Using cord slightly thinner than that used for the lower stays, add the topmast stays, all these are single lines and can be followed in our rigging sketch.

Topmast shrouds are added next, either built on a jig or direct on the model. It is possible to make a compromise here if you wish. The lower shrouds can be correctly tied from shroud to shroud by the ratlines and the smaller upper shrouds glued together on a jig as for smaller models.

For the topmast shrouds, drill four small holes through your mast tops on each side, main and fore tops only. Cut sixteen lengths of cord and seize a deadeye in one end of each. Commencing with the foremast hole, pass the cord through and secure to the foremost shroud about 1 in. below the top, thus erecting the deadeyes to take the topmast shrouds and forming the puttock shrouds, as in Fig. 5.

An item to add to interest and authenticity is to add relieving tackles to each side of foremast and main mast, as in Fig. 6. To do this, secure a deadeye in the second eye-bolt in each channel, and add a pair of pendant blocks to each mast under the top. Secure a piece of rigging cord to the first eye-bolt in the channel, take it up through the pendant block and down to a double block.

A second piece of cord is secured to the deadeye in the channel, taken up through the double block, down again through the deadeye, up through the second sheave of the double block and down to the belaying point at the rail.

Next, complete the remaining stays in the sketch.

We now come to the work of preparing the sails, and as we desire to improve our rigging details, adding as much of authentic detail as possible, we

will use fabric instead of parchment. Lawn (a very fine linen) is ideal but almost unobtainable, and in recent models I have used with success draughtsmen's tracing cloth, washed free of colour and ironed.

Fig. 7 shows the bolt-ropes around each sail. If handy with a needle, you can sew these on, sewing through the cord and not around it; if you doubt your ability to do this, pin down your cloth to a board and glue your bolt-ropes in position, afterwards cutting them out with a razor blade, around the sails.

Now persuade a lady member of the family to machine or sew parallel lines down the sails, spaced 1/4 in. apart, to represent the bolts of canvas from which the sails were made. If sewing on the bolt-ropes, it is as well to ask the lady friend to put a very small hem around each sail first.

Heraldic designs on the sails are problematical. Contemporary prints and pictures believed to represent the 'Ark Royal' all vary in the designs portrayed. Designs used on my own model, and most likely to be those used, if any, while our ship was the flagship of Lord Howard, will be given with final rigging details in our next and last article of this series.

(NOTE. In kit instructions, topmasts are shown in error aft of the fore and main-mast. They should be stepped in front of the masts.) (332)

If you have any shipmodelling queries, don't be afraid to write us. Our experts should be able to help you, and the service is free.

A MAGIC FRAME

(Continued from page 411)

the reservoir has a superficial area of 3 1/2 ins. by 1 1/2 ins., which is just under 5 sq. ins. We have, therefore, contrived matters so that the space between the glasses is as thin as possible, whilst the space in the reservoir is as thick as possible, thus making the volume of space and, consequently of sand about the same in both cases.

Having made the 'working' part we can now prepare the frame—almost a routine job for those who have a mitre block. The frame is made from 1 in. by 1/2 in. section wood with a 1/4 in. by 1/2 in. rebate as shown. The front of the moulding would look better if ploughed into grooves and hollows, as indicated in the sketches, but this is not essential. When the frame is assembled, and after it has set firm, an extra 1/4 in. is cut out of one end. See Figs. 3 and 4. This could, however, be done before assembly.

This extra depth accommodates the 'reservoir' end. The (CDEF) unit is laid in the rebate of the frame. A spot or two of glue might hold it. It is as well to aim at a reasonably tight fit, however (without danger of breaking the glass).

To fill up the recess still remaining, a piece of thick cardboard is used for the back flap (see Fig. 6). After cutting this to size, well gum the inner face and sprinkle sand (of the same type as previously used) on it. Leave overnight. Then tilt off superfluous sand. It should be impossible to tell whether one is seeing the actual back flap through clear glasses (i.e. presumably through one glass) or the sand between the glasses.

The back flap is cloth-hinged on and the whole, except for the front, covered with leatherette, etc., paper.

As this is a constructional article and

not one on conjuring generally, detailed accounts of tricks involving the use of the frame must be omitted through lack of space. One point must be stressed, however. Do not merely show that this frame vanishes a card and then makes it come back again. (The frame is reversed back to front as well as turned upside down whilst a magic spell is being said). If you do, people will soon suspect that the frame is somehow 'mechanical'. Do not, in fact, say that the frame is a 'magic' one. As a mere hint, you can already 'load' it with, say, the four of spades and have it sand-covered. Have a card 'chosen' (in reality forced), i.e. a duplicate four of spades. Vanish this by one of the many methods described in books on conjuring and then show that it has found its way into the frame.

If you can get coloured sand, so much the better.

An 'appearance' is better, as one can then open the back and remove the card, and, by so doing, suggest that there is 'no deception'. (305)

MISCELLANEOUS ADVERTISEMENTS

STOP smoking in three days or money back. S. Decals, 2/d. stamp.—Triumph Systems (H6), Heavitree, Exeter.

PICTORIAL and triangular packet free. Send 2/d. stamp and request bargain approval.—W. Parry (H), 61 Collage St., Ammanford, Carmar.

200 DIFFERENT Empire stamps, 3/9. Approval.—H. Whitby, Godshill, Fording-bridge, Hants.

HOME production workers required—either sex, interesting job. S.A.E. brings fullest details.—BCM/ASHGROVE, London, W.C.1.

20 BRITISH Colonials free with approvals. Postage.—W. E. Tucker, 6 Higher Church St., Barnstaple, Devon.

SPARE time homeworkers, either sex, urgently required. Clean work, good pay. Write—Area 343, 88 Rutland Street, Leicester.

INTERESTING work available for all in spare time. Experience unnecessary. Send S.A.E. for details to—Leathaveave Co. (Dist. 37), 2 Tudor Rd., Leicester.

PERSONAL pencils, four in box with your name or name stamped in gold on each pencil, 2/6, post paid, write name required in block letters.—T. Smith, 13 Glenbank Parade, Belfast.

STAMPS FREE!! Twenty unused (2/d.).—G. H. Barnett, Limington, Somerset.

DOUBLE-EDGED 16in. Pruners, Saws, 8/-, post paid.—Hobbies Ltd., Dept. 99, Dereham, Norfolk.

STAMPS. 100—6d.; 500—1/6; 1,000—2/6; Foreign/Colonial approvals.—Pavoley, 12 Leader Close, Coventry.

PLYWOOD offers, in 5/- and 10/- parcels, post free. Money-back guarantee.—Esedraw, 21 Spring Grove Rd., Kidderminster.

AGENTS and mail order agents required for Royal Ball Pen Refill Outfits, etc. Good commissions. S.A.E. for full particulars.—BATT BCM/DUPLICATE, London, W.C.1.



with **JOHN WAYNE** in 'NEW FRONTIER' **ROD CAMERON** in 'THE PLUNDERERS' **WILLIAM ELLIOTT** in 'THE GALANT LEGION' **RUSSELL HAYDEN** in 'HOSTILE COUNTRY' Extra films from huge list 1/- each. **BOB STEELE**: 'SIX GUN MAN', 'TEX RITTER': 'WHISPERING SKULL', 'HOPALONG CASSIDY': 'SUNSET TRAIL', 'RUSSELL HAYDEN': 'NORTH OF THE BORDER', 'LAUREL & HARDY': 'WAY OUT WEST'.

Capt. CARLSEN'S TRIUMPH! THE SAGA OF 'THE FLYING ENTERPRISE' 3/- extra.

'TROOPING OF THE COLOUR', 'FUN AT THE ZOO', 'BRITISH BIRDS', 'TEST MATCH THRILLS'.

DAN DARE: 'SPACESHIP TO VENUS', 'DAN DARE': 'MEKONTA', 'JOHN WAYNE': 'FIGHTING KENTUCKIAN', 'ROCKETSHIP X.M. MOON', 'RANDOLPH TURPIN': 'THE TURPIN TRIUMPH', 'BRUCE CABOT': 'TRANS-CONTINENT EXPRESS', 'FESTIVAL OF BRITAIN'.

From all good stores and toy shops OR DIRECT, post and packing 1/- extra, C.O.D. 1/- extra, FROM **FILM STIPS, EDLESBORO, DUNSTABLE, Beds.**

GENUINELY interested persons required to Undertake light, clean assembly work in their own homes. Good rates of payment. Stamped addressed envelope to—Dept. P/198, Universal Products, 5 Cornhill, Lincoln.

DEAL in Stamps—a fascinating booklet on the stamp trade, 2/9, post paid. Catalogue of books and courses on request, 6d.—D. B. Johnson, 256 Wakefield Rd., Drighlington, Bradford, Yorks.

STAMP collectors duplicates. Half price. 514 days' approval.—Hale, Millford House, Main Road, Middleton-on-Sea.

STAMPS.—Free air set to first 12 applicants. Sending 2/d. stamp and requesting our approvals. Latter consist of interesting, worthwhile stamps at reasonable prices.—Willett & Carville, 69 St. Vincent Crescent, Glasgow, C.3.

MODELS. You can make lasting stone-hard models with Sankey's Pyruma Plastic Cement. Supplied in tins by Ironmongers, Hardwaremen and Builders' Merchants. Ask for instruction leaflet.

LEARN shorthand by April 30th (1 Hour's study nightly). 1st lesson, 2/d. stamp.—Duttons (Dept. H.B.), 92 Gt. Russell St., London, W.C.1.

DUPLIX self-adhesive transfers for decorating fancy goods, trays, plastics, etc. List and samples, 3d.—H. Axon Harrison, Jersey.

DOLL'S house fittings and papers; send S.A.E. for list. Doll's house plan special; send 2/6. Trade supplied.—Zimplan, 88 Ware Road, Hoddesdon.

LORRY kits, 4 mm. and 7 mm. scale. Also large range of spare parts from which to build to your own design. Send for fully illustrated catalogue—price 1/-.—Wilson's Lorries Ltd., 6 Gt. Winchester St., London, E.C.2.

AMERICA'S famous hobby magazines. One Year's supply Popular Mechanics, 32/-; Popular Science, 28/6; Homecraftsman, 16/6; Popular Homecraft, 18/-. Free Booklet listing all others sent on request.—Willen Ltd. (Dept. 57), 101 Fleet Street, London, E.C.4.

PLYWOOD offers. Gaboon in various thicknesses. Handy sized parcels for the cabinet, toy, model maker, and all handicrafts. Parcels made up in £1 and 10/- lots. Carriage paid. Send P.O. to—Reeves, Plywood and Timber Merchant, 33 Front Street, Monkseaton, Whitley Bay, Tel. W.B. 4677. Parcels are now despatched on day of receiving order.

EARN £££ Weekly with '114 Ways to be Your Own Boss', 5/6 only. Money back guarantee if dissatisfied.—Stebbing Publications Ltd., High Wycombe.

HOME Watch and Clock Repair Outfit. Includes watchmaker's magnifying eyeglass, tweezers, screwdrivers, oilers, oil, brush, dusting powder, plus illustrated explanatory book. Watch and clock repairing simplified. In container, 12/9 inclusive.—D. Barber (Dept. H.), 5a Station Parade, Ashford, Middx.

WHEELS for Toys, etc., in Hardwood, Plastic and Rubber Tyred Metal. Doll's House fittings and papers. Doll's Cot and Pram fittings. Decorative Transfers. Beads for Counting Frames and other Toy Accessories. Fine Art Pictures for Jig-Saws, etc. Stamp for lists. Trade Supplied.—Joyden Toy Co., 193 Chase Side, London, N.14.

CONJURING and Magic. New tricks and Pocket novelties every month. Lists, 4d.—Roboast, Magician, 363 Sandycroft, Kew Gardens.

KUKLOS Annual. Indispensable cyclists' handbook. Tours, resthouses, money saving hints, 2/9, post free.—Burrow, Publishers, 2 Imperial House, Cheltenham.

10/ Worth valuable stamps free! Approvals. Postage Essential.—Mousley Stamps, Heanor, Derbyshire.

SMOOTH white plywood, 36x9 1/2 x 1/4 in., 8 for 23/-; 30x9 1/2 x 1/4 in., 8 for 19/4; 24x9 1/2 x 1/4 in., 8 for 16/-; C.W.O. post free. Plywood hardwood lists, 1/d. 1/d. S.A.E.—Dope, H., JDD, Storage, East Dulwich, S.E.22.

SHIP Modellers should get in touch with Scottish Modelcraft, St. Mary's, Dumfries. 1/- secures handbook and lists and details of our comprehensive and friendly service.

100.000 Government Surplus Bargains. Single 20 amp. toggle switches in neat bakelite case, 9d., post 3d. Ditto, in bank of three, 3/-, post 4d.; bank of five, 4/6, post 6d. Aluminium rivets, handy boxes, approx. 1 lb. assorted, 2/6, post 6d. Inter room telephone sets ideal household 'upstairs/downstairs' inter-communication, complete, 9/6, post 6d. Hundreds of other bargains for the Handyman. Send 3d. stamp for list. Money back guarantee.—Milligan's, 24 Harford Street, Liverpool, 3.

THE only full list of Car Index Numbers alphabetically arranged is in Where's That Car. Front Of All Booksellers, 9d., or The Publishers (1/d. Postage).



You can build this GARAGE

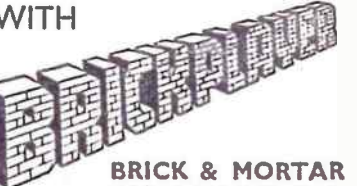

BRICK & MORTAR BUILDING KIT

It enables you to build Houses, Inns, Railway Stations, Signal Boxes, or from your own imagination. All railway models will fit 'O' gauge scale. Buildings can be permanent or dismantled by merely soaking in water and the bricks used again and again.

BRICKPLAYER KITS AT 28/6 AND 52/6 ARE AVAILABLE FROM GOOD TOYSHOPS, HOBBY SHOPS, AND DEPARTMENTAL STORES.

ACCESSORY PACKS			Price
No.	Contents		
100	100 Full size Bricks	3/-
101	52 1/2-Bricks and 72 1/2-Bricks	3/-
102	Gable and Peak Bricks	3/-
111	Capping and Roof Tiling	2/6
112	Concrete Roofing	2/6
114	Bag of Brickplayer Cement	1/3
115	Roofing Cement	9d.
8107	2 Bay Windows with 31 Splay Bricks		3/9

METAL WINDOW AND DOOR FRAMES
F1 F2 F3 F4 F6 F8 F10
8 1/2d. 6 1/2d. 7 1/2d. 5d. 4d. 6d. 7 1/2d.

8108 Sheets of Glazing, 1" x 6" (Plastic) ... 1 1/2d.
If your dealer cannot supply, write for address of nearest stockist to:

J. W. SPEAR & SONS LTD.
(Dept. H) ENFIELD MIDDLESEX

YOU CAN BECOME A HANDICRAFTS INSTRUCTOR

EXPERIENCE NOT ESSENTIAL
Men who enjoy making things in wood or metal can turn their hobby into a permanent and interesting career. Short hours, long holidays, and security in a job you would really enjoy, can be yours if you become a Handicrafts instructor. Let us send details of the easiest and quickest way to get the necessary qualification.
We guarantee "NO PASS—NO FEE"

If you would like to know about our unique method of preparing you for one of these appointments, write today, and we will send you our informative 144 page Handbook—free and without obligation. Mark your letters "Handicrafts Instructor"

BRITISH INSTITUTE OF ENGINEERING TECHNOLOGY BIET
595 Shakespeare House
Stratford Place London, W.1

STOP SMOKING

You can overcome the smoking habit in 3 days or money back. Safe, pleasant, permanent. The only scientific way. No Will Power necessary. "Conquered the habit in 21 days. Am delighted".—F.C. "Within 2 days I was free from the tobacco habit".—W.G. "Was a smoker for 2 years and broke the habit in 2 days".—F.N. "I haven't smoked a cigarette for 5 weeks".—J.E. "I used to smoke 20 a day... now I have no desire to smoke".—J.M. Recommended by "Health and Efficiency Magazine". Complete course 6/6. Details 1/d. stamp. Sent under plain cover.—STEBBINGS, 28 (H/105), Dean Road, London, N.W.2. Established 1928

BE TALLER

EVERYONE can now increase his or her height from 1 to 5 inches. There are over 200 bones in the body and many of these are in positions at each of which a proportionate increase of height can be developed by the Stebbing Scientific Height Increasing System—or money back. Recommended by "Health & Strength" for 23 years. The first, original and the one Guaranteed System. L.P., aged 25, gains 3 ins. S.J., aged 17, gains 4 ins. C.T., aged 34, gains 3 1/2 ins. Complete Course 10/- post free. Details 1/d. Sent under plain cover. Stebbing System, 28 (H/105), Dean Road, London, N.W.2. Established 1928.

FLEXIMOULD

FOR PLASTER CASTING

WALL PLAQUES, FIGURES, GARDEN ORNAMENTS, BOOK-ENDS, ETC. MADE IN YOUR OWN HOME. THE ALL-FAMILY HOBBY THAT ADDS POUNDS TO YOUR INCOME.

Write for **FLEXIMOULD ILLUSTRATED LEAFLET** to **DOHM LTD. (DEPT. H)**
167 VICTORIA ST., LONDON, S.W.1

FOR THOSE WHO SEEK PLEASURE AND PROFIT IN LEISURE

POPULAR Handicrafts

This special issue has illustrated instructions for making a variety of woodwork projects. Don't miss the exclusive article on making a model of the famous 'Flying Enterprise'. There is also full coverage of many handicrafts, and a Market Section.

SPECIAL IDEAL HOME NUMBER
Specimen copy 1/2 from the publisher:
H. BURT, LINK HOUSE, 24 STORE STREET, LONDON, W.C.1

BROOK GRYPHON

FRACTIONAL H.P. ELECTRIC MOTORS

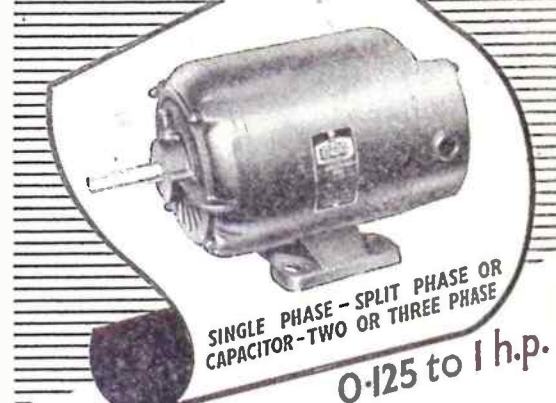

SINGLE PHASE - SPLIT PHASE OR CAPACITOR-TWO OR THREE PHASE
0.125 to 1 h.p.

A smaller edition of the famous BROOK motor... Just the thing for your workshop or domestic machine
BROOK MOTORS LIMITED HUDDERSFIELD • ENGLAND

1.L.F.230

J. WOTTON (Dept. H.)
140 HOLLINGS ROAD, BRADFORD, YORKS
ALL TYPES OF MOULDS
3/- each
TOYS, ORNAMENTS, PLAQUES, ETC.
New 1952 Illustrated Catalogue. Send 6d. stamps, refunded on first order over 10/-

H.A.C. SHORT-WAVE EQUIPMENT

Suppliers for over 18 years of Radio S.W. Receivers of quality. One Valve Kit, Price 25/-; Two Valve Kit, Price 50/- Improved designs with Denco coils. All kits complete with all components, accessories and full instructions. Before ordering, call and inspect a demonstration receiver, or send stamped addressed envelope for descriptive catalogue.
'H.A.C.' Short Wave Products, (Dept. 22.)
11 Old Bond Street, London, W.1

Hobbies LIMITED
BRANCHES
LONDON
78a New Oxford St., W.C.1
(Phone MUSeum 2975)
87 Old Broad Street, E.C.2
(LONDON Wall 4375)
117 Walworth Road, S.E.17
(RODney 5509)
GLASGOW
326 Argyle Street
(Phone CENTral 9442)
MANCHESTER
10 Piccadilly
(Phone CENTral 1787)
BIRMINGHAM
14 Bull Ring
SHEFFIELD
4 St. Paul's Parade
(Phone 24671)
LEEDS
10 Queen Victoria Street
(Phone 28439)
HULL
10 Paragon Square
SOUTHAMPTON
25 Bernard Street
BRISTOL
30 Narrow Wine Street
(Phone 23744)
Head Office & Factories—HOBBIES LTD., DEREHAM, NORFOLK

FREE! to those
 who wish
 to Qualify in any of
 these
 subjects

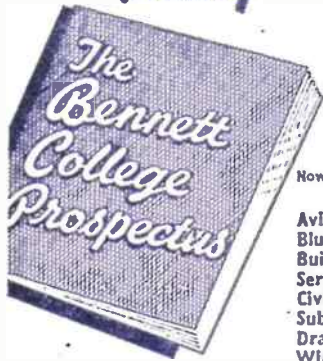

Now where does your career lie?

Accountancy Exams •
 Aviation - Eng. & Wireless •
 Blueprints • Book-keeping •
 Building • Chemistry • Civil
 Service • Commercial Art •
 Civil Eng. • All Commercial
 Subjects • Diesel Engines •
 Draughtsmanship • Electric
 Wiring & Lighting • General
 Cert. of Education • Internal
 Combustion Engines • Joinery
 & Carpentry • Languages •
 Mech. Eng. • Motor Eng. •
 Mathematics • Public Speak-
 ing • Plastics • Plumbing •
 Press Tool Work • Quantity
 Surveying • Radio Service
 Engineering • Radio (Short
 Wave) • Sheet Metal Work •
 Salesmanship • Short Tech.
 Courses • Secretarial Exams. •
 Shorthand • Surveying •
 Teacher of Handicrafts • Tele-
 communications • Television •
 Transport • Viewers, Gaugers
 & Inspectors • Wireless Tele-
 graphy • Works Manage-
 ment • Workshop Practice •
 and many others

You can start on a Bennett Course

FOR ONLY **30/-**
 and monthly instalments of 15/-

This book costs you nothing.
But it offers you success in
terms of your career.

BY POST, specialised
 Tutors in these and many
 other subjects give individ-
 ual and understanding
 attention to Bennett Col-
 lege Students to whom
 books are free. Tuition is
 guaranteed until you
 qualify. State your subject.
 Send coupon for
 prospectus as it
 applies to you.

**TEAR
 OUT**

To the Governor, Dept. Z.62.

The BENNETT COLLEGE
 SHEFFIELD, ENG.

Send me the free book on how I can Qualify in.....

(subject)

NAME

ADDRESS

AGE (if under 21)

PLEASE WRITE IN BLOCK LETTERS

THIS HOBBY MEANS BUSINESS!

Make and Sell on Sight

Plaques - Statuettes - Ash Trays - Wall Vases - Art
 Models - Groups - Plinths - Garden Ornaments - Lamp
 Stands - Advertising Displays - Decorative Buttons,
 Toys, Brooches, Ornaments, etc., etc.

CAST KARLENITE PLASTIC MARBLE in ELASTOMOLD FLEXIBLE MOULDS

Karlenite is an entirely new artificial stone plastic which sets
 rock hard with a scintillating crystalline structure like marble or
 Alabaster for colour, veining, texture, density and hardness. It is
 enormously strong, highly resistant to heat and impervious to
 water. Literally any type of veining can be simulated to any com-
 bination of colours, and a wide range of 'Veining Pigments' is
 available for this purpose.

Elastomold is high quality synthetic rubber material for making
 permanent flexible moulds. Ideal for repetition casting in quantities
 of dozens, hundreds or thousands as needed and always faithfully
 reproduces the most minute details of ornamentation and surface
 texture. Elastomold is suitable for casting articles in Cement,
 Plastic or Karlenite. Moulds can be taken from models made of
 wood, metal, plastic, stone, glass, earthenware, ivory, etc., and on
 completion of the run the Elastomold material can be remolded for
 new moulds.

Cast and mould in your own home, school, club, studio or
 workshop. The method is amazingly simple, producing quality
 models and designs with the utmost economy. No heavy outlay.
 Unlimited Scope.

Send for full details of this interesting and profitable
 hobby. It means business.

KARLENA ART STONE COMPANY LTD.

Plastics A.F. Division

55 Deansgate Arcade, Deansgate, Manchester, 3

Start picture-making this Easter



JOHNSON OUTFITS FOR HOME PHOTOGRAPHY

This picture shows the No. 1 Printing Outfit
 containing everything necessary for making
 prints from your own negatives. Can be used
 for the dish development of roll film. It includes
 plastic printing frame, safelight lamp, dishes,
 measure, all chemicals and detailed
 instructions. **32/6**

There are four larger outfits in the series
 or you can buy the additional items singly
 as the standard of your work improves

SEE YOUR DEALER

JOHNSONS OF HENDON LTD.