

Hobbies

WEEKLY

CONTENTS

	Page
Flower Girl' Holder -	1
Casket for the Dressing Table	3
A Toy Engine & Trucks	4
The 'Jumping Card' Box	5
Bridge for the Garden	7
Combined Stool and Rocker	8
Indoor Cricket Game -	9
Novel Shaving Mirror	11
Measuring Devices -	12
Safe Household Steps -	13
The 'Singing Tubes' -	14

DESIGN SHEET FOR
TOY TIMBER LORRY

October 3rd, 1951

Price Fourpence

Vol. 113 No. 2918

This is The First Number of a New Volume

Real blooms for this 'FLOWER GIRL' HOLDER

EVEN at a casual glance one can see that this is a very attractive novelty, whilst when one comes to construct it, one finds some very interesting work. As will be seen, the model consists of a plywood cut-out, gaily coloured, of a flower 'girl' (such as are to be seen sitting under the Eros statue in Piccadilly Circus, London) with bonnet and shawl, with a basket of flowers in front of her. The flowers are real ones, cut or grown in a pot of a small variety, the basket forming a screen for a small jar, such as an empty fish-paste jar, or a small flower pot.

Art Not Necessary

Some readers, not very confident of their powers as artists may be apprehensive about preparing and painting the main figure, but they can rest assured that painting ability of a Royal Academy standard is not required nor even desired. There should be a quaint touch about this model.

The first thing to do is to prepare full size, the main design for which a squared-up diagram is given. It is as well to

prepare this completely on paper and then from this, trace down on to $\frac{1}{8}$ in. plywood, just the outline, which is cut round with a fretsaw. Other details can be traced off later, as will be described.

Note that the main back extends from point (P) in the diagram (1) all round the figure to (Q). A separate piece limited by lines (R), (S), (T), (U) may be required. It all depends on how you are going to make the basket.

The figures (1-11) on the left, and the letters (A-G) at the bottom are for easy reference. The nose and mouth, for example, can be said to be in square (9D), and the feather of the hat in (11C). There is no need, as just hinted, to make a slavish copy of the diagram. Swing in something like the diagram at the top right-hand corner of the diagram. This gives the main flow of lines in the figure.



Ideally, the method shown in Fig. 6 is best for making the basket and is quite easy to do, the only snag being to get the basket-making material. Only a small quantity is required although some handicraft suppliers put up $\frac{1}{4}$ lb. lots. However, if one can get some No. 6 cream cane for the upright stakes and some No. 3 for the weaving, one is equipped for a fine job. It is possible to

All correspondence should be addressed to The Editor, Hobbies Weekly, Dereham, Norfolk.

use some cane from an old broken down cane needlework basket, or something similar, or strands from an old shopping basket can be split up finer with a knife and left to soak for a fairly long time until they are pliable again. It is possible to use whippy twigs gathered from the hedgerows. The true handyman is always an adept at improvisation. One can even use plastic knitting needles and thin plastic strip.

The Base

The base is proportioned as in Fig. 3, and has nine holes (approximately $\frac{1}{8}$ in. diameter) bored with a twist drill to



weaving is done (on a simple 'over and under' basis) the 'overs' in one round become the 'unders' on the next.

The stakes are left longer than the actual finished height of the basket so that they can be finished off as in Fig. 8. One stake is bent under-over-under its three fellows and then cut off. No. 2 stake now becomes No. 1 and is similarly bent over, and so one proceeds. Fig. 8 is purely diagrammatic. The stakes 2, 3, etc., are actually longer than shown. All cane should be well damped before working. The base is best painted before the basketry is done, a light grey being suggested to represent a pavement.

Simple Alternative

Perhaps the simplest alternative to actual basket work is shown in Fig. 7. For this, set out the part (R), (S), (T), (U) in Fig. 2. (The basket work shown thereon is just a hint for painting afterwards). Fig. 7 shows how a box-

then glue on, using elastic bands, etc., to keep the lot in position until the glue sets.

The back is well glasspapered and given a priming coat, papering again lightly if necessary. The paper pattern can then be applied again and the various markings traced down. The following are, of course, just suggestions.

It is assumed that each colour is dry before others are placed over it

First paint the whole of the face and neck flesh colour, extending the colour beyond the true boundaries. Flesh tint can be made of white, a little yellow and very little red. Enamel paints are best and most permanent. Paint the whole of the shawl a mustard yellow. Paint the crease marks on the shawl a dark brown. Later, paint horizontal lines in groups of three in red, right across the shawl, each group being about $\frac{1}{4}$ in. apart. Then paint vertical lines in groups of two, in green, each group being $\frac{1}{4}$ in. apart, thus getting a plaid effect. The blouse is

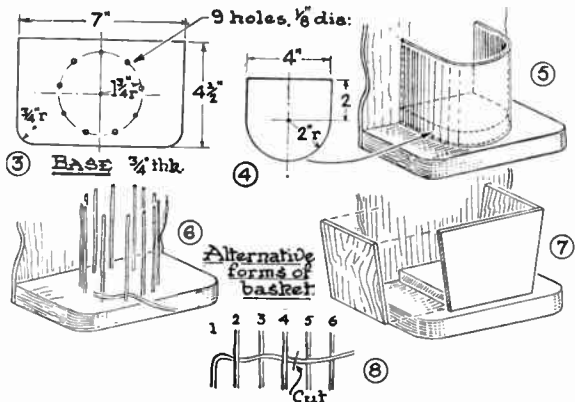

Alternative methods of constructing the basket

take the stakes. These stakes can be forced tightly in, though a better way is to have them in pairs somewhat like long, narrow U's or hairpins, i.e. the stake goes through one hole, then, on the underside, across and up through the next hole. A small groove is made in the underside to take the crossed-over part of the can and to enable the base to stand flat. The 'odd man' of the nine stakes, of course, is just inserted in a tight hole. The idea of using an odd number of stakes is that when the

like arrangement is built up. The exact proportions of this depend on the size of the jar or pot you propose to use.

Another method is shown in Fig. 5. Here the false base has a semicircular end and thin plastic sheet is used to make the U shaped container. Both this and the arrangement shown in Fig. 7 may have imitation basket work over it. One can cut strips of card, or, better, use the wood suitably cut down from the chip baskets that watercress is packed in. Do a simple 'over and under' weaving and

painted salmon pink with white spots. The eyes are black, the nose and lips red, the chin markings red-brown light. Two 'rosy-apple' cheeks are painted on in red. The hair is blue-black. The hat is black with a red band round it. The lower part, roughly corresponding to the woman's skirt, is painted black. When quite dry, the back can be tacked to the base and the model is complete, ready to lend a gay patch of colour to any room. (478)

Casket for the Dressing Table—(Continued from page 3)

hardware stores. They are usually electro-plated and look well with the mirror and the woodwork suitably finished.

Regarding hinges, the types shown in the sketches Figs. 1 and 3 are effective and much more simple to fix than the ordinary type. These boxes would look well made up in whitewood with the

appropriate decoration shown carried out in wood stains.

Another finish, too, could be made by painting the boxes cream or white or even a suitable pastel shade. Two coats would be required, the top coat being high gloss (which would take water colour if desired) finished with a clear varnish over. A suitable shield for a

monogram would look effective on the No. 1 box, and turned knobs should be chosen to lift the lids. (474)

Don't neglect the advertisement pages of 'Hobbies Weekly.' They are always worth your attention.

Alternative designs for a lady's CASKET FOR THE DRESSING TABLE



Fig. 1—The first design

THE use of the fretsaw in making something practical for a lady's dressing table is here illustrated by the two designs given on this page, and we propose giving an outline of their construction and finish. These caskets can be made almost any size, and roomy enough to contain puff, scissors, clips, manicure set and the many other small toilet requisites of a lady's dressing table.

As a casket will be more or less always on view, it should be made up carefully and painstakingly finished.

appearance seen in the cross section. The back lid is similarly cut and hinged, but it is not allowed to fall below a certain angle, being held in a more or less upright position by a small fillet or stop block glued along on top of the fixed part of the lid.

The back lid is seen in its upright position in Fig. 2. In the casket shown in Fig. 3 there is only one lid. This is cut through at the back top edge, and the narrow piece thus cut is fixed to the box as seen in the section Fig. 4. The advantage of this wider lid is that a mirror can be fixed on its underside.



Fig. 3—The alternative

floor in each case may be from 8ins. to 8½ins. long by 5ins. wide, all wood being ½in. thick.

Upon the floor, the two ends will be glued and screwed, the outline for the ends being given in Figs. 5 and 6. The back rail or side of the box in Fig. 4 measures 4ins. wide, while the front rail of both boxes is 2ins. wide. So also is the back rail of the box (Fig. 1).

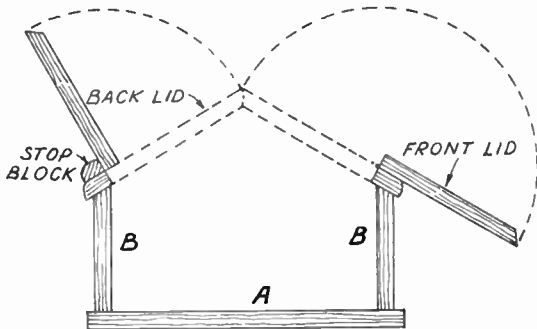

Fig. 2—Showing how the lids of the first casket work

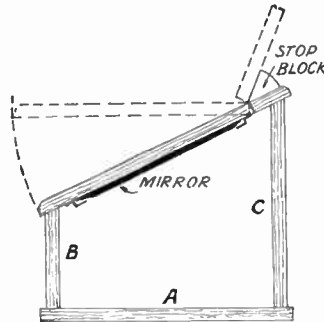

Fig. 4—The lid arrangement of the second casket

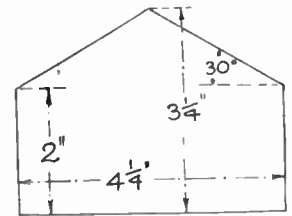

Fig. 5—Dimensions for the sides of design 1

There is a certain novelty about each design shown. That in Fig. 1 for instance, has two lids which open out and come together at a point at the top. Now look at Fig. 2 to see how these lids look when folded open and at rest. The front lid is cut through on a line ½in. from its front edge, and the piece so cut is hinged to the remainder, giving it the

Here again a stop block is fixed to the back rail to hold the lid at a convenient angle. The construction of each box is very similar, the floor (A) and the front (B) being of the same dimensions, and by comparing the two sections, Figs. 2 and 4, it will be seen that the back (C) in Fig. 4 is higher and supports the fixed rail of the lid. The suggested size of the

Hinging the Lids

If desired, the four top edges of the base could well be rounded off with glasspaper to give a good effect. The method of fixing the hinges to the boxes and lids is shown in Fig. 7. Cut shallow recesses for the flaps of the hinges, and see that they are flush when let in, so that a close joint is made when the lids are closed. Careful attention must be given to the chamfering of the edges of the lids (Fig. 1) to make them meet evenly all along.

In Fig. 4, which is a section through the box of design No. 3, the position of the mirror is shown on the lid, a mirror from 3ins. to 3½ins. wide being chosen for the purpose. The kind of mirror clip suggested to hold it in place is shown in Fig. 8. These can be purchased at any

(Continued foot of page 2)

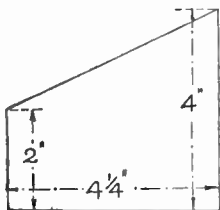

Fig. 6—Dimensions for design 2

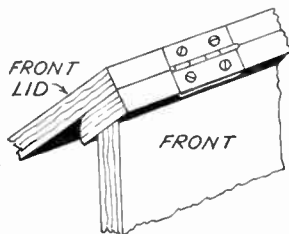

Fig. 7—The method of fixing the hinges

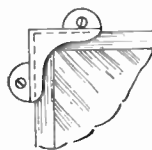
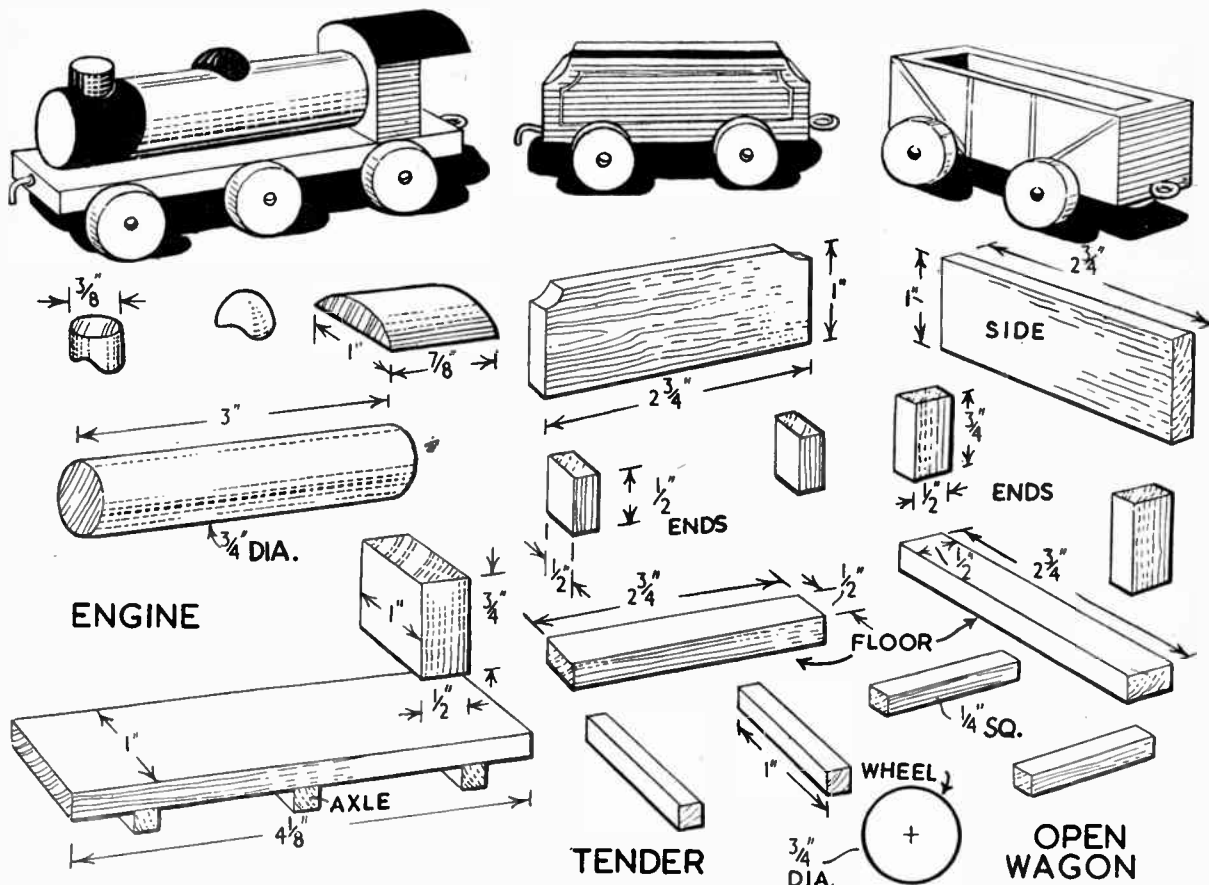

Fig. 8—Holding the mirror in place

A TOY ENGINE AND TRUCKS

FROM ODDMENTS OF WOOD



All the necessary constructional details are given here

THIS is the first of a series of articles dealing with the construction of toys from oddments of wood and round rod. The average fretworker has an accumulation of small pieces that are of little use for anything except small models and toys, and the toys shown above are designed to use up just such pieces. Even the largest piece is only $4\frac{1}{8}$ ins. long, and the smaller pieces are as little as $\frac{1}{2}$ in. square.

Construction

Sort out pieces of $\frac{1}{2}$ in. and $\frac{1}{4}$ in. wood and mark out the various parts to the measurements shown above, $\frac{3}{8}$ in. or even $\frac{1}{4}$ in. wood can be used so long as you adjust the dimensions accordingly.

Under the illustrations of the engine, tender and open wagon you will find helpful details of the parts that go to make up each item. Study these carefully

until you are quite clear about the method of construction.

The engine is made up of $\frac{1}{2}$ in. and $\frac{1}{4}$ in. wood, the main piece on which the boiler rests measuring $4\frac{1}{8}$ ins. by 1 in. by $\frac{1}{4}$ in. Three axles are glued to the piece as shown in the diagram. The axles in every case measure 1 in. by $\frac{1}{2}$ in. square. These can be cut from odd lengths of $\frac{1}{2}$ in. square stripwood. The boiler is simply a piece of $\frac{1}{2}$ in. diameter round rod which is screwed to the main piece from the underside. The remaining parts are shaped and merely glued in place.

The tender and open wagon are both of similar construction, each consisting of two sides, two ends, a floor and two axles. Measurements for these two differ only slightly. Notice the sides of the tender are cut away slightly at the top corners.

Making the Wheels

For these a piece of $\frac{3}{4}$ in. round rod is

required. Mark off in lengths of $\frac{1}{8}$ in. or $\frac{1}{4}$ in. and cut with a tenon saw. You will find that the most accurate way of doing this is to place the round rod in a mitre cutting block. Make a hole neatly in the centre of each wheel with a small fretwork drill and fix the wheels in place with fine $\frac{3}{4}$ in. roundhead screws. To couple the engine, tender and wagon together you will need six small screw-eyes. Three of these are opened out to form hooks as shown in the illustration. A piece of string can be attached to the hook on the engine for pulling along.

Painting

Clean up the toys carefully with glasspaper, removing excess glue with a penknife. Paint inside and out in bright colours, using a good high gloss enamel. Two coats should be sufficient to give a smart and durable finish. (468)

Mystify your friends with THE 'JUMPING CARD' BOX

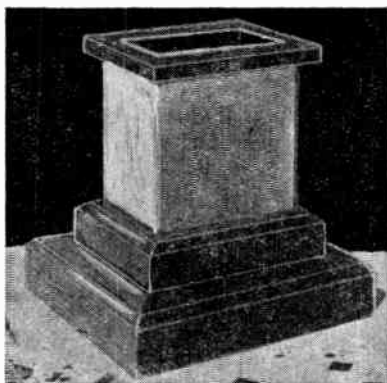

WHILST a considerable number of conjuring tricks can be done by sleight of hand alone, or with simple, unprepared (or only slightly 'faked') everyday articles, the amateur conjurer especially, likes to have some apparatus, as it makes a nice show. Conjuring apparatus is notoriously expensive, but here is an excellent 'classic' piece of apparatus any conjurer-craftsman can make. It is not just a 'paper idea'. It has not only been made up by the writer but has actually been used in public shows well over a hundred times without mishap. Every possible dimension and view has been given, so no difficulty should be encountered.

The Effect

The effect is that a card is freely chosen by a member of the audience, and placed by himself in an envelope, etc., which he retains. The rest of the cards are placed in a box on a plinth (of the type illustrated, and which forms the subject of this article). The member of the audience is asked to look at his card again, on a pretext of checking up its value, or some other excuse. He finds that it has vanished. Attention is drawn to the box. At a word of command the chosen (?) card springs out of the box into the air.

The box, of course, is mechanical, though it has the advantage of looking genuine in the sense that it is obviously designed to hold a pack of cards, and is not a complicated-looking gadget obviously designed to conceal a lot of tricky 'works'.

Although looking quite solidly constructed, the box is in two parts. There is the upper box to which is attached a rim of moulding (the upper stage of the two-stepped base), and which is shown in Fig. 6, and the main base, the lower of the two steps, shown in Fig. 2. The top part sits in the opening of the lower part (Fig. 5 gives some idea of this). But whilst the fit is good the long way, there is $\frac{1}{4}$ in. extra the short way in the lower framed part, so that the upper

part can be pushed backwards and forwards $\frac{1}{4}$ in.

There is a flat spring (J) attached to the bottom of the upper part. This normally engages in a recess on one side of the lower frame. But when the upper box part is pushed forward, the spring is pulled out of its recess and snaps upwards. The upper box is divided into two parts. One, floored, contains the cards put in in view of the audience. The other compartment, open at the bottom, contains a duplicate of the

chosen card. (Details of how to manage this duplication will follow). This duplicate rests in the first place on the spring, but when the spring snaps upwards, the card is shot up into the air for some distance. Figs. 7 and 8 make this quite clear.

It is best to start off by making the lower frame (F). This is of $1\frac{1}{2}$ ins. square stuff with a $\frac{1}{4}$ in. rebate as shown. (The $\frac{1}{4}$ in. bevel is done when the frame is made up). The expert and well equipped will prefer to plane a rebate in

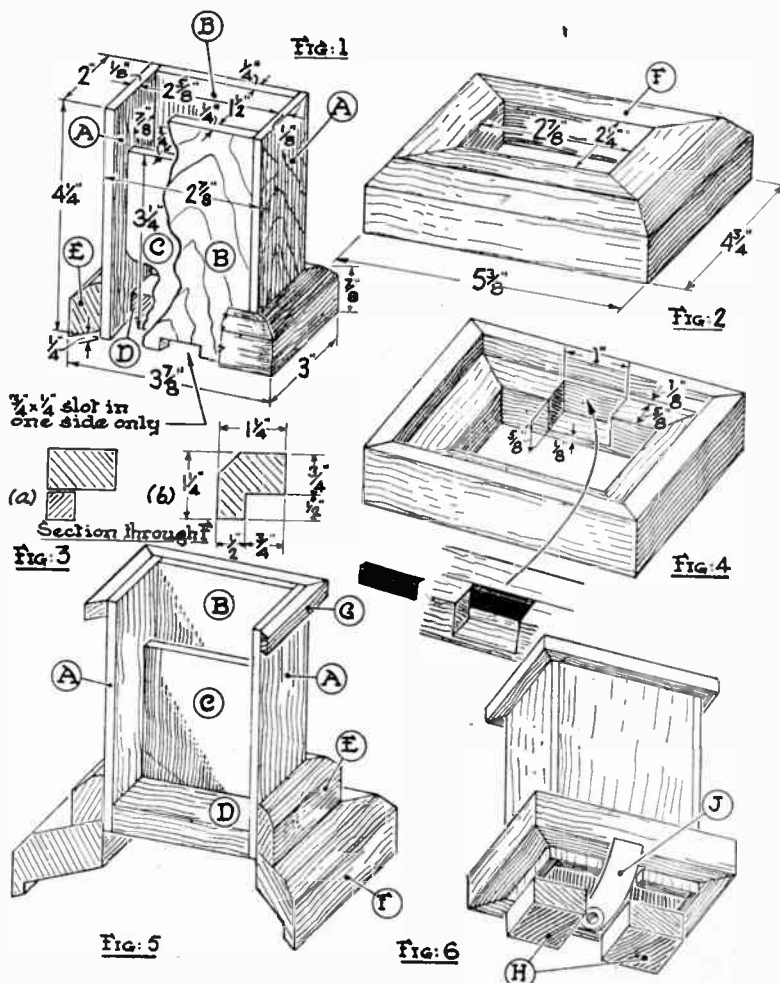

Drawings showing how the box is made

the wood but failing this, it can be made up of two pieces as shown in Fig. 3 (a). All the dimensions are given in Fig. 2. The corners are neatly mitred, exactly as for picture framing, using a proper mitre block, and after the glue has set, the corners are strengthened by cross-corner screwing, nailing or various other means given in all books and articles on picture framing.

Turning the frame over, a recess is made as shown and dimensioned in Fig. 4. Though soft wood can be used, as the whole job is afterwards painted or enamelled, it makes a better and more lasting job if hardwood is used.

The upper box (Fig. 1) is now made. This is fully dimensioned in the diagram which shows some parts broken away in order to reveal others. Note the partition (C) with its floor (D). A view of this, but from the other direction, is

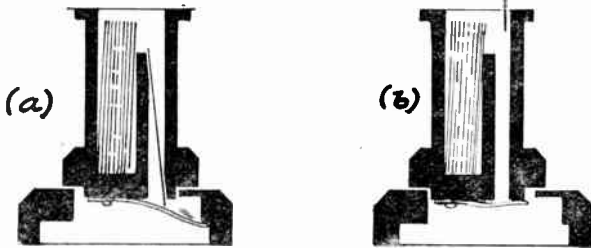

Figs. 7 and 8 — How the box works

given in Fig. 5. Note that a notch is cut at the bottom of one side (the narrow partition side) only. Make the plain box first without the surround (E), testing it by 'offering' it to the lower frame. There should be a $\frac{1}{4}$ in. movement from back to front but no more, from side to side, than to ensure easy working. This ascertained, apply the surround (E) which is of $\frac{3}{8}$ in. by $\frac{1}{2}$ in. stuff. Note that this surround is NOT flush with the bottom of the box but $\frac{1}{4}$ in. up. This can clearly be seen in Fig. 6.

Fitting the Spring

The spring is next obtained. This is a $2\frac{3}{4}$ ins. length of $\frac{3}{16}$ in. wide clockspring. As this is very difficult to drill without the trouble of taking out the temper and then re-tempering again, a piece of spring is chosen at the extreme end of the coil, where a hole is already drilled. The spring is best cut, by the average amateur, by gripping firmly and squarely with pincers at the desired spot and bending back and forth until it snaps.

By means of a screw and washer, the spring is attached by one end to the underside of the floor of the upper part, the position being so adjusted that the spring, when depressed, will just engage with the lower part of the recess in the lower frame. (Shown shaded in Fig. 4). When, as already explained, the upper part is pushed over (a movement not

noticed by the audience) the spring is pulled out of the recess and sends a card flying. To guard against wear, it is essential to put a tiny angled piece of tin (cut from a tin can), the wings being about $\frac{1}{8}$ in. by $\frac{1}{4}$ in., securing with two small panel pins.

Guide blocks (H) are about $\frac{3}{8}$ in. wide and $\frac{1}{2}$ in. or so deep and extend from the back of the floor of the lower part to the edge of the opening, i.e. $\frac{3}{8}$ in. long. Their outside long sides are flush with the outside of the main upper box. They are glued and screwed to the floor. Rim (G) on the top of the box is purely

good enamel are advised. The writers' model is in light green and dark green but orange (or yellow) and red would look very gay. Avoid anything that shows up soiling and which scratches too readily. The conjurers 'props' must be capable of standing up to hard wear.

As this is a constructional article and not primarily one on practical conjuring, and especially as space is getting short, we cannot go into details as regards actual presentation. As a card is already 'loaded' in the apparatus, the member of the audience must have a duplicate 'forced' on him. There are at least a dozen good ways of doing this, many being described in books on conjuring and which form part of the conjurer's elementary education. Though somewhat inferior, the unskilled amateur may use a pack of cards all alike (obtainable from conjuring stores) provided he does not keep making the same card appear before the same audience.

Vanishing the Card

As regards making the card disappear, here again, there are at least a dozen good ways. A very good one, indeed, is to use a 'Roterberg' card box (from conjuring stores) or if, as is feared, this is too expensive, then a 'card slide' (from the same source). The 'Sand Frame' may well be used, and it is hoped that, as space permits, a constructional article on this will appear in *Hobbies Weekly*.

In use, the box is held in both hands, which are slightly cupped, palms uppermost, with the thumbs behind the box, care being taken the 'free' side of the box is away from the operator.

One last word. Having spent a lot of time making the apparatus and perfecting the trick, do not make yourself cheap by exposing the secret to persistent enquiries, especially those who profess to admire your handiwork. Put the apparatus out of sight when the trick is over and proceed to another item. (476)

ornamental, and is, say, $\frac{3}{4}$ in. square section.

When first using this box the constructor may feel the need to use a thin flat strip of wood, inserted through the 'duplicate card' partition, so as to depress the spring to enable it to engage properly, but after a while one gets the knack of setting the spring without such an aid.

Decoration (once the model is well tested) is largely a matter of personal preference. Glasspaper well and fill all nail, etc., holes. Two or three coats of

A Pull-along Toy Timber Lorry

An attractive toy, this timber lorry is the subject of this week's free design (No. 2918). It can be made quickly and yet will be sturdy enough to stand up to much rough treatment. Any small child would delight to have one as a present.

For making this toy a complete kit of materials including wood, stripwood, and six turned wheels can be obtained from Hobbies Branches or post free from Hobbies Ltd., Dereham, Norfolk, price 5/1 including tax.

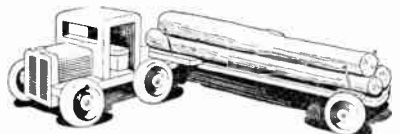

You can make this Japanese style BRIDGE FOR THE GARDEN

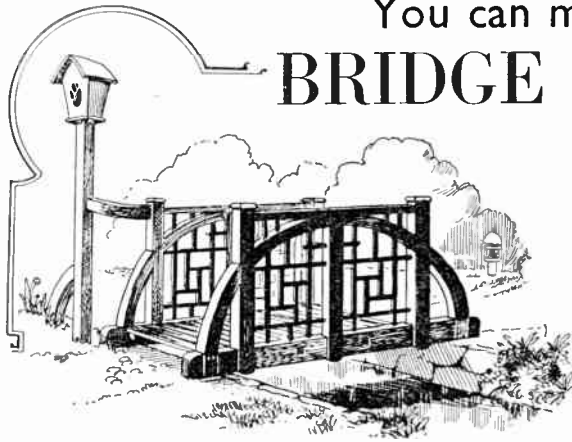

THERE is no prettier ornament for a small garden than a Japanese bridge, and if no lake or pond is available to build this over, then one could easily be made. A small garden stream or even a pool from 5 to 6ft. wide could be made and lined with large stones, the bed of the stream being composed of clay or even hard rubble and concrete.

But we are not so much concerned with the making of the stream as the making of the Japanese bridge shown above. It might be added that the surroundings should be in keeping with the bridge. It is possible to obtain small concrete ornaments of Japanese design which go to make a garden of this sort most attractive.

A sketch of the bridge shows the arrangement, with the lamp at the side, which is to be illuminated at night. The elevation of the bridge is shown in Fig. 1, while the plan is shown at Fig. 2, and from these two diagrams, the construction of the bridge may be understood.

Oak would be the ideal wood, but a good quality deal, stained with a dark preservative, would answer equally as well. Each side of the bridge consists of three uprights,

oak dowel pins.

The circular braces are set out with a radius of 3ft. 2ins. from the joint marked (C) on the centre upright. The braces should be set out full size and they measure 4ins. wide each way, the length being determined accurately from the full-size lay-out. The correct joint where these braces meet the main uprights is shown in Fig. 4. These should be accurately cut and pinned with oak dowel pins. Fig. 4 also shows how the top horizontal member is tenoned into the uprights, while a sinking is made in this top member to admit a stub tenon on the

middle upright. Simple cappings are formed for the side uprights from 6in. square stuff 1in. thick.

The filling in between the uprights consists of 1in. square stuff all halved together and doweled at various places where it crosses. The actual design needs to be set out full-size and the pieces arranged and cut to fit the curved top braces. The ends of the filling will fit into small mortises in the posts.

The Sides

Two complete sides of the bridge must be made up and connected together by means of four cross bearers, consisting of 5in. by 2in. stuff, mortised into the main bearers as shown, in Fig. 5, where it will be noticed that the cross bearer is not cut away to any great extent so as not to weaken the joint.

The ends of the bearers may be flush with the outer faces of the girders, or they may project about 1in. for appearance's sake. This latter applies only to two central cross bearers. The top cross rail or hand rail will be 4ft. 9ins. long by 4ins. wide by 2ins. thick. This, as before mentioned, is tenoned into the side posts and the two arises planed away.

The bearers for the platform of the bridge consist of 4in. by 2in. material

(Continued foot of page 10)

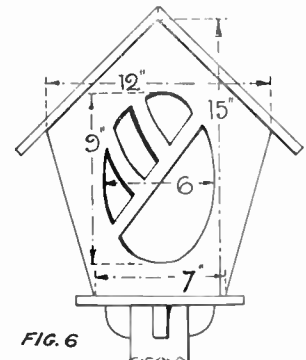
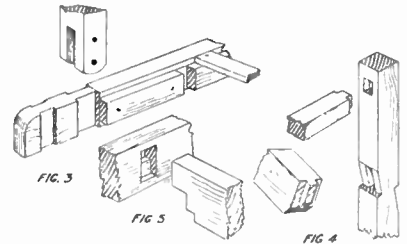
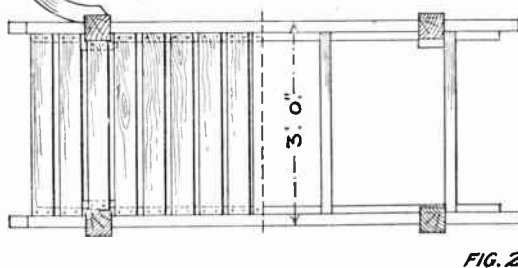
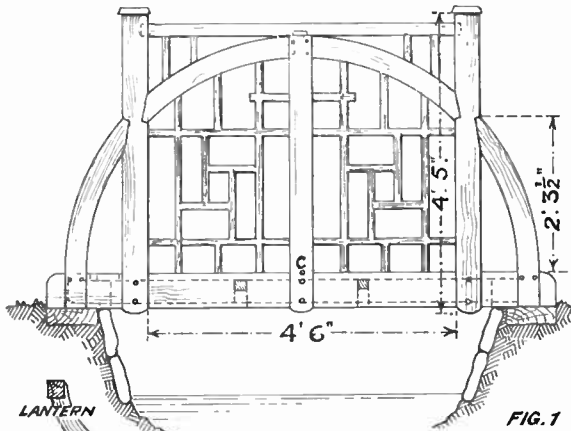

Toddlers can enjoy themselves in a COMBINED STOOL AND ROCKER

THIS combined stool and rocker is a novel and serviceable little article to make up for the toddler. After the little one has had a spell with the rocker, this latter is just turned upside down and immediately converted into a stool for sitting up to a low play table.

The article can be made throughout from deal or even box wood, if this is in good condition and thick enough for the job. Wood $\frac{1}{2}$ in. or $\frac{3}{4}$ in. would answer well. If a box is to be used for the sake of its wood, it should first be carefully knocked apart and the nails removed and straightened for re-use. The wood should be cleaned up, and, of course, the various pieces must be of equal thickness, so that if two pieces are glued edge to edge they will make an even surface.

Making the Sides

The sides are drawn out and cut to the measurements given in Fig. 1, which is a section through the rocker. The grain of the wood should run horizontally, so that it may be necessary to make up the width of 12ins. by gluing up two 6in.

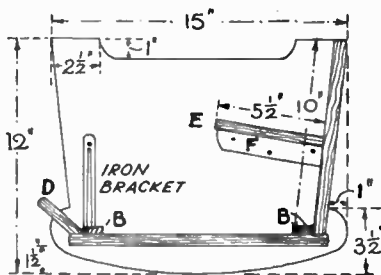
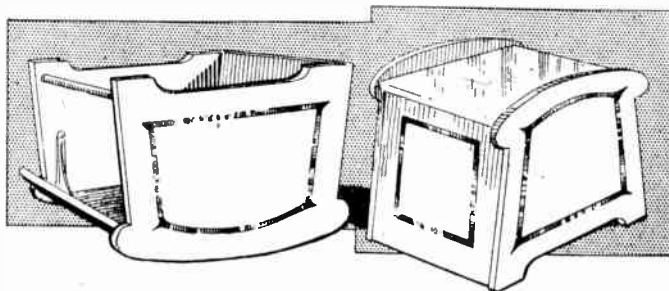

Fig. 1 Side view, giving dimensions

boards or three 4in. boards. The two sides will be materially stiffened up after the back upright has been screwed in place.

Glue the boards together to form a rectangle measuring 15ins. by 12ins., then on this set out the outline in pencil. Run a pencil line $1\frac{1}{2}$ ins. up from the bottom edge and another $3\frac{1}{2}$ ins. up. At 1in. in from the vertical edges and on the top line, that is at $3\frac{1}{2}$ ins. up, fix the point and run the shaping line to meet the top corner. Cut the bottom edge curve by first bending a thin slip of wood or a piece of cane to the curve required. Hold the cane firmly in place and draw a pencil line. Draw in freehand, or, perhaps, with a pair of compasses, the bluff curves which continue on from the main base curve.



Next form the sinking along the top edge of the side to the measurements given. The whole outline is then cut with a coarse fretsaw and the cut edges cleaned with coarse and fine glasspaper. Lay this cut-out on the second side piece and draw round it with a fine-pointed pencil. Complete this in the same way.

The floor of the rocker, which also forms the top of the stool, measures 13ins. long by 10ins. wide. The ends should be slightly rounded off. If a single width board cannot be obtained for this floor, then two boards will have

surface it is chamfered where it meets the floor. This chamfered part is glued and screwed to the floor, and it will be seen from the cross section (Fig. 1) that it lies at a convenient shape for the feet.

The seat (E) is 10ins. long and $5\frac{1}{2}$ ins. wide, and its front edge should be rounded and smoothed while its back edge is square and fits the back at rightangles. Nail or screw the seat to the two sides and to the back. Two small support fillets may be added to go under the ends of the seat as (F) in Figs. 1 and 2. To support the open ends of the sides, add two iron brackets as shown. They should be screwed to the top flat surface of the fillet (B).

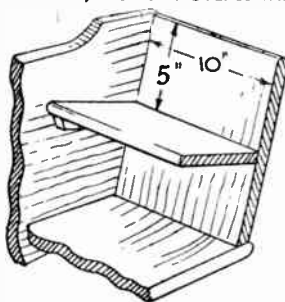

Fig. 2 Section showing how the seat is fixed

to be glued together, and battens nailed or screwed across the inner surface as (B) in Fig. 1. One batten will be placed just inside where the upright end comes, and one where the iron bracket is fixed. These battens will prevent the boards splitting or coming apart.

The back of the rocker, which also forms the back of the inside seat, and the footboard (D), are made next. The back measures 10ins. square and should be planed off a little on its lower edge to bed down properly on the floor. The top edge should be rounded and made smooth to handle. The floor, be it noted, has its underside touching the first line drawn, that is $1\frac{1}{2}$ ins. up from the rocker edge (see Fig. 1).

The footboard (D) measures 10ins. long and 3ins. wide, and on its under

As an additional support for the tops of the sides, a turned rod about $\frac{1}{2}$ in. diameter may be bored for and glued in securely. See this rod in the sketch of the rocker. It would be advisable to use oval nails wherever possible in nailing the article together, as these nails prevent the wood splitting. The heads of all nails should be punched well down and the sinkings then filled with suitable stopping. A good stopping for this purpose can be made by mixing sawdust with glue, or, of course, ordinary putty will answer very well.

The woodwork inside and out should be cleaned with coarse and fine glasspaper. Two coats of paint should then be applied inside and out, and do not forget the youngsters love bright colours. Red and green are good, and any pastel shade of matt paint would please the lucky owner of such a rocker-cum-stool as this. If paint is not available, then a coat of stain and varnish is the next best thing.

If thought desirable, the top of the stool may be covered with American cloth or Rexine, and a shallow padded cushion can be formed of horsehair or straw. The material must be laid between the rocker sides and the ends turned over on the end edges of the floor, and tacked down neatly. (472)

Recapture summer thrills with this INDOOR CRICKET GAME

THERE are always some occasions when an eagerly-anticipated game of cricket has to be 'scratched' because of unsuitable weather. So why not make up this indoor table set, to ease the disappointment at such times? It will be useful, too, at this time of year, as a welcome change from the more usual indoor games, and to keep the spirit of King Willow alive during the 'off season'.

The game is played with small ball-bearings, which can be bought quite cheaply from any cycle stores. The cut-out figure of the bowler has an elastically-operated arm for aiming the balls at the wickets, which are of the swinging type, and the fellow at the other end, cut in the shape of a batsman, has a moving bat operated by means of a knob at the side of the case. The base is

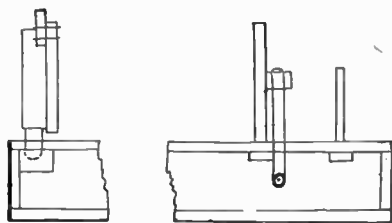

Fig. 1—The layout of the 'players'

in the form of a shallow box, which houses the belt operating the batsman and also provides a handy place for keeping the various pieces safely together when not in use.

Materials Required

The measurements given make up a board which is 18ins. long and 9ins. wide,

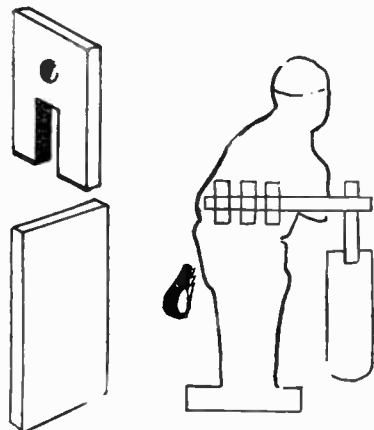

Fig. 3—Details of the bat, and 'batsman'

but this can easily be varied to suit whatever material is available. Wood of $\frac{1}{2}$ in. thickness is allowed for except where otherwise stated. The lid of the case is in two parts, one, at the batting end, being fixed down permanently and the other piece hinged on to form a lid. They can be pieced in any proportion most convenient, but take care to see that the join is not just in front of the batsman where the balls will 'break'. A fixed piece 10ins. by 9ins. and a lid 8ins. by 9ins. does quite well. The base, too, can, if necessary, be pieced in two or more parts to use up small pieces of wood. Or stout cardboard will do for this, if well fixed on. For the remainder, only very small pieces of wood and an oddment of dowelling are needed, and these are shown in full in the Cutting List.

Cutting Out

Make a start by cutting the parts for the case. The two long sides have a $\frac{1}{4}$ in. hole bored in them, $4\frac{1}{2}$ ins. from the batting end, to take the batsman spindle. The sides can then be screwed to the base, but do not add the top pieces yet. Lay these out in the position they will be and draw a pencil line down the centre lengthways. On this line bore a hole of $\frac{1}{2}$ in. diameter, $\frac{1}{2}$ in. from the end where the bowler will stand, and make a slit $1\frac{1}{2}$ ins. by $\frac{1}{2}$ in., crossways, 5ins. from the other end, and $2\frac{1}{2}$ ins. from the front edge for the batsman. Then cut two holes each $\frac{1}{2}$ in. square and 1in. apart (one each side of the line) and $2\frac{1}{2}$ ins. from the batting end, for the wickets to stand in. In the case of the batsman and wicket holes, glue an oddment of wood over the holes on the underneath side, for them to be pushed up to. To prepare the case for the bowler, cut a block of wood 1in. square and about $\frac{3}{4}$ in. thick, bore it to a depth of $\frac{1}{2}$ in. with a $\frac{1}{2}$ in. bit, and screw it to the end of the case, in the centre and on the inside, flush with the top edge, so that when the lid is closed the $\frac{1}{2}$ in. hole in the lid exactly fits over the hole in the block.

The Batsman

The shape for the two cut-out figures is shown at Fig. 2, ruled up in $\frac{1}{2}$ in. squares for easy copying. Note that the piece for the batsman has a $\frac{1}{4}$ in. lip at the

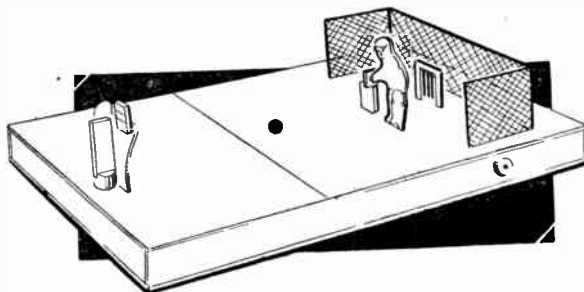

bottom, to fit the slit cut in the lid. For the moving bat two little pieces are needed—one 1in. by $\frac{1}{2}$ in. for the handle and the other $1\frac{1}{2}$ ins. by $\frac{1}{2}$ in. for the blade. Cut a slit $\frac{1}{2}$ in. wide and $\frac{1}{4}$ in. long in the handle piece, so that the blade can

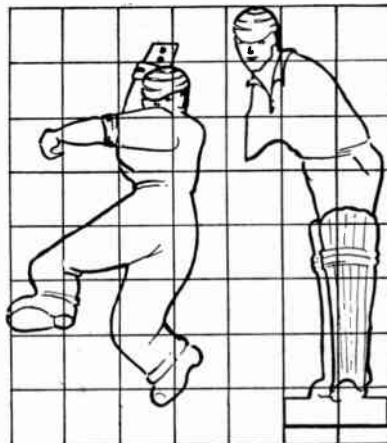

Fig. 2—Outlines of the figures

be glued firmly into it, as shown at Fig. 3. Before doing so, however, bore the handle with a $\frac{1}{4}$ in. hole, $\frac{3}{8}$ in. from the top, for the bat spindle. This spindle is a piece of $\frac{1}{2}$ in. dowel 2ins. long. To carry it two little stays are needed, each 1in. by $\frac{1}{2}$ in. Bore them with the $\frac{1}{2}$ in. bit, then screw them on to the back of the batsman $1\frac{1}{2}$ ins. from the bottom, as shown at Fig. 3. Cut two discs for pulley wheels $\frac{3}{8}$ in. diameter out of a piece of three-ply, make a $\frac{1}{2}$ in. hole in the centre of each, and make a groove round their edges for the string belt. Glasspaper the spindle until it turns easily in the holes in the bearers, drill two fine holes for pins to hold it in place, then fix it in the bearers with one of the pulleys glued on in the middle, as shown at Fig. 3. Glue the bat on to the projecting end of the spindle, making sure that it clears the cut-out figure when it turns up and down.

Cut another piece of the $\frac{1}{2}$ in. dowel $9\frac{3}{4}$ ins. long and glue on to it the other pulley wheel, not quite in the centre but $4\frac{1}{2}$ ins. from one end. Fix it into the holes cut for it in the case by a pin through at each end, with $\frac{1}{2}$ in. projecting at one end and only enough for the pin at the other. On the longer end glue a disc of wood $1\frac{1}{4}$ ins. in diameter, for the turning-knob. Immediately under the pulley on the batsman drill two large holes for the belt, and thread a piece of string through them. Tie the knot as

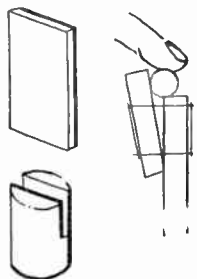

Fig. 4 -The 'bowler,' and how he works

tightly as possible, to make sure the belt does not slip when some enthusiast strikes a ball for six!

The Bowler

Having cut out the figure for the bowler, drill two holes in the upraised arm, and two similarly spaced in the little piece 1 in. by $\frac{3}{8}$ in. that fits behind the arm. Note that this back piece extends about $\frac{1}{2}$ in. above the top of the arm when the two sets of holes are placed together. Through these holes a piece of strong elastic is threaded, and tied with a knot. Glue a matchstick on the two outsiders as shown, to prevent the elastic from becoming worn on the edges of the holes. The stronger the elastic is, the better. Only a little play on it is needed, but this can easily be adjusted when the game is completed and a little practise at throwing the balls shows just how it needs to be.

At the back of the bowler a strut $3\frac{1}{2}$ ins. by $\frac{1}{2}$ in. is screwed, projecting $\frac{1}{2}$ in. at the bottom. Cut a piece of $\frac{1}{2}$ in. dowel 1 in. long, make a $\frac{1}{4}$ in. slit in it to a depth of $\frac{1}{2}$ in., then glue the bottom of the strut

into it as shown at Fig. 4. This dowel now fits into the $\frac{1}{2}$ in. hole in the case, and allows the figure to be moved round for taking aim at the wicket. To get the range just right requires a little practise when the model is complete; but it makes it easier if the bowler is fixed into the dowel piece at a very slight forward slant, to make sure the ball is thrown downward and breaks just in front of the batsman.

The Wickets

The wickets are cut from a piece

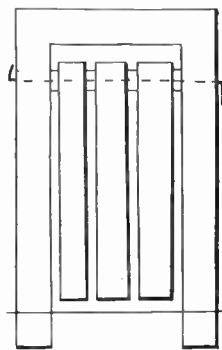

Fig. 5 Showing how the wicket is hinged to swing when struck by the ball

$2\frac{1}{2}$ ins. by $1\frac{1}{2}$ ins. Mark it out $\frac{1}{4}$ in. from the two long sides and $\frac{1}{4}$ in. from the top and cut out the centre piece to leave the three-sided frame. Mark off on the centre piece that has been cut out, three strips $\frac{1}{4}$ in. wide, and shorten it to a length of $1\frac{1}{2}$ ins. Then cut out the three strips, which form the hanging wickets. Clean them up well with glasspaper, then drill a fine hole through each, edgewise, $\frac{1}{4}$ in. from the top, and a similar hole through each side of the frame, $\frac{1}{4}$ in. from the top. Then thread the three wickets on to a stiff piece of wire (with a small washer between each) and fix the wire in the frame, bending it over at the ends, as seen in the sketch at Fig. 5. Make sure the wickets swing easily when the stand

is pushed into the two holes made for it in the case.

The Nets

A simple net around the batsman adds a finishing touch to the game and saves much searching for wandering balls. This can easily be made from four lengths of stiff wire 4 ins. long and an oddment of muslin or similar material 19 ins. long and $3\frac{3}{4}$ ins. wide. Sew one wire on to the muslin at each end and the other two wires at a distance of $5\frac{1}{2}$ ins. from the ends. Then drill four

CUTTING LIST (for wood of $\frac{1}{4}$ " thickness except where stated)		
No. of Pieces	Description	Size
The Case		
2	Top and base	$18" \times 9"$
2	Sides	$18" \times 2"$
2	Ends	$8\frac{1}{2}" \times 2"$
1	Bowler block	$1" \times 1" \times \frac{3}{4}"$
1	Batsman knob	$1"$ diameter
1	Batsman spindle	$9\frac{1}{2}"$ of $\frac{1}{4}"$ dowel
1	Pulley wheel	$1"$ diameter
The Batsman		
1	Cut-out figure	$3\frac{3}{8}" \times 1\frac{1}{2}"$
2	Spindle stays	$1" \times 1" \times \frac{3}{4}"$
1	Bat handle	$1" \times 1" \times \frac{3}{4}"$
1	Bat blade	$1" \times 1" \times \frac{3}{4}"$
1	Pulley wheel	$1"$ diameter
1	Pulley spindle	$2"$ of $\frac{1}{4}"$ dowel
The Bowler		
1	Cut-out figure	$3\frac{1}{2}" \times 1\frac{1}{2}"$
1	Arm piece	$1" \times 1" \times \frac{3}{4}"$
1	Strut	$3\frac{1}{2}"$ of $\frac{1}{2}"$ wood
1	Stand piece	$1"$ of $\frac{1}{4}"$ dowel
The Wickets		
1	Stand	$2\frac{1}{2}" \times 1\frac{1}{2}"$
3	Wickets (same piece)	$1" \times 1\frac{1}{2}"$

small holes in the top of the case for the projecting ends of the wires to be pushed into.

Finishing Off

Fix the lid part of the case on with a pair of neat hinges. The model can then be finished off in any particular way that is preferred. Clear varnish is, perhaps, the easiest, and looks quite well if all the woodwork has been well cleaned up. Alternatively, coloured enamels may be used and can be made very effective. The cut-out figures will, of course, be white, with pink or buff on the flesh parts. The wickets can be buff and the case a grassy green. (470)

Bridge for the Garden—(Continued from page 7)

nailed inside the main girders to support the planking or footboards, which are 4 ins. by 1 in. or $1\frac{1}{2}$ ins., spaced out with 1 in. between them. They are nailed direct to the top of the bearers as shown in detail Fig. 3. The whole bridge should be supported on creosoted baulks as a foundation, as shown in Fig. 1, consisting perhaps of parts of old sleepers about 9 ins. by 3 ins., let into the soil as shown.

The Lantern

A detail of the lantern is shown in

Fig. 6 with suggested measurements for it. The lantern consists of four sides of $\frac{1}{2}$ in. wood erected upon a piece of $\frac{1}{2}$ in. wood 9 ins. square. The sides are made to taper downwards, and two are formed into a gable, these two having perforations cut in them to let out the light. The roof may be of $\frac{1}{2}$ in. wood, two pieces being wanted 14 ins. long by 11 ins., mitred at the ridge.

The whole should be nailed together with copper nails and erected on top of

the post as shown, four shaped brackets being fixed underneath to give additional support. This lantern, like the wood of the bridge, should be coated with wood stain preservative. The post should be 4 ins. square, and of sufficient length to allow it to be driven down into the soil about 18 ins. A shaped strut is shown at the bottom, and should be mortised into the post, and also a shaped hand rail, which is a continuation of one of those of the bridge. (438)

Make this self-illuminating NOVEL SHAVING MIRROR

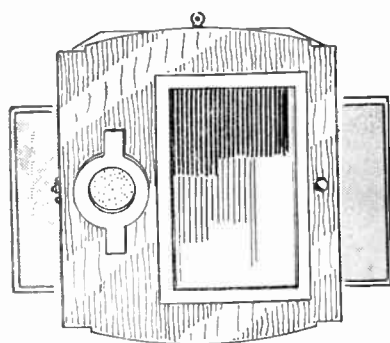

It is a difficult matter to find a really satisfactory position for a shaving mirror, as usually only half the face is properly lighted, leaving the other half in shadow. One can nowadays buy a self lighted mirror, but this, apart from being expensive, also needs a house current to operate, a convenience everybody does not enjoy. For such, the mirror illustrated, would be helpful, as it provides an electric lamp, operated by

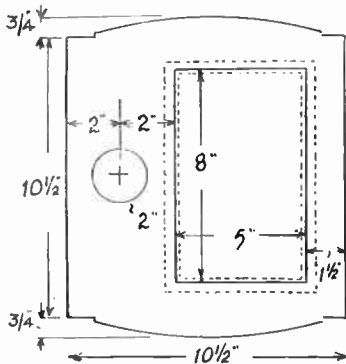

Fig. 1

a battery, which directs a beam just where needed. The whole affair is reversible, to light up the left or right side as necessary. Incidentally, accommodation is provided inside for shaving tackle, as well.

The Front

The front of the cabinet, as we can describe it, is shown in Fig. 1. The dimensions given are for a mirror of 8ins. by 5ins. or less, but any other size larger would serve if the width and length are amended in proportion. Setting out the front can be done direct to the wood, cutting it to the full

dimensions, and pencilling a line across the middle, the opening for the mirror being marked each side of the line. On this line, the centre for the lamp window can also be pricked in with an awl. The top and bottom edges are set out with a sweeping curve as shown.

The case, Fig. 2, is made of wood, 3/4 in. thick. A good piece of deal would do here, or a better wood, oak for example, if obtainable. The dimensions are, of course, suitable to the size of front given; if the latter is increased, the case must be increased in size proportionately. On the left side a pair of recesses are cut out to receive hinges, so that the front can open for access to the shaving tackle, or to fit a new battery. The vertical division is nailed in, and sufficient space should be left for the battery, say, 4ins. A middle shelf is provided for the shaving tackle. The parts can be just glued and nailed together. A back, of plywood, is then glued and nailed on. At this stage fit the hinges to case and front, and add a

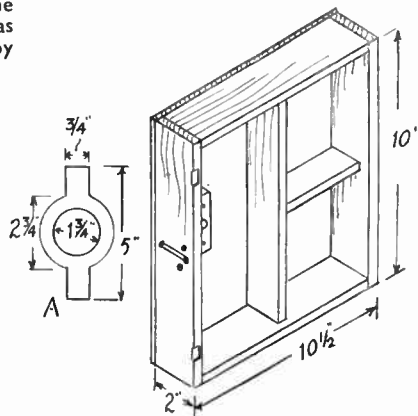

Fig. 2

small but suitable catch to keep the front safely shut.

The mirror opening is surrounded with a frame of four strips of 1/2 in. fretwood. Fit this part to overlap the edges of the opening by 1/8 in. to leave a rebate for the mirror to fit in behind, in the usual way. The frame, by the way, is indicated in Fig. 1 by dotted lines. For gluing over the lamp window to the left of the mirror, set out the pattern for an overlay on the 1/2 in. wood, shown at (A). Cut this out, and glue in position.

The mirror can now be fitted in, and kept in place by nailing at the back the piece of wood cut out when sawing the

opening. This piece will need to have its edges shaved down to fit in, and allow room for nailing. In the lamp window a circle of thin plastic, clear or opal, would do nicely, or celluloid would serve also. It might be possible here to use a watch glass, as the opening need not necessarily be 2ins., but could be amended to suit. The arrangement for the electric lamp can now be taken in hand, and is quite simple to carry out.

CUTTING LIST

Sides of case (2) - 10ins. by 2ins. by 3/4 in.
Ends (2) - 9 3/4 ins. by 2ins. by 3/4 in.
Division and shelf - 1ft. 4ins. approx. of 3/4 in. by 1 1/2 ins. wood.
Back panel - 10ins. by 10 1/2 ins. by 3/4 in. (plywood).
Front panel - 12ins. by 10 1/2 ins. by 3/4 in. (plywood).

For overlay and frame - 4ins. by 9ins. panel of 3/4 in. fretwood.

Firstly, in the left side, fit a switch controlling the light. The switch arm is a 2ins. length of springy brass, about 1/4 in. wide, such as a terminal from an old battery. This is drilled at one end, and a round-headed brass screw driven through the hole into the side of the case. Place a thin brass washer under the switch arm, and another washer above it, and see the screw is driven in tightly enough to grip the arm firmly, yet allow it to move as desired. The free end of the switch arm is curled round for an easy grip for the fingers.

Two round-headed brass screws are now driven in to act as contact studs for the switch arm to press against. These are arranged convenient to the arm, as shown in Fig. 2. All three screws employed are 3/8 in. long, to stick out of the wood on the inside of the case for interior connections.

(Continued foot of page 12)

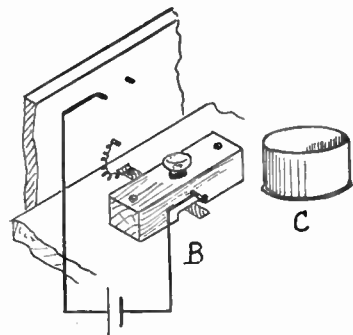

Fig. 3

Some helpful circular MEASURING DEVICES

THE measuring and dividing up of circular objects often presents difficulties. It is not easy to find the exact centre of a dowel rod or a circular disc that is wanted for a toy wheel. An even more tricky job is to divide the circumference of a circle into a certain number of equal parts.

For finding the centre of circular articles the little tool shown in Fig. 1 is extremely useful and if you have much to do of this class of work it will pay to make a set of about three in different sizes.

Best of Metal

It is best made of metal, but for the larger sizes, wood may be used. Sheet brass is probably the best material to use and it is the easiest to work with. 16 gauge is about the right thickness.

Care should be taken to set it out correctly, as even a fraction of an inch out will make the tool useless. For a medium size tool, take a piece of brass sheet 4ins. long and about 2ins. wide. Draw the line (A) (Fig. 1) along the centre, and, about 1in. from one end, draw another line (B) exactly at right angles to it.

Now mark the places for the two pins $\frac{1}{8}$ in. from the centre line (A), and drill these very carefully. Quite small holes are best, as this size can be drilled and fitted with much more accuracy than large ones.

With a metal fretsaw, cut round the edge of the tool as shown in Fig. 1, making the cut slightly outside the marks. Finish off with a file, and be very careful to get the straight edge (A) cut exactly on the line.

The two pins can be filed up from a piece of brass or mild steel wire and

then soldered in securely. These pins can project on either side of the tool if desired, which allows it to be used both ways.

Fig. 2 shows the method of using the tool to find the centre of a disc. Place the tool with the two pins touching the circumference of the disc and draw a line

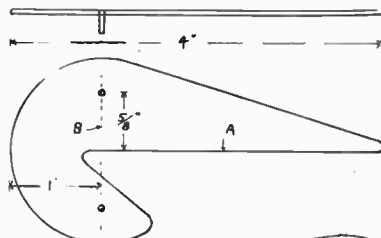

Fig. 1—A tool for finding the centre of circular articles

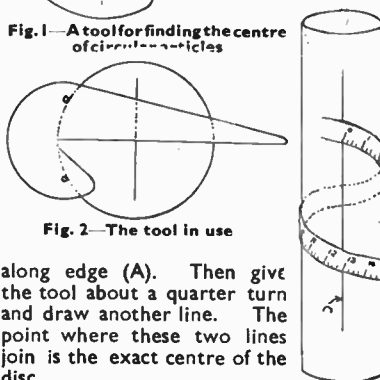

Fig. 2—The tool in use

along edge (A). Then give the tool about a quarter turn and draw another line. The point where these two lines join is the exact centre of the disc.

To test the accuracy of the tool, place it on a disc and draw a line as before. Then turn the tool over and from the same spot draw another line. If these two lines coincide, the tool is accurate, if not, slightly file part of line (A) and test again.

Besides this use, the tool may also be used as a set square for marking lines at right angles from a straight edge. The tool is not suitable for circles less than $1\frac{1}{2}$ ins. diameter. For smaller work, the measurements given can be halved or made even smaller—the distance between the two pins will determine the size of the work it will take.

Second Device

The second measuring device to be described in this article is not a tool in itself but a method of dividing a circular rod or tube into equal parts. The only pieces of apparatus needed is a tape measure—preferably a steel one.

We will assume that we have a rod with a circumference of $10\frac{3}{4}$ ins. and we want to divide it into 13 equal parts. Having spent some considerable time in working out how much each division must be, we find that we have no measure capable of doing the job. In this case the distance is slightly more than $\frac{4}{5}$ ins. and we should have to guess the exact measurement, which is not at all a satisfactory way.

There is, however, a very simple way of doing the job. First draw a line along the rod as shown at (C) in Fig. 3. Place the zero mark of the tape measure on this line, twist the tape round the rod in a spiral with the 13ins. mark on the same line but further along and make a mark at every inch.

The rod will now be divided into 13 equal parts, and the job done quicker than it has taken to describe the method here. Any size rod or tube can be divided up into any number of parts by using this method and marking off the inches or parts of an inch, whichever may be easier. (338)

Fig. 3—Dividing a circular rod into equal parts

Novel Shaving Mirror—(Continued from page 11)

Lamp Holder

The lamp holder is a 3ins. long strip of wood, 1in. wide and $\frac{3}{8}$ in. thick. In the centre of this, underneath, a groove $\frac{1}{8}$ in. deep and $\frac{1}{8}$ in. wide is cut out, and above this a $\frac{3}{8}$ in. hole is bored through the wood for the lamp. The detail sketch, Fig. 3 (B) shows this, and other details, also the wiring. In one side of the wood, in a line with the centre of the lamp hole, drive in a brass screw. Now fix the lamp holder to the back of the case, with the lamp hole opposite the circular window in the front. Push a 2.5 volt bulb in the holder, and turn the side screw until it contacts the screw portion of the bulb.

A $\frac{3}{8}$ in. strip of springy brass, about

2ins. long, is screwed at one end to the back of the case, with the remainder of the springy brass under the lamp, where it should contact the pip at the bottom. Connect this brass strip with the screw of the switch arm, by means of a short length of D.C.C. copper wire. Lengths of similar wire are connected to the side screw of the lamp and one stud contact of the switch respectively, as shown by thick black lines in Fig. 3, and is ready for a test.

About the best battery to use is one of the cycle lamp kind, these last quite a while on full current, especially as the light need not be on more than the time necessary to actually shave. The

leads from screw and stud contact are twisted round the terminals of the battery, and on moving the switch, the lamp should light up. If it does not, examine the contacts to the lamp, where the failure can be seen and put right. A simple reflector, added to the lamp, will help to make the most of the light.

This is shown at (C) and is merely the bottom of an empty tin, with a hole cut out from its centre to slip over the bulb, and two holes above and below it for screwing the reflector to the wood lamp holder. This completes the work, it only being necessary now to stain and polish the whole, and fit a wall plate to the back for suspension purposes. (453)

You can make these really SAFE HOUSEHOLD STEPS

BESIDES being light and strong, these steps are quite safe to use in the house. They cannot slip, and because of their lightness they are very useful. Added to this, they are convenient in that they can be folded and put away out of sight.

Measurements

Detailed measurements are not necessary, since the construction will be worked out step by step according to the size of the article required. The first thing to decide is the height of the platform from the ground. In the case of the diagram here (see Fig. 1), it is 3ft. Taking the average person as 5ft. 6ins., this will give a head room of 8ft. 6ins. Naturally, if the rooms are much higher than this the platform will be correspondingly higher.

The sides are cut from $\frac{1}{2}$ in. wood 3ins. wide, and the steps are housed into a depth of $\frac{1}{2}$ in. Take care when cutting these that you make a pair, with

fixing the platform. These legs, ledges and brace are all cut from $\frac{1}{2}$ in. wood, the brace and legs being screwed securely in place.

The Platform

A piece of wood 19ins. long by 13ins. wide is needed here, and this should be of $\frac{1}{2}$ in. plywood, if possible. If plywood is not available, make sure that the grain runs from the front crossbar to the ledge at the back. If the grain runs the other way it would be liable to crack under a person's weight, resulting in the complete collapse of the steps.

The stops on the platform are made from any suitable pieces of wood, planed true and screwed securely in position. The stop on the underside needs particular attention, as this prevents the steps from collapsing when in use.

Note that the sides are held together by small bolts. Washers should be added to prevent the bolt cutting into the wood.



round a $\frac{1}{4}$ in. diameter rod and riveted as shown. The exact dimensions of the hinge are not critical, and the hinge itself should be fitted after the steps are completed, in order to find the correct position.

Finish

If the steps are to be used inside, it is not essential to paint the woodwork, but the metal portions should be

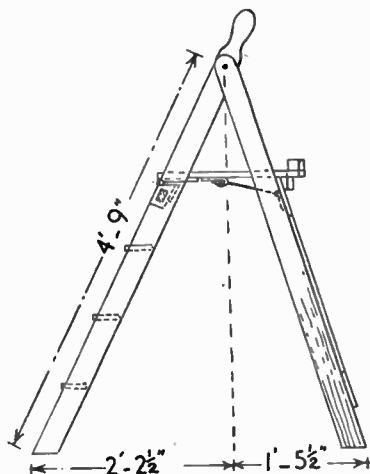

Fig. 1—The general dimensions

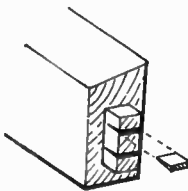
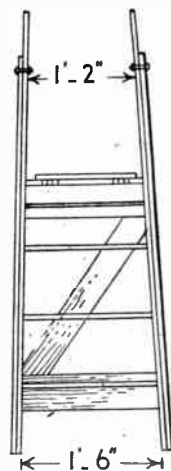

Fig. 2—Wedging the tenon

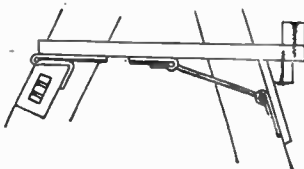

Fig. 3—The hinge arrangement

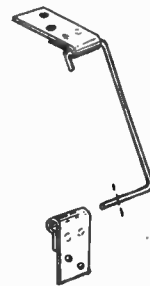

Fig. 4—The long hinge

the housings facing each other and sloping correctly. The main crossbar upon which the platform rests at the front is cut from 2ins. by 3ins. wood, and is tenoned into position as shown in Fig. 2. V-shaped slots are cut in the tenon and the wedges driven home after fixing. The wedges are smeared with glue and driven hard home with a mallet.

The back legs have two cross ledges and a brace as shown. The top ledge should be fairly deep, say, 6ins., to allow for adjustment of the long hinge when

The Hinges

A glance at Fig. 3 shows the general arrangement of the hinges. The front hinges are 'back-flap' hinges and are bent to fit round the front crossbar as shown. The hinges can be let into the crossbar if desired. The long back hinge must be made as in Fig. 4. The length of the middle portion, which is of $\frac{1}{4}$ in. diameter metal rod, should be about 6ins. Allow sufficient length for turning the ends. This measurement should be checked before the hinge is made. Two pieces of sheet metal are drilled, bent

enamelled to prevent rusting. On the other hand, two coats of good quality enamel would improve the appearance and would be easier to keep clean. (436)

FOR VIOLINISTS

To take the black stains from a violin (they are caused by resin from the bow), apply some turpentine with a soft rag. This treatment will also renew the polish.

An easy experiment with THE 'SINGING TUBES'

A PUZZLING scientific phenomenon—tubes which sing on their own—is quite easy to reproduce with the minimum of apparatus. All you require are two 6in. lengths of tube, about $\frac{3}{4}$ in to 1in. in diameter, one tube of lead and the other of brass. Flatten the lead tube slightly so that it will rest on a flat surface without rolling, and clean it well. The brass tubing should have a relatively thin wall, and one end can be flattened slightly, so that when rested on the lead tube, as shown in the sketch, it will not roll off.

reasonably hot—not red heat—simply lay it in the position shown, with one end resting on top of the lead tube and

the other on the flat surface, and leave to cool.

Musical Note

As the brass tube cools down, it will commence to give out a musical note, shrill or deep, depending on the quality of the tubing and the thickness of its walls. It will continue to 'sing' for quite a long time, with no apparent cause.

Overcoming Reluctance

If, in duplicating the experiment, you find that the tube is reluctant to sing, give the surface a smart tap with the hand. This will seldom fail to start the necessary vibration which will continue as before. Normally, however, this action will start on its own. (486)

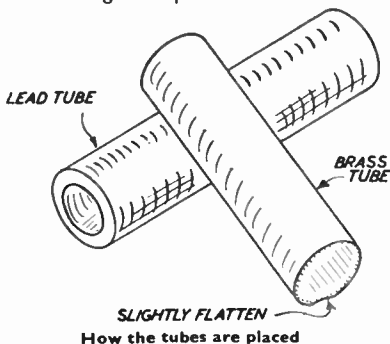

Heat over Gas

Hold the brass tube in a pair of pliers and heat it up over a gas flame. When

Absolutely Free

to all genuine collectors. Complete Set of 5 beautiful old Mint Russian stamps 1919. Send 2½d. Stamp for postage, and request my amazing discount approvals and Price List to:

M. D. CLINTON, 18 Leigh Road, WORTHING



TURN YOUR SPARE-TIME INTO CASH

Men and women wanted to make Bennett Model Bungalows at Home
Fascinating, simple, well paid work

No selling involved.

Send stamped addressed envelope for full details.

BENNETT MODELS, Duncan Road, Richmond, Surrey

ENJOY MAKING
PLASTER FIGURES
WITH
FLEXIMOULD



No experience is required to cast religious figures, wall plaques, ash trays, garden ornaments, candlesticks, book-ends, vases, coats-of-arms, articles for window display, cake decorations, cameos and animals, etc. Make a profitable business with this pastime.

Write today for free details of
'FLEXIMOULD' to
DOHM LTD. (DEPT. H)
167 VICTORIA ST., LONDON, S.W.1

PUPPETS
Kits of parts to make two Fully Jointed 12 inch puppets with controls.



15/6 post free
Send stamped addressed envelope for illustrated list of complete puppets and books

ZIMPLAN



PEDAL MOTOR CAR
Any amateur can make this strong smart modern pedal car for children 2 to 5. Plan and instructions with list of available metal parts

2/6 post free

**88 WARE ROAD
HODDESDON, HERTS**

Tommy Trump says :-

No increase in price of

DOUBLE ACE

10 for 1'3½

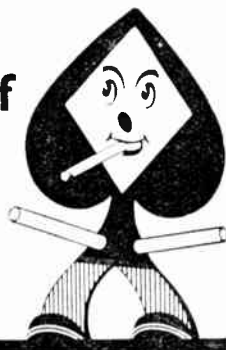

TOOLS FOR THE HANDYMAN



TOOL CLIP

For holding any handled tool. Spring steel. Holed for hanging.

7d. each

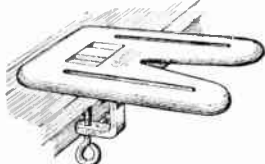

STEEL CUTTING TABLE

With clamp for easy fixing to bench. 6ins. by 4ins., strong and light. 3/-

BENCH STOP

3½ins. by 2ins. — Spring loaded top. 6/-



SINGLE HANDED SCREWDRIVER

5ins. long. Ideal for small work. 1/8



MODEL MAKER'S BENCH VICE

Strong, light and rigid, 2in. opening. 6/3

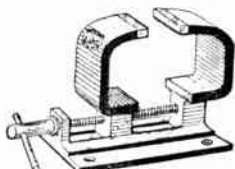

Obtainable from Hobbies Branches in London, Glasgow, Manchester, Birmingham, Leeds, Sheffield, Hull, Southampton, Bristol and Ironmongers everywhere. Or post free from Dept. 99, Hobbies Ltd., Dereham, Norfolk.



FRETWORK HAMMER

8ins. long. Strong and light for small work. 1/4

YOU CAN BECOME A HANDICRAFTS INSTRUCTOR

EXPERIENCE NOT ESSENTIAL

Men who enjoy making things in wood or metal can turn their hobby into a permanent and interesting Career. Short hours, long holidays and security in a job you would really enjoy, can be yours if you become a Handicrafts Instructor. Let us send details of the easiest and quickest way to get the necessary qualification.

We guarantee "NO PASS—NO FEE"

If you would like to know about our unique method of preparing you for one of these appointments, write today and we will send you our informative 144 page Handbook—free and without obligation. Mark your letters "Handicrafts Instructor".

BRITISH INSTITUTE OF ENGINEERING TECHNOLOGY

BIET

595 Shakespeare House
Stratford Place, London, W.1

SHIPS
GALLEONS
LOCOS
ARCHITECTURAL
SUBJECTS
ENGINEERING
MOVING
TOYS
ETC.

Micromodels

TRADE MARK

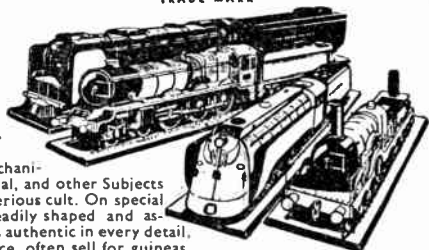

Building Micro-model replicas of beautiful Mechanical, Architectural, and other Subjects has become a serious cult. On special cards, units readily shaped and assembled models authentic in every detail. Cost a few pence, often sell for guineas. Send stamp for illustrated Descriptive Catalogue.

MICROMODELS LTD., 6 (H) Racquet Court, London, E.C.

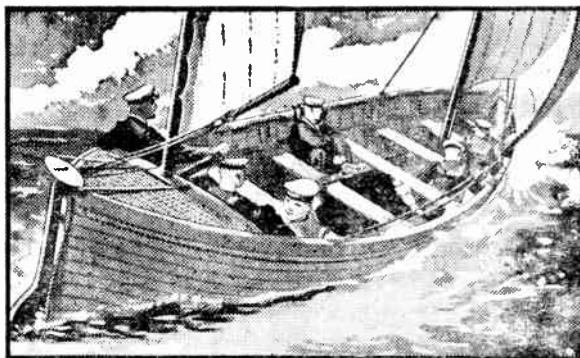

The Navy's at home at sea!

"You've got to be nippy on your sea legs and handy with your hands when you're a sailor in the Navy. We're learning all about it here and boy, it's exciting! Our instructor's son is a Seaman Boy in the "Illustrious". He says it's grand in a carrier. I'll be off to sea myself soon now... the Navy's the life all right!"

BOYS AGED 15-16 years 3 months can enter the Seaman Branch of the Royal Navy now. Pay in the Navy is good... with cash grants and improved pensions on retirement.

You'll be better off in the ROYAL NAVY

FREE BOOK: Post this coupon today to D.N.R., Dept. BB/37, Admiralty, London, S.W.1.
(Applications from U.K. only.)

Name

Address

Age

1,000 STAMPS—5/-

'ALL OFF PAPER'

Genuine Collectors Duplicates. No G.B. My 'E1000' catalogue, perforation gauge and GIFT COUPON given ABSOLUTELY FREE with each order. Every stamp covered by my unconditional money-back guarantee.

Send 5/- to

AUBREY SELBY, 66 Donnington Road, London, N.W.10



THE BOLSTER HOME WATCH AND CLOCK REPAIR OUTFIT

These precision jewellers' instruments include watchmaker's magnifying eyeglass, finest watch tweezers, set watchmaker's screwdrivers, watch and clock oil, oilers, dusting powder, clock brush, plus illustrated instructional manual for the amateur. In container 12/6 post free.

Senior Outfit includes everything above, plus watch jewels luminous compounds, dial renewer, jewellers rouge, explanatory book. Price 21/- post free.

BOLSTER INSTRUMENT Co. (Dept. H. W.), 5a Station Parade, Ashford, Middx.



BRANCHES

LONDON
78a New Oxford St., W.C.1
(Phone MUSEUM 2975)

87 Old Broad Street, E.C.2
(LONDON Wall 4375)

117 Walworth Road, S.E.17
(RODney 5509)

GLASGOW
326 Argyle Street
(Phone CENTral 5042)

MANCHESTER
10 Piccadilly
(Phone CENTral 1787)

BIRMINGHAM
14 Bull Ring

SHEFFIELD
4 St. Paul's Parade
(Phone 26071)

LEEDS
10 Queen Victoria Street
(Phone 28639)

HULL
10 Paragon Square

SOUTHAMPTON
25 Bernard Street

BRISTOL
30 Narrow Wine Street
(Phone 23744)

Head Office & Factories—HOBBIES LTD., DEREHAM, NORFOLK

'00' GAUGE 'LINESIDE' KITS REALISM FOR RAILWAY MODELLERS

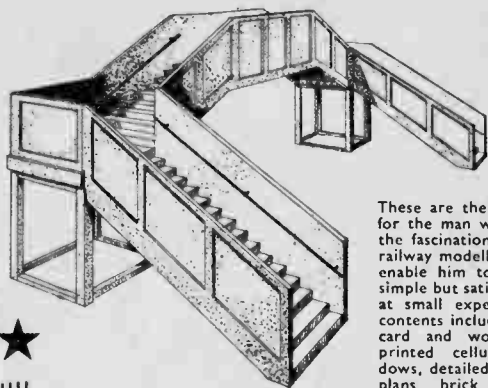

LARGE SIGNAL CABIN ... 3/8
WATER TOWERS (2 types in 1 kit) ... 2/9
COUNTRY STATION ... 5/6
PLATFORMS ... 3/8
FOOTBRIDGE ... 2/9
Postage: Single kit 6d. (two or more 10d.)

These are the ideal kits for the man who enjoys the fascination of scenic railway modelling. They enable him to start on simple but satisfying jobs at small expense. Kit contents include printed card and wood parts, printed celluloid windows, detailed authentic plans, brick and tile building papers.

THE FULL MODELCAST LIST FOR 1951 details more than 600 plans, planbooks, kits and accessories covering every aspect of the modelmaker's art, ships, aircraft, road vehicles, houses, etc. It costs 1/- post free and includes a 1/- refund voucher for use in buying Modelcraft goods.

MODELCAST

77 (F), GROSVENOR ROAD, LONDON, S.W.1

'KARLENITE'

PLASTIC MARBLE

The entirely new Art Stone for casting Bookends, Ashtrays, Wall Vases, Statuettes, etc. 'KARLENITE' sets granite-hard with scintillating crystalline structure which very closely resembles marble or alabaster. It is enormously strong, highly resistant to heat, and impervious to water. Literally any type of natural 'veining' can be simulated in any colour and a wide range of pigments is available for this purpose.

MAKE YOUR OWN FLEXIBLE MOULDS

with 'Elastomould' Synthetic Rubber Solution. By means of this simple technique, you can easily prepare permanent elastic moulds for repetition casting, plaques, bookends, etc., in quantities of thousands.

'Elastomould' will faithfully reproduce even the most minute details of ornamentation and surface texture.

It is incredibly simple to use, and moulds can be prepared from any type of pattern including Wood, Metal, Plaster, Stone, Glass, Ivory, etc.

Such moulds are ideally suitable for casting in Plaster, Cement and 'Karlenite'.

Start your Own Business. Send 1s. for full details of this easy, fascinating and profitable hobby.

MONEY REFUNDED TO BONA FIDE ENQUIRERS

Dept. H.3, Karlena Art Stone Company, Ltd.,
55 Deansgate Arcade, Deansgate, Manchester, 3.

EXTRA CASH IN SPARE TIME

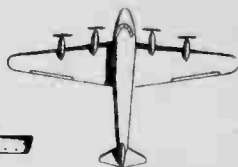
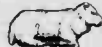

A fascinating way of earning extra cash in spare time from odd pieces of lead Small Outlay—Large Profits. Sample mould 3/6d. Casting moulds, deep-cut and ordinary type Aeroplanes, Soldiers, Farm and Wild Animals, Cars, etc. Stamped envelope for full list Illustrated Catalogue 9d.

MASTERCRAFT MOULDS
69, ST. MARKS ROAD, HANWELL, LONDON, W 7

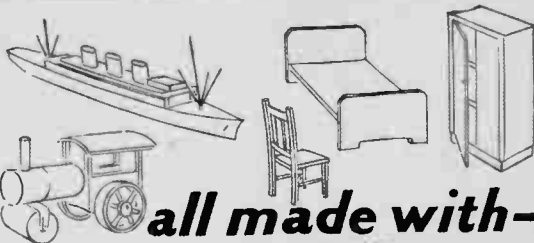

all made with-



Croid

THE MODERN GLUE

Aero Glue. The strongest glue in the world.

Universal Glue. Cold glue ready for use from tube or tin.

Waterproof Cement. Specially prepared for balsa wood.

Whyte Paste. For paper work and photo-mounting, etc.

CROID LTD.,
IMPERIAL HOUSE,
KINGSWAY, LONDON, W.C.2

Hobbies

WEEKLY

CONTENTS

	Page
Smoker's Cabinet and Stand -	17
Folding Workbox -	19
Metal Etching and Engraving	20
Those Puzzling Speakers	21
Replies of Interest -	22
The Craft of Knotting -	23
For a Tropical Aquarium	24
Showcase for a Model Galleon -	25
Money for Club Funds	26
Collecting Stamps -	27
'Doggy' String Holder -	28

October 10th, 1951

Price Fourpence

Vol. 113 No. 2919

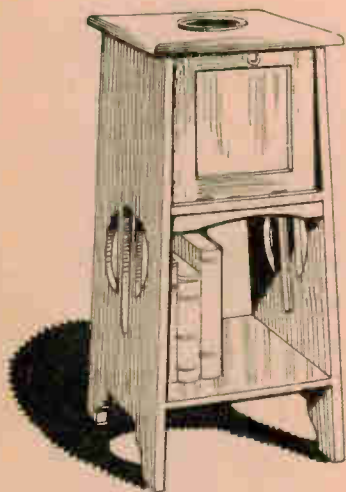

THIS article is just the thing for the amateur home carpenter to make.

As can be seen from the illustration of the finished article, the stand is extremely simple in form, yet it does not lack a certain amount of character. Such a stand could be quickly made and give pleasure to any smoker.

Easily Finished

It could be made entirely from $\frac{1}{2}$ in. wood and if some oak could be obtained or even mahogany, either variety of wood would be easily finished with oil or stain and varnish or polish.

Oak again, lends itself to a finish of light stain and a rubbing of linseed oil or wax polish. Mahogany, of course, calls for french polish, and as all surfaces of the stand are plain and easily workable, this

For the Male - a SMOKER'S CABINET AND STAND

finish should be carried out in the orthodox manner with the polishing bob.

Two sides are first prepared and cut to the measurements given in Fig. 1. It will be seen from the front view (Fig. 2) that the sides stand parallel with each other and are held by two shelves which are housed into the sides, as shown in Fig. 3. Mark off on the sides the distances of 4 ins. from the bottom edge of the sides, then $\frac{1}{2}$ in. and finally 12 ins. and another $\frac{1}{2}$ in. The grooves which form the recesses may be cut across $\frac{1}{4}$ in. deep with the tenon saw, the waste wood being cleaned out with a narrow chisel.

Cut Grooves Carefully

As seen from Fig. 3, the grooves or recesses are stopped off about $\frac{3}{4}$ in. from the front edge of the sides, and therefore must be cut down carefully before the tenon saw is used. The middle portions of the sides are decorated by making three simple shaped frets, the measurements for these being given in Fig. 1. This fretted design would be best done on paper. When the outline is complete, transfer it to the wood by means of carbon paper and a hard well-pointed pencil.

When cutting the panel, use a fairly coarse saw and then clean up the edges afterwards with coarse and fine glasspaper. The inside edges of the cut frets must be carefully covered with either varnish or polish in several coats with a small brush. The lower edges of the sides have openings cut out as seen in Fig. 1. Measurements are added for draughting the outline, which is cut round with a coarse fretsaw, and afterwards cleaned up with glasspaper.

Two shelves will be wanted, the lower one being $7\frac{1}{4}$ ins. by $9\frac{1}{4}$ ins. The former measurement allows for each end to enter the end recesses $\frac{1}{4}$ in. as mentioned previously. Note that it would be advisable to cut, glue and screw the lower shelf in place between the sides before the upper one is handled. Like this, the exact length of the upper shelf can be checked for length direct before it is cut and prepared for gluing. The sawn edges of the shelves must be made smooth to nicely fit the grooves.

Dowels or Screws

Glue the shelves in place, but because of the end grain, the glue will have no great holding power, and therefore

All correspondence should be addressed to The Editor, Hobbies Weekly, Dereham, Norfolk.

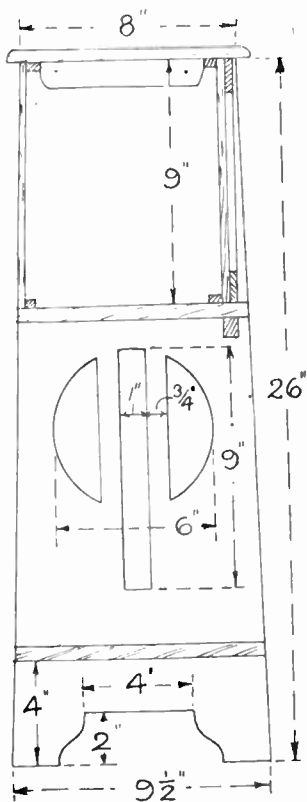

Fig. 1 Side view with dimensions

some glued dowel pins or even screws should be run through the sides into the shelf ends. Hardwood pins make the strongest joint and look quite neat after the projecting ends have been cut and glasspapered level with the surface of the sides. A small shaped rail 1 in. deep and 1/2 in. thick is glued and screwed beneath the upper shelf, as seen in Fig. 2.

The top of the stand is a plain piece of wood measuring 9 3/4 ins. by 8 ins. with its corners slightly rounded off and made smooth. The top edges all round, too, might be shaped and rounded as shown. A chromium-plated or oxidised copper ash tray could be sunk into the top of the stand, as desired, a hole being cut to the required diameter with the fretsaw before it is fixed.

In Fig. 4 is shown how the top is

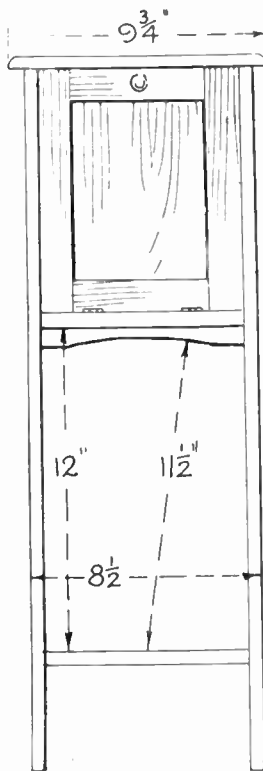

Fig. 2 Front view

firmly fixed to the sides. Screws through the top into the end grain of the sides would not form a good fixing, so two fillets of wood about 1 in. by 1/2 in. in section should be glued and screwed along inside, and the top then glued and screwed to this.

The back of the cabinet may consist of plywood or fibreboard cut to carefully measured sizes. Fixing fillets about 1/2 in. by 1/2 in. in section are nailed along the top of the shelf and underneath the top, as seen in Fig. 1. Similar fillets are fixed at the front of the cabinet against which the door will close. Measurements for the positions of these latter fillets are best taken when the door has been made. The shelf fillet for the door should be fixed 1 in. back from the front edge of the shelf.

The door is a simple piece of work, and

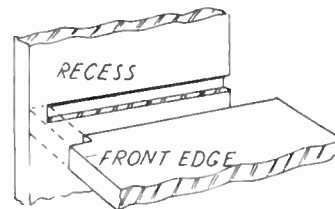

Fig. 3—How the shelves are housed

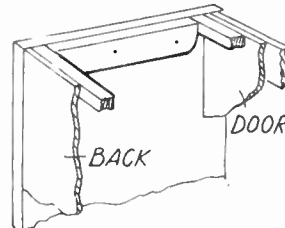

Fig. 4—Showing the positioning of the fillets

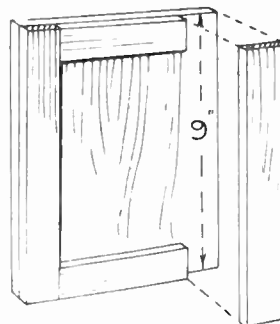

Fig. 5—Details of the door

consists of a square of wood measuring about 9 ins. by 7 1/2 ins. by 1/2 in. thick, with four rails glued and screwed on.

To ensure a good fit, the opening for the door should be checked direct from the work, and the panel cut to go into it. The rails are 1 1/2 ins. wide by 1/2 in. thick, and it should be noted that the upright members run right up the height of the door, while the cross rails go in between them. The recesses for the 1/2 in. hinges should be cut deep enough to take both flaps, as seen in Fig. 2. A simple turned wood knob may be fixed to the door, or a flat shaped handle, cut from spare 1/2 in. wood, can be glued and screwed on.

(471)

Folding Workbox—(Continued from page 19)

Some little care must be exercised in the placing of the strips on the box and the trays. First, taking in hand the trays, run a line in pencil centrally—that is, 1/2 in. up from the bottom line along the sides (see dotted line in Fig. 1). Then set out 1 in. and 2 ins. from the inner upright edges of the tray as shown, and prick in holes in the wood at these points. Next deal with the box. Set down 3 ins. from

the top edge and draw a line extending to the edge. Then, from the latter, set in again the 1 in. and 2 ins. distances on this line and prick in again on the line. Thus the positions for all the screws should have been accurately marked.

It would be advisable to make a trial with, say, a pair of the strips at first before actually driving home the screws, to make quite certain that the trays meet

evenly and correctly centred with the box top edge. When all is well, run in the round-head screws, putting thin brass washers between the strips and the sides of the box and the trays.

Cut four feet for the box from 3/4 in. or 1 in. wood, and glue and pin them strongly, allowing two of their edges to project slightly for good effect. Stain or paint the box as desired.

(427)

Both novel and useful— FOLDING WORKBOX

THIS is a workbox which is both novel and useful. There is a good sized box, and hinged to the top of this are two shallow trays for reels of cotton, silk, threads, and the many little gadgets which go to make up the kit of the busy housewife. Such an article would make an ideal Christmas or birthday gift.

The front view of the box is given in Fig. 1, and shows the top compartments or trays closed over the top of the box, while the dotted lines on the right give an idea of how that compartment will appear when thrown back. It will be seen that when both trays are thrown back, ample room is given for access to the large compartment below.

The system of hinging the trays to the

ends (C), all of $\frac{3}{8}$ in. wood. To make a really satisfactory and strong job the corners of the box should be pin-jointed together as shown, and glued with angle fillets such as (D) put along on the floor and ends to hold the floor firmly in place.

The floor fits between the sides and the ends as seen in the sectional diagram Fig. 2. Where a floor fits into a frame as in this case, it is always better to mark out the outline of the floor direct from the frame, which ensures a perfect fit. It would not do to cut the floor first and, having knocked the pin-jointed frame together, expect anything of a good fit.

It will, however, be very necessary to check the inside angles of the frame for squareness with the tri-square or a set-square after gluing the parts together. If the worker should not use the pin-joint

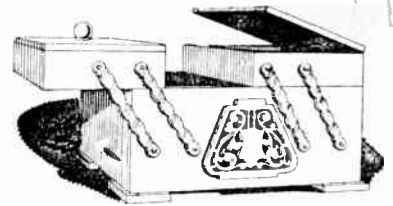

shaped flat piece could be glued on each lid.

Shallow recesses are cut to receive the hinges as seen in the detail. These may be cut down with the fretsaw to the depth of the two flaps of the hinges and then cleaned out with a sharp pocket knife or chisel. Two pairs of stout 1 in. brass hinges should be obtained for the job.

The trays are attached to the box by four pairs of bars made from stout brass and put on with roundhead brass screws. The outline of one of the bars is given in Fig. 3 and from this an enlargement can be made on paper, carefully following the

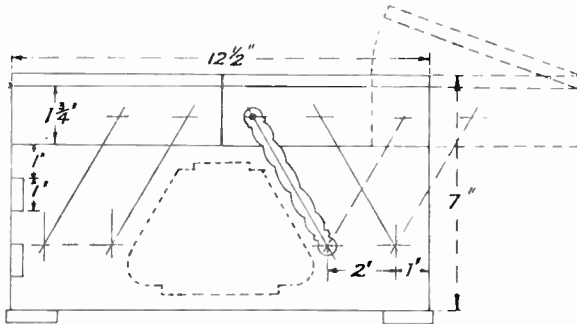

Fig. 1—Side view, giving dimensions

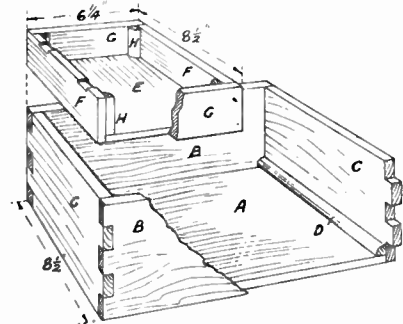

Fig. 2—A cut-away drawing showing construction

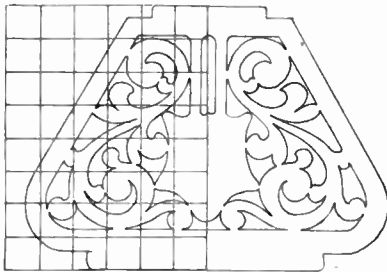

Fig. 3—Patterns for the arms and overlays

lower box is interesting, and works on the old principle of the parallel rules used in the drawing out of a number of straight and parallel lines on paper.

Box Sizes

The box measures $12\frac{1}{2}$ ins. long, $8\frac{1}{2}$ ins. wide and 5 ins. high. It consists of a floor (A) (Fig. 2), two sides (B), and two

method for the angles of the box, but simply butt and glue them together, then the joints and angles must be strengthened by the addition of angle fillets wherever possible.

Tray Construction

The construction of the trays is shown again in Fig. 2 and the sizes of the rails (F) and (G) which are all $1\frac{1}{4}$ ins. wide are given in this diagram, the rails (F) going in between the rails (G) will be 8 ins. long, as all the wood for the trays is $\frac{3}{8}$ in. thick. Here again, the floor (E) goes in between the rails (F) and (G), and is held by the angle fillets (H).

The lids for the trays are cut to the exact outline of the frame and cleaned down evenly all round. They consist of a single piece of wood, and if they require stiffening at all to hold them from warping, then a narrow rail could be glued across each and screwed. The piece, of course, should run at right-angles to the grain of the wood. The handle on the lids may consist of just a turned knob glued into the top, or a

squares, which measure 1 in. by $\frac{1}{2}$ in. Above this diagram of the bar is given the outline of a suggested overlay which may be cut in duplicate and glued to the sides as shown in the sketch and to the dotted lines in Fig. 1.

The enlarging of the overlay design can be done by drawing a number of $\frac{1}{2}$ in. squares full size on a piece of paper and then following the scroll work on the one half from the illustration given. When the one half is finished, this may be traced off and reversed to give the completed design shape. The pattern can then be pasted to the wood and cut out with the fretsaw in the usual way.

A sheet of stout brass large enough to take the eight strips should be obtained and the paper pattern gummed down to it. When the one strip has been cut and cleaned with the file, and the two holes drilled, this may be drawn round as a template for getting the other seven strips. Metal cutting saws should, of course, be used for cutting the brass.

(Continued foot of page 18)

Using Nitric Acid for METAL ETCHING AND ENGRAVING

THE appearance of many plain brass or copper ornaments can often be improved by careful etching or engraving. Unless, however, one has considerable use for it, an electric engraver does not justify the outlay involved.

Acid etching is a perfectly satisfactory alternative, and while not so quick or deep in line as the electric engraver, it is in some respects superior, giving much finer and clearer detail.

If one closely examines some engraved work, it will be seen that the lines consist of many small indentations. Acid etching, however, gives clean cut lines entirely devoid of any roughness.

Interesting Process

Acid etching is an extremely interesting and simple process, and is well within the capabilities of the average handyman. The process is as follows: The metal to be etched is covered with an acid resistant coating of wax which is technically termed 'ground'. A suitable design is then scribed through the wax with a sharp instrument, and the metal is then immersed in a corrosive acid solution, or the acid applied locally with a feather.

After a sufficient length of time, the metal is washed free of acid, and the wax 'ground' removed, revealing the etched or engraved design.

To prepare the wax 'ground' three parts of yellow beeswax are melted together with one part of pitch and one part of lampblack, and afterwards poured into a suitable mould to harden.

The most suitable way to melt the ingredients is in a receptacle placed in boiling water. The constituents should be broken into small pieces, and, when melted, thoroughly stirred to obtain a uniform mixture.

The mould can consist of an empty shoe or wax polish tin, with a disc of paper in the bottom to prevent any sticking. When the mixture has hardened in the tin, it can be easily removed by running a thin bladed knife around the sides of the tin, after which a sharp tap or two should remove the contents.

The brass or copper article which is to be etched, is thoroughly cleaned of any surface grease with ammonia. It is then gently heated over a low gas jet or bunsen burner, and, when sufficiently warm, the 'ground' is applied by rubbing over the surface. The melted wax will flow smoothly and evenly over the surface of the work. If it does not, slightly increase the heat until the wax flows easily.

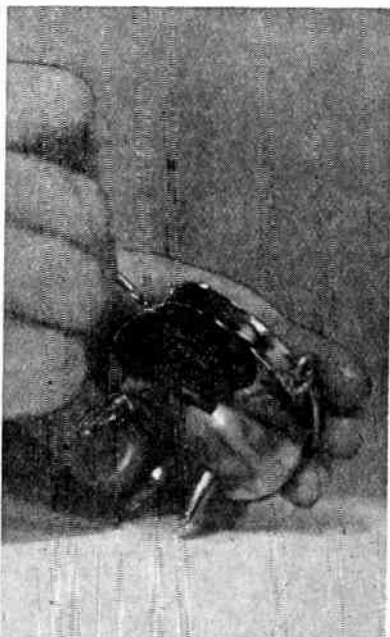

A picture showing the design being scribed on the wax 'ground'

With small objects of an uncomplicated design, it is better to stand them completely in the acid bath, and in this instance, it is, of course, necessary to apply the 'ground' over the entire object.

With larger articles, it may be rather difficult to immerse in the acid bath, and local application may be necessary. In this case, the 'ground' need only be applied in the immediate vicinity of the etching.

When the 'ground' has been satisfactorily applied, the work is placed on one side to cool and harden. Then it is ready for the design.

The design is made by scribing through the 'ground' to the metal underneath with a sharp instrument such as a pointed knitting-needle. For fine and delicate lines, a sharp point is required, while a comparatively blunt point will produce thick lines.

When the design has been completed, it is ready for the etching bath.

The bath is prepared by mixing to the proportion of one fluid ounce of nitric acid with four of water. *The acid should be added to the water, not vice versa and it should be added gradually, to avoid splashing.*

Before proceeding any further, a word of caution is necessary. Nitric acid is

extremely corrosive and will destroy practically everything it comes into contact with. When mixing or working with the acid, always wear rubber surgical gloves. Only purchase sufficient acid for the job in hand, and when used, immediately dispose of it in a hole dug in the garden well away from any flowers or vegetation, and at once replace the earth.

The receptacle for the acid bath should, of course, be of material unaffected by the acid. A glass ovenware dish is suitable for the purpose, as are also porcelain photographic dishes.

Etching Time

The diluted acid solution is poured carefully into the receptacle and the article either placed in the bath or the acid spread over it with a feather. The amount of time to complete the etching will, of course, depend upon the desired depth. As a guide, five to ten minutes' application should be sufficient for average requirements.

During the actual etching process, small bubbles will be seen forming along the lines. These should be gently removed with a feather, as their presence prevents the full and efficient action of the acid upon the metal.

When the etching is completed, the article is immersed for a short while in a strong soda or ammonia solution to neutralise the acid. It is then placed in boiling water to remove the 'ground' and dried upon a piece of soft cloth.

Finishing

Black or coloured cellulose enamel is then quickly applied over the etchings, and immediately removed from the surface with a piece of non-fluffy cloth. The enamel will, of course, remain in the etchings, and so bring them into sharp relief. When the enamel is thoroughly dry, the article is well polished, and a clear lacquer applied to prevent subsequent tarnishing.

Suitable lacquer may be obtained from hardware stores etc., or may be made by dissolving 2ozs. of bleached or pale shellac in 4 fluid ounces of methylated spirit.

The lacquer is applied very quickly with a soft brush, and the article placed in a warm, draught-free room to dry and harden.

(456)

Designs are given free with every other issue of Hobbies Weekly, but not with back numbers.

Our radio expert deals with THOSE PUZZLING SPEAKERS

It is clear that quite a number of radio constructors are in doubt about the various types of loud-speaker which are available, and which should be used for any particular purpose. As a result, they may not succeed in obtaining proper results. Actually, however, no particular difficulty need arise, provided a few facts are kept in mind.

Moving Coil Speakers

These are most frequently used, and a typical model, with its transformer, is shown in Fig. 1. The metal frame supports the cone, and a powerful permanent magnet. The small coil (from which the speaker receives its name) is attached to the cone, and moves in a

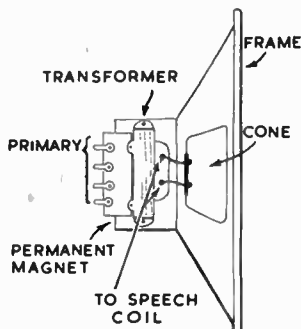

Fig. 1—The popular moving coil speaker

is suitable), with a hole of appropriate diameter. The speaker is secured to the board by bolts or wood-screws passed through the holes in the frame rim. Normally, a cabinet is used, but the baffle-board arrangement is particularly suitable for extension speakers, when the board can be hung from the picture-rail, in a corner of the room, or otherwise positioned as convenient.

If the speaker is used without any kind of cabinet or baffle volume will be reduced, and the lower frequencies, in particular, will almost disappear.

Gauze or other thin material is usually placed over the back of the speaker cut-out, before securing the speaker in place, in order to improve appearances and exclude dust, etc.

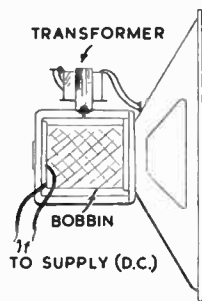

Fig. 2—The mains energised type

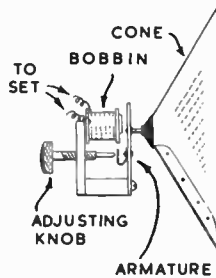

Fig. 3—A moving iron cone speaker

Energised Speakers

These are the same as those already described, except that there is no permanent magnet. Instead, a large bobbin, shown in Fig. 2, magnetises the core. A direct current needs to be passed through the bobbin winding during the whole of the time that the speaker is functioning. Such speakers are not suitable for battery sets, but are found in some mains receivers, where ample current is available. Usually, the bobbin resistance is 2,000 to 3,000 ohms or so, and the leads from it are taken to H.T. negative and H.T. positive in the set, at the rectifier. Some speakers have a bobbin of lower resistance, and this is intended to be wired in series with one H.T. supply lead.

If, by hand, such a speaker can be used in a mains set or amplifier. But if a speaker is to be bought, the permanent magnet type is normally best, as it is simpler to use.

Moving Iron Types

The moving iron cone speaker largely used years ago is still found in some sets,

and though actual details vary, it is normally similar to that shown in Fig. 3. Here, the bobbin winding is connected straight to the receiver. Currents fluctuate in it according to the programme, thus making the armature and cone vibrate.

The adjusting screw enables the armature to be set as near to the bobbin pole as possible, as volume is then at its greatest. The cone is usually detachable from the projection to which it is screwed, and is sometimes turned completely round so that the speaker unit lies within it. The adjusting knob will then be found in the centre of the speaker fret cut-out, instead of at the back. If recessed and slotted, it can be adjusted with a screwdriver or coin. It

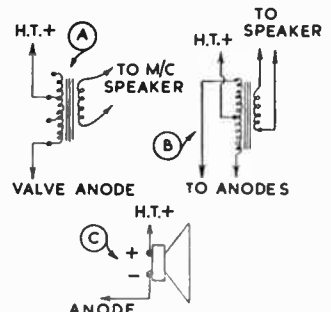

Fig. 4—High impedance speaker connections

small circular gap in the magnet. Two flexible leads come from the coil to tags, which are wired to the secondary of the transformer.

The primary of the transformer will have several tapings, usually brought out to tags, except in the cheaper type, where two leads only may be found. (Which means that different ratios cannot be selected, as when three or more tags or leads are present.)

The speaker is manufactured in various sizes from 2½ ins. to 12 ins. and more, this measurement referring to the approximate diameter of the cone. Average sets use a 6 or 7 in. speaker. Larger speakers will be found in the more powerful receivers, in radiograms, and so on, while smaller speakers will be used in portables and other sets where space is important. The larger speakers are more expensive, but give slightly better results.

Speaker Mounting

For proper results, the speaker must be mounted in a cabinet, or secured to a fairly large baffle-board. The latter consists of a simple flat board (plywood

only needs re-adjustment at long intervals.

Such speakers should also be mounted in a cabinet, and give good results with small battery-operated sets. On very loud signals the armature tends to rattle against the bobbin pole.

While dealing with the old type speakers, it should be noted that some of the very old horn speakers, still occasionally seen in second-hand shops, can give quite good results, with small sets. As with the type just mentioned, they are wired directly to the receiver.

Transformer Connections

A proper speaker-matching transformer must be used between the output anode circuit in the receiver and any type of moving-coil speaker. In Figs. 1 and 2 the transformer is shown attached to the speaker itself; sometimes it is enclosed in a casing which also serves as a stand for the speaker.

Moving-coil speakers are often sold without transformer, in which case the transformer must be purchased separately. It is essential that the transformer

secondary be of the same impedance as the speaker speech-coil (usually 2-3 ohms, though some 15 ohm models exist). Because of this, it is best to buy speaker and transformer together.

The primary of the transformer should be suitable for the type of output valve. If it is not, volume and reproduction will not be at their best. If the primary has several tappings, as at (A) in Fig. 4, it is merely necessary to select those tappings which give best results.

If no tappings are present, the transformer is designed for use with one type of output valve only. They are designed for three categories of output valve: (1) Battery pentode; (2) Battery triode and mains pentode; (3) Mains triode. The constructor should assure he obtains the correct type. A tapped transformer is only slightly more expensive, and will be useful if other types of receiver are eventually built.

With push-pull circuits there are two output valves. Here, a centre-tapped transformer of appropriate type is wired as in (B), Fig. 4. The centre-tapping must go to the H.T. positive, with equal ratios each side to the valve anodes.

(C) shows the moving-iron and horn speakers, demonstrating that no transformer is used. They are wired directly

to the set, the polarity marked being followed. (No polarity is observed with moving-coil speakers.)

'Extension' Connections

The moving-coil speaker without transformer can be used for extension purposes, because a transformer will already be present in the receiver. This transformer will feed the speaker in the receiver, and can also operate the extension speaker, if wired up as shown. (If the transformer is actually mounted on the speaker, the connections will be

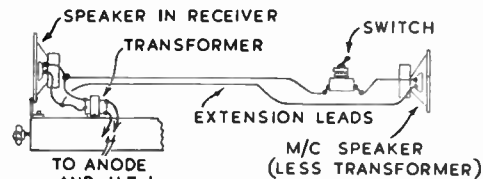

Fig. 5—Low impedance 'extension' connections

the same.) The switch is suggested so that the extension speaker can be silenced, when not required.

This circuit can usually be fixed up without difficulty, so that an extension speaker can be used, even if no proper extension speaker sockets were fitted by

the manufacturer. It can, of course, also be used with home-constructed sets. Fairly stout wire should be used for the extension leads.

The Type to Buy

A moving-coil one is best. Its size will depend upon the type of set, being smaller for portables than for large sets. Energised speakers can only be used with mains sets; they are a little cheaper, for a comparable type, than the permanent magnet speakers, but *must* be energised with a correct direct-current voltage, which limits their usefulness.

For average, all-round purposes, a 5 or 6 in. speaker is useful, especially if it has a multi-ratio transformer. If the constructor only intends to make up one set, or will use only one type of output valve in all his sets, a single-ratio transformer is equally good.

Prices depend largely on size, being from 9/- for a 3½ in. speaker upwards. Single-ratio transformers cost from 2/6 upwards, multi-ratio ones being somewhat more. If not misused, both speaker and transformer can have many, many years of useful life. (446)



Hanging Lincrusta Paper

PLEASE tell me the correct way to hang lincrusta paper. (F.P.—Portsmouth).

FOR hanging lincrusta you will need a special paste, which can be bought at most oilshops or hardware stores. If you wish to make up a paste yourself, melt in a water vessel 1lb. Scotch glue; make a paste of 4lb. flour in the usual way and add the hot glue to it. Size the wall before starting. Trim the lincrusta to size with a sharp knife, paste both lincrusta and wall, and hang it immediately after pasting. Plan the job to have as few joints as possible. For instance, you may be able to lay it in horizontal strips instead of vertical ones. In either case, see the joints butt close together.

* * *

Eliminator Needed

I HAVE an Ultra Battery Superhet receiver and would like to convert it into an A.C. mains amplifier. If it is possible to do this, will you please tell me how? (P.M.—Limerick).

AS the valves and other components will not be suitable for mains operation, the only feasible solution is to retain the battery receiver in its present form, but to use an eliminator to obtain current from the mains. If you have D.C. mains, the latter would prove a fairly easy solution.

* * *

Trouble with Plaster

I AM trying to make plaster novelties out of gelatine moulds, but find the plaster generates heat and spoils the face of the mould. It seems some other substance is needed to mix with the gelatine. Could you please tell me what the correct mixture is? Also I would like to make these novelties from something like the plastic marble that is about now. Is it possible to add some substance to plaster of paris to get this effect, if not, could you tell me where I could obtain quantities of the plastic marble? (P.F.—Newcastle).

IT would appear that the excessive heating you mention, is due to low-grade plaster containing some unslaked

or insufficiently slaked lime. We suggest you try again, using superfine dental plaster of paris. Ordinary plaster as prepared for building purposes is not completely suitable for small plaster novelties—a superfine plaster is highly desirable. We do not know of anything you can add to gelatine to make it heat resisting, but you can use rubber or a plastic made by Virnyl Products Ltd., of Mitcham, Surrey. Variegated colours or a marble effect can be obtained by staining the plaster in a base colour—for example—pink, by adding sufficient water soluble stain to the plaster, then drop quantities of other colours in patches into the plaster, then pour into the mould as usual. The effect is quite good because the various blobs of colour become striated as the plaster flows into the mould, and give a very pretty effect.

* * *

Pocket Crystal Set

REGARDING the article on a Pocket Crystal Set, would you inform me whether the permanent type crystal would be as satisfactory as the one specified? (S.W.—Bristol).

A PERMANENT type crystal detector of good quality would give the same results as the adjustable kind, and may be wired in in the latter's place. If you intend to use the small crystal-diode type with metal ends, do not solder to this, as the heating causes deterioration of efficiency; bare wires may be twisted on the ends, or small clips fashioned.

Hints and tips on THE CRAFT OF KNOTTING

THE ancient craft of knotting is undergoing a revival, as well it might. Suitable materials are reasonably cheap and easily obtainable, and the necessary skill can be acquired in a very short time.

The first knot to be mastered is known as the square knot. This is described below in the making of a bracelet, and can be used by itself to turn out a variety of attractive and useful articles.

The reader will find it easiest to first of all practise making the knot with some soft, thick string.

Making a Bracelet

Attractive bracelets can be made from plastic covered wire. This can be bought at any Woolworth's stores at 1½d. a yard, and is obtainable in white, black, green, yellow, blue and red. Two colours are

Take the right hand cord behind the core and out through this loop (Fig. 3). Pull the cords tight. This forms one half of the knot (Fig. 4A).

To make the second half of the knot, take the right hand cord and lay it across the core and under the left hand cord. Take the left hand cord behind the core and out through the right hand loop (Fig. 4B). Pull the cords tight. This makes the complete knot (Fig. 5).

Repeat the knot for the desired length of the bracelet, when the resulting pattern should be similar to that shown in Fig. 6. Snip the outside cords off close to a loop and leave about an inch of the core beyond the knotting. To fasten the bracelet, these end pieces are pushed through the loop at the other end of the bracelet, and doubled back to form a hook.

A knotted belt can be made from this

Cut the strings to the required length and divide them up into sets of four. Slip each set of four strings on to a thin cane (Fig. 7) so that all the cords lie side by side.

Begin the knotting at the left hand side. Take the first four strings and tie ONE square knot. Move to the next set of four and tie another. Repeat this until each set of four strings has been given one complete knot. This completes the first row.

To start the second row, ignore the first two strings on the left hand side and pick up the next four strings. This means there will be two strings from the first set and two from the second. Tie these into one Square Knot and move to the next four strings, and so on across the width of the belt.

The third row, and all odd-numbered rows is exactly the same as the first row; the fourth and all even-numbered rows is the same as the second.

The finished belt can be provided with a buckle, or the threads can be cut off a little way from the last row of knots to form a tassel. Such a belt can be used as a tie on girdle.

A variety of coloured strings can be

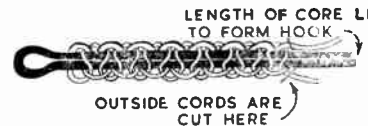
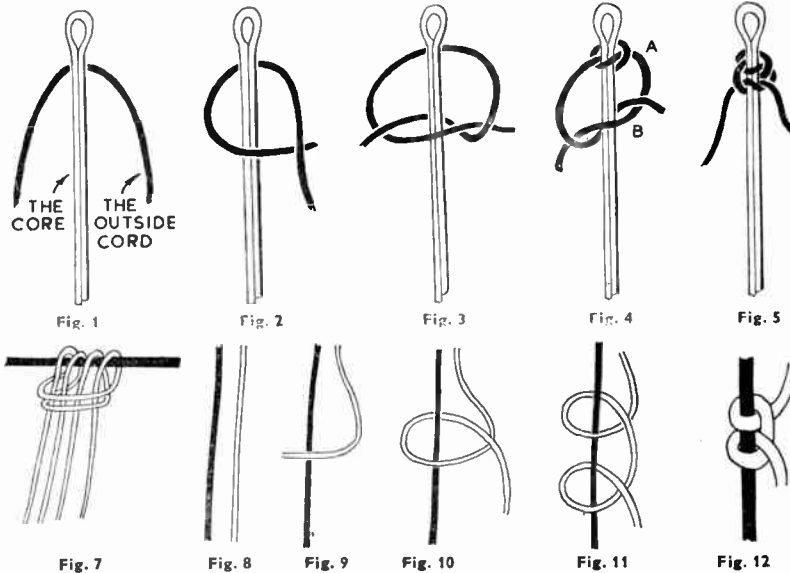

Fig. 6

used in the making of these belts and many really beautiful patterns can be worked out.

The Half Hitch Knot

The core of the half hitch knot can be of one or more threads. The following description is for a single-thread core.

Lay the two cords side by side (Fig. 8). Take the right hand cord and lay it over the core leaving a loop on the right hand side (Fig. 9). Now take the cord behind the core and out through the loop (Fig. 10). This is half of the knot.

Repeat the process exactly to make the second half of the knot (Fig. 11). The complete half hitch knot is shown in Fig. 12.

A very effective finish can be given to the string belt already described by completing it with two or three rows of half hitch knots.

Spiral Knotting

Long knotted cords can be used for

(Continued foot of page 24)

needed, the core (Fig. 1) being one colour and the outside cord another.

The core is a double cord and one end is formed into a loop. The outside cord is roughly six times the length of the core.

Making the Square Knot

Lay the two doubled cords or wires together as in Fig. 1. Take the left hand cord and lay it at right angles across the core and under the right hand cord (Fig. 2). Notice the loop on the left hand side of the core.

plastic covered wire in exactly the same way, except that the core is made up of four or six strands instead of just two. Care must be taken to see that the centre cords continue to lie side by side and are not forced one on top of the other by the tightness of the knotting.

A String Belt

A string belt has quite a different character and appearance from the plastic belt, and it can be made to any width. The material used is fine string, dyed if necessary, or cotton or silk threads.

What you should know about stock FOR A TROPICAL AQUARIUM

ALL enthusiastic aquarists sooner or later feel a desire to keep a few tropical fish, of which there are many species quite suitable for maintaining in the ordinary tank aquarium.

There is one important thing to note, however, and that is that for a tropical aquarium a higher temperature of the water is necessary. This should be kept at an average of around 75 degrees F. Therefore, it is necessary to provide heating for the tank by means of an electric or other type of heater. Any good aquarists' supply stores will furnish the aspirant with all that is required.

All who have had experience in aquaria and kept cold-water fish will experience little or no difficulty in maintaining a few tropical fish after setting up the necessary type of tank or tanks. However, there are so many kinds of fish now available for a tropical aquarium that it is a problem to make a selection. It is a big subject to deal with, and here it is only intended to name a few of the more suitable species for a beginner.

Live-bearers

This is a family of small tropical fish from America, and the beginner will do well to start with the Guppy (*Lebistes reticulatus*) or Millions. The female of which breed is about 2½ ins., and the male somewhat smaller. Males are coloured and the females plain. They do well in any suitable aquarium where no big predatory fish are also kept. Some of the guppies now being bred for sale are really handsome. It is a peculiarity of these fish that, in breeding, the eggs hatch within the body of the female, and come forth as tiny free-swimming fish, able to fend for themselves.

A smaller variety is the Platy or Moon Fish. Male 1½ ins. and female about 2 ins. This fish (*Platypoecilus maculatus*) is a pretty one, and may be of red, blue, gold, black, and spangled, the result of scientific selective breeding.

Others of this family include the Red Swordtail (*Xiphophorus hellerii*) a larger fish of about 3 ins. with a fine long tail; and the Albino Swordtail, and the Berlin Swordtail.

The Black Mollie (*Mollienisia*) is a 3½ in. fish. The male has a large dorsal fin. Mollies are often velvety-black, lovely, smooth and solid.

The Guppy is the most hardy of all these, and requires less care and attention than the others named. Guppies produce young frequently. The Swordtail is, perhaps, more interesting to the beginner, but it is larger, and needs more water space. Also, the male will eat the fry, therefore he is better removed from the tank when the young are born. Swordtails are very prolific.

Characins

Another extensive family are the Characins, many of them sporting an extra 'adipose' fin, between dorsal and tail. Some varieties are beautiful. There is in this group the Beacon Fish (*Hemigrammus ocellifer*) which is a popular favourite for the beginner. It is hardy, hence its suitability for the tyro. It has a bright brassy eye and spot at the base of the tail, from which its name is derived. Length 1½ ins.

Another hardy Characin is the Neon Tetra. It thrives in a well-balanced aquarium, being a 'good community' fish. Also, it is one of the most striking of aquarium fishes, with brilliant stripes of iridescent green or greeny-blue and red. But there may be difficulty in obtaining this fish nowadays. Neon Tetra, with its brilliance of colours and its green eyes, is almost lovely beyond belief. We saw a tank containing several specimens last year, and they were really wonderful.

At the same exhibition, we also admired some Glowlight Tetra (*Hyphessobrycon gracilis*)—marvellous fish brightly lit up. Then we have the Flame Fish (*Hyphessobrycon flammeus*) a most beautiful member of the Characin family, hardy, amicable, and most suitable for a beginner. It has red fins and part of its body is scarlet; there are black bars on the shoulder, and the dorsal and anal fins are edged with black. Length 1½ ins. Other varieties of this group include the Black Widow, length some 2½ ins., and resembling the Flame Fish in shape, but for the most part of a deep black colour,

and the Glass Fish (*Ambassis lala*) which is like an animated piece of glass. Length about 1½ ins. Translucent in hue; not easy for tyros.

The Characins best suited to beginners to experiment with are the *Beacon Fish* and the *Flame Fish*.

Panchax

Of this group of Killifishes the *Panchax chaperi* is an excellent fish for the beginner. Panchax are carnivorous. They are hardy and not aggressive. *Chaperi* has black-edged pointed fins, and blackish bars on the body of the male with the scales edged red. The female is quite plain. For the starter wishing to breed tropicals this species will prove suitable. Length 2 ins. Though taking dried foods readily, live food is the better, very small worms and blood worms being essential in their diet to produce really good quality fish.

Panchax *chaperi* can be kept in one of the smaller tanks, say, 12 ins. by 8 ins. by 8 ins., which is another recommendation to a beginner.

Others

Among other fish ideal for beginners mention must be made of the Carps, the Zebra Fish in particular, an inexpensive tenant for the community tank, with a long blue-striped body with silvery shades. Length 1½ ins. The Zebra (*Danio rerio*) is a very active fish. Another fish of this group is the Harlequin, with a gold and black body. Fins are red. This fish is difficult to obtain, and is therefore of little use to the amateur.

As the newcomer gains experience there are many other species that afford great interest, and there is no limit to his possibilities of breeding tropical fish.

Those would-be aquarists desirous of setting up a tropical aquarium will find a good book on the subject very helpful, with instructions on feeding, maintenance, breeding, and so on. Begin in a small way, and as your knowledge grows by experience then add to your varieties of fish. There is no limit to your enjoyment once you become an out-and-out enthusiast. (463)

The Craft of Knotting—(Continued from page 23)

many purposes. Serviceable ones can be made by using only the square knot. If the first half only of the square knot is used an attractive spiral effect is obtained.

Knotted Scarf

To make a knotted scarf use the same

process as for the belt. The scarf must of course be wider—having a greater number of threads—and should be made from fine wool or other soft material.

A Mesh Effect

When using any kind of thread a mesh

effect can be had by using the square knot and leaving half an inch or so between each row of knots. (434)

REMEMBER — Tell your friends about Hobbies.

You can make a SHOWCASE FOR A MODEL GALLEON

THIS week we are giving details and instructions on the making of a showcase for a model galleon.

Quite a number of workers who have toiled long hours, and feel proud of their achievement, have asked us to supply them with details of such an article. The size of the showcase will, of course, depend upon the size of the model which is to go in it and we are therefore not giving any specific sizes here, but intend to let the worker measure up his model and set out the overall sizes.

The case should contain the model comfortably, allowing plenty of space all

or so in from the edges, must be coated with glue, then laid on the frame and one or two countersunk screws run in to make a secure fixing. Upon this base is built up the framework of the case itself, and the ease of gluing up and general fit of all the parts will depend upon the accuracy of the cutting of the various rails and mouldings. Four pieces of Hobbies grooved moulding No. 45 act as corner posts, with narrow rails glued in the grooves to hold it all together until the glass is slid down into the grooves and the top placed over and screwed securely to the top rails of the end section.

Each end section can be made up independently. They consist of two pieces of grooved moulding and two cross

filled with putty or plastic wood filler. Having finished the two end frames so far, and cleaned up the ends of the moulding so they are flush with the top and lower edges of the two rails, proceed with the two rails connecting the end frames.

Connecting Rails

These two rails are about 1 in. wide by $\frac{3}{8}$ in. thick and they may be glued in the grooves at the lower ends of the moulding, see Fig. 2. At this point the two end frames, with their connecting rails,

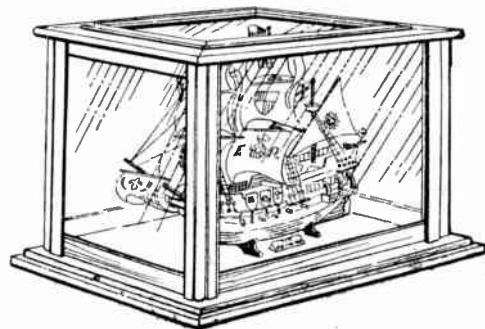

Fig. 1

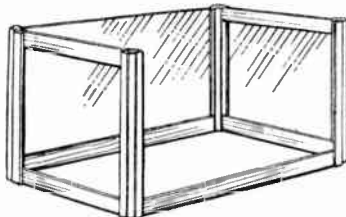

Fig. 2

round to show it off to advantage. The sides, ends and top, as the sketch of the finished article shows, are all panelled glass to give a clear view of the ship from all angles.

The base will be the first part to construct, and this will be made up, as Fig. 1 shows, from four pieces of $\frac{3}{8}$ in. thick wood cut to the necessary lengths from $1\frac{1}{2}$ in. wide stuff, mitred at the ends and glued up and nailed.

Get the Frame Square

Take care to get the frame square by having the mitres a true 45 degrees, and, after gluing up, by testing them with the set square or try square. If this open frame is inaccurate, then the floor piece which goes on top of it will not fit properly and the margin all round will not be equal on all sides. The floor may be $\frac{3}{4}$ in. thick, unless the model happens to be a really large one, then it should be $\frac{1}{2}$ in. thick.

The underside of the floor, for an inch

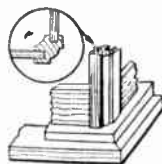

Fig. 3



Fig. 5

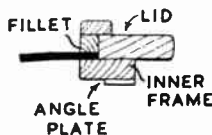

Fig. 6

rails about $\frac{3}{8}$ in. thick. Take care to cut the ends of the rails square across so that a perfectly square frame results when the four pieces are glued up. Test the accuracy of the right angles with a set square or try square before the glue hardens—do not attempt to strain the joints afterwards, or the glued portions will be ruined and the glue cracked away from the joints.

It must be understood that the glass for these end frames must be run into place in the grooves of the moulding before the top rails are glued in. The sizes of glass required for the ends of the case will be carefully checked direct from the actual frame. The glass should rest evenly on the lower rail and the top rail be pushed into place along the top of the glass. Any space left in the grooves of the moulding between the glass should be

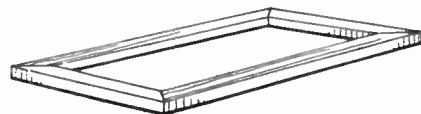

Fig. 4

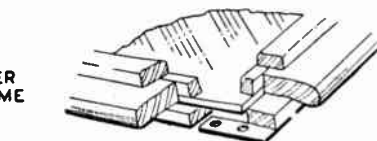

Fig. 7

should be prepared for securing to the base. To do this properly, the exact position of the ends of the moulding and the rails must be found and marked in pencil. Holes are bored down ready for the screws, which later will be driven up through the base and into the rails and moulding.

While this work is being done, support the top ends of the frames by temporary cross rails either let into the grooves or just laid on the outer surfaces and nailed. The two pieces of glass for the sides should now be cut, the same precaution regarding check measurements from the actual frame being taken. At Fig. 3 is shown a useful diagram of a position of one corner of the case completed, giving the relative position of the parts with an

(Continued foot of page 26)

Ways of making MONEY FOR CLUB FUNDS

MANY clubs find the need for raising funds and this cannot always be done by an exhibition alone. Some ideas on articles which members or friends can make will always be welcome.

Plan to make lines which are in short supply. Produce lines which normally carry as much as 100 per cent Purchase Tax when sold in a shop. Give variety to the articles and display tastefully. Perhaps a local draper will come in and set them out for you. He will also come and help you with pricing. Keep prices reasonable. Do not charge too much and do not hold an auction and cut prices, as this will upset best part of your supporters.

Good Demand

Leather articles are always in demand. Most craft shops supply leather splits, leather papers and strawboards. Purses and hold-alls are best sellers. Do not attempt to make larger articles. People go to the large stores for these.

Art shops stock yarn twist similar to pipe cleaners but coloured. The strips are 14ins. long and made in nine attractive shades. You will have no end of fun making these into grotesque animals of all sorts and shapes. These soft fluffy animals are worn on coats and serve as mascots.

Showcase for a Galleon—(Continued from page 25)

enlargement of the corner moulding showing the rails glued in.

It will be seen from the detail that the base is quite plain, but, if desired, a small moulding could be glued into the angle formed between the two members. The top of the case consists of two distinct frames. The top and larger one, is made up from thickish wood about 1½ins. wide, the lower one—which also forms the rebate for the glass—from ¾in. stuff from ¾in. to 1in. wide.

Fig. 4 shows the method of mitring up the rails of the main frame, while the rails of the under frame are 2ins. less in length and similarly mitred. Get all the mitres similarly cut to angles, and see that, in gluing up, the internal angles of each frame are true right angles.

Glue the two frames together, keeping a true width of margin all round in the rebate so formed. To strengthen the corners of the frames, four brass angle plates are screwed to the extreme angles of the under frame as seen in the detail, Fig. 5. This detail shows the underside of the frames and the position of the plates.

Raffia lines are good sellers and this material can be bought at any Art and Craft shop in bundles of assorted colours for about 6/6. Normal small hanks cost about 6d. You can also get a twopenny instruction leaflet on this. Here is a job for a group of people to get down to. Cardboard shapes are available in circles, ovals and other shapes for table mats. If anything, these may be one of the best lines because production cost is low and a fair figure can be got for a finished set of mats.

Another Seller

Decorated cork mats also sell well and can be purchased in the plain shape and finish. These can be stained, or you can use transfers on them. Another idea is to stencil flowers and figures on them. Art enamels can be used for painting the designs. Choose about six shades and keep your jars corked and stoppered so that there is no waste.

You can get more money for lines if they are nicely wrapped. Stationers sell coloured household cellophane and this is ideal for making coverings for these lines and the customers can see what they are getting.

Perhaps some friends will make up some soft toys and these most certainly should sell well as prices are rocketing higher each week on some of these toys. But be careful with designs chosen

because some are very unpopular. For a ready sale make the following:—Baby Lamb, Elephant, Camel, Donkey, Sitting Rabbit, Billy Rabbit, and Teddy Bear.

Boxes of bricks are always sure of a sale. You may be able to get a builder to cut you up the blocks. Try some in 1½ins. square size, as the normal ones sold in toy shops are always too large. For letters you may be able to get sets of these in transfer form if you see a local model shop. They used to be stocked for model bombers and there are still plenty of stocks of them.

You may also be able to follow the designs of the smaller building sets with the pillars, half-circles and other sections. Quite a few of these sets could be made up from a small supply of wood. At the moment they are off the market so you will be sure of a sale. See that the ends are well cleaned down.

Wooden Jigsaws

Wooden jig-saws will soon be scarce and these can be made up cheaply. Choose designs to suit children and these can be cut from journals and children's books. For the younger children make some with about fifteen to eighteen pieces. There is always a shortage of these at all times. Ducks on Water, Rabbits and Farm Scenes are best used here. (461)

Measure the rebate opening for the glass, allowing this to drop in easily without binding or wedging in tightly. To fix the glass, nail in four square fillets about ¼in. square in section round the edge as shown in the section Fig. 6. Over this again, to hide the joint and to make a neat finish around the top, glue on four oblong fillets mitred and perhaps held down firmly with small brass nails.

To show clearly the relative positions of the parts forming the top, the detail Fig. 7 should be studied. This gives one corner of the top with certain members

cut away so that all the pieces are shown in their respective positions. The brass angle plate is also clearly shown in this sectional diagram. The top must be laid in place over the glass and grooved mouldings, the hollowed out backs of which exactly take the corners of the underframe.

Two round-headed screws run through the top rails of the side frames will make all secure. The wood suggested for this showcase is mahogany which could be stained or varnished, or oiled up just as it is. (467)

BETTER DART FLIGHTS

If you use your darts a lot, then you will find it costs quite a lot to keep buying flights. You will find that old negatives come in useful for making reliable flights. First remove the cap and take out old flights, then take one of these flights and cut some more like it, out of your negatives. Fix in the darts, and the job is done.

REPAIRING TABLE KNIVES

If the blade of a table knife has become loosened from its handle here is a tip on refixing it. Put some powdered resin in the hole in the handle and heat the end of the blade. While still hot the blade should be inserted in the handle, and when the resin has set, the blade will be quite tight in the handle again.



OF LIONS AND FISHES

THE accompanying illustration of the Afghanistan stamp was kindly provided by Mr. A. Johnson, of Parkestone.

At first sight, one might think that Mr. Johnson has sent a very badly torn specimen yet that is just one of the interesting points about the stamp. Afghanistan, unlike most of the other countries issuing stamps did not use a cancelling device of the usual type, but the issuing clerk tore off, or cut out, a piece of the stamp, very like the method that is used when one goes to the cinema. You pay at the desk, receive a piece of paper that the usherette tears when she shows you to a seat. The same with the stamp.

The face which is seen in the centre of the stamp is supposed to be that of a lion, and as the design for each stamp was drawn separately, they all differ



The interesting Afghanistan Stamp, loaned by Mr. Johnson

slightly from one another, although they are all of the same value. So that from 1870, when they were first issued, until 1878, there are many stamps differing slightly from each other.

After 1878 the lion's face type of stamp disappeared and more commonplace types were issued. Although the stamp was issued in 1870, yet the date on the stamp is that of the Mahommedan year 1288. This is shown on the right of the lion's mouth as one looks at the stamp; the figures are not English but Arabic. The value is indicated by the writing in the inner circle above the lion's head.

Clumsy Coinage?

We may sometimes think that the British system of coinage is clumsy with its 4 farthings equal to 1d., 12 pennies to 1/- and 20/- to £1, but what would you say if you had to use the Afghan

currency? 12 shahi equal to 6 sanar, equal to 3 abasi, equal to 2 kran, which equals 1 rupee. There was a slight change in 1909 when 60 paisa were made equal to 1 rupee, and in 1927 100 pous equal to 1 Afghani (66 paisas).

The second illustration, of the Canadian 1 dollar stamp, comes from Mr. Reg. Gibbs, of Hanover, Ontario, who has so kindly and so frequently sent new specimens of stamps for illustration.

The stamp is blue in colour and was engraved by the Canadian Bank Note Company. It will replace the 1 dollar stamp now printed in purple and showing a picture of the train ferry. It is not difficult to see that the subject of the design is to acquaint the world with the fact that fishing is a most important industry of Canada. Next time you come across a tin of salmon, have a good look at it and most likely you will see that it came from Canada.

The exports of fish in 1949 were valued at very nearly 100,000,000



The Canadian example from Mr. Gibbs



Whale catcher depicted on a stamp from the Falkland Islands

dollars. The Grand Banks off the coast of Newfoundland rank as a Canadian fishing ground.

The central part of the design is self-explanatory, a fisherman hauling in a net, but the rest of the stamp may need a little explanation. For example, notice that the ground work of the outer border is made up of fishing net, you can clearly see the corks that prevent the net from sinking. These are shown next to the stamp perforation. The fish and shell fish

that are illustrated, taken in a clockwise order starting with the seal at the bottom, are clam, tuna or albacore, halibut, herring, mackerel, cod, shrimp, scallop, lobster, Atlantic salmon, Sockeye salmon, Lake trout, whitefish, haddock and oyster. If you use a good magnifying glass, then just below the fisherman's left hand you will see the date 1951.

Interesting Examples

Although fish do not figure very much on postage stamps as part of their designs, there are a few interesting examples that can be quoted. Two examples of fishing boats can be recalled. The specimen illustrated from the Falkland Islands is the 1½d. value of the centenary set issued in 1933, and gives us a whale catcher. There is also a fishing boat on the stamps of St. Pierre et Miquelon—surrounded very realistically by sea gulls. This stamp was issued in 1932. In 1909 the same French Colony issued a stamp with the head of a fisherman and also a picture of a sailing fishing boat, while in 1938, a picture of St. Pierre harbour was given, showing a couple of fishermen in the foreground with a nice catch of fish laid out on the quay side at their feet.



Barbados stamp showing a native fishing

In 1947, stamps appeared showing fish being weighed, a fishing trawler and also a fishing village. The best picture of fish from this country is given on the 1947 postage due stamps. On these you have a cod-fish swimming in a way which reminds one of the stamp from Iceland showing the same fish.

Newfoundland is another country which has placed fish on its stamps as a major part of the design. In one of its early sets, that which came out in 1866, the cod-fish and the seal appeared. A salmon is on the 24 c. stamp of the 1897—or rather, a picture of salmon fishing—the actual fish first appears on the 1932 set entitled 'The king of the rivers'. The salmon is shown jumping.

(Continued foot of page 28)

'DOGGY' STRING HOLDER

THIS doggy string holder makes an admirable novelty for those who are looking for something out-of-the usual, but which is not difficult to make.

As will be seen from the set of illustrations, the project consists of a base on which are mounted pieces which represent front and back pairs of legs. There is a dowel passing through the pair of holes, which has a wooden ball permanently fixed to one end, and decorated like a comical dog's head. This dowel and head can be compared to a pin which fixes a large ball of twine (representing the dog's body). The loose end of the twine is wedged in a slit cut in the dog's mouth.

The Ends

The two ends can be marked out directly on to $\frac{3}{8}$ in. solid wood. Allow extra space at the bottom so that a $\frac{3}{8}$ in. diameter hole can first be drilled and then the wood sawn across so as to get the semicircle required. After the two ends have been cut separately, they can be temporarily fixed together and final smoothing done to the pair.

The base is very simply made as dimensioned, and the two ends can then be screwed on from beneath (nails are not so good). When screwing up, temporarily insert a length of $\frac{3}{8}$ in. dowel so that the two ends are in alignment.

The head should be a wooden ball about 2 ins. diameter. A search should be made in toyshops for such a ball. If any difficulty is encountered in obtaining such a ball, the reader may use the domed end of a sock darning. If using a wooden ball, drill a $\frac{3}{8}$ in. diameter hole about 1 in. deep in it so as to take one end of the dowel rod in a tight fit. A touch of glue when assembling will make a good permanent fit. The other end of the dowel is tapered off, the tapering starting from a point clear of the hind-

Quite a novelty—a

STRING HOLDER

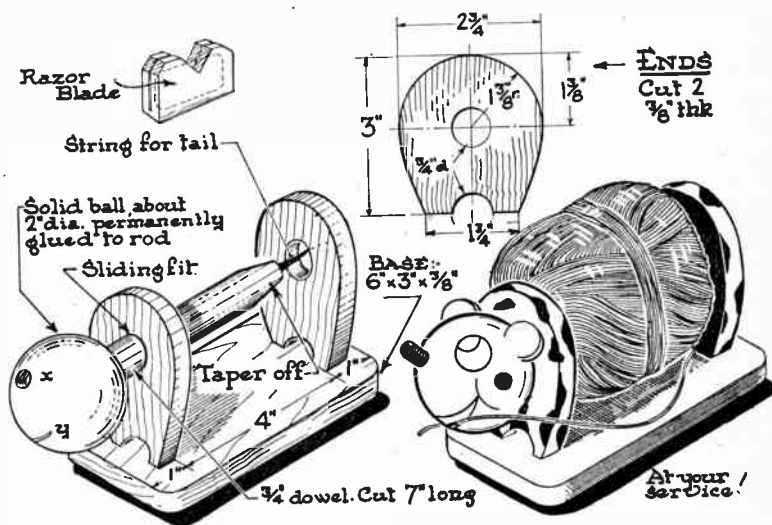

These drawings make the method of construction clear

legs part. A piece of string is inserted for a tail.

At point (X) of the ball, a $\frac{3}{8}$ in. diameter hole is drilled, about $\frac{1}{2}$ in. deep, to take a piece of dowel to form a comical nose. A tenon-saw slit (Y) is cut where the mouth comes. The ears can be any suitable plastic counters or plain buttons. Slots are cut in the head for them so that they are about one-third of their diameter in. They should be a tight fit so that plastic wood may be needed for neatening up.

Finishing

The eye is just painted on, but this comes last of all. First give the whole model a thorough glasspapering and then a priming coat. Aluminium paint is good for this. Paper again if necessary. Then paint with bright enamels. (The rod itself does not need painting). Remember always, that these novelties

owe a lot to their attractive finish and enamel paints will not hide and cover ill-prepared work but will only show up faults worse than ever. So take great care with the finishing.

As regards colours—please yourself, bearing in mind that there is no need, in such a novelty, to keep to naturalistic colours. If you fancy a green dog with yellow spots, well, why not? Definitely keep off dark colours; no dark browns or blacks, for example.

Although not shown on the final drawing, a useful addition to this model would be a simple string cutter made with a used razor blade as sketched. Take care that the blade is well guarded and that no one (especially a young child) can possibly cut their hands in reaching for this model.

Such a model is both decorative and useful and can be made in quantity for selling at bazaars, etc. (477)

Stamp Corner—(Continued from page 27)

In the same set on the 1 c. value, you have a mass of cod-fish, a picture such as one would see on looking down into the hold of a fishing smack.

The 25 c. and the 30 c. show, respectively, the sealing fleet 'Off for the Hunt' and the fishing fleet 'Leaving for the Banks' (The Grand Banks which form such an ideal fishing area off the coast). The 15 c. value shows us a baby seal—so that in the 1932 set we have no less than five stamps each dealing with fishing.

Practically the same designs appear on the 1937—the additional Coronation set—the long stamps each with a medallion portrait of King George VI.

On the new Barbados stamps, the 6 c. shows a picture of a native casting a circular net into the water—and it is quite an art to keep the net open during flight. To our ideas there is another curious way of fishing shown on the stamps of British Guiana—shooting at fish with a bow and arrow. Then again,

on the stamps of Niue, the new 9d. value shows a man standing with a spear poised ready to throw it at a fish.

The most familiar sight to us is on the Finnish stamp, the 1946 Red Cross issue. On this stamp, you see fishermen pulling in a full net.

Although there are not very many instances of fishing on stamps, yet a few more examples may be found. Can you find them? (459)

LARGE 15c. Mozambique depicting Fort, absolutely free request approvals.—Clinton, 18 Leigh Rd., Worthing.

THE 'Toff'—an exciting new walking novelty. Plans, instructions, 1/-, post 1½d. Kits for making the 'Toff', 4/-, post 6d. Perspex galleon kits; floral; crinoline; engraved, coloured, bevelled Perspex pieces. Egg trim sandglasses. Details sent with above plan.—T. & D. Hughes, Manor Park, Flint, N. Wales.

40 DIFFERENT stamps free, including Silver Wedding, U.P.U., Victory, Silver Jubilee, Coronation, Pakistan, etc. Send 3d. postage and request approvals.—J. F. Smith, 39 Manor Park, London, S.E.13.

500 WORLD stamps, all different! Amazing value, 4/-. — H. Whitby, Godshill, Fordingbridge, Hants.

STAMPS.—Beautiful Nicaragua Triangle free to approved applicants. 50 Pictorials and Commemoratives, 1/8. 25—1/-.—W. E. Tucker, 6 Higher Church St., Barnstaple, N. Devon.

MODEL makers, toy makers, home handymen. —Bumper set of samples and advice on these subjects, 2/6.—Sutton Models, Billericay.

GENUINELY interested persons required to undertake light, clean assembly work in their own homes. Good rates of payment.—Dept. 918, Universal Products, 5 Cornhill, Lincoln.

MECHANICAL Wood Toy maker—a book of interesting moving toys with 158 illustrations and patterns—2/6. Home Woodwork—50 useful things to make, 188 illustrations—2/6.—G. F. Rhead, Hartest, Bury St. Edmunds.

100 DIFFERENT Empire stamps including G.B., 2/6, 5/- and 10/-, post free 2/6. 50 different China free to applicants for approvals.—Bisson, 46 Sumatra Road, London, N.W.6.

NICOTEXIT the guaranteed smoking deterrent. Stops you smoking immediately. C.O.D. price 5/6 per bottle from The Nicotexit Co. (MP), 62 High Street, Croydon.

WANTED—amateur or professional with suitable equipment to turn small quantity of marionette wooden bodies—preferably living in or near Manchester.—Box 222, Hobbies Weekly, Dereham, Norfolk.

EXCELLENT stamps in lots, 2/6, 5/-, plus postage.—G. Hall, 398 Newark Rd., Swallowbeck, Lincoln.

STAMPS FREE! Twenty unused (2½d.).—G. H. Barnett, Limington, Somerset.

A STAMPED envelope brings details of highly profitable home work.—The G.C.C.S. (Dept. H.), BCM/NEWPLY, London, W.C.1.

LONELY? Then write Secretary, U.C.C.—5 B.B. Hay Street, Braughing, Herts. Genuine. Est. 1905.

HOBBIES BRANCHES

LONDON

78a New Oxford St., W.C.1

(Phone MUSEUM 2975)

87 Old Broad Street, E.C.2

(LONDON WALL 4375)

117 Walworth Road, S.E.17

(RODNEY 5509)

GLASGOW—326 Argyle Street

(Phone CENTRAL 5042)

MANCHESTER—10 Piccadilly

(Phone CENTRAL 1787)

BIRMINGHAM—14 Bull Ring

SHEFFIELD—4 St. Paul's Parade

(Phone 26071)

LEEDS—10 Queen Victoria Street

(Phone 28639)

HULL—10 Paragon Square

SOUTHAMPTON—25 Bernard St.

BRISTOL—30 Narrow Wine Street

(Phone 23744)

FAMOUS MEN packet free. 15 different stamps portraying Hitler, Caesar, San Martin and other notable men. Send 2½d. stamp for Gift 70 to—R. Crookes, 198 Buxton Road, Mile End, Stockport, and ask to see my approvals.

YOUNG man with workshop, saws, benches, etc., wishes to contact firms in all wood lines. Toys and puzzle cutting undertaken, large or small orders.—Box 111, Hobbies Weekly, Dereham, Norfolk.

INTRODUCTIONS—pen friends, companionship or marriage.—V.C.C., 34 Honeywell Road, London, S.W.11.

EMPLOYMENT—homeworkers required by a few reliable firms. S.A.E. for particulars.—Box 99, Hobbies Weekly, Dereham, Norfolk.

PLYWOOD offcuts in 5/- and 10/- parcels post free. Money-back guarantee.—Ezedraw, 21 Spring Grove Rd., Kidderminster.

STAMPS on approval. Half catalogue. Liberal discount.—W. Pawson, 5 Wensley Avenue, Hull.

MODELS. You can make lasting stone-hard models with Sankey's Pyrama Plastic Cement. Supplied in tins by Ironmongers, Hardwaremen and Builders' Merchants. Ask for instruction leaflet.

LEARN Shorthand by November 10th. (1 hour's study nightly). 1st lesson, 2½d. stamp.—Duttons (Dept. H.B.), 92 Great Russell Street, London, W.C.1.

DUPLEX self adhesive transfers for decorating fancy goods, trays, plastics, etc. List and samples, 3d.—H. Axon Harrison, Jersey.

DOLL'S House fittings and papers; send S.A.E. for list. Doll's House plan special; send 2/6 Trade supplied.—Zimplan, 88 Ware Road, Hoddesdon.

LORRY Kits, 4mm. and 7mm. scale. Also large range of spare parts from which to build to your own design. Send for fully illustrated catalogue, price 1/-.—Wilson's Lorries Ltd., 6 Great Winchester Street, London, E.C.2.

PLYWOOD offcuts. Birch and Gaboon in various thicknesses. Handy sized parcels for the cabinet, toy, modelmaker, and all handicrafts. Parcels made up in £1 and 10/- lots. Carriage paid. Send P.O. to—Reeves, Plywood and Timber Merchant, 33 Front Street, Monkseaton, Whitley Bay. Tel. W.B. 4677. Parcels are now despatched on day of receiving order.

BLUSHING, shyness, nerves, self-consciousness, fears, ended. Details under plain cover, 1½d.—Stebbing Treatment, 28 (HB) Dean Road, London, N.W.2.

£5 to £20 weekly earned at home, running your own Mail Order business. Details, 1½d.—Stebbing Publications Ltd. (HB), Naphill, High Wycombe.

AMERICA'S famous hobby magazines. One Year's supply Popular Mechanics, 32/-; Popular Science, 28/6; Homecraftsman, 16/6; Popular Homecraft, 18/-. Free booklet listing all others sent on request.—Willen Ltd. (Dept. 57), 101 Fleet Street, London, E.C.4.

EARN £££s Weekly with '114 Ways to be your own Boss', 5/6 only. Money back if dissatisfied. Stebbing Publications Ltd., Naphill, High Wycombe.

HOME Watch and Clock Repair Outfit. Includes watchmakers magnifying eyeglass, tweezers, screwdrivers, oilers, oil, brush, dusting powder plus illustrated explanatory book. Watch and Clock Repairing simplified. In container, 12/9 inclusive.—D. Bolster (Dept. H.), 5a Station Parade, Ashford, Middx.

BE Taller in 14 days or money back. Details, 1½d.—Stebbing System, 28 (HB) Dean Road, London, N.W.2.

HAVE you got your Juneero Riveting Jig yet? From all Hobby shops or post free from Juneero Ltd., Stirling Corner, Boreham Wood, Herts.

CONJURING and magic. New tricks and pocket novelties every month. Lists, 4d.—Robotsi, Magician, 363 Sandycombe, Kew Gardens.

GENUINE home employment making envelopes for us; we buy all you make and pay 50% on cost rates. Send 1½d. S.A.E. to—BCM/TRIVIT, (HW), London, W.C.1.

STAMPS Free—Empire Packet including Pictorials and Victorians free to approval applicants.—Robert J. Peck, 7A Kemp Road, Bourne-mouth, Hants.

WHEELS for toys, etc., in Hardwood, Plastic and Rubber Tyred Metal. Doll's House fittings and papers. Doll's cot and Pram fittings. Decorative Transfers. Beads for Counting Frames and other toy accessories. Fine Art Pictures for Jig-Saws, etc. Stamp for full lists. Trade supplied.—Joyden Toy Co., 193 Chase Side, London, N.14.

HOMEWORKERS required; either sex. Light Assembly, part or full time. S.A.E.—Esprey, Box 18, 41 Wade Street, Lichfield.

NOVEL Calendar designs painted on plywood for cutting out, with date cards. Inexpensive gifts—profitable to sell. Sample, 2/-; half dozen, 11/-, including postage.—Cleaver (HW), 50 Windsor Road, London, N.W.2.

9.5 Popular Film Hire Library. 3d. Stamp Lists.—Wayland, 223 Longley Road, Tooting, London.

TRICKS for everyone—vanishing candle, 1/3; tightrope ball, 2/6; cut and restored rope, 1/3; window mystery, 1/3; phantom cigs., 1/6. Free to all spending 5/-.—Magicians Den, Wimborne Road, Winton, Bournemouth.

50 Free Stamps including pictorials to all applicants enclosing 2½d. and requesting approvals. Medium and Junior Postal Only.—Beeze, 116 Newton Road, Mumbles, Swansea.

EARN cash spare time making Bennett Model Bungalows. We show you how and buy your work at top rates. Stamped addressed envelope brings free details.—Bennett Models, Duncan Road, Richmond, Surrey.

INTERESTING work available for all in spare time, experience unnecessary. Send S.A.E. for details to—'Leatheweave' Co. (Dist. 37), 2 Tudor Road, Leicester.

START making money at home whole or spare time on production of Slippers and useful Leather Goods. Material provided. Write for rates of pay and full details.—Dept. X, Grange Co., 2 Curzon Street, Leicester.

100,000 Government Surplus Bargains. Inter-room telephone sets, no batteries required, nothing to wear out, complete 9/6, post 6d. 4v. buzzers, 3/-, post 4d. Aluminium rivets, approx. 1 lb. assorted, 2/6, post 6d. Sample parcels, guaranteed to contain at least 15/- worth assorted electrical and other useful items, in handy wooden box, 5/-, post 1/8. Send 3d. stamp for full Mail Order catalogue. Money back guarantee.—Milligan's, 24 Harford Street, Liverpool, 3.

KUKLOS annual. Indispensable cyclists' handbook. Festival edition. Tours, resthouses, money saving hints, 2/9, post free.—Burrow, Publishers, 2 Imperial House, Cheltenham.

AMATEUR Radio—world's greatest hobby! Send today for free copy of interesting literature and illustrated catalogue (enclose stamp for postage) Famous Globe-King kits from 25/-. Write direct to makers.—Johnsons Radio, (Dept. H), 46 Friar Street, Worcester.



EYELETS! EYELETS! EYELETS!

Ideal for Handicraft and Model Making. Eyelets consisting of one leather washer, one aluminium washer and one eyelet. 3/6 wide.

1/6 PER GROSS
(Post Free)

WRITE TODAY

C. & G. S. TRADING CO.
1-3 Mill Hill, Griffin Hotel Buildings,
LEEDS, 1. Tel. Leeds 29021/2

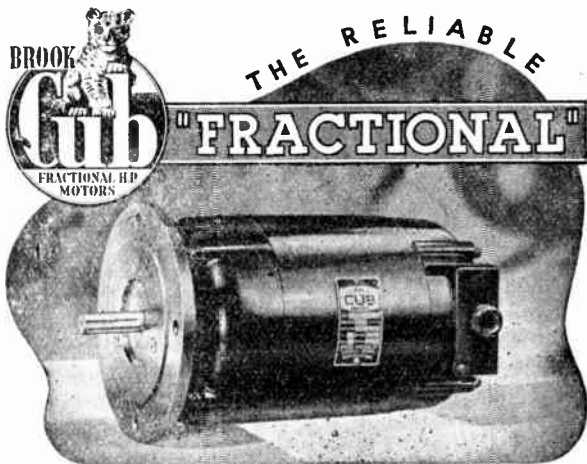

For every purpose in the small home workshop . . . use a BROOK 'CUB' $\frac{1}{4}$ h.p. motor. Single or split phase.

Electric Motors from 0-25 to 200 H.P.



SMALL WORKS HUDDERSFIELD LHM.14

YOU CAN BECOME A HANDICRAFTS INSTRUCTOR

EXPERIENCE NOT ESSENTIAL

Men who enjoy making things in wood or metal can turn their hobby into a permanent and interesting Career. Short hours, long holidays, and security in a job you would really enjoy, can be yours if you become a Handicrafts instructor. Let us send details of the easiest and quickest way to get the necessary qualification.

We guarantee "NO PASS—NO FEE"

If you would like to know about our unique method of preparing you for one of these appointments, write today, and we will send you our informative 144 page Handbook—free and without obligation. Mark your letters "Handicrafts Instructor".

BRITISH INSTITUTE OF ENGINEERING TECHNOLOGY

BIET

595 Shakespeare House
Stratford Place, London. W.1

WEBLEY AIR PISTOLS



Marvellously accurate for target practice. No licence required to purchase for use on enclosed premises.

Senior Mark I
Junior Webley Air Rifle
Write for List. **WEBLEY & SCOTT LTD.**
166 WEBMAN STREET, BIRMINGHAM. ENG.

**For Profitable Pleasure
Make 'OSCAR ELEPHANT'**

No mechanism—yet walks down any incline in lifelike manner. Worth the cost of the plans to learn the secret. Principle can be applied to other toys. Simple, cheap to make from odd wood. Sells on sight. Patterns, instructions, only 3/6

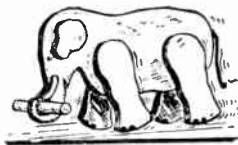

SEND NOW TO: Dept. HW/D
6, CEDAR HOUSE, ERLANGER ROAD, LONDON, S.E.14

The acid-free cored solder for every handyman

This new, non-resin cored solder is an indispensable addition to every home workshop, replacing stick solder and fluid and paste fluxes. It contains two cores of Arax Flux, a flux so fast that Arax Multicore Solder can even be used for soldering blued spring steel without pre-cleaning. Flux continuity is assured, there is no waste, and no extra flux is required. The flux residue can be easily washed off with water.



SIZE 8 CARTON 5 - EACH



A COMPLETE RANGE OF MULTICORE SOLDERS IN THIS SINGLE HANDY KIT
The Multicore 2 - Solder Kit contains two specifications of Arax Multicore for metal soldering and two specifications of Ersin Multicore for electrical and radio work.

MULTICORE SOLDERS LTD.
MELLIER HOUSE, ALBEMARLE ST., LONDON, W.1 REGent 1411

SPECIAL MOULDS

Some new lines for the Craftworker

Sets of moulds for Cake Decorations, Christmas Novelties and Brooch Making at 12/6 for a set of 8 moulds. Plaster moulds for all types of Ornaments and Plaques from 6/6. Dolls Masks and Faces, 3 sizes, set 15/6. Dolls Heads, 25/- for mould. 150 Toy Making moulds at 3/- each. New Father Christmas and Snowman, 2 1/2 in. flexible moulds, 12/6. Buy direct and save money. New catalogue illustrated 9d. post free. All moulds are made of strong aluminium or vinimould. They are made to last. 4 sample moulds of Toy Soldiers or Sailors, 12/- post free.

COCK OF THE NORTH MOULDS
140 HOLLINGS ROAD, BRADFORD

Is This Saw in Your Kit?

You can cut almost anything in wood with this Coping Saw. The blade is 6 1/2 ins. long and can be turned to cut at any angle. No tool-kit is complete without one. Get yours NOW.

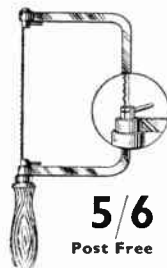

5/6
Post Free

Buy from any Hobbies Branch or post free from Hobbies Ltd., Dept. 99, Dereham, Norfolk

Airborne supply!

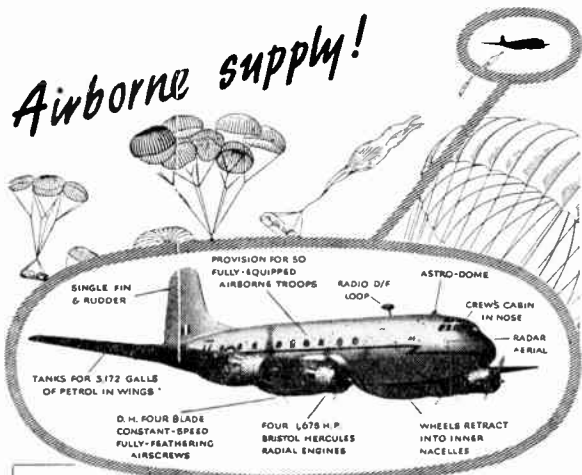

**HANDLEY PAGE
HASTINGS**

R.A.F. Transport Command's latest aircraft. Crew of 5, capacity for 50 troops. Four 1675 h.p. Bristol Hercules engines. Maximum speed: 354 m.p.h. Range: 2,000 miles. Wing span 113 ft.

There may be 50 lives depending on the brains and skill of the men who fly and maintain this aircraft, so naturally they must be pretty smart. That's why the Royal Air Force is always on the look-out for suitable boys to join their Apprenticeship Scheme. These boys get a flying start to a thrilling career at one of the R.A.F.'s fine residential schools, without cost to their parents and with good pay to spend. In this way the R.A.F. gives them the right kind of start for their future as key men in the finest air force in the world.

If you are over 14 this coupon brings you free a 26-page illustrated book about thrilling careers in the R.A.F. If you are 12 to 14 it brings you full details about the A.T.C.

TO: ROYAL AIR FORCE (H.S.56A), VICTORY HOUSE, LONDON, W.C.2

NAME.....
 ADDRESS.....
 AGE.....
 DATE OF BIRTH.....

**EVERY CAR THAT PASSES
YOU WILL FIND THE INDEX MARK
ALPHABETICALLY ARRANGED IN
HERE'S THAT CAR FROM?**

Price 9d.

from all Booksellers or from the Publishers (1½d. postage)

RALEIGH PRESS, EXMOUTH

**ENJOY MAKING
PLASTER FIGURES
WITH
FLEXIMOULD**



No experience is required to cast religious figures, wall plaques, ash trays, garden ornaments, candlesticks, book-ends, vases, coats-of-arms, articles for window display, cake decorations, cameos and animals, etc. Make a profitable business with this pastime.

Write today for free details of

'FLEXIMOULD' to

**DOHM LTD. (DEPT. H)
167 VICTORIA ST., LONDON, S.W.1**

MASK...MAKE...

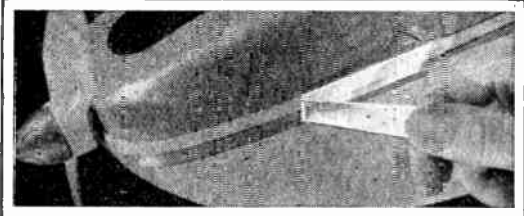

MEND...WITH

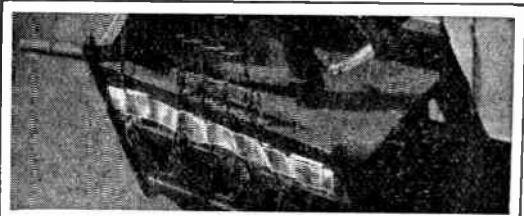

Sellotape

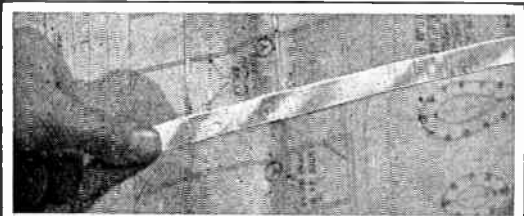

Whatever your hobby, Sellotape is your greatest ally. For masking paintwork, holding parts while gluing, protecting plans—and a thousand other useful jobs—it's Sellotape every time. It sticks at a touch without moistening. It fits evenly on a curving surface. There's coloured Sellotape for easy indexing, for recognition tags, and decorating. You just can't do without it. Get some today—and remember, if it doesn't SAY Sellotape —it isn't!

Stocked by all Stationers



The Bennett College

FOUNDED 1900

LIMITED



The Most Progressive and Most Successful Correspondence College in the World!

POSTAL TUITION is YOUR way to SUCCESS in the career of your choice—act NOW!

Is your Career here?

Accountancy Exams.
Applied Mechanics
Aviation Eng. and Wire
Blue Prints
Boiler Making and Eng.
Carpentry and Joinery
Chemistry
Civil Engineering
Civil Service

All Commercial Subjects
Commercial Art
Concrete and Structural
Engineering
Diesel Engines
Draughtsmanship
Engineering
General Certificate of
Educ. Exam.
G.P.O. Eng. Dept.
Journalism

Languages
Mathematics
Metallurgy
Mining. All Subjects
Plumbing
Police, Special Course
Radio Service Eng.
Salesmanship
Secretarial Exams.
Sheet Metal Work
Shorthand (Pitman's)

Short Story Writing
Short Technical Courses
Surveying
Teachers of Handicrafts
Telecommunications
Television
Transport Inst. Examinations
Viewers, Gaugers Inspectors
Wireless Telegraphy
Works Managers

★ If you do not see your own requirements above, write to us on any subject. Particulars Free.

Post this Coupon—TODAY!

and take the first step towards a position of responsibility in the Career of your choice.

To Dept. 62. THE BENNETT COLLEGE LTD. SHEFFIELD

Please send me (free of charge) particulars of.....
PLEASE WRITE IN BLOCK LETTERS

NAME

ADDRESS

AGE.....

Add realism to your Model Railway!

WITH '00' GAUGE

PLATFORM ACCESSORIES



This set of intriguing platform accessories is just what you need to add realism to your model railway.

Die cast and hand painted in bright colours, this set, No. 7, is '00' Gauge scale, and consists of a four-wheel porter's trolley, bicycle, chocolate machine, three milk-churns and weighing-machine. Price 2/6 complete set, including post and packing. Send now for this set.

We have a complete range of '00' Gauge model railway accessories. Send stamped addressed envelope for descriptive list.

TRADE ENQUIRIES ALSO INVITED

R. B. N. CO.

(DEPT. H) 180, BROADHURST GDNS., WEST HAMPSTEAD, LONDON, N.W.6
TELEPHONE, MAIDA VALE 1070

how about some Seelastik?



Every time this door slams a little more of the mortar or putty drops out. Why? Because it sets hard and shrinks and does not really stick.

They should have used Seelastik.

Seelastik forms a watertight, airtight seal and remains flexible and elastic when set; it sticks tenaciously even to highly polished surfaces, such as glass, as well as to any combination of brick, cement, stone, plaster, wood, metal, tiles, glazed earthenware . . .

A Seelastik seal costs 1/4d. to 1 1/2d. a foot, depending on its width. It is light-coloured, and can be painted 24 hours after it is put on.

You can buy Seelastik — packed in handy cartridges, and applied by the Expandite gun (50/- with two nozzles) — or in 2/- and 3/- tubes, which are self-contained sealing tools.

Seelastik

SEALS THE GAP

EXPANDITE LTD., CUNARD ROAD, LONDON, N.W.10

Printed by BALDING & MANSSELL, LTD., London and Wisbech, and Published for the Proprietors, HOBBIES LTD., by HORACE MARSHALL & SON LTD., Temple House, Tallis Street, E.C.4. Sole Agents for Australia and New Zealand: Gordon & Gotch (A'sia) Ltd. For South Africa: Central News Agency Ltd. Registered for transmission by Canadian Magazine Post.

Hobbies

WEEKLY

CONTENTS

	Page
A Small Rocking Horse	33
Model Village Smithy	35
For the Kitchen	37
Festival Bookends	38
A Child's Desk	39
Replies of Interest	40
Making a Plough Plane	41
Shipmodeller's Corner	42
More Toy Railway Trucks	43
Ways of Storing Negatives	44
DESIGN SHEET FOR LETTER RACK	

October 17th, 1951

Price Fourpence

Vol. 113 No. 2920

A welcome present for youngsters — A SMALL ROCKING HORSE

THE well known type of rocking horse depicted is usually too large for a young child, though excellent for older children. A reduced size would delight kiddies though—one that a toddler could play on, without the necessity for an older person to supervise. The subject of this article deals with such, as it is but half the dimensions of the commercially made toy, and a child would feel safe and be safe also on it. Incidentally it is easy to make and involves no difficult work making the horse.

Deal Will Do

A side view of the stand is given in Fig. 1 and an end view in Fig. 2. For the wood, a good quality of deal will serve nicely. The sizes of timbers are given in a cutting list and need therefore no mention in the text. Cut the ground members to length, these consist of one long timber with two side ones, jointed across. These joints are of the simple halved variety, common to all woodworkers, and clearly shown in Fig. 3. Glue and nail these across, as in the diagram.

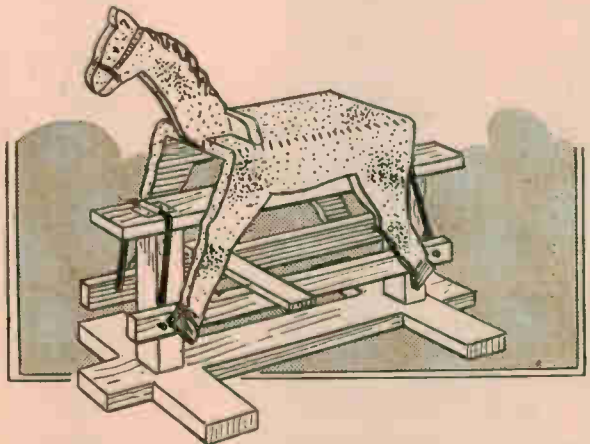

At each end an upright post is to be fitted which supports part (A) on which the rockers swing. These posts, shown at (B) in the side view, are cut to the length, plus $\frac{1}{4}$ in. at top and bottom for tenons, of the stub variety. Cut these $\frac{1}{4}$ in. square. Mortises for them are cut in the ground members, as in detail, Fig. 3.

See inside for a free Design for a Letter Rack

The easiest method is to bore out a $\frac{3}{4}$ in. hole first with a centre bit, and chop out the corners with a chisel. Cut board (A) and after chiselling out the mortises for the posts each end, $\frac{1}{4}$ in. deep, glue over the posts and leave for a while for the glue to get hard.

Stiffen the joints at the base with 3 in. steel brackets, screwed where shown in

Figs. 1 and 2. For the rockers, seen at (E) in Fig. 2 and in position at (D), get some $\frac{1}{2}$ in. wrought iron rod and bend to the shape and dimensions given in the drawing. Readers who may not feel confident enough to do this job themselves could have it done for them by any smith or ironworker locally. The sizes must be strictly adhered to though, and the work competently done. These are laid across part (A), just over the centre of the posts, and held in position by metal straps, 2 ins. wide, with the centres raised to U-shape enough to hold the rockers in place yet allow of free motion.

Rocking Bars

A pair of rocking bars (C) are then cut. At a distance from each end of $1\frac{1}{2}$ ins. bore a $\frac{1}{4}$ in. hole through these bars and slip them on the 'stick-out' ends of the rockers. This arrangement is clearly seen in the end view of the stand, Fig. 2. Though there is not much fear of the bars riding off the rockers, it would make for

All correspondence should be addressed to The Editor, Hobbies Weekly, Dereham, Norfolk.

definite safety if a hole were drilled through the projecting ends of them and a split pin inserted to keep the bars from slipping off. A footboard is then screwed across the bars, a little in advance of the centre for the kiddies' feet to rest upon. This is not shown in Fig. 1, but can be seen in the general view of the rocking horse. This board could be screwed underneath bars (C) instead of on top, if more convenient and suiting the length of leg of the child, but that is a matter for the reader to exercise his own judgment on.

At Fig. 5 is a pattern of the parts of the horse, drawn over 1in. squares. It would be a good plan here to reproduce the squares full size on paper of stiff variety, copy the outlines of the parts and then cut out. The patterns could then be pressed down on $\frac{3}{8}$ in thick board, and a

pencil run round them. Copy them on the board, with the grain of the wood running lengthwise as in the drawing, and cut out with a bow or coping saw.

Dovetailed Legs

It will be seen that the legs are to be dovetailed to the side pieces. Reduce the dovetails on the legs to half thickness, lay them on their respective sides in correct position, and pencil round the dovetails, then chisel these out of the sides to a depth of half the thickness of the wood. Make a neat close joint and glue and screw in securely. It is perhaps needless to remind the reader that the legs must be properly poised and if the two side parts are laid left and right on the bench, and the legs fitted to each, no mistake is likely to occur.

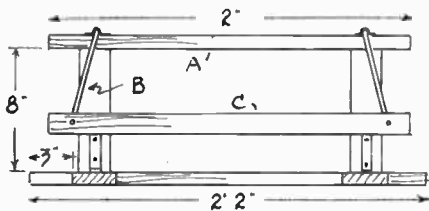

Fig. 1

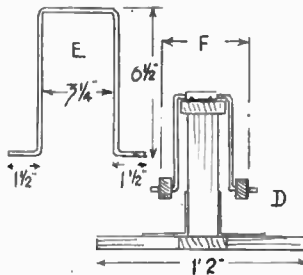

Fig. 2

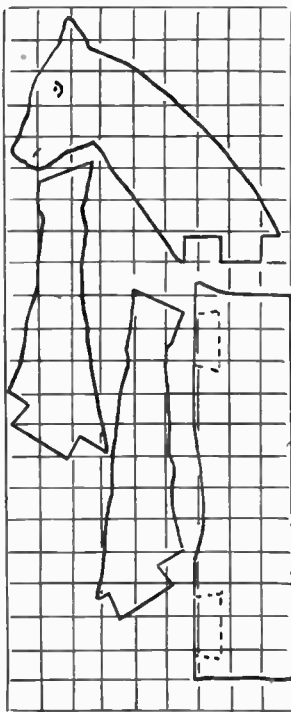

Fig. 5

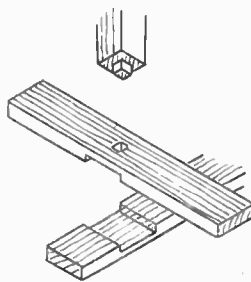

Fig. 3

The Seat

A piece of the board is needed for the seat. Cut this to 12ins. long, and with width (F) (Fig. 2). Lay the horse's head on the board and mark on the latter the correct spot for a mortise to fit the tenon. Glue and nail the legs and sides to the seat, as in detail, Fig. 4, and in the angles underneath, as shown at (G), screw 2in. steel furniture brackets each side, four being required. Now round off the side edges of the seat for comfort, and glue the head in position. Additional strength for the head can be gained by driving a screw in from beneath the seat into it. Fit the horse on with stout screws driven through the hoofs into rocking bars (C).

Painting

This practically completes the job of construction. The stand can be painted or varnished, the horse painted grey or brown. Grey looks well, and if stippled with a darker tint of the paint (easily made by mixing a trace of black with a little of the colour) in patches, a quite

CUTTING LIST

Ground member—2ft. 2ins. by 3ins. by 1in.
Ground member (2)—1ft. 2ins. by 3ins. by 1in.
Posts (2)—9ins. by 2ins. by 2ins.
Board (A)—2ft. by 3ins. by 1in.
Parts (C) (2)—2ft. by 1 1/2ins. by 3/4in.
Seat—1ft. by 6ins. by 1in. (approx.)
Footboard—1ft. 4ins. by 3ins. by 1in.
For the horse—3ft. run of 3/8in. by 9ins. board.

FITTINGS

3in. steel brackets (4).
2in. steel brackets (4).
3ft. 3/8in. iron rod (approx.).

professional effect results. The whole should receive a coat of clear varnish to finish.

The hoofs can be black, and details of the head, eyes for instance, picked out with a small brush. Mane can be made from a piece of fur, or just painted on;

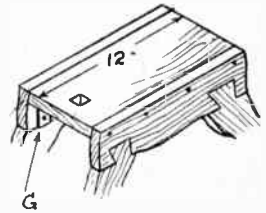

Fig. 4

bridle can be painted on also if preferred. A pair of leather reins can be added, or a pommel board, a piece of wood 3ins. wide and 8ins. long, screwed across the seat and tilted towards the horse's head, substituted for the child to rest its hands on when rocking the horse. (498)



LETTER RACK

For making the Letter Rack from this week's Free Design (No. 2920) the necessary materials are obtainable from Hobbies Ltd., Dereham, Norfolk, price 7/4, including purchase tax, and post free.

All about building a MODEL VILLAGE SMITHY



The completed smithy and tree

UNDER the spreading chestnut tree, the village smithy stands with its huge wooden horseshoe round the porch, and half-timbered plaster front, making a fine subject for a model, as can be seen by reference to the photograph. Such a model can be made entirely as a self-contained subject, or can be adapted to fit in with an existing model village the reader may be making, in which case it may be necessary to change the dimensions in order to suit the scale of the whole project. The same consideration may apply if the reader wishes to use lead figures of a blacksmith, horses, etc., and, naturally, wants to keep everything to scale. We will assume that the published dimensions are to be kept to.

Based on Reality

(We may note, incidentally, that this model has been based on actual smithies noted by the writer at Penhurst (Kent), Glynde (Sussex, as illustrated in the photo) and at Colley Weston (Northants). There are, no doubt, others featuring the wooden horseshoe, and the reader may possibly fill in extra details by actual reference to some smithy.)

The second composite photograph shows the model smithy and tree, as will be described, plus model figures obtained from a toy shop, the whole being set against a photographic background of an actual village street.

The first thing to do is to make a paper pattern or template of the horseshoe (20), drawn on a doubled piece of paper cut out and then opened to give a perfectly symmetrical shape, which is then cut in $\frac{1}{4}$ in. oak-faced plywood. The nail holes need not actually be cut through the wood but can be (a) just painted on, (b) incised with a very small chisel or knife, or, (c) represented by small pieces of fairly thick card glued on afterwards.

The main front (1) is now marked out and cut from $\frac{3}{8}$ in. plywood. The main cutting lines have been drawn very thick for easy reference. The chain dotted lines mark the position of pieces of stripwood (10), the roof (8), chimney (9), etc. The arch of the door is struck from two centres (x) and (y). A back is not at all necessary in the usual way, but where the present model is part of a larger scheme and spectators may see the back of it from certain viewpoints, a back may be made by duplicating the front but omitting the door and window openings.

The stripwood, etc., is not, at this stage, added to the front.

The base (2) is simply made from a piece of $\frac{1}{2}$ in. solid wood, dimensioned as shown, whilst the sides (3) (4) are also cut, noting that a window is required in one side only. The front and sides are nailed, box-fashion, to the base, but before this is done, the porch (11) had better be constructed. This is fully dimensioned in the sketch.

Triangular corner glue-blocks are used at the junctions of walls and front, and also along the slanting top to provide a bearing for the roof pieces (16).

Making the Chimney

Before the roof pieces (dimensioned at (8)) are applied, the chimney, shown in position at (9) and detailed at (14) is made. It has to be cut, at the base, at an angle of 45 degrees to take on to the roof (to which it is screwed, from below). The right-hand sketch at (14) shows how the chimney may be made to look more ancient: more in keeping with an old-world subject and not looking as though it had just rolled off the assembly line.

With the chimney applied, the roof pieces may be glued and tacked on. The stripwood at the front, together with the horseshoe is then applied. The spaces between the stripwood and the horseshoe are now filled in with plaster as shown at (12). Half fill an old cup with water and let some plaster trickle in, stirring gently all the time until the mixture is like a thick cream. Then



The real thing. A picture of Glynde Forge, Sussex

apply carefully to the front with an old spoon as shown, levelling off with any small flat piece of wood, being reasonably neat but not disdaining an incidental roughish look. You do not want the smithy to appear as sleek as the front of

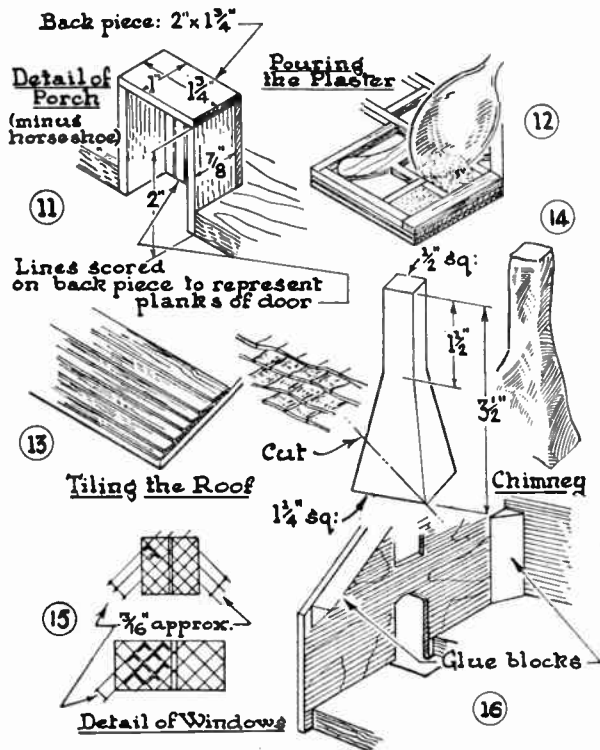
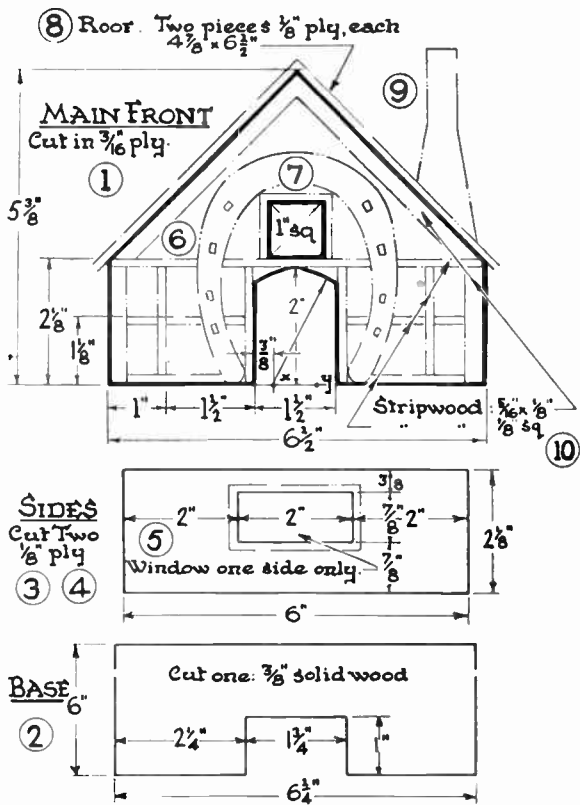

the latest chain-store building in the High Street!

Daub some plaster over the sides, too, to get a rough-cast look. It would be an advantage to roughen the sides by scratching with the corner of a chisel, to provide a key for the plaster.

The roof is now 'tiled'. This is done with strips of cardboard, not too thin, about $\frac{1}{8}$ in. wide, the first being glued to the front edge, and the second overlapping a little, as in weatherboarding (13). At the risk of repetition, however, the writer would stress that a brand-new look is not desired. A picturesque effect can be obtained by making, with a patch of card, plaster, plastic wood, etc., one or two 'bumps' on the roof so that when the strips are glued over, there is a typical age-old sagging appearance. The card strips can be cut with slightly wavy edges.

An even better effect could be obtained by rolling out strips of Pyruma modelling material and fixing them on with appropriate cement sold for the purpose. This material would certainly be useful for making the tiles at the ridge.

The window panes have still to be fitted, but these are best applied when the model has been painted. If any plaster has got on the front 'timbering' it can easily be sandpapered off. A couple of

The drawings above and right give all the measurements and constructional details necessary for both the smithy and tree

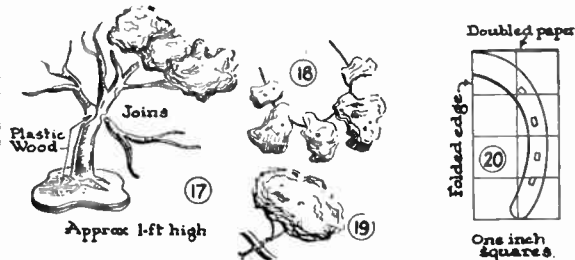

coats of size are then given to the model, and when quite dry, the plaster is painted yellow, suitably discoloured in places to represent age and also lightened in other places to represent recent repair work. Study an actual building for the 'gen'. Poster paint will do quite well if the model is varnished afterwards, to stop dust working in.

The varnish, however, should not look aggressively shiny. If it does, paper down with very fine glasspaper. The chimney may be represented as being either of brick or of plaster. In any case, the upper part will be shown blackened a little. The roof is a red-brown, suitably blended with shades of green, yellow, purple, etc., to get a mellow effect. The realist in model making may even add a messy, lichen effect or show an occasional loose tile. The whole effect should be one of mellow old age but not of decay

and dilapidation. The timber work at the front can be darkened.

The windows, shown in position at (5) and (7) and in detail at (15) are made of transparent plastic material (the blank or very faint films which the photographic developing and printing merchant returns to you are ideal for this purpose). Diamond shaped spaces, as detailed, are ruled in indian ink. It is best to rule the lines first, in pencil, on a scrap piece of paper and then trace off. Make the windows larger than required, as they are to be glued on from behind and a margin for gluing is required.

The Tree

Although described in connection with this particular model, the tree will come in handy for all manner of architectural

(Continued foot of page 38)

A counter table FOR THE KITCHEN

AN attractive modern idea from America, this counter takes the place of an ordinary table and is a permanent fitment in a convenient corner of the kitchen for quick 'snacks'. Stools are used for seating. At the end of the counter are three useful shelves.

Accommodation for Four

The dimensions given will accommodate four—at a squeeze—two each side. It is better, however, to plan for only one-sided operation, leaving the other side free for serving.

The counter itself has an overall length of 41 ins.—see Fig. 1. It should be cut from $\frac{3}{8}$ in. material for preference, with one end semi-circular. The length

go below 10 ins. in width.

The shelf parts are cut from ply or similar material. These are purely semi-circular in shape. The leg member is rectangular—Fig. 2. Two side members are also required to stiffen the leg assembly.

The leg and the two side legs are glued and screwed to the counter—Fig. 3—and backed up with a length of triangular stock, glued in place. Make sure that this assembly is square and true.

Fixing the Shelves

The three shelves can then be screwed to the leg. The larger diameter shelf is

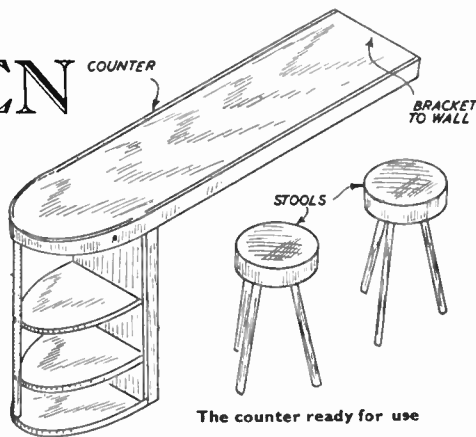

The counter ready for use

Facing Strip

A facing strip of $\frac{3}{4}$ in. by $\frac{1}{2}$ in. stripwood is then glued around the upper edge of the counter, as shown in Fig. 5. Strip of this size will bend readily to the curve of the end without steaming or wetting, if good straight-grain stock is chosen. One of two pieces will be required, scarf-jointing, as indicated. It is best to attach these strips with panel pins, as well as gluing.

Bright Colours Preferred

The assembly can then be stained and polished or painted. Finishing in a bright colour is more in character with the piece and cellulose lacquers are easy to apply. For best results, first fill the grain of the wood and glasspaper perfectly smooth. If possible, apply the

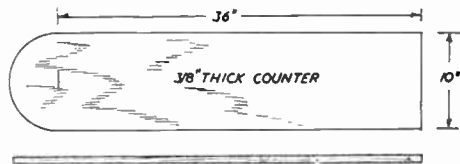

Fig. 1

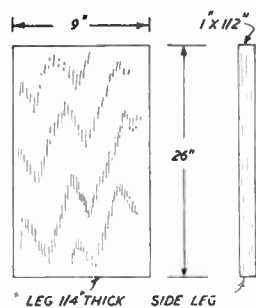

Fig. 2

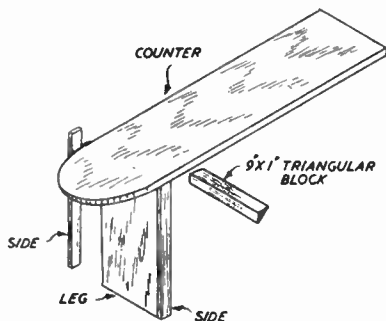

Fig. 3

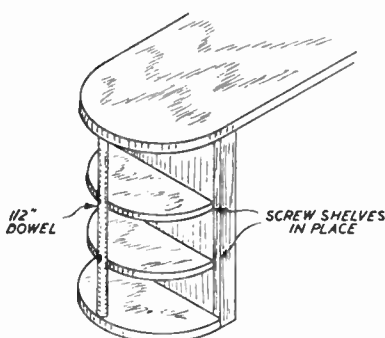

Fig. 4

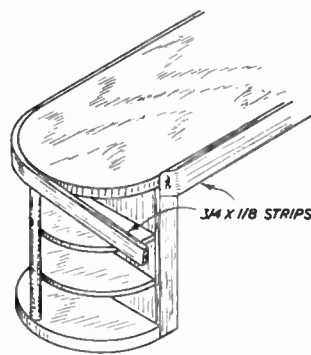

Fig. 5

dimension given is quite suitable for ordinary use, but there is no objection to increasing the width. This will depend almost entirely on the amount of space available where the fitment is to be located. The 'free' end must be bolted or bracketed to a wall or similar permanent vertical member—so plan your overall dimensions accordingly. If necessary, reduce the length, but do not

screwed flush with the bottom—Fig. 4 and the two other shelves spaced equidistant between top and bottom. To complete the assembly, mount a length of $\frac{1}{2}$ in. diameter dowel in blind holes drilled in the underside of the counter and top of the base shelf, and screw through this dowel into the shelves. A touch of glue will also improve these joints.

lacquer with a spray gun.

Linoleum Top

The top of the counter should be covered with linoleum, ply veneer or similar, as painted surfaces do not take kindly to constant wear. Try whatever scheme suggests itself, for it is a relatively simple matter to strip worn or damaged covering off and replace. (489)

To remind you of 1951— 'FESTIVAL' BOOK-ENDS

IN response to inquiries from readers, we have prepared drawings for the 'Festival of Britain' book-ends which are illustrated on this page. Those of our readers who have been to the South Bank Exhibition may like to make up these book-ends as a reminder of their visit.

The diagram in Fig. 1 shows that each 'end' is made up primarily of three pieces of wood. These are cut from $\frac{1}{2}$ in. wood to the measurements shown, and are screwed and glued together, using countersunk screws. The drawing at

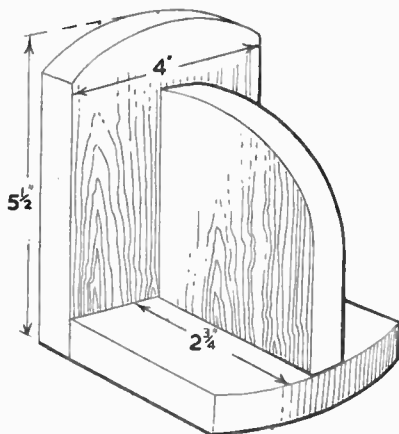

Fig. 1—The dimensions

Fig. 2 gives the exact shape of the buttress. Use the 'square' method for enlarging, dividing the base into eleven

equal parts, using these divisions as the sides of your squares. Enlarge the squares to $\frac{1}{4}$ in. For those who are unable to do the enlargement, a full size tracing is obtainable from the Editor. A stamped envelope must be enclosed.

The Festival Emblem is intended to be an overlay, possibly of $\frac{1}{16}$ in. wood or even of suitable metal, cut out with a metal-cutting saw. Metal-cutting saw-blades may be obtained by post, direct from our Mail Order Dept. at Dereham, Norfolk. Two overlays are required for each end, and they must be glued in position and clamped together until the glue has set.

To finish off, the main part of the book-ends may be polished or varnished and the Festival Emblems suitably coloured. The head should be coloured red and white, while the points of the star should be blue, white and red. In

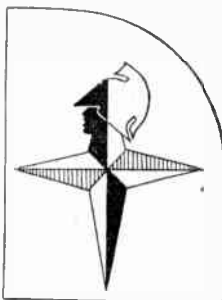
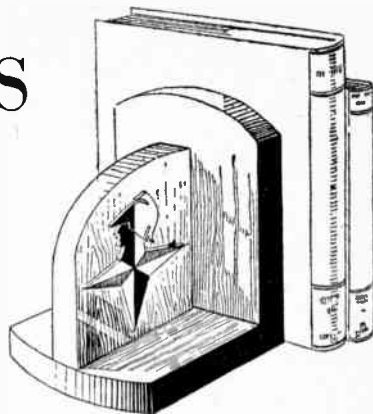

Fig. 2—Details of the buttress



the picture of the finished thing the blue is shown solid black, the red shaded and the white left plain.

Inlay

Instead of making the Festival Emblem an overlay, you may like to cut it as an inlay decoration. Trace it carefully on to the buttress piece and cut out with a fine grade fretsaw. Drill a small hole in the centre of the star portion to start the blade and then proceed to cut very carefully and deliberately. Do not press too hard on the sawblade, but let it more or less find its own way along the pencilled lines. Keep the saw upright all the time and allow the pieces to drop out as cut.

Stain or paint each piece to represent woods of different shades. The red portions could be padouk, the blue walnut, and the white, sycamore. The white can be obtained by using chinese white with a little yellow added. The pieces are now glued back in their original positions and the whole thing varnished. (109)

Model Smithy—(Continued from page 36)

models. The method described is, of course, only one way of doing it. First, a suitable piece of bushy twig is required to represent the trunk and branches. Very often a root can be utilised for the purpose. You will be very fortunate, indeed, if you can find a suitable piece that needs no trimming. Usually some side pieces have to be trimmed off whilst extra branches have to be added to 'bald' places. To add extra branches, just make a hole in the trunk, taper off the end of the extra branch, neaten off with plastic wood.

The base is an irregular piece of plywood from the scrap box, sufficiently large to prevent the tree overturning. The trunk is screwed to it and out-cropping roots represented by plastic wood, suitably shaded afterwards.

Obtain a cheap sponge and dye it

green, or better, obtain a sponge—usually artificial, already dyed green as natural sponges do not readily take dye. Break off small pieces, tease them out and then thread them on reasonably stout wire as shown, so as to get a fan-shaped clump of foliage, several of which are bound to the tops of twigs.

Well-Balanced Tree

Aim at getting a well-balanced tree (which is about 12in. high). Study an actual tree. It is rather too much to expect that the tree should be a perfect miniature of, say, a chestnut tree, and only the out-and-out specialist would attempt to show, for example, chestnut tree 'candles', though this has been done by gluing on grains of rice, sago, etc. (Readers in, or visitors to, London, should see the fine dioramas in the

Imperial Institute, South Kensington, an inspiration for this kind of modelling.)

Reference to an actual smithy will show that the smith is usually far too busy to bother about gardening, and his smithy is usually surrounded by clumps of nettles, from which peep rusty parts of machinery, etc. Loofah, dyed in household dyes and teased out will come in useful here. The approach to the doorway (it is presumed that the model smithy and tree are mounted on a larger base) can be made of rough plaster with some sand sprinkled on in places and touched here and there with green.

Indeed, much of the fun in this kind of model making lies in following the basic instructions up to the all-but-last stages, and then adding one's personal touches. So, with this, we can safely leave the reader. (492)

Detailed instructions for making A CHILD'S DESK

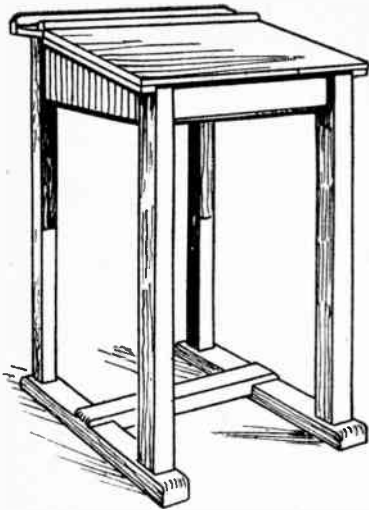

ILLUSTRATED here is a first-rate little desk on which the children can do their homework, write letters to their chums, and so on. It is of sturdy construction and neat appearance, and has a lift-up lid which is shaped conveniently for writing. There is a useful space for holding books and stationery, and the usual school paraphernalia.

The height of the desk has been designed for the young child, but it can easily be increased if thought desirable. The width might also be increased 2ins. or more if for an older child.

How to Start

First, draw the sectional view as in Fig. 1 full size. This will assist in marking off the right shape on the top of the legs. Take the legs and mark out the mortises for the rails. Fig. 3 shows the mortise and tenon joints used, and will help in the pencilling out. Note the circled diagram in Fig. 3, which shows how the rails meet together in the cut-through mortises in the legs. It means that the ends of the tenons must be cut to an angle of 45 degrees.

At the bottom end of each leg, cut a tenon as seen in Fig. 4 $\frac{1}{2}$ in. wide and 1in. deep, the latter being the thickness of

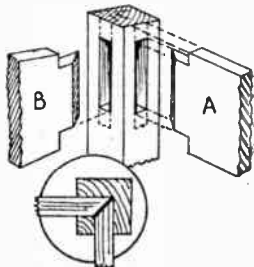

Fig. 3—The joints used for the rails

the floor rails (D). Now lay the front legs on the drawing and mark off the correct shape of the top and saw them across accurately on the line.

The rails (A), (B) and (C) are cut to length, allowing 1in. each end for the tenons. Cut these to correspond with the mortises, and as they have to meet together in the legs, mitre the ends as before mentioned.

The shape of the side rails will be marked off from the drawing. Note that the front rail will have to be slightly bevelled on its upper edge to conform with the shape at the top of the legs.

Fit all together temporarily. Cut the floor rails (D) to length, and, in the

rails and with the corners cut away and trimmed round to clear the legs. Screw the floor to the rails as shown in Figs. 1 and 5. Now cut the bottom cross rail (E) to length, and at each end form a sinking $\frac{1}{4}$ in. deep by 2ins. wide to fit nicely into the floor rails. Glue the rails and put in screws from beneath. The ends of the floor rails, and those of the cross rail should be rounded off and made smooth.

The top of the desk is in two parts. First cut piece (F) and fit it temporarily with a nail each side, partly driven in. For the desk lid itself (G) it may be necessary to glue two boards together to make up the width. These would be

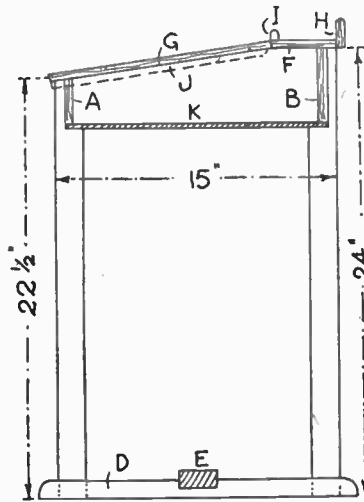

Fig. 1—Side view with dimensions

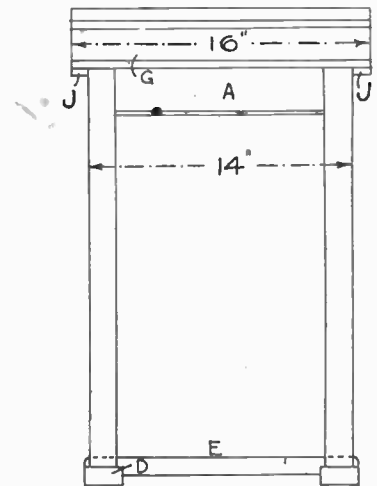

Fig. 2—Front view

centre of each, saw across and chisel out a groove $\frac{1}{4}$ in. deep and 2ins. wide as in Fig. 4 to receive the bottom cross rail. At the correct distance apart, cut the mortises for the legs to enter. Now glue all the pieces together.

When the glue has set hard, the floor (K) of the compartment can be fixed. A piece of plywood would be best for this, cut to sufficient size to cover all four

better doweled or tongued and grooved together, in fact, tongued and grooved matchboards could be used if the bevelled edge is left on the underside.

To keep the desk lid flat and free

(Continued foot of page 40)

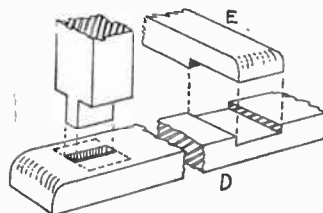

Fig. 4—Details of the joints at the base

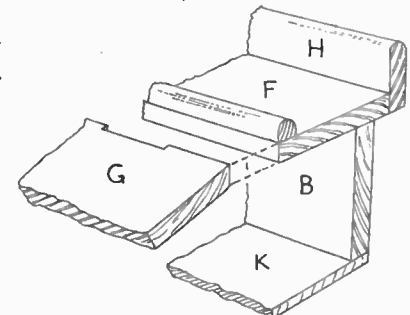

Fig. 5—Where the top is hinged



REPLIES OF INTEREST



Range Coil Note

KINDLY let me know if I may use an R.I. Micrion Dual range coil in the All-dry One-valver published in *Hobbies Weekly*, January 10th, 1951. Six terminals on the base are marked A.S.E. G. R.A. R.E. There are two more on the can. sides; these are not marked. If I may use the coil, how are the connections made to the other components? (A.F.—Catford).

NO standard method of marking Ncoils by particular manufacturers exists. However, it is probable that your coil is intended to be connected as follows:—(A) to Aerial. (S) to one contact of an on-off type switch. (E) to Earth line of set. (G) to grid condenser (fixed plates of tuning condenser). (RA) to detector anode. (RE) to fixed plates of reaction condenser. Moving plates of reaction condenser and remaining contact of switch mentioned go to earth line of set. Assuming the coil is the normal type, medium waves will be tuned with the switch closed, and long waves when it is opened. It is not possible to say what the unmarked terminals are for; one may be connected to the shielding can. If so, earth this.

Fixing Tapestry

PLEASE inform me how I can fix a tapestry in a firescreen—how can I keep it taut? (J.W.—Cockfosters).

MAKE a wood frame of $\frac{3}{4}$ in. by $\frac{3}{4}$ in. wood to the size of the firescreen, and on this fasten the tapestry either with tacks or drawing pins to the edges of the frame or the back. The method to bring the tapestry quite taut is to tack in the following order. Two tacks at top, pull stuff tight and tack to the bottom.

Two tacks one side, pull tight again and tack the opposite side. Now add two more tacks at the top, then repeat at the bottom then the side, drawing the tapestry tight each time. Repeat in the above order until only the corners are left, which are then neatly folded and finally tacked to complete. The material will then be quite taut all over and ready to place in the screen.

Marquetry Pictures

I AM making marquetry pictures in wood and would like to know how it is possible for me to colour these with stain to show the grain of the wood through the stain. I want colour stain, e.g. red, blue, green, yellow, etc. Must I stain before glasspapering or after? (R.O.—Rochdale).

ANILINE dyes soluble in water or methylated spirit, will be suitable for your purpose; the spirit dyes being considered better for hardwoods. With water dyes, a little gum should be added; with spirit dyes a small percentage of white polish, to set the stain and prevent it rubbing off. With regard to your second query, staining the pieces before gluing would be preferable, but for one snag. Levelling off afterwards with scraper and glasspaper would remove some of the stain, and a patchy result occur. We consider the best method would be to join the parts as usual, and level off. Then to mop the surface with rice water (water in which a little rice has been boiled) and when dry, glasspaper again. This should be repeated once or twice to build up a body on which the stain is unlikely to run. Then the separate parts can be stained, but a steady hand and small brush will be needed.

Renovating Woodwork

I HAVE a radiogram cabinet which has got rather badly scratched. I would like to know if it is possible, and how I could darken or deaden the scratches with or without darkening the whole cabinet. (S.B.—Leiston).

APART from scraping and repolishing, it is difficult to entirely remove scratches from any polished woodwork. About the best treatment as a substitute, is to rub over the scratched area with a mixture of linseed oil and turpentine with a little vinegar added. A gentle application should do much to lessen the prominence of the marks. After which, a cloth damped with methylated spirit should be rubbed over to remove any trace of greasiness. A good application of furniture polishing cream will restore the polish, and after several applications the scratches if not entirely removed, should be much less conspicuous.

Using an Old Motor

I HAVE a motor removed from an old Goblin cleaner, and should like to know if it would be possible to make a small circular saw or bench lathe work with any degree of efficiency with this motor. Also, what size saw and pulleys would be best suited for the circular saw in particular? (A.H.—Terenure).

IT is unlikely that the motor exceeds $\frac{1}{4}$ h.p., and this would be insufficient for large sawing or turning. Small sawing jobs (joinery, and similar work) would be possible, and a 3ins. or 4ins. diameter saw is normally used for this, with a reduction gear ratio of about 4:1 or 5:1, which could be obtained by pulleys 2ins. and 8ins. in diameter. If deep cuts in hard wood are not anticipated, a smaller ratio might prove satisfactory, especially if the saw is small. For small wood turning, a similar ratio can be used. As you have comparatively little power, big work should not be anticipated, but small jobs should be within the motor's capabilities.

Child's Desk—(Continued from page 39)

from warping, glue and screw two ledges as (J) in Figs. 1 and 2 to the end edges. Next cut two shallow recesses to receive both flaps of a pair of 1in. hinges as seen in Fig. 5. Now remove the back rail (F) from its temporary fixing, and connect up with the lid. Refix the top rail with glue and screws, noting how the ledges along the edges make a close fit to the front pair of legs. Finish along the back of the desk with the narrow rail (H) which must be rounded off along its top edge as seen in the section Fig. 1 and in detail Fig. 5.

Put in a small bead (I) also to the front of rail (F), the top being rounded in a similar manner to rail (H). Clean up all the woodwork with coarse and fine glasspaper, and trim away all sharp edges and corners.

Give the whole article a coating of size to fill the grain of the wood and a finishing coat of clear varnish. If desired, the desk could be painted a suitable colour, say, pale blue or green.

The cutting list given here will be found useful when getting out the wood for the job, and cutting it ready for

assembly.

(473)

CUTTING LIST

- A. Front rail—13ins. long, $2\frac{1}{2}$ ins. by $\frac{1}{2}$ in.
- B. Back rail—13ins. long, 4ins. by $\frac{1}{2}$ in.
- C. Side rail (2)—14ins. long, 4ins. by $\frac{1}{2}$ in.
- D. Floor rail (2)—17ins. long, 2ins. by 1in.
- E. Cross rail—15ins. long, 2ins. by 1in.
- F. Top rail—16ins. long $3\frac{1}{2}$ ins. by $\frac{1}{2}$ in.
- G. Top (desk)—14ins. long, 12ins. by $\frac{1}{2}$ in.
- H. Back ledge—14ins. long, $1\frac{1}{2}$ ins. by $\frac{1}{2}$ in.
- I. Front ledge—14ins. long, $\frac{1}{2}$ in. by $\frac{1}{2}$ in.
- J. Side battens (2)—12ins. long, 1in. by $\frac{1}{2}$ in.
- K. Floor—14ins. long, 13ins. by $\frac{1}{2}$ in.

There's nothing difficult about MAKING A PLOUGH PLANE

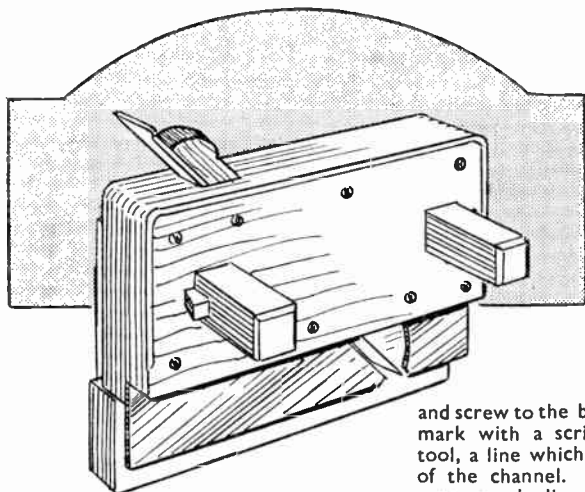

THIS important part of the woodworkers' kit is an expensive tool to purchase now, but fortunately can be made at home with little or no expense, bar the necessary irons. For all work involving panels, its usefulness lies in cutting the grooves in which the panels fit, and thus avoids the extra trouble and time involved in heading in, or the unworkmanlike method of just nailing the panels on from inside. The only material needed is a piece of hardwood such as beech, mahogany, or oak for example, $\frac{3}{4}$ in. thick or thereabouts.

Careful with Screws

A side view and cross section of the body of the plane are given in Fig. 1. Cut two pieces of the wood to the dimensions of (A) and screw both together. Be careful in placing the screws, in fact it would be as well to use only four at first, one in each corner, about $\frac{1}{2}$ in. in, and in the case of the two bottom screws, 1 in. up. In these parts a sloping channel is to be chiselled out for the plane iron and wedge. Pencil lines across the top and bottom at the distances from the left side shown. Now separate the two pieces and join the lines at top and bottom to show the slope of the channel.

On these lines cut the grooves on (A) and (B) $\frac{1}{8}$ in. deep. Hold them together and test with a cutting iron to see that the iron fits in the channel satisfactorily. Now measure off, and from the measurements cut the wedge to the shape and approximate length indicated in the diagram by dotted lines. It will be seen from the sectional view that part (B) is

$\frac{1}{2}$ in. less in width than (A), as a strip of this width should be sawn off the bottom edge and the rough edge left planed smooth. Now rescrew both together again.

To the extended portion of (A) below (B) a strip of metal (C) is to be fixed. Cut this from mild steel or other suitable metal, $\frac{1}{8}$ in. thick, and where shown in the drawing drill some screw holes

and screw to the body of the plane. On it mark with a scribe or sharp pointed tool, a line which will be a continuation of the channel. Remove and saw (C) across on the line. Shape it a little where the iron will rest upon it, and rescrew it in position. The piece sawn off is then cut and filed to the shape shown in the drawing, and also rescrewed in place.

necessary both slide holes to ensure an easy movement. All being satisfactory, cut the parts (D) from $\frac{3}{4}$ in. wood to the dimensions given. The actual fence (F) is also cut from the $\frac{3}{4}$ in. wood and is the same length as the plane body and $1\frac{1}{2}$ ins. wide. Screw slides (E) to parts (D) strongly, fit the slides in their respective holes and push up until parts (D) butt up against the plane. In this position screw fence (F) in place.

Smooth Movement

Now try the movement of these parts which should be smooth and easy, and the fence should hold well when fixed in any position with the wedges. The screws in (F) should be well countersunk, leaving no edges outside to scrape the wood while guiding the path of the plough. Now strengthen the whole with more screws, also well countersunk, to bind the two parts of the body plane firmly together. The position of these is shown in the view of the completed tool.

The top corners of the plane should be rounded off a little, and a chamfer worked on both sides stopped at $\frac{1}{4}$ in. from the

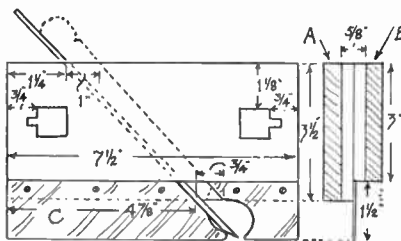

Fig. 1—Side view and cross section of the plane

Try the iron and wedge in position and see that a small space, say $\frac{1}{8}$ in., exists between the iron and the end portion of metal part (C). A little filing here may be necessary.

For the fence, shown in isometric projection in Fig. 2, a couple of $\frac{3}{4}$ in. square holes must be cut through the body. Mark the position of these accurately, and first bore out $\frac{3}{4}$ in. holes straight through with a centre bit, and chop out the corners with a chisel. On the other edges of these holes cut sloping slots for wedges. These can be $\frac{1}{2}$ in. by $\frac{1}{2}$ in. on the front, and $\frac{1}{2}$ in. square at the back. For them provide a pair of wedges, as in detail Fig. 3.

From Fig. 2 the shape of the fence will be made clear. Cut the slides (E) $\frac{3}{4}$ in. square and 6 ins. long. Plane to size very accurately and glasspaper as may be

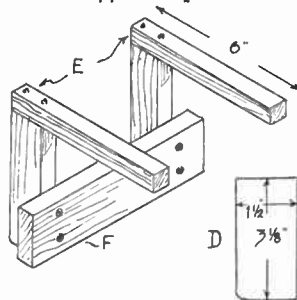

Fig. 2—Details of the fence

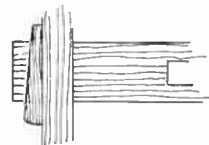

Fig. 3—How the wedges are fixed

bottom. This will make the plane more comfortable to the hands. The ends of the slide look better if a neat bevel is worked round. Both finishes are clearly shown in the general view.

Cutting irons for these planes, which can be bought at any tool shop, vary from $\frac{1}{2}$ in. wide to $\frac{3}{8}$ in., but for most users $\frac{3}{8}$ in. and $\frac{1}{2}$ in. size will be enough; others may be purchased as the need arises.

(495)



The SHIP MODELLER'S Corner



IN the making of ship models it is necessary to have some means of making the various small turnings required, such as deadeyes, guns, stanchions, wheel, etc. Commercial items are very often not to the scale you require, and they are usually costly. And the keen model maker, naturally, desires to make every item himself, and most have to do so by laborious hand methods.

A Question of Pocket

The purchase of a lathe is out of reach of the pocket of many, especially the young beginner, and for the purpose of assisting our readers to get the best out of their hobby, I am going to describe a very efficient little lathe that can be made at home quite simply and at low cost—one such as I used myself years ago, before I obtained a Hobbies lathe. For those who

Building a Small Lathe For Shipmodellers (by 'Whipstaff')

the lathe is complete, will be screwed to the bench permanently, or for greater convenience, it can be used in the bench vice by adding a strip of wood 2ins. by 1in. screwed to the underside of the bed and running the whole length of the base, as in Fig. 1. This strip is held in the vice, the lathe bed resting on the jaws of the vice.

Next prepare two pieces 4ins. by 3ins. by 1/2 in. by marking across the top of each piece a line 1in. down from the top as in Fig. 2. In the exact centre of each line a hole must be drilled; in one piece 3/16 in. to take the handle of the drill, in the other 1/4 in. to hold the drill next the chuck.

Place each piece in turn in the vice and drill down 3/4 in. from each side to take the 1 1/2 ins. fixing screws. Now cut along the two pieces, straight along the pencilled line through the centre of the drilled holes. Thus you have the two clamps to hold the drill firmly. Line the inside of the clamp holes with rubber cut from an old cycle inner tube to make them grip firmly.

Piece (A) with 3/16 in. hole, is glued and screwed to the left hand end of the base, and piece (B) (1/4 in. hole) on the base at a distance of 4 1/2 ins. from piece (A) (see Fig. 3). Now two strips 1/2 in. by 1/2 in. are glued and screwed to the edges of the base from piece (B) to the end of the base to raise the upper bed 1/2 in. from the base.

bolt in the slot head downwards. This, with a wing nut, will hold your tailstock, which can be moved along and secured at will by the wing nut.

To make a tailstock, we need a piece of wood 3ins. by 3 1/2 ins. and 3/4 in. thick. Again mark a line across the top 1in. down and find the exact centre of the line. At this point, drill a hole to carry the stock being turned. It is advisable to make three tailstocks to take stock 1/4 in., 3/8 in. and 1/2 in., because all your turnings will not be exactly the same size.

Glue and screw this piece to the end of a block 3ins. by 3ins. by 3/4 in., drilled with a 1/4 in. hole to take the bolt.

A block of wood approximately 1 1/2 ins. by 1 1/2 ins. by 1 1/2 ins. is now glued in the angle of these two pieces to support the stock for turning. The size will vary according to the size of hole drilled to carry the stock, but it must have the upper surface level with the bottom of this hole.

The tailstock is now slipped over the bolt and the wing nut tightened, and by placing our stock in the drill chuck, through the hole in the tailstock, it is resting on the block ready for us to commence turning.

A better appearance is given to the lathe by rounding the upper corners of the clamp pieces and tailstock.

A Few Tools

We now need some tools for turning and for small work. Much use can be made of small files of varying shapes.

A small turning chisel can be made from an old file or piece of tool steel. For gouges, small gouges similar to those sold by X-Acto are useful.

It would be of help to purchase a set of turning tools, when available, similar to those supplied in sets of three by Hobbies Ltd., if you have had no experience in the making of tools.

For those who can make their own, I will, in a later issue, give instructions on the making of chisels, gouges, scrapers, etc., from old files and hacksaw blades.

Scrapers are useful if turning many numbers of similar items; guns, for example. Cut to the profile of the article and use for finishing off after turning with a chisel. They ensure uniformity of shape and size.

Special tools can be made for most jobs and simplify the turning of all items so necessary to the ship model enthusiast.

(440)

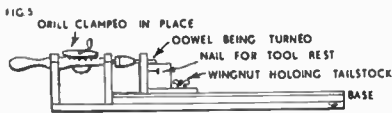
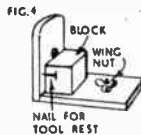
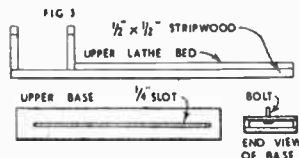
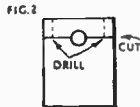
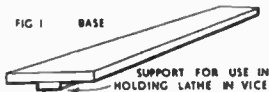

Stages in construction

do possess a Hobbies lathe, I will, in a later article, deal with the numerous accessories that can be made to widen the scope of the work that it can be used for.

For our small lathe we need a hand drill. All measurements must be adapted to the take of drill you have. Mine was a Miller's Falls and all measurements given apply to this particular make.

Our base is a piece of 3/4 in. deal, 24ins. long by 3ins. wide. This, when

The Upper Base

The upper base is a piece of 1/2 in. plywood with a slot 1/4 in. wide fretted out 17ins. long down the exact centre. The upper base, being 18ins. by 3ins., is then screwed and glued to the top of the base after inserting a 1/4 in. or 3/8 in.

MORE TOY RAILWAY TRUCKS

FROM ODDMENTS OF WOOD

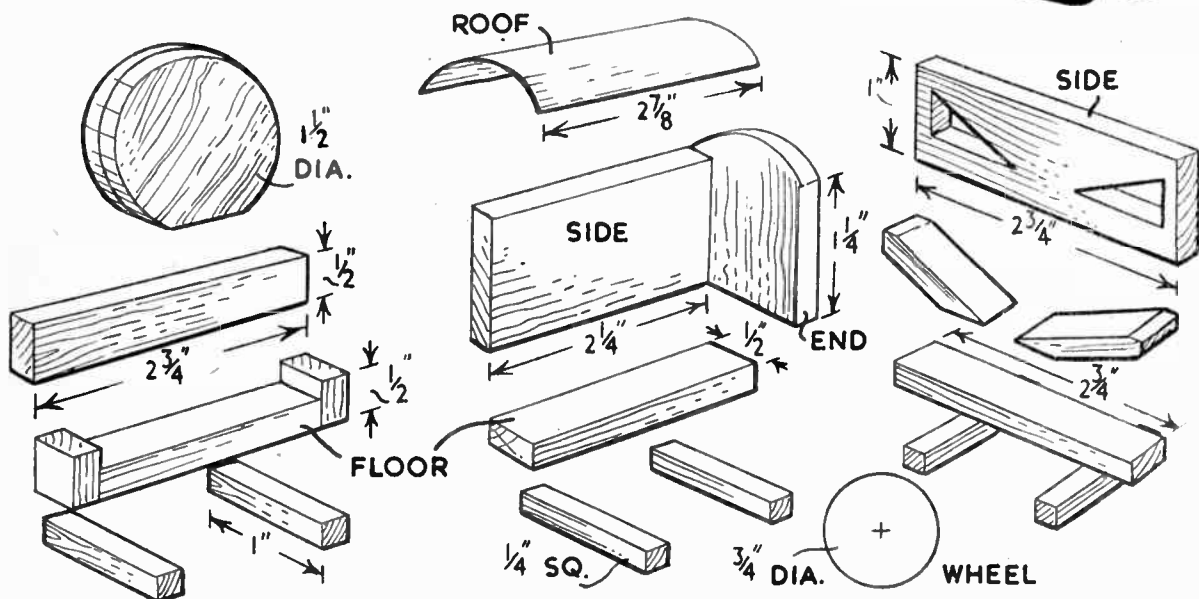
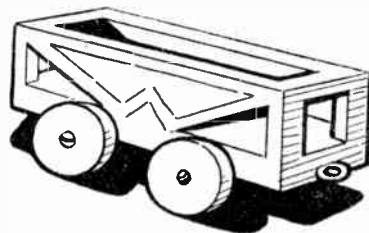
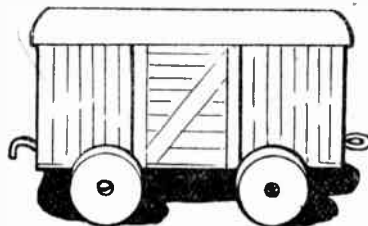
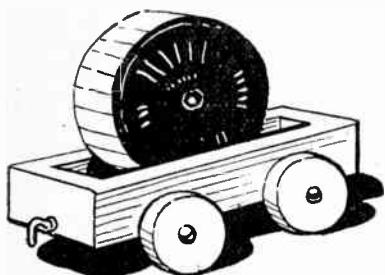

FLAT TRUCK WITH CABLE DRUM

THE small toys shown here are accessories to the engine, tender and open truck given in our issue of October 3rd. They are made on exactly the same principle, 1/4 in. wood being used throughout. The shaping in each case has been kept to a minimum, so that it is possible to make up the three in an evening and even get on a first coat of paint.

The Flat Truck

The body is made up from five pieces of wood, two sides and ends, and the floor. The sides are 2 3/4 ins. by 1/2 in. and the ends 1/2 in. square. The floor is 2 3/4 ins. by 1/2 in. Glue the ends to the floor as shown, and then glue the sides in position. The axles are cut from 1/4 in.

LUGGAGE VAN

square stripwood and are each 1 in. long. Glue them in position, keeping them approximately 1 1/2 ins. from centre to centre.

The cable drum is represented by two circular pieces of wood 1 1/2 ins. diameter. Glue these together and trim off about 1/2 in. from the bottom. Now glue in position in the truck.

The Luggage Van

The two sides, each measuring 2 1/2 ins. by 1 1/2 ins., are glued to the floor, also 2 1/2 ins. long. To these are glued the ends which are 1 1/2 ins. high overall, and 1 in. wide. The top of each end is curved to take the roof which is made of thin card 2 1/2 ins. long and approximately 1 1/2 ins. wide. The two axles are now glued in place as for the flat truck.

HOPPER WAGON

The Hopper Wagon

There is a little more detail with this one, the sides being fretted, and the ends shaped and sloping. Two triangular pieces are cut out of each side as shown. The ends are each 1 1/2 ins. by 1/2 in. and are chamfered to fit the floor and sides. The floor is 2 3/4 ins. by 1/2 in. and goes between the sides as shown in the sketch. The axles are as for the previous two.

All that remains now is to make the wheels and add the hooks and eyes. Obtain a piece of 3/4 in. round rod and cut off in 1/2 in. lengths to form the wheels. A small hole must be carefully drilled in the centre to take a thin 1/8 in. round-head screw. To find the exact centre of

(Continued foot of page 45)

Simple and efficient ways of STORING NEGATIVES

MOST of us will now have finished our holidays for another year, and, it is hoped, the great majority will find themselves with a further batch of negatives. The question we each should ask ourselves is 'What am I going to do with these films?'

Many of you will possibly attach a greater value to this year's taking because you have been persuaded to do your own developing, and have realised not only how very easy the work is, but also how much more enjoyment and pleasure it has added to the hobby. You really do feel that you must do something to keep them in good condition, always ready to hand for making more prints, and, perhaps, at a future date, one or two enlargements from the best of them.

Those amateurs who have not taken the plunge and are still content to let the chemist round the corner do the developing and printing will, in all probability, have a dozen or two negatives and one print from each parked in a wallet and stowed away in one of his pockets, or, if that amateur happens to be a lady the wallet will find rest, of a kind, in a handbag.

Possible Value

Now those negatives have cost money, and it is quite possible for them to become very valuable some time or other in the years to come. Anyone who started photography at the beginning of this century will tell you that, if he had kept all his good negatives, many of them would now be priceless because of their historic or other special interest. Many negatives in those days were glass plates and could not be kept in pockets or handbags, and in any case it is a bad policy to keep films in this manner, for they are bound to become scratched, finger-marked or cockled.

Decide without further hesitation to take care of all your negatives, not, however, by just dropping the wallet into a drawer in your desk or box in your den at home. Make up your mind to adopt one of the systems detailed. I can assure you that you will be always pleased that you did so, and surprised what a time saver it is, how quickly it grows, and how proud you feel about it.

Many readers will be thinking that there are some negatives in the collection that are not worth keeping. This is a question which the individual is best able to answer. Obviously, a grossly under- or over-exposed negative, or one

that is completely spoiled by fogging or movement or any blemish that prevents a reasonably perfect print being made from it, should be destroyed for it will only become a nuisance. Portraits and snaps of parties taken on various outings and picnics are a class on their own, and you will find it is advisable to treat them as such and allot them a special envelope.

The first of the systems is one which I would advise for those amateur whose collection amounts to about two hundred negatives in the course of a year, and includes a general run of subjects such as Landscapes, Seascapes, Animals, Historical Buildings, etc.

You all know what a card index cabinet is. Any stationer's shop can supply the necessary drawers, and all you require is a single drawer to take envelopes about 4½ ins. by 3 ins., or 6 ins. by 4½ ins. These are standard sizes and the drawers are obtainable in wood or strong thick cardboard. My first experience was with the larger size and it served its purpose splendidly until my annual number of negatives became considerably larger and the work necessitated filing in a more selective manner.

To acquire the drawer at a minimum expense, look in any 'junk' shop. It is often possible to pick up one for a shilling or two. Next, purchase a supply of good quality envelopes that will stand a fair amount of handling—100 will do for a time—and also a dozen index cards. With these few items you can get busy straight away.

Ways of Filing

There are two different ways of filing. You can collate under the titles of subjects or occasions. If the former, then sort out Landscapes from Seascapes, Woodland Scenes, Figure Studies and so on from your collection of negatives for the year 1951. Place each group in a separate envelope and mark that envelope on the flap '1951, LANDSCAPES No. 1', '1951, SEASCAPES No. 2'. Continue with each group in this way, giving each subsequent one the next number. Then take one of the index

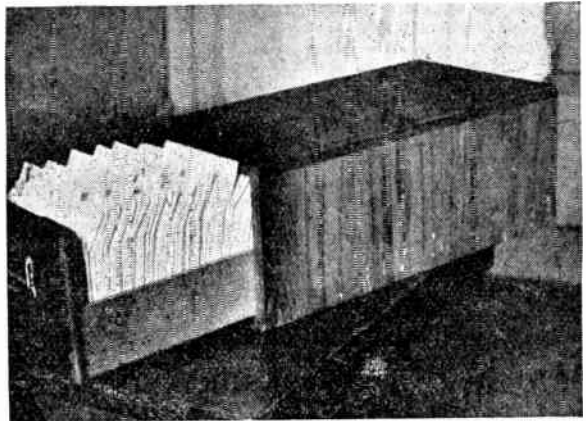

A suitable filing cabinet

cards, and head it 1951, and below this make a list of all the groups showing the number in a column on the left hand side as No. 1 Landscapes, No. 2 Seascapes, No. 3 Woodland Scenes, and so on until the whole of the series is recorded on the index card for the year. Each succeeding year will have its own index card and its own batch of envelopes, and be sure to mark each envelope with the date of the year on the flap.

When this part of the system is completed, place the index card in front of the envelopes in their right order in the drawer. You can then be quite satisfied that your collection of negatives is safely protected for all time, and that any particular one can be found in a few seconds.

Should you prefer to collate under the titles of Occasions then select such titles as Holidays at Blytheton, Picnics in Camford Woods, Sports Day at Shelford, Harvesting at Dunmouth, Wedding Snaps, Garden Portraits, etc.

Now for the filing method for those among our readers who make use of the hobby at all times of the year and whose collection runs into a fairly large number of negatives of various types. Although it was suggested that the other system is suitable for smaller collections, this one is equally as good for 100 as for 5,000, especially if the negatives are likely to be used for printing occasionally or referred to for any purpose. But it requires rather more work in its initial stages.

During the last ten years it has been my privilege to visit many holiday resorts and other towns and districts in Gt. Britain, and, of course, my camera has been my constant companion, with

the result that my collection of negatives runs into several thousands. But I can immediately find any one of that crowd by a simple reference to a numbered index.

Separation Cards

Every town visited has what is best described as a separation card. It is just the same pattern as the index card referred to in the other system, but on the tab the name of the town is very clearly written in block letters. Behind this is a batch of envelopes each with one or more negatives enclosed. If there is more than one, then they are of the same subject or duplicates. Each envelope bears a number, and the title of the negative. If more than one, then mention is made of how many. Underneath this, is the date of the exposure, time of day, make of film, stop used and exposure time, and the developer used. And there is still sufficient space left for details relating to printing data. At the extreme top of the envelope is the name of the town and year, as CROMER, 1945.

The numbers run consecutively from one upwards. When the system was started, Hindhead was the first town and its numbers reached about 80. Then came Penzance, and that started off at 85, reaching, say, 125. The third place started at 130, going to 165, and so on as the collection grew. These numbers are the key to the success of the system and must serve as the index for when any negative is wanted. A loose leaf book contains every number with the title of the negative alongside it and every town

has its own one or more leaves. Page one of the book is for Hindhead, page two for Penzance, and so on right through the whole of the places visited and photographed. Inside the cover of the book is a slip bearing the complete list of towns with their page numbers.

If a negative is required of a seascape, one can be found in either of the seaside places, and all that is necessary is to turn up, say, Scarborough on page 14, and a wave scene negative will be found in envelope No. 1356, which is behind the separation card marked Scarborough. If this particular one has been printed before, all the details of exposure time, make of bromide paper and developer are mentioned on the envelope so a print can be made without wasting any time or material on test prints, and if, for any reason, any other data is wanted, such as the make of film, it is all there. Included in the cabinet drawer are sections for London and also for my local town. In fact, with such a means of storing and classifying, it is possible to use it for every negative made. It can, therefore, be adapted to file and index quite successfully your collection, even if it includes only one or two visits a year outside your own locality.

No Time Waste

Whenever this scheme has been mentioned to groups of amateurs, the question has always been put 'Why waste time giving them all numbers?' The answer is that it is not a waste of time.

If you want to keep negatives you must do it methodically, otherwise when

any particular one is wanted, where are you going to look for it, and how long will it take you? Also, will it be in a fit condition to print?

The quickest way to work the scheme is not to allow too many negatives to accumulate before filing them. When a spool of film has been developed, cut each negative from it, place it in its envelope, put the particulars carefully on the envelope, and, when the eight or a dozen are so protected, record them in the loose-leaf book and give each one its number. By doing it in this way, the time taken is just a few minutes and those minutes will prove invaluable, and you will be very proud of your drawer-full of negatives as the years pass on.

It has already been suggested that any negative that is spoiled should not be kept, but if a number has been given to that negative it should be retained. Sometimes, owing to unfortunate circumstances or conditions, a faulty exposure has been made of a very special subject which may have historic value a few years hence. Do not destroy it for, as you increase your knowledge of the art, you may, perhaps, be able to improve the printing quality of it.

This 'super' filing system has now been in practice for ten years and has never let me down. It is the result of several years' experience. I have had dealings with many devices such as book-form wallets, special boxes and other contrivances for holding a dozen or more negatives, but not one of them has given the 100 per cent satisfaction of my own scheme. (108)

Toy Railway Trucks—

(Continued from page 43)

the wheels for drilling, a card template can be made. Mark a $\frac{3}{16}$ in. circle on a piece of thin card and push the point of the compass right through the centre. Now cut out the template with the scissors and lay it on the wheels for pricking off the centre.

Six small screw eyes are needed for coupling the trucks together. Three of these are opened out as will be seen in the sketches.

Painting

Do not try to follow out actual practice too closely as regards colouring. Keep them grey and black if you wish but do not try to paint on too many details. Use quick drying enamel and stand aside for at least a week before wrapping up to send as Xmas presents. (107)

Watch future issues for more toy trucks and railway accessories.

HOBBIES BRANCHES

LONDON

78a New Oxford St., W.C.1
(Phone MUSEUM 2975)

87 Old Broad Street, E.C.2
(LONDON Wall 4375)

117 Walworth Road, S.E.17
(RODney 5509)

GLASGOW—326 Argyle Street
(Phone CENTRAL 5042)

MANCHESTER—10 Piccadilly
(Phone CENTRAL 1787)

BIRMINGHAM—14 Bull Ring

SHEFFIELD—4 St. Paul's Parade
(Phone 26071)

LEEDS—10 Queen Victoria Street
(Phone 28639)

HULL—10 Paragon Square

SOUTHAMPTON—25 Bernard St.

BRISTOL—30 Narrow Wine Street
(Phone 23744)

AMAZING COWBOY FILM STRIPS

featuring

John Wayne in
NEW FRONTIER

Rob Cameron in
THE PLUNDERER

Wm. Elliott in
THE GALLANT LEGION

Jimmy Ellison in
HOSTILE COUNTRY

These thrilling Western Dramas 1½ each

This Cinevuer gives perfect cinema screen picturisation for all Strip films 2/9

From Stores, Toy Shops, etc. or in any difficulty direct from

FILM STRIPS

EDLESBOROUGH, Nr. DUNSTABLE, Beds.

Send 4/- to cover Post and Packing of your selected Film Strip and Cinevuer



YOU CAN BECOME A HANDICRAFTS INSTRUCTOR

EXPERIENCE NOT ESSENTIAL

Men who enjoy making things in wood or metal can turn their hobby into a permanent and interesting Career. Short hours, long holidays and security in a job you would really enjoy, can be yours if you become a Handicrafts instructor. Let us send details of the easiest and quickest way to get the necessary qualification.

We guarantee "NO PASS—NO FEE"

If you would like to know about our unique method of preparing you for one of these appointments, write today, and we will send you our informative 144 page Handbook—free and without obligation. Mark your letters "Handicrafts Instructor".

BRITISH INSTITUTE OF ENGINEERING TECHNOLOGY

BIET

595 Shakespeare House
Stratford Place, London, W.1

ENJOY MAKING PLASTER FIGURES WITH FLEXIMOULD



No experience is required to cast religious figures, wall plaques, ash trays, garden ornaments, candlesticks, book-ends, vases, coats-of-arms, articles for window display, cake decorations, cameos and animals, etc. Make a profitable business with this pastime.

Write today for free details of

'FLEXIMOULD' to

DOHM LTD. (DEPT. H)

167 VICTORIA ST., LONDON, S.W.1

THE BOLSTER HOME WATCH AND CLOCK REPAIR OUTFIT



These precision jewellers' instruments include watchmaker's magnifying eyeglass, finest watch tweezers, set watchmaker's screwdrivers, watch and clock oil, oilers, dusting powder, clock brush, plus illustrated instructional manual for the amateur. In container 12/6 post free.

Senior Outfit includes everything above, plus watch jewels luminous compounds, dial renewer, jewellers rouge, explanatory book. Price 21/- post free.

BOLSTER INSTRUMENT Co. (Dept. H.W.), 5a Station Parade, Ashford, Middx.

1,000 STAMPS—5/-

'ALL OFF PAPER'

Genuine Collectors Duplicates. No G.B. My '£1000' catalogue, perforation gauge and GIFT COUPON given ABSOLUTELY FREE with each order. Every stamp covered by my unconditional money-back guarantee.

Send 5/- to

AUBREY SELBY, 66 Donnington Road, London, N.W.10

BE TALLER

I Guarantee to increase your height in 12 days or return your money. New gland and spinal discovery increases height 2 to 5 inches.

'I have gained 4½ inches in height and feel fresher first thing in the morning. My weight increased from 9-stone 4-lb. to 10-stone 3½-lb.'—P.D., Witham. 'Since taking your Course I have increased in stature from 5 feet 1 inch to 5 feet 4 inches, a matter of 3 inches.'—H.G., Chesterfield. 'My increase is 2 inches and I really do feel ALIVE'.—E.T.

Guaranteed harmless. Full Course 10/- post free, Air Mail 14/-. Details free for 1d. stamp. Sent under plain cover.

J. H. MORLEY

(H/85), TERRY HOUSE, NAPHILL, HIGH WYCOMBE, ENGLAND.

Established 1936

TOOLS FOR THE HANDYMAN



TOOL CLIP

For holding any handled tool. Spring steel. Holed for hanging.

7d. each

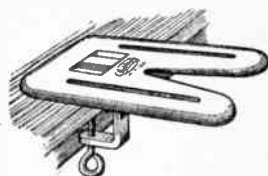

STEEL CUTTING TABLE

With clamp for easy fixing to bench. 6ins. by 4ins., strong and light. 3/-

BENCH STOP

3½ins. by 2ins. — Spring loaded top. 6/-



SINGLE HANDED SCREWDRIVER

5ins. long. Ideal for small work. 1/8



MODEL MAKER'S BENCH VICE

Strong, light and rigid. ¾in. opening. 6/3

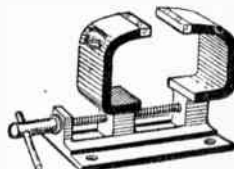

Obtainable from Hobbies Branches in London, Glasgow, Manchester, Birmingham, Leeds, Sheffield, Hull, Southampton, Bristol and ironmongers everywhere. Or post free from Dept. 99, Hobbies Ltd., Dereham, Norfolk.



FRETWORK HAMMER

8ins. long. Strong and light for small work. 1/4

TURN YOUR SPARE-TIME INTO CASH

Men and women wanted to make Bennett Model Bungalows at Home Fascinating, simple, well paid work

No selling involved.

Send stamped addressed envelope for full details.

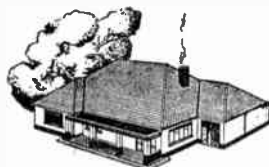

BENNETT MODELS, Duncan Road, Richmond, Surrey

A Handy Glasspaper Block

A wooden block with special handle which holds glass-paper taut and always in place. In two sizes, 3in. price 1/4; 5in., price 2/6, post free.

HOBBIES Ltd. DEREHAM Norfolk, and all Branches



SPECIAL MOULDS

Some new lines for the Craftworker

Sets of moulds for Cake Decorations, Christmas Novelties and Brooch Making at 12/6 for a set of 8 moulds. Plaster moulds for all types of Ornaments and Plaques from 6/6. Dolls Masks and Faces, 3 sizes, set 15/6. Dolls Heads, 25/- for mould. 150 Toy Making moulds at 3/- each. New Father Christmas and Snowman, 2½in. flexible moulds, 12/6. Buy direct and save money. New catalogue illustrated 9d. post free. All moulds are made of strong aluminium or vinimould. They are made to last. 4 sample moulds of Toy Soldiers or Sailors, 12/- post free.

COCK OF THE NORTH MOULDS

140 HOLLINGS ROAD, BRADFORD

For wood,
card,
plastic,
leather,
metal etc.

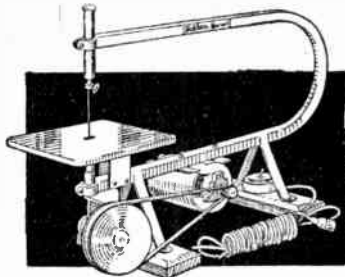

TREADLE OR MOTOR FRETSAWS

Whatever the handyman or craftsman is cutting or making, one of Hobbies Fretmachines will help with the job. For toy making, fretwork, model making, it provides easy and speedy cutting in all kinds of material. A pleasure to use, a factory for output, a lifetime of service. **FROM**

80/- to £11 - 2 - 6

Obtainable at any Hobbies Branch or good class ironmonger or hardware stores. Or carriage paid U.K. from :



HOBBIES LTD., (Dept. 99), DEREHAM, NORFOLK

THE FINEST HOBBY OF ALL

LEARN MODERN
SWING
THE APM WAY



FAST POSTAL METHOD
(Guaranteed Tuition)

Treat written music as a mere pattern for a breath-taking SWING STYLE. Playing Dance Music has no life until you can SYNCOPATE.

Whether Beginner, Advanced or Somewhere Between, Talented, Old, Lethargic or Keen Send for interesting details without obligation.

THE ASHRIURNHAM
PIANO METHOD, APM (47a), 221 Acton Lane, London, W.4

MAKE MONEY-making casts with VINAMOLD

The ORIGINAL Flexible Mould

For pleasure or profit and without previous experience you can mass produce any object from a chessman to a large statue with 'Vinamold'. It is easy to work, gives excellent results, and can be used over and over again. 'Vinamold' has been used with complete success for years by leading industries, including all the big film studios. Trade enquiries are invited.



Write for full details and instructions to:—

Vinyl Products Limited, (Dept. H1), Butter Hill, Carshalton

RAWLPLUG PRODUCTS

INDISPENSABLE
IN THE WORKSHOP
HANDY IN THE HOME



The Rawlplug Popular Outfit.
Larger sizes are obtainable.

Rawlplug Devices include Rawlbolts for heavy duty fixings, Rawlanchors and Toggle Bolts for thin or hollow materials and Rawlclips for instant fixing of conduits and cables to girders—a device in fact for every need.

Rawlplug fixing devices and products can be obtained from Ironmongers, Hardware Dealers, Stores or Model Makers Suppliers.

RAWLPLUG

FIXING DEVICES AND TOOLS

Whatever your fixing problems, there's a Rawlplug Device that will solve it for you—easily and quickly. Rawlplugs make neat and absolutely firm fixings in any material from brick or tile to stone or slate, with a size for every screw from No. 2 up to 1/2" coach screws. Rawlplug Tools are easy to use and ensure a perfect hole without damage to surrounding surfaces. Other Rawlplug devices include Rawlbolts for heavy duty fixings, Rawlanchors and Toggle Bolts for thin or hollow materials and Rawlclips for instant fixing of conduits and cables to girders—a device in fact for every need.



SCRAPER

A remarkably efficient and economical scraper, built to last a lifetime. Gives smooth finish without chatter or scratching. Easy-grip handle made solid with blade carrier in seasoned hardwood, polished and varnished. Total length approx. 6". Fitted renewable 2 1/2" Cadmium Plated Steel Blade, with cutting edge ground like a razor.



DUROFIX

The indispensable adhesive for instant use on crockery, glass, wood, metal, celluloid and the thousand and one things handled by the hobbies enthusiast. Instant drying, insulating, waterproof and heatproof. Durofix is grand for repairs to electrical, sports and leather goods.



DUROGLUE

UNDILUTED ANIMAL
GLUE OF INCOMPARABLE
STRENGTH

Ready for instant use for the many purposes for which an extra strong glue is needed. Wood, cloth, fabric, felt, leather and any greaseless surface can be stuck with Duroglue.



PLASTIC WOOD

APPLIED LIKE
PUTTY, DRIES
LIKE WOOD

Can be cut, planed, polished & painted like wood. Will take nails and screws like wood. It does not blister, crack or decay. Rawlplug Plastic Wood is actually the best quality product of its kind on the market.



TILE CEMENT

Rawlplug Tile Cement is a liquid cement possessing very strong adhesive qualities. For replacing tiles to walls, floors, fireplaces, hearths, curbs, etc., in kitchens, lavatories, bathrooms, halls, bedrooms, reception rooms, etc.

B389M

THE RAWLPLUG COMPANY LTD. LONDON. S.W.7.



CHARLES ATLAS
twice won
the title
The most
perfectly
Developed
man"



Will You Give Me 7 Days to PROVE I Can Make YOU a New Man?

DO you want big, smashing, sledge-hammer muscles all over your body? Husky, broad shoulders? A deep, powerful chest? All the pep and vigour of a "hard as nails" athlete? Give me just 7 days—one short week. That's all I need to give you the PROOF that I can make you a New Man—give you a real he-man build, massive shoulders, biceps, and glowing health that resists sickness, ends pimples, constipation and other troubles. Once I was a soft, skinny, 7-stone weakling! Then I discovered "Dynamic-Tension." It gave me the body that twice won for me the title "The World's Most Perfectly-Developed Man!" And what my amazing system did for me—it can do for YOU, too.

Send for 48-page FREE Book

Make me PROVE in just 7 days that I CAN give you the big, smashing muscles—powerful shoulders. Take the first step TO-DAY. Post the coupon for YOUR Free Copy of "Everlasting Health and Strength". Do it Now! Address to CHARLES ATLAS (Dept. 102/X), 2, Dean Street, London, W.1.



CHARLES ATLAS

(Dept. 102/X) 2 Dean St., London, W.1

I want the proof that your system of "Dynamic-Tension" will make me a New Man. Send me your book, "Everlasting" Health and Strength FREE and details of your amazing 7-Day Trial Offer.

Name.....
(Please print or write clearly)

Address.....

For the model maker, handyman, radio mechanic, etc.

JUNEERO TOOL KITS

No. 1 JUNEERO TOOL KIT, containing Multi-Purpose Tool, "Xakto" Slide Gauge and Protractor, Scroll Tool, Shears, Screwcutting Die, Screwdriver and Spanner, Design Sheets and instructions. **Price 37/6**

No. 2 COMPLETE JUNEERO TOOL KIT As No. 1 with the addition of the new Punching and Riveting Jig. **Price 45/-**

A WORKSHOP IN A BOX

(As the inclusion of materials in these Kits would render them liable to Purchase Tax NO material is included). For the newcomer to Juneero an Assorted Parcel of Juneero Spares (value 15/10) is available at 15/-.

Send 1½d Stamp for price list of Kits and Accessories to:-

JUNEERO LTD.

Stirling Corner, Boreham Wood, Herts.

YOUR PICTURES WILL IMPROVE AFTER YOU HAVE READ THIS BOOK NEW HOME PHOTOGRAPHY

Even if you only possess a box camera, this book will show you how to turn out first class photographs. Written by two experts, a photographer and a scientist, the information is imparted in a way you can easily follow.



There is nothing too stodgy, or too technical, for the average camera user to understand.

Nearly 100 pages, with 130 illustrations, packed with practical and easy-to-follow hints and dodges. How to take good photographs both out of doors and by artificial light. Hints on portraiture; film developing, contact print making and enlarging are all explained. Get a copy as soon as you can. It will bring a new pleasure to your hobby.

MOST PHOTOGRAPHIC DEALERS NOW HAVE COPIES ON SALE OR THE BOOK WILL BE SENT POSTAGE FREE FROM JOHNSONS AT THE PUBLISHED PRICE IF YOU MENTION HOBBIES WEEKLY WHEN WRITING FOR IT

PRICE
2/6

JOHNSONS OF HENDON LTD.

DEPT. H., 335 HENDON WAY, LONDON, N.W.4

Hobbies

WEEKLY

CONTENTS

	Page
A Doll's Dropside Cot -	49
Working with Bamboo -	51
Modern Table - - -	52
Magnetic Recording Apparatus	53
New Mechanical Drawing Aid -	54
A 'Talking' Duck Toy -	55
Blowing Big Soap Bubbles -	55
Books to Read - - -	56
A Chameleon Colour Toy	57
Simple Weighing Balance -	58
Stamp Collecting - - -	59
Replies of Interest - - -	60
'Talking' Duck Toy Patterns -	63

October 24th, 1951

Price Fourpence

Vol. 113 No. 2921



For a little girl— A DOLL'S DROPSIDE COT

THE doll's cot shown in the sketch is of modern design and would make a pleasing gift for a little girl. It measures 20ins. long, 12ins. wide, and stands 16ins. high, and would accommodate a doll measuring 15ins. or so in length.

A hard wood is preferable to a soft wood for its construction, beech therefore being better than deal, although quite a sound article may be made from the latter variety.

The Framework

At Fig. 1 is shown one of the sides and one of the ends. The four uprights are 16ins. long and 1in. square, and mortises are cut according to the larger details in Fig. 2.

The tops of the posts should be either chamfered or rounded off. On one face of two of the uprights must be nailed lengths of $\frac{1}{2}$ in. square stripwood or rounded beading, so that a groove is formed in which one of the sides of the

cot may slide up and down. The method of making the grooves is shown in the enlarged detail Fig. 3.

Connecting Rails

The rails connecting the legs or uprights are 1in. by $\frac{1}{2}$ in. in section, and

each must be carefully marked out and the centres bored with a $\frac{1}{4}$ in. twist drill. They are then ready for the bars which consist of $\frac{1}{2}$ in. round dowelling. At (A) in Fig. 4 are given the correct spacings to be set out with the shallow mortise (C) in the lower rail, for the penguin panel which is fretted and coloured up as shown in detail in Fig. 5. As this panel will be of $\frac{1}{2}$ in. wood, the actual size of the mortise must be 2ins. by $\frac{1}{2}$ in. In the upper rail, however, the mortise will be

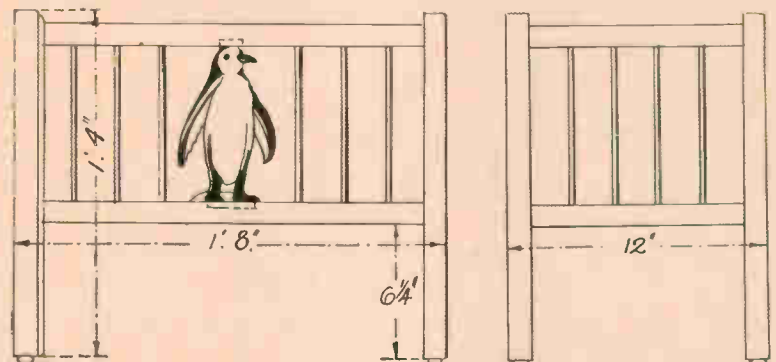

Fig. 1—Side and end views with dimensions

All correspondence should be addressed to The Editor, Hobbies Weekly, Dereham, Norfolk.

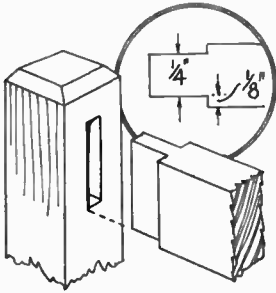

Fig. 2—Details of the joints

only 1 in. long, the other spacings being shown at (A) in Fig. 4 for this rail.

The Panel

The panels of wood for the penguins must be nearly $8\frac{1}{2}$ ins. long by 5 ins. wide. Over one of them, draw 1 in. squares and the outline as shown in Fig. 5. Cut round with the fretsaw and clean up the edges. Then lay this cut-out on the second panel and mark round it with a sharp pencil.

Finish this the same way and insert one end of each in the mortises in the rails. Next cut off twelve pieces of $\frac{1}{2}$ in. diameter rod 8 ins. long, and glue the ends into the rails, finally knocking on the top rails after just touching the extremities with glue.

The Sliding Side

The sliding side of the cot has the two long rails cut short to work easily between the uprights.

The spacing of the rods for the ends of the cot are shown at (B) in Fig. 4. Both top and bottom rails have tenons, and the upright rods are the same length as those for the sides.

The long fixed side and the two ends will be glued and cramped up if possible.

Ply Floor

The floor of the cot consists of a piece of $\frac{1}{2}$ in. wood, plywood if this can be obtained, and it should measure about

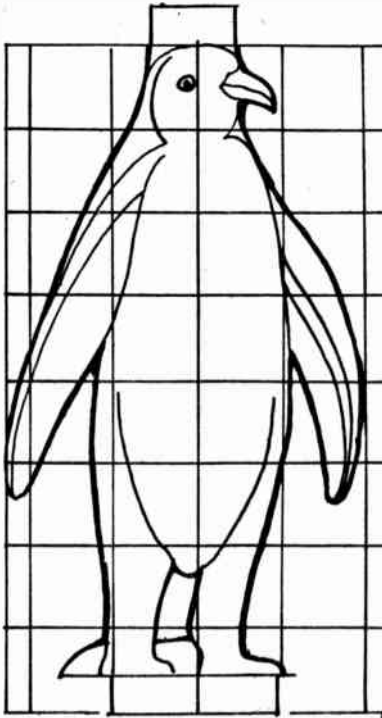

Fig. 5—Outline of the figure

Working with Bamboo—(Continued from page 51)

lock it against slipping in one direction. In both these joints the faced-off cane can have the end cut away to connect the wall of the other cane intimately. The joint will be a little stronger as a consequence, but, more important, the appearance of the joint will be improved.

The fourth type of joint is the corner joint as might be used in making a square frame. The ends of the canes are mitred at 45 degrees in the usual way and one tube is then plugged with a soft dowel. A hole is then drilled through the outside wall of the other tube, as shown in Fig. 4, through which a small wood-screw passes. A coating of glue on the mating surfaces should also be used. The main point to remember here is that the drilled hole must be a clearance size

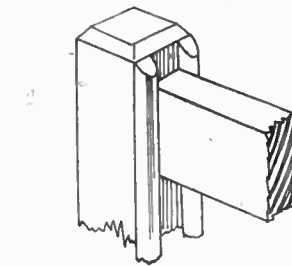

Fig. 3—The grooves for the drop side

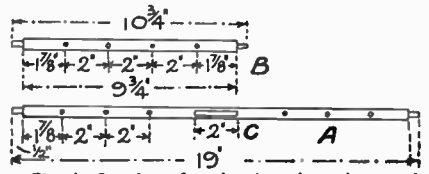

Fig. 4—Spacings for the dowels and penguin panel

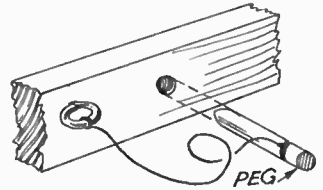

Fig. 6—The peg for holding the side in position

$19\frac{1}{2}$ ins. by $10\frac{3}{4}$ ins., with the corners notched out to fit round the uprights. Nail or screw the floor to the underside of the lower rails on the side and two ends, and put round inside some pieces of angle fillet to strengthen the joints.

The sliding side of the cot is inserted in the grooves from the top, and may be supported level with the other parts by a peg of hard wood or even metal pushed through the lower rail and into a small block of wood which has previously been glued to the top surface of the floor. Fig. 6 shows the peg, etc.

All the woodwork should receive a thorough cleaning with glasspaper, and then be given two coats of paint or enamel, the penguin panels being picked out afterwards in black and white as shown in Fig. 1.

The top ends of the four uprights should be either rounded off and made smooth, or chamfered all round as seen in detail Fig. 2 for sake of safety. The upright edges of the legs should be slightly rounded and made safe for handling. Metal domes might be inserted in the feet of the uprights to make for smooth running. (106)

for the woodscrew used. If smaller, as the screw tries to expand the bamboo, it will split. Again thread binding is to be preferred for a really strong joint.

Finally, there is the lap joint—Fig. 5. The simplest way to do this is simply with thread binding, facing off the mating faces of the two canes so that they are in intimate contact throughout their overlapping length. The bound joint can be stabilised with the use of small dowel, glued in place as shown, drilling the holes necessary for the fixing of the dowels.

With these standard joints, and utilising the peculiar property of bamboo—that it can be readily bent over an open flame—almost any type of open

framework can be attempted. The finished article will then already have a polished surface which can be enhanced simply by further polishing. The wood cannot readily be stained or dyed, but it will take paint well.

A point in design is always to attempt to balance out the appearance of the inevitable 'knuckles', matching paired members against one another as far as possible. The colour of individual canes can also vary slightly, from a very pale straw colour up to a rich reddish brown, sometimes mottled. The latter, however, is rare. The main thing is to match all canes as nearly as possible for colour and diameter before starting the work. (481)

Some useful notes on WORKING WITH BAMBOO

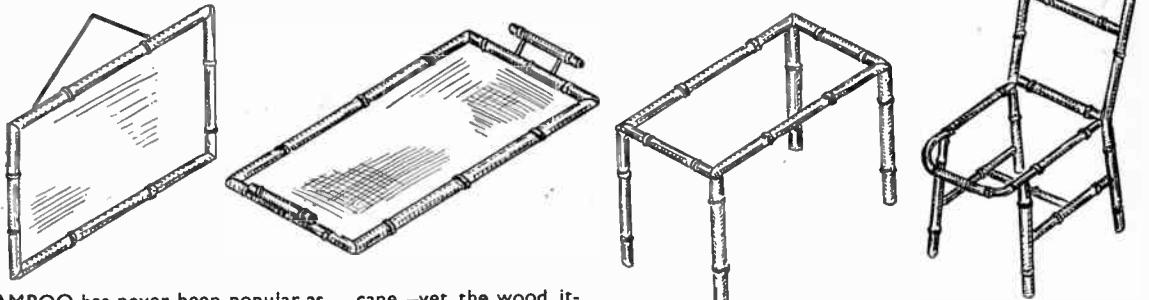

BAMBOO has never been popular as a medium of construction, yet most attractive and unique articles of furniture can be made from it, provided the right technique is used. Bamboo is a queer wood. 'Cane' stock can vary in diameter from a fraction of an inch upwards to 4ins. or 5ins. The latter stock is by far the minority. It is difficult, these days, to obtain canes greater than about 3/4in. in diameter and the average run is smaller.

Bamboo canes have a hard shiny exterior with a polished appearance. This surface does not readily take glue; nor is bamboo readily pinned or screwed. Attempts to do this usually split the

cane—yet the wood itself is tough and flexible.

Bamboo articles are best made from whole canes, rather than attempting to get really large canes and split these down into rectangular stock like any other stripwood. For one thing the cane length is invariably beset with 'knuckles' anything between 6ins. and 8ins. apart—and seldom more than 10ins. apart. A length of bamboo split in excess of about 10ins. with a consistent appearance and strength is rare.

Construction in bamboo, then, really resolves itself into a problem of working with tubular lengths which will not glue together satisfactorily, cannot readily be pinned or screwed, and certainly cannot be treated like metal tubes. Yet it is

lashed with thread. A coating of glue over the thread binding will then make a permanent joint, the glue rendering the thread a rigid shell fitting rather than sticking to the bamboo itself. If a joint of this type is load-bearing it can be locked by a short length of dowel glued through a hole drilled in one of the bamboo members. Glue will hold this dowel satisfactorily. It is only the shiny outside of the bamboo cane which is unaffected.

The simple butt joint is shown in Fig. 2. A hole is drilled through one wall of one tube and into this is glued a short length of dowel. This dowel is a light force fit into the hollow core of the

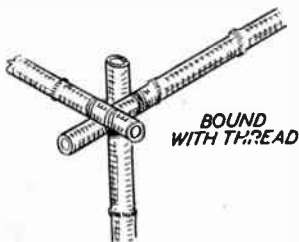

Fig. 1

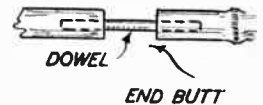
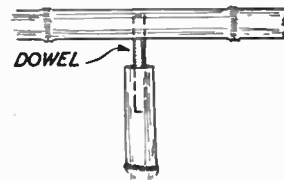
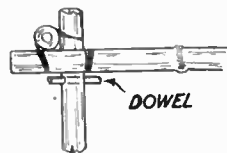

Fig. 2

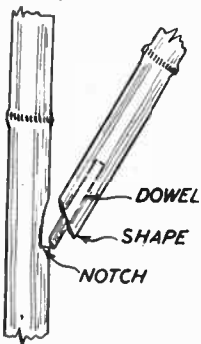

Fig. 3

quite easy to get round these difficulties.

There are four basic joints which are suited to bamboo construction and these, with variations, can be used in constructing almost any type of framework. The first, and most obvious, is the lashed joint of Fig. 1, where all the tubular members are brought together and then firmly

other member, into which it is also glued. Where permissible this type of joint can be considerably strengthened by thread binding.

The angled joint is shown in Fig. 3. Here the method is similar, using a short length of dowel as reinforcement, but one of the canes should be notched to receive the end of the other and thus

(Continued foot of page 50)

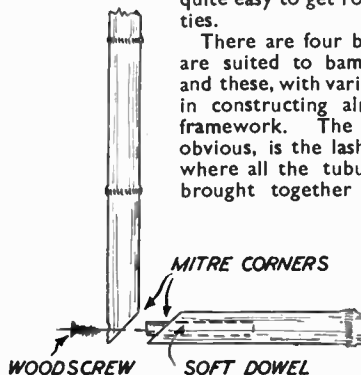

Fig. 4

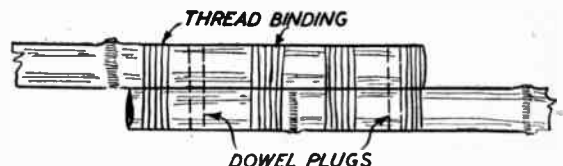

Fig. 5

It isn't hard to make this MODERN TABLE

THE use of 'frame' legs immediately stamps this table as different and, incidentally, somewhat simplifies construction. By canting the legs inwards along diagonal lines, an amazing degree of leg-room is obtained, whilst the stability of the table is exceptional. Where a light table is required, this is the type which is almost impossible to tip over.

Table top parts are shown in Fig. 1. It does not matter how the 4ft. by 2ft. top is formed, as long as the ultimate surface is smooth. The whole top is later covered with plastic sheet or some similar material, so basic appearance is not important.

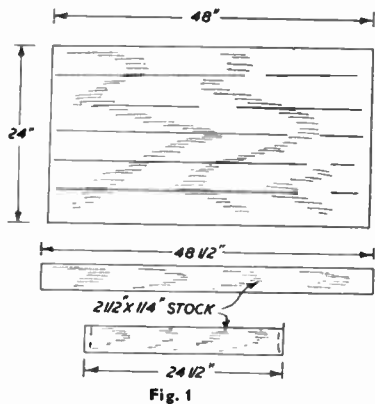

Fig. 1

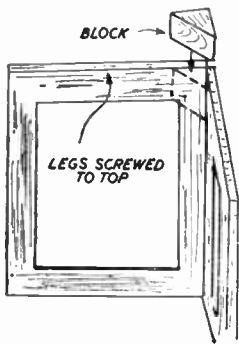

Fig. 5

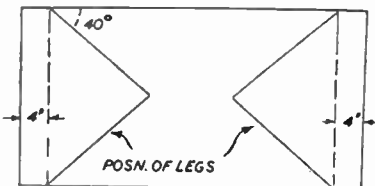

Fig. 6

The side frames will be fully revealed, however, so choose good grained stock for these. These are mitred at the corner joints and glued to the top to form a shallow tray—Fig. 3. Corner blocks should be employed to give greater strength and rigidity. These can be cut from any scrap material and

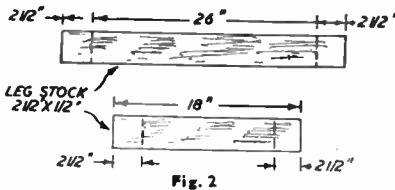

Fig. 2

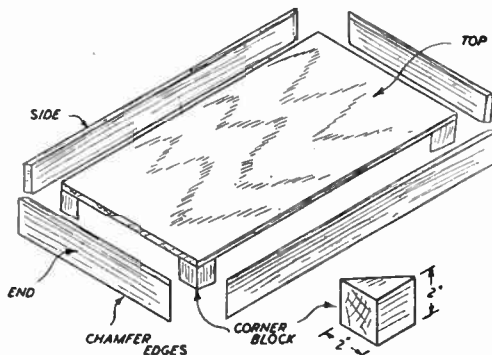
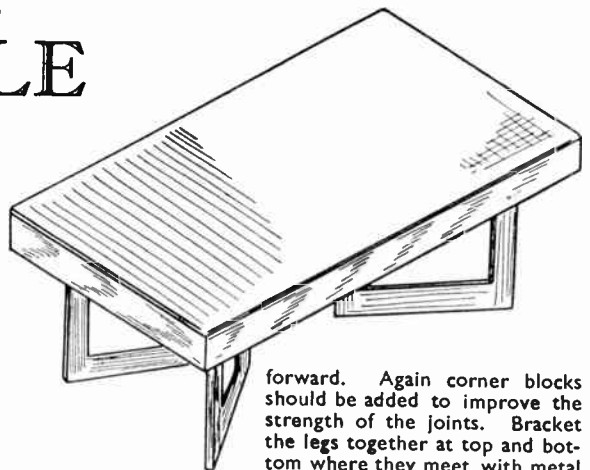

Fig. 3

glued in place. They will not show in the final assembly. Be sure, however, to make a good job of the mitred corners and slightly chamfer off the bottom edges of the outer frame.

The four legs are each built up as simple rectangular frames with halved joints. Two pieces 26ins. by 2 1/2ins. by 1/2in. are required for the vertical frames and two 18ins. by 2 1/2ins. by 1/2in. for the horizontal frames of each leg. Assemble with screws and glued joints as in Fig. 4 and make absolutely certain that each leg frame is identical, and truly square.

Each pair of legs is then screwed through from the table top in diagonal pairs—Figs. 5 and 6. The position of the legs on the underside of the table top can be marked out from Fig. 6, when assembly should be quite straight-



forward. Again corner blocks should be added to improve the strength of the joints. Bracket the legs together at top and bottom where they meet with metal

Before making this assembly permanent, check for squareness and levelness with the table the right way up. The whole assembly can then be finished off—staining and polishing or painting. If a colour finish is to be used, apply with a spray gun, if possible. This is particularly advantageous with cellulose finishes.

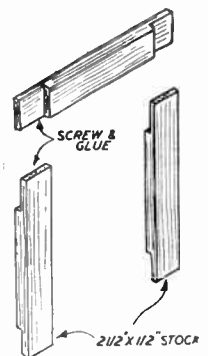

Fig. 4

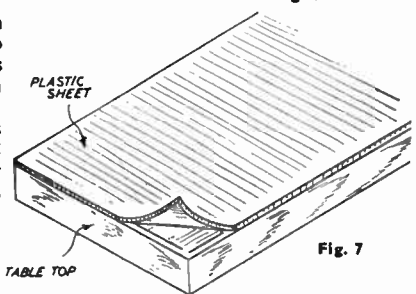
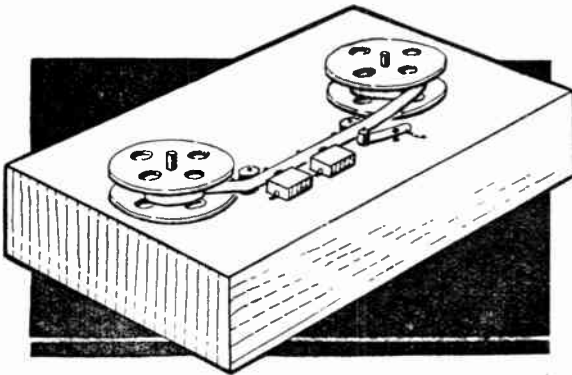

Fig. 7

The table top should then be covered with a single sheet of coloured plastic, preferably a material which is heat and acid proof. If any difficulty is experienced in obtaining suitable material, clear Perspex or even a sheet of glass can be used.

The first article of a series on MAGNETIC RECORDING APPARATUS



AS readers have expressed interest in the possibility of constructing a magnetic recording apparatus, it is proposed to cover this subject. The required apparatus can be divided into a number of separate units. First of all, some means of winding the tape at an even speed is required, and this part of the recorder is described here. In addition, recording, play-back and erasing heads will be required, and an

recording head, which now operates an amplifier, so that the impulses stored on the tape are reproduced through a loud-speaker in the usual way. With suitable design, the one head can be used for both recording and play-back.

The erase head is used only when it is desired to wipe the existing recording off the tape, and it is fed either with a strong direct current, or with a powerful high-frequency alternating current, for this purpose. The tape can then be used again.

The sounds to be recorded are fed into the recording head, which consists of a magnet with a small gap. The moving tape is accordingly magnetised by the fluctuating current, and this is how the actual recording takes place.

When it is desired to play the tape, it is fed in exactly the same way past the

40ft. per minute speed is satisfactory for normal purposes, and can be obtained by using a 2in. diameter driving wheel placed on the spindle of an old gramophone motor (the turntable speed of which can normally be adjusted between 60 and 80 R.P.M. or so). This is the arrangement adopted in the unit described here.

Dimensions of Parts

These are only given where critical. The exact size of the motor board does not matter, and may depend upon the size of the motor itself, and the reels to be used. The latter are available in various sizes, that containing 600ft. of tape being the smallest commercially supplied. The tape is $\frac{1}{4}$ in. wide.

The motor board can be made from 5 or 7 ply, with sides of sufficient height to enable the motor to clear the bottom. The motor board should be attached to the case by screws only, so that it can be lifted out for adjustment of the underneath mechanism. Any unnecessary cramping of space should be avoided as it would only make construction more difficult.

Spring Roller

This is shown in Fig. 2 and holds the tape against the driving wheel. The roller can be $\frac{1}{2}$ in. to 1in. in diameter, and it should turn smoothly on a proper pivot bolt. It may be of wood or similar material. If of metal, a short length of rubber tubing of suitable diameter may be stretched over it.

Important Points

Any fluctuation in the speed with which the tape moves will spoil reproduction, as will vibration or looseness,

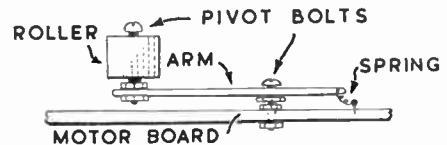

Fig. 2—Details of the spring roller

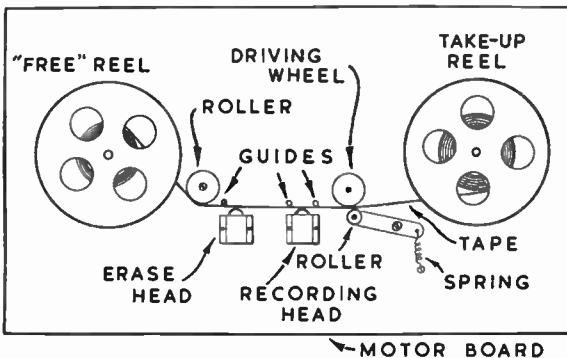

Fig. 1—Layout of the reels and other parts

amplifier of good power. These items will be dealt with later.

Recording Method

The way in which recording takes place will become clear on reference to Fig. 1. The magnetic tape is wound upon the 'free' reel, to begin with. From here, it is taken past the erasing and recording heads, being held level by small guides. It then passes between the driving wheel and a spring-loaded roller, which presses the tape against the wheel so that the tape is drawn smoothly from the first reel. The tape is taken up by a second large reel.

which can make the recording useless. Sound mechanical construction is, therefore, necessary throughout; the whole should be strongly made, and all axles, bearings and wheels should be accurately balanced and true. Even a slight variation in speed will spoil results.

The exact speed at which the tape moves is not critical, provided it is maintained at the same rate for both recording and play-back. A usual speed is about 40ft. per minute, and this is suitable for normal purposes. When high-quality rendering of musical items is required, the speed is frequently increased, perhaps, twice or more. The

The arm is about $2\frac{1}{2}$ ins. long, and is pivoted on a second bolt, washers being used if necessary to avoid any excessive looseness. A light spring keeps the roller in contact with the driving wheel. A further roller, fixed to the baseboard at the left of the erase head, helps to guide the tape from the 'free' reel.

Driving Mechanism

This is shown in Fig. 3, a gramophone motor being used. The motor needs to be fairly powerful. It may be of the clockwork type, but an electric motor will have a more regular speed, and not require re-winding. The motor is

mounted low enough for a wheel to be placed on the spindle, as shown. This can be done by using spacing-pieces under the fixing bolts.

The driving wheel should be true and absolutely smooth, and is best of brass. It may be somewhat wider than the tape, say, $\frac{1}{2}$ in. wide or so. If it has been arranged to replace the original gramophone turntable, it will require a central hole which tapers slightly, so that it can be tapped on to the spindle. All the existing gearing, governor

the mechanism in Fig. 4. Both reel and the flat wheel shown are fixed to the spindle, which is pivoted in the bearings illustrated. A wheel, driven by the belt in Fig. 3, is free upon the spindle, and turns the reel because the weight of the latter presses the flat wheel and friction disc upon the top of the belt-driven wheel. A continuous slipping will take place, and this will increase as the tape is wound more and more on to the reel, and the latter revolves more and more slowly.

tend to drag the tape at increased speed past the driving wheel on the motor spindle. The motor may also be slowed.

The 'free' reel merely rests on a suitable axle, so that it can revolve as the tape is drawn smoothly away.

Rewinding

After recording or playing the tape, it has to be re-wound on to the first reel. To simplify construction, no mechanism to do this has been included. It may be done by hand, if a small handle is fixed to the 'free' reel. Some mechanisms make provision for the 'free' reel to be driven

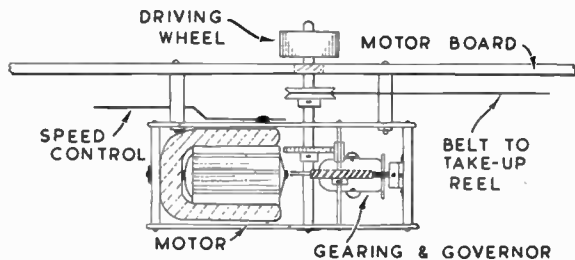

Fig. 3—Motor and driving wheel

arrangement and other parts in the motor are left unchanged.

Take-Up Mechanism

The take-up reel has to be driven, but only through a friction drive. When recording begins the tape will be winding on the centre of the reel, which is of small diameter. But as more tape is wound on, the diameter will increase, so that the reel must revolve much more slowly. This is arranged by

Simple Arrangement

This is, perhaps, the simplest possible arrangement, here, but it can function satisfactorily. The adjoining surfaces of the driven wheel and flat wheel should be true and smooth, and various materials may be tried for the friction disc. Something such as fairly soft fibre is required, as only a very light friction, sufficient to keep the take-up reel revolving, is necessary. Heavy friction must be avoided or the take-up reel will

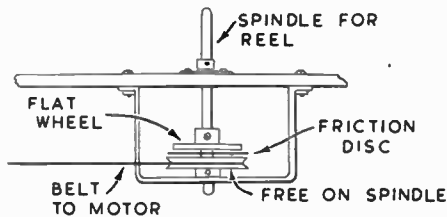

Fig. 4—The take-up reel mechanism

from the motor, through a belt or similar means, for re-winding. Others arrange so that the empty spool may be placed upon the spindle originally occupied by the take-up reel, the latter being transferred to the 'free' reel axle until re-winding is completed, when the reels are replaced in their original positions. The arrangement adopted will depend upon the constructor.

It is hoped to deal with suitable amplifiers, etc., later. (491)

NEW MECHANICAL DRAWING AID

AN entirely new drawing instrument, known as the 'Quickdraw', has been placed on the market. It enables sketches, plans, diagrams or other outlines to be made rapidly and accurately to scale.

The pantograph to which the template is attached ensures that the principal lines are vertical or horizontal whatever the position of the template.

Automatic Isometric

As seen from the photograph the shaped edges of the template enable lines to be drawn at any of the principal angles, including those for isometric drawing. Circles of various sizes may be drawn quickly and accurately and small perforations in the instrument enable a number of equally-spaced horizontal lines to be drawn at intervals of $\frac{1}{16}$ in., or even $\frac{1}{32}$ in. is possible. The scales are in

fractions of an inch and in millimetres. The template and pantograph are made of plastic and are mounted on a light board contained in a portfolio, one drawing pin only being required to secure the paper in position. The largest size of drawing possible is given as 13 ins. by 10 ins., although smaller reproductions are easily possible.

Wide Range

A wide range of work is able to be carried out without the need of any additional instruments whatsoever, although it can, where necessary, be used

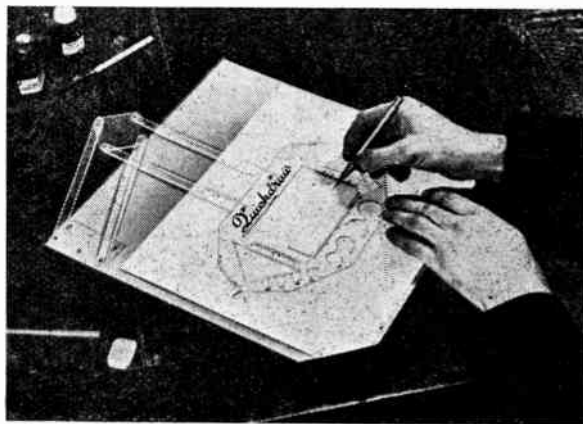

The instrument in use

in conjunction with compasses, scales or protractors, being particularly useful, therefore, when full drawing office facilities are not available.

The Quickdraw Company of 127 Gunnersbury Avenue, London, W.3, are the suppliers of this new appliance.

(109)

For the youngsters— A 'TALKING' DUCK

MOST youngsters have a habit of talking to their animal toys. So they are sure to be pleased with this duck, who 'talks back' in quite a realistic manner, his moving beak emitting a loud clacking noise when worked by the lever at the back. The toy is fitted on to wheels, so that it can be pulled around for a change when the conversation grows monotonous!

Full size patterns for cutting out will be found on the inside back cover, and the sketch below shows the simple lever arrangement which is mounted between the two cut-outs, and operates the beak.

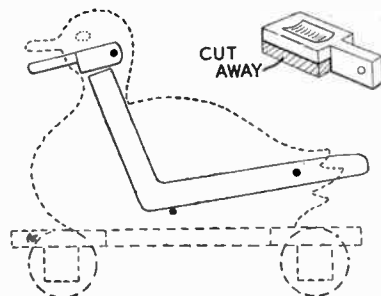

Fig. 2—Constructional details

Materials Required

A piece of $\frac{1}{2}$ in. wood or $\frac{3}{8}$ in. plywood is quite suitable for all the parts, except the moving beak (marked A) and the beak filling piece (marked B), which should be cut from $\frac{1}{2}$ in. stuff. Four wheels 1 in. in diameter can be cut from either thickness of material, and the toy is made stronger if these wheels are screwed to two pieces of $\frac{1}{2}$ in. by $\frac{1}{2}$ in. glued on the underneath side of the

base. Apart from the wood, the only other requirements are three nuts and bolts about 1 in. by $\frac{3}{8}$ in. with washers to match and a little brightly coloured enamel to give the toy a good finish.

Cutting Out

Paste the patterns on to the two pieces of wood (or make tracings if it is preferred to retain the patterns for a 'repeat') and cut round each piece neatly with the fretsaw. Do not cut out the slits in the base yet, since their widths will vary a little according to the thickness of the wood and washers used. Cut out four discs for the wheels and two strips of $\frac{1}{2}$ in. by $\frac{1}{2}$ in. by 2 ins. long for the wheel brackets. Then drill the three holes in each duck and a small hole in the centre of each wheel.

After the moving beak piece has been cut out in the $\frac{1}{2}$ in. stuff, drill the hole in that, too, then cut out a piece 1 in. by $\frac{1}{2}$ in. edgewise, at the front, as shown at Fig. 2. If the centre of the beak is gouged out a little to make a hollow, as shown, this makes a louder 'quack', but keep the edges the full height all round so that it makes good contact with the fixed part of the beak.

The Base

Fix the two cut-out ducks together by means of the bolts, with the lever and the beak piece in between (and not forgetting the washers), and screw the nuts up, leaving enough play for the two moving parts to swing freely. Then stand the duck up on the centre of the

Full-size patterns for this toy
on page 63

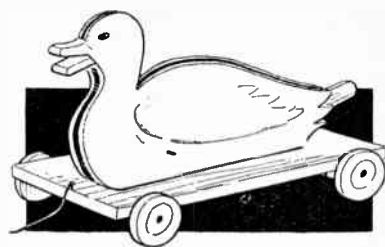

Fig. 1—The completed toy

base and mark the exact position for the slit. Then glue the ducks into the base and the two struts on to the underneath side of the base, for the wheels.

Put a bolt through the hole at the bottom of the duck, to act as a stop for the lever, then adjust the other bolts if necessary so that the lever and beak work smoothly. The lever should rest on the stop until pressed, and fall back into that position as soon as the finger is taken off the other end of it. When the nuts have been adjusted just right, it is a good plan to put a second nut on top of the first in each case, to prevent the first from working loose when the toy is in use.

Finishing the Beak

Having cut out the little beak-filling piece try it in between the two cut-outs and rub it down until it just pushes in. Then glue it into position and, when the glue is dry, rub down the outside edges until it is flush with the pieces on each side of it, and makes one solid piece. It is well worth while taking special care to make a good flat surface on the underneath side so that when the moving piece comes up it meets it with a good 'clack'.

Do not bore holes for the wheel screws, but just give them a start and finish off with the screwdriver, then they will fit tighter. Finish the toy with gay colours, and fix a piece of string on the front to pull it along. (103)

The art of BLOWING BIG SOAP BUBBLES

THERE is no particular secret to blowing really big soap bubbles, say, between 12 ins. and 18 ins. in diameter. All you need is a different kind of 'pipe'.

Instead of an ordinary clay 'bubble pipe', try using a tin funnel, as shown in Fig. 1. The funnel should be about 4 ins. to 6 ins. in diameter. Fit a length of plastic or rubber tubing over the end to blow through.

It is quite simple to make up a satisfactory bubble mixture. Dissolve a

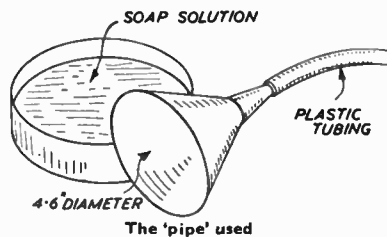

quantity of soft soap in warm water to make a fairly thick solution, like cream. Then add a little glycerine and mix up well.

Dip the open end of the funnel into this mixture and remove with a sideways movement to pick up a film of soap solution across the end. Then simply blow! Probably you will have to blow a really large bubble in two or three stages, stopping the end of the plastic tube with the tip of the tongue or clamping the tube shut between finger and thumb whilst you pause to take a new breath. See which one of you can beat all records and be the first to blow a 2 ft. bubble in this fashion. (487)

Books to Read!



A review of interesting books for craftsmen which have been recently published. Obtainable through newagents or booksellers or direct from the publishers mentioned.

Miniature Landscape Modelling

By John H. Ahern

FROM the pen of one of the best known names in model railways comes a book which will find a ready demand among hosts of modellers, a book which tells you all you need to know about the craft of making your landscapes look natural. From the author's wide experience he is especially well qualified to deal with this fascinating art, and even those who have no model railway, but like building things with their hands, can learn from this volume. It is a book which fills a gap in the literature of modelling, and to many readers it will reveal a new and altogether pleasant field of endeavour. The easy production of such things as mountains, rivers, canals, harbours, trees, grass, bushes, is fully described and illustrated. No true railway modeller can afford to be without Mr. Ahern's book.

Published by Percival Marshall & Co. Ltd.,
23 Gt. Queen Street, London, W.C.2—
Price 10/6.

Kuklos Annual 1951

Edited by B. W. Best

THE 29th edition of this popular Annual is now on sale, and, as ever, it represents sound value for money. As always, it is full of interest to all cyclists; in fact it is their indispensable friend and guide. Whether you use your cycle for getting backwards and forwards to work or for touring the British Isles on holiday, the book will be of equal use to you. Published by Ed. J. Burrow & Co. Ltd., Cheltenham and London—Price 2/6.

The 'M.E.' Lathe Manual

By Edgar T. Westbury

THE lathe is one of the most versatile machine tools, and one of the most important—and this book will become just as important as a text book for those who would make the proper use of this tool. The book is intended to supplement rather than to supplant the publishers' earlier publications 'Practical Lessons in Metal Turning and Screw Cutting', and 'The Beginner's Guide to

the Lathe'. While it deals mainly with the subject of lathe operation from the aspect of the model engineer, it will be found helpful by all individual users of lathes whether amateur or professional. It will be of particular interest to those who wish to get the best possible service from comparatively simple machines, and who wish to produce accurate work. Undoubtedly it is one of the most comprehensive books on the model engineering lathe so far produced.

Published by Percival Marshall & Co. Ltd.,
23 Gt. Queen Street, London, W.C.2—
Price 12/6.

Your Penmanship

By K. U. Ockendon

YET another title in the Sylvan Press 'Your Home Crafts' Series, this is a book which should serve two purposes. First, it should encourage and help the amateur who, fascinated by a broad nib pen, feels inspired to use it for decorative purposes, and secondly, the serious students of Writing and Illuminating will find in it the essentials of their craft concisely set forth. The author has for many years practised Writing and Illuminating, executing memorial books and other works of a similar nature, and she is well fitted to guide the hand of the learner.

Published by The Sylvan Press, 24 Museum Street, London, W.C.1—Price 9/6.

In the Workshop (Vol. 3)

By 'Duplex'

FOR several years now, 'In the Workshop' has been one of the most popular features of the 'Model Engineer'. At the request of readers, the publishers have made a selection of these articles into book form. The first volumes enjoyed an immense success and a similar success should be enjoyed by this latest work. It takes the model engineer a step further in the pursuit of workshop efficiency. Detailed working instructions are given in a form which will appeal to the beginner and to the more advanced worker, and, in addition, these descriptions are greatly enhanced by the inclusion of numerous drawings and diagrams. Altogether this is a book which should make a practical workshop guide.

Published by Percival Marshall & Co. Ltd.,
23 Gt. Queen Street, London, W.C.2—
Price 9/6.

The New Home Photographer

By A. R. Pippard, B.Sc.
and K. P. MacDonnell

FROM one of the best known names in the world of photography (Johnsons of Hendon), comes a copy of their latest work on this fascinating hobby. It is a book full of good advice for all those who wish to take pictures, and a careful study of it will repay the reader a hundredfold. Its price is modest in view of the quantity and quality of the contents, and no photographer, whether 'snapshotter' or more advanced amateur, will be sorry if he buys a copy.

Published by Johnsons of Hendon Ltd.,
London, N.W.4—Price 2/6.

Models in Bottles

By R. F. C. Bartley

THIS is yet another title from the House of Percival Marshall, and maintain their usual high standard. It deals with an art which has hitherto been practically limited in its design to ships. Who has not heard of the ship in the bottle? Mr. Bartley, however, has gone further and evolved a new method by which practically any subject can be bottled, and the field has become suddenly unlimited. Designs include windmills, landscapes, fairy stories, stage coaches, etc. Like all Marshalls books this one is well illustrated and the text is clear. The reader will be presented with endless possibilities and many hours of creative enjoyment.

Published by Percival Marshall & Co. Ltd.,
23 Gt. Queen Street, London, W.C.2—
Price 7/6.

Angling for Beginners

THIS little handbook, published by Spratts Patent Ltd., at modest cost, will be welcomed by many who are taking up the hobby of fishing. It is not intended for the expert angler, but rather for the novice who has decided that he will while away a few hours occasionally by the side of a quiet stream or river. The contents should be helpful and interesting to any young angler. Published by Spratts Patent Ltd., 41-44 Bow Road, London, E.3—Price 1/6.

Full instructions for making A CHAMELEON COLOUR TOY

MOST of us are familiar with the old-time Chameleon Spinning Top which, when different coloured rings were thrown over it, would form a perfect rainbow of changing colour schemes. It was a fascinating toy for the youngsters, some of whom would delight in making the coloured rings and try out, on their own account, all sorts of colour variations. Here is shown how to make a simple mechanical contrivance to work by hand and emulate the old-time top, but to make each colour experiment more lasting.

In the illustration is shown how the finished article will look when completed and painted up. The method of working the toy is simple and is easily explained in the plan Fig. 1 and the sectional diagram Fig. 2.

A shallow box is first made, and at one end of this an upright spindle is pivoted.

pulleys and disc is given in Fig. 1 and from this also will the construction of the box be understood.

We commence the making of the toy by outlining and cutting the sides and ends of the box (A) and (B) respectively in Fig. 1. Sides (A) are $6\frac{1}{4}$ ins. long by 1 in. wide, and ends (B) $2\frac{1}{2}$ ins. long by 1 in. wide. Wood $\frac{1}{2}$ in. thick is used throughout in making the toy. The floor (C) of the box is shown in Fig. 3 and its size is $6\frac{1}{2}$ ins. by 3 ins. On this piece is set out the measurements of the square of wood which is to be cut out, the idea of its removal being to allow space for

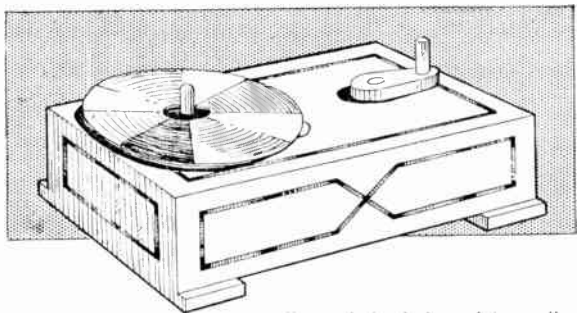

the handling of the belt and its pulleys inside, when the box has been finally assembled. Clean the edges of the piece (C) before attaching the side and end rails (A) and (B). This gluing up, however, will not be carried out yet.

Next prepare the four discs (E) and (F) in Fig. 2. These are drawn with com-

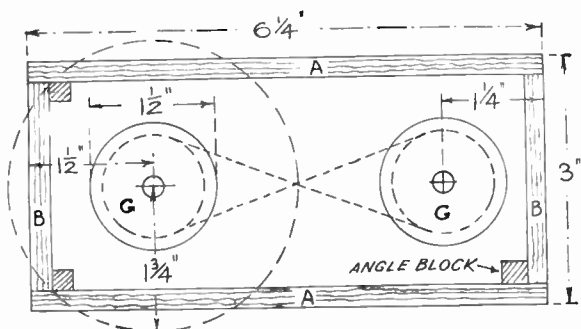

Fig. 1—Plan view of the toy

At the lower end of the spindle, and situated inside the box, is a grooved pulley. At the top of the spindle is fixed a wood disc running clear of the actual top of the box. It is upon this disc that the coloured paper or card discs and rings will rest, and will be actuated when the whole is brought into operation.

How it Works

At the opposite end of the box, a shorter spindle is pivoted, and on the top of this is glued a crank and handle. Inside the box again, and on the shorter spindle, is a similar grooved wheel to the one previously mentioned. It will thus be readily seen that when the two grooved wheels are connected by a belt and the crank brought into use, the spinning disc is carried rapidly round and the colour effects obtained. Much, of course, depends upon the speed of the disc to get the variety and change of colour. The plan of the box showing the

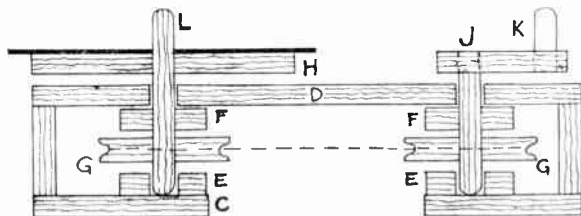

Fig. 2—Sectional drawing showing the working parts

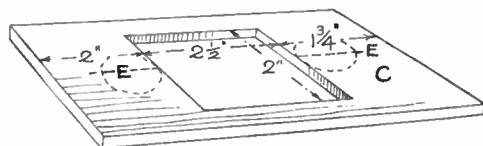

Fig. 3—Details of the floor

passes set at $\frac{1}{2}$ in. radius, and in the centres $\frac{1}{2}$ in. holes must be cut, these holes in one pair of discs (E) must be enlarged—or cut round with the fretsaw to full $\frac{1}{8}$ in. so as to give freedom of movement of the upright spindles—see Fig. 2.

Now take in hand again the floor (C) and run a centre line in pencil lengthways each side of the open square—see Fig. 3, and on this glue the two discs (E) in exact position shown by the dotted lines; see also cross section Fig. 2 for these two discs.

The top (D) of the box can now be made and is cut to the same outline as the floor. Two full- $\frac{1}{2}$ in. diameter holes must be made in the top, centred to the

(Continued foot of page 58)

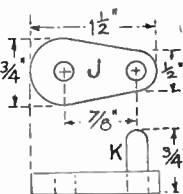

Fig. 4—The parts of the crank

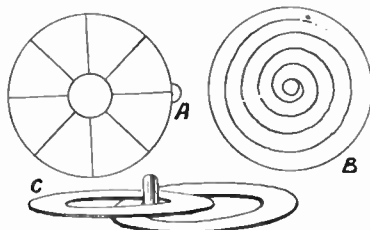

Fig. 5—Some alternative discs

For measuring out chemicals, etc., make this SIMPLE WEIGHING BALANCE

THIS easily made balance should prove useful for measuring out chemicals for use in your experiments, or when making up photographic solutions from powders and crystals, and, no doubt, there are household uses to which it could be put also.

What You Need

Nothing more is needed than the lid from a cocoa tin or something similar, to be used as a tray, a weight of about 1½ozs., a piece of wood about 18ins. long by ½in. by 1½ins., and some cord or wire. None of these measurements are critical, and are given just as a guide.

The wood should be cut so that it tapers from 1½ins. at one end to about ½in. at the other, and prepared with glasspaper. Two holes are drilled as indicated, the first being ¼in. from the end of the wood, and the other at approximately the centre of balance. The tray is suspended from the first of these, and the second is the hole through

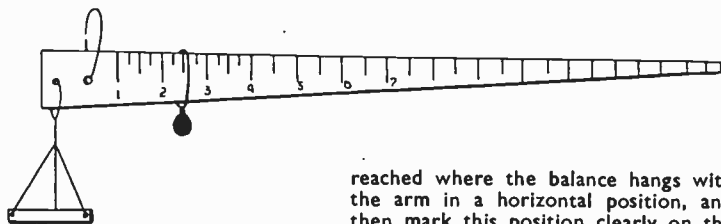

which wire or cord is passed to act as a fulcrum.

Fixing the Weight

The weight must be threaded or fastened with wire so that it can be hung from the long arm of the balance. Be sure to fasten it in such a way that it slides easily along the arm.

For the marking of the scale it is necessary to use some articles, the weight of which is known. As an example, three reasonably new pennies weigh 1oz. Place these in the tray, and move the weight along until a position is

reached where the balance hangs with the arm in a horizontal position, and then mark this position clearly on the side of the arm. Repeat this with other known weights, such as an unopened packet of tea, until the limit of the arm is reached. It will be realised that with one weight of 1oz., one of 2ozs. and one of 3ozs., all even ounce markings up to 7 can be obtained. No doubt you can soon obtain the intermediate markings, and those of a ½lb. and above.

The size of the tray can be selected to suit your requirements, but it must not be changed after the scale has been graduated, or the balance will be altered.

The method of use will present no difficulties. (458)

Chameleon Colour Toy—(Continued from page 57)

measurements given in plan Fig. 1. The sides and ends (A) and (B) are next glued to the top of the box, see Fig. 2, and, for additional strength, four ½in. square blocks of wood should be glued in the angles formed between sides and ends (see plan). Next turn to the making and assembling of the crank and its spindle, and the long spindle (L) and disc (H).

Moving Parts

A detailed outline of the crank (J) is given in Fig. 4. Cut this out carefully, keeping the two holes a bare ¼in. diameter so that the spindle and the handle (K) may fit tightly. The spindle must be 1½ins. long and the handle (K) ½in. long.

Now take the spindle (L). This is about 2½ins. long; and the disc (H) to go over its top must be 3ins. in diameter and is glued ½in. down the spindle as seen in Fig. 2. The two pulleys (G) are next made 1½ins. in diameter with ½in. holes in the centres. The grooves are cut round the edges by means of a rat-tailed file, the discs being held conveniently in a vice during the process. Cut the grooves deeply so that the belt has a substantial hold when in use.

Careful attention must now be paid to the assembly of these working parts. Taking the crank first, proceed to (1) glue crank to spindle, (2) push spindle through top (D), and work on the disc (F), first wiping the spindle with glue where this disc will eventually come, that is, just clear of the underside of the top (D), see section Fig. 2. (4) Push on pulley (G), adding glue to spindle as for disc (F). The distance from the lower surface of pulley to the end of spindle should be full ½in. Note that the end of the spindle is rounded where it goes into disc (E) on the floor.

The same procedure takes place for the longer spindle, bearing disc (H). All should now be ready for putting on the floor (C). The end of each spindle should automatically find its place in the discs (E), and the floor thus fit the side and end rails, where it can be either glued or screwed with roundhead screws. Thus the floor can easily be removed if necessary for any adjustment. Two end battens of wood may be screwed to the floor, see sketch, to raise the toy slightly above the table top to clear the roundhead screws. The belt connecting the two pulleys may consist of an ordinary stout elastic band in

which case it must be put on before the floor is secured.

The Colour Discs

These may be of stout paper or thin card about 3½ins. in diameter. At (A) in Fig. 5 is given one idea of how to divide up the circle ready for painting in In water colour. The 'pimple' shown at (A) is intended as a means to change the colour scheme. While the discs are in motion, just a touch of the finger will alter their position on the wood disc, thereby varying the colouring. It will be understood that two or more card discs can be placed in the 'table' at one time. At (B) a spiral disc makes for a unique effect.

When rings of coloured card (with larger middle openings) are used, each is, of course, of one colour. Then, when these spread out due to centrifugal force, a much livelier and ever-changing scheme is produced. There are endless ways of making up the different colour schemes by varying the shapes, and, of course, the colours. The woodwork of the toy may be neatly finished in oil paint, a matt finish with art shades proving effective.

A panelled effect might also be got by a careful choice of colouring. (105)



Cleaning and Repairing your Specimens

STAMP collectors are urged to collect clean undamaged specimens only, yet sooner or later there comes a time when a keen collector finds himself with a scarce stamp (not easily replaceable) in a somewhat grubby condition, and is in a dilemma whether (a) to include it in his collection as it is, (b) to reject it altogether, (c) clean and repair it.

'Condition' Counts

In the very early days of the hobby, before 'condition' became almost a fetish, mere fragments of stamps were collected. Today, even the most careless collector would not like to see stamps with torn corners or even half-stamps marring the pages of his album. Many stamps, in the course of their wanderings—through post offices, sorters, postmen, office-cleaners, half-a-dozen collectors, etc.—have become soiled and faded. Surely a little cleaning up is not wrong?

Before any used stamp can be cleaned, it must have the paper removed from it. A dealer friend informed the writer that he shovels piles of them in a bucket of lukewarm water, stirring the mass occasionally. When the stamps are thoroughly wet, the adhering paper can be easily slid off. The treatment also washes the dirt off any soiled stamps.

Naturally, such treatment is given only to cheap approval and packet mixture stamps and the reader is hardly advised to try this. Better-class stamps are floated carefully on a basin of water, wetting the paper only, not the actual stamp.

This particularly applies to stamps

printed on 'chalky' paper (introduced first for British issues from 1904) and to 'fugitive' colours, such as brilliant aniline, the idea being to prevent cancellations being washed out, and the stamps used again. These stamps, together with certain overprints and post-marks, will be completely ruined if wetted. They can be floated very cautiously on warm water, until the original gum is moistened sufficiently for the stamp to be slid off. Alternatively the adhering paper can be pulled off with tweezers—a risky operation, however, and one in which it is impossible to remove every scrap of paper. As a precaution, salt water is often used for soaking off such stamps.

Some collectors wash their stamps with soap and water. Others use pure benzene, especially if the stamp is inclined to be greasy. By pressing the stamp with a warm iron between sheets of clean blotting paper, grease is removed, and any creases smoothed out.

A Cause of Curling

Dry warm weather causes unused stamps to curl up. Attempts to press them flat sometimes results in cracks. One can breathe on the back, or put them in a tin box beside damp blotting paper.

Stamps frequently fade or alternatively blacken. When the metallic base of such pigments as vermilion start to oxidise, the stamps are apt to darken. A cautious use of peroxide of hydrogen is necessary.

Flood the stamp with this, and dry rapidly near a fire. Or use a dilute solution. In any case, do not leave the stamp in the peroxide too long, and wash in cold water as soon as the oxide

stains disappear. Some early stamps are particularly susceptible to oxidation, especially many reds, oranges, and some blues, these turning brown or black in many cases.

The peroxide should be applied with a camel hair brush in such a way that the whole stamp is covered at once. Failure to assure this, will result in the stamps looking patchy. Be careful with that peroxide! Peroxide of hydrogen affects the gum of stamps.

Most modern hinges are easy to peel off, but occasionally we come across some that are obstinate. A drop of water applied with a camel-hair brush will soak them off, and if done carefully, will not affect the gum of an unused stamp.

Legitimate 'Freshening'

These are legitimate ways in which a collector can freshen his stamps. Needless to say, no one would be so foolish to try to clean up a stamp of great value. That is a job for an expert.

I might have written that it is hardly worth while to clean up cheap stamps when perfect copies can be easily obtained. At the same time, practice in handling cheap and common stamps serves one in good stead when one's collection grows and better specimens are handled.

It is inevitable that a stamp subjected to much cleaning will lose its sharpness of printing, and tend to become slightly blurred, with a faint difference in colour. If a line-engraved stamp looks very smooth and glossy when held up to the light, there is a chance that it has been pressed—probably after cleaning. You will find, on most stamps, that if a drop of water is allowed to fall on the face, it remains a drop for a few seconds. With a repaired stamp, it soaks in almost at once.

The difficulty with cleaning is to know when to stop. It is legitimate, we may agree, to remove a greasy finger-mark, but fraudulent to fill in a thinned patch on the back of a stamp. Where is the precise dividing line? I would say that it is permissible to remove from the stamp any dirt, grease or slight crease occasioned through mishandling. It is legitimate to bring back chemically the same pigment that was originally in the stamp. It is not permissible to alter the actual structure of the stamp, i.e. by tampering with the paper (replacing missing corners, etc.). In other words, you may clean, but not repair (475)

HAVE YOU made this attractive Galleon yet?



Yes, it's the 'Mary Fortune', one of Hobbies latest galleons, and made from Design No. 2914 published in September. Many workers are making this perfect miniature to give someone as a Christmas gift. Others are making it to add to their collection of galleon models. **The complete kit costs only 5/-.** Get yours today from Hobbies Branches, or post free from Hobbies Ltd., Dept. 99, Dereham, Norfolk.



REPLIES OF INTEREST



For Open-Air Work

PLEASE inform me how, and what to use in connecting together a moving coil speaker and microphone, for use in the open at displays, if possible using mains? (C.H.—Brighton).

YOU will need an amplifier and for open-air use in large gatherings, 10 or 15 watts output will be required; this will make necessary a four or five valve mains amplifier. Smaller amplifiers and microphone and speaker connections have been dealt with in detail in back issues. If you wish to purchase a ready-made amplifier, Pratts Radio, 1070 Harrow Road, N.W.10 have various models; their 10 watt model is £9/9/-. If you wish to build such an amplifier, L. Ormond Sparks, 48A High Street, Swanage, Dorset, can supply diagrams at 2/6 and it is suggested you write to him for a list, including stamp for reply. The output really required will depend upon the purpose in view.

I would be grateful for information as to how I might further my knowledge about coins, their value, etc. (B.M.—Bilston).

A GREAT deal of useful information about coins, can be had at relatively small expense from the catalogues of collections in the great museums. These can be had from H.M. Stationery Office through any bookseller to order. There is, for example, the Catalogue of British Museum Coins. There are also many books on the subject, for instance, Silver Coins of England, by Kenyon—probably now only obtainable second-hand. An enquiry from W. & G. Foyle Ltd., 119-125 Charing Cross Road, London, W.C.2 will most likely result in a list of all available works on the subject. In estimating the value of coins, so much depends on scarcity and condition, and the 'fashion' among collectors, that it is impossible to give you any specific advice, but you could obtain catalogues or price lists from the big coin dealers.

Coin Collecting

ONE of my hobbies is coin collecting, but I have many I know nothing about.

Perspex Cement

CAN you advise me on a solution for joining Perspex (to repair a Perspex sir k)? (E.W.R.S.—Attleborough).

EVERY CAR THAT PASSES YOU WILL FIND THE INDEX MARK ALPHABETICALLY ARRANGED IN WHERE'S THAT CAR FROM?

Price 9d.

from all Booksellers or from the Publishers (1½d. postage)

RALEIGH PRESS, EXMOUTH

KITS for OLD TIME SHIPS

Hobbies range of Ship Models includes Elizabeth Jonas, Cutty Sark, Victory, Mayflower, etc. Complete kits of wood, sail material, guns, pulleys, cord, etc., with full size patterns of parts and planed wood ready to cut out, shape and construct. A fascinating pastime.

Kits for models 7ins. long and upwards.

Ask for free illustrated lists at Hobbies Branches or from Hobbies Limited, Dept. 99, Dereham, Norfolk.

Miscellaneous Advertisements—(Continued from page 61)

HOMEWORKERS required, either sex, light Assembly. Part or full time. S.A.E.—Esprey, Box 18, 41 Wade Street, Lichfield.

NOVEL Calendar designs painted on plywood for cutting out, with date cards. Inexpensive gifts—profitable to sell. Sample, 2/-; half dozen, 11/-, including postage.—Clever (H.W.), 50 Windsor Road, London, N.W.2.

EARN cash spare time making Bennett Model Bungalows. We show you how and buy your work at top rates. Stamped addressed envelope brings free details.—Bennett Models, Duncan Road, Richmond, Surrey.

CONJURING and magic. New tricks and pocket novelties every month. Lists, 4d.—Roboati, Magician, 363 Sandycroft, Kew Gardens.

GENUINE Home Employment making envelopes for us; we buy all you make and pay 50 per cent on cost rates. Send 1½d. S.A.E. to—BCM/TRYIT (HW), London, W.C.1.

'OSCAR Elephant' is wooden—but walk! Profitable novelty toy. Patterns, instructions, 3/6.—Dept. HO, 6 Cedar House, Erlanger Road, London, S.E.14.

INTERESTING work available for all in spare time. Experience unnecessary. Send S.A.E. to—'Leathaweave' Co., Dist. 37, 2 Tudor Road, Leicester.

START making money at home whole or spare time on production of Slippers and useful Leather goods. Material Provided. Write for rates of pay and full details.—Dept. X, Grange Co., 2 Curzon Street, Leicester.

'PERSPEX'—Flat, clear and coloured. Cut to sizes and shapes.—Henry Moat & Son Ltd., Atom Works, Newcastle, 1.

100,000 Government Surplus Bargains. Sample parcels (guaranteed containing 15/- worth assorted electrical and other useful items) in handy wooden box, 5/-, post 1/8. Aluminium rivets, approx. 1lb. asstd., 2/6, post 6d. Inter-room telephone sets, no batteries required, ideal household 'upstairs/downstairs' use, complete, 9/6, post 6d. Send 3d. stamp for catalogue full of interest to the Hobbyist and Experimenter. Money back guarantee.—Milligan's, 24 Harford Street, Liverpool, 3.

THERE are several makes of Perspex cement on the market, all very similar, and there is little to choose between them. You could make your own cement by shredding scraps of Perspex into Acetone until the mixture assumes the consistency of syrup. Put the Acetone into a small bottle, shred the Perspex in a little at a time and shake the bottle to dissolve the Perspex. Always keep the bottle tightly corked, and never on any account bring it near a naked light. Acetone is highly inflammable and is very dangerous if handled near an open flame.

Personal Portable Two

REGARDING the Personal Portable Two: If this were built as instructed, but a midget interval transformer used instead of a full-size one, would this cause such a reduction in volume as to become inaudible? (A.B.—S.W.12).

THE extent to which results are influenced, will depend upon the characteristics of the transformer. Some cheap midget transformers will give less volume than resistance-capacity coupling, while those produced by some good-quality manufacturers maintain a standard of efficiency almost equal to that of a large transformer. In no case should reproduction become inaudible. If you made a comparative test between your midget transformer and a full-sized one known to be of proper efficiency, this would show what reduction in volume would arise.

9.5 Popular Film Hire Library. 3d. Stamp lists.—Wayland, 233 Longley Road, Tooting, London.



EYELETS! EYELETS! EYELETS!

Ideal for Handicraft and Model Making. Eyelets consisting of one leather washer, one aluminium washer and one eyelet. 8 1/2 wide.

1/6 PER GROSS
(Post Free)

WRITE TODAY

C. & G. S. TRADING CO.

1-3 Mill Hill, Griffin Hotel Buildings, LEEDS, 1. Tel. Leeds 29021/2

FREE—first five applicants only. One Gt. Britain stamp (Cat. 5/-, 10/-). 100 stamps (including Triangulars, Pictorials). Request approvals, discount allowed. Bargain packets, 50 World Pictorials, 3/-; 100 World Pictorials, 5/6; 100 Denmark, 2/9. Enclose 2½d. postage.—Quality Stamp Co., 'Elm Grove', Huddersfield-Rd., Halifax.

LEATHER cuttings, suitable for Leatherweave. Cost £2. Carriage paid, 30/-.—Cowan, 22 Kingsmead, Upton, Chester.

10 CANADA free. Send 3d. stamp for discount approvals.—Bernard A. Sherwood (S/H), 11 Philip Road, Ipswich.

1940 U.S.A. Defence set offered free; request approvals.—Clinton, 18 Leigh Rd., Worthing.

STAMPS.—Beautiful Nicaragua Triangle free to approval applicants. 50 Pictorials and Commemoratives, 1/8. 25—1/—W. E. Tucker, 6 Higher Church St., Barnstaple, N. Devon.

MODEL makers, toy makers, home handymen. Bumper set of samples and advice on these subjects, 2/6.—Sutton Models, Billerica.

GENUINELY interested persons required to undertake light, clean assembly work in their own homes. Good rates of payment.—Dept. 918, Universal Products, 5 Cornhill, Lincoln.

MECHANICAL Wood ToyMaker—a book of interesting moving toys with 158 illustrations and patterns—2/6. Home Woodwork—50 useful things to make, 188 illustrations—2/6.—G. F. Rhead, Haretest, Bury St. Edmunds.

NICOTEXIT the guaranteed smoking deterrent. Stops you smoking immediately. C.O.D. price 5/6 per bottle from—The Nicotexit Co. (MP), 62 High Street, Croydon.

INDUSTRY packet free. Six interesting stamps showing Copper and Gold Mines, Rice Harvesting, Coffee Plantation, Chemical and Iron Works. Send 2½d. for Gift 61 and approval books.—R. Crookes, 198 Buxton Road, Mile End, Stockport.

YOUNG man with workshop, saws, benches, etc., wishes to contact firms in all wood lines. Toys and puzzle cutting undertaken, large or small orders.—Box 111, Hobbies Weekly, Dereham, Norfolk.

A STAMPED envelope brings details of highly profitable homework. — The G.C.C.S. (Dept. H.), BCM/NEWPLY, London, W.C.1.

INTRODUCTIONS—pen friends, companionship or marriage.—V.C.C., 34 Honeywell Road, London, S.W.11.

HOBBIES BRANCHES

LONDON

78a New Oxford St., W.C.1
(Phone MUSEum 2975)

.87 Old Broad Street, E.C.2
(LONDON Wall 4375)

117 Walworth Road, S.E.17
(RODney 5509)

GLASGOW—326 Argyle Street
(Phone CENTral 5042)

MANCHESTER—10 Piccadilly
(Phone CENTral 1787)

BIRMINGHAM—14 Bull Ring

SHEFFIELD—4 St. Paul's Parade
(Phone 26071)

LEEDS—10 Queen Victoria Street
(Phone 28639)

HULL—10 Paragon Square

SOUTHAMPTON — 25 Bernard St.

BRISTOL—30 Narrow Wine Street
(Phone 23744)

EMPLOYMENT—work at home; full/part-time. S.A.E. for particulars.—Box 99, Hobbies Weekly, Dereham, Norfolk.

PLYWOOD offcuts, in 5/- and 10/- parcels, post free. Money-back guarantee.—Ezedraw, 21 Spring Grove Rd., Kidderminster.

AMATEUR Radio—world's greatest hobby! Send today for free copy of interesting literature and illustrated catalogue (enclose stamp for postage). Famous Globe-King kits from 25/-. Write direct to makers.—Johnsons Radio (Dept. H.), 46 Friar Street, Worcester.

SPECIAL sale bargain. 5 Triangulars, 25 Large Pictorials, 100 stamps of the World. All for 3/-. Approvals applicants receive free gift.—Kirby, 42 Poulton Street, Kirkham, Preston, Lancs.

MOTOR bench fretsaw. The Hobbies Marvel. Just plug in to your lighting circuit and switch on. Particulars from Hobbies Ltd., Dept. 99, Dereham, Norfolk.

FREE! 30 different worth-while stamps (usually 1/-). Request approvals; enclose postage.—Box No. 444, Hobbies Weekly, Dereham, Norfolk.

MAKE your own Xmas cards and calendars from brilliant coloured leaflets of British birds, 7ins. x 5ins., by well-known artists. 1/- dozen assorted, post free. Sample, 2½d. stamp.—Vawser and Wiles (London) Ltd., 356 Kilburn High Road, London, N.W.6.

MODELLERS! 1/- fetches 17ins. x 12ins. Model fort instructions, diagrams and photo. Genuine bargain. Unrepeatable at this price.—'Kildare', Aylesford, Kent.

STAMPS. Triangular sets. Lithuania Airs. S3—1932, 1/2. 3—1933, 1/2. 3—1942, 1/-. 6 Liberia Zoo, 1937, 1/3. 10 Mozambique Air, 2/-. 3 Nicaragua, 1947, 6d. Postage 2½d.—R. Townsend, 73 Forest Road, Loughton, Essex.

ADVERTISER wishes to contact someone who can model five-inch heads from plastic wood. Would pay good prices for really excellent work.—Box No. 333, Hobbies Weekly, Dereham, Norfolk.

400 STAMPS. Good variety including Pictorials, 2/-.—Rummins, 25 Pendennis Park, Bristolion, Bristol.

HYPNOTISM! Learn to use this mystic power. Complete course of hypnotism, personal magnetism and auto-suggestion, 5/- only, post free. Fullest details, 3d.—BCM/NEWDALE, London, W.C.1.

FREE—stamps catalogued 5/- to applicants for ½d. approvals.—Cox, 17 Stoneleigh Park Road, Ewell.

MODELS. You can make lasting stone-hard models with Sankey's Pyruma Plastic Cement. Supplied in tins by Ironmongers, Hardwaremen and Builder's Merchants. Ask for instruction leaflet.

DUPLEX self-adhesive transfers for decorating fancy goods, trays, plastics, etc. List and samples, 3d.—H. Axon Harrison, Jersey.

DOLL'S house fittings and papers; send S.A.E. for list. Doll's house plan special; send 2/6. Trade supplied.—Zimplan, 88 Ware Road, Hoddesdon.

LORRY kits, 4 mm. and 7 mm. scale. Also large range of spare parts from which to build to your own design. Send for fully illustrated catalogue—price 1/-.—Wilson's Lorries Ltd., 6 Great Winchester Street, London, E.C.2.

£5 to £20 weekly earned at home running your own Mail Order business. Details, 1½d.—Stebbing Publications Ltd. (HB), Naphill, High Wycombe.

BLUSHING, shyness, nerves, self-consciousness, fears ended. Details under plain cover, 1½d.—Stebbing Treatment, 28 (HB) Dean Road, London, N.W.2.

PLYWOOD offcuts. Birch and Gaboon in various thicknesses. Handy sized parcel for the cabinet, toy, model maker and all handicrafts. Parcels made up in £1 and 10/- lots. Carriage paid. Send P.O. to Reeves, Plywood and Timber Merchant, 33 Front Street, Monkseaton, Whitley Bay. Tel. W.B. 4677. Parcels are now despatched on day of receiving order.

STAMPS FREE!! Twenty unused (2½d.).—G. H. Barnett, Limington, Somerset.

AMERICA'S famous hobby magazines. One Year's supply Popular Mechanics, 32/6; Popular Science, 28/6; Homecraftsman, 16/6; Popular Homecraft, 18/-. Free Booklet listing all others sent on request.—Willen Ltd. (Dept. 57), 101 Fleet Street, London, E.C.4.

EARN £5-£20 weekly dealing in stamps. Booklet, testimonials, 1½d.—M. Scbbing, Terry, Naphill, High Wycombe.

HOME Watch and Clock Repair Outfit. Includes watchmaker's magnifying eyeglass, tweezers, screwdrivers, oilers, oil, brush, dusting powder, plus illustrated explanatory book. Watch and Clock repairing simplified. In container, 12/9 inclusive.—D. Bolster (Dept. H.), 5a Station Parade, Ashford, Middx.

IS ONELY? Then write the Secretary, U.C.C.—L 5 B.B. Hay Street, Braughing, Herts. Genuine. Est. 1905.

HAVE you got your Juneoro Riveting Jig yet? From all hobby shops or Post free from Juneoro Ltd., Stirling Corner, Boreham Wood, Herts.

STAMPS Free—Empire Packet including Pictorials and Victorians free to approval applicants.—Robert J. Peck, 7A Kemp Road, Bourne-mouth, Hants.

WHEELS for Toys, etc., in Hardwood, Plastic and Rubber tyred Metal. Doll's House fittings and papers. Doll's cot and Pram fittings. Beads for counting frames and other Toy accessories. Fine art pictures for ligswags, etc. Stamp for lists. Trade supplied.—Joyden Toy Co., 193 Chase Side, London, N.14.

(Continued foot of page 60)

100 Beautiful Pieces of FURNITURE YOU can make!



160 PAGES

Save yourself pounds!
A WONDERFUL BOOK

Popular Mechanics famous Craftsman's Library—for every handyman's shelf! **DRAWINGS AND SCALED DIAGRAMS** Complete suites & every type of occasional furniture. Exclusive designs. **PAGES IN BRILLIANT COLOUR!** Contains hundreds of diagrams. Lush colour photographs. Full how-to-make instructions. Unique. **ORDER YOUR COPY TODAY**

ONLY 21/6 POST PAID 23/- C.O.D.

To: **A. THOMAS & CO. (FH)**, 111 Buchanan St., BLACKPOOL. I enclose remittance 21/6 for one POST PAID copy of above : OR send C.O.D.

Name.....

Address.....

YOU CAN BECOME A HANDICRAFTS INSTRUCTOR

EXPERIENCE NOT ESSENTIAL

Men who enjoy making things in wood or metal can turn their hobby into a permanent and interesting Career. Short hours, long holidays, and security in a job you would really enjoy, can be yours if you become a Handicrafts instructor. Let us send details of the easiest and quickest way to get the necessary qualification.

We guarantee "NO PASS—NO FEE"

If you would like to know about our unique method of preparing you for one of these appointments, write today and we will send you our informative 144 page Handbook—free and without obligation. Mark your letters "Handicrafts Instructor".

**BRITISH INSTITUTE OF
ENGINEERING TECHNOLOGY**

595 Shakespeare House
Stratford Place, London, W.1

BIET

Develop Self-Confidence—Master JU-JITSU



Amazing new methods show you how to 'get tough' and make any attacker helpless with lightning speed—or money back. The Morley Rapid Ju-Jitsu Course teaches you all the knock out blows, shows you how to throw a stronger man helpless to the ground, gives absolute mastery. Develops body, gives self confidence. You can acquire this devastating weapon in a few weeks. For both sexes. Complete fighting system, 10/- (or \$1.00 bill and 40 cents in stamps). Air Mail, 15/-.

Powerful Arms Course, 2/9. Powerful Chest, 2/9. Powerful Legs, 2/9. Powerful Abdomen, 2/9. 114 Ways to be your Own Boss, 5/6. Details 2½d.

JOHN J. MORLEY (HB/91), Terry House, Naphill, High Wycombe, England. Established 1936

PERFECT PASTIMES FOR PLEASURE & PROFIT

In these days value for money is of paramount importance. Full value is offered in

POPULAR **Handicrafts** MONTHLY 1/-

The magazine that provides a unique service for the home, handicraft worker.

Each issue includes a Woodwork Section, Instruction Course, General Instructional Articles, Features—News—Reviews in all branches of handicraft; including a MARKET SECTION for the sale of work.

On sale at newsagents, booksellers and handicraft shops, or send 14s. 0d. for 12 months to:

H. BURT, LINK HOUSE, 24 STORE STREET, LONDON, W.C.1

SPECIAL MOULDS

Some new lines for the Craftworker

Sets of moulds for Cake Decorations, Christmas Novelties and Brooch Making at 12/6 for a set of 8 moulds. Plaster moulds for all types of Ornaments and Plaques from 6/6. Dolls Masks and Faces 3 sizes, set 15/6. Dolls Heads, 25/- for mould. 150 Toy Making moulds at 3/- each. New Father Christmas and Snowman, 2½in. flexible moulds, 12/6. Buy direct and save money. New catalogue illustrated 9d. post free. All moulds are made of strong aluminium or vinimould. They are made to last. 4 sample moulds of Toy Soldiers or Sailors, 12/- post free.

COCK OF THE NORTH MOULDS

140 HOLLINGS ROAD, BRADFORD

Turn your own candlesticks, ash-trays vases, bowls

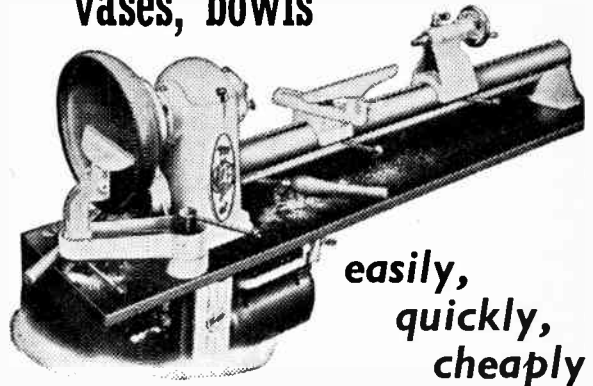

easily,
quickly,
cheaply

Pleasure—and profit—can be yours with the ML8 Wood-working Lathe, first choice of the Home Craftsman. Turning Capacity: 8" swing x 30" between centres. See your Tool Merchant for all details.

MYFORD

ENGINEERING CO. LTD., Beeston, Nottingham

NEW AND PERFECT Ex-Government

SIGNAL LAMPS

For day or night use. 3½in. lamp, morse key, view finder, mirror reflector, fully wired, in strong waterproof case with spare parts tin and coloured discs. Swivel base, metal screw-in stand. Adaptable as car, motor-cycle, workshop, studio spotlight. Ideal Scout Troops, Boys' Clubs, signalling instruction, etc. Post 1/3 13/6
Special Spare Bulbs 2/6

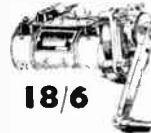

18/6

HAND GENERATORS

L.T. 6-3 volt, 2-6 amp.; H.T. 320 volts, 60 M/amp. at 120 r.p.m. New and complete. Post 1/6

Illustrated Bargain Catalogue Free.

PRIDE & CLARKE LTD., (Dept. P.W.)
STOCKWELL ROAD, LONDON, S.W.9. BR1xton 6251

STOP SMOKING

You can overcome the smoking habit in 3 days or money back. Safe, pleasant, permanent. The only scientific way. No Will Power necessary. "Conquered the habit in 2½ days. Am delighted".—F.C. "Within 2 days I was free from the tobacco habit".—W.G. "Was a smoker for 2 years and broke the habit in 2 days".—F.N. "I haven't smoked a cigarette for 5 weeks".—J.E. "I used to smoke 20 a day . . . now I have no desire to smoke".—J.M. Recommended by "Health and Efficiency Magazine". Complete course 6/6. Details 1d. stamp. Sent under plain cover.—**STEBBINGS, 28 (H/102), Dean Road, London, N.W.2. Established 1928**

EARN £££'s WEEKLY

114 WAYS TO BE YOUR OWN BOSS

114 tested ways of earning a second income at home, with little or no capital. Many are earning £5-£20 weekly. Money back if not delighted. Post free, only 5/6. Details 1d. Catalogue of Money-making Hobby Books and courses, 2d. **STEBBING PUBLICATIONS LTD., 28 (H/102), Dean Road, London, N.W.2**

Patterns for the 'Talking' Duck (See page 55)

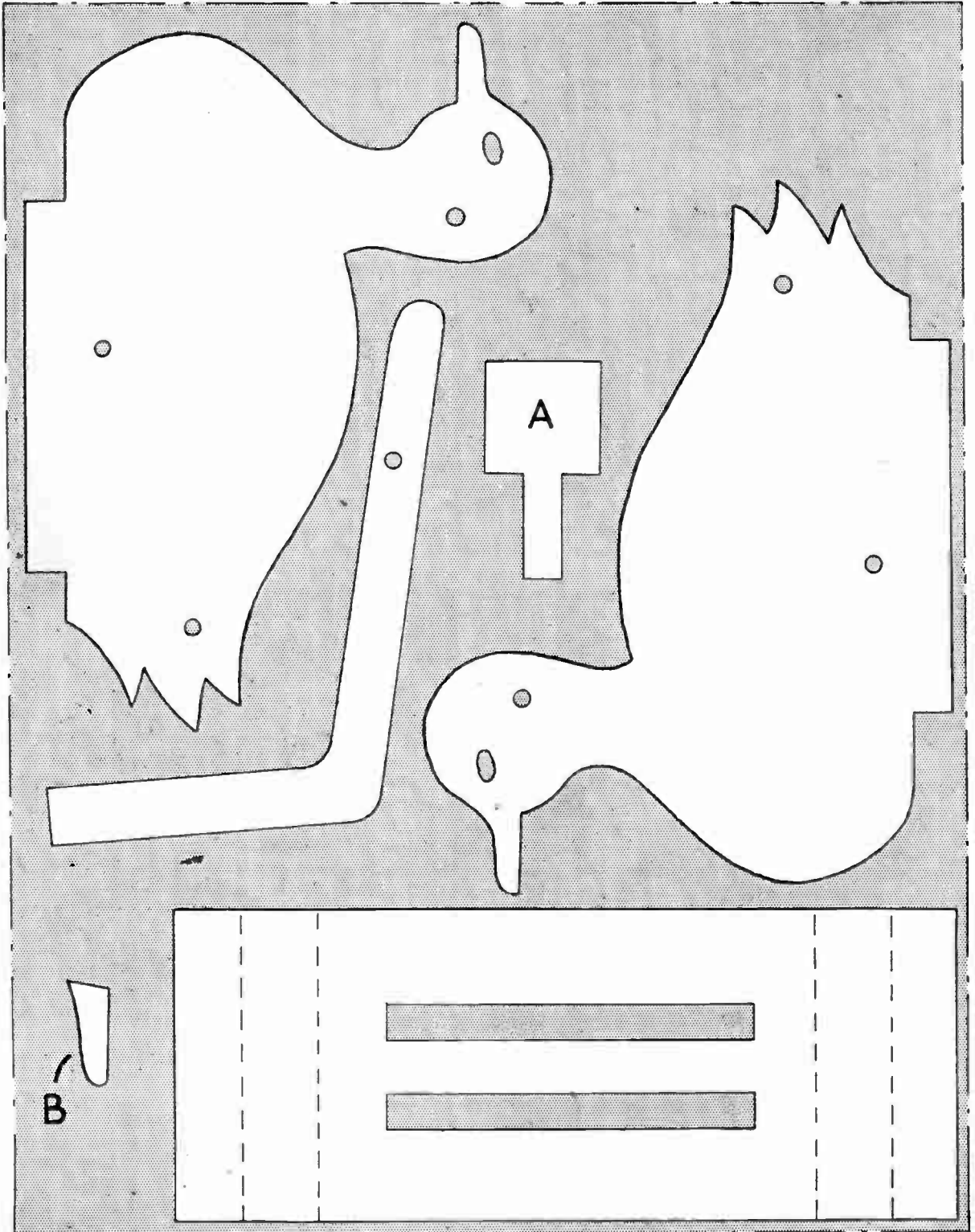

The Bennett College

FOUNDED 1900



LIMITED

The Most Progressive and Most Successful Correspondence College in the World!

POSTAL TUITION is YOUR way to **SUCCESS**
in the career of your choice—act NOW!

Is your Career here?

Accountancy Exams.
Applied Mechanics
Aviation Eng. and Wire
Blue Prints
Boiler Making and Eng.
Carpentry and Joinery
Chemistry
Civil Engineering
Civil Service

All Commercial Subjects
Commercial Art
Concrete and Structural
Engineering
Diesel Engines
Draughtsmanship
Engineering
General Certificate of
Educ. Exam.
G.P.O. Eng. Dept.
Journalism

Languages
Mathematics
Metallurgy
Mining, All Subjects
Plumbing
Police, Special Course
Quantity Surveying
Radio Service Eng.
Salesmanship
Secretarial Exams.
Sheet Metal Work

Shorthand (Pitman's)
Short Story Writing
Short Technical Courses
Surveying (R.I.C.S. Exams.)
Teachers of Handicrafts
Telecommunications
Television
Transport Inst. Examinations
Viewers, Gaugers, Inspectors
Wireless Telegraphy
Works Managers

★ If you do not see your own requirements above, write to us on any subject. Particulars Free.

Post this Coupon—TODAY!

and take the first step towards a position of responsibility in the Career of your choice.

To Dept. 62. THE BENNETT COLLEGE LTD. SHEFFIELD

Please send me (free of charge) particulars of.....
PLEASE WRITE IN BLOCK LETTERS

NAME

ADDRESS

AGE.....

Add realism to your
Model Railway!

WITH '00' GAUGE

PLATFORM ACCESSORIES



This set of intriguing platform accessories is just what you need to add realism to your model railway.

Die cast and hand painted in bright colours, this set, No. 7, is '00' Gauge scale, and consists of a four-wheel porter's trolley, bicycle, chocolate machine, three milk-churns and weighing-machine. Price 2/6 complete set, including post and packing. Send now for this set.

We have a complete range of '00' Gauge model railway accessories. Send stamped addressed envelope for descriptive list.

TRADE ENQUIRIES ALSO INVITED

R. B. N. CO.

(DEPT. H) 180, BRADFORD ST., WEST HARTLEPOOL, N. DURHAM.
TELEPHONE: MAIDA VALE 1070

how about some
Seelastik?



Every time this door slams a little more of the mortar or putty drops out. Why? Because it sets hard and shrinks and does not really stick.

They should have used Seelastik.

Seelastik forms a watertight, airtight seal and remains flexible and elastic when set; it sticks tenaciously even to highly polished surfaces, such as glass, as well as to any combination of brick, cement, stone, plaster, wood, metal, tiles, glazed earthenware...

A Seelastik seal costs 1/4d. to 1 1/4d. a foot, depending on its width. It is light-coloured, and can be painted 24 hours after it is put on.

You can buy Seelastik — packed in handy cartridges, and applied by the Expandite gun (50/- with two nozzles) — or in 2/- and 3/- tubes, which are self-contained sealing tools.

Seelastik

SEALS THE GAP



EXPANDITE LTD., CUNARD ROAD, LONDON, N.W.10

Printed by BALDING & MANSELL, LTD., London and Wisbech, and Published for the Proprietors, HOBBIES LTD., by HORACE MARSHALL & SON LTD., Temple House, Tallis Street, E.C.4. Sole Agents for Australia and New Zealand: Gordon & Gotch (A'sia) Ltd. For South Africa: Central News Agency Ltd. Registered for transmission by Canadian Magazine Post.

Hobbies

WEEKLY

CONTENTS

	Page
Model of Galleried Inn	65
Tabletop Football Game	67
Simple Hygrometer	68
Optical Toy	69
Simple Hammering Toy	70
How to Catch Pike	71
Completing a Toy Train	72
Extension Speaker Cabinet	73
Home Chemistry	74
Replies of Interest	75
Handy Window Conservatory	76
Gt. Britain on Stamps	77
DESIGN SHEET FOR CANBERRA JET BOMBER	

October 31st, 1951

Price Fourpence

Vol. 113 No. 2922

Make a realistic MODEL OF A GALLERIED INN



THE artist's impression of an old-time coaching scene could well be taken for a representation of the real thing. Actually it is sketched from a model, or rather three models: the inn, the archway leading to the courtyard and the coach itself.

We give, herewith, the instructions for making the inn, and an article on making the extension will immediately follow. A little later it is hoped to give instructions for making the coach. The

scale of these models is exactly the same as for the *Old Curiosity Shop* given in our issue of September 13th, 1950 and the *Village Smithy*, given in our issue of October 17th, 1951. At a later date it is hoped to provide plans for making a quaint old bow-fronted shop so that one can make a fascinating model street of old-time buildings.

The first thing to make is the front (1) This is laid out on $\frac{1}{8}$ in. plywood (grain of top layers, vertical).

The part actually to remain is shown shaded. The only part likely to cause a slight difficulty is the balustrading. Note, in the first place that the sign — is a draughtsman's convention to indicate that the $1\frac{1}{4}$ in. space is to be divided into three equal spaces and the 2 in. space divided into five equal parts. With centre (a) and radius (a-b) one side of a baluster can be drawn. Similarly with (c-d) and with other centres but with the same radius.

All correspondence should be addressed to The Editor, Hobbies Weekly, Dereham, Norfolk.

On the other hand, avoid going to the other extreme and making it look too dilapidated and merely dirty.

Making the Windows

The ideal material for the windows is photographic roll film. Most of us have had negatives that are quite blank, or where the image is so faint as to be hardly noticeable. Experienced model-makers save these things. Should we have no suitable negative to hand, we can soak an old, useless one, in lukewarm water, and wipe off the emulsion. Dry carefully. The material is pinned over a previously prepared drawing, and a series of lines made in indian ink. The ideal instrument for this is a draughtsman's ruling pen, but a mapping, or even ordinary pen will do, if care is taken not to charge it too fully.

The lines should not be too thin. Make sure the horizontal lines are dry before the vertical ones are ruled, as otherwise the ink will run at the intersections. The celluloid is then cut with a margin of at least $\frac{1}{4}$ in. all round. The three lower windows can be cut in one piece. Do not fix them until after the main model is painted. When ready to fix, however, glue the celluloid windows on from behind with ordinary tube glue. It holds quite well. Place the inked side *inwards*, so that the windows may be cleaned (with a swab of cotton-wool) if necessary. Above all things, try to prevent glue oozing out on to the window. It looks very ugly.

As regards the painting, readers may have their own colour scheme, but for guidance, the writer recommends: Gallery rails and window surrounds — green. Moulding—brown and yellow. Door—dark brown. At bottom—yellow brown.

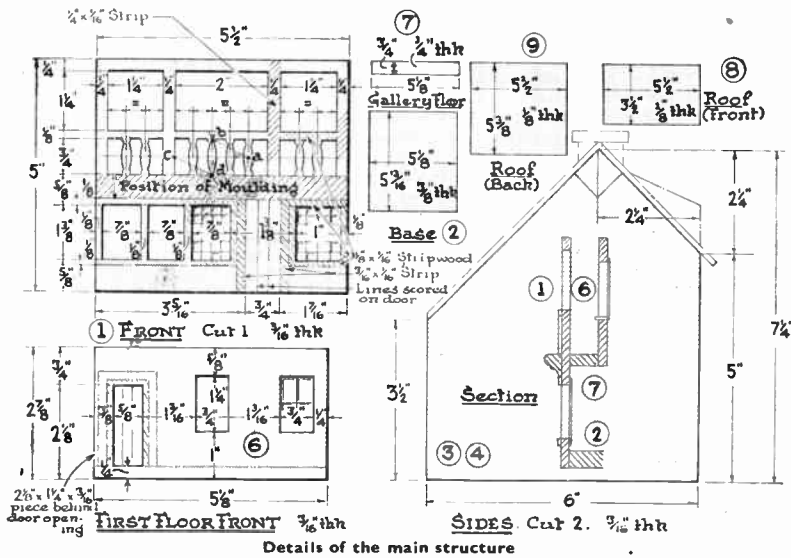

Details of the main structure

Take great care to cut the balusters symmetrically and smooth off all rough edges.

Glue a piece of $\frac{1}{2}$ in. wide moulding of the type shown in the section drawing across the front, where indicated, securing with small nails from behind if desired. Against the four pillars supporting the gallery roof, glue four strips of

wood, whilst two lines are scored on the wood (with a penknife, making a tiny Vee groove) to represent the boards of the door. This completes the front, except for the window 'glazing', which is added later.

The Base

Whilst waiting for glue to dry, the base (2) and sides (3 and 4) may be cut out. The dimensions of these parts are given in the drawings. Cut also the ridge 1 in. square. Next cut the gallery floor, also the first floor back. In this piece, the door is cut right out, and another piece of wood suitably scored placed behind to represent the door proper. There is a surround of $\frac{1}{8}$ in. by $\frac{1}{16}$ in. stripwood, and note also that pieces of $\frac{1}{4}$ in. by $\frac{1}{16}$ in. stuff are used to represent window sills.

This gallery floor and first floor front are nailed in position (see the photograph and also the section drawing) and since, when the main front is put on, they will not be so easy to get at, they are coloured first. Poster colours are used. These are ideal for the work, having great covering power and giving a slightly matt surface which looks really like dis-tempere walls. We can paint the floor a neutral grey, and the wall a yellow or cream. In all models, avoid making the colour look too new.

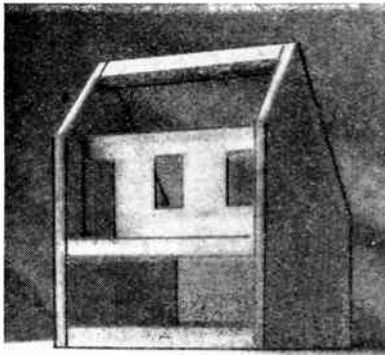

The model during construction

$\frac{1}{4}$ in. by $\frac{1}{16}$ in. stripwood 2 $\frac{1}{8}$ ins. long. Along the top rail of the balusters, glue three pieces of $\frac{1}{8}$ in. by $\frac{1}{16}$ in. strip wood. Those who are sticklers for detail can, with a fretwork file, round off the bellies of the balusters, but this is by no means essential.

Similar stripwood (which, by the way, is glasspapered down from the standard $\frac{1}{8}$ in. square stripwood, preferably after being glued down in position), is used to surround the windows. The horizontal strips are fixed first, and then the verticals. The upright sides of the doorway are pieces of $\frac{1}{8}$ in. by $\frac{1}{16}$ in.

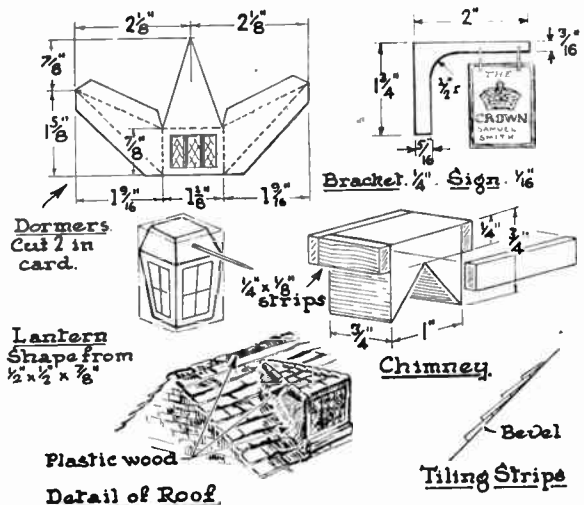

Detail of Roof

More drawings to help the modeller

Fix on the roof pieces, nailing to the ridge, and gluing to the sides. As the model-maker will probably have to make his model street in separate units so as to be more easily transportable, and easier to store, the inn and the arched extension are described as separate parts. They may well be made as one, however.

If the reader so desires, the roof pieces and the corresponding tiling can be made to cover the two models. We describe, however, the roofing for one model.

The chimney stack is easily made from the diagram. Note that the chimneys should be of different heights and diameters, for effect. The dormers are cut out of stiff, but not too thick cardboard. Two are required. They are scored and bent along the dotted lines. It is a good plan to paint the front (in water colours this time) before fixing, as it is much easier to paint when in the flat. Glue each dormer about $\frac{1}{2}$ in. from the ends of the model and almost touching the front. When set, glue on the window sill strip as shown in the drawing.

An interesting job is the 'tiling' of the roof. This is done with strips of fairly thick cardboard $\frac{1}{4}$ in. wide, and a little longer than the roof, so that they can be trimmed off neatly afterwards. Take a sheet of white card, of sufficient size to cut all the strips required and paint it a red-brown with poster paints. (The

colour of old tiles has fascinated artists. When one looks carefully, one discerns tones of red, brown, purple, green, etc.) When dry, cut the strips and apply them to the roof, starting from the bottom. The principle is the same as nailing down



The completed model

weather boards. There is a small diagram which explains matters. Glue them down well, and tack them temporarily with ordinary pins till the glue sets. The pins are easily removed afterwards. 'Tile,' also, the dormers, and finally apply plastic wood to the ridges to represent

their appropriate tiles, and also to neaten things off.

The lantern is shaped from $\frac{1}{2}$ in. square strip. Shape this before cutting it off the strip. It is then easier to hold. The lower part is covered with tin foil on which the bars, etc., are painted, whilst the top is coloured, say, red. A short piece of stiff wire, pointed both ends (with a file), secures the lantern over the door. The sign board of card and arm of plywood are now cut out. A red crown and lettering on a yellow background is suggested.

The whole is given a coat of varnish, which 'fixes' the poster paint, and prevents dust working in. Take care that the varnish does not become aggressively shiny. Rub it down with very fine glass-paper if it does.

It will be noticed that at this stage, the inn model still looks rather bare. The reason is soon ascertained. It is an empty house. There are no curtains to the windows. These are made of little scraps of patterned paper, those in the 'bar parlour' being horizontal and extending about half way up the window.

There is no real need to fix a back to the model. The sides are rather bare, of course, but it is anticipated that the reader will want to make other models and which can abut on the inn just made, thus hiding the dead wall. (493)

Have fun with this

TABLETOP FOOTBALL GAME

FOR one of the best and most exciting games of indoor football you need only a collection of pennies, a halfpenny, and two empty matchboxes—and, of course, a table. Your pennies are the 'men'. The halfpenny is the 'ball'. Split one long side off the tray of each matchbox and place upside down at each end of the table—and there are your goalposts.

How to Play

To play the game you simply flick the 'man' (the penny) against the 'ball' (the halfpenny) and so propel the ball forward. You can use two complete teams of eleven pennies a side, or restrict the number of 'men' on each side to three or four. This will depend on the size of the table. A small table is rather overcrowded with two full teams of eleven 'men' each. To distinguish between the 'men' on each side, one team should comprise pennies with the heads facing upwards, the other team facing 'tails' upward.

There are several ways of playing the game. Both players can flick their men at the same time, playing continuously one

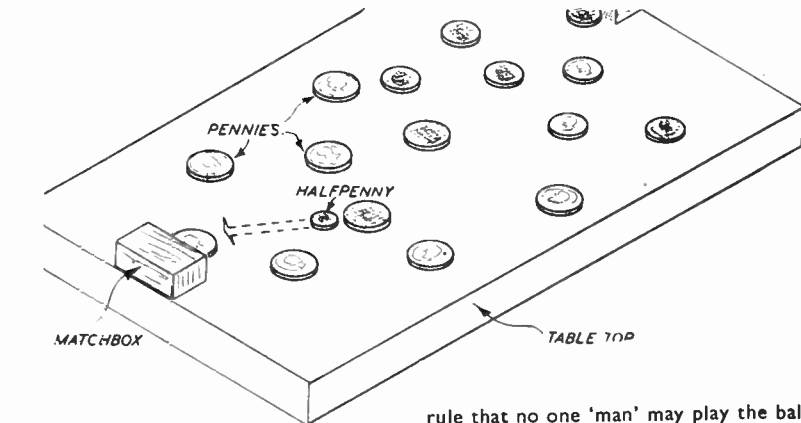

against the other all the time like a real football match. This is quite the most exciting way. Another method is for the players to take it in turns. All the while one player succeeds in hitting the ball each time, he continues to play. If he misses the ball, or hits it against an opposing team member, then the other player starts his turn, and so on. If you use this method it is as well to make a

rule that no one 'man' may play the ball more than three times in succession. Another good rule is that no goal shall be scored by a 'Kick' starting from over the half way line.

Use the rules of football for the main rules of the game. For throw-ins, the ball should be brought into play 'shove ha'penny' fashion. You can introduce other rules which you may find necessary as you go along. (485)

Be 'weather wise' with this SIMPLE HYGROMETER

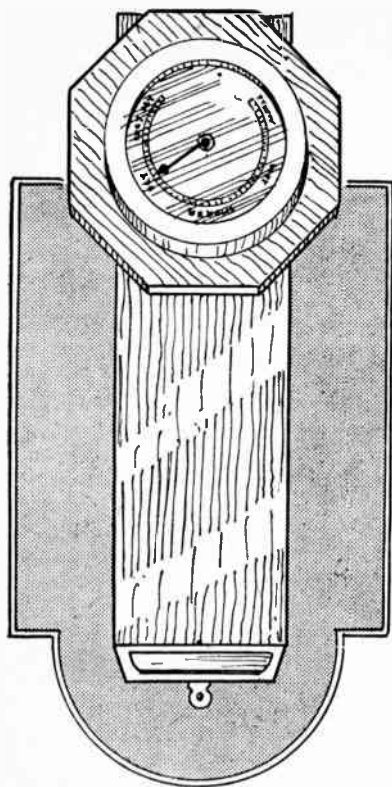

Take the works apart and discard all wheels except the two shown in Fig. 2, the wheel carrying the spring, and the centre wheel to which the spring wheel is geared. The clock frame is then screwed to the front of the case, with its centre spindle protruding through the hole (A). The spindle should not protrude more than $\frac{1}{8}$ in., so it may be necessary to interpose metal washers between the works and case to ensure this. It should be noted here, that the average of these American clocks measures 4 ins. diameter, but if the works to be employed are from a larger clock, it may be necessary to amend the dimensions of the case to allow the works ample room. However, this should not entail any particular difficulty.

The operating material to be used is string, as this contracts in damp weather. A satisfactory quality to employ is the stout kind used by the grocer, white in colour usually. This has to pass over metal pulleys, and as a foundation for fixing the pulleys to, a block of wood at

where it is tied to a screw hook, driven in block (B).

To tension the string, a rubber band, or better still, a helical spring, is hooked to the spring wheel, opposite the string, and is then stretched, as at (D) to a screw hook, driven in the side of the case. A study of the interior shown in Fig. 1 will make the above clear. A careful adjustment of both string and spring should be made, until a pressure of the finger against the string makes the central spindle twist a little, and resume its former position when the pressure is released. The minute hand of the clock is pushed on the spindle to act as the pointer of the instrument.

For a dial, a circle of white paper or thin card 4 ins. diameter is required. In the centre of this a $\frac{3}{8}$ in. hole is cut out. The dial is then divided into degrees, and neatly lettered. Stormy, etc., like the real thing. As the pointer spins anti-clockwise, 'Stormy' should be to the left on the dial.

The dial cover is shown in Fig. 3, front and side view. Make this from $\frac{1}{2}$ in. fretwood to the octagonal shape shown, and in the centre cut out the opening to the diameter given, if the glass is a 4 in. diameter. If a larger size, then cut the opening $\frac{1}{2}$ in. less diameter than the glass. Two rings of $\frac{1}{8}$ in. fretwood are now needed to hold the glass in position. The inner ring, which is glued over the opening, should have a circle cut out the size of the glass, and the outer ring,

THE hygrometer as a weather forecaster is second only to the barometer. It is a quite easily made instrument and well worth the trouble of construction. The pattern illustrated makes use of the works of a discarded clock, of the cheap American fashion, so no troublesome business of gear wheels is involved.

Fig. 1 shows a view of the interior works and a side section. The front and back of the case can be made of $\frac{1}{8}$ in. fretwood, the sides of slightly thicker stuff, say, $\frac{1}{2}$ in. wood. Both back and front are cut to the same dimensions, and in the front only, at centre (A), a hole, $\frac{3}{8}$ in., is bored through to allow the spindle carrying the pointer to pass. In the side pieces, three holes, 1 in. diameter, are bored through each to let air pass to the inside. These should be covered on the inside with fine porous material, like muslin for instance, to exclude dust.

Make the top and bottom parts, then glue the sides, top and bottom together. The front and back pieces are best screwed on, for possible removal should anything go wrong with the 'works'. Remove the works of the clock from its case, and take care of the glass front, which will be needed to cover the dial of the instrument later.

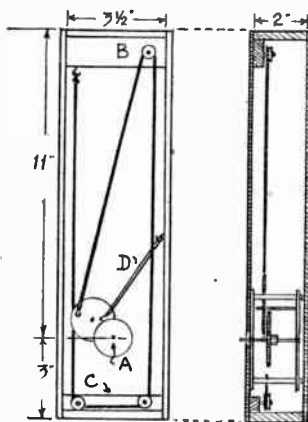

Fig. 1

top and bottom of the case, inside, seen in Fig. 1, at (B) and (C) should be glued in. Make these of the right thickness of wood to bring the pulleys in line with the spring wheel of the works.

Any small metal pulleys can be employed here. Those used for running curtains on are excellent, and can be purchased for a few pence at hardware stores. Suitably sized round-headed brass screws will do nicely to fix them to the blocks. To one end of the string tie a wire hook and fit this to a spoke of the spring wheel. The string is then carried over the top pulleys, down to and under the two bottom pulleys, then up again,

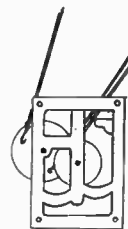

Fig. 2

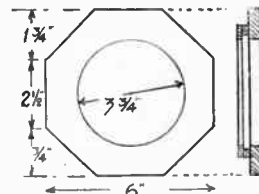
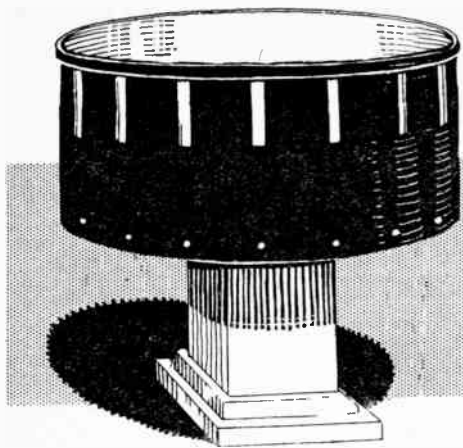

Fig. 3

an opening $\frac{1}{2}$ in. less in diameter. Paste or glue the dial to the case, and screw the cover on. The glass is then inserted and the outer ring screwed on to keep it there. It is as well, however, to defer fixing the outer ring until the instrument's pointer is adjusted, which can be done by reference to a barometer, or, if such an instrument is not available, to correspond with the weather of the moment. It is wise to let the instrument settle itself for a few days before adjusting the pointer. Finish as preferred and hang in the hall, using suitable suspension plates. (500)

'Pin-men' come to life in this OPTICAL TOY



DESCRIBED here is an interesting optical toy, which years ago was called a 'Zoetrope' or 'Wheel of Life'. It consists of an open cylinder which is mounted on a firm base and revolves upon a fixed upright spindle.

In the side of the cylinder there are sixteen slots through which the operator looks at a strip of 'animated' pictures, by which we mean that each of the sixteen or so pictures shows the subject in various attitudes. When the cylinder is spun round, the figures come to life, as it were, and perform in a similar manner to the cinema picture.

To make the pictures a strip of stoutish paper or thin card is first cut $1\frac{1}{2}$ ins. wide and 14 ins. long, and this is bent and fits round the bottom half of the cylinder as shown in the sectional view, Fig. 1.

To get the pictures properly spaced, the card is first placed in the cylinder as

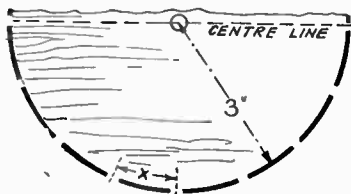

Fig. 2

suggested, and pencil outlines of the apertures made in pencil direct from the actual cylinder slots. When the paper strip is removed, there will be sixteen spaces on it, and it is in the centres of each of these that the figures are drawn in ink and colour. On the half plan given in Fig. 2 a section of the cylinder is shown, and the spacing of the slots. Each picture, therefore, is spaced at (X) centres, but this will automatically come right when the above procedure is carefully followed. Various subjects will occur to the worker to introduce on to his 'strips'. There can be a series of

pin-men figures for instance so much fancied by the young artist as being simple of execution.

We give a simple suggestion here (Fig. 3) of a pin-man doing his morning 'physical jerks'; this makes quite a good continuation picture. Then again, our pin-man can be pictured jumping in a hurdle race, the up and down movements looking quite life-like in performance. The writer has seen a good picture where a negro is being flung over the head of his donkey. Such a figure picture as this, however, is a little more difficult of execution, but will doubtless, be treated as an experiment by more ambitious workers.

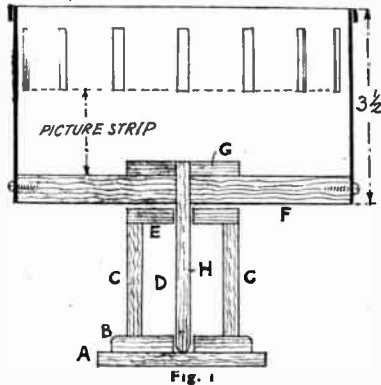

Fig. 1

The Pedestal Base

The first consideration in commencing to make the toy will be the pedestal and base, and this takes the form of a hollow box of four sides, a single flat top and two pieces to form the lower base. In Fig. 4 an exploded view of the seven parts is given. The lower piece (A) in Fig. 1 measures 3 ins. square by $\frac{1}{4}$ in. thick, piece (B) glued on top of it is $2\frac{1}{2}$ ins. square and the same in thickness. In the centre of the latter piece there is a hole $\frac{1}{8}$ in. in diameter to take the end of the centre spindle.

For the pedestal, two pieces 2 ins. square, as (D) in Fig. 4, and two pieces 2 ins. by $1\frac{1}{2}$ ins. as (C) are cut, cleaned up and glued together. Clean off the two ends of the pedestal before gluing on the top and the base. The top member (E) is 2 ins. square, and has a hole cut in the centre as piece (B). When all these parts have been built up and glued together, they may be either painted or stained and varnished. Any odd pieces of wood

may be used, as they will be well covered. It is suggested that four long fret pins be put through piece (E) into the sides of the pedestal, as the end grain of these latter pieces will not nicely hold the glue.

The Cylinder

Now lay aside the completed pedestal, and commence work on the revolving cylinder. The first piece to prepare will be the large disc (F), and this is of $\frac{1}{4}$ in. wood drawn with compasses set to 3 ins. radius, as plan Fig. 2. In the centre of this piece bore or cut a hole a bare $\frac{1}{8}$ in. diameter to receive the round spindle (H). Before gluing in the latter, however, a top disc (G) must be glued on to assist in making a really firm fixing for the rod. This disc is 2 ins. in diameter and has a similar hole made in it to disc (F).

The cylinder side may consist of thin plywood or stout card cut square each end and 14 ins. long by $3\frac{1}{2}$ ins. wide. Set up a width of $\frac{1}{4}$ in. from the lower long edge, to indicate where it will be glued to the disc (F). Then from this line set up $1\frac{1}{2}$ ins. (the width of the picture strip), and then again above this a width of $1\frac{1}{2}$ ins. which will be the depth of the slots in the cylinder side. Next set out the sixteen spaces. These will each be $\frac{1}{8}$ in. wide and $1\frac{1}{2}$ ins. long. Cut them with a sharp-pointed knife and keep the edges as clean as possible.

(Continued foot of page 70)



Fig. 3

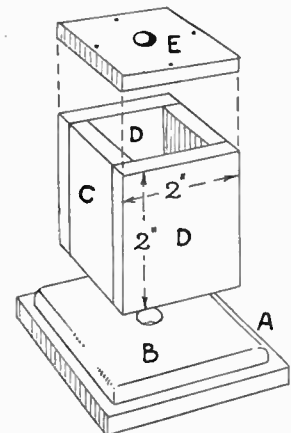

Fig. 4

Keep small children happy with a SIMPLE HAMMERING TOY

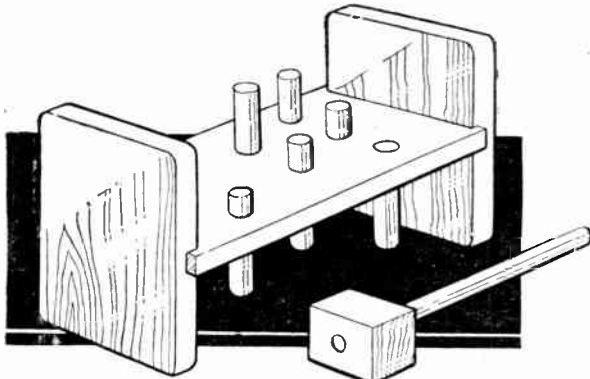

Fig. 1—The finished toy

At some time during their development, small children like to have something to hammer, and may be kept amused by being given a small hammer and some nails. But the wrong nails get hit, and iron nails may even be chewed, so that the hammering toy shown (Fig. 1) is a worthwhile device.

The idea, briefly, is to fix pieces of $\frac{3}{8}$ in. diameter dowel rod quite firmly into the

level bar of a wide and shallow capital 'H' of wood. When the child has hammered the rods down on one side the toy can be turned over and the process repeated. The ends can be made of any wood over $\frac{1}{2}$ in. thick, but a centre of similar thickness should preferably be of material such as material which does not easily split.

Start by cutting the two ends 5 ins. by 4 $\frac{1}{2}$ ins. and rounding the corners. Then mark out with a square on each end a central groove the width of the centre bar of the toy. Cut the sides of the grooves with a tenon saw to a depth of half the wood thick-

ness, and chip out the wood with a chisel. The centre piece should now fit tightly into the end pieces.

Before assembly of the toy, holes must be drilled for pieces of dowel rod. The pegs are of such a length that when they have been hammered flush their ends just fail to touch the floor. With the dimensions given, 2 in. pieces of dowel will be suitable. The holes should be drilled with a wood drill of exactly the same size as the dowel rod. Do not drill the holes too closely together or the child will find it impossible to hit the dowel rod pegs in one at a time.

If the centre part is 8 $\frac{1}{2}$ ins. by 5 ins., the holes for the pegs can be $\frac{1}{2}$ in. in diameter spaced 2 ins. apart. Fix this centre piece in position with panel pins—give the toy a coating of enamel, and leave it hung up by string to dry.

Take an $\frac{1}{2}$ in. piece of the dowel rod for a mallet handle. The head should be of a good non-splitting wood such as beech, and its size should be 2 $\frac{1}{2}$ ins. by

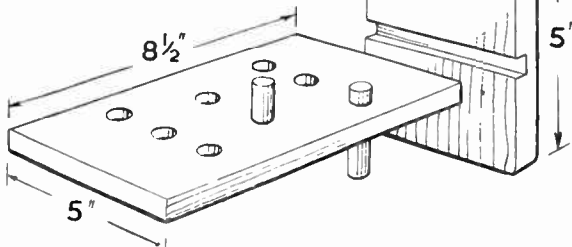

Fig. 2—Showing the dimensions and the method of assembly

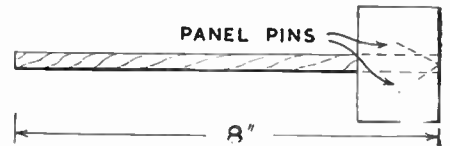

Fig. 3—Details of the mallet

2 ins. by 2 ins. It should be bored accurately in the centre of one of the long faces. Tap the dowel rod into the head of the mallet, and drive a pair of thin panel pins diagonally into the wood, as shown, to obviate any chance of the mallet head flying off the handle.

The noise is less than that of a drum, and the toy is a three-year-old's idea of heaven for a while! (110)

Optical Toy—(Continued from page 69)

Now bend the strip round the wood disc and glue it firmly, putting in a few roundhead screws as extra fixing. To further strengthen the extreme upper edge of the cylinder, glue on a strip of stout card about a $\frac{1}{4}$ in. or so wide. The whole job should now appear like Fig. 5, except that this diagram is, of course, cut through to show the inner disc and the larger one with its fixing.

The spindle may now be prepared from a piece of $\frac{1}{2}$ in. diameter rod about 3 $\frac{1}{2}$ ins. long. Care must be taken in cutting off the rod to get the correct length, for there must be a clearance between the underside of the cylinder floor (F) and the top member (E) of the pedestal. This clearance allows for free action when the cylinder is spun round

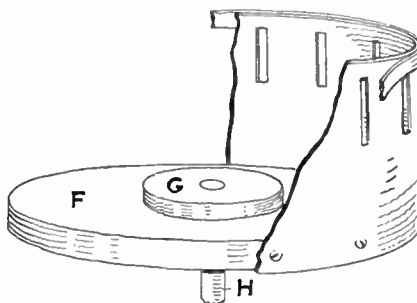

Fig. 5

by the hand. The lower end of the spindle should be rounded off evenly where it touches the base (A). A thin

metal or ivory disc $\frac{1}{4}$ in. diameter may be dropped into the socket formed in (B), as this will also make for freedom of movement of the whole top.

The inside of the cylinder should be finished white, while the outside should be matt black.

The spindle must be very securely glued into the disc (F) and (G), and the top surface cleaned off level, and painted white or lined with white paper. (104)

MODEL JET BOMBER

For making the Model 'Canberra' from this week's free design (No. 2022) a kit of materials is obtainable from Hobbies Branches or post free from Hobbies Ltd., Dereham, Norfolk, price 4/3 including tax.

A few expert hints on HOW TO CATCH PIKE

DO not get it into your head that pike-fishing is only for the experienced angler; and do not presume that an expensive and elaborate outfit is necessary. You can start pike-fishing now, and it will not be so very difficult if you have already had some experience with other fish such as perch. The difference is that pike attain much heavier weights and grow to bigger sizes than the other 'coarse' fish as roach, chub, etc., and, therefore, you require much stronger tackle to deal with them.

Everybody knows the pike. Specimens up to 40lbs. have been recorded. Perhaps the biggest authenticated specimen caught in British waters was the monster taken from Lough Conn in July, 1920. A pike of from 10lbs. to 20lbs. may be considered a good fish. Probably you will be well content if you catch a 7-pounder to start with! Pike give good sport, though in some waters they are less vigorous than in others. River pike are, perhaps, more hard-fighting when hooked, than lake or pond pike. This fish is widely distributed and is met with in rivers, canals, brick-pits, meres, weedy ponds, old moats, gravel pits, drains, Broads, and even in waters sacred to the salmon and trout. Backwaters and weir-pools in bigish rivers are other excellent spots to fish.

Methods and Baits

There are various methods of catching pike, viz., live-baiting with float tackle; ledgering; with paternoster tackle; and spinning. The latter is the most artistic, but requires some practice.

Most beginners start off with float-fishing, using a small live fish for baiting the hook.

You want a rod of about 8ft. to 10ft. long, of cane with greenheart top, or a similar general rod. A 'Nottingham' type or 'Aerial' type reel about 4ins. diameter, which should be fitted with line guard and carry not less than 60yds. to 80yds. of best quality undressed silk line, and a trace of gut substitute. Some anglers prefer fine twisted wire or annealed steel wire for the trace. The float can be of the egg-shaped cork, split one side, and with loose wooden peg to secure it to line, so that easy attachment or detachment can be made—the 'Fishing Gazette' type is indicated. Or a big barbel float will do. Some make shift with corks out of beer barrels, with a hole bored in the centre, and a peg made out of a round piece of wood. We know anglers who use several small floats of the cork-bodied variety instead

of one big float; others use a bigish cork and a smaller float attached to the line a little distance above the big one—this is called a 'pilot' float.

In addition to the trace, you need fastened to it a weight—a round lead or leads will serve—to hold down the live bait—the bigger the bait the more weight you need. Finally there is the snap-tackle itself, of which there are many types. Perhaps you cannot better the 'Jardine' pattern. We have done a lot of pike-fishing using a single triangle hook on a wire trace. With such a simple hook-tackle there is less of it to scare off a suspicious fish. In baiting with the single triangle the small hook of the



SNAP TACKLE



PIKE FLOAT
"FISHING GAZETTE"
PATTERN

triangle is thrust just under the dorsal fin of the bait.

When using snap-tackle, the bait is carefully impaled on the snap by inserting the top triangle at the forward end of the dorsal fin of bait, the reverse hook of the lower triangle being passed through the skin behind the pectoral fin. On getting a bite on a baited snap-tackle one pauses just a second or two and then 'strikes', or, perhaps, it is better to tighten the line and give a steady pull than to snatch too quickly.

Baits include small fish as roach, dace, bleak, gudgeon, minnows, etc. You cannot beat a dace—a lively fish and showing up its silvery sides as it swims around. Remember, the fresher your live-baits the more likely to attract pike. To transport them to the scene of action you require a bait-kettle fitted with an inner strainer—which you lift out to extract a bait, instead of having to grope about in the water in the 'kettle' or can. If you cannot afford a proper zinc bait container with strainer, you can make do with any kind of holder—a milk can of family size; or any sort of can provided it is large enough to accommodate your

baits properly. A piece of wire may be used for a handle.

Casting the Baited Tackle

Throwing or casting out the baited tackle calls for some practice—but you will soon get the hang of it. Give your rod-top a good forward swinging movement, with the bait hanging down from the rod-point at the end of about 1yd. or so of line—the baited tackle will then swing out over the water, and after a little practice you will be able to drop it just between those weed-beds or in that little nook by the rushes, or well out right into the middle of the river or away into the lake, as the case may be. Then, having got the bait into a likely spot, all you have to do is to wait whilst the little fish harnessed to the tackle below the float works to and fro, and a pike takes a fancy to it.

Keep an eye on the float. If your luck is in, sooner or later the big float will be jerked in a manner that will convince you it is not the live-bait pulling at it. In a few seconds it—the float—will start 'running off', now jerked under, now bobbing up again, until at last it slides under. Gather in any slack line and drive the hooks home into the pike's jaws with a strong pull. Do not be in too big a hurry to 'strike'—exercise a little patience, it will pay in the long run.

Hold your fighting captive from any weed-beds, and if possible 'play' him in water clear from all plant-growths. He will rush around and plunge determinedly, for a pike is no mean antagonist; but do not hurry him too much, and keep him 'ambling' up and down and around until he is practically exhausted. Then put on pressure and wind him in until within reach. You can use a gaff to land him with or a big landing-net. Experienced anglers can secure a pike by placing finger and thumb in the fish's eye sockets—but leave it to the experts; use gaff or net.

Never attempt to unhook a pike without first propping open its jaws with a 'gag' of some sort; if you have not a proper pike-gag, use a piece of stick—anything that will keep the fish from snapping its jaws together whilst your fingers are fumbling with the hooks. Remember a pike's jaws are well supplied with rows of sharp recurved teeth, and he knows how to use them.

This method of live-baiting with float-tackle is the best for the beginner, and it can be practised on all kinds of water, still or flowing. Pike-fishing is at its very best from October onwards through winter. (114)

COMPLETING A TOY TRAIN

FROM ODDMENTS OF WOOD

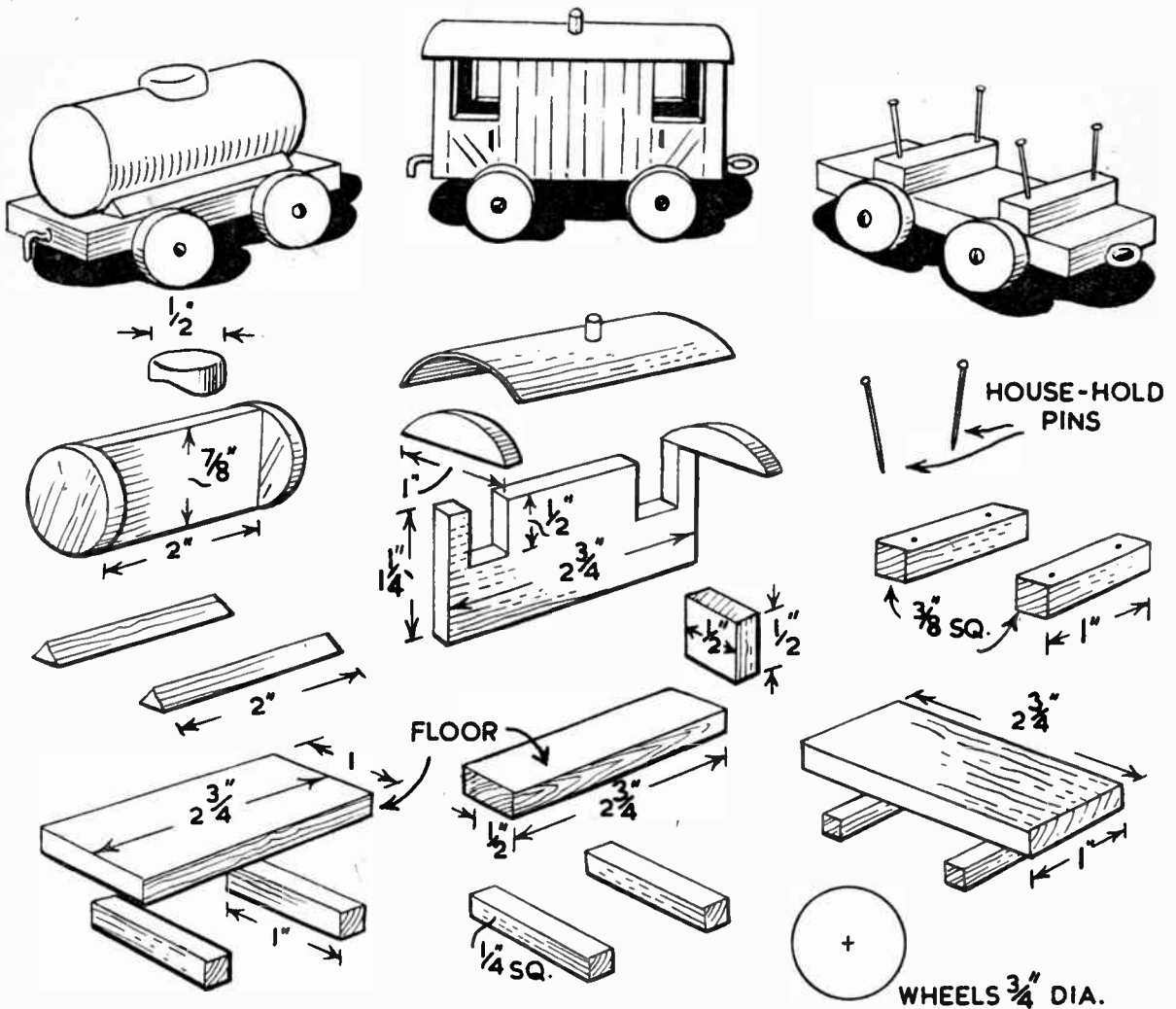

PETROL TANK

HERE are three more trucks to complete the Goods Train described in previous issues. The train now consists of Engine, Tender, Open Truck, Luggage Van, Flat Truck with Cable Drum, Hopper Wagon, Petrol Tank, Timber Wagon and Brake Van. With these seven different trucks you can make a train of considerable length. For instance the Petrol Tank can be repeated three or four times and painted to represent different petrol companies. It can also represent oil

BRAKE VAN

wagons or milk wagons which are of the same basic design.

The open trucks, too, can be repeated any number of times and made to carry various loads. The flat truck can be made to carry a furniture container and so on.

In future issues we shall deal with a few of the other accessories such as the water tank, loading gauge, signal, etc.

As in the previous patterns a picture of the finished truck is shown with dimensions and sketches of various parts underneath. The diagrams of the Petrol Tank are self explanatory except for the

LUMBER WAGON

tank itself. This is made from two circles of $\frac{1}{4}$ in. wood $\frac{3}{8}$ in. diameter, which are held together by the crosspiece shown. A piece of thin card, a post-card will do, is bent round this framework and glued in place. A couple of elastic bands will hold it in place while the glue is drying. The $\frac{1}{2}$ in. diameter circle of $\frac{1}{4}$ in. wood on the top is shaped underneath to fit the tank top. Wrap a piece of glasspaper round the tank and rub the circle of wood on this until the underside will fit.

(Continued foot of page 73)

A well-designed and efficient EXTENSION SPEAKER CABINET

AN extension speaker fitted in kitchen, bedroom or workshop is often much appreciated, and the type of cabinet used for it can be quite simple. Its main purpose is to act as a sound-box so that the loudspeaker can operate properly, and the type of cabinet shown here is good from this point of view. It is intended to hang from the wall, and is quite inconspicuous. If a picture-rail is available, it can be suspended from this and the leads taken along the rail out of sight. The cabinet slopes so as to direct the sound slightly downwards.

Cutting the Pieces

The dimensions of these are shown in Fig. 1, and $\frac{3}{8}$ in. plywood is used throughout. The pieces should be sawn accurately, and given a smooth finish. A

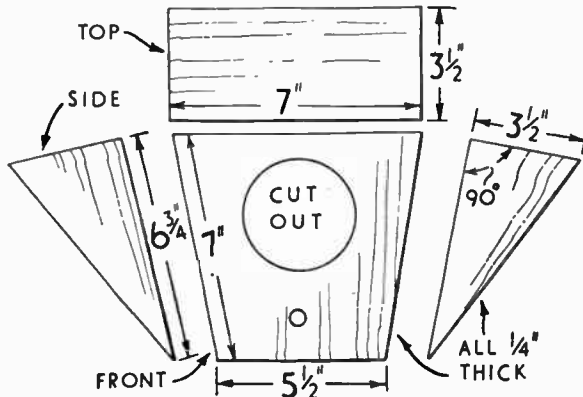

Fig. 1—Dimensions of the pieces

small hole is drilled for the on/off switch. Above this is the speaker cut-out, which should be suitable for the diameter of the unit actually employed. A fairly small speaker was used, requiring a hole $\frac{1}{4}$ in. in diameter. Some speakers are smaller, while others will require a larger hole. (If a large unit is used, it may also be necessary to increase the depth of the cabinet slightly).

Toy Train—(Continued from page 72)

The Brake Van

The ends go between the sides, and the floor between them both. Openings are cut in the sides and the height of the ends give openings there also. Two shaped pieces are glued on each end and the roof glued to this. The roof is cut from post-card, slightly overlapping all round. A small piece of rounded wood is

The edges of the cut-out should be smoothed down well with glasspaper, and the pieces may then be secured together with $\frac{3}{8}$ in. panel pins. Glue may be added beforehand, for additional strength.

Finishing Off

All the corners and edges of the cabinet should be well rounded and smoothed with a rasp, as this considerably improves the finished appearance. Two hooks are then attached, for suspending the cabinet, or a small bracket may be screwed to the top. The whole should then be varnished, a fairly light colour generally being preferable.

When the cabinet is dry, a piece of gauze or speaker-fabric is stretched across inside the cut-out, and the speaker screwed in position. Do not

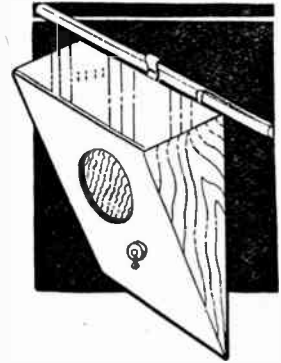

run along the picture-rail or skirting board, or otherwise placed as proves most convenient.

If the receiver has extension sockets for a low-impedance extension unit, it is only necessary to fit suitable plugs to the leads and plug into these sockets. If no such sockets are present, then locate the two leads which go from the

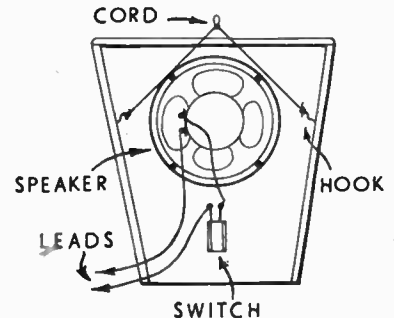

Fig. 2—A back view of the completed circuit

use long screws, or these will penetrate right through to the front.

Wiring Up

Fig. 2 shows the connections, the switch being included in one lead so that the extension speaker can be switched off when not required. Twin flex or similar wire can be used for the leads to the receiver, which should be

speaker transformer in the receiver, and join the extension leads to these. The transformer may be mounted on the speaker in the receiver, in which case the two short leads going from the transformer to tags near the cone will be the ones to which connections must be made. (447)

stuck on to represent the chimney.

The Lumber Wagon

This presents no difficulty whatever. When the wagon has been painted it is completed by tying in place two or three twigs, about $\frac{3}{8}$ in. to $\frac{1}{2}$ in. diameter.

Note that all wheels are $\frac{3}{8}$ in. diameter and are cut from $\frac{3}{8}$ in. round rod. Note

also that with the exception of the two $\frac{3}{8}$ in. square pieces on the Lumber Wagon all parts are cut from $\frac{1}{8}$ in. wood. Screw eyes are used for connecting the trucks. A pair are needed for each truck, one being opened out and bent as shown. Colour the trucks with enamel, making the petrol tank red or yellow and the other two grey or brown. (117)

Sodium pyrophosphate used in HOME CHEMISTRY

THE sodium pyrophosphate which we shall need for our experiments is not easy to obtain from the laboratory furnishers, but, as we mentioned in our article on sodium phosphate, it is easily prepared from sodium phosphate itself.

Place some sodium phosphate in a crucible (or on a deep tin lid from which the tinning has been removed by burning in the fire). Light your spirit lamp or bunsen and place it beneath the crucible. The sodium phosphate quickly melts in its water of crystallisation.

As the heating proceeds the water boils away and leaves a white mass. Continue the heating until it is red hot, and then allow it to cool.

the other experiments to prepare a small quantity of sodium pyrophosphate for each (the process needs only a few minutes), rather than prepare one large quantity for all, since it is difficult to heat a large quantity if you have no furnace.

Best Converted

Therefore this first specimen is best converted into the crystalline form for your specimen collection. To obtain the crystals, dissolve the substance in the smallest possible quantity of boiling water, filter and allow the solution to cool. Crystals will form and after standing overnight may be dried on a clean porous tile or brick.

Pyrophosphates are, of course, salts of

precipitate of lead pyrophosphate falls.

Continue adding lead acetate until no more lead pyrophosphate is precipitated. It is possible to find this 'end point' easily with heavy precipitates, for they sink quickly to the bottom of the vessel leaving a clear solution above in which we can observe whether more precipitate is formed on further addition of a reagent.

Many precipitates, however, are bulky and do not sink for some hours. Lead pyrophosphate is one of these. Therefore to find the end point, filter a little of the precipitation liquor containing the lead pyrophosphate and receive the filtrate in a test tube containing a little lead acetate solution (Fig. 1).

If a precipitate forms, return the contents of the test tube to the precipitation liquor and to the latter add more lead acetate solution. Now test another filtered sample. Continue in this manner until a sample gives no further precipitate. This tip for finding an end point is accurate and quick, often reducing the work of a few hours to a few minutes.

Now filter the lead pyrophosphate and wash on the filter with plenty of water. Divide the precipitate roughly into two parts. Dry one in the oven for your chemical stock.

The other half we can quickly convert into pyrophosphoric acid. Transfer it to a test tube, add water and shake it up so as to form a suspension. Now generate sulphuretted hydrogen from ferrous sulphide and dilute hydrochloric acid, and bubble the gas through the suspension (in the open air, for sulphuretted hydrogen is the main reason why chemistry is dubbed 'stinks!').

In a few moments the lead pyrophosphate will begin to blacken. This usually starts at the top (Fig. 2). The blackening is due to lead sulphide forming, pyrophosphoric acid simultaneously going into solution.

When the pyrophosphate has become quite black, the reaction is complete. Filter off the lead sulphide and pour the colourless filtrate of pyrophosphoric acid into a saucer. Leave it in the saucer until it no longer smells of sulphuretted hydrogen. You can then bottle it for your chemical stock.

This acid will not keep indefinitely, for it slowly passes into orthophosphoric acid. If you wish to use it some time, first neutralise a few cc. with sodium carbonate solution and test with silver nitrate solution. If a white precipitate forms it is still pure; if there is a

(Continued foot of page 75)

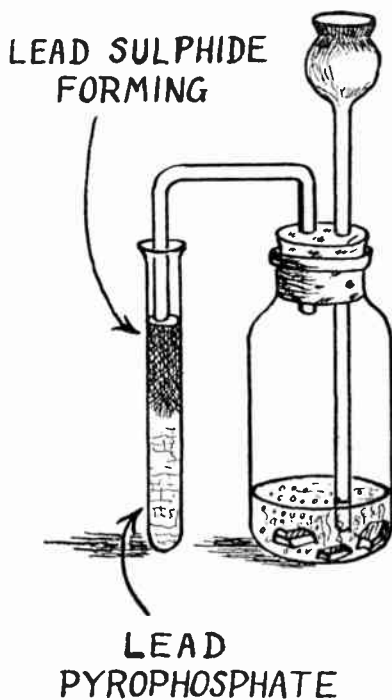

Fig. 1

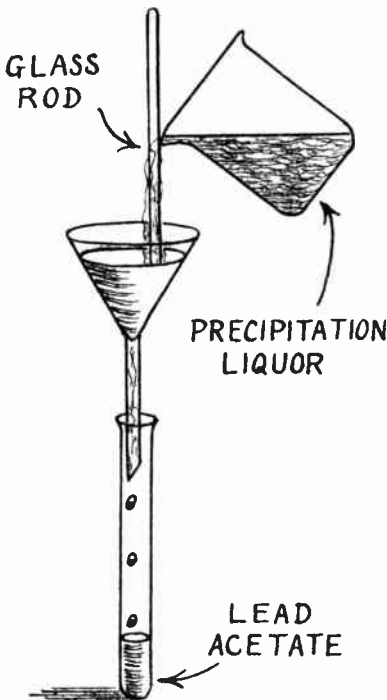

Fig. 2

The white mass you have obtained is no longer sodium phosphate, but sodium pyrophosphate. You can readily prove this by dissolving a little of it in water and adding silver nitrate solution, when a white precipitate of silver pyrophosphate forms, instead of the yellow precipitate of silver orthophosphate given by ordinary sodium phosphate.

You will find it most convenient for

pyrophosphoric acid. Apart from those of the alkali metals, most of them are insoluble in water.

This insolubility is a useful property, for it provides a way of making pyrophosphoric acid.

Prepare another portion of sodium pyrophosphate and dissolve it in water. Now add lead acetate solution a little at a time, stirring rapidly. A white pre-



Electric Welding

COULD you give me any information on making a homemade electric arc welding outfit, working off A.C. mains? (M.K.—Sleaford).

YOU will require a welding transformer capable of giving a large current. The size of this transformer will depend upon the size of the work anticipated; for average purposes an output of 200 amps or so will be required. Small welding can be accomplished with smaller currents, but very large work may require higher currents. A carbon electrode in an insulated handle is usual; one lead is taken to this, the second clipped to the work. The arc consists of an extremely powerful spark struck between work and electrode, and goggles should be worn to avoid the possibility of eye injury from looking at the arc. It does not seem feasible to make the transformer, as it is unlikely laminations of sufficient size could be purchased from normal suppliers. Apart from this, you will need stout leads, carbons, a wooden or other insulated handle, a large clip and a proper tinted eye-protector.

Plaster Problem

IAM making a model of an hotel. The surrounding grounds are to be made from plaster of paris. The plaster I have sets much too quickly for me to mould it. I wonder if you can tell me of any inexpensive way of regulating the setting time. The model is built on a base of fibre-board, so a reduction in the strength of the plaster does not matter. (L.R.—Portsmouth).

THE setting time of ordinary plaster of paris can be retarded by adding a small amount of glycerine to the water when mixing the plaster. Unfortunately no hard and fast rule can be given for the proportion, but about a teaspoonful of glycerine in a quart of water should be enough; we recommend you to make a few experiments with different proportions and then adhere to that which best suits your purpose.

* * *

Telephone Bell

IHAVE been using a telephone hand-generated bell between sick-room and living room. I would now like to work this off a bell push and battery (or A.C. 230 50 cycles), as a door bell. I find a 4-5v. battery just pulls the striker on to one magnet core, but I cannot understand how to break up the current to operate the bell successfully. (A.L.—London, S.W.).

APPARENTLY the generator delivered interrupted current. For D.C. or operation from a mains transformer, you will need to arrange the usual type of buzzer contacts, so that when the hammer is drawn towards a bell, the circuit is interrupted, and the hammer returns to its previous position. Wiring for any one energising coil should be:—battery to one end of winding; other end of winding to one contact; second contact to bell-push; bell-push to battery. More than 4-5 volts may be required.

* * *

Faulty Viewfinder

LATELY I bought a secondhand camera. It is a folding Coronet and takes 120

film. With the last two rolls of film the foreground was very much up in the snap and the subject almost beheaded. In the view-finder, which is attached to the camera front as is usual with folding cameras, I could see the picture nicely placed, but the above was the result. Maybe the view-finder is crooked, but it looks to be straight. Please could you tell me what is wrong, and whether it would be advisable to have a collapsible direct view-finder attached to the camera-side? (J.J.G.—Drogheda).

THERE are two main reasons why a view-finder will not register a true record of the image as it appears on the negative. The finder may have received a knock which has slightly bent the bracket that holds it to the front of the camera, and, therefore, put it out of square with the lens and the film. The second cause is that the camera is not being held square when exposing. Carefully examine the finder before making any further exposures, then place the camera on a perfectly level table or stand; now make a rough sketch of the scene or building as it is shown in the finder, and then expose the film. If the result still indicates a faulty finder, then return the camera to a dealer showing him the film; usually it is a very trifling adjustment that is wanted.

Stains on Veneer

IHAVE been doing some veneer work recently, and wonder if you can tell me how to remove glue stains therefrom. (N.S.B.—E.5).

IF you have employed just the ordinary brand of glue, you may be able to reduce the stains by rubbing over with hot water, but we fear if the glue has penetrated through the veneer, some slight stains may still remain. In the latter case, a careful dabbing with a household bleach may complete the job. Stains from Casein glue may be removed by careful application of diluted oxalic acid. This being a poison should be handled with care.

Home Chemistry—(Continued from page 74)

yellowish precipitate, decomposition has set in and a fresh specimen should be made.

If you add sodium pyrophosphate solution to magnesium sulphate solution a white precipitate of magnesium pyrophosphate forms. This is not a good way of making magnesium pyrophosphate, however, for the precipitate is gelatinous and bulky and not easy to wash.

A quick and easy way is to heat some of the double salt, magnesium ammonium phosphate, mentioned in our article on sodium phosphate. So place

some in a crucible and heat it up to a red heat. Water and ammonia will be given off. On allowing the crucible to cool you will find you have obtained a white mass of magnesium pyrophosphate.

In quantitative analysis use is made of magnesium pyrophosphate to determine the amount of magnesium in ores and magnesium salts. The magnesium is precipitated from the solution of the treated ore or salt as magnesium ammonium phosphate, and this heated to convert it into pyrophosphate. From the weight of magnesium pyrophosphate obtained, a simple calculation shows the

amount of magnesium present in the ore or salt.

Lastly, let us prepare the unusual substance stannous pyrophosphate. Mix solutions of stannous chloride and sodium pyrophosphate. The stannous pyrophosphate forms at once as a heavy curdy white precipitate and you can wash this to purity either by decantation, or on the filter until the wash waters no longer give a turbidity with silver nitrate solution. You can then dry it in a coolish oven for your specimen collection. (445)

All about making a HANDY WINDOW CONSERVATORY

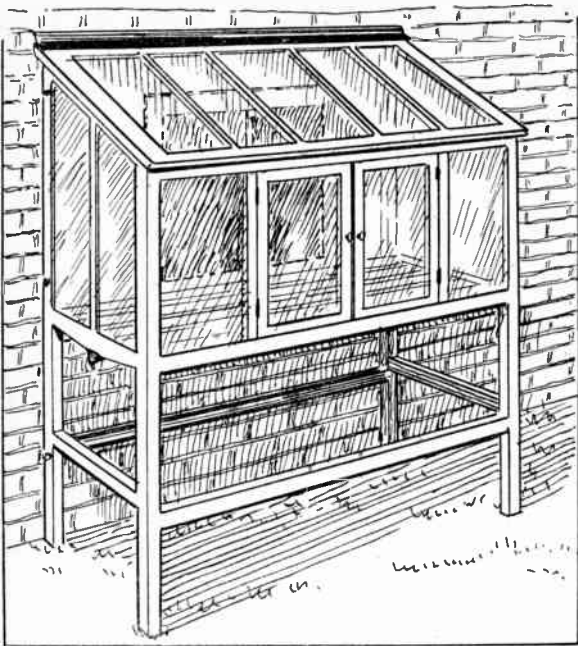

READERS who have a ground floor window, looking on no more pleasing prospect than a back yard, say, would find the window conservatory illustrated a pleasing 'block out'. It would serve well as a small outside conservatory if a window one is not desired, and would be just the thing to house a few plants during the winter or summer when a larger greenhouse is not necessary. A study of the drawings will show that it is an economical structure, both as regards timber and glass, and need present no difficulty in making to any handy woodworker.

Possible Amendments

A front elevation is given in Fig. 1 and a side one in Fig. 2, minus the roof. The measurements and sizes of timber should, when possible, be adhered to, but it is realised that if used to cover a window, the height may need some amendment—windows vary such a lot. However, this matter need cause no trouble, but it will render the cutting list rather useless unless it is amended to suit. To save much repetition, the sizes of timbers employed are given in the cutting list mostly. Where omitted, such sizes will be found in the text.

Cut the four uprights to lengths given, then mark off on them the correct positions of the mortises which hold the rails. Referring to these, those of the bottom rails are just plain joints, the tenons on the rails being cut as in Fig. 3 (F). Note here that these rails are not in line with those fitted at the sides,

being just below or above the front and back rails. Cut the tenons on the rails $\frac{1}{2}$ in. thick and 1 in. long. The middle rails at the front have their tenons mitred to meet together in the mortise, as at (E). The back tenons are as for the lower rails, it being seen that no middle rail is fitted across the back at all, the whole back of the structure, except for the bottom rail, being open.

The top front rail is also tenoned across, but the tenons in this case are shouldered in the usual fashion. The top sloping side members are fitted across, as in the detail (D) and just nailed on. Glue the whole together, using a casein waterproof glue for choice. To keep the sides square with the rest at the rear, and lessen strain, nail a temporary bar of wood across at the top,

and leave for awhile for the glue to set hard.

The side central sashbars are cut from $\frac{1}{2}$ in. by $1\frac{1}{2}$ ins. wood, and grooved and glued in. The uprights (A) are also set in similarly. Between these, the two windows, framed up from wood, $1\frac{1}{2}$ ins. by $1\frac{1}{2}$ ins. are hinged to open outwards. The spaces thus left for the glass are $12\frac{1}{2}$ ins. wide, a convenient width for cut glass for greenhouse use. To make the necessary rebates in these to hold the glass, prepare some slips of wood $\frac{1}{2}$ in. thick and $\frac{3}{4}$ in. wide, and glue and nail round the interior of the openings, as at inset (C) just $\frac{1}{2}$ in. in from the front. These slips look much neater if one corner is bevelled off. This method simplifies the work of making sash windows, the preparation of jointing needed when proper sash mouldings are employed being rather tricky to an amateur.

Easy Arrangement

To make it easy for the plants to be watered inside the conservatory, the following simple arrangement is fitted up so that superfluous water can drain away. A piece of wood $1\frac{1}{2}$ ins. wide and

(Continued on page 78)

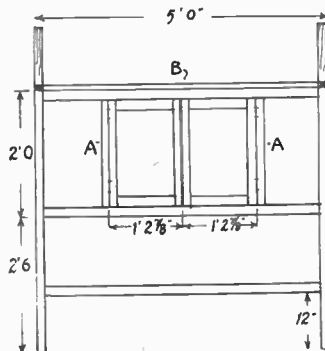

Fig. 1

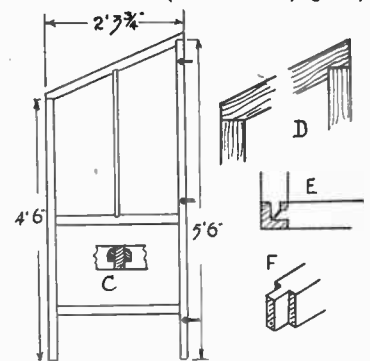

Fig. 2

Fig. 3

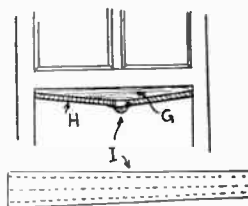

Fig. 4

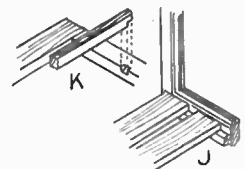

Fig. 5



GT. BRITAIN ON STAMPS

AT long last Gt. Britain has launched out to give—it would almost seem rather grudgingly—a little space on her postage stamps to some of the interesting things which are to be found in these islands.

It is really rather a remarkable thing that, up to now, the only British scenes which have appeared on stamps have appeared on stamps from other regions. In one example, we have one of the most British of institutions, the Houses of Parliament, appearing on a foreign stamp. It was France who, in 1938, issued a stamp on which we find depicted the Houses of Parliament and the Arc de Triomphe. This was, of course, in commemoration of the visit of King George VI and Queen Elizabeth to France.

Then another country, this time Russia, produces a rather unusual British scene, a grave in Highgate Cemetery—

value showing a picture of Eddystone lighthouse. This set was really very well got up for sale to the collector. It could be purchased together with a sheet describing each of the lighthouses which were shown on the stamps. There were seven stamps in the set, each of which, except for the 3d., showed a lighthouse situated somewhere on the coast of New Zealand.

The Cenotaph in Whitehall, known to all as the memorial from which is broadcast each Armistice Sunday the Service of Remembrance, appears on two stamps given to us in 1935 by Australia on the occasion of the 20th anniversary of the Australian and New Zealand Army Corps (ANZAC) landing at Gallipoli; the values and the colours of these two stamps being 2d. scarlet and 1/- black, the latter is quite a desirable stamp to have, either used or unused. The statue of King Richard 1, which is

the first is a picture of Cabot's ship the 'Mathew' leaving the Avon. — Well, frankly, it might be the 'Mathew' leaving any other river, so far as the view is concerned, because there is nothing to indicate or identify any particular place. However, Cabot started from Bristol and that is on the Avon so we must accept the statement. The stamp was the 10c. of the set of 1897 commemorating the 400th anniversary of the discovery of Newfoundland by Cabot, and that date was also the 60th of the reign of Queen Victoria.

The next set showing scenes of the Mother Country is the Sir Humphrey Gilbert set, as it is called. It was issued in 1933 to commemorate the 350th anniversary of the annexation of Newfoundland by Sir Humphrey. There are four designs which concern us this time. The first is the 2c., and that has a picture of Compton Castle in Devon, where



The Houses of Parliament on a French Stamp



Another stamp showing the Houses of Parliament



An Australian issue depicting the Cenotaph



Eton College on a Newfoundland stamp

the grave of Karl Marx. The stamp was issued in 1933 to commemorate the 50th anniversary of the death of Marx.

Those are two examples of British scenes on foreign stamps, but if we go to the colonial stamps then we have numerous examples.

Two colonies stand out above all other for the number of views of Gt. Britain they have shown. They are New Zealand and Newfoundland (now no longer a stamp issuing colony). New Zealand started her British scenic gallery in 1945 with a picture of the statue of Peter Pan which is found in Kensington Gardens. This was followed in the next year with a picture of St. Paul's Cathedral on the 1½d. value of the Peace issue, and the following year the statue of Eros took the place of the statue of Peter Pan for the design of the annual health stamp.

Also from New Zealand, in 1947, came the issue of the lighthouses—the 3d.

to be found in London, is pictured on the 18 piastres of the 1928 of Cyprus.

Jersey, one of the Channel islands, issued six stamps in 1943 and four of them have pictures of places. There is Portlet Bay on the 1d., Corbiere Lighthouse on the 1½d., Elizabeth Castle on the 2½d., and Mont Orgueil Castle on the 2d. The ½d. value has a picture of an old Jersey farm and the 3d. shows farmers gathering vraise or sea-weed, which is put on the ground just as we put on manure. In 1948, the two stamps issued in commemoration of the liberation had similar pictures.

Now turn to the stamps of what was our oldest colony, Newfoundland. As you know she is now united with Canada and uses Canadian stamps. Nevertheless, we shall find many English scenes on the stamps which she issued up to 30 March, 1949.

If we take the scenes in the order in which they appeared on the stamps then

Sir Humphrey lived. Actually when he decided to travel, he set out with the idea of finding a North West passage to India. His first attempt was not successful, but on his second effort he landed in Newfoundland and annexed it. But in order to undertake these voyages, he had to sell his estates.

The 4c. stamp of the same set shows a picture of Eton College where Sir Humphrey was educated. The 8c. is entitled 'Fleet leaving Plymouth 1583'. That is what it is called, but, as was mentioned in the case of the "'Mathew" leaving the Avon', any other place might have been substituted for Plymouth and no one would have doubted it. The highest value of the set, the 32 cents gives a picture of Gilbert's statue at Truro.

As we mentioned at the start, we have two views of our own on the new 2/6 and 5/-, and many people will say 'About time, too'.

(460)

Window Conservatory—(Continued from page 76)

1in. thick, bevelled down from the centre outwards to $\frac{1}{2}$ in., is nailed under the side middle rails at each end, as shown at (G) in Fig. 4. To these pieces, boards are nailed across to act as a bottom to the conservatory. These are shown at (H) and it should be noted that the boards do not meet at the centre, but leave a space about 1in. wide for the water to flow down.

Zinc Gutter

This space is bridged underneath by a gutter made from zinc, as shown at (I). For it, cut a strip of the metal 1in. longer than the length of the conservatory, 2 $\frac{1}{2}$ ins. wide at one end, and 4ins. wide at the other. Bend a $\frac{1}{2}$ in. portion of each side edge over at right angles to form a long flange for screwing the gutter under the boards (H). Then bend upwards on a central line to make a V-shaped channel sloping downwards. Screw this in place.

To each end middle rail, inside, nail lengths of board as depicted in Fig. 5 (J) for the plants to stand upon. These are spaced 1in. apart and rest on fillets nailed to the rails. The whole structure can now be lifted in position and fixed to the wall, over the window, with iron holdfast nails, made for such a purpose. Three to each side will be enough, placed about where shown in Fig. 2. The heads of these are flattened, and pierced for screws to be driven into the wood. It is best to drive these in the walls between the bricks; they enter easier that way. The temporary wood

nail $\frac{3}{8}$ in. by $\frac{1}{2}$ in. strips of wood to form the rebates for the glass.

To the top front rail of the conservatory, plane up and nail across a strip of wood, as at (B) Fig. 1, to fill up the gap between rail and side top members. Now screw the roof on. A zinc flashing at the back of the roof should be fitted to prevent water

entering, between it and the wall. Give the whole a coat of red priming colour, then glaze. Finish with two coats of good quality exterior paint. The bottom boards (H) are best treated with creosote to resist the effect of so much water running off them. An inside bolt to one window, and catch to the other, will complete the lot. (499)

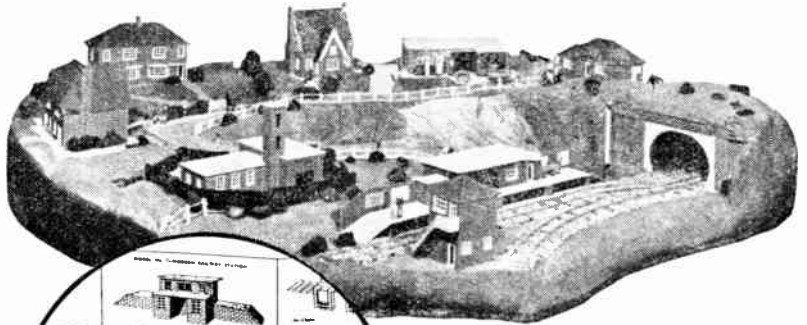

**Build this
Realistic Model Village
with**

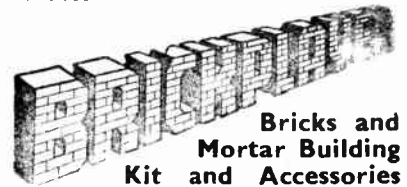

CUTTING LIST	
Upright, front (2)	—4ft. 6ins. by 1 $\frac{1}{2}$ ins. by 1 $\frac{1}{2}$ ins.
Upright, rear (2)	—5ft. 6ins. by 1 $\frac{1}{2}$ ins. by 1 $\frac{1}{2}$ ins.
Side rails (4)	—2ft. 3ins. by 2ins. by 1 $\frac{1}{2}$ ins.
Front and rear rails (4)	—4ft. 11ins. by 2ins. by 1 $\frac{1}{2}$ ins.
Uprights (A) (2)	—1ft. 8 $\frac{1}{2}$ ins. by 1 $\frac{1}{2}$ ins. by 1 $\frac{1}{2}$ ins.
Sloping roof members (2)	—2ft. 8ins. by 2ins. by 1 $\frac{1}{2}$ ins.
Windows (4)	—1ft. 8ins. by 1 $\frac{1}{2}$ ins. by 1 $\frac{1}{2}$ ins.
Windows (4)	—1ft. 3ins. by 1 $\frac{1}{2}$ ins. by 1 $\frac{1}{2}$ ins.
Bottom boards (2)	—5ft. by 12ins. by $\frac{3}{4}$ in.
Shelf boards (7)	—4ft. 9ins. by 3ins. by 1in.
Roof frame (2)	—2ft. 9ins. by 3ins. by 1 $\frac{1}{2}$ ins.
Roof frame (2)	—5ft. 2ins. by 3ins. by 1 $\frac{1}{2}$ ins.
Remainder from scrap.	

ENTER FOR THE BRICKPLAYER COMPETITION

Prizes of £10 10s., £5 5s., and £3 3s. and a number of consolation prizes of Brickplayer Accessories will be awarded for winning models.

Write for full details.

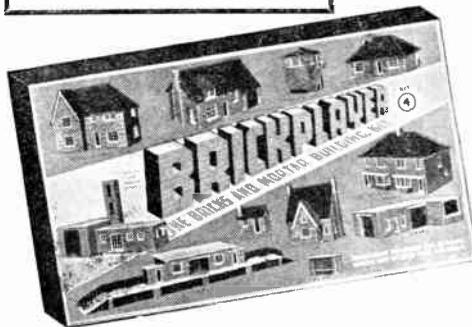

The Brickplayer Kit contains miniature bricks in all required shapes, mortar, roofing, metal windows and doors, plans and instruction booklet. All models are architect designed to 'O' gauge scale. Buildings can be permanent or dismantled by merely soaking in water, and the bricks used again and again.

Brickplayer Kits at 28/6 and 52/6 and Accessories are available from good toyshops and stores.

If your dealer cannot supply, write for address of nearest stockist to:

**J. W. SPEAR & SONS
LIMITED**

Dept. "H", Enfield, Middlesex

**YOUR IDEAL
CHRISTMAS GIFT**

bar across the top can now be removed in readiness for fitting on the roof.

For the roof, make up a frame of 1 $\frac{1}{2}$ ins. by 3ins. timber, large enough to extend beyond sides and front by 1in. Cut four sash bars of $\frac{1}{2}$ in. by 1 $\frac{1}{2}$ ins. wood, and notch them across the frame at equal distances apart. The simple notching joint mentioned is shown at (K) in Fig. 5. Glue the bars in, and round each, $\frac{1}{2}$ in. down from the top,

TOOLS FOR THE HANDYMAN



TOOL CLIP

For holding any handled tool. Spring steel. Holed for hanging.

7d. each

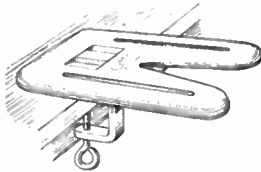

BENCH STOP

3½ ins. by 2 ins. — Spring loaded top.



SINGLE HANDED SCREWDRIVER

5 ins. long. Ideal for small work.

1/8

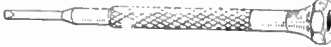

Obtainable from Hobbies Branches in London, Glasgow, Manchester, Birmingham, Leeds, Sheffield, Hull, Southampton, Bristol and ironmongers everywhere. Or post free from Dept. 99, Hobbies Ltd., Dereham, Norfolk.



FRETWORK HAMMER

8 ins. long. Strong and light for small work.

1/4

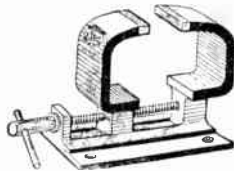

MODEL MAKER'S BENCH VICE

Strong, light and rigid, 2 in. opening.

6/3

STEEL CUTTING TABLE

With clamp for easy fixing to bench. 6 ins. by 4 ins., strong and light. 3/-

TURN YOUR SPARE-TIME INTO CASH

Men and women wanted to make Bennett Model Bungalows at Home
Fascinating, simple, well paid work

No selling involved.

Send stamped addressed envelope for full details.

BENNETT MODELS, Duncan Road, Richmond, Surrey

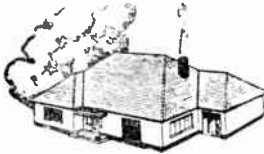

A Handy Glasspaper Block

A wooden block with special handle which holds glasspaper taut and always in place. In two sizes, 3 in., price 1/4; 5 in., price 2/6, post free.

HOBBIES Ltd., DEREHAM Norfolk, and all Branches

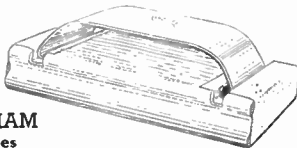

'A B A D A N'

OIL WELL CRACKING PLANT & MODEL TANKER

Send for list of 100 Micro-models, Ships, Galleons, Locos, Architectural and Engineering Subjects, Moving Toys, etc.

Building these miniature replicas has become a serious cult. Printed on special cards, the units are readily cut, shaped and assembled to form perfect three-dimensional models authentic in every detail. They cost but a few pence, but often sell for guineas. Send 2½d. for Illustrated Catalogue.

MICROMODELS LTD.,
3 (H) Racquet Court, London, E.C.4

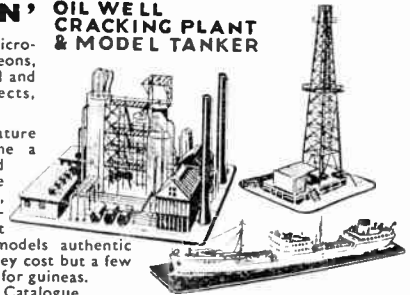

MICROMODELS



BRANCHES

LONDON
78a New Oxford St., W.C.1
(Phone MUSeum 2975)
87 Old Broad Street, E.C.2
(LONDON Wall 4375)
117 Walworth Road, S.E.17
(RODney 5509)
GLASGOW
326 Argyle Street
(Phone CENTral 5042)

MANCHESTER
10 Piccadilly
(Phone CENTral 1787)

BIRMINGHAM
14 Bull Ring

SHEFFIELD
4 St. Paul's Parade
(Phone 26071)

LEEDS

10 Queen Victoria Street
(Phone 28639)

HULL

10 Paragon Square

SOUTHAMPTON
25 Bernard Street

BRISTOL

30 Narrow Wine Street
(Phone 23744)

Head Office & Factories—HOBBIES LTD., DEREHAM, NORFOLK

1,000 STAMPS—5/-

'ALL OFF PAPER'

Genuine Collectors Duplicates. No G.B. My '£1000' catalogue, perforation gauge and GIFT COUPON given ABSOLUTELY FREE with each order. Every stamp covered by my unconditional money-back guarantee.

Send 5/- to

AUBREY SELBY, 66 Donnington Road, London, N.W.10



THE BOLSTER HOME WATCH AND CLOCK REPAIR OUTFIT

These precision jewellers' instruments include watchmaker's magnifying eyeglass, finest watch tweezers, set watchmaker's screwdrivers, watch and clock oil, oilers, dusting powder, clock brush, plus illustrated instructional manual for the amateur. In container 12/6 post free.

Senior Outfit includes everything above, plus watch jewels luminous compounds, dial renewer, jewellers rouge, explanatory book. Price 21/- post free.

BOLSTER INSTRUMENT Co. (Dept. H. W.), 5a Station Parade, Ashford, Middx.

Tommy Trump says :-

No increase in price of

DOUBLE ACE

10 for 1'3½

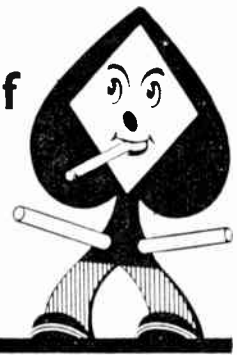

"You must have a wonderful lathe?"



"Rather! I turned my Wolf Cub Electric Drill into a lathe and it only cost me £3.12.3."

"That's very cheap—how do Wolf do it?"

"I had a Wolf Cub (that cost me only £5.10.0), then I bought this Lathe Set for £3.12.3. I clamped in the Wolf Cub—and there you are, a real electric Lathe Kit!"



"Is that all Wolf Cub Home Constructor Equipment?"

"Oh no! next I shall buy a Saw Set like this for £2.16.6, fit my Wolf Cub and I shall have a real Electric Saw Kit!"

"How marvellous!"



Yes, and that's not all the story!

Wolf Cub

HOME CONSTRUCTOR KITS

★ Write at once for large size, fascinating, fully picturised folder, "Profitable Pleasure."

KILL RADIO INTERFERENCE



Specially designed for use with Wolf Cub Drills. Supplied ready to attach to "Cub" lead. Conforms fully with official regulations. Only 23/6.

FIT A SURATEL SUPPRESSOR

Television Suppressors also available for fitting by Wolf Service Engineers. 8/6 inclusive.

★ Prices and descriptions subject to alteration without notice.

WOLF ELECTRIC TOOLS LIMITED · PIONEER WORKS
HANGER LANE · LDNOON · W.5 Telephone: PERIVALE 5631-4

BUILD THIS

ACCURATELY SCALED DOLL'S HOUSE

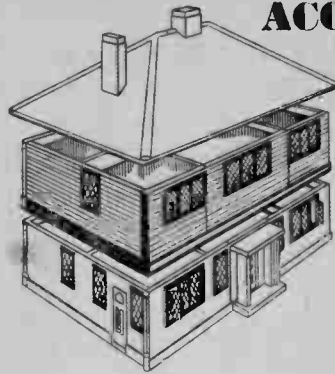

With a MODEL CRAFT plan, you can build a 2in. to 1ft. true-scale cottage or bungalow, the latter being easily convertible to a house. Fittings are available. Sliding panels make rooms individually accessible. Plans are clear and building is straightforward.

BUNGALOW PLAN (GB106) ... 4/6
CONVERSION TO HOUSE PLAN (GB107) ... 2/6
COTTAGE PLAN (GB108) ... 2/6

Postage—1 Plan, 3d., 2 or more plans, 6d.

★ **THE FULL MODEL CRAFT LIST** details more than 600 plans, planbooks kits and accessories covering every aspect of the modelmaker's art. Included are ships, aircraft, road vehicles, houses, etc. It costs 1/- post free and includes a 1/- refund voucher for use in buying Modelcraft goods.

MODEL CRAFT

77 (F.) GROSVENOR ROAD, LONDON, S.W.1

'KARLENITE'

PLASTIC MARBLE

The entirely new Art Stone for casting Bookends, Ashtrays, Wall Vases, Statuettes, etc. 'KARLENITE' sets granite-hard with scintillating crystalline structure which very closely resembles marble or alabaster. It is enormously strong, highly resistant to heat, and impervious to water. Literally any type of natural 'veining' can be simulated in any colour and a wide range of pigments is available for this purpose.

MAKE YOUR OWN

FLEXIBLE MOULDS

with 'Elastomould' Synthetic Rubber Solution. By means of this simple technique, you can easily prepare permanent elastic moulds for repetition casting, plaques, bookends, etc., in quantities of thousands.

'Elastomould' will faithfully reproduce even the most minute details of ornamentation and surface texture.

It is incredibly simple to use, and moulds can be prepared from any type of pattern including Wood, Metal, Plaster, Stone, Glass, Ivory, etc.

Such moulds are ideally suitable for casting in Plaster, Cement and 'Karlenite'.

Start your Own Business. Send 1s. for full details of this easy, fascinating and profitable hobby.

MONEY REFUNDED TO BONA FIDE ENQUIRERS

Dept. H.3, Karlena Art Stone Company, Ltd.,
55 Deansgate Arcade, Deansgate, Manchester, 3.