

Hobbies

WEEKLY

CONTENTS

	Page
Picturesque Well Head	113
House Name Plate	114
Figure Work in Box Decoration	115
Corner Cabinet	116
Club Secretary's Desk	117
Guide to Fishing Gear	119
Gay Window Boxes	120
Editor's Notebook	121
Books to Read	122
Extending Bookstand	123
The Home Handyman	124
Figure Work in Box Decoration Patterns	127

June 6th, 1951

Price Fourpence

Vol. 112 No. 2901

Enhance your garden with a PICTURESQUE WELL HEAD

THIS picturesque old 'wishing well' should prove a most attractive ornament for many a garden, back or front. It is, of course, non-practical, the brick 'well' itself being filled with earth and stocked with gay flowers. It is by no means difficult to make and should not prove expensive if second-hand materials are used—a point in its favour in these hard times.

Use Old Materials

Indeed, even if one had unlimited money with which to purchase new materials, old materials are to be recommended, as it is essential that the well looks old. An 'olde' well made of brand-new materials would look absurd. Moreover, a well which is supposed to be, say, a hundred years old would, apart from having weather-beaten timber and mellowed tiles, have some sags and bulges. Thus, whilst aiming at sound construction, the maker should not try to be too much of a slave to the plumb-line and spirit-level or have too much of a 'two by four' complex.

In any case, although the writer is describing a well head actually made and not merely a 'paper idea', it is almost impossible to give exact measurements, as so much depends on the timber available and on the roller used. This, as a matter of fact, is a wooden roller from an old mangle (though other alternatives may suggest themselves). So many

people nowadays are using the smaller type of wringer or the wringer fitted to a washing machine, that the old type with large wooden rollers is becoming outdated and the old rollers can usually be picked up very cheaply.

For the rest—the timber, bricks, and tiles—the constructor will probably find it best to scrounge around builders' yards, especially those in the country where, for example, mellowed old tiles and bricks taken from an old cottage are stacked away for possible future use. Old gate or fence posts may furnish some of the more massive timber.

Construction

The method of construction we show is not necessarily one that would be employed by a 'regular' builder but has been chosen for its suitability for amateurs and takes into consideration that it may be necessary, one day, to dismantle the lot, perhaps, when re-planning a garden, or when moving house. A light concrete base, as shown, is not absolutely essential, but is much advised. It need not, as hinted, be very thick and should not be larger than really necessary. Some people are far too prone to lay down, it seems, acres of concrete in a garden.

First prepare the upright posts (A).

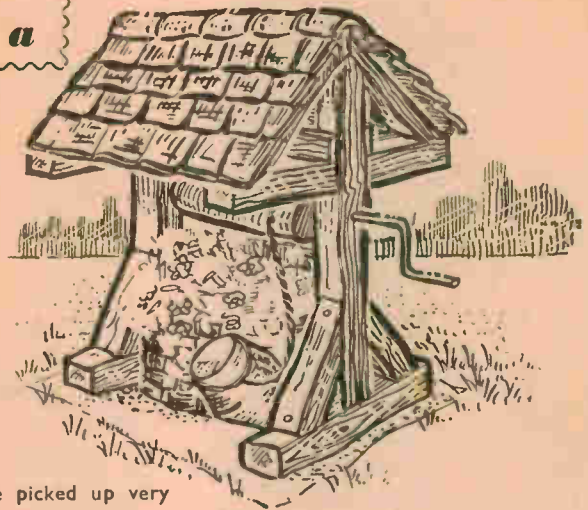

These are approximately 6ft. tall and of about 6ins. by 4ins. wood if that can be managed. They rest on bases (B), supported by struts (C). These latter are held by means of long coach screws. The cross piece (D) is about 6ft. long, too, and secured, by means of a halving joint, to the upright (A) about 2ft. down from the top, so that when the pieces (E) are fitted, the pitch of the roof is about 30 degrees. A shorter cross piece can be used but will, of course, give a steeper roof.

Dummy Handle

Cross pieces (G) had better be screwed before parts (E) are fitted. The length of parts (G) depends on the length of the roller obtained. The width need not be quite as great as the illustration suggests. It might be mentioned that the handle shown is really a dummy. It does not actually wind up the roller, although the roller is later fitted with a rope or chain coiled round it. From a country ironmonger a real well bucket might be obtained, but

All correspondence should be addressed to The Editor, Hobbies Weekly, Dereham, Norfolk.

this is not absolutely necessary. One might even find, if one makes enquiries at country sources, a leaky old abandoned well bucket which will serve one's purpose just as well.

The well head itself is built of bricks—

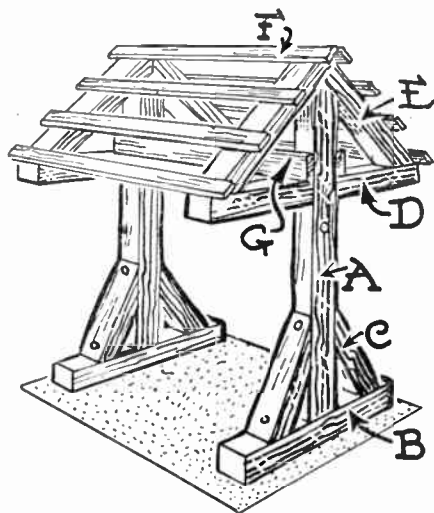

Fig. 1—Constructional details

second-hand ones for best effect. As it is afterwards to be filled with earth, and the earth needs aerating, it is best to lay the bricks so that holes appear, as shown

in the detail sketch. Only lightly mortar the bricks so that they can fairly easily be knocked down again if necessary.

The battens (F) are about 2ins. by 1in. in section and are to take the tiles—plain tiles or pantiles. Cleft wood shingles (wooden tiles) look well. The tiles overlap by 3 or 4ins. This will enable one to position the battens (F). Another set of tiles is placed along the ridge and cemented in position.

Preserving the Wood

The wood will chiefly be left in its natural condition, though a coat of dark brown proprietary wood preservative may well be applied, not only for protection, but to give the whole job a good colour. The base (B)

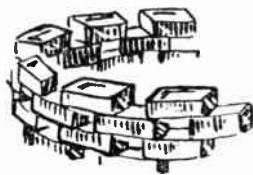

Fig. 2—The brickwork

should be well treated with preservative, otherwise rotting may occur. Indeed, it is on account of this possibility that the use of a concrete base

is suggested, rather than placing the bases directly on the ground.

It will be appreciated that instead of a base (B) and strut (C), post (A) could be carried right down into the ground. But little, if any, material would be saved this way, as the post would have to be carried well down and well concreted. In this case, however, the brick work could be carried round in two C-shaped sections to embrace, so to speak, the uprights.

There should be no chance of the structure being pushed over, especially if base (B) is long enough, but should there be any tendency to this, it is a simple matter to anchor the whole affair by means of rag bolts driven through (B) and embedded in the concrete.

Useful For The Garden

Instead of having a few odd plants put in the 'well', the gardener might find the affair useful for those plants which, whilst appreciating slant-wise morning and evening sunshine, need protecting from the fiercer rays of the direct overhead midday sun.

Readers will appreciate that, with only slight modification as regards height and possibly the use of new materials instead of old, a lych gate for the house can be made on these same principles. (302)

Make your own HOUSE NAME PLATE



NAME plates for houses have been popular for a long time. They can be hung in the porch or fastened to the front gate, and in either case they make an attractive addition to the front of the house.

The making of these name plates should provide no difficulty at all for the average hobbyist. The only tools needed are a $\frac{1}{4}$ in. gouge or 'veiner', a matting punch and a mallet.

Choosing the Wood

The best wood to use is, of course,

oak, but almost any kind of hard wood can be put to good use.

The first step is to cut and plane the block of wood to a convenient size. Good average measurements are 9ins. by 2 $\frac{1}{2}$ ins. by $\frac{1}{2}$ in., but these will vary according to the length of the name of the house.

On a sheet of paper, carefully mark out the name of the house. When this has been satisfactorily completed, lay the paper on the block of wood, put a sheet of carbon paper in between, and trace the letters on to the wooden block.

frame surrounding the letters.

Now very carefully chisel away the wood from around the letters so that the whole word stands out from the block. Use the gouge sparingly so that the background to the letters is as smooth and as level as possible.

Finish off the background by tapping it down with a matting punch and mallet.

Finishing Off

Chamfer the edges of the block and



Marking out the board. The dotted surface shows where the matting punch is used on the background

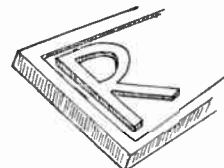

Enlarged drawing showing how the letters stand out from the board

Beginning the Carving

The next step is to cut round the outline of the letters with the $\frac{1}{4}$ in. gouge or veining tool. Work a little to the outside of the line and cut $\frac{1}{4}$ in. deep. In the same way mark round the rectangular

clean up with some fine glasspaper. Rub the block with a swab dipped in linseed oil and give a final coating of clear varnish.

If the name plate is to be hung in the porch, screw two metal eyelets into the back and suspend it with a pair of fine chains. Alternatively, the plate can be screwed to the front gate. (258)

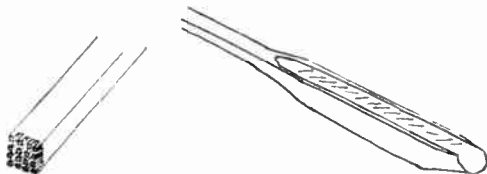

A matting punch and gouge

Practical advice on FIGURE WORK IN BOX DECORATION

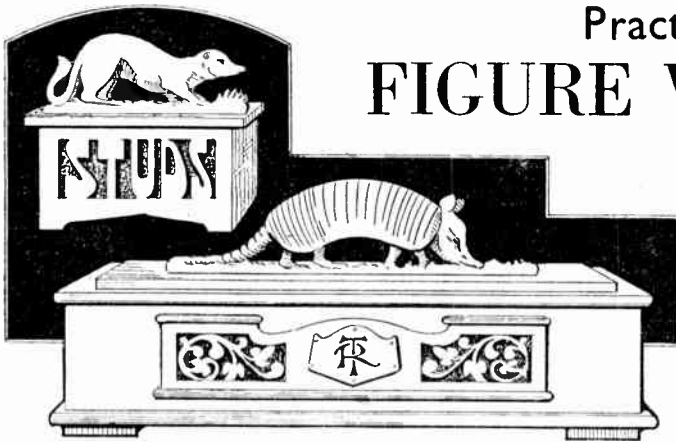

ANIMALS in fretwork have always been popular. They add a distinctive character to articles to which they are introduced, and have, in the past, been seen as embellishments in the form of overlays to plaques, brackets, cabinets, etc.

With the two articles given here, however, they take on a new form in the way of providing handles for boxes.

We think that when the reader glances at the sketches of the two boxes shown on this page, he will at once agree that a distinctive and novel note is struck with the introduction of the mongoose and armadillo. The two boxes are useful and convenient sizes; one, it is suggested, for holding gent's soft collars, and the other for studs, cuff links, etc.

Box Construction

The construction of the boxes can be easily followed from the diagrams, which give all the necessary dimensions for cutting the various pieces.

Wood $\frac{1}{2}$ in. thick is used throughout, with the exception of the overlays, which may be of thinner wood or ivory. The box shown in Fig. 1 has the sides and ends butted together, and a floor glued on, this floor projecting slightly all round to form a base.

**Full size patterns
for the figures are
given on page 127**

Under the base there are four turned or square feet glued to the corners. In Fig. 2 we show an alternative and rather neater joint than the plain butt joint of Fig. 1.

Fancy Angle Plates

The mitred joint is somewhat difficult to make, as the 45 degrees mitre must be

cut accurately if a closely fitting corner is to be the result. This joint, too, is not strong, as glue applied to the cut end grain does not bind the two parts well together.

To strengthen the corners, therefore, it is suggested that brass angle plates be added and screwed on. Round-head $\frac{1}{4}$ in. screws make the best fastening, and are more easily driven home.

There is a simple fretted overlay suggested for the front of this box, and the method of finishing the lower and top edges of it is shown in Fig. 3. The three strips shown are cut about $\frac{1}{4}$ in.

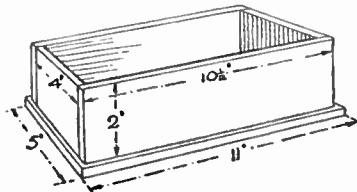

Fig. 1—Dimensions of the collar box

wide and the front edge and the two end edges of each are rounded off before the strips are glued up to the overlay.

For the overlay, we have been able to give a full size pattern on cover III, all ready for sticking down to the piece of wood and cutting out. Space has been arranged for a shield (cut from metal or ivory) to be pinned on. Alternatively, a monogram, either engraved or drawn on in indian ink, would look well here.

A full size pattern of the shield, and also suggested outlines for the metal corner strips if they should be required are included on the pattern sheet.

The Lid

The lid of the box should be the same size as the base, with the edges nicely rounded off. To hold the lid in place—it

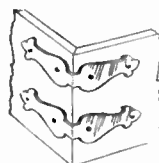

Fig. 2—Alternative to a plain butt joint

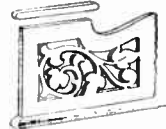

Fig. 3—Finishing the top and bottom edges of the overlay

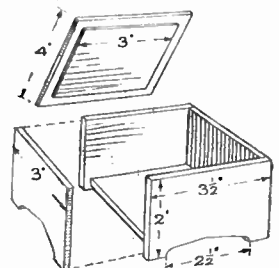

Fig. 4—Details of the second box

is not to be hinged to the box—a piece of thin wood is cut to the same shape and size as the interior opening of the box, and is glued on underneath the lid.

The handle for this box is in the form of an armadillo, and here again we are able to give a pattern for this full size on cover III all ready for sticking down on the wood and cutting out. The outline should be cut with a fine fretsaw, and the markings put in in paint or indian ink.

The Second Box

The second box, designed to contain studs, etc., is shown in constructional form in Fig. 4. Here again the sides are simply butted together.

The bottom edges of the sides are shaped to the measurements shown, and the floor—a plain section of wood $\frac{3}{8}$ in. square—is fixed $\frac{1}{4}$ in. up from the base line. Small blocks of wood glued beneath the floor will help to strengthen the fixing.

The lid to this box is also shown in Fig. 4, with the overlay piece glued on underneath to hold it in place. A plain square of wood should have a $2\frac{1}{4}$ in. mortise cut in it for the handle—tenon (B) which is shown full size on the pattern sheet.

The handle should be cut from $\frac{1}{2}$ in. wood and the markings copied from the pattern and painted up naturally in browns of varied depths.

Cutting The Word 'Studs'

The word 'studs' is intended to be cut as an overlay in thin wood and glued to one of the sides of the box, or the lettering could be cut in the actual side of the box and a thin piece of wood glued in at the back of the lettering as a lining. The pattern for the wording is included here.

The actual finish to the boxes depends upon the variety of wood used. If mahogany, then french polish or varnish would be suitable, but if whitewood, then clear varnish would be as good as anything. (282)

Fill a vacant space with this CORNER CABINET

THIS cabinet will conveniently fill a vacant corner, and would be handy for showing off some fancy china. It is purposely designed to use as little solid wood as possible, wood being dear, and scarce nowadays. Simplicity of construction is marked, and any amateur woodworker could undertake construction with confidence.

The back of the cabinet, or rather backs, as there are two of them, can be cut from plywood, or possibly a good quality of hardboard. Cut two to the dimensions given at (A) in Fig. 1, and where the horizontal fillets, which support the bottom and shelves are shown, square pencil lines across. From

CUTTING LIST

- Rear vertical strip—4ft. by 1in. by 1in.
- Front angle pieces (2)—4ft. by 3½ins. by ½in.
- Door sides (2)—2ft. 10½ins. by 2ins. by ½in.
- Door rails (2)—1ft. 2ins. by 2½ins. by ½in.
- For bottom and top cross piece—4ft. 6ins. of 6ins. by ½in. wood.
- Plywood backs—one 4ft. by 1ft. 2½ins. by ½in. and one 4ft. by 1ft. 2½ins. by ½in.
- For shelves and top, plywood—4ft. 2ins. by 1ft. 1in. by ½in.
- For side fillets—9ft. of ½in. square deal.
- Moulding—about 2ft. run.
- Remainder from scrap wood.

a strip of 1in. square wood, cut a piece the same length as the backs. To this the backs are nailed and glued, to be at rightangles to each other. If one back has to cover the cut edge of the other, then its width should be lengthened by the thickness of the plywood (½in. or ¾in., perhaps) so that both sides will be equal.

Cut two pieces of ½in. thick wood for the front angle parts. These are 3½ins. wide, and the same length as the sides or backs. They are shaped at their lower ends as in detail (C), and their inner edges planed to a bevel of 67½ degrees. These parts are a shade on the full size, so a trifle may have to be planed off their outer edges to reduce the inside faces to 3ins. These parts are nailed and glued to the backs, as seen in the detail of construction given at (B). The inside fillets, on which the bottom of the cabinet and shelves, rest, are strips of ½in. square wood, screwed across. The screws are driven in through the plywood, and the assistance of a friend will be helpful here to hold the fillets firmly to the pencilled guide lines while they are being screwed in position.

The Bottom

The bottom of the cabinet (Fig. 2) is cut to the shape shown, from ½in. wood, two pieces being required, most likely, to make up the depth. The shape is easily drawn out, being a square with an angular piece sawn away. At the rear corner saw out a piece 1in. each way, to fit over the rear vertical strip attached to the plywood backs. Fix the bottom to the lowest fillets with screws, and drive oval nails through the front angle pieces into it as well. From the ½in. wood cut a top front piece to the shape of the bottom, measuring from the

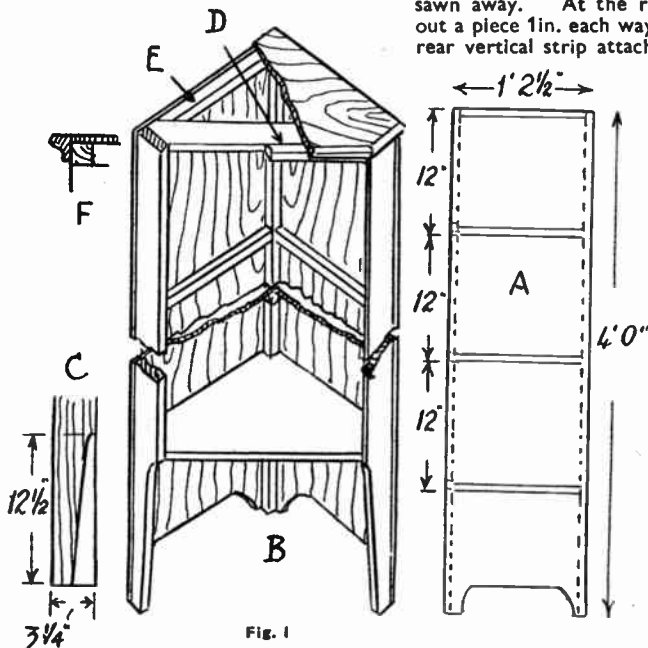
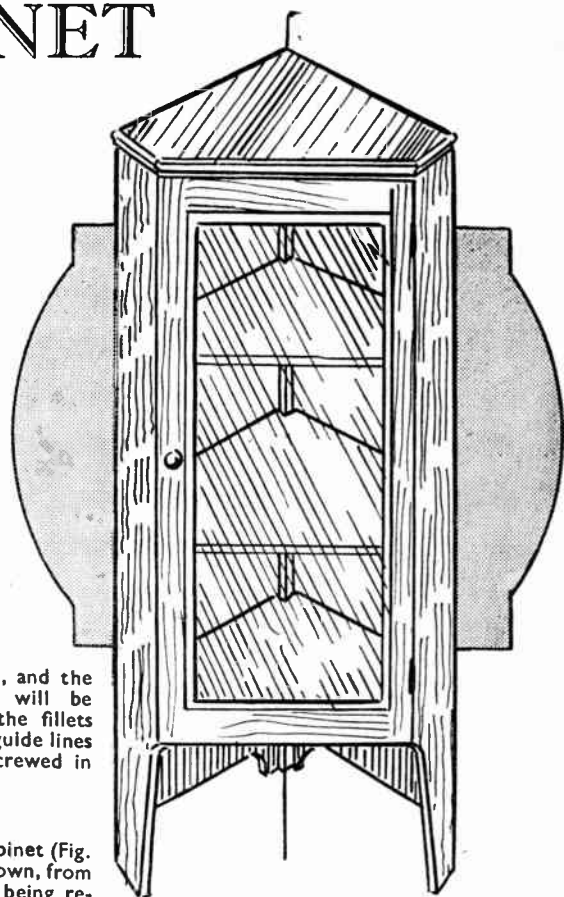

Fig. 1

front edge to the dotted line, say, a width of 3½ins. Nail this across the top, and between this and the rear vertical strip, screw fillets, as shown at (E).

A filling strip of ½in. wood, ½in. thick, is glued and nailed across, as at (D) to fill the space between the angle side pieces and top cross piece. The ends of this must be bevelled to about 67½ degrees at each end to butt correctly up against the bevelled edges of the angle pieces. This will, of course, be apparent when fitting it in. Now level off the top with a smoothing plane, finely set. From plywood, cut a top to the cabinet, this is partly shown at (B), and glue and pin on.

(Continued foot of page 118)

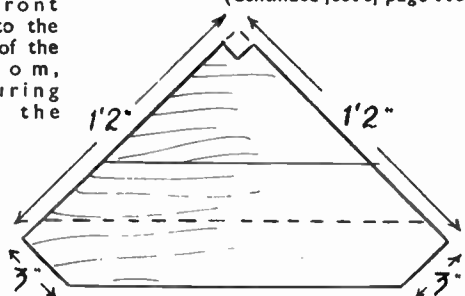
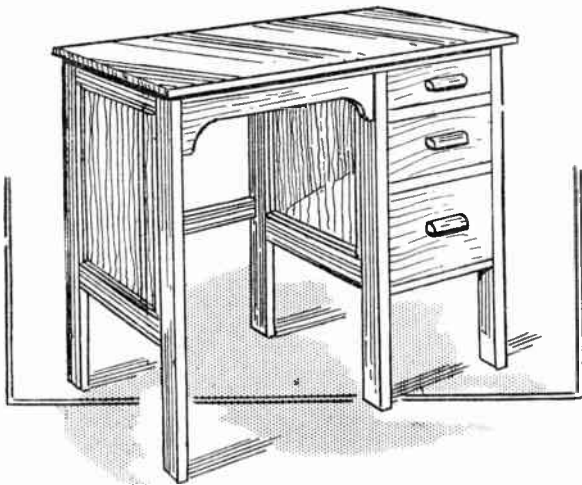

Fig. 2

There must be many who need a CLUB SECRETARY'S DESK



dowel joints, or the more usual mortise and tenon ones. Dowelling is all right if correctly done, otherwise the frames will be out of winding. If mortising and tenoning is adopted, and the writer would certainly vote for it, the tenons should be 'blind' not through, a length of 1in. being enough, and be shouldered at top and bottom. Most woodworkers know all about that, so further details may be unnecessary. The frames should then be pannelled,

DOUBTLESS there are many readers of 'Hobbies' who act as secretaries to sports clubs, and other associations. To all such workers the desk illustrated would prove welcome. It is somewhat smaller than the professionally made article, and, therefore, occupies less space, rather valuable when the secretarial work of the reader may have to be dealt with in the common living room.

with three-ply, or substitute board of a suitable quality. Prepare a few lengths of $\frac{3}{8}$ in. thick by $\frac{1}{2}$ in. wide beading, and glue and nail this round the openings, to leave a $\frac{3}{8}$ in. deep rebate behind for the panels. Mitre the beading neatly at the corners. Cut the panels a close fit for the openings, glue the inside edges of the beading, then press the panels in, and nail them to the beading, as in detail (A). One panel, intended for the left side of the desk, is now put aside. The other two, which will form the sides of the pedestal, are now taken in hand. In one (the left side of the pedestal), where shown at top and rear, by shaded lines,

CUTTING LIST	
Frames, sides (6)	2ft. 6ins. by 2ins. by $\frac{1}{2}$ in.
Frames, rails (6)	1ft. 4ins. by 2ins. by $\frac{1}{2}$ in.
Panels (3)	1ft. 7ins. by 14ins. by $\frac{1}{2}$ in.
Rear panel	1ft. 5ins. by 12ins. by $\frac{1}{2}$ in.
Longitudinal rails (3)	2ft. 9ins. by 2ins. by $\frac{1}{2}$ in.
Spandrel	1ft. 8ins. by 4ins. by $\frac{1}{2}$ in.
Drawer rails (3)	12ins. by 1ins. by $\frac{1}{2}$ in.
Drawer runners (6)	1ft. 3ins. by $\frac{1}{2}$ in. by $\frac{1}{2}$ in.
Drawer fronts	12ins. by 4ins. by $\frac{1}{2}$ in.
Drawer fronts	12ins. by 5ins. by $\frac{1}{2}$ in.
Drawer fronts	12ins. by 7ins. by $\frac{1}{2}$ in.
Drawer bottoms (3)	1ft. 4ins. by 11ins. by $\frac{1}{2}$ in.
Drawer sides and ends	$\frac{3}{4}$ in. by 4ins. by 4ft. run.
Drawer sides and ends	$\frac{3}{4}$ in. by 5ins. by 4ft. run.
Drawer sides and ends	$\frac{3}{4}$ in. by 7ins. by 4ft. run.
Beading	$\frac{3}{8}$ in. by $\frac{1}{2}$ in. by 22ft. run.
Desk top strips	$\frac{1}{2}$ in. by 1ins. by 10ft. run.
Edge lipping	$\frac{1}{2}$ in. by $\frac{1}{2}$ in. or $\frac{3}{4}$ in. by 10ft. run.
Desk top	3ft. by 1ft. 7ins. by $\frac{1}{2}$ in. or $\frac{3}{4}$ in.

cut out notches, $\frac{1}{2}$ in. by 2ins. for the longitudinal bars which hold the parts of the desk together. Where shown by the horizontal cross lines on back and front uprights of each frame, mark off the places at the distance apart given, for the grooves in which the drawer rails and runners will occupy.

Cut these $\frac{3}{4}$ in. wide and $\frac{1}{2}$ in. deep, and note that the rear ones, which should, of course, be exactly opposite the front ones, are cut only 1in. long, only to half the width of the wood. Be careful here to cut these grooves on the inside of each frame—you cannot make a mistake if you place the frames on the bench, beaded side downwards, and then pencil the lines for the grooves across each. At this stage cut the drawer rails from $1\frac{1}{2}$ ins. wide wood, and nail them in their respective grooves. These being $\frac{1}{2}$ in. short of the front grooves will leave $\frac{1}{2}$ in. of each groove into which the runners will enter. For nailing, use 2in. oval nails, and drive well home. A little glue, added to each joint will make for security.

Cut the drawer runners from the $\frac{3}{4}$ in. wood, making them $\frac{1}{2}$ in. thick, and long enough to extend across the frames and into the grooves at the rear. Nail or screw them in. A space will be left, about $\frac{1}{4}$ in. or $\frac{3}{8}$ in. deep between the panels, and uprights of the frames, and to ensure free running of the drawers, slips of wood, planed to the necessary thickness, are glued to the panels to bring them level with the frames. This is shown in the detail of construction at (B) in Fig. 2. Indicated here, also, are two of the notches cut for the longitudinal bars in the middle frame, and mentioned before.

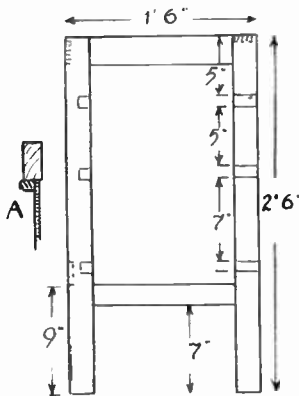

Fig. 1—Dimensions of the frames

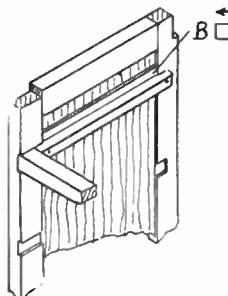

Fig. 2—Fixing the drawer runners

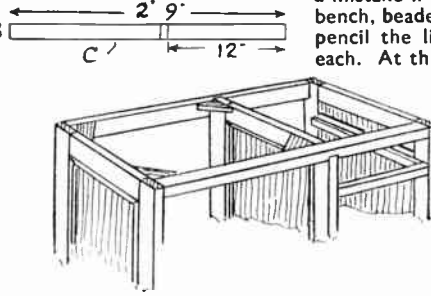

Fig. 3—Joining the three frames

Though the desk has a real professional appearance, the work involved has been so simplified that its construction can be confidently undertaken by the average woodworker. Another thing in its favour is the use of plywood, or plywood substitute, to lessen considerably the amount of solid wood required.

Three Frames

To commence the work, make up three frames to the dimensions given in Fig. 1. These frames are constructed from $\frac{3}{4}$ in. by 2ins. deal. They can be joined together at the corners with

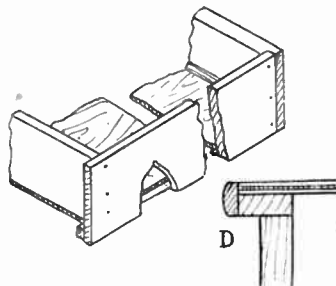

Fig. 4—Details of the drawers and desk top

Now cut these bars to the length given at (C) in Fig. 3. In each cut out a groove, where shown, $\frac{3}{8}$ in. deep and $\frac{3}{4}$ in. wide. The bars are now fitted across, being nailed to all three frames where shown in Fig. 3. The third bar, fitted across the rear of the desk, lower down, is not seen in Fig. 3, but can be clearly observed in the view given of the completed desk. At the corners of the knee-hole space, between pedestal, and left end, screw corner blocks, as shown in the drawing, to bring the whole structure square. It is, perhaps, unnecessary to mention that if the blocks are to fulfil their purpose, they themselves must be sawn to correct right angles. Cut them about 3 ins. each way from spare bits of the $\frac{3}{4}$ in. board, and screw and glue securely in the corners.

To stiffen the knee hole at the front, cut a spandrel from 4 ins. wide wood, shaped up as seen in the general view, and screw across the opening, just under the longitudinal top front bar. It would add a little more strength to this part if a pair of 3 in. steel furniture brackets were screwed to the frames, and top bar, at each side, just behind the spandrel mentioned. The latter, by the way, will look neater if fitted across, not flush with the front, but $\frac{1}{2}$ in. back from it. The carcass should now present the appearance seen in Fig. 3, at least the upper portion of it.

The drawers, a constructional detail of which is given in Fig. 4, are simply made. The fronts are cut from $\frac{3}{4}$ in. board, and their side edges rebated $\frac{3}{8}$ in. deep, and $\frac{1}{2}$ in. wide for the drawer sides.

These latter parts, also the ends, are cut from $\frac{3}{8}$ in. thick wood. Dimensions will be, of course, taken from the drawer openings, and the depths can be up to the ends of the runners. The ends of the drawers are not cut the full depth of the sides, as the bottoms are to be nailed to them; their exact depths will be $\frac{3}{8}$ in. less, plus the thickness of plywood used for the drawer bottoms, for instance, if $\frac{1}{2}$ in. ply is employed, the ends will be $\frac{3}{8}$ in. less in depth than the sides.

Plane up some strips of deal to $\frac{3}{8}$ in. square section. Cut them to the inside length of the drawers, and nail and glue one to each side, level with the bottom edge. There should now be room between these and the edge of the drawer ends to push the bottoms through, which are then nailed both to the ends, and side strips. At the front, the bottom can fit in suitable grooves, ploughed on the face of the drawer, or alternatively a triangular fillet can be glued to inside face and bottom, as seen in the drawing. If the question arises why not a fillet across the drawer face, as well as the sides, the answer is it would scarcely allow room for drawer stops afterwards.

Try the Drawers

Now try the drawers in place, if well made they should slide in and out quite easily. The drawer stops, mentioned above, are slips of wood, 1 in. long and $\frac{1}{2}$ in. thick, two being required for each drawer. These are glued and nailed to the drawer rails at the correct position in for the drawers

to butt up against them when in level. They prevent the drawers going in too far, and presenting an unsightly appearance. A rather neat effect can be created here by fitting the stops so that the drawers project just $\frac{1}{8}$ in. in front of the rails, the corners of the projecting parts being nicely rounded or bevelled off.

Panelling the Back

The back of the pedestal can now be panelled in, a job done similarly to that performed already to the frames with the sole difference that the beading is fitted in to the back portion of the opening, and then the panel positioned in and nailed. Prepare four strips of wood, $\frac{1}{2}$ in. by $1\frac{1}{2}$ ins., and nail and glue these to the top of the desk carcass. A fifth strip is also prepared, and fitted across to the top edge of the middle frame. These pieces should be mitred at the corners, and should overhang $\frac{3}{8}$ in. all round. Level off the top surface, then to cover in the top, glue and nail a panel of plywood over. This top plywood can be $\frac{1}{2}$ in. thick, but do use $\frac{3}{8}$ in. stuff if obtainable, as a firmer top will result. Cover the edges of plywood, and under strips, with $\frac{1}{2}$ in. lipping, as shown in detail (D).

This completes the work of construction. The desk should have all nails punched down, and the holes stopped level, be well glasspapered, and then stained oak colour and varnished. Suitable handles or pulls will complete a most useful piece of furniture. (280)

Corner Cabinet—(Continued from page 116)

When the glue is hard, level off the outside edges of the top with the carcass, and glue and pin pieces of $\frac{1}{2}$ in. moulding to the front and angle sides. These will cover the cut edges of the top, as in detail (F). In the absence of a suitable strip of moulding, a length of wood $\frac{1}{2}$ in. by $\frac{1}{2}$ in. could be substituted, which could be bevelled off a little to make it somewhat of triangular section. Three pieces of this will be needed, the meeting edges being mitred to $67\frac{1}{2}$ degrees to fit. This practically completes the carcass.

For the two shelves, cut pieces of plywood to the same pattern as the bottom (Fig. 2) or, if more substantial shelves are preferred, make them of the $\frac{3}{8}$ in. thick board instead. These, in all probability, can be worked in position, but if any difficulty arises, unscrew the side fillets first. The shelves are fixed across to the fillets with screws, and nails, if of the thicker wood, driven through the angle pieces. All nails employed should be of the oval variety, and for pins, mentioned, use those sold as panel pins, the best for the work.

All nails should be well punched down, and the holes filled up with plastic wood, or other suitable stopping. Give the completed carcass a thorough rubbing, first with medium, and then with fine glasspaper.

The door, Fig. 3, is made up to the dimensions given, with 2 ins. wide side pieces and $2\frac{1}{2}$ in. wide rails. A simple mortise and tenon corner joint is recommended, as at (G), then no awkward cut edges are revealed when the door is opened. The opening is framed with $\frac{1}{2}$ in. wide strips of thin wood, mitred at the corners, and overlapping the opening by $\frac{1}{2}$ in. to form an interior rebate for the glass panel. This is shown at (H). The edges of this framing can well be slightly bevelled. At the same time, similar strips of wood can be glued to the angle pieces of the cabinet, if the cut edges of the plywood backs, which are visible at the front, are

objected to.

The side edges of the door are bevelled to fit the angle sides. The angle of bevel is $67\frac{1}{2}$ degrees, but if a gauged line, $\frac{3}{8}$ in. from the edges, is scratched along on the inside face, and the edges planed to this line, the bevel should be about right. Test the door for fit several times, during the bevelling, to ensure it is not overdone, and the fit of the door spoiled through taking off too much. Hang the door with a pair of $1\frac{1}{2}$ in. brass butt hinges, and fit a suitable cupboard or cabinet catch. If one of the common type is used, the inside arm, attached to the knob, and which swings round to lock the door, will have to be bent to an angle of 45 degrees, as will be seen when fitting is taking place. The glass panel is fitted to the door with slips of wood, in the usual way.

Finish of the cabinet will depend to some extent on the wood used. A coat of stain will be given first to all parts, inside and out. Then the show parts of the cabinet, that is, those parts on view when the cabinet is in place, can be varnished or polished. The top is also polished, and accommodates a fancy vase, plant pot, or anything preferred.

As the show wood is so limited, a first class piece of furniture can result if oak or other fancy hardwood is employed. The shelves are best covered with green baize or velvet, if a piece of the latter is available. (259)

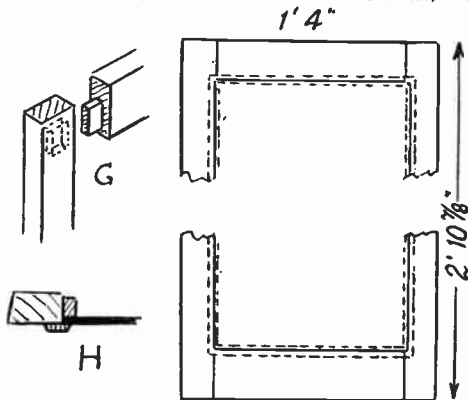

Fig. 3

Here is a helpful GUIDE TO FISHING GEAR

SUCCESSFUL fishing does not always need expensive tackle. Knowing where and how to fish is more important, and can bring very satisfying results with simple, and comparatively cheap tackle. Between the angler and a well hooked fish stretches a series of objects—a rod, reel, line, float, cast, lead shots, and a hook. It is in this order that they will be discussed.

Rods

Rods are usually two- or three-piece, and of bamboo, greenheart or lancewood, while some have a lancewood top and bamboo lower joints. (This excluding the split cane job, which is in the more expensive class). A three-joint rod is preferable to a two-piece, because three joints of 3½ft. each make a 10½ft. rod, which is a useful and convenient length for angling and easy to transport by cycle, bus or train. 5ft. sections may prove inconvenient when travelling, and there is considerable likelihood of damage. When not in use the sections should be kept in a partitioned cloth case to protect the varnish, and the small wire rings, through which the line is threaded.

These bags or cases are quite easy to make either by hand or with a sewing machine. One leg of a pair of disused trousers would provide the material.

The Reel and Line

For a beginner a cheap reel of wood or bakelite 3ins. in diameter will prove quite handy. On it wind 20yds. of green plaited silk line of 6 or 8lbs. breaking strain. The line should be treated with Mucilin or some other grease, which must be well rubbed in to preserve the silk and to make the line above the float lie buoyantly on the surface of the water.

To do this, tie the line to some

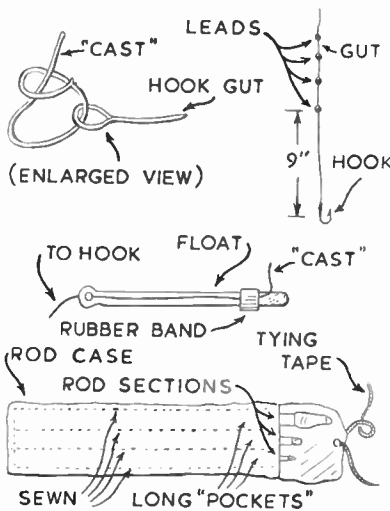

convenient object and unwind 2yds. Now rub a piece of flannel about 3ins. by 1in. on the grease until it is well soaked, and then wrap it round the line. Hold the reel in one hand so that it cannot revolve and pull the run-out line tight. With the other hand rub the flannel up and down the extended line until it makes a sound like a banjo string. Afterwards treat the next 2yds. or so in the same way, and so on until the whole line is greased.

When you return from a fishing trip, wind the damp portion of line between two nails about 2yds. apart in the side of a shed, so as to expose it to the air and dry it. Grease the end 4 or 5yds. each time before use to ensure a long life for the tackle, and a quick strike when a bite is obtained.

The Cast and Hook

The 'cast' is composed of a float, a

length of gut or nylon, a few round split-head shot, and a hook bound to a short length of gut. The complete cast can be bought ready made up and wound on a half section of bamboo, ready to tie to the silk line.

Casts can be made from a 1yd. length of 3X thickness nylon, looped to a No. 12 hook. The hook will, of course, be on its own length of gut, and no knot is necessary, as will be seen from the diagram. It is advisable to moisten the loops in water or in the mouth for a minute or two as dry gut is liable to crack.

Useful Float

A useful float should be about 4ins. long, and as thick as a pencil, white and with a red-tipped top. The bottom is usually flattened and has a small hole through which the cast is passed, before being drawn through the rubber band at the top.

The float can be moved up or down the cast at will, and it will remain at any spot chosen. It is thus possible to adjust the depth of the bait according to the depth of the water.

About 9ins. from the hook squeeze on one lead shot, followed by two or three others at 1in. intervals away from the hook.

Baits

Paste made from dried bread dipped lightly in water and kneaded in the hands until it is rather sticky and will stay on the hook as a small pellet, is popular. Maggots may be bought from a tackle shop—take your own tin. Small reddish worms can be found in the garden, or in an old manure heap. These are the commonest and most useful baits for still or running water.

Some experts use cheese, boiled wheat, and hemp seed, but the worms and maggots will often provide as ready a catch. (283)

Replies of Interest

Wire Recording

MY hobby is electrical wire recording, and my problems are (1) to construct an efficient wire laying mechanism, (2) to make an efficient recording head. At the moment I have one using metal with 210 turns of copper covered wire, but I get a lot of hissing when the wire passes over the head, thus making the recording very distorted. I am using Meccano parts for my machine, with an electric motor and a wireless with provision for pick-up, and loudspeaker for my amplifier. I would like to know how to build an amplifier for this type of work. (R.J.—Newport).

IN order to reduce background noise and similar distortion caused by vibration, friction, lack of regular

wire-speed, and so on, high standard of mechanical efficiency is necessary. All vibration, looseness of bearings, and so on, must be avoided. The spools should be situated at some distance, with guide rollers or similar means to take the wire straight across the head, the pole or poles of which should be machined perfectly smooth, and slightly convex. It is desirable to wind through pressure rollers at constant speed, the take-up spool being turned through light friction obtained by it being loose on the spindle, but under pressure from a spring. The wire will then dispose itself satisfactorily. Direct winding on the spool will result in irregular wire-speed. Any amplifier, preferably with an output

of at least 5 watts, can be used for such purposes.

Radio-Gram

CAN I connect a gramophone to my radio, and play my own records? (J.D.—Ballivor).

A GRAMOPHONE pick-up may be connected to any receiver. Take one lead to the grid socket of the first valve handling low-frequency signals (this may be located from a valve-book, or from the diagrams in various back issues). The second lead is taken to grid bias negative, 1½ to 6 volts, in a battery set. If the set is mains operated, take this lead to the metal chassis.

Add colour to your homes with GAY WINDOW BOXES

THERE is nothing more attractive or charming than a garden full of flowers. Quite often, however, this is not at all possible, as the only space out of doors may be just a concrete yard.

Even under these extreme conditions no one need despair, for it is possible to make a very nice 'garden' in a window box and have flowers practically all the year. Upstairs and downstairs windows are equally suitable and with two or three boxes well planted it should be possible to make this Festival of Britain Year a really outstanding one.

Simple to Make

Window boxes are quite simple to make, and are equally easy to keep in an attractive condition. The flowers can be admired by passers-by as well as by the occupants of the room. It has the added advantage that it can be attended to without the backache usually associated with gardening.

No really definite sizes can be given, as individual requirements are so varied, and the boxes must be made up to fit the available space. The idea of this article is to make suggestions about designs and general construction and to give hints on sowing and after care.

There are two ways in which a window box can be used. We may grow all the plants in individual flower pots and stand them in the wooden framework, or, what is more usual, fill the box with soil and plant directly. In the first place only a skeleton framework is necessary, but a much more substantial structure must be made to hold the soil for the other type.

The Best Woods

Oak or elm are the best woods to use if the box is wanted to last several seasons, although many other kinds are suitable, including pine, and, if taken care of, will stand for quite a while.

For small windows, the thickness of the wood used need not be more than $\frac{3}{4}$ in., and in many cases $\frac{1}{2}$ in. should be sufficient. The thickness must, however, be increased to about 1 in. for large sized windows, unless two or more shorter boxes are made and placed side by side.

The depths of the boxes will be determined somewhat by the kind of plants that it is intended to grow. Anything between 6 ins. and 9 ins. should be suitable.

The width of the window sill will give some indication for the width of the box. It can project over the front a little, but not sufficient to make it overbalance. Quite a lot of useful work can be done in a box about 9 ins. wide.

Extra strength is given to the box by making the end pieces of thicker wood and also by letting the front project 1 in. or 2 ins. over the sides as shown in Fig. 1. This also shows the $\frac{3}{4}$ in. drainage holes in the bottom, which are essential if the plants are to be kept healthy.

Fig. 2 shows how the front may be ornamented to make the box look attractive. There are many designs which can be used for this purpose, and the ever-popular strips of bark or log sections nailed on are equally suitable.

Fixing

Careful consideration should be given to the method of fixing the box to the window sill. If left unfastened, it can be

recommended for the inside. The best way to prevent the moisture from decaying the woodwork is to char it with a red hot iron or with a blowlamp. This is quite easy to do, and is very effective—and is not injurious to plant life like oil paint. Some people favour the idea of lining the inside of the box with metal such as tin or zinc.

Some houses have a small projecting ledge or porch over the front door. It is possible to have an attractive little garden here, and the space available may be fitted with a box similar to the window sill boxes.

Interchangeable Boxes

The really keen window box gardener would have two or even three interchangeable boxes for each window, and thus secure a succession of flowers for most of the year. One box would be filled with bulbs for spring flowering, and another got ready with summer plants to take the place when the bulbs fade. This one can then be replanted, or another one used for autumn flowers.

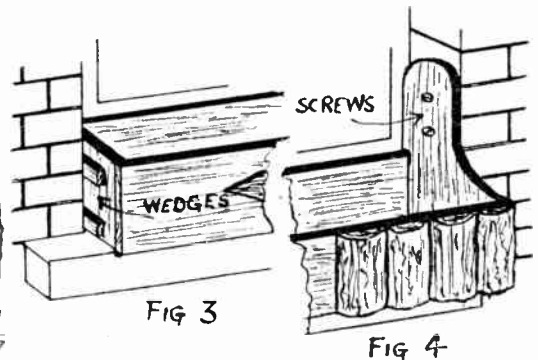
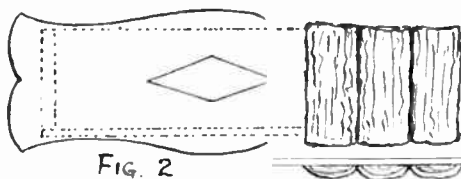
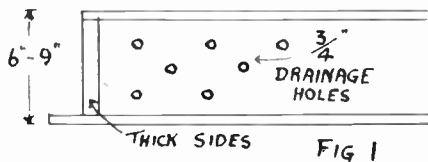

somewhat dangerous, especially if the box is on an upstairs sill. Wedges can be used at each end as shown in Fig. 3, but a better method is to make the end pieces taller as shown in Fig. 4 and screw into the brickwork, which should be previously plugged.

Another idea is to fix a strong screw eye into the front of the box, and then fix a wire to the top of the window frame. This can be very effective, as climbing plants may be trained up the wires.

Preserving

Before the boxes are placed in position and filled up, they should have some form of preservative applied to them. The outsides are best treated with two coats of good oil paint, but it is not to be

**Tell your friends about
Hobbies Weekly.
They, too, might like
to read it**

Although a window box is best with a south aspect, there are many plants that prefer a shady position. Place plenty of pieces of broken earthenware, etc., in the bottom of the box to improve the drainage before filling up with soil, which can contain some leaf mould, sand and a little bone meal.

Geraniums and petunias always produce a good show of blossom, and, with the ever-popular lobelia and dwarf nasturtium, will bloom all the summer. For shady positions, plant pansies, begonias, canary creeper and ferns. Good climbing plants for the sides are convolvulus, creeping jenny and nasturtium.

Watering window boxes, or pot plants in them, needs special care. They should not be allowed to become too dry especially during hot weather. Giving too much water is an even more serious fault, and should be guarded against. When water is needed, try to judge the amount required to wet all the soil and do not slop it about carelessly, otherwise a lot may be lost besides making an unnecessary mess. (244)

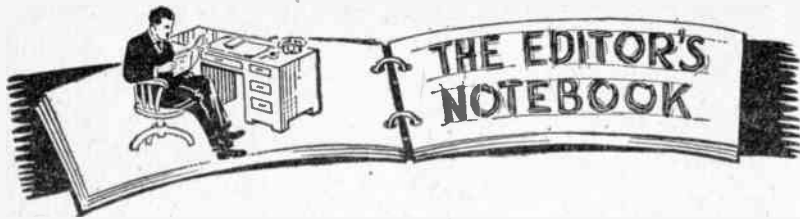

The exhibition was a great success, and attendance figures broke all records.

* * *

Arts and Crafts

HERE is a note for modellers in Birkenhead and district. In August, the Borough Police are holding an arts and crafts contest, to be run in conjunction with their annual flower show.

The contest was inaugurated last year and immediately proved successful. Details and entry forms can be obtained from: The Secretary, Arts and Crafts

Models on Show

THE two photographs on this page will be of interest not only to north country modellers, but to others elsewhere, too. They were taken at an exhibition held earlier in the year at Stocksbridge, Nr. Sheffield. One shows part of the stand of the Sheffield Model Societies. The other is Hobbies' own stand, arranged by our Sheffield branch.

In the top photograph, the display of ships was contributed by the Sheffield Ship Model Society. The aeroplanes are the work of the town's Society of Aeromodellers.

It is of interest that the occasion was not specifically a model exhibition. Indeed, no. Held at the steel works of Messrs. Samuel Fox & Co. Ltd., it was an exhibition of fuel saving. The idea of having a model display in such an exhibition was to increase the interest of the staff and public, rather than leave them stranded among an array of lagged pipes and valves! And the model makers served their purpose, for many thousands of people passed through the exhibition.

Incidentally, responsible for Hobbies' stand was Mr. G. H. Wilkin, the company's Sheffield manager, who is also secretary of the Sheffield Society of Aeromodellers.

Models Exhibition at Manchester. In all, eleven models of all types were shown—and eight awards were gained.

Among the winners was our Mr. Wilkin, who carried off a trophy for a

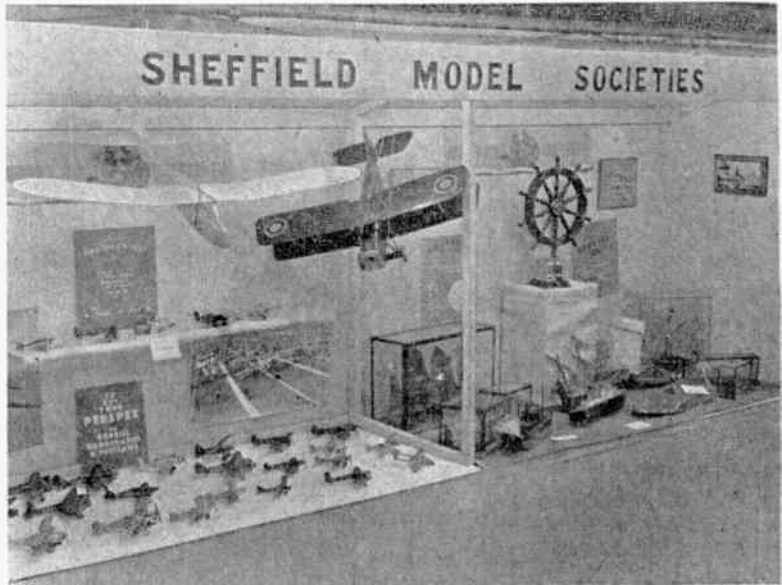

The Sheffield Model Societies' exhibits at the Stocksbridge Show.

Eight Awards

THESE Sheffield chaps seem to be altogether keen modellers. Soon after the Stocksbridge Exhibition, some of them exhibited at the Northern

model of the galleon 'Royal Sovereign', made from a Hobbies design sheet, and a second prize for an inlaid wood picture, also from a Hobbies design.

Contest, Chief Constable's Office, Birkenhead.

* * *

Bricklaying

ON March 28th we published an article on bricklaying for beginners, and, by now, some of you may be merrily busy with trowel and plumb-line. I sincerely hope you have not got

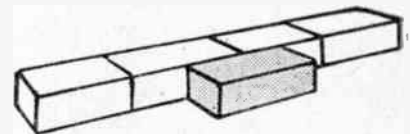

How Fig. 7 of our article on bricklaying should have looked

far, however, for we have discovered an error in one of our drawings. It occurs in Fig. 7 where, in the top drawing, the brick in the second course of the strengthening pier is shown half a place out.

We are printing here an amended drawing, and apologise for the inconvenience any of our readers may have been caused.

The Editor

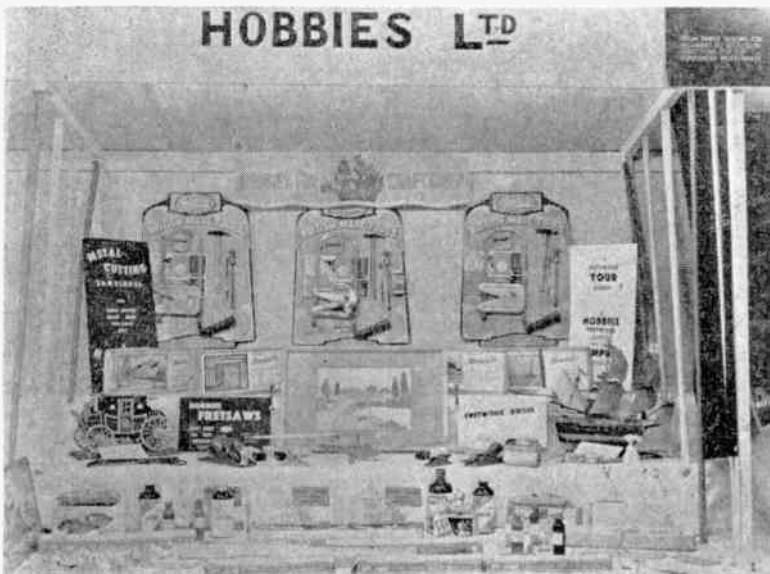

Another picture from the Stocksbridge Exhibition, showing our own display

Books to Read!

A review of interesting books for craftsmen which have been recently published. Obtainable through newsagents or book-sellers or direct from the publishers mentioned.

Four Main Lines

By Hamilton Ellis

THIS volume is another splendid work by the author of *The Trains We Loved*, and will, doubtless, be just as enthusiastically received. For almost 125 years, the steam railways of Great Britain were worked by a succession of companies which either fought each other, or made alliances with each other. With the coming of the four main companies, there was still 'war', but this time it was a defensive war—against such new and fierce competitors as road and air transport. Then came national ownership—the birth of British Railways. Yet, inevitably, the four great lines have kept certain distinctive characteristics, which nationalisation can never obliterate. It is with these four main lines that Mr. Ellis' book deals, and anyone even remotely interested in railways will find the time given to reading this book well repaid. Published by George Allen & Unwin Ltd., Ruskin House, 40 Museum Street, London, W.C.1—Price 16/-

Home Decorator

By F. J. Christopher

THIS is another of the well-known Foyles Handbooks, and is written by a noted craftsman. He gives clear instructions for the guidance of all who wish to save cost—and derive pleasure—in decorating their own homes. The whole book is written in plain, easily understood language, and the illustrations are in keeping with the text. Published by W. & G. Foyle Ltd., 119-125 Charing Cross Road, London, W.C.2—Price 2/6

Oxford Junior Encyclopaedia

Volume IV—Communications

THE reviewer must confess that he has not seen the previous volumes of this encyclopaedia, but if they were as good as volume four, then they were excellent indeed. The book covers communications in all its aspects—by land, sea, and air, by languages (ancient and modern), by signs and symbols, by 'bush telegraph' and by broadcasting. A great part is devoted to the story of ships and the sea, and also well covered are railways and tramways, etc. Needless to say, the volume contains much that is of interest and use to the model-maker. Published by Oxford University Press, Amen House, Warwick Square, London, E.C.4—Price 30/-

Woodworker Annual

Volume LIV

WE are sorry not to have mentioned until now, the current *Woodworker Annual*. As always, it represents value for money from beginning to end. It is packed with articles on all aspects of woodwork, and the working drawings are of the standard readers have come to expect from *Woodworker*. The book abounds with instructions for making a great variety of useful articles. Published by Evans Brothers Ltd., Montague House, Russell Square, London, W.C.1—Price 12/6

Netmaking

By P. W. Blandford

IN this, the second enlarged edition, the author of *Rope Splicing*, etc., covers the subject of netmaking in all its aspects. Every method, all the shapes of meshes, and, in fact, everything necessary to the complete netmaker, has been covered, and anyone wishing to make his own nets could not do better than buy a copy of this book. Published by Brown, Son & Ferguson Ltd., Glasgow, S.1—Price 4/6

Your Jewellery

By J. Leslie Auld

EVER thought of making your own jewellery? It can be done—and easily, too, by following the instructions in this book. The author's aim has been to provide a book which would enable everyone, even the veriest novice, to produce interesting and satisfactory work by traditional technique. And since the book not only describes 'how to do it', but also explains the underlying reasons why, it is also of value to the quite advanced craftsman. Published by Sylvan Press Ltd., 24 Museum Street, London, W.C.1—Price 9/6

Cigarette Card Collecting

By A. J. Cruse

FROM the pen of the author of *Cigarette Card Cavalcade* comes this introduction to the hobby of collecting cigarette cards—a hobby which has developed amazingly in the past 50 or so years, and one which claims the attention of such diverse elements as Royalty, schoolboys, peers, shop assistants, officers of H.M. Forces, politicians—and a hundred and one others. If you are

interested in this hobby, you should be sure to get a copy. Published by Vawser & Wiles (London) Ltd., 356/8 Kilburn High Road, N.W.6—Price 2/6

British Journal Photographic Almanac 1951

AMONG photographers, this book is also well known that little need be said about it. Notice of its publication is usually sufficient to send most of them hurrying to get a copy while stocks last. For the young beginner, we would say that this Almanac is indispensable. All the formulae and instructions you need—as well as many outstanding articles, etc.—are contained within its pages. Published by Henry Greenwood & Co. Ltd., 24 Wellington Street, Strand, London, W.C.2—Price 5/-

Danger Ahead

By Richard Blythe

HERE is a book that will meet a ready response from all who love railways. There is an introduction by T. S. Lascelles, and the illustrations are by Dick Hart. The author entertainingly tells the story of railway signalling since the pioneering days of the 1830's. He explains for the first time how signals looked and how they worked, and he also traces the development of various types of automatic signalling. Published by Newman Neame Ltd., 29 Percy Street, London, W.1—Price 10/6

Your Toymaking

By J. P. McCrum

THIS is yet another in the Sylvan Press' excellent *Your Home Crafts* series, and, like its predecessors, it is written by an acknowledged expert in his particular field. The book deals with the making of wooden toys, and all the components are easily made by anyone prepared to master the making of a rectangular block. The drawings and photographic illustrations are of a high standard. Published by Sylvan Press Ltd., 24 Museum Street, London, W.C.1—Price 9/6

The advertisement pages of Hobbies Weekly are always worth your careful attention.

For the 'bookworm' here is an EXTENDING BOOKSTAND

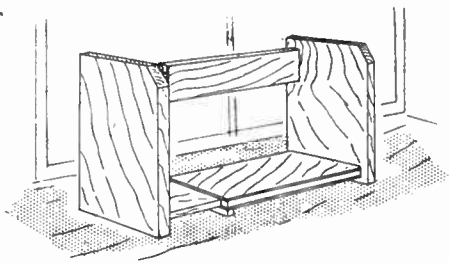

TO those who write or read much, a table bookstand is almost indispensable. It can, however, be very inconvenient. If it is too large, the books in it are untidy, or if it is too small it fails to serve its purpose.

The bookstand described here can be made by any amateur carpenter, and its width can be adjusted from 11½ ins. to nearly 2ft. Bookworms will appreciate just how useful this can be!

The stand consists of two ends joined by a back rail and a bottom shelf on which the books rest. Both the rail and the bottom have a telescopic construction so that the distance between the ends can be altered at will. The solid centres of the rail and bottom are let into the left-hand end; the wooden sleeves, into which they slide, are let into the right-hand end.

Materials

It is best to use the same wood throughout the bookstand. Plywood is used in the construction and, if possible, it should be faced with the same kind of wood that is used for the ends. Oak is the most satisfactory wood to use and oak-faced plywood offcuts are obtainable.

The cutting list with this article will enable you to buy all the materials before commencing construction.

The Bottom Shelf

This is made in two movable parts. The first is a solid centre with a 5 ins. by ½ in. cross-section; the second is the tube or sleeve, into which the first slides, made of two pieces of 6 ins. wide plywood held apart at their outer edges by two lengths of ½ in. square wood. The tube is supported by a fillet of ½ in. square wood (E) underneath its open end. The two parts fit together as shown in Fig. 1.

The first step in the making of the bottom shelf is to clamp the centre piece (C) firmly between the two pieces of plywood (B) so that a sandwich is formed. Then glasspaper the edges of all three pieces together to ensure that they are all exactly the same size. The solid 5 ins. by ½ in. cross-section piece is made by cutting a ½ in. wide strip of each side of piece (C). The sawn edges should be glasspapered smooth and the

½ in. square strips glued or nailed with ½ in. panel pins between the outer edges of the two 6 ins. by 12 ins. pieces of plywood. The solid 5 ins. by ½ in. section piece will slide neatly into the sleeve so formed. One end of this sleeve must be closed with the plug (D). It should be held in place with a couple of panel pins from each side. The bottom shelf is now complete.

The Back Rail

The back rail is similar to the bottom shelf, except that it is 2 ins. wide instead of 6 ins. It is made in the same manner. The three 2 ins. by 12 ins. pieces, (F) and (G), should be clamped together and their edges glasspapered. Next cut a ½ in. wide strip off each edge of part (G) which is 2 ins. by ½ in. by 12 ins. Glue or nail these two ½ in. square strips between the outer edges of the two 2 ins. by 12 ins. pieces of plywood (F). One end of this sleeve should now be blocked with the plug (H). After glasspapering, the 1 in. by ½ in. by 12 ins. centre piece will slide nicely into the sleeve and will project ½ in. from the end.

The Ends

The ends are cut from ¾ in. thick wood. The shape shown in Fig. 2 can, of course, be altered.

Once again it is advisable to clamp both ends together and glasspaper their edges down so that they are absolutely identical. It will improve the appearance and the durability of the bookstand if the back, top and front of each end is given a very slight chamfer.

The next operation, cutting the mortises for the shelf and rail, is the trickiest one in the whole job. Care must be exercised to get the mortises absolutely accurate. You will notice that the sizes of the mortises are different in the two ends, although the depth of

all of them is ½ in. The first step is to mark their positions on the ends in pencil, shading in the waste wood. Now you would be well advised to check the actual rail and shelf ends against the pencil marks as a cut of the wrong size will cause considerable trouble. You will save time if you drill out some of the waste wood. It is a good tip to fix a paper clip on to the bit, just ½ in. from its tip, so that you do not drill too deeply. The mortises will have to be cleaned out with a chisel. Test each of the joints and make sure that it is a good fit. If you have cut any of the mortises too large, the joint will have to be wedged with a thin slither of wood which should afterwards be cut flush with the end.

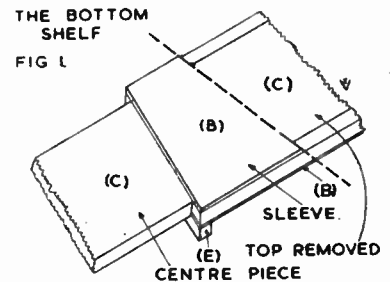
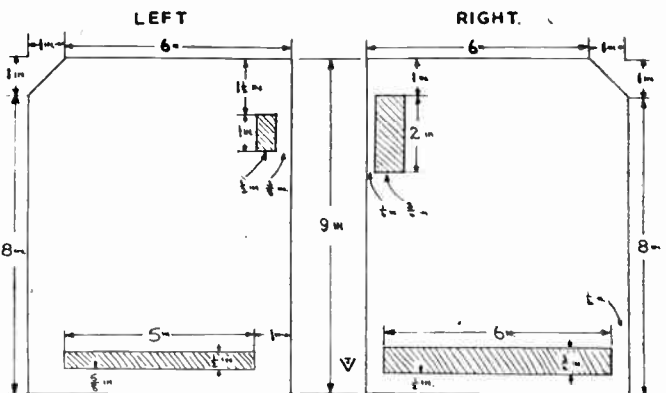

FIG. 2. THE ENDS MORTISES ARE SHADED.



Finishing and Assembling

Whether the bookstand surface is finished before it is assembled or vice versa is a matter for you to decide. I prefer the former method because I find it difficult to get an even finish in

(Continued foot of page 124)

Part	No.	Material	Size
(A) Ends	2 off	in. wood	7ins. x 9ins.
(B) Bottom Shelf, Faces	2 off	in. plywood	6ins. x 12ins.
(C) Bottom Shelf, Centre	1 off	in. wood	6ins. x 12ins.
(D) Bottom Shelf, Plug	1 off	in. square wood	5ins. long
(E) Bottom Shelf, Supporting Fillet	1 off	in. square wood	6ins. long
(F) Back Rail, Faces	2 off	in. plywood	2ins. x 12ins.
(G) Back Rail, Centre	1 off	in. wood	2ins. x 12ins.
(H) Back Rail, Plug	1 off	in. square wood	1in. long

Here are some more jobs for THE HOME HANDYMAN

THE happy handyman can make himself out a list of jobs he can do on wet days—and then see that he has just those extra hinges, screws, hooks and other oddments so necessary to save time and ensure that the work is going to be done according to plan. The writer keeps a little notebook and jots down what he wants. There is nothing

bleak looking, and there is little that you can do with the side windows as these are shallow. These windows are also fairly deep which does not improve the appearance.

Do Not Darken the Room

Fix up a pelmet on the lines shown and bring this down about 15ins. Judge the depth for yourself and avoid darkening the room, although this darkening will be somewhat compensated for by the wide and deep centre bay window. The cut-away effect will do much to take off the square look of the bay.

Try to drape in damask, folk-weave or some similar hard wearing material, which, apart from being pleasant are also very much neutral in colouring and prevent the treatment from being overbearing or Victorian in aspect. The corded effect is then added with ordinary rug wool, or lamp shade trimming, and should be fawn, orange, red or gold. The base of the curtains has a contrasting shade of deeper fawn.

Such a window makes it difficult to have even a table in position. Try a small, low table and a cut-down chair similar to the one shown. This was an ordinary tapestry chair, the legs of which had become unsafe. It was cut to about 15ins. high, re-covered to match the curtains, and a padded section made to fit over the rather ornate and out-of-date back. Chairs like this can be easily obtained

one must consider the positions of the windows and doors, and the size and shape of the actual room. If you make the fitments even 6ins. too high they will tend to overburden the room.

For Books

Shown in sketch 3 is an idea for a built-in fitment to hold books, with a handy cupboard and shelf for other items. The fire-place fitment is rather

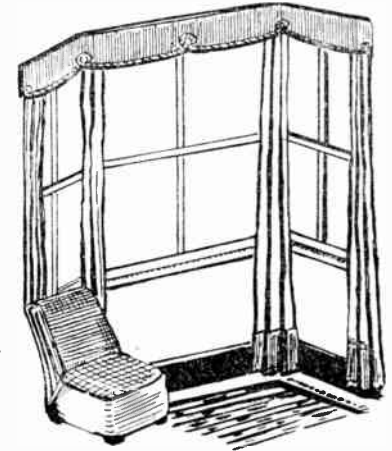

Fig. 2—Treatment for an old-fashioned bay window

high and the wall narrow, so the obvious and best idea is to limit the shelves to one long one and three short ones. Note that the cupboard comes near to the door and thus splits up the solid mass which would be made if the cupboard was built right in on the fire-place. On the other hand, if you made two cupboards, this would make the space look too solid.

The cupboard should be raised 3ins. off ground level as shown, and the shelves are made with 1in. floorboard. If the fitment is built in property not belonging to you, then the best plan is to fit it up with boards forced into position against the wall and the fire-place. Just a light tack will hold these sections in position.

Well made, the fitment should look very effective. One could line the top shelf with cut pastel-shaded plastic. This is effective and prevents grease marks from getting on the woodwork. It is rather expensive, but will always do for another job should you move. Fit the cupboard with a modern stream-line handle of about 4ins. in length. (255)

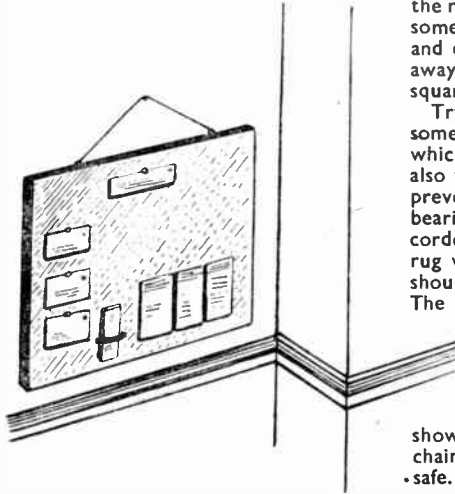

Fig. 1—The notice board in position

more annoying than running out of something at the critical moment.

Home Notice-Board

If you have a house full of youngsters, you will know that the family noticeboard can be an asset, especially when the holidays come along and all members (young and old) are in and out at odd times. All you require is a board about 18ins. by 24ins. to hang in the hall or lobby. Line the board with green baize. You can then put notices and messages on it, and also provide a space for letters for the different members of the family.

You might also have a neat little pocket in which to keep bus, tram and train time-tables. This will save the usual scramble when these books are required.

Shown in sketch 2 is one of those rather old-fashioned types of bay window which take so much dressing. The front window is square and rather

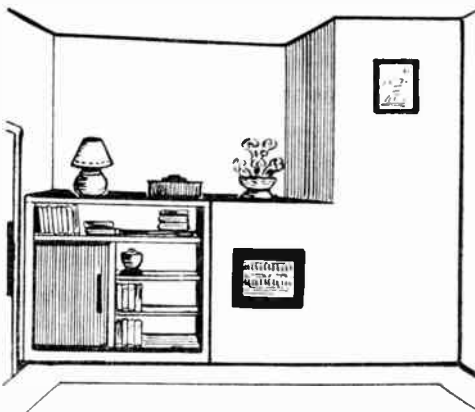

Fig. 3—Built-in fitment for books

and the style of the legs does not much matter as these are more or less removed in the new plan.

In planning improvements in rooms,

Extending Bookstand—(Continued from page 123)

the corners of an assembled article. The finish is again dependent on your taste, but you cannot do better than consult a handbook on wood-finishing which will contain information outside the scope of this article. You can, however, obtain a pleasant soft finish by

staining the wood and polishing it with white wax polish.

Care with the Joints

All the joints should be glued and pinned from the back, in the case of the rail, and the bottom in that of the shelf.

Leave the bookstand to dry for a day or two and check it occasionally to make sure that the joints are square. A small strip of felt glued to the underside of each of the ends and the supporting fillet will add the finishing touch to a very versatile bookstand. (277)

MISCELLANEOUS ADVERTISEMENTS

The advertisements are inserted at the rate of 4d. per word prepaid. Name and address are counted, but initials or groups, such as E.P.5. or £1/11/6 are accepted as one word. Postal Order and Stamps must accompany the order and advertisements will be inserted in the earliest issue. Announcements of freework goods or those shown in Hobbies Handbook are not accepted. The charge for use of a Box No. is 1/- extra. Orders can be sent either to Hobbies Weekly, Advert. Dept., Dereham, Norfolk, or Temple House, Tallis St., London, E.C.4

SPECIAL. 1/- brings details—photo of 17ins. x 12ins. model fort.—Kildare, Aylesford, Kent.

CASH in on new plastics industries. S.A.E. for details of moulding course, including formulae.—W.H.M.Fyfe, 15 Derwent Ave., Dundee.

SPARE-TIME employment, clerical assembly, stampmaking, etc. 100 firms.—'Spare-Timer' (1/-), 43 Douglas Avenue, Heanor, Derbyshire.

EARN money by home craftwork. S.A.E.—D2, Biltex, Chiswick.

INTRODUCTIONS. Pen friends, companionship for marriage.—V.C.C., 34 Honeywell Road, London, S.W.11.

TABLE model kaleidoscope. Make this new, interesting model at negligible cost. Really profitable hobby. Detailed illustrated instructions. 1/6 P.O. to—Model Publications, 10 Audries, Kirby Road, Walton-on-Naze.

100 DIFFERENT Empire stamps including Great Britain, 2/6, 5/- and 10/-. Post free 2/6.—Bisson, 46 Sumatra Road, London, N.W.6.

MAKE 'Oscar Elephant'. No mechanism—but he walks! Made from odd wood. Easy. Profitable. Full-size patterns and instructions, 3/6.—Dept. H.W., 6 Cedar House, Erlanger Road, London, S.E.14.

STAMPS. 25—1d.; 100—4d. S.A.E. approval books, free gifts.—Pavely, 12 Leeder Close, Coventry.

PERSONS are wanted for spare time work, making up fancy goods at home. Experience unnecessary. Write for details.—Dept. 918 Universal Products, 5 Cornhill, Lincoln.

40 DIFFERENT stamps free, including Silver Wedding, U.P.U., Victory, Silver Jubilee, Coronation, Pakistan, etc. Send 3d. postage and request approvals.—J. F. Smith, 39 Manor Park, London, S.E.13.

RADIO. We stock a wide range of components and valves. Our 1951 Catalogue sent free upon request.—M. Watts & Co., 8 Baker Street, Weybridge, Surrey.

STAMPS. Triangulars, airmails, pictorials, 5 value over 2/- free. Send 3d. requesting approvals.—Johnson, 7 Old Mill Lane, Forest Town, Mansfield.

WANTED. Bound volumes or loose copies, 'Magnet', 'Gem', 'Union Jack', 'Boys', 'Friend Libraries', 'Schoolboys' Own Libraries', 'Sexton Blakes', 'Nelson Lees', 'Chuckles', 'Jester', etc.—W. C. Martin, 93 Hillside, London, N.W.10.

STAMPS FREE!! Twenty unused (2½d.).—S.G. H. Barnett, Limington, Somerset.

MODELS. You can make lasting stone-hard models with Sankey's Pyrama Plastic Cement. Supplied in tins by Ironmongers, Hardwaremen and Builders' Merchants. Check for instruction leaflet.

DUPLEX self-adhesive Transfers for decorating fancy goods, trays, plastics, etc. List and samples, 3d.—H. Axon Harrison, Jersey.

DOLL'S House fittings and papers; send S.A.E. for list. Doll's house plan special; send 2/6. Trade supplied.—Zimplan, 88 Ware Road, Hoddesdon.

LORRY Kits, 4 mm. and 7 mm. scale. Also large range of spare parts from which to build to your own design. Send for fully illustrated catalogue, price 1/-.—Wilson's Lorries Ltd., 6 Gt. Winchester Street, London, E.C.2.

PLYWOOD offcuts. Birch and Gabbon in various thicknesses. Handy sized parcels for the cabinet, toy model maker, and all handicrafts. Parcels made up in £1 and 10/- lots. Carriage paid. Send P.O. to—Reeves, Plywood and Timber Merchant, 33 Front Street, Monk-seaton, Whitley Bay, Tel. W.B. 4677. Parcels are now despatched on day of receiving order.

LUSHING, shyness, nerves, self-consciousness, fears, ended. Details under plain cover, 1d.—Stebbing Treatment, 28 (HB) Dean Road, London, N.W.2.

BE TALLER in 14 days or money back. Details, 1d.—Stebbing System, 28 (HB) Dean Road, London, N.W.2.

£5 to £20 weekly earned at home, running your own Mail Order business. Details, 1d.—Stebbing Publications Ltd. (HB), Naphill, High Wycombe.

3/- PER MOULD. One price only in catalogue. For Toy Soldiers, Sailors, Airmen, Ships, Planes, Farmyard and Zoo Animals, etc. Illustrated Catalogue, 6d. each. Full list free.—Robin Hood Moulds, 140 Hollings Road, Bradford.

AMERICAN Magazines post free for one year. A Popular Mechanics, 32/-; Popular Science, 28/6; Mechanix Illustrated, 22/6; Popular Homecraft, 18/-. Stamp for full list of others.—Willen Ltd. (Dept. 57), 101 Fleet Street, London, E.C.4.

PLYWOOD Birch. Grade III. 30" x 6½" x ½", 24 for 15/-. Sanded Lagos Mahogany, 13" x 8" x ½", 18 for 12/-. 36 for 20/-. Solid Brownish Mahogany, 1½" x 1½", P.A.R., 24" long, 8 for 15/6; 36" long, 5 for 15/6. Immediate delivery. C.O.D. List, 1d. S.A.E.—Dept. H.J.D.D. Storage, East Dulwich, S.E.22.

MADE big money so can you. Enclose envelope.—H. Wamsteker, Box 34, Wynberg, Cape, Africa.

PLYWOOD Offcut Parcels. Nothing under 12" x 12" x ½". 15 sq. ft. parcels, 7/6, post paid. Immediate despatch.—Breezecraft Limited, 113 High Street, Staines. 3461/2.

EARN £5 to £20 weekly running your own Mail Order business. Details, 1d.—Stebbing Publications Ltd., Naphill, High Wycombe.

USE Spare time on profitable homework making fancy goods. Write for free booklet.—(Area 544), 54 Southgate Street, Leicester.

HOME Watch and Clock Repair Outfit. Includes watchmaker's magnifying eyeglass, tweezers, screwdrivers, oilers, oil, brush, dusting powder, plus illustrated explanatory book. Watch and clock repairing simplified. In container, 12/9 inclusive.—D. Bolster (Dept. H.) 5a Station Parade, Ashford, Middx.

LONELY? Then write Secretary U.C.C., 15B.B. Hay St., Braughing, Herts. Genuine. Est. 1905.

HOME WORKERS required, either sex, light assembly, part or full time. S.A.E.—Esprey, Box 1A 41 Wade Street, Lichfield.

LUMINOUS Paint, 2/- per tin.—Box No. 44, Hobbies Weekly, Dereham, Norfolk.

HAVE you got your Juneero Riveting jig yet? From all Hobby shops or post free from—Juneero Ltd., Stirling Corner, Boreham Wood, Herts.

STAMPS Free. Empire Packet including Pictorials and Victorians free to approval applicants.—Robert J. Peck, 7A Kemp Road, Bournemouth, Hants.

MODEL Makers and Handymen. Bumper set of lists, books, plans and samples, 2/6.—Sutton Models, Billericay.

PERSONS willing to devote few hours per week to clean interesting work. Excellent pay.—Dept. 11, Chas & Co., Albert Street, Loughborough.

EARN Money French Polishing. Complete course, other wood finishes. Formula for manufacturing polishes and stains for only 5/- post free from—BCM/MERCIA, London, W.C.1.

INTERESTING Work available for all in spare time; experience unnecessary. Send S.A.E. for details to—Leathaweave Co. (Dist. 37), 2 Tudor Road, Leicester.

BRUSH on New-Een Composition and renew Band recolour your old leather three piece suite for 12/6. Also for car seating, etc. In Red, Green, Blue, Maroon leather shades, 12/6 pint or trial tin 3/6 post free.—New-Een (5), 101 Kings Cross Road, London, W.C.1.

WHEELS for Toys, etc., in Hardwood, Plastic and Rubber Tyred Metal. Doll's House fittings and papers. Doll's Cot and Pram fittings. Decorative Transfers. Beads for Counting Frames and other Toy accessories. Fine Art Pictures for Jig-Saws, etc. Stamp for lists. Trade supplied.—Joyden Toy Co., 193 Chase Side, London, N.14.

100,000 Government Surplus Bargains. Aluminium rivets, handy boxes, approx. 1lb. assorted, 2/6, post 6d. Transformers, 230/12v. 10 amp., 25/-, post 1/6. Generators, 12v. 500 watt., brand new, 21/-, carriage 4/-. 70 ohm variable resistances, 9d., post 3d. Toggle switches, 20 amp., 9d., post 3d. Strong elastic cord, multi-core, ¾" dia., 10yds., 3/6, post 9d. Hundreds of other bargains. Send 3d. stamp for new catalogue of motors, drills, grinders, switches, lamps, batteries, etc. Money back guarantee.—Milligan's, 24 Harford Street, Liverpool, 3.

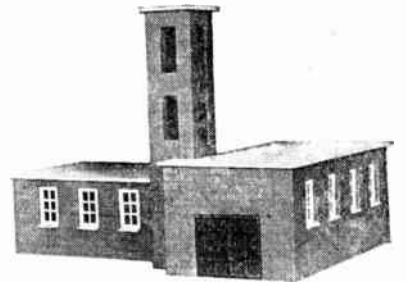

YOU can build this Fire Station WITH BRICKPLAYER

BRICK & MORTAR BUILDING KIT

It enables you to build Houses, Garages, Railway Stations, Signal Boxes, or from your own imagination. All railway models will fit 'O' gauge scale. Buildings can be permanent, or dismantled by merely soaking in water and the bricks used again and again.

BRICKPLAYER KITS AT 28/6, AND 52/6 ARE AVAILABLE FROM GOOD TOYSHOPS, HOBBY SHOPS, AND DEPARTMENTAL STORES.

ACCESSORY PACKS		Price
No.	Contents	
100	100 Full size Bricks ...	3/-
101	52 ½-Bricks and 72 ¾-Bricks ...	3/-
102	Gable and Peak Bricks ...	3/-
111	Capping and Roof Tiling ...	2/6
112	Concrete Roofing ...	2/6
114	Bag of Brickplayer Cement ...	1/3
115	Roofing Cement ...	9d.
8107	2 Bay Windows with 31 Splay Bricks	3/9

METAL WINDOW AND DOOR FRAMES						
F1	F2	F3	F4	F6	F8	F10
8½d.	6½d.	7½d.	5d.	4d.	6d.	7½d.
8108 Sheets of Glazing, 1½" x 6" (Plastic) 1½d.						

If your dealer cannot supply, write for address of nearest stockist to:
J. W. SPEAR & SONS LTD.
 (Dept. H) ENFIELD MIDDLESEX

FOR FACES & PLACES



ILFORD
SELOCHROME
FILM



PUPPETS

Kits of parts to make two Fully Jointed 12 inch puppets with controls.



15/6 post free

Send stamped addressed envelope for illustrated list of complete puppets and books



PEDAL MOTOR CAR

Any amateur can make this strong smart modern pedal car for children 2 to 5. Plan and instructions with list of available metal parts

2/6 post free

ZIMPLAN

88 WARE ROAD
HODDESDON, HERTS

YOU CAN BECOME A HANDICRAFTS INSTRUCTOR

EXPERIENCE NOT ESSENTIAL

Men who enjoy making things in wood or metal can turn their hobby into a permanent and interesting Career. Short hours, long holidays, and security in a job you would really enjoy, can be yours if you become a Handicrafts instructor. Let us send details of the easiest and quickest way to get the necessary qualification.

We definitely guarantee
"NO PASS—NO FEE"

If you would like to know about our unique method of preparing you for one of these appointments, write today, and we will send you our informative 176 page Handbook—free and without obligation. Mark your letters "Handicrafts Instructor".

**BRITISH INSTITUTE OF
ENGINEERING TECHNOLOGY**

BIET

595 Shakespeare House
Stratford Place, London, W.1

**EVERY CAR THAT PASSES
YOU WILL FIND THE INDEX MARK
ALPHABETICALLY ARRANGED IN
WHERE'S THAT CAR FROM ?**

Price 6d.

from all Booksellers or from the Publishers (1d. postage)

RALEIGH PRESS, EXMOUTH



BRANCHES

LONDON

78a New Oxford St., W.C.1
(Phone MUSEum 2975)
87 Old Broad Street, E.C.2
(LONDON Wall 4375)
117 Walworth Road, S.E.17

GLASGOW

326 Argyle Street
(Phone CENTral 5042)

Head Office & Factories—HOBBIES LTD., DEREHAM, NORFOLK

MANCHESTER

10 Piccadilly
(Phone CENTral 1787)

BIRMINGHAM

14 Bull Ring

SHEFFIELD

4 St. Paul's Parade

LEEDS

10 Queen Victoria Street
(Phone 28639)

HULL

10 Paragon Square

SOUTHAMPTON

25 Bernard Street

BRISTOL

30 Narrow Wine Street
(Phone 23744)

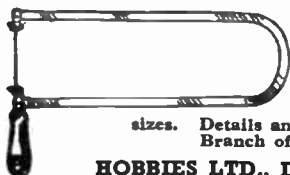

FRETWORK HANDFRAMES

—for the fretworker, model maker and handyman. Made by Hobbies. In various

sizes. Details and prices on application at any Branch of Hobbies Ltd. or

HOBBIES LTD., DEREHAM, NORFOLK

See page 115

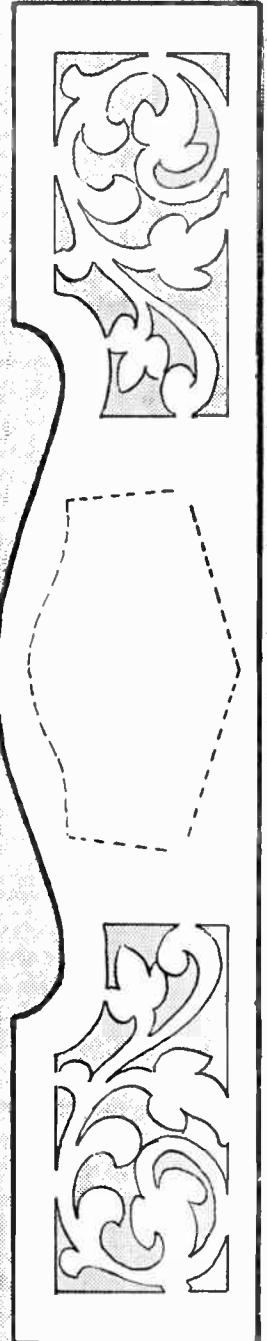
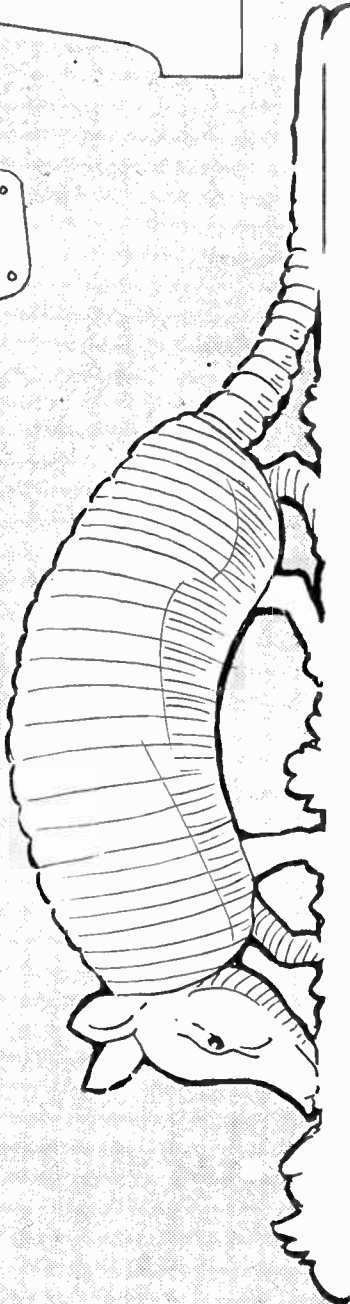
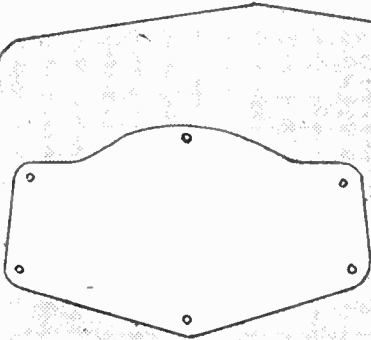
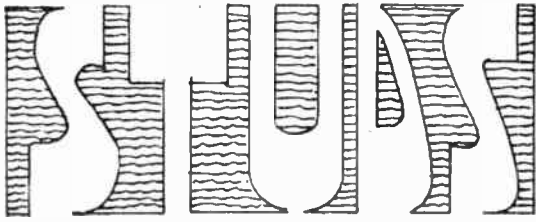

STUDY
AT
HOME

IN YOUR
SPARE
TIME

THE BENNETT COLLEGE

*will set you on the right
course for success*

You make sure of planned progress in the career of your choice when you let the most progressive, most successful Correspondence College in the world coach you through the post. By friendly, individual training we equip you with the specialized knowledge you must have for a well-paid key position.
Make the first move TODAY—post the coupon below!

**ALL TEXT BOOKS ARE
FREE!**

to Students of The Bennett College Ltd., we send as many volumes as the subject demands and they become your personal property.



IS YOUR CAREER HERE? IF NOT, WRITE FOR FREE ADVICE

Accountancy Exams.
Agriculture
Applied Mechanics
Auctioneers and
Estate Agents
Aviation (Engineering and Wireless)
Blue Prints
Boilers
Book-keeping. Accountancy, and Modern Business Methods
Builders' Quantities
Building, Architecture, and Clerk of Works (A.R.I.B.A. Exams.)
Carpentry and Joinery
Chemistry
Civil Engineering
Civil Service
All Commercial Subjects
Commercial Art
Common Prelim. E.J.E.B.
Concrete and Structural Engineering
Diesel Engines
Draughtsmanship. Electrical or Mechanical

Engineering. All branches. Subjects and Exams.
General Certificate of Education Examinations
General Education
G.P.O. Eng. Dept.
Heating and Ventilating
Institute of Municipal Engineers
Journalism
Languages
Mathematics
Metallurgy
Mining. All Subjects
Mining. Electrical Engineering
Motor Engineering
Naval Architecture
Plastics
Play Writing
Plumbing
Police, Special Course
Preceptors, College of
Press Tool Work
Pumps and Pumping Machinery
Quantity Surveying—Inst. of Quantity Surveyors Exams.

Radio Service Engineering (Short Wave)
Road Making and Maintenance
Salesmanship
Sanitation
School Attendance Officer
Secretarial Exams.
Sheet Metal Work
Shipbuilding
Shorthand (Patman's)
Short Story Writing
Speaking in Public
Structural Engineering
Surveying (R.I.C.S. Exams.)
Teachers of Handicrafts
Telecommunications (City and Guilds)
Television
Transport Inst. Examinations
Viewers, Gaugers Inspectors
Weights and Measures Inspectors
Wireless Telegraphy and Telephony
Works Managers

COUPON. CUT THIS OUT

IF YOU ATTEND TO THIS NOW
IT MAY MAKE A WONDERFUL
DIFFERENCE TO YOUR FUTURE.



To DEPT. 62
THE BENNETT COLLEGE LTD.
SHEFFIELD

Please send me (free of charge)

Particulars of..... (Cross out line which does not apply.)
Your private advice

about
PLEASE WRITE IN BLOCK LETTERS

Name

Address

.....State Age if under 21.....

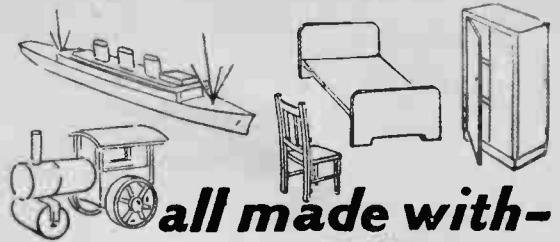

all made with-



Croid

THE MODERN GLUE

Aero Glue. The strongest glue in the world.

Universal Glue. Cold glue ready for use from tube or tin.

Waterproof Cement. Specially prepared for balsa wood.

Whyte Paste. For paper work and photo-mounting, etc.

CROID LTD., IMPERIAL HOUSE, KINGSWAY, LONDON, W.C.2

EXTRA CASH IN SPARE TIME

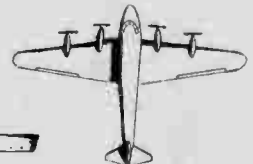
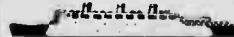

MASTERCRAFT MOULDS

69, ST. MARKS ROAD, HANWELL, LONDON, W.7

Hobbies

WEEKLY

CONTENTS

	Page
'Galloping Dobbin'	- 129
Back-of-Door Wardrobe	131
A Seaside Raft	- - 132
Experiments with Magnets	- 133
Hints for Handymen	- 134
Garden Dining Set	- 135
'Percy Penguin'	- - 136
Winding Transformers	137
A Practice Dartboard	138
Simple Electrical Work	139
Attractive Candelabrum	140
Home Chemistry	- - 141
DESIGN SHEET FOR POST CARD PHOTO FRAME	

June 13th, 1951

Price Fourpence

Vol. 112 No. 2902

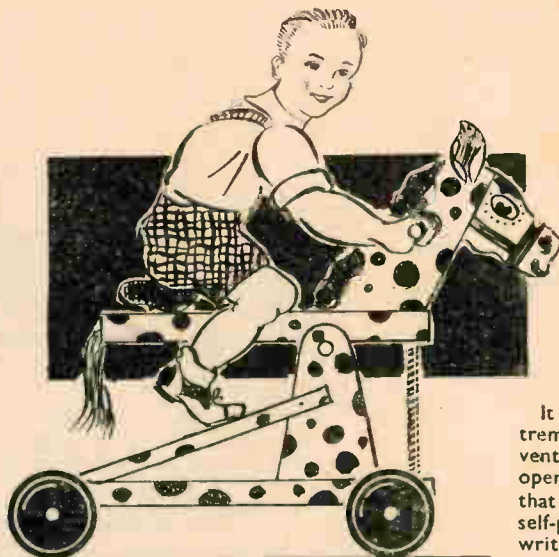

Any youngster would love 'GALLOPING DOBBIN'

HERE is a very attractive toy that will give unending delight to a young child, and which can be made mainly of scrap wood at very little cost. As can be seen from the illustration which heads this article, the toy incorporates, among other things, the best features of the good old rocking horse and the see-saw.

'One-Man See-saw'

It is, in fact, a kind of one-man (or one-child) see-saw, consisting of a pivoted beam in the form of a horse (the spots in the drawing indicate a dappled grey horse), with a seat at one end of the beam and a fairly strong spring at the other.

The young rider sits on the saddle, places his feet on the sleeping footrest and grasps a handle at the head. Then, bouncing himself up and down he can, in imagination, gallop away over hill and dale. The wheels are optional. They are not operated by the rider. They enable

the toy to be moved from one place to another more easily.

It would not take a tremendous amount of inventive skill to have wheels operated by the rider, so that the whole thing is self-propelled, but the writer advises against this as a general principle, as it cannot be too strongly urged that this is a toy for very young children. For this latter reason, and also on account of the fact that scrap wood is used, it is not possible to give definite dimensions though some are suggested. The whole job is to be 'tailored' to suit the young rider, and he or she must be measured. Before committing oneself to permanent joints, etc., test the whole

thing by making a temporary assembly, seating the child on it and making adjustments if necessary.

As can be seen from Fig. 1, the model consists of the head unit (A) which is further detailed in Figs. 2, 3, 6, 7 and 8. Through this goes a handle (B). The main beam consists of two battens (C) with an end spacer (D). The beam is supported by two uprights (E) mounted on a thick sub-base (F) which in turn is mounted on the wide main base (G). The pivot is shown at (L). Battens (J) take the wheels if used. If no wheels, these battens are still necessary to maintain stability. On two sloping battens (H) a footboard (K), further shown in Fig. 4, is placed.

Dimensions

As regards dimensions, it will greatly help if the child has a miniature tricycle from which dimensions can be taken. As a very rough guide (it is quite impossible to give dimensions that will suit every child, and the whole purpose of taking this model is to provide a 'custom built' toy, not a shop mass-produced one) the upright (E) can be 9ins. tall and 6ins. wide at the base. The beam pieces (C) can be about 1ft. 8ins. long and 2ins. wide. Note that they are not pivoted centrally. The main base (G) can be about 2ft. long and as wide as possible to prevent any possibility of overturning. This, of course, is provided for in the battens (J), which can be

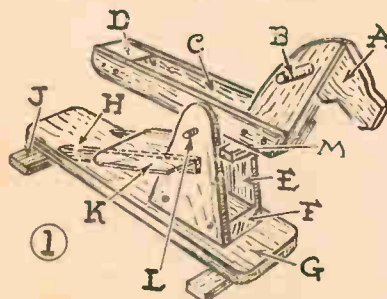

Perspective drawing showing method of construction

All correspondence should be addressed to The Editor, Hobbies Weekly, Dereham, Norfolk.

as long as required. From the top surface of the base (G) to the top of the beam (C) will be about 10ins., and from here to the top of the saddle will be about another 2ins. These dimensions apply to a *small* model.

The saddle can be adjustable up or down and back and forth, whilst the sloping footrest has been deliberately designed so that the young rider can place his feet where most convenient. The total height from ground (i.e. floor level, etc.) to saddle top will be about 1ft. 4½ins. Do not make the model too tall, partly because the youngster has to mount it and—one never knows with children—he may fall off.

The Head

Work on the horse's head is started by taking a 12ins. by 4½ins. by 1½ins. piece of wood (the dimensions are approximate only and can be made to fit in with oddments of scrap wood you may have) and shaping as shown, making, in addition, a slot as though for a bridle joint. Into this goes the piece detailed in Fig. 2. The end (X) is left as long as possible and trimmed off afterwards as shown in Fig. 7. The head and neck are screwed together, but first allow for a metal or wooden handle (B) to pass through.

The neck is 'sandwiched' between the battens (C) and screwed firmly.

From the front of the beam to the pivot (L) is about 6ins. It is possible to bore a hole through the centre line of parts (C) to take a long bolt to act as pivot (L). A stronger pivot, however, could be obtained by fixing a pair of pipe clips (Fig. 5) under the battens (C). In this way the batten is not weakened by the drilled hole. If using a pipe clip, however, take care not to use a flimsy one, as there is considerable strain on this joint.

Part (D) is 1½ins. wide. As regards the saddle, it may be possible to obtain, either new, or from 'junk' sources, a very small cycle saddle. Otherwise a hassock-like seat can easily be arranged.

Plywood ½in. thick would be excellent for parts (E). Plywood ¾in. thick would be enough for part (K). Battens (H) are screwed to the base and on to parts (E).

Important Part

Now comes the important part—the provision of a spring. One should be looking around for a suitable spring coincidentally with making this model. It will be roughly 6ins. long and the

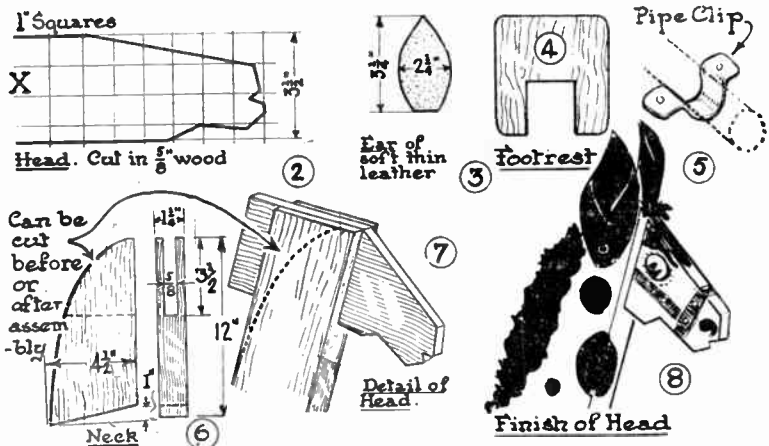

More drawings to help the constructor

tension should be such that it should easily support the weight of the child when sitting still, and should 'give' slightly but not too lively when the child starts 'bouncing'. Good-class ironmongers and tool shops usually have a selection of springs. It may be necessary to use two or three lighter springs instead of one strong one (this certainly allows for adjustment of tension, though it does not make for so neat a job). As a makeshift one can use the type of rubber strands used in certain types of exercisers. The writer of this article feels sure, however, that his readers have the ingenuity and enterprise to overcome any difficulty connected with the spring. On the spring, of course, the whole working of the toy depends.

Safety Measures

At (M) is seen an optional bar or dowel of wood so placed that if the head of the horse is tipped too far forward (one never knows what children will do!) the bar hits the fore edge of (E) and the descent of the beam (C) is checked. At the same time, take care that this is not likely to crush a young hand placed there. Perhaps a safer method would be to fix a strong cord or strap from the underside of part (D) to the base (G) below, having 1in. or 2ins. of slack.

The spring must be very strongly secured, as, if it gives way, the seat will fall with a sudden jolt. As a safety-first measure a rubber pad (possibly made of three or four old rubber heels) may be fastened below (D) to take the bump should this occur—which is extremely

unlikely. Another method is to fix a strap or cord slackly *inside* the spring.

The writer must admit that he has been, if anything, too apprehensive about the possibilities of anything breaking. He will equally quickly admit that, especially where young children are concerned (and the really older children must be 'warned off') it would be extremely unlikely that they would have the strength to break such a robust toy. But for the sake of, say, an extra half-hour's work, 100 per cent perfect safety can be guaranteed, and that, surely, is a very small extra 'premium' to pay.

The spring at the front might well be encased in a canvas 'sleeve'.

Finishing

All sharp edges are rounded off and the toy given a priming coat (white lead or aluminium paint). This, when dry, is papered down lightly, and the toy given at least two coats of light grey—possibly ready made grey, or white with a very little red and blue added. When these coats are dry, the eye is painted on, together with the spots (in dark grey. Avoid black in children's toys if possible).

Straps are fixed to the head as shown in Fig. 8, using large brass-headed nails from the upholsterers stores. The ears are of leather (Fig. 3) nailed on. The mane is an odd strip of fur glued on (failing fur, it can just be painted on). The tail is a frayed-out piece of rope.

Then comes the great moment when Dobbin is ready to ride! (312)

Back-of-Door Wardrobe—(Continued from page 131)

wanted for frocks, a shelf or two could be fitted inside the upper compartment if needed. The lower cupboard already has a shelf, and is just right for shoes.

There are several ways of fixing the wardrobe to the back of the door. A length of ½in. square wood can be glued and tacked all round the inside of the framework at the back and screwed to the door with 1½ins. screws through this.

Brass glass plates form another method of fixing, two being used at the top, two more at the bottom and another two about half-way down for screwing to the centre bar of the door. The top and bottom ones can be fitted to the outside, but the centre pair should face inside so as not to show.

Steel angle brackets may be used in a like manner and fixed in the same places as the glass plates. The sizes and positions

of the door panels and bars will determine whether the top and bottom ones may be fitted inside or outside.

Well glasspaper all the woodwork, and if it is decided to make it match the existing paint of the room, give an undercoat followed by two coats of good oil paint, allowing plenty of time in between for the paint to set hard. As an alternative finish, the wardrobe may be stained and then varnished. (292)

To save space, make a BACK-OF-DOOR WARDROBE

WHERE to put one's clothes is always a problem, especially in a small house. The bedroom may not be large enough for the more usual wardrobe, or such an article may be too expensive these days.

A hook or two on the back of the door partly solves the problem, but it is an untidy method as well as allowing the clothes to get very dusty.

The Ideal Place

The back of the door, however, is an ideal place to fix a small wardrobe. It takes up very little room and does not interfere with the opening and closing of the door.

It was originally designed for the bedroom of a schoolboy, but was later amended so as to be suitable for any

total weight can be kept to a minimum.

The wardrobe is made to fit an average size door, which measures 2ft. 6ins. across and 6ft. 6ins. high. Should the door happen to be an outside, or even quite small, the measurements can be modified to suit.

Cut two side pieces 5ft. 6ins. long, 5ins. wide and $\frac{1}{2}$ in. thick, and also four pieces 21ins. long, 5ins. wide and $\frac{1}{2}$ in. thick. Two of these and the two sides are glued and nailed together to form the framework. The other two short pieces are fastened near the base to form the bottom of the upper compartment and the shelf in the lower one. The distance between each of these is 5ins., as shown in Fig. 2.

Two bars 22ins. long, 3ins. wide and $\frac{1}{2}$ in. thick are fixed on to the front of the upper compartment, one right at the top and the other 11ins. up from the base. The two long doors fit in between these two bars, while the door at the base is hinged to the bottom bar.

Doors of Ply

All the doors are made up of thin ply with an edging of stripwood to give them a finish and to strengthen them. For the long doors, cut two pieces of ply 4ft. 1in. long, 11ins. wide and about $\frac{3}{8}$ in. thick. The bottom door is 22ins. long, 11ins. wide and the same thickness.

The stripwood edging is $1\frac{1}{2}$ ins. wide with a thickness of between $\frac{1}{4}$ in. and $\frac{3}{8}$ in., so as to equal the thickness of top and bottom bars. Halved joints would be best and stronger for the corners, although

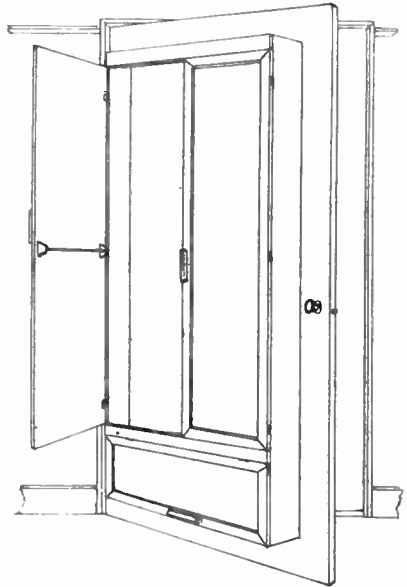

through the supports, and these are fastened with $\frac{3}{8}$ in. countersunk screws from the outside of the door, using two for each.

Now you can glue the strips round the doors, and also tack them on from the inside with fine panel pins. When making the doors it is a good plan to cut the ply a shade too large, and, when all is glued up and set, to lightly plane the edges to fit.

All the doors are fitted with plain wood handles cut to the shape shown in Fig. 4. They are all the same size and

5ins. is a good length to make them. Two $1\frac{1}{2}$ ins. screws fitted from the inside of the doors will be sufficient for each handle.

The Hinges

Brass hinges $1\frac{1}{2}$ ins. long are required for all the doors, two being enough for the bottom door, but it would be better to use three on each of the long doors.

To keep the two long doors closed, small spring ball catches are fitted to top and bottom of each. The bottom door should not need a catch, as its own weight will be sufficient to keep it shut.

It would be an advantage to tack a 1in. wide strip of thin wood on the inside of the top and bottom bars of the upper compartment to keep the doors from being pushed in too far. These door stops can project about $\frac{1}{4}$ in.

One or more cup hooks are screwed into the top of the wardrobe to take coat hangers, and, if wanted, other coat hooks can be screwed on to the back of the wardrobe, which, of course, is the room door. If the full length is not

(Continued foot of page 130)

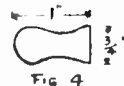
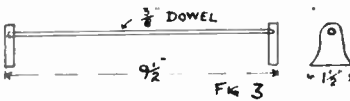
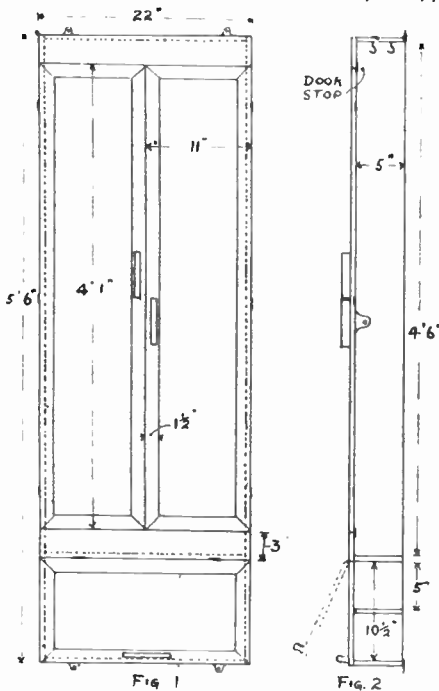

member of the household. Extra length is given to the upper portion to enable a lady's frock to hang full length, but it is quite easy to alter the internal fittings to suit individual requirements.

The wardrobe has been designed so as to be economical with the wood required, and the construction will not present any difficulty.

Owing to its position, it would look best painted to match the door and other woodwork of the bedroom. For this reason, plywood has been used for the door panels, and a light softwood could be used for the general framework.

No back will be necessary, as the wardrobe can be built up on to the door, and by using a light wood and ply, the

they may be mitred if desired. In either case the lengths will be, four pieces 4ft. 1in. and four of 11ins. for the long doors and two pieces 22ins. and two of 11ins. for the bottom door.

Before fixing the edging to the long doors, the inside rails should be made and fitted. The fixing screws will then be covered up by the edging slips on the doors. One rail is fixed to each door, but more can be used if wanted. They are very useful for hanging up ties, socks or stockings as the case may be, and probably many other uses will occur to the user.

Fig. 3 shows the shape and sizes of the rail and end supports. The $\frac{3}{8}$ in. hole for the dowel rod is drilled only half-way

Just the thing for the holidays— A SEASIDE RAFT

MANY of us have seen rafts at the seaside, some of very rough construction, indeed. However roughly made, a lot of fun can be got out of them and one is well worth the making.

The particular raft described here is portable, so that it can be conveyed from place to place during the season and stored at home when not in use. A coat of paint every season and it should last for years. The raft depends upon car inner tubes for its buoyancy—a great advantage, as the tubes can be deflated when not in use and packed in a small space. The back rest is hinged, and, when let down, forms (with the side pieces) a box-like container into which the tubes can be packed.

A glance at the illustrations will show how simple the whole affair is. It can be made cheaply, too, as no great amount of wood is required.

Timber to Use

For the timber, red deal can be used, and should be reasonably free from knots. Fig. 1 is a plan view, and shows

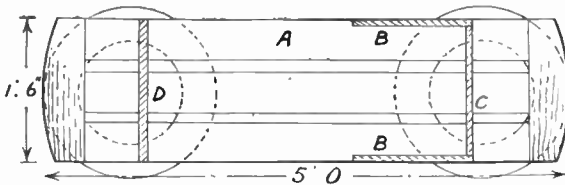

Fig. 1—Plan showing main dimensions

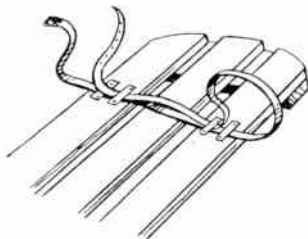

Fig. 3—How the straps are arranged

the position of the inner tubes underneath. Fig. 2 is a side view.

Prepare the end battens (A), and screw the floor boards to them with brass screws from underneath. Countersink all the screws, and make sure to use none but brass, as iron ones will rust eventually.

With the floor boards $4\frac{1}{2}$ ins. or so wide, a space of about 1 in. will be left between them, allowing water to run away.

Side and Foot Rest

The side pieces (B) are nailed to back piece (C), and the whole screwed to the floor boards. The foot rest (D) is now screwed across.

In all probability the distance from the

front shown for this part will be found quite convenient, but as people's length of leg varies such a lot, its position can be altered to suit individual requirements. Round off the ends of the raft as shown.

The back flat board consists of three pieces of board tongued and grooved together and secured at the back with battens screwed across. Paint the tongues and grooves with thick paint before knocking the boards together. The back rest can now be hinged to (C) with brass hinges.

To keep the back rest at a convenient and restful angle a pair of brass stays can be used as shown in detail Fig. 2, and in the sketch.

Alternative

There is scope for alternative treatment here, especially if the person using the raft is rather broad in build.

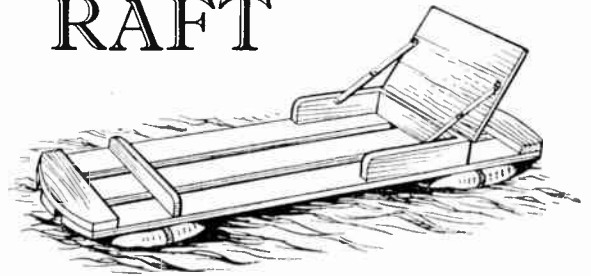

which the strap passes. One end then goes round the tube, then under the leather straps again, and is passed around the tube once more on the opposite side and there fastened. Partially inflate the tubes before fixing the straps. When finally fixed, inflate the tubes fully.

Rub off all sharp edges of the raft with coarse glasspaper and finish the whole surface with a thorough scouring of medium glasspaper until smooth and free from splinters and roughness. Give the wood a coat of priming colour to fill the grain, and then two coats of best lead paint. Some bright colours would be appropriate.

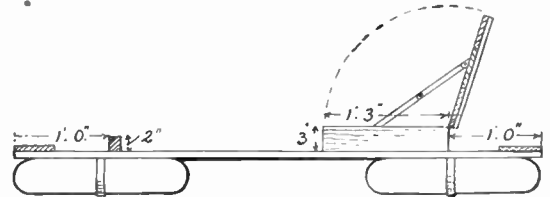

Fig. 2—Side view

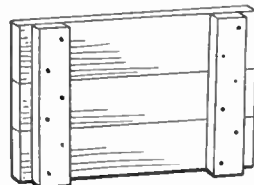

Fig. 4—The backboard

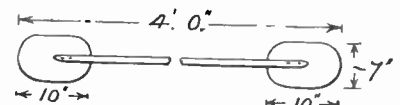

Fig. 5—Useful paddle

In such a case, the sides of the body may tend to rub against the stays during the motion of paddling. To prevent this, strong cords can be used as stays, or stout webbing, perhaps, would suffice.

Almost any garage can supply a pair of second-hand car inner tubes cheaply enough, but see that they are sound, or have them made so before purchasing.

Fixing the Floats

The tubes can be fixed to the underside of the raft with leather or webbing straps. The former will last longer, of course, and the lengthy straps used for securing luggage are the best kind to use.

Fig. 3 shows an underside view of one end of the raft and explains the arrangement of the straps. Four leather strips are screwed at the spots shown, under

Use good quality outdoor paint, not the cheap interior stuff, as salt water plays havoc with the latter.

For easy conveyance, the tubes are deflated, packed between the side pieces of the raft, and the back rest folded down. Pass the straps over all to secure the tubes, and then the raft can be easily carried as an item of ordinary luggage if travelling by train or car.

A light double-bladed paddle will be required. This can be bought, but, for a simple, knock-about craft of this nature, a cheap and simple paddle can easily be made as shown in Fig. 5. The blades are cut from $\frac{3}{4}$ in. thick oak or beech, and the handle from a broomstick.

Shave the edges of the blades, reduce the ends of the broomstick to form flats, and screw the blades to the flats, and then finish with paint or varnish. When packed for travelling, the paddle can be strapped flat to the underside of the raft and will be safe from breakage.

(293)

Here are some interesting EXPERIMENTS WITH MAGNETS

THERE are many stories, probably all untrue, about the first discovery of the black iron oxide which has magnetic powers. This strange stone was found in the Roman province of Magnesia and was given the name 'magnetite'. From this word we get our own word 'magnet'.

Magnets can be made in a variety of shapes but the two most common are the bar magnet and the horse-shoe magnet.

The Poles

Whatever its shape a magnet has two poles, a North Seeking Pole and a South Seeking Pole, briefly called the North Pole and the South Pole.

By means of a paper saddle (Fig. 1) and some thread, suspend a bar magnet and a horse-shoe magnet, some distance apart, so that they swing freely. They will come to rest pointing in a N—S

west of this and must be allowed for by navigators.

Two Laws

Allow the suspended bar magnet to become quite steady and notice which is the North Pole. (This end of the magnet is generally marked with a N or with a line, and will also, of course, be pointing to the north).

Towards this end of the suspended magnet bring the *South Pole* of a second bar magnet held in the hand. Slowly bring them together. Notice how the suspended magnet swings to meet the magnet in your hand. This gives us the first law, which is—unlike poles attract each other.

Now try and bring the North Pole of the magnet in your hand towards the North Pole of the suspended magnet. The latter is continually driven away. Thus we see that like poles repel each other.

To make this pattern permanent, first of all dip the sheet of paper into a tray of molten paraffin wax and then allow it to dry. This will take only a minute or so. Now perform the experiment again until a suitable pattern is obtained. If the flame from a bunsen burner is played lightly over the paper the wax melts, and, on cooling, grips the iron filings, thus making a permanent record of the experiment.

To illustrate the two magnetic laws trace the lines of force of two magnets first with the unlike poles together and secondly with the like poles together.

Magnetic Induction

Magnetic induction is the power of magnetism to enter into iron. Hang a chain of small nails from a magnet as

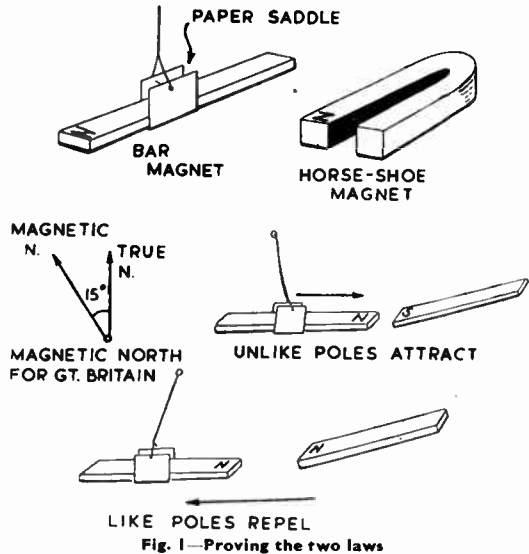

Fig. 1—Proving the two laws

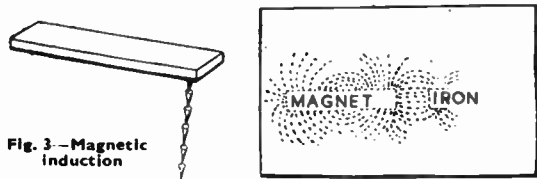

Fig. 4—Making an ordinary piece of iron act like a magnet

direction with the North Pole pointing towards the north.

We must remember here that the magnetic North Pole is not in the same place as the geographical North Pole. True North is shown by the direction of shadows thrown by the sun at mid-day, or by the direction of the Pole Star. Magnetic north as shown by the compass can be a few degrees east or

the paper sprinkle some fine iron filings. These can be bought very cheaply and are best sprinkled from a cocoa tin, in one end of which small holes have been punched.

Hold one end of the sheet of paper on the table to prevent its shifting and tap the sheet lightly with a pencil. This will cause the filings to move into the pattern of the lines of force (Fig. 2).

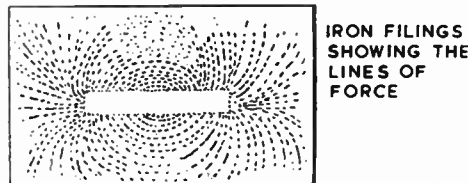
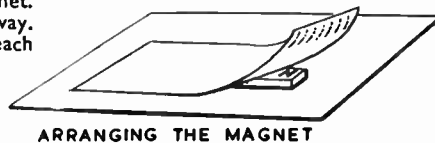

LINES OF FORCE SHOWING THE TWO MAGNETIC LAWS

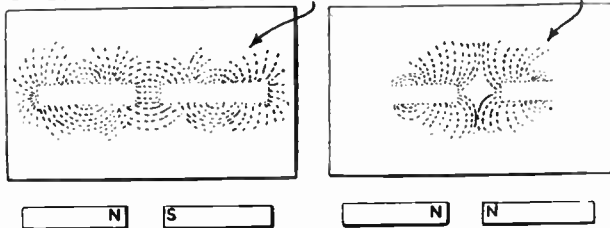

Fig. 2—Experiments to show lines of force

This magnetic influence is caused by invisible lines of force which surround a magnet and make up its magnetic field.

To Show Lines of Force

Cover a bar magnet with a sheet of stiff white paper, and over the paper sprinkle some fine iron filings. These can be bought very cheaply and are best sprinkled from a cocoa tin, in one end of which small holes have been punched.

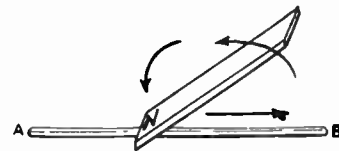

Fig. 5—Magnetizing a knitting needle

shown in Fig. 3. Gently slide the first nail off the magnet. As soon as it leaves the magnet the whole of the chain is broken. The individual nails are magnets only while they are in direct contact with the bar magnet.

The reason for this can be illustrated with the iron filings experiment. First of all try to trace the lines of force of a piece of un-magnetized iron. The filings, of course, will not move into any

(Continued foot of page 134)

'Old Hand' gives us more HINTS FOR HANDYMEN

Is it Square?

THE accompanying photograph shows a by no means uncommon mishap with amateur carpenters. A frame may, apparently, be perfect in every joint yet when cramped up, found if properly viewed, to be in 'winding'. Always keep a look out for this (by bending down and sighting over the ends of the frame. To correct the matter the cramps must be loosened, and the frame twisted by hand to be as flat as possible, even if it means that one or two of the joints open slightly. Take care, too, that the corners are square. This can either be done with a large set square or by measuring over the diagonals, as shown.

Measuring

The measuring is done by making pencil marks on a strip of wood. Circumstances arise, however, where it is necessary to take these diagonal measurements inside a carcase where a long strip cannot be used. This may be done by taking two thin strips of wood with one end of each pointed like a blunt pencil and then after adjusting them (using the fist of the left hand like a tube) clamping together with a small clamp or two. The whole lot can then be turned to test the other diagonal.

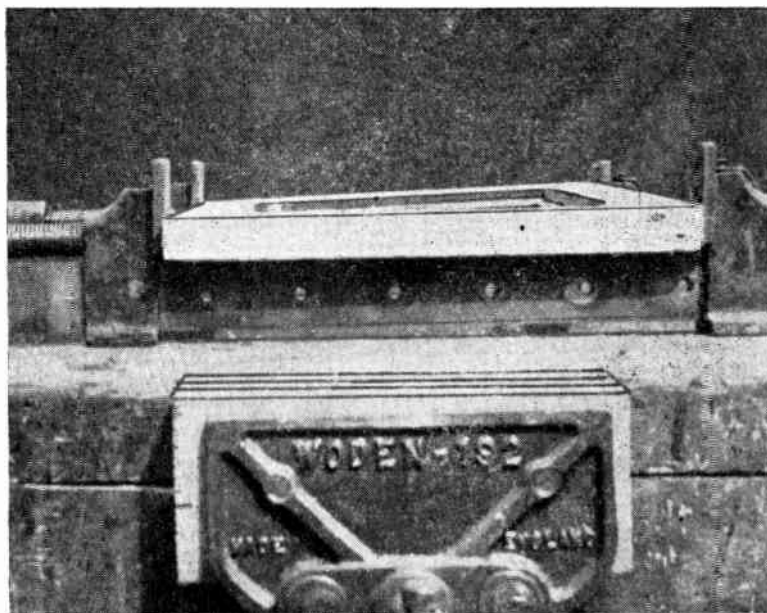

A common case of 'winding'

Novel Wood Finish

EVERY handyman will know the usual wood finishes—paint, enamel, french polish, etc., but here is a novel finish that can be tried in appropriate cases.

JAPANESE 'SUGI'. This is suitable for fairly large areas. Hold the wood over the flame of a gas ring for about five minutes, keeping it moving all the time so that the wood surface is charred though not

actually burnt. Then brush briskly with a stiff wire brush, going in the direction of the grain.

The softer part of the wood will be removed leaving the harder grain standing up in relief, a dark chocolate colour against light. After dusting well and glasspapering, the surface is given a coat of clear varnish, or oil stain applied freely and wiped off with cheesecloth.

Soft Woods not Suitable

Very soft woods are not suitable for this process. Hardwoods may need several charrings and brushings. Fir plywood gives particularly good results. Instead of holding the wood over a gas ring, a blowtorch may be used, particularly if a flame spreader is used. The work to be treated is placed vertically with the grain running up and down. The torch is applied to the top of the board and slowly brought down, the process being repeated.

It is essential to burn and to brush in the same direction, otherwise unpleasant highlights appear.

Before trying this on a piece of valuable work, practise on odd pieces of wood. (222)

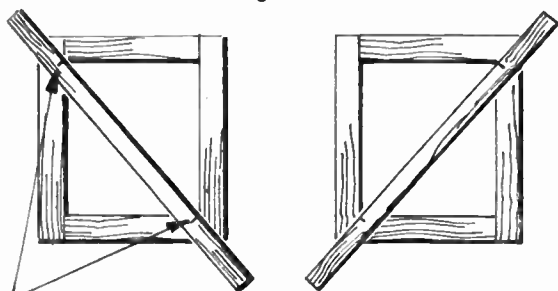

Pencil marks on lath

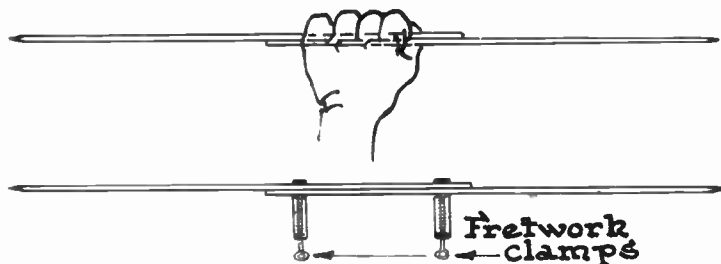

These diagrams make clear the methods described in the text

Experiments with Magnets —(Continued from page 133)

kind of pattern. Now, under the same piece of paper put the same piece of un-magnetized iron and, a little distance from it, a bar magnet (Fig. 4). Repeat the experiment when the lines of force will show that the un-magnetized iron is behaving like a magnet and has a North

and South Pole.

Magnetizing a Knitting Needle

Lay a steel knitting needle (AB in Fig. 5) on a flat surface. Grip end (A) to start with and stroke the needle with the North Pole of a bar magnet. Stroking

means rubbing in one direction only as illustrated in Fig. 5. Give 50 strokes towards end (B) and then 50 strokes towards the South Pole this time towards end (A). The greater the number of strokes, of course, the more strongly will the knitting needle be magnetized. (273)

Have meals outside with a GARDEN DINING SET

When putting on the canvas the chair must be in the 'open' position. A 10ins. wide strip will be found suitable for the back, and all canvas should be doubled where the nails are driven through.

To fold the chair, it is only necessary to unhook the stays and push the side frames inwards.

The Table

The table legs are 3ft. 6ins. long, 1½ins. wide and 1in. thick, and are assembled into two frames by means of rails of the same end-section. One rail is 1ft. 11ins. and the other 1ft. 9ins. long, and both have a ½in. wide and 1in. deep tenon sawn out of each end. Mortises for these tenons are cut on the legs, with their bottom edges at 4ins. from the bottom of them, and the two frames are glued and cramped. One pair of legs fits inside the other, and they are connected by wing nuts and bolts through their centre (drawing C).

For the actual top, boards ¾in. thick are glued and cramped together to make a panel 3ft. 6ins. square, which is then rounded over to circular shape. Alternatively, a light wood framing can be made and covered with a circle of plywood. In the exact centre of the table top a hole 1½ins. square is made.

Hinges are then fixed to the underside of the table top and to the top of the legs

(Continued foot of page 136)



WHEN the weather is kind, tea on the lawn is something to look forward to, but such enjoyment is often marred by the necessity of moving pieces of quite bulky furniture out into the garden. This 'garden set' has been designed to overcome that problem. Both the chairs and the table are light in weight and they both fold up compactly for storage in a convenient outhouse or shed.

Beech, if available, would be a suitable timber for the construction.

Start With The Chairs

The work can be started on the chairs. For each chair, two back and two front legs are required, these being respectively 3ft. 1in. and 2ft. 1in. long, and of 1½ins. square material. These are made up into two side frames by means of three rails to each. The bottom and seat rails are both 1ft. 9ins. long by 1½ins. square, while the arm rail is 2ft. long and of 4ins. by 1in. section.

Tenons ½in. wide and 1½ins. long are cut on both ends of the two square rails, and corresponding mortises for these are cut on the two legs. A tenon ½in. wide by 1½in. deep is also cut on the top of the front leg.

The mortises on the legs have their lower edges at 4½ins. and 1ft. 5½ins. from the bottom of the legs. When these have been worked, the two rails can be glued and cramped into place and the arm rail added. At the back of the latter a 1½ins. square slot is cut so that it can be housed round the back leg, while a mortise is cut towards the front end to take the tenon on the front leg. This rail is glued into place, and a thin dowel can be driven through the arms of the prong at the back to

fit into the back leg; the top edge of the overhanging part of the arm can be gently rounded over.

Drawing (A) gives a side view of the assembled frame.

The two frames are connected by stays that are 2ft. long, 1½ins. wide and ¾in. thick. These are hinged on the bottom on opposite edges of the up-rights, and have small hooks set in the end-grain of their upper ends. These hooks connect into screw eyes driven into the inside faces of the legs.

Drawing (B) shows the assembled chair without the canvas.

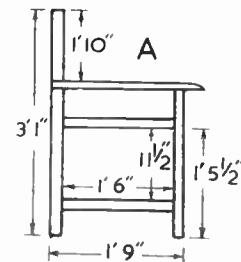

Fig. 1—Dimensions for the chair side frames

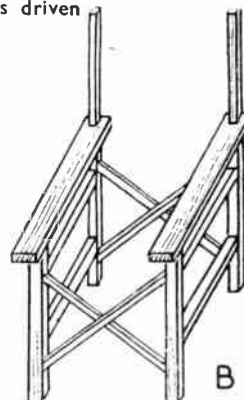

Fig. 2—Chair assembled without canvas

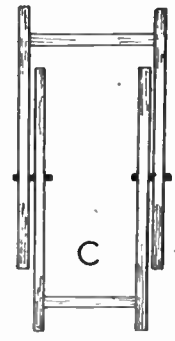

Fig. 3—The table frame

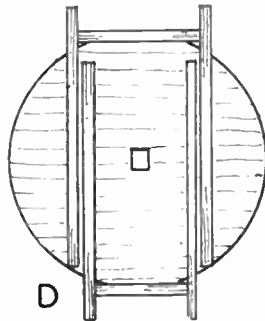

Fig. 4—Underside of the table, with top in position

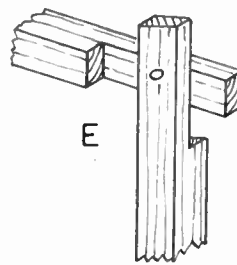

Fig. 5—Suggested joint for sun-shade column

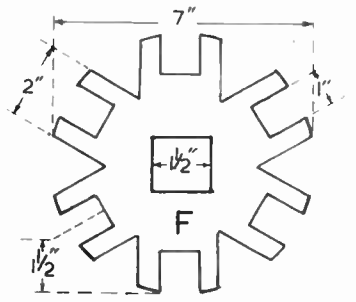

Fig. 6—Details of the blocks on which the shade can be formed

A simple push-along toy— 'PERCY PENGUIN'

HERE comes a period in most youngsters' lives when they derive an immense amount of pleasure from playing with simple push-along toys. One theory is that this type of plaything fulfils the growing child's demands for power over something.

Of course, not all of us have families of such tender years, but if you have passed this stage with your own youngsters I can still guarantee that Percy Penguin will make a most acceptable present for any child.

My own young son obviously feels no end of a big fellow when he is pushing his toy penguin about. In fact, he is so enchanted with it that I make no excuse for passing along the necessary instructions to enable other parents to construct a similar toy.

Made From Scraps

Our queer little penguin is made chiefly from odds and ends to be found in the average scrap-box. At the most you should have no more than a total outlay of a few pence. The complete material list is as follows:—

A small rectangle of wood (acquired from an old packing-case) measuring 11ins. long by 4ins. wide and $\frac{1}{2}$ in. in thickness; two wooden wheels about 2 $\frac{1}{2}$ ins. each in diameter; a curtain rod or a 3ft. length of dowel-rod some $\frac{1}{4}$ in. in diameter; a piece of old inner-tube or an old hot-water bottle; glasspaper, and paint, etc.

Glasspaper both sides of the rectangle of wood and then rule one side in pencil with 1in. squares. Copy the outline of Percy Penguin, as illustrated at Fig. 1. Now carefully cut round this outline with a fretsaw and smooth the freshly-sawn edge with a file and glasspaper.

A hole must be made in the back of the toy to receive the length of rod by which your youngster can propel the

penguin around. Make the hole about 1in. in depth and drill it in the region of Percy's shoulder-blades—if he had shoulder-blades!

The two wheels may either be salvaged from another broken toy, cut from another piece of scrapwood with a fretsaw, or bought for a few pence from a handicraft stockist. Make a small saw-

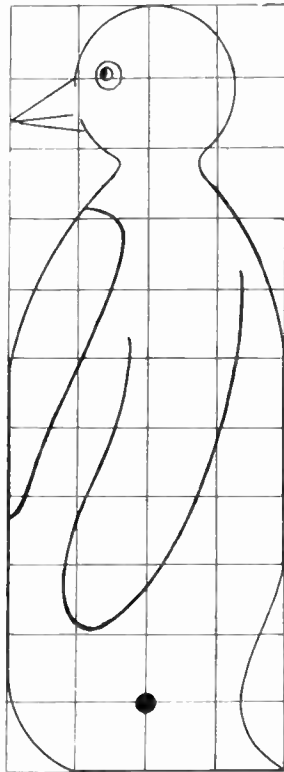

How to set out 'Percy'

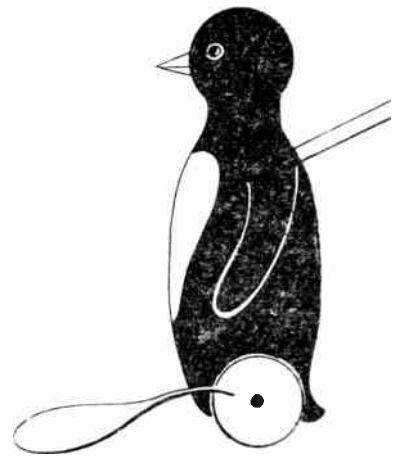

cut in the side of each wheel for a depth of 1in. and then drill a hole $\frac{1}{4}$ in. in diameter through the centre of both wheels and through the lower part of the toy.

Fitting The Wheels

The next task is to fit the wheels. This is accomplished by cutting off a short length of wooden rod for the axle. In order that the feet may flap forward alternatively, the wheels must be secured to the axle. To do this, make a small saw-cut in the ends of the wooden rod and then, when the wheels are fitted, small wedges may be hammered home and thus retain the wheels firmly in position. If desired, the ends of the axle may be dipped in glue before insertion into the wheels, thus making doubly sure of the joints.

Now cut two 'feet' from your piece of scrap rubber, each about 7 or 8ins. long and 2ins. across at their widest point, narrowing to the thickness of the wheels where they are glued into position in the two saw cuts made for them.

All that remains to be done is to paint your toy in as life-like a manner as possible. Insert a suitable length of rod into the hole made between Percy Penguin's shoulder-blades, and then your toy is complete and ready for its first try-out. (309)

Garden Dining Set—(Continued from page 135)

to fasten the latter to the table. A view of the underside of the table in the folded position is given at (D).

Although it is possible to use a continuous column for the sun-shade, it is advisable to have the top of this adjustable according to the sun.

The lower part of the column (which is 1 $\frac{1}{2}$ ins. square) is 4ft. long and passes through the hole in the table top so that its lower end is on the ground. The upper part of this column is 3ft. long, and the bottom of the column and the top of the lower column carry a 6in. long halved joint each, as shown at (E); they are fastened together by a wing nut and bolt.

It is sometimes possible to buy a second-hand golfing umbrella which can be used as the sun-shade, but if not, one must be made.

To do this two 7ins. circular blocks, 1in. thick, are needed and a hole 1 $\frac{1}{2}$ ins. square is cut through the centre of each. A series of notches is then cut round the edges of these blocks, the six pairs of prongs having 1in. between their inside edges (see F). One block is dropped over the top column and the other fixed permanently to the top of it.

The umbrella ribs and stays are 1in. square, the former being 2ft. 6ins. and the latter 1ft. 3ins. long. The ribs are bolted between the prongs on the fixed

block, while one end of each stay is bolted about halfway along a rib, its other end being bolted into the movable block.

By pushing the movable block upwards, it will be seen when the ribs are at the correct angle, and a small hole can be drilled through the top column just below this point. A small peg passed through the hole in the column will hold the movable block in its correct place.

To avoid waste in cutting the canvas to shape, it is advisable to prepare a paper pattern of the correct size, while the strips of canvas should be sewn edge to edge to get the desired width before cutting. The shape will be found to be circular, but with a segment cut from it. The meeting edges of this segment will need to be sewn together. (298)

POSTCARD PHOTO FRAME

The necessary wood, glass and hinges for making the Frame from this week's free design (No. 2902) is obtainable for 7/3 inc. purchase tax, post free.

Practical advice on WINDING TRANSFORMERS

MANY constructors must have to hand burnt-out or damaged transformers, and it is worthwhile to re-wind these, either for their original purpose or with a new object in view. Old transformers can be obtained cheaply from dealers in surplus equipment, and may be re-wound for a variety of purposes. Microphone and speaker transformers may be made, or those for coupling between valves or for providing current from the mains for models, battery charging, or other purposes.

If made with ordinary care such transformers can give years of useful service, and it is proposed to give full details of the number of turns, etc., required.

The Core Stampings

Transformer cores are made up from a large number of stampings or thin metal pieces, which are usually 'T' and

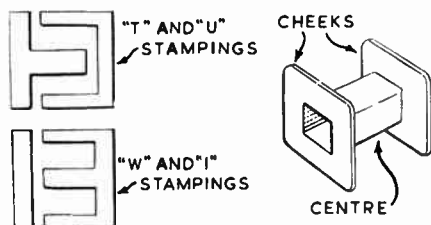

Fig. 1—Core stampings and bobbin for transformers

'U' shaped, as shown in Fig. 1. 'W' and 'I' shaped stampings are also found, and are equally satisfactory. New stampings may be bought in various sizes, but it is usually cheaper to obtain an old transformer, if one is not to hand. Stampings are covered with thin paper, paint, or other insulating material on one side, and this should not be removed.

Solid cores are not suitable for transformers of any kind because eddy currents are induced in the core itself, which greatly reduces efficiency.

The Bobbin

This is also shown in Fig. 1 and forms a spool upon which the windings will be placed. The centre piece is hollow, and of such a size that the centre limb of the core can be accommodated. For small transformers, a bobbin can be made from stout cardboard, two cheeks being glued to the centre piece, which is made by marking out and bending a strip of card.

To increase strength the ends should fit over the centre tube. If a poor bobbin is used, it may collapse when winding is in progress. For larger transformers, such as those for mains use, a bobbin can be made from thin plywood. Metal must not be used for the bobbin.

Assembling a Transformer

When the winding is completed the core is placed in position. A 'T' stamping should be placed in from the right, and a 'U' stamping from the left. The second 'T' stamping goes in from the left, and the second 'U' is placed on from the right. The whole core is built up in this way, stampings being placed on from alternative sides. (The junction between the limbs of the stampings will, therefore, appear at each end of the bobbin alternately, this overlapping method making the core most effective). With other types of stampings adopt the same system.

When all the stampings are placed in, the transformer will appear as at (A) in Fig. 2. A convenient method of mounting is to cut two strips from tin or other metal and bend these so that when the feet are screwed or bolted down the transformer is held, as shown at (B). If an

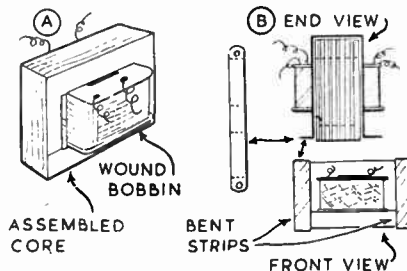

Fig. 2—An assembled transformer

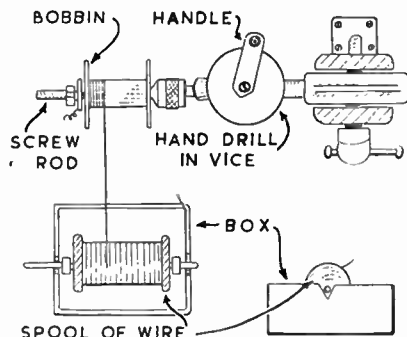

Fig. 4—A quick winding method

old transformer is being utilised, some such method of clamping it will already be available.

Anchoring Leads

Windings will be described later, and if the wire is fairly stout then it is merely necessary to allow ends a few inches long to come through small holes made at suitable points in the bobbin cheeks. If very thin wire is used, however, there is the danger that this may be broken off near the bobbin. This can be avoided by using an insulated tag board and taking the ends of the windings to

this. Connections are then taken to the tag board, which may be bolted at the top of the transformer.

A second method is to take some thin flex and solder it to the wire being used for winding. Cover the joint with insulating tape, then put on the winding. The joint lies inside the bobbin, the flex coming out through a small hole in the cheek.

Wire and Winding

With an old transformer it is usually possible to unwind the wire on to a spare reel and use it again. Otherwise a reel or so of new wire will be required, and enamelled wire is used, being cheap. All windings should be quite even and fairly tight. With very thick wires turns should be put on side by side. With the thinner wires this is not required and it is only necessary to guide the wire so that the bobbin is filled up fairly evenly.

Some types of transformer require a large number of turns and winding will

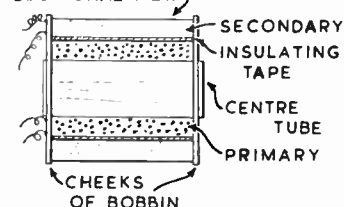

Fig. 3—Arrangement of the windings

be made much easier (besides being more even) if the arrangement shown in Fig. 4 is adopted. The spool of wire should be placed at some distance from the bobbin, and the wire can then be guided with one hand while the drill handle is turned with the other.

Count the gear-ratio of the drill, and divide the number of turns to be put on by this figure, which will give the number of times the handle should be turned. (For example: ratio, 5 to 1, 200 turns required. So turn handle 40 times).

The screwed rod is held in the drill chuck, and a nut tightened against a washer at the end of the bobbin, to hold it firmly.

Disposition of Windings

Fig. 3 shows a sectional view through a wound bobbin. The primary, normally of the stouter gauge which is employed, except with output transformers, goes on first. A good layer of insulating tape is then put on to assure the secondary turns cannot touch those of the primary, which might cause a breakdown of insulation. The secondary is then wound on, and covered with a final layer of tape or paper for protection.

The ends of the windings are taken through the cheeks, or soldered to

(Continued foot of page 139)

Keep up your game with A PRACTICE DARTBOARD

As many readers doubtless enjoy the ever popular game of darts, a practice board may be welcome, on which they can improve their dexterity to the astonishment of their friends. A board for this purpose can be very easily made, as there is no need to 'wire' it, thus avoiding a somewhat tedious job. The board can, however, be used for a friendly game in the family circle just as well as the professional pattern, but not for match play.

Quite a good board can sometimes be made by the simple expedient of screwing boards together, with a batten at top and bottom, if a few pieces of soft deal are at hand, free from knots. The darts will often stick quite well, but before employing such a construction, it is wise to test the wood beforehand. Such boards are somewhat noisy, and not to be compared with one showing end grain. In these the darts stick well, and make little sound.

Not Difficult

This more satisfactory kind of board is by no means difficult to make, if a short length of planed timber, of sufficient sectional area can be obtained. A good size is 4ins. by 6ins., but a little less will serve if the larger size cannot be got. A suitable length might be bought at a timber yard, where short ends can

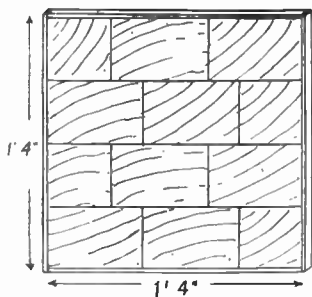
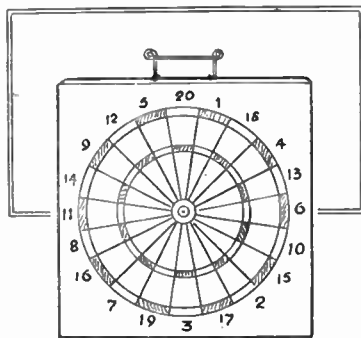

Fig. 1—How the wood slices are arranged

generally be picked up cheaply. With such a length, it is a good plan to get the merchant to cut the wood for you, as it takes only a few minutes with the aid of a circular saw. The thickness of the slices can be anything from 1in. to 2ins., according to the length of wood available.

If this is not, for any reason, practicable the wood must be sawn through at home. Keep the slices as uniform in thickness as possible, by sawing straight, and gauging the saw lines afresh after each slice. These slices should then be arranged conveniently on a bench, in the order in which they will be fixed together, to make a board of the requisite size. A minimum size is given in Fig. 1. From this diagram, it will be seen that the slices are so arranged that



the vertical joints are broken, brick-laying fashion.

Gluing

Spread a sheet of newspaper on the bench, which must have a flat level top, and glue the slices edge to edge on it, pressing them well into contact to better ensure tight adhesion. When the glue is hard, lift the board off the paper and turn over. Well glasspaper this surface to smooth it, and remove any scraps of the paper adhering to it. A good flat surface should result, and if the back surface is a little irregular, owing to shades of difference in the thickness of the slices, it does not matter a bit.

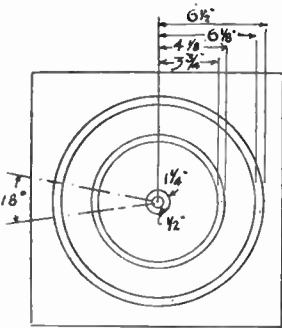

Fig. 2—Designing the board

Trim the edges level, and to them glue and nail edging strips all round, 1/2in. thick.

The design of the board should be marked out on paper, to be afterwards glued to the board. Choose a sheet of smooth stout paper for this, and on it pencil the size of the board. Pin the paper to a flat board, and with the aid of an ink compass and indian ink, mark out the circles to the diameters given in Fig. 2. Those readers who do not possess an ink compass can do this job with a home-made gadget, shown at (A) in Fig. 3.

This is a length of wood, say, 1in. wide and 1/2in. thick, with a small hole near one end for a centre, and from it other holes at the radii given in Fig. 2. These latter holes should be just large

enough to admit the end of one of those ink pencils so popular just now. In use, the gadget is secured to the centre of the paper with a thin nail or screw, so that it is free enough to be swung round. The circles are easily described by putting the ink pencil in the holes, one at a time, of course, and then swinging the gadget full circle, as in the sketch, Fig. 3.

Protractor Convenient

For the radial divisions, a protractor is the most convenient instrument to use, and, incidentally, it is one which every hobbyist should own, being invaluable in many ways. The divisions are 18 degrees, and can be marked out and lines drawn through the marks to the centre. It should be noted here that the first division should be marked out on either a horizontal line drawn through the centre of the circles, or a vertical one, with 9 degrees each side. From this first division the remainder can be marked out round the board.

Fixing the Design

Cut the design to size, lay it face down on to a piece of paper (newspaper will serve) and coat it with thin hot glue. Then press it down to the board and rub over it with a clean rag to make it adhere well. Take care to avoid creases, and work quickly, as the glue soon sets. This practically completes the board. The colouring of the 'double' and 'treble' divisions is optional, but it

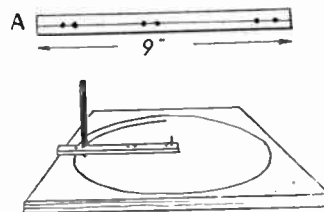

Fig. 3—Home-made marker

certainly makes these important parts of the board more prominent.

For suspending the board, make a wire attachment, as in the general view, and hook this to a pair of screw eyes, driven in the top. This arrangement allows for a couple of nails or screws for hanging, and is better than the simple wire loop, commonly employed, as the board has not the same tendency to shift sideways when the darts are pulled out.

Precaution

It is most advisable to interpose a sheet of plywood or hardboard behind the dartboard before using it, as darts will go astray sometimes, and a wall pitted with dart holes may bring down on the players the righteous anger of the housewife. (296)

More advice on SIMPLE ELECTRICAL WORK

Repairs

IN a previous article, attention was given to the most common form of electrical repair work, namely, the repair of flexible cables. Now the time has come to consider some other simple repairs which are within the capabilities of the home handyman.

Fuses

Readers will be aware that fuses are, in effect, the 'safety-valves' of the electrical installation.

The action of a fuse is to melt when subject to the degree of heat developed by the passing of an electric current greater than that for which the apparatus is designed and, since the fuse is connected in series with the circuit to be protected, the melting of the fuse automatically breaks the circuit.

It follows that the fuse will be of little use unless it is fitted with a piece of fuse wire which will melt at the proper time, but not otherwise. If the wire is too thin, it will probably melt under normal operating conditions and create a constant nuisance involving unnecessary repair work. On the other hand, if the wire is too thick, the fuse will not melt until current is flowing at a dangerously high level with an accompanying risk of fire or otherwise to the installation and the premises containing it.

The method of repairing a fuse, if not already known, will be clear from the

accompanying sketch. The remnant of the old piece of fuse wire is removed and replaced with a new piece of fuse wire of suitable rating. The usual ratings of fuse wire are as follows:—

5 amp.—Lighting circuits.

15 amp.—Power circuits.

Opening the fuse box, in all except very old installations, will automatically break the circuit and render the fuse-holder 'safe', but it must be remembered that parts of the fuse box circuit remain 'live' and must not be touched. Danger points on the fuse box are indicated in the sketch.

Replacing Defective Switches

Before attempting the replacement of a defective tumbler switch, the electric supply system must be switched off at the main. As a precaution, verify the

safety of the system by closing one or two of the house lighting switches momentarily to ensure that the circuit is, in fact, 'dead'.

Little difficulty is likely to arise in the replacement of a switch and the sketch will make the method clear.

When connecting the supply cables to the new switch it is as well to double the cable ends back for a short length (say, $\frac{1}{2}$ in.) before inserting them into the switch terminals—this makes for better contact.

If a two-way or other multiple contact switch is being replaced, the connecting cables should always be marked with scraps of paper or otherwise before removal to make sure that they are connected back to the correct places.

(276)

(To be concluded)

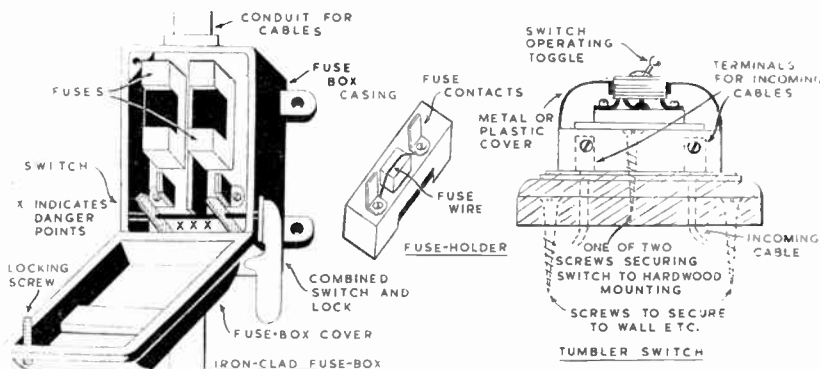

Winding Transformers—(Continued from page 137)

short lengths of flex, as already described.

Microphone Transformer

Here, a ratio of about 1:50 to 1:100 step-up is required, and the primary must carry a heavy current. 50 turns of 22 S.W.G. wire can be used for the primary, with 2,500 turns of 42 S.W.G. or similar wire for the secondary. If space permits, the ratio may be increased by putting on up to 5,000 turns on the secondary. The exact number is in no way critical. If a large bobbin is in use, use 100 turns on the primary and double the number of secondary turns.

Primary will be connected to energising battery and microphone. Secondary to first valve grid and grid-bias (or chassis, with mains sets).

Interval Transformer

Here, a ratio of 1:3 or 1:4 is required, with a high primary inductance. The primary can, therefore, consist of 1,000 turns, 38 to 42 S.W.G. wire, and the secondary of 3,000 to 5,000 turns, according to space, of 42 S.W.G. wire. If a big bobbin is in use a superior transformer to the average can be made

by employing up to 5,000 turns on the primary, and increasing the number of secondary turns proportionately (e.g. if 2,000 turns are used on the primary, then 6,000 turns will be required on the secondary to provide a 1:3 step-up ratio).

Output Transformer

This can employ about 3,000 turns on the primary for a battery triode or mains pentode valve, or about 6,000 turns for a battery pentode. Or a 6,000 turn winding tapped at 2,000 turns may be used, so that 2,000, 4,000 or 6,000 turns may be employed at will. 40 to 42 S.W.G. wire can be employed for battery valves. For small mains valves use 34 or 36 S.W.G. wire. Large valves taking a heavy current will require 32 S.W.G. wire.

The secondary consists of 100 turns of 20 S.W.G. wire, which will form only two or three layers. Primary goes to valve anode and H.T. positive; secondary to speaker.

Mains Transformers

Transformers cannot be used on D.C. mains. With A.C. mains the

voltage may be stepped up or down to any required figure. A larger core than for the foregoing transformers is needed, and one of 1 sq. in. cross-sectional area (e.g. the area of the end of the centre-piece of the bobbin) is convenient. With this, 8 turns are employed for every volt on either primary or secondary windings. 200 V. mains will, therefore require 1,600 turns, 210 V. mains, 1,680 turns, and so on. (Tappings may be made so that the component is suitable for a variety of voltages). Wind the wire in even layers, putting a layer of paper between each layer of wire. For an average transformer use 28 to 30 S.W.G. wire. 32 S.W.G. can be used on a small one; 24 or 26 S.W.G. wire on a very large one.

Wind 8 turns on the secondary for every volt required (e.g. 48 turns for 6 volts, and so on). 20 S.W.G. wire can be used for up to 1 amp. Up to 2 amps. employ 18 S.W.G., with 16 S.W.G. for up to 3 amps. and 14 S.W.G. for up to 5 amps. The secondary may be tapped to provide a variety of voltages for different models, etc.

(266)

Enrich your dinner table with these ATTRACTIVE CANDELABRUM

As a means of illuminating the tea table or dinner table for parties or for special occasions, the candle is often much preferred to other forms of light. It gives a soft diffused light which at times can be quite charming.

It is obvious that more than one candle will be needed and for that reason some nice multiple candlesticks or candelabrum as they are called, have been designed.

They have been in use for close on two thousand years, and during that time many different materials have been used to make them. From the crude metals of the ancient Romans and Greeks, the silver and cut glass of Tudor times, to the very modern plastics of today, each beautiful in its own way.

The subject of this article is made entirely of wood. It can be used alone as a centre piece, or a set could be made by the addition of two single candlesticks

base is marked (J) in Fig. 3.

Next cut the octagons for (H), 3½ ins. across and ¼ in. thick and bevel the edges of these to an angle of 45 degrees. On top of this is another ¼ in. piece (G), measuring 3½ ins. and these three pieces complete the base.

Piece (F), which we will call the stem, requires a little more care to make. Start with a block 1½ ins. square and 2 ins. long, and mark out octagons on each end. The top one is ½ in. across, while the bottom one occupies the whole space of 1½ ins. Four carefully placed saw cuts joining up the top and bottom marks will give us the final shape.

The piece (E) in Fig. 3, which holds the centre candle and bridgework, is 4 ins. long, 1 in. wide and ½ in. thick. Cut off the corners and drill a ¼ in. hole ¾ in. from one end as shown in Fig. 2.

(D) is a separating piece, ½ in. across

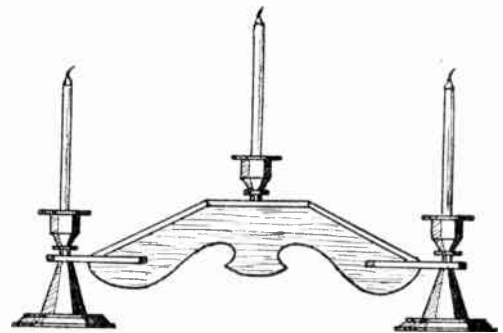

Fig. 1—The finished article

and ½ in. thick, and as it has a ¼ in. hole drilled in the centre, it would be best to drill this first and then cut the piece to size and shape.

Cut (C) and (A) from ½ in. wood, (C) is 1 in. across and has a ¼ in. hole in the centre, while (A) is 2 ins. across and has a centre hole of ⅝ in. to take a candle.

The remaining piece (B), which is called the sconce, is 1½ ins. long and 1½ ins. across at the top, and, at a distance of ¾ in. down, it starts to taper off to ½ in. It would be advisable, also, to drill the holes first and then cut to shape afterwards. The top hole for the candle is drilled a shade larger than ¾ in. and to a depth of ¾ in. The hole is then continued right through with a ¼ in. drill.

Drill a ¼ in. hole in the top of piece (F) about 1 in. deep. Now pieces (B), (C), (D), (E) and (F) can be glued together with a ¼ in. dowel to hold them in position.

The base piece (G) can first be screwed to the stem (F) and then (H) and (J) glued on to this, thus completing the two end candlesticks.

The Centre Bridge

We now have the centre bridge portion to make, and this is clearly shown in Fig. 2. The main support is 13 ins. long, 3½ ins. wide and ¼ in. thick. Slots are cut in the ends to fit piece (E) on the end candlesticks, and these are ½ in. wide and 2 ins. long.

On the top of this centre bridge are glued three strips of wood 1 in. wide and ¼ in. thick. The centre one is 4 ins. long and has a ¼ in.

(Continued foot of page 141)

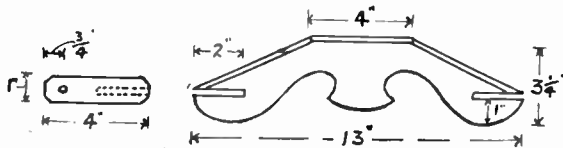

Fig. 2—Details of the centre bridge

corresponding in design to the end ones of the candelabrum.

A wide range of woods is available for the construction, and the final choice must rest with the maker. Dark woods such as walnut or mahogany would stand out well on a white tablecloth, while if a light wood is used it could be enamelled in a pleasing pastel shade. It is best to use a hardwood of some kind, if possible.

Although the design looks somewhat complicated it is not at all difficult to make. It has been greatly simplified by being made in sections and then built up. As most of the pieces are octagons or eight-sided sections we will first describe how to set out an exact figure easily.

Taking the 4 in. base as an example draw out a 4 in. square as shown in Fig. 4, the corners of which are marked (A). Now draw the diagonal lines (C) and (D) through these corners, and on either side of them draw parallel lines 2 ins. away. This forms the second square with corners marked (B). The result shown by the thick lines is a perfect octagon measuring 4 ins.

Commence by making the two outside candlesticks as shown in Fig. 3. For the bases cut two pieces of ½ in. wood 4 ins. square, cutting off the corners to form octagons as shown in Fig. 4. This

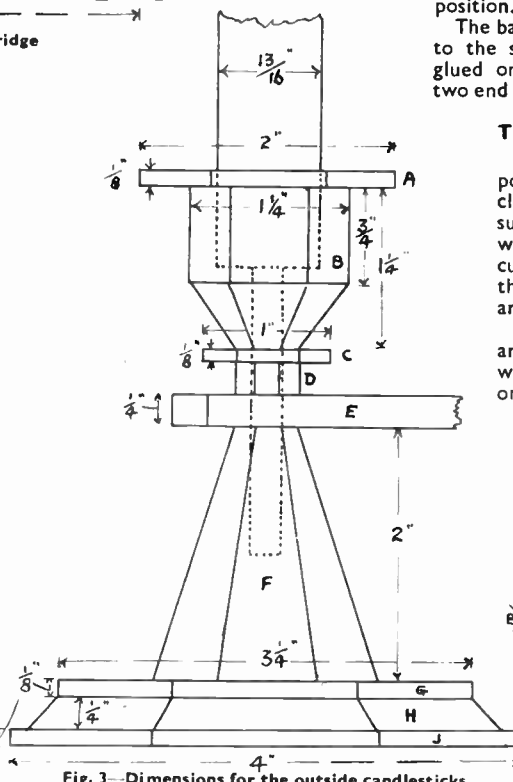

Fig. 3—Dimensions for the outside candlesticks

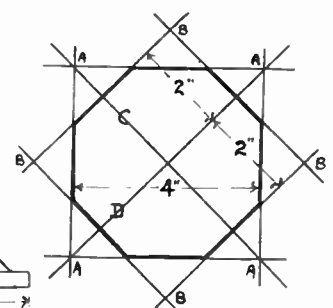
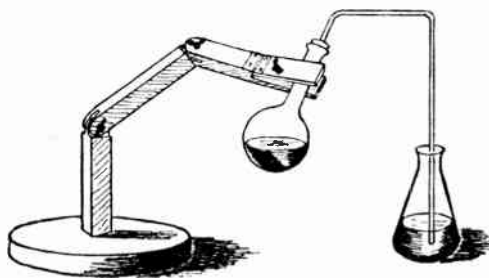

Fig. 4—Forming the octagon bases

The home chemist should make this UNIVERSAL CHEMICAL HOLDER



In our issue of February 14th we gave plans for a filter stand. This week we give the details for making a cheap substitute for its companion piece—the retort stand.

Every home chemist needs at least one stand and clamp, whether it be to hold a reaction tube, a condenser, a flask or a burette, and a large number of experiments call for two or more.

Inexpensive

Complete with clamp, the smallest retort stand costs in the neighbourhood of 12/-. The universal holder shown can be quickly and easily made for a fraction of the cost. The only materials needed are 3ft. or so of 1in. by $\frac{1}{2}$ in. stripwood, an 8ins. square of 1in. board, three wing nuts and bolts and a pair of small hinges.

By means of the wing nuts the jaw may be fixed in any desired position.

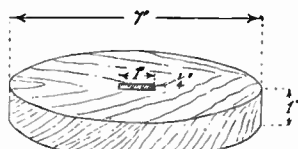

Fig. 1—The base

Though the wide and thick base ensures stability, a piece of sheet lead recessed into the underside of the base is an added advantage.

Make the base first. With compasses and pencil draw a 7ins. circle on the 1in. thick board. Then mark off the 1in. by $\frac{1}{2}$ in. slot in the centre. The circle can be cut out with a fretsaw despite the thickness of the wood. The main point is—as with all fretsawing—to work without too much forward pressure. The slot may be cut by the usual drill

and chisel method, or with the fretsaw if care be taken. Keep a shade to the inside of the lines to ensure a tight fit.

For the lower pillar (Fig. 2), mark off the upper curve shown on the centre lamination, drill a hole of the diameter of the bolt you will use, and centre the hole $\frac{1}{2}$ in. from the curve. Now fretsaw along the curve and glasspaper smooth before cutting off the 5ins. length.

On either side of this piece are now fixed two 3ins. lengths of the 1in. stripwood, leaving a 1in. tongue clear at each end. Waterproof cement is best to use for this type of laboratory fitting.

Testing

Now try pushing the lower undrilled tongue into the slot in the base. It will probably be a shade too large to go in, owing to your having cut the slot inside the lines. This is all to the good, for it is easier to glasspaper the tongue to the right thickness than to cut the slot exactly right. Glasspaper and test until it just slides into place. Make sure the bottoms of the side laminations fit flush and that the tongue does not protrude below the base (which would make an unsteady stand). Apply cement to the inside of the slot and to the bottoms of the side laminations, press in and leave to dry.

For the middle pillar (Fig. 3), cut a

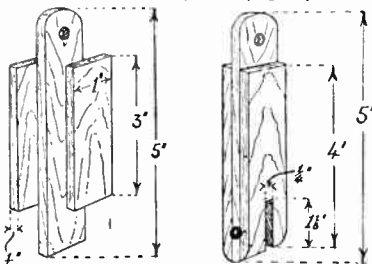

Fig. 2—Lower pillar Fig. 3—Middle pillar

5ins. centre lamination from 1in. stripwood and shape and drill in the same way as for the bottom pillar. Cut two 4ins. lengths for the outer laminations, cement them in place, leaving the round end of the centre lamination protruding 1in. and leave to set overnight under pressure.

Before drilling the lower bolt hole and slot, round off the lower end with rasp and glasspaper. Carefully drill the hole next, then fretsaw out the slot.

For the clamp components (Fig. 4), saw and shape up two 5ins. lengths first. On one mark off the centre line, which is sawn later.

Place the hinge in position on the centre line and $\frac{1}{2}$ in. from the right hand hinge flap mark off the position of the bolt hole. The hole at the rounded end of the clamp is, as with the pillars, centred $\frac{1}{2}$ in. from the end.

Clamp the two pieces of wood together with their ends flush with each other, and drill the holes. The holes at the jaw end should now be enlarged a little into an oval shape to allow free movement of the bolt when the jaw is opened. Alternatively, these jaw holes may be cut from the start into an oval with the fretsaw.

Next saw in halves one of the 5ins. components, cut the $1\frac{1}{2}$ ins. spacing piece and cement into position. When quite set fix on the hinge, put the jaw bolt in position and see if the jaw opens and shuts without binding on the bolt shaft. If it binds, enlarge the holes with a round file at the points where the binding occurs until all is well.

Two 1in. squares of cork or sheet rubber should be cemented into the jaw tips to protect the glass apparatus gripped therein. And to protect the

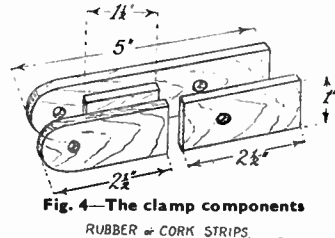

Fig. 4—The clamp components

RUBBER or CORK STRIPS

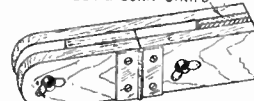

Fig. 5—Completed clamp

wood of the stand itself, washers should be inserted between bolt heads and nuts and the wood.

As with the filter stand, aluminium paint is the most suitable and scientific looking finish. (279)

Attractive Candelabrum—(Continued from page 140)

hole drilled in the middle for the dowel of the candle sconce. The two end strips are nearly 5ins. long and had best be cut to size when the framework is fitted and glued together.

Make the centre sconce with pieces (A), (B), (C) and (D) and fasten together with a $\frac{1}{2}$ in. dowel, leaving $\frac{1}{2}$ in. projecting to be glued in to the centre strip of the bridge.

The whole can now be glasspapered, using a fine grade on a wood block so as to keep the corners sharp. Finish off by staining, if necessary, and then polishing with either a wax finish or french polish. If it is to be enamelled it should be given a coat of size first and then lightly glasspapered before applying the two coats of enamel.

If it is decided to make two or more

single candlesticks to form a set, the stem marked (F) in Fig. 3 should be made 2ins. or 3ins. longer. The bar (E) is omitted entirely and in its place another piece similar to (C) can be fitted if thought necessary. Otherwise the construction and measurements are exactly the same as for the end candlesticks. (249)

For wood,
card,
plastic,
leather
metal etc.

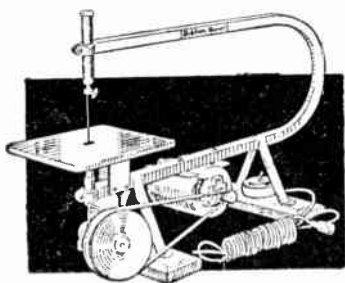

TREADLE OR MOTOR FRETSAWS

Whatever the handyman or craftsman is cutting or making, one of Hobbies Fretmachines will help with the job. For toy making, fretwork, model making, it provides easy and speedy cutting in all kinds of material. A pleasure to use, a factory for output, a lifetime of service. **FROM**

80/- to £11 - 2 - 6

Ask to try one at any Hobbies Branch or good class ironmonger or hardware stores. Or free illustrated leaflets on request to:

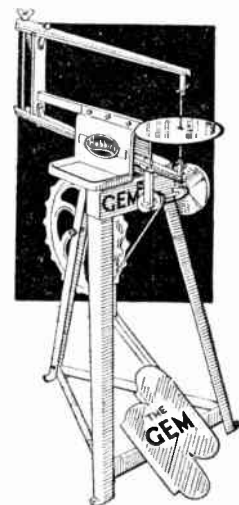

HOBBIES LIMITED, DEREHAM, NORFOLK



THE BOLSTER HOME WATCH AND CLOCK REPAIR OUTFIT

These precision jewellers' instruments include watchmaker's magnifying eyeglass, finest watch tweezers, set watchmaker's screwdrivers, watch and clock oil, oilers, dusting powder, clock brush, plus illustrated instructional manual for the amateur. In container 12/6 post free.

Senior Outfit includes everything above, plus watch jewels luminous compounds, dial renewer, jewellers rouge, explanatory book. Price 21/- post free.

BOLSTER INSTRUMENT Co. (Dept. H. W.), 5a Station Parade, Ashford, Middx.

KITS for OLD TIME SHIPS

Hobbies range of Ship Models includes Elizabeth Jonas, Cutty Sark, Victory, Mayflower, etc. Complete kit of wood, sail material, guns, pulleys, cord, etc., with full size pattern of parts and planed wood ready to cut out, shape and construct. A fascinating pastime.

Kits for models 12½ ins. long and upwards.

Ask for free illustrated lists at Hobbies Branches or from Hobbies Limited, Dereham, Norfolk.

YOU CAN BECOME A HANDICRAFTS INSTRUCTOR

EXPERIENCE NOT ESSENTIAL

Men who enjoy making things in wood or metal can turn their hobby into a permanent and interesting Career. Short hours, long holidays, and security in a job you would really enjoy, can be yours if you become a Handicrafts instructor. Let us send details of the easiest and quickest way to get the necessary qualification.

**We definitely guarantee
"NO PASS - NO FEE"**

If you would like to know about our unique method of preparing you for one of these appointments, write today, and we will send you our informative 176 page Handbook—free and without obligation. Mark your letters "Handicrafts Instructor".

**BRITISH INSTITUTE OF
ENGINEERING TECHNOLOGY** **BIET**

595 Shakespeare House
Stratford Place, London, W.1

WEBLEY

AIR PISTOLS

Marvellously accurate for target practice. No licence required to purchase for use on enclosed premises.

Senior Mark 1
Junior Webley Air Rifle

Write for List. **WEBLEY & SCOTT LTD.**
166 WEAMAN STREET, BIRMINGHAM, ENG.

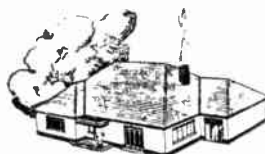

**TURN YOUR
SPARE-TIME INTO CASH**
Men and women wanted to
make Bennett Model
Bungalows at Home.

Fascinating, simple, well paid work

No selling involved.
Send penny stamped addressed envelope for full details.

BENNETT MODELS
Duncan Road, Richmond, Surrey



BRANCHES LONDON

78a New Oxford St., W.C.1
(Phone MUSEum 2975)
87 Old Broad Street, E.C.2
(LONDON Wall 4375)
117 Walworth Road, S.E.17

GLASGOW

326 Argyle Street
(Phone CENTral 5042)

Head Office & Factories—**HOBBIES LTD., DEREHAM, NORFOLK**

MANCHESTER

10 Piccadilly
(Phone CENTral 1787)

BIRMINGHAM

14 Bull Ring

SHEFFIELD

4 St. Paul's Parade

LEEDS

10 Queen Victoria Street
(Phone 28639)

HULL

10 Paragon Square

SOUTHAMPTON

25 Bernard Street

BRISTOL

30 Narrow Wine Street
(Phone 23744)

Tommy Trump says:- "Always ask for

DOUBLE ACE

The ACE of cigarettes"

10 for 1/3½

FOR ALL 'SPORTS'



MASK...MAKE...

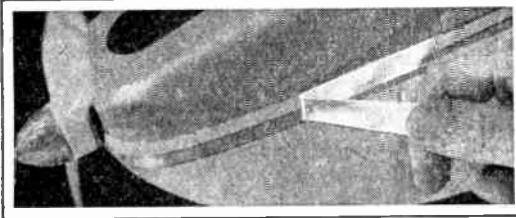

MEND...WITH

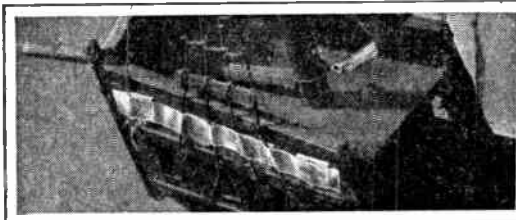

Sellotape

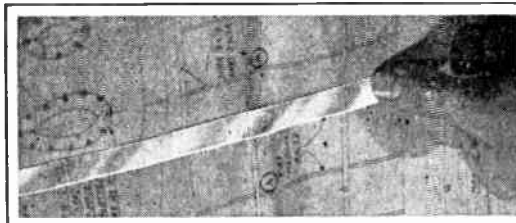

Whatever your hobby, Sellotape is your greatest ally. For masking paintwork, holding parts while gluing, protecting plans—and a thousand other useful jobs—it's Sellotape every time. It sticks at a touch without moistening. It fits evenly on a curving surface. There's coloured Sellotape for easy indexing, for recognition tags, and decorating. You just can't do without it. Get some today—and remember, if it doesn't SAY Sellotape —it isn't!

Stocked by all Stationers



G & C

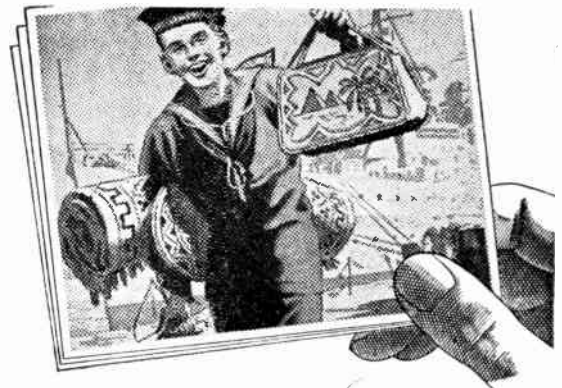

“Like my rabbits...?”

Can't see them? What do you think I'm holding? Sure, *they're* the rabbits — Service language for presents for the folks at home. When we got that big rise in pay I decided I'd do the folks proud . . . can send Mum home a bit extra, too. Not bad for a Seaman Boy, eh? I certainly landed lucky when I got into the Navy . . .

BOYS AGED 15-16 years 3 months can enter the Seaman Branch of the Royal Navy. Higher pay—better prospects than ever. The Navy needs the right Boys NOW.

Make the ROYAL NAVY your career

WRITE TODAY for FREE booklet to: D.N.R., Dept. Y/37, Admiralty, London, S.W.1. (Applications from U.K. only.)

Name

Address

Age

For all kinds of woodwork

HOBBIES FRETSAWS

Not only in fretwork and model making but in a hundred and one woodwork, composition plastic, leather or metal sheet jobs you'll find a fretframe handy. And the best blade for any is the saw which is made here by Hobbies from good steel and the experience of forty years of manufacture. Every dozen is distinctly labelled.

IN 3 GRADES

Blue Label ... 1/- per doz.

Yellow Label ... 1/3 ..

Metal Cutting .. 1/4' ..



Obtainable from Ironmongers' Stores and Hobbies Branches, or by post from **HOBBIES LTD., DEREHAM, NORFOLK**

BILL, YOU SURE HAVE A SWELL BUILD! DID YOU TRAIN FOR A LONG TIME WITH WEIGHTS AND PULLEYS?

ABSOLUTELY NOT! THE ATLAS WAY—WITH NO APPARATUS—MAKES MUSCLES GROW LIKE MAGIC!

Charles Atlas

Twice winner of the title: *The World's Most Perfectly Developed Man.*

Here's the Kind of NEW MEN I Build! Do YOU Want to Be One?



CYRIL ROSE, of London, E.1, one of my successful pupils, whose recent poses have created wide interest.

..And I'll PROVE in Just 7 DAYS I Can Make YOU One!



SEND FOR 48 PAGE FREE BOOK

Let me show you the amazing results produced for thousands of other men! I'll send you my famous book, "Everlasting Health and Strength". It's a valuable book and it's FREE. Post the coupon TO-DAY addressed to **CHARLES ATLAS** (Dept. 102/T), 2 Dean Street, London, W.1.

CHARLES ATLAS (Dept. 102/T), 2 Dean Street, London, W.1.

I want the proof that your system of "Dynamic-Tension" will make me a NEW MAN. Send me your Book, "Everlasting Health and Strength", FREE, and details of your amazing 7-DAY TRIAL OFFER.

Name.....
(please print or write clearly)

Address.....

THAT'S all I ask—SEVEN DAYS! In the first week I'll PROVE that I can give you, too, the kind of body men respect and women admire! You will actually see and feel the improvement in even this short time. And as the weeks go by you will see yourself transformed into a NEW MAN—a stronger, healthier, more handsome man! I was once a skinny, timid weakling of only 7 stone. I didn't know what real health or strength were. I was afraid to fight—ashamed to be seen in a bathing costume.

You'll see and feel results in 1 week! Then I discovered the amazing secret that changed me, like magic, into "The World's

Most Perfectly Developed Man"—the title I won twice. What it did for me, it can do for you, too! My secret is "Dynamic-Tension". It is the tested, natural method of developing you inside and out! It not only can give YOU the powerful, rippling muscles you'd like to see in your own mirror... it also digs down into your system after such needless joy-killing conditions as ordinary constipation, indigestion, underweight and overweight. My "Dynamic-Tension" method will make a NEW MAN of you in double-quick time—and I'm ready to PROVE it to you in a 7-day TRIAL OFFER. Unless you get results in the first week it costs you absolutely NOTHING!

Announcing

'LINESIDE' KITS for 'OO' Gauge

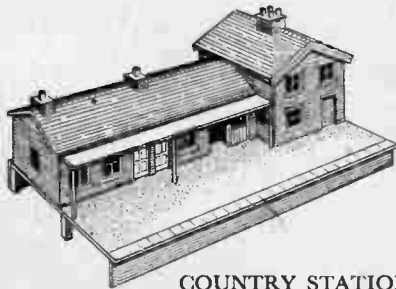

COUNTRY STATION 5/6

These kits contain plans, brick and tile building papers, printed card and wood parts and printed celluloid windows. Really authentic and detailed true-to-scale designs. The first off are:—

LARGE SIGNAL CABIN 3/8

WATER TOWERS (2 types in 1 kit) 2/9 PLATFORMS 3/8

Postage: Single kit 6d.; 2 or more 10d.

★ The full Modelcraft List for 1951 gives details of over 600 plans, planbooks, kits and accessories for every branch of modelmaking. It costs 1/- post free and includes a 1/- refund voucher for use in buying Modelcraft goods.

MODEL CRAFT LTD.
77 (F) GROSVENOR ROAD, LONDON, S.W.1.

"KARLENITE"

PLASTIC MARBLE

The entirely new Art Stone for casting Bookends, Ashtrays, Wall Vases, Statuettes, etc. "KARLENITE" sets granite-hard with scintillating crystalline structure which very closely resembles marble or alabaster. It is enormously strong, highly resistant to heat, and impervious to water. Literally any type of natural 'veining' can be simulated in any colour and a wide range of pigments is available for this purpose.

MAKE YOUR OWN

FLEXIBLE MOULDS

with 'Plastimould' Synthetic Rubber Solution. By means of this simple technique, you can easily prepare permanent elastic moulds for repetition casting, plaques, bookends, etc., in quantities of thousands.

'Plastimould' will faithfully reproduce even the most minute details of ornamentation and surface texture.

It is incredibly simple to use, and moulds can be prepared from any type of pattern including Wood, Metal, Plaster, Stone, Glass, Ivory, etc.

Such moulds are ideally suitable for casting in Plaster, Cement and Karlenite.

Start your Own Business. Send 1s. for full details of this easy, fascinating and profitable hobby.

MONEY REFUNDED TO BONA FIDE ENQUIRERS

Dept. H.3, Karlena Art Stone Company, Ltd.,
55 Deansgate Arcade, Deansgate, Manchester, 3.

Hobbies

WEEKLY

CONTENTS

	Page
A Sturdy Garden Swing	145
Simple Plywood Baskets	146
Rope-Soled Sandals	- 147
Float Fishing is Fun	- 148
Working Toy	
Roundabout	- - 149
Trick Turning	- - 150
Model Russian Fighter	151
Balance Scales	- - 152
Garden Tree Seat	- - 153
Modernising a Bedstead	154
Avoid Common	
Mistakes	- 155
Model Russian	
Fighter Patterns	- 159

June 20th, 1951

Price Fourpence

Vol. 112 No. 2903

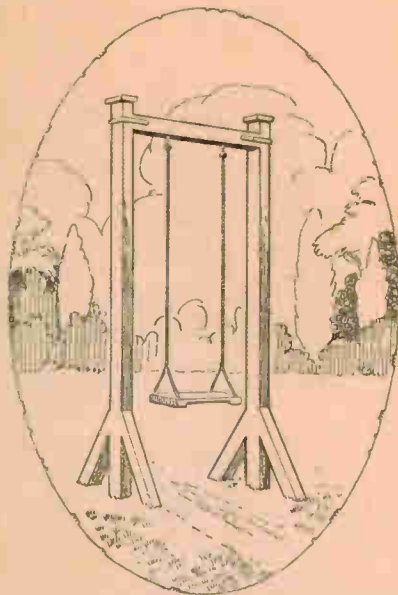

MANY happy minutes can be spent on a garden swing, and, apart from the fun, swinging is valuable as an exercise.

It is not a difficult job to make and erect a suitable swing, the main essentials being stability and structural strength. Some people are apt to think that two posts and a crossbar will serve, but there is a little more to it than that, for there is the safety factor to be considered.

Suitable Timber

For the swing proposed here, some suitable dimensions are given in Figs. 1 and 2. For the timbers, use 4ins. by 3ins. sound red deal, except for the ground sill and struts, which are partly in the ground, and can be 4ins. by 2ins. stuff.

Cut the two upright posts to the measurements shown, and then, at a distance of 3ins. from the top of each,

How to make A STURDY GARDEN SWING

cut a mortise $1\frac{1}{2}$ ins. by $\frac{1}{4}$ ins. long and 1in. deep, for the crossbar. This joint can be further strengthened by cutting a shallow housing, so that the whole end of the cross rail may go into the post as seen in the detail (Fig. 3).

Ground Sill and Struts

Next, cut the ground sill and the struts. The sill should be stub-tenoned to the posts in the manner shown in Fig. 4, and the struts are obliquely set into the sill and secured with stout nails or screws, as seen in the side view of the swing (Fig. 2).

The struts are first marked off for length, then the top ends are set out as shown, so that the actual angle between upright and strut is 30 degrees. At the foot end, of course, the angle is 60 degrees. Allow at each point—top and bottom—for the portion of the strut that recesses into the post and sill, and cut this carefully with the tenon saw to make a close-fitting joint. The struts should go into the sill and posts a distance of about $\frac{3}{4}$ in.—not more, for fear of weakening them.

The struts should not be nearer than 2ins. from the ends of the sill, or the latter may split away. Before the cut ends of the struts are nailed into the sill they should be thoroughly creosoted, and so should the recesses and the whole portion that will be below ground.

When dry, nail the posts to the sill in the centre, and the struts to the sill and posts. Long cut iron nails are best for

this job. The cross rail connecting the tops of the posts is cut 3ft. 3ins. long, the tenons as shown being cut each end to properly fit the mortises in the posts. Glue these in and then bind the joints well together by adding iron stirrups, as shown at Fig. 3. These are of stout strip material drilled for screws and bent up to fit round the posts. Couch screws could be added, if desired, to go through the ends of the iron stirrups—which should be drilled, of course, to take them—and into the ends of the tenons of the rail.

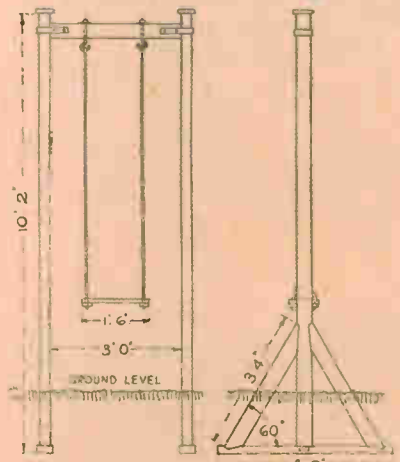

Figs. 1 & 2—Front and side elevations

All correspondence should be addressed to The Editor, Hobbies Weekly, Dereham, Norfolk.

The top of the posts could be cut off to a point as a suitable finish, or, better still, flat capping pieces cut square and nailed on, as shown in Figs. 1 and 2.

Nail a batten temporarily across the posts, near the bottom, to hold them

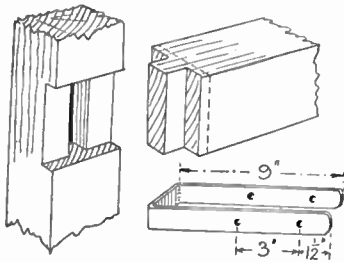

Fig. 3—Joining the crossbar to the uprights

the right distance apart while being erected.

The Seat Fitting

The seat is a piece of board 1in. or more thick, and cut about 18ins. long and 8ins. wide. Round off the two long edges and make them perfectly smooth with glasspaper. Then, at each end of the seat board, screw on cross battens 3ins. wide and 1in. thick.

Through the seat and battens, bore the holes for the ropes, two at each end, and round off the sharp edges of the holes to avoid damage and fraying of the ropes.

A single rope, say, about 8ft. long, is used for each side of the seat. Thread this through the holes in the seat, bring up one end alongside the long length, and bind the two together with tarred twine, as seen in the detail

(Fig. 5). The two ropes must be carefully judged when fixing and binding, to see that the seat is level at the finish.

Galvanised 'Thimbles'

At the top end, near the crossbar, the ropes should be passed over a galvanised iron 'thimble', brought down and bound to the side ropes with tarred twine in a similar way to the seat ropes below, (see Fig. 6). For suspending the ropes from the cross rails, play for safety and use proper swing hooks. These are like bolts, and are threaded at the top for

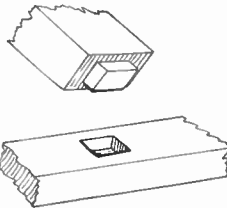

Fig. 4—How the uprights are stub-tenoned to the sills

nuts and washers, the lower end having good deep hooks.

The swing is now ready for erection. Having selected a suitable part of the garden, dig out two narrow trenches to receive the sill and struts. A depth of about 18ins. will be required, but if the soil is loose and at all inclined to hold water, then the trenches should be deeper, and it may even be necessary to put in some concrete round the struts to make a rigid job. Give the lower parts of the posts and struts a second coat of

creosote before dropping them into the trenches.

Before ramming the earth round the posts, test them with a plumb line to get them perpendicular and the crossbar perfectly horizontal. The wood above ground can be given two coats of good oil paint on top of a priming coat of lead paint. To help prolong the life of the ropes, it would be wise to take them down during wintry weather.

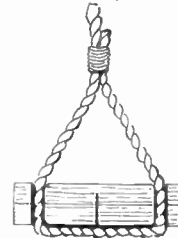

Fig. 5—How the ropes are fixed to the seat



Fig. 6—A 'thimble' with its rope in position

If it is found that the seat has a tendency to slip backwards or forwards in its looped ropes, then a strong iron staple could be put round the ropes on the underside of the seat and hammered in (see Fig. 5).

A little oil or grease should occasionally be wiped on the hooks and the 'thimbles', and some thick grease can be put on the bolts, etc., on the top of the crossbar from time to time. (341)

How to make a SIMPLE PLYWOOD BASKET

TO make this simple basket, mark and cut out two pieces of $\frac{1}{8}$ in. ply as shown in Fig. 1. Fret out appropriate initials in the centre of one or both panels, and drill three $\frac{3}{8}$ in. diameter holes as indicated.

The two side panels should then be assembled on $\frac{3}{8}$ in. diameter dowels, as shown in Fig. 2 and Fig. 3. The two top corner dowels are each 3ins. long, and the lower dowel is 2ins. long. Glue the dowels in place and allow to set.

When dry, cover in around the curved pieces with a strip of 1mm. ply, as shown in Fig. 4. A good glue joint is

necessary to prevent the ply separating later, and pins can be used to advantage for temporary tacking. Finally, trim the overlap of the 1mm. ply off and glass-paper the assembly down lightly. The joints may be strengthened, if desired, by binding around with tape well soaked in glue.

To complete the basket, a coloured cord handle is plaited between the two upper dowels, as shown in Fig. 5. Make this of convenient length and finish off neatly at each end. The basket itself can be polished, or stained and polished or, given a coat of bright cellulose lacquer.

Any of these final treatments are well worth the extra time and trouble.

The same layout and method of construction can be used for other materials, plastics in particular. Bright plastic sheet can be cut and cemented together, using wood dowels as before or plastic rod. Initials may be cut out of contrasting colour sheet plastic and cemented in place. Plastic sheet, when used for the two main panels, should not be less than $\frac{1}{8}$ in. thick. Another interesting variation is to make the side panels of ply and the covering strip of transparent plastic, cemented in place. (329)

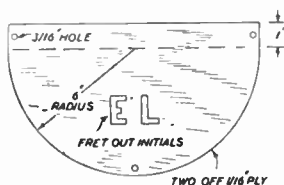

Fig. 1
The sides

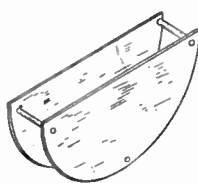

Fig. 2
Assembling with dowels



Fig. 3
End view of assembly

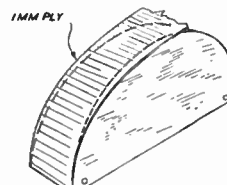

Fig. 4
Covering the bottom

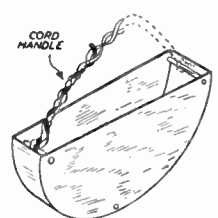

Fig. 5
Fitting the cord handle

Make a pair of ROPE-SOLED SANDALS

THE making of rope-soled sandals for camp use, etc., is an interesting and profitable hobby. Many camping enthusiasts like to make some of their own equipment, and this extends to articles of wear. The work can be done in the open, at camp, or can be carried on right into the winter months, making several pairs for sale or for personal use. The hard-wearing sandals about to be described have actually been made (the diagrams being sketched from the actual object), so readers can go ahead in perfect confidence that, pro-

At frequent intervals, knot off. Thus, should the thread get cut by accident or wear, the thread will be limited in its tendency to separate. In other words, applying a sewing machine analogy, use a lockstitch and not a running stitch. The stitches, obviously, must be strong.

To finish off, the rope (usually three-stranded) must be tapered off (Fig. 4). Unravel the strands for about 6 ins. Cut one off. Twist the remaining strands together for about half their length and then cut off another one. Bind the whole lot together and stitch in place.

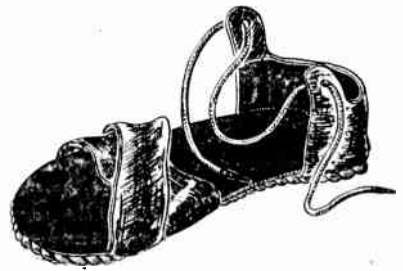

vided the instructions are followed, things will work out right. The holes in the heel pieces (for the laces) can be left just as plain pierced holes but metal eyelets will make a much stronger job, less likely to tear out, and mean only a minute or so extra work and almost negligible cost. The eyelets (which can usually be purchased from upholsterers stores, home crafts stores and the like), are in two parts: a short tube-like part and a washer-like part. When the tube-like part is pushed through the material and the washer-like part slipped over, a part projects, and this has to be riveted over. This is a simple matter if one has a special punch, but a very good makeshift (see Fig. 10) is to use a ball bearing. In the diagram (A) and (B) are the two parts of the eyelet, (C) is the material, (D) is a ball bearing and (E) is a hard metal surface. A sharp tap on the ball bearing with a hammer will clinch the eyelet neatly.

heels, you will require a pair of thin leather heels, marked off from the thick ones. As indicated in Fig. 7, the sole is 'sandwiched' between the thick and the thin heels, held with bifurcated rivets. In order to show this clearly, the heel piece has, in Fig. 7, been shown merely as a 'phantom'. The actual arrangement is as at Fig. 8.

Cross-Straps

In the drawing which heads this article, there are a pair of cross-straps to form the toe piece. These can be of leather or webbing and are sewn securely

(Continued foot of page 148)

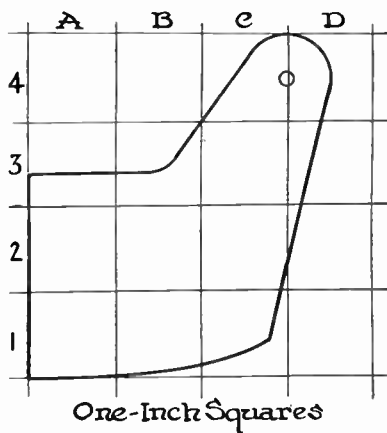

Diagram of the heel pieces

Heel Pieces

A squared-off diagram for the heel pieces is given but it is necessary to point out that this is but an average size which may have to be altered. Cut it out of brown paper first and try it over the foot. Thin leather is used, probably from an old leather music case, school-bag or something similar. Four pieces are needed, two for each heel. If leather is not available, alternative arrangements such as illustrated in Fig. 9 may be made.

Two heel pieces are stitched together as shown in Fig. 5. In Fig. 6, we see the heel piece being sewn to the sole which is upside down. After sewing, the sole is reversed, i.e. the heel piece is turned inside out so to speak. Especially for outdoor use, many readers will like to have a leather heel instead of merely a flat all-over rope sole. If you decide on a built-up heel, do not have the sole upside down (as in Fig. 6) when stitching on the heel piece, but have it the right way up, so that the heel piece goes under the leather heel (Fig. 8).

These leather heels can be bought ready-cut and this certainly saves a lot of cutting. In addition to the thick leather

vided the instructions are followed, things will work out right.

The basis of the sandal is coarse white clothes line as sold in, say, 20yd. lengths at all the Stores. For each sole you will want 3 or 4yds. (depending, obviously, on the size of the sole), but do not cut the rope until the sole has been fully wound (as in Fig. 1).

Before starting the winding, make a paper or cardboard pattern of the sole, tracing round from an existing sandal or slipper. Sandals are, of course, much roomier than ordinary shoes and very much broader.

Starting the Soles

To start the sole (alike for both feet), lay down about 4ins. of rope and then double it back on itself. Now make two complete turns around it and after this, carry the loop well down into the heel part (see Fig. 2). Continue winding until the sole is large enough.

As you thus form the sole, the rope is sewn together on the inside (i.e. feet side), using shoemaker's waxed (ordinary cotton is quite useless) thread and a tapestry needle. This short blunt needle can be obtained at most shops where wool and canvas, etc., for tapestries are sold. A large darning needle will serve. Just sew between the strands (Fig. 3).

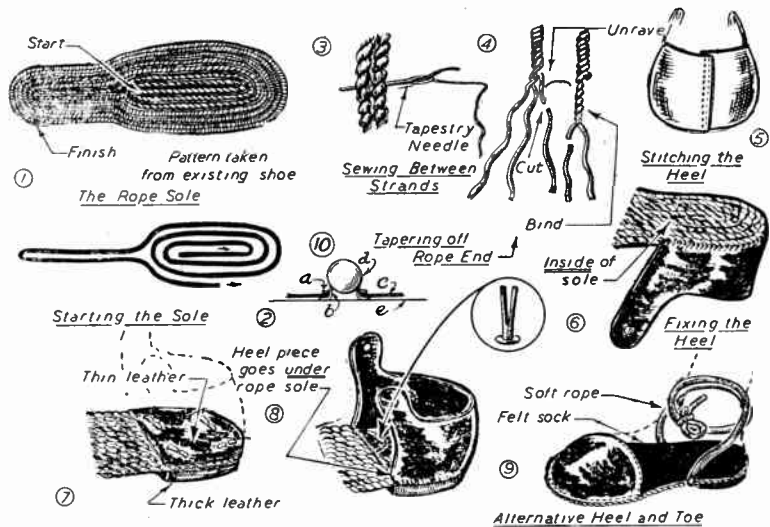

Drawings which explain the construction of the sandals

For roach, bream, dace, etc., FLOAT FISHING IS FUN

FISHING with float tackle for such fish as roach, bream, dace, chub, rudd, perch, carp, gudgeon, etc., is good fun during summer week-ends and holidays. Each year many would-be anglers take up the sport, and it is to these we address a few hints on various requirements to make a start. Later on you will doubtless add to your gadgets as experience leads you to more ambitious experiments.

All fishing tackle is expensive nowadays, so that you will need to practice economy. Therefore, keep your list of equipment to the necessities, at first. What comprises that list?

Rod and rod bag, line, casts, reel, floats, hooks to gut, basket, keep-net, landing-net, split shot, boxes for bait, bag for ground-bait, angler's knife, small pliers for pinching shot on cast, disgorgers for extracting hooks, plummet for plumbing the depth of water, and a tin of vaseline for greasing the line. You may also include float caps of rubber or quill.

Looks rather formidable, and it is possible to manage with just rod, reel, line and hook, but you will be handicapped unless you acquire a complete outfit.

Rods

Let us take the rod first. It is better to obtain a general rod that will cope with all the species mentioned. Get an all-round rod with cane butt, cork balance handle, greenheart or lancewood top, made in three joints, with reel fittings and 'bridge' or 'stand-off' rings. For bank fishing, such a general rod should be from 10½ ft. to 12 ft. long. See that your rod is light to handle. Choose it carefully.

Reels

There are many patterns of reels for float-fishing. The fixed-spool reel is up-to-date, but for the young beginner the ordinary wood or metal reel with revolving spool will serve. A useful type is the 'Nottingham' centre pin pattern, 3 ins. or 3½ ins. diameter. It should have a line guard attached. The narrow drum type is much in favour with match anglers. Another handy reel is the 'Aerialite' which is made of Bakelite and is fast replacing the old-fashioned wood reels for all types of float-fishing. There are other kinds, but they are expensive, and those mentioned will serve the beginner quite well.

Lines

The line, of course, is most important. For the tyro the best is an undressed plaited silk line for all kinds of bottom fishing. It should be not less than 30 yds. to 40 yds., speckled or green, size No. 1. (For delicate fishing as for roach, 2/0 will be useful). For heavy fish like bream, chub, tench, carp, a No. 3 or No. 4 will be of advantage.

Casts

You can buy casts nowadays of drawn gut, or such substitutes as Nylon, Luron, etc. Synthetic gut casts are made in one continuous length, without intermediate knots. We have found these very satisfactory. Ask for 'Monoflow' casts, strength 2x and 3x, 1 yd. in length. 'Luron' is also recommended, and also Nylon. The match angler uses casts as fine as 6x and 8x, but the beginner will find the stronger sizes from 1x to 4x more reliable for a start.

Hooks

For general float-fishing, few hook patterns are better than the 'crystal' hooks to gut or other material such as Nylon. You can buy all kinds of hooks ready tied to gut or similar, in short lengths, or, if preferred, in 1 yd. gut bottoms, as they are called. You can also get hooks tied to 1 yd. lengths of Nylon, etc. One advantage in using the short stuff is that when of a finer strength than the cast itself, and you catch your hook in a snag under water and have to sacrifice it by breaking away, you may retain the cast itself intact. It is more economical to lose hooks on short gut than to lose 1 yd. casts!

Other Patterns

Other patterns of hooks include the gilt, the round-bend, Kendal sneck bend, and the 'Model Perfect', etc. Hooks of whatever kind you use must be very sharp-pointed and of good quality. Sizes to be stocked run from No. 4 to No. 16, the smaller sizes for the small fish as dace, bleak, etc.

Gut and other casts may be had in various tints—green, sorrel, mist-blue, natural. We like mist-blue for general use, green when fishing weedy ponds.

Always test casts, and hooks to gut, carefully before using.

Floats

Floats are of many kinds. For fishing in

canals and sluggish drains a light crow quill is recommended. Porcupine quills are also useful. But for fast waters, the swan quill or goose quill is needed. On lakes and meres where it is necessary to cast long distances from punt or boat, a cork shoulder float or a barrel float are useful types, also for rivers having a good depth with swift current, as when barbel fishing in such spots.

Fine Fishing

Small floats for fine fishing include porcupine quill with small egg-shaped cork. Then we have the self-cocking float for roach, chub and barbel, which opens, and the weight can be adjusted with lead shot to suit any type of water, fast or slow. Celluloid floats are very light, as are those made of xylonite. For very deep swims, deeper, say, than the length of your rod, the 'slider' float is the thing; this pattern is designed to allow it to slide down the line on to the shots when you wind in, and so prevents the float coming into contact with the rod top.

A medium goose-quill, a crow quill, and a porcupine each about 4 ins. or 5 ins. long and a cork on porcupine about 1½ ins., will do very well for the beginner fishing in normal water, and in steady swims of medium depth; also for ponds and lakes for all kinds of fish save pike.

Other Items

Having dealt with the chief items, we turn our attention to the sundries. A basket, for instance, to hold your odds and ends. Some anglers swear by the seat-basket, which makes a capital hold-all, and also serves as a comfortable seat. Then there is the French wicker creel. However, if you have to economise, you can probably find a bass or bag at home that will suffice.

A disgorgers is essential, one with a hole or ring at the end so that you can attach a thin cord which in turn is tied to your button-hole. You have it handy then. The disgorgers, of course, is to extract the hook without damaging the fish.

You need an old duster or piece of rag to wipe your hands instead of using your handkerchief—after handling a wet fish! You ought also to have a landing-net, in case you have the luck to catch a whopper, and a keep-net in which to put the fish and keep them alive until the end of the day, when they are returned to the river. (318)

Rope-Soled Sandals—(Continued from page 147)

to the rope sole. The rope sole is afterwards covered with a felt sock tacked on. This can be either ready-made or else cut from an old felt hat, etc. Another piece of felt can be tacked inside the heel to prevent possible chafing. A gaily coloured lace completes the job.

Fig. 9, however, shows an alternative toecap and heel piece. The former can, if necessary, be of canvas. The latter is of soft cotton rope. A considerable number of variations are possible, however. One can use the cross-over toe straps with the type of heel shown in Fig. 9, or the

type of heel piece as shown, for example, in Fig. 8 with the toepiece as indicated in Fig. 9. One can use toe and heel pieces from old sandals, the soles of which have worn out, but other parts remaining in fair condition. (316)

The children will want this WORKING TOY ROUNDABOUT

THE working roundabout shown in the sketch should delight the heart of any youngster lucky enough to have one made up.

It stands $7\frac{1}{2}$ ins. high and is 8 ins. square at the base. It is worked by means of a cross spindle in the base, around which is a strong belt, or an elastic band, directly looped up to a central column. This central column carries the conical top, from the underside of which hang the four wires and the horses.

It will be seen that, when the whole top is revolved, the horses and wires swing outwards in quite realistic fashion.

One end of the cross spindle projects beyond the face of one of the sides of the base, allowing the spindle to be turned by finger and thumb quite easily. Some workers, however, may choose to fit a small crank, with handle to make its action, perhaps, somewhat easier.

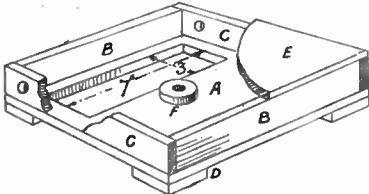

Fig. 1—The base

The formation of the base is shown in Fig. 1, where (A) is a piece of wood $\frac{1}{4}$ in. thick and $8\frac{1}{2}$ ins. square. In this piece there must be cut an opening measuring 7 ins. by 3 ins., to facilitate the easy handling of the belt when looping it round the two spindles. On the floor (A) is glued a 1 in. disc of $\frac{1}{4}$ in. wood with a $\frac{3}{8}$ in. hole in the middle. This is to take the lower end of the centre spindle

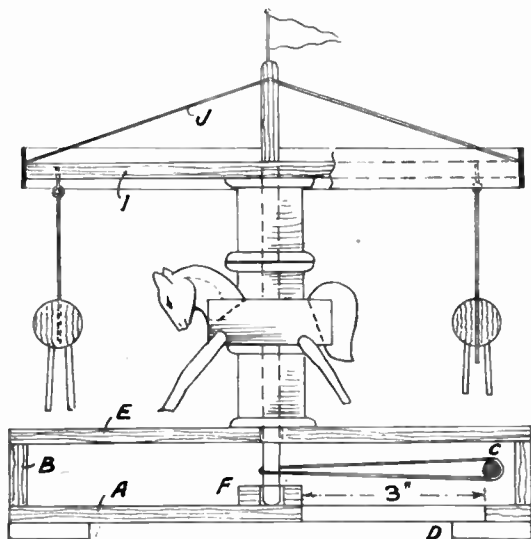

Fig. 3 Sectional drawing of the whole toy

as seen in the sectional diagram Fig. 2.

Looking again at Fig. 1 you will see that the sides of the base are made up of the two pieces (B), measuring 8 ins. long by 1 in. wide, and the two pieces (C), which are $8\frac{1}{2}$ ins. long and 1 in. wide. Wood $\frac{1}{4}$ in. thick is used throughout for all parts of the toy.

In the two sides (C) holes must be cut as shown, to take the $\frac{1}{2}$ in. diameter cross spindle. In Fig. 2 is shown how this spindle is connected up with the belt which runs around the upright spindle.

The top of the base consists of a piece of wood the same size as the floor, but the only opening in it is the central hole, made a full $\frac{1}{2}$ in. diameter to take the upright spindle. The base is finished by the addition of four corner feet (D), which are plain $1\frac{1}{2}$ ins. squares of $\frac{1}{4}$ in. wood.

The Centre Column

Next make the column which stands upon the base, and which supports the top and cone of the roundabout. Here are brought into use—and they suit the case admirably—three ordinary cotton reels of the type shown in the sectional diagram in Fig. 3. To help the worker, we give as an enlarged detail in Fig. 5 the size of one of these reels, so that the upper part of his model may be proportionate to the base.

First, glue together two of the reels

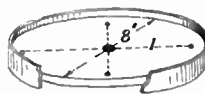

Fig. 4—The top

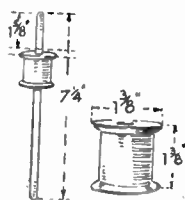

Fig. 5 The upright spindle and cotton reels

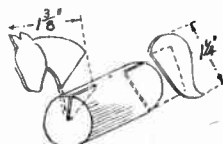
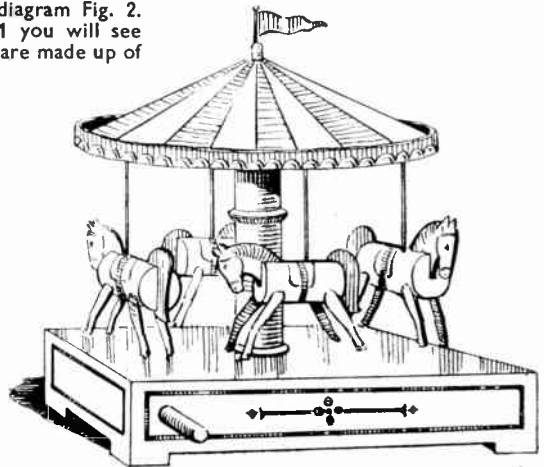

Fig. 6—Details of the horses



and then glue these to the top (E) of the base, making sure that the holes in the reels coincide exactly with that cut in the top of the base.

Now lay the work so far finished aside, and proceed with the revolving top (I) and its cone. Cut a circle of wood 8 ins. in diameter, with a $\frac{1}{2}$ in. hole in its centre as Fig. 4, and round its edge glue a strip of stout card to form a

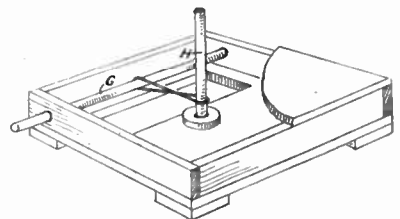

Fig. 2—How the model works

valance to finish off the conical top. Short brass fretpins may be driven in at intervals round the card to make a firm fixing.

Next, draw on one side surface of the top the two dotted lines shown in Fig. 4, these being, of course, at right angles to each other. At a distance of

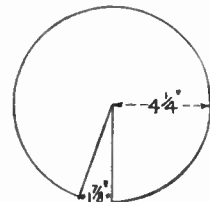

Fig. 7 Correct shape of the cone cover

$\frac{1}{2}$ in. in from the outer edge of the circle of wood, and on the dotted lines, bore fine holes and run in the four screw eyes seen in Fig. 3, which take the upper ends of the wires supporting the horses.

Now, take up the third cotton reel and glue it to the underside of the disc of wood, here again making the two holes coincide with each other in a similar manner to the top of the base.

The upright spindle is next prepared, and a piece of $\frac{1}{2}$ in. round rod is again used. Cut the rod to the length shown in Fig. 5, and push it through the reel and the disc (I) to the measurement given. The hole in the reel will be found to be a little larger in diameter than $\frac{1}{2}$ in., and, therefore, a little wedging with small pieces of wood must be done to make a firm fixing.

Next prepare the wires which support the horses. Cut three pieces of medium thickness wire to 3ins. lengths, and form a loop on one end of each piece to engage the screw eyes in the top disc. Do not actually fix them to the eyes, however, until the horses have been made and the wires connected to them.

Making the Horses

The making of the four horses is a fairly simple job. Two methods of making them are described here, and the simplest is to just outline the horses in pencil on to plain flat pieces of $\frac{1}{2}$ in. or $\frac{3}{4}$ in. fretwood and saw round them with the fretsaw. A little shaping could be done with chisel, knife and file to give reality to the otherwise flat bodies, etc.

The method of making the horses

shown in our diagrams gives a much more realistic effect and, of course, entails a little more work. They will, however, pay for the extra time and trouble expended.

For the bodies of the horses, get a piece of $\frac{3}{4}$ in. round rod 8ins. long, and cut it into four 2ins. lengths. Clean off the cut ends and make them smooth, then make two sloping saw cuts, one each end of the bodies to receive the head and the tail (see Figs. 3 and 6). The correct amount of slope can be judged from the former diagram. The saw-cuts should be made with a fine tooth tenon saw, so that the width of cut will be sufficient to receive the head and tail which are made from thin plywood or stout card, the former being preferable.

The Heads and Tails

The outlines of the head and the tail are given in Fig. 6, and the two measurements shown should be sufficient guide to get their proportions nearly enough correct to suit the body. Glue the parts in the body slots and then make the four simple legs from wood or card as suggested for the head.

Shape the body slightly, where the legs are to go before gluing them on. Having completely made up one of the horses, take this as a guide for the remaining three. Paint the horses up in bright paint or enamel and show saddle

and girth band and any other item all in paint to get as realistic an effect as possible. Bore fine holes down through the bodies of the horses, and push the wires through, making a small turn-up underneath to hold the bodies rigid.

Shaping the Covers

To get the correct shaping of the cone cover, which is to fit on the circular top, as (J) in Fig. 3 and in the sketch, see the diagram Fig. 7. In this diagram is shown the correct manner of cutting the material—stout card—to fit the top and the projecting upright spindle properly. Describe a circle with the compasses, using the radius measurement given, then set out the vee piece $1\frac{1}{2}$ ins. wide as shown. Cut this vee piece out, but leave about $\frac{1}{4}$ in. as a tab on one side for lapping and gluing underneath to hold the cone well together. Draw the divisions on the cone and paint in bright colours. To do this successfully, take a pair of dividers, or a pair of compasses will do, and step round with these, say, twelve divisions. This will ultimately give six divisions of each colour, e.g. red and cream as suggested in our sketch. A little flag, made of stout paper or card can be threaded on a stout pin and inserted at the point of the spindle.

It now only remains to assemble the whole toy and clean up and paint all parts not already painted. (304)

Some 'Inside Information' on TRICK TURNING

THE toyshops nowadays are chockful of model animals, etc., cast with extraordinary precision in plastic. No doubt the shortage of wood has been one reason for the increasing use of plastics though, obviously, the ease with which plastics can be cast and moulded has much to do with it.

Yet a few decades ago, Noah's Ark sets in toyshops were provided with solid wooden animals. It seemed, at first, that they were each carved by hand—a legitimate and, indeed, worthy procedure, if only one or a few sets were required, but hardly a commercial method when—as was the case—the animals were turned out in great quantity to sell cheaply.

All Turned

Actually they were turned on a lathe. At first mention this seems incredible, as, for example, a model cow or elephant has no resemblance to, say, turned wooden skittles or cricket balls. Yet the diagrams show how this was done.

First a ring of wood, peculiarly shaped was turned out. Fig. 1 shows such a ring with a segment taken out to show details. It will be appreciated that if a thinner segment be cut, a model animal results, needing only a few deft cuts with a sharp knife to take off square edges and to open out between legs, etc.

Fig. 6 shows, but in a somewhat

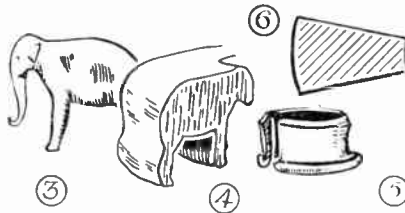
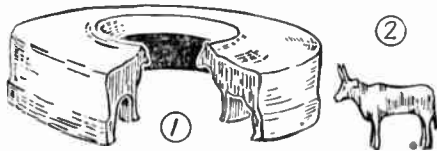

exaggerated way, that the animal was, in plan view, of somewhat segmental shape but this was hardly noticed especially, as just mentioned, when simple shaping and rounding by means of knife cuts was made.

Fig. 4 shows how the elephant (Fig. 3) was turned. Naturally, there was a limit to what one turning could do. The elephant's tail, for example, was turned separately (Fig. 5) and afterwards stuck on.

Trick Vase

Fig. 7 shows another turnery novelty. We have what appears to be a rather

Victorian-looking vase for flowers. Yet when arranged to cast a shadow, this shadow takes the form of a silhouette portrait of some recognisable person—usually of some famous statesman, military leader, etc.—prominent at the time such vases were in fashion.

We mention these items as a matter of general interest but it is quite possible that some readers, equipped with lathes and necessary skill will 'have a go', especially at the shadow vase which can be made quite small—about the size of an egg cup. A careful profile drawing—possibly taken from a photograph—is first needed. (313)

Build this solid scale

MODEL RUSSIAN FIGHTER

THIS drawing is of the Russian MIG-15, one of their standard jet fighters, reported to have seen service in the Korean battle zone. Top speed is well over 600 m.p.h. and the aircraft is also very manoeuvrable. Characteristics of this machine are the cigar-shaped fuselage and the heavily swept back wings and tail unit.

The Fuselage

Start the model by marking out the fuselage side elevation on a piece of wood $\frac{7}{8}$ in. square and $4\frac{3}{4}$ ins. long. Any soft wood which can readily be carved will do, such as balsa, pine, and so on. Cut a vertical slot in the block as indicated and then fret out to side elevation shape. Mark on the plan shape, and cut or fret to this outline also.

The next stage is to carve the fuselage block to circular section. The cross section should be a true circle from front to rear, and card templates can be used to check the work as it proceeds. Finish off by glasspapering down really smoothly, and then treat with at least two coats of wood filler, glasspapering again between each coat.

The two wing panels are fretted out of $\frac{1}{4}$ in. material—not plywood, for this will be impossible to carve to section. Each panel should be tapered in thickness towards the tip and then carved to aerofoil section. Again check with the aid of card templates.

The fin is cut from $\frac{1}{4}$ in. wood and the tailplane from $\frac{1}{4}$ in. material. The fin is carved to a symmetrical section and glasspapered smooth. The tailplane is also carved and glasspapered to a symmetrical section but leaving the centre portion square. This fits into the slot in the fin and the two components are glued or cemented together, after making sure that they are square with one another.

Cut the joining spar from $\frac{1}{4}$ in. thick material. This fits in the slot in the fuselage, and each stub spar protruding is used to locate a wing panel. Glue the wings panels in place accurately and leave the assembly to set. The fin, with tailplane mounted across it, is next cemented to the rear of the fuselage in a truly vertical position, and the basic assembly is complete.

Fillets of plastic wood should next be laid over the wing-fuselage, fin-fuselage and fin-tailplane junctions, and the whole model can then be glasspapered down perfectly smooth and treated with wood filler. Continue this process until all the surfaces are glass smooth, then score on lines representing the panel lines, and the outlines of the control surfaces. Various detail components can later be added.

The boundary layer fences or gates on the upper surfaces of the wings (two on each wing) can be cut from thin card and cemented in place. Shape the radio mast from a sliver of wood and push and cement this in place. The three guns under the nose of the fuselage can be made by fitting balsa fairings around a small length of wire, glasspapering to

short length of dowel with a bent pin for the axle. Push the pin into the dowel and bind with cotton and cement. The main leg should be pushed into a small hole drilled in the undersurface of the wing and cemented in place. The small strut is made from a pin, and the undercarriage doors can be made from thin card, glued to the dowel and to each other. A length of wire pushed into the leading edge of the starboard wing to represent the pivot head then completes the main detail.

Colour Scheme

Colour scheme of the MIG-15 is aluminium (metal) finish all over. Use a good quality aluminium paint, and it will be possible to polish the surface with metal polish and give it a fine gloss,

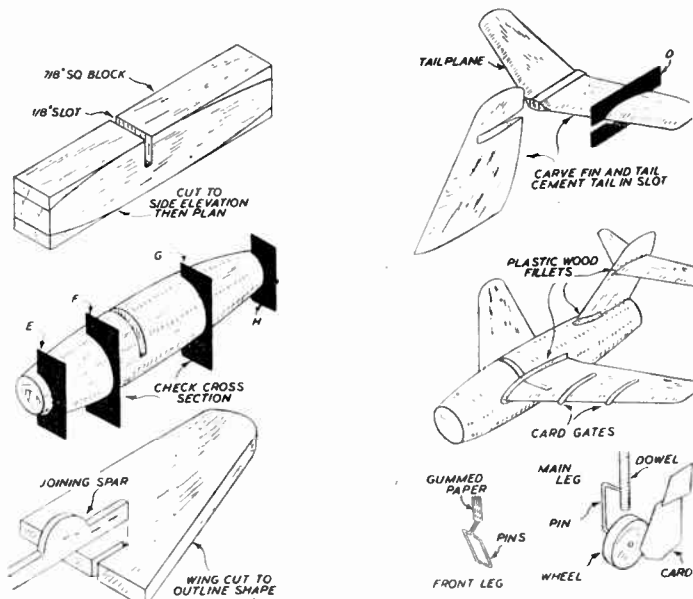

Drawings showing stages in the construction of the model

shape and cementing in place. The cockpit canopy can be bought, or moulded from thin plastic, or carved from wood, painted and cemented in place. In any case, it is best to leave the fitting of the canopy until the model has been completed and painted.

If the undercarriage is to be mounted in the 'down' position, suitable legs can be made from pins, paper and dowel. The front legs are made from two pins, cranked as shown in the lower sketch. Solder the upper part of the two pins together, then bind with three or four layers of gummed paper, and push in place in the fuselage. The nosewheel doors are cut from thin card and cemented in place.

Each main leg can be made from a

just like metal in appearance. Plenty of patience at this stage is necessary for a really first class job. The main secret lies in applying the paint over a surface which has been properly filled and glasspapered down to a smooth, hard surface.

Insignia

Insignia consist of red stars (five pointed), each with a thin white outline. These are located one on either side of the fin, one on each side of the fuselage immediately aft of the wings, and one on each wing tip, above and beneath. The lettering MIG-15 (Russian equivalent) is generally added on each side of the fuselage below the front of the canopy, in red or black. (327)

Complete plans

for this model appear
on page 159.

Scale of the drawings is

$\frac{3}{16}$ in. to the foot.

Making a pair of BALANCE SCALES

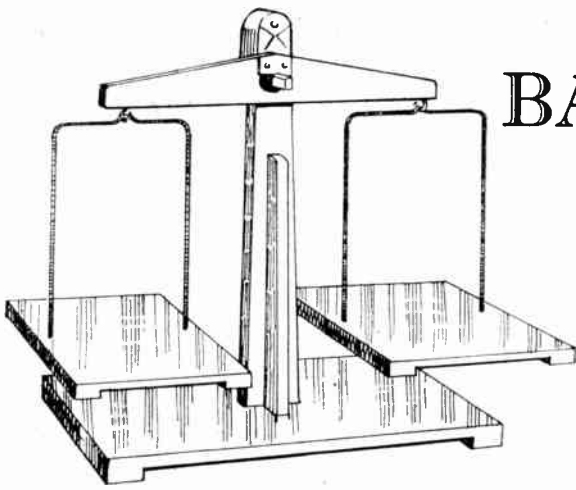

A PAIR of balance scales is a useful article to have in the home. For photography and chemistry it is essential, but it is also useful for such things as weighing small packets for the post or for general domestic use.

The simple balance illustrated can be made from spare pieces of fretwood and will be accurate enough for most purposes. The base is a plain oblong piece of wood measuring about 12ins. by 6ins. If a smaller balance is required, one having, say, a base about 6ins. to 8ins. long, this would not be difficult to make, as all the parts would be proportionate to those shown here, and the balance principle would remain the same.

The upright standard and its two struts, one at the front and one at the rear, can be cut from fretwood about $\frac{1}{2}$ in. or $\frac{3}{8}$ in. thick as Fig. 1. The main upright or standard has a tenon cut on its base which should fit snugly into a corresponding mortise. The struts are simply glued on. A piece of $\frac{1}{2}$ in. thick wood should be glued to the back of the standard, just above the top of the rear strut, and trimmed to the same shape as the standard.

The narrow slot cut near the top of the standard is intended to accommodate the knife-edge on which the beam will rock, this knife-edge may be a cut from a piece of hard wood such as oak or beech, or may consist of a piece of

stout gauge strip iron about $1\frac{1}{2}$ ins. long and $\frac{1}{2}$ in. wide with its upper edge filed to a sharp ridge. The slot should be cut a tight fit for it, so that when it is tapped in position it will fix itself rigidly.

Care should be taken over the fixing so that the knife-edge or that part which extends beyond the front face of the standard juts out quite square, and truly horizontal. Fig. 3 shows these details.

In Fig. 2 a pattern of the beam is given. This must be redrawn full size on to the wood. At Fig. 4 is a group of parts marked (A) and (B), and these should be cut from brass sheet or stiff tinplate, the former material being preferable. Plates (A) and (B) should be screwed either side of the beam with

their lower edges level with each other, and on the line shown drawn across the hole 1in. from the bottom (see Fig. 2).

If (A) and (B) are fixed together before the holes are bored, and then the holes drilled through both together, both plates can be fixed to the beam with one pair of small bolts. Across the centre of the bottom edges file a tiny notch, to drop over the knife-edge.

At about $\frac{1}{2}$ in. from the ends of the beam, put in small screw eyes to take the wires of the scale pans. The pans are pieces of fretwood each about 5ins. by 4ins., and with cross stiffening pieces about 1in. or so wide and glued on to the underside. Each pan is suspended by wire bent up to the shape shown in Fig. 5. The wire hangers pass through holes in the pans and are bent back a little underneath to prevent them slipping out.

The beam can now be hung on the knife-edge and the pans suspended from the hooks.

Plate (C), Fig. 4, is shaped to the top of the standard and fixed with a round-headed screw.

The pans can now be balanced. Place on one of them a small screw or two until the pointed tips of plates (B) and (C) coincide, or nearly so. Then take off the pan and drive the screws in underneath. A little careful filing of the heads of the screws can be carried out until the beam balances correctly.

Weights will be needed to suit the purpose for which you have made the scales, and no doubt some suitable ones can be purchased. If, on the other hand great accuracy is not important, a quite useful and fairly accurate set of weights can be made from pieces of fretwood and chips of lead or lead shot.

A suggestion for some of these home-made weights is shown at Fig. 6. Here the weights consist of discs of fretwood, three to each weight. The middle disc should be rather thicker than the other two discs, and it should have a portion of its interior cut away as shown. The lower disc should be the same diameter as the thicker one, and it is to be glued on. The top disc is rather less in diameter, and after the lead has been inserted in the 'box' the top disc is screwed on. All the weights must, of course, be properly tested against real weights. (303)

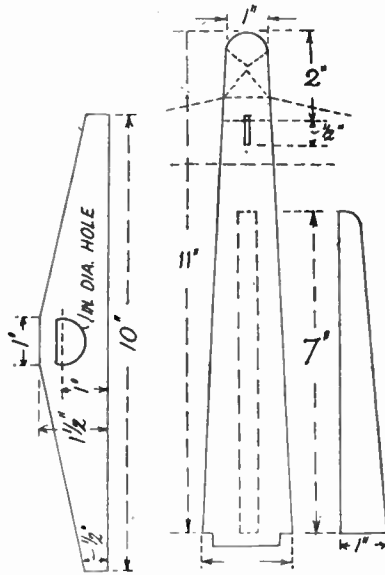

Fig. 1—The standard and struts.

Fig. 2—Details of the beam

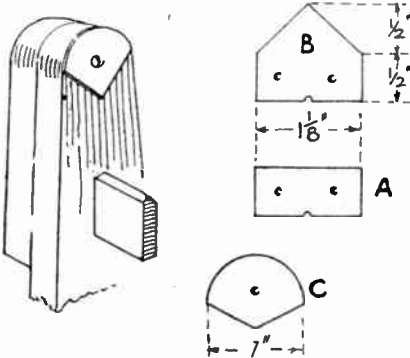

Fig. 3—The knife-edge balance

Fig. 4—Brass parts

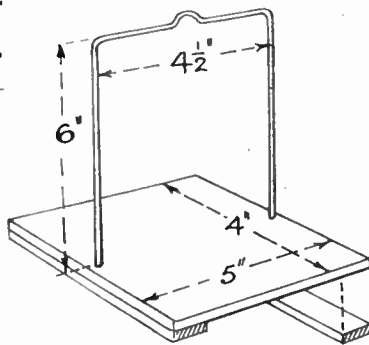

Fig. 5—Construction of the pans

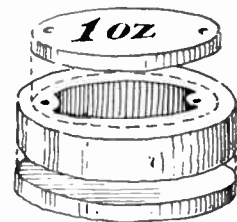
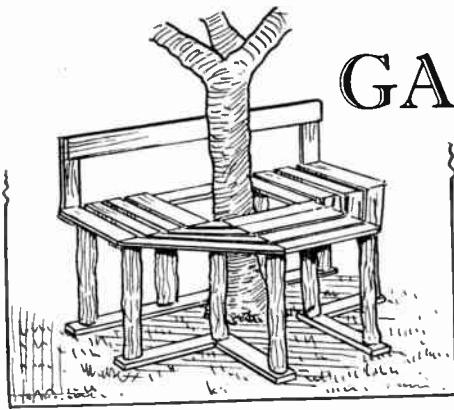

Fig. 6—Suggestion for weights

How to make a GARDEN TREE SEAT



WHERE readers have a suitable tree in their garden, it is a good plan to build a seat round it, for a comfortable rest—weather permitting, of course. Often such a seat is designed to encircle the tree, but a slightly different idea is shown in the drawing—here the seat rings only part of the tree, enabling a short back rest to be included, which permits of lounging, as well as sitting. On a nice sunny day, given a book, and the leisure, what could be better under the shade?

Rear of the Seat

Make a start on the work by constructing the rear portion of the seat,

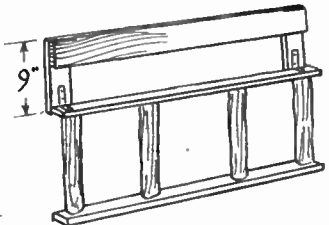

Fig. 1—Rear part of the seat

shown in Fig. 1. Dimensions for this are given in the plan view of the seat, and in detail, Fig. 3, the latter showing the proposed height. Size of timbers are given in the cutting list, and need not be repeated here. Cut the ground and seat rails to length given first. The legs can, for economy's sake, be sawn from rustic wood of $2\frac{1}{2}$ ins. diameter. See this wood is well seasoned before using. The length of the legs shown at (D) (Fig. 3) does not include the amount needed for a bottom tenon, so the needful extra must be added.

Having cut the legs to length, upend them, and at the bottoms saw away to leave tenons, 1 in. by $1\frac{1}{2}$ ins. as at (C). In the ground rail, at a distance from the ends of $1\frac{1}{2}$ ins., cut the necessary mortise slots for the end legs. For the inner pair of legs, cut the mortises $12\frac{1}{2}$ ins. away from the end ones. Glue the legs in, using a casein glue for preference, then nail the long seat rail over. To support the back rest, screw the short uprights to the edge of the seat rail, one at each end, and screw the back rest itself across them, as in the sketch. A

little extra support is advisable here, so steel furniture brackets are suggested, which can be screwed at each end. Link the horizontal arms of these flush in the seat rails, to offer no projection for the slats to be fitted on afterwards.

Placing the Back

Now take a look at the plan of the seat, and note how the back part, just described, is placed, with two right-angled supports in front, to complete what we may describe, as the seat framework. The construction of the rightangled supports will be seen at (A) in Fig. 3. The short ground and seat rails are halved together at true right-angles, as at (B) and glued and nailed. Mortises for the legs are cut in the ground rails at $1\frac{1}{2}$ ins. from the ends, and in the centre of the joint. The legs are then glued and nailed in, as before, with the seat rails well nailed above.

Alternative

Where the need for economy in wood is not so necessary, the pattern of leg,

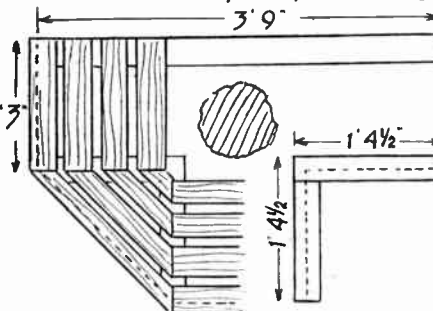

Fig. 2—Plan view of the seat and legs

shown at (D) can be substituted for the rustic wood, if preferred. These legs are cut from $2\frac{1}{2}$ ins. square timber, provided with the needful bottom tenons, of course, and with the corner angles stop chamfered for effect. Before proceeding with fixing the seat slats, the ground may need levelling round the tree. Place the parts made in position, as in the plan view, Fig. 2, and test with a spirit level. See these parts bed down satisfactorily, and all approximately level with each other. This being made right, cut the straight slats, not the angular corner ones, to the length given.

Now nail the slats across from the back part at the rear of the tree to the rightangled supports at the front, noting that these slats, while covering the rear seat rails, only come half way over the front ones, to leave room for

fixing the angular corner slats later. Nailing of the front slats can now take place, connecting the rightangled supports. Finish off the work by fixing the angular slats across the corners, these being carefully measured on the job, and cut at their ends to 45 degrees.

GOOD NEWS FOR AEROMODELLERS

During the coming weeks of the summer we shall be publishing a number of articles (with $\frac{1}{2}$ scale drawings) on the construction of flying model aircraft. Two rubber-powered models are already in course of preparation, and we hope, also, to give details for a power control-line model, and others, at later dates.

These articles are written by an acknowledged expert, and no aeromodeller should miss them.

The exact lengths of these corner slats cannot conveniently be given, so are not detailed in the cutting list, an approximate length of timber being included, from which they can be sawn. It should be mentioned that the slats should overhang the rails at the front by 1 in. and be spaced an equal distance apart, say, $\frac{5}{8}$ in. It is best to round off the front edges of the outer slats, and also to glasspaper the upper edges of all; it makes the seat more comfortable. This rounding of the sharp edges also applies to the back rest.

Creosote Well

The ground rails should be well creosoted, as a protection against the weather, the remainder can also be so treated, but a better appearance results if painted green or white, or just varnished. (294)

CUTTING LIST

Rear rails (2)—3ft. 9ins. by 3ins. by 1in.
 Front rails (8)—1ft. 4 $\frac{1}{2}$ ins. by 3ins. by 1in.
 Back rest—3ft. 9ins. by 4ins. by 1in.
 Back supports (2)—9ins. by 3ins. by 1in.
 Seat slats (12)—1ft. 3ins. by 3 $\frac{1}{2}$ ins. by $\frac{5}{8}$ in.

For angular slats—11ft. run of $\frac{5}{8}$ in. by $2\frac{1}{2}$ ins. wood.
 Legs from rustic wood, or 14ft. of $2\frac{1}{2}$ ins. square deal.

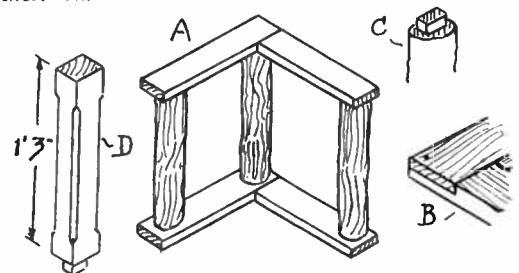

Fig. 3—Details of the legs

Do away with the 'brass fittings' by MODERNISING A BEDSTEAD

THERE are still a large number of old fashioned iron bedsteads in use, and although they may be in quite good condition, their owners would in many cases like something more modern. Expense may have been the reason for not changing, or, perhaps, it was the idea of parting with an old favourite.

Neither of these causes need prevent anyone from having a smart modern design and still retain most of the old framework. The majority of these old bedsteads are made of tubular iron which makes the conversion quite easy.

Effective Designs

Very many effective designs can be used and the time and cost of doing the job can be kept quite low. A typical iron frame bedstead is shown in Fig. 1, and although this type was greatly favoured by our grand parents, the modern wood panel is now very popular and more in keeping with the bedroom furnishings of today.

Besides fitting in better with present-day design, the lower head, and especially the foot, of the bed greatly helps to make the bedroom look much larger and more dignified.

Provided the old bedstead is made of tubular metal, and most of them are, then the job will be quite easy. The first thing to do is to cut off all unwanted metalwork, and then into the tubular feet is built up the wood panelling forming the head and foot boards. No hard and fast rule can be laid down regarding where to make the cuts, as the design of the bedstead will determine this. For instance, in Fig. 1 four cuts were necessary, and these are shown marked (A).

In Fig. 1 the hole in the tube forming the foot is 4ins. deep, but this will vary with different designs. In order to make a sound job it should not be less than 4ins., but may be anything over this.

Not much difficulty will be found in cutting the metal if a hacksaw is used, but keep clear of any cast mouldings that may be used to ornament and hold together any part of the framework as

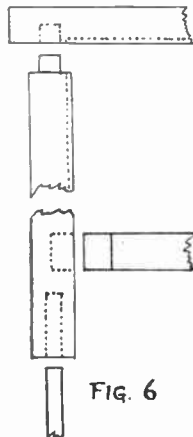

FIG. 6

How joints are made

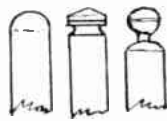

FIG. 7

Designs for tops of end posts

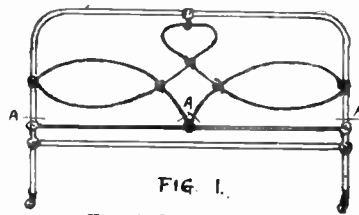

FIG. 1.

The old fashioned bed

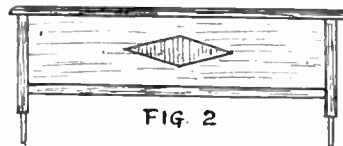

FIG. 2

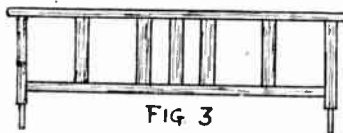

FIG. 3

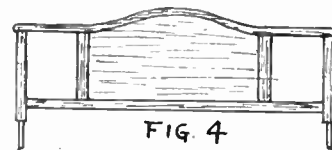

FIG. 4

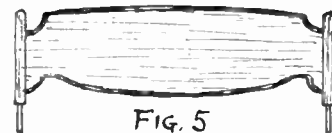

FIG. 5

Figs. 2-5—Suggested schemes for modernising

they are made of cast iron and would soon ruin the saw.

When all unwanted parts have been sawn off, the ends of the tubes should be levelled off and any rough parts smoothed with a file. A final touch can be given with one or two grades of emery cloth, which can be followed with a coat of black enamel to match the remainder of the framework. This not only improves its appearance but keeps it from rusting.

The entire head and foot panels are built up on to a pair of wooden posts made to fit into the tubular feet of the bed. The size of the holes will be somewhere in the region of between 3/4 in. and 1 in. diameter.

Draw a Plan

Draw up a rough plan of the panels and do not rely upon a haphazard design. Try to keep the pattern of the existing bedroom furniture in mind when doing the planning and try to follow its lines as nearly as possible.

There are two methods of making the end posts, the best of which is to make each in one solid piece. An easier way is

to fit a piece of dowel rod into the tubular foot and also into the wooden end posts.

Taking the latter method first, cut four posts to the length required. A good size for the top pair is 15ins., while for the foot pair 7 1/2 ins. will generally be found enough. If the posts are to be square, 1 1/2 ins. will usually be sufficient but should you decide to have round ones, they ought to be slightly larger in section.

Drill one end of each post to a depth of about 3 ins. to take the dowel rods and glue these in firmly. The dowels should fit into the holes tightly and they need to fit into the tubular iron bedstead legs fairly tightly, too. When drilling the posts see that the holes are upright, otherwise the finished panels will lean over and look amateurish.

Plywood forms a useful material for the panels, and Fig. 2 shows a simple but effective design that could be carried out quite easily. The top and bottom bars are made of 1 1/2 ins. by 1 in. wood, the top one laying flat on the end posts, while the bottom bar is fixed upright.

Both bars have mortise and tenon joints to fix them to the posts, and these can be cut to a depth of about 3/4 in. The top bar may be left plain or else a moulding may be worked round its edge as shown. Fig. 6 shows in detail how all the joints are made and fitted.

No definite measurements can be given as bedsteads vary so much in size, but the best way of working is to lightly tap the posts into their respective tubular feet and then to measure up carefully.

The ply panel is fixed by cutting a 1/4 in. groove in the bars and two end posts and gluing up securely. An overlay or some other form of ornament can be attached to the panels if desired.

The design shown in Fig. 3 is made up in a similar manner to the last, but instead of a plywood panel, thin slats of wood are used. These are best fixed by cutting grooves for each one, and they may be of any width and any number may be inserted.

Pleasant Variation

A curved top bar forms a very pleasant variation and should not be too difficult to make. It can be either 1 1/2 ins. wide and laid flat as the previous ones, or it can be cut from a 1 in. thick board and let into the end posts like the bottom bar.

The entire space may be panelled like Fig. 2 or just the centre part as shown in Fig. 4. When the top bar is let into the sides of the end posts the tops of these posts can be ornamented in quite a variety of ways. Fig. 7 gives a few suggestions which are suitable for this purpose.

Some very beautiful ends may be made by using much thicker panels of solid wood; walnut and mahogany being

(Continued foot of page 156)

How amateur photographers can AVOID COMMON MISTAKES

It has quite frequently been mentioned in these articles that it is possible to obtain 12 good negatives on a roll of film of 12 exposures, or 8 on one of eight exposures. It is, undoubtedly, a splendid record, for, being 100 per cent, it must be unbeatable, and, consequently, some folks are inclined to be sceptical.

If you carefully examine each negative from your next spool (whether you have developed it yourself or had it 'D and P' round the corner by the local chemist), and find any that are not good, you should ascertain exactly what went wrong in your calculation or manipulation. If you can do this, then you are not likely to repeat the mistake, and you will be taking an important step towards that 100 per cent.

Too Haphazard

In the course of many years' experience in judging competitions and handling many thousands of amateur's prints, I have always been convinced that the great majority of amateurs, many of them keen and enthusiastic in the hobby, are far too haphazard in their methods. They are very much inclined to leave everything to the camera and to chance it. That word 'chance' is definitely responsible for a lot of failures and semi-failures. I am quite sure that a few seconds' thought before pressing the

trigger would produce a better result, and, in some instances, prevent the exposure being made.

This is not only my opinion; it is recognised by a large number of those engaged in various branches of the trade connected with the amateur side. Just recently, a man who had spent all his working life in photography made the startling remark that eight out of every dozen exposures made by amateurs were 'spoils'. This seemed to me to be a rather extreme estimate, but he would not give way. On the contrary, he was so sure of his judgment that he added this remark: 'If the quality of the negatives was to be compared with those submitted for exhibiting in the main photographic exhibitions, then the number of spoils must be unquestionably higher'.

Well, here we are at the commencement of another season, and it is up to each one of us getting enjoyment out of this most interesting hobby to do everything possible to get our average up to at least ten good results out of every dozen exposures. So let us consider some of the causes of failure.

Do not Blame the Camera

First, let us clear our minds of any blame relating to the camera or films and papers. The quality of present-day apparatus and material has never been higher. If by chance something has

gone wrong with the camera and it is not functioning as it ought, even then it would be as well to make sure first of all that the fault is not with the way we are handling it, rather than grumble at the makers.

Quite a common experience, especially among early beginners, is to find that the film is sticking and refuses to wind, and so allow another section to be brought into position for the next exposure. That is no fault of the camera. It is due entirely to the manner in which the roll of film was placed in the holder at the start. Instead of giving just that little extra care and seeing that the end of the cover paper of the film was inserted squarely in the slit of the empty spool, it was simply pushed through and left at that. Then, when exposures were being made and the winder started to function, the cover paper began to find its way over the disc of the spool, and, eventually, so much of it got over that the winder became tighter and tighter until it very naturally refused to budge.

Force is Useless

It is no use trying force to make it shift. That is very risky, for it is possible to do more damage. The remedy is to wait until it is possible to get into a darkened room, first taking a note of the number on the back of the spool, then to open the camera, remove the spool, rewind it on to its original spool



Two illustrations of Loch Katrine. The left hand picture shows the difference caused by careless trimming of the print—the horizon is running uphill!

and then carefully re-insert the end of the cover paper on the open spool. Replace the back of the camera, switch on the light, and wind the film until the number that is due for exposure is revealed.

Curious Markings

Some negatives in your collection may have curious markings, such as flashes of a darker colour than the surrounding image. Sometimes these occur on the sides of the negative. Usually they are an indication that light is creeping in, and in many instances this can be traced to allowing the camera to be out of its case for some time and exposed to sunlight. It may be due to a little hesitancy just before making the exposure. When you are ready to expose, and not before then, is the time to place your finger on the trigger. It is easy to give a slight movement to the trigger and thereby let a tiny shaft of light through.

The markings on the slides can often be prevented by making quite certain that the back of the camera is right home and properly fastened after recharging with a new spool of film. If the marking appears on every negative, and in the same position, then the trouble is probably caused through a very tiny pin-hole somewhere in the body or the bellows of the camera or in the lens panel. If you cannot find the defect yourself by holding the lens, or front, part of the camera to a light and having the back open to enable you to carefully scrutinise every nook and corner of the inside; then take a few of the negatives and the camera to the nearest photographic dealer.

Every amateur knows that a large number of our early failures are the result of errors of exposure, and it is not the intention to dwell on this problem now, except to advise every reader to get an exposure meter before making the first photographic excursion of the season.

There is no real reason why you should go in for one of the expensive photo-electric meters. These are exceedingly good for the professional who is specialising in some particular subjects, but for the beginner, the calculator, or the visual types of meters are a great help in overcoming the difficulties attending the consideration of light values, subject and speed of film, etc. Johnson's catalogue gives illustrations of several types ranging from 2/6 to about 12/-. The great value of any meter is that its use means that you are no longer taking chances. And this, of course, means that you intend to reach that 100 per cent good results.

Modernising a Bedstead—(Continued from page 154)

specially suitable for this purpose. Thicker panels of plywood are also useful, and if obtained with one side faced with a figured wood, would form a very attractive article. Fig. 5 shows a good example of this method.

It has only been possible to give a few ideas that may be incorporated to form quite a pleasing bedstead head and foot

panels. Many others will, no doubt, occur to the handyman which could be made up with little difficulty. All these designs were drawn up for double size bedsteads, but they are equally serviceable for single size and may be adapted to fit these if wanted.

The matter of finishing must be left to the maker. The wood can be left in its

Whatever type of meter you may decide is the best for your purpose, do read the directions issued with it, and make yourself thoroughly familiar with the way it functions. And, when you have proved its readings to be correct, make use of it on every occasion and do not be persuaded to make any further change.

Just a word about the storing of negatives. It is asking for trouble to carry negatives in a wallet in your pockets, or to leave them lying about in your den or any old box or drawer. Scratches and spots of dust are almost certain to get on to them sooner or later, and these, together with finger markings, will, undoubtedly, spoil the subsequent prints.

Each one of those negatives cost money, and you took a certain amount of interest and pleasure in exposing them, so why not take a similar pleasure in their storing. Small bag envelopes, rather larger than the size of the negative, can be purchased for a few pence per hundred, and if one of these is used for each negative, with full data and title written on the front of the envelope, all risk of damage or loss is removed. The envelopes should, of course, be placed in a box for reference.

Print-Making

It would not be right to finish this article without a few hints regarding print-making, and while some of the errors in this direction can be attributed in the first instance to the negative, or even to the actual exposure of the film, yet others are a matter of misjudgment or careless manipulation in printing.

Quite a common fault—possibly the commonest as regards the actual image—in finished prints is showing the horizon line running uphill. It is more glaring in the case of seascapes, of course, but it can also be seen in other subjects. Curiously enough this fault is seldom obvious to beginners, and even some of the more advanced amateurs are guilty.

The two illustrations of Loch Katrine will serve as examples. The initial cause of the error was the view-finder, which, either through carelessness or because it got shifted slightly by catching in my sleeve, was not completely resting on its base. Therefore, its parallel lines were not square with the film section about to be exposed. Some of you who own folding cameras will know the type of view-finder referred to. It is the one that can be turned over when a horizontal picture is to be taken instead of an upright.

When such a misfortune occurs, the remedy can only be found in the print-

making. Either the negative and piece of printing paper must be placed in contact in such a way as to get the line of the horizon level (and this means using a larger printing frame so as to permit adjustment of the negative or paper) or the print must be made in the ordinary way as a contact and then trimmed before mounting.

Trimming should be started by cutting a piece from the base or top of the print first, then carefully measuring this new base line with the horizon line. If this is found correct, proceed with cutting away the other three edges. Unfortunately the size of the resulting print is considerably reduced, but it is better to have a small one that is correct. If printing is made by enlarging, then no waste need occur, for the paper can be pinned to the easel in such a way as to correct the error at the start.

Spots on Prints

These can be black or white and many of the latter are simply due to careless manipulation. In other words, you have possibly had the negative lying about, with the result that dust has settled on it, and you have not taken the trouble to remove it. If the spot is not a matter of dust but is a blemish in the film and cannot be removed, then it means that the white spot it has caused on the print will have to be treated after the print is dry. Most white marks respond to a blacklead pencil.

Black marks on prints are most frequently the result of airbells made when pouring the developer rather carelessly on to the film. If such an airbell is not seen at the time and removed quickly it leaves a circular spot of clear transparent celluloid on the negative, and if this is not filled in with a spotting medium it means that a black spot will occur on the print.

Finishing

In conclusion, something must be written about finishing, which some folk seem to think does not require any serious consideration. As a matter of fact, it is disappointing at times for judges to have to turn down entries because of poor mounting, i.e. crooked edges, paste marks on the surface of the prints, edges not stuck down, finger markings on print or mount. These are just a few examples, and yet, despite the ease with which they can all be avoided, there is never a competition or exhibition without some entries being received bearing the trade mark of a careless and untidy worker. (262)

natural state and wax finished, or it may be stained and french polished, or even varnished. Then again, some pleasing effects can be obtained by painting or enamelling the panels and either leaving them plain or fixing an attractive transfer. Painting in a suitable design in oil paints would also form a nice finish for the panels. (291)

MISCELLANEOUS ADVERTISEMENTS

The advertisements are inserted at the rate of 4d. per word prepaid. Name and address are counted, but initials or groups, such as E.P.S. or £1/11/6 are accepted as one word. Postal Order and Stamps must accompany the order and advertisements will be inserted in the earliest issue. Announcements of freework goods or those shown in Hobbies Handbook are not accepted. The charge for use of a Box No. is 1/- extra. Orders can be sent either to Hobbies Weekly, Advert. Dept., Dereham, Norfolk, or Temple House, Tallis St., London, E.C.4

PERSONS are wanted for spare time work, making up fancy goods at home. Experience unnecessary. Write for details.—Dept. 918, Universal Products, 5 Cornhill, Lincoln.

WANTED. Bound volumes or loose copies 'Magnat', 'Gem', 'Union Jack', 'Boys' Friend Libraries', 'Schoolboys' Own Libraries', 'Sexton Blakes', 'Nelson Lees', 'Chuckles', 'Jester', etc.—W. C. Martin, 93 Hillside, London, N.W.10.

EARN money by home craftwork. S.A.E.—D2, Biltex, Chiswick.

INTRODUCTIONS. Pen friends, companionship or marriage.—V.C.C., 34 Honeywell Road, London, S.W.11.

TABLE model kaleidoscope. Make this new, interesting model at negligible cost. Really profitable hobby. Detailed, illustrated instructions, 1/6 P.O. to—Model Publications, 10 Audries, Kirby Road, Walton-on-Naze.

MAKE 'Oscar Elephant'. No mechanism—but he walks. Made from odd wood. Easy. Profitable. Full-size patterns and instructions, 3/6.—Dept. H.W., 6 Cedar House, Erlanger Road, London, S.E.14.

PERSONAL—the fascinating magazine for all hobbyists. Crammed with pen friend addresses, personal advertisements, hobby announcements, etc. Specimen, 1/.—'Woolf's' Publicity, 7 Princes Street, Hanover Square, London, W.1.

SPARE-TIME employment, clerical, assembly, toy-making, etc., 100 firms.—'Spare-Timer' (1/-), 43 Douglas Ave., Heanor, Derbyshire.

STAMPS FREE!! Twenty unused (2½d.).—S.G. H. Barnett, Limington, Somerset.

1,000 stamps free! Send 3d. for details and request discount approvals.—Duffield, BCM/NEWDAL, London, W.C.1.

FREE—45 worth-while stamps. Just send 2½d. stamp for approvals.—C. Rogers, 31 St. Leonards Ave., Hove 3, Sussex.

CIGARETTE cards, surprise packets and lists, 1/- and 2/6.—Verity, 193 Sandford Road, Bradford, Yorkshire.

BUILD your own saw bench— $\frac{1}{2}$ " x 12" saw shaft, plates, bearings and nut, £1 9s. 8d.; ditto, with ball bearings, £2 11s. 2d. Belts, pulleys, special shafts supplied. S.A.E. for list.—Sullivan, 19 Allen Road, Wednesbury.

ALL printing requirements at keenest prices—Distribution publicity service available for authors, business men, hobbyists. State requirements.—'Woolf's' Publicity, 7 Princes Street, Hanover Square, London, W.1.

CASTING moulds for lead soldiers and animals. Handbook with illustrated catalogue, 2/6. Sample mould, 3/6.—G. F. Rhead, Hartest, Bury St. Edmunds, Suffolk.

MODELS. You can make lasting stone-hard models with Sankey's Pyrama Plastic Cement. Supplied in tins by Ironmongers, Hardwaremen and Builders' Merchants. Ask for instruction leaflet.

EARN Shorthand by 20th July (1 hour's study nightly), 1st lesson, 2½d. stamp.—Duttons (Dept. H.B.), 92 Gt. Russell Street, London, W.C.1.

DUPLEX self-adhesive Transfers for decorating fancy goods, trays, plastics, etc. List and samples, 3d.—H. Axon Harrison, Jersey.

DOLL'S House fittings and papers; send S.A.E. for list. Doll's house plan supplied; send 2/6. Trade supplied.—Zimplan, 88 Ware Road, Hoddesdon.

LORRY Kits, 4 mm. and 7 mm. scale. Also large range of spare parts from which to build to your own design. Send for fully illustrated catalogue. Price 1/.—Wilson's Lorries Ltd., 6 Gt. Winchester Street, London, E.C.2.

PLYWOOD offcuts. Birch and Gaboon in various thicknesses. Handy sized parcels for the cabinet, toy, model maker, and all handicrafts. Parcels made up in £1 and 10/- lots. Carriage paid. Send P.O. to—Reeves, Plywood and Timber Merchant, 33 Front Street, Monkseaton, Whitby Bay. Tel. W.B. 4677. Parcels are now despatched on day of receiving order.

MADE Big money so can you. Enclose envelope.—H. Wamstecker, Box 34, Wynberg, Cape, Africa.

PLYWOOD offcut parcels, nothing under $12" \times 12" \times \frac{1}{8}"$, 15 sq. ft. parcels, 7/6, post paid. Immediate despatch.—Breezcraft Limited, 113 High Street, Staines, 3461/2.

EARN £££ weekly with '114 Ways to be your Own Boss', 5/6 only. Money back if dissatisfied.—Stebbing Publications Ltd., Naphill, High Wycombe.

USE sparetime on profitable homework making fancy goods. Write for free booklet.—(Area 544), 54 Southgate Street, Leicester.

HOME Watch and Clock repair outfit. Includes watchmaker's magnifying eyeglass, tweezers, screwdrivers, oilers, oil, brush, dusting powder, plus illustrated explanatory book. Watch and Clock repairing simplified. In container, 12/9 inclusive.—D. Bolster (Dept. H), 5a Station Parade, Ashford, Middx.

ALONE? Then write Secretary, U.C.C.—5B.B. Hay St., Braughing, Herts. Genuine. Est. 1905.

LUSHING, shyness, nerves, self-consciousness, fears, ended. Details under plain cover, 1d.—Stebbing Treatment, 28 (HB) Dean Road, London, N.W.2.

E Taller in 14 days or money back. Details, 1d.—Stebbing System, 28 (HB) Dean Road, London, N.W.2.

£5 to £20 weekly earned at home, running your own Mail Order business. Details, 1d.—Stebbing Publications Ltd. (HB), Naphill, High Wycombe.

3/- PER MOULD. One price only in catalogue. For Toy Soldiers, Sailors, Airmen, Ships, Planes, Farmyard and Zoo Animals, etc. Illustrated catalogue, 6d. each. Full list free.—Robin Hood Moulds, 140 Hollings Road, Bradford.

LUMINOUS Paint, 2/- per tin.—Box No. 44, Hobbies Weekly, Dereham, Norfolk.

AMERICAN Magazines post free for one year. Popular Mechanics, 32/-; Popular Science, 28/6; Mechanix Illustrated, 22/6; Popular Homecraft, 18/- Stamp for full list of others.—Willen Ltd. (Dept. 57), 101 Fleet Street, London, E.C.4.

PLYWOOD Birch, Grade III, $30" \times 6\frac{1}{2}" \times \frac{1}{8}"$, 24 for 15/-; Sanded Lagos Mahogany, $13" \times 8" \times \frac{1}{8}"$, 18 for 12/-; 36 for 20/-. Solid Brownish Mahogany, $1\frac{3}{4}" \times 1\frac{1}{4}"$, P.A.R., 24" long, 8 for 15/6. Immediate delivery C.O.D. List, 1d.—S.A.E. Dept. H.J.D.D. Storage, East Dulwich, S.E.22.

INTERESTING work available for all in spare-time. Experience unnecessary. Send S.A.E. for details to—Leathaweave Co. (Dist. 37), 2 Tudor Road, Leicester.

BRUSH on New-Een composition and renew Band recolour your old leather three piece suite for 12/6. Also for car seating, etc. In Red, Green, Blue, Maroon, leather shades. 12/6 pint or trial tin 3/6 post free.—New-Een (S.E.), 101 King's Cross Road, London, W.C.1.

WHEELS for Toys, etc., in Hardwood, Plastic and Rubber Tyred Metal. Doll's House fittings and papers. Doll's Cot and Pram fittings. Decorative Transfers. Beads for Counting Frames and other Toy accessories. Fine Art Pictures for Jig-Saws, etc. Stamp for lists. Trade supplied.—Joyden Toy Co., 193 Chase Side, London, N.14.

100,000 GOVERNMENT Surplus Bargains for the Model-maker and Handyman. Perspex cleaning kits of Nos. 1, 2 and 3 polishes, 3/9, post 1/-. Metal ammunition boxes, $12" \times 7" \times 6"$, with hinged lid and handle, ideal tools, etc., 2/6, post 1/-. Aluminium rivets, handy boxes, approx. 1 lb. asstd., 2/6, post 6d. Box spanners, 6 B.A., long handled (for 'ungettable' nuts), 1/6, post 3d. Spring loaded plunger switches (ideal foot switch, etc.), 1/-. 10 amp. 4d. Transformers, heavy duty, 230v./12v. 10 amps., 25/-, post 1/6. Send 3d. stamp for full list of other bargains. Motors, generators, switches, cable, etc. etc. Money back guarantee.—Milligans, 24 Harford Street, Liverpool, 3.

HOMEWORKERS required. either sex. light Assembly. Part or full time. S.A.E.—Esprey, Box 18, 41 Wade Street, Lichfield.

HAVE you got your Junero Riveting Jig yet? From all hobby shops or Post Free from—Junero Ltd., Stirling Corner, Boreham Wood, Herts.

STAMPS Free. Empire packet including Pictures and Victorians free to approval applicants.—Robert J. Peck, 7A Kemp Road, Bournemouth, Hants.

PERSONS willing to devote few hours per week to clean interesting work. Excellent pay.—Dept. 11, Chas & Co., Albert Street, Loughborough.

EARN money French Polishing. Complete course, other wood finishes, formula for manufacturing polishes and stains for only 5/-, post free from—BCM/MERCIA, London, W.C.1.

HOBBIES BRANCHES

LONDON

78a New Oxford St., W.C.1

(Phone MUSEUM 2975)

87 Old Broad Street, E.C.2

(LONDON Wall 4375)

117 Walworth Road, S.E.17

GLASGOW—326 Argyle Street

(Phone CENTRAL 5042)

MANCHESTER—10 Piccadilly

(Phone CENTRAL 1787)

BIRMINGHAM—14 Bull Ring

SHEFFIELD 4 St. Paul's Parade

LEEDS—10 Queen Victoria Street

(Phone 28639)

HULL—10 Paragon Square

SOUTHAMPTON—25 Bernard St.

BRISTOL—30 Narrow Wine Street

(Phone 23744)

AMAZING COWBOY FILM STRIPS

featuring

Bob Steele in
'SIX GUN MAN'

Buster Crabbe in
'WILD HORSE PHANTOM'

Tex Ritter in
'THE WHISPERING SKULL'

Hopalong Cassidy in
'SUNSET TRAIL'

These thrilling Western Dramas 1/- each

This Cinevuver gives perfect cinema screen picturisation for all Strip films 2/9

From Stores, Toy Shops, etc. or in any difficulty direct from

FILM STRIPS

EDLESBOROUGH, Nr. DUNSTABLE, Beds.

Send 4/- to cover Post and Packing of your selected Film Strip and Cinevuver



For wood,
card,
plastic,
leather,
metal etc.

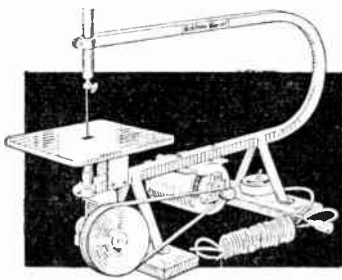

TREADLE OR MOTOR FRETSAWS

Whatever the handyman or craftsman is cutting or making, one of Hobbies Fretmachines will help with the job. For toy making, fretwork, model making, it provides easy and speedy cutting in all kinds of material. A pleasure to use, a factory for output, a lifetime of service.

FROM

80/- to £11 - 2 - 6

Ask to try one at any Hobbies Branch or good class ironmonger or hardware stores. Or free illustrated leaflets on request to:



HOBBIES LIMITED, DEREHAM, NORFOLK

BE TALLER

I Guarantee to increase your height in 12 days or return your money. New gland and spinal discovery increases height 2 to 5 inches.

'I have gained 4½ inches in height and feel fresher first thing in the morning. My weight increased from 9-stone 4-lb. to 10-stone 3½-lb.—P.D., Witham. 'Since taking your Course I have increased in stature from 5 feet 1 inch to 5 feet 4 inches, a matter of 3 inches'.—H.G., Chesterfield. 'My increase is 2 inches and I really do feel ALIVE'.—E.T.

Guaranteed harmless. Full Course 10/- post free, Air Mail 14/-. Details free for 1d. stamp. Sent under plain cover.

J. H. MORLEY

(H&B), TERRY HOUSE, NAPHILL, HIGH WYCOMBE, ENGLAND
Established 1936

Is This Saw in Your Kit?

You can cut almost anything in wood with this Coping Saw. The blade is 6½ ins. long and can be turned to cut at any angle. No tool-kit is complete without one. Get yours NOW.

Buy from any Hobbies Branch, or direct from Hobbies Ltd., Dereham

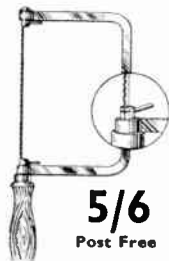

5/6
Post Free

YOU CAN BECOME A HANDICRAFTS INSTRUCTOR

EXPERIENCE NOT ESSENTIAL

Men who enjoy making things in wood or metal can turn their hobby into a permanent and interesting Career. Short hours, long holidays, and security in a job you would really enjoy, can be yours if you become a Handicrafts instructor. Let us send details of the easiest and quickest way to get the necessary qualification.

**We definitely guarantee
"NO PASS—NO FEE"**

If you would like to know about our unique method of preparing you for one of these appointments, write today, and we will send you our informative 176 page Handbook—free and without obligation. Mark your letters "Handicrafts Instructor".

**BRITISH INSTITUTE OF
ENGINEERING TECHNOLOGY** **BIET**

595 Shakespeare House
Stratford Place, London, W.1

EVERY CAR THAT PASSES YOU WILL FIND THE INDEX MARK ALPHABETICALLY ARRANGED IN WHERE'S THAT CAR FROM?

Price 6d.

from all Booksellers or from the Publishers (1d. postage)

RALEIGH PRESS, EXMOUTH

The new JET BOMBER



First Jet Bomber of the R.A.F. THE CANBERRA

Made by English Electric, the Canberra goes into service with Bomber Command this year. Two Rolls-Royce Avon axial flow turbojet engines, and crew of three. Wingspan 64 ft. Tricycle undercarriage and pressurised cabin. All details of performance and bomb-load are still secret.

New, faster, more powerful machines are going into service with the Royal Air Force. So, naturally, the men who handle them must be pretty smart. The R.A.F. Apprenticeship Scheme gives bright boys a flying start on a thrilling career. Without cost to their parents and with pocket money to spend, Apprentices get the education and training that will fit them for their future as the key men of the finest air force in the world.

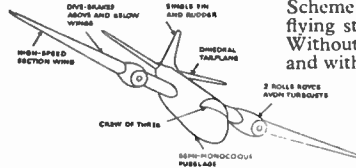

Opportunities *for You* in the **R.A.F.**

If you are over 14 this coupon brings you a free 26-page illustrated book about thrilling careers in the R.A.F.

If you are 12 to 14 it brings you full details about the A.T.C.

TO: ROYAL AIR FORCE (H.S.51A) VICTORY HOUSE, LONDON, W.12.

NAME _____
ADDRESS _____
AGE _____ DATE OF BIRTH _____

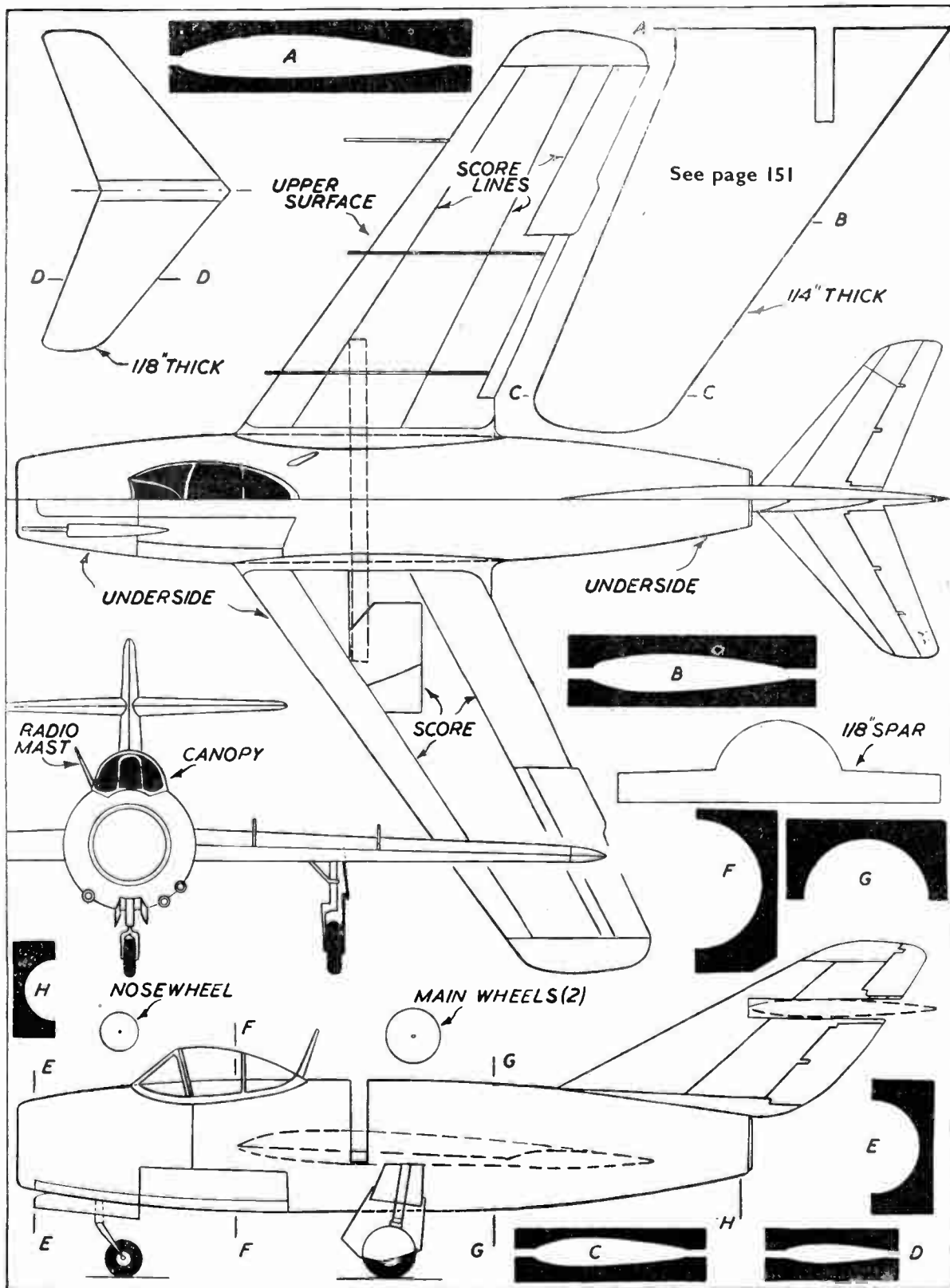

See page 151

STUDY
AT
HOME

IN YOUR
SPARE
TIME

THE BENNETT COLLEGE

*will set you on the right
course for success*

You make sure of planned progress in the career of your choice when you let the most progressive, most successful Correspondence College in the world coach you through the post. By friendly, individual training we equip you with the specialized knowledge you must have for a well-paid key position. Make the first move TODAY—post the coupon below!

**ALL TEXT BOOKS ARE
FREE!**

to Students of The Bennett College Ltd., we send as many volumes as the subject demands and they become your personal property.



IS YOUR CAREER HERE? IF NOT, WRITE FOR FREE ADVICE

Accountancy Exams.
Agriculture
Applied Mechanics
Auctioneers and
Estate Agents
Aviation (Engineering and Wireless)
Blue Prints
Boilers
Book-keeping, Accountancy, and Modern Business Methods
Builders' Quantities
Building, Architecture, and Clerk of Works (A.R.I.B.A. Exams.)
Carpentry and Joinery
Chemistry
Civil Engineering
Civil Service
All Commercial Subjects
Commercial Art
Common Prelim. E.J.E.B.
Concrete and Structural Engineering
Diesel Engines
Draughtsmanship. Electrical or Mechanical

Engineering, All branches. Subjects and Exams.
General Certificate of Education Examinations
General Education G.P.O. Eng. Dept.
Heating and Ventilating
Institute of Municipal Engineers
Journalism
Languages
Mathematics
Metallurgy
Mining. All Subjects
Mining. Electrical Engineering
Motor Engineering
Naval Architecture
Plastics
Play Writing
Plumbing
Police, Special Course
Preceptors, College of
Press Tool Work
Pumps and Pumping Machinery
Quantity Surveying
Inst. of Quantity Surveyors Exams.

Radio Service Engineering
Radio (Short Wave)
Road Making and Maintenance
Salesmanship
Sanitation
School Attendance Officer
Secretarial Exams.
Sheet Metal Work
Shipbuilding
Shorthand (Pitman's)
Short Story Writing
Speaking in Public
Structural Engineering
Surveying (R.I.C.S. Exams.)
Teachers of Handicrafts
Telecommunications (City and Guilds)
Television
Transport Inst. Examinations
Viewers, Gaugers
Inspectors
Weights and Measures
Inspectors
Wireless Telegraphy and Telephony
Works Managers

COUPON. CUT THIS OUT

IF YOU ATTEND TO THIS NOW
IT MAY MAKE A WONDERFUL
DIFFERENCE TO YOUR FUTURE.



To Dept. 62
THE BENNETT COLLEGE LTD.
SHEFFIELD

Please send me (free of charge)

Particulars of..... (Cross out line which does not apply.)

Your private advice

about

PLEASE WRITE IN BLOCK LETTERS

Name

Address

State Age if under 21

One
plastic material
MAKES MANY PERMANENT
MODELS and utility objects, from simple instructions in illustrated Booklet—please read below.



**ONLY 4P
IN STAMPS
BRINGS BOOK**

... showing how such models as those above, and many others, can be made, without skill or special tools, from Sankey's PYRUMA Plastic Cement. Ready for immediate use in its plastic state, Pyruma sets or bakes to stone-hardness, and can be painted or enamelled in all colours according to instructions.

Pyruma is inexpensive, and easily obtainable in tins from Ironmongers, Art Material Dealers and Hobbies Shops. Send 4d. in stamps for illustrated Instruction Book



J.H. SANKEY & SON, L^{TD}

LONDON

Est. 1857

ESSEX

FOR AMATEUR PHOTOGRAPHERS

Unitol

CONCENTRATED LIQUID
FINE GRAIN DEVELOPER



**JOHNSON
J-20 TANK**

For developing size-20 roll films in daylight. Takes 10½-oz. of solution. Easy-to-load, sturdy one-piece spiral. Pouring lip for splash-free emptying. Triple light-trapped lid. Complete with new Two-Way Agitation movement and a Calculator Disc.

Price 25/-

Always ready for instant use. No filtering or dissolving needed. Fresh, active solution for every film. One ounce of Unitol, suitably diluted, is used once to develop one film and the solution is poured away. No trouble, no waste. Gives wonderful negatives. A simple calculator is also sold, giving developing times for all dilutions from 6 to 25. Unitol is ideal for the tank development of roll films.

225cc. (8-oz.) ... 3/6

570cc. (20-oz.) ... 6/6

Unitol Calculator .. 4d.

JOHNSONS OF HENDON
LONDON, N.W.4 EST. 1743

Hobbies

WEEKLY

CONTENTS

	Page
Simple Writing Desk	- 161
Replies of Interest	- 162
Craftsman's Table	- 163
Launching a Gilder	- 164
Radio Construction	- 165
Dutch Pictures	- 166
Try Garden Camping	- 167
A Handy Kitchen Drier	167
Corner Wardrobe	
Fitment	- 168
Garden Walls in Concrete	169
Your Camera by the Sea	170
Simple Electrical Work	171
Doll's Push-Car	- 172
Home Chemistry	- 173

DESIGN SHEET FOR
LORD'S PRAYER TABLET

June 27th, 1951

Price Fourpence

Vol. 112 No. 2904

*The home craftsman can make
this*

SIMPLE WRITING DESK

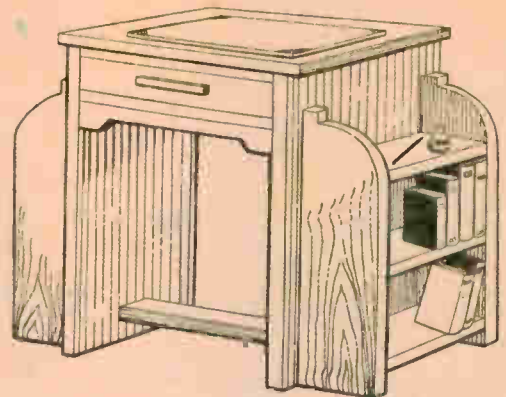

A STURDY writing desk of the type illustrated can easily be made by the home craftsman. It is compact in size, has a useful drawer fitted beneath the top, and is provided with bookshelves at each end. These are handy for reference books if the desk is intended for 'serious' writing, but, if not, extra book storage space is always welcome.

Materials and Finish

Hardwood, finished with stain and polish, or softwood painted or lacquered, are equally suitable for the construction. Solid timber has been specified throughout, but, by careful planning, the design can be modified to make use of plywood or hardboard on a framework of 1in. square wood.

The two sides are 2ft. 5ins. high, 1ft. wide and $\frac{3}{4}$ in. thick, boards being glue-jointed along the edge to gain the required width.

These sides are connected by a cross-rail at the bottom, and a wide bearer towards the top, this last forming the floor of the drawer opening. Both are 1ft. 6ins. long, the rail being $2\frac{1}{2}$ ins. wide by $1\frac{1}{2}$ ins. thick, and the drawer base 12ins. wide by $\frac{3}{4}$ in. thick. For ease of construction, both are simply cut dead-square at the ends to the exact length, and are screwed into place through the

uprights, all screw-heads being well countersunk. The rail is in the centre of the width of the two sides and has its lower edge 3ins. from the bottom of them, while the lower edge of the drawer base is 2ft. 0 $\frac{1}{4}$ in. from the bottom of the upright.

Two shaped rails are fitted immediately beneath the drawer floor, fitting flush with the front and back edges of the framework. These rails are 1ft. 6ins. long, $2\frac{1}{2}$ ins. wide and $\frac{1}{2}$ in. thick. They are glued on the long edge that butts against the under-side of the drawer front, and are also held by screws through the uprights into their end-grains. The exact shaping of these rails is shown in drawing (A).

Prepare Book-Shelves

Before fitting the top, it is advisable to prepare and fix the book-shelves at each end. These are of simple construction. For each set of shelves, two uprights 2ft. 2ins. high, 6ins. wide and $\frac{3}{4}$ in. thick are used. At the top of each upright a vertical cut 1in. deep is made 1in. from the back edge, and from the bottom of this cut, the edge takes on a semicircular snapping as shown at (B). Three shelves are used to connect each pair of uprights, these having their bottom edges at 2ins., 10 $\frac{3}{4}$ ins. and 1ft. 7 $\frac{1}{2}$ ins. from the bottom of the uprights. All shelves are

6ins. wide, $\frac{3}{4}$ in. thick and 8 $\frac{1}{2}$ ins. long, and are screwed into place.

As each set of shelves is completed, they are screwed into position on the ends of the desk, their outside edges being set in 1in. from the front edge of the uprights. When these are in place, all screw-heads should be treated with plastic wood, as it will be rather difficult to do this successfully at a later stage.

The Top

The actual table top measures 1ft. 9ins. long, 12ins. wide and $\frac{3}{4}$ in. thick. It is screwed to the top edges of the upright, overhanging the outside edges of the side uprights by $\frac{3}{4}$ in. at each end. Again, all screws must be well countersunk and the resulting holes treated with plastic wood.

This completes the construction of the main carcass, the principal dimensions of which are shown at drawing (C).

Before starting work on the drawer, it is advisable to check up on the dimensions of the drawer opening, which should, if the carcass has been correctly made, measure 1ft. 6ins. long by 4ins. wide.

A panel of $\frac{3}{4}$ in. thick wood is sawn and planed so that it fits into the drawer opening, being just sufficiently on the slack side to form the drawer front. A

All correspondence should be addressed to The Editor, Hobbies Weekly, Dereham, Norfolk.

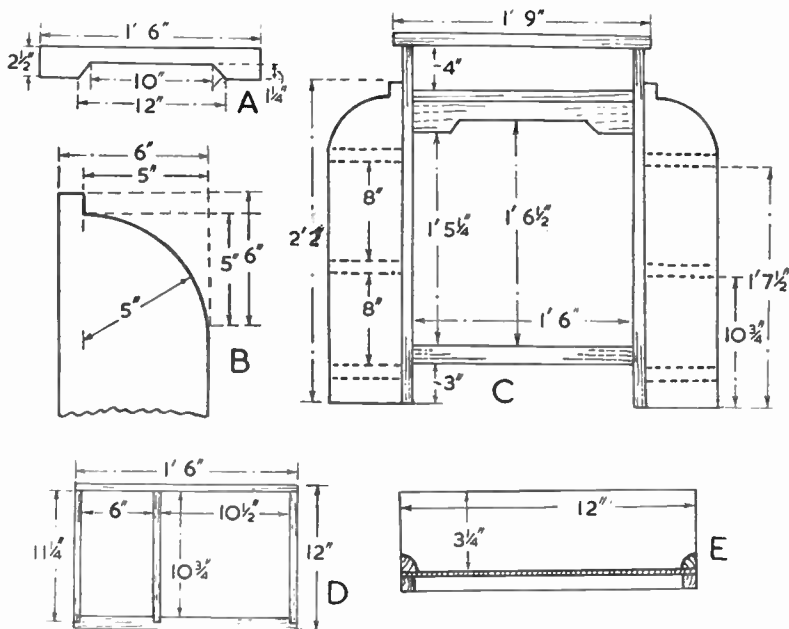

similar panel, but only $\frac{1}{2}$ in. thick, is cut for the drawer back.

The drawer sides, also $\frac{1}{2}$ in. thick, measure 11 $\frac{1}{4}$ ins. long. A rebate $\frac{1}{2}$ in. wide and $\frac{1}{4}$ in. deep is cut on the inside face of the ends of the drawer front, and the ends of the drawer sides are glued and nailed into these rebates, while the back is glued and screwed on to the rear

ends of the sides.

Partition Strip

A partition strip can be placed across the inside of the drawer, fitting between the long sides, the outside edge of the strip being 6 ins. from one of the drawer sides. This partition strip is 11 ins. long and 3 $\frac{1}{4}$ ins. wide, its top edge being flush

with the top edges of the drawer. The rear end of this strip butts against the inside of the drawer back, while the front edge rests in a slot cut on the inside face of the drawer front.

Four strips of $\frac{1}{2}$ in. square wood are glued and screwed to the inside of the drawer framework fitting flush with its bottom edges. As these strips cannot be seen from inside the drawer, they can be merely butted together at the corners. Immediately above this framework a panel of $\frac{1}{2}$ in. plywood is laid, but this is neither glued nor nailed into position.

More strips of $\frac{1}{2}$ in. square wood are taken and planed to quarter-round section, and these are then fitted round the inside of the drawer immediately above the plywood. The strips are held in place by fine nails that run into the drawer sides and not into the plywood. Mitre joints should be used on the corners where the shaped strips meet.

A sectional view of the drawer is given at (E), while the main dimensions in plan are given at (D).

The Drawer Pull

A ready-made drawer pull in metal, erinoid or plastic can be easily purchased, but a wooden one is probably more in keeping with the design. It can be quite simple, say, of $\frac{3}{4}$ in. square section chamfered on the outside edges and screwed into place from inside the drawer. Alternatively, a more comfortable pull can be made by fastening a broad, thin chamfered strip to a smaller block of square end-section, having the smaller block against the drawer front. (342)



Finish For Fretwork

PLEASE tell me the best way to give a lasting finish to the fretted parts of boxes, tea caddies, etc., as varnish is apt to wrinkle on the edges of intricate patterns, and I understand french polish is more for plain work, and for someone who knows the art of french polishing. (D.C.—Clevedon).

A FREQUENT trouble when varnishing fretwork, is caused by ragged edges of the fretted openings, which drag the varnish from the brush. But really, varnishing in the common manner is not particularly suitable for such work. A better finish is ensured by following out the method advocated below. Go over the work with a polish rubber, not charged too full with french polish; press moderately on the rubber and work with circular strokes. Leave for awhile, then give a second and, perhaps, a third application, by which time the surface should present a shiny appearance, if a little patchy. Then, with a small soft brush, apply polisher's glaze, or thinned down shellac varnish. Work the latter (or the glaze as well), not across the frets, but following their lines

of designs, so as to avoid as far as possible, crossing the openings. This should give a good finish, with none of the wrinkles mentioned.

Making Sea Water

CAN you help by telling me how to make sea water for keeping some shrimps, mussels or cockles, sea-weed, etc.? (R.S.—Slough).

A SEA-SALT substitute can be made from the following formula:—dissolve in one gallon of water (spring or rain water for preference to tap water), the following ingredients: common table salt 3 $\frac{1}{2}$ ozs., and Epsom salts $\frac{1}{2}$ oz., both avoirdupois weight, and chloride of magnesium, 200 grains, and chloride of potassium, 40 grains, both troy weight. Though in real sea water there are other substances, the above will be sufficient for your purpose. Of course, nothing beats the real stuff straight from the sea for a marine aquarium, but the formula here given should prove a useful substitute. As the water evaporates in time, fill up with clean rain water. When first

filling the tank, mark the level by sticking a strip of gummed paper on the glass side, to give you a guide when you need to add the fresh water, as it is needful to maintain the fluid at same level. As the water evaporates, the various salts are left in the tank, as only distilled water is absorbed by the atmosphere.

Cycle Dynamo Use

I HAVE read with interest, your articles on radio construction. I have an old cycle dynamo in good working order, and would like to know if it is possible to build a small radio to work off 6 volts A.C. (H.J.—Stafford).

A RECEIVER may be made to operate from 6 volts, but unless some regular method of driving the dynamo were employed, the output would fluctuate to such an extent that results would be erratic. This also applies to the direct operation of a bulb from the dynamo, the latter being driven by wind. It is for this reason that an accumulator is used with wind-charging plants, this providing a regular output, despite the force of the wind. For such purposes, a direct-current dynamo is necessary, and a circuit for a wind-charger of this type appeared in *Hobbies Weekly*, dated January 7th. Provided some method of driving is available, there is no reason why the dynamo should not be used for lighting a small bulb, bearing in mind the above.

A many-purpose CRAFTSMAN'S TABLE



THIS table fills a variety of purposes, being adjustable to 4 degrees, from a gentle slope to a vertical position. In its normal position it constitutes a light table, useful for many hobbies and crafts. Raised to the first position, it provides a comfortable writing surface; in the second position, the slope is convenient for drawing on; the third position is about right for painting, and in the vertical, a flat board for enlarging, or even as a support for a screen, on which a home cinema can project its pictures. Its uses are innumerable, according to the particular needs of the reader.

Construction

A side view is given at Fig. 1, and a front view at Fig. 2, with dimensions. Cut the sides to length given in the cutting list, and at the bottom, saw out two tenons, $2\frac{1}{2}$ ins. wide and $\frac{1}{2}$ in. deep, for fixing to the feet. At 2 ins. down from the top, and 2 ins. up from the bottom, reduce the width, as shown. At the top, each side, mark centres, as shown in inset, with an awl, and at the left side, from the centre, strike a quarter circle. Trim this end to the curve, and at the centre bore a $\frac{1}{2}$ in. hole for a bolt, on which the table top swings.

Important Distance

At the centre, marked on the right, bore a $\frac{1}{2}$ in. hole, and if measurements are correct, the distance between the holes, from centre to centre, will be exactly 7 ins. It is important to get this distance right. At the right again, a projecting piece of wood must be added, as shown at (A) in Fig. 1 and also at Fig. 4. These pieces are cut to the size given, and glued and dowelled in place. The lower corners are afterwards rounded off a trifle.

At the middle of each side piece, a couple of mortises are cut out, to accommodate the crossbar. These are

$\frac{3}{4}$ in. wide and $1\frac{1}{2}$ ins. long. Now cut the two feet. In these chisel out mortises, $\frac{1}{2}$ in. deep, for the tenons on the sides to fit in. Note here that the sides are fitted to the feet at 4 ins. back from the front edges of these feet, and not exactly central. Bevel off the edges of the feet, then glue the sides to them.

The Crossbar

Cut the crossbar to length given in Fig. 2, plus $\frac{3}{8}$ in. extra at each end for the tenons. Cut the tenons $1\frac{1}{2}$ ins. long, separated by a space of $2\frac{1}{2}$ ins. A good fit is required here. Shape the crossbar, as shown in the drawing, then glue to the sides, and add a round-headed screw to each joint, driven in between the tenons. Across the sides, at the top back, screw a bar, where shown by shaded outline at (A). Make sure at this stage that the width between the sides is 2 ft., as in the front view of the table. Important this.

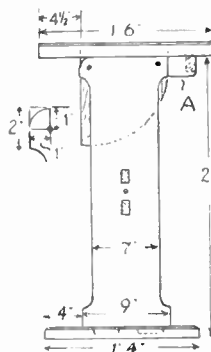

Fig. 1—Side view

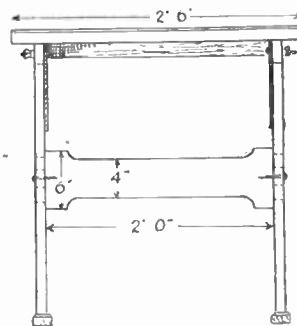

Fig. 2—Front elevation

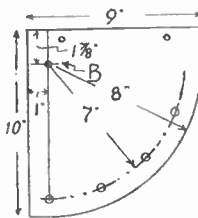

Fig. 3—Pattern for the quadrants

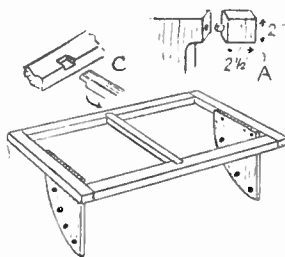

Fig. 4—Details of the top

Two quadrants of $\frac{1}{2}$ in. plywood are now to be made, for adjusting the top to the required slope. The pattern for these is given in Fig. 3, and about the best method of getting them alike will be to set the pattern out on one piece of the plywood, nailing this to the second

CUTTING LIST	
Sides (2)	—2ft. 4 $\frac{1}{2}$ ins. by 9 ins. by $\frac{3}{4}$ in.
Feet (2)	—1ft. 4 ins. by 2 ins. by $1\frac{1}{2}$ ins.
Middle crossbar	—2ft. 1 $\frac{1}{2}$ ins. by 6 ins. by $\frac{3}{4}$ in.
Back crossbar	—2ft. by 1 $\frac{1}{2}$ ins. by $\frac{3}{4}$ in.
Top frame sides (2)	—2ft. 6 ins. by 3 ins. by $\frac{3}{4}$ in.
Top frame ends (2)	—1ft. 6 ins. by 3 ins. by $\frac{3}{4}$ in.
Top frame middle bar	—1ft. 1 in. by 1 $\frac{1}{2}$ ins. by $\frac{3}{4}$ in.
Table top	—2ft. 6 ins. by 1ft. 6 ins. by $\frac{3}{8}$ in. or $\frac{1}{2}$ in. plywood.
Quadrants (2)	—10 ins. by 9 ins. by $\frac{1}{2}$ in. plywood.

Fittings—1 pair of $\frac{1}{2}$ in. by 2 ins. iron bolts, with washers and wing nuts. 4 screw eyes.

piece, and then cutting and boring both together to better ensure uniformity. At the centre from which the radii are struck (centre B), bore a $\frac{1}{2}$ in. hole for the bolts. On the inner curve, about where shown, bore $\frac{3}{8}$ in. holes. Take some care to bore these holes exactly on the line of the curve. At $\frac{1}{2}$ in. down from the top edges, bore holes for the screws for fixing the quadrants in position.

Frame-Covered Top

The table top consists of a frame covered with plywood. The outside dimensions of this are given in Figs. 1 and 2. The joints can be the ordinary mortise and tenon ones or just half laps, as preferred. Across the centre a $1\frac{1}{2}$ ins. wide bar is notched in, this simple joint being detailed at (C) in Fig. 4. If wood of the size given in the cutting list is employed, the inside measurement, lengthwise, will be 2 ft., exactly the same as that of the crossbar across the sides. It will be as well to measure the latter, and if any difference exists, which a slight error in construction may have caused, the table frame could be amended to suit.

(Continued foot of page 164)

Use a kite for LAUNCHING A GLIDER

MOST fellows graduate to the making and flying of scale model aircraft from the humble glider. There is good fun to be got out of the latter even when it is a simple home-made model, but it is not long before the beginner looks round for some mechanical method of gaining 'altitude' and 'duration' to get more enjoyment from the sport.

Very often, elastic is used to assist the take-off, sometimes in the form of a catapult. A much easier and better method is to launch the glider from a kite, and when this is done the model will come down slowly in a series of flat curves.

Small Hook

The first step is to make a small hook from a piece of wire, and to lash this to any convenient stick that forms part of the kite framework. The hook need only be large enough to take a length of kite string, while stout thread will be sufficiently strong to lash the hook in place (see drawing A).

The actual launching string needs to be twice as long as the kite string itself,



A

Fig. 1—How the hook is attached to the kite frame

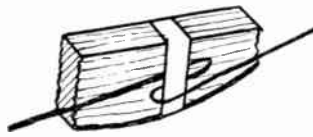

B

Fig. 2—Method of holding glider on release string

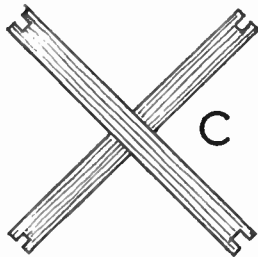

C

Fig. 3—Box kite frame

and can be of the same material. A fairly large knot is tied in the middle of the launching string to prevent its being pulled right through the hook, then one end of the string is inserted through the wire. Both ends of the launching string can then be knotted.

An elastic band must be passed round the body of the glider close to the tail, being wrapped twice or more round the wood if the band is too large to make a good fit.

The glider is placed close to the launching string just below the knot marking the half-way mark. A small loop is made in the string, and this is forced under the elastic band. A small knot tied in the string will help to keep this loop in place (drawing B).

When the kite is being flown in the usual way, the glider is suspended just below it, with the doubled launching line stretching down to the ground as shown on the sketch of the kite in operation. A sharp tug on that part of the line on which the glider is attached will jerk the loop free, the glider will drop straight down for a few feet, and then flatten out to glide down to earth.

It may be found that it is not an easy matter to get the kite off the ground and flying properly, and to take the glider up with it at the same time.

This difficulty can be overcome by having a much longer length of launching line. The glider is fastened to the line as before, but is left on the ground until such time as the kite is flying at a suitable height. By pulling on the appropriate string the glider will be hauled up to the ring on the kite, while a sharp jerk on the other end of the cord will launch it.

The ordinary pear-shaped kite is not strong enough to be used for glider-launching, but a suitable box kite is quite easily made.

Stripwood $\frac{3}{8}$ in. square and 3ft. long can be used for the main framework, with $19\frac{1}{2}$ ins. long, $\frac{3}{8}$ in. wide and $\frac{3}{8}$ in. thick pieces for the stretchers.

Four stretcher pieces are needed, these being fastened together in two

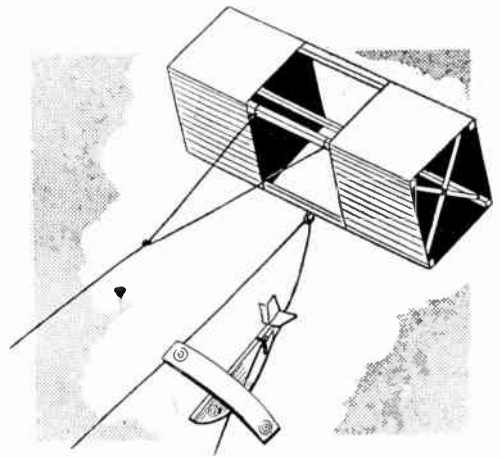

pairs. At both ends of each stretcher piece a small notch is cut to a width of $\frac{3}{8}$ in. and a depth of $\frac{1}{4}$ in. These notches are intended to fit over the main framework. Each pair of stretcher pieces are joined together in the exact centre to form a cross-piece as shown at (C).

The main framework pieces are then put into these notchings, the braces being arranged so that the outside faces are set back $5\frac{3}{8}$ ins. from the ends of the main strips.

For covering the ends of the kite, two strips of silk or similar material 1ft. 1in. wide will be needed. A hem $\frac{1}{8}$ in. wide is made along each edge of both strips, and a thin piece of twine is threaded through the hems to keep the material taut.

Some assistance will probably be needed in stretching the covering material over the frame. The fabric should be pulled as tight as possible, and the two ends of each strip should be sewn together with a slight overlap on the meeting edges. If a little glue is smeared on each main framework strip just before the fabric is pulled round it, it will be found to help in keeping the material taut.

Before permanently fixing the string, it is advisable to merely tie it to the frame until experiments show that the kite is well balanced. One length of string is fixed with its ends just inside each of the covering strips, while the main string is fastened in the centre of this, as shown on the drawing. (297)

Craftsman's Table—(Continued from page 163)

Now screw the quadrants to the inside end edges of the frame, as at Fig. 4, exactly $4\frac{1}{2}$ ins. from the front edge. Try the frame in position on the stand; it should be a good fit, with the quadrants in contact with the sides. Push a pair of $\frac{1}{4}$ in. by 2 ins. iron bolts through (from the inside) quadrants and sides. Everything O.K., the frame should be easily swung up to the vertical.

Level off the top surface of the frame, as may be necessary, then glue and pin the plywood top over. A weighted box or anything heavy can be placed over until the glue is set hard, then the edges trimmed level with the frame. Shape up from dowel rod a pair of pegs to push through the holes in sides and quadrants, to keep the table at the required level. These pegs should have screw eyes

driven in and short lengths of thin cord attached. The free ends of the cord can be tied to other screw eyes, driven in the sides, to keep the pegs from being mislaid.

No elaborate finish is desirable for this table. After glasspapering, a coat of light oak stain could be given, followed by a coat of clear varnish. Leave the top surface plain. (321)

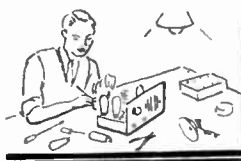

SIMPLE RADIO CONSTRUCTION

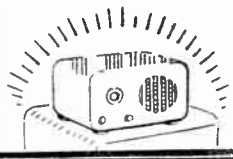

MAKING CHOKES AND CONDENSERS

By utilising materials which will probably be to hand, the radio enthusiast can make a high frequency choke suitable for the receiver he is constructing. Such a choke will function as efficiently as a ready-made one, even though ready-made chokes are comparatively expensive. It is also possible to make small fixed and pre-set condensers, suitable for connecting in series with the aerial lead-in, and for other purposes.

Sectionalised Windings

The purpose of a high frequency choke, as its name suggests, is to prevent the passage of high frequency (radio) signals, while allowing direct current and low frequencies to pass. This result is achieved by winding many turns of wire in a suitable manner designed to minimise self-capacity across the complete choke windings. The desired effect is best obtained by breaking the winding up into sections.

In Fig. 1 a choke suitable for any long and medium wave set is shown. The centre tube or former is about $\frac{1}{2}$ in. in diameter (this is not critical), and seven discs of insulating material are glued to it. These may be of stout cardboard, thin plywood, or any other insulating material, and about $\frac{1}{4}$ in. space is left between each disc and the next.

Two small bolts are used to form terminals to connect the finished choke into a receiver, and the tube is mounted upright by being a tight push fit into a small square of 3-ply forming the base.

To wind the choke, take a reel of 42 to 36 S.W.G. wire, either enamel covered or silk covered, and secure the end to one terminal. Wind the first space almost full, then take the wire on into the second space, winding this almost full. Continue in this way until the six spaces are all wound nearly full, then end off the wire at the second terminal. The actual number of turns does not matter, but there should be at least 150 in each space. If less turns are used the choking effect will be reduced, especially on long waves.

A Short Wave Choke

In a short wave receiver conditions are rather different and fewer turns are required, while the capacity between sections must be even less. The simplest way to make an efficient choke for these frequencies is to take a glass test tube about $\frac{1}{2}$ in. in diameter and wind on this six compact piles of thin insulated wire, with about $\frac{1}{4}$ in. clear space between sections. This is shown in Fig. 2 at (A) and 50 turns are used in each pile.

The ends of the windings may be secured by binding with glued thread, or

by using adhesive tape or sealing-wax. If the ends are left a few inches long they can be taken directly to the parts in the receiver. A convenient method of mounting is to screw a cork to the baseboard of the set.

In Fig. 2 an even smaller choke is shown at (B) and this can be suspended directly in the wiring. A tube about $\frac{1}{4}$ in. in diameter is used and the choke is wound with 42 S.W.G. enamelled wire. Wind on 50 turns closely side by side, leave a space of about $\frac{1}{4}$ in., then wind the second section, and so on. This choke will be suitable for wavelengths from 15 to 50 metres. The choke shown at (A) can be used on wavelengths up to 100 metres or so satisfactorily.

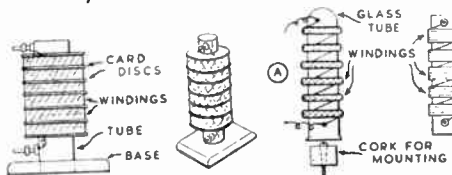

Fig. 1—A long and medium wave H.F. choke

Fig. 2—Chokes for a short wave receiver

the terminal head.

The closer the plates, and the larger the area of overlap, the greater will maximum capacity be. The minimum capacity can be a very low figure if the top plate springs up a $\frac{1}{16}$ in. or so. With the dimensions given, the maximum capacity (terminal screwed completely down) will be about .0001 mfd.

Small Fixed Condensers

A condenser of small capacity is readily made by taking two insulated wires, such as shown at (A) in Fig. 4, and twisting them together. This method is still found in certain modern, ready-made receivers because it enables the capacity to be adjusted by varying the

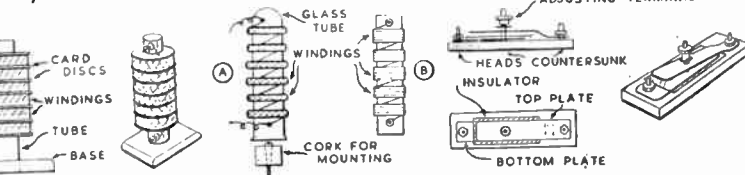

Fig. 3—Aerial or trimming condenser

length twisted together.

The thinner the insulation on the leads, and the greater the overlap of the leads, the higher will the capacity be. With an overlap of about .1 in. the capacity will be roughly .00005 mfd. if the insulation is of the thin type on some kinds of connecting wire.

Larger condensers can be made as shown at (B), which is similar to Fig. 3, except that no adjustment is provided. Such condensers can be used for quite a wide variety of purposes. It is possible to reduce the capacity, if desired, by turning the top plate a little aside so that there is less overlap with the bottom plate.

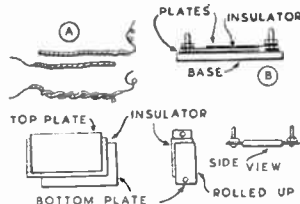

Fig. 4—Making small fixed condensers

Do not varnish the windings of any of the chokes, or dip them in heated wax, or this will severely reduce their efficiency.

A Pre-Set Condenser

This can be made up as shown in Fig. 3, a suitable size for the base being $\frac{3}{4}$ in. by $1\frac{1}{2}$ in. Ebonite is best for this, though other insulating materials can be used. The two metal plates are cut from brass, aluminium, tin, or other thin metal, and are each about $\frac{1}{2}$ in. wide by $1\frac{1}{2}$ in. long. Each has a clearance hole about $\frac{1}{4}$ in. in diameter drilled for the adjusting terminal screw, and a smaller hole, at the end, for the bolts used to secure the pieces.

Both pieces are bolted down tightly in the positions shown. A slip of insulating material is placed between the plates, so that they are not in actual contact even when the terminal head is fully screwed down. This slip may be of celluloid, or even paper. The top plate is bent so that as the terminal is unscrewed the plate springs up, thus reducing the capacity. A washer is desirable under

Foil and Paper Condensers

(C) in Fig. 4 shows the method actually employed in making most small fixed condensers. Two pieces of tinfoil are taken and a piece of insulating paper placed between them. The whole is then folded over and over until a small, flat shape is obtained. If this has been carried out properly the two pieces of tinfoil will not be in contact. The condenser is then fitted with leads or terminals and inserted in a case, or dipped in pitch or similar material.

Condensers of this type can be made in a few moments by using ordinary silver-paper. For insulation, grease-proof or similar paper is best, though ordinary paper can be used. If the silver-paper ends are pressed flat a small bolt can be put through for

(Continued foot of page 166)

Try making unusual and pretty DUTCH PICTURES

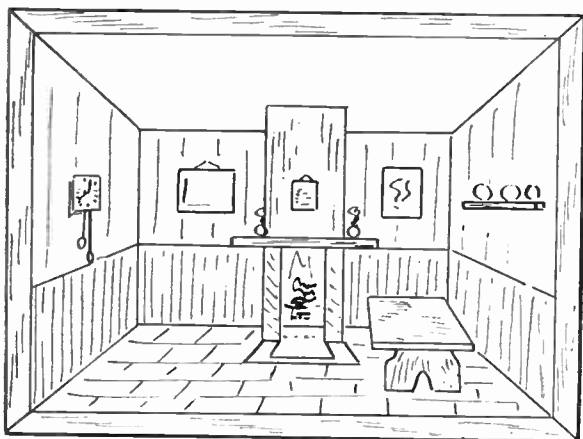

Fig. 1—The finished picture

VISITORS to Holland never fail to be impressed by the built-up pictures sold in the shops for wall decorations—homely, fireside scenes where the furniture and fittings in the room are built up or modelled in mock perspective and glued into a built-up frame. These little models are unusual and very pretty. Yet it is quite a simple matter to duplicate one. Once the frame is built it is simply a matter of one's own skill and interest as to how much detail is added, the colouring adopted, and so on.

A Good Start

The size chosen for our model is about the same as the smaller Dutch pictures found in the shops of Holland. This would provide a good start, using the minimum of materials. Larger 'pictures' can then follow. There is, in fact, no real upper limit. Some of the best of the original examples, for instance, were 2ft. or more in length and even fitted with electric lighting, as well as a wealth of minor detail.

So much for the general aspect. Fig. 1 shows a typical

view' or 'scene' and represents a front view of the completed model. The side elevation, Fig. 2, shows how the body of the picture is recessed and the various fittings, such as the chimney, mantelpiece, table, and so on, are stuck to the back of the picture and project forwards. No part projects beyond the front edge of the picture itself.

Simpler Construction

Most of the originals are carved from fairly thick wood. The construction we have adopted is simpler, utilising $\frac{1}{8}$ in. material for the side members and $\frac{3}{16}$ in. thick stock for the back pieces. The 'frame' is then a separate member attached around the edge as shown in the assembly drawing—Fig. 4. We would recommend the use of a fairly soft wood for all the parts, rather than ply, so that it can readily be trimmed and chamfered to fit. The same applies to the frame which is best made from $\frac{3}{16}$ in. by $\frac{1}{8}$ in. material.

All joints are glued. To strengthen the assembly, the side joints may be bound with strips of tape or thin material, glued in place.

The frame is fitted by laying the assembly face down on a flat surface and chamfering four lengths of $\frac{3}{16}$ in. by $\frac{1}{8}$ in. stock to fit against the sloping sides, and finally cutting to fit each other at the corners. Glue the frame in place, leaving the assembly face down until set.

The interior detail may then be modelled and glued in place. We suggest first that the background be painted—the three walls, ceiling and floor. The floor can be scored to represent tiles. The fireplace and chimney assembly is simply glued to the back wall, adding a suitable strip of material for the mantelpiece. Small ornaments, vases, etc., can be fashioned and glued to the mantelpiece. Similarly a few pictures, a clock and a shelf of plates can be stuck in place.

The Table

The table projects forwards and downwards. The rear edge is stuck to the rear wall and the front is supported on legs. In plan view the table top is foreshortened to preserve the proper perspective appearance. In a similar manner, all sorts of other fittings can be added.

In most of the original Dutch pictures the 'frame' is rounded off and carved and decorated. Generally it is finished black with gold trimming. Finish and degree of detail is, in any case, a matter of personal choice. (286)

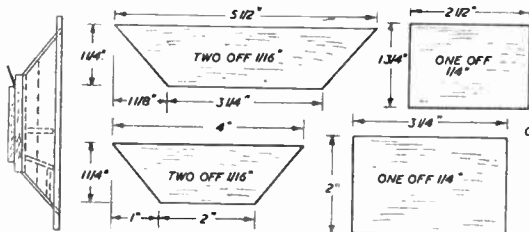

Fig. 3—Parts for the frame

Fig. 2—Side elevation

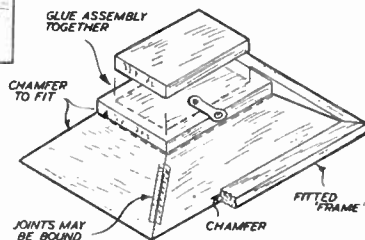

Fig. 4—Assembly

Making Chokes and Condensers—(Continued from page 165)

connecting up. Quite large capacities, suitable for a variety of purposes, can be made up in this way. The capacity can be reduced by unwinding slightly, or pulling the ends outwards.

Using the Components

The H.F. chokes can be used in 1-valvers or larger sets. In a 1-valver, one choke lead will go to the detector valve anode and the second to the negative headphone terminal. With larger sets, the second connection will

go to the coupling transformer primary, or to the coupling condenser, if resistance capacity coupling is used.

The small capacity condensers mentioned are most suitable for connecting in the aerial lead to increase selectivity of tuning. The type in Fig. 3 is particularly suitable for this, as the capacity can be adjusted for best results.

The other condensers can be used in any circuit position where a small

condenser is required—as grid condenser, for coupling and tone control, etc. In many such circuit positions no appreciable voltage will be present across the condenser. If such a condenser is used in a circuit position where a high voltage is applied to it, assure that the metal plates do not touch, and that the insulating medium employed is of waxed paper or other equally effective material. Otherwise a short-circuit or leakage may arise. (288)

If you can't get away TRY GARDEN CAMPING

WEEKEND camping in the garden, or in a field within sight of home, can be grand fun and a tonic for those who cannot get away for a complete change of air and scenery. Self-discipline is the main essential for making a success of such a weekend, and it is economical in the extreme.

Garden campers must be able to ignore the close proximity of the house, the kitchen oven, electric light and other facilities. If they cannot resist running indoors, the weekend will not be successful, and it certainly will not be camping. We found that out by experience.

Never Mind the Neighbours

Neighbours may look through their curtained windows with astonishment at first. But when they see the sport they will most likely follow the example.

Preparations for the camp should be made exactly as if it were proposed to go five or fifty miles away, with the glorious exception that transport difficulties do not come into the arrangements.

There is much pleasure to be had from preparing and planning for the weekend, especially when considering that the campers have to put out of mind the fact that they will be near to home conveniences.

Do not prepare the site. Do not put the tent up in advance, and do not take half the kit into the garden. All the equipment should be assembled indoors a day or two before the day of 'departure'.

A good plan is to imagine that, at a certain hour, a taxi is calling to take campers and their outfits to the station. The weekend starts from the moment the taxi is scheduled to arrive.

At that time, instead of the tent or bivouacs and pots and pans being taken to a waiting car, they should be carried into the garden and placed where they are to be used.

When the door is locked behind them, the garden campers should never visit the house again except for a pre-arranged reason. Milk can be collected from the doorstep. Two concessions may be made.

Out Of Bounds

First, each member of the party may be allowed to go to the bathroom once or twice a day on condition that they carry back a supply of drinking water. Secondly, if a change of clothing becomes essential, perhaps a call for that reason might be allowed. But the house should otherwise be taboo.

If the teaspoons are forgotten in the rush to get the 'taxi', then leave them indoors and improvise. It will add to the fun of the camp.

Adequate food should be taken and oil stoves can be used for cooking. Some

people may prefer to dispense with the cookers if there is wood in the district and fuel can be found for real camp fires.

Incomplete Planning

If early attempts at a garden weekend are not entirely successful, it will be found almost without exception that the fault lies in incomplete planning.

We forgot knives, forks, spoons and a mallet on our first attempt. Unforgivable. But we refused to go indoors to get them and punished ourselves by going to a shop to buy these necessities, as anyone would have had to do a hundred miles from home. They proved useful in the house when they were taken in after the weekend.

On a visit to the bathroom, one of our campers yielded to the temptation to collect some egg cups and a forgotten tin of mustard. The entire party felt guilty about this throughout the week-

end, with the exception of one stalwart who refused to use the egg cups and steadfastly declined the mustard.

Experiment, if you wish, with the idea of a weekend half in and half out of the house, running in when there is a shower, cooking the meals indoors and carrying them out, but you will not get much satisfaction from it. And it will not be so near to a complete change as a really full-time garden weekend.

'Far Away'

Get out some camping books and imagine you are going far away. Insist on a fixed time for departure and see that the campers are completely prepared by that time.

Do not keep the ghost taxi waiting, even if you cannot find the tin opener. And if you forget or lose the key of the house, do not worry. It may prove the best thing that could happen. (334)

A Handy Kitchen Drier

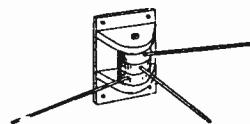

QUITE a common sight in many kitchens is a cord slung between two walls to hang the tea cloths on to dry after use. This is a somewhat untidy method, besides being a nuisance to passers-by.

It is always a problem to know how to dry the cloths in a small kitchen, especially during wet weather, and the adjustable drier described on this page is just the thing for these conditions.

The three rods can be placed at any angle, and when not in use can be folded away close to the wall. More rods can be added if wanted, but for most purposes three will be found ample.

The drier is mounted on a hardwood board measuring 7½ ins. long, 5 ins. wide and ¾ in. thick. Four holes drilled in the corners allow it to be screwed on to the wall in a convenient position.

The arms of the drier are made of ¾ in. dowel rod about 18 ins. long and inserted into circular wood blocks. Cut three blocks of hardwood 3 ins. diameter and 1 in. thick, and drill a ½ in. hole in the centres. Drill another hole in the side of each to a depth of 1 in. for the dowel rod, making sure you drill them perfectly true. If the rods are made to fit tightly in the holes there will be no need to glue them in. The actual length of the dowels is not important—about 18 ins. should be sufficient, but this may be

altered to suit individual requirements.

The two pivot blocks which hold the three circular arm blocks in position are 4 ins. long, 5 ins. wide and ¾ in. thick. Cut these to the shape shown in the sketch, and drill a ½ in. hole in both for the pivot and then fix them to the back board with 1½ in. wood screws.

The distance between the two brackets should be just sufficient to hold the three blocks with light pressure. If too loose the arms are liable to swing round easily while undue tightness is not recommended.

The pivot is a piece of ½ in. dowel rod and is held in position by a panel pin fixed through the top bracket. The woodwork can be left in its natural state or it may be painted to match existing kitchen fittings, which are usually either cream or green, or a combination of these colours. (200)

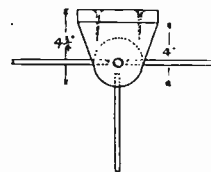
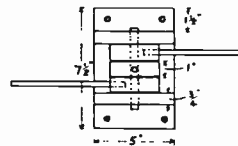

Dimensions of the drier

For a small room — a

CORNER WARDROBE FITMENT

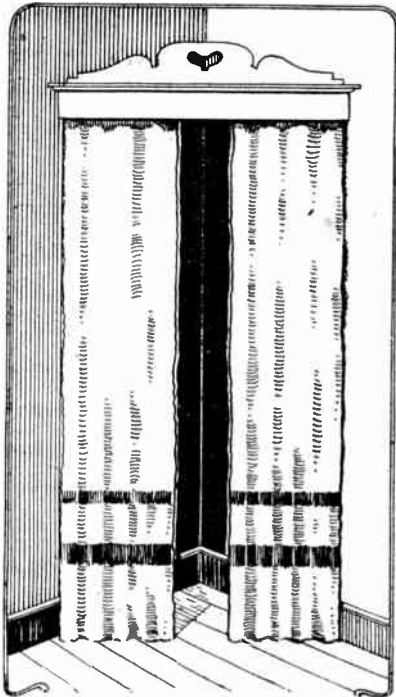

Fig. 1

A CORNER wardrobe fitment is fairly simple to make, and would be suitable for a small room where space is limited, or for a spare room where the extra expense of a solid wardrobe is not thought necessary.

All the material required for the fitment, exclusive of curtains, may be bought fairly reasonably, and paint or stain and varnish is still obtainable at no great cost.

A view of the complete wardrobe is shown at Fig. 1, a plan at Fig. 2, and a view showing the interior fittings at Fig. 3, while Figs. 4 to 8 show details concerning the construction.

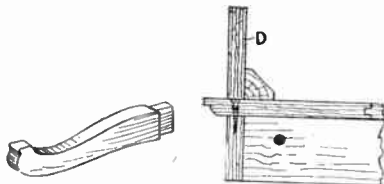

Fig. 6

Fig. 7

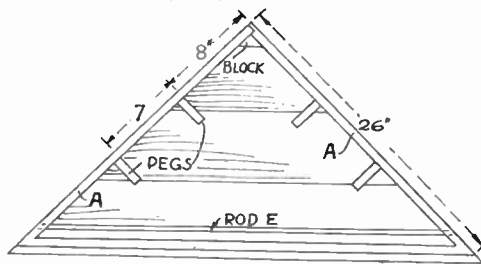

Fig. 2

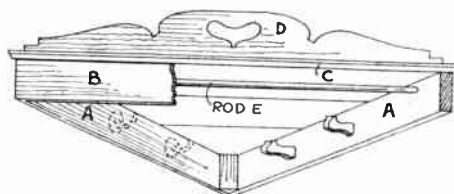
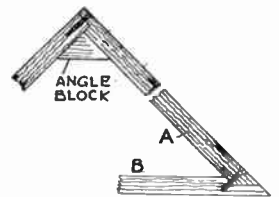

Fig. 3



Figs. 4 and 5

wood as shown at Fig. 6. A piece of hard wood might be found preferable for this, and it is first planed up to $\frac{3}{4}$ in. square in section. Each piece is then shaped out as seen in the diagram, a suitable length being about 3 ins., and a tenon is formed at the back end as indicated. Mortises are then cut in the sides (A) to receive the hooks, which should be fixed in the positions indicated in Fig. 2.

Fixing

The sides and front can now be finally cleaned up and fixed together. In the place of the wood hooks shown, ordinary iron ones can be used, and should be screwed on the rail

as indicated by the dotted lines on the left rail of Fig. 3.

In fixing the wooden hooks into the sides, first see that the tenons fit properly before gluing and wedging them in. The joints between the sides and between the sides and the front should be glued together and securely screwed, while the joints between the sides could be further strengthened by the addition of an angular block glued into the corner as shown at Fig. 4.

The top of the fitment (C) should be about $\frac{1}{2}$ in. thick. It can be made up in two or three widths according to the width of wood available, and the joints should be tongued and grooved together, as seen in the enlarged detail Fig. 7.

The front edge of the top should overhang about 1 in., and a simple moulding might be worked as in the section, Fig. 7. Alternatively, a plain rounded edge would look quite well, and be easy to work with rasp, file and glasspaper. The top is finally fixed in position with nails driven into the top edges of the sides and front. The fitment is finished with a shaped pediment rail (D), as shown in the illustrations. This rail should be cut from wood about $\frac{1}{2}$ in. thick to the outline given.

An enlarged view of half the pediment is shown at Fig. 8. The lines ruled across the illustration represent 1 in. squares and they will be found helpful in drawing in the correct outline, etc. The pediment rail is glued to the top of the fitment and further strengthened

by the addition of glued wood blocks as shown in Fig. 7.

An iron rod (E), or a length of wood dowel rod must be added and fixed underneath the top as shown. The rod can be fixed into holes made in the side rails, and suitable curtain rings provided, these being put on the rail before it is fixed, of course.

The whole fitment should be fixed to the walls at a height of about 6 ft. above the floor. It will be found a good plan to provide four small wood plugs in the wall for the actual fixing, or rawlplugs, of course, would make a secure fixing. The provision of curtains will, naturally, be left to one of the lady members of the household. (319)

All about building GARDEN WALLS IN CONCRETE

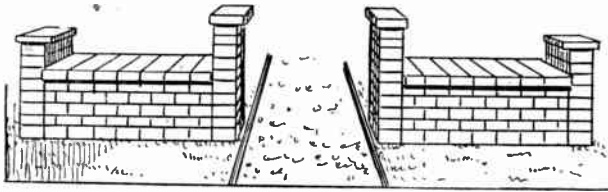

THE use of concrete in the garden is not so well understood as it might be. For paving, parting walls, rose pillars, seed frames, etc., it is excellent material, standing all weather conditions far better than wood. In this article, dwarf walls are dealt with, so designed as to present a pleasing entrance to the garden, or as a division between flower and vegetable portions.

A detail of the walls is given in Fig. 1, while their general appearance will be gathered from the view at the head of the article. Variations of this style of wall can, of course, be made, and the length will depend on the dimensions of the garden they are meant for. The height of the walls can be 1ft. 6ins., that of the ends 2ft., and the inside pillars, forming the entrance, 2ft. 6ins. These can be increased as personal wishes dictate.

Size of Bricks

The size of the bricks is suggested to be 6ins. square, with 6ins. by 8ins. for the coping slabs on top, and a number of half size bricks, 3ins. by 6ins. for bring-

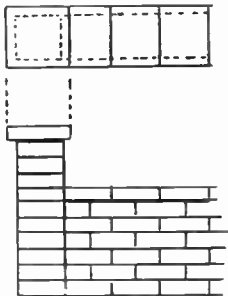

Fig. 1—Detail of the walls

ing the ends of the walls level. The bricks are 2ins. thick, and allowing for mortar, say, $\frac{1}{2}$ in. each layer, the necessary number of all sizes can be estimated by simple arithmetic. The top slabs on end and entrance pillars should be 8ins. square, and as only four of this size are needed, they can be moulded separately from the rest.

Select a flat piece of ground, and spread damp sand over it to a depth of $\frac{3}{4}$ in. and roll flat, or if a roller is not available, stamp down and draw a flat edged strip of wood across to level it all over. The dimensions of this must be equal, at least, to the size of moulding

frame, calculated for the number of bricks required, though if a large number the moulding can, of course, be done in two or more jobs, using the same frame. Having decided on the length of the walls, a trench for a foundation upon which they can be built, should be excavated some 6ins. deep. Mark this out with strings, stretched tightly between pegs, driven in the ground, as at Fig. 2. Fill this trench with a rough concrete mixture, using as an aggregate, gravel, broken clinkers or crushed cinders, in fact, anything suitable to hand. The mixture for this will be cement, 1 part; sand, 3 parts; aggregate, 5 parts. Mix well dry, sprinkle water over, and again mix, then spread in the trench, and level off the top. While this is setting, prepare the frame for the moulding of the bricks.

This consists of four strips of wood, 2ins. wide and, say, 1 $\frac{1}{2}$ ins. thick. Just nail the strips to form a frame of the required interior dimensions. With bricks of the size suggested, a frame 4ft. wide, internal measurement, will accommodate six coping slabs, or eight bricks in a row. Lay the frame on the levelled groundwork of sand, and prepare a mix as follows. Cement, 1 part; sand, 3 parts; no aggregate.

An old bucket can well be employed

get hard. About a week will be enough for this, and in the meantime the bricks should be kept damp.

For the mortar, the mix is 1 part cement to 4 parts of sand. Lay the mortar to a thickness of $\frac{1}{2}$ in. and press the bricks on firmly, removing any surplus mortar with the trowel. Note, by reference to Fig. 1, how the half bricks are used to even up the ends of the wall, and take care to get the whole as truly vertical as you can. The coping slabs on the walls extend over back and front just 1 in. The separately cast slabs for the tops of the pillars extend 1 in. over them all round.

Better Effect

A better effect, if involving a little more work, is effected by making the pillars wider than the walls. For instance, with the 6ins. walls here, the pillars could be made of the 6ins. by 8ins. bricks, the only alteration needed here being to cast the extra number of coping slabs necessary, with a proportionate decrease in the number of 6ins. square bricks.

The method of brick making described here applies equally well for slabs for a rose pergola, crazy paving, and dwarf walls to outline a garden pool. In fact, the limit of their use as garden ornamentation is endless, and the materials reasonably cheap and almost everlasting.

The same method advocated above can be employed also for crazy paving, and obviates entirely the expense of

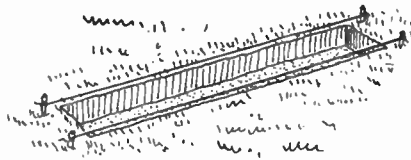

Fig. 2 Foundation trench

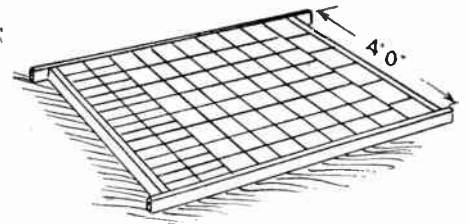

Fig. 3 How the bricks are marked

for measuring the parts, and the mix should be well shovelled until a uniform grey colour throughout. Mixing should, when possible, take place on a rough wood platform. The water should be sprinkled over the whole, and repeatedly turned over until uniformly moist. Do not use too much water, about half bucket to every four parts will be sufficient. Shovel this in the frame until full up, and level off the surface with a long straight-edged strip of wood.

About an hour afterwards, mark off the surface of the concrete to the size of the bricks with a trowel, as in sketch, Fig. 3, the trowel penetrating the concrete about half way through its thickness. Leave for a day, or, perhaps, two days, then lift the bricks, break them at the trowel marks, and stack to

purchase and conveyance of the more usual broken flag stones for this purpose. The mix is shovelled and levelled in the frames and the trowel used to partially cut through the concrete as for the bricks, but the cuts should be of irregular shape instead of formally square or rectangular. (295)

Lord's Prayer Tablet

All necessary material for this week's design (No. 2904) can be obtained from Hobbies Branches or from Hobbies Ltd., Dereham, Norfolk, for 20/2 including tax, post paid.

Hints to remember when you have YOUR CAMERA BY THE SEA

COMMERCIAL seaside 'finishers', who are always a most reliable guide to matters pertaining to photography by the sea, tell us that, while a vast quantity of successful snaps taken by amateurs pass through their hands each season, there is always a large percentage of failures brought about in the main by people not ap-

ever, to remove the cap when taking a picture!

If you have no case for your box camera, try to get into the habit of carrying it with its back towards the direction of the wind. It is all just a question of a little more care than usual, and when this becomes 'second nature' all will be well.

When picture-making on or near the

1/25 second (which is all that many cameras will give) shows signs of over-exposure!

This brings us to the piece of advice that is often given. Do not load with fast films when you intend the whole roll to be used in brilliant light on a shore. Ordinary speeded material will give much better results.

The danger of over-exposure could be checked by stopping down, but this introduces other factors, and on the whole it is better to use slower films.



A pretty harbour scene on the Yorkshire coast

preciating the particular factors that influence picture-making on the coast.

To help readers who may be taking snaps under these coastal conditions about now, we, therefore, give a few hints on this branch of camera work.

The Great Enemy

A word first about care of apparatus. The great enemy of cameras on the shore, or even in the streets of seaside resorts, is sand, and every care should be taken to keep the penetrating stuff from getting where it can do damage. One grain inside a shutter is enough to cause a jam, while a similar amount getting in between the leaves of a diaphragm stop can cause almost irreparable ruin. And sand grains in the winding gear will produce lines and scorings that will quite spoil any film.

Sand can, however, be kept out. If there is a case, always leave the camera in it till just before snapping, and replace immediately afterwards, taking care, of course, that the case itself is quite free of grains. Never place a camera down on loose sand, especially if there is a wind blowing.

Folding cameras are easier to keep safe than the box type, and if you have one of the latter kind it is a good idea to make a 'cap' to fit in the round opening in the front. A piece of rubber or a cork carefully fashioned to the right size will do admirably, quite preventing loose sand from entering. Remember, how-

ever, make a point of listening to the 'click' of the shutter and 'feeling' the quality of the trigger action. If either give an impression of ineffectiveness, examine at once for a jam. Seaside finishers report that sand-jammed shutters are by no means an infrequent cause of spoil films.

The next important point in coastal photography is the question of exposures. These vary greatly from the exposures necessary at the same hour and with the same light further inland.

On account of the great expanses of sand, sky and water, light on the coast is always more 'actinic' than the same quantity elsewhere, so much so, in fact, that the lens has only to be open roughly one third of the inland exposure to give the same result.

Over-exposing is Easy

A few years ago, with the fairly slow films of the period, this only meant that the negatives were just a little more generously exposed than usual, but with the modern high-speed films, it means that pictures can be easily over-exposed during the more brilliant part of the day, and records that were compiled some time ago by some seaside dealers showed that a common cause of failure had become over-exposure.

Actually, most of the fast 'chrome' films require only 1/400 second exposure in summer between 11 a.m. and 3 p.m. at f/8 on or near the sea. No wonder that

Good Pictures in Dull Light

The high actinic value of seaside light suggests, however, something else—that you can take good snaps on the shore in dull light when results elsewhere would be hopeless. And it also means that you can take much later on into the evening.

Snaps (and by this we mean about 1/25 second exposure) can be taken during the summer months between 11 a.m. and 3 p.m. in a light that we would call 'very dull', with an f/8 aperture. Also 1/25 second snaps can be attempted (with ordinary light) up to 7 and 8 p.m. in the evening.

A great danger with seaside pictures is that they will be harsh with the strong cutting sunlight, and the vigorous papers used by most finishers make matters worse. If you do your own developing the best way to retain all the brightness of the sunshine and yet have no clogged shadows is to use the water-bath development.

Briefly, this is to place the film for a few moments only in developer and then leave it stretched for several minutes in plain water; then back in the developer and again in water, and so on, developer and water alternating till the development is complete.

A handy accessory for shore work is a lens hood. This is merely a small cone of black card which fits on the front cell of the lens and, though obtainable commercially, can easily be made from a blackened post-card.

The effect of the hood is to allow only the rays that form the picture to reach the film, cutting off unwanted rays that come from the bright surrounding sand and sky and tend to spoil the picture. Hoods are more particularly needed on lenses that protrude well from the camera.

A word with regard to the composition of pictures. If they contain the horizon, do not let this division of sky and sea cut the picture exactly mid-way, but let it be in either the upper or lower half, dependent on whether the sky or foreground is more important. Should there be a good cloud effect the horizon may be kept in the lower half, but if not, keep it in the upper, and, above all, keep the horizon level. Sloping horizons spoil any picture.

Then again, for good pictures do not stand with the sun right behind you, but to the rear and to one side. This will give relief to the various items. The lens hood will allow for quite pronounced side lighting with perfect safety.

About what to take. Readers will, of course, have their own views on this, but here are a few general hints. Groups are very nice, but do not have too many, as they make very monotonous viewing later on. Get your people to be doing something—games, paddling, swimming, gymnastics, anything, in fact, as long as there is a second interest. An album made up of this sort of snap is fine, but full of groups, no.

The 'looking down' angle forms a novel way to get shore pictures. That is, pointing the camera down from promenades and piers on to the shore views you wish to take. Good sharp pictures of crowded beaches make very interesting pictures taken this way. The final collection should certainly contain a few of these.

Water-edge pictures, taken by looking down from a pier, also make pretty and interesting studies, the receding waves making all sorts of designs in foam and water when seen from above.

Ships at sea, taken from the shore, are usually disappointing. This is because the short-focus lenses fitted to most



The action of the water has been well caught in this picture, together with some of the windy sharpness of the N. Wales coast, where it was taken

cameras reduces them—even the Queen Mary—to such a small scale that the final pictures are all water with an infinitesimal and hardly discernible ship in the far distance!

If there is a harbour or dock handy, however, some good results can be obtained of sailing or other vessels, and, of course, one can always obtain 'close-ups' of pleasure boats, including trippers embarking in the classical 'Skylark' at the edge of the tide.

Pictures of just 'the sea', although it may have looked charming under a blue sky, are seldom much good unless there is a fine cloud effect, when a bay with distant headland, etc., can give a picturesque print. Boisterous days, with big clouds and a lively sea—and good light—are the days for these pictures.

Evening sky effects are sometimes good and are worth attempting, though if you are making a special point of these use panchromatic films, as these give a better rendering of the various shades of red. At other times of the day, chromes give all that is necessary.

Evening silhouette pictures are also worth trying. These are somebody or something (a boat, for instance) standing out against a glorious sky. Remember, it was a picture of this type that won a really big money-prize some time ago in a photographic competition. (336)

Concluding our hints on

SIMPLE ELECTRICAL WORK

Fault Tracing

IT is sometimes necessary to trace a fault in an electrical installation or in some item of electrical apparatus. As an instance, the closing of a switch on an outlet socket may fail to energise an electric fire which is connected to it. The questions arise whether there is a fault such as a 'blown' fuse on the supply circuit; whether the connecting cable is defective; or whether the electric fire is itself at fault.

Dealing with these questions in that order, the condition of the supply circuit can be easily verified by connecting some other item of apparatus, such as an electric iron or table lamp, to the same socket and noting the effect on that apparatus of switching on the current. If the supply circuit is found to be in order, the fault will be either in the connecting cable (including plugs, etc.) or in the electric fire, so one or other of these possibilities must be eliminated.

At this stage it is necessary to sound a note of warning. The absence of normal functioning must not be taken as indicating that the apparatus is 'dead' in the electrical sense—the reverse is often the case, and the operative parts of electrical apparatus should not be touched until the apparatus has been disconnected from the supply main.

After disconnection, the next step is to test the connecting cable for con-

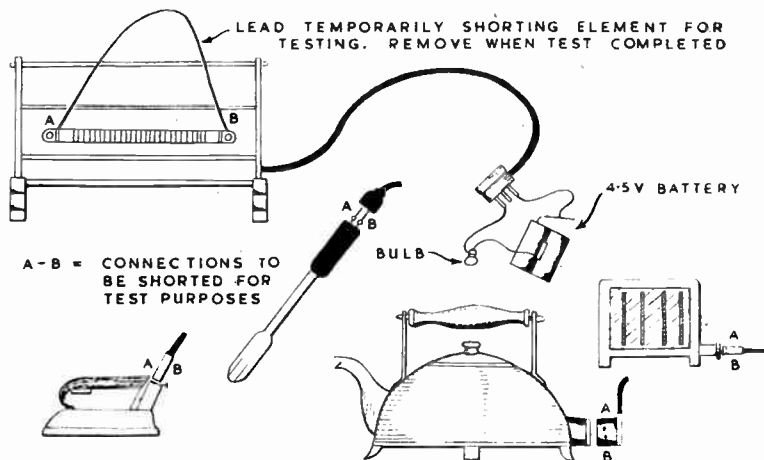

tinuity with a torch battery and bulb in the way shown in the sketch. It should be noted that the fire element is shorted, temporarily, while the test is made. The result of this test may determine the fault, for if the bulb lights it may be assumed that the plug, connections and cables are in order, and that the defect will be found in the element.

If, however, the bulb fails to light, the fault may be in the plug or in the connecting cables. Tests of each in turn with the battery and bulb will soon eliminate the parts of the circuit which

are sound and find the point of defect.

Much the same kind of test may be applied to apparatus such as electric smoothing or soldering irons, electric kettles, toasters and so on, and an indication of some of the more usual test points are shown in the sketches.

One last point to remember. If the apparatus at fault is connected to an outlet-socket by means of a two or three-way adaptor, the adaptor itself may sometimes be at fault and should be carefully inspected to make sure that proper contact is being achieved. (276)

Any little girl would treasure this DOLL'S PUSH-CAR

MANY of the dolls now sold are of good size, some almost lifelike, in fact, and a kiddie can get tired carrying it about, quite as well as an adult, when nursing a baby. The little pushcar illustrated would prove a welcome present to the child, as the doll can be wheeled about the house or street quite easily, and save the mother having, as sometimes happens, to carry the doll herself, when her young daughter tires.

Easily Made

The car is of simple design, and easily made. Any suitable wood can be employed, not too thick, as a clumsy affair is not desirable. Deal, $\frac{1}{2}$ in. thick for most parts would make a substantial article, that would stand some knocking about, as most children's toys suffer at times. Regarding the wheels, these are 4 in. ones, and are best bought ready made, being reasonable in price, and certainly looking better than the average of the home-made ones.

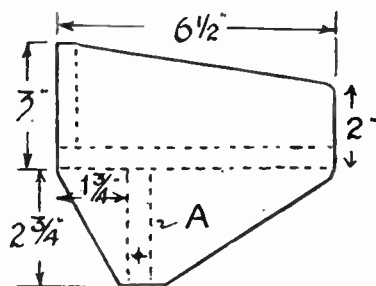

Fig. 1—Dimensions of the sides

The sides of the car are shown at Fig. 1, the shape being pencilled out direct to the wood to save time. The easiest method here is to pencil out a rectangle to the outside dimensions first, then the lining out of the pattern is simplified. The position of the seat, backrest and under crosspiece (A) are shown clearly by the dotted lines.

Cut the seat, taking its dimensions from Fig. 1 and 2, the latter a front view. To the bottom of the seat, at a distance from the rear end of $1\frac{1}{4}$ ins., as

CUTTING LIST

Sides (2) $6\frac{1}{2}$ ins. by $5\frac{1}{2}$ ins. by $\frac{1}{2}$ in.
Seat $6\frac{1}{2}$ ins. by 6 ins. by $\frac{1}{2}$ in.
Crosspiece (A) 6 ins. by $2\frac{1}{2}$ ins. by 1 in.
Backrest 6 ins. by $6\frac{1}{2}$ ins. by $\frac{1}{2}$ in.
Handle 2 ft. 6 ins. by $\frac{1}{2}$ in. by $\frac{1}{2}$ in.
Grip 4 ins. by $\frac{1}{2}$ in. by $\frac{1}{2}$ in.

One pair of 4 in. wheels.

shown, nail and screw the crosspiece (A) cut from 1 in. thick wood. On the inside faces of the side pieces, run pencil lines across, to show where the seat is to be fixed. The sides can then be securely glued, and nailed, to the seat and crosspiece.

All the sharp corner angles should now be neatly rounded off, except at the top rear corners, where the backrest joins it. Here they are left alone. The backrest is then cut to size, and it should be noted here that the full width of this part is $\frac{1}{2}$ in. wider than the width between the sides, given in Fig. 2. The top of the backrest is cut to a smooth curve, with a radius of 6 ins., and those portions of the side edges reduced in width where the rest comes between the sides of the car. This, of course, will be obvious. Using wood of $\frac{1}{2}$ in. thickness, a slip, $\frac{1}{2}$ in. wide and $2\frac{1}{2}$ ins. long will be removed from each side edge for this purpose. A nice, close fit ensuring, the backrest can then be nailed in position.

The Handle

For the handle, a length of $\frac{1}{2}$ in. square wood, should be cut, as at (D) in Fig. 3. If a piece of ash or oak can be found for this part all the better, as the handle should be tough. It can be cut to the length given, plus $\frac{1}{2}$ in. for entering the grip. This is detailed at (E), and has a $\frac{1}{2}$ in. by $\frac{1}{2}$ in. mortise cut through its middle, the appropriate end of the handle being reduced to a tenon to fit it.

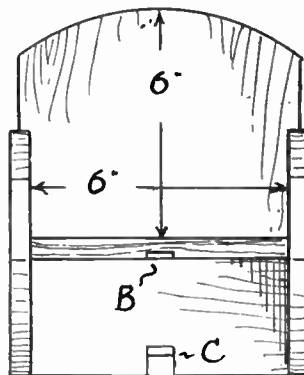
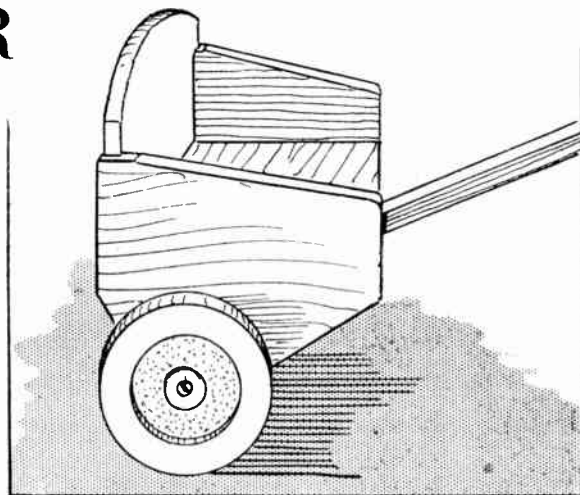

Fig. 2—Front view of seat, back and sides

The ends of the grip should be nicely shaped up, as in the drawing, for the comfort of young fingers, and then be glued to the handle.

It is necessary for the handle to be fitted to the car with an upward slope, so that the car tends to slope backwards when being pushed along. To ensure this, it is screwed to the bottom of crosspiece (A), and also to the front part of the seat. A notch is sawn, and chiselled



out of the former, as shown at (C), being $\frac{1}{2}$ in. deep at the back and rising to about $\frac{3}{4}$ in. or a little less, at the front. A smaller notch is also cut under the front edge of the seat, as at (B), this latter notch being about $\frac{1}{2}$ in. deep only, and slightly sloped downwards at its rear. In these notches the handle is securely fitted with screws, with its extreme end underneath bevelled off, as in the detail of its fixing (F) in Fig. 3.

Now punch all nail heads down, and give the completed article a thorough rubbing all over with glasspaper, to leave no rough edges or splinters anywhere. Give the woodwork a priming coat, then undercoat, and a final one of hard gloss paint or enamel. Children like gay colours, and a brilliant green or red, would not be out of place. The grip, and the handle as well, would be left plain, or given a coat of varnish, then the wheels can be fitted.

The exact position for these is indicated by a black dot in the side view of the car in Fig. 1, being 2 ins. from the

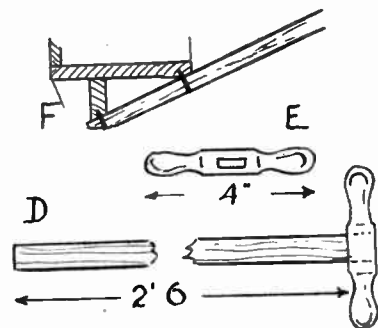

Fig. 3—Details of the handle

rear end and $\frac{1}{2}$ in. up from the bottom. Be careful to see, when purchasing the wheels, that the axle screws, and washers necessary are included. Place a washer between each wheel and the sides of the car, bore a hole with a gimlet in the correct spot, and drive the axle screws

(Continued foot of page 173)

More interesting experiments in HOME CHEMISTRY

If the world's deposits of chromite, the ore used for the manufacture of potassium bichromate, suddenly became exhausted, many branches of industry would come to a standstill.

As potassium bichromate is used in the dyeing of silk, wool and leather, for making pigments for pottery, linoleum, rubber and paint and for many more purposes, industrial chemists would be very busy, indeed, finding substitutes cheap enough to be of commercial value.

In organic chemistry, too, it is a valuable chemical on account of its strong oxidising properties. A simple experiment will demonstrate this.

Pour a little potassium bichromate solution into a test tube, add dilute sulphuric acid and then methylated spirit. Warm it gently and the solution becomes green. If you now smell at the mouth of the test tube you will find the odour of the meths. has disappeared and its place taken by the peculiar, penetrating odour of acetaldehyde. The bichromate has oxidised the alcohol of the meths. to acetaldehyde. The bichromate itself has been reduced to a green chromium salt.

Basis of Photography

This property of becoming reduced by organic matter was used as the basis for an early method of photography. We can use a simplification of the method for making shadow silhouettes, as shown in Fig. 1.

From a photograph or newspaper illustration, trace a side view of a person on thin semi-transparent paper by laying the paper on the picture and carefully pencilling the outline. Gum the tracing on to black paper. When dry, carefully cut out along the pencil line with a sharp knife or fine-pointed scissors, so as to form the stencil shown in Fig. 1.

Next sensitize a piece of drawing paper by soaking it in strong, cold potassium bichromate solution. This must be done by candlelight only. After five minutes soaking, drain and pin up the paper in a dark cupboard to dry.

When the paper is dry, cover it with the stencil and expose it to full daylight in a photographic printing frame or between two sheets of glass. The yellow, exposed part of the paper begins to darken in about a minute and after an hour the bichromate paper may be removed in a candlelit room.

A brown shadow silhouette will be found at the exposed part. The un-

exposed parts will still be bright yellow. To fix the image simply wash the print several times in warm water until the waters are no longer coloured yellow.

Barium Chromate

Barium chromate is the pigment known as 'yellow ultramarine'. To prepare it, add potassium hydroxide solution gradually to potassium bichromate solution until the latter is no longer acid to litmus paper. Now add barium chloride solution. A pale yellow precipitate of barium chromate will form. Continue adding barium chloride until no



STENCIL



SILHOUETTE

Fig. 1—Shadow silhouettes

more precipitate forms. Wash by decantation until the wash waters no longer give a precipitate when a sample is tested with silver nitrate. Filter, and dry the precipitate in the oven.

From this barium chromate we can make chromic acid. Place some in an evaporating basin. Boil it for a few minutes with a little dilute sulphuric acid. Remove the burner, and when the chromate has settled, pour a few drops of the clear solution above into calcium chloride solution. If no white precipitate forms, decant the liquid off the chromate into a second basin. Add more sulphuric acid to the chromate and repeat the boiling and testing.

When a precipitate is formed with calcium chloride, reject that portion and bottle the contents of the second basin for your chemical stock. This orange-coloured solution of chromic acid is useful for preparing soluble chromates, it being merely necessary to act upon the carbonate or hydroxide of the appropriate metal and to evaporate to the crystallisation point. The insoluble white residue in the first evaporating basin is barium sulphate and may be washed and dried as another specimen.

If you ever wish to study the reactions of chromium and have no chromium salts at hand, you may easily

prepare a solution of a salt of this metal from potassium bichromate. Bubble sulphur dioxide (made by heating a mixture of anhydrous ferrous sulphate and sulphur in a hard glass test tube) into potassium bichromate solution. The orange colour changes through brown to dark emerald green.

This solution now contains a chromium salt, as we can prove by making chromium hydroxide from it. First boil the solution to drive off dissolved sulphur dioxide; then add sodium hydroxide solution until no more grey-green chromium hydroxide is precipitated. Wash it well on the filter and dry in the oven.

Brilliantly

Mercurous chromate is another brilliantly coloured salt which is easily prepared. Mix solutions of mercurous nitrate and potassium bichromate, when a heavy, fiery orange-red precipitate of mercurous chromate will form. Wash it by decantation, filter off and dry in the oven.

Mercurous chromate has the interesting property of decomposing into

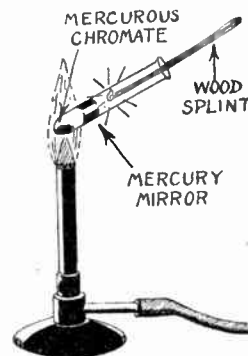

Fig. 2—Experiment with mercurous chromate

mercury, oxygen and chromium sesquioxide when heated. Place some in an ignition tube and heat it strongly. A mirror-like ring consisting of minute globules of mercury will form part way up the tube, and if you plunge a glowing wood splint into the tube it will burst into flame again (Fig. 2).

When no more oxygen is being given off (when the glowing splint is no longer rekindled), let the tube cool. If you shake out the residue you will find it has become moss-green chromium sesquioxide. (289)

Doll's Push-Car—(Continued from page 172)

home. If correctly positioned, the screws should enter the crosspiece (A) in the middle of its edges, and find a firm footing, as it were. See the screws are not too tight, as the wheels must rotate

easily, but without any side wobble.

A welcome addition to the finished article would be a small strap, nailed inside the car, to hold the doll, and prevent it tumbling out. Quite likely a

suitable little strap can be found in the home, or else one can be made from a strip of thin leather or American cloth, with a buckle taken from some unwanted article. (265)

YOU CAN BECOME A HANDICRAFTS INSTRUCTOR

EXPERIENCE NOT ESSENTIAL

Men who enjoy making things in wood or metal can turn their hobby into a permanent and interesting Career. Short hours, long holidays, and security in a job you would really enjoy, can be yours if you become a Handicrafts instructor. Let us send details of the easiest and quickest way to get the necessary qualification.

**We definitely guarantee
"NO PASS—NO FEE"**

If you would like to know about our unique method of preparing you for one of these appointments, write today, and we will send you our informative 176 page Handbook—free and without obligation. Mark your letters "Handicrafts Instructor".

**BRITISH INSTITUTE OF
ENGINEERING TECHNOLOGY**

395 Shakespeare House
Stratford Place, London, W.1

BIET



BRITFIX BALSA CEMENT

★ The ideal transparent cement for Balsa Ply Wood, Hard Woods, and Plastics, combining rapid drying with utmost tenacity.

Remember
**STICK BY
BRITFIX**

½oz. Tube 6d.
1oz. Tube 10d.
2½oz. Tube 1/6

THE HUMBER OIL Co. LTD., HULL



THE BOLSTER HOME WATCH AND CLOCK REPAIR OUTFIT

These precision jewellers instruments include watchmaker's magnifying eyeglass, finest watch tweezers, set watchmaker's screwdrivers, watch and clock oil, oilers, dusting powder, clock brush, plus illustrated instructional manual for the amateur. In container 12/6 post free.

Senior Outfit includes everything above, plus watch jewels luminous compounds, dial renewer, jewellers rouge, explanatory book. Price 21/- post free.

BOLSTER INSTRUMENT Co. (Dept. H.W.), 5a Stratton Parade, Ashford, Middx.

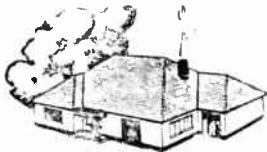

TURN YOUR
SPARE-TIME INTO CASH
Men and women wanted to
make Bennett Model
Bungalows at Home.

Fascinating, simple, well paid work
No selling involved.

Send stamped addressed envelope for full details.

BENNETT MODELS,
Duncan Road, Richmond, Surrey

Is This Saw in Your Kit?

You can cut almost anything in wood with this Coping Saw. The blade is 6½ ins. long and can be turned to cut at any angle. No tool-kit is complete without one. Get yours NOW.

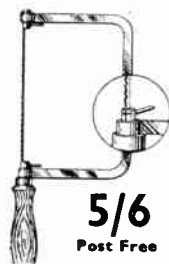

5/6
Post Free

Buy from any Hobbies Branch, or direct from Hobbies Ltd., Dereham



MANCHESTER
10 Piccadilly
(Phone CENTRAL 1787)

BIRMINGHAM
14 Bull Ring

SHEFFIELD
4 St. Paul's Parade

LEEDS
10 Queen Victoria Street
(Phone 28639)

HULL
10 Paragon Square

SOUTHAMPTON
25 Bernard Street

BRISTOL
30 Narrow Wine Street
(Phone 23744)

BRANCHES

LONDON

78a New Oxford St., W.C.1

(Phone MUSEum 2975)

87 Old Broad Street, E.C.2

(LONDON Wall 4375)

117 Watworth Road, S.E.17

GLASGOW

326 Argyle Street

(Phone CENTral 5042)

Head Office & Factories—HOBBIES LTD., DEREHAM, NORFOLK



STEEL BOXES

Ex-W.D. strong steel ammunition boxes, 19" x 7" x 7" inside size. Hinged lid, two carrying handles, perfect condition. Suitable for tools, etc. 5/3
Post 1/6

SPONGE RUBBER SLABS

16" x 9" x ½" blue sponge or red crepe rubber. New ex-Gov. Limited quantity only. With table. 4/9
Post 10d.

RUBBERISED CANVAS

Superior quality, 3-ply grey, white backed immensely strong, easy to sew or stick, waterproof and dustproof. 9/9
Post 1/3 (yard)

BALLOON FABRIC

Double texture, 40" wide, easy to stick or sew. Ideal car covers, etc. 9/9
Post 1/3 (yard)

Illustrated Catalogue Free

PRIDE & CLARKE LTD., (Dept. P.W.)
STOCKWELL ROAD, LONDON, S.W.9. BR1xton 6251

STOP SMOKING

You can overcome the smoking habit in 3 days or money back. Safe, pleasant, permanent. The only scientific way. No Will Power necessary. "Conquered the habit in 2½ days. Am delighted".—F.C. "Within 2 days I was free from the tobacco habit".—W.G. "Was a smoker for 2 years and broke the habit in 2 days".—F.N. "I haven't smoked a cigarette for 5 weeks".—J.E. "I used to smoke 20 a day . . . now I have no desire to smoke".—J.M. Recommended by "Health and Efficiency Magazine". Complete course 6/6. Details 1d. stamp sent under plain cover.—STEBBINGS, 28 (H/99), Dean Road, London. N.W.2. Established 1928

MONEY-MAKING BOOKS

114 WAYS TO BE YOUR OWN BOSS—114 Tested ways of earning a second income at home with little or no capital 5/6
MONEY FROM MAIL ORDER—How to start and run a Mail Order business at home and earn pounds weekly 5/6
HOW I WRITE AND SELL THRILLERS—By the author of 73 successful thrillers 4/6
Catalogue of Money Making Books free.
STEBBING PUBLICATIONS LTD., 28 (H/99) Dean Road, London. N.W.2. Established 1928

GRIPS the SCREW AND DRIVES IT HOME INTO THAT AWKWARD SPOT!

SO QUICK, SO EASY! A LITTLE MIRACLE!
This new precision driver GRIPS the smallest grub screw or large wooden screw firmly, instantly—and drives it quickly home into any awkward spot. Saves time & labour.
ORDER TODAY 4/- MAILEX SUPPLY COMPANY (H)
POSTPAID FOR ONLY 70 POYNTERS ROAD, DUNSTABLE, BEDS.

KITS for OLD TIME SHIPS

Hobbies range of Ship Models includes Elizabeth Jonas, Cutty Sark, Victory, Mayflower, etc. Complete kit of wood, sail material, guns, pulleys, cord, etc., with full size pattern of parts and planed wood ready to cut out, shape and construct. A fascinating pastime. Kits for models 12½ ins. long and upwards.
Ask for free illustrated lists at Hobbies Branches or from Hobbies Limited, Dereham, Norfolk.

MYFORD

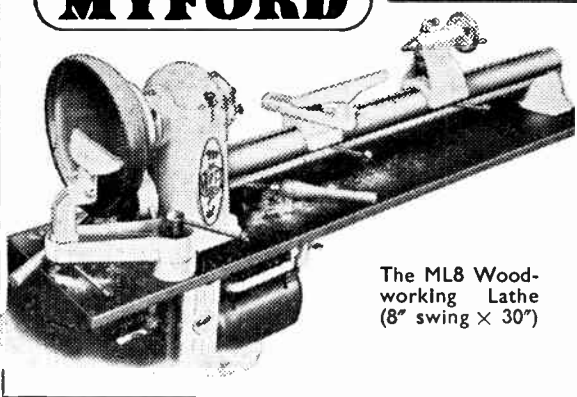

The ML8 Wood-working Lathe (8" swing x 30")

It's a pleasure

Bowl-turning presents little difficulty and gives a great deal of pleasure to the capable woodworker who has a Myford ML8 Lathe in his workshop. The near-finished job being turned on the ML8 (above) is now a fine, polished, mahogany bowl, and all operations of sawing, turning, sanding and polishing were accomplished on this lathe. Powerful attachments enable several important carpentry jobs besides actual wood turning; see your Tool Merchant for full information.

Myford Engineering Co. Ltd., Beeston, Nottingham



The
bristles
won't
come
out!

Harris—the paint brush
with a name to its handle

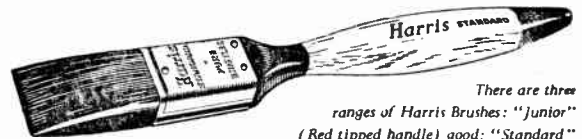

There are three ranges of Harris Brushes: "Junior" (Red tipped handle) good; "Standard" (Brown tipped handle) better; "Super" (Rosewood handle) best.

L. G. HARRIS & CO. LTD., STOKE PRIOR, WORCESTERSHIRE
CRC 27

For all kinds
of woodwork

HOBBIES FRETSAWS

Not only in fretwork and model making but in a hundred and one woodwork, composition plastic, leather or metal sheet jobs you'll find a fretframe handy. And the best blade for any is the saw which is made here by Hobbies from good steel and the experience of forty years of manufacture. Every dozen is distinctly labelled.

IN 3 GRADES

Blue Label	...	1/-	per doz.
Yellow Label		1/3	"
Metal Cutting		1/4	"



Obtainable from Ironmongers' Stores and Hobbies Branches, or by post from **HOBBIES LTD., DEREHAM, NORFOLK**

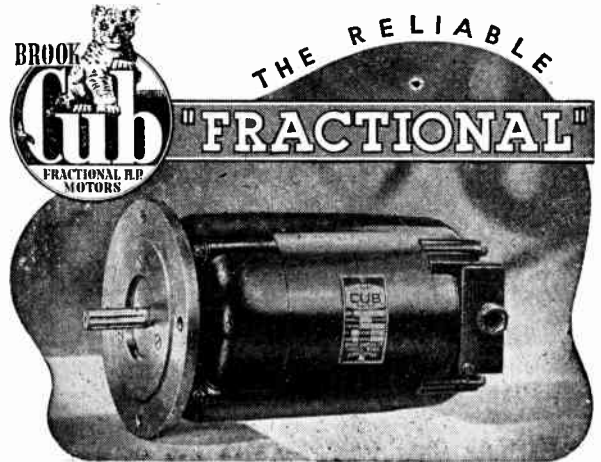

For every purpose in the small home workshop . . . use a BROOK 'CUB' 1/4 h.p. motor. Single or split phase.

Electric Motors from 0.25 to 200 H.P.



EMPRESS WORKS HUDDERSFIELD

I.H.M 148



"You must have a wonderful lathe?"

"Rather! I turned my Wolf Cub Electric Drill into a lathe and it only cost me £3.7.6."

"That's very cheap—how do Wolf do it?"

"I had a Wolf Cub (that cost me only £5.10.0), then I bought this Lathe Set for £3.7.6. I clamped in the Wolf Cub—and there you are, a real electric Lathe Kit!"



"Is that all Wolf Cub Home Constructor Equipment?"

"Oh no! next I shall buy a Saw Set like this for £2.16.3, fit my Wolf Cub and I shall have a real Electric Saw Kit!"



"How marvellous!"

Yes, and that's not all the story!

★ Write at once for large size, fascinating, fully picturised folder "Profitable Pleasure".

Prices and descriptions subject to alteration without notice

Wolf Cub

HOME CONSTRUCTOR KITS

WOLF ELECTRIC TOOLS LIMITED · PIONEER WORKS
HANGER LANE · LONDON · W.5 Telephone: PERIVALE 5631-4

★ CHOSEN ON MERIT FOR THE FESTIVAL OF BRITAIN

Making Toys, Models or Novelties is a paying pastime—

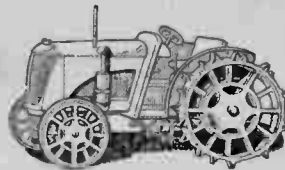
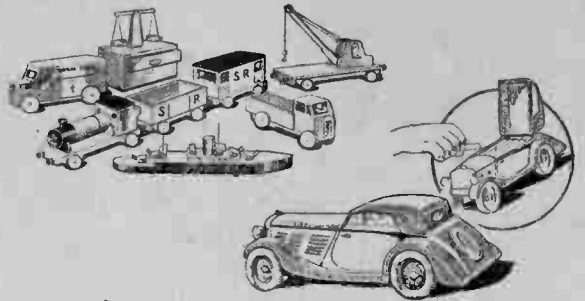

with
a

HOBBIES A1 FRET MACHINE

A Treadle Fretmachine provides a factory in the home. The treadle movement is easy, the machines running smoothly and fast. It is astounding the amount of work they will do in wood up to 3/4 in. thick. Both hands are free to handle the work which can be manipulated up to 1ft. 7in. behind the sawblade. Machines are comfortably operated from a chair, rigid and easy running. The A1. has cast legs with wooden arms and special tension arrangement. Spare sawblades, a design and Instruction Manual supplied with each. Price ready to use **£7-2-6**

Carriage paid U.K.

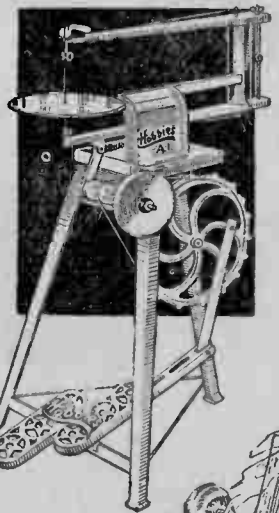

Full range of Machines can be seen at any Hobbies Branch. Or ask particulars from large stores or ironmongers. Illustrated leaflets free on request to Hobbies Ltd. Dereham, Norfolk.

