

Hobbies

WEEKLY

CONTENTS

	Page
Electric Dart Board	- 145
Pecking Chicks Toy	- 147
Christmas Decorations	148
Stage Light Dimmer	- 149
Bureau Inkstand	- 150
A Lavatory Light	- 151
Chemical Apparatus	- 152
Matters of Interest	- 153
Crinoline Lady Table	
Mat Holder	- 153
Rustic Ash Trays	- 154
Stamp Collecting	- 155
Seagrass-top Stool	- 156

December 6th, 1950

Price Fourpence

Vol. III No. 2875

AN ELECTRIC SCORING DART BOARD

THIS novelty dart board can provide a lot of fun. Scores are indicated visually by the appropriate light flashing on, whilst a maximum or 'bull' on the centre of the target rings an electric bell. The simple target shown has four scoring positions, but the same principle can be extended to multiple scoring up to, if desired, the full 1 to 20 and 25 and 50 'bull' scores on the conventional dartboard. Each score, however, requires its own individual indicating lamp and so the five-score target has been chosen as a simple example.

How it Works

Principle of operation is this. The target face is backed by two wire gauze panels. The first wire gauze panel is divided in a similar pattern to the target face, each portion being separate from its neighbours and insulated from the rear wire gauze disc by a further intermediate wooden disc, which also forms the backboard of the target itself.

The gauze segments are then wired up to a battery and lamp circuit, so when a dart penetrates both the front or 'recording' gauze and the rear gauze, the metal shaft of the dart actually completes the electrical circuit for that particular signal lamp which, therefore, lights up. In the case of a 'bull' score, the electric bell circuit is completed.

Target Components

Components of the target are shown in Fig. 1. These consist of a target face marked off into four equal sectors, with a circular bull ring. Diameter of the target is 9ins. and that of the bull ring

1½ins. These dimensions are purely suggestions and can be varied, as required.

The five recording gauze panels are cemented to the rear of the target face, these being cut to have ¼in. clearance between adjacent pieces (see Fig. 2). Backing this is a further 9in. diameter disc of soft wood, and finally cemented to the rear, a 9in. disc of wire gauze. In section the target assembles as in Fig. 3.

For the wooden parts of the target,

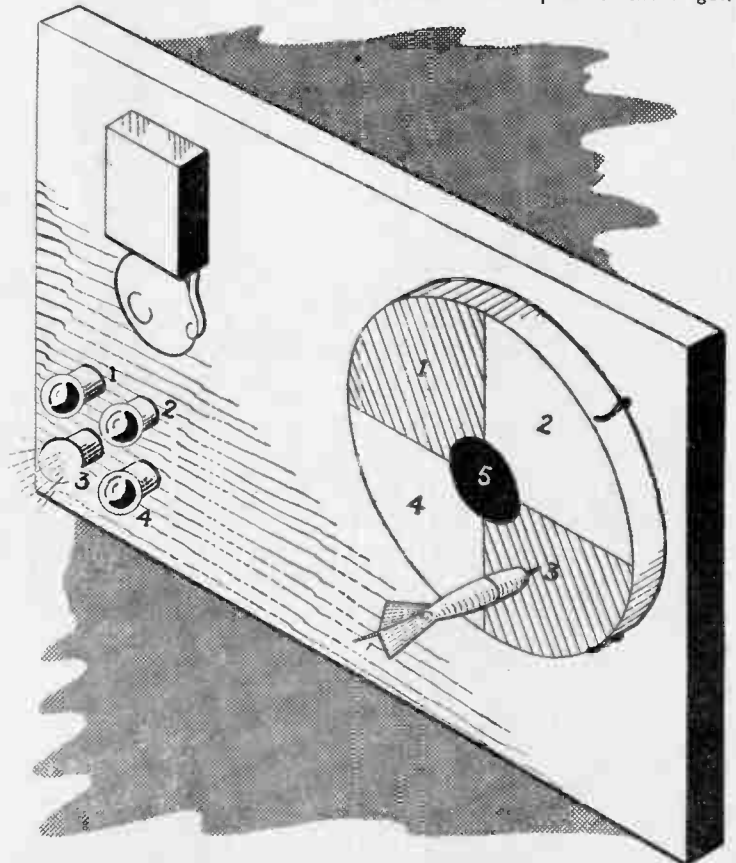

All correspondence should be addressed to The Editor, Hobbies Weekly, Dereham, Norfolk.

balsa is specified as being a soft wood, readily obtainable and one which does not easily split. The wooden discs must be soft to allow the dart to penetrate through to the rear gauze, otherwise the electrical circuit will not be completed.

finally assembled and cemented together. These wires must be soldered to the gauze, the wires from the sector-shaped divisions passing along the outside of the completed target to the rear, whilst the bull lead passes through a hole in the centre of the backboard and the rear wire gauze disc. All wires should be insulated and care taken to ensure that no part of the circuit is shorted out.

The lampholders, bell and target can be assembled on any suitable backboard. In

Checking Faults

Failure of any of the circuits to work can be quickly checked. Provided the dart point protrudes through the rear gauze disc the target circuit should be complete, when the wiring to the bulb and the bulb itself should be checked. There will be certain 'dead' spots on the target where no score will be recorded.

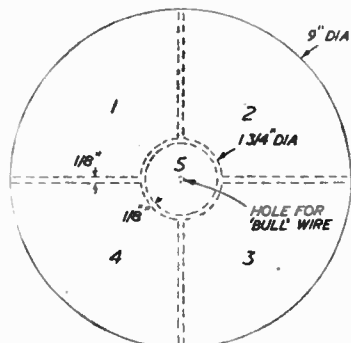
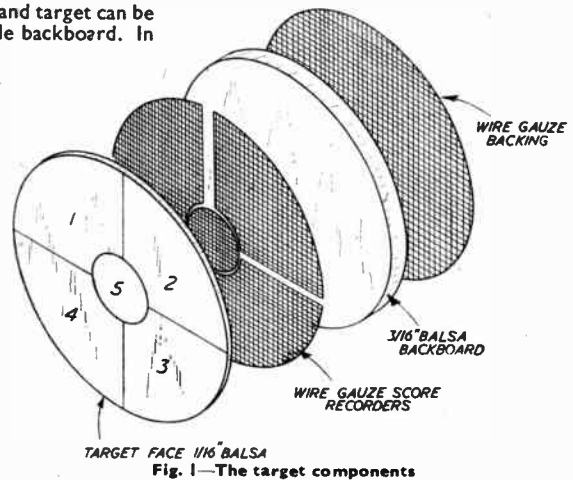
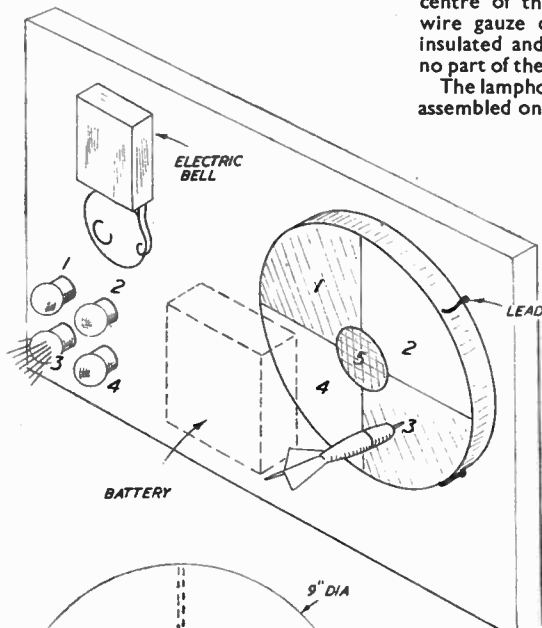

Fig. 2—Target layout

Soft balsa is ideal in this respect. Hard balsa, however, is like most other harder woods; it will split fairly readily.

Cork would, of course, be an ideal material for the backboard, if obtainable, or even wallboard or similar material. Any of these should be available in 9in. widths. In the case of balsa sheet, this is usually sold in 3in. widths and three 9in. lengths will have to be cemented together to provide the required width for the target face and backboard discs.

The Wiring

The wiring diagram (Fig. 4) is important and must be followed carefully. All the wires should be soldered in place before the target components are

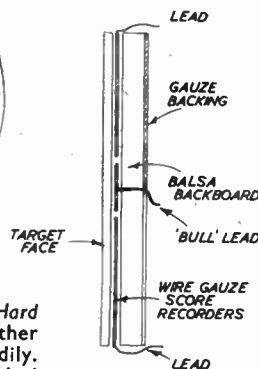

Fig. 3—Section of the target

wiring up the lampholders, note that the sockets of all the lampholders are connected together and thence to one side of the battery. The bulb contacts go to the respective score recording sectors.

No switch is shown in the diagram, but it would be advisable to put one in the battery lead, so that the target can be switched on or off as desired. If no switch is used, the battery must be disconnected each time after use.

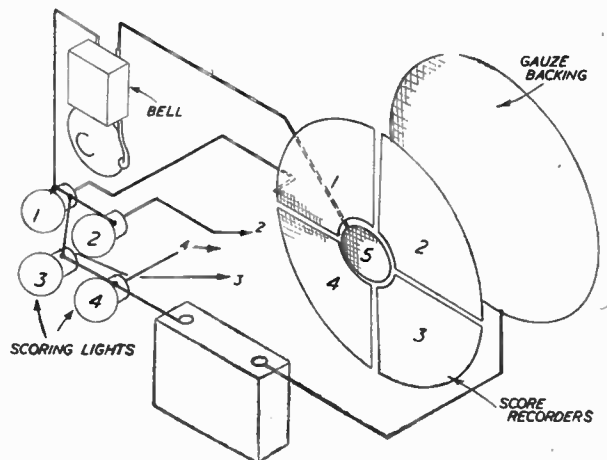

Fig. 4—Diagram of the wiring

These are on the lines, corresponding to the small spaces between adjacent score recorders.

You can, if you wish, reduce the chance of this happening to a minimum by working to only the barest clearance— $\frac{1}{16}$ in. being more than adequate, which is very much less than the width of the dart shaft. However, this needs very careful workmanship to avoid shorting out adjacent recording panels. (279)

HOBBIES BRANCHES —

LONDON
78a New Oxford Street, W.C.1
87 Old Broad Street, E.C.2
117 Walworth Road, S.E.17

GLASGOW
326 Argyle Street

MANCHESTER
10 Piccadilly

BIRMINGHAM
14 Bull Ring

SHEFFIELD
4 St. Paul's Parade

146

LEEDS
10 Queen Victoria Street

HULL
10 Paragon Square

SOUTHAMPTON
25 Bernard Street

BRISTOL
30 Narrow Wine Street

A simple novel mechanical piece of amusement

PECKING CHICKS TOY

A YOUNGSTER would find much amusement in this type of pull-along. When drawn by a string, the pair of chicks peck away busily. It is quite easy to make and would be an acceptable Christmas gift for a child.

The body parts are shown grouped together in Fig. 1. The pecking board (H) can be cut from $\frac{3}{8}$ in. deal. Run a line along the middle and on this bore two pairs of $\frac{1}{4}$ in. holes, just $\frac{1}{4}$ in. apart, for the chicks to be fixed in. About $\frac{1}{4}$ in. in front of these, and between them, cut $\frac{1}{4}$ in. by $\frac{1}{2}$ in. slots for the operating cords. In the centre of the board, where shown, cut another $\frac{1}{4}$ in. by $\frac{1}{2}$ in. slot for part (D) to fit in.

Platform Parts

The sides of the body (B) are also cut from $\frac{3}{8}$ in. deal. At the spots indicated bore $\frac{3}{8}$ in. holes through for the axles of the wheels. Now glue and nail the sides to the board. Cut part (D) from $\frac{1}{4}$ in. fretwood, and make the tenon at the top to fit the central slot in the pecking board. Where shown make a small hole with a bradawl.

The part can now be glued in position and should point downwards, as shown by the dotted outline on (A). A rocker (C) is carefully cut from $\frac{1}{4}$ in. fretwood to the shape shown in the drawing. Drill a small hole near the centre, and at the spots indicated, right and left of this, partly drive in $\frac{3}{8}$ in. round-headed brass

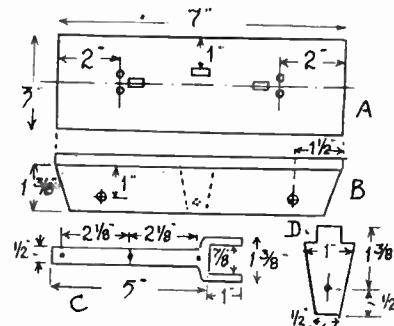

Fig. 1—The main platform parts

screws. Fit the rocker with a $\frac{1}{2}$ in. screw through its central hole to part (D) and see it can swing up and down freely.

Wheels

A pair of 2 in. wood wheels will be needed. These can be cut from fretwood or bought ready-made as preferred. Bore them centrally $\frac{3}{8}$ in. The axle is a length of $\frac{3}{8}$ in. round wood rod, cut long enough for the wheels to fit on when the axles are in place. These items are shown in Fig. 2.

To operate the rocker, a cam is cut from $\frac{1}{4}$ in. wheel, as at (F). Describe the $\frac{3}{8}$ in. circle first, and then at a centre, $\frac{1}{8}$ in. from one side, bore a $\frac{3}{8}$ in. hole to fit the axle.

The cam should be glued to the axle, not at the centre but with one face side touching it. It will be best here to glue one wheel on the axle first. Then push through the bearing holes, threading the cam on. Apply the glue to the spot on the axle where the cam is to come, and push the cam in place.

The second wheel can then be glued on. A thin fretwork nail might be driven through the cam into the axle to prevent it loosening at all, if it is thought that the glue is not holding it too well. Fix the second pair of wheels on to finish this part of the job.

The Chicks

When the glue is hard, draw the body along and if all is O.K., the rocker will swing quite freely. Now mark out and cut the parts forming the pecking

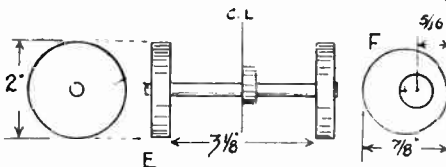

Fig. 2—Wheels and axle fitting

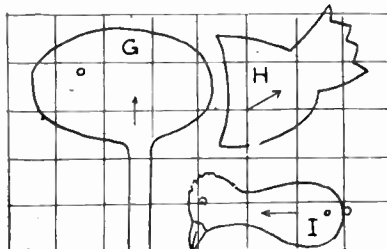
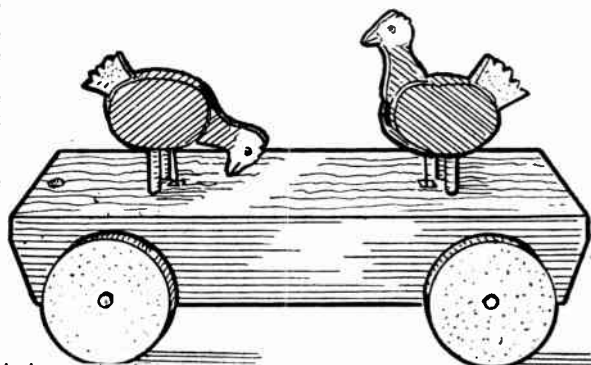

Fig. 3—Outline of chicks

chicks. These are drawn over $\frac{1}{4}$ in. squares. Copy them full size and trace through carbon paper on to $\frac{1}{4}$ in. fretwood, the arrows showing the direction of the grain of the wood. Cut two each of parts (H and I) and four of parts (G). Glue parts (H) between two of (G), leaving a gap between for the head and neck to swing in.

Heads to Move

Small holes are bored in (G) where shown, for the pivot nails on which the heads swing. The heads (I) are thoroughly glasspapered to thin the wood enough to ensure an easy fit between the sides (G). A pivot hole, an easy fit for the nail, is bored, where



indicated, and in the edge of the wood, near this, a tiny wire hook is fixed to which the connecting cords can be tied.

A pin makes quite a good hook. Drive in, and be careful the pin does not enter the pivot hole, cut off to $\frac{3}{8}$ in. long and bend this to an eye. Now pivot the head in with a thin wire nail.

It must be a loose enough fit here to drop down off its own weight, if the toy is to work satisfactorily. Tie the connecting cords on, round the legs a bit, just enough to fit the holes in the pecking board, and glue the chicks in place.

Method of Fitting

Drop the cords through the slots in the board and tie the ends to the screw heads in rocker (C). A method is necessary here. Turn the wheels until the forward end of the rocker is up, then tie the cord of the chick above to its screw head. Turn the wheels until the rocker is down and the rear end up, and tie the cord of the second chick. All should now work smoothly. A suitable hole is bored in the front of the pecking board for attaching the drawing cord.

Finish the toy in suitable colours. For making this article the following Hobbies panels of wood are required—one of L.D.6 and one G.4, with the wood for wheels, if home-made, extra.

Wood Like Ivory

TAKE $\frac{1}{2}$ oz. of isinglass, boil gently in $\frac{1}{2}$ pt. of water till dissolved, then strain it, and add flake white powder until the mixture becomes white and of the consistency of cream. Give the box or ornament three or four coats of the solution, letting each coat dry before the other is applied, and polish with a clean cotton duster. A few grains of carmine or chrome yellow will produce a slightly pink or amber tint.

Now is the time to make your preparations for XMAS DECORATIONS

CHRISTMAS decorations are always expensive, as they have to carry a heavy purchase tax of 100 per cent. There are many ideas you can make, with just a little imagination. Do not overlook the use of the coloured tissue paper on sale at model shops for covering model aeroplanes.

Most of the central decorations should be concentrated over the fireplace, but with all due precaution against fire. In the picture is shown a large cut-out of Father Christmas which can be made in wood or cardboard. Tall ornamental candles in vivid colours are now available and these can be set in four or six green apples cut in the centre.

A Set Piece

Make a centre set-piece by working out a wire frame in the shape of a star (see Fig. 1) always popular at Christmas. Criss-cross the shape with thinner wire, as shown, and then you can fit in a good layer of outdoor evergreen or furze. Touch off the edges with cotton wool and again a circle in the centre of cotton wool. Glitter powder and a little paste on the cotton wool will also add to the realism.

For the centre you need the largest silver ball you can find. If you have the smaller coloured glistening balls, then set these out on the points.

Thin wires stretched from each picture rail will enable you to hang down all sorts of smaller and simply-made ornaments. This system also helps you to keep the decorations up and out of the way of the heads of the company.

'Snow' and Holly

Roll balls of cotton wool and into these you can stick small sprigs of holly or berries in their natural colours or painted in art enamels of bronze, gold, red, yellow or silver. Note the design set out by graduated lengths in front of the fireplace. Some rooms look nicer decorated up to the fireplace, because this takes the decorations away from the centre room light and does not obliterate it so much.

Cotton wool is expensive but if you intend to go in for quite a few snow scenes, you can make this up cheaper by

Wire Straightening

THE following is a very successful method of straightening wire. Pass the wire round the handle of your vice or other round object and pulling the wire tight, work it to and fro, and it is only a matter of seconds before all the kinks are out.

getting a 1/- roll of white crêpe paper. Cut this into three sections across the grain. Force it on to a broom handle, so that it creeps up to the broom head. When you take it off it will be really wavy and just like heaped snow. Dabs of paste and glitter wax or powder will set the effects off.

Silver stars by the hundred can be cut from 1yd. of silver foil. Make three templates in different sizes.

If you do not go in for the more expensive garlands, then try cutting up strips of crêpe paper and twisting before fixing. Four bright shades will effect wonders and cost only 4/-.

One great attraction can be the real snow tree. If you are lucky to have a small tree, take this out in the garden and mix up some thin whitewash. Spray the tree and the effects will amaze all your friends.

Dinner table centre-piece should be the crowning effort. Cover a flower pot with crêpe, and make a centre stem of dowel rod or cane. Set a bright globe at the top. With a couple of packets of drinking straws you can wire these on, as shown in Fig. 2, and before doing this, dip them in various colours of enamels. Sealing wax blobs on the ends will add to this decoration. The tree is now ready for the icicle strip which will hang conveniently over the straws. This tree will also be strong enough to hang small gifts on in brightly coloured packets.

If you have a circular mirror or a silver tray, set this underneath with a little mound of cotton wool around the pot. Ring the edge round with cotton wool, berries and other suitable materials. The tiny figures shown (at Fig. 3) can be cut out in fretwork and set on small dummy sledges. A set of figures can be found in any toy book. If you can get the candle holders these will look well on each figure.

Simple Decorations

Do not overlook the use of brightly coloured fir cones as tree decorations, as they live any tree up and cost so little and look effective when used with other ornaments. Small horseshoes in silver card are always effective and much appreciated by all.

Sprigs of all sorts of outdoor ever-

greens can be used and you can frost them over with powdered washing soda. To do this, brush a little liquid glue or paste lightly over the foliage and then dust over with the soda. Shake the foliage out of doors to remove surplus. Oddments of ribbon, coloured wool, ornamental tie-up string can all be used, and in fact any colourful scraps should be used. Cords used in piping needlework can be painted in silver and are most effective.

Place names on the table will be

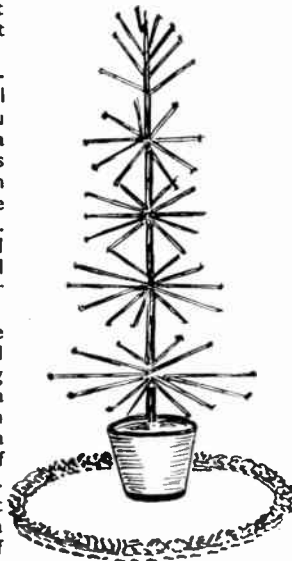

Fig. 2—A table centre piece

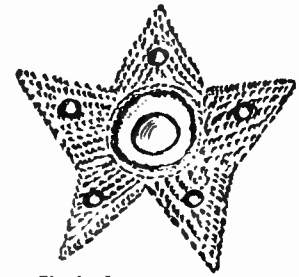

Fig. 1—An attractive star



Fig. 3—Another novelty

another method of making the place gay. Collect some cotton reels and paint in bright shades. Just a little card can be set up in each together with a sprig of holly. Gum the top and sprinkle with glitter powder. If you have golden tinsel thread, then tie the names on with this.

Powder and Pictures

There are many substitutes and one may not have thought of Epsom salts as a glitter powder. This can be applied with paste.

Cut-outs from any toy book make ideal novel decorations and they are so well coloured and designed that people will be amazed at the originality of your schemes. Why not make a set in fretwork and then give them away to the children afterwards.

Save all the small cream cartons. Paint in bright shades. Get some cones and set a wire in the centre. Tip the cone ends with gold, silver and red. Set them in the little pots. With these ideas you should spend little, create something novel and enjoy the work all through.

(316)

A simple and effective method of arranging a STAGE LIGHT DIMMER

WE are now right in the time of amateur dramatics, school concerts and the like, and it generally falls to the lot of the handyman to wire up the footlights and arrange other illuminations on the stage. In doing this the need often crops up for some sort of apparatus that will allow of the lamps to be faded out slowly and equally slowly brought back to a state of full intensity. Indeed, some of the 'ghostly-ghostly' plays greatly favoured by amateur dramatic societies depend entirely for certain effects on dimming.

The apparatus to produce 'fading' is not hard to make and is officially known as a dimmer. There are several types, but the simplest is the 'liquid resistance' dimmer in which the current is passed through a vessel containing water to which salt or soda has been added, the amount of resistance depending on how far through the solution the current has to travel.

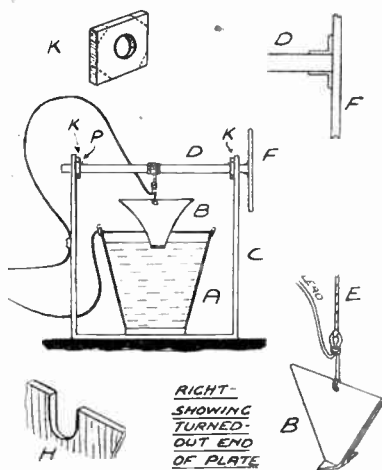

Fig. 1—Section and detail of parts

Fig. 1 shows the arrangement of a dimmer and the parts required for use with current up to 5 amps. The part (A) is an ordinary household metal bucket and (B) a triangle of thick tin made up of a diamond shape bent over about its shorter diagonal.

At the bottom, the points of the triangle are turned out to form a foot and a good area of contact when the plate is right at the bottom of the bucket and full current is flowing.

Better Results

Better results are obtained if the sides are curved inwards and the triangle should be so sized that its top corners touch the bucket side when the foot is on the bottom. The shape is best secured by experimenting with a sheet of card which can be snipped and trimmed till everything is right.

The piece (C) is an ordinary tea chest

or other box in which the bucket goes. This acts as a support for the spindle (D) and covers the whole apparatus so the operator is right away from anything that may be 'alive'.

To assemble, put the bucket in the box and breaking a lead from the lights, take one of the loose ends so left through a hole in the box. Either attach the end to the handle loop on the bucket or, stripping a length of insulation, wrap it right round the bucket at the point where the slope of the side ceases at the bottom.

A bolt through the metal makes a better terminal still, but rather mars the container for household work later on.

In any case, if the wire is quite tight round the bucket or well fastened to the handle loop, good results will be had. There must, however, be no question of a loop shaking down or a handle contact becoming loose during a show, for all the lights depend on this joint for their current throughout.

Whatever the method used, carry the insulation as near to the point of contact as possible.

Top Spindle

Now fit the spindle on top. This is merely a length of round rodding—a discarded brush stale if straight will do, or a bit of old curtain pole. Two vertical channels are made in the top edge of the box as (H) opposite one another and the spindle is fitted with a single cross bar (F) at the end which, it will be found, protruding at both sides, enables one to impart an even turning action to the rod. If desired, of course, a simple handle could be fitted, but this really is not necessary. Fit also the wooden washers (K), held by the nails (P) to prevent the spindle slipping sideways.

Take the other end of the cable, break and fasten this to the central point of the metal triangle (B) and then suspend the triangle from the spindle by the length of cord (E). Wrap the cord, which should be thin and pliable, round the wood several times and attaching to the cable below as shown. If correctly adjusted it should be possible by rotating the spindle to lower the triangle right to the bottom of the bucket or conversely raise it to the top.

To fix the cord firmly to the spindle put several tacks through the flattened end. The danger of the wood suddenly starting to rotate idly in a loose circle of the cord must be entirely eliminated. Nothing can be left to chance.

To allow the cable to come down easily with the plate, it should be clipped to the side of the box as shown so a big easy loop is formed that will sink with

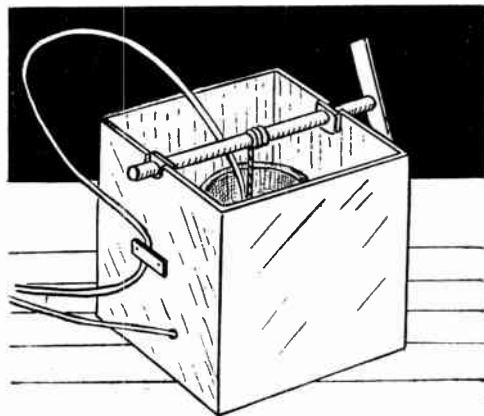

the weight without putting any drag on it.

The resistance solution can now be added. Fill the bucket with clean water, lower the weight till it touches the bottom and switch on. If all is in order, the lamps will burn at their full intensity as the current is complete.

How it Works

Draw the triangle to the top of the bucket and the lights go out. Now add the salt or soda which has the effect of reducing the resistance of the water. When the resistance has been reduced sufficiently, the lamps begin to glow very faintly and this is what is wanted—that the lamps shall be dimmed out at the top of the bucket.

Now if the weight is lowered and more of the triangle is immersed, the point goes nearer to the bottom and the side to the bucket side, the lamps will burn with greater intensity.

Thus we have the control we want and our dimmer is completed. Incidentally, should you be working with D.C. and not A.C., it is better to introduce the dimmer into the negative cable—that is the one that is bringing the return current from the lamps.

Removing Rust

MOST readers find it rather difficult to remove rust from their woodwork tools. Here is a way of doing it quite easily. First of all obtain an old scrubbing brush, a small amount of sand, and a drop of water. Dip the brush in the water and sprinkle the sand on the article you wish to clean, such as a saw, chisel, etc. Then scrub it with the brush for a few minutes and after washing and drying, it will look as good as new.

Matchboxes and a little wood used to make a useful BUREAU INKSTAND

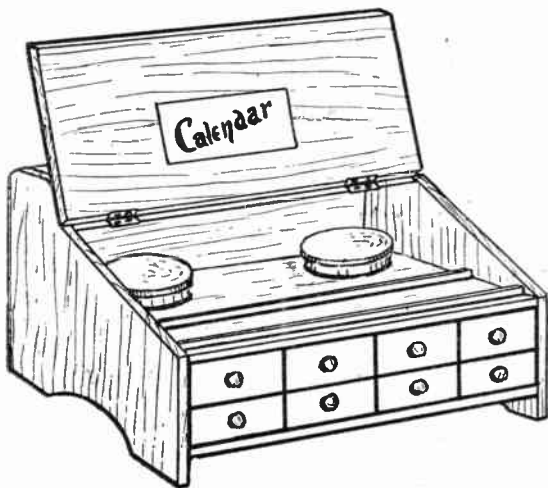

PEOPL**E** who have a lot of writing and other business to attend to and especially club secretaries, will find the little inkstand described on this page very useful. Not only does it hold the containers for black and red ink, but the many small drawers are ideal for holding all the accessories that help to make the job so much easier.

It is nice to be able to lay your hands on paper clips, rubber bands, pen nibs, india rubber, stamps, etc., without having to hunt all over the place for them. To say nothing of the time saved.

Matchbox Drawers

The stand illustrated is made of eight matchbox drawers, but it is possible to add many more to suit your own individual requirements. The measurements quoted, therefore, are only approximate; also the sizes of the matchboxes and the ink containers may vary a little. It would be best to first collect these materials and then to build the inkstand around them.

If the matchboxes are all the same make you will be sure that they are alike in size, and also see that they are quite sound and that the 'drawers' slide easily.

Glue together the eight boxes in two rows as shown. Or if you decide to make a larger set you may make it either ten boxes in two rows or twelve boxes in three rows. When the glue has set, work can start on the actual construction.

All the wood used in the model bureau is $\frac{1}{2}$ in. thick and it can be any kind you like, a hardwood such as oak, walnut or mahogany would probably look best, unless you decide to paint or enamel the finished article. In that case you could even use $\frac{1}{2}$ in. plywood.

Cut two pieces of wood 6 ins. long and $4\frac{1}{2}$ ins. wide to form the top and bottom of the matchbox drawers. Before fixing in position the top piece must have two circles cut in it to take the ink containers. The smallest size potted meat jars have been used for this purpose: they are 2 ins. high and the top measures $1\frac{3}{4}$ ins. diameter. A neat metal cap with a rubber band inside fits tightly over the top and keeps the ink from evaporating.

When using only two rows of matchboxes the jars rest on the bottom board, but if you decide

to have three rows, an extra piece of wood will have to be fitted for the jars to rest on. A matchbox glued at each end will give the correct height for this.

Set Back

When gluing the matchboxes between these two boards, set the boxes back about $\frac{1}{8}$ in. from the front. The reason for this is that all the drawers are faced with a thin piece of wood, which

shape shown in the side view for the sides of the case— $4\frac{1}{2}$ ins. wide and $5\frac{1}{2}$ ins. long. These pieces project $\frac{1}{4}$ in. above the top of the actual cabinet so as to form a support for the lid when opened. If this is sloped slightly the lid will lean back at the correct angle to display the calendar pad fixed on the inside.

The Back

The size of the back is 6 ins. long and $4\frac{1}{2}$ ins. wide and this can be cut, together with the top of the stand which is 6 ins. long and 1 in. wide.

Glue on the two sides, back and top—small panel pins can be used to strengthen the work if thought necessary. These should be punched in slightly and the holes filled in and made smooth.

It may be necessary to put the ink jars in position before the top bar of the case is glued on; this will depend on the actual size and shape of the jar you are using for the purpose.

In front of the jars are two strips of wood, which form a container for pens and pencils. They are made from $\frac{1}{2}$ in. strips of square wood and have the top edges slightly rounded.

Lid Portion

The lid is cut $6\frac{1}{2}$ ins. long and $4\frac{1}{2}$ ins. wide which will allow the hinge edge to be bevelled to the correct angle. Two

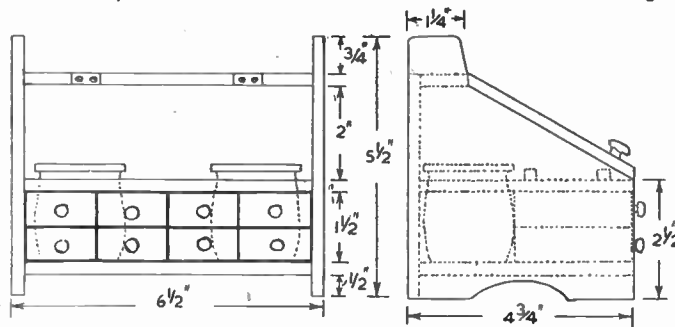

A front and side view showing parts and useful dimensions

not only improves the appearance but helps to strengthen the drawers, and also keeps the drawers from being pushed in too far.

Knobbed Fronts

The drawers can be finished off at this stage by fitting the fronts and when dry, the knobs can be fitted. There are many ways of doing this—small screw eyes, round-headed screws, or shoe buttons can be used, or even the metal rings used for passe partout framing.

The more modern way is to glue on a narrow strip of wood either plain or shaped to form a finger grip.

Next cut two pieces of wood to the

miniature hinges are slightly sunk into both edges and screwed carefully in place. The addition of a knob to the lid completes the construction of the stand.

After glasspapering the woodwork, the stand can be finished in any style—french polished in the natural state, or varnished and stained, or the entire surface can be painted or enamelled. The metal tops of the ink jars can be enamelled to match, or can be made black and red to distinguish the two inks.

The insides of the drawers should be lined with white or tinted paper, using either a good paste or thin glue. This makes them not only tidy but strengthens the cases considerably. (275)

Battery, glass paste jar, flex and switch to make A LAVATORY LIGHT

USUALLY the domestic lavatory is not provided with any illuminant, and so a light of some kind is really necessary at night time. As a brilliant one is not required, that from a torch bulb and battery will serve very well. The arrangement depicted provides the lamp as a separate article, so that it can be fitted exactly where considered most convenient, while the battery box is provided with a switch and is fixed against the door, handy when the latter is opened.

The battery box is made of $\frac{1}{4}$ in. fretwood, and is shown in a front view (minus cover) and a side section in Fig. 1. Note the interior dimension; these should accommodate a 3 volt cycle lamp battery, but could be amended to suit any other battery chosen. Make the four sides of the box first, gluing and nailing them together, then cut the back and glue the box to it, strengthening the joints with a few small screws through the back.

Cover Piece

Strips of the wood $\frac{1}{4}$ in. narrower than the sides of the box are nailed across inside, one at the bottom and one $\frac{1}{4}$ in. down from the top. A cover is now cut of a size to fit the box; it rests upon the two strips mentioned, and is kept in place by a pair of small metal clips, as shown in the general view. The battery should now be tried in place, and should fit in comfortably when the cover is fitted on.

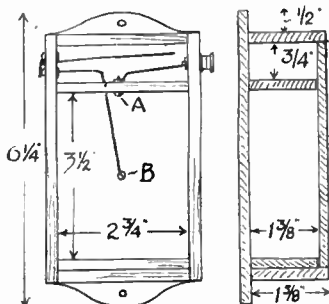
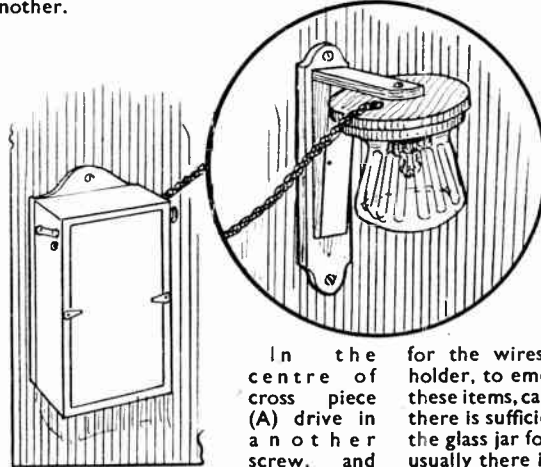

Fig. 1—Front view and section

For the electrical connections, first fit in the right hand side, near the top, a pair of brass terminals. Opposite these, on the left hand side, fit a small switch. Quite a good one can be made as follows. Cut a springy strip of brass, $\frac{1}{4}$ in. wide and $1\frac{1}{2}$ ins. long, punch a hole through near one end, and file away the burr.

On both sides of the hole place a small brass washer, and drive a screw through the lot into the side of the box, at about $\frac{1}{2}$ in. in from the rear edge. Opposite this, drive in a pair of screws, centres $\frac{1}{2}$ in. apart. The screws should be $\frac{1}{2}$ in. round-headed brass ones and will protrude through the wood to the

inside of the box. The switch arm should be free enough to press firmly on these screw heads as it is shifted from one to another.



In the centre of cross piece (A) drive in another screw, and one also in the centre of the back of the box, as at (B). The battery, when in position, should contact these screws satisfactorily and a test should be carried out to see they do.

For the electrical connections, run a length of D.C.C. wire from screw (B) to one of the studs of the switch. A second length of the wire is soldered to screw point (A) and is then connected to one of the terminals. A third length of the wire goes from the second terminal to the screw point of the switch arm, to which it is soldered.

This finishes the battery box, which can then be nailed to the wall in the most handy place against the door for the left hand to feel, and operate the switch, when the door is opened.

Lamp Holder

For the lamp, a case is made from the $\frac{1}{4}$ in. fretwood. Parts for this are shown in diagram Fig. 2. Cut the back (C) and shape up. At the spot shown, saw out a $\frac{1}{4}$ in. by $\frac{1}{4}$ in. mortise slot for the horizontal arm (D) to fit in. This arm is cut out to the length given, plus $\frac{1}{4}$ in. extra for the tenon at its rear end, which should be cut, of course, to suit the mortise slot.

A solid wood bracket piece (E) is now cut from $\frac{1}{2}$ in. thick wood. It is $\frac{1}{2}$ in. wide, and is planed to a downward taper, as shown. Glue the arm (D) to its back piece, and the bracket to the same, where shown by the 'dotted outline, to support it.

Writing on Wood

WHEN writing on wood in ink, this runs and blobs. To prevent this rub the wood with powdered resin.

The lamp holder, Fig. 3, is a simple affair. Cut a disc of the fretwood to the diameter given, and a ring of the same thickness wood, $\frac{1}{8}$ in. less all round, with a hole in the centre just the right size to admit the rim of one of those small jars of meat paste. These make excellent lamp shades. The jar is held in position by three small metal clips, as shown in the drawing.

A small plastic or metal lamp holder is screwed inside to the disc, and a hole bored in the latter, at one side, for the wires, connected to the lamp holder, to emerge from. In reference to these items, care must be taken to see that there is sufficient room in the interior of the glass jar for the lamp holder to fit in, usually there is, but test first, as amendments in size all round can easily be made beforehand, but not afterwards. Fix the disc with a single screw to the horizontal arm (D). All being satisfactory, enamel the lamp case any colour preferred, fit in the lamp, etc., and nail the whole to the wall of the lavatory, in any convenient spot.

Lamp and Battery

Now carry the wire connections from the lamp to the terminals on the battery box, and light up for a trial. See the wires do not dangle but are fixed to the wall with small staples in security. A

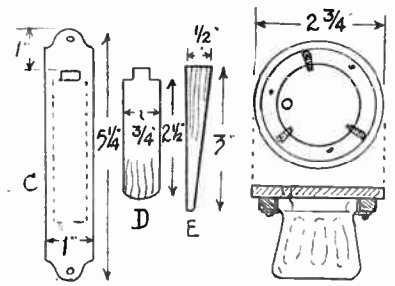

Fig. 2—Parts of the lamp bracket

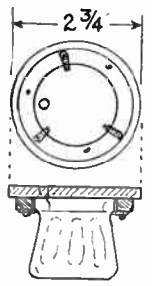

Fig. 3—The globe holder

2.5 bulb is the right kind to employ for a battery of the cycle lamp kind. With a $4\frac{1}{2}$ volt battery, a 3.5 volt lamp could be installed, but would not last so long unless the battery is much larger than the usual torch pattern.

For making this article a 7 ins. by 14 ins. panel of $\frac{1}{4}$ in. wood will be required. Measure out the parts carefully, as there will be no surplus, in fact, it may be necessary to cut one of the lamp holder discs from a spare scrap of wood already in possession. Of course, an extra panel 4 ins. by 9 ins. of the wood will obviate this.

A new chemistry series deals first with home-made CHEMICAL APPARATUS

WITHOUT doubt the most expensive item in experimental chemistry is the purchase and replacement of apparatus. However, it is possible to cut down this cost substantially by adapting everyday articles, and it is hoped the following substitutes will leave more money for chemicals in the home chemist's pocket. Furthermore, even if you have already any of the pieces of glass apparatus dealt with, it is better to use the substitute whenever possible, so as to lessen the average risk of breakage.

Beakers

For cold or lukewarm liquids use jam jars for large quantities and unribbed fish paste jars for small quantities. As these have no spout, when pouring from them, hold a glass rod against the rim. The liquid will run down it without dribbling. Jam jars even have an advantage over ordinary beakers in that the shoulder will hold back a precipitate when you are decanting the wash waters.

Flasks

For cold liquids clear glass bottles may be used. Though these cannot be heated on wire gauze or sandbath, they are satisfactory in or on water or oil baths if placed in the bath before the heating is

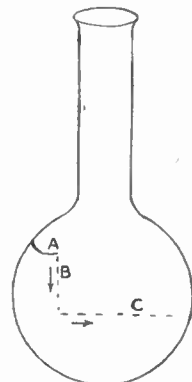

Fig. 1—An evaporating basin from a cracked flask

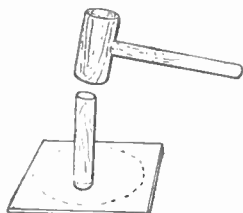

Fig. 2—Making a lead evaporating basin



led right round the flask until the bottom is severed.

If the crack is in the position (A) in Fig. 1, it must be extended downward via the vertical dotted line (B) to the dotted line (C). Once at (C) keep reheating the rod in the bunsen or spirit lamp flame and placing it about $\frac{1}{16}$ in. beyond the end of the crack.

As the crack extends, turn the flask and the crack will keep growing until the rod cools, when it must be reheated. The last $\frac{1}{16}$ in. usually severs itself by the movement of the flask in the hand. You can use the basin so made for all evaporations, but not for ignitions.

For quick evaporation of non-acid solutions a lead basin can be made easily by beating out a square of sheet lead, as shown in Fig. 2. Place a 6 in. square of the metal on firm packed earth or on a grass plot, having first scribed a circle on the lead. With a round ended piece of broom handle proceed to beat a hollow. When deep enough, trim the basin edges with metal shears or heavy scissors and bend a spout with pliers. Then rub down the rim flush on a sandstone flag.

Crucibles

A hard glass test tube serves well, a loose plug of woolly asbestos being used for a 'lid' when one is needed. Where the chemical to be heated does not attack iron a suitable piece of tube of this metal with one end closed may be used. If a piece with one end closed is not handy, heat

one end flat; you can use this where heating does not produce fusion.

Tripods

Take three 18 $\frac{1}{2}$ in. lengths of stout iron wire. Bend up each piece 7 ins. at each end at right angles to form the legs. Now bind the legs in pairs with fine wire, as shown in Fig. 3, and curve out the feet to give steadiness. If the frame wire is not stout enough to prevent a little splaying of the feet, this may be remedied by running a length of thin wire all round from foot to foot and drawing taut.

Pipeclay Triangles

Thread three 2 in. lengths of broken clay pipe stem or narrow iron, brass or copper tube with 5 in. lengths of thin iron wire and twist the wire ends together with pliers, as in Fig. 4.

Test Tube Brushes

Cut a 2 in. long by $\frac{3}{8}$ in. wide strip of sponge (or several thicknesses of absorbent cloth) and double it over a thin stick 8 ins. long. Now bind down the free ends with cotton thread. This swab, if of sponge, cleans better than a brush.

Water Baths

An enamel pint mug or a small saucepan is a good substitute. If the top is too broad for any piece of apparatus, take a press lid from a tin and cut a circular hole in the middle. The dia-

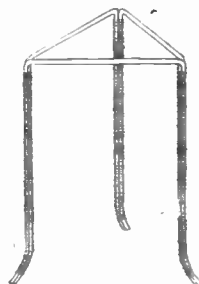

Fig. 3—A tripod from iron wire

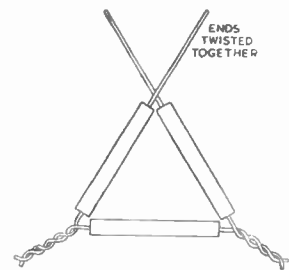

Fig. 4—An easily-made pipeclay triangle

started. It is sudden heat which cracks thick glass, not gradual heat. The writer has seen bottles used thus in some of Britain's biggest industrial laboratories.

Evaporating Basins

Where a quick evaporation is not needed, uncoloured saucers serve very well in the domestic oven or on the water bath. Cracked flasks and retorts can be easily converted into evaporating basins by the following method if the crack does not run into the bottom. First dry the flask. The method relies on the fact that a hot glass rod held a little past the end of a crack causes it to extend. By repeated heating and application of the rod, the crack may be

a piece of thin tube such as a length sawn from a bicycle handlebar and hammer

Broom Handle Uses

THERE are many uses for broom handles and here are some. As a towel holder (that is a roller), handles for tools, rasps, trowels, etc.; cricket stumps, too, and checkers are never to be forgotten. If you are a carver, you can make fancy door knobs, half moulding. Useful in wardrobes, too, for hanging clothes hangers. For the house ladder they make good rungs.

meter of the lid must be such that its flanges rest on the rim of the mug or saucepan. A series of these lids graded in diameter and fitted concentrically enable any size of flask or evaporating basin to be used on the bath.

Spatulas

A whittled piece of wood, a strip cut from aluminium scrap, a length of thick copper wire beaten flat at one end or a spoon handle will serve.

Porous Tiles

Scrubbed porous bricks or old house tiles are splendid and drain wet crystals quickly. After each use, soak them in several changes of water before drying in a hot oven. (283)

(To be continued)

MATTERS of INTEREST

Be most careful with insulation; use mica for all hot points, and provide an efficient third wire or earth wire, properly connected to an efficient earth, as a safeguard should a short circuit occur in the electric poker.

Extension Only

I HAVE enclosed a 6½ in. speaker in a cabinet for use as an extension from a 5-valve Mullard Sp. het. A.C., and I would like to be able to cut out the reproduction to the receiver's speaker so that only the extension is playing. (W.J.C.—Belfast).

A SWITCH can easily be fitted to silence the receiver speaker while leaving the extension speaker operating. Locate the leads in the receiver which go from the secondary of the speaker transformer to the speech-coil of the speaker itself; cut one of these and connect an on/off switch in circuit. Volume control at the extension point may be obtained by using a 10,000 ohm potentiometer. Connect outside tags of this to the two extension wires from receiver. Connect extension speaker to slider of potentiometer and one tag, when control of volume will be possible with a high-impedance extension speaker. If you are using a low-impedance extension speaker (moving-coil without transformer) this method is not suitable. Instead, use a wire-wound resistor of about 10 ohms maximum, connected in one extension lead. If available, an old filament rheostat is suitable.

Microphone Repair

IS it possible to repair a microphone in which some of the carbon granules have been lost? (P.M.—Darlington).

IF many of the granules have not been lost, the microphone will probably work satisfactorily if in such a position that the remaining granules can make contact with the internal electrodes. For a repair, it would be necessary to fill almost completely with new granules, and these are likely to be difficult to obtain. It should not be overlooked that some free space is always left in the section holding the granules.

Electric Poker Work

I WISH to make an electric poker set for burnt wood engraving. I know you have to cut down the voltage through a transformer, but what voltage to cut down to, and what is amperage required? (J.M.W.—Bristol).

IN its main essentials, an electric poker for wood burning is the same as a small electric soldering iron. It is not essential to use a transformer, but where this is done, two or three heats can be provided by suitable tapings on the secondary side of the transformer. There is no rule in the matter, but a step-down transformer giving output voltages of about 40 to 60 volts should be

suitable. The wattage required is more or less conditioned by the desired temperature of the bit, but something about 25 to 40 watts should be ample, hence an amperage of ½ to ¾ amps would be appropriate. The resistance of the heating element must be adjusted to suit, and should be such that the heating element works at as low or dull a red heat as possible, or even at a 'black' heat. A resistance of about 60 to 80 ohms would probably be suitable.

Cement Fixing

IS there a waterproof hard-setting cement I can use to make a satisfactory finish between a glazed-steel type of bath and hard-board? (D.W.—Gateshead).

NO bond between glazed metal and hard-board. Satisfactory results can generally be achieved by the use of Alabastine or plastic wood. The latter will adhere firmly to the hard-board. The plastic wood can be finished with any cellulose paint or synthetic finish.

The Crinoline Lady Table Mat Holder

NOW is the time for making those presents for Christmas, gifts to help swell the annual bazaar stalls, for personal presents, or to be sold to friends who themselves have a gift problem. These table mats will also find a ready sale for a nominal sum of a few shillings to help defray the cost of materials for some of those more expensive models that most of us always intend to tackle. Further to assist you a full size pattern of the lady is shown on page 157 of this issue.

Making in Quantities

If you intend making a number of these articles, you will find that you can save time and waste of materials by first copying each piece on to thin card with a tracing, and carbon paper. Then carefully cut these templates out with a sharp knife or scissors. Now all that you need to do is place the templates in the most economical position on wood, and quickly run a pencil round the edges.

The Mats

With this table mat design, the mats can be cut from sheet cork, rubber or waterproof plywood. Alternatively a set can be made from individual decorative mats that can be obtained at the cost of only a few shillings from a local department store. It is suggested that a set consists of one large mat, two medium size mats, and four small mats.

The holder for the mats is an attractively painted crinoline lady, with a base and back. The whole model consists of three pieces, which can be seen in the detail at Fig. 1.

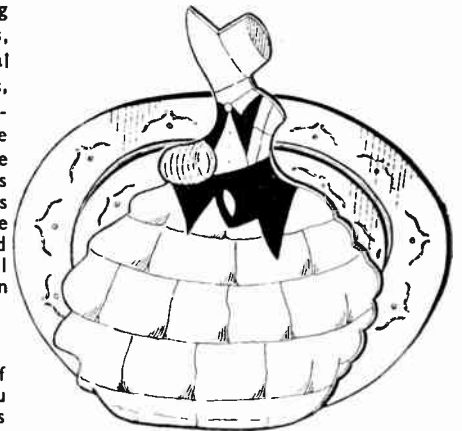

The Base

The base should be cut from solid wood ½ in. thick and 2½ ins. long. The depth of this piece is controlled by the number of mats that it is intended to store in the holder. This can be judged by placing all the mats together and adding ½ in. to the total width, to ensure the mats can be stored in the holder without fitting too tightly.

The Back and Crinoline Figure

The crinoline figure and the back of the holder can be cut from the illustrated pattern on page 157, using ⅜ in. or ½ in. plywood. Before assembling, the three pieces should be coloured with a stain applied with a pad of smooth cloth or cotton wool. Stain every edge and surface of each piece, with the exception of the front of the crinoline

(Continued on page 157)

Full size patterns are on page 157

There is nothing difficult in the operation of making RUSTIC ASH TRAYS

It is simple to buy perfectly well designed plastic ash trays but they often 'look cheap'. The lines of the mould in which the plastic was forced into shape can be seen or, perhaps, the only colour available is some prismatic shade totally out of keeping with your furnishing. In short the object lacks the appeal of a craft made ash tray, which can also be a useful present.

The ash tray shown is simple to make and may cost nothing if you can get or have the three components on hand. You will want a piece of tree just over

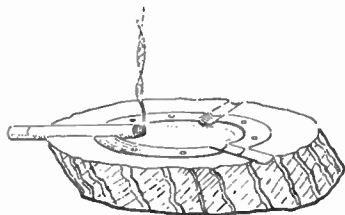

Fig. 1—A simple attractive holder

3ins. through from bark to bark. You can either get this from firewood or, if you are lucky, cut it from a tree branch whose bark you like.

Copper Sheeting

For one ash tray enough copper sheeting for a disc 3ins. in diameter will be required. You may find a scrap on some building site, as the material is used for roofing. It can be obtained from builders' merchants, who may let you have a small piece—plenty for your purpose. Lastly for each ash tray you will require half-a-dozen brass brads not more than $\frac{3}{4}$ in. long.

Saw through the piece of firewood or tree branch at about 45 degrees to get a slice 1in. thick, of the sort shown in Fig. 1. There is no reason why the slice should not be cut square if you require a symmetrical object. Glass-paper the wood well to bring out the end grain.

Beating Metal

Mark out a 3in. circle on a piece of your copper sheet and cut it out with a pair of tinsnips. If you have no suitable metal block for beating out the copper centre of the ash tray you will be able to make what you require from lead. Melt some lead on the stove in an empty 1in. deep polish tin about 3ins. in diameter. Beware of splashes, so lower in lead scrap gently with pliers or pincers. When the tin has been nearly filled, cut off the heat, skim off the litharge (lead oxide) with a scrap of wood, and leave the lead to solidify.

Use a round-headed hammer to beat a shallow depression about 1in. across in the lead block. Place the copper circle

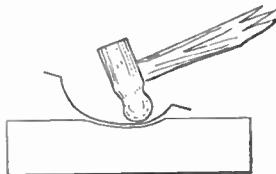

Fig. 2—Beating to shape

over this hole and gently tap away with the hammer, as shown in Fig. 2.

You will find it quite simple to make a regular circular depression about $\frac{1}{2}$ in. deep and extending to within $\frac{1}{2}$ in. of the edge of the copper, even though your lead block has only a comparatively

shallow hole. In fact a deep hole in the lead will lead into difficulties. On opposite sides of the copper it is now necessary to mark out the depressions which will hold lighted cigarettes. These are $\frac{3}{4}$ in. wide.

Place a piece of rounded iron bar on the edge of the lead block and tap with the hammer till a semi-circular channel is formed, as shown in Fig. 3. It may be necessary to cut away the edge of the tin first.

Cigarette Channels

Place the copper disc with its marked rim over the channel, and with the aid of the same metal bar and the hammer, tap until the cigarette channel has been formed. Once again the bar need not correspond with the diameter of the channel. Repeated taps will enable the channel to be widened with a thin bar. A quite serviceable channel can be made with a bar of larger diameter than $\frac{3}{4}$ in., such as the circular side of a cold chisel!

When another channel has been tapped opposite to the one finished, the ash tray centre is ready for fitting to its wooden base. Of course, three or even more channels can be indented at regular intervals round the copper rim if desired.

Mark out the site of the main ash depression on the wood base and with a small chisel, gouge or sharp knife, begin hollowing out the wood until the copper top is prevented from lying flush by the cigarette channels round the rim.

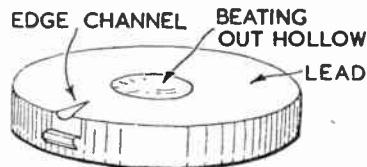

Fig. 3—The former base

With care cut corresponding cigarette channels on the wood at exactly the right places to make a good fit.

Varnished Wood

Mark out the places on the copper rim where you intend to put securing brads. Tap holes with a small steel nail or steel brad. Next give your wood base several coats of varnish. The bark especially will absorb plenty. If you have no varnish, wax polish will do quite well.

Drive home your brass securing pins with the copper in place and the job is ready for having a shine given to the metal with metal polish.

The ash trays can be varied in a number of ways—there is no need for a piece of virgin wood for a base for instance. Perhaps, carefully-made ash trays may help solve your Christmas present problem.

(292)

An Instructive Panoramic Model

THIS interesting and attractive mechanical model was made by the boys of St. Michael's Secondary School, Chatham, and is a realistic replica showing how electricity is distributed from the power house to the consumer. Various sections were made to light up and work, and having completed their enjoyable construction work, the boys, as you see in the picture were able to press switches to prove the mechanical ability of the various parts. It proved a great attraction, naturally, whenever it is on exhibition.



(Reproduced by the courtesy of the Chatham Observer)



Some French Colonials

NO doubt a great many collectors of foreign stamps fight shy of the French Colonials, and there is a reason for this. Before the war anyone who answered an advertisement offering so many picturesque stamps free, would almost certainly have sent to him some of the low value stamps of the French Colonial issues.

Some of these are certainly very picturesque, and since in those days the lowest value of the French Colonial stamp was 1 centime, which meant that one hundred such stamps could be bought for a franc, you see why they were given away.

Interesting Points

Things are rather different now. You do not find such low values; in some cases the lowest is 10 centimes and sometimes it is considerably higher. Also there are certain difficulties in importing stamps into this country.

It is rather a pity that there is such a prejudice against these stamps, as some of them have very interesting designs. Such as curious ways of obtaining a living or curious means of transport, with the occasional stamp showing the two connected.

For example, the 1927 postage due stamps of Cameroons give a picture of natives felling a mahogany tree—the way they have of obtaining a living. Then on the stamps of the French Equatorial

of the trunk would be useless when he had done the work.

The stamps of Dahomey show how well the natives can climb trees. A man seems to be able to walk up a tree rather than climb it. The secret is, of course, the support that he has, rather like the belt that the telegraph linesman has, so when at the top he can stay there and yet have both hands free to work.

During the 1914—1918 war the stamps of Dahomey were overprinted for use in Togo during the Anglo-French occupation. Then when the French stamps for this area appeared in 1922, they showed a picture of coconut trees 'Le Cocotier'.

From the Coconut

We must remember that the coconut tree is far more to the native than just supplying a fruit at which to shy sticks or balls at a fun fair. From the coconut they get coir which is made into sailcloth or cordage; copra which is the dried white kernel and which is exported to America and Europe for the oil which is obtained and used for margarine.

Then there is the desiccated coconut that gives the flavour to our coconut-ice; the white liquid which is in the nut is used by the natives to make a drink, and the hard shell makes a particularly valuable form of charcoal—the charcoal that is used in the making of gasmasks comes from coconuts.

The second illustration comes from

The third illustration is to remind you of olden times. This stamp gives us a picture of a Carthaginian galley. Large galleys frequently had both sail and manpower, as is visible in this case. Note also another characteristic of this type of vessel—the decorated prow. This is what gave rise to the figureheads once fixed to the ship's prow underneath the bowsprit. Although now out of date some are preserved in museums.

This stamp is one of the high values of the 1906 set. On the lower values of the same set we have a picture of Hadrian's aqueduct. Those living in the north of England will probably know Hadrian's English ruin, the Hadrian's wall.

On the 1926 set from Tunis we have a third reminder of ancient days—the ruins of the Amphitheatre at El Djem. Those who have no copy of this stamp can get an excellent idea of the picture from a view of the ruins of the Colosseum at Rome.

A Mosque

The last illustration we give is of a stamp from the French Ivory Coast. Not many people would guess by looking at the picture what it is intended to be. At first sight they might even take it for some form of giant cactus but actually it is a picture of the Mosque at Bobo-Dioulasso.

As a contrast to these ruins of stone and brick the French Colonial stamps show us some very flexible buildings,



Fig. 1—Gaboon timber transport

Fig. 2—Guadeloupe sugar mill

Fig. 3—Carthaginian Galley

Fig. 4—Ivory Coast Mosque

Africa and also on those from Gaboon we see natives transporting these huge logs by making them into a raft. The illustration is sufficiently clear for you to see that the natives have built on the rafts cabins in which they live during the journey from forest to saw mill.

Tree Felling

If you have a stamp showing the tree felling, look carefully at it and see if you can decide why they cut the tree down such a height from the ground. As you know, in England when they cut down a tree they cut it as close to the ground as possible to prevent waste.

Well, the mahogany tree has very protruding roots and if the native cut as close as in England then he would have to do ever so much more work and the end

of the trunk would be useless when he had done the work. The stamps of Dahomey show how well the natives can climb trees. A man seems to be able to walk up a tree rather than climb it. The secret is, of course, the support that he has, rather like the belt that the telegraph linesman has, so when at the top he can stay there and yet have both hands free to work. During the 1914—1918 war the stamps of Dahomey were overprinted for use in Togo during the Anglo-French occupation. Then when the French stamps for this area appeared in 1922, they showed a picture of coconut trees 'Le Cocotier'.

Another vegetable product which comes to us on French Colonial stamps is the dates which are being gathered on the Tunis Parcel Post issues. On the higher values of the 1947 Martinique set and also on the postage due stamps of 1933 we see that in this French Colony we could do ourselves very well indeed on the various fruits which are produced.

tents, straw huts, and mud huts. First the straw hut—for these you have to look at the 1930 issue of postage due stamps from Tchad. These houses certainly look very curious. The mud houses which are shown on the lower values of the 1938 set from French Guinea appear to be very far from comfortable. They are not so high as those mentioned before and what light gets inside seems only to come through the roof.

Two pictures of the chief's hut are shown on the stamps of New Caledonia. The 1948 seems to be an enlargement of the 1928, or at least a part of it. The higher values of the 1938 set from Mauritania show a pleasant camping scene; one advantage they have over us is the weather.

Complete instructions for wood working and weaving a SEAGRASS-TOP STOOL

OUR illustration here shows a neat little stool with a seat of woven seagrass. This material is very popular and chairs and stools covered with it give a room a cosy appearance, and it is very comfortable to sit upon.

The legs are worked up from 1½ in. square wood; oak or beech being suitable. We give the length of the legs here as 12 ins., but they may be longer or shorter than this, according to choice. In Fig. 1 is shown the simple shaping of each leg with added measurements for setting out.

The eight rails connecting the legs consist of ½ in. hardwood rods cut off in lengths of 11 ins. and glued into holes bored ½ in. deep to receive the ends. The first thing to do in preparing the legs is to lay all the four pieces, after cutting them to length, side by side on

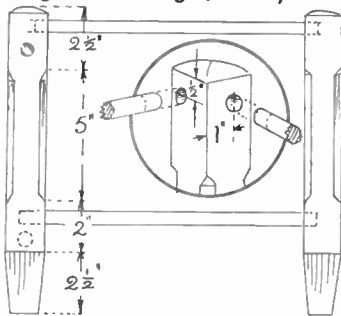

Fig. 1—Details of construction

the bench or table, keeping one end hard up against a straight edge or block of wood.

Now set out the distances from the foot end, as shown in Fig. 1, and mark across them all in one operation, using a tee square or a try square for this purpose.

Next draw lines in pencil across the diagonals on the top ends of the legs. These lines form guides for shaping, as shown in the enlarged detail in Fig. 1. Note also the lower extremities of the legs taper off to 1 in., this again being set out on all faces of the legs as a guide for cutting.

Rails

Looking again at the detail in Fig. 1 we note the holes for the rods are centred ½ in. down from the shaping line at the top, and 1 in. from the back edge of each leg. All four of the lower rails are spaced similarly, the plan, Fig. 2, shows the arrangement clearly in a section of the top surface.

The positions of the centres of the rods are again drawn on all four surfaces at one operation as for the general shaping of the legs. With a ½ in. diameter twist drill all the holes are made ½ in. deep. It might be a good plan, to gain strength, in the general construction of the stool, to arrange the rails as shown on

the left leg of the stool, shown in Fig. 1. Here it will be seen that the rails are set centrally in the width of the leg and are lower on two sides, that is they do not all follow round evenly.

Strength Joint

It is suggested, too, that the ends of the rails might in this case go into the legs a depth of 1 in., which is a distinct advantage regarding strength. If the latter course be adopted, the four lower rails will have to be 12 ins. long as against 11 ins. for the top four.

When boring the holes for the rods see the brace is held perfectly upright, and dip the ends of each rail in glue before driving them in.

Another necessary precaution is to make a shallow V cut along the ends of each rail so surplus glue and air may escape during the process of driving in.

Test the finished frame for squareness and see that equal measurements occur between all the legs so the weaving may be accurately carried out.

The Seagrass Top

The special seagrass for making the seat is obtainable in skeins or hanks and sold by weight. The seagrass is bought in long lengths and several yards should, therefore, be wound off on to a stick previous to commencing to weave. The simplest method of weaving is shown in Fig. 2, which gives a clear plan of the seat.

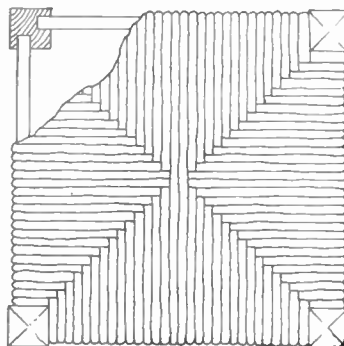
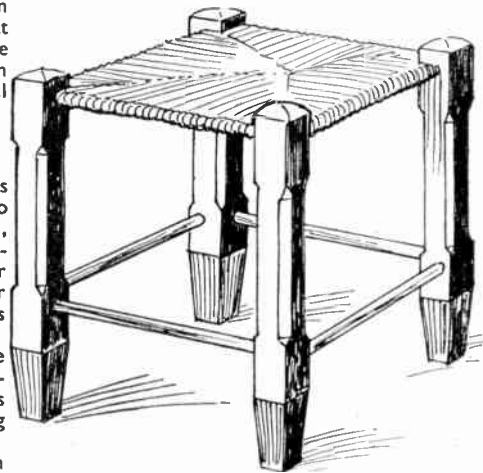

Fig. 2—Plan of top

In the diagram, Fig. 3, is shown exactly how to start and how the interlacing of each strand is made. In the end of the seagrass first make a knot and then, putting in a small staple, fix the seagrass to one of the rails as shown. Now carry the seagrass over rod (A) and under it and over and under (B) to (C).

Here it goes over and under and is brought back over (A) again and under on to (D) where it passes over and under again and is brought up over itself and over rod (C) again and so on to (B) where



it passes over and under again and so over (D).

Close Weaving

At this point we have completed one round and have arrived at the starting point where the interlacing process is repeated. It should be explained, perhaps, that the seagrass is purposely shown very slack and the thickness exaggerated in the diagram, and that in actual weaving, of course, each turn is drawn tightly as possible over the rails.

Each time the seagrass is brought over the rods, too, it must be kept hard up against its neighbour, so that the spaces are completely filled and all strands kept evenly and straight across.

Joining

When it is necessary to make a join in the seagrass, the knot should be made underneath and, therefore, out of sight. For sake of strength make the well-known reef-knot, shown as an enlarged diagram in Fig. 3.

The legs and the four lower rails should be stained with oak or mahogany stain and afterwards waxed and brushed up or rubbed with soft rag. If it is required to paint the stool, then it should have an undercoating of suitable paint and the finish of enamel or cellulose enamel.

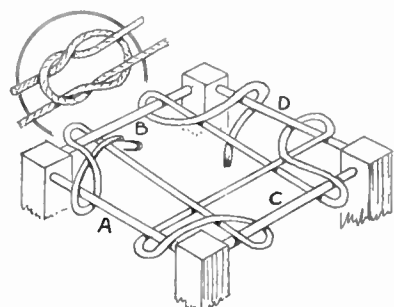

Fig. 3—How to weave

Crinoline Lady Table Mat Holder—(Continued from page 153)

figure. That is to be later painted with gay enamels and should be given a coat of grey flattening paint to ensure a more pleasing finish.

Drill a small hole, with a Hobbies drill point at the three positions marked. (A in the lady), (B and C in the back). Glue the three pieces as indicated in Fig. 1, and before the pieces set in position, tap a gramophone needle just below the surface of the wood in holes (A), (B) and (C). Make sure the back

section and the crinoline front section set squarely on the base section. When the three pieces are perfectly secured, and the glue dry, the holes can be filled with plastic wood.

Painting

The success of this model can be assured or ruined by the care with which the painting is carried out. It is much better to take time over each stage, letting the colours dry, rather

than spoiling the effect by being too eager to complete the model. The full size pattern gives the actual marking.

The following colours are suggested for the crinoline figure, although, of course, they can be varied to suit individual taste. The actual crinoline skirt, Cambridge blue, and the folds in Oxford blue. Muff, white with shadow lines in dark blue. Bodice or coat in magenta or dark red. Front of blouse and collar in yellow with buttons in blue and brooch at the neck in green. Bonnet, orange, with dark blue lines and shadow to indicate back of the bonnet.

Neck, pale pink. Parcel, deep pink, and string lines in dark blue.

The attractiveness of the model will be greatly increased if the corners of the folds on the actual crinoline are lightly shaded in dark blue with a half dry brush in the manner of the effect obtained by an air-brush. As this operation, however, needs a certain facility with a brush, it would be better, if this particular effect were obtained by the less experienced, by small fine lines.

Finishing

To add the all important 'finishing touch', a piece of felt or baize should be glued to the underside of the base. Place the mats in the holder, and then wrap the whole model in Cellophane paper. (289)

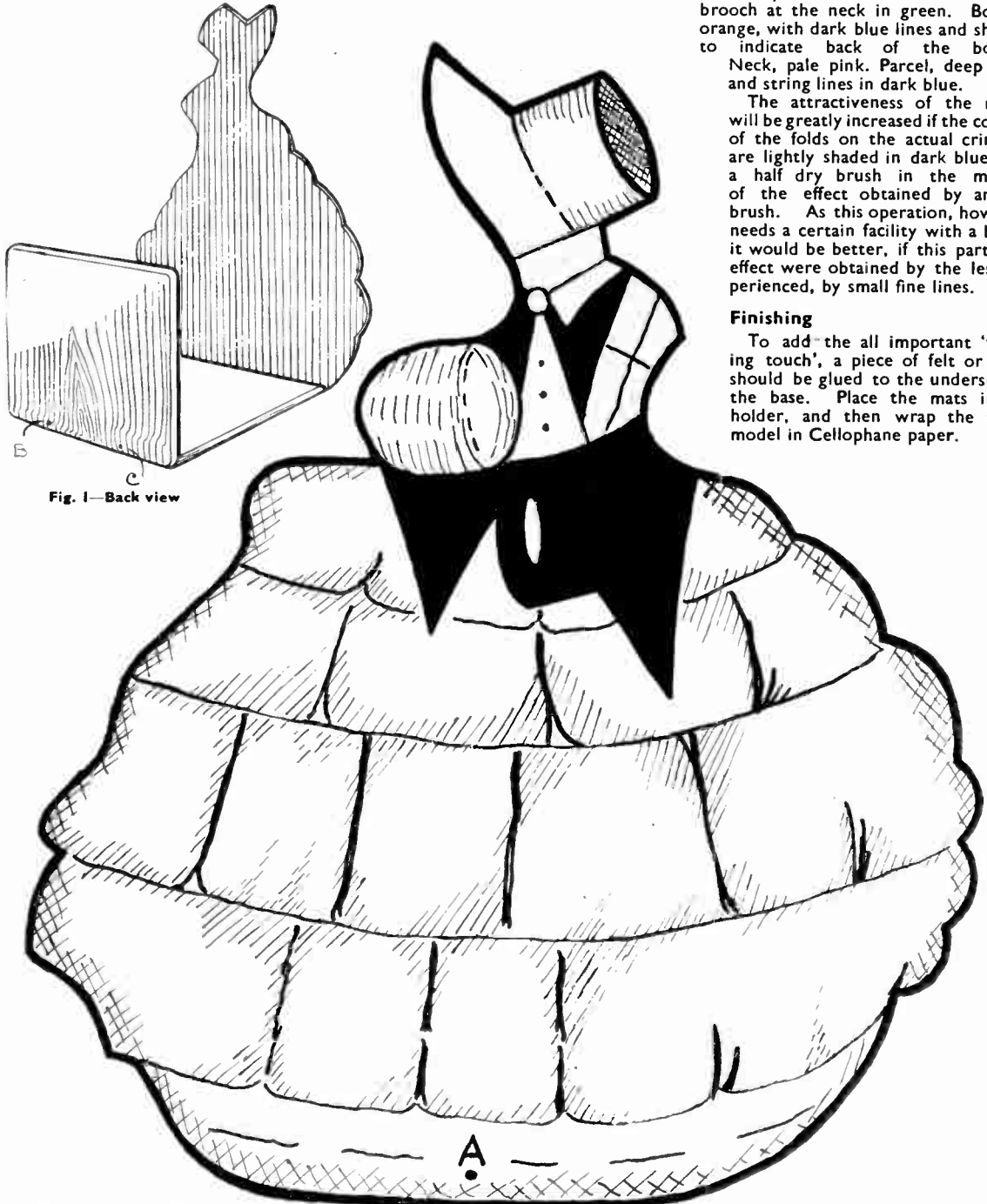

Fig. 1—Back view

MISCELLANEOUS ADVERTISEMENTS

The advertisements are inserted at the rate of 3d. per word prepaid. Name and address are counted, but initials or groups, such as E.P.S. or £1/11/6 are accepted as one word. Postal Order and Stamps must accompany the order and advertisements will be inserted in the earliest issue. Announcements of fretwork goods or those shown in Hobbies Handbook are not accepted. Orders can be sent either to Hobbies Weekly, Advert. Dept., Dereham, Norfolk, or Temple House, Temple Avenue, London, E.C.4

STAMPS—world mixed, 1/- a 100; 5/- a 1,000. Gift voucher free.—Selby, 66 Donnington Road, London, N.W.10.

5x5 SNAP enlargements, 6d. Films developed, 6d. Return service.—Bailey, 72 Marshfield Road, Goole, Yorks.

INTRODUCTIONS. Pen friends, companionship or marriage.—V.C.C., 34 Honeywell Road, London, S.W.11.

MAKE 5/- an hour, genuine home employment. Full instructions, 3/-.—R. Lowes, Simonburn, Northumberland.

3 GIANT stamps Prince Ranier—free. Request approvals and enclose S.A.E.—Jeffreys, 2 Bay View, Craigavon, Port Talbot.

CASTING moulds for lead soldiers, Indians and cowboys, animals and novelties. Sample mould, 4/-. Catalogue, 6d.—G. F. Rhead, 2 Waldegrave Park, Twickenham.

100 BRITISH Colonials (Cat. Approx. 10/-). 2/6, postage extra.—Clark, 23 Wordsworth Rd., Coventry.

START making money at home, whole or spare time, making fancy leather and felt goods. Material provided. Write for rates of pay, etc.—Grange Co., 2 Curzon Street, Leicester.

BE Taller. Quickly! Safely! Privately! No appliances—no tablets—no dieting. Details, 6d. stamp.—Malcolm Ross, Height Specialist, BCM/HYTE, London, W.C.1.

MODELS. You can make lasting stone-hard models with Sankey's Pyrama Plastic Cement. Supplied in tins by Ironmongers, Hardwaremen and Builders' Merchants. Ask for instruction leaflet.

TRANSFERS for decorating toys, trays, furniture, fancy goods. List and samples, 3d. Flowers, pixies, dogs, nursery rhymes.—H. Axon Harrison, Jersey.

LEARN Shorthand by January 6th (1 hour's study nightly). 1st lesson, 2½d. stamp.—Duttons (Dept. HB), 92 Gt. Russell St., London, W.C.1.

RUBBER Tyred Metal Disc Wheels finished in red, green or blue enamel. 2ins., 2/6; 3ins., 3/- per set of four. Post paid. Other sizes available up to 9ins.—The Joyden Toy Co., 193 Chase Side, London, N.14.

DOLL'S House fittings and papers; send S.A.E. for list. Doll's house plan special; send 2/6. Trade supplied.—Zimplan, 88 Ware Road, Hoddesdon.

STAMPS FREE!! Twenty unused (2½d.).—G. H. Barnett, Limington, Somerset.

BE Taller in 14 days or money back; details, 1d.—Stebbing System, 28 (HB) Dean Road, London, N.W.2.

CONSTRUCTIONAL Kits, 4mm and 7mm scale Lorries. Also large range spare parts from which to build to your own design. Price lists, 1d.—Wilson's Lorries Ltd., Dept. H., 1/6 Gt. Winchester Street, London, E.C.2.

BLUSHING, shyness, nerves, self-consciousness, fears, ended. Details under plain cover, 1d.—Stebbing Treatment, 28 (HB) Dean Road, London, N.W.2.

100,000 GOVERNMENT surplus bargains. 230v. A.C. bench drills, comprising 230v. A.C. mains motor, intermittent rating, and ½th capacity chuck, brand new, 39/6, post 1/6; 12v. drills (work from car battery), 10 amps., 19/6, post 1/6; 230v. A.C./D.C. mains motors, continuous rating, 20/-, post 1/6; numerous low voltage motors, neat and small, for models, etc., from 9/6; aluminium rivets, approx. 1lb. assorted, 2/6, post 6d.; hundreds of other bargains for the handyman. Send 3d. stamp for list. Money back guarantee.—Milligan's, 24 Harford Street, Liverpool, 3.

PLYWOOD offcuts. Birch and Gaboon in various thicknesses. Handy sized parcels for the cabinet, toy, model maker, and all handicrafts. Parcels made up in £1 and 10/- lots. Carriage paid. Send P.O. to Reeves, Plywood and Timber Merchant, 33 Front Street, Monkseaton, Whitley Bay. Tel. W.B.4677. Parcels are now despatched on day of receiving order.

WHEELS for Toys, and other accessories. Full lists will be sent on application to The Joyden Toy Co., 193 Chase Side, London, N.14.

£5 to £20 weekly earned at home, running your own Mail Order business. Details, 1d.—Stebbing Publications Ltd. (HB), Naphill, High Wycombe.

FASCINATING and profitable hobby, casting ornaments, toys, etc. You can easily make these yourself. Paints, brushes, and all accessories. Illustrated catalogue of 700 moulds, plus latest list of rubber moulds, with instructions, 9d., post free.—Cock of North Moulds, (H), 140 Hollings Road, Bradford.

AMERICAN Magazines post free for 1 year. Popular Mechanics, 32/-; Popular Science, 28/6; Mechanix Illustrated, 22/6; Popular Homecraft, 18/-. Stamp for full list of others.—Willen Ltd. (Dept. 57), 101 Fleet Street, London, E.C.4.

ATTRACTIVE Pictorial Stamps on Approval.—G. Smith, P.T.S., 95 Ocean Road, South Shields.

PLYWOOD. 72×4½×⅜in., 20 for 25/-; Gaboon sanded two sides; Birch, 36×9×⅜in., 10 for 15/-; Veneered Plywood, 24×24×⅜in., 5 for 35/-, ⅜in. thick, 2 for 25/-; Strips Block-board, ⅝×⅝×27ins. long, 3/- doz. Softwood lids, 39×13½×⅜in., 7 for 20/-; List of other plywood and Oak, 2d. All above prices carriage paid for C.W.O.—Dept. H.3, JDD. Storage, 71 Northcross Road, S.E.22. BRI.7441.

CONJURING. 3d. for new lists and free magical competition.—De Hempsey, 363 Sandycombe, Kew Gardens.

USE spare time on profitable home-work making fancy goods. Write for free booklet.—(Area 544), 54 Southgate Street, Leicester.

MAKE your own Jig-saw Puzzles. Fine Art Pictures, various reproductions and sizes. Also suitable for framing. Stamp for full list.—Joyden Toy Co., 193 Chase Side, London, N.14.

NOVEL Calendar Designs painted on plywood for cutting out. With date cards. Inexpensive gifts, profitable to sell. Sample, 2/-; half dozen, 10/-, including postage.—Cleaver, 50 Windsor Road, London, N.W.2.

HOMEWORKERS required, either sex, light assembly. Part or full time. S.A.E.—Esprey, Box 18, 41 Wade Street, Lichfield.

HOME Watch and Clock Repair Outfit. Includes watchmaker's magnifying eyeglass, tweezers, screwdrivers, oilers, oil, brush, dusting powder, plus illustrated explanatory book. Watch and clock repairing simplified. In container, 12/9 inclusive.—D. Bolster (Dept. H.), 5a Station Parade, Ashford, Middx.

HARDWOOD Ball Beads, ⅜in. diameter, suitable for children's counting frames, etc. 5/3 per hundred, plus 1/9 P.T.—Joyden Toy Co., 193 Chase Side, London, N.14.

PERSPEX and acetate; cut any size from 2/6 sq. foot.—W.M. Products, 2 The Mall, Ealing, W.5. Eal. 3881.

MAGICIANS Tricks, crazy cut-outs, Monly 1/3. Parcels, 5/6. An evening's entertainment. Lists, 3d.—De Hempsey, 363 Sandycombe, Kew Gardens, Surrey.

MODEL Makers and handymen. Bumper set of lists, books, plans and samples. 2/6.—Sutton Models, Billericay.

LEARN self-defence quickly or money back. Details of Wharton Course, 1d.—Stebbing Publications (H), 28 Dean Road, London, N.W.2.

9.5 Film Library, projectors, films, for sale. Stamp for lists.—Wayland, 223 Longley Road, Tooting, London.

the strong point
of every hobby...



Aero Glue. The strongest glue in the world.
Universal Glue. Cold glue ready for use from tube or tin.
Waterproof Cement. Specially prepared for balsa wood.
Whyte Paste. For paperwork and photo-mounting, etc.

CROID LTD., IMPERIAL HOUSE, KINGSWAY, LONDON, W.C.2

YOU CAN BECOME A HANDICRAFTS INSTRUCTOR

Experience not essential

Men who enjoy making things in wood or metal can turn their hobby into a permanent and interesting Career. Short hours, long holidays, and security in a job you would really enjoy, can be yours if you become a Handicrafts instructor. Let us send details of the easiest and quickest way to get the necessary qualification.

**We definitely guarantee
"NO PASS—NO FEE"**

If you would like to know about our unique method of preparing you for one of these appointments, write today, and we will send you our informative 176 page Handbook—free and without obligation. Mark your letters "Handicrafts Instructor."

**BRITISH INSTITUTE OF
ENGINEERING TECHNOLOGY**

595 Shakespeare House
Stratford Place, London, W.1

BIET



Swann Morton

CRAFT TOOL

The perfect, razor-sharp utility tool for modellers in Balsa Wood, also for Biologists, Students, Commercial Artists, Photographers, etc. 2 interchangeable blade shapes.

Handle and two blades 2/- post free. Spare blades 6s for 2/6 post free. Send P.O. to

FAMILY PRODUCTS
92-94 BRADFIELD RD.
SHEFFIELD 6

Trade enquiries invited

FOR STAMP COLLECTORS



The Ideal
Xmas
Gift

PRICE

27/6
EACH

Postage
6d. extra
Abroad
1/6

Place stamp in slide—insert slide—press the switch and the watermark shows up—illuminated. Battery operated. Moulded Plastic construction, pocket size. Obtainable from stamp dealers, booksellers and stationers, or direct from

WALLACE LTD

94 OLD BROAD STREET, LONDON, E.C.2
Entrance London Wall, E.C.2 Tel. LONDON Wall 5306/7

A new solder

FOR WORKSHOP
AND HANDYMAN

- CONTAINS 2 CORES OF FLUX
- NO EXTRA FLUX REQUIRED
- REPLACES STICK SOLDER, FLUID AND PASTE FLUXES
- IF DESIRED FLUX RESIDUE READILY WASHES OFF WITH WATER
- SO FAST THAT IT WILL EVEN SOLDER BLUED SPRING STEEL WITHOUT PRE-CLEANING



SIZE 8
CARTON

No. 10 KIT 2/- each

5/- each



Available in 5/- retail cartons (4 specifications) or 2/- Multicore Solder Kit contains 2 specifications Arax Multicore Solder and 2 specifications Ersin

Multicore Solder for electrical wire to tag joints. Now obtainable from many stores. In case of difficulty 5/- cartons or 2/- Multicore Solder Kits sent post free on receipt of postal order or stamps.

MULTICORE SOLDERS LTD., MELLIER HOUSE, ALBEMARLE ST., LONDON, W.1

STUDY
AT
HOME

IN YOUR
SPARE
TIME

THE BENNETT COLLEGE

will set you on the right course for success

You make sure of planned progress in the career of your choice when you let the most progressive, most successful Correspondence College in the world coach you through the post. By friendly, individual training we equip you with the specialized knowledge you must have for a well-paid key position. Make the first move TODAY—post the coupon below!

ALL TEXT BOOKS ARE FREE! We send as many volumes as subject chosen demands, they become your property.



IS YOUR CAREER HERE?

IF NOT, WRITE FOR FREE ADVICE

Accountancy Exams.
Agriculture
Applied Mechanics
Auctioneers and Estate Agents
Aviation (Engineering and Wireless)
Blue Prints
Boilers
Book-keeping, Accountancy, and Modern Business Methods
Builders' Quantities
Building, Architecture, and Clerk of Works (A.R.I.B.A. Exams.)
Carpentry and Joinery
Chemistry
Civil Engineering
Civil Service
All Commercial Subjects
Commercial Art
Common Prelim. E.J.E.B.
Concrete and Structural Engineering
Diesel Engines
Draughtsmanship. All branches
Engineering. All branches. Subjects and Exams.

General Certificate of Education Examinations
General Education
G.P.O. Eng. Dept.
Heating and Ventilating
Institute of Housing
Institute of Municipal Engineers
Journalism
Languages
Mathematics
Metallurgy
Mining. All Subjects
Mining, Electrical Engineering
Motor Engineering
Naval Architecture
Novel Writing
Plastics
Play Writing
Plumbing
Police, Special Course
Preceptors, College of
Press Tool Work
Pumps and Pumping Machinery
Quantity Surveying—Inst. of Quantity Surveyors Exams.
Radio Service Engineering

Radio (Short Wave) Road Making and Maintenance
Sanitation
School Attendance Officer
Secretarial Exams.
Sheet Metal Work
Shipbuilding
Shorthand (Pitman's)
Short Story Writing
Social Welfare
Speaking in Public
Structural Engineering
Surveying (R.I.C.S. Exams.)
Teachers of Handicrafts
Telecommunications (City and Guilds)
Television
Transport Inst. Examinations
Viewers, Gaugers
Inspectors
Weights and Measures Inspectors
Wireless Telegraphy and Telephony
Works Managers

COUPON. CUT THIS OUT

IF YOU ATTEND TO THIS NOW IT MAY MAKE A WONDERFUL DIFFERENCE TO YOUR FUTURE.

To DEPT. 62
THE BENNETT COLLEGE LTD.
SHEFFIELD

Please send me (free of charge)

Particulars of

Your private advice

about

PLEASE WRITE IN BLOCK LETTERS

Name

Address

(Cross out line which does not apply.)



GREATEST VALUE for MONEY
IN HOME WORKSHOP
& HOME HANDYMAN
TOOLS

You will be amazed at the many jobs you will do with new power, speed, confidence and real enjoyment. The Wolf Cub is more than an electric drill—it is the power unit of all the kits you see illustrated. Once you own the 'Cub' a small additional outlay enables you to widen the scope of your activities to the extent you desire. Think of the economy and the new profitable pleasure that will be yours! There's never been anything like this before!

WOLF CUB 4" HOME CONSTRUCTOR ELECTRIC DRILL



Wolf
HOME CONSTRUCTOR
Cub ELECTRIC DRILL
also
POWER UNIT
TO ALL THIS EQUIPMENT

PRICE
£4.19.6
COMPLETE

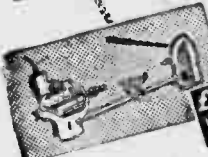

WOLF CUB HOME CONSTRUCTOR LATHE KIT

£7.19.6
INCLUDING WOLF CUB



WOLF CUB HOME CONSTRUCTOR DRILLING, GRINDING AND POLISHING KIT

£8.17.9
INCLUDING WOLF CUB

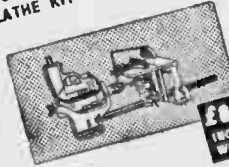

WOLF CUB HOME CONSTRUCTOR SAW KIT

£8.0.0
INCLUDING WOLF CUB

★ **LOW PRICE CONVERSION SETS**
Converts Wolf Cub or any Kit to form complete Wolf Home Constructor Equipment at attractive low prices.

Ask your tool supplier for full details or write direct to:

**WOLF ELECTRIC TOOLS LIMITED, PIONEER WORKS
MANGER LANE, LONDON, W.5. Telephone: PERIVALE 5631-4**

Hobbies

WEEKLY

CONTENTS

	Page
Automatic Garage	- 161
Tumbling Clown Toy	- 163
Simple Tricks for Xmas	164
All Mains 3	- - - 165
Home-made Cards and Calendars	- 167
Double Photo Frame	- 168
Novelty Gift Cake	- 169
Fixing the Xmas Tree	170
Books to Read	- - - 171
Step Ladder Extension	172
Push-along Disc Toy	- 173

PRESENTATION DESIGN
FOR MECHANICAL
TIGER TOY

December 13th, 1950

Price Fourpence

Vol. III No. 2876

MODEL cars or a doll's house will be well set off by this ultra-modern garage, which foreshadows things to come by automatically opening the doors and switching on the light when the car approaches. Full instructions are given for making it up as a separate piece of work, but the idea could, of course, be incorporated into any other work as required.

Wood and Works

The measurements given make up a garage 6ins. high and 6½ins. wide, and wood of ¼in. thickness is allowed for. As will be seen, only small pieces of wood are required, or stout cardboard could be used if reinforced at the corners. The 'works' are quite simple, the doors

A MODEL ELECTRIC AUTOMATIC GARAGE

being opened by elastic and the lighting provided from a torch battery.

Both are operated by the runway, which is made to drop slightly as soon as a car alights on it. This releases the doors, which are then pulled back by the elastic. It also closes the wiring circuit, to light up a flash-bulb from the torch battery concealed in the roof.

A piece of wood or cardboard 11ins. by 6ins. is required for the base. The edge

that will form the end of the runway is tapered off, as shown in the sketch. The sides of the garage are 3½ins. high and 4½ins. wide, and it will be seen from Fig. 1 that windows are cut out in these, and covered with Cellophane or similar transparent material.

The roof consists of two pieces 5½ins. by 4½ins., with one of the long edges on each bevelled to meet with a point at the ridge. One of these sections is glued permanently to the walls, but the other is hinged at the top, to allow easy access to the inside of the model. A strip of stout paper or thin card, if folded lengthways and glued to the two parts, forms quite a satisfactory hinge.

Front and Back

Start off by marking out two identical pieces for the front and back, each 6ins. wide to a height of 3½ins., then tapered to a point at a total height of 5½ins. When these are cut out, one piece, forming the back, is ready. The other has to be cut into five pieces for the front.

First cut off the top triangle piece which will measure 2½ins. from top to base. Next cut a 1in. strip from either edge of the other piece, so we have two pieces 3½ins. by 1in. to go by the side of the doors. Finally cut the other piece in half the long way, to make the two doors. Then shorten them ½in. so they both measure 3½ins. by 2ins. The doors are thus ½in. shorter than the piece that goes down either side of them, so that

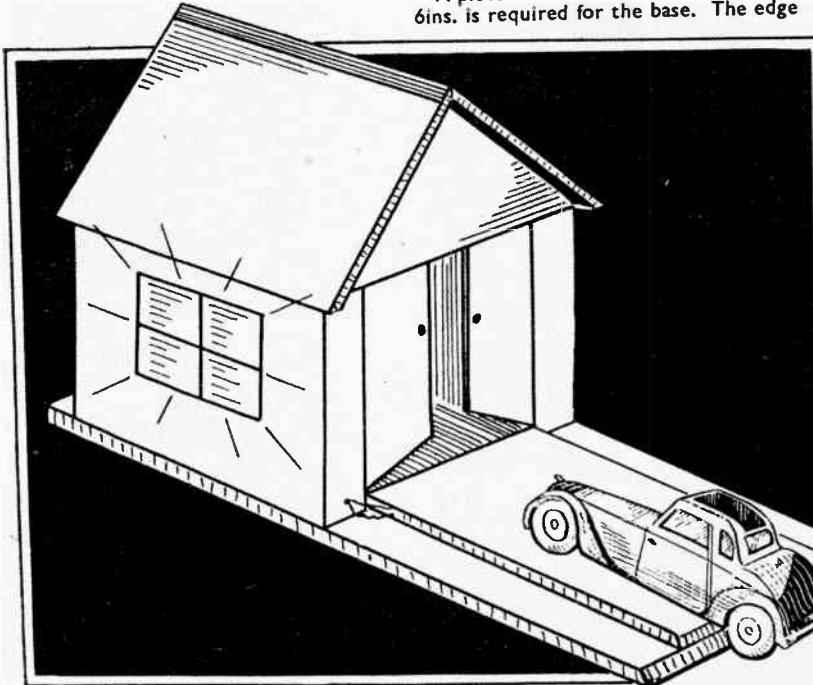

All correspondence should be addressed to The Editor, Hobbies Weekly, Dereham, Norfolk.

when the floor is added to the inside of the garage, to keep the run-in level, these doors will clear it.

The Runway

The runway is a piece of wood 4ins. wide and 5½ins. long. Where it meets the tapered edge of the base it is also tapered, to make a smooth incline for the cars. Later this piece is hinged to the base with stout paper or card, as shown, the other end of it just reaching up to the garage doors.

A little catch is required, to engage the runway with the doors. This is simply a piece of stiff brass or tin, 1in. long and ½in. wide. Bend it to a rightangle ¼in. from one end, then fix it to the runway with two screws. It needs to be exactly

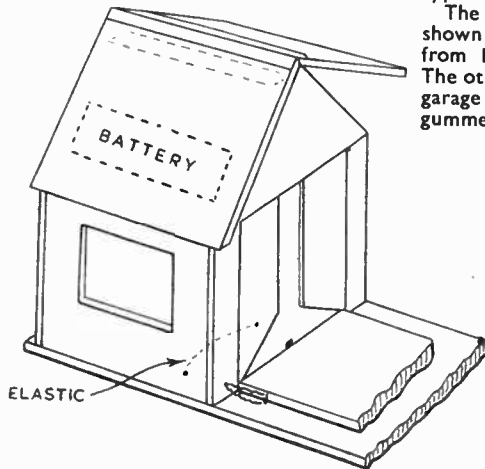

Fig. 1—The garage and floating platform

in the centre of that edge which comes up to the doors.

It will be seen from Fig. 2 how this little metal piece is fixed with the bent edge projecting ¼in. or sufficiently to engage the bottom edge of the doors when the runway is in the raised position. The same detail shows the two small screws which are put one in the under side of the runway and the other in the base exactly underneath it, to form the electrical contact maker.

The Lighting

Before we put on the hinged part of the roof or the garage doors, it is best to fit in the lighting. First cut a strip of wood 4½ins. long by 1in. wide, and screw down in the middle of it a flash-bulb holder (which can be obtained from any electrical stores for a few pence). This piece is then glued or screwed to the front and back of the garage, immediately under the eaves.

To economise space, use a single-cell type torch battery. This is held between two little carriers, cut from brass or tin and screwed to the underneath side of the fixed half of the roof. Fig. 3 shows how the two pieces are cut and bent, and

then screwed down to hold the cell between.

In order they may make good contact, it is necessary to cut off the overhanging

CUTTING LIST		
No.	Description	Size
1	Base	11ins. by 6ins.
2	Sides	4½ins. by 3½ins.
2	Roof	5½ins. by 4½ins.
2	Front and Back	6ins. by 5½ins.
1	Runway	5½ins. by 4ins.
1	Lamp Strip	4½ins. by 1in.
1	Floor	5½ins. by 4½ins.

flange of cardboard that the makers usually put at the top and bottom of this type of round single cell battery.

The wiring up is quite simple and is shown at Fig. 4. One wire goes direct from bulb holder to battery contact. The other travels down the inside of the garage front (held down with strips of gummed paper) and comes out through

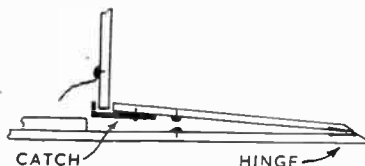

Fig. 2—Section showing contact catch

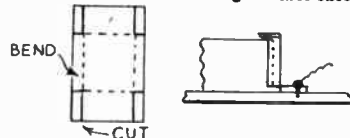

Fig. 3—Holder for battery

a hole in one front upright, as shown. Here it is connected to one of the screws forming the contact maker in the runway. Then take another piece of wire, connect it to the other runway contact, pass it through the hole in the front, then up the inside and so to the other battery contact.

We now have a circuit that is closed when the two runway screws touch, and is broken when they part, as they do when the runway is in the 'up' position.

The Doors

The doors are held in place with small metal hinges; or stiff paper like the roof hinge will do equally well. Before fixing them, however, put a screw in each at the back near the bottom, and two more on the front side to form door handles. Fig. 1 shows how the elastic is fixed round the two inside screws, and engaged on two others on the inside of the garage walls.

This elastic will need a little adjustment to get just the right length, since much depends on the kind of elastic used. It should be long enough to allow the doors to be pulled shut without undue strain, but short enough to pull

the doors right back when the runway releases them.

In time the elastic may stretch, of course, and have to be shortened or replaced. So it is quite a good plan always to leave the doors in the open position when the model is not in use. Then the elastic will last much longer than if always left in the stretched position.

To set the garage for use, the doors are pulled forward and the runway raised until the catch engages behind the doors. The pull of the elastic on the doors holds the runway up in position.

Testing Out

Having fixed the runway in position, we can now try out the arrangement and make such little adjustments as are necessary to ensure the model working

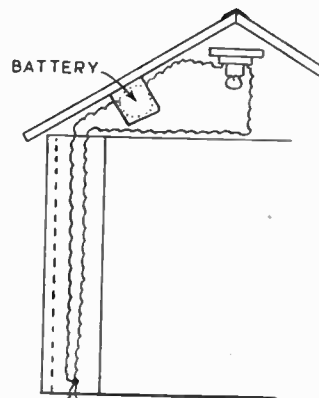

Fig. 4—Section showing wiring

smoothly. Pull the doors shut, then lift up the runway, adjusting the little metal catch until it just engages behind the doors and holds them both closed.

Now press lightly on the runway, as a car would in driving up to the garage doors, and see that when the runway drops the doors are released. It may be that the turned-up edge of the catch needs shortening a little, to allow the doors to pass over it. Check also that the two screws forming the light contact are in their correct positions, so that contact is made when the runway drops.

Finishing Off

Having tested the works we can now finish off the model. Cut a piece of wood 5½ins. by 4½ins. and glue it inside the garage to form a floor, to bring the level up to that of the runway when in the down position. A few experiments should soon bring about the desired result and make running in quite satisfactory.

For the outside, the model can be painted or (what is probably more suitable in this case) papered with imitation bricks and tiles, with the special Dolls' House papers obtainable from Hobbies Ltd. (302)

Have you got a Hobbies Handbook? 1/- everywhere

A simple novelty to make for Christmas is this TUMBLING CLOWN TOY

WE have frequently been asked to give details of this toy which appeared in these pages some few years ago. It is quite an old-fashioned novelty, which still has a great claim on the amusement side for the children. It will certainly be a source of entertainment to the modern child, and will probably be quite new to thousands of our boys and girls.

As will be seen from the diagrams, the toy consists of a block of wood representing the clown. He is placed at the top of the ladder and upon being released, he turns over and over, down the ladder, catching on to each rung in turn on his descent.

The Clown Block

The toy is by no means difficult to make, nor will it take long to construct. Fig. 1 shows three stages in making the clown block. A piece of wood of $1\frac{1}{2}$ ins. by $1\frac{1}{4}$ ins. section and $3\frac{3}{4}$ ins. long is

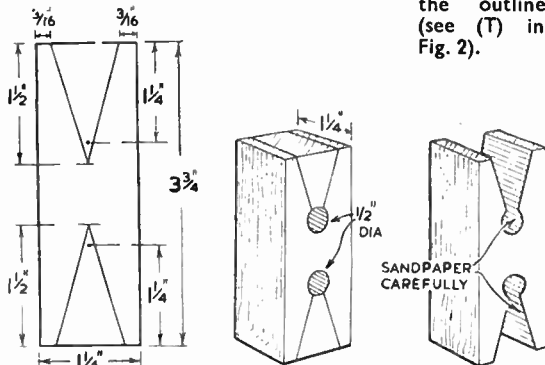

Fig. 1—Marking out, and cutting the clown block

marked out, as in Fig. 1 (A). Holes, $\frac{1}{2}$ in. diameter, are then bored through, as seen in (B) Fig. 1, and finally the block is gripped in the vice and the wedge-shaped pieces cut out with a tenon saw. It is most important to get these openings quite smooth. Bored holes may be rough, so it will be necessary to get busy with the glasspaper.

In Fig. 2 we see how the clown is painted on the two plain sides of the wood block.

As many workers find it difficult to draw the human figure, the simple comic one shown should not be too difficult. The proportions are easily drawn by putting lines across the illustration and then redrawing them on the wood and using them as guide lines for the finished outline. The paint used should be in bright colours, a good enamel would be best.

If several of these toys are being made for sale, perhaps, there will be no need to mark out each figure separately. Draw one out in outline on metal or cardboard, making this a template for drawing round in pencil direct on to the wood. A strip of the template material may be left on each end to bend over the wood to hold the former in place while pencilling in the outline (see (T) in Fig. 2).

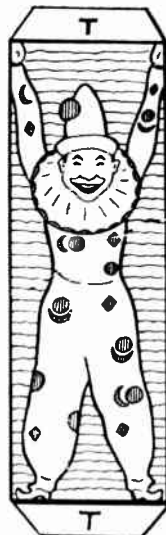

Fig. 2—The figure

effect when the clown is performing. There must, however, be a limit to the length of the ladder if it is required to stand up on a base, as in our sketch of the finished article.

The size of the base and its side brackets can only be got by trial when the ladder length has been decided upon. The sides of the ladder can be

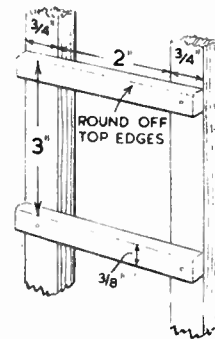

Fig. 3—The ladder parts

of almost any size in section of wood—say, $\frac{3}{4}$ in. by $\frac{3}{4}$ in. The edges should be smoothed up with glasspaper and the sharp corners taken off.

The cross steps of the ladder are made from stripwood, $\frac{3}{4}$ in. wide by about $\frac{1}{4}$ in. thick. Trim all the pieces to this section accurately, so the figure of the clown falls evenly and smoothly. Also see that the upper edges of the steps are rounded over and made smooth with glasspaper.

Ladder Assembly

Fig. 3 shows exactly how the ladder parts are assembled. Keep the steps quite square with the uprights, and glue and pin them on, using small brass fretpins for the job. Do not forget to prick in the holes beforehand for the pins, to avoid splitting the wood.

The flat base and its side supports should be of $\frac{1}{2}$ in. or $\frac{3}{4}$ in. wood, firmly nailed and glued together. It must be pointed out here that unless great care is taken to get all the parts accurate, the clown on his descent will occasionally miss his footing and fall off the ladder.

This will also happen if the ladder is not held upright. Follow out the instructions given here, and make any little further adjustments to the steps necessary after testing the clown. Clean the wood thoroughly before applying the paint or enamel.

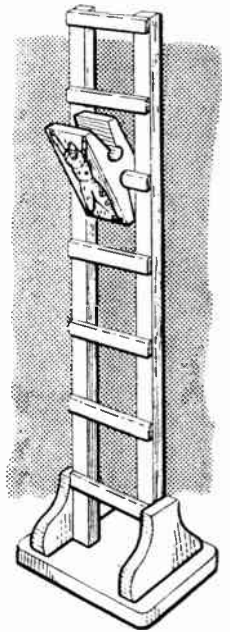

Design for making THE NODDING TIGER TOY

Full size patterns for making this novelty in wood, are presented on our gift design sheet. The necessary kit of materials (No. 2876) is obtainable from Hobbies Branches and Agents, for 4/5 or post free from Dereham, Norfolk, for 5/3.

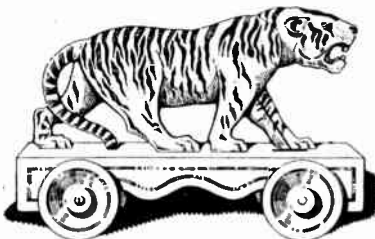

Entertain your friends with these simple CAN-YOU-DO-IT? TRICKS

TO make a party go well you should always have plenty of 'can you do it?' stunts up your sleeve which can be brought out as and when required. This type of diversion invariably holds the interest for a time and often produces much laughter and fun as the aspirants continually fail to perform the desired action or whatever the trick demands. Here then are some of this kind of diversion.

First we have the mysterious ash. Things have eased off a bit and a few of you are sitting round smoking. 'Can anyone keep the ash on their cigarette till it is smoked right out?' you ask. Everybody starts to smoke most carefully and there is plenty of gaiety as one

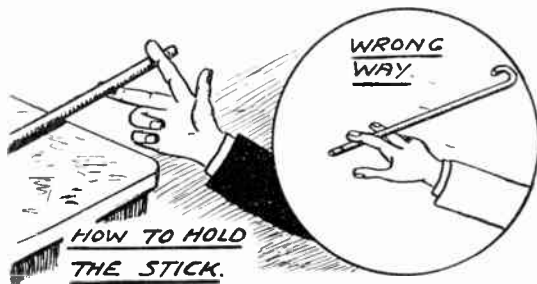

Fig. 1—How to lift the walking stick

ash after another tumbles off. Yours, however, sticks out straight and stiff and gradually attention is focussed on how marvellously you are keeping your ash on, and when it is still there at the last puff, amazement knows no bounds.

And the secret? Well, unobserved you ran a very fine needle down the whole length of your cigarette, which has the effect of keeping the ash in position.

Walking Stick Lifting

'Lifting the walking stick' is quite a good stunt. Place a not-too-light walking stick on the table with its ferrule end protruding over the edge. Now you say 'can anyone lift this stick off the table and hold it horizontal in the air with two fingers, the first and second, touching the ferrule end only?' Nearly everyone will try with the fingers as in the inset sketch of Fig. 1, with the result that it is quite impossible to get the stick even off the table, never mind

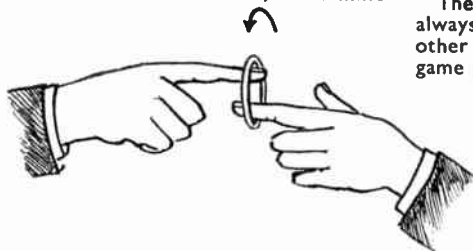

Fig. 3—Flicking the elastic band

raising and holding it horizontally in the air.

The feat can be performed, however, by turning the hand palm up and fitting the end between the fingers, as shown. The whole weight of the stick is then taken by the second finger which, of course, becomes a rigid bar under the pressure.

Coin Tricks

Two interesting coin 'can-you-do-its' are shown in Fig. 2. In both cases the question is can you flick away the paper or card and still leave the coin in position, in the one trick on the edge of the glass, and in the other still on the finger tip.

Both seemingly impossible feats can be accomplished, the secret lying entirely in the quality of the flick given to the material which should be of a smart nature. Furthermore, the paper strip, which is $\frac{1}{2}$ in. wide and about 1ft. long, is held so that the coin is as near as possible horizontal, while the card for the finger trick is $1\frac{1}{2}$ ins. square and of a smooth surface.

It is good to practise both these stunts before bringing them out so that you can show doubters that they can really be

done. The blow is given to the paper strip with the edge of the hand and to the card by a jerk of the first finger of the otherhand. Both these tricks are good laugh raisers, as coins continually fall about and have to be retrieved.

With Elastic Band

'Shedding the elastic band' should definitely be tried sometime during the evening. Here you demonstrate to the guests exactly what they have to do. Making sure they can all see what is being done you hold a band on the first fingers, as Fig. 3, and then twirl it rapidly round by rotating the fingers, one round the other, as per the arrow. Suddenly you bring the finger tips together and the band falls to the floor.

The guests now try but the band always remains threaded over one or other of the fingers. It is the sort of game people like to keep on trying and it is always amusing in itself to see a lot of people sitting twirling their fingers—for you can hand out quite a lot of bands together.

To get the band to fall clear the secret lies in first, and for a fraction of a second only, closing the left finger and thumb and the right finger and thumb together

inside the circle of the elastic, and then quickly bringing the right thumb to the left forefinger and the right forefinger to the left thumb. The hands brought thus in contact, it will be found that the band automatically falls off.

Acrobats

A dexterity 'can you do it' is to crawl round a chair, without touching the ground. That is the competitor starts seated on the chair with his feet raised and after crawling right round the back, must end up once more seated. It can be done, and it is all a question of balance. Most people fall off or topple the chair over when half way round.

Lifting a chair by one leg only, with one hand only, and that grasping the leg at its floor end calls for both strength of wrist and dexterity, but quite a lot of the latter for there is everything in getting well down on your knees beside the chair before attempting the lift. Of course, choose a suitable chair for this trick and not one that is impossibly heavy.

The Falling Coin

But back to something less strenuous, though none the less interesting. A good test for the eye and general reactions is the catching of a falling coin before it reaches the floor. Bring back the arm till the hand touches the ear

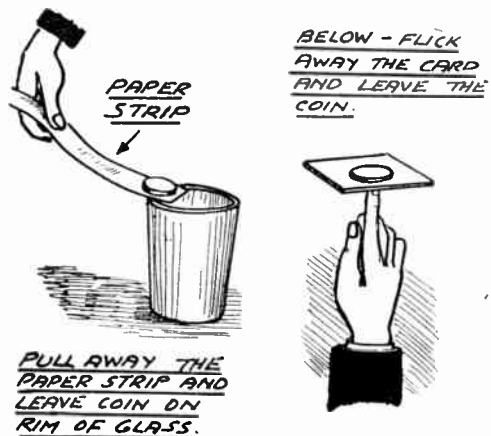

Fig. 2—Two simple coin tricks

which will mean that the elbow is sticking out in front. On the very tip place a coin.

Then bring the hand sharply forward, which, of course, throws the coin off, your job being to catch it before it reaches the ground with that hand. Most people can do this after a little practice, but the first tries are amusing.

The thing is to aim for a point just below the elbow and not out in front, as one might imagine would be necessary.

Another good coin trick is to place two coins on the back of the hand, one

(Continued foot of page 166)

How the radio enthusiast can build himself AN ALL-MAINS THREE

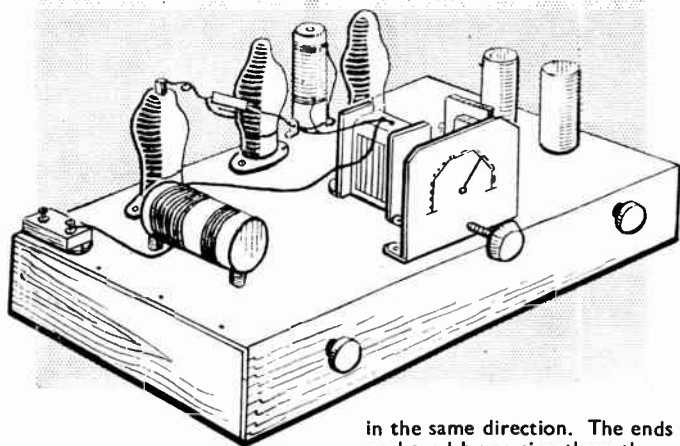

THE constructor who wishes to take advantage of mains supplies should experience no difficulty in building the receiver described herewith, which will give excellent results, though unnecessary complication has been avoided. It is suitable for any A.C. or D.C. mains of up to 250 volts, and the circuit is given in Fig. 1.

Two pentodes are employed for detection and output, with the third valve providing rectification in order to obtain the high tension current from the mains. The grid bias necessary is obtained by the voltage drop across the 440 ohm resistor, and the valve heaters are operated directly from the mains.

Tuning Coil Construction

Any ordinary ready-made Medium Wave, or Long and Medium Wave, tuning coil can be employed, if to hand. If one is to be wound, this can be done from Fig. 2, 32 S.W.G. enamelled wire being employed, and an insulated tube about 1 1/2 ins. in diameter. The smaller winding, used for reaction, consists of 40 turns, side by side. The larger winding consists of 75 turns, also side by side.

A space of about 1/4 in. is left between the coils, as shown, and all turns must be

in the same direction. The ends may be anchored by passing them through pairs of small holes, and they should be left long enough to reach the various components to which they will be connected. The aerial tapping is at approximately the centre of the larger coil.

Such a coil will function as well as a ready-made one, and can be mounted by small bolts, with spacing washers between the coil former and chassis.

Chassis Construction

It is of advantage to make this from wood, to avoid dangers of short circuits or shocks which might arise with a metal chassis. Three-ply is suitable for top, front and rear, with slightly thicker wood for the side runners. A chassis 7 ins. by 9 ins. by 2 ins. deep is convenient, and no difficulty will arise in making this.

The front runner is drilled for the on-off switch and reaction condenser. The former is of the rotary type, so that the knobs match. The back runner is fitted with a small socket strip for the speaker connections. A 1/4 in. hole is also drilled here for the mains supply leads.

The tuning condenser and reduction drive are bolted on the top of the chassis, in a central position. Many different types of drives are available, and that chosen can depend upon personal preference. As ample current is available, it is advantageous to fit a dial-light. Besides its normal purpose, this will also show when the set is switched on.

Three holes are cut for the valve-holders. The best size here will depend upon the style of holder, but holes about 1 in. in diameter will normally be suitable. Bolt the holders with the key-ways all facing to the right, as in Fig. 3.

The mains dropper, which will become quite hot, is fixed at the extreme rear edge of the chassis. The choke is bolted down, and its leads taken through small holes (marked 'X' and 'Y' in Fig. 3 for identification). If the 8 mfd. condensers are circular, with projecting tags, these can be fitted over holes about 3/8 in. in diameter.

Some condensers have a bush and large nut; others employ small fixing feet. Cardboard condensers will normally have coloured flexible leads (red will be positive), and it may be necessary to devise a small bracket from thin metal, to hold these. The type of condenser does not matter, provided it is of the capacity and voltage-working shown in the Component List.

Above-Chassis Wiring

All this is shown in Fig. 3. The detector will have a top cap (the grid) and a

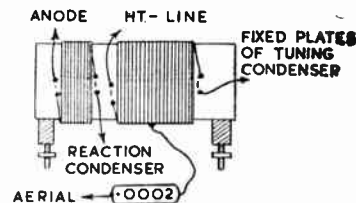

Fig. 2—The tuning coil

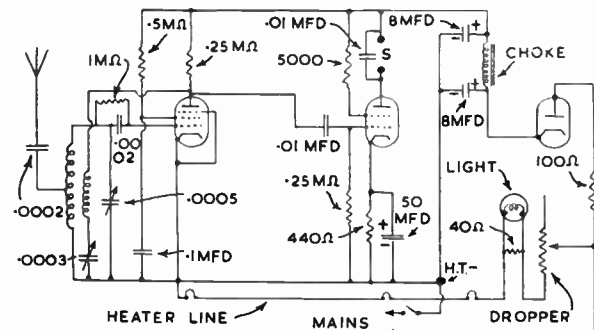

Fig. 1—Theoretical circuit of the receiver

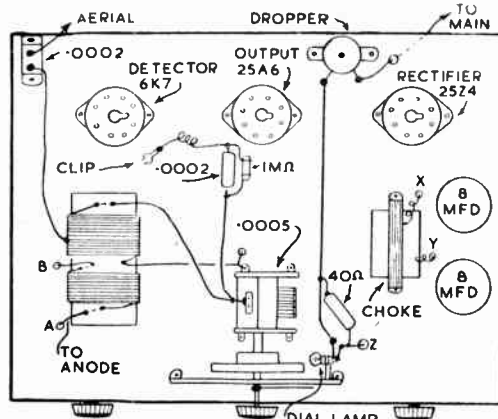

Fig. 4—The wiring diagram

short lead goes from this to the .0002 mfd. condenser and 1 megohm grid-leak, which are supported in the wiring. The .0002 mfd. aerial condenser provides a point for the aerial to be connected. It should not be omitted because it prevents mains voltages reaching the aerial.

The mains dropper will normally have two fixed and one movable clip. One connection is taken to one fixed clip; the second connection to the movable clip. The second fixed clip and any other movable clips which may be present are ignored. Insulated wire should be used

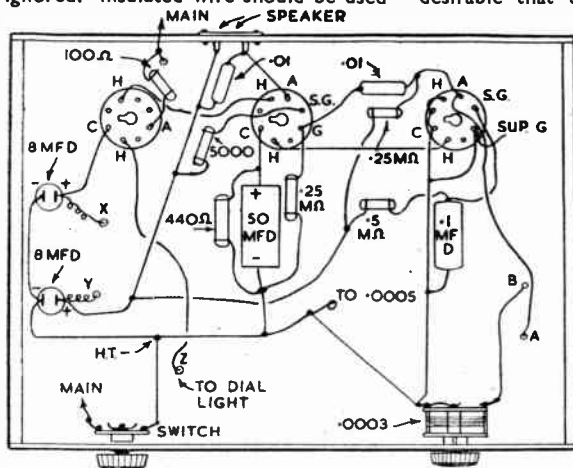

Fig. 3—The chassis lay-out

for all connections. The mains-supply leads should be of good twin flex, and ending in a proper wall plug or adapter, to suit the supply source socket.

Wiring Below the Chassis

By following Fig. 4 the remainder of the wiring can be completed. Note that the two 8 mfd. condensers and the 50 mfd. bias condenser have the polarity indicated, and this must be followed. The other condensers and all resistors can be connected either way round. Keep all grid and anode leads as short as possible, and away from other leads, especially those carrying A.C. or slight humming may be induced.

Only a few leads pass through the chassis. Leads (X) and (Y) are from the choke. A lead goes from the 100 ohm resistor and main to the dropper. A

further lead goes from the H.T. negative line to the moving plates (frame) of the tuning condenser. An examination of Figs. 3 and 4 will make these points quite clear. With the detector valve-holder three tags (heater, metallising and cathode) are all joined together.

Important Notes

As with all 'Universal' or A.C./D.C. receivers, one mains lead becomes the H.T. negative line, and, in consequence, is in contact with all components connected to this. It is, therefore, desirable that the receiver should be incorporated in a proper cabinet, so that no bare parts, including the framework of the tuning dial, if of metal, can be touched. Before making any alterations, the set should be disconnected by withdrawing the mains plug.

In normal circumstances no shocks will be felt even if parts connected to the mains are touched. However, if the user is standing on a conductive floor, a tingling, or more powerful shock, may be felt. It is, therefore, best to avoid touching metal parts when the set is plugged in to the mains.

One mains lead is normally at lower potential, in respect to earth, and this is frequently marked on the plug or socket. If so, it is preferable that this point be the one going to the receiver switch, as in some cases there will be less chance of any hum arising. If the low-potential socket is not known, try the effect of reversing the mains-supply leads to the receiver.

No earth is normally required. If one is employed a 500 V. .05 mfd. condenser should be wired in the earth lead, which is taken to the H.T. negative line of the set.

Adjusting the Receiver

Set the dropper clip so that about $\frac{2}{3}$ th of the element is in circuit. Connect a

moving-coil speaker with transformer for mains pentode, and also the aerial. After switching on the dial, light should light up immediately, but about 45 seconds will pass before the set reaches normal operating temperature. If the period is longer, withdraw the mains plug and move the dropper clip so that less resistance element is in circuit.

When this clip is correctly adjusted,

COMPONENT LIST

- Three octal valveholders.
- .0005 mfd. tuning condenser with reduction and knob.
- .0003 mfd. reaction condenser with knob.
- On-Off switch (Mains Type).
- Two 8 mfd. 350 volt-working smoothing condensers.
- 50 mfd. 50 volt-working bias condenser.
- .3 amp., 800 ohm mains dropper.
- .0002 mfd. mica aerial condenser.
- Ditto, grid condenser.
- .01 mfd. mica coupling condenser.
- .01 mfd. paper condenser for speaker tone-control. .1 mfd. 250 V. paper condenser.
- Two .25 megohm, .5 megohm, and 1 megohm resistors ($\frac{1}{2}$ to 1 watt).
- 100 ohm, 440 ohm and 5,000 ohm 1 watt resistors.
- 40 ohm 1 watt resistor and 6.3 volt .3 amp. dial light with insulated fixture.
- Small mains smoothing choke.
- 6K7, 25A6, and 25Z4 valves. Wire and former for coil.

the set should reach normal operating temperature in about 45 seconds, as mentioned, and the clip can then be screwed tight. (If a suitable meter is available, adjust the clip until the heater voltage, as read on either output or rectifier valve sockets, is 25).

Tuning and reaction controls are used in the usual way, and the dropper clip will only need further adjustment if the receiver is taken to a mains supply of different voltage. In the case of D.C. mains, no signals will be heard if the polarity is incorrect, so it will be necessary to reverse the mains plug in the supply socket, or change over the receiver leads.

The receiver can operate a large speaker well, and for best results it is absolutely essential that the latter be fitted in a cabinet, or secured to a baffle-board. Finally, it should be noted that the receiver cannot operate with no dial-light. If a dial-light is not required, omit it and the 40 ohm-resistor, taking a lead directly from the dropper to the rectifier heater.

Tricks—(Continued from page 164)

just above the knuckles and the other about 2 ins. higher and then sharply flinging them into the air with an upward jerk of the hand, catch them both with, of course, the same hand. Try first with one coin if two seems impossible and then go on to two. Some persons who are clever at this trick can retrieve even three coins placed between the knuckles and the wrist.

For table-top 'can-you-do-it' tricks we have the building of a tower with

playing cards, the putting of five matches on the table in such a way that they each touch every other one, and the placing of two florins, two sixpences and one shilling in such a way that each coin touches at some point every other coin. These are all good stunts and take just about the right amount of effort to get them done.

Well there you get the idea. There are quite a lot of these stunts but unless

you give them some thought one can never think of them when wanted, so starting with these given here, keep your eyes and ears open and make a list which will be ready at hand when your party comes along.

As a general piece of advice, never let one trick go on too long. If it seems just a bit too hard or is not raising the desired interest, whip it on one side and bring out the next stunt from your bag.

Make your personal greetings by using this NOVELTY CARD FINISH



NO matter how nice a 'shop bought' Christmas card or calendar, it never quite has the individuality of one made by yourself. There are a number of ways by which these things can be produced at home, of course, but here is a really novel finish for both the ordinary greeting card or greeting calendar that you might like to try this year, the novelty lying in the binding of the edges.

Material Needed

Required is some cardette or parchment of suitable tone to go with the pictures you intend to use, and a good amount of plastic thread. Also needed is one of those very small thumb punches. Pictures appear on both the cards and calendars and it is nice if you can use your own summer snaps. Tiny photographs are not much use, but a well filled $3\frac{1}{2}$ in. by $2\frac{1}{2}$ in. print is quite suitable for the items suggested.

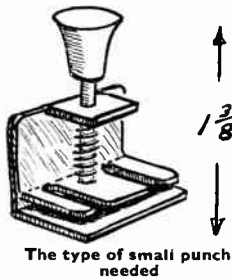

The type of small punch needed

If the pictures you wish to use are black and white, the material used for the card or calendar should be white or silver-grey. Should they be a sepia, then a whole range of yellows and browns will do. Never mount a black and white print on brown card, as the effect is not at all nice.

Should you not be using your own print but coloured pictures from another source, then a card which tones must be found by trial and error, but broadly a

delicately tinted picture needs a delicately tinted mount, while a heavily coloured one looks better on a heavily coloured base.

A vertical greetings card can be made for upright pictures, but a horizontal one for pictures wider than they are high. Should your camera give prints of the $2\frac{1}{2}$ ins. by $2\frac{1}{4}$ ins. square format, then vertical cards can be used by setting the print rather above the centre point. On the other hand, square cards can be made, but the square snap does not fit well into a horizontal card. In getting a pleasing result there is far more in correct mounting than it might first appear.

Single Sheet Cards

Having obtained the prints and card, the latter being procurable at most printers in sheets of about 2ft. square, work can start. Use a sharp blade for the cutting, with a steel edge for guidance, and carry out the process on a thicker piece of material, so that a good clean cut can be obtained.

As can be seen by the sketch, each greetings card consists of a single sheet folded about its middle. For an untrimmed snapshot of $3\frac{1}{2}$ ins. by $2\frac{1}{2}$ ins., the card size should be $5\frac{1}{2}$ ins. by $4\frac{1}{2}$ ins. This means cutting from the main sheet a rectangle of $10\frac{1}{2}$ ins. by $4\frac{1}{2}$ ins. Fold so the two halves lie perfectly over one another. For a vertical card the first rectangle is $8\frac{1}{2}$ ins. by $5\frac{1}{2}$ ins.

Next, before mounting the print, punch the holes for the plastic binding. For quick and accurate punching, one of the tiny thumb presses now on the market is essential, as this can be rapidly slipped along the edge of the rectangle, punching as you go. Equal distancing of the holes being assured by always setting the punch so that the last hole made comes in a slot on the press. The distance of the holes in from the edge is automatically constant.

The cumbersome pliers punch is useless for a job like this when long lines of punch holes have to be quickly made. A thumb punch costs about 4/-.

Mounting and Binding

With the holes made, now mount the pictures a trifle above centre, otherwise they have rather a dropped appearance. Use a paste mountant, as this is not damp in any way and holds the picture firmly at the first contact. Most gums are too moist.

Still before the final binding, add a greeting below the picture and the

word 'From', with a dotted line running from it in the centre. 'A Happy Xmas' should be done in the type of letter shown, as even a person with no artistic ability cannot go wrong with the outlines.

Coloured Lettering

After these have been put in, the letters are all painted in solid with a flat colour, as red, green or yellow. Black should only be used when the whole motive of the card is black and white. On a dark brown card, gold paint looks well. The 'From' on the inside of the back of the card can also be in these stone letters or squarely printed.

Lastly comes the binding. Plastic thread can be bought at most fancy shops and chain stores in a whole range of colours. Start at one corner of the card, leaving the end loose, and work steadily hole by hole right round till the same corner is reached. Here join the

A HAPPY XMAS

An easy style of lettering to use

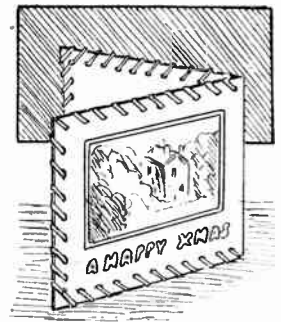

**THE
FINISHED
CARDS.**

The completed cards with their bound edges

ends by a small stitch. When the binding is complete, the card is finished, and it should now be kept under slight pressure till required.

Photograph Pictures

As well as Christmas cards, very good calendars can be made by this binding method, your own photographs again being used if desired. As the finished article will hang on a wall, a bigger surround to the picture can be given, and a $3\frac{1}{2}$ ins. by $2\frac{1}{2}$ ins. print can well be used on a rectangle of card $5\frac{1}{2}$ ins. wide by 7 ins. deep—the picture being horizontal. For vertical photographs or other pictures, a rectangle 5 ins. by 8 ins. gives a well-proportioned appearance.

(Continued foot of page 168.)

Show two postcard pictures in this swing DOUBLE-SIDED FRAME

THE photo frame has undergone great changes during recent years.

Many striking designs have appeared, ranging from the ultra plain to those very skilfully adorned with wood carving. The novel photo frame illustrated and described on this page, while being quite plain is, nevertheless, really very attractive, and makes a useful addition to the home furnishings.

By having the actual frame pivoted at the top and bottom, it is possible to display two different photos alternatively. The construction of the frame is quite easy and if carefully made,

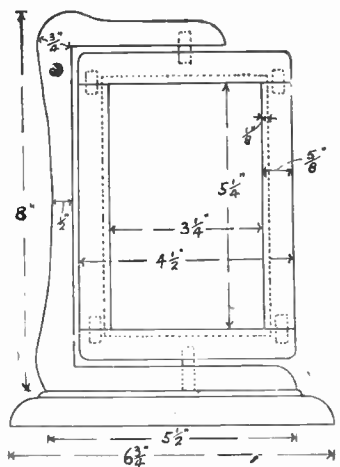

Section of parts with the dowels shown dotted

would form an ideal Christmas present that is bound to receive a hearty welcome.

The sizes given are for the ever popular post card, but it is an easy matter to alter the proportions to other useful sizes.

Suitable Wood

Mahogany or walnut are good woods to use and are not difficult to work with. An added charm is obtained by using two entirely different woods. The frame can be dark, such as walnut, while the stand is a light wood like sycamore.

Card Finish—(Continued from page 167)

Calendars always require some sort of hanging tab and a simple one can be made at the mid-top point with a short length of coloured 'baby ribbon' held to the back with a wide strip of strong adhesive paper. Or, of course, a hanging tab could be fashioned from the plastic thread used for the edge binding.

In all cases the actual calendar is pasted in a central position beneath the picture. The method of hanging the

Commence by making the frame, the wood of which is $\frac{5}{8}$ in. square. A piece 21 ins. long will be sufficient for all four sides and it would be as well to make the groove for the glasses before cutting it up. We will assume that two pieces of thin glass and the two photos will not exceed $\frac{1}{4}$ in. in thickness, which is the width to cut the groove. It is not necessary to make it any deeper than $\frac{1}{8}$ in., provided that the bottom of the groove is cut nice and square and even.

Dowelled Corners

Now cut the strip up into the correct lengths—two pieces $5\frac{1}{2}$ ins. for the sides and two pieces $4\frac{1}{2}$ ins. for top and bottom. These four pieces are not mitred as is usual for picture frames, but are held together with four dowels, as shown in the sketch.

Be careful to measure up and make all these a very good fit, more especially those in the top. The bottom bar and the two sides can be glued together, but the top is made to lift off, so that the glasses can be taken out and the photos changed if required. One side of each dowel can be glued in and it does not matter whether it is in the side pieces or in the top bar.

It will be found that the glass groove is not wanted right at the ends of the top and bottom bars. Therefore, before fitting the dowels, glue in a piece of wood $\frac{1}{4}$ in. by $\frac{1}{8}$ in. and $\frac{1}{2}$ in. long. If you do not like this method, you can cut the grooves in the top and bottom bars separately, leaving each end solid, but this is much more difficult.

When the frame is fitted together, all the edges are rounded off with glasspaper. The four corners may also receive this treatment if desired.

The Stand

Now we are ready to make the stand to hold this frame, for which only two pieces of wood are used. The top piece, shaped like a square letter C, is cut from the solid, extra strength being given at the corners by leaving the wood somewhat thicker here.

It is not necessary to keep strictly to the design shown so long as the gap between the frame and stand is maintained at about $\frac{1}{8}$ in. A piece of wood 8 ins. long, $5\frac{1}{2}$ ins. wide and $\frac{3}{4}$ in. thick is

needed. No difficulty should be experienced if a thick coarse fretsaw is used to cut this.

The three inside edges which are next to the photo frame are finished quite flat by using a piece of glasspaper folded round a strip of wood. The opposite outside edges at the top and side should be glasspapered to a nice half-round surface in a similar manner. The bottom edge, however, is left flat where it will be screwed on to the base strip.

Carefully measure the positions and drill two holes for the $\frac{1}{4}$ in. dowel rod pivots, the top one is drilled only half way through and then glued in. The hole in the bottom is drilled right through and the dowel cut so that when

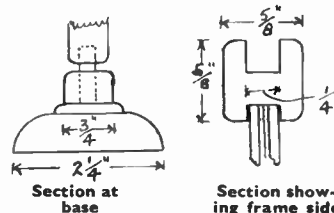

pushed into the frame, it is level with the baseboard which holds it in place.

By removing this pivot the frame can be taken out for changing the photos when required.

Baseboard

The baseboard is $6\frac{3}{4}$ ins. long, $2\frac{1}{4}$ ins. wide and $\frac{3}{8}$ in. thick. Should any trouble be experienced in cutting the moulding, the base can be finished off with a straight bevel, but this would spoil the design by introducing sharp edges. In such a case both the frame and the C shaped mount should also have sharp edges instead of the rounded ones in order to complete the harmony of design.

The baseboard is screwed on to the C piece by two wood screws inserted from the underside.

For a nice finish there is nothing better than french polish, provided the wood has been well glasspapered to secure a smooth surface. Some very pleasing results can be obtained by using enamels, which are now on the market in a variety of delightful shades.

(300)

booklet below the card (a usual practice) does not look well with bound calendars. Incidentally suitable calendars, measuring about $2\frac{3}{4}$ ins. by $1\frac{1}{2}$ ins. and in a whole range of colours, can be obtained from any stationers, ready for pasting into position. They only cost a penny or so.

With regard to the binding of the calendars, this is just the same as for the cards, a start being made at one corner

and a final stitch holding all firm when the corner is once more reached.

Finally, while it is important with both, especial care should be given with the calendars to get the colours of the print, mount and binding to tone. Thus a pleasing choice is a sepia print, sun-coloured mount and sepia binding. But there are plenty of other happy mixtures.

Novelty and presents for your friends from this CHRISTMAS GIFT CAKE

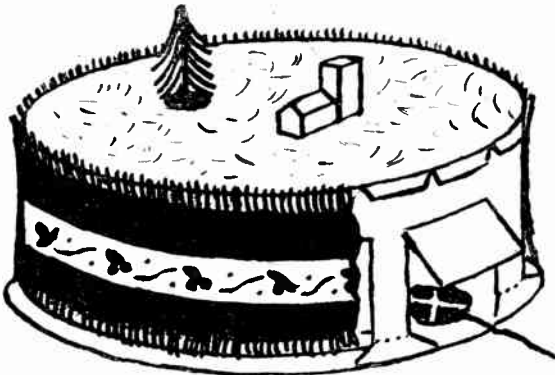

THIS novel Christmas cake will make a nice decoration for your Christmas or New Year party, and also pleasantly surprise your friends and relatives when they find that it contains paper hats, mottos, and presents.

This 'cake' will not take you long to make, and the cost will be less than the usual snowman or Yule log, containing presents that one can buy in the shops at Christmas time. Of course, you have the added advantage of being able to vary the value of your gifts inside the cake, according to your pocket.

Simple Materials

All the materials that you need are a sheet of stout cartridge paper (preferably white), 25ins. by 20ins. This can be obtained from any good stationer; a bottle of paste or Gloy; an 11in. cake board (if necessary a piece of thick cardboard cut to an 11in. diameter circle will do); a cake band, a small quantity of cotton wool, a couple of small decorations for the top of the cake, such as a Father Christmas or a Fir tree, and a sharp pair of scissors.

The cake is made to contain eight presents, in such a manner that when the cake band is removed, each guest can pull a piece of string and the gifts will be drawn out from the cake, through small flaps cut from around the side. These, of course, remain hidden until the cake band is removed.

The Top

The top of the cake is a 10½ins. circle of cartridge paper, with an inner circle of 10¼ins. Cut round the outer edge of the circle, then

weight, and prevents the gifts from sliding from side to side of the cake.

Side

The side is cut as shown in Fig. 3. Cut along black lines and fold on dotted lines, with the exception of line H.J., which serves as a glue overlapping mark to make a circular band of paper. The length of the side is 33ins., composed of eight sections, as shown in Fig. 3.

Unless you are fortunate in obtaining a piece of paper this length, it will be necessary to make the side by cutting a length 24½ins. long (six sections, plus ½in. for overlap) and adding a further two sections of 8½ins. (again a ½in. allowed for overlap).

Cut eight portions for the gift divisions, as shown in Fig. 4. Fold in half down the line A.B., then fold again

edges C.E. towards the centre to make shape indicated.

Construction of Cake

Having made the circular side 33ins. long, place inside the circular top and glue tab edges round the top edge. Bend the eight tabs of the side marked (A) outwards, and glue to the cake base which already has the centre pillar glued to the centre. We now have completed a drum shape (see Fig. 5).

Raise the eight flaps round the side and glue the eight gift divisions to the cake board, behind each leg of the side and running into the centre pillar. This operation will call for careful manipulation. The cotton wool is now glued in a thin layer over the top of the cake and the Father Christmas or Fir Tree, etc., glued in position.

The Gifts

To complete the cake, take your eight gifts, wrap them in Christmas paper, keeping them to a neat size, so they will easily pass through the flap. Tie a short length of string to each package, so it projects over the edge of the cake board and tie your cake band in position around the cake. Your Christmas novelty is then finished.

Make the whole thing as firmly as possible so you can keep it for use on another Christmas. Make it look as realistic as possible without having decorations too elaborate. Gifts must, of course, be small enough to pass easily through the apertures in the side.

The Editor can supply the name of a firm from which caps, mottoes and inexpensive gifts can be obtained. (322)

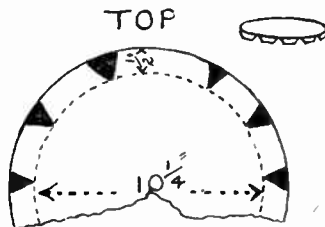

Fig. 1—Marking out the top

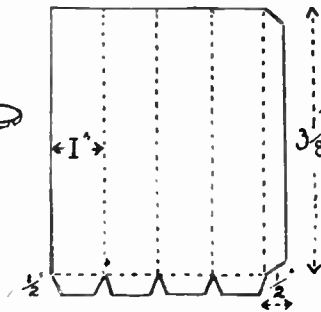

Fig. 2—The central pillar

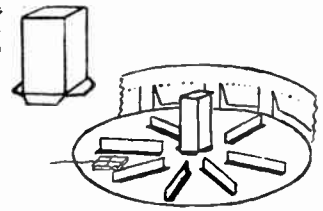

Fig. 5—Interior construction

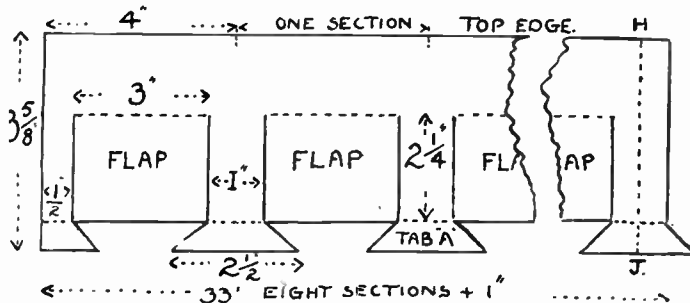

Fig. 3—The main side with flaps and gluing tabs

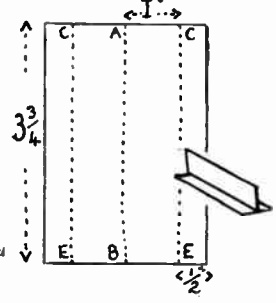

Fig. 4—The partition pieces

Hints on securing rigidity and safety in FIXING THE XMAS TREE

If your Christmas tree is small there will be little difficulty in fixing it firmly in a container of one sort or another, but if this year the Yule-tide fir is to be of some size, the question of safe anchorage may not be quite so easy—and big trees must be safely erected, otherwise they can become a danger.

An ideal base for even quite a large specimen is one of those big forcing pots used by market gardeners. Filled with soil these are heavy and solid, but it is not everyone who can procure a pot of this kind and other things then have to be pressed into service.

An apple barrel from the greengrocer or a garden tub (as used for shrubs) make good containers, as will smaller terra-cotta flower pots (for smaller trees). But where none of these things can be obtained, then an ordinary box must be used.

In all cases the container should be filled with either damp soil or clay, the tree being 'planted' in this. Clay is better as it gives a greater weight and can be more satisfactorily pressed round the stem.

Additional sturdiness is obtained by fitting some sort of bar across the top of

gives a really good anchorage, but it is not necessary if the stem of the tree is long and clay is used for the filling.

When a box has perforce to be used, it may be found rather light, but standing firmness can be given by fixing on a cross-base as Fig. 2. For rapid making, the cross should be of at least 1 in. thick strip, half-jointed at the centre so that the box lies flatly on top. Screws into the box at suitable points will make everything secure.

When a tree is very tall it is always best to have some sort of guy wires at the top to a picture rail or other fastening in the wall, as this gives the whole tree a final firmness. You can thus go ahead putting on presents and decorations with the greatest confidence, all fear of the steadily increasing weight causing sagging or leaning over being completely banished.

If in a corner, the guy wire fastened to the stem can go across at an angle as (b) Fig. 3. If it is against a flat wall, the wire should come from the picture rail, round the tree and back to the rail as (a).

If in the middle of the room, then a single wire right across to either side will give all the safety necessary—the wire in this case being camouflaged with coloured paper.

sufficiently wide to give good standing. The collar (b) which takes the stem at the top must be quite a sturdy block, not less than 1 in. thick, while the corresponding piece at the bottom should also be of suitable thickness, though not having to take screws into its edges.

Surrounded by green cloth, this sort of a stand forms a solid-looking cone out of which the tree seemingly sprouts, giving a novel and unusual appearance. This type of container is seen to advantage when the tree is to be viewed from some little distance—as, say, on a stage or at the end of a hall.

A word about making the tree itself look its best. The trouble with many of the present-day 'tops' is that they are rather limp. The boughs easily sag, while the spines themselves appear to have little body. However, things can be helped to a certain extent by lashing two pieces of wood to the stem about half way up, at right-angles to each other and at right-angles to the stem, thus forming a simple horizontal cross. Fig. 4 shows the idea.

The use of this arrangement is that weak boughs beneath can be wired to it, so giving greater rigidity to the whole tree, and the bars can be made to take the weight of heavier decorations.

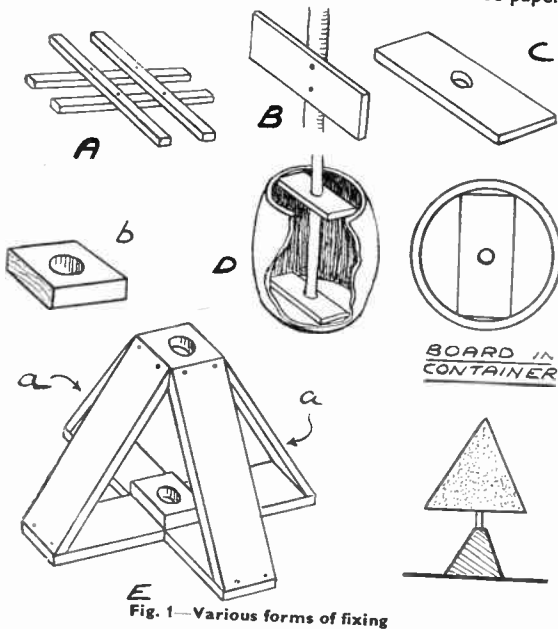

Fig. 1—Various forms of fixing

container to which the stem is attached or into which it slips. This extra support can be a frame as (A) Fig. 1 or a board on edge to which the stem is screwed (B), or again a flat board as (C) with a hole in the centre. In all cases the cross pieces must be jammed tightly in the top of the pot, barrel or box.

If desired, a second piece can be put at the bottom of the container as (D). This

Should you wish to break right away from the conventional pot, barrel or box container and have your tree growing out of a cone-like bank, then the frame as shown in Fig. 1 (E) can readily be made, the size of the members depending on the size of the tree.

The sloping pieces (a) need not be of heavy material, the main thing being that the cross of the base must be

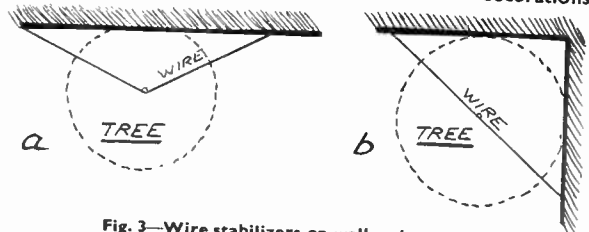

Fig. 3—Wire stabilizers on wall and corner fittings

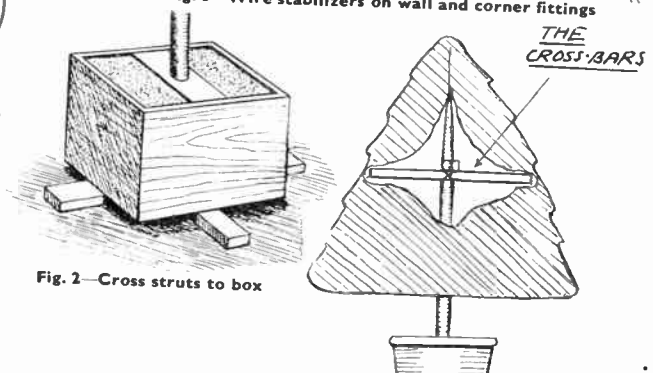

Fig. 2—Cross struts to box

Fig. 4—sprawling the boughs

Camouflaging of these extra pieces with green paper and dabs of cotton wool is quite easy. Of course, the cross-pieces must be lashed very rigidly to the stem, but this is not hard with the standard diagonal lashing used in bridge building. Care must be taken when fitting not to damage the tree, the boughs being gently parted and held to one side as the tying is effected.

Books to Read!

A review of interesting books for craftsmen which have been recently published. Obtainable through newsagents or book-sellers or direct from the publishers mentioned.

The Home Handyman

by F. Lockwood

HOW many times is the home handyman at a loss to know just how to undertake the job requested of him. It is probably a simple thing if he only knows the way, and one which hardly seems worth calling in an expensive professional tradesman. Well, here is the book he wants and which will save him its cost of 5/- many times over. About loose knife handles, re-making a mattress, renovating pictures, book repairs, sharpening scissors, etc., are only a few of the hundreds of jobs the average fellow about the house is asked to do. It even covers subjects like repairing watches, re-stringing tennis racquets, overhauling sewing machines, etc. The book is fully indexed, with clear type and drawings, bound in strong linen cover to withstand frequent use. Published by Newnes and Pearson Ltd., Southampton Street, Strand, London, W.C.2—Price 5/-

Locomotive Body Construction

by Ernest F. Carter

THE layman would hardly think a subject such as this could warrant the preparation of a 60-page book, but every keen railway modeller will agree that it is a most helpful piece of work essential to those whose aim is realism and accuracy. Mr. Carter who is a contributor to our own pages, is acknowledged an authority on such matters. Apart from which he has a pleasing, helpful method of explanation which reduces the most technical business to the knowledge and ability almost of the beginner. The use of eyes and pencil in everyday observation on railway matters is strongly put forward, even apart from the use of tools and materials to bring about the desired result. Published by Percival Marshall & Co. Ltd., 23 Great Queen Street, London, W.C.2—Price 3/-

Your Textile Printing

by Evelyn Brooks

OUR recent articles on silk screen printing have proved how increasingly popular this hobby has become. All kinds of fabric printing can be undertaken, for almost every room in the house, apart from personal adornment. The author deals with the whole processes involved and the photographs of her own work prove the ability to show others and the wonderfully practical results which can be obtained. The chapters deal with methods, tools preparation, apparatus, materials and

equipment and the whole book is generously interspersed with diagrams and drawings which explain points clearly for the merest beginner. Apart from the practical side there is an interesting chapter on the history of fabric printing where we learn that this type of craftsmanship, far from being a modern art, was practised by the Egyptians in the 5th century, whilst interesting examples of patterned cloth are represented on the wall of a tomb about 21,000 B.C.

Published by The Sylvan Press Ltd., 24 Museum Street, London, W.C.1—Price 8/6

Build your own Match Fishing Rod

by G. Lawton Moss

SO many readers follow our periodical articles on Fishing that this book is bound to appeal. It is, perhaps, the ambition of every fisherman, not only to land the best weight in the match event, but to do it with a rod which is worth using because he made it to suit his own needs and fancies. Bought rods, too, are very expensive, but following these details you have made one for yourself to all your requirements—easy to manipulate, strong, light, well balanced, with a quick action in the tip. What more could you want? Whilst termed a match rod, you will have something which can be used also for ordinary everyday fishing.

Published by The Technical Press Ltd., Gloucester Road, Kingston Hill, Surrey—Price 4/6

Furniture Designs

by Charles H. Hayward

THIS large, well bound and printed book is just the work for the

experienced amateur carpenter. It contains no more than can be dealt with by the home craftsman who has and can handle the tools found in a good workshop. The requirements for each room are dealt with in turn, and detailed constructional advice given on each article. Beyond that there are scale elevations, full drawings and details, cutting lists and material advice, for every subject mentioned. There are large pieces of furniture for living rooms and bed rooms, there are incidental accessories for kitchen and hall. Construction is simple and straightforward with the necessary room for a carpentry bench and a good range of tools.

Published by Evan Bros., Ltd., Montague House, Russell Square, London, W.C.1—Price 10/6

Lampshade Making

by F. J. Christopher

READERS are constantly writing to us for help on this subject, and we are now happy to recommend this little book for their guidance. The advice given is from a practical source, for Mr. Christopher is an experienced instructor and demonstrator, and there is much helpful advice here, whether you are merely making one or two shades for your own home or propose undertaking the work as a commercial venture for selling among your friends. The work is well worth trying, in view of the very high prices for the manufactured articles, apart from the pleasure of the craftsmanship enjoyed. All points of the work are dealt with from material and tools to shapes, frames, construction, finish and uses. Altogether an excellent book for the home craftsman who wants

Punch Holder

THE hammer and nail punch are two tools nearly always needed, and you can easily keep them together by the simple means illustrated. Drill a hole into the handle of the hammer deep enough to take the length of the drill

after having cut off a short length to form a lid. Or, of course, a small circle of tin can be nailed on instead.

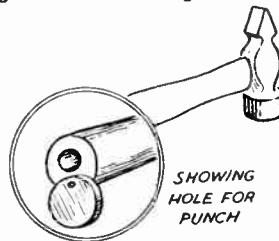

A Painting Clip

WHEN you want to paint both sides of a piece of wood, you find it hard because your fingers may damage the

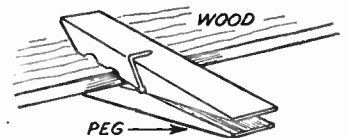

paint of one side. All you have to do is to take a small clothes peg and let it grip the wood just as the picture shows, and you find it easy to paint.

to be practical and original in his efforts.
Published by W. & G. Foyle, Charing
Cross Road, London, W. C.—Price 2/6

Rubber Motors

by R. H. Warring

ANY of our readers keenly interested in constructing and flying model aeroplanes will find ample repayment for the purchase and perusal of this book. It is written by an author who is recognized as an expert, whilst its contents cover all the beginner and experienced flier need know. There are chapters on rubber itself, its function and construction for driving purposes, how to fit, test and trim, with charts and table to prove all that they are required to do to the amateur. Photographs are on almost every page, showing some practical uses or some of the well known authorities on model work with some of their own planes.

Published by Harborough Publications, The
Aerodrome, Billington Road, Stanbridge,
Near Leighton Buzzard—Price 3/6

* * *

Electro Plating for the Amateur

by L. Warburton

WE are particularly pleased to learn of the publication of such a book as this, because we received quite a number of letters from readers who are anxious to try their hand at the work. We have assumed, of course, that those readers are wise enough and old enough to do the work carefully and realize the need for caution with the acids. But this book puts them entirely wise, and covers the whole subject in simple and progressive manner. As the author says, the processes are not adaptations of commercial and highly expensive or technical ones, but the outcome of his own extensive experiments over many years. Small scale electroplating has a fascination for many workers in metal, and here is how they can do it. The type of apparatus required, the tank, preparation, and, finally, actual operation are all dealt with and additions, diagrams and tables provided where necessary.

Published by Percival Marshall & Co. Ltd.,
23 Great Queen Street, London, W.C.2—
Price 5/-

Atoms and Atomic Energy

by R. W. Hallows

IT has been our pleasure before to review earlier books by the same author, on radar, television, and wireless. Now he has produced another, this time on a subject which does not carry the same pleasant or practical background that the others do. Indeed, the matter is, in its technicalities very involved, but Mr. Hallows has the unusual gift of being able to deal with the most abstruse subjects in everyday language in methods of presentation which make thoroughly understandable, and almost pleasant, reading. The book, of course, is particularly of interest to those well versed in physics, but the steps and progress of the science through the pages of the book becomes clear and fascinating, rather like following clues and hypothesis in a clever detective novel. Whilst not exactly a light bedtime story, the book does yield a fascinating lucidity and knowledge for even the ordinary man.

Published by Messrs. Chapman and Hall,
37 Essex Street, London, W.C.2—Price 10/6

The housewife will be delighted to have this handy STEP LADDER ATTACHMENT

WORKING on a pair of steps can sometimes be very awkward for the home decorator or handyman. It is not at all comfortable to have a pail of whitewash or distemper balancing precariously on the somewhat narrow top of the steps. Besides running the risk of knocking it over at any moment, it does not allow the free movement necessary to wield a brush successfully.

All these difficulties can be avoided by making the little platform shown in the drawing. It can be attached to any pair of

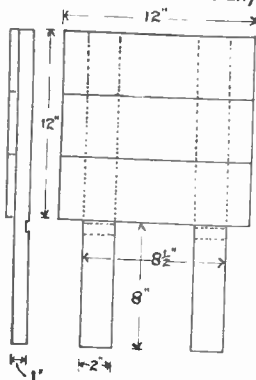

Lay-out and side view of attachment

steps very quickly and will hold a pail at a comfortable working height, while allowing work to proceed in an easy manner.

By making the platform 12ins. square it will fit any ordinary household steps, and is large enough to hold the usual size pail. It will not project much more

than the space taken by the steps when fully open, which allows it to be used right up to the corner of a room.

It does not matter what kind of wood is used—any odd scraps will do, so long as they are quite sound.

Platform Supports

The platform is supported on two bars of 2ins. by 1in. wood about 20ins. long. The actual length will depend on the size of the steps and also on the position of the platform on the steps. If used near the top 20ins. will be about right, but if it is to be placed two steps down, extra length must be added—say about 4ins., making the bars 24ins. long.

The wood for the platform need not be more than ½in. thick. Any number of boards can be used to make up the necessary width of 12ins., or a number of slats 1in. or 1½ins. wide, with a space in between would be quite suitable. If you decide on this latter method, do not put the slats too far apart. It is probably best to have a solid platform, so that it will hold various tools and materials such as nails and screws without falling through the spaces.

The platform is supported on a strip of wood fixed to the back legs of the steps, while the ends of the platform bars rest under the top or second tread of the steps.

The position of the supporting strip must be determined when the steps are in position for use, allowance being made for the small groove cut on the

under side of the platform bars which keeps the platform from sliding out. Quite a shallow groove will be sufficient; anything more than ¼in. would weaken the bars too much.

Many improvements can be made to the platform once it is tested out. A

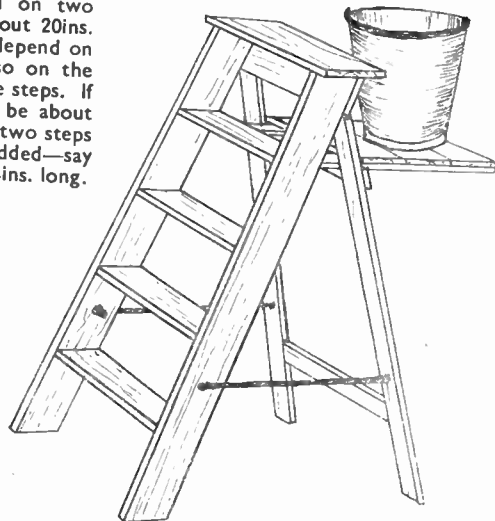

very useful attachment was made by the writer for holding tools and other odds and ends used during the work in hand.

It took the form of a box with both sides open, and was attached to the under side of the platform. A depth of about 4ins. would be a very useful size to make it, thus making it into a sort of portable work bench.

(301)

Any youngster would love this simple push-along WHIRLING DISC TOY

A RATHER novel push-along type of toy this, which includes a rapidly rotating coloured disc, the colours of which can be changed at will. It would be amusing and interesting to any young kiddie, and provide exercise as well. A nice Christmas gift.

Some $\frac{1}{2}$ in. thick deal is suggested for making the body part, to make it strong enough to stand up to plenty of work, as it is likely to get at the hands of a healthy child. Parts of the body are shown, with dimensions, in Fig. 1. The top board (A) should be carefully marked out from a length of wood, long enough to include it and a suitable handle.

Handle Length

This part (the handle) can be of any reasonable length, perhaps, 24 ins. would suit well. If, owing to the length of wood obtainable, cutting in one piece would be inconvenient, a portion of the handle part only can be cut as one, and the remaining handle cut separately and screwed to it.

The board cut, mark and saw out the slots, etc., carefully. The side bearing parts, which carry the wheels (B) are next cut, and holes for the axle bored $\frac{1}{4}$ in. where shown. These are then fitted to the board, being screwed and glued strongly in position. A post (C) is to be cut, which carries a spindle on which the disc rotates.

The easiest way to tackle this part is to cut first a $1\frac{1}{2}$ in. wide strip of the wood to

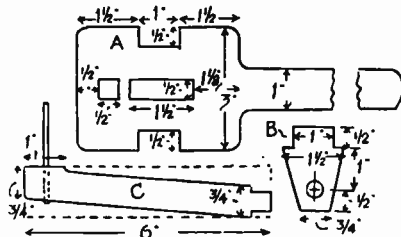

Fig. 1—Details of main parts

6 ins. long, it should not then be a difficult matter to mark out the shape correctly. See the tenon at the bottom makes a tight fit in its mortise slot in the top board. This is the one nearest the front.

In the centre of the top of this, at $\frac{1}{2}$ in. down, drive in a $2\frac{1}{2}$ in. wire nail. File the head off, leaving about $1\frac{1}{2}$ ins. sticking out. On this the disc will rotate. Glue part (C) in its place. The handle part should be finished off by glass-papering the edges to smoothness, and shaping up the end to afford a comfortable grip to young fingers.

Wheels

A pair of 4 in. wooden wheels will be required, and readers are urged to purchase these, the successful running of

the toy demanding true wheels and it is not easy by any means to ensure this at home without the use of a lathe. All sizes of wheels can now be bought reasonably priced, and are scarcely worth the trouble of making anyhow.

Axle and Pulley

An axle of $\frac{3}{8}$ in. round wood rod will be required, long enough to fit across the bearings and leave enough for gluing the wheels on, as in drawing, Fig. 2. A pulley is to be made, and glued to the centre of the axle.

For this cut three discs of $\frac{1}{4}$ in. fretwood, two with diameters of 2 ins. and one with diameter of $1\frac{1}{2}$ ins. Glue the three together, bevel off outwards the edges of the larger discs, and bore the $\frac{3}{8}$ in. to fit the axle. Glue one wheel on, push through the side bearing, threading the pulley on, and then glue the remaining wheel in place. Allow enough latitude for the wheels to revolve without scraping the sides of the toy.

Now the whole article can be painted. Make it look bright and cheerful with gay brilliant colours. It is as well to leave the axle plain, also the groove of the pulley, as any paint applied to that part will most certainly be scraped off by

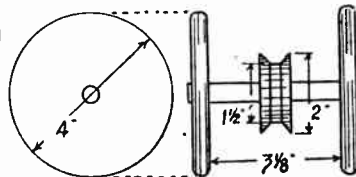

Fig. 2—Wheels, axle and pulley

the cord afterwards.

A smaller pulley for the rotating disc should now be made. It is constructed similarly to the larger pulley already mentioned, to a diameter given in Fig. 3, and a hole bored through it to fit easily the nail spindle in part (C).

The disc itself can be cut to the diameter given from stout cardboard, and is glued to the pulley, a hole being cut at its centre to allow passage on the spindle. It is best here to see the edge of this hole does not contact the spindle at all, as if at all tight it may prevent the rapid rotation of the disc.

Colour Discs

Colour the disc as indicated in the drawing. This can be done with crayons, but a brilliant colouring is better

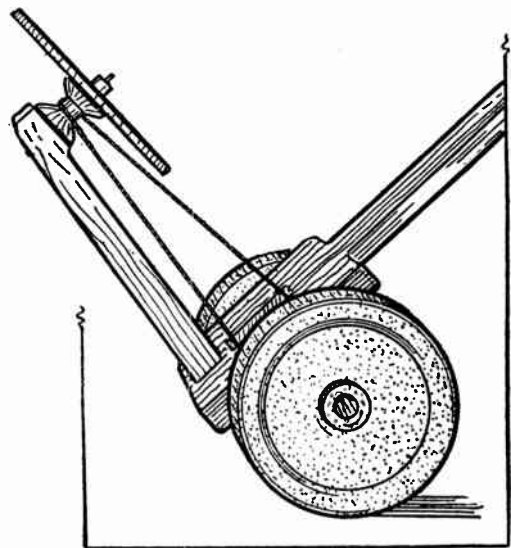

ensured with pigments of the poster paint quality. Alternatively, some of the bright coloured labels on tins of food stuff might provide enough for such a small disc and, of course, the reader is not limited strictly to the colours named in the drawing.

A second disc, of thinner cardboard, is cut to the same diameter. It is covered with white paper, and has four openings cut out, as at (D). This is fastened to the rotating disc with a pin. Now connect both the pulleys with a thin cord or twine, and as the toy is pushed along, the disc should rotate rapidly and show pleasing rings of colour. These will alter with every slight adjustment of disc (D). It may be a good plan here to stick a cork on the end of the spindle, if the disc tends to ride off it.

Wood Obtainable

With different colours on the rotating disc, and assorted shaped openings on the second disc, the combination of colours is unlimited. If buying the wood, one Hobbies panel of each of the following will be required—N.D.8 and G.4. Stick for handle extra, also wheels.

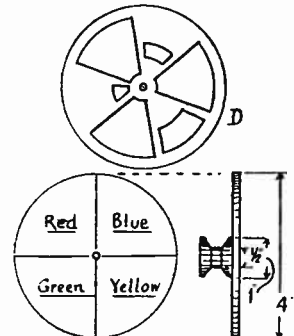
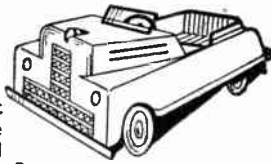

Fig. 4—Colour discs and holder

PEDAL MOTOR CAR



This new simplified chart enables any amateur to make a strong smart modern Pedal Car suitable for children 2 to 5 years. Complete plan and instructions 2/6 post free

Wheels and other parts for Pedal Cars and Dolls Houses available. Send stamped addressed envelope for list

ZIMPLAN 88 WARE ROAD
HODDESDON, HERTS.

BOYS!

THIS PROJECTOR IS JUST THE JOB!
3 Lens Optical System. Brilliant pictures.
HOURS OF FUN

* EXCITING NEW FILM STRIPS *

Battle of Britain
Ships of the Navy
Britain at Sport
West Indies Tour Series
Brumas
The Royal Family

THIS 35mm STRIP PROJECTOR GIVES YOU YOUR OWN FILM SHOW IN YOUR OWN HOME

TRANSFORMER MODEL A.C. MAINS ONLY 22/6
BATTERY MODEL 17/6 EACH COMPLETE READY TO USE

Dennis Compton's Cricketing Days British Railways P.S. Why not send for complete list of films from 6d. to 2/6 and details of the WONDER Home Strip Projector.
FILM STRIPS EDLESBORO NR. DUNSTABLE

YOU CAN BECOME A HANDICRAFTS INSTRUCTOR

Experience not essential

Men who enjoy making things in wood or metal can turn their hobby into a permanent and interesting Career. Short hours, long holidays, and security in a job you would really enjoy, can be yours if you become a Handicrafts instructor. Let us send details of the easiest and quickest way to get the necessary qualification.

We definitely guarantee "NO PASS—NO FEE".

If you would like to know about our unique method of preparing you for one of these appointments, write to-day and we will send you our informative 176 page Handbook—free and without obligation. Mark your letters "Handicrafts Instructor."

BRITISH INSTITUTE OF ENGINEERING TECHNOLOGY

595 Shakespeare House
Stratford Place, London, W.1

BIET

SUPERB CHRISTMAS GIFTS FOR YOUR PALS

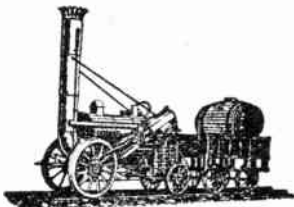

Here is our second in the series and one we are proud to introduce as probably the most fascinating of all models. Our 'TRUKIT' Series No. 1 Historic Locomotive Constructional Outfit, builds up into Stevenson's world famous 'ROCKET' to Gauge 'O' 7 mm. scale. Whilst not a working model, it unquestionably makes up without the slightest difficulty or imagination into a truly magnificent

little model. No one owning a model railway can afford to miss this unique opportunity for such trivial expense—in fact, your layout is incomplete without this grand old veteran to grace your siding. We know we shall have great difficulty in meeting the demand, so please don't delay, or we may have to disappoint you. Send P.O. to-day for 11/5 post free.

MURRAY HILL & CO. (Dept. H.)

MAIL ORDER HOUSE, BEDFORD SQUARE, SIDMOUTH, DEVON

"KARLENITE"

PLASTIC MARBLE

The entirely new Art Stone for casting Bookends, Ashtrays, Wall Vases, Statuettes, etc. 'KARLENITE' sets granite-hard with scintillating crystalline structure which very closely resembles marble or alabaster. It is enormously strong, highly resistant to heat, and impervious to water. Literally any type of natural 'veining' can be simulated in any colour and a wide range of pigments is available for this purpose.

MAKE YOUR OWN FLEXIBLE MOULDS

with 'Elastomould' Synthetic Rubber Solution. By means of this simple technique, you can easily prepare permanent elastic moulds for repetition casting, plaques, bookends, etc., in quantities of thousands.

'Elastomould' will faithfully reproduce even the most minute details of ornamentation and surface texture.

It is incredibly simple to use, and moulds can be prepared from any type of pattern including Wood, Metal, Plaster, Stone, Glass, Ivory, etc.

Such moulds are ideally suitable for casting in plaster, Cement and Karlenite.

Start your Own Business. Send 1s. for full details of this easy, fascinating and profitable hobby.

MONEY REFUNDED TO BONA FIDE ENQUIRERS

Dept. H.2, Karlana Art Stone Company, 55
Deansgate Arcade, Deansgate, Manchester, 3.

PHOTOGRAPHY

Build Your Own Enlarger

Contains full instructions and clear, large-scale working diagrams for constructing seven different types of enlargers and enlarging accessories. 77 diagrams. 7/6 (Postage 4d.) ... 7/6

Hints, Tips and Gadgets

for the Amateur Photographer

Gives new and novel ideas to save the amateur photographer time and money. Illustrated with over 125 drawings and photographs. 7/6 (Postage 4d.) ... 7/6

Obtainable from photo dealers or in case of difficulty from

THE FOUNTAIN PRESS

(Dept. H.W.) 46/7 CHANCERY LANE, LONDON, W.C.2.

CYCLOP FLOODLIGHTING LAMP REFLECTORS



Fitted in cycle or inspection lamp they will floodlight the road or your work. No black centre. Wonderful difference. — And by using one in a front battery lamp and fitting same with light red glass you can also make yourself the most powerful rear lamp in the world. LET THEM SEE YOU! — Smashing! BATTERY MODELS, 8 or 12-sided for wide or bright beam, 1/6 DYNAMO, 12-sided, 2/6

From Halfords & all good cycle dealers or post 3d.
KORVING LTD. (HB2), 12 Duke Street, London, S.W.1



THE BOLSTER HOME WATCH AND CLOCK REPAIR OUTFIT



These precision jewellers instruments include watchmaker's magnifying eyeglass, finest watch tweezers, set watchmaker's screwdrivers, watch and clock oil, oilers, dusting powder, clock brush, plus illustrated instructional manual for the amateur. In container 12/9 post free.

Senior Outfit includes everything above, plus watch jewels, luminous compounds, dial renewer, jewellers rouge, explanatory book. Price 21/- post free.
BOLSTER INSTRUMENTS, (Dept. H. W.), 5a Station Parade, Ashford, Middx.

FOR STAMP COLLECTORS



Place stamp in slide—insert slide—press the switch and the watermark shows up—illuminated. Battery operated. Moulded Plastic construction, pocket size. Obtainable from stamp dealers, booksellers and stationers, or direct from

J. & A. WALLACE LTD

94 OLD BROAD STREET, LONDON, E.C.2
Entrance London Wall, E.C.2 Tel. LONDON Wall 5306/7

ENGINEERS

★FREE BROCHURES★

NEW COURSES

Technical training is vital to your success. Our Home Study courses have now been very widely extended in range.

Write or 'phone for FREE BROCHURES detailing our courses of TECHNICAL TRAINING IN ALL BRANCHES OF ENGINEERING covering the syllabus of the examinations for A.M.I.Mech.E., A.M.I.E.E., A.M.I.P.E., City and Guilds, etc. Moderate Terms. Facilities for easy payment.

'THE COLLEGE BACKED BY AN INDUSTRY'

Write to Dept. 31

E.M.I. INSTITUTES

10, PEMBROKE SQUARE, NOTTING HILL GATE, LONDON, W.2. TELEPHONE: BAYSWATER 5131/2

Associated with
"H.M.V."
MARCONIPHONE
COLUMBIA
ETC.

I.12a

EXTRA CASH IN SPARE TIME



A fascinating way of earning extra cash in spare time from odd pieces of lead. Small Outlay—Large Profits. Sample mould 3/6d. Casting moulds, deep-cut and ordinary type Aeroplanes. Soldiers, Farm and Wild Animals, Cars, etc. Stamped envelope for full list. Illustrated Catalogue 9d.

MASTERCRAFT MOULDS
69, ST. MARKS ROAD, HANWELL, LONDON, W.7

OPPORTUNITIES in the ROYAL NAVY

PAY IS BETTER

The Navy's just had the biggest rise in pay in the history of the Service! For example an Able Seaman, unmarried, can now earn 70/- per week instead of 46/8; a married Leading Seaman can get 142/4 instead of 109/1—and there are many extra allowances over and above. And your food and board are paid for you in the Navy.

PROSPECTS ARE BETTER

The need for skilled men in the Navy continues to increase. Everyone entering the Service gets the opportunity and training to learn an interesting job that pays well, offers regular rises and a career.

PROMOTION IS BETTER

If you work at your job you can be sure of promotion in the Navy. The Service is expanding... creating new opportunities for men from

the lower deck to attain commissioned rank.

LEAVE IS GENEROUS

The long seasonal leaves give the man in the Navy generous holidays with full pay and allowances. And short leaves are also given at every opportunity—as well as time off for all kinds of sport.

TRAVEL IS WORLD-WIDE

You enjoy seeing the world with the Navy. At all the foreign ports where the Navy calls there is usually generous shore leave, with money in your pocket and cheery shipmates to go with you to see the sights.

THE JOB IS WORTH WHILE

The man in the Navy is doing a great service to his country. This active, adventurous life you lead in the Service is helping to keep the Navy an alert, efficient fighting force.

Make the ROYAL NAVY

your career

For full details write D.N.R. Dept. T/37, Admiralty, London, S.W.1. Candidates must reside in the United Kingdom.

'PERSPEX' and 'CRINOTHENE'

for the handicraft worker

'Perspex' acrylic sheet is available in transparent, translucent and opaque colours in a wide, useful range of sheet sizes and thicknesses. It can be fabricated as easily as wood or non-ferrous metals, using standard equipment.

'Crinothene', a decorative plastic sheeting supplied in many attractive colours, is ideal for lampshades.

For further information, please apply to the nearest I.C.I. Sales Office.

'Perspex' is the registered trade mark of the acrylic sheet manufactured by I.C.I.

'Crinothene' is the registered trade mark of polythene sheet manufactured by I.C.I.

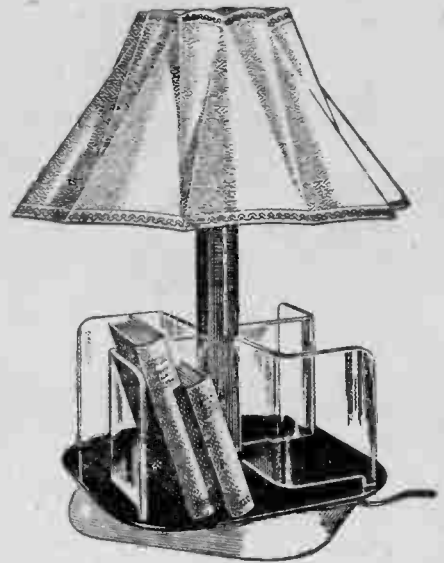

IMPERIAL CHEMICAL INDUSTRIES LIMITED, LONDON, S.W.1.



Topical Tips on Taping!

Toys have no ending with "Durex" mending

There are no tears when you can tape with "DUREX"! Broken toys are speedily and invisibly repaired without fuss or mess. It's just one of a thousand jobs "DUREX" does.

"DUREX"
Cellulose TAPE

Trade Enquiries:
Durex Abrasives Ltd., Birmingham, 8

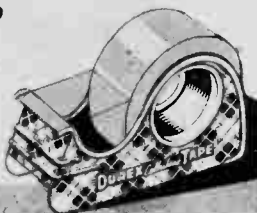

CASCO

**COLD
water
GLUES**



supersede this

Most hobbies require Glue—"CASCO" fills the bill for either new work or repairs. It is an absolute necessity for the Modelmaker for Pretwork, Toymaking, etc. Easy to mix in cold water Casco is simple to use and almost impervious to heat and moisture. "CASCO" Grade "A" is the world-famous Casein Cold Water Glue manufactured in Great Britain, Australia, U.S.A. and Scandinavian countries. Conforms to MODERN BRITISH STANDARDS SPECIFICATION 1444, TYPE A.



Stocked by Ironmongers, Builders' Merchants, Hardware Stores, etc.



DISTRIBUTORS:

Gt. Britain: Charles Cleeve & Co. Ltd.
45 Gt. Peter St., London, S.W.1.

Eire: C. B. Waller, 60 Middle Abbey St., Dublin
M. J. Galligan, 16 Oliver Plunkett St., Cork

FREE! Send for literature and Free Sample to the manufacturers
LEICESTER, LOVELL & CO. LTD.
(Dept. HW), NORTH BADDESLEY, SOUTHAMPTON

Hobbies

WEEKLY

CONTENTS

	Page
A Toboggan - - -	177
The Editor's Notes -	178
Xmas Party Magic -	179
The Home Decorator -	180
Home-made Dart Board	181
Home Chemistry - -	182
A Letter Board - -	183
Door Draught Excluder - -	184
Toothbrush Holder -	185
Ship Modeller's Corner	186
Photography - - -	188

December 20th, 1950

Price Fourpence

Vol. III No. 2877

A Straightforward way of MAKING A TOBOGGAN

SNOW, being a very uncertain visitor in this changeable climate of ours, makes it very desirable for those liking to enjoy the sport of tobogganing, to have the toboggan ready for it, otherwise, by the time the article is completed the snow may have vanished.

A Sturdy Article

Of course, some fun can be got out of any rough and ready affair, but a properly made and strong article is much to be preferred. The toboggan illustrated comes about midway, between the crude article, and the expertly built professional affair, and if kept painted, will last some years, and be always ready when the snow does make an appearance. Hardwood, like beech, is

about the best wood to use, but quite a good article can be made from good quality deal.

Sides and Crossbars

A side view is given in Fig. 1 and an end view in Fig. 2, with suitable dimensions. Cut the sides from wood 1in. thick, and round the bottom corners to a quarter circle. Between the sides three crossbars are to be mortised and tenoned across. The mortises for these are shown in the side view and should be just 1in. square.

Those at the forepart of the toboggan are cut at a distance from the front of 6ins., and are 1in. from the top and spaced 2ins. apart. At about 1in. from where the sides are reduced in width, cut out a second and identical pair of mortises.

One crossbar goes across near the rear end, about 6ins. from it as a matter of fact, and here a single mortise is cut, 1in. down from the top. The total length of these three crossbars is the same as the outside width of the toboggan. A half view of them is given in Fig. 3, from which it will be seen that they differ in width, the 6in. ones, two of which will be required, being fitted across the wide part of the sides, and the narrower one across at the rear of the toboggan.

Make Strong Joints

Cut the tenons at the ends to suit the mortises in the sides, naturally. Make a good fit to all and glue them across. Strengthen the joints afterwards with screws to make a sound job.

Now, across the top, nail some 6in.

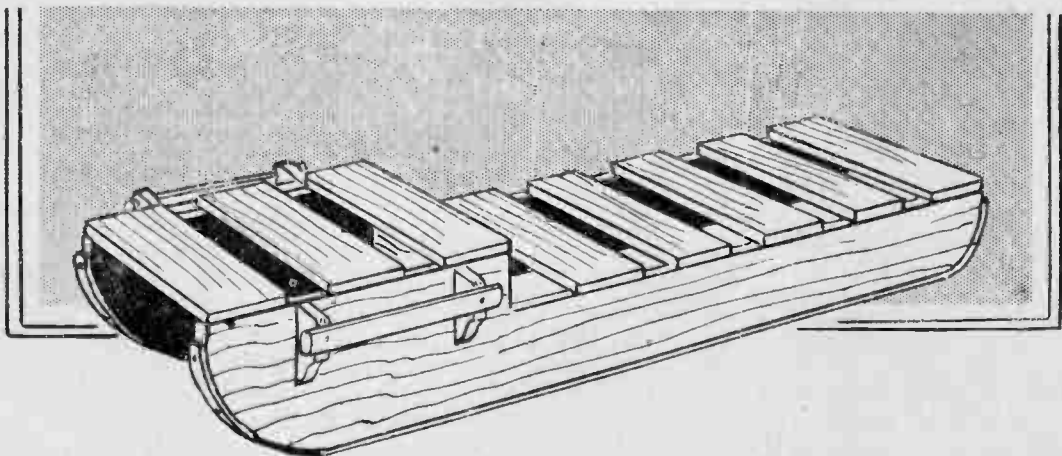

All correspondence should be addressed to The Editor, Hobbies Weekly, Dereham, Norfolk.

wide pieces of wood, stout quality, to last well. Space these 3ins. apart, the end ones being level with the ends of the toboggan. All sharp corner edges of these parts should be rubbed off with glasspaper, especially the sawn edges at the sides.

To the sides, foreparts of these, handle grips are to be fitted, for the

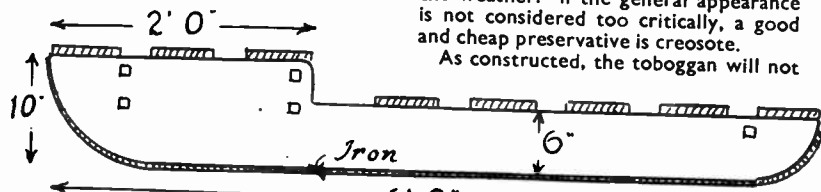

Fig. 1—Side view and dimensions

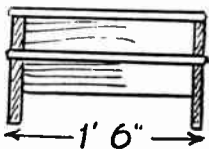

Fig. 2—End view

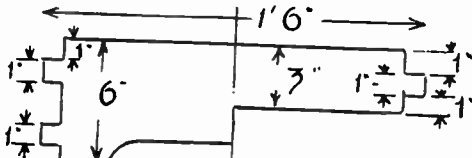

Fig. 3—Half view of crossbars

both for lasting wear and ease in running, and about the cheapest to use is strip iron, $\frac{3}{8}$ in. wide and $\frac{1}{8}$ in. thick. Such metal can be fairly easily bent to the end

MATERIAL

- Sides (2)—6ft. by 10ins. by 1in.
- Crossbars (2)—1ft. 6ins. by 6ins. by 1in.
- Crossbars (1)—1ft. 6ins. by 3ins. by 1in.
- Top slats (8)—1ft. 6ins. by 6ins. by 1in.
- Handles and brackets from scrap wood.

curves cold, and fixed with screws, well countersunk. Other metal that may be available could also be employed, but iron lasts the longest, and is much the cheapest.

When milder weather makes its

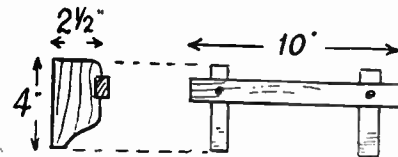

Fig. 4—Handle grip details

tobogganist to grip as he or she travels down the slope. These are detailed in Fig. 4. Cut the grips from hardwood, 1in. wide and $\frac{1}{2}$ in. thick, and round off all the sharp edges to provide a comfortable grip. The brackets for these are shaped up, as shown, from pieces of $\frac{1}{2}$ in. thick wood. They are securely screwed

give the length of service that might be expected unless the sides are shod with metal, though a good substitute is to screw $\frac{1}{2}$ in. thick strips of hard oak or beech to the bottom edges of the sides, those that come in contact with the snow.

Metal is, however, by far the best,

appearance, and any further chance of snow dwindles away, give the toboggan, when dry, a fresh coat of paint or creosote, and put away ready for the next season. A length of rope, attached to the rear of it, will be helpful when drawing the toboggan up the hill for the next run.

From The Editor's Notebook—

WILL all readers please give their full name and address when writing to me—or to anyone else, for that matter? You see, I have quite a number of problems sent along where the reader wants a reply in these pages, and is then disappointed because he does not have them. Several reasons prevent me doing it. The query may not be of sufficient general interest to warrant inclusion; I have to plan and prepare these pages a long while before they actually appear. Room is very valuable and has to be filled with articles which will appeal to the greatest number. Apart from all this, readers may be sure of a reply by post, to almost any problem or letter. An answer is sent to them as soon as possible, and then the answer may appear in these pages for the benefit of others. In any case it is impossible to put an answer, as I am so frequently requested, into 'next week's issue'.

I SUPPOSE you have never thought of the time taken just to print this *Hobbies Weekly*—even apart from the time spent in its editorial preparation. Remember, for instance, that the paper for one issue alone would stretch over a hundred miles if the pages were laid end to end! And the fast machines used

in the printing take days to run off the complete issue. Then the issues have to be sent to a distributing centre, from which they are forwarded to all parts of the country to arrive in time for the anxious reader each Wednesday morning. If everyone lived in London this would reduce time considerably, but you must remember readers who live in the North of Scotland, Northern Ireland, etc.—who also expect their *Hobbies*. So you might remember these points, will you, next time you feel disposed to write and ask for something to be put into 'next week's issue'.

I HAVE mentioned before the quaint hobby some people have in making models of Churches and similar buildings from matchsticks. The record must, I think, be held by Mr. T. Willsdon, of 29 West Camp, Cheltenham Road East, near Gloucester, who recently completed his 193rd. Even though he has been doing it for 30 years, an average of nearly seven a year, is not bad going!

THERE certainly is more in bridge building than meets the eye—especially if you make a hobby of collecting details of them. This unusual job is one enjoyed by Mr. E. C. Oakes, the Water Engineer for Preston Corpo-

ration, and he now has a unique collection of pictures, plans, etc., of bridges all over the world. When you think of it, there is an amazing range of them—London's famous bridges, the great arch over Sydney Harbour, the timber lattice bridges of the Canadian Pacific Railway, the weird primitive efforts in Burma, etc. Another suggestion here for readers who like the unusual.

READERS will probably know that the last of London's trams are now on their way out, so gradually a well-known sight will be no more enjoyed—if 'enjoyed' is the right word! Trams will soon become a relic of the past and should, therefore, prove of historic value as a model. In consequence I am having prepared a design of a modern Tramcar which I hope to publish in these pages for readers to make. Be sure to get your copies regularly in order not to miss it!

HAVE you all got your copies of the *Hobbies 1951 Handbook*, because there has been a tremendous run on them. Although 175,000 were printed, I gather that this is not likely to meet the demand, and there is little hope of a reprint when this edition has been sold.

The Editor

You can entertain and mystify your friends with this XMAS PARTY MAGIC

A CONJURER should always be up-to-date and here is, literally, a Trick With A Date. Produce a calendar pad and ask someone to turn to any month and ring round a square block of four dates, as indicated in Fig. 1. Any four can be chosen and the performer does not, of course, know which have been chosen. Yet if the spectator gives him the total of the four numbers, the conjurer immediately tells him the dates selected.

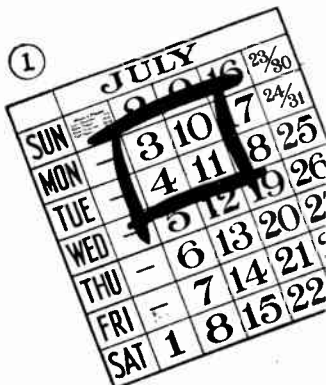

Fig. 1—Marking a block of dates

The secret lies in quite a simple calculation, though it is a wise policy in such cases to convey the impression that the result is arrived at by other means and one must certainly do the calculation mentally.

Of the total given to you (in the present example, it is 28), divide by four (7) and then subtract four (3). This gives the lowest of the dates. The next is obviously 3 plus 1=4. Those on the other side of the square block are seven more, i.e., 3 plus 7=10, and 4 plus 7=11 (or, in the latter case you can simply add 1 to the 10).

To vary the proceedings and divert any possible probing into the secret, ask for a three by three block of nine numbers to be ringed off, as in Fig. 2, to give one example. Tell your assistant that you do not want to give him a lot of adding up to do. He can simply add the lowest and the highest numbers in the block and give you the total.

When you have been told this, mentally divide by two, which gives you the centre number, of course (in the present case, 24—2—12). The numbers to the left and right of this will, respectively be 7 less and 7 more (i.e., 5 and 19), whilst the others will be one more and one less than 5 (4 and 6), and the same with 19. Try to visualise a blackboard with these figures being chalked up.

Study the theory of this and then you will see that the first number can also be obtained by dividing the total by 2 and

then subtracting 6. Having obtained this figure (4) add to it 7 and 14, getting 11 and 18. Thus your key figures are 4, 11, 18 and you can, almost in a flash, reel off 4 5 6, 11 12 13, 18 19 20.

Milko!

The magician puts a large tray on his table (in case of accidents) and on it stands a water-carafe. This he covers with a cardboard tube, shown empty. From a milk bottle he pours the contents into the now hidden carafe. On top of the cylinder he puts a plate, and on this (over the carafe) he stands another empty milk bottle.

	SEPTEMBER		
SUN	3	10	17
MON	4	11	18
TUE	5	12	19
WED	6	13	20
THU	7	14	21
FRI	1	8	15
SAT	2	9	16

Fig. 2—Another date trick

the conjurer proposes, magically, to put matters right.

After the usual hocus-pocus, the conjurer lifts off the silk and lifts the plate, raising the cardboard cover. Sure enough the liquids have changed round!

The trick is a chemical one, though there should be no suspicion of this. In the usual old 'wine and water' trick everyone knows that chemicals have been used, but not so in this.

The alleged 'milk' is made by combining a strong solution of calcium carbonate with one of sodium carbonate (washing soda). The carafe, apparently empty, actually contains a little hydrochloric acid ('spirits of salts'). The 'milk' immediately turns to 'water'. That is why the card tube is used.

The 'water' has some photographer's hypo added and in the second milk bottle is a little sulphuric acid. The action in this case is not instantaneous, so there is time to pour first and then cover.

The exact quantities of chemicals must be found by experiment and great care

should be taken that the solutions are safely disposed of and not left about for someone to mistake for genuine milk or water, nor use the bottles in their uncleaned condition. Before being challenged to 'drink it!', get on with another trick! Here is a good one.

The Fireproof Handkerchief

Display a lady's handkerchief or a very fine scarf. Show that it is whole and perfect. Take a lighted cigarette (your own, or, if not a smoker, one from a spectator). Blow on the end gently to get a bright glow and then boldly stab it on the soft and dainty material. Normally one would expect a very bad burn, since there is no deception (or hardly!). The burning tip of the cigarette actually does meet the material. But, unknown to the audience, the conjurer has brought up a penny and has draped the 'kerchief tightly over it, so that the hot end of the cigarette is stubbed against the metal which not only extinguishes the glow, but conducts off the heat.

Practice on an old scrap of expendible material first. The coin is easily concealed in the hand both before and after the trick.

And talking of coins, here is a useful Coin Vanish which can be done at any time, impromptu, with well turned-back cuffs.

Hold up a penny or a half-crown in the left hand so it is about 9ins. from the

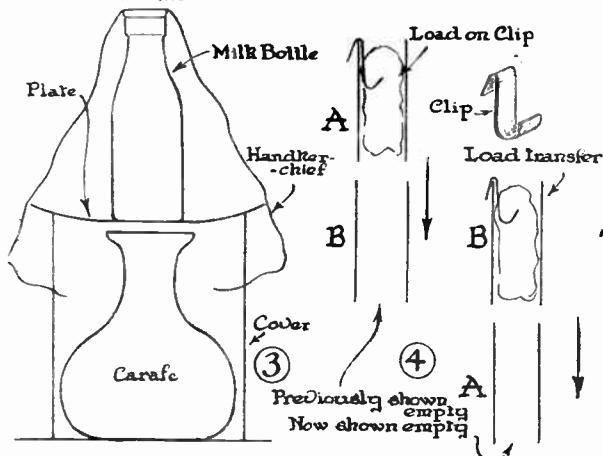

Fig. 3—Milk and carafe parts

Fig. 4 - The matchbox trick

outside breast pocket of the jacket. A clean handkerchief is taken by one corner between the first and second fingers of the right hand (Fig. 5). The handkerchief is draped over the coin and left hand, but during this action, the first finger and thumb of the right hand 'steal' the coin and, whilst still holding part of the handkerchief, drop it in the breast pocket (which should be clear of fountain pens, etc.). Possibly, at this

moment, the left hand should be raised a little (Fig. 6).

Continue with the draping and gradually move the covered hand away from the body. Do not do it suspiciously quickly nor be in too great a hurry to show that the copper has vanished.

Where Did It Come From?

Tricks with apparatus obviously made only for conjuring purposes are apt to be regarded with suspicion. In the trick to be described we use the most innocent and simplest of apparatus—just two matchbox covers chosen from various brands so one can pass over another. The larger (B, Fig. 4) is shown quite empty and to emphasise the fact, the other cover (A) is pushed through it downwards. This second cover is also shown quite empty. Yet when the appropriate magic words have been said, a large silk handkerchief is taken from the 'empty' covers.

The handkerchief you will probably have to buy from a conjuring depot as it needs, for proper effect, to be made of very fine silk. A surprisingly large handkerchief of this kind can be packed

into the small compass of the matchbox cover. Should the regular article prove too expensive, however, a smaller

the silk handkerchief packed round it. Experiment is needed to find out how best to do this, as it is important that the handkerchief does not slip from its moorings at the critical moment—now to be described.

The loaded box (A) is passed downwards through the other (B—previously shown empty). As it does so, the overhanging clip catches on the first box and the load is transferred to the 'empty' (?) box just shown. Opportunity should be taken to get the clip to the bottom (by turning the box) as, when finally showing the handkerchief, it will be easier to



Figs. 5 and 6—The two stages of the vanishing coin trick

handkerchief of more conventional material can be used.

The only other gadget you require is a simple strip of sheet metal (not too flimsy) bent up as shown. This is hooked over the end of the smaller matchbox and

conceal the clip.

Before actually revealing the handkerchief, the two boxes should be placed one over the other like an inverted T, letting the audience see through the lower empty box.

Notes on treatment of distempered ceilings for THE HOME DECORATOR

WHEN one is decorating a room, distempering the ceiling can be a most doubtful proposition. New ceilings are more or less easy, but when dealing with a ceiling which has had many coats of various concoctions, one wonders which is the best way to tackle the job. A good workman plans his job

of covering is going to be used. In the past it was usual to make up one's own mixture consisting of whiting, glue size and a dab of blue. This was superseded by manufactured distempers in the form of powders, followed by the more modern oil bound water paints.

These modern water paints, although slightly more expensive (approximate

water paint. It should never be applied to a ceiling which has been previously covered with an unbound distemper without first washing or scraping off all the unbound material. If the unbound distemper is left on it will brush up and mix with the water paint, giving a patchy and uneven surface, calling for a second coat with little better results.

If the nature of the existing covering is unknown, it can be tested by rubbing the surface firmly with the finger. Should there be any tendency for the material to rub off, then the ceiling should be washed or scraped. This may be the hard way, but it certainly pays dividends. The author has tried both ways and the following are the results.

Ceiling A—Lightly wiped over with damp cloth ... ½ hour
One coat of water paint ... 1 hour
Second coat of water paint ... 1 hour
Time 2½ hours, cost 8/-, result poor.

Ceiling B—All unbound material washed off with wet cloth ... 2 hours
One coat of water paint ... 1 hour
Time 3 hours, cost 4/-, result perfect.

From these conclusions we leave the reader to decide on his method of attack. Is he going to work hard and have a good job at less cost, or is he going to work almost as hard, with double the cost and a poor job? (305)

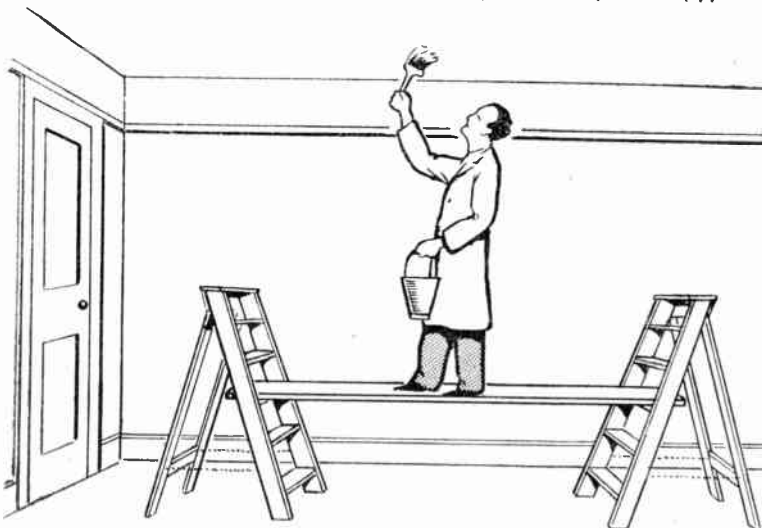

and works to a schedule. The handyman's schedule usually starts Friday evenings and any trouble with the ceiling will soon throw the plan out of gear.

First, it should be decided which type

cost per 10ft. by 12ft. ceiling, 5/- to 6/-, are by far the best in the long run, for when the time comes to renovate the ceiling, one coat of good water paint will give a first class job.

One thing is certain when using

Have enjoyment and save money with a HOME-MADE DART BOARD

No apology is needed for describing the making of a dart board, for darts is certainly one of the most popular of indoor pastimes. Unfortunately, a full-size board is not cheap to buy, but any handyman can make the one described below at very little cost.

The first essential is a circle of wood of 1½ ins. thickness. This is not cut from an ordinary plank, but through the thickness of the trunk, so the face and back of the board is made up of what would ordinarily be 'end-grain'. Most timber merchants will cut such a 'butt piece' if asked to do so, but wood at least 1ft. 4 ins. in diameter should be obtained.

Elm is Best

If possible, a piece of elm should be selected for the board, for this wood will hold darts firmly without splintering, and, if put in a tub of water at intervals, will swell just sufficiently to close the holes made by the darts.

Having obtained the wood, tap a fine nail into the centre of one face, and, with a pencil held in a looped string of 8 in. radius, draw a circle to mark the outside of the board (see Fig. 1). Then, with a mallet and chisel, work round the outside of the pencil line to reduce the wood to its proper circular shape, keeping the sides of the board perfectly upright.

The Circles

The next step is to mark out the scoring circles in pencil. The looped string and pencil is again used for this, and six circles are needed, these having a radius of 6 ins., 5½ ins., 3½ ins., 3¼ ins., ½ in. and ¼ in. (see Fig. 2). These pencil markings should be made fairly heavily, so they will be easy to follow when the wiring is being done.

The centre nail should then be withdrawn and the spokes that mark the different scoring beds are pencilled in. The easiest way of marking these is to set a pair of dividers to 1½ ins. and to 'step out' this distance round the outside circle. Draw lines from these points towards the centre point, but stop short at the ½ in. radius circle.

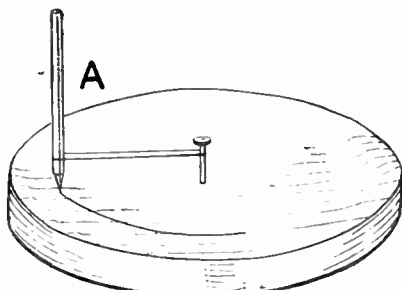

Fig. 1—Marking the circles

Alternatively, the lines can be marked out with a protractor, being drawn so an angle of 18 degrees is made between adjacent lines. Fig. 3 shows the board after all marking out is finished.

Wiring

The board is now almost ready for wiring, but before actually starting work on this, a few small nails should be tapped into the board at intervals around the various circles. These nails should be placed alternately just inside and outside the pencil lines, so they will hold the wire exactly on the marking.

To conform to the rules of the game, wire of No. 17 gauge must be used throughout for the wiring. Approximately 22ft. of this is needed in different lengths, but its cost is not great.

A length of the wire is taken, one end of it is filed to a sharp point, and it is then bent down at right-angles to make a prong ¼ in. in length. This prong is tapped into the wood and the wire carried right round the circle (passing between the guide nails as necessary) and back to its starting point. Here it is cut off to length, but again a ¼ in. long sharpened prong is made, so this end of the wire can also be tapped into the wood.

It is very necessary that the two ends of the wire should meet as closely as possible. If the worker is handy with a soldering iron, it is a sound idea to measure off the required length of wire, make the two prongs, solder them together and tap them into the wood simultaneously, relying on the guide nails to get the circle of wire into its proper position.

All circles must be wired in the same way, and then the spokes can be put in. These spokes are 6½ ins. long overall.

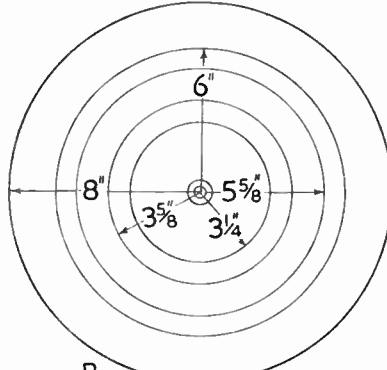
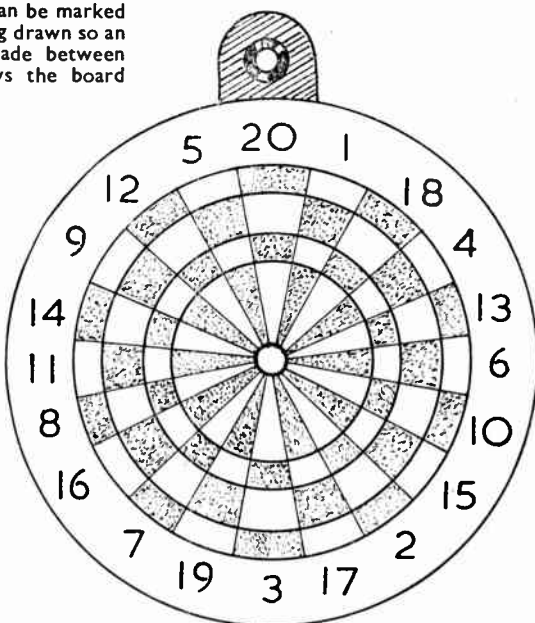

Fig. 2—Diameters of circles



with a ¼ in. long sharpened prong at each end, the prongs being bent over at right-angles with the pliers. They are simply tapped into place to cover their pencil markings, and again guide nails can be put in to help to get them in the right position.

Stapling

When all the wiring has been done, the guide nails can be pulled free. The whole of the wire is lightly hammered down so it is in close contact with the wood.

A supply of very small staples is then made up from odd scraps of wire, the ends of these staples being sharpened with a file. These staples are used to hold the spokes firmly in place, two staples being used to each spoke. One staple is put over each spoke just inside

(Continued foot of page 182)

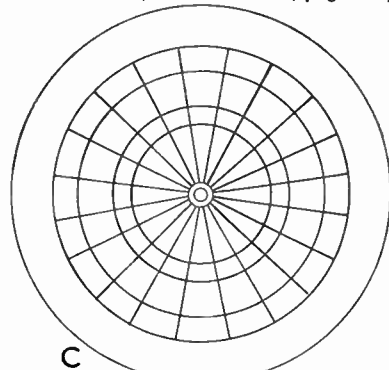

Fig. 3—The completed wiring

Simple apparatus to make when undertaking HOME CHEMISTRY

THIS new series on Chemistry by the amateur covers a number of simple 'tricks' which can well be introduced at any party. First of all, however, it is a question of apparatus. This need not be an expensive item, however, for as explained here and in our first article, much can be made at home from everyday odds and ends.

The cheapest condenser costs 4/6, yet with a straight adaptor (cost 9d. to 1/-), two corks, a length of glass tubing and a piece of wide metal pipe, one can be rigged up, as shown in Fig. 1.

The metal jacket (which may be of iron if aluminium, copper or brass is not available) should have an internal bore of 1½ ins. to 1¾ ins. Cut off a 2ft. length with a hacksaw. Select two sound corks to fit the ends and with the cork borers make two holes in each, one for the condensing tube, the other for the water supply tube.

Making a Condenser

Insert the adaptor in one cork and join it to the glass tubing with a piece of indiarubber tubing; press in the water outlet tube and slip the whole into the jacket, pressing the cork tight.

Into the other cork press the water inlet tube, slide the cork up the condenser tube and press tight. If the jacket is of iron, dismantle and dry it in the domestic oven after each use to minimise rusting.

A calcium chloride tube for drying gases is quickly made from a test tube

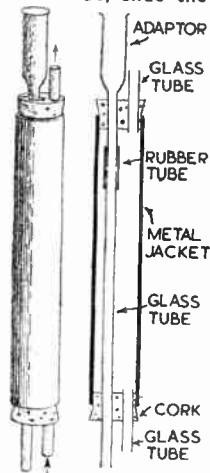

Fig. 1—A cheap condenser

or a length of wide glass tubing, as shown sectionally in Fig. 2. Select sound corks which fit the tube and before boring, squeeze well to soften them, as this will make them fit gas tight.

As shown by the arrows, the gas passes down the long glass tube to the bottom of the test tube and then is dried by passing over the calcium chloride to the short outlet tube. In the other the direction is one-way. The test tube type may also be used vertically with concentrated sulphuric acid, the gas in this case being dried by bubbling through the acid.

Beehive Shelf

For a beehive shelf take a tin 3½ ins. in diameter and scribe a line all round 2½ ins. from the bottom. Cut round this line. Next cut out an inverted U-shape to take the gas delivery tube, and then make a ½ in. hole in the centre of the base part of the tin, as shown in Fig. 4.

A pneumatic trough is another expensive item, but an enamel wash bowl is just as efficient. If you have no spare bowl, a half size biscuit tin will serve. Give it several coats of paint to waterproof it. Failing a biscuit tin, make a wooden box of similar dimensions, paying particular attention to the joins and then paint it well inside.

Gas Jars

Gas jars exist ready made in all homes—common jam jars. The 1lb. size is most useful. One or two should be kept in stock with ground edges for experiments where you need to keep the gases for a short time by closing them with a greased glass plate. To grind the edges flat, use first a paste of sand and water, rubbing with a circular motion on a stone flag, then coarse emery and

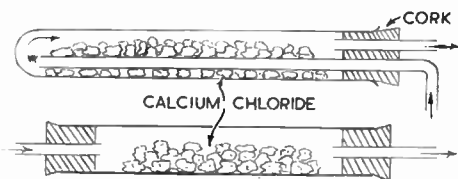

Fig. 2—Simple gas-drying tubes

water and finally fine emery and water.

If you have a 10ccs. or 25ccs. graduated pipette, you can with its aid, make useful measuring cylinders. A 100ccs. and a 250ccs. are the most used, so hunt out two tall cylindrical bottles which will hold a little more than these volumes. Start with the 250ccs. bottle, setting it on a level surface.

Marking Off

Stick on a narrow label vertically and drop in 10ccs. of water from your pipette. Carefully mark the level on the label by means of a horizontal line and also write on the number of ccs. Continue adding and marking 10ccs. at a time until you reach the 250ccs. mark. Varnish the label to waterproof it. The 100ccs. measure is made similarly, but graduated in units of 5ccs.

If you have access to a glazier's diamond you can scribe a scale direct on the glass, of course, and dispense with the label.

For a filter funnel stand a tall tin of the press-lid type can be adapted. Cut a hole in the lid to support the funnel. Then cut out a large section (almost half of the circumference) from the side to accommodate the receiving vessel, as shown in Fig. 4. Cut down to the bottom, but leave a ½ in. to 1 in. band at the top to give rigidity. If the receiving vessel is too low when filtering, raise it by slipping a small wood block under it

(283)

(To be Continued)

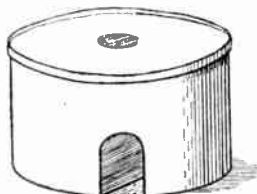

Fig. 3—Tin beehive shelves

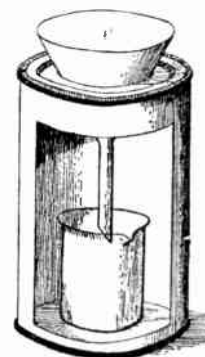

Fig. 4—A funnel stand

Dart Board—(Continued from page 181)

the 5½ in. and 3½ in. circles, and driven well down into the wood.

All scoring spaces must then be coloured, using two very distinct shades, such as red and blue. A good quality flat paint should be used, and the colours put on the scoring areas alternately in the manner shown on the picture of the finished board. The wood outside the outer scoring ring can be painted black or white as desired.

The scoring values of the different segments have then to be marked. These figures can be painted on, but it is customary to use numbers made from wire. They are easily twisted to shape with a small pair of pliers and stapled into position. The order in which the figures must be arranged is shown on the drawing.

The actual board is completed by screwing a hanger to the back, and only

a set of darts is needed before it can be taken into use.

Darts is very much a game of skill and the actual darts must be balanced to a nicety. For this reason home-made darts are rarely very successful, but having made his own board so cheaply, no player will grudge the half-a-crown or so that is necessary to buy a good set of well balanced brass darts.

(294)

For canteen, hostel, club or hotel this is a useful LETTER BOARD

WE have had requests from workers for a letter Board or Rack which would be suitable for a club in which they are interested. Now, such a board should be strongly made and nicely finished. Regarding size it is hardly possible to lay down any hard and fast rule, and most likely the board would be made to suit some particular wall space.

Useful Size

The board here described is of a very useful size, being 21ins. high and 15ins. wide. It is intended in the following notes to give four methods of framing and finishing the board. Plywood $\frac{1}{2}$ in. thick is suggested as being most suitable, but should this be unobtainable, then one of the many kinds of composition board will answer equally well.

The simplest way of finishing the board is merely to cover it with a piece

edges of the board, as shown at the top of diagram Fig. 1, and to the suggested pattern given in the picture of the finished board.

The second method of finishing the board is shown in Fig. 2. Here the baize is cut the same size as the board, and tacked closely along the upper edge of it. On top of the baize and on all four sides and flush with the edge of the board are fixed strips of wood about $\frac{1}{2}$ in. or $\frac{3}{8}$ in. wide by $\frac{1}{2}$ in. thick.

Small countersunk or round-head screws will do for fastening these strips, which should be neatly mitred at the corners. Around the outer edge of the board screw four edging fillets consisting of $\frac{3}{4}$ in. by $\frac{1}{2}$ in. strips, which have their top edges neatly rounded off and their ends mitred, as shown in the figure and the enlarged detail in Fig. 2.

This method makes a very strong and neat job, but it should be mentioned that if cross tapes are required, then these should be put on before the narrow $\frac{1}{2}$ in. or $\frac{3}{8}$ in. fillets are secured.

Frame Effect

More of a picture-frame effect is obtained by the third method, Fig. 1 (D). The board is covered with the baize, and a solid rebated moulding is used, and is fixed by running screws obliquely through the moulding into the backing board. The moulding suggested is an ordinary deep tray moulding obtainable at almost any good woodworking supplies shop.

Careful measurement will need to be taken, however, in preparing the mitres on the ends of each length of moulding. The inside measurement of the moulding, that is, the rounded edge which fits down upon the baize, should measure $\frac{1}{2}$ in. less in length in every case than the edge for which it is intended.

In the fourth method the moulding is solid and not worked with a rebate. The board is covered with the baize, the edges being also covered with the baize and brought underneath the board and tacked from the back, see Fig. 1 (C). This gives a very simple and strong board, but as the moulding is a little deep, it may not be suitable for all cases. It certainly stiffens the main backing board, which, if of rather large measurements, is of a de-

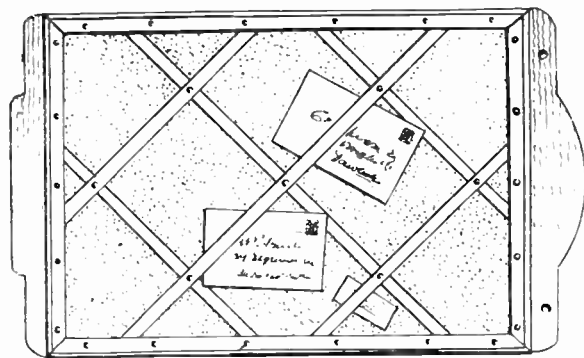

vised advantage. Always remember to make holes with a suitable awl before inserting the screws. This will prevent the wood from splitting.

Tape Fixing

A suggestion may be carried out when securing the tapes on the face of the board. A number of celluloid discs, the number required in the case under review being seven, should be cut about $\frac{3}{8}$ in. in diameter and a hole made in the centre through which will pass the round-head screws.

The woodwork should be lightly glass-papered and given a coating of clear varnish. Ordinary oil paint would, of course, make a good and suitable finish.

It will be noticed in our illustration of the finished article that we have included shaped rails to the top and bottom of the board. This is, perhaps, a purely decorative addition, but it does, at the same time, help to stiffen the board for hanging.

Each rail should lap down on the board a distance of from 1in. to 1 $\frac{1}{2}$ ins. and be screwed securely with countersunk screws. If the rails lap as suggested 1 $\frac{1}{2}$ ins. down on the board, then the upper rail

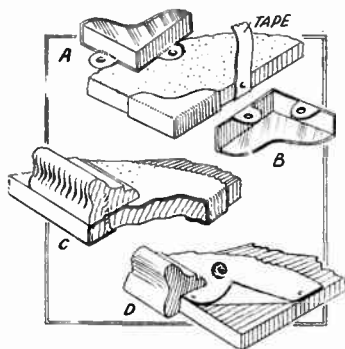

Fig. 1—Details of corners and types of edging

of green baize, cut 1in. larger all round than the board itself and nailed at the back with small tacks. The corners of the baize should be cut across, lapped and nailed and four nickel-plated mirror clips screwed to the back, as Fig. 1.

The clips, as purchased, have their lugs or screwing eyes turned outwards as (A) in this diagram, and to make them fit the corners, these lugs will require to be bent inwards as (B)—a little job that can very easily be done with a pair of pliers. The diagram (B) shows the clip inverted, the better to illustrate how the lugs appear when bent ready for fixing.

Fitting the Baize

In tacking down the baize, lay this upon the bench or table with the board placed centrally upon it, meaning there must be an equal margin of baize all round. Draw one edge over and tack it securely, the tacks being not more than about 1 $\frac{1}{2}$ ins. apart. Now draw over the opposite side margin of baize, and tack this down. Finally draw over the two remaining edges and make it all secure.

The letter tapes are nailed to the

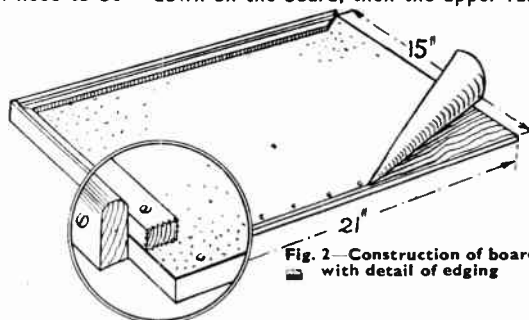
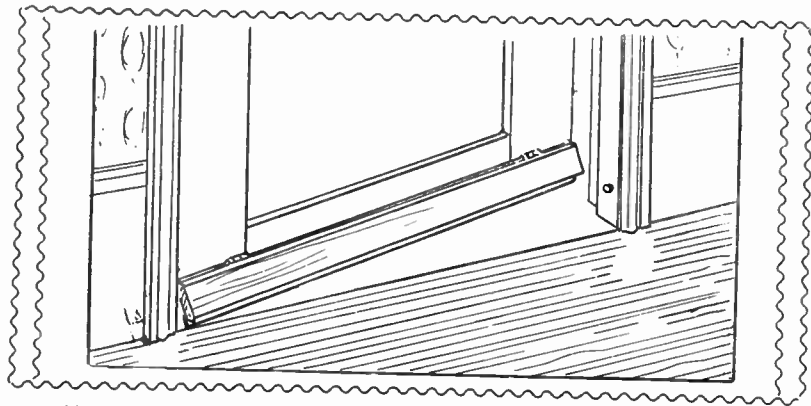

Fig. 2—Construction of board with detail of edging

would measure 4ins. in width, and the lower one 3ins.

Remember, by the way, that all the woodwork must be glasspapered clean and given whatever finish you desire. Before the cloth backing and tapes are added. You can stain and polish in the usual way or give a coat of clear varnish to the wood, or even paint.

Any door can be fitted with this automatic DRAUGHT EXCLUDER



A VERY handy affair this, putting an effective stop to those annoying draughts which find their way through the space between the bottom of the door, and the floor. It is quite a simple gadget, and can be made with strips of wood, and a little patience. It is so constructed that, when the door is opened, it rises and does not catch against carpet or other floor covering, dropping again to exclude the draught directly the door is shut.

Simple Mechanism

The mechanism is very simple, with nothing to go wrong, unless the spring breaks, and then it is no trouble to fit a fresh one whatever. It should be fitted to the outside of the door. Two strips of wood are required for the fitment, as are detailed in Fig. 1.

Cut from $\frac{1}{2}$ in. thick wood, any kind available, though a hardwood, like oak or beech, would be better than deal for wear. Cut the strips $\frac{3}{4}$ in. less in length than the width of the door, measuring the latter on the outside when closed, as the distance wanted is that between the jambs.

The outer of the two strips has a small bevel worked along the top and bottom outside edges. It is then hinged to the other strip, the narrower one, with $\frac{1}{2}$ in. iron backflap hinges. Choose hinges which work rather freely, stiff ones might put too much strain on the spring which raises the outer one clear of the floor. Cut recesses

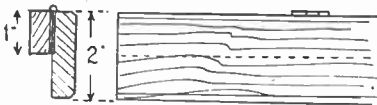

Fig. 1—End view of wood

hole in the draught excluding part of the gadget into which the opposite bent end

of the spring can be inserted. Make sure the spring is strong enough to force the part up promptly, when released from the retaining catch by the door being opened.

To the rising piece, at the bottom, a strip of felt or rubber should be nailed, where shown at (D) to press upon the floor. A length of an old cycle or motor car inner tube, would be excellent for this part. It should, if thin quality, be bent double and nailed along to extend $\frac{1}{2}$ in. below the wood.

Now raise the front part, and in the narrower back strip, bore screw holes for fixing to the door. Well countersink these screw holes for the screw heads to lie slightly below the surface and form no obstruction to the rising part closing properly down. Finish the work either with a coat of varnish or paint, to match the door, as preferred.

Making the Spring

The spring (C) can be made from a 2 in. length of steel springy wire. Bend $\frac{1}{4}$ in. of the ends of this at opposite right angles, as seen in the drawing. Insert the bent top end in its hole, and make a second

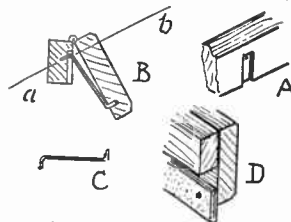

Fig. 2—Details of fittings

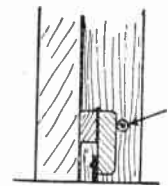

Fig. 3—The catch

part to the door, touching the pencil line.

See the end of it just touches the jamb on the hinged side of the door, the other end will then be $\frac{1}{4}$ in. short of the opposite jamb and so should not rasp against it as the door is opened. See this part is A1, and if any rasping does take place, file the edges of the wood until it passes the jamb freely.

Now fix the catch in the position shown and try the action. All being well, as the door closes the catch will force the draught excluder down to the floor and effectually stop any wind from entering the room.

The Editor and Staff of 'Hobbies Weekly'

send Hearty Christmas Greetings

to all Readers

Novelty Toothbrush Holder

THE extreme importance of teaching children to look after their teeth is realised by all parents. The proper use of a tooth brush cannot be learnt too early, and anything that attracts the child's attention to this article is to be commended.

This teddy bear tooth brush holder shown, finished in bright colours, cannot fail to do this, and will make an attractive present for any child. It is quite simple to make from a few pieces of wood, and a full size pattern is shown.

It is possible to construct the holder practically from odds and ends left over from other jobs, since none of the dimensions is critical. Moreover, only three pieces of wood are required. You need a piece of ply roughly $5\frac{1}{2}$ ins. square for the figure. A base piece is wanted $5\frac{1}{2}$ ins. long and 2 ins. to $2\frac{1}{2}$ ins. wide, and should be about $\frac{1}{2}$ in. thick to give weight, so the holder stands securely. A small block of wood is also required about $\frac{1}{2}$ in. thick, to form the brush holder.

The idea is to arrange the brush so it appears to be held by the teddy. This is accomplished by supporting it in a slot cut in the base, and also with a block glued over this slot.

First, it is necessary to cut out the teddy bear figure, using the full size pattern.

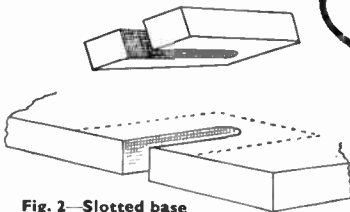

Fig. 2—Slotted base and block

Next, a rectangular piece of wood is cut for the base, the exact length of the base of the figure and 2 ins. to $2\frac{1}{2}$ ins. wide. A slot to support the brush is then cut in the front of this base piece, so that the brush is at right angles to the figure which appears to hold it in its hand.

The best position (see Fig. 1) is found by trial, since the handles of various makes of brush differ in size. It will, therefore, be necessary to obtain the brush before cutting is begun.

The hole may be cut by means of a fretsaw and finished off to shape with a small file. It should be of such a size that the handle of the brush slips in easily, but without wobbling about.

To give the brush additional support, a similar slot is cut in a small block of wood. This block should be about $\frac{1}{2}$ in. thick, its width and length being governed by the slot that has to be cut in it. This is then glued to the back of the figure and also to the base piece, so that it covers the previous slot exactly (see Figs. 2 and 3).

After glasspapering the finished holder, it should be painted in gay colours. The small pots of enamel obtainable are ideal for this purpose. A suggested colour

scheme is to have the teddy bear yellow, the trousers red and the ground green.

Lines between the colours and the features should be put in afterwards in black with a fine brush. A touch of white in the eyes on the nose, and a little red on the tongue, will complete the front.

While painting, do not forget the edges of the figure, which should be

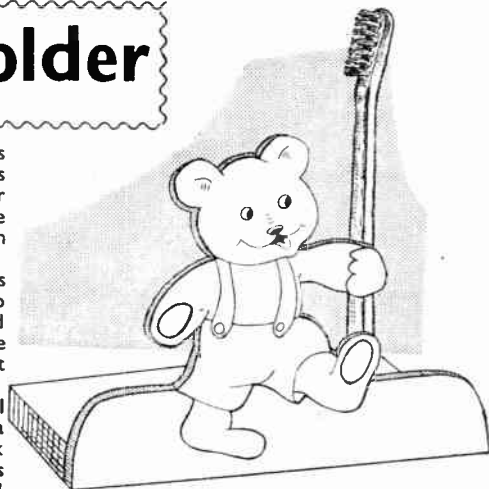

Fig. 1—A rear view

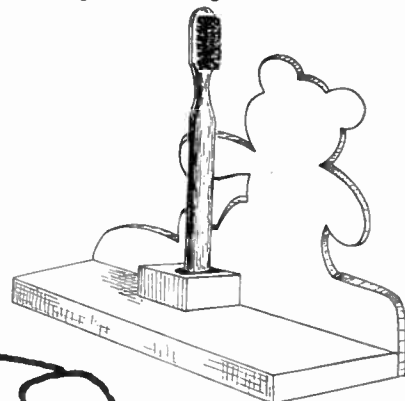
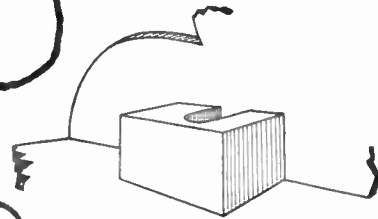
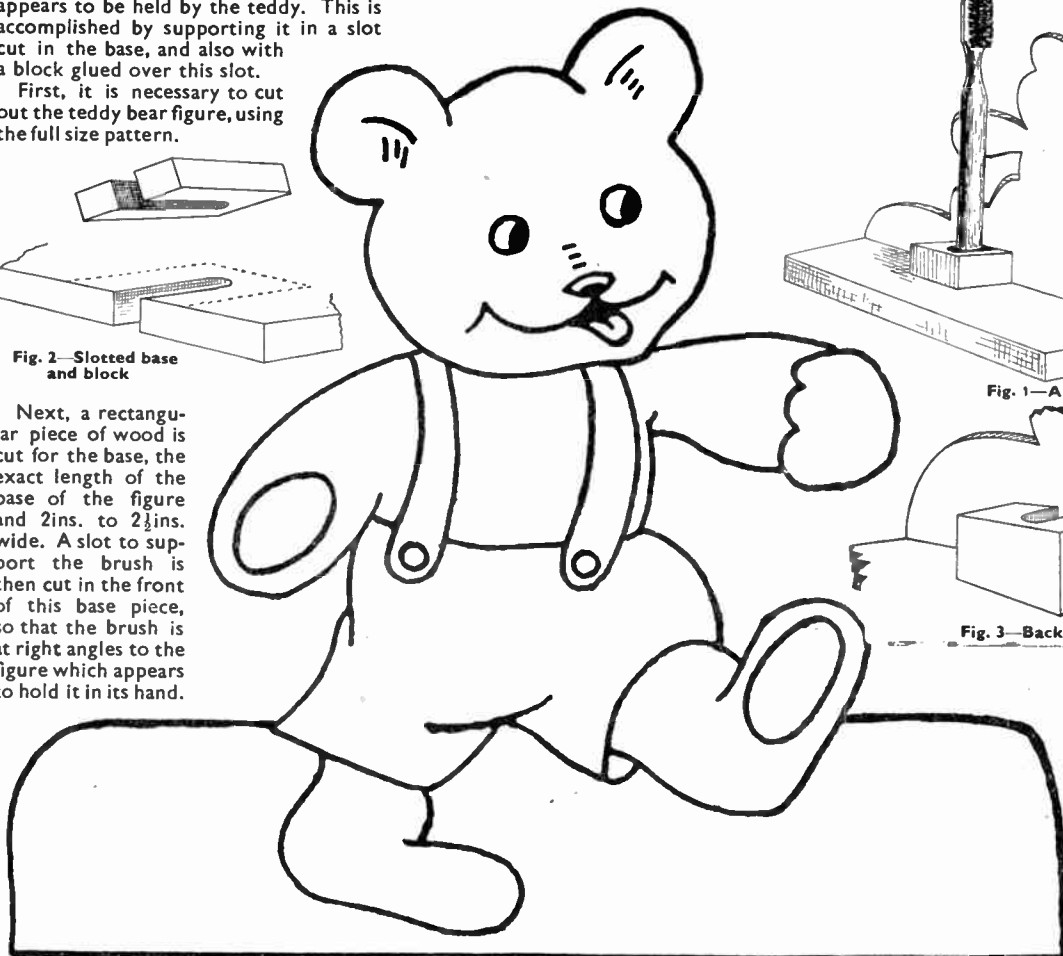

Fig. 3—Back guide block



done at the same time in corresponding colours. All that now remains is to give the back and base, not forgetting underneath, a coat of some suitable colour, and the job is complete. (321)





The SHIPMODELLER'S Corner



RECENTLY a large National newspaper ran a series of articles entitled 'It's fun finding out'. Of all hobbies, this is most true of ship modelling. The research or 'finding out' is, indeed, one of the most interesting and fascinating facts of our hobby, as I hope to prove in this series.

My choice of the 'Royal Sovereign' as the first of Hobbies kits to be dealt with individually in this section of our favourite weekly, was guided by the fact that first, it is out of the usual run of ship kits; secondly, it is an ideal choice for illustrating the steps that result in the model that presents a real picture of the original ship that inspired our kit and design, especially for the beginner. Later articles will also be included for the advanced modeller and also the modeller of more modern types.

Having purchased our kit, let us consider our design in relation to the facts and information we can unearth about the original vessel. Do not forget that research is going on all the time. The history of Naval Architecture is a vast subject and new facts are always coming to light after designs and kits have been prepared.

We know that the name 'Royal Sovereign' was bestowed on the famous Sovereign of the Seas after she was completely rebuilt in 1659-1660. In 1651 her upper works had been cut down to reduce her height and raise the lower gunports some 12ins. higher above the water; she also lost the spar deck in the waist, this being removed when her upper works were cut down.

After her complete rebuild in 1659-1660 she had lost the old-fashioned extensions to her after galleries. Apart from these alterations she had been changed little in outward appearance.

In order to help us in building an accurate model, that is as accurate as our scale allows, let us study the available sources of information.

She was designed by Phineas Pett; laid down at Woolwich in 1636; the building of the ship being supervised by Peter Pett, son of Phineas Pett; finally being completed and launched on October 13, 1637.

She was so expensive to build that the 'Ship Money Taxes' imposed to build her and other ships, laid the foundation of Charles I overthrow and death.

One source of valuable information and detail is John Payne's engraving of this vessel. It was for a considerable time doubted if this engraving actually depicted the Sovereign, but the discovery of a Naval Manuscript giving details of 'Royals' fore-mast and main-mast and topgallant sail on mizzen,

makes it reasonable to accept Payne's portrait of her as fairly accurate.

It was the provision of these sails in his drawing that caused it to be in doubt; these particular sails not coming into general use until nearly 150 years

Building the Galleon 'Royal Sovereign'

by 'Whipstaff'

later. The discovery of the above document proved that the Sovereign in sail plan was over a century in advance of her time.

A second source of information is the famous document describing the vessel in detail and published by Thomas Heywood in 1637, the year of her launch. A copy of this document is before me as I write.

He goes into great detail in describing her elaborate carvings; gives details of size. Length by keel 128ft.; extreme length from fore-end of beak-head to after-end of stern approximately 232ft. Main breadth was 48ft.; tumble home extreme; height from keel to the top of lanthorn 76ft.

She had five lanthorns and the largest would hold ten people standing upright without being actually crowded one against the other.

Her decks consisted of three flush decks, fore-castle, half-deck, quarter-deck, and she had a round house.

Portholes were pierced as follows: 30 in lower tier, 30 in middle tier, and 26 in the upper tier. This, of course, means half that number on each side of the hull.

Tons and tonnage were 1,522 tons, burden 1,141 tons, depth in hold 19.3ft. and actual draught 22.2ft.

Heywood stresses the fact that there was no colour about her except black and gold.

Let us now assemble our facts:

- I. She was elaborately carved. Now we cannot copy these carvings in detail at the scale of our present model, but we can achieve the effect of this magnificent scheme of decoration.
- II. We know we can use our Hobbies

design of fore-castle and three decks, because we know that at the time that our design represents her, she had been cut down in her number of decks.

- III. It is now reasonable to accept Payne's portrait of her to be fairly accurate and can proceed to rig her as was the custom in the days of the spritsail-topmast.

The 'Royals' can be added or not according to personal taste. The spars for these sails are included in Hobbies design.

Our rigging, of course, will be simplified. To try and depict the full involved rigging of this period on a model to this scale is not necessary, nor is it desirable.

One of the greatest gifts the ship modeller can cultivate is the gift of knowing what detail to include and what to leave out in the particular scale to which he is working.

We will choose sufficient rigging to give an authentic picture of the rigging of the period, and to achieve a model, that in its rigging, will look right.

Now proceed to cut out your parts for the hull and assemble and carve it as usual.

Your fore-castle, half-deck and

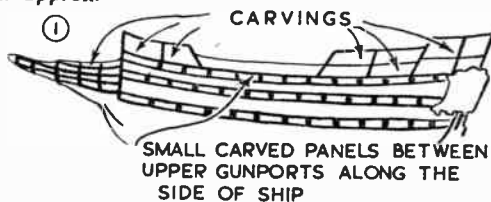

SMALL CARVED PANELS BETWEEN UPPER GUNPORTS ALONG THE SIDE OF SHIP



2. WALES
GUNPORT BRACKETS

3. PREPARED STRIP

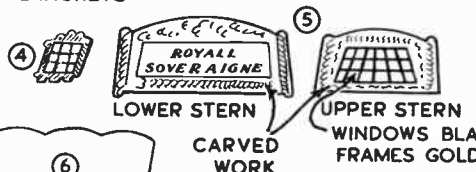

4. LOWER STERN

5. UPPER STERN
WINDOWS STERN
FRAMES GOLD
CARVED WORK

quarter-deck, before being glued in position, will be much improved if cut, the aft end of the fore-castle and forward ends of the other two decks, into three gentle curves, as in Fig. 6. These bulkheads were in this shape on the Sovereign and many other ships.

On the Sovereign they were elaborately carved and gilded, but on this small scale it will be sufficient to paint them in tiny patterns of black and gold.

Having assembled your hull, make two temporary gunwale pieces of card and pin in position. Having done so, use dividers to mark off the centre of every gunport; the gunports cut in your temporary bulwarks or gunwales will act as guides for positioning.

This done, make a template of stiff card to the size of your gunports on your Hobbies painting plan. In the exact centre pierce it with a fret-pin. By placing the point of this pin in centres you have marked with your dividers, you can draw around the template with a sharply pointed pencil, thus assuring each porthole is correctly placed and all of the same size.

Do not be content with painting your port-holes on the hull, sink them in about $\frac{1}{16}$ in. to $\frac{1}{8}$ in. in depth; this is quite easy if you use a chisel $\frac{1}{16}$ in. less in size than the square of your finished port. This is a great improvement and gives the real effect of the hollow hull.

On consulting our engraving we find that the Sovereign had six wales per side, the lower actually ran through the centre of the lower row of ports and had to be cut through for each port, but for our small model we will run it along the lower edge of the ports.

Use Bristol board, veneer or $\frac{1}{2}$ in. ply and cut several strips $\frac{3}{16}$ in. wide. Glue and pin these in position to represent the wales, placing them to run along the upper and lower edges of the ports, as in sketch (1); the heavy lines are the wales.

Glue and pin wales to the beakhead, as shown in the sketch also. Now, using similar strips, panel out your bulwarks, following the heavy lines in sketch (1), thus dividing the upper works into sunken panels, later to be filled with our imitation carvings.

Our next operation will be to affix the gun-port brackets. On the actual ship they were carved shapes, but for our little ship we will be content to insert straight strips $\frac{1}{16}$ in. wide on each side of each port between the wales, see sketch 2.

Small squares of thin $\frac{1}{2}$ in. ply are cut to the size of the gunports to make our port lids; these can be glued in open position above the portholes.

In packing kits, as in every other activity of life, mistakes can sometimes occur. On one occasion I found the large guns supplied to be actually of larger size than the gunports through which they were supposed to operate. If this occurs with any model, do not enlarge the gunports. Overscale gunports spoil the effect of any model.

Instead, either turn your guns down to correct size or make a fresh set from dowel rod. In our present model our gunports are barely $\frac{1}{4}$ in. square, so have your guns $\frac{1}{8}$ in. in the widest diameter, so that when pinned and glued in your hollowed-out ports, there is a slight clearance all around; it is these small details, simple though they are, that help to produce that authentic appearance.

Along the upper sides between the ports of the top tier were oblong

panels containing carvings; sketch 3 shows three of the designs on the panels of the original vessel. Spaces between beakhead wales were also carved.

Having completed our hull, let us proceed to capture that effect of beautiful carvings on the upper works.

Take one panel at a time, smear over it a little liquid glue, place on it a small portion of plastic wood and work it into a design or merely rough it up, using a gramophone needle mounted in a handle made from dowel rod.

A thin coat of plastic wood (about $\frac{1}{32}$ in. or it will be overscale), and do not fill each panel completely. To avoid monotony and more faithfully depict the actual carved work, leave small irregular portions of the panel in the corners and at the edges, varying each panel. The portions left bare, though tiny, are to be painted afterwards antique brown with a small pointed brush.

Your tiny panels for in between the upper ports are better prepared on a strip of cartridge paper and afterwards cut to size with a razor blade; see sketch 3.

Now proceed with the stern work. The upper stern should be patterned in the centre with very narrow strips of card in window effect, or you can cut tiny windows out of a piece of Bristol board and glue on. Around this decorate with plastic wood as for your panels; see sketch 5.

The lower stern we decorate with plastic wood around the edges, leaving a centre panel for our name plate.

The side overlays are decorated in the same manner to form windows, as in sketch 4. All window spaces to be

painted black; all imitation carvings, gold.

Below the waterline paint the body of the hull white; above the waterline all the hull except the carved work is black, a matt black for preference.

For our name plate take a piece of Bristol board to the size of our panel, and with a fine brush, paint the name Royal Sovereign, afterwards going round the edges with a mapping pen and Indian ink.

You will find this method produces a good name plate. It is the simplest way to produce good lettering, as most types of gold paint run slightly and it is difficult to get clean cut letters. It only remains to fill in the background to your letters in black with either pen or brush and glue your name plate in position.

I have found 'Ardenbrite' metallic gold paint is most effective for ship models.

The beakhead bulkhead we find from Heywood was decorated by six carved figures, three on either side of the centre doorway to which a short set of steps led.

These figures can be copied by four strips of plastic wood, worked up as for your panels.

For those who want a simple method of imitating carved work here is a tip from a modeller abroad.

Purchase a packet of embossed paper d'oylies and cut out portions of small designs. When glued in position and gilded, the result is very effective for small models.

In our next and last part of this article I will deal with the affective rigging of our model.

A Model Tram Builder



(Photo by Courtesy of the Kentish Times)

HERE is another type of model which its builder finds fascinating and popular. Mr. R. Elliott of 51 Glenuew, Abbey Wood, is an expert at making model trams, and is now at work designing and making one for the Festival of Britain. These trams are now fast disappearing off the roads and we are preparing a design for publication later, so readers may have a reminder of them.

How art, industry, commerce and warfare are assisted by INQUISITIVE CAMERAS

If you were to put the following question to the next 20 persons you meet and, out of sheer curiosity, recorded their answers you would possibly be surprised to find how very few people really realise the important part photography is taking in our everyday life. Put the question to yourself and before reading this article, give your own reply and then see whether your own knowledge and observations render an adequate appreciation of the wonderful and valuable achievements of the camera and its many and varied applications.

A Little-known Subject

What is the work of a camera? That is the question in its simplest form and many of your 20 friends will immediately think of it as the apparatus used by a professional photographer in his studio. Others will say they use it on their holidays for taking snapshots. One or two might suggest that it is used by pressmen for getting records of current events. You might also receive a reply to the effect that it is used for shooting cinema films.

Those are the sort of answers you will be given by the great majority. If there is a very keen and enthusiastic amateur amongst your score of friends, he or she might go much farther and, perhaps, give a very interesting response. Generally speaking, however, the man in the street has never allowed his imagination to wander into the almost illimitable areas in which the camera is doing important work.

Air War Work

We know of the extraordinary reconnaissance work of the Air Force during the last war. How, by means of their cameras, the results of their efforts could be checked. That very practical help of the movements of the enemy could be passed on to the army or navy. That they could penetrate all the dodges of camouflage, detect the presence of submarines and many other items of immense value in the conduct of the war.

One firm of film manufacturers claimed to have supplied so much film for war services, that if it was joined up, there would be sufficient to encircle the world about three times!

Over Distances

Do you know that the cameras which our men carried on the planes were so supremely good that it was possible to make an exposure from three miles up over a district and the enlargement made from the negative would be so sharp and clear in its definition that one could almost look down the factory chimneys? Distance is no bar to the inquisitive lens.

A few years ago it was considered unique to display a photograph taken from the air of a factory or works. But this was eclipsed when whole suburbs or districts were so treated and, because these proved so accurate, whole countries have now been surveyed in this way. In the course of this work agriculture has received considerable help as to the suitability of certain districts for the growing of crops, etc. Also archaeological research has benefited for the remains of ancient towns and sites have been located, long since hidden from the human eye by the dust of ages but not so from the inquisitive eye of the camera.

Writing of long distances reminds us that photography has revealed much to the astronomer. It has been said that the human eye can only see about 10,000 stars, but the camera has managed to find something like a hundred thousand million. It has traced planets and comets in their courses; the mountains of the moon and the corona of the sun have been recorded on photographic plates for the use not only of the present day astronomers in their work, but for those who follow them in future generations.

Stars close to the sun and quite invisible to the eye of man have been nosed out and their record is now placed with many millions of other record plates held in the libraries of the observatories and universities throughout the world.

Telephotography

Telephotography for the taking of distant and inaccessible objects has long been of service to geographers, topographers, explorers and others interested in procuring permanent records of contours, mountains, geological deposits and even the crater interiors of volcanoes.

Naturalists have gained much knowledge of the habits of birds and animals in their native haunts and have given the world some wonderful and instructive photographs resulting from their exposures.

Let us now turn our attention to the

small things which are to be found under our very noses yet are invisible, or almost so, to the naked eye. Photo-micrography is the medium by which biologists, medical students and other interested persons have learned and are learning much for the benefit of mankind generally.

Microscopic

When the microscope is used in conjunction with the camera there seems



Industrial X Ray chest examination undertaken in mass miniature radiography
Photograph by Ilford Ltd.

to be no limit to the information which it will reveal. Disease in plant and animal life can be traced and prevented. Medical men can follow the development of bacteria from its inception to maturity, watching and recording all its activities during every movement and stage in its existence, be that short or long. At the same time they obtain results that are of infinite value in the laboratory research work, for they can be used to prove the efficacy or otherwise of the many tests and experiments that are made for destroying the germs or preventing their propagation and possibly their complete extermination.

In Minerals

Who can estimate the value of such work? We might take this a step further and recall that photo-micrography is a very useful help to the metallurgist in his examination of ores and native metals for discovering percentages of other and inferior metals or foreign bodies. This is very necessary work where a high quality of pure metal is required in the finished product. These are just one or two examples of where the inquisitive eye of the camera can see what the human eye cannot.

Inquisitive? Yes very. Why, it will even pry into your own body and reveal to a surgeon exactly where and what your trouble is, so he can make quite a

small incision, instead of one of several inches as in the days before radiology. Thus he can get straight down to it and make such a highly successful job, that before you know where you are, you are out of the hospital and on the road to recovery.

Radiography

Radiography is akin to photography and resembles it in many respects. It is impossible to say how many lives have been saved through the instrumentality of X-Rays, but we do know that if it had been in use during the South African war, in the same efficient manner as it was during the 1914/18 war, we should have been able to prevent at least 60 per cent of the deaths through wounds. Today it is possible to insert to the stomach a special camera so that exposures can be made of the affected parts. One might call it nosing into the innermost parts.

Radiology is also prominent in other directions. It will locate a flaw in a piece of steel, reveal foreign bodies in food-stuffs, make an accurate recording of the composition of a lump of coal or other mineral and prove the genuineness or otherwise of your jewellery.

Industrial Plans

During the last few years the camera has butted into many other spheres of life particularly in industry. The following two examples will serve to prove its worth. In an aeroplane there are about 6,000 parts made of aluminium alloy and cut from templates.

Normally such templates are laid out manually from blue-prints. Messrs. Kodak devised a photographic means of producing these direct on the metal from which the part is to be made, and it is estimated that this saved approximately £5,000 per model and shortened the time between designing and the test flight by from two to four months.

On Productivity

Some few years ago in a large factory where a number of girls were employed on hand work it was noted that the output per girl varied considerably and that some always produced more than others. To reach a solution of this variation a cine operator was engaged and the girl whose output was most consistent, and who always seemed less fatigued was supplied with two small electric lamps one on each wrist.

A length of film was then exposed on her hands while she was doing her work. The lights were then transferred to others who were not quite so good and several film strips exposed. When these were developed they showed that the best girl made far less movements with her hands than the others and that the movements were more methodical. Her film was used eventually for demonstrating to the other workers what movements to avoid and the ultimate result was a very large increase in the daily output.

Photography can be useful also as a sales agent. A firm of engineers specialising in transporter machinery have, in

the course of many years had to produce many types of machines and of various patterns and have found the camera most useful for making records of each piece of plant. Prints are made and numbered, filed and indexed. When a piece of a machine is required, the print of a piece showing similar requirements is sent to the interested party and usually results in an order being received. The specification bearing this indexed number is then turned out and work proceeds without making new designs and plans.

For Engineering Work

Engineering, however, is not the only industry inquisitively attacked by the camera. It is in evidence in shipbuilding, locomotive assembling works and those where automobiles are massed produced. Wherever constructional or planning is a daily occupation there is usually a darkroom for the photographer. Architects and many other professional men constantly have recourse to the cameraman and it is well

known that advertising agencies recognise its immense value and importance as do also those responsible for new fashions in clothes and decorations.

Press Pictures

When you open your newspaper in the morning the first thing you note is that the camera has been nosing around again. What a marvellous change has developed in press illustrations. To realise this one should take a look at some of the illustrated papers of the last century. For example one showing the finish of the Derby with three or four of the horses passing the winning post, each with its four legs outstretched to their full extent. Very different and far less truthful than the actual photographic reproductions with which we are now so familiar. In these days, too, the camera is sometimes called upon to corroborate the judges decision—a case of eye versus lens.

(To be Continued)

The final letters of our series— Photographic Alphabet

X-Ray Photography

THIS is a very interesting and useful branch of camera craft. X-rays or Röntgen rays were discovered by Professor Konrad Wilhelm Röntgen in the year 1895, and they have the property of passing through an apparently opaque substance and affecting a photographic plate on the other side.

They are largely used in medical work, as while they make skin transparent, they show up as dark lines the bone structure and as dark areas, growths and such like. Thus the nature of a fracture can be studied or the exact position of a growth placed.

X-raying has now become a very precise science and there are many good openings for trained radiologists in our hospitals. The rays are also being used increasingly in the commercial world for testing materials.

Yellow Safe-light

A 'SAFE-LIGHT' is an illuminant in which a photographic material can be handled without becoming 'fogged'. In other words a light which has no effect upon it at all. With different emulsions (the sensitive layer on film and papers) different coloured lights have to be used as they are not all insensitive to the same part of the spectrum. Thus 'ordinary' film and plates are not sensitive to red, so they can safely be developed by the light of a ruby lamp and this is the colour we usually associate with dark-room work.

Panchromatic film and plates are sensitive to red, and a dull green is the

only light in which they can be handled without danger of fog. So the panchromatic 'safelight' is of this colour.

Bromide paper, however, while being quite sensitive, is not so receptive as plates and this can be safely worked in a yellow light. White light would cause a greying in and red is deeper than is required, but yellow has been proved just right.

Yellow is a very comfortable light to work in as one can see everything about the room quite comfortably—which is certainly not the case with red or green safe lights. Most dark-room lamps have yellow and red glass panels in front, the red one being removed when working with bromide paper.

With regard to 'safe-lights' in general. Photographic materials of every kind are really to some degree sensitive to all lights, so even when using a safe-light, do not have it too bright or too near the material and let inspections near the lamp be as brief as possible.

Zeit

THIS is a camera marking sometimes shown as 'Z', which you may come across if you happen to get hold of a German-made camera with German inscriptions. Zeit means 'time' and the 'Z' marking is equivalent to our 'T'.

That is, if you place the pointer on the front of the camera to 'Z' and press the trigger the shutter opens and remains open till you press again. Thus the 'Z' marking is for giving time exposures, with the camera on a tripod or some other rigid support.

MISCELLANEOUS ADVERTISEMENTS

HOME Woodwork; 50 useful things to make. A practical handbook with 188 illustrations, 2/6 posted. Modern Wood Toy maker; a new handbook with 192 effective designs and illustrations, 2/6 posted.—G. F. Rhead, 2 Waldegrave Park, Twickenham.

INTRODUCTIONS. Pen friends, companionship or marriage.—V.C.C., 34 Honeywell Road, London, S.W.11.

35 mm. CINEMATOGRAPH films. 35 Cowboy, comedies, drama, etc. 50ft., 2/6; 100ft., 3/6; 250ft., 7/6. Sample set, film strips of above subjects, 1/3.—Jones, 51 Cranford Drive, Hayes, Middx.

MAKE 5/- an hour, genuine home employment. Full instructions, 3/.—R. Lowes, Simonburn, Northumberland.

START making money at home, whole or spare time, making fancy leather and felt goods. Material provided. Write for rates of pay, etc.—Grange Co., 2 Curzon Street, Leicester.

MODEL makers' spares, including tools and 103 new Bassett Lowke yard rails, £2/10/-. S.A.E. for list.—Box 18, 41 Lichfield, Staffs.

STAMP bargains, all different. 20 U.S.A., 5d.; 20 Argentine, 5d.; 25 San Marino, 9d.; 50 French Colonials, 1/3. Postage please.—J. Watts, Linby, Notts.

STAMPS FREE!! Twenty unused (2½d.).—G. H. Barnett, Limington, Somerset.

40 DIFFERENT stamps free, including Silver Wedding, U.P.U., Victory, Silver Jubilee, Coronation, Pakistan, etc. Send 3d. postage and request approvals.—J. F. Smith, 39 Manor Park, London, S.E.13.

PERSONS are wanted for spare time work, making up fancy goods at home. Experience unnecessary. Write for details.—Dept. 918, Universal Products, 5 Cornhill, Lincoln.

MAKE money! Ply offcuts, 3/-, 5/- and 10/- parcels.—Mayco (D), 117 Station Rd., Sutton Coldfield.

BE Taller. Quickly! Safely! Privately! No appliances—no tablets—no dieting. Details, 6d. stamp.—Malcolm Ross, Height Specialist, BCM/HYTE, London, W.C.1.

MODELS. You can make lasting stone-hard models with Sankey's Pyruma Plastic Cement. Supplied in tins by Ironmongers, Hardwaremen and Builders' Merchants. Ask for instruction leaflet.

TRANSFERS for decorating toys, trays, furniture, fancy goods. List and samples, 3d. Flowers, pixies, dogs, nursery rhymes.—H. Axon Harrison, Jersey.

PRESSED Metal Wheels. 1½ins., 1/3; 2ins., 1/9 per dozen. Or in stove enamel finish, red, green or blue at 6d. per dozen extra. Tax included. Post paid.—The Joyden Toy Co., 193 Chase Side, London, N.14.

DOLL'S House fittings and papers; send S.A.E. for list. Doll's house plan, special; send 2/6. Trade supplied.—Zimplan, 88 Ware Road, Hoddesdon.

LORRY Kits, 4 mm. and 7 mm. scale. Also large range of spare parts from which to build to your own design. Send for fully illustrated catalogue, price 1/-.—Wilson's Lorries Ltd., 6 Gt. Winchester Street, London, E.C.2.

BLUSHING, shyness, nerves, self-consciousness, fears, ended. Details under plain cover, 1d.—Stebbing Treatment, 28 (HB) Dean Road, London, N.W.2.

100,000 GOVERNMENT surplus bargains. Inter-room telephone sets, ideal for household 'upstairs/downstairs' use, no batteries required, complete and ready for use, 8/6, post 6d.; gear units, containing numerous useful gear wheels, 2/6, post 6d.; aluminium rivets, approx. 1 lb. asstd., 2/6, post 6d.; sponge rubber strip, ideal draught excluders, anti-rattle beading, etc., approx. 18ft. x 1½ins. x ½in., 2/-, post 9d.; 70 ohm. variable resistances, 9d., post 3d.; 20 amp. toggle switches, 9d., post 3d.; hundreds of other brand new bargains for the model maker or handyman. Send 3d. stamp for full catalogue of bargains. Money back guarantee.—Milligan's, 24 Harford Street, Liverpool, 3.

BE Taller in 14 days or money back. Details, 1d.—Stebbing System, 28 (HB) Dean Road, London, N.W.2.

PLYWOOD offcuts. Birch and Gaboon in various thicknesses. Handy sized parcels for the cabinet, toy, model maker, and all handicrafts. Parcels made up in £1 and 10/- lots. Carriage paid. Send P.O. to Reeves, Plywood and Timber Merchant, 33 Front Street, Monkseaton, Whitley Bay. Tel. W.B.4677. Parcels are now despatched on day of receiving order.

£5 to £20 weekly earned at home, running your own Mail Order business. Details, 1d.—Stebbing Publications Ltd. (HB), Naphill, High Wycombe.

FASCINATING and profitable hobby, casting ornaments, toys, etc. You can easily make these yourself. Paints, brushes and all accessories. Illustrated catalogue of 700 Moulds, plus latest list of Rubber Moulds, with instructions, 9d., post free.—Cock of North Moulds (H), 140 Hollings Road, Bradford.

HARDWOOD Wheels. 2ins., 1/-; 3ins., 2/- per set of four. Tax included. Post paid. Other sizes available.—The Joyden Toy Co., 193 Chase Side, London, N.14.

HARDWOOD Ball Beads, ¾in. diameter, suitable for children's counting frames, etc. 5/3 per hundred, plus 1/9 P.T.—Joyden Toy Co., 193 Chase Side, London, N.14.

AMERICAN Magazines post free for one year. Popular Mechanics, 32/-; Popular Science, 28/6; Mechanix Illustrated, 22/6; Popular Homecraft, 18/-. Stamp for full list of others.—Willen Ltd. (Dept. 57), 101 Fleet Street, London, E.C.4.

PLYWOOD. 72 x 4½ x ¾ in., 20 for £25/-; Gaboon, sanded two sides; Birch, 36 x 9 x ¾ in., 10 for 15/-; Veneered Plywood, 24 x 24 x ¾ in., 5 for 35/-; ½ in. thick, 2 for 25/-; Strips Block-board, ½ x ½ x 27ins. long, 3/- doz. Softwood lids, 39 x 13½ x ¾ in., 7 for 20/-. List of other plywood and Oak, 2d. All above prices carriage paid for C.W.O.—Dept. H.3, JDD. Storage, 71 Northcross Road, S.E.22. BRI.7441.

USE spare time on profitable home-work making fancy goods. Write for free booklet.—(Area 544), 54 Southgate Street, Leicester.

MAKE your own jig-saw Puzzles. Fine Art Pictures, various reproductions and sizes. Also suitable for framing. Stamp for full list.—Joyden Toy Co., 193 Chase Side, London, N.14.

NOVEL Calendar Designs painted on plywood for cutting out. With date cards. Inexpensive gifts, profitable to sell. Sample, 2/-; half dozen, 10/-, including postage.—Clever, 50 Windsor Road, London, N.W.2.

HOMEWORKERS required, either sex, light assembly. Part or full time. S.A.E.—Esprey, Box 18, 41 Wade Street, Lichfield.

CONJURING. 3d. for new lists and free magical competition.—De Hempsey, 363 Sandycombe, Kew Gardens.

PERSPEX and acetate, cut any size from 2/6 sq. foot.—W.M. Products, 2 The Mall, Ealing, W.5. Eal. 3881.

MAGICIANS tricks, crazy cut-outs. Only 1/3. Parcels, 5/6. An evening's entertainment. Lists, 3d.—De Hempsey, 363 Sandycombe, Kew Gardens, Surrey.

ATTRACTIVE Pictorial stamps on approval.—G. Smith, P.T.S., 95 Ocean Road, South Shields.

MODEL Makers and handymen. Bumper set of lists, books, plans and samples, 2/6.—Sutton Models, Billericay.

EARN £5 to £20 weekly running your own Mail Order business. Details, 1d.—Stebbing Publications Ltd., Naphill, High Wycombe.

9.5 Film Library, projectors, films, for sale. Stamp for lists.—Wayland, 223 Longley Road, Tooting, London.

HOME Watch and Clock Repair Outfit. Includes watchmaker's magnifying eyeglass, tweezers, screwdrivers, oilers, oil, brush, dusting powder, plus illustrated explanatory book. Watch and clock repairing simplified. In container, 12/9 incl.—D. Bolster (Dept. H.), 5a Station Parade, Ashford, Middx.

PROMOTION

WITH INCREASED PAY

That is what the younger generation are seeking—Promotion, and more money. How to get it is the big question. There's only ONE certain way and that's by systematic training such as the I.C.S. have given to millions and are giving today to tens of thousands of ambitious young men striving to add to their earning power.

Find out how the I.C.S. can help YOU. We teach a Wide range of subjects Here are some of them:

Accountancy	Commercial Art	Radio and Television
Advertising	Commercial Training	Radio Servicing
Architecture	Coal Mining	Salesmanship
Building	Draughtsmanship	Sales Management
Business Management	Electrical Eng.	Sanitary Eng.
Carpentry and Joinery	Horticulture	Structural Eng.
Chemical Engineering	Mechanical Eng.	Surveying
Civil Engineering	Motor Engineering	Works Management

LETTERS AFTER YOUR NAME

Do you wish to put 'letters after your name' that will give you recognized professional status of great and life-long value? I.C.S. students have won brilliant successes in various Technical, Commercial, Professional, Civil Service, and other Examinations, including the following:

<i>Technical Exams:</i>	Home Office Mining	C. Inst. Accts.
R.I.B. Accts.	M.O.T. Certifis.	C. Inst. Secs.
Inst. of Builders	B. Inst. Radio	Corp. Inst. Secs.
Inst. Civil Engrs.	P.M.G.	Inst. Book-keepers
C. & G. Elec.	C. & G. Wireless	Inc. Sales Managers
Inst. Fire Engrs.	R.A.F. Wireless	U.C.T.A. in Sales
Inst. Marine Engrs.	I.I.A. Foremanship	General Certificate
Inst. Mech. Engrs.		of Education
I.M.E. for Bldg. Insp.	<i>Commercial and Educ.</i>	University Entr.
Inst. Municipal Engrs.	<i>Exams.</i>	School Certif.
Inst. Struct. Engrs.	Advertising Assoc.	Coll. of Precepts
R.I.C. Surveyors	I.I.P. Advertising	

I.C.S. Examination students are coached until successful and all Instruction Manuals and Textbooks are supplied to them free.

International Correspondence Schools Ltd.
(Dept. H.B.11) International Buildings, Kingway,
London, W.C.2



CRAFTWORKER

THE MODERN MAGAZINE OF CRAFTS FOR ALL

- Every kind and type of tool and material is offered in *Craftworker*
- Instructions in all Crafts at Home are published in *Craftworker*
- A Market Section is included in each issue of *Craftworker*

A COMPLETE SERVICE

Specimen Copy 1/2 from the Publishers

Craftworker (DEPT.), Broadway, Broadstairs

BE TALLER

I Guarantee to increase your height in 12 days or return your money. New gland and spinal discovery increases height 2 to 5 inches.

'I have gained 4½ inches in height and feel fresher first thing in the morning. My weight increased from 9-stone 4-lb. to 10-stone 3½-lb.—P. D., Witham. 'Since taking your Course I have increased in stature from 5 feet 1 inch to 5 feet 4 inches, a matter of 3 inches'.—H.G., Chesterfield. 'My increase is 2 inches and I really do feel ALIVE'.—E.T.

Guaranteed harmless. Full Course 10/- post free, Air Mail 14/-. Details free for 1d. stamp. Sent under plain cover.

J. H. MORLEY

(H 83), TERRY HOUSE, NAPHILL, HIGH WYCOMBE, ENGLAND
Established 1936



THE SCHOOLBOYS EXHIBITION IS COMING AGAIN IN JANUARY

If you have a camera and are in London during the holidays go to the Horticultural Hall and learn how you can develop your roll films in Johnsons famous daylight tanks. Demonstrations will go on all day long. You can see prints made, too, and help to expose and develop them yourself. It will be the high spot of the holidays.

There are Johnson Tanks to take every kind of film. This picture shows the UNIVERSAL model, for five different sizes (price 29/-). There is also the J-20 TANK made specially for the popular size-20 film. Very economical in use and only costs 22/6.



All dealers sell Johnson Tanks.

JOHNSONS OF HENDON

London N.W.4 Established 1743

YOU CAN BECOME A HANDICRAFTS INSTRUCTOR

Experience not essential

Men who enjoy making things in wood or metal can turn their hobby into a permanent and interesting Career. Short hours, long holidays, and security in a job you would really enjoy, can be yours if you become a Handicrafts instructor. Let us send details of the easiest and quickest way to get the necessary qualification.

We definitely guarantee
"NO PASS—NO FEE"

If you would like to know about our unique method of preparing you for one of these appointments, write to-day, and we will send you our informative 176 page Handbook—free and without obligation. Mark your letters "Handicrafts Instructor."

BRITISH INSTITUTE OF
ENGINEERING TECHNOLOGY **BIET**
595 Shakespeare House
Stratford Place, London, W.1

'THE MODEL RAILWAY CONSTRUCTOR'

If you are interested in the fascinating hobby of model railways you must read this leading monthly magazine. Every issue full of constructional articles and photographs. Send to-day for a specimen copy (1/2 post free) to—

'VELMEAD' (Dept. 4) CHURCH CROOKHAM, Hants.

WEBLEY AIR PISTOLS

Marvellously accurate for target practice.

No licence required to purchase.

Senior Mark 1

Junior Webley Air Rifle

Write for List. WEBLEY & SCOTT LTD.
166 WEAMAN STREET, BIRMINGHAM, ENG



STUDY
AT
HOME

IN YOUR
SPARE
TIME

THE BENNETT COLLEGE

will set you on the right course for success

You make sure of planned progress in the career of your choice when you let the most progressive, most successful Correspondence College in the world coach you through the post. By friendly, individual training we equip you with the specialized knowledge you must have for a well-paid key position.

Make the first move **TODAY**—post the coupon below!

**ALL TEXT BOOKS ARE
FREE!**

We send as many volumes as subject chosen demands, they become your property.



IS YOUR CAREER HERE?

IF NOT, WRITE FOR FREE ADVICE

- | | | |
|--|--|--|
| Accountancy Exams. | General Certificate of Education Examinations | Radio (Short Wave) Road Making and Maintenance |
| Agriculture | General Education | Sanitation |
| Applied Mechanics | G.P.O. Eng. Dept. | School Attendance Officer |
| Auctioneers and Estate Agents | Heating and Ventilating | Secretarial Exams. |
| Aviation (Engineering and Wireless) | Institute of Housing | Sheet Metal Work |
| Blue Prints | Institute of Municipal Engineers | Shipbuilding |
| Bollers | Journalism | Shorthand (Pitman's) |
| Book-keeping. Accountancy, and Modern Business Methods | Languages | Short Story Writing |
| Builders' Quantities | Mathematics | Social Welfare |
| Building, Architecture, and Clerk of Works (A.R.I.B.A. Exams.) | Metallurgy | Speaking in Public |
| Carpentry and Joinery | Mining. All Subjects | Structural Engineering |
| Chemistry | Mining. Electrical Engineering | Surveying (R.I.C.S. Exams.) |
| Civil Engineering | Motor Engineering | Teachers of Handicrafts |
| Civil Service | Naval Architecture | Telecommunications (City and Guilds) |
| All Commercial Subjects | Novel Writing | Television |
| Commercial Art | Plastics | Transport Inst. Examinations |
| Common Prelim. E.J.E.B. | Play Writing | Viewers, Gaugers Inspectors |
| Concrete and Structural Engineering | Plumbing | Weights and Measures Inspectors |
| Diesel Engines | Police, Special Course | Wireless Telegraphy and Telephony |
| Draughtsmanship. All branches | Preceptors, College of | Works Managers |
| Engineering. All branches. Subjects and Exams. | Press Tool Work | |
| | Pumps and Pumping Machinery | |
| | Quantity Surveying —Inst. of Quantity Surveyors Exams. | |
| | Radio Service Engineering | |

COUPON. CUT THIS OUT

IF YOU ATTEND TO THIS NOW
IT MAY MAKE A WONDERFUL
DIFFERENCE TO YOUR FUTURE.



To DEPT. 62
THE BENNETT COLLEGE LTD.
SHEFFIELD

Please send me (free of charge)

Particulars of (Cross out line which does not apply.)

Your private advice

about

PLEASE WRITE IN BLOCK LETTERS

Name

Address

MYFORD

*Christmas Greeting
To All 'Hobbies' Readers*

*We wish you the Compliments
of the Season and trust that
1951 will be a year of peace
and advancement, and a good
year in your workshops.*

MYFORD ENGINEERING CO., LTD.
BEESTON : : NOTTINGHAM



✈ So may you—one day.
If you are chosen to be an R.A.F. Apprentice you will be trained for a skilled trade, and continue your general education. You will have far more opportunities for sport than most boys. You will be well fed and cared for, and receive good pocket money. And you may end up not only with a commission—but with a flying commission.

Send the coupon. It will not commit you to anything. It may lead to great things.

TO:—AIR MINISTRY, INFORMATION BUREAU, DEPT. HS.44J.
KINGSWAY, LONDON, W.C.2.

It ran between 15 and 17). Please send details of R.A.F. Apprenticeships.

NAME

ADDRESS



Hobbies

WEEKLY

CONTENTS

	Page
Toy Fort - - -	193
Peg Puzzles - - -	195
All-in Cardbox - - -	196
Push-along Wheel - - -	197
The Garden Fishpond - - -	198
Chinese Flower Vase - - -	199
A Saw Trestle - - -	200
Antofret Cutting - - -	201
Craftsman's Notes - - -	202
Home Improvements - - -	203
Fireplace Screen - - -	204
Scrap Wood Toys - - -	205
ARTICULATED TRANS-PORTER DESIGN SHEET	

December 27th, 1950

Price Fourpence

Vol. III No. 2878

ONE of the most popular toys for any boy is, probably, a fort, and we give here details for making a simple but very attractive one. Looking at the picture, Fig. 1, we note at once the most prominent feature of the toy—the Keep or Castle, as it is more generally called. This stands on a spacious 'parade ground' enclosed within four parapet walls, the tops of which, to the front of the castle, are battlemented.

In the front parapet wall, and central with it, is a gateway and draw-bridge leading to an outer wall with ramps sloping downwards each way.

The Wood Needed

Wood $\frac{3}{4}$ in. thick is suggested for all the wooden parts of the toy. Where wood cannot be got of sufficient width for the wide faces of the castle, two or, perhaps, three pieces can be butted together and glued up or pieces of wall-board used.

A SIMPLE TOY FORT

A toy such as this will receive rough usage, so the whole should be built strongly, and angle fillets and glued blocking pieces added wherever possible and, of course, out of sight.

There are four distinct units to be made to complete the toy. Each can be made separately and can be packed conveniently in the box-like section of the 'parade ground'.

The floor or base-board is 15ins. square, and may consist of wallboard or stout strawboard. The sides to go round this are 4ins. wide, and when this frame is together, the actual opening should be 15ins. square. The floor is glued and pinned in the frame $1\frac{1}{2}$ ins. down from the top edge, as shown in the sectional diagram Fig. 2.

The cutting in of the battlements to the tops of the parapet walls must, of course, be carried out before they are assembled. Where the gateway stands in the front parapet wall an opening must be also cut $3\frac{1}{2}$ ins. wide, to allow the former to stand on the floor. The battlements are arranged to allow for this, as in the sketch Fig. 1. The front and rear walls should measure 15ins. by 4ins. and the two side walls which go in between them $14\frac{1}{2}$ ins. by 4ins.

The Gateway

The gateway is a simple piece of work and a front view with all dimensions is in Fig. 3. Two such pieces are cut and cleaned up, and then a third piece, as the perspective sketch shows in Fig. 3, is sandwiched in between them. Note here the middle battlement is omitted and the opening between the two end remaining battlements cut lower. Glue the three sections well together and finally clean up edges and surfaces ready for painting.

The drawbridge is $3\frac{1}{2}$ ins. long and 4ins. wide—the width of the gateway, and it is hinged to the lower edge of the gateway by means of pieces of tape about $\frac{1}{2}$ in. wide creased up and glued to the top surface of the bridge piece and to the front of the gateway each side of its opening.

The top surface of the bridge should thus be level with the main floor when the former is lowered to the ramp, as seen in Fig. 1. Two pieces of small-link chain may be fastened to the

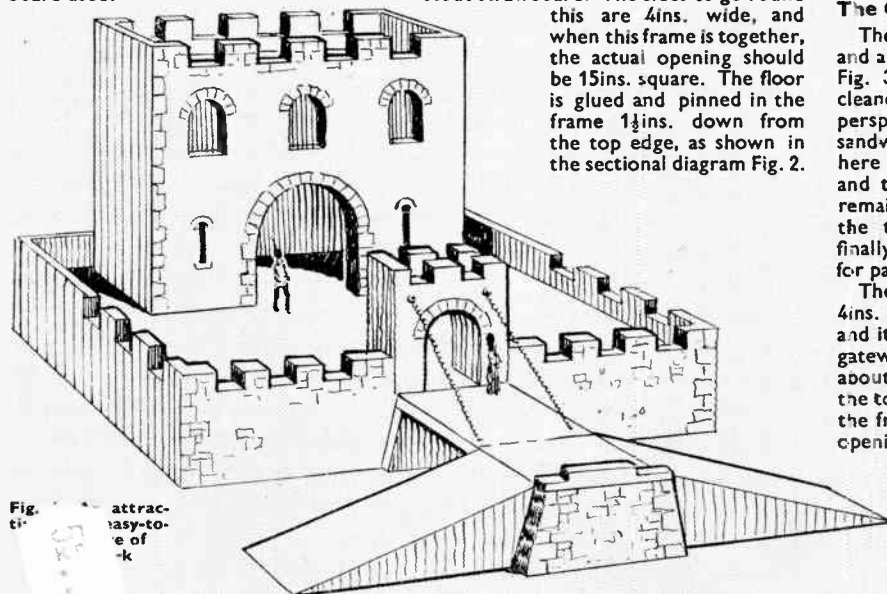

Fig. 1. attractive toy of -k

All correspondence should be addressed to The Editor, Hobbies Weekly, Dereham, Norfolk.

bridge and to the top of the gateway, as shown.

The roadway is shown in detail in Fig. 4 and consists of five pieces of wood. It is made so the top roadway is level with the main roadway of the castle and

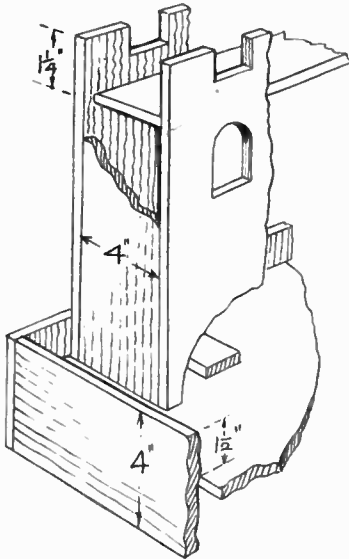

Fig. 2 - Showing general construction

with the drawbridge. Two pieces forming the sides of the ramp are first cut to the shape shown, the actual length from end to end of the pieces being 11½ ins., and its width ¾ in. The square or flat portion at the top should be 3½ ins. wide.

Front Road Entrance

From this the two sloping ends can be set out. Having drawn out and cut one side, the other can be outlined on the second piece of wood by drawing round it. Now cut a piece of wood 3½ ins. long by 2½ ins. wide and glue and nail it to the top of the two sides. This forms the continuation of the drawbridge roadway.

Each sloping ramp will be made from wood measuring 6 ins. long by 2½ ins. wide, the top end being slightly bevelled to meet the top road piece. Glue and nail the pieces to the shaped sides, letting the lower ends overlap, as the

dotted lines show in Fig. 4. The projecting ends will later be cut away and glasspapered level with the lower edges of the sides, just as shown in the detail and the sketch.

The finish can be made attractive by the addition of an extra thickness of wood on the face of the outer side. This piece should measure about 4 ins. by 2 ins. and be shaped simply along its

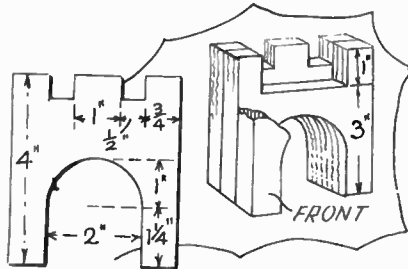

Fig. 3 - Details of drawbridge gateway

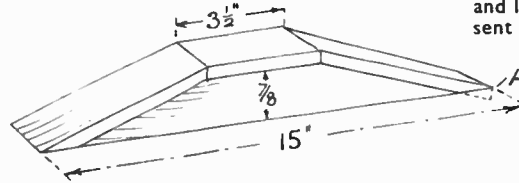

Fig. 4 - The front road and ramps

top edge and sides. To stiffen the construction of the ramp one or two cross pieces may be put across inside between the sides and nailed from the outside. This may be done before the outer wall piece is added, the nail heads being thus quite covered.

The Castle is an interesting piece of work but quite simple to undertake. The front and rear walls may, if desired be identical in outline, but the archway should be omitted in the rear wall.

Make a full-size drawing of the front on paper from the detail at Fig. 5, noting carefully all the dimensions shown. Cut out openings and outline with the fretsaw and clean up. Use this cut-out as a template for making the rear side, omitting, as suggested, the outline of the arch.

The two sides are held together at the

top by a square of wood measuring 8½ ins. by 4 ins. and this should be fixed 1½ ins. down from the top as Fig. 2. Stiffening fillets of angle or square wood should be glued underneath the roof before the sides are added. Two more simple squares of wood 8 ins. long by 4 ins. wide form the side walls of the castle and they are glued and pinned to the front and rear walls.

Walls and Windows

The walls, just inside the archway, may be stiffened by putting pieces 4 ins. long by about 1½ ins. wide from wall to wall, as detail Fig. 2 shows. If it is intended to fasten the castle to the base, then screws could be run through the latter into the crossbars.

To get a good effect in the windows, they may have celluloid glued inside and then ink lines drawn across to represent lead glazing. The whole of the walls should be painted stone colour or grey, and lined in black or brown to represent stone jointing. The arches should have their stones carefully lined in.

The parade ground and other paths or roadways should be light brown in colour. Another method of finishing the ground area, instead of the paint as

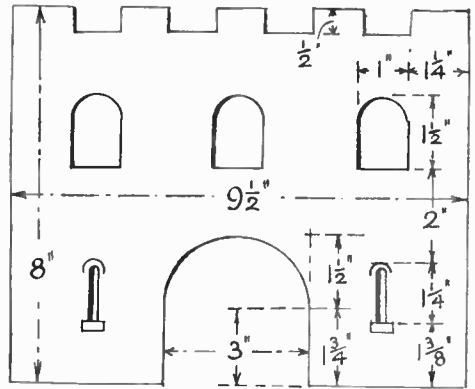
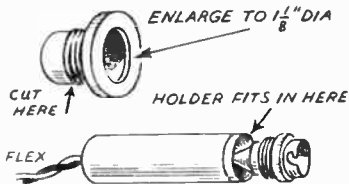

Fig. 5 - How to mark out the front

suggested, the surfaces may be coated with glue, upon which sand or very fine cork dust or saw dust is sprinkled; either gives a good realistic effect. (326)

Safety Lamp

TAKE an ordinary shaving stick container—the type for which you buy refills, and cylindrical in shape and made of bakelite or other insulating material. Unscrew the base, cut down the surplus portion as shown in the



sketch, and enlarge hole to clear 1½ ins. diameter. This will allow it to fit over the holder like a lamp shade, using the shade carrier ring to keep it in position. Next drill the top of barrel to take flex and, since the base is already threaded, it can be screwed into position, thus giving complete coverage and perfect insulation of holder.

Depth Gauge

HOW an ordinary spring clothes peg may be used to prevent a bit boring a deeper hole than required, is shown in the sketch. The peg should be attached to the bit at a height corre-

sponding with the depth of the hole to be bored. In this way, when the lower edge of the peg touches the surface of the woodwork you will know you have reached the required depth.

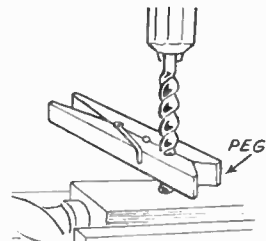

The first of two simple games to make to have FUN WITH PEG PUZZLES

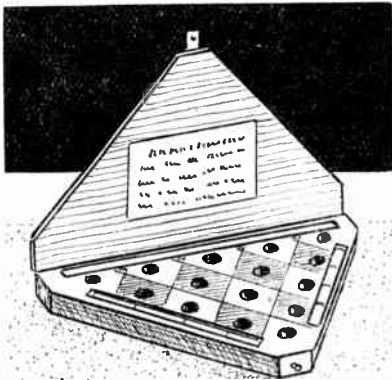

Fig. 1—The completed board in use

PEG puzzles are always intriguing, and just the things to hand out to guests for a few minutes diversion—or play yourself in odd moments. The aim in most varieties is to leave a single peg in a certain hole, play being according to definite rules, but in others, different coloured pegs have to be made to change places.

Like other hand-held games, more fun can be got out of them if solidly and neatly made. Ramshackle looking puzzles often seem to convey the impression that they are not worth solving. So care in making is quite worth while.

Two puzzles are shown here, one of the 'single peg' type, and the other of the interchanging kind. Wood of $\frac{3}{8}$ in. and $\frac{1}{2}$ in. thickness is used for the main blocks, with layers of $\frac{1}{8}$ in. plywood for base and lid. The underside layer of plywood is the simplest way of closing the holes and giving a bottom to the trays for the pegs.

First then the game shown in Fig. 1. Here is a triangular board in which is fifteen holes, all of which bar one, are supplied with short wooden pegs. The hole left vacant is at the middle of the bottom row and is clearly indicated by being surrounded by a coloured circle. All but this hole are given a peg and play starts by 'jumping' as in draughts, the peg jumped over being taken away, the aim being to leave the last peg in the central hole of the lower line.

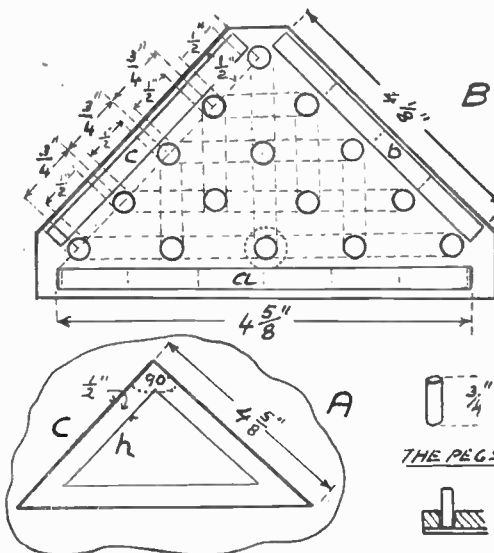

Fig. 2—Details of construction

The marking out of the board is shown in diagrams A and B, Fig. 2. Draw the triangle (C) with a right-angle at the top and sides of $4\frac{5}{8}$ ins. Scribe the line (h) $\frac{1}{2}$ in. from each of the sides and divide up, as shown in (B). At each $\frac{1}{2}$ in. space, now put a complete circle of that diameter. Join lines across between each pair of holes, also vertically downward which by their intersections give the positions of the inside circles. Mark, too, the lines at which the corners have to be cut off and draw in the three rectangles (a), (b) and (c) which are to be taken out as receptacles for the pegs.

The board being fully marked out, fix it on some firm base and with the main triangle as yet not cut out, drill a $\frac{1}{8}$ in. hole at each circle position. Also before the triangle is cut, take out for nearly a $\frac{1}{2}$ in. depth, the side channels with a sharp blade. Run the point along the outlines against a steel rule and then prise out the intermediate slice of wood with the gentlest of sideways pressures.

When all this has been done and the circular holes and channels cleaned out, the main triangle can be taken from the rest of the wood. Here again, to get perfectly clean edges it is good to run along the sides of the figure with the razor blade against the steel rule. This breaks the surface neatly and the rest of the cutting can be done with a fine saw. Sawing right away might easily break the small walls of the three channels.

Finally square out the board, as shown in the sketch of the completed game and Fig. 3, and stain or paint the alternate squares a contrasting colour, as with an ordinary draught board.

Now comes the lid and base. These are two pieces of $\frac{1}{8}$ in. plywood, the same shape as the main block just made. The base is secured to the underside of the

main piece with a few sprigs and glue, while the top is fastened with a cloth hinge to the longer side of the triangle, the cloth being glued at the back as Fig. 4, so that the lid can hang down if desired. In the closed position the lid is held at its peak by a simple strap holder taken over on to a pin in the front edge of the main block.

Lastly come the pegs. These should, if possible, be made of hard wood and must fit the holes easily, but not so that they lie over at an angle. They must be coloured in some bright hue, and dye, rather than paint, will be found best for the job. These important items are $\frac{6}{8}$ ins. long, so that six can be housed in the bottom channel and four each in the two side channels.

Lid and base can be finished in the same colour as the dark squares and for neatness the words 'FOURTEEN PEG PUZZLE' could be put on the lid in bright yellow or red paint, the letters as shown, being used which look well and make it impossible to go wrong in the outline. Also if desired, the aim of the puzzle could be set out on a small sheet of paper and glued on to the inside of the lid.

You can give quite a lot of variety in your own play to the puzzle by tinting one peg another colour and setting this at random about the board, this being the peg which has to be the one left at the lower centre.

Or again the hole in which the last peg has to be left can be changed, a new hole being decided upon at each try. Indeed, one of the advantages of peg 'jumping and removing' games is the number of aims that can be brought in, the ingenious player generally being able to invent quite a number for himself.

(To be continued)

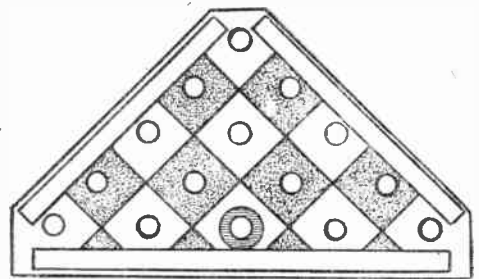

Fig. 3—Plan view of completed board

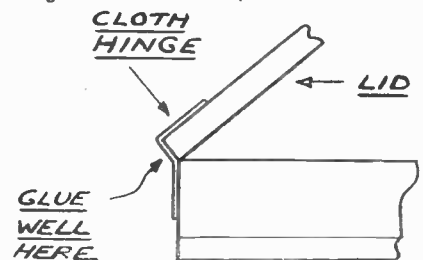

Fig. 4—How to hinge the lid

The handyman can easily construct AN ALL-IN CARDBOX

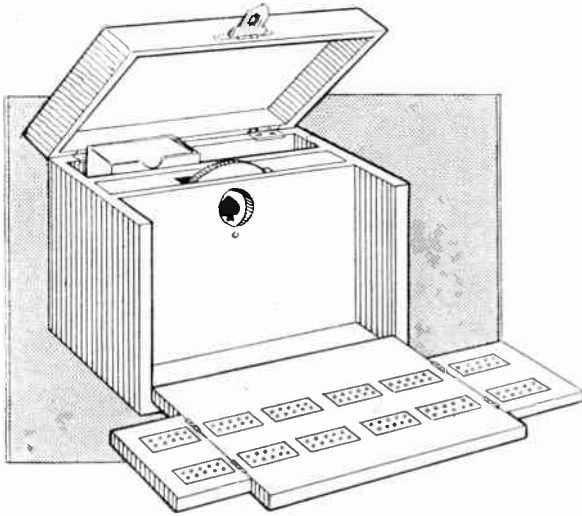

Fig. 1—The box open and Fig. 2 (below) closed

THIS novelty games box presented to our readers this week for making up will, undoubtedly, make an instant appeal. There is space for two packs of playing cards, a novel trump indicator, and a folding full-length cribbage or peg board. The whole closes up into an ordinary box, the lid of which is held in place by a neat brass catch, as Fig. 1 and Fig. 2 will show.

The construction of the box is simple, and is made up from $\frac{1}{8}$ in. wood throughout. The size overall is, length $6\frac{1}{2}$ ins., width 3 ins. and height $4\frac{1}{4}$ ins.

The box is made from pieces cut to the following sizes: bottom and top each $6\frac{1}{2}$ ins. by 3 ins.; two sides each $6\frac{1}{2}$ ins. by $3\frac{3}{4}$ ins.; and two ends each $3\frac{3}{4}$ ins. by 3 ins. The ends are glued between the bottom and top, and one of the sides is also glued between the ends and between the bottom and top.

The remaining side which is not a fixture between the ends, is screwed temporarily in place. The reason for this must be made clear. When the glue has hardened, a line will be drawn at a distance of $\frac{1}{8}$ in. down from the top edge all round the box.

The box is then held firmly and a saw cut made on the line, thus making two

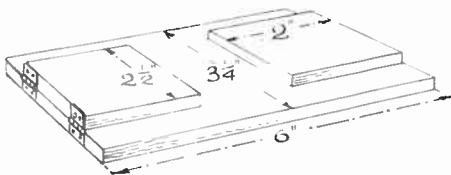

Fig. 3—Base with hinged flaps

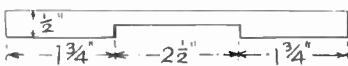

Fig. 6—The spacing piece

Two partitions are next cut 6 ins. by $3\frac{1}{2}$ ins. In one of them there will be a hole cut 1 in. in diameter through which the trump suit will be seen, as in Fig. 3. The other will be plain and will be glued in the box 1 in. distant from the back. The front partition can then be glued in $\frac{1}{2}$ in. away from its companion.

MATERIAL REQUIRED

One piece— $13\frac{1}{2}$ ins. by $3\frac{1}{2}$ ins. Top and bottom.
One piece— $12\frac{1}{2}$ ins. by 4 ins. Sides.
One piece—8 ins. by $3\frac{1}{2}$ ins. Ends.
One piece— $12\frac{1}{2}$ ins. by $3\frac{1}{2}$ ins. Partitions.
One piece— $12\frac{1}{2}$ ins. by 4 ins. Disc, flaps on lid, etc.
Two pairs $\frac{1}{8}$ in. brass hinges.
Two pairs $\frac{1}{8}$ in. brass catches.
One catch for lid.

The next step is to make the disc bearing the five indicators. Cut out the disc shown in Fig. 4 from $\frac{1}{8}$ in. wood, and on it paste a piece of stout hard-surface paper and then draw in the five signs

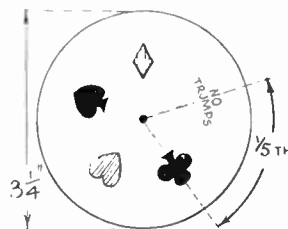

Fig. 4—The trump disc

196

distinct pieces. The top tray-like section is afterwards hinged to the larger portion to form the lid. This is plainly illustrated in Fig. 2. The front of the box—that piece which was previously screwed to the ends, is removed and the smaller top piece cut from it, and glued to the top to form the front rail of the lid.

shown, keeping their extremities not more than $1\frac{1}{8}$ ins. from the centre point of the disc.

Make a $\frac{1}{8}$ in. hole in the centre of this and hold it in place between the two partitions and judge the position for the pivot hole to be made in the front. Bore a hole right through both partitions, seeing the bradawl or drill passes through the hole in the disc.

Now put in a round-headed screw to fix into the back partition and see that the disc revolves freely round it. The cut-away portion in Fig. 5 is to show the positions of the various parts. At Fig. 6 is detailed the $\frac{1}{8}$ in. piece of wood which will close the space between the two

partitions. Cut at the same time, allowing the disc to project slightly for handling.

The next step will be the making of the front which is hinged to the bottom of the box. The piece for this front has, of course, already been prepared, so it will now only be necessary to cut

and hinge the two end flaps. Fig. 3 shows clearly these and the manner in which they are hinged to the front. The direction of the grain of the wood must be noted.

Marking

When the flaps are thrown open they will appear as Fig. 2 and the twelve squared spaces shown will be drawn in in pencil and the lines afterwards gone over with indian ink. The holes must be carefully spaced out and drilled with a fine drill.

The whole article should be made from a good wood such as mahogany, and finished with either varnish or french polish.

The cutting list of wood will be found useful when setting out and making up this novelty.

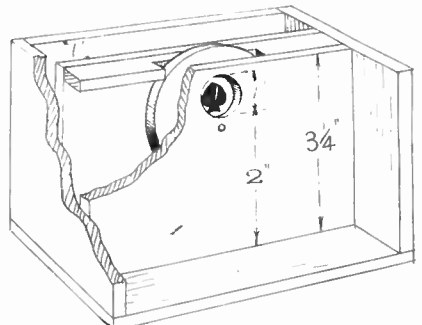

Fig. 5—Interior cut-away view

This simple mechanical toy to make is A PUSH-ALONG WHEEL

THIS mechanical novelty would please any young child as a Christmas present. It represents a form of Big Wheel, a popular attraction at some fairs, and rotates as it is pushed along, so that the kiddie can see it working. Fretwood or plywood, with a small piece of deal, are the materials required for its construction.

Body Part

The body part, Fig. 1, consists of a base with two side pieces to act as bearings for the wheels. These parts can be built up from $\frac{3}{8}$ in. deal, quite thick enough for such a job. The slot at the rear end is cut out wide enough for the handle, a length of deal, $\frac{3}{8}$ in. thick

MATERIAL REQUIRED

One piece of $\frac{3}{8}$ in. deal—10 ins. by 4 ins.
Panel of $\frac{1}{8}$ in. fretwood—8 ins. by 20 ins.
Pair of 4 in. wheels and stick for handle— $\frac{3}{8}$ in. by 1 in. wood, with approximately 1 ft. of $\frac{3}{8}$ in. diameter round wooden rod.

and 1 in. wide. Mortises are cut in the base, in which the standards supporting the big wheel are fitted. These should be $\frac{3}{8}$ in. wide and $\frac{1}{2}$ in. long, supposing fretwood is to be used for them; if plywood the width will be, of course, suitable if the thickness of wood exceeds the $\frac{3}{8}$ in. mentioned.

Pulley Connections

The fifth slot, that between the bottom pair of mortises, is $\frac{1}{2}$ in. wide and $\frac{3}{4}$ in. long. It is for the twine, connecting the pulleys together, to run through. In the two bearing parts, through which the axle of the wheels run, bore $\frac{3}{8}$ in. holes through, exactly where shown. Fix these parts to the base, underneath, with the axle holes truly in line at $1\frac{1}{2}$ ins. from the front edge. Now bore a $\frac{3}{8}$ in. hole through the sides of the slot in which the handle is to be fixed, for securing the handle later on.

The wheels and axle are shown in

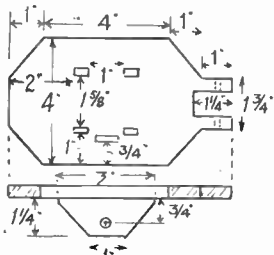

Fig. 1—The platform and sides

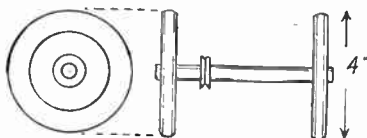

Fig. 2—Wheel and pulley detail

Fig. 2. The wheels can be cut from $\frac{3}{8}$ in. or $\frac{1}{2}$ in. wood, but it would be better to purchase these, as accurate wheel cutting is no easy job without a lathe. The central holes are bored, of course, to suit the axle, a length of $\frac{3}{8}$ in. round wood rod. The length of this should be measured across the base, with enough added on to admit the wheels with a trifle over.

Assembly

Cut a 1 in. diameter disc of fretwood and file a groove round its edge. This will do for one pulley. Bore it to fit the axle. Glue one wheel on, push the rod through its bearing holes, and with the wheel not quite touching the sides of the base, make pencil marks on the axle for the place on which to fit the pulley, which should come directly under the slot above. Glue the pulley on, then the second wheel.

Support Standards

For the pair of standards, cut two at (A) in Fig. 3, from $\frac{3}{8}$ in. wood to the shape given. The slot at the top is just $\frac{3}{8}$ in. wide. To the length of the standards, add $\frac{3}{8}$ in. for the two tenons at the bottom. These will be cut to the size, and spaced apart, to suit the mortises in the base. On the centre, and at $\frac{3}{8}$ in. from the bottom, bore a $\frac{3}{8}$ in. hole through both for the axle of the second pulley already mentioned. Now glue the standards in the base.

Cut a piece of $\frac{3}{8}$ in. rod about 2 ins. long for the axle, and cut and shape a second 1 in. diameter pulley. Glue this pulley to the axle, as at (B) and push the rod through the bearing holes in the standard. Keep it from riding out by inserting a small nail through the rod at the end opposite the pulley.

Now connect the pulleys together with twine or thin cord, and see, when

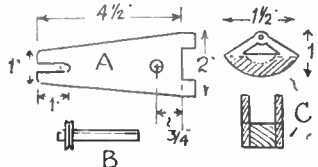

Fig. 3—Wheel support parts

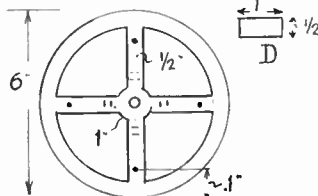
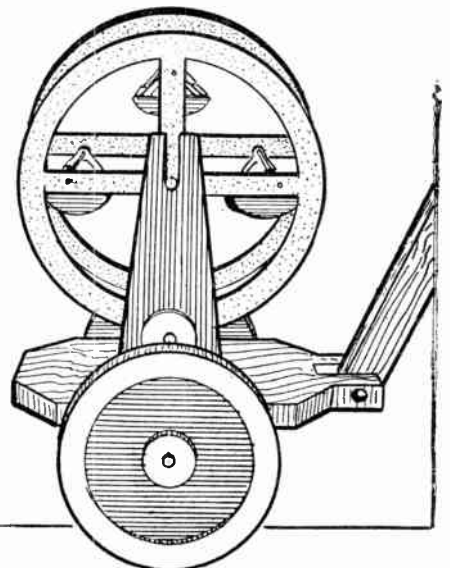

Fig. 4—The main wheel shape



the body is pushed along, that the axle, through the standards, rotates evenly and easily. This freedom of action can be better ensured by lubricating the bearing holes of both axles with a spot of paste, made by mixing powdered blacklead with a little lard. Be careful not to mess the wood up when applying the lubrication, just work it in the holes carefully with a stick of wood.

The Large Wheel

The big wheel, itself, Fig. 4, is cut from the $\frac{3}{8}$ in. fretwood to the diameter given. Bore the central holes $\frac{3}{8}$ in. Cut two 1 in. diameter discs of $\frac{3}{8}$ in. fretwood, and glue these, one to each of the wheel sides, to the outside of them. Then continue the axle holes through them. It would, perhaps, be easier to glue these discs on first, then to bore the holes through both thicknesses at once.

The distance pieces (D), four of which are required, are cut from scrap bits of fretwood, and glued and nailed between the sides of the wheel at $\frac{3}{8}$ in. distances from the centre, about where shown, in fact, by the dotted cross lines.

Axle

It will better ensure the axle holes being kept in alignment, if the axle is pushed through and kept there while the distance pieces are being fixed between. The axle is a $2\frac{1}{2}$ in. piece of the round wood rod. At the spots shown on the wheel side, drill holes to take pieces of stiff wire for the boats to swing on.

The boats (C) in Fig. 3, consist of side pieces of $\frac{3}{8}$ in. wood, cut to the complete shape, with a $\frac{1}{2}$ in. thick piece of deal between, cut to the shape shown by shaded lines. The holes at the top are drilled to suit the wires mentioned.

(Continued foot of page 196)

Some hints on the proper winter care of a GARDEN FISHPOND

If your garden is suitable for the purpose, a fish-pond or pool, properly stocked with plants and fishes, will prove of endless interest to you and your friends. The construction of such can well be carried out during winter at favourable periods, but it is not wise to attempt making a pond during frosty weather.

More and more people are attempting this fish pond hobby, even in small gardens. It can be made, of course, to fit in with size of garden, but the bigger it is, the more fish it will support. Even a pool 5ft. or 6ft. long by 3ft. wide and some 18ins. deep will prove attractive. In a large garden a much bigger pond is possible.

There is nothing really difficult in constructing a pool, but it is obvious that much care must be taken to ensure that it is perfectly watertight. In writing of such a pool it is to be noted that one refers to a 'stagnant' piece of water—that is, a pond that does not require the constant use of mains water, neither requiring a pump to circulate the water.

The object is to retain as much of the original water with which the pond is filled at first as long as possible without having to change it. To this end plants must be introduced to aerate the water.

Suitable plants include *Anacharis*, *Ranunculus*, *Sagittaria*, *Callitriche*, and *Myriophyllum*. These aerating aids are your best allies in the pond, but must be controlled when necessary.

Making the Pond

First, there is the excavation of the ground to the required size and shape—round, square or rectangular as desired. When this has been done, the bottom and sides must be well lined with good concrete, to the proportions of one bucket of cement, two buckets of sand and three buckets of shingle or small pebbles, and half-a-bucket of water.

You mix the sand and cement together first, and then add the rougher stuff. Thoroughly mix with water until the material is of an even consistency and colour. Cover both bottom and sides with the mixture to at least a thickness of 3ins. to 4ins. Make certain that all the corners—if making a square or oblong pond—are well cemented, in order to prevent any leakage.

When the concrete is absolutely set

and dry, it is not yet ready for use. New concrete is harmful to fish life, as many beginners have found out to their regret. So you have to fill the pond and leave it to soak, then empty it and refill. Even a third time will not do any harm, but will be all the safer before introducing your fishes, and plants.

Helpful Plants

Usually the amateur will find that the water in the pond tends to become cloudy. After the introduction of the necessary aerating plants and fish, however, it should gradually clear. Remember, in obtaining plants, to use the better oxygenators as *Anacharis* or Canadian water-weed. This is excellent for the purpose, especially as the fish will browse amongst it. You can get this weed and others already mentioned, from dealers.

The bottom of the pond will need to be covered sand and loam in which to plant the aerators. To plant *Anacharis*, tie a few strands together with knitting wool, attach a small stone, and sink it into the sand. *Callitriche* (starwort) is also excellent. Plant some strands separately in the loam and sand.

If your pool is properly stocked with the several oxygenating plants, water snails, and other creatures, the water will clear itself in course of time. But some scum may collect, especially in hot weather, and this can be raked off. Indeed, as soon as any surface scum appears, get it out at once, for it quickly spreads and will quickly cover a small pond if left.

Likely Pond Fish

Likely fish for your pond can be obtained from the dealers in aquaria, or you can get certain species from local ponds where fishing is permitted. The tench, particularly the golden variety, for one, the mirror carp for another, and, best of all, the golden orfe, which is certainly one of the most suitable. This fish will attain 10ins. in length in a roomy pond. It likes a meat diet, and will also catch insects in summer at the surface.

Minnows are adaptable to a pond life, and are attractive little fish for a small pond, but they should not be introduced to a water where you desire to keep and breed goldfish. Of the latter varieties the shubunkin is an interesting one, and will breed during the warm weather without trouble. They can be

fed on chopped worms, dried foods, insect larvae, etc.

Roach, rudd, and dace may also be used for stocking a pool, but avoid perch, which are depredators and eat other small fish. If procuring the stock, fish locally from a nearby pond or stream—they are better if caught from a 'stagnant' water for your purpose. Procure them as young ones; they will soon settle down in their new quarters and grow into attractive fishes. Also get Planorbis snails and a few freshwater mussels to act as scavengers and provide natural food also.

Shade and Sunshine

When constructing a pond bear in mind that fish do love a spot of shade. Endeavour to arrange something that will afford this at some part of the water; in bright sunshine fish will appreciate it. Water lily plants in a fairly roomy pond will provide shelter and shade; they are easily planted.

By the way, if convenient to you, when making the pond have a shallower part, as this will be more natural for the fish, which in their native habitat are used to shallows and deeps.

No Overfeeding

Do not overfeed, pond fish, as what they do not consume only drops to the bottom and decomposes, fouling the water. Give them plenty of room, do not overcrowd. Where a garden is fairly large and there is ample spare ground round the pond, it is nice to grow a few marginal plants as Flowering Rush, Yellow Iris, Water-mint, and Water Forget-me-not.

All this, of course, the size of pond, area of marginal ground to be planted, shape, etc., must be left to the amount of space available. You can make a sunken pool—or a raised pool; the former can be made more artistic. A point for the amateur to watch, when constructing his first pond, is the necessity of having the top edge level all round.

A garden fish pond, when well made and sited, and properly planted and stocked with the right kind of fish, can be a source of perpetual interest and pleasure, summer and winter. Thinking of the latter season, be sure and have a depth of at least 18ins. at one part of the pond, so the fish will have a place of retreat if weather is very severe and the water freezes. (319)

Push-along wheel—(Continued from page 197)

Glue them together and either clamp up until the glue is hard, or nail with fine fretwork nails.

Fit the four boats to the wheel with suitable lengths of the wire. Glue the axle rod in and test the action. If all is O.K., the whole can be painted, pre-

ferably in brilliant colours. If the wheel tends to slip, then cover the axle, going through the standards and on which the rims of the wheel rest, with a covering of thin rubber. A strip off an old inner tube would do nicely, and should be glued round.

Finish the article by fitting the handle to the body with a $\frac{3}{16}$ in. iron bolt through the slot. Cut this handle to a length to suit the child for which the toy is intended, and fix it at the right angle, by means of the bolt, for the article to run along level.

A glass jar and some wood converted into a pleasing CHINESE FLOWER VASE

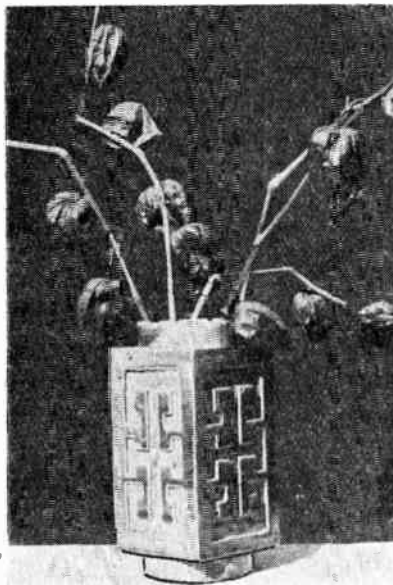

The picturesque holder in use

ONE never seems to have quite enough flower vases in the home—at least, really distinctive ones. But this Chinese pattern vase is certainly unusual and attractive and not at all difficult to make. The photograph gives a good idea of what it looks like, though it cannot convey the charming colour effect of the green vase and the orange 'Chinese Lanterns'.

Jar Container

The 'vase' is actually a box-like container for the glass jar, this latter being a suitable pickle, mayonnaise, preserve, etc., jar, approximately 6ins. high and 2ins. diameter. If it is possible to obtain plastic sheets and these are joined in a water-tight way, the interior glass jar can, of course, be omitted. But we will describe the wooden-cased affair. This, when properly made and painted, gives the effect of glazed pottery ware.

Fig. 3 shows, at a glance, the main body work—just a plain nailed-up wooden box to contain the jar. In the top piece (obviously of plywood), a hole is cut so that the jar can be taken in or out. We will presume that the sides are 3ins. wide. If they are otherwise, the dimensions of the overlay must be altered. Note that the top and bottom overlap the sides, all round, by $\frac{1}{4}$ in.

The Sides

The sides of the box must be quite smooth. This is easily done by laying a sheet of glasspaper face up on a flat board and then rubbing the box sides over it. The hole in the top can be neatened off by wrapping glasspaper

round the actual jar and turning it round.

The next step is to prepare the pattern for the overlays. Fig. 1 shows a half pattern. When drawn, this can be reversed, on the centre line (C.L.), and a complete pattern, as in Fig. 2, made. As the pattern consists entirely of straight lines, no difficulty should be encountered in preparing it.

Four Patterns

Four patterns are required. These are pasted down to $\frac{1}{4}$ in. plywood and when dry, cut out with a fretsaw. In Fig. 1, the actual pattern is shown stipple-dotted.

The pattern, as dimensioned is correct for a box with sides $5\frac{1}{2}$ ins. by 3ins. and with bevelled edges (Fig. 4). If, however, the carcass is of some other size, the dimensions will have to be altered, chiefly by altering the $\frac{1}{4}$ in. dimensions marked 'nominal' in Fig. 1. Again, if it is desired to fit the overlays as in Fig. 5, one overlay must be as wide as the box and the other, thus plus two thicknesses of overlay.

The utmost care should be taken to get sharp square corners on the overlay. Whenever possible, approach a corner from two directions (Fig. 6). Make some files by wrapping (or better, gluing) glasspaper on to pieces of stripwood and get all angles sharp and clean.

The overlays are now glued on to the sides. Apply the glue thinly, and if any oozes out, clean it off with a pointed stick, etc., before it gets hard. Dried glue left on the model will completely spoil its look.

Finishing

Keep the sides under pressure until

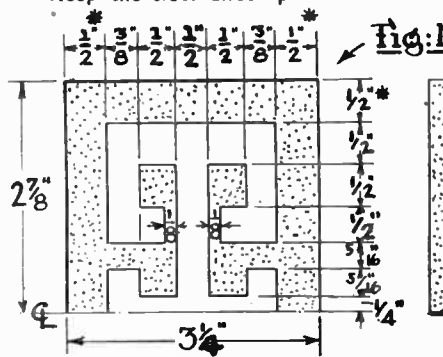

* Nominal dimensions
Half-Plan of Overlay.

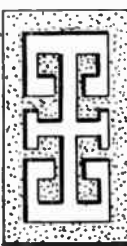

Fig. 2

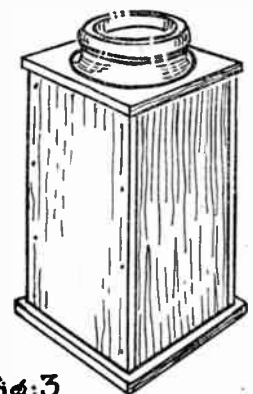

Fig. 3



Fig. 4

Bevel

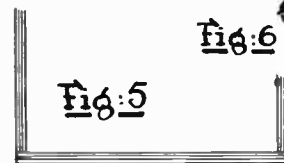
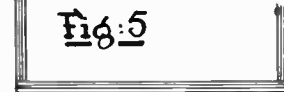
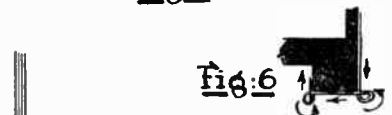

Fig. 5

Fig. 6



the glue has dried. Then glasspaper well, so that the top and bottom parts are flush with the sides. Clean off all sawdust, using a small brush to get it out of the hollows and then apply a coat of size or aluminium paint. This dry, paint with enamels or one of the so-called Chinese lacquers. Green (jade) is a particularly apt colour.

Several thin coats are much better than one thick one, and great care must be taken to prevent paint piling up in the hollows. The top of the glass jar can be painted, too, inside and out. The jar, of course, is removable for refilling, etc.

An Alternative

In the photograph, a slightly different arrangement has been followed, and is offered to readers as an alternative. The

A Safe Screw

IF you wish to put in a screw so it is impossible to get it out again, do it this way. Whatever job you want to put the screw in, first of all drive it in, then file the top of the screw down to the level of the slot where the screw-driver fits. It is impossible to get the screw out if done like this.

writer was fortunate in getting a plastic cylinder. The top and bottom of this can be seen in the photograph, the middle, of course, being screened by the wooden carcass which is forced on to it. The cylinder was converted into a water-tight jar by having a plastic disc cemented in the bottom.

The home handyman and carpenter should make this SAW TRESTLE

EVERY home handyman ought to have a pair of sawing trestles, for not only do they conduce to more accurate work but they save lots of 'hard labour'. Quite a number of amateurs spend most of their energy, when sawing, in steadying the wobblers of an old kitchen chair or the like, used as a support.

Apart from being used for sawing, the trestles are useful in plenty of other jobs—when assembling larger pieces of carpentry; for use during home decoration, etc.

The chief aim should be to make really substantial trestles with strong joints. A flimsy shaky trestle will defeat the very purpose for which it was made. The fact that no one is likely to admire such a utilitarian piece of equipment for its beauty of design and finish, nor the fact that, after some years, it is likely to be pitted with saw-cuts, should be an excuse for crude workmanship or shoddy joints.

Secondhand Wood

The present writer used wood from a front garden gate. This gate had rotted badly at the joints and base and was replaced by a metal one. When the rotted wood had been cut away, quite a lot of useful wood was still left. Some of it was of 4in. by 2in. section, which is exactly what the writer would have chosen if new wood had been ordered. But although this section has been specified on the drawings, it will be understood that wood of other sections can be used, provided it is not too thin. If using old wood, keep a look-out for old nails that may damage the saw, etc. If there is not sufficient wood for a pair of trestles, one may first be made.

The top piece (A) is easily dealt with, being merely a 2ft. 3in. length of 4in. by 2in. wood. To mark off the sloping uprights (B), however, it is best to lay out a full-size plan in chalk, either on a

large sheet of brown paper or drawn on the floor (see Fig. 3).

First draw a vertical *a* and a base line *b*. Mark off 8ins. to point *c*, at the base. Mark off the vertical height (1ft. 7ins.). At the top, mark off point *d*, 2ins. down. Now lay the 4in. wide wood (cut to approximately 2ft. long), so that one side touches *d* at the top, and the other touches *c* at the bottom. The wood is shown in Fig. 3 in chain-dotted line. With an adjustable bevel (indicated at *g*) lines *f e*, *c b* and others horizontal to the ground may be marked off.

The adjustable bevel is not on the priority list of an amateur's tools but it is by no means a fancy luxury and it will soon repay its not-too-high cost. With the bevel thus set, the position of the cross rail (C) can be marked off, starting at 3½ins. from the base. This cross-piece is of 3in. by 1in. section and is dovetailed in pieces (B), as shown in Fig. 5.

The tops of pieces (B) will look as shown in Fig. 4. Rails (D) are cut from ¾in. stuff, 4½ins. wide. The ends can be left projecting and then sawn off in line with the legs (B) after being fixed with screws. Before this is fixed, however, brackets (E) are attended to, as they have to be screwed to part (D), and this cannot conveniently be done after (D) has been fixed.

These brackets are of 3in. by 2in. stuff, 5ins. long and shaped as shown. They are screwed to top piece (A) as well. All other joints are firmly screwed with

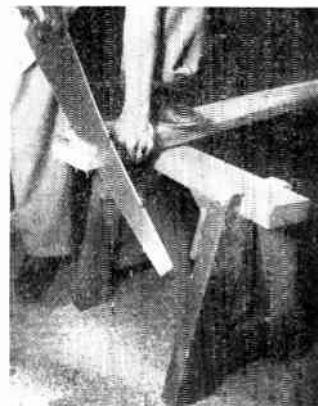

long screws, not too thin, and it is most essential to drill preliminary holes for the screws, otherwise driving them in will be either extremely laborious or even impossible.

These brackets are essential, as it is not convenient to have another cross rail lower down, as it would get in the way of the saw.

Despite all care it will often be found that the trestle does not stand on an 'even keel', but a piece of rubber nailed on the short leg will remedy the matter.

The photograph shows the trestle actually in use and to kill two birds with one stone we have also included a useful hint on sawing. It is sometimes found that a plank—possibly a shelf to fit into a wall recess—is a little too long, sometimes only ½in. or so. To saw this much neatly off a plank with a handsaw is a tricky job.

All one needs do, however, is to lay this plank over another and saw the two planks together, the lower plank (the 1in. or 2ins. which is sawn off being regarded as expendable) having a fair amount taken off—enough to support the thinner cut, above. The illustration shows the idea at a glance (314)

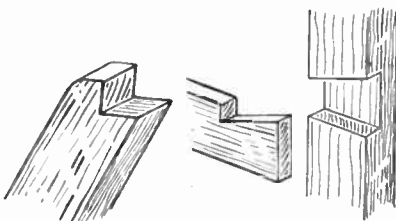

Fig. 4 Top of leg; Fig. 5—Dovetail of crossrail

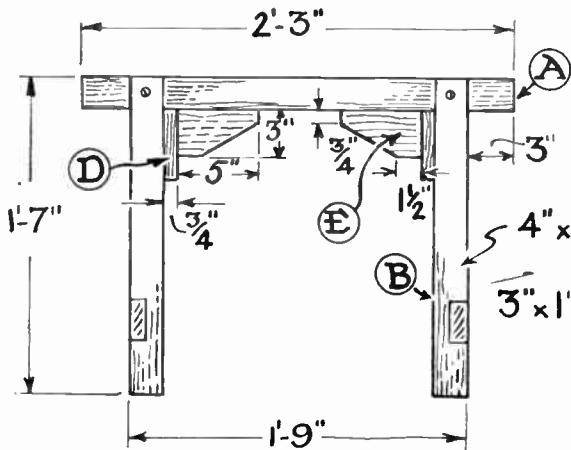

Fig. 1—Side elevation showing main parts

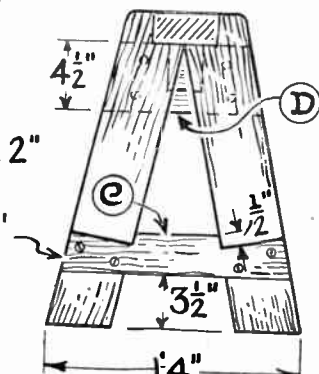

Fig. 2—End view and dimensions

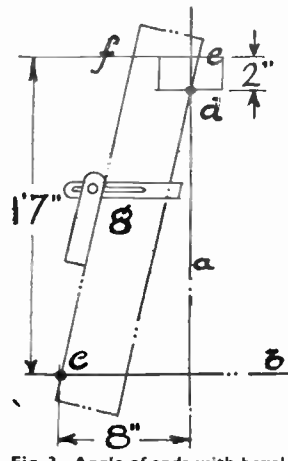

Fig. 3—Angle of ends with bevel in place

Economy in wood and a novel method shown in ANTOFRET CUTTING

SOME of our readers who have followed the pages of *Hobbies Weekly* for many years will remember the introduction and popularity of a type of wood-cutting called Antofret. In those days, both paper and wood were plentiful, and special designs and parcels were introduced for what was a popular procedure.

Unfortunately, restrictions of all material prevented the subsequent carrying on of this phase, and the coming of the war caused its disappearance altogether. But although the large designs previously published are impossible, the principle of the work remains, and the novelty and usefulness of it as explained here, will probably appeal to many who have not previously known of it or given it much thought.

Several Steps

The point is, that a single piece of wood can be made to provide two or three surface levels, and so make for economy, as well as usefulness. The matter is quite simply explained, and the owner of a fretwork frame or machine can easily try out his own experiments with pleasing results.

In the ordinary way, the fretsaw must

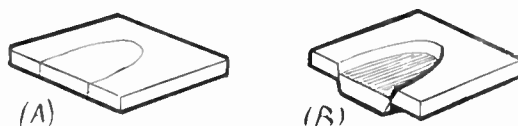

How the sloping cut makes a dropped piece

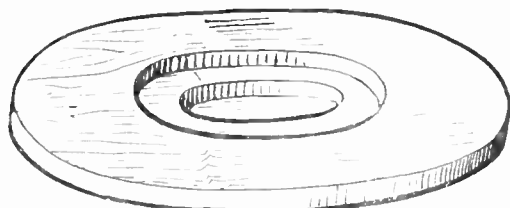

Three steps of wood from one piece

be maintained perfectly vertical in its cutting, so that any interior fret cut from a piece of wood can be pressed through either way. But imagine for a moment that you are cutting an inside circle in a piece of wood with the saw held slightly at an angle. You go right round the circle and then extract the saw in the ordinary way.

Cutting Angle

Instead of the wood, however, falling out either side, you will find that by pressing it through one way, it will stick and become wedged into the surrounding piece. The angle of the sawcut is very slight, and the nearer it is to vertical, the further the piece of wood can be pressed through.

Then, too, of course, the thickness of the actual wood makes a difference. If

you are cutting a thick, say, $\frac{1}{2}$ in. piece, then the projecting part pushed through and wedged can go $\frac{3}{4}$ in. outwards before it becomes fixed. The diagrams here show exactly what happens, and you can see how easy it is to make a second and raised surface from a single board.

It is impossible to give any definite angle of cutting because it will vary not only with the thickness of wood, but also with the grade of saw used. Obviously, if a coarse grade blade is doing the work, a much thicker line is cut away, and the wood will press through further.

The user of the handframe must be particularly careful to ensure exactly the same angle the whole time, otherwise the part pressed out will not meet its surrounding framework at all points.

At one time there was a special tilting table provided, which allowed that part to be sloped so that the upright saw was maintained in operation. If you find, however, with the ordinary flat cutting table that it is a little difficult to get the correct angle constant, then you may like to arrange a wide wedge of wood between the cutting table itself and the workbench which slopes the table at the required angle.

This as previously mentioned, varies with each thickness of wood, but the

variation is so slight that the table at the same angle is quite satisfactory.

Machine Workers

The machine worker, naturally, has an added advantage here in that he can actually tilt the table of the machine. It is held rigid by an arc of metal tightened to the underside by two wingnuts. Loosen these two wingnuts slightly, and then depress the table either to the right or left, and screw the wingnuts tight again.

Make your test cut in the same thickness of wood as you propose to use, and by trial and error, get the table at the right angle, finally tightening the nuts to maintain it at that the whole time. Another point to remember is that the direction in which you cut, will make the difference of whether the piece

cut out is pressed up or down. You can see this also in the diagrams herewith.

Up or Down

The saw cutting with the top sloping inwards, allows the work to be pressed up. The reverse angle, naturally, provides for the part to be pressed out downwards. Some people in cutting, work from left to right, whilst others take the reverse direction. It does not really matter which is done, providing the same direction is maintained throughout the whole operations.

Remember, too, that this type of cutting effects great economy in wood, because no part of it is wasted. Normally if you want, say, a small pin tray with a rim and a base, you have to cut two boards and glue them together. In this Antofret method, the same piece of wood is used, the base portion being merely pressed downwards to form the recess required.

Drill on the Line

Because of this using of the material, you must ensure the drill hole is made actually on the cutting line, and preferably at the angle at which you are going to saw. For the same reason, it is best to use a fine drill point, and a sawblade which is coarse enough to fill that drill hole. If you make a large hole and use a fine saw, then, obviously, the actual hole will be quite visible in the finished part.

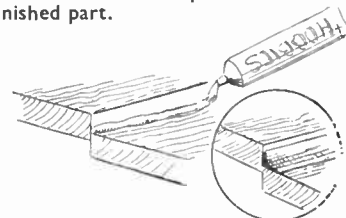

Glue run into the inside angle

Normally, if you cut out the interior work like this, it can be pressed through the main piece and there sticks very firmly. You can, however, if you wish, add a slight coating of glue along the edge of the two parts that meet, to make additional strength. If, too, you are using the cut parts in a base or something similar where the underside will not be seen, then you can run in a tiny ribbon of glue to the angle of the

(Continued foot of page 202)

A Craftsman's Notebook

A Fine Miniature Railway
BUILDING models interests people of all ages, in all walks of life, and in all parts of the world, as we see from the splendid examples of completed models frequently illustrated in these pages. In a newspaper I recently read of yet another fine piece of work accomplished by a Vicar. And from what I saw of it in an accompanying photograph, the model certainly looked realistic.

This particular model, a railway, contained everything one could wish for—though, of course, it is one of the fascinations of models of this sort that one can keep on adding extra touches till in some cases it could extend over the whole floor of an attic or spare room.

Besides trains, signals and electrically-operated points, further touches of realism included such buildings as cinema, post office, mill, and shops, in the vicinity of the station. While adjoining the railway itself there were the warehouses, engine sheds, and water tower. And I gather that there is still some further work to go into it.

Unusual Nesting Places

BIRDS sometimes choose most unusual places for their nests, and I have heard of eggs being hatched in an excavator, and a petrol pump, which were in actual use when the birds first started to build there.

Blue-tits, particularly, seem to favour awkward out-of-the-way places. While staying on a farm I went to try my hand at restoring an old water pump that had stood unused for a long time in a corner of the yard. Imagine my surprise when I started dismantling operations on finding a nest of young ones inside. Needless to say I postponed my attempts on the pump until the occupants, which turned out to be tits, were safely away.

On another occasion I saw a pair of tits making frequent journeys to and from a tiny crevice in the brick wall of an old building. So small was the entrance

Antofret—(Continued from page 201)

cut on the underside, as you see illustrated in the diagram here.

The usefulness of this work will be obvious if you give it a little thought. A three-step base to, say, a table lamp, can be cut from a single piece of wood recessed, braced with one or two rim pieces can be made (as shown above); double bases to hold a model can be cut from a single piece of wood.

Although we have previously mentioned a circle as being cut, there is little reason why various other shapes cannot be used. The circle or ellipse is the easiest, as it does not involve any

one would never have suspected there was a nest behind, yet the birds approached and entered at surprising speed. Each time they left they carried in their beaks a tiny bit of white stuff, which I think were bits of shell being carried away and dropped far from the nest so that no evidence of its presence would be strewn about the entrance.

Curing a Leaky Tap

WHEN a tap continues to drip after being turned off, the remedy is usually a new washer, the fixing of which has been described previously in these notes. Sometimes, however, the tap is in order in this respect, but water oozes

Design for a Model Transporter

THIS week's gift design is for making an attractive model of the Crane's Transporter from full size patterns provided. A kit of material (No. 2878) is obtainable from Hobbies Branches for 4/5 or post free from Hobbies Ltd., Dereham, Norfolk for 5/3.

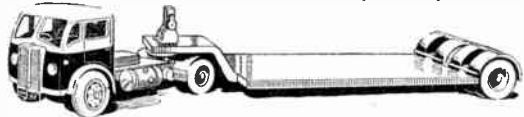

out at the top near the handle. In this case the stuffing box may be at fault.

You will see the 'stuffing box' just below the handle, and to get at the inside the circular nut with a milled edge will have to be unscrewed—gas-pliers will probably be necessary to loosen it.

Any old bits of stuffing inside this container should be poked out and replaced with fresh material. Soft thin twine well greased (tallow or lard will do) should be stuffed firmly into the box till nearly full. Then replace the metal cover, turn the water on and off a few times to settle the new material in place, and finally tighten the cap.

Early Days of the Cinema

IN 1903 a film called *The Great Train Robbery* was produced by Edison, with G. M. Anderson (Broncho Billy) in

the leading part. Though only a modest 800ft. in length (less than 15 minutes showing time) it was an important stepping stone towards the popularity of the cinema as a means of entertainment. For this was the first complete story film. Previously they had been of a news or scenic nature.

Movies were only beginning fifty years ago, of course, and even if pictures dithered and there was an appearance of 'raining' on the screen, the experience of seeing them actually move was new and marvellous. Well worth the 2d. it cost to go in.

As their entertainment and commercial value was realised it no longer sufficed to throw films in with music hall

turns as novelty items or dash them off in fairground sideshows. By 1902 cinemas began to open, the Nickelodeons (so called because of the Nickel admission) becoming popular in America. At that time an American innovation, known as Hale's Tours, was to equip the interior of the hall like a railway coach and show films taken from the front of a train. When the show started the hall rocked gently and the audiences had the impression of going on an actual journey.

Films, as well as cinemas, improved, and the next dozen years saw the beginning of the regular weekly news reels, the slapstick comedies which set audiences rocking in their seats, the thrilling serials which left the leading players in such a predicament at the end of each instalment the audience simply had to go the following week.

cornering. If you want angles at all in your work, get them as open as possible, such as shown in the tray above.

No Sharp Angles

A rightangle is comparatively simple, providing the saw is turned quickly at the corner, and, of course, maintained at its correct angle. Anything more acute than 90 degrees is not to be recommended. This type of cutting is also helpful if you want to have a little raised panel or a small decorative piece on a large object, and will save cutting and gluing a second piece of wood.

For this type of work you can even go a stage further and carve the raised piece to shape it for decoration of a leaf or a flower, or a geometrical design. When the cutting and gluing is completed, the wood can be finished in the normal way—either by stain and polish or paint, varnish, etc.

Having offered the suggestion and explained the method, we have no doubt, that many readers will try their hand at this novelty, and be able to introduce it into quite a number of articles to make either for use or decoration.

Some further suggestions for the handyman for HOME IMPROVEMENTS

KEEPING coal or coke in the flat is quite a problem and an inconvenience and a spare cupboard makes the ideal small coal cupboard. The first step is to bring the floor of the cupboard up a bit so you do not damage skirting and floor. Slope this downwards to the opening, as shown in the detail at

but first of all you must bring the pelmet structure out a little more. It cannot be too deep and probably 6ins. to 12ins. will do it. Build the framework like a roof, as shown, from $\frac{1}{2}$ in. tongued and grooved boards. Take it back 6ins. on either side, which will help to balance the shape of the bay better and not make it look shallow and long.

plete legs, this will be quite suitable. It does not matter if the back legs are bent and the front ones straight.

Clean up the side pieces and see all nails are removed. Small castors can be fitted to enable it to be pushed around. so everybody in the working party can use it. Paint or enamel it to make it attractive.

Now get the handy member of the family to make the deep pocket-like interior from gay cretonne or other suitable material. Note the pockets in the sides for smaller items. Use upholstery nails for fixing.

Two-tier Tray Stand

Greengrocers are selling some very nice shallow fruit trays. They are from good wood and can be cleaned up with the glasspaper block quite easily. Some are about 15ins. by 18ins. Get a couple of these, knock in the projecting nails and clean up. Reinforce the corners with a few light tacks, as they may come adrift when you start to cut away for the legs.

Get four clean square legs about 1 $\frac{1}{2}$ ins. in size and 20ins. high. Take the corners out of both trays so the legs will go through the top box and also through the bottom one. Have the bottom tray about 6ins. from the floor. Now fix together and you have a handy tray (Fig. 4) for the accessories, with a useful home below for the garments being made. Also, knitting and other sewing can be left here instead of being piled up on settee or easy chair.

If there is quite a bit of sewing, then fit a $\frac{1}{2}$ in. dowel rod along one side in screw hooks. Cotton reels are then fitted and you can see what colour you want and draw off as much as you need.

Castors can be fitted and the addition of pocket-like pouches on the end could hold other items such as oddments of wool. Pattern books can also be fitted up in a similar bag. A quickly-made box like a knife box will be handy for knitting needles, tapes and other items.

The worker may think of other ideas but the main function is to make it a self-contained mobile needle-work unit on four wheels. The larger the wheels the better, so that it can be used in the garden. (284)

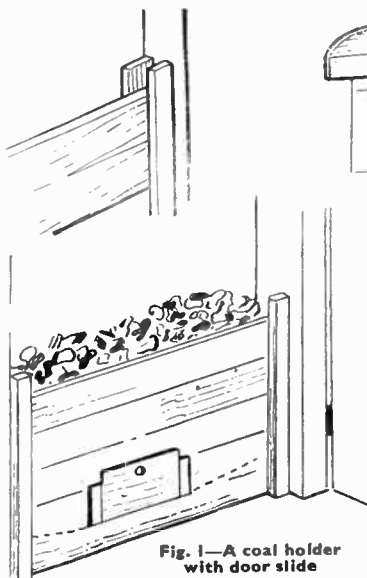

Fig. 1—A coal holder with door slide

Fig. 1. The floor need only be raised about 9ins.

At each side of the cupboard door, and allowing for the clearance of door, fix two uprights, as shown in the small sketch. Fix so there is sufficient space for the boarded front to be taken out. The boards for the front can be in two sections if space is limited.

Make the opening hatch just large enough to get the shovel in and level with the false floor of the bunker. Due to its height off the floor you will prevent dust and dirt spreading. Coal should be tipped in from the top.

Log Holder

For those in a flat here is a suggestion for storing a few logs ready for burning. Buy a medium sized tin bath with the handles at each side. Paint it in a gay colour of green or yellow and bind the handles with raffia or coloured cane. You can make a mottled effect to match the room furnishing by dappling it with a sponge in another shade.

Many of us have come across the not-too-deep bay window, but we feel that this is certainly the best place to have the favourite settee. To put the settee in and bring the curtains round and over, it does so spoil the effect and also the curtains. It never looks right and the whole arrangement looks untidy. Plan to make a light pelmet (see Fig. 2)

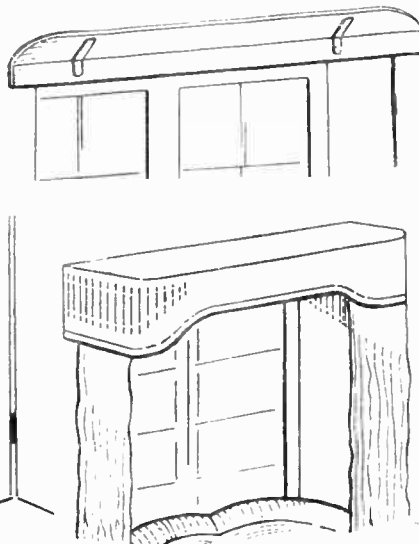

Fig. 2—Bracket and fixing for pelmet

Fasten a fixing board along the full length and then fit the new part to this. Small angle brackets will be best to hold the cross struts. Stain or paint the underside before fitting up, and then you will be able to fit the new type curtain railway to this. Make the pelmet about 9ins. deep and from thin plywood lined with parchment. Failing this, you can use fabric.

Simple Workstand

An old chair frame which can be no further use can form a good workstand (see Fig. 3), where you can see all the materials at a glance. As long as you have the four side sections and com-

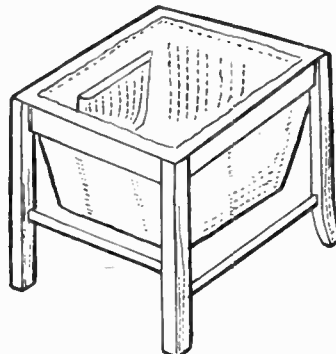

Fig. 3—A simple workstand

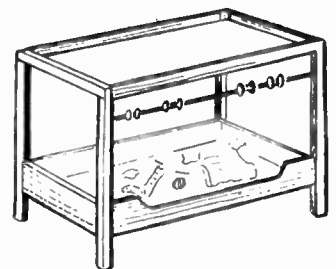

Fig. 4—A two-tier tray stand

The home carpenter should find no difficulty in A FIREPLACE SCREEN



A WELL made fire screen is an attractive feature in any living room. Even though it is most in use during the summer, the making of it, and especially the glazed tapestry centre (if desired), is essentially a job for the winter months.

The tapestry design and materials can be purchased at any reasonably well stocked needlework supplies shop. The design is usually printed in colours on the actual canvas, and a supply of coloured threads, together with needles and a leaflet of instructions, are usually included.

There are many handymen who would not disdain to do the tapestry work themselves, but, naturally, such work offers a fine chance for a lady, be she mother, lady friend or wife, etc., to co-operate.

Alternative Centres

It is not essential to have a tapestry centre, however. A picture or set of pictures can be used, to quote one alternative.

Such a job is best done in a good hardwood, such as oak or mahogany. The writer used mahogany taken from an old piece of broken-up furniture. Softwoods (deal) are hardly suitable.

The first thing to do is to make the stiles (part 1). These are of 1in. by $\frac{3}{4}$ in. section, and should be cut about 24ins. long. The $\frac{3}{4}$ in. width faces the front. The only part of the job that is likely to cause extra care and skill is in making a rebate (clearly shown in Fig. 5), which is stopped at point (X) 15 $\frac{3}{4}$ ins. from the top end. In

the case of the rails, parts 2 and 3, this rebate job is easier, as it is carried right through.

The Rebate

There are several ways of working the rebate. The writer prefers to use a small metal plough plane and making a groove, as shown in sketch (Y) (Fig. 5), working with the fence of the plane on the left, and using a $\frac{1}{8}$ in. cutter.

A marking gauge with the pin set rather more forward than usual is then used to score, rather heavily, a line $\frac{1}{8}$ in. from the bottom. Then, with the aid of a chisel, the waste is easily removed and the rebate is left as at (Z). If necessary, this may be cleared with a small metal bull-nose plane or a regular rebate plane.

In the case of the stopped rebate, however, as much as possible should be done with the plough plane as just described, and the rest shaped by chisel.

The Styles

Take great care, by studying the diagrams, to get the rebates of the two stiles facing inwards. The two stiles are not absolutely identical, but are, as engineers say, 'handed'.

The top rail (2) is just a 16 $\frac{1}{2}$ in. (finished size) length of 1in. by $\frac{3}{4}$ in. wood, with a $\frac{3}{4}$ in. by $\frac{1}{4}$ in. rebate running straight

through. As indicated in Fig. 5, when the fitting up is done, a small piece must be cut each end from the narrow part of the rebate on part 2.

Part 3 is a 16in. length of 2in. by 1in. wood. The straight-through rebate is first cut and then the arched shaping is done. The small sketch under Fig. 1 dimensions the shaping here. For a simple job this shaping can be omitted, but shaping makes the finished job more graceful.

Legs

The legs (part 6) can sometimes be bought ready cut, and if they are of a suitable size, they may well be used. Fig. 3, however, details by the well known system of squaring-up, a suggested shape, cut from 1in. thick wood, with the grain going somewhat diagonally if possible. The actual shape of one leg (four required) is shown stipple dotted. The rest of the diagram shows the position of the leg in the centre.

As can be seen from Fig. 2, the legs are fixed neatly to each side of the lower end of each stile and, if well done, the three parts look as though they were cut from one piece of wood.

One leg is simply screwed to the stile, as at (P) Fig. 13. To secure the other, a double-ended screw is used. Fit one part of it in the end of the stile (Q) (Fig. 3). Then press the other leg against it and turn this leg as though screwing up a screw-cap bottle. Add a little glue to the facing surfaces before you start.

The end of the stile is left with 1in. or 2ins. to spare, and when the glue is dry, shape the bottom arch, and with a finest plane, neaten up the base.

To shape the pieces, parts 6, use a

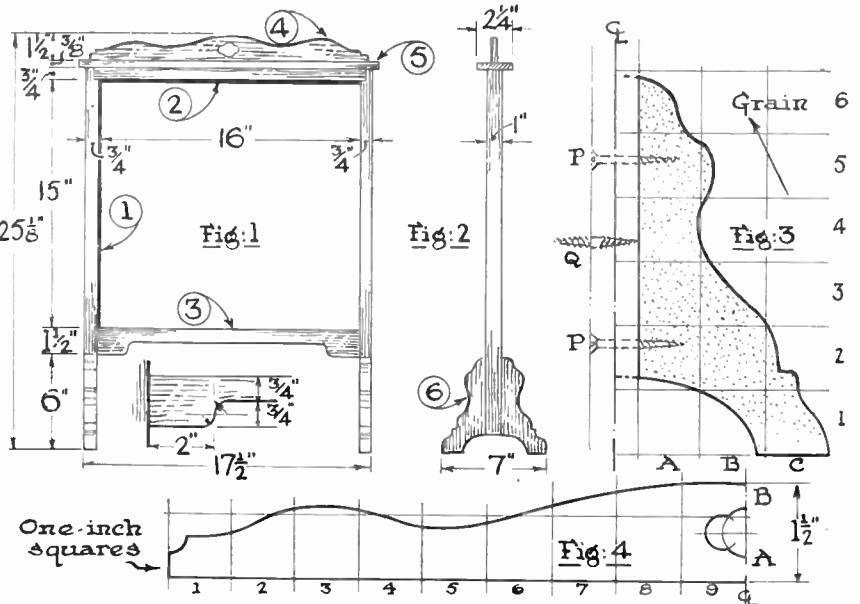

bowsaw or a toymaker's fretsaw. Part 4 also calls for shaping. A half pattern is shown in Fig. 4. Double a strip of paper. Draw the design on it, keeping the centre line (marked C.L.) on the fold of the paper. Cut with scissors, the shape so drawn. Open out the paper and you will have a perfectly symmetrical full size design. This part is accommodated on a strip of $\frac{3}{8}$ in. wood, 17 ins. by 1 $\frac{1}{2}$ ins. (finished size).

The centre decoration is done with $\frac{3}{8}$ in. and $\frac{1}{2}$ in. diameter bits in a brace.

Part 5 is just a plain strip of $\frac{3}{8}$ in. wood, 2 $\frac{1}{2}$ ins. wide and 18 ins. long.

Assembly

To assemble, fit part 4 to 5 by means of small screws from below. Fit rails 2 and 3 to the stiles. A screw must be used for fixing at each corner. Drive it well below the surface and neatly plug the holes with plastic wood, neatening off when dry.

Combined parts 4 and 5 are now screwed, from below, to rail 2. In Fig. 5 the parts have been shown 'exploded' and also conventionally broken, so as to economise in drawing space.

A general testing for squareness and uprightness, etc., now follows. Make

sure the screen stands on an 'even keel'. In the centre there should be a rebate into which the tapestry, etc., can be dropped. A plywood panel is now cut to fit into the 'well', and this panel can be used as a template for the glass.

A few small tacks at the corners will hold it, but take care that the weave of the canvas is not distorted. Thoroughly clean the inner surface of the glass. Then insert the glass and then the tapestry-mounted plywood panel.

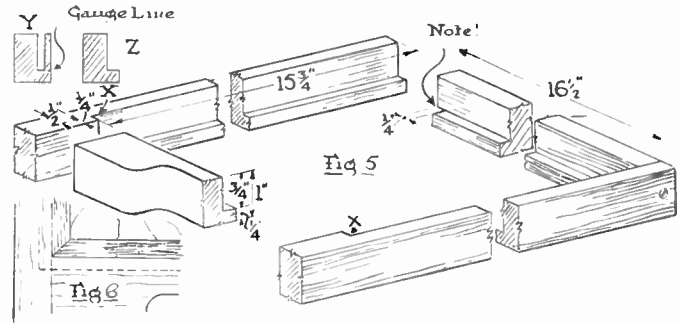

Make sure that the glass rests flat within the rebate. Some work with a chisel may be needed to prevent rocking.

This done, the job may be french polished. It is much more convenient to do it now than when the panel and glass are fitted.

The tapestry, suitably trimmed to size, is mounted on the plywood panel.

To hold the panel in, get some strips of approximately $\frac{3}{8}$ in. section strip wood and fit them in, as indicated in Fig. 6, with a mitre at the corners. Small panel pins are used to tack these strips in.

Thus one completes a well worthwhile job, the finished appearance of which can be gauged from the photograph.

Simple Toys from Scrap Wood

WE give here one or two illustrations which are almost self-explanatory. They are of figures which may be cut from workshop scraps of 3- or 5-ply. Fig. 1 is more detailed than the others, while Fig. 2 shows how the parts of the camel are made up, and the scale dimensions.

The other illustrations under Fig. 3 are offered in the nature of suggestions which may prove fruitful to the hobbyist's imagination. They all stand up and their limbs, heads and tails are freely movable.

The features of the camel are painted on here with poster colours. In the pig, which has a much larger (or rounder) head, the eyes, nose and mouth may be cut out and glued on separately. Painting will still be necessary but the general effect will be more attractive. If you

first stain the complete figures, by the way, this will serve as a very good painting foundation.

Small calendars, if desired for utility, are quite plentiful. The bow should be made from brightly coloured ribbon and tied as neatly as possible. A variety of different animals like this will decorate a Christmas tree or serve as little hand-outs for the New Year. (324)

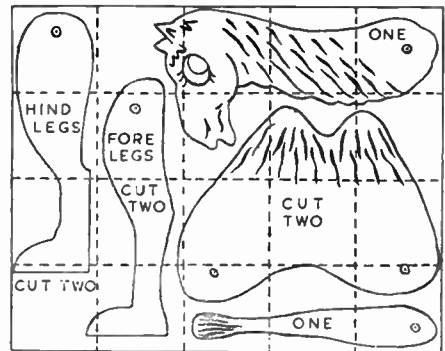

1" SQUARES
Fig. 2—Shapes to mark out in lin. squares

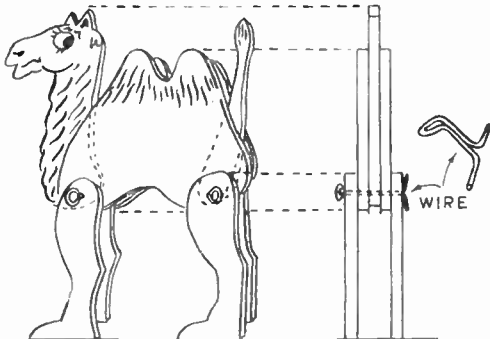

Fig. 1—Side and end view showing construction



Fig. 3—Some other simple suggested figures



IT'S New- but ANYONE CAN DO IT!

WRITE TODAY FOR YOUR KIT



PRINT YOUR OWN PHOTOGRAPHS ON SCARVES, TIES, HANDKERCHIEFS, GREETING CARDS, ETC., ETC.

With the **YANKEE PHOTO KIT** it's easy to make up to 150 perfect permanent prints from your own negatives on cloth, paper, cards and almost any surface. Simple and easy. Cannot harm fabric or negative. Send today for kit with complete instructions. **5/-**

Y.P.K. PRODUCTS COMPANY (Post 4d)
Major Size 8/6
688 Christchurch Road, Boscombe 3, Hants.

PLASTIC MARBLE

New Artificial Stone for casting Bookends, Ashtrays, Wall Vases, etc. Sets granite-hard with a scintillating crystalline structure closely resembling Alabaster. Enormously strong, highly resistant to heat, and impervious to water. Any type of 'natural veining' can be simulated in any colour.

FLEXIBLE MOULDS

Are easily prepared with 'Elastomould' Synthetic Rubber Solution. Sold in handy liquid form. Makes ideal moulds for casting Plaques, etc. Will faithfully duplicate the most minute details.

Send 1/- for full details of this easy, fascinating and profitable hobby. Money refunded to bona fide enquirers.

Dept. H.I. **KARLENA ART STONE CO.**
55 Deansgate Arcade, Deansgate, Manchester, 3.

BRITFIX BALSACEMENT

★ The ideal transparent cement for Balsa Ply Wood, Hard Woods, and Plastics, combining rapid drying with utmost tenacity.

Remember **STICK BY BRITFIX**

Small Tube Now 4½d.

Large Tube 7d.

THE HUMBER OIL CO. LTD., HULL

YOUR WORK WILL BE EASIER WITH A HOBBIES FRET MACHINE

For any type of light woodwork, toy making, model making or fretwork. Easy running, well made, a joy to use, a factory for output. Cuts wood, sheetmetal, plastic, card, leather etc., for 101 jobs.

70/- to £10

Particulars from any Hobbies Branch, ironmonger or stores, or from Hobbies Ltd. Dereham, Norfolk

Treadle or Motor

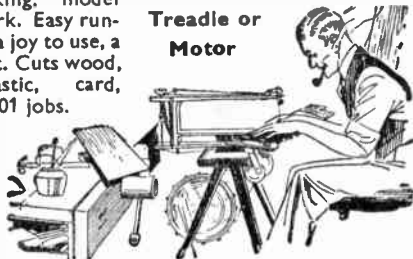

YOU CAN BECOME A HANDICRAFTS INSTRUCTOR

Experience not essential

Men who enjoy making things in wood or metal can turn their hobby into a permanent and interesting Career. Short hours, long holidays, and security in a job you would really enjoy, can be yours if you become a Handicrafts instructor. Let us send details of the easiest and quickest way to get the necessary qualification.

We definitely guarantee "NO PASS—NO FEE"

If you would like to know about our unique method of preparing you for one of these appointments, write today, and we will send you our informative 176 page Handbook—free and without obligation. Mark your letters "Handicrafts Instructor."

BRITISH INSTITUTE OF ENGINEERING TECHNOLOGY

595 Shakespeare House
Stratford Place, London, W.1

BIET

AMAZING ^{Ex. Govt} BARGAIN SIGNAL LAMP

In stout double-compartment waterproof steel case.

- 3½-inch lamp, for day or night use.
- Swivel base with metal screw-in stand.
- Viewfinder and reflector.
- Morse key-board. Fully wired fitted to folding lid.
- Adaptable as car, motor cycle or studio spot light and numerous other uses.

7/6

Post 1/3



Write for illustrated lists.

PRIDE & CLARKE LTD.

Dept. P.W., STOCKWELL RD., S.W.9. Phone: BRixton 6251

CYCLOP FLOODLIGHTING LAMP REFLECTORS



Fitted in cycle or inspection lamp they will floodlight the road or your work. No black centre. Wonderful difference. — And by using one in a front battery lamp and fitting same with light red glass you can also make yourself the most powerful rear lamp in the world. **LET THEM SEE YOU!** — Smashing! **BATTERY MODELS**, 8 or 12-sided for wide or bright beam, 1/6 **DYNAMO**, 12-sided, 2/6

From Halfords & all good cycle dealers or post 3d.
KORVING LTD. (HB2), 12 Duke Street, London, S.W.1



THE BOLSTER HOME WATCH AND CLOCK REPAIR OUTFIT



These precision jewellers instruments include watchmaker's magnifying eyeglass, finest watch tweezers, set watchmaker's screwdrivers, watch and clock oil, oilers, dusting powder, clock brush, plus illustrated instructional manual for the amateur. In container 12/9 post free.

Senior Outfit includes everything above, plus watch jewels, luminous compounds, dial renewer, jewellers rouge, explanatory book. Price 21/- post free.

BOLSTER INSTRUCTIONS, (Dept. H.W.), 5a Station Parade, Ashford, Middx.



BRANCHES

LONDON

78a New Oxford St., W.C.1
(Phone MUSEum 2975)
87 Old Broad Street, E.C.2
(LONDON Wall 4375)
117 Walworth Road, S.E.17

GLASGOW

326 Argyle Street
(Phone CENTral 5042)

Head Office & Factories—**HOBBIES LTD., DEREHAM, NORFOLK**

MANCHESTER

10 Piccadilly
(Phone CENTral 1787)

BIRMINGHAM

14 Bull Ring

SHEFFIELD

4 St. Paul's Parade

LEEDS

10 Queen Victoria Street
(Phone 28639)

HULL

10 Paragon Square

SOUTHAMPTON

25 Bernard Street

BRISTOL

30 Narrow Wine Street
(Phone 23744)

EVERY DAY

Use Sellotape for fixing labels 'for keeps' on tins of screws and nails, etc. — then you can spot the tin you want at a glance.

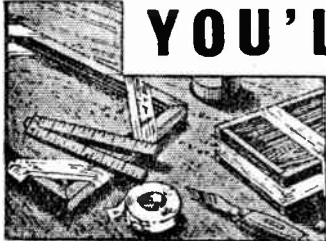

YOU'LL NEED

Use Sellotape to hold small parts in position while gluing. It's much quicker than string and just as strong.

SELLOTAPE

Whatever your hobby—Sellotape can help. It's self-adhesive, sticks at a touch, leaves no mark on wood or metal. Get some today—

BUT INSIST UPON SELLOTAPE

Stocked by all good Stationers



THE POPULAR
1/-
DISPENSER

G & O

new MARK II BENCH SAW

Introducing the vastly improved Mark II version of the popular Masco Bench Saw—best of the old features retained, but note new points gained from world-wide use by purchasers.

1. Solid base to avoid distortion.
2. Improved rise, fall and tilting adjustments with strengthened fixing lug.
3. Saw table 2½ in. longer, stronger ribbing.
4. Protractor Quadrant Angle Guide.
5. Thicker 6 in. diameter saw blade to prevent flexing under side pressure.
6. Adjustable fence of improved design with positive locating device.
7. Phosphor bronze bearings.
8. Ground Spindle.
9. Stouter three point mounting.

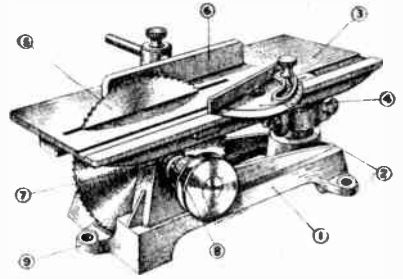

Note also that direction of saw now clockwise to take advantage of greater length of table and provide greater protection as saw now working behind the pillar supporting the table instead of in front of it.

What users say: '... a very compact job', '... a cabinet maker ... will do ... a lot of work normally ... have to do by hand', '... the saw a great help ... will rebate grooves, cut small tenons ...', '... I am pleased with it ... it will save a lot of time ...'

EASY PAYMENT TERMS 25/- Deposit with order and six monthly payments of 17/6. No references or guarantors required.

IMMEDIATE DELIVERY POST FREE

£6.6.0

MODEL ACCESSORIES SUPPLY CO.

The Aerodrome, Billington Road, Stanbridge, Nr. Leighton Buzzard, Beds.

GREAT NEWS!!!

GREAT NEWS!!!



Every model enthusiast is always on the look out for some new and particularly outstanding model to add to his collection. Here is such an opportunity for YOU. An exclusive and entirely original 'OO' 4 mm. scale model American Heavy Duty Freighter, which is amazingly easy to build up with the aid of our 'TRUKIT' Series No. 1 Truck Constructional Outfit. Not only does it make a really superb model, but is, at the price,

unrivalled. It is simple, realistic and foolproof. Other models will be following equally fascinating, so don't delay, start your 'TRUKIT' collection now. The demand is heavy and we do not want to disappoint you, so send P.O. to-day for 9/3 post free, to ensure despatch by return.

MURRAY HILL & CO., (Dept. H.)

MAIL ORDER HOUSE, BEDFORD SQUARE, SIDMOUTH DEVON

STOP SMOKING

You can overcome the smoking habit in 3 days with the Stebbing Anti-Smoking treatment—or money back. Safe, pleasant, permanent. No Will Power necessary. The ONLY scientific method. Improve your health and save pounds. J. Conroy (Tipperary) writes: 'I stopped smoking in 2½ days. I've better health now'. E.F. writes: 'I had been an habitual smoker for 19 years. It is 19 days since I had a cigarette and I certainly shan't start again now'. T.R.: 'I have no longer the wish to smoke and feel 100 per cent better in health'. Not a physical culture course. Amazing results. Complete Course 6/- (or \$1.00 bill).

Details 1d. Sent under plain cover.

STEBBINGS, 28 (H/88) Dean Road, LONDON, N.W.2.

Established 1928

MODEL CRAFT LIST for 1951

1/- Post Free or from your dealer.



Galleons, clippers, strange craft, sailing yachts, power boats, war and merchant ships, aircraft, railway and roadside features, cars, lorries, trams, buses, etc., etc.

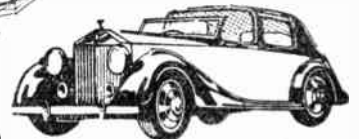

1/- REFUND VOUCHER is enclosed in every copy of the list for use when ordering Modelcraft goods from the list.

MODEL CRAFT LTD.

77 (F), GROSVENOR ROAD, LONDON, S.W.1

One plastic material

MAKES MANY PERMANENT

MODELS and utility objects, from simple instructions in illustrated Booklet—please read below.



ONLY 4D
IN STAMPS
BRINGS BOOK

... showing how such models as those above, and many others, can be made, without skill or special tools, from Sankey's PYRUMA Plastic Cement. Ready for immediate use in its plastic state, Pyruma sets or bakes to stone-hardness, and can be painted or enamelled in all colours according to instructions.

Pyruma is inexpensive, and easily obtainable in tins from Ironmongers, Art Material Dealers and Hobbies Shops. Send 4d. in stamps for illustrated Instruction Book.



J.H. SANKEY & SON, L^{TD}

ILFORD

Est 1857

ESSEX

Give a Wolf ELECTRIC SOLDERGUN

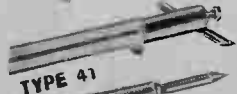

TYPE 41

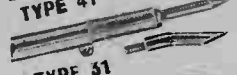

TYPE 51

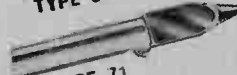

TYPE 71

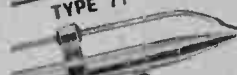

TYPE 51

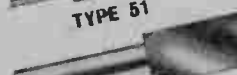

TYPE 81

OFF-STRAIGHT EASY-GRIP HANDLE
PERFECT CONTROL
QUICKER HEAT-UP
LOCALISED HEAT
LOW CURRENT CONSUMPTION
MAINTAINS CORRECT HEAT
A MODEL FOR EVERY PURPOSE

Write for **FREE** illustrated technical literature with full descriptions of each model, its range of applications, and the features which make these fine Wolf solderguns the best value ever offered.



TYPE 21

from all leading tool merchants and factors



WOLF ELECTRIC TOOLS LTD
HANGER LANE, LONDON, W.5

Telephone: PERIVALE 5631-4



BROOK
Cub
FRACTIONAL H.P. MOTORS

THE ECONOMIC
"FRACTIONAL"

Standard Motor without feet

For every purpose in the small home workshop use a **BROOK "CUB"** $\frac{1}{4}$ h.p. motor. Single or split phase.

Electric motors from 0.25 to 200 H.P.



EMPEROR WORKS

HUDDERSFIELD

L.H.M.150

The bristles won't come out!

Harris—the paint brush with a name to its handle



There are three ranges of Harris Brushes: "Junior" (Red tipped handle) good; "Standard" (Brown tipped handle) better; "Super" (Rosewood handle) best.



L. G. HARRIS & CO. LTD., STOKES PRIOR, WORCESTERSHIRE

CRG 25

Imported by **BALDING & MANSSELL, LTD.**, London and Wisbech, and Published for the Proprietors, **HOBBIES LTD.**, by **HORACE MARSHALL & SON, LTD.**, Temple House, Tallis Street, E.C.4. Sole Agents for Australia and New Zealand: **Gordon & Gotch (A'sia) Ltd.** For South Africa: **Central News Agency Ltd.** Registered for transmission by Canadian Magazine Post.