

# Hobbies

## WEEKLY

### CONTENTS

	Page
A Rocking Horse - -	1
Model Harvester - -	3
Handyman Gadgets - -	4
A Witch Bowl - - -	5
Knitting Holder - - -	6
Working Model Pump	7
Electrical Reversing Switch	8
Furniture Conversion -	9
Jig-saw Puzzles - - -	10
Newspaper Rack - - -	11
Doll's House Standard Lamp	12
Stamp Collecting - - -	13

October 4th, 1950

Price Fourpence

Vol. III No. 2866

## A MECHANICAL ROCKING HORSE

**T**HIS design of rocking horse is of the safety pattern, and of simplified construction, at least the horse portion is. The completed job would make a welcome present for any youngster, and comparatively inexpensive to make, especially considering what the commercial article would cost to buy now. There are no difficult joints to battle with, nothing that any amateur woodworker need fear to tackle.

### Floor Stand

A front and end elevation of the stand are given in Fig. 1 with most of the dimensions. Any sizes of timbers not given will be found in the cutting list at the end of the article. The floor framing consists of one long member, with two shorter cross ones. These are cut from 1in. thick deal. The cross ones are nailed to the long member at 6ins. in from each end.

Fit across at true rightangles and position the nails to leave 1in. square at the centre of the joints free—here a mortise is to be cut to receive the posts. Cut the mortise 1in. square through both. The work of cutting these through can be much simplified by boring a 1in. hole through first with a centre bit to remove most of the wood.

### End Posts

The posts are cut from wood 3ins. square and are sawn at their bottom ends to form 2in. long tenons to fit the mortises. At each end of the long floor member glue and nail 2in. wide strips of 1in. thick wood. The detail sketch (C) in Fig. 2 explains the above details.

Now glue the posts in position and strengthen these parts with a steel angle bracket to each post, as shown in Fig. 1. Some strain comes on the posts when the rocking horse is in use.

Across the top of the posts nail a board of 1in. deal, 3½ins. wide, as at (A). On this the rocking irons, now to be dealt with, are fitted. The irons are bent up to the shape shown at (D) in Fig. 2. from round iron rod, ¾in. diameter.

Some readers will probably be able to bend these up themselves, but those

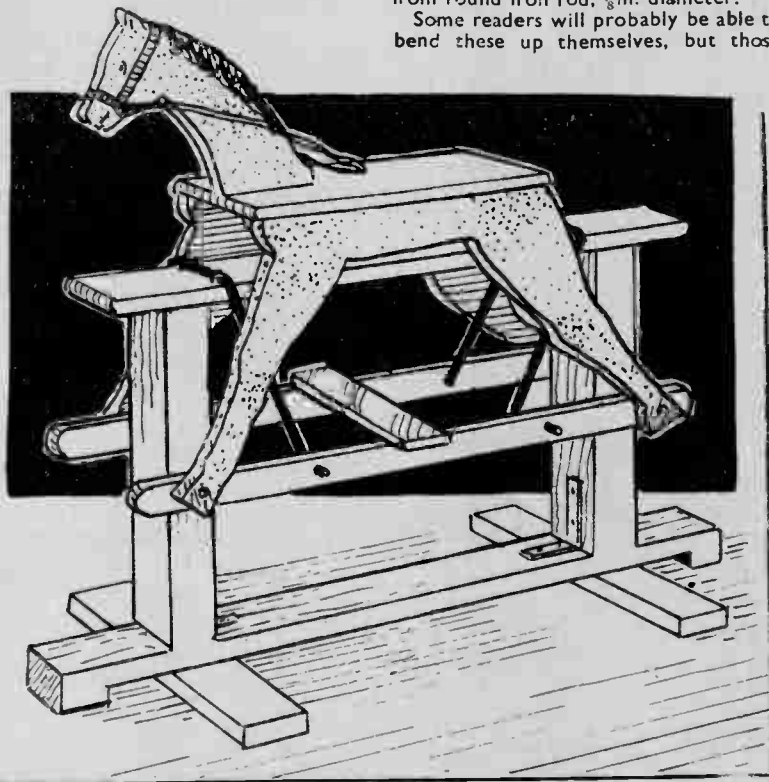

All correspondence should be addressed to The Editor, Hobbies Weekly, Dereham, Norfolk.

doubting their ability, or perhaps lacking the tools, would be better advised to get them shaped up at a local smiths, or iron works. They must be accurate as to dimensions. They are fitted on board (A), at about the positions shown in the side view of the stand.

They must be fitted to swing quite freely. The usual fitting to allow of this is made of sheet iron or brass, bent over the iron rod, U shape, with a flange each side for screwing to the board. An

The parts of the horse are shown drawn over 2in. squares. About the simplest method here is to draw the requisite number of 2in. squares on a sheet of cartridge paper and then copy the diagram as accurately as possible, full size. Cut the parts out with scissors, lay on the wood and pencil their shapes on by running the pencil round. A soft pencil is best for this job. The parts can be cut out with a bow saw, or keyhole saw.

position. The sides, with legs fitted on, are then glued and screwed underneath the seat board where shown by the dotted lines. Glue the head in position, screw underneath through the seat board into the head above, one screw each side of the tenon.

Between seat board and side glue

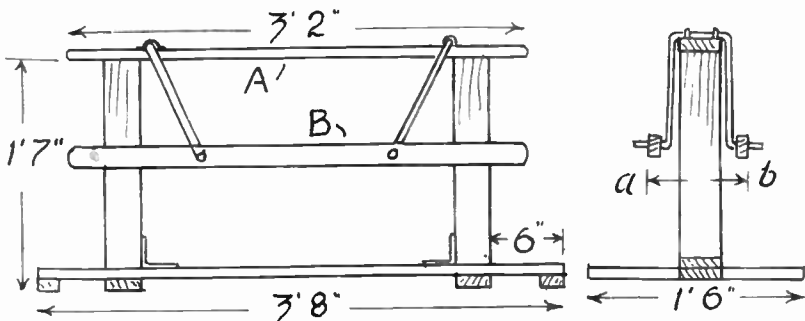

Fig. 1—Side and end view with helpful dimensions

**CUTTING LIST**

Floor member—1in. by 3ins. by 3ft. 8ins.  
 Floor members (2)—1in. by 3ins. by 1ft. 6ins.  
 Posts (2)—3ins. by 3ins. by 1ft. 7ins.  
 Board A—1in. by 3½ins. by 3ft. 2ins.  
 Strips B (2)—1in. by 2ins. by 3ft. 2ins.  
 Seat board—1in. by (?) by 1ft. 11ins.

**FOR THE HORSE**

1in. by 9in. board. 7ft. run.  
 ½in. round metal rod for rocking irons, about 5ft.  
 One pair 5in. steel furniture brackets

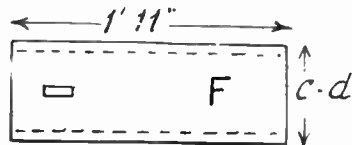

alternative fitting here would be a pair of iron staples to each, driven over, not of course tightly, but loose enough to allow of a free swinging movement to the irons.

At the lower ends of these a wood bar each side, (B), is to be slipped on. These can be 2in. wide strips of 1in. wood, with holes for the irons bored in at the spots shown, some 11ins. from each end. Across these nail a footboard, 4ins. wide and about 12ins. long. Parts (B) should now swing easily at a push without scraping against the posts. Get this satisfactory.

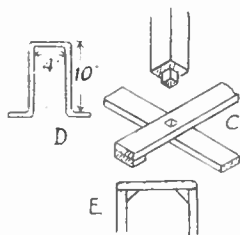

Fig. 2 Post and rocker details

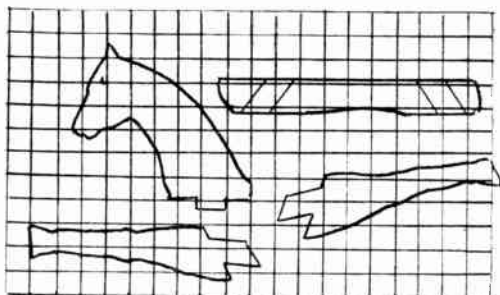

Fig. 3 Outline of horse's head and legs

### The Horse

Now for the horse. Quite a plain affair this requiring no intricate carving, or building up. First cut the seat board, shown at (F) in Fig. 3. This is cut from 1in. board to the length given.

For the width (c - d), measure across the rocking strips, as shown in the end view, Fig. 1, the actual distance (a - b) being taken, and the thickness of wood to be used for the legs, etc. being added to it. For instance, if a - b measures 7ins., and 1in. wood used for the legs, etc., then width c - d will be 9ins.

Place the horse's head on the seat board and pencil round the tenon on its lower end. Chisel out the mortise and see a tight fit ensues. The legs are to be grooved into the side pieces shown above them in the drawing. Lay the tenons of the legs at the angle shown by the cross lines on the sides, and run a pencil along the edges to mark the exact width of the tenons on the side pieces. Here saw and chisel out grooves across to half the depth of the wood.

Reduce the tenons on the legs to half thickness and glue and screw the legs in

triangular strips of wood to strengthen this part, as seen in detail sketch (E) in Fig. 2. This completes the horse portion, so far as the work of construction comes in, which should be screwed to strips (B).

### Cleaning and Painting

The stand and horse can now be cleaned up and painted. Any nails should be punched well home and stopped. The stand can be painted, or varnished as preferred. The horse should be painted in either case, brown or grey, the latter colour is usually preferred. A little refinement can be added here by first painting the horse white, or very light grey, and then stippling it in darker grey in patches.

Add the harness over the horse's head, which can be just narrow strips of American cloth, and a pair of reins of leather to grip hold of. A strap, as used for fastening down luggage, would make quite excellent reins. Paint or enamel the metalwork black. If you can find a strip of fur, glue this to the horse's head for a mane. Details of the features, by the way, can be put in in black with a fine brush.

An excellent finish to the horse is a coat of clear varnish, and of course, an upholstered pad for a saddle can be added as a finishing touch.

### Useful Gadget

SOME readers may like to know of the following useful gadget for holding cloths in the workshop or garage. Take two pieces of 3-ply 1½ins. wide by whatever length you want. Hold them together and cut holes 1in. in diameter and ½in. apart in the middle of the width. Take a piece of motor car inner tubing and glue it firmly between the 3-ply pieces and nail all three together. With an old razor blade, cut ¼in. slits at rightangles, in each visible disc of rubber. Mount the whole on blocks to keep the rubber 1in. or so off the wall, and the job is done. The cloth is pushed into the

hole through the rubber with the finger and when the latter is withdrawn, the

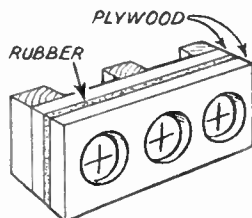

cloth sticks firmly in place. It is quick, easy, and does not tear the cloth.

# There is really nothing difficult in attempting A MODEL HARVESTER

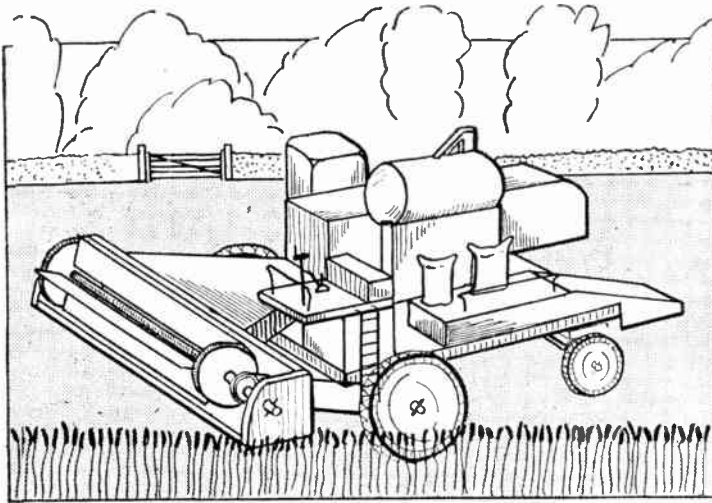

**T**HE interesting addition to our farm set shown here will need no introduction to those of our readers who live near the corn-growing parts of the country, or to those fortunate enough to spend some of their holidays there at harvest time. Originally brought over here from the vast prairie-farms of America, these huge harvesting machines are now coming more and more into use here, so that no model farm set is really complete without one.

They are, indeed, a fine sight to watch, as they roar round the field, not only cutting the growing corn but threshing the grain out of it at the same time, so enabling the modern farmer to accomplish as much work each day as formerly took much longer. Apart from helping to ensure our food supply for the next year.

## How it Works

There are, of course, a number of different kinds of combine-harvester now being used, and our little model is based on one of the most usual patterns. This type of machine is self-propelled with a powerful petrol engine. As it is driven round the field the corn is pushed down to the cutting knives by the sails (or 'reel' as the farmer calls it) and is carried up an elevator to the threshing box.

From here the corn and chaff are carried by another elevator up to the bagging and sorting drums, whilst the straw is delivered out at the back of the machine. On the bagging-up platform stands another man who manipulates the sacks and as each becomes filled with corn or chaff he pushes it off the machine down the delivery chute.

## General Construction

These various parts are shown on the general plan, at Fig. 1. Our little model cannot, of course, copy all the intricate pieces that go into the making of these big machines; but a lifelike appearance is added to the finished model by the reel revolving as the toy is pushed along. Most of the pieces are cut from the solid and glued or screwed to the base. The construction is quite simple, and none of the pieces is larger than can usually be found amongst the handyman's offcuts from larger work.

## The Chassis

The carriage itself consists of a piece of board 5ins. long and 4ins. wide. It will be seen from Fig. 2 and Fig. 3 that the larger pair of wheels is at the front, on a

fixed spindle. The smaller pair are at the back, and are on a loose frame for steering which is held to the base with a nut and bolt. If rubber-tyred wheels are available, these give a good finish to the model; but quite a realistic imitation can be made with wood if diagonal cuts are made round the edges, to suggest the tread of the tyres, and the outside  $\frac{1}{16}$ in. of each wheel and the edges are painted black to look like rubber.

## The Threshing Box

The body of the threshing box is made from a block  $4\frac{1}{2}$ ins. by  $1\frac{1}{2}$ ins. by  $1\frac{1}{2}$ ins., as shown at Fig. 4. About half-way along its length a piece  $\frac{1}{2}$ in. wide is sawn off, and the two top corners at the back are rounded off. This rear part forms the cover for the straw-delivery machinery.

An elevator is cut L shape from a piece  $2\frac{1}{2}$ ins. by  $\frac{1}{2}$ in. and held to the main block with glue or screws. Note that the short return end is pointing down slightly, since this has to meet the top of the bagging drum.

## The Engine House

The Engine House is cut from wood 1in. by 1in., and is  $2\frac{1}{2}$ ins. high, as shown at Fig. 5. The four top corners are rounded off, and later, when we come to the important work of painting the model, the radiator is painted in with black paint, on one side, as shown.

## The Control Seat

Fig. 6 shows how the control seat is fixed up. It consists of a 1in. cube, a strip glued on top  $1\frac{1}{2}$ ins. by 1in., and a piece for the seat 1in. long of  $\frac{1}{2}$ in. by  $\frac{1}{2}$ in. With a little ingenuity and a length of stiff wire a little rail, a ladder, and the gear handles can easily be made up, and fitted into holes drilled in the blocks. A

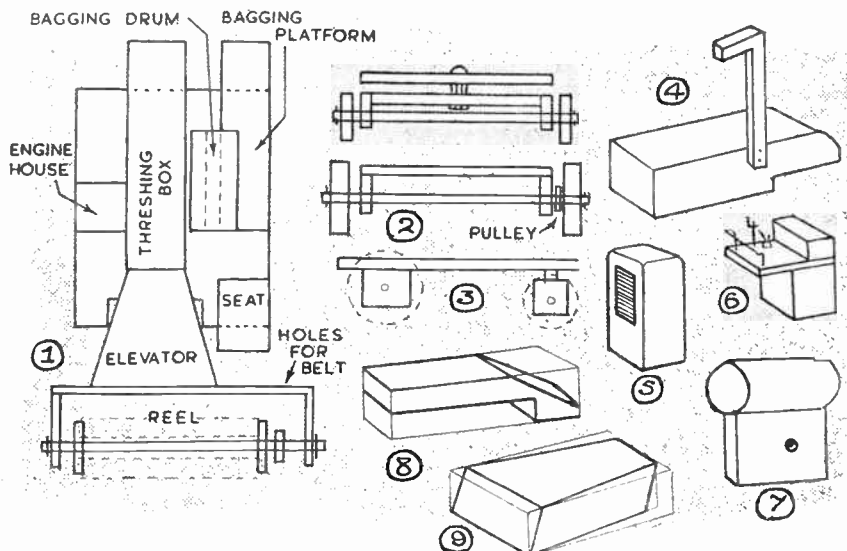

little more of the wire, with a disc of thin metal, forms the revolving handle, by which means the operator raises and lowers the reel and cutting blades at the front of the machine.

### The Bagging Drum

Two parts form the bagging drum, as shown at Fig. 7. The base is a piece 2ins. by 1½ins., about ½in. thick, and the top piece is a 2in. length of 1in. dowel. The dowel is grooved to allow the base to fit into it a little, and at the back the top is cut away slightly to allow the L shaped piece of the threshing box to fit into it.

The bagging-up platform is made from a piece 1in. by 1in. and is 4ins. long. The cutting out is quite simple, as shown at Fig. 8. Two little rails, also made from the stiff wire, are fitted into holes drilled in the block. A realistic touch is given to the model by making one or two little sacks and filling them with sand or sawdust, to stand on the platform, as shown in the sketch of the finished model.

### The Reel

We now come to the reel and elevator, which is in three parts. The revolving part consists of a piece of ½in. dowel, two discs 1in. in diameter glued on the dowel, and four pieces of stiff card, to form the sails, glued into slits cut in the discs. The housing for the

reel is made from thin plywood or stout cardboard.

The elevator casing (that carries the corn, when it is cut, up to the machine above) is made from a block 3ins. long,

CUTTING LIST		
No. of Pieces	Size	Description
1	5" x 4"	Base.
2	Discs 1½" diam.	Front wheels.
2	Discs 1" diam.	Rear wheels.
2	1" x 1" x ¼"	Front wheel supports.
2	¾" x 1" x ¼"	Back wheel side supports.
1	3¼" x 1" x ¼"	Back wheel top support.
2	5¼" of ½" dowel	Carriage spindles.
1	4¼" x 1½" x 1½"	Threshing box.
1	2½" x 1" x ½"	Threshing box elevator.
1	2½" x 1" x 1"	Engine house.
1	1" x 1" x 1"	Seat block.
1	1½" x 1" x ½"	Seat, horizontal.
1	1" x 1" x ½"	Seat.
1	2" x 1½" x ¼"	Bagging machine base.
1	2" of 1" dowel	Bagger top.
1	4" x 1" x 1"	Bagger platform.
1	6" of ½" dowel	Reel spindle.
2	Discs 1" diam.	Reel ends.
1	1¼" x 1¼" x ¼"	Reel housing sides.
2	5" x 1¼" x ¼"	Reel housing base.
1	5" x 1" x ¼"	Reel housing back.
1	3" x 2¼" x ¼"	Reel elevator.

2½ins. wide and ½in. thick (Fig. 9). The ends of this piece are then cut on the slant, to the extent of ½in. and it is

glued one end to the reel housing and the other end to the front of the block that forms the threshing box.

To get this into position it is necessary to cut a piece out of the front of the base board, as shown, just wide enough for the elevator case to rest in.

### The Drive

It will be seen that the reel is not quite in the centre of the reel housing. This is to leave room for a pulley wheel on the same spindle, from which a belt of cotton or thin string connects it to another pulley wheel on the front spindle of the chassis, as shown at Fig. 1.

Unless special pulley wheels that will fit the dowel-spindles are available, it is usually easiest to make them up from three thicknesses of thin wood or cardboard. In this way a good deep groove can be provided, and if the two pulley wheels are lined up carefully before being glued into place, there will be no trouble with the belt coming off when the model is pushed along.

One of the things that makes the sight of these big machines at work so attractive, is the very bright colours in which they are often painted. So model-makers who are handy with a brush can really let themselves go with bright red, blue, or yellow, not forgetting to outline each piece of the machine with neat black lines about ½in. from the edges. (250)

### Small Clothes Aider

THIS is another gadget that will appeal to the ladies. The cross bars are each about 2ft. long, and about 1in. by ½in. section. You can buy the laths already cut to size, and they only want sanding.

A brass screw-eye is put in the centre.

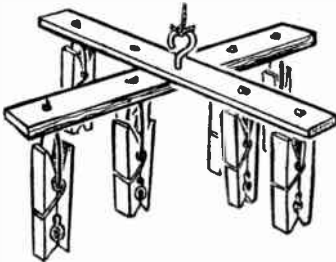

It is a good idea to place a small wooden draughtsman taken from some cheap set, under the lower lath, and drive the screw eye into this as well, so that the lower lath does not work loose.

The pegs are simply tied on, holes being drilled in the laths for this purpose. This is a useful gadget for drying stockings and gloves.

### Just like the Picture

THE pictures on the fronts of seed packets are certainly highly attractive and guaranteed to buoy up the hopes of amateur gardeners. Usually the seeds are planted and the empty paper packet

is stuck on a stick at the end of the seed row, to get rotted away by sun and rain.

One gardener saves all his seed packets and trims them neatly so that he has two panels—one with a picture of the plant and the other with the printed instructions (on some of the latest packets there are additional notes referring to the food value of the plant, with recipes in the case of unusual vegetables).

These are pasted neatly in a book—a loose-leaf one so that one can arrange the names of the plants in alphabetical order.

The result is, in effect an encyclopaedia of plants, with cultural directions and lovely pictures in colour.

### A Useful Stool

A BOY Scout Commissioner once told the writer of these notes 'Scout H.Q. and Rover Dens seldom have decent chairs.' The making of a chair requires the use of a bench fitted with a good vice, also some large cramps. These facilities are often lacking to amateurs who, too, may also lack the skill to tackle the making of a chair.

Why not make a stool? A dozen, in fact. An honest-to-goodness plain stool with a 'backwoods' look. First obtain a piece of tree trunk, about a foot in diameter, and with a cross-saw cut off neat slices 2ins. thick. If you do not know how to use a cross-saw now is the time to find out. It brings out those biceps! If you have no means of sawing the log yourself, a local sawmill will do the job cleanly and fairly cheaply.

The legs are about 1½ins. diameter, with the lower ends rounded off. The most important part is fixing the legs to the top. This is done by what is known as 'fox' wedging. If it is done well, it is impossible to get the leg out again. With an auger, about 1in. diameter, bore a hole about two-thirds of the way through the top.

Now taper the tops of the legs so that they fit the holes a trifle on the loose side, but not too much. Make a little wedge, and cut a slit in the top of the leg, a trifle too small for it. Obviously when the whole lot is assembled and driven well and truly home, the wedges expand and cause the leg to grip tightly. If your wedge is too tight, however, it will split the top of the stool.

In order to be kind to the seats of trousers, you might try upholstering the tops of the stools or covering them with leather.

If you are unable to obtain a suitable log, a thick piece of planking will be quite suitable. Your first few stools will probably be rather rough, but eventually you will recapture that pride of craftsmanship that the machine age has not yet killed.



# A novelty attraction you should attempt is THE WITCH BOWL

**H**AVE you ever heard of a 'witch bowl'? Well perhaps not, but it is an intriguing little novelty for an occasional shelf or mantelpiece which any handy person can put together, especially if of an artistic bent. 'Witch Bowls', too, make good presents.

The photographs on this page show both sides of a completed bowl. The general idea is that there is a round top upon which there has been painted a small series of flowers, leaves, or even a tiny scene. Looked at from the painted side the effect is quite neat and attractive, but when the bowl is reversed, and you view the design *through* the round top, a vastly magnified impression is given.

## A Long-neck Flask

The amount of magnification is almost startling and if the scene, or whatever it is, has been really carefully executed, the impression is produced of looking into a little wonder world hidden away within the bulb.

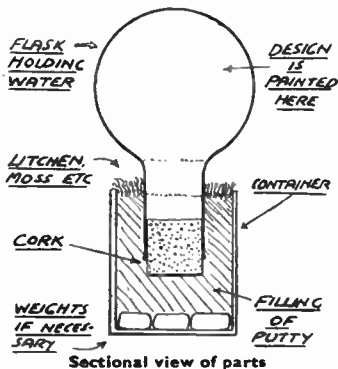

Now as to making one of these novelties. The top round section or bulb is one of those fairly long-necked flasks which can be bought for chemistry work from dealers in such equipment. Should you not know an address the Editor will be able to help in this respect and give you a dealer's name.

These flasks are made in a whole range of sizes and the particular dimension you use is a matter of choice, but a flask with a diameter of 2ins. to 3ins. is very convenient to work with and does not look too big amongst surrounding ornaments.

## Filled with Water

Magnifying power is given by filling the flask right up with perfectly pure water, the neck then being stoppered with an ordinary, but tight-fitting cork. The flask is held inverted in the lower container, which may be any neat jar, by a surround of putty finished off on top with lichen (or similar green stuff) intermixed with some bright pebbles.

This container must of course be

stable enough to hold the flask firmly without danger of its tilting over and therefore should not be too light or have a too small base. Great stability if necessary can be given by placing a few lumps of lead in the bottom of the jar before putting in the putty and stones.

Now about painting the design. Transparent oil paints only should be used, as when the bowl is viewed from the magnifying side the brilliant colours, which are half the charm, are given by the light shining through the design. Transparent oil colours in small tubes can be obtained from any artist colourman. For putting on, the pigments are thinned with a medium like Canada Balsam which makes the colours 'take' well on the smooth surface and not run into blobs.

## Decoration

The finest of brushes should be used and some readers might find it convenient to work looking through a reading glass. Draw out the design first on a piece of paper and experiment with sunflowers and bulrushes and the like, till a satisfactory lay-out has been obtained.

Should you not be too good at painting, a scrap or tiny piece cut from a greeting card can be pasted to the glass, face in.

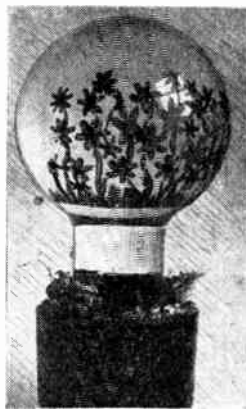

The painted front



Magnified pictures on the back

This leaves the plain paper back looking out and on this another scrap of the same size is pasted—facing out. Viewing through the glass, the inner scrap will be seen greatly magnified, but of course much darker than with painting as the light will not be coming through the colours.

If sending a witch bowl as a present through the post, care must be taken in packing. Padded round about they will travel all right in a strong box, but if you have any doubts try and deliver the completed bowl yourself, if at all feasible.

## A Reader's Double-Size Galleon

**N**OT an ordinary replica of the famous 'H.M.S. Bounty,' although made from the patterns of our popular design. You see, its maker, Mr. R. J. Abbott of Lower Castle Road, Gibraltar, built it double the size given in the plans, and is the sixth model made from our designs, in 18 months. Mr. Abbott gives the hint that small washers from an old piano make excellent pulley blocks, when filed round the edge. So if you have an old piano handy—



# An ideal gift to make for a lady friend is this KNITTING HOLDER

**T**HIS is a really handy article which will be greatly appreciated by the women-folk of your home—a holder and carrier for any knitting that may be in progress. It is quite simple to make and forms an ideal gift for any lady.

The sketch of the completed carrier gives a very good idea of how the finished article looks, but there is some choice in size. The dimensions given are for a 15in. holder, but the writer has seen one of 17ins. made with every success. Quite a big number of knitting-needle types will fit snugly into a 15in. length.

## Main Portions

To make, first required are the two ends as (A), Fig. 2. Cut from any pieces of nice wood,  $\frac{3}{4}$ in. thick, they are  $4\frac{1}{2}$ ins. by  $3\frac{3}{4}$ ins. and have the corners rounded to a curve of  $\frac{1}{2}$ in. radius. The marking out of the corners is done by feeding a halfpenny up to them and drawing round it—a halfpenny being just 1in. in diameter. The detail at (B) shows one of the finished ends.

Next comes the main body of the carrier (C). This is originally a rectangle of card cut to 15ins. by 17ins. upon which is firmly glued a covering of leatherette.

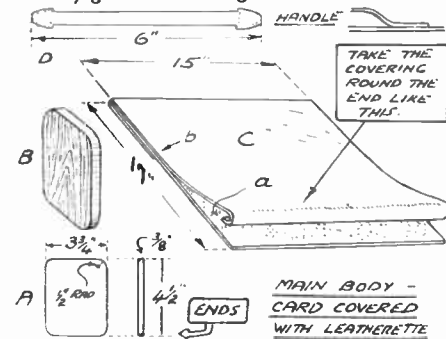

Fig. 2—Detail of parts needed

Or you can use some similar tough, but thin and pliable material. It is good if this material can cover both sides, but as a minimum it must entirely cover one side of the card and be caught round the one end as (a) and taken 7ins. round the other as (b).

The correct preparing of this composite sheet is really the secret of making a good carrier. Plenty of fairly weak glue must be used for affixing the leatherette and it has to be well rubbed into the card (and on to the back of the leatherette) to temporarily make the sandwich dampish throughout.

When the gluing has been done (a flat brush being best for this) the leatherette is stretched over the card and the composite sheet is put for a little time under pressure. It is then watched carefully and taken from the pressure for fitting just before it is completely set and dry. It will then be stiff but still having a

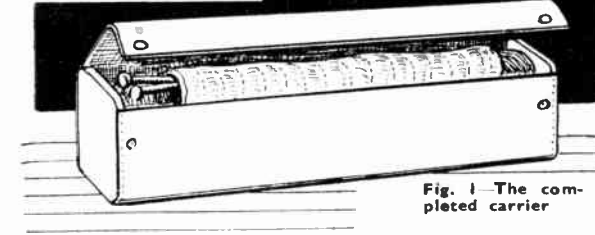
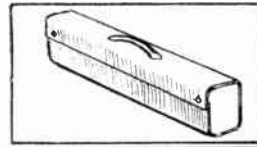

Fig. 1—The completed carrier

certain pliability which allows it to be curved without cracking.

The putting together of end-pieces and sheet is carried out as Fig. 3, and the central composite has to be carried round the sections (A) and secured by a close series of short but fairly large-headed 'pins'.

A start is made from the edge of the 'composite', where the covering is only just turned in for a little, and at a point just below the curve of the ends. Much

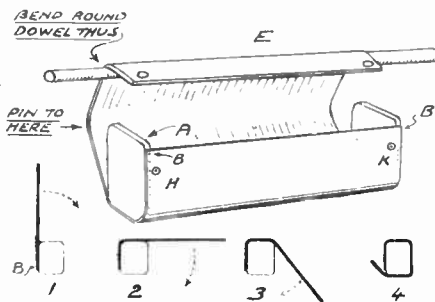

Fig. 3—Assembling the bag parts

depends on giving the sheet a good straight bend at the correct places. Used as shown a length of dowel is a very useful help in doing this.

## Pinning the Ends

Commence with the two pins (B) and (B1) and then, giving a curve over the dowel down the entire length, take the sheet round the first corner as (2). Curving again with the dowel negotiate the second corner as (3) and so right round the shape as (4). The pins must be put in progressively as the curving proceeds so as to get the sheet quite tight against the wood.

The pinning finishes at the point shown, the rest of the material forming the top and flap (E). As will be appreciated it is all a matter of careful bending and pinning to get a nice-shaped box, without twist or other fault.

While the case is on one side com-

pletely drying out—which will not take long—cut the simple handle (D) Fig. 2. This is a strip of leather, 6ins. long and  $\frac{1}{2}$ in. wide in the middle, but widening out to two rough arrow-head or heart shapes at the ends so it can be easily stitched on. A length of old strap slightly wider than  $\frac{1}{2}$ in. and trimmed down in the centre will do well for this.

## Press Studs

When all is quite dry (and not before) put on the two press studs (H) and (K). These are placed close up to the wood of the end-pieces to give the best possible rigidity when pressing the two halves of the carrier it will be found is stiff enough not to require any further fastening in the middle.

Lastly, put on the leather handle you have just made. This is held in position by stitches round the wider shapes at either end. The fixing can be done with an ordinary sewing machine if the stitches are made slowly by turning the flywheel by hand instead of using the handle. For the fitting, the lid must be temporarily straightened out.

The holder is now complete bar any finish you wish to apply. The leather, except for being well polished, can remain as it is, but the wooden ends should be stained and polished or polished alone if two pieces of nicely grained wood have been used.

Should you have made the holder for a present and it has to go through the post it is best to fill the inside with tightly wrapped paper to prevent the danger of crushing in the fairly heavy knocks parcels often receive in transit. The paper—to give a 'presenty' effect—should be of a nicely coloured variety.

A more complete present would be made in some cases, where the requirements of the recipient are well known, by sending the carrier fitted with a set of knitting needles and wool.

## Model Hedges

**F**OR painting model railway hedges, etc., dissolve  $\frac{1}{2}$ oz. gum arabic in 3ozs. water and add emerald green. Then strain off and use as paint.

# A novelty you can easily make is this WORKING MODEL PUMP

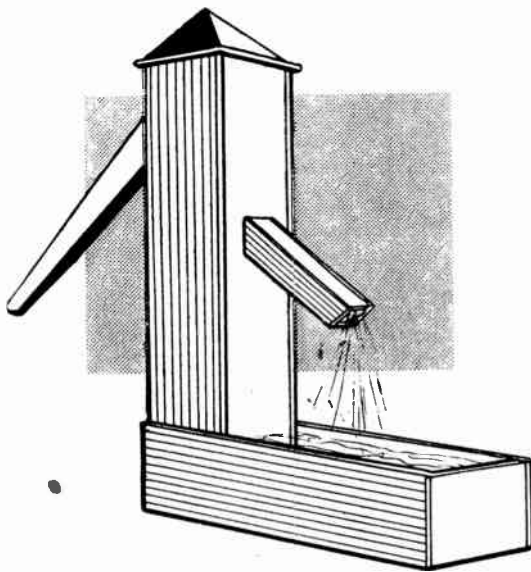

fully cut all parts, especially the slide valve, as the successful working of the model will depend on this fitting well.

It does not really matter what kind of wood is used as the entire model will have to be painted. A hardwood, however, or plywood is to be preferred for the job—the closer grain giving a smoother finish, thus enabling the slide to operate with greater ease. With the exception of the base-board having a thickness of  $\frac{1}{2}$  in., the entire model can be made of  $\frac{3}{4}$  in. wood.

Commence by making the shell of the actual pump, the internal measurement of which is exactly 2 ins. square. In order that the pump may work perfectly it is necessary to be very exact with this part—the inside must be exactly square and all sides measure 2 ins. all the way from top to bottom. The details at Fig. 1 are quite helpful for construction.

## Back and Front

Cut two pieces of wood  $10\frac{1}{2}$  ins. long and 2 ins. wide for the sides, one piece  $10\frac{1}{2}$  ins. long and  $2\frac{1}{2}$  ins. wide for the front, and one piece 11 ins. long and  $2\frac{1}{2}$  ins. wide to form the back.

Drill a  $\frac{1}{2}$  in. hole in the front piece for the water outlet about 4 ins. down from the top. There is also another hole or slot right at the bottom of this piece of wood for the water to enter from the trough. A slot about 1 in. long

and  $\frac{1}{2}$  in. high would probably be best.

Make a short spout having an internal measurement of  $\frac{1}{2}$  in. square and about 3 ins. long to fit over the outlet hole. It should slope at an angle of about 45 degrees and is glued to the front piece and secured with two small pins.

## Handle Bearings

Cut a slot at the top of the back piece of wood and fix the two brackets to form the bearings for the pump handle. It would be an advantage to make this handle of somewhat thicker wood, and  $\frac{3}{4}$  in. is quite suitable for the purpose. The side view shows the shape and angle to cut the handle lever. The distance between the two pivot holes is 2 ins. and the length of the handle part from the main pivot hole is 6 ins. A piece of stout wire can form the pivot, but this must be made so that it can be taken out when needed.

At this stage the two sides and front can be glued and pinned together, leaving the back to go on after the fixed valve has been fitted into position.

A piece of wood 2 ins. square and having a  $\frac{1}{2}$  in. diameter hole drilled in the centre is required for the valve seating. The valve is made by hinging a piece of thin rubber on top of the board so that it allows the water to be drawn up through the hole and then closes by the weight of water on top. A piece of cycle or motor cycle inner tube cut plenty large enough to well cover the hole is fastened at one end by a couple of small tacks.

The exact position for the fixed valve is not important—from  $1\frac{1}{2}$  ins. to 2 ins. up from the bottom would be about right. This piece should be well glued and tacked in position; and this advice applied to all other joints in order to

**T**HERE is always more interest attached to the making of a model when it is of the workable type. The little village pump described in this article is an excellent example of a working model. When carefully made it will pump water in an extremely efficient manner and will continue so long as the pump handle is kept working.

It is quite a simple model to make, but special care must be taken to get all parts cut exactly to size to ensure a perfect fit. The model works on exactly the same principle as the pumps which are so common in country districts, so now let us have a few words on how it does actually operate.

## The Mechanism

First the trough is nearly filled with water, then the pump handle is lifted which forces the air out of the inner chamber. Pushing the handle down now raises the slide valve, and it is this action that draws some of the water out of the trough through the fixed valve.

When the handle is again lifted this valve will close, at the same time opening the slide valve and letting in some of the water. By lowering the handle now the slide valve is again raised, and this time the water in it should reach the spout hole and start to flow out into the trough, thus completing the cycle of events.

## Careful Construction

This may sound rather complicated, but in actual practise it is really quite a simple operation. The making of this model is a very good test of skill in cutting out and fitting together the various parts. It is very necessary accurately to mark out and then care-

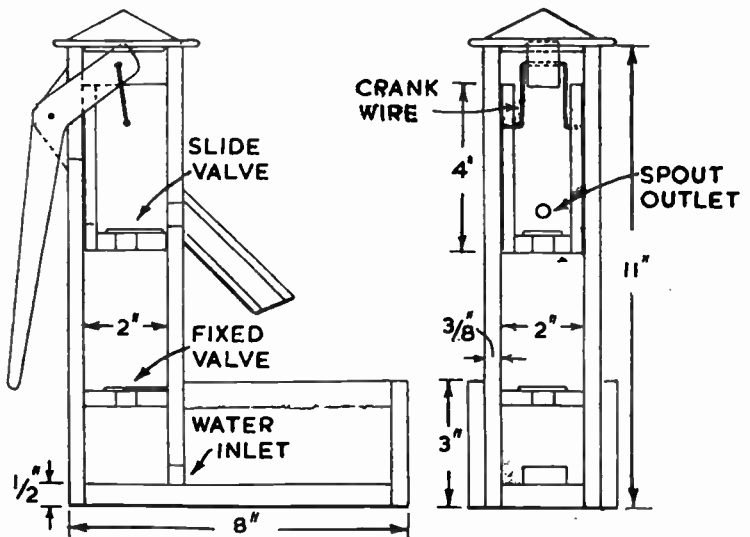

Fig. 1—A side and end view showing construction and sizes

make the model quite tight, otherwise it may not function correctly.

### Slide Valve

The slide valve should be the next part to make, and special care must be taken over this. It must be a sliding fit in the 2in. square tube, but should not be too tight. The slide takes the form of a three-sided box, the fourth side being open to allow the water to flow out of the spout, while the valve in the bottom is made exactly the same as the fixed valve.

A good length for the slide valve is 4ins. but this is not important. The pump will be more efficient in operation if the slide is 'packed' similar to a motor car cylinder. A narrow groove about  $\frac{1}{8}$ in. deep is cut round the slide near the base and a piece of felt or similar material fastened with a few fine panel pins.

The connection with the pump handle is made by a piece of stout wire bent into the shape shown in the front view.

The length for this is best found by experiment. When the pump handle is down, the slide is at its highest position and the bottom should be nearly level with the spout hole, thus allowing all the water to pour out.

The back of the pump tube with the handle attached will have to be lightly screwed in position for the measurements to be worked out. It will be found that by taking out the pivot wire of the pump handle, the slide and handle can be lifted out of the tube together, which is helpful in forming and adjusting the cranked wire.

### Water Trough

Very little skill is needed in the making of the remainder of the pump. The water trough needs two sides 8ins. long and 3ins. wide; a piece 2 $\frac{1}{2}$ ins. long and 3ins. wide for the front, and the base which is  $\frac{1}{2}$ in. thick, 7 $\frac{1}{2}$ ins. long and 2 $\frac{1}{2}$ ins. wide.

The top of the pump can be left open,

but it would look more finished if a cap is fitted as shown. This is made to lift off to enable the slide to be taken out if needed.

### Painting

Before painting see the inside of the tube and also the slide valve is glass-papered quite smooth. Then give the entire woodwork two thin coats of good oil paint. The woodwork of the two valves should be painted before the rubber is tacked down.

Another point to remember is that the back of the pump has not yet been fixed in position, so as to enable the inside of the tube to be painted. When this piece is fixed, it can be made watertight by putting a little soft putty round the join, or even running some paint in and screwing down tightly immediately and allowing to dry thoroughly.

It is quite possible to make all the other joints in this manner instead of using glue if you prefer. (254)

## For use with electrical motors or models make A REVERSING SWITCH

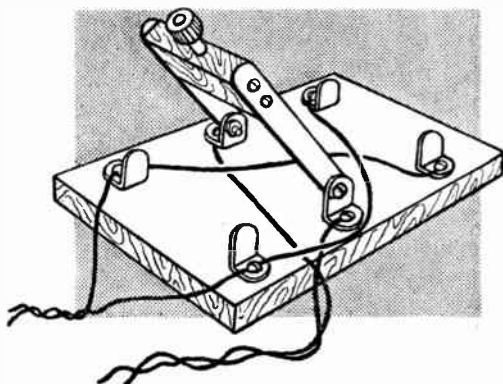

THOSE who have made up an electric motor or use one for driving models will find it useful to be able to reverse the motor at will. To accomplish this, a special switch is necessary, but this switch can be made up from oddments.

### Making the Switch

The drawing at Fig. 1 indicates the form the switch takes. Two metal strips are pivoted by means of small bolts on the angle brackets marked 2 and 5. A piece of wood is fitted between the ends of these strips so both work together, and they can contact brackets 1 and 4 or 3 and 6, according to which way the small knob (which is screwed to the wooden piece) is thrown.

A small baseboard 1 $\frac{1}{2}$ ins. by 2 $\frac{1}{2}$ ins. and about  $\frac{1}{4}$ in. thick is used for the switch. The six brackets can be bent up from tin or brass and are held in place by wood

screws. Brackets 1, 3, 4, and 6 do not have holes (as have the centre brackets) but are curved slightly so that the contact strips can press between them.

The small wooden piece will need to be about  $\frac{1}{2}$ in. by  $\frac{3}{8}$ in. by  $\frac{1}{2}$ in. Small screws or tacks hold the contact strips to this piece. The strips themselves are about 1 $\frac{1}{2}$ ins. long and  $\frac{3}{8}$ in. wide. The switch should move each way easily, but without looseness. If necessary, bend the brackets a little to assure good contact is made.

The detail at Fig. 2 illustrates the connections, and no difficulty should arise if the wires are joined on just as shown. 'A' is the wiring for a permanent

motor have. The connections are numbered to agree with Fig. 1 and when the switch is upright the motor will be 'Off'. Thrown to one side the motor will run 'Forward'; while moving the switch knob over to the other side will bring the motor into 'Reverse'.

### Another Type

Where the motor has a field magnet which is not permanent, but wound with wire and magnetised from the battery, the connections shown in Fig. 2 at 'B' are used. The simplest way to wire up here is to locate the two ends coming from the field winding and connect them to points 2 and 5.

Now connect points 4 and 6 to the parts in the motor where the ends of the field were originally connected. After putting on the two short leads from 1 to

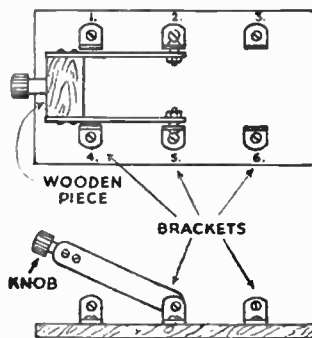

Fig. 1—Plan and side view

magnet motor. That is, a motor which has a horseshoe, permanent magnet for its field (or fixed) magnet, as many small

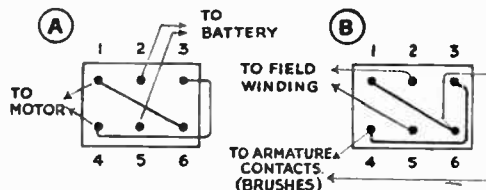

Fig. 2—The electrical connections mentioned

6 and 3 to 4 the motor can be set rotating either way, by moving the switch.

With the latter type of motor, the reversing switch does not provide an 'Off' position, so the battery should be disconnected, or the usual on-off switch used.



# Save space and expense by undertaking these ideas for FURNITURE CONVERSION

**W**E should not despise some of the old bits of furniture we see at the junk shop for sometimes they can be just the thing for us to turn into a modern home unit. The old version of the sofa can be modernised by the handyman and made not only into a useful and comfortable place to sit or rest, but it can also be made into a very handy place to keep all manner of goods.

Presuming the springs are still intact and in place you need do little more than re-cover it perhaps. The end can be covered in with panel board with cut-out at the bottom. This will strengthen the legs. A framework as shown at Fig. 1 can then run the full length and take two odd drawers which can be picked up at the dealers.

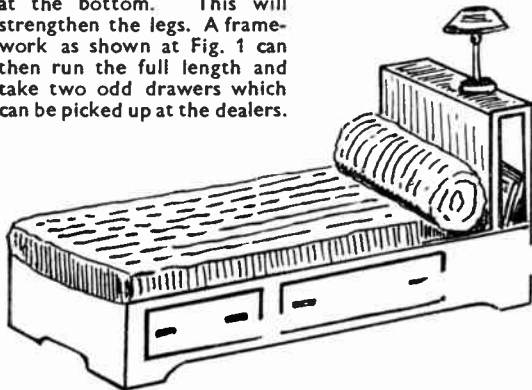

Fig. 1—A convenient reading rest from an old sofa

There is no need to put in a floor, but only the runners for the drawers. If the drawers do not fill the whole space then fill in the gap by leaving the panel board. Remove the old type handles and add some of the new types of moulded wood. You can add another short leg in the centre if it is needed.

It is the back and the head which may be unsightly and this can now be removed as you have strengthened up the structure all round. In place of the head, build in the panel illustrated and with the shelf at the top and finishing panel fitting down to the couch.

This will make a very useful place for a reading lamp and a home for papers and other journals. It will also prevent you having to get any other form of addition to the upholstered part.

As the whole of the old framework has been covered and presuming you have carried the job out in plywood or panel board you can now stain it to your own liking.

## Bed Light and Books

Having a light over the bed, books in plenty and close at hand is the envy of most people. The idea seen at Fig. 2 was first planned to cover a disused fireplace, but it is a good scheme and could be carried out in the average boy's bedroom. The main piece is the panel at the head of the bed and this should extend to

from the back of panels and glued to the side board. Allow space for making the bed. A special bed head fitment can then be fitted on the head panel. Choose the type which distributes the light in a narrow panel as this is better than a bright direct light.

## Corner Dressing Table

We sometimes find that there is not all the room we need perhaps in the 'box' room when it has to become a bedroom. Therefore the idea of building this corner dressing table can be carried out quite simply with plywood or

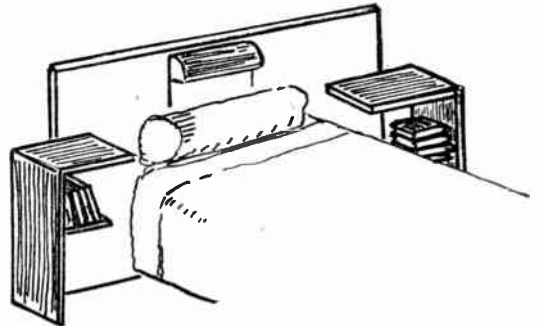
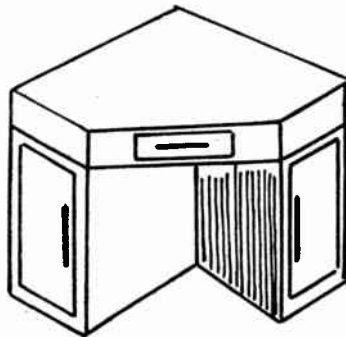

Fig. 2—A fireplace cover with book rests and overhead light



A space-saving corner table and stool

about 9ins. on either side and cut so it forms the back of the bookshelves.

The shelves are kept quite simple and made from 1in. wood. They are screwed

hardboard. As shown at Fig. 3 it is first constructed to the wall with 1in. by 1in. wood.

By this means it will allow two quite useful cupboards which open well out of the way on either side. These run back on one side to the wall and on the other to the side of the first cupboard.

This is the most simple plan.

One drawer is fitted and kept a little narrow as there is not space for it to run back too far. When completed add the modern wood handles, and keep all the edges

flush, which is the modern trend.

Colouring can follow the general scheme of the room in which it is kept, and should be of glossy enamel.



## Tuck-away Stool

Not only can we save on the actual corner fitment but if you follow the construction of the stool this will take up no space when not in use as it fits into the aperture under the table. Design the cut-away at the base and make the lid to take off as this will then serve as a home for all the slippers or other oddments. If made separate you can cover it with damask or some similar materials.

Although a little expensive one can get plastic sheet in  $\frac{1}{8}$ in. thickness cut to measure and this would make a splendid finish.

(253)

## Model of Florence Nightingale's Coach

**T**HIS realistic model is copied from the actual carriage used by Florence Nightingale (The Lady with the Lamp) in her humane work of nursing in the Crimean War, 1854 to 1856. It can be completed in wood and card from the patterns with this issue and the Kit of materials (No. 245 Special), price 6/7 from Hobbies Branches or post free 7/4 from Hobbies Ltd., Dereham, Norfolk.



# All the necessary hints for those making JIG-SAW PUZZLES

**T**HIS is the second and concluding article on a popular pastime for anyone with a fretsaw. The puzzles can be made simple or difficult, large or small, cheap or costly. Let us consider the matter of cutting.

There is no hard and fast rule about shapes themselves, so that when the pencil marks have been rubbed off lightly, nobody can tell whether you have actually sawn to the cutting line or run off a little. This does not mean, of course, that you can be quite haphazard in your cutting.

The saw must be controlled so that if it goes up to another piece at rightangles, it must not run into the opposite part and so leave an unsightly sawcut. For this reason, the various curved lines are simpler.

## Experimental Work

Until you have become more experienced, the work may seem a little slow, particularly in the link pieces type, because here you have to constantly keep moving the wood to produce the curves, the narrow necks and the 'swollen' pieces with nicely rounded lines. As mentioned previously it is worth trying out a small simple piece of work first, to get the 'hang' of the work on a part which can be thrown away without undue loss if spoiled.

The handframe, of course, must be kept strictly upright all the time so the saw cuts evenly and vertically at all pieces. You will realise that if this is not done, the resulting piece of wood will have sloping edges and so be wedge shaped. In consequence, it will not slip into place easily, and may even become stuck in its surrounding part.

## Machine Work

The machine user, of course, does not have this trouble so much, although even here it is easy to sweep round a curve only to find the saw is cutting at a slight angle. In every case, the wood must be held close to the saw and firmly on the table. By maintaining a steady up and down stroke without trying to force the saw through the wood too hard, you can proceed evenly and gently.

There will not then be the annoying 'jump' of the wood from the table, and its consequent breakage of either the saw or the wood itself. With the fingers laid flat along the wood, you get a better purchase on the board than if holding it down only with the finger tips.

## Hints on Cutting

Do not forget that the picture will be rejoined when the parts have been cut out, so that a wide sawcut should not be made. Use a fine sawblade, therefore, which will cut away as little as possible of the actual picture itself. Commence the cutting from one corner, gradually

extending your operations across the picture.

As each part is cut, lay it aside, thus building up the subject again in its actual jigsaw parts. If it is likely you are unable to complete the whole thing at one sitting, put the spare parts on a piece of wood which can act as a tray for you to take away and bring back, when next you start on the subject. It will only mean waste of time if you jumble all the parts and have to sort them again when you restart work. The straight outline edge of the picture should be cut first.

## Cleaning the Back

When the whole of the work of cutting has been completed, the underside must be cleaned up with glasspaper to take away any saw burr. To do this, lay a piece of stiff card or wood over the picture, turn the tray holding it right over, and you will have reversed the material, bringing the plain wood uppermost. A good plan is to make a frame of waste wood round the outer edge of the puzzle, in order that you may glasspaper it without shuffling the parts about unduly.

If the saw has not been pressed forward too hard, there will be very slight burr, but if there is, it may also be due to the unsatisfactory plywood which you have used. This is a point to bear in mind when buying the actual boards, because some ply is much more loosely knitted together than others. If possible, try a piece with a sawcut to test this before beginning.

The parts being all cleaned, the work is virtually completed, and it only remains to find some useful container in which the actual picture parts can be

housed. The ideal is a large flat box, on which a duplicate picture of its contents can be pasted. This again is a point to think of when you are buying in the first place. If you have a box suitable, you will need two pictures—one to cut and one to put on the box cover.

Failing boxes, the jig-saw can be kept in little 'sack' containers made of flowered cretonne, with the neck of the sack hemmed for a piece of ribbon with which to draw the whole thing tight. If you can get hold of new and fairly large milk cartons, these can also be converted into containers with simple decoration pictures pasted on the outside covering any advertising. Here again, piece of coloured ribbon threaded to form a handle, finishes the receptacle suitably.

## Fancy Boxes

In any case, the parts should be kept together, and even chocolate boxes can be used for the purpose, their outer surface being covered with some of the fancy paper or doll's house paper now obtainable. If you are proposing to make these puzzles as presents, you can add a suitable greeting label pasted to the top to allow for the wording which you wish to include.

We mentioned earlier, the question of supplying shopkeepers, and one or two points in this may be worth bearing in mind. The shopkeeper, of course, could be shown a sample and given a price at which you could offer them. This price must be quite cheap, because he has to re-sell with a profit, at a price which will appeal to the public. The standard of cutting must be quite high, and the finish to any box or container be attractive and colourful.

## For Selling

The stationer or bookseller who supplies you with the pictures, may be interested in their re-sale as jig-saws, but it is advisable to take him a sample completed so that he can see exactly what he is buying. Then, of course, you must be careful to keep the standard of the rest of the work up to the original sample.

Allow yourself plenty of time for the cutting, and obtain a date from the shopkeeper by which he must have the actual puzzles delivered. He may not want them all at once, or you can even suggest that if he sells a certain number and wants more, you can supply them within a named period.

Thus, cutting jig-saws is a pleasant and profitable occupation, and the subject should be considered by the craftsman, for the enjoyment of himself or his friends, or as a sideline by which he may earn a few shillings. The matter, as we said in the first instance, requires forethought and the gathering together of the various few parts required for the interesting operations.

## Glasspapering

**W**HEN glasspapering difficult mouldings, instead of using the glasspaper on a piece of plain wood or in the hand, get an old pack of playing cards, put the glasspaper round one long edge and press the whole lot firmly on the moulding to take shape. Hold the pack tightly and the moulding can be smoothed much better and quickly.

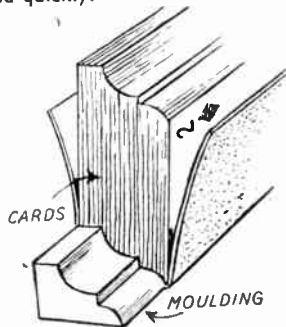

# This simple stand of wood and fabric makes a useful NEWSPAPER RACK

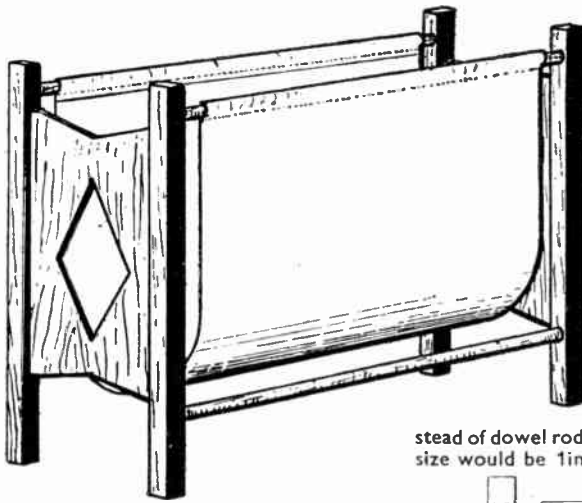

is used. Dowel rods of  $\frac{1}{2}$  in. diameter are cut to form the top and bottom rails and are let into the legs to a distance of  $\frac{3}{4}$  in. As the length of the finished article is 16 ins., these rods will have to be 15  $\frac{1}{2}$  ins. long. Make them a fairly tight fit in the legs, then it will only be necessary to use a spot of glue to secure them in position.

The bottom rails could be made of flat strips of wood instead of dowel rod if preferred. A suitable size would be 1 in. wide and  $\frac{3}{4}$  in. thick.

Plywood of good quality is very suitable for these side panels if desired. Instead of making the ends of solid panels another method would be to use either dowel rods or thin strips of wood. Three bars at each end would be needed in order to make it strong enough, the top and bottom ones being about 1 in. away from the side bars so as not to weaken the legs.

## Variation

Another very pleasing variation is to make the top of the rack about 2 ins. wider than the bottom, or you might even consider making it the reverse way.

When all the joints are glued tight and have set hard, the rack is glass-papered smooth and the wood is then ready for finishing. This can be done in

**N**EWSPAPERS and magazines lying about in various places can be very untidy, besides which it is most annoying to have to hunt about when a particular copy is needed. It is much nicer to keep them all together in a neat little rack where a special copy can be found at a moment's notice.

The newspaper rack described here is simple to make and also forms quite an attractive piece of furniture. It can be made of a wood that will match an existing suite of furniture and even the design could be slightly modified to harmonize with it. The fabric container is very accommodating in taking odd shape publications easily.

## Suitable Materials

The kind of wood to be used must be left to the discretion of the maker, although one of the recognised hardwoods is to be preferred. The measurements given are for a rack suitable for the average size newspaper or magazine but can be altered to suit any special requirements.

The four legs are cut from square wood and are 14 ins. long. If made of a hardwood 1 in. square would be sufficient, but they will need to be 1  $\frac{1}{4}$  ins. square to provide extra strength if a softwood

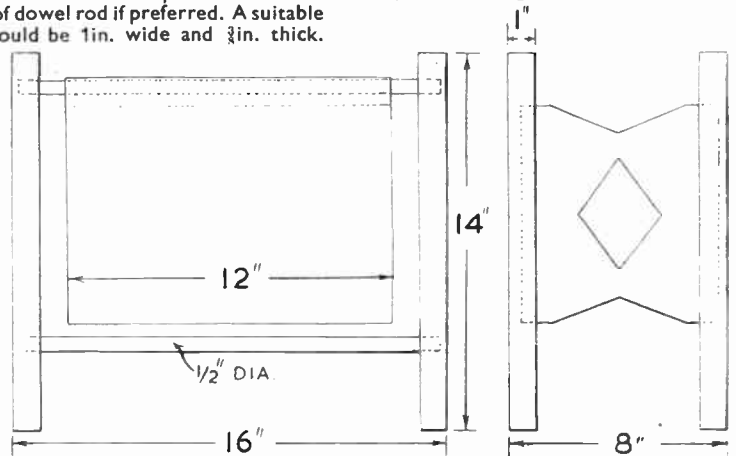

A side and end view with dimensions of parts needed

They are glued into slots cut to a depth of about  $\frac{1}{4}$  in.

These two side pieces are held in position at the desired width (which can be about 7 ins. or 8 ins.) by flat panels of wood which form the ends of the rack. The wood used for these should be of good quality, as there will be quite a strain especially when the rack is full of papers. Panels  $\frac{1}{2}$  in. thick will be sufficient provided the legs are grooved to a depth of from  $\frac{1}{4}$  in. to  $\frac{3}{4}$  in. Only a thin film of glue will be needed to fix them if they have been made a tight fit.

quite a variety of ways—stained and french polished, varnished or enamelled, whichever takes your fancy.

## Fabric Bag

The completion of the rack is carried out by sewing the material chosen to hold the papers, on to the two top rods. Any fairly strong fabric is suitable for the purpose—it can be a piece of deck chair canvas, hessian, casement curtain material or anything else of a similar nature. (255)

## Stamp Collecting—(Continued from page 13)

It is rather difficult to go into the various regions of China which have at different times issued stamps—in a great number of cases for only a very short time. You will certainly need to have a good catalogue in order to pick out the overprints which were put on the stamps to indicate the various regions they came from.

In this connection it would be quite good enough if you had an old out-of-date catalogue. That is to say, one which is

not so old that it was issued before the states became stamp issuing. But unless you want the catalogue to compare the very latest prices with those of a year or so ago then you should be able to buy a catalogue say three or four years old at a much cheaper rate than a new one.

Let us take a glance at the stamps of China as a case in point. Overprints have been put on to these stamps to make them ready for use in Formosa (Taiwan), Kirin and Heilungchang (Manchuria),

North Eastern Provinces (also Manchuria), Sinkiang (Chinese Turkestan), Szechwan Province, Yunnan Province, and Tibet.

That seems rather a formidable lot to contend with, and as a suggestion to the beginner it would be best to have the suspected stamps all together on a page, then later on to place them in special pages as knowledge comes.

# A straightforward and simple working model DOLL'S HOUSE LAMP

**H**OW pleased the owner of a doll's house would be to possess a miniature standard lamp that lights up just like the one in her own drawing room.

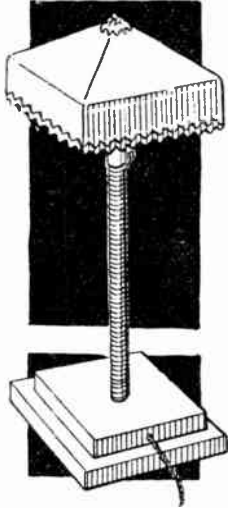

Instructions for making such a lamp are given below in conjunction with various illustrations.

For the base from hardwood  $\frac{1}{4}$  in. thick cut two pieces, one 2 ins. square and the other  $1\frac{1}{2}$  ins. square. In the centre of the larger piece bore a hole  $\frac{3}{8}$  in. in diameter, and in the smaller a hole  $\frac{8}{16}$  in. in diameter (see Fig. 1).

Carefully glue the two pieces together, clean up with glasspaper and chamfer off the edges.

When quite set, drill an  $\frac{8}{16}$  in. diameter hole at the joint between the two pieces of wood, pointing into the large recess on the bottom. This is for the flex to pass through. Another hole  $\frac{1}{8}$  in. in diameter is drilled through the top section about  $\frac{8}{16}$  in. from the centre hole.

## The Central Pillar

The bulb holder is held in position by means of a brass or mild steel rod  $\frac{4}{16}$  in. long and  $\frac{1}{16}$  in. in diameter. At a distance of  $\frac{1}{4}$  in. from one end and  $\frac{1}{2}$  in. from the other end, cut a thread to take an  $\frac{1}{16}$  in. whitworth nut. On the end threaded for  $\frac{1}{16}$  in., screw a nut as far as it will go. Push this end through the hole in the base and secure with another nut. A second nut is added to form an electrical connection inside the recess of the base. The construction is clearly seen in Fig. 2.

## The Bulb Holder

The bulb must be of the small screw type used in flash lamps, but the glass part must, however, be spherical. Suitable brass bulb holders can be obtained from one of the cycle stores. These bulb holders have a small brass

base which is held to the main section by a screw. This is removed as it is not required for the model.

The top end of the pillar which has been threaded for  $\frac{1}{16}$  in. will be found to fit this screw hole tightly, and the bulb holder should be screwed on to the pillar until it penetrates sufficiently far inside the holder to form a contact for the bulb.

## Electrical Connections

For the electrical connections obtain a length of plastic covered single strand wire about 2 ft. long. This is sold for wireless connections and is made in various colours, white being most suitable for this model. Connect one end of the wire to the side stud on the bulb holder, and twist round and round the pillar like a spring until the whole length of the pillar has been covered. The loose end is now passed through a small hole in the top section of the base.

These connections can now be tested by connecting the loose end of the plastic wire to one terminal of a battery, joining the central pillar to the other terminal of the battery with a piece of fine electric wire, and putting in a suitable bulb. Make any adjustments that are necessary.

The whole lamp standard can then be painted in gold colour, or any other shade to suit the doll's house. When thoroughly dry obtain a length of the thinnest twin flex bell wire that can be bought. Pass one end through the hole in the side of the base, sepa-

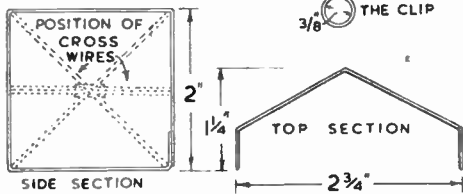

Fig. 3—Parts of the wire frame

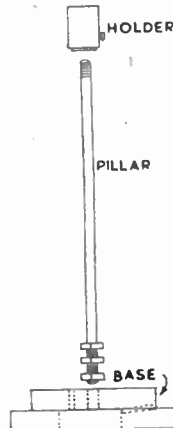

Fig. 2—Section of model

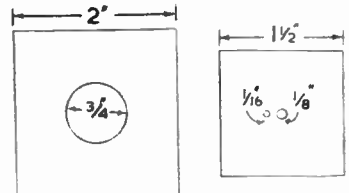

Fig. 1—Sections of the base

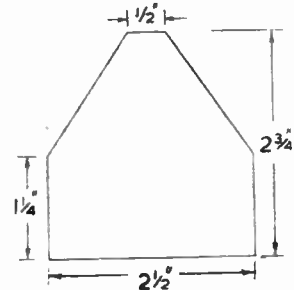

Fig. 4—Shape of shade panel

as those used in the home. The frame is made from copper wire, preferably tinned, about  $\frac{3}{16}$  in. thick. Start by making a full-sized drawing of each section as shown in Fig. 3. Two square sections will be required, two sections to form the top and two soldered together to form the clip by which the frame is held to the bulb.

Cut and bend the wire to shape, leaving an extra  $\frac{1}{16}$  in. for overlap. Cut the clip section  $\frac{1}{16}$  in. longer than required and trim off after fixing. The sections are now soldered together. This can best be done by using a solder paint with flux included and applying heat, using a bunsen burner or spirit lamp. The parts to be jointed must be held together with a pair of long-nosed pliers.

## Clip and Cover

Make the square sections first and then join the top sections by soldering the upright parts to each corner of the square frames. The clip is made by soldering the two pieces together, afterwards opening the rings about  $\frac{1}{4}$  in. at the bottom and finally soldering them to the top square section of the frame. The rings must be pointing downwards

and in the centre of the frame.

The cover for the frame is made from a piece of coloured silk. Cut four sections to shape as shown at Fig. 4, and sew each of these together, keeping the stitches  $\frac{1}{16}$  in. from the edge. Trim, turn inside out and stitch to the frame, finishing by trimming with braid or fringe.

The lamp is made to a scale of approximately 1 in. to equal 1 ft., but these measurements can be varied slightly to suit individual doll's houses. (230)

rate and bare the leads and connect one to the plastic wire and the other to the centre pillar.

Wrap a little insulating tape round the joint between the flex and the plastic wire, and push the whole well into the recess at the base of the lamp. The other end of the flex is for connection to the battery supplying the doll's house.

## Lamp Shade

The shade is built up on the same lines



## Issues from KOREA

**S**INCE the centre of world thought at present is Korea it would appear to be a suitable time to have a few notes on the stamps of this area. Since so much has appeared in the Daily Press about Korea everyone should know exactly where it is to be found and also just what it looks like on the map.

Korea first issued stamps in 1885 which was some 45 years after the introduction of the penny post in this country and also a great many years after most other countries had adopted cheap adhesive stamps. Twenty years later, in 1905, the Korean postal service was amalgamated with that of Japan which, of course, meant that Japanese stamps were in use after that date.

Since Korea was a stamp-issuing country for only 20 years and also as her population was less than twenty million (most of these being engaged in agriculture) it is not surprising that one does not meet with many Korean stamps. As readers of *Hobbies Weekly* already know, some countries are fashionable, but Korea is not one of them. If it was a fashionable country then the stamps would be worth considerably more than they are.

During her 20 years as a stamp-issuing country Korea issued about 70 specimens. Of the two stamps which are illustrated here the smaller one was issued in 1900 and the larger in 1903. The 1900 issue was printed in the stamp printing bureau of the Korean administration at Seoul while the other was engraved and printed at Paris by the French Government works.

From 1900 Japan has maintained post offices in Korea and the stamps she used were the current Japanese with an overprint of two characters at the

bottom. These were in use until 1905 when, as mentioned before, Japan took over the control of the Korean Posts and used Japanese stamps everywhere. So since that date one has only the Japanese stamps to describe for Korea.

### With Peace Dove

The only one of real interest in connection with the area with which we are dealing is the stamp issued in 1936 illustrated here. Japan has not used many maps as themes for designs of stamps but this one shows the area of the world. Korea, or Chosen as it is sometimes called, is filled in in black. Notice the 'Dove of Peace' above—let us hope that it is there for some purpose now.

After the last war and on the collapse of Japan when the American and the

The 1942 set which was issued to commemorate the 10th anniversary of the foundation of Manchuria shows one value—the 6 fen bearing a design of women dancing rather like a chorus in Gilbert and Sullivan's opera 'The Mikado'.

Then, in 1940 they issued a stamp to commemorate the foundation of Japan—it was the 2600th anniversary. The design of one of the set is entitled the 'Dragon Dance'.

The 1936 set shows a picture of a wagon load of soya beans and that is the specimen that you see illustrated here, because it may serve to remind readers of one of the places from which



Korean issue of 1900



Japan shows a map in 1936



Manchuria crops soya beans



Korea issued this in 1903

Russian Forces marched into Korea, then, of course, the stamps which up to that date had been Japanese, were issued by the occupying authorities. The United States of America were for the area south of the 38th parallel north latitude and Russia for the area north of that line.

### 57 Varieties

Since February 1946 the number of stamps issued for the southern area, that is the area occupied by the United States is no less than 57. That is that in 3½ years there has been nearly as many stamps issued as was issued in the previous 20 years. The northern part has not had nearly so many as that.

Close to Korea we find Manchuria and this republic did not issue separate stamps until 1932. Of the stamps that have been issued since then none can be called really interesting although two will come under the category of quaint.

we get soya beans. It is the bean from which the flour is made and used at Christmas time to give the flavour for almond icing on the cakes. A great many of the stamps have had maps on them, in fact the map of Manchuria is the favourite theme for the stamps of that country.

North Mongolia or, as it is also called, Tannou Touva Republic, issued stamps first in 1926. In 1927 she issued the largest and most curious set that any country has ever issued: stamps of all shapes and sizes and with some quaint pictures on them.

### Mongolia

Look at the last illustration. It is supposed to be a North Mongolian farmer riding on a reindeer, yet the stamp of just slightly lower denomination shows a farmer riding on a horse. Then, in the same set, we have a camel caravan, a mountain goat, a stag, archers, and a girl carpet weaver. Quite a variety of subjects for a set of stamps and certainly a variety of methods of transport.

By the way, these stamps are quite cheap, though it is hardly likely they will ever rise very much in value so readers should not waste money on purchasing them except as curiosities.



A large North Mongolia stamp with reindeer

(Continued foot of page 11)

Develop Self-confidence—Master

# JU-JITSU



Amazing new methods show you how to 'get tough' and make any attacker helpless with lightning speed—or money back. The Morley Rapid Ju-Jitsu Course teaches you all the knock out blows, shows you how to throw a stronger man helpless to the ground, gives absolute mastery. Develops body, gives self confidence.

You can acquire this devastating weapon in a few weeks. For both sexes. Complete fighting system, 10/- (or \$1.00 bill and 40 cents in stamps). Air Mail, 14/-, Details 2½d.  
**JOHN J. MORLEY (HB 99), Terry House, Naphill, High Wycombe, Englan**  
 Established 1936

## PEDAL MOTOR CAR

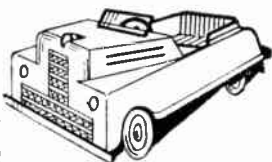

This new simplified chart enables any amateur to make a strong smart modern Pedal Car suitable for children 2 to 5 years. Complete plan and instructions  
 2/6 post free

Wheels and other parts for Pedal Cars and Dolls Houses available. Send stamped addressed envelope for list

**ZIMPLAN** 88 WARE ROAD  
 HODDESDON, HERTS.

IT'S New - but ANYONE CAN DO IT!

WRITE TODAY FOR YOUR KIT

PRINT YOUR OWN PHOTOGRAPHS ON SCARVES, TIES, HANDKERCHIEFS, GREETING CARDS, ETC., ETC.

With the YANKEE PHOTO KIT it's easy to make up to 150 perfect permanent prints from your own negatives on cloth, paper, cards and almost any surface. Simple and easy. Cannot harm fabric or negative. Send today for kit with complete instructions.

5/-

Y.P.K. PRODUCTS COMPANY POST FREE  
 866 Christchurch Road, Boscombe 3, Hants

# NICOTEXIT

THE GUARANTEED SMOKING DETERRENT

- ★ POSITIVELY STOPS SMOKING IMMEDIATELY and for several hours after each application. Purchase price refunded if it fails to do so.
- ★ ONE BOTTLE IS USUALLY SUFFICIENT to establish control of smoking in any form. It is not poisonous.

Invaluable to all who smoke too much

5/6 Per Bottle Post Free

Obtainable only by post from Sole Concessionaires for Great Britain:—

THE NICOTEXIT COMPANY (Dept. B.4.)  
 62 High Street, Croydon, Surrey

## EXCITING NEW FILM STRIPS

DENIS COMPTON'S 'MY CRICKETING DAYS'

'BRUMAS' THE LOVABLE BABY POLAR BEAR

SPECIAL PRESENTATION BOX COMPLETE WITH CINE VIEWER 5/- EACH

From all good Toy and Sports Shops or post free from

FILM STRIPS EDLESBORO Nr. DUNSTABLE

P.S. Why not send for complete list of films from 10/11 (Battery Model) 6d. to 2/6 and details of the WONDER Home Strip Projector. 19/6 (All mains Model)



TURN YOUR SPARE-TIME INTO CASH  
 Men and women wanted to make Bennett Model Bungalows at home.  
 Fascinating, simple, well paid work  
 No selling involved.  
 Send penny stamped, addressed envelope for full details.  
**BENNETT MODELS,**  
 137, Grays Inn Road, London W.C.1.



THE BOLSTER HOME WATCH AND CLOCK REPAIR OUTFIT  
 These precision jewellers instruments, include watchmaker's magnifying eyeglass, finest watch tweezers, set watchmaker's screwdrivers, watch and clock oil, oilers, dusting powder, clock brush, plus illustrated instructional manual for the amateur. In container 12/9 post free.  
 Senior Outfit includes everything above, plus watch jewels, luminous compounds, dial renower, jewellers rouge, explanatory book. Price 21/- post free.  
**BOLSTER INSTRUMENTS, (Dept. H. W.), 5a Station Parade, Ashford, Middx.**



BRANCHES

LONDON

78a New Oxford St., W.C.1 (Phone MUSEum 2975)  
 87 Old Broad Street, E.C.2 (LONDON Wall 4375)  
 117 Walworth Road, S.E.17

GLASGOW

326 Argyle Street (Phone CENTral 5042)

Head Office & Factories—HOBBIES LTD., DEREHAM, NORFOLK

MANCHESTER

10 Piccadilly (Phone CENTral 1787)

BIRMINGHAM

14 Bull Ring

SHEFFIELD

4 St. Paul's Parade

LEEDS

10 Queen Victoria Street (Phone 28639)

HULL

10 Paragon Square

SOUTHAMPTON

25 Bernard Street

BRISTOL

30 Narrow Wine Street (Phone 23744)

## WEBLEY

AIR PISTOLS

Marvellously accurate for target practice.

No licence required to purchase.

Senior Mark 1

Junior Webley Air Rifle

Write for List. **WEBLEY & SCOTT LTD.**  
 166 WEAMAN STREET, BIRMINGHAM, ENG.



BUY A FOYLES HANDBOOK!

**Leatherwork • Basketry**

by F. J. Christopher . Price 2/6 each

From all Booksellers or the Publishers

W & G FOYLE LTD

119-125 CHARING CROSS ROAD LONDON WC2

## Plans for a model of the Inca raft 'KON-TIKI'

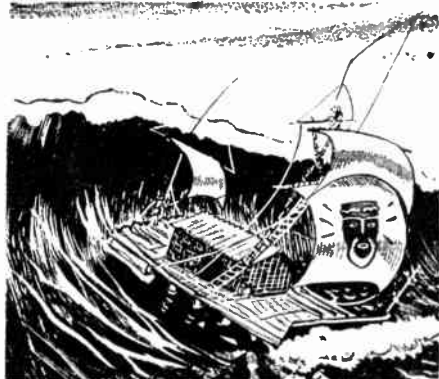

The Craft which drifted from Peru to the South Sea Isles

Thos. Heyerdahl, the builder of the 'KON-TIKI', believed that the South Sea Isles were first populated by a fair-skinned race, who fled from Peru by raft when the Incas conquered them about 1,000 years ago. To demonstrate that his theory was plausible he and five companions, five Norwegians and a Swede made the same journey on a balsa wood raft of the type which the ancient inhabitants of South America are known to have used and which the Incas inherited from them. It is an epic story which you should read and commemorate by making a model of Heyerdahl's 'ship'. Four sheets of plans size 20ins. by 15ins. 2/8 post free.

**MODEL CRAFT LTD.**  
77 (F) GROSVENOR ROAD, LONDON, S.W.1

## MODEL CONSTRUCTIONAL KITS

that are well known for quality and low price

### AIRYDA MODEL AIRCRAFT



Include both flying and non-flying types; sizes and prices to suit all Modellers. Each kit complete with plan, building instructions and all necessary parts.

### AQUILA MODEL SHIPS & BOATS

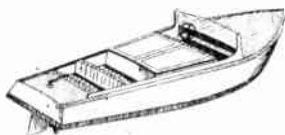

This series includes Motor Launches, Cabin Cruisers, Motor Yachts, Cross Channel Steamers, etc. Sizes range from 20ins. to 39ins. in length; and prices from 18/- to 62/6.

### ANORMA MODEL BUILDINGS



This range of Model Buildings includes shops, houses, factories, railway buildings, etc., which are all designed to 4 mm. scale suitable for OO gauge Model Railway lay-outs, etc.

Full particulars can be obtained from your local dealer, or send for particulars to:

**MODELLERS SUPPLY LTD**  
DEPT. HO/1  
ASPLEY, HUDDERSFIELD

the strong point  
of every hobby...



**Aero Glue.** The strongest glue in the world.  
**Universal Glue.** Cold glue ready for use from tube or tin.  
**Waterproof Cement.** Specially prepared for balsa wood.  
**Whyte Paste.** For paperwork and photo-mounting, etc.

**CROID LTD., IMPERIAL HOUSE, KINGSWAY, LONDON, W.C.2**

## YOU CAN BECOME A HANDICRAFTS INSTRUCTOR

### Experience not essential

Men who enjoy making things in wood or metal can turn their hobby into a permanent and interesting Career. Short hours, long holidays, and security in a job you would really enjoy, can be yours if you become a Handicrafts instructor. Let us send details of the easiest and quickest way to get the necessary qualification.

**We definitely guarantee  
"NO PASS - NO FEE"**

If you would like to know about our unique method of preparing you for one of these appointments, write to-day, and we will send you our informative 176 page Handbook—free and without obligation. Mark your letters "Handicrafts Instructor."

**BRITISH INSTITUTE OF  
ENGINEERING TECHNOLOGY**

595 Shakespeare House  
Stratford Place, London, W.1

# BIET



## Swann-Morton CRAFT TOOL

The perfect, razor-sharp utility tool for modellers in BalsaWood, also for Biologists, Students, Commercial Artists, Photographers, etc. 2 interchangeable blade shapes.

Handle and two blades 2/- post free. Spare blades six for 2/6 post free. Send P.O. to

**FAMILY PRODUCTS**  
92-94 BRADFIELDRD  
SHEFFIELD

Trade enquiries

# 'PERSPEX' and 'CRINOTHENE'

*for the handicraft worker*

'Perspex' acrylic sheet is available in transparent, translucent and opaque colours in a wide, useful range of sheet sizes and thicknesses. It can be fabricated as easily as wood or non-ferrous metals, using standard equipment.

'Crinothene', a decorative plastic sheeting supplied in many attractive colours, is ideal for lampshades.

For further information, please apply to the nearest I.C.I. Sales Office.

'Perspex' is the registered trade mark of the acrylic sheet manufactured by I.C.I.

'Crinothene' is the registered trade mark of polythene sheet manufactured by I.C.I.



IMPERIAL CHEMICAL INDUSTRIES LIMITED, LONDON, S.W.1.

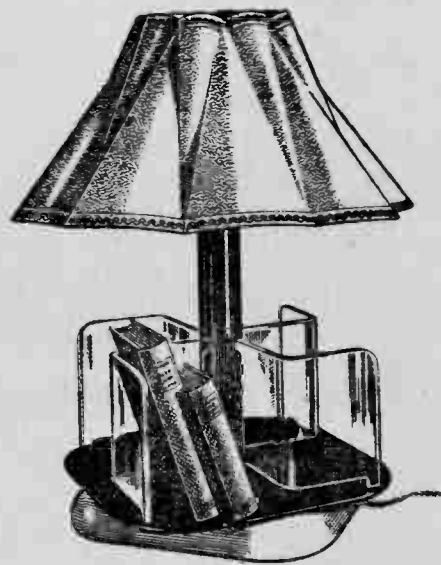

## EXTRA CASH IN SPARE TIME

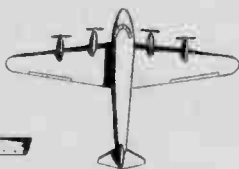
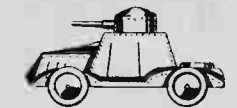

A fascinating way of earning extra cash in spare time from odd pieces of lead. Small Outlay—Large Profits. Sample mould 3/6d. Casting moulds, deep-cut and ordinary type Aeroplanes, Soldiers, Farm and Wild Animals, Cars, etc. Stamped envelope for full list. Illustrated Catalogue 9d.

MASTERCRAFT MOULDS  
69, ST. MARKS ROAD, HANWELL, LONDON, W.7

## A new solder

FOR WORKSHOP  
AND HANDYMAN

- CONTAINS 2 CORES OF FLUX
- NO EXTRA FLUX REQUIRED
- REPLACES STICK SOLDER, FLUID AND PASTE FLUXES
- IF DESIRED FLUX RESIDUE READILY WASHES OFF WITH WATER
- SO FAST THAT IT WILL EVEN SOLDER BLUED SPRING STEEL WITHOUT PRE-CLEANING



No. 10 KIT 2/- each

SIZE 8  
CARTON

5/- each



Available in 5/- retail cartons (4 specifications) or 2/- Multicore Solder Kit contains 2 specifications Arax Multicore Solder and 2 specifications Ersin Multicore Solder for electrical wire to tag joints. Now obtainable from many stores. In case of difficulty 5/- cartons or 2/- Multicore Solder Kits sent post free on receipt of postal order or stamps.

MULTICORE SOLDERS LTD, MELLIER HOUSE, ALBEMARLE ST., LONDON, W.1



# Hobbies

## WEEKLY

### CONTENTS

	Page
A Wall Safe - - -	17
Editor's Notes - - -	18
Modern Crystal Set -	19
Handyman Suggestions	20
Cigarette Server - -	21
Home Furniture	
Conversions - -	22
A Trinket Box - - -	23
Stuffing Birds - - -	24
A Vertical Enlarger -	25
Naturalist's Walking	
Stick - - -	26
A Utility Cabinet - -	27
Doll's Electroliner -	28
Trinket Box Patterns -	31

October 11th, 1950

Price Fourpence

Vol. III No. 2867

**T**HIS handy piece of household carpentry is just the thing to hold perishable foodstuffs, keeping them cool and free from dust and flies. It is of the size suitable for hanging on the wall, or standing, perhaps, on a convenient shelf. Alternative construction is also given for those who may prefer one to stand on the floor.

#### The Wood Required

A front elevation and a side section are shown in Fig. 1 with suitable dimensions. For the wood for frames,  $\frac{7}{8}$  in. by 2 in. deal is suggested. The front

## A HANGING OR STANDING WALL SAFE

elevation shows only half of the door, to reveal interior construction a little. The work is quite within the scope of the average amateur carpenter, there being no difficult joints to encounter.

Make up the two side frames to dimensions given. The corner joints look better if mortised and tenoned as is usual in good work. Here the tenons on the cross bars should be cut with a shoulder, as at (B) in Fig. 2, and when chiselling out the accompanying mortises for them, it is as well to cut the side uprights a little over the finished length, to lessen any danger of breaking through the mortises at the ends, top and bottom. The surplus can, of course, be sawn off when the frames are finished.

#### Halving Joints

A less business method of jointing the frames together is to use the simple halved joints for the corners, but to avoid the ugly appearance of the cut ends of the crossbars showing up in front, make the joints as at (C) in Fig. 2, where they are shown stopped at  $\frac{1}{2}$  in. in. A much neater effect is so created. However, this is for the carpenter who may consider the extra trouble of the mortises and tenons too much for the job.

A detail of the further construction of the safe is given at (D). The bottom of the safe can be made up of  $\frac{3}{4}$  in. thick boards, quite stout enough for a hanging article of this kind. The bottom is nailed to fillets, the fillets themselves being screwed to the inner sides of the frames at the place shown.

#### Door Aperture

Take particular note here that this bottom, also the fillets, are  $\frac{1}{4}$  in. short of the front, to admit the door in level, and  $\frac{3}{8}$  in. short of the back for the back of the

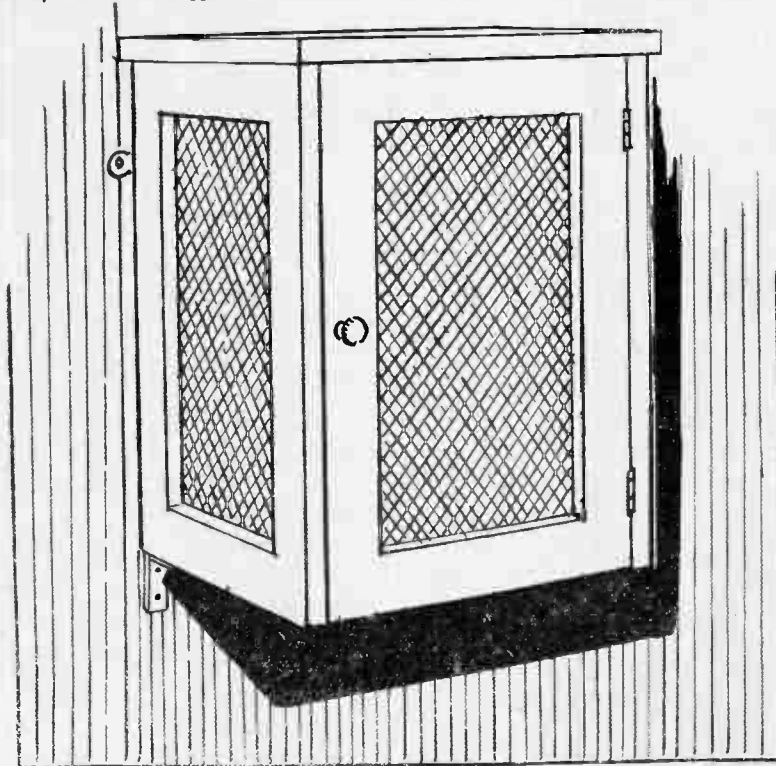

All correspondence should be addressed to The Editor, Hobbies Weekly, Dereham, Norfolk.

safe to lie level also, the back being nailed to the bottom.

Across the top of the safe, screw two bars of  $\frac{7}{8}$  in. by 2 in. wood. These also are short of the front and back the same as the bottom of the safe. By this arrangement the door, when fitted, will butt up against both bottom and top front bar. The top of the safe, of  $\frac{3}{8}$  in. wood, can now be nailed over.

It should be level with the back and extend beyond sides and front just about  $\frac{1}{2}$  in. The back of the safe should be cut from  $\frac{3}{8}$  in. thick matchboarding, and be a tight fit between the sides. It is

plywood for this part, but the thicker wood suggested.

The door is framed up similarly to the sides and should be an easy fit in place.

#### CUTTING LIST

Side frames (4) —  $\frac{3}{8}$  in. by 2 ins. by lft. 8 ins.  
 Side frames (4) —  $\frac{3}{8}$  in. by 2 ins. by lft. 2 ins.  
 Door (2) —  $\frac{3}{8}$  in. by 2 ins. by lft. 8 ins.  
 Door (2) —  $\frac{3}{8}$  in. by 2 ins. by lft. 1 in.  
 Top cross bars (2) —  $\frac{3}{8}$  in. by 2 ins. by lft. 1 in.  
 Top and bottom of safe —  $\frac{3}{8}$  in. by 8 in. board, 5 ft. run.  
 Back —  $\frac{3}{8}$  in. by  $4\frac{1}{2}$  in. matchboarding, 5 ft. run.

the inside, but a much neater method is to fix it in place with beading both sides, as in inset drawing (A) in Fig. 1. A bit more trouble, admittedly, but worth it in the writer's opinion.

Screw a pair of stout brass wall plates to the rear of the safe, and screw to the wall. It is advisable also to either fit underneath the safe a pair of 6 in. steel brackets, to take the major portion of the weight, or, if a brick and plaster wall is in use, a pair of wall plates of the pattern shown at (E) in Fig. 3.

These latter ones are driven between the lines of bricks, so should be fitted first, then the safe stood upon them, and holes bored through the brass plates higher up into the wall to receive the plugs for the screws.

The sides for a safe to stand on the floor, are shown in Fig. 3, the fillets for the bottom being screwed to the

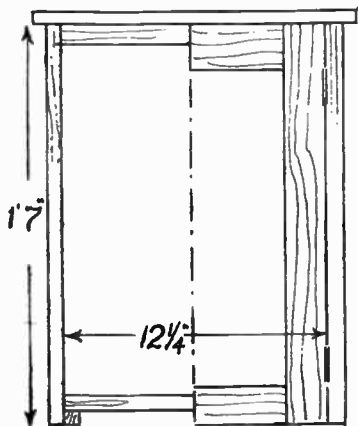

Fig. 1—Front and side elevation showing constructional details

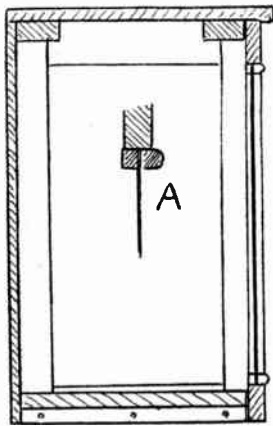

Fig. 2—The joints to use

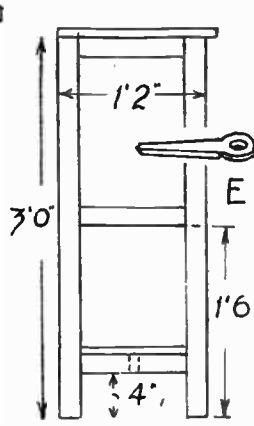

Fig. 3—Framework of sides

nailed to the back edges of top rear crossbar, and the back edges of the safe bottom.

As it forms an integral part of the structure, keeping it firm and square, it is well not to be tempted to use thin

Hinge it with 2 in. iron or brass butts, and fit with a cupboard catch or just a plain button fastener, as preferred.

The openings can now be covered with perforated zinc to keep out dust and flies. The zinc can be nailed over on

middle crossbar. The width can well be 16 ins. Construction otherwise is similar to the hanging safe. A crossbar connects the lower side rails and a wood shelf could very conveniently be nailed across, as an addition.

## From The Editor's Notebook—

WE have, from time to time mentioned the hobby of cigarette card collecting which was so popular before the war when every packet of cigarettes contained one of a set of cards of historical, nautical, geographical or general interest. Apparently new cards are now becoming available again, although not in packets of cigarettes. As usual we are having left-overs from what cannot be sent abroad because these cards were originally intended to go into packets in South Africa. But Premier Malan banned them and the complete sets were put in shops in this country. Sets of 'Famous British Ships'—including *San Demetrio*, *Cossack*, *Jervis Bay*—and 'The History of Aviation' have been on sale in shops at 25 for 1s.

ARRANGEMENTS and details for a collective hobbies exhibition are now being undertaken in Northampton by the members of the local Rotary Club. Readers living in the area should keep their eyes open for further announcements because they are sure to want to take part. It is hoped to hold it

in March next year, and although this may sound a long time hence, you must not forget that models up to exhibition standard cannot be made in five minutes. Details are obtainable from Mr. F. G. Slaughter at 14 Castilian Street, Northampton.

THERE has probably always been an interest in collecting lead soldiers, but nowadays, with the all-pervading khaki there cannot be the bright variety of former times. But at least one collector made almost a life study of it, and finished up with 50,000 pieces. Mr. Leicester Hewitt, who died recently started his hobby 64 years ago.

When he was thirty-seven, he gave up his position as joint managing director of a Leicester group of newspapers to devote more time to his collection. He never married, never allowed any other interest to interfere with his hobby. Each day he was 'on parade' for six and a half hours in the garage of his house at Hunstanton, Norfolk, where his collection was set out.

He even attended military manoeuvres

and consulted War Office experts to keep his collection up to date.

THE hobby of butterfly collection was dealt with during the summer in these pages, and those who decided to take up the hobby will have a difficulty in beating Mr. C. F. D. Colls, of Worksop. He has obtained no less than 4,000 specimens, which include over 500 varieties of moths and 54 varieties of butterflies. He uses breeding cages such as we recommended, rearing from both the egg and caterpillar stage.

YOU never know what you come across when you start collecting! Two brothers, John and Geoffrey Buries, of Old West Road, Gravesend collect swords—no less than 28 of them—including a Burmese execution sword. But they have had luck, for having paid 7/6 for a rusty old rapier they cleaned it up and found the hilt was of solid silver. Good going, wasn't it?

The Editor

# All the details for the simple construction of a MODERN CRYSTAL SET

ONE great bugbear of the old type crystal set is the delicacy of adjustment of the cat's whisker on the crystal. When the sensitive point has been found, the slightest vibration or jar is sufficient to knock the whisker off. True, there are so-called permanent detectors of the double crystal type, but these are, in fact, only semi-permanent. They still require adjustment and are not so sensitive as the cat's whisker and crystal.

## A Stable Detector

War-time research on radar has, however, changed all this. It was found during the war, that for certain purposes the thermionic valve was useless, and it was necessary to find an alternative. The cat's whisker and crystal was found to be admirably suited for the purpose but was, of course, too delicate as it stood,

for active service. After considerable research a completely stable detector was evolved.

The modern detector consists of a specially processed crystal with a tungsten cat's whisker sealed into a ceramic tube. It is absolutely permanent and rock steady, and maintains its adjustment indefinitely, provided that it is not misused. They are quite plentiful, and most radio dealers carry stocks of these crystal valves, as they are now called, at prices ranging from about 2/6 to 7/6. A sketch of these radar-type crystals is given in Fig. 1 (a and b).

There are many different types of crystal and some are more suitable than others for crystal receivers. Type CS7A which is used by the writer, is excellent for the job, but if this cannot be obtained, then your dealer will keep you right if you explain what it is for. As they vary slightly in size no dimensions have been

given for the crystal holder, but no difficulty should be experienced in making this item once the crystal has been procured.

The detail at Fig. 2 (a), (b) and (c) shows the component parts and method of assembly of the crystal holder. It consists of a small cube of wood with a groove cut along one face wide enough to accommodate the crystal. A 1/8 in. brass plate is screwed to one end with small wood screws, and on the other end a small piece of springy brass is held by two small screws near the bottom.

The wood block should be slightly shorter than the length of the body of the crystal, so when it is inserted in the holder with the pin protruding through the hole provided for it in the 1/8 in. brass end plate, the springy brass is bearing hard against the other end of the crystal, as shown in Fig. 2 (c).

A small piece of paxolin provides a cover for the holder and is held in position by four small wood screws. Paxolin is obtainable in most radio shops.

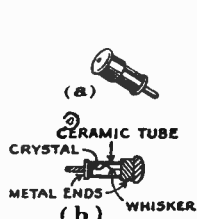

Fig. 1—Type of crystal and sectional detail

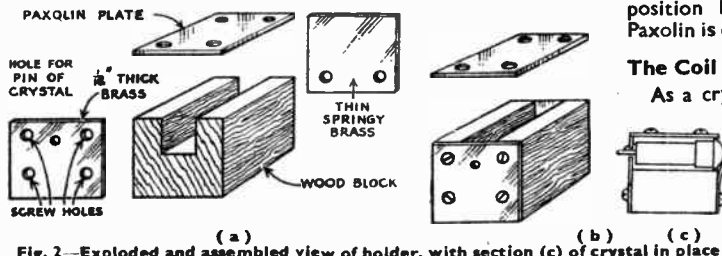

Fig. 2—Exploded and assembled view of holder, with section (c) of crystal in place

## The Coil

As a crystal set does not amplify, it is necessary that it be as efficient as possible in order to obtain maximum benefit from the minute amount of radio power coming in via the aerial. For this reason

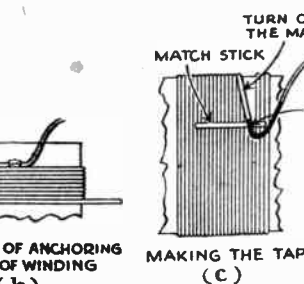
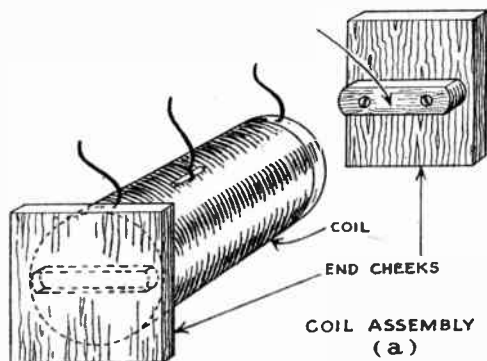

Fig. 3—Various details of the coil

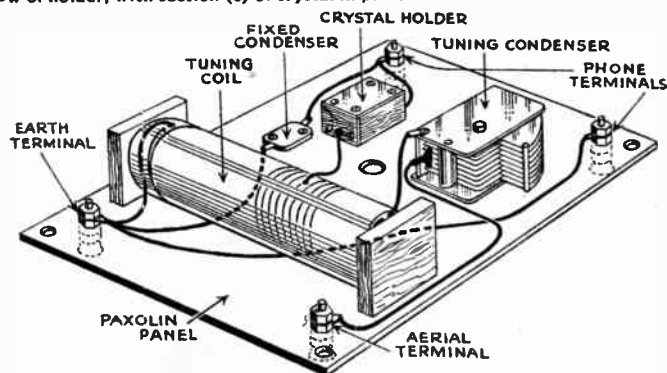

Fig. 4—A helpful view of set showing components in position

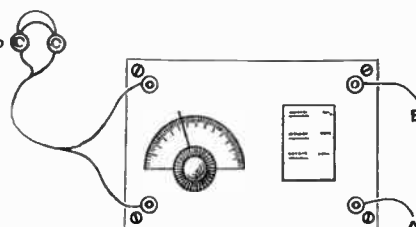

Fig. 6—Front view of panel

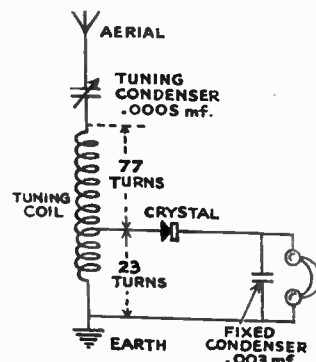

Fig. 5—The theoretical circuit

the coil is quite large by normal standards.

The former consists of a paxolin tube 6ins. long by 3ins. in diameter. A cardboard tube will do if it is thoroughly dried in an oven, then immersed in melted paraffin wax. The coil is wound with 20 S.W.G. double cotton covered wire.

Before the winding is commenced, two small holes are made  $\frac{1}{2}$ in. from each end of the tube, as shown in Fig. 3 (b). The holes should be just large enough to allow the wire to pass through, and about  $\frac{1}{4}$ in. should be allowed between one hole and the other.

### Winding the Coil

The winding is begun by passing the end of the wire down through one hole and back through the other. This free end should be about 8ins. long. Count the turns carefully as they are wound on, and at the 23rd turn place a match stick on the winding and wind the 23rd turn over it, then carry on winding.

The turns immediately following the 23rd turn are pushed under the matchstick until the winding is clear of it. When a total of 100 turns have been wound on to the tube, cut the wire from the reel and thread the free end of the coil through the two holes at this end of the tube. Leave 8ins. or 9ins. free for connections.

The 23rd turn, which was wound over the match, is the tapping point and is now protruding above the surface of the coil. A length of wire is cut from the reel (again about 8ins.). The cotton covering is scraped from the tapping point and one end of the wire is soldered to it.

Mounting blocks, or end cheeks, are

now made to support the coil. They are made from wood and the construction should be quite clear from Fig. 3 (a), whilst the other points with regard to the coil winding will be seen in Figs. 3 (b) and (c).

### Assembly

Other components required are, a .0005 microfarad tuning condenser, .002 microfarad fixed condenser, tuning scale and knob, four terminals, a small quantity of 20 S.W.G. tinned copper wire, some systoflex, and a few small wood screws. Fig. 4 shows the set built on to a paxolin panel  $\frac{1}{8}$ in. thick for mounting in a small wooden cabinet.

If desired, of course, this method of construction need not be adopted. The set could be built on to a baseboard with no cabinet; it is a matter of individual taste.

In this case, the crystal holder is fixed to the panel by two small wood-screws and, similarly, the coil is fixed by two wood-screws in each end cheek. The fixed condenser may be fixed to the panel by means of nuts and bolts if holes are already provided in the component for this purpose.

### Single-hole Fixing

If there are no fixing holes in the condenser, then it may be supported in the wiring for it is quite small and light. Nearly all small tuning condensers such as used in this set, have provision for single hole fixing by means of a large nut on the threaded shank which carries the spindle. For baseboard mounting feet are usually provided.

Wiring of the set should present no difficulty if Figs. 4 and 5 are carefully studied before starting. To assist those

who have little experience of diagrams of this description, here is a point to point description of the wiring.

Aerial to one terminal of the tuning condenser. Other terminal of the condenser to that end of the coil remote from the 23rd tapped turn. Other end of the coil (nearest the tap) to earth terminal.

Tap on the coil to one terminal of the crystal—it is only necessary to solder the wire to one of the brass plates. Other terminal of the crystal to one phone terminal. Remaining phone terminal to the earth terminal. One fixed condenser terminal to the earth terminal, and the other to that phone terminal which is connected to the crystal.

That, then, completes the wiring and it is now only necessary to don the phones, fix on the aerial and earth, and twiddle the condenser knob until the stations roll in.

### Aerial Necessary

Incidentally, a good aerial is necessary if the listener lives more than a few miles from a station. It should be as high as possible and about 80ft. in length. A good earth is also required. This can be a spike or large tin buried in the soil, or failing that, connection to a main water pipe.

A front view of the writer's set is shown in Fig. 6. The tuning dial used here is an ex-V.D. component marked from 0—100. The station chart was, therefore, pasted on the front panel to enable other members of the family to tune in without trouble. This set has in fact been in great demand for bed-time listening.

No doubt many readers will be anxious to make their own for similar use. (139)

---

## Two Handyman Suggestions

### When Stoppers Stick

THE man-about-house is often asked to deal with the tricky problem of removing a glass stopper from a bottle in which it has jammed. If gentle taps have no effect, try this way. Tie one end of a fairly thick string to a hook on the wall.

Give the string one turn around the bottle neck, and hold the other end in the hand, so that the string is taut. Move the bottle back and forth. The friction of the string will cause the bottle-neck to become warm, and expand quicker than the stopper, thus enabling the latter to be removed.

If this treatment fails, and the bottle is of some value—say an antique carafe—ask a chemist to mix up the following solution: 2 parts of alcohol, 1 part of glycerine, and 1 part of common salt. Apply this to the stopper, and let it soak through. After a few hours the solution should have done its work.

Sometimes one is asked to try to remove a cork which has accidentally been pushed into a bottle. It can usually

be removed with a piece of string in either of two ways: (1) Insert a doubled string in the neck of the bottle and manoeuvre so the cork lies within the 'U' of the string. Get it near the neck, and with a sharp jerk pull it out. (2) Instead of a looped string use a thin string which has a large knot tied at the end. The principle is the same as the foregoing.

### Freshen up the Wallpaper

WHEN wallpaper looks dingy, a considerable improvement can be effected by sweeping it with a special wallpaper brush. Indeed, this should be done regularly. There comes a time, however, when, although the paper is not dirty enough for replacement, it would benefit from a cleaning-down process.

Wallpaper Cleaner is a doughy substance which can be purchased from a builder's supply warehouse, but it can be made more cheaply at home, in bulk.

You will need the following ingred-

ients: 1½lbs. whiting; 5lbs. of plain flour; 3ozs. of ordinary salt; 5ozs. of soda ash; 4ozs. of powdered pumice stone; ½oz. of oxalic acid (be careful with this as it is poisonous); and 4ozs. sal-ammoniac. All these are mixed, dry, and just before use, a portion is mixed with water to form a stiff dough, and a few drops of kerosene added.

This doughy ball is rubbed over the wallpaper in long sweeps, and as the face of the material becomes soiled, it is kneaded into the rest. Apart from cleaning wallpaper, the material is also useful in cleaning the edges of books.

It occasionally happens that grease gets splashed on a wall, and this is very unsightly. It can be removed by covering the spot with a piece of thick, good-quality blotting paper, and holding a hot iron against it. An electric iron is best, of course, as the heat may better be maintained, but ordinary flat-irons serve well if two or three are used in relay.

Stains caused by dampness can usually be traced to walls which need repointing.

# Here is another type of easy-to-make table CIGARETTE SERVER

In a previous article instructions were given for a simple cigarette 'server', for use at parties or on dinner tables, or indeed anywhere when guests are expected to help themselves. Here are details of a rather more elaborate server which will hold twelve standard-sized cigarettes.

A piece of  $\frac{1}{4}$  in. material is required first on which two circles each of 2 in. diameter can be scribed. Inside both the circles the six-sided figure shown is drawn, this being obtained by placing the leg of the compass, which is still set at the 2 ins. at any point on the circumference and by swinging in both directions making two marks (on the circumference)—one on either side.

Move the compass leg to one of these points—it does not matter which—and swing again, continuing thus right round the circle. If correctly done the circumference should divide exactly into six equal parts. Join the points so found by straight lines and the desired shape is secured.

## Two Hexagon

The six-sided shapes are then scribed out, the one as (A) and the other as (B), Fig. 2. On both shapes lightly mark in the radii from the six points to the centres and put in the line (a) which is a  $\frac{1}{4}$  in. from the points, along the radii, that is a shade less from the outside edges.

On the second piece (B), the one that is going to be the upper level, mark the points (b), a  $\frac{1}{4}$  in. more along the radii. The holes which are to take the cigarettes are of  $\frac{3}{8}$  in. radius and points  $\frac{1}{8}$  in. further still along the radii give the centres of the corner ones, and these can be drawn in.

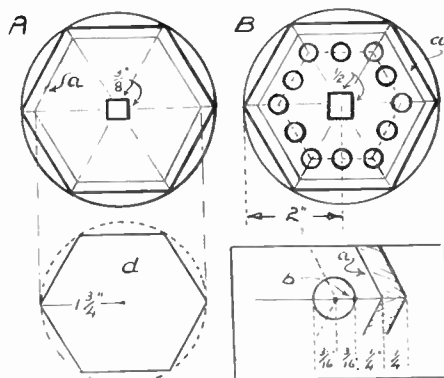

Fig. 2—How to make the shapes

Now join the centres of these six corner holes and you get the centre-line for the intermediate openings which lie mid-way along the flat sides. The centres of these secured, they also can now be marked in.

Next required is the second base-piece

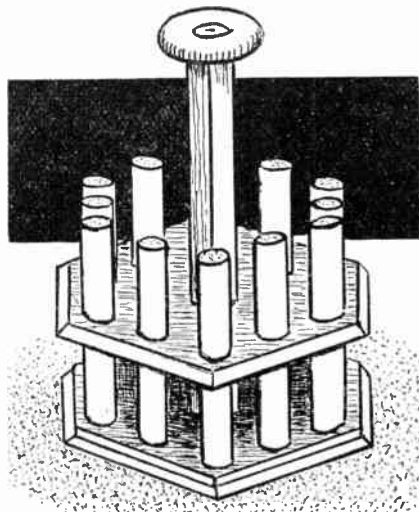

Fig. 1—A completed stand for 12 cigarettes

(d). This is from a thin section of material,  $\frac{1}{8}$  in. or  $\frac{3}{16}$  in. thick. The shape is obtained by drawing a circle of  $1\frac{3}{8}$  ins. radius, marking off the circumference as above in radii lengths, and again joining up the points found.

Temporarily fasten this piece to the top (B) with two or three fine sprigs and aligning it to the line (a). Carefully bore down through the two sections at each hole position. A standard cigarette is just  $\frac{3}{8}$  in. diameter so the apertures are first taken out to this measurement and then eased off with a round file or glasspaper wrapped round a thin pencil or skewer, till a nice comfortable fit is secured for the standard 'smoke'.

## The Base

When all is ready separate the pieces and bevel the edges of the top and under sections (A) and (B) as far as the first line (a). This will give a pleasing slope. After this secure (d) to the base-piece (A) with glue, putting under pressure while drying takes place. See to it that the edges of (d) nicely meet the top of the bevel, glasspapering a little if necessary to obtain this end.

A base having twelve circular depressions has now been made and at this junction check to see that all these are quite free from unwanted bits of glue, etc., as at the best they only just grip the ends of the cigarettes.

Now take a  $\frac{1}{2}$  in. square opening out of the centre of (B) and another of  $\frac{3}{8}$  in. sides from the middle of the base. These are for the handle (G) (Fig. 3). It would be nice if this latter could be turned on a lathe at the top to some pleasing shape, but in lieu of this finish, a square-section length of wood with a 'button' on top

will do quite well.

In either case the lower end (g) is taken to a square section of  $\frac{3}{8}$  in. sides for  $\frac{3}{8}$  in. up, and to a  $\frac{1}{2}$  in. section for the next  $1\frac{1}{8}$  ins. up. If a square section handle is being used throughout, this section can be retained to the top, otherwise any turned part would start here. The length of the handle is  $5\frac{1}{4}$  ins.

## Handle Piece

The top of the handle is completed with any of the circular 'buttons' that can be obtained at dealers in wood fittings. It should not be too large—about  $1\frac{1}{2}$  ins. doing nicely. The button is secured to the top of the handle with a round-headed chromium screw, a chromium washer being put between the head and wood to give a bright finish.

Assembly of the three main parts can now be effected. If well cut this will not be difficult as the square hole should grip the upright fairly tightly and at a true right-angles. This ideal is not always obtained, but it is essential that the main pieces are perfectly horizontal and at an accurate ninety degrees to the upright. To this end two blocks of wood of the same thickness should be slipped between the pieces as gluing and drying proceeds,

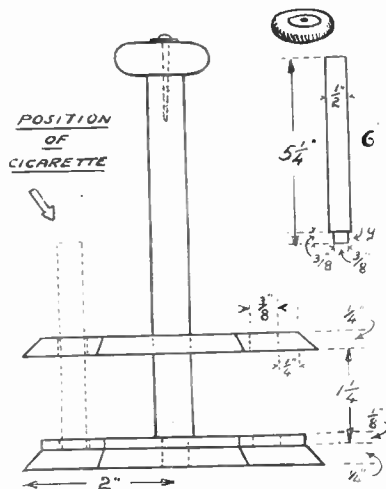

Fig. 3—Section and detail of spindle

the upright being checked with a set square.

As with the first server described, finish can be with stain or stain and polish, or if good wood has been used a plain finish could be adopted. A too-dark livery should definitely be avoided, anything to do with cigarettes for some reason always looking better in a fairly light setting.

Thin baize should finally be glued to the underside of the base to give safety on even the most highly polished surface. The server as given is designed for the standard cigarette.

# Practical improvements brought about by these HOME CONVERSIONS

SO many of us find today with the family growing up and the steadily increasing cost of houses that we have got to make some more room somewhere in the house. Many of us are quite fortunate if we have a loft room. Unfortunately, we cannot always find the right type of furniture, but we can have a look round the second-hand dealers and pick up some interesting bits and pieces.

## An Attic Dressing Table

In Fig. 1 is a little chest of drawers which we often see at the dealers. It is a bit out of date but still it can form the basis for a window fitment up in the loft. Clean it up and mend the drawers. Mount it a little off the floor, although some of them have a fancy scroll and foot at the base. Adjust it to meet the bottom of the window.

Now, on each side, extend the shelf with a wide sweep as shown. Fit this first in  $\frac{1}{2}$  in. board and then cover the top with plywood or Lloyd Board to give a

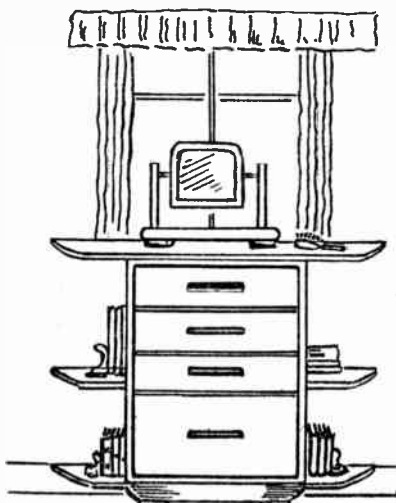

Fig. 1—A hold-all dressing table

neater finish. The shelves below are most handy and follow the lines of the top sections. Bring one to the height of the skirting on which it can rest, but do not have it lower as it will create dust. Plastic sheet is now available and cut to the required shape and size would make a very attractive finish.

## Tray Arrangement

There is no doubt that the average cupboard used for clothes does also have a very large amount of space wasted which could be used to advantage with a little planning. This can be done by arranging that the larger things on the shelves do not come too high. You can re-arrange your shelves to

achieve this but the main secret of space gaining is in the making of the light wood trays or boxes, as shown in Fig. 2. These should be carefully measured and made from plywood with strengthened corners. They should fit cleanly underneath the shelf when the door is shut. Make certain that they will clear the side of the cupboard with ease.

As the boxes will be used for small items, perhaps, you can make separate partitions in them so the items are kept tidy and neat. Smaller items can be put into shallow cardboard boxes as this system is always a good space saver.

## A Newspaper Holder

Newspapers are always strewn all over the average house but the obvious suggestion is to find a place where they can be stowed without getting in the way. You can probably fix this in some narrow part between the wall and the sideboard. Being at an angle (see Fig. 3), one can sort out the papers and choose the one he or she wants without disarranging them.

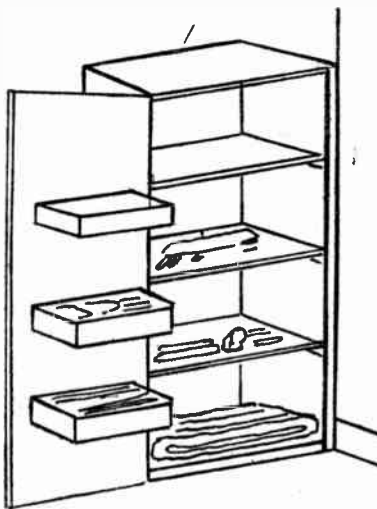

Fig. 2—Boxes inside the door



Fig. 3—A leaning newspaper rack

You will need a piece of fairly good  $\frac{1}{2}$  in. plywood about 12ins. by 16ins. Plug the wall so the two brackets are screwed on. Two of the ordinary flat

iron brackets can be bent to an angle of 30 degrees and fitted as shown. Stain the fitment or paint to match the room. Do not let it get overloaded, otherwise it will cease to be useful.

## A Cocktail Cabinet

Whether it is the advent of Television or not we cannot say but there are plenty of very good gramophones about today which can be picked up cheaply. These can be converted at very little expense into a cocktail cabinet or an attractive piece of furniture for the drinks (see Fig. 4).

The lower cupboard which housed the records may need little alteration, although you may like to put on some more modern doors. Add some of the new streamlined handles in a pleasing colour. The slats or grid can be removed and any other fittings taken out of this part. Here you can keep other items used for festive occasions.

## Under-Lid Compartment

As the lid is most likely well domed it

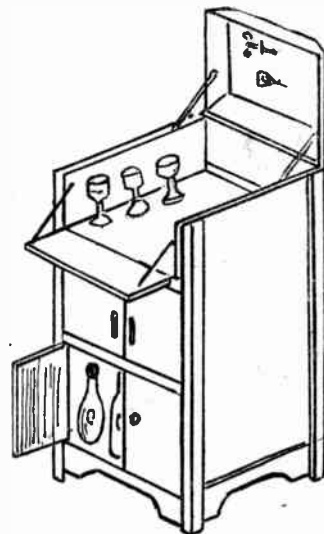
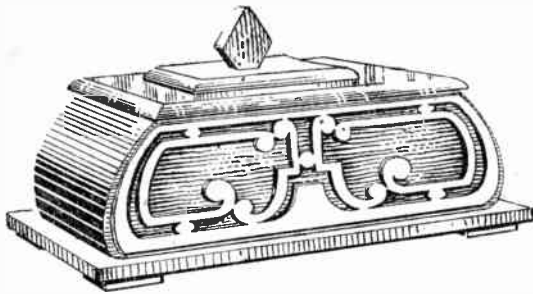

Fig. 4—A converted gramophone cabinet

will need little improvement to make it suitable for the glasses, etc. If there is not sufficient depth this can be altered and a flap hinged on to make an additional table. Cork-screws and other necessary instruments can be fitted in the domed roof. All other fittings can be left in position, as they will still function in their new role.

All these alterations and conversions can be made by the home handyman, and there are doubtless many others which will suggest themselves. Keep your eyes open at any local sale of furniture or in the window of those second hand dealers where you can pick up articles cheaply and convert easily to your own particular requirements. (201)

# Patterns on page 31 for this handsome BEAD OR TRINKET BOX



The attractive completed box

**Q**UITE a modern touch is introduced into the attractive little box shown in our illustration at Fig. 1. This article would be very suitable as a birthday or Christmas gift for a lady, and would look well when nicely polished and finished on the dressing table. We have been able to devote a whole page in this issue to the full size details of all those parts which would otherwise need enlarging from a smaller diagram or tracing by means of carbon paper.

## Suitable Wood

The wood required for the box will be  $\frac{1}{4}$  in. thick for the base, the lid, and the top overlay on the lid; some  $\frac{3}{8}$  in. stuff for the two sides and smaller pieces of  $\frac{1}{2}$  in. for shaping for the ends. The handle could be either  $\frac{1}{4}$  in. or  $\frac{3}{8}$  in. thick, and the overlays on the sides may be of quite thin wood but preferably  $\frac{1}{4}$  in. stuff or even ivory.

An endeavour should be made when buying the wood to get good contrast in shade or colour between the main wood and the fretted overlays. Of course contrast can be got by stains, the box being perhaps of light coloured mahogany, while the overlay is white. Stain should, in this case, be applied to the mahogany to increase the depth of tone before the overlay is stuck on.

## Copy the Patterns

The construction of the box is simple. The patterns show the side overlays contained within the outline of the side. It will be necessary, therefore, to trace in the outline of the two sides direct on the wood by means of carbon paper, then this leaves the overlay pattern intact for sticking down to the thin overlay material.

Two pieces of the thin material can be pinned together and the pattern then stuck down to the uppermost layer and the two pieces thus cut together simultaneously. This method saves a great amount of time. The method of making the floor and base is given in

Fig. 1. The latter consists of four mitred strips, given full size on the pattern page. Mark these out on to the  $\frac{1}{4}$  in. or  $\frac{3}{8}$  in. wood and cut them in the usual way with the fretsaw.

The four pieces are glued together, and the inside angles may be further strengthened by adding four glued angle blocks as seen at (B) in Fig. 1. On this open

frame will be glued the  $\frac{1}{4}$  in. thick floor measuring  $6\frac{1}{2}$  ins. by  $2\frac{1}{2}$  ins. This is seen in Fig. 1 as a sectional diagram and shows how the piece must have an equal margin each side and each end of the mitred base strips so as to allow the sides and ends of the box, when made up, to stand evenly all round.

The enlarged circled diagram in Fig. 1 shows, by section, how one end of the box will appear when it is glued to the base and in relation to the floor piece. Small square glued blocks about  $\frac{1}{4}$  in. in section and cut from spare wood may be added beneath the floor as seen at (C) in Fig. 1.

## Box Construction

The box is built of two sides and two ends. It is assumed that the two sides have been outlined on the wood and cut out and cleaned up, so the next process will be the fixing of the ends. Turning

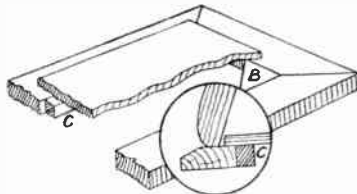

Fig. 1—Floor construction

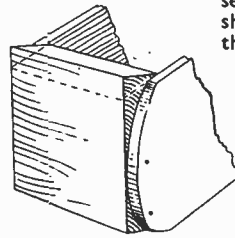

Fig. 2—The end block

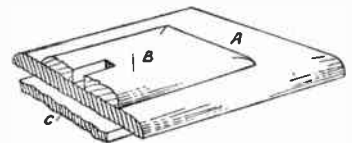

Fig. 3—The 3-piece lid

again to our patterns we see these are of thicker wood than the rest of the box, viz.  $\frac{3}{8}$  in. It will be necessary therefore, to choose one of two methods of making the ends.

If two pieces of wood  $\frac{1}{4}$  in. thick and of the same variety as the remainder of the box can be obtained then these can be used straight away. If, however, this thickness is unobtainable, then a different variety of wood is quite permissible and could be cut and shaped and afterwards covered with a thin veneer of wood glued on.

## Rounded Ends

We show in Fig. 2 the best way of fixing the ends to the sides, previous to shaping and paring away the unwanted wood, using the shaped edges of the sides as a guide for this work. Screw through sides of the box to strengthen the connection or use long fret pins for this purpose.

If, say, mahogany is used for the ends, then the shaping can first be done with the pocket knife or chisel for getting off the corners of the blocks and the remainder of the shaping done with the rasp and file, finishing off with glasspaper. When all the shaping has been done satisfactorily, the whole box may be glued to its base. Glue a couple of  $\frac{1}{4}$  in. square angle fillets, or better still, triangular fillets along inside so as to strengthen the joints.

The lid of the box consists of three plain pieces of wood glued together as (A), (B) and (C) in the diagram Fig. 3. The main large section (A), measures  $5\frac{1}{2}$  ins. by  $3\frac{1}{2}$  ins. by  $\frac{1}{4}$  in. thick, and to the top of this is glued a piece shown as (B) on the pattern sheet. This, and the main section of the lid has its edges shaped as shown in the cross hatched section on the sheet.

## Lid Fitting

As the lid is a simple lift-off cover a means must be found to hold it in place. We therefore add a third layer (C), and this goes beneath the large main lid, the exact size being best obtained by measuring the opening of the top of the box itself when it is made up. The piece (C) is  $\frac{1}{4}$  in. thick. Note the  $\frac{1}{4}$  in. by  $\frac{1}{4}$  in. mortise cut centrally in piece (B), this is to receive the tenon on the small handle shown full-size on the pattern sheet.

The finish to be put upon the box will be left to the individual worker, and the variety of wood used, will of course, have some control over the finish. Four square feet as shown on the pattern page and cut from spare wood will add to the appearance of the box.

## HOBBIES 1951 HANDBOOK

is now on sale with 112 pages, a large free design, colour cut-out supplement and 16 pages of colour. Ask at any Hobbies Branch or Newsagent. Price 1/- (postage 3d.)

# Further instructions on the fascinating hobby of STUFFING BIRDS

**W**HEN the work described in the first article has been done and the whole process of the stuffing and wiring is satisfactorily completed, the actual mounting should not be long delayed. Time wasted at this point allows the specimen to 'set', and difficulty may then be experienced during the final poising of the model.

In practice, it may be found advantageous to prepare the small tree branch or stone on which the specimen is to be mounted at the same time as the stuffing is being carried on. It can be worked in while the skin is drying off.

## Type of Base

The choice of a base for the model will depend on the model itself. Tree-perching birds will be required to be mounted on a twig to give the most natural effect, while birds of prey are best set off on a small rock or shingled level. The beginner was advised to practice on a starling, and it will be assumed that this has been satisfactorily stuffed.

A small branch of apple or pear, not newly-cut wood, serves well; it should have a slight fork and be roughly 9ins. in length. Nail it securely to a platform about 8ins. by 5ins. and  $\frac{1}{2}$ in. deep (four ply wood would serve), setting it about the middle. If two specimens are being mounted make the platform and branch larger accordingly.

## Natural Additions

When this has been done it must be adorned with moss, lichen, stones, and touched up with paint to give it a suitable appearance. In all his work the taxidermist aims continually at naturalness.

The platform should be coated chiefly with moss, though a little lichen at the

base of the twig often helps to give a very natural effect. Glue the moss on in a fairly thick layer, making sure that its thickness is penetrated by the glue. Paint the sides of the shallow platform a green which matches the moss as nearly as possible.

Several kinds of lichen can be used on one model, and a supply is easily gathered from orchard trees and decaying logs. Suitable moss is also found on old logs, and in most garden lawns.

Paint the twig before attaching any lichen, which should be generally green, with a touch here and there of brown and ochre. When it is dry, stick on small pieces of various lichens. Do not put too many pieces, or the base will look overdone. Touch them up with slight dabs of greens and browns, and a slight splash of ochre. Again, the beginner is

it will be found that one foot will be below the other; and the body must be gently manipulated to give it a natural poise on the splayed legs. The wings should be lifted slightly away from the body, and set to the desired position by the wires inside them. Similarly, set the poise of the head by means of the neck wire.

Play the claws of the foot so they grasp the twig, pinning them into position for a few days if necessary until they set. Be gentle with these, as they soon become brittle.

## The Final Touches

When the final touches to the placing and poise of the specimen have been done there is little more work. A very tiny dab of red at the base of the beak may be added, and the beak itself can be

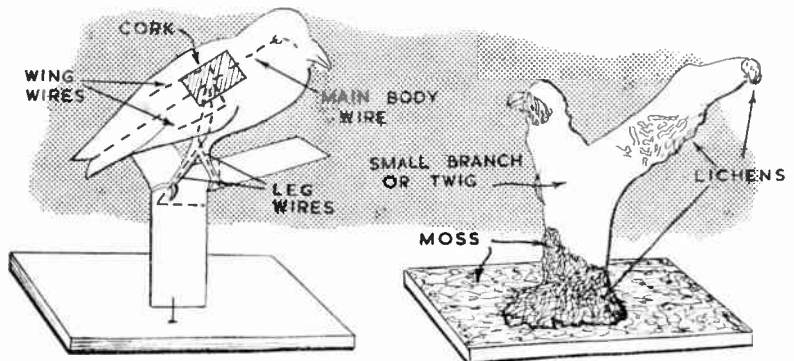

Details of bird mounting and natural branch base work

warned not to use too much paint for it can always be added, but is not easily taken away at a later stage.

If a bird of prey is being dealt with pebbles would be used on the platform, and perhaps a stuffed mouse or broken egg-shell added for effect.

## Mounting the Specimen

When the base is complete, decide the position and poise of the specimen. On these will depend the placing of the feet. Drill a fine hole through the twig, and pass the feet wires through it with the aid of pliers. The wires should be wound round the twig once, and can be hidden by a piece of lichen. The feet should rest tightly and securely against the wood.

The model is now nearing completion, but the beginner will probably experience difficulty in giving the bird a natural poise. If, as is advised, attention is given to the specimen in its natural state it should not be too difficult. A point worth bearing in mind is that a slight turn or twist of the head often puts the finishing touch. This is because it is an extremely natural movement of all birds, irrespective of habit and habitat.

Unless a flattened twig is being used,

given a thin coating of yellow. Use paint which is only the slightest bit brighter than the natural colour.

A coating of light varnish can be given to the legs and feet. Care must be taken not to allow any of the paint to touch the plumage of the bird.

## Brush the Plumage

If the plumage at the breast of the bird, where the cut was made, does not lie too well brush it gently with a fine-haired brush or comb with a fine comb. Do not wet it in an attempt to make it lie down. The whole specimen can be brushed gently to make the plumage lie naturally and to keep it dust-free from time to time if it is not to be put into a case. Cased specimens are far more common, but a well-constructed uncased model often has a far more pleasing effect.

Annealed wires which are best used for taxidermy number from the largest, Size 1, but only Sizes 16-22 will be required for birds mounted at first by the beginner. Artificial eyes number from the smallest, Size 1, and are obtainable in various colours such as brown, hazel, yellow, green and blue, and so on. Oil colours, in tubes, are best used for touching up the models. (249)

## HOBBIES BRANCHES—LONDON

78a New Oxford St., W.C.1  
87 Old Broad Street, E.C.2  
117 Walworth Road, S.E.17

## GLASGOW

326 Argyle Street

## MANCHESTER

10 Piccadilly

## BIRMINGHAM

14 Bull Ring

## SHEFFIELD

4 St. Paul's Parade

## LEEDS

10 Queen Victoria Street

## HULL

10 Paragon Square

## SOUTHAMPTON

25 Bernard Street

## BRISTOL

30 Narrow Wine Street



# There is a big demand by amateur photographers for a VERTICAL ENLARGER

HERE comes a time when the amateur photographer is dissatisfied with prints the same size as his negatives. The lack of funds, however, may prevent him from progressing in his hobby. In this article an enlarger is described which will suit the purse and requirements of beginners to this fascinating art.

It can be made for less than £1 and has been designed for negatives up to 2½ ins. square, so enlargements can be made up to whole plate.

The tools needed are simple and any reader of *Hobbies Weekly* is almost bound to have them in his workroom.

The most important things are, of course, the lenses. The condenser lenses are of the moulded type and cost about 5/- each. The focusing lens the author used was taken from an old 120 box camera—the camera purchased for the purpose costing 6/-.) It was, however, the result of a little patient enquiring at junk shops.

## Focal Length

It is important that you choose a camera that produces a negative 3½ ins. by 2½ ins., because the focal length of the lens will be 4 ins. or just over. This enlarger has been designed for use with a 4 in. lens. The other items you need are two tins, wood, three right angle brackets, paper, gum, paint, etc.

The first things to make are the focusing tubes, which are made of paper.

Obtain a round former about 1½ ins. in diameter, such as a small round bottle or a short length of stout pole. Cut strips of brown paper roughly 5 ins. wide. Start winding the paper round the former, gumming all the time until a thickness of ⅜ in. is reached. Bind the surface with transparent tape.

## A Second Tube

Then immediately over the top of that build another tube exactly the same thickness. The windings should be as tight as possible, and a liberal amount of gum will make a strong job. Put these in a warm place to dry, and when dry, cut them down to 2½ ins. For future reference we will call inner tube (A), and outer tube (B).

The next thing to make is a jig of strong thin cardboard (see Fig. 2). Obtain a tin over 3 ins. high and not less than 3½ ins. in diameter. Cut the rim down to 3 ins. from the bottom of the tin. Find the centre of the base and puncture it with a fine nail. Put the mark (X) of the jig over the mark of the tin, plot the positions, cut out the square and drill the holes.

Get a piece of 1 in. thick wood and cut a circle out so it fits snug in the tin. Cut another circle out of the wood so tube (B) makes a good tight fit. These have to be fixed later, but it is important that they fit exactly square.

## Lens Holder

The lens holder is cut from ¾ in. hardwood and is made to fit tight inside tube (A). Another central hole is made in this disc, slightly smaller than the lens. The lens can now be glued on the circle by the use of a very strong glue on the extreme edges. Make particularly sure none gets on the centre of the lens.

The lens holder is now glued 1 in. inside tube (A). Cut the crosspiece out of ¾ in. hardwood (see Fig. 3). Two pieces of good quality glass are now

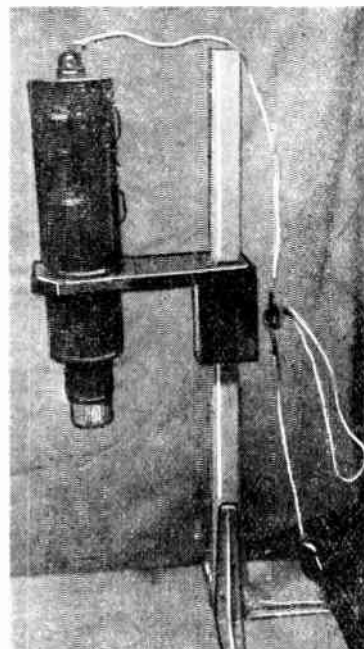

Photograph of the enlarger in use

needed. If they have to be cut for the purpose it is wise to rub the edges down smooth on a carborundum stone soaked with turpentine. Lay the glass on the crosspiece so the margin on each side of the square is equal. Tack on the two runners which are slightly thicker than both the pieces of glass together.

## The Lamphouse

The lamphouse finishes this part of the enlarger. It consists of a tin 3½ ins. diameter and about 8 ins. long. Your local hairdresser may be able to help you with one of the tins he gets his shaving powder in. The bottom of the tin has to be cut and drilled to the size of the jig. At the top and bottom of the tin you will need ventilation holes covered by strip metal (see Figs. 1 and 4). Drill a 1½ in. hole in the lid of the tin and fix a bulb holder. Connect this with a length of flex with a suitable plug on the end. It will be found most useful to put a switch in the flex about 2 ft. from the lamphouse.

Now the whole thing is ready for  
(Continued foot of page 26)

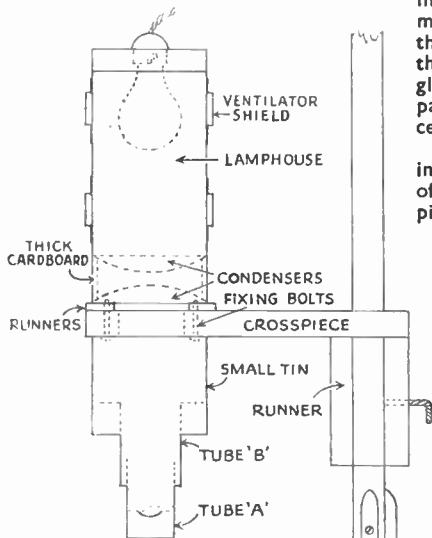

Fig. 1—A side view showing position of parts

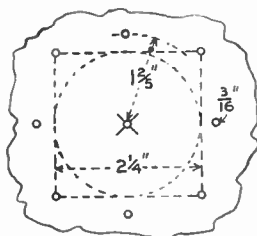

Fig. 2—The cardboard jig

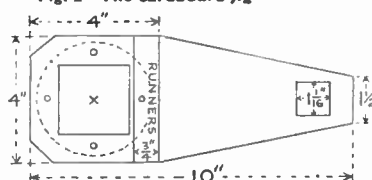

Fig. 3—Dimensions of the taper arm



Fig. 4—Ventilator shield

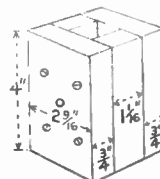

Fig. 5—Runner piece for the pillar

# Carry your impedimenta easily inside this bamboo NATURALIST'S STICK

**T**HE field naturalist, whatever his particular calling, is often encumbered with a great number of small articles which are very necessary for his work. It is possible to carry many of these in an unusual and useful way, and this article is intended to show how a walking-stick, which in itself is a most valuable asset to the naturalist, can be improvised for the purpose.

The stick itself is of bamboo, about  $1\frac{1}{2}$  ins. diameter, and this can be purchased from a shop or furniture dealer. It should be about 3 ft. long overall and have only two joints, equally spaced on its length. Burn and hollow out the top to a depth of a few inches, and fashion a small block which will fit tightly or screw into the hole.

This should not be as long as the hole burnt into the stick, as on to the bottom of the new block may be fastened a small trowel or spike which will be most useful for digging up pupae specimens. It can also be stuck into the trunk of a tree to assist in climbing and can be screwed firmly into the base of the block. Into the head may be fitted a small compass. This should be sunk so its surface is level with the end of the stick, and there is little likelihood of its becoming broken as it is normally shielded by the hand.

## Hollow inside of Stick

The complete portion of the bottom joints of the stick is then hollowed out in the same way. This gives a receptacle of 2 ft. or so in length. To take the place of the original wood make a small wooden bar of a few inches which fits easily into the hole.

This bar should in turn be hollowed, and the end which will be the end of the stick when it is in position should be shaped so that it will plug into the stick, and also have two small holes drilled into it. A small brass ferrule will strengthen this base of the stick, and prevent it from splitting.

The two small holes are for a loop of wire which may be carried in this hollowed block, together with a fine net which will roll and fit easily into the space as well. This net is useful for

catching butterfly specimens and water animalcula. If the ferruled end of the new block fits into the hollowed end of the stick a few extra inches can be added to the stick as a whole if this is ever required.

A small test tube should be carried in the hollow portion of the stick. When netting water specimens this can be fastened to the bottom or centre of the net with an elastic band, and while the water drains from the net the specimens will sink into the tube.

## What can be carried

What is carried in the remaining space in the stick is largely a matter of choice.

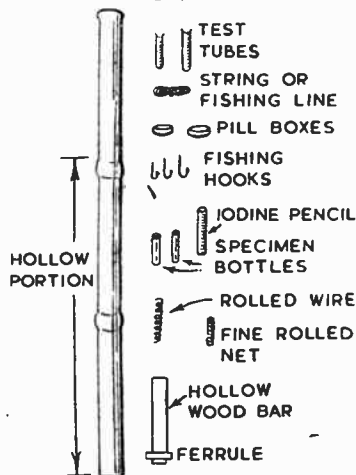

What the hollow stick can hold

Several small phials may be inserted, as these are always required. A tube of methylated spirits, some cotton wool, string, fishing line and hooks, screws, an iodine pencil, a tape measure, dipping-tube, a small bottle or two. All these can be carried and there should still be some space left. Several small lenses will also take up very little room.

## For Measuring

The length of the stick can be marked off with a knife into feet, and will be found a useful measuring-stick. It can

then be used to measure heights. If the rough height of a tree is wanted drive the stick into the ground, mark its shadow, and measure it. Then measure the length of the shadow of the tree from which its height can thus be calculated.

## An Improvised Telescope

A useful observation glass can be made simply which is easily used in conjunction with the walking-stick. The best lenses for this are a convex 1.50 and a concave 16 or 20. These numbers represent the strength of the glasses. In the lid of an empty blacking tin or a similar one cut a hole about the size of a silver threepenny piece, and place the concave lens in the lid.

To make it fit tightly cut a strip of cardboard and glue it firmly round the inside of the lid to make the lens sit in position. Over the lens glue a piece of black paper with a hole about  $\frac{1}{8}$  in. in the centre. The eye-piece is then complete, and on to it should be soldered a 'screw-eye'. This is screwed into the 'eye' end of the walking-stick when the observation glass is used.

From the bottom half of the tin cut a circle almost the size of the convex lens, and mount the lens inside with a cardboard ring as before. On to the rim of this half of the tin solder the stem of a ferrule which will slide up and down the walking-stick. When in use a strong elastic band will be sufficient to keep this sliding object-lens in a desired position.

It will be realised that when the observation glass is in use one sees all round the object-lens as well as through it, but this is to some extent an advantage as the object to be focused is easily seen before the observation lens is brought upon it. The two lenses are best carried in the pocket when not being used in conjunction with the stick.

An air hole or two may be drilled in the hollow part of the stick, and such specimens as lizards, beetles, and larvae can then be carried inside without them dying.

This simply-made walking-stick will be seen to have a multitude of uses, and is really an invaluable aid to the naturalist.

(261)

## Enlarger—(Continued from page 25)

assembly. Three  $\frac{1}{2}$  in. by  $1\frac{1}{2}$  in. nuts and bolts are all that are needed. Put all the holes in alignment and pass the bolts from inside the lamphouse down into the smaller tin. You will notice the fourth hole is not used or it would obstruct the negative carrier. Finally the wooden circle is glued in position in the smaller tin along with tube (B).

The base is 18 ins. by 11 ins. off  $\frac{3}{4}$  in. softwood, whilst the upright is a piece of hardwood 1 in. square and 2 ft. 6 ins. long. It is fixed in position with three strong

5 in. angle brackets. The runner is made of  $\frac{3}{4}$  in. hardwood (see Fig. 5).

The crosspiece is fixed firmly on the runner with four screws. A hole should be drilled in one side of the runner, so a threaded rod can be screwed in. The rod should be of sufficient length so it can be bent at rightangles to allow it to be turned easily.

Finally the condensers. These should fit snug in the bottom of the lamphouse. The top condenser is suspended over the first by means of a piece of thick card-

board 2 ins. wide, 11 ins. long, bent round the inside of the tin (see Fig. 1).

As an alternative to the condensers, a piece of diffused glass over the hole in the lamphouse will be nearly as good, but exposures will be much slower. A piece of diffused glass costs only a few coppers.

The illumination should be provided by a 100 watt enlarging lamp. A coat of matt black paint on all but the movable parts and the baseboard will give it a pleasing appearance.

(232)

# For the handyman or craftsman this is an ideal HOME UTILITY CABINET

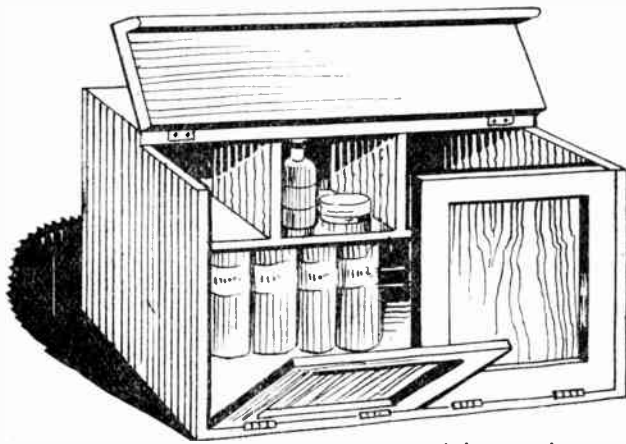

**T**HE cabinet shown in our illustration at Fig. 1 would serve many useful purposes—as a photographic store or for the young chemist or as a home medicine cabinet. It can be made up from Hobbies prepared panels of wood. Now, in spite of our cabinet being of ample proportions—it measures 16½ ins. long, 8 ins. wide and 10½ ins. high—wood ½ in. thick only has been used throughout. It has, however, been so constructed that the fixing fillets inside and the shelving and partitions make an extremely strong and rigid case.

The worker may choose to supplement the glue and screws with brass angle plates screwed in either inside the cabinet or at some of the outside corners.

## The Floor

The floor may be made from one complete panel of wood 20 ins. by 8 ins. cut across at 16½ in. length (see Fig. 2). Upon the floor the two sides are erected,

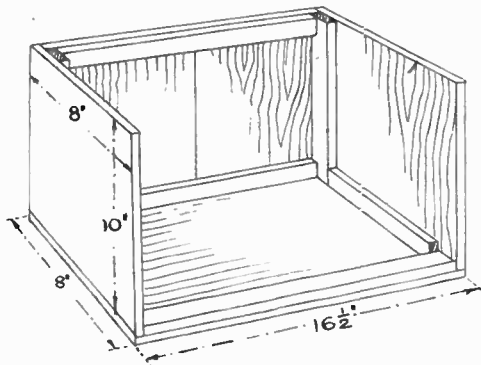

Fig. 2—The bottom, sides and back of case

measuring 10 ins. by 8 ins. As fixing end grain of wood is not the strongest, we have introduced a glued fillet to the angle inside, between the sides and floor.

One of these strengthening fillets is seen in Fig. 2, which, by the way, shows the thicknesses of wood exaggerated to indicate the joints of the wood and the

and bottom by cross fillets glued and screwed on. Another fillet runs along the front edge of the floor. This is to take the hinges of the doors as well as to strengthen the cabinet at this point.

The simple arrangement of the partitions inside the cabinet is seen in Fig. 3, where the dimensions of the three parts are also given. Notches must be cut as shown to fit round the fillets inside the case. Careful measurements should be taken for an accurate fit.

The doors are hinged along their lower edge and let down from the top, making for easy access to the interior of the cabinet. Each door measures 9½ ins. by 8 ins., one complete Hobbies standard panel can therefore be used for the pair.

## Door Stiffeners

To stiffen each door, and also to give a panelled appearance, four rails are cut and glued on as Fig. 4. Make the butt joints as close as possible, and when the glue has hardened thoroughly, insert

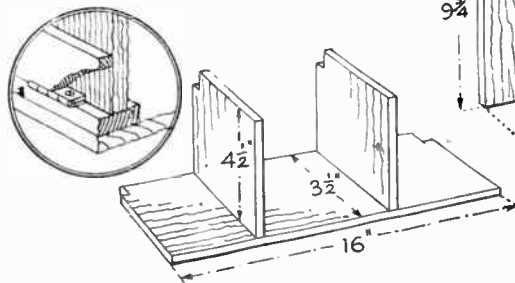

Fig. 3—Inside partition and shelves

some screws from the back of the doors into the rails. The points of the screws must not penetrate the front surfaces of the rails, therefore some care must be taken to choose the proper length of screw for the purpose. Trim the edges of the doors to fit exactly between the sides of the cabinet and between the

lower fillet of the case, and flush with the top edges of the sides.

The method of fixing the hinges is shown in the enlarged diagram in Fig. 4. Cut shallow recesses in the lower rails of each door to take both flaps of the hinges, then screw them in place. Hold each door in turn against the floor fillet of the case and, turning down the flap of the hinge, prick the holes for the remaining screws into the front fillet.

## Drop Lid

For the top lid of the cabinet we require a complete panel of wood. This will be cut through lengthways to form the folding front flap as seen in Fig. 1. The panel will be cross-cut at one end, a piece about 3½ ins. being taken off. The two sections will be held together by a pair of stout hinges, after which the back section will be screwed firmly to the back fillet of the case and to the sides.

Wooden dowel pins may be inserted here into the end grain of the sides, the pins being previously dipped into or brushed with glue to make a good hold. A shallow fillet of wood should be glued and screwed along the front edge of the opening lid flap, to stiffen and act as a lip for holding the two front doors in place.

The finish to be put upon the wood outside and inside the cabinet must be left more or less to the individual worker. The kind of wood used will also influence the finish.

If plain white wood has been adopted, then two coats of paint would form the ideal finish. If, on the other hand, the worker has been fortunate enough in obtaining mahogany, then this wood may be simply stained and varnished or brush polished. In the latter case it would be advisable to just stain the wood inside

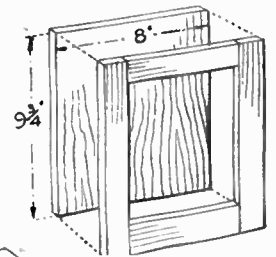

Fig. 4—The Door

the cabinet and omit the varnish or polish.

If brass angle plates are to be added as advised for strength, then these will be put on after the painting or staining has been done.

To make the cabinet to the dimensions given here, five of Hobbies K4 standard panels will be required.

# Add to the doll's house lighting, this handsome DOLL'S ELECTROLIER

THE lighting system of many Doll's Houses consists of a small volt electric bulb fixed to the ceiling. How much more realistic a true-to-scale model electrolier would be, and by following the instructions given below, such a model can be easily made and without special tools.

The fitting consists of a wooden frame to which are attached the bulb holders and the central column. Fixed to the top and bottom of the carrier are two metal crosses, insulated from each other to form the electrical contacts between bulb holders and central column. The lamp is completed by fitting small shades to each bulb.

## The Frame

From a piece of  $\frac{1}{4}$  in. thick plywood cut a 3 ins. square. On this mark out a cross as shown at Fig. 1, each arm being  $\frac{1}{2}$  in. wide. Drill  $\frac{1}{8}$  in. diameter holes  $\frac{1}{4}$  in. from the end of each arm, and one in the centre where the arms cross. Slightly countersink the holes on both sides of the wood. Carefully cut out the cross,

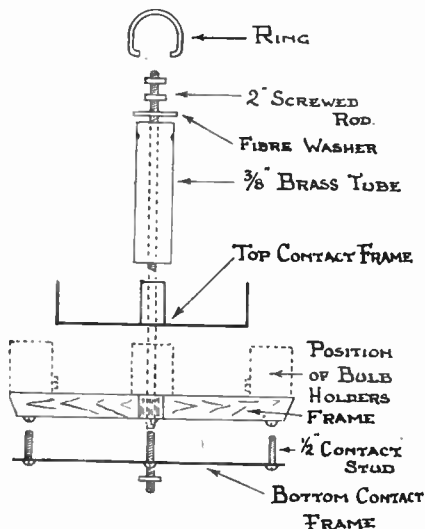

Fig. 2—The various parts exploded for detail

The central column is made in two parts, both being insulated from each other. Obtain an  $\frac{1}{8}$  in. diameter screwed rod 2 ins. long, complete with three nuts, with which to form electrical contact with the bottom metal frame.

The other connection is made from a piece of brass tubing  $\frac{3}{8}$  in. in diameter and  $1\frac{1}{2}$  ins. long. At one end drill two holes  $\frac{3}{8}$  in. in diameter, opposite to each other, to take a split metal ring. Also at this end drill another hole and tap to take an  $\frac{1}{8}$  in. stud, to which one end of the flex is attached. This metal tube makes contact with the top metal frame.

## Bulb Holders

Small brass screw-in type bulb holders to take a flash lamp bulb are sold which have a brass base screwed to them and this must be removed as it is not required. Replace the screw that holds this base with an  $\frac{1}{8}$  in. whitworth screw  $\frac{1}{2}$  in. long, so each holder can be attached to the frames.

holders. Remove, drill  $\frac{1}{8}$  in. holes and re-assemble, this time screwing the contact strip to each holder. The ends

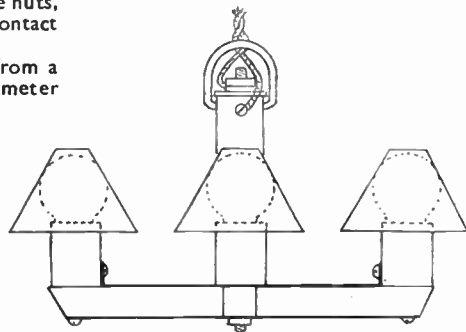

of the strip can now be trimmed off. All is seen in the assembly at Fig. 2.

Having made sure that there is no connection between the bottom and top contact frames, a thin layer of insulating tape can be bound round the threaded rod. Put the metal tube over the rod making contact with the top metal frame. Place a fibre washer on top of the tube and tighten up with a nut.

Bulbs can now be fitted and the model tested, using the outside of the metal tube as one contact, and the threaded rod as the other. Make any adjustments that are necessary.

Make and fix a small brass ring to fit the holes in each side of the centre tube, making sure that it does not touch any part of this rod put a second nut to form a terminal for the flex.

## Painted Finish

The model can now be painted, gold being very effective for such a fitting. The electrolier is hung from a hook in the ceiling of the doll's house. It may be necessary to have a short length of light brass chain fixed from the hook in the ceiling to the ring of the lamp, for it to be hung at the correct height.

From the terminal on the threaded rod and the stud in the side of the centre column, connect silk-covered twin bell flex to the electricity supply for the doll's house. It may be necessary to adjust the balance of the fitting when suspended, and this can be done by binding a few turns of copper wire round one or more of the bulbs.

For the shades cut a piece of very thin parchment to the shape shown at Fig. 3. Join the edges with quick-setting glue and place over the bulbs, which should be of the spherical type. The shades can be held in position with a touch of heat-resisting glue. (248)

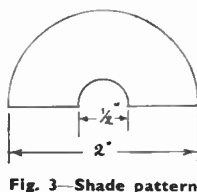

Fig. 3—Shade pattern

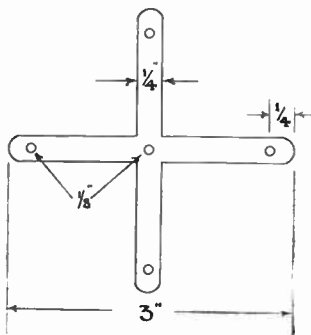

Fig. 1—The main arms shape

file and glasspaper the edges, shaping the underneath side of each end as shown.

For the metal contact frames obtain a piece of very thin sheet brass or aluminium. The brass called 'shim' and used in motor engineering is most suitable. Using the wooden frame as a pattern, cut out two crosses, one for the top and one for the bottom of the frame.

In the centre of the top one drill a hole  $\frac{3}{8}$  in. diameter and bend the ends of the arms upwards for  $\frac{1}{2}$  in. An  $\frac{1}{8}$  in. diameter hole is drilled in the centre of the bottom frame, and  $\frac{1}{8}$  in. holes  $\frac{1}{4}$  in. from each end, to correspond with the holes in the wooden frame.

## Assembly

Place the flat metal contact strip on to the wooden frame and pass the threaded rod through. Put a nut on the end of the rod, and push the rod up until the nut makes contact with the metal strip. Attach the bulb holders to each end by first pushing the holding stud through the frame and making contact with the strip.

Now place the smaller contact strip over the screwed rod, but it must not touch this rod when fixed. The upturned ends will now touch the sides of the holders. In the middle of these mark the position of the studs in the side of the

Our Advertisement pages  
are always worth reading

# MISCELLANEOUS ADVERTISEMENTS

The advertisements are inserted at the rate of 3d. per word prepaid. Name and address are counted, but initials or groups, such as E.P.S. or £1/11/6 are accepted as one word. Postal Order and Stamps must accompany the order and advertisements will be inserted in the earliest issue. Announcements of fretwork goods or those shown in Hobbies Handbook are not accepted. Orders can be sent either to Hobbies Weekly, Advert. Dept., Dereham, Norfolk, or Temple House, Temple Avenue, London, E.C.4

**SOUTH Africa Set, 10 free.** Stamp approvals.—Ashmount House, Marshfield Road, Goole, Yorks.

**40 DIFFERENT stamps free, including Silver Wedding, U.P.U., Victory, Silver Jubilee, Coronation, Pakistan, etc.** Send 3d. postage and request approvals.—J. F. Smith, 60 Boyne Road, London, S.E.13.

**STAMPS—1,000 unsorted, 5/-.** 500 different, 5/-. Free pictorials to approval applicants.—Robert J. Peck, 7A Kemp Road, Bournemouth, Hants.

**IF you have nothing to occupy your leisure, why not try something interesting and profitable?** Experience is not required in leathercraft. Send large S.A.E. for our brochure, free of obligation.—Leathaweave (Dist. 37), 3 East St., Leicester.

**STAMPS—world mixed, 1/- a 100; 5/- a 1,000.** Gift voucher free.—Selby, 66 Donnington Road, London, N.W.10.

**INTRODUCTIONS.** Pen friends, companionship or marriage.—V.C.C., 34 Honeywell Road, London, S.W.11.

**STAMPS Free!!** I twenty unused (2½d.).—G. H. Barnett, Limington, Somerset.

**STICK insects for autumn and winter observation.** Ovae, with instructions, 2/6.—Henry Hynd, Barton, Bedford.

**USE spare time on profitable home-work making fancy goods.** Write for free booklet.—(Area 544), 54 Southgate Street, Leicester.

**IMADE big money, you can do same.** Send envelope, for my system tells you how.—J. H. Wamsteker, Box 34, Wynberg, Cape, South Africa.

**MAKE your own Jig-saw Puzzles.** Fine art pictures, various reproductions and sizes. Also suitable for framing. Stamp for full list.—Joyden Toy Co., 193 Chase Side, London, N.14.

**9.5 Film Library, projectors, films,** for sale. Stamp for lists.—Wayland, 223 Longley Road, Tooting, London.

**PLYWOOD Offcuts, ¾ in. and ½ in. up to 12×9 ins.** Ideal toymaking, etc. In parcels, 5/6, post free. Apply Ansell's, Barnabas Road, Birmingham, 23.

**NOVEL Calendar designs painted on plywood for cutting out.** With date cards. Inexpensive gifts, profitable to sell. Sample, 2/-; half dozen, 10/-, including postage.—Cleaver, 50 Windsor Road, London, N.W.2.

**HOMEWORKERS required, either sex, light assembly, part or full time.** S.A.E.—Esprey, Box 18, 41 Wade Street, Lichfield.

**BE Taller. Quickly! Safely! Privately!** No appliances—no tablets—no dieting. Details, 6d. stamp.—Malcolm Ross, Height Specialist, BCM/HYTE, London, W.C.1.

**FASCINATING and profitable hobby** casting ornaments, toys, etc. You can easily make these yourself. Paints, brushes and all accessories. Illustrated catalogue of 700 moulds, plus latest list of rubber moulds, with instructions, 9d. post free.—Cock of North Moulds (H), 140 Hollings Road, Bradford.

**AMERICAN Magazines post free for one year.** Popular Mechanics, 32/-; Popular Science, 28/6; Mechanix Illustrated, 22/6; Popular Homecraft, 18/- Stamp for full list of others.—Willen Ltd. (Dept. 57), 101 Fleet Street, London, E.C.4.

**IMMEDIATE delivery.** Figured Oak Plywood, 24×24×¾ in., 5 for 35/-; 24×24×½ in., 2 for 25/-. Mahogany box bottoms, 7½×9¼×½ in., 9/- dozen. New Birch, grade III, 30×9×¾ in., 10 pieces, 15/-. Box sides, 35×6×¾ in., 10 for 15/-. All post paid C.W.O. List of plywood, 2d.—H4/JDD Storage, 71 Northcross Road, East Dulwich, S.E.22. Open every Wednesday from 6—9 p.m.

**PRIME imported recessed hardwood** wheels, 2½ ins. diameter, 3/- dozen, 14/- half gross, 26/6 gross. Post free. Pressed metal, hardwood and metal disc wheels, doll's house windows, doors, papers. Catalogues, 6d.—Jasons, 135 Nags Head Road, Ponders End, Middlesex.

**B LUSHING, shyness, nerves, self-consciousness, fears, ended.** Details under plain cover, 1d.—Stebbing Treatment, 28 (HB) Dean Road, London, N.W.2.

**CONJURING.** 3d. for new lists and free magical competition.—De Hempsey, 363 Sandycombe, Kew Gardens.

**PITMAN or Gregg Shorthand.** Rapid postal courses. Particulars.—Shaw's Commercial School, Lancaster.

**WHEELS for toys, and other accessories.** Full lists will be sent on application to The Joyden Toy Co., 193 Chase Side, London, N.14.

**100,000 Government surplus** bargains. 230v AC Bench Drills with ½th capacity chuck, 39/6; 230v AC/DC Electric Motors, £1, other voltages from 9/6; Aluminium Rivets, approximately 1 lb. asstd., 2/6, post 6d.; Sponge Rubber Strip, approx. 18ft.×1½ ins.×½ in., 2/- per roll, post 9d.; small red Warning Lights, 6d., post 3d.; hundreds of other bargains. Send 3d. stamp for catalogue.—Milligan's, 24 Harford Street, Liverpool, 3.

**BE Taller in 14 days or money back.** Details, 1d.—Stebbing's System, 28 (HB) Dean Road, London, N.W.2.

**HARDWOOD Ball-Beads, ¾ in. dia-** meter, suitable for children's counting frames, etc. 5/3 per hundred, plus 1/9 P.T.—Joyden Toy Co., 193 Chase Side, London, N.14.

**PLYWOOD offcuts.** Birch and Gaboon in various thicknesses. Handy sized parcels for the cabinet, toy, model maker, and all handicrafts. Parcels made up in £1 and 10/- lots. Carriage paid. Send P.O. to Reeves, Plywood and Timber Merchant, 33 Front Street, Monkseaton, Whitley Bay. Tel. W.B.4677. Due to exceptional demand we cannot promise delivery under eight days.

**£5 to £20 weekly earned at home,** £5 running your own Mail Order business. Details, 1d.—Stebbing Publications Ltd. (HB), Naphill, High Wycombe.

**MODELS.** You can make lasting Mystone-hard models with Sankey's Pyrama Plastic Cement. Supplied in tins by Ironmongers, Hardwaremen and Builders' Merchants. Ask for instruction leaflet.

**TRANSFERS for decorating toys,** trays, furniture, fancy goods. List and samples free. Flowers, pixies, dogs, nursery rhymes.—H. Axon Harrison, Jersey.

**EARN Shorthand by November 11th** (1 hour's study nightly). 1st lesson, 2½d. stamp.—Duttons (Dept. HB), 92 Gt. Russell St., London, W.C.1.

**RUBBER tyred metal disc Wheels** finished in red, green or blue enamel. 2 ins., 2/6; 3 ins., 3/- per set of four. Post paid. Other sizes available up to 9 ins.—The Joyden Toy Co., 193 Chase Side, London, N.14.

**DOLL'S House fittings and papers;** send S.A.E. for list. Doll's house plan special; send 2/6. Trade supplied.—Zimplan, 88 Ware Road, Hoddesdon.

**CONSTRUCTIONAL Kits, 4mm. and 7mm. scale lorries.** Also large range spare parts from which to build to your own design. Price lists, 1d.—Wilson's Lorries Ltd., Dept. H., 1/6 Gt. Winchester Street, London, E.C.2.

**HOME Watch and Clock Repair Out-** fit. Includes watchmaker's magnifying eyeglass, tweezers, screwdrivers, oilers, oil, brush, dusting powder, plus illustrated explanatory book. Watch and clock repairing simplified. In container, 12/9 inclusive.—D. Bolster (Dept. H), 5A Station Parade, Ashford, Middx.

**PERSPEX and acetate, cut any size** from 2/6 sq. foot.—W.M. Products, 2 The Mall, Ealing, W.5. Eal. 3881.

**MAGICIANS Tricks, crazy cut-outs,** Monly 1/3; parcels, 5/6. An evening's entertainment. Lists, 3d.—De Hempsey, 363 Sandycombe, Kew Gardens, Surrey.

**PERSONS wanted to make model** bungalows at home. Simple, interesting, clean, regular work. Top rates paid. Send stamp addressed envelope for details.—Bennett Models, 137 Gray's Inn Road, London, W.C.1.

**Topical Tips on Taping!**



**Toys have no ending with "Durex" mending**

There are no tears when you can tape with "DUREX"! Broken toys are speedily and invisibly repaired without fuss or mess. It's just one of a thousand jobs "DUREX" does.

**"DUREX" Cellulose TAPE**

Trade Enquiries: Durex Abrasives Ltd., Birmingham, 8

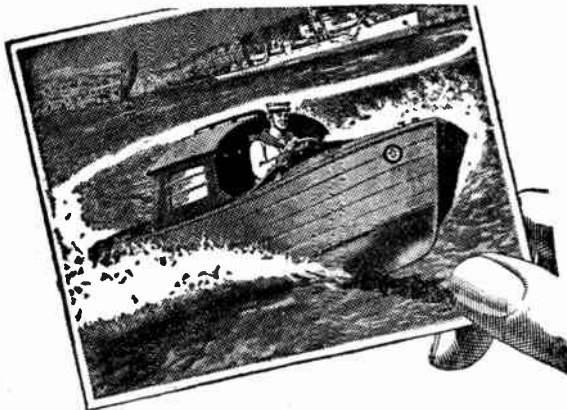
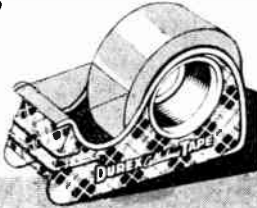

**"Sam's doing a sweep . . ."**

He's coxswain, you chump—he *doesn't* clean the funnels. He's doing a sweep—a wide turn—to bring the boat's head into the wind so's he won't bump when he comes alongside. I started as coxswain when I stepped up to Leading Seaman last August. It's one of the best jobs going, but you've got to be smart—they say a ship's known by her boats. I remember the first trip I made . . . in Alex. harbour . . ."

For full details of how to join and descriptive booklet 'Here is the Navy,' write to THE DIRECTOR OF NAVAL RECRUITING, Dept. F/37, ADMIRALTY, LONDON, S.W.1.

Make the **ROYAL NAVY** your career



**COLD water GLUES supersede this**



Most hobbies require Glue—"CASCO" fills the bill for either new work or repairs. It is an absolute necessity for the Modelmaker for Fretwork, Toymaking, etc. Easy to mix in cold water Casco is simple to use and almost impervious to heat and moisture. "CASCO" Grade "A" is the world-famous Casein Cold Water Glue manufactured in Great Britain, Australia, U.S.A. and Scandinavian countries. Conforms to MODERN BRITISH STANDARDS SPECIFICATION 1444, TYPE A.



Stocked by Ironmongers, Builders' Merchants, Hardware Stores, etc.



**DISTRIBUTORS:**

Gt. Britain: Charles Cleeve & Co. Ltd. 45 Gt. Peter St., London, S.W.1.

Ire: C. B. Waller, 60 Middle Abbey St., Dublin M. J. Galkigan, 16 Oliver Plunkett St., Cork

**FREE!** Send for literature and Free Sample to the manufacturers **LEICESTER, LOVELL & CO. LTD.** (Dept. HW), NORTH BADDESLEY, SOUTHAMPTON

**YOU CAN BECOME A HANDICRAFTS INSTRUCTOR**

Experience not essential

Men who enjoy making things in wood or metal can turn their hobby into a permanent and interesting Career. Short hours, long holidays, and security in a job you would really enjoy, can be yours if you become a Handicrafts instructor. Let us send details of the easiest and quickest way to get the necessary qualification.

**We definitely guarantee "NO PASS—NO FEE"**

If you would like to know about our unique method of preparing you for one of these appointments, write today, and we will send you our informative 176 page Handbook—free and without obligation. Mark your letters "Handicrafts Instructor."

**BRITISH INSTITUTE OF ENGINEERING TECHNOLOGY**

595 Shakespeare House Stratford Place, London, W.1

**BIET**

**THE MOTOR SHOW IS COMING! "WHERE'S THAT CAR FROM?"**

and **"POPULAR CARS"**

(40 Illustrations) 6d. each

from all Booksellers and Stationers

**Raleigh Press, Exmouth**

**HANDCRAFT SUPPLIES (NORTHERN)**

STOOL AND TABLE LEGS (Plain Turned). TWIST PATTERN. SEAGRASS. Natural, 1/11 lb.; Coloured, 2/9 lb. (approx.). WOODEN WHEELS, 1½ ins. and 2 ins., 3d.; 3 ins., 5d.; 4 ins., 8d.; 5 ins., 1/- each. BLACKBOARD PAINT, 1/3. LICENCE FREE TIMBER, PLYWOOD, HARDBOARD, ETC. MAIN HOBBIES AGENTS. DISCOUNTS FOR SCHOOLS, CLUBS, HOSPITALS. Carriage paid on all above. 15lb. orders can be sent C.O.D. PLYWOOD OFFCUTS, 5/-, 10/-, 20/- bundles. Carriage Paid. Send s.a.e. for Latest Price Lists. You can order by post with complete confidence—write to:

15-17 RIDLEY PLACE, NEWCASTLE-ON-TYNE. Phone: 27950

**Trinket Box  
Pattern Parts**  
(See page 23)

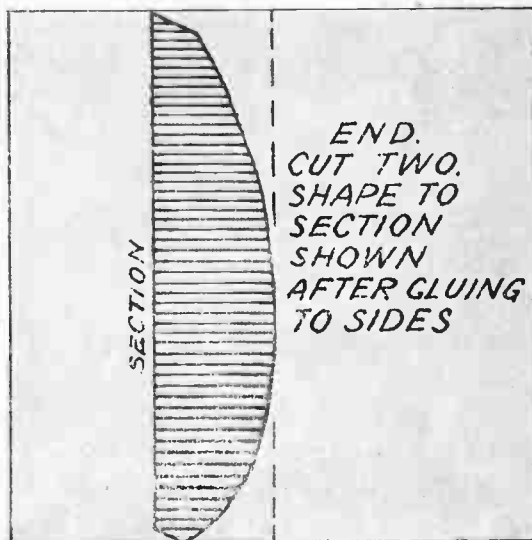
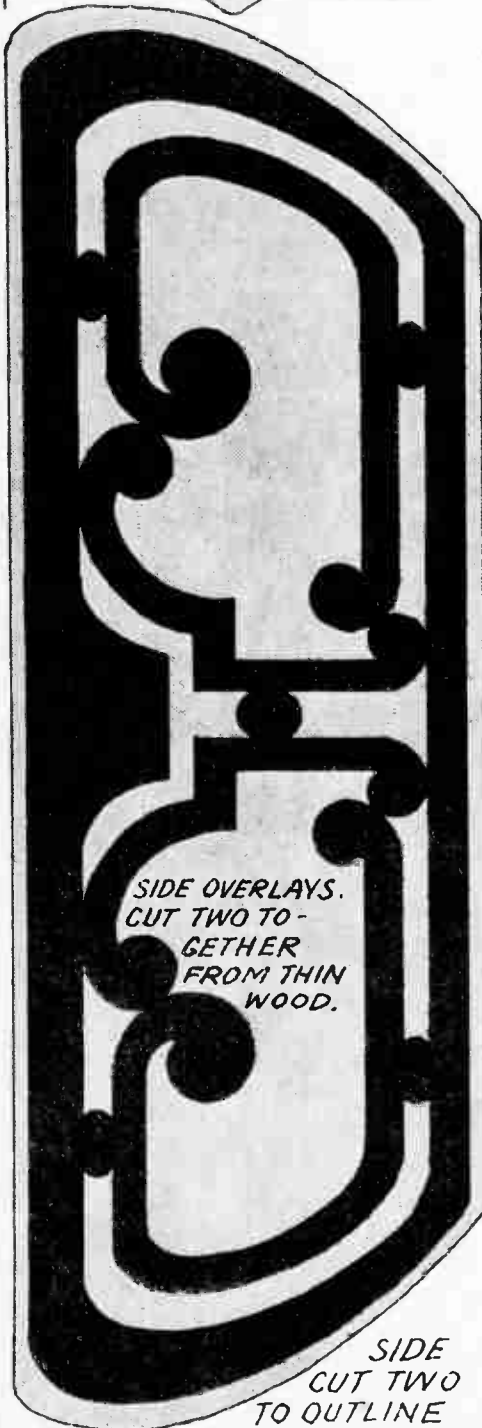
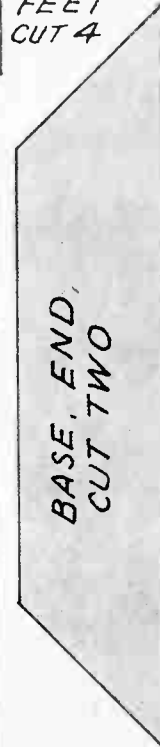
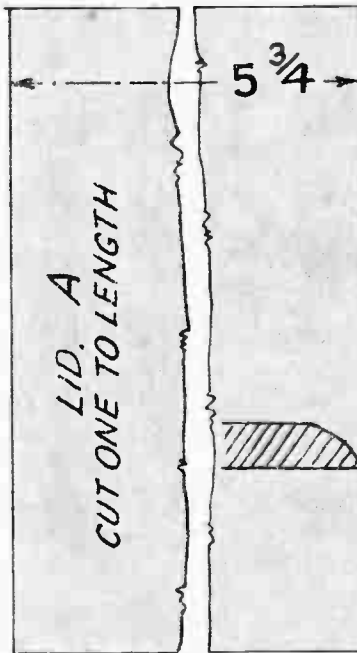
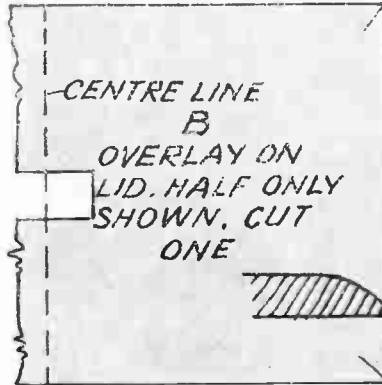
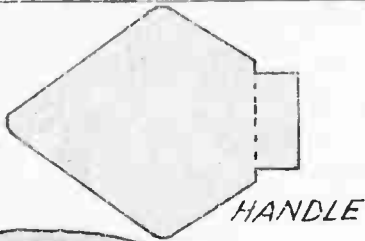

# THE STEPPING STONES TO SUCCESS!

Don't hesitate about your future! Go forward, confident that The Bennett College will see you through to a sound position in any career you choose. The Bennett College methods are individual. There's a friendly personal touch that encourages quick progress and makes for early efficiency. Take the first important step **NOW** and fill in the coupon below.



## CHOOSE YOUR CAREER

Accountancy Exams.	General Certificate of Education Examination	Radio Service Engineering
Aviation (Engineering and Wireless)	General Education and G.P.O. Eng. Dept.	Road Making and Maintenance
Book keeping, Accountancy, Modern Business Methods	Heating and Ventilating	Sanitation
Building, Architecture, and Clerk of Works (A.R.I.B.A. Exams.)	Institute of Housing Engineers	School Attendance Officer
Cambridge Senior School Certificate	Journalism	Secretarial Exams.
Carpentry and Joinery	Languages	Sheet Metal Work
Chemistry	Mathematics	Shipbuilding
Civil Engineering	Matriculation	Shorthand (Pitman's)
Civil Service	Metalurgy	Short Story Writing
All Commercial Subjects	Mining, All Subjects	Surveying (R.I.C.S. Exams.)
Commercial Art	Motor Engineering	Teachers of Handicrafts
Common Prelim. E.J.E.B.	Naval Architecture	Telecommunications (City and Guilds)
Diesel Engines	Novel Writing	Television
Draughtsmanship, All Branches	Plastics	Transport Inst. Examinations
Engineering.	Play Writing	Viewers, Gaugers, Inspectors
All branches, Subjects and Exams.	Police, Special Course	Weights and Measures Inspectors
	Press Tool Work	Wireless Telegraphy
	Pumps and Pumping Machinery	
	Quantity Surveying	
	—Inst. of Quantity Surveyors' Exams.	

If you do not see your requirements above, write to us on any subject. Full particulars free.

## COUPON. CUT THIS OUT

IF YOU ATTEND TO THIS NOW IT MAY MAKE A WONDERFUL DIFFERENCE TO YOUR FUTURE.

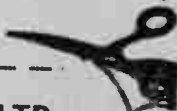

TO DEPT. 62  
THE BENNETT COLLEGE LTD.  
SHEFFIELD, ENGLAND.

Please send me (free of charge)

Particulars of..... (Cross out line which does not apply.)

Your private advice

about:

PLEASE WRITE IN BLOCK LETTERS

Name

Address

**GREATEST VALUE for MONEY**  
IN HOME WORKSHOP  
& HOME HANDYMAN  
TOOLS

You will be amazed at the many jobs you will do with new power, speed, confidence and real enjoyment. The Wolf Cub is more than an electric drill—it is the power unit of all the kits you see illustrated. Once you own the 'Cub' a small additional outlay enables you to widen the scope of your activities to the extent you desire. Think of the economy and the new profitable pleasure that will be yours! There's never been anything like this before!

WOLF CUB HOME CONSTRUCTOR ELECTRIC DRILL



WOLF CUB HOME CONSTRUCTOR LATHE KIT



WOLF CUB HOME CONSTRUCTOR DRILLING, GRINDING AND POLISHING KIT



WOLF CUB HOME CONSTRUCTOR SAW KIT

★ **LOW PRICE CONVERSION SETS**  
Converts Wolf Cub or any Kit to form complete Wolf Home Constructor Equipment at attractive low prices.

Ask your tool supplier today for full details or write direct to:

**WOLF ELECTRIC TOOLS LIMITED, PIONEER WORKS HANGER LANE, LONDON, W.5. Telephone: PERIVALE 5631-4**



# Hobbies

## WEEKLY

### CONTENTS

	Page
An Ironing Table - -	33
Metal Paper Holder - -	35
Model Railway Hints - -	36
Woodturning - - -	37
Bamboo Novelties - -	38
A Specimen Case - -	39
Orange Box Uses - -	40
Keeping Guinea Pigs - -	41
A Simple Bird Table - -	41
Fishing for Dace - -	42
A Wire Straightener - -	42
Growing Miniature Trees	43
A Toy Model Shop - -	44
Photographic Alphabet	46
Three Home Gadgets - -	47

DESIGN SHEET FOR  
PULL-ALONG CARAVAN  
TOY

October 18th, 1950

Price Fourpence

Vol. III No. 2868

## A SIMPLE FOLDING IRONING TABLE

**A** VERY handy article this, most useful to the housewife when the time arrives to do the family linen. It folds flat and occupies little space, but when opened out for work, stands very steady and firm. It is quite a simple job of woodworking, one within the scope of any amateur carpenter.

The folding leg parts are shown grouped together in Fig. 1. The inner legs are made up first, and are drawn at (A). Cut these from red deal if possible, to the length given. Cut the top cross-bar to length and fix with screws. It will be seen that this pair of legs splay outwards, so space them apart at the bottom to outside measurement of 1ft. 1in. and keep them so fixed until the diagonal braces are fitted, then free them. A spare strip of wood, nailed across them at the bottom will fix them temporarily. This should be done before the top bar is screwed across.

### Angle of Legs

Where shown by the short dotted lines across, drill  $\frac{1}{4}$ in. holes through for rivets, which afterwards hold the two pairs of legs together, like those of a deck chair. Now trim the ends, as shown at (B) and (C), about 20 degrees being sawn off each for the legs to bed flat on the floor. Note the direction of these cuts—this is important.

The diagonal bars are cut from  $\frac{1}{4}$ in. by  $\frac{3}{4}$ in. wood, and nailed across approximately where shown in the drawing, on the side opposite to the cross-bar.

The outer legs (D) are now cut. These are rounded at their top ends and a hole bored through at  $\frac{3}{4}$ in. down from the top. The bottom ends are cut at a similar angle to the inner legs.

At the distance down from the top shown, bore  $\frac{1}{4}$ in. holes for the rivets. Now fix these legs to the inner pair with Iron  $\frac{1}{4}$ in. rivets, with washers outside. Do not clench the rivets too tightly, as a

little freedom is necessary to allow the legs to fold up and open freely.

Cut a cross-bar (E) from  $\frac{3}{4}$ in. by 2in. deal, and approximately 7ins. long. The actual distance should be measured

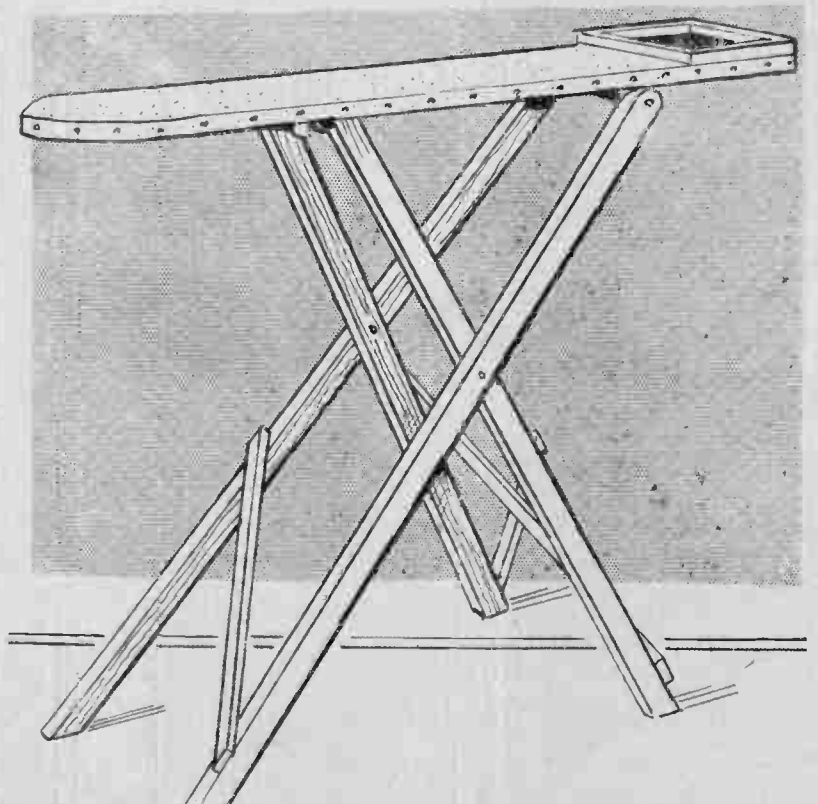

All correspondence should be addressed to The Editor, Hobbies Weekly, Dereham, Norfolk.

across where the holes in the tops of the legs come, and there should be about  $\frac{1}{8}$  in. clearance each end for the legs to swing without rasping against the bar. A couple of  $1\frac{1}{2}$  in. round-headed screws, stout ones, are to be used as pivot screws here.

The holes for these to enter the ends of bar (E) are bored  $\frac{3}{8}$  in. up from the bottom edge of the bar. Fix the legs to this with the screws, not too tightly. While the legs are still folded flat, nail a single diagonal brace across the outer ones. This is plainly shown in the general view of the article.

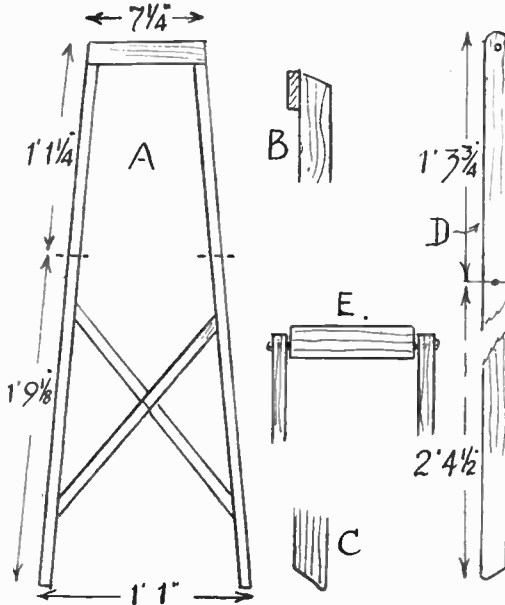

Fig. 1—Shape and dimension of legs, with details

The ironing board, Fig. 2, is cut to the shape shown from a single board of  $\frac{3}{4}$  in. deal. Where shown at (F) screw across a piece of wood,  $\frac{3}{4}$  in. thick and  $1\frac{1}{2}$  ins. wide, just 7 ins. in length. The bar (E) to which the outer legs are pivoted, is screwed across also, where shown.

Owing to the width of these pieces of wood, to avoid using too long screws, a good plan is to bore  $\frac{1}{2}$  in. holes first, some 1 in. deep, then to continue

through the wood with a hole large enough to allow the screw to be pushed through. Screws  $1\frac{1}{2}$  ins. long can then be used for fixing, the heads, of course, sinking in the larger holes.

The table can now be opened out and any necessary tightening of the rivets or screws carried out. This should not be overdone, or the table instead of standing firm may tend to wobble. Enough freedom only is required to enable the table to be folded up or opened out without strain.

A metal spring catch is advisable, to keep the table, when opened out, in position. A simple affair of this, and sketched in detail (G) Fig. 3. It is a short piece of steel or springy brass, screwed

At the square end of the ironing table glue and nail four  $\frac{3}{8}$  in. wide strips of wood to make a frame in which the iron

**CUTTING LIST**

Inner legs (2)— $\frac{3}{4}$  in. by  $1\frac{1}{2}$  ins. by 2ft.  $10\frac{3}{4}$  ins.  
 Top bar— $\frac{3}{4}$  in. by  $1\frac{1}{2}$  ins. by 7 $\frac{1}{2}$  ins.  
 Diagonal braces (2)— $\frac{3}{4}$  in. by  $\frac{3}{4}$  in. by 1ft. 6 ins.  
 Outer legs (2)— $\frac{3}{4}$  in. by  $1\frac{1}{2}$  ins. by 3ft. 8 $\frac{1}{2}$  ins.  
 Diagonal brace— $\frac{3}{4}$  in. by  $\frac{3}{4}$  in. by 1ft. 8 ins.  
 Bar (E)— $\frac{3}{4}$  in. by 2 ins. by 7 ins.  
 Table— $\frac{3}{4}$  in. by 8 $\frac{1}{2}$  ins. by 3ft. 9 ins.  
 Bar (F)— $\frac{3}{4}$  in. by  $1\frac{1}{2}$  ins. by 7 ins.

can rest when not in use. This is shown at (H) and a piece of asbestos sheet is nailed to the table, inside the frame, for the iron to sit on without fear of burning the wood.

The completed table is then covered

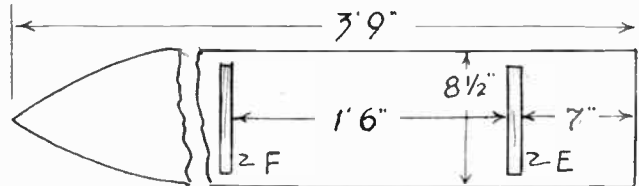

Fig. 2—The ironing board, with position of cross pieces

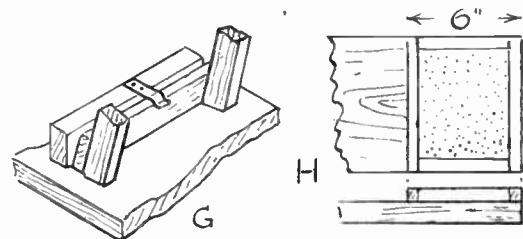

Fig. 3—Holding clip for legs and the iron-rest

to the bar (F) and with its free end bent to a curve to slip over the top cross-bar attached to the inner pair of legs, and which butts up against bar (F) when the table is open.

The detail shows its shape clearly, and it should not be difficult to bend the metal to shape, and fix it in place. The top edge of cross-bar, over which the spring fits, should be rounded off neatly to allow it to pass under the spring easily.

with a thickness of old blanket or close woven canvas, with an outer cover of white calico tacked round the edges. The article can be left plain, the usual practice, or varnished as preferred, and when completed, will make a welcome addition to the household equipment. A comparatively small quantity of wood is required for making, and a cutting list given will show the sizes, etc., of all parts needful.

**Our Free Design Supplement for CARAVAN TOY**

THIS novelty can be built in wood and painted in bright colours quite easily from the full size patterns on the large instruction sheet presented with this issue. It is made the most simple by the Kit of Material (No. 2868) which contains planed wood of correct thickness for all parts. Obtainable for 4/2 from any Hobbies Branches sent post free for 5/- from Hobbies Ltd., Dereham, Norfolk.

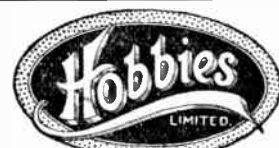

**BRANCHES**  
**LONDON**  
 78a New Oxford St., W.C.1  
 (Phone MUSEum 2975)  
 87 Old Broad Street, E.C.2  
 (LONDON Wall 4375)  
 117 Walworth Road, S.E.17  
**GLASGOW**  
 326 Argyle Street  
 (Phone CENTral 5042)  
**Head Office & Factories—HOBBIES LTD., DEREHAM, NORFOLK**

**MANCHESTER**  
 10 Piccadilly  
 (Phone CENTral 1787)  
**BIRMINGHAM**  
 14 Bull Ring  
**SHEFFIELD**  
 4 St. Paul's Parade  
**LEEDS**  
 10 Queen Victoria Street  
 (Phone 28639)  
**HULL**  
 10 Paragon Square  
**SOUTHAMPTON**  
 25 Bernard Street  
**BRISTOL**  
 30 Narrow Wine Street  
 (Phone 23744)

# Try your hand at sheet metal cutting in this PAPER HOLDER

**H**OW many readers have tried their hand at pierced metal work? It is, in many ways, no more difficult than wood fretwork, and provides a pleasant change of hobby. The article illustrated is a simple example of such work, comprising a newspaper holder, and letter rack below, mounted on a wooden backboard. It is a useful article and prevents the daily paper lying about the room, and the mantelpiece being made untidy with letters stuffed behind the ornaments.

Sheet metal can be easily cut with Hobbles metal-cutting blades, which are used in the usual way in a fretwork handframe or machine.

## The Metal

A medium thickness of metal is advised, strong enough for the purpose and not too difficult to cut. Somewhere about 18 S.W.G. would be about suitable for the job. Quite a small piece is required, and brass, copper or aluminium would all be fairly easy to cut. Special metal cutting blades are required for sawing metal, having different shaped teeth for the work to those used for wood. These can be employed in the ordinary frame, however.

A half pattern for the shaped pieces is given in Fig. 1, drawn over 1 in. squares.

### MATERIAL REQUIRED

- 1 panel 18 S.W.G. metal—6ins. by 9in
- 1 panel wood— $\frac{1}{2}$  in. or  $\frac{3}{4}$  in. thick. 6in by 10 $\frac{1}{2}$  ins.
- 5 round-headed brass or copper screws,  $\frac{1}{4}$  in.
- Metal-cutting saws.
- Fixing screws.

Copy these squares full size on to thin paper, and gum down to the metal. Drill the necessary small holes for entry of the saw at the most convenient places, then saw out the openings in the design.

Sawing is much the same as for wood, but slower, also it is wise to avoid overheating the blade by too vigorous work, it may snap. Do not press the saw forward too hard, rather let it 'feel' its way, as it were, and when it gets hot, cease work for a minute or so to cool it down a little.

## Three Parts

With the openings all sawn out, cut along the outlines, leaving the outside outline last. The perforated panel of metal will then be separated into three parts. The largest will be for the front of the paper rack, the next in size for the letter rack, while the smallest will serve for a plate to be screwed to the rear of the backboard, and serve to hang the rack to the wall. No waste here at all, except, of course, the small pieces cut out to make the design, which can,

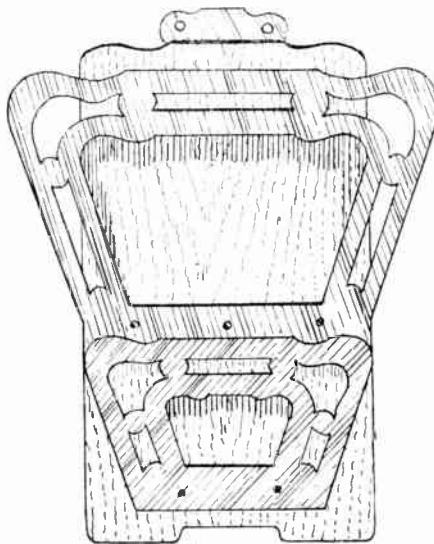

possibly, be used up some time, when small pieces of metal may be needed.

At the bottom of both rack fronts, on a line  $\frac{1}{2}$  in. up, drill holes for screws to fix the fronts to the backboard, also drill holes in the wall plate piece, both for screwing it to the backboard, and to the wall. Lay the parts in hot water to soak off the design. When dry, smooth up the edges of the fretted openings and outlines with a file.

## Back Shape

The backboard, Fig. 2, can be cut to the shape given from any suitable wood available, not less than  $\frac{1}{2}$  in. thick. This, or  $\frac{3}{4}$  in. thickness in oak would do very nicely. If a piece of commoner wood has to serve, such as deal or even decent box wood, then a coat of enamel would hide its texture and make it look presentable after all.

With the backboard nicely smoothed and cleaned up, two strips of wood must be prepared, to which the metal fronts can be screwed. These are planed on their outer front edges to a bevel to fix the metal fronts at an angle, as seen in the side view, Fig. 3.

These strips are  $\frac{1}{2}$  in. wide, and vary in thickness, as shown

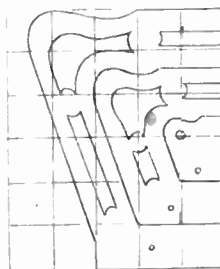

Fig. 1—Back decoration

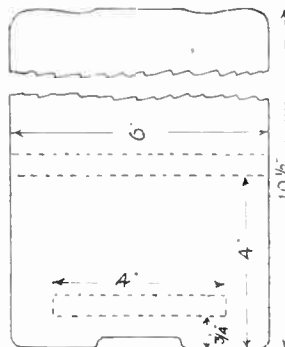

Fig. 2—Wood backboard

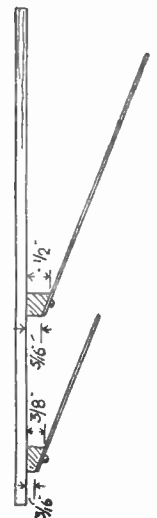

Fig. 3—Side view

in the drawing. The top one goes the full width of the board, the bottom one is just 4ins. long. Glue them both to the backboard in the position shown in Fig. 2, by dotted lines. The fronts are then partially fixed with  $\frac{1}{4}$  in. round-headed brass screws. Be careful, when drilling these screw holes, to use a size of drill suitable to the screws.

Now remove the metal fronts. Go over them back and front with fine emery cloth first, then with flour emery. Polish up with rotten stone and water or rouge, until the surface is quite satisfactory. Avoid, after this treatment, touching the polished surfaces with the hands.

## Lacquer Finish

The metal parts should then be lacquered. Both hot and cold lacquers are available, the cold lacquer is applied to the metal as it is, or slightly warmed. The hot lacquer should have the metal surface made quite warm before being applied. A soft brush is used for lacquering, and care must be taken to avoid any dust getting on the work while the lacquer is still tacky.

The backboard can be stained and varnished according to the wood it is cut from. If it is to be enamelled, give it one or two coats of paint first to impart a body to the work, then, when dry, lightly rub over with a piece of worn glasspaper and dust off before applying the final coat of enamel, or high gloss paint. Almost any colour may be used, if a preference is possible, then a green or red colour would show up the polished metal well, also black if aluminium is employed for the metal parts.

The article is fixed to the wall, preferably with two screws, instead of one, in order to prevent it tilting to one side when papers and letters are inserted or withdrawn.

# Your lay-out will be improved by following these MODEL RAILWAY HINTS

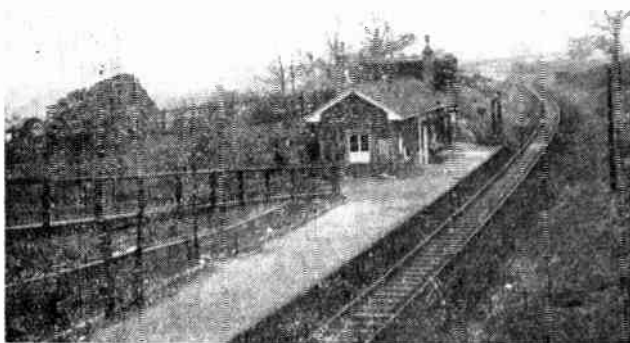

A typical single-line through station

**M**OST model railway enthusiasts seem to pay much more attention to the design of their locomotives and rolling-stock than they do to the planning of station layouts, and the general realism of a model line can suffer badly through this lack of care.

It must not be imagined that the mere laying of lots of track, points, crossings and junctions will produce a 'railway-like' model—on the contrary, although a showy layout may be made in this way, it will be devoid of any semblance to the real thing.

In a very small layout there is always the desire to incorporate all the various details which go to make up a railway, but such masterful completeness is not generally possible, particularly on a small line.

By crushing—or attempting to crush—too much track into a small area, station platforms become ridiculously shortened so they cannot accommodate a train of any length. The inclusion of far too much built-up scenery also precludes the use of the space it occupies for the accommodation of track.

## Allow for Growth

In short, a model line should never be planned with the idea of filling up as much of the area available as possible, but should be started by designing and eventually laying a simple plan and letting it grow gradually, increasing length of run and station platforms as opportunity arises.

If a continuous 'main line' design is contemplated, then it should be laid around the perimeter of the space available, allowing about 5ins. or 6ins. between the track and the baseboard edge. With such a layout of, say, 12ft. by 7ft., and of rectangular shape, there will not usually be found room for more than two small stations; one on each of the longer sides of the rectangle.

By the study of the diagram it will be seen that on a simple layout so designed a circuit of 32ft. can be incorporated; the station platforms being located on the 5ft. long straight sections. A curved section

at each end 11ft. long will then still give that amount of separation needed to give the stations an isolated appearance. These curves are of 3ft. radius and will allow six-coupled engines and vehicles with long fixed wheelbases to

travel without fear of derailment.

Station sidings can be added in each of the four corners, if desired, but if proper prototype practice is to be followed, these should always enter the main line by trailing points. Thus if the circuit is to be run in a clockwise direction, the station sidings should be located in the left-hand corner and the right-hand bottom corner of the layout. (They are shown in solid lines on the diagram.)

If desired these sidings can be lengthened by curving them round in the bins. space between the curved portion of the main line and the edge of the baseboard,

tank loco and a train of four bogie coaches will occupy about 6ft. of track, hence the platforms of each terminal station should be of this length at least. Twelve feet of the available layout length being thus occupied by stations, not much can be accomplished in less than about 40ft. of baseboard.

This inter-station run is the all-important thing to remember when designing any layout, and is one of the main considerations which cause model railway operational enthusiasts to follow 4mm. scale, instead of the 'O' gauge on which the previous calculations have been made.

## Combination Type

A combination of the 'two through stations' with the 'terminal' type layouts can be arranged by placing a facing ('main-line') point at the entry to one of the through stations, taking a branch from thence to a small terminus located diagonally in the central area of the baseboard. Scenery should be suitably arranged to mask the terminus from both of the through stations, and buildings, fencing and walls can all play a part in giving each of the three stations an air of isolation.

It will be seen that by careful study, planning on paper, and construction, a small model railway can be made to

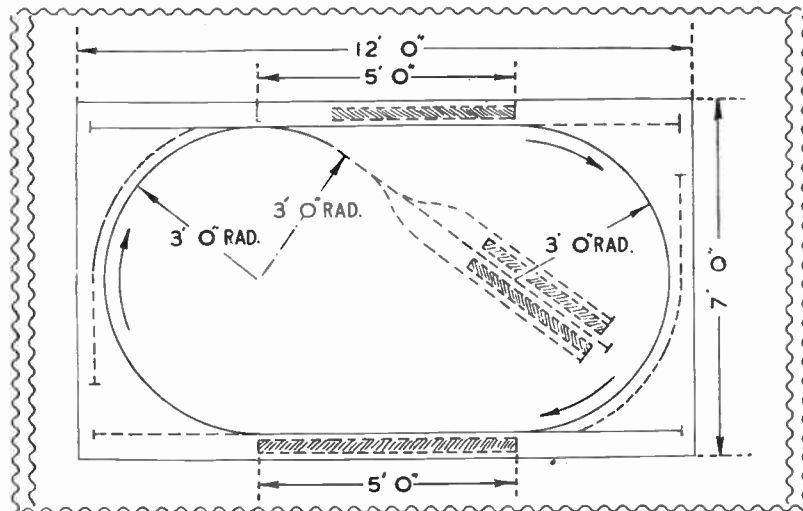

as shown by dotted lines; such sidings will then have accommodation for a short goods train or a 'local' train with its tank locomotive.

If, however, the layout is to be made from point to point, as would be the case if the space available is of a longer and narrower shape, then it is best to start in a small way, for it is rather difficult to plan on paper a really good operative system without a certain amount of trial and error.

It should be remembered that a small

simulate the real thing more perfectly—not only in appearance, but in operational possibilities.

The disadvantage of all model lines is well known to be the smallness of the radius of the track curves which space limitations impose, but even so, a great deal can be done to minimise this fault and to create the illusion of length and real railway atmosphere which is so ardently sought after by all lovers of the 'real thing'.

# The first of a short practical series all about WOODTURNING

**T**HE woodworker who does not try his hand at turnery is not getting the best from his hobby. Many fellows fight shy of lathe work, as they consider it both expensive and difficult to do, but actually turnery is very little more complicated than ordinary bench work. Once a few simple principles have been mastered, some really high-class work can be turned out easily and quickly.

## Types of Machine

Obviously, some form of lathe is needed. Nowadays this piece of equipment may be rather expensive, but on the other hand it will give a lifetime of valuable service. A price list of Hobbies amateur's lathes is obtainable on request. (Twenty-five years ago Hobbies Ltd. were selling lathes at what now seem to be ridiculously cheap prices, but these machines are still giving their owners every satisfaction).

If a new lathe is out of the question, it may be possible to get hold of a sound second-hand model. Failing this again, the ingenious craftsman can soon rig up a 'bodger lathe' of the type described below.

## Essential Parts

Lathes vary in size, layout, method of driving, and so on, but a front view of a typical simple machine is given at Fig. 1. This has a headstock (H) and a tailstock (T), each having a centre (C) between which the wood is held for turning. A movable tool-rest (R) can be moved along the top of the framework or 'bed'. Pulleys (P) are sometimes provided so that the lathe can be run from an overhead shaft, but the treadle (TR) is most commonly used as the driving force.

Other refinements may be added to the lathe, and mention of these will be made later.

The 'bodger lathe' is so-called because it is used by the 'bodgers'—skilled country craftsmen of parts of Buckinghamshire who still use this simple form of lathe which they use for turning furniture parts. A front view and end

elevation of such a lathe is given at Fig. 2.

Wood is used throughout for the making of this lathe. It has two long bottom rails, each of which carries a series of holes for about half its length. The head and tailstock are simply shaped pieces of stout wood, the latter having a hole drilled through its tongue so that by passing a bolt through it and through two appropriate holes in the rails, it can be held firm at any required distance from the headstock. In the centre of each wooden upright a steel nail is driven (at the junction of the dotted lines on the end-section), these being sharpened up and used as centres.

The instrument is fixed at a convenient height for working, and a springy pole is fixed horizontally about 4ft. above it. A cord comes from the end of this pole, passes once right round the piece of wood held between the centres, and passes down to a simple treadle. When the treadle is depressed, the wood spins forward, and when the foot is taken off the treadle, the wood turns back. Cutting is done as the wood spins towards the operator, and the tool is lifted away as the timber runs back.

## Treading

In handling a bodger lathe, success is only possible if the treading is correct, and this statement is equally true of work done on the more modern lathe. Before trying any practical woodturning, therefore, it is advisable to have half-an-hour's practice at treading.

aiming at achieving a free and rhythmic movement.

## The Cutting Tools

A few common woodworking tools have their uses in turnery, but certain special tools are also needed.

The actual cutting tools are known as 'scrapers', 'chisels', 'parting tools' and 'gouges'. These can normally be ob-

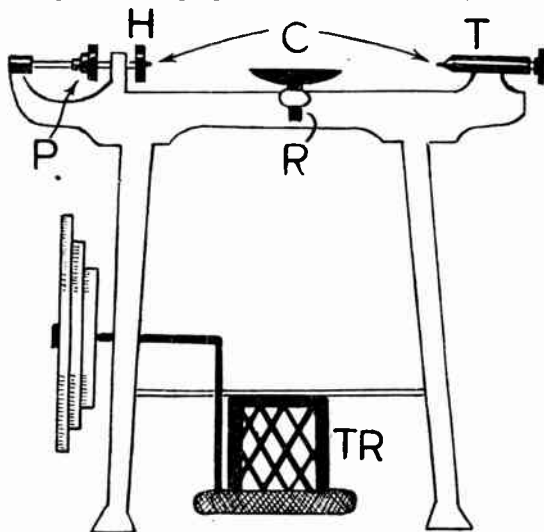

Fig. 1—A diagram of the main parts in all types

tained in various widths of blade from  $\frac{1}{2}$  in. upwards, but the  $\frac{1}{2}$  in.,  $\frac{3}{4}$  in. and  $1\frac{1}{4}$  in. sizes will probably be the most useful. At present they are in short supply for amateurs.

The scraper (A of Fig. 3) greatly resembles an ordinary woodwork firmer chisel; it is used for smoothing a rough surface in the manner to be described later. The chisel has a sloping cutting edge and is sharpened and ground on both sides (see B of Fig. 3).

The parting tool differs from the chisel in that it is V-shaped at the bottom, while the gouge has a half-round section; these tools are shown at (C) and (D) respectively of Fig. 3.

All these tools must be kept sharp.

(Continued foot of page 38)

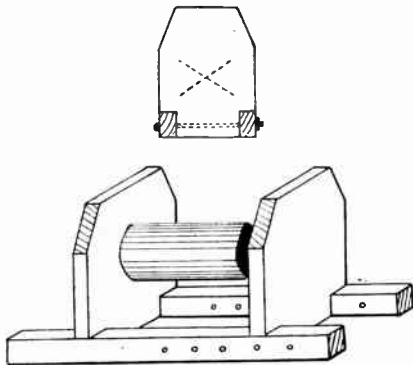

Fig. 2—A localized type of 'bodger' lathe

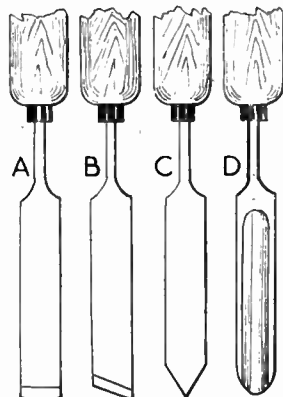

Fig. 3—The scrapers and cutters required



Fig. 4—Sharpening the gouge on a slip

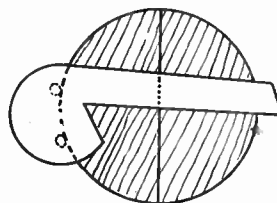

Fig. 6—Finding a centre

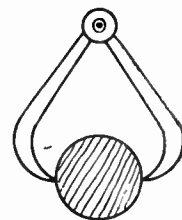

Fig. 5—Outside callipers

# A few odd lengths of material will provide these BAMBOO NOVELTIES

**T**HOUGH the bamboo curtain pole is practically extinct, there is still a use for these memories of the past. If rescued from the obscurity of lumber room or garden shed, they may be converted by the handyman.

It is a good plan to start with the pencil case, with which any small girl or boy will be delighted. On prodding a ruler down an open end of the pole, you will find there is an obstruction. This is a transverse wall which occurs at the same point as the outer raised ring. As these are found all along the pole we have a series of cylindrical boxes.

With a fretsaw cut off a section of the pole, leaving two transverse walls

the body of the case makes the lid. After glasspapering the other end wall, give the whole job a good polishing with furniture polish.

## Pepper Shaker

The pepper shaker is made in a similar way, except that a piece is cut out between the two transverse walls to shorten it. A good overall length is 3ins. Use a fretwork drill for making the holes in the top and, of course, arrange them in a neat circle with one hole in the middle.

For the ash tray you need a  $\frac{1}{2}$ in. slice from a seasoned tree branch. Glasspaper this very well, occasionally brushing out the wood dust from the end grain with an old dry tooth brush until an unbroken shining surface is shown on holding the branch slice in a reflecting light. Unless this is done varnish will show even minute roughnesses.

Next glue the slice of bamboo on to it and for the cigarette rest glue on a piece of elder, which is hollow within.

piece of  $\frac{1}{2}$ in. twig (beech or oak) or dowel, and the finger ring a circle cut from bamboo.

The bamboo pillar should be about 3 $\frac{1}{2}$ ins. long, with the slot and notches for the elevator cut on both sides of the bamboo. The slot can be cut in one operation by sawing down from the top. If you clamp the bamboo to your fret cutting table, you will find the notches easier to cut out. Use a fine saw and, if necessary, true them up with a rat tail file.

Now cut the hole in the top piece to take the candle. This job is best done with the fretsaw, too, first using the fret drill to make a hole for the saw. Glue all the pieces together and give the candlestick a thin coat of varnish.

As there is enough material in the average curtain pole for several each of the novelties, it might simplify the old problem of what to give for birthday or Christmas presents, especially in these times when many things are so dear.

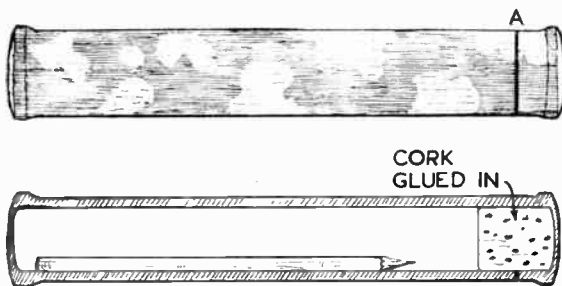

The pencil box complete and in section

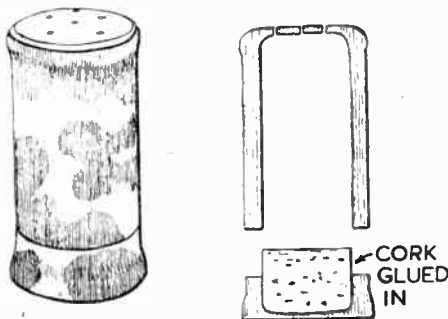

A pepper pot showing glued cork stopper

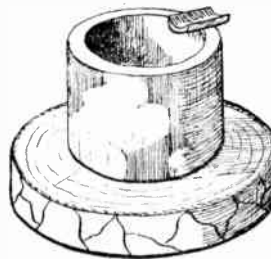

A simple ash tray and base

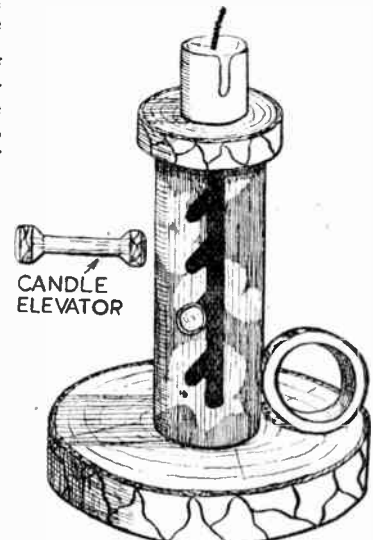

A novel candlestick with elevator

intact. Next cut off one end in the position (A) in the diagram. The saw-cut should be made about  $\frac{3}{4}$ in. from the end. Glasspaper the transverse wall flush and then glue in a cork. This, pressed into

A novelty on the candlestick is the elevator which may be pushed up a notch as the candle burns down. The base and top are  $\frac{1}{2}$ in. branch slices well polished. The elevator is a whittled

From the remaining scraps of bamboo unusual napkin rings can be made, provided your pole happens to be wide enough internally to take a rolled-up table napkin. Cut these  $1\frac{1}{4}$ ins. wide. (262)

## Woodturning—(Continued from page 37)

and for this an ordinary oilstone and a carborundum slip are needed, the latter being a small shaped sharpening stone that can be held in the hand. Chisels and scrapers are sharpened in the same way as firmer chisels, but with the gouge, the bevel is first rubbed down on an oilstone (giving a slight rocking movement to keep the bevel even) and is then finished off on the edge of a carborundum slip, as shown on Fig. 4.

Callipers will be required for measuring the diameter of turned work.

Fig. 5 shows a pair of simple 'outside callipers' used for measuring external diameters. If any face-plate turning of bowls or cups is to be done at a later stage, 'inside callipers' will also be needed. These closely resemble outside callipers but have the points of the legs bent outwards.

The final item that might be mentioned is the 'centre' (shown at Fig. 6) used for finding the centre of a piece of round work. Such centres can be purchased or can be home-made from thin metal or

plywood. The shape can be seen from the drawing. On the underside of the instrument two pins are set in equidistant from the edge. If these pins are held against the edges of the wood in two separate places and a pencil is drawn along its straight edge, the two lines will cross in the centre of the wood.

In the next article of this series the use of the tools in simple turning exercises will be considered. (262)

(To be Continued)

# The collector of shells, coins, rock etc., should make this 2-TRAY SPECIMEN CASE

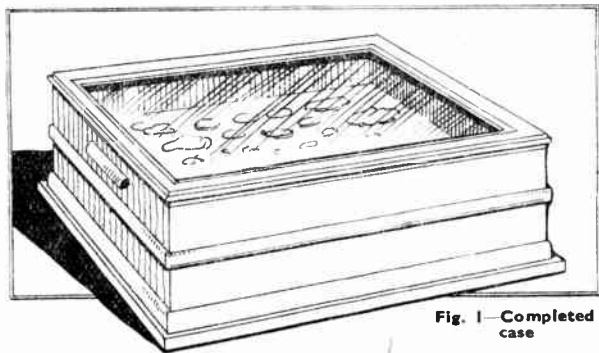

Fig. 1 - Completed case

THE display case shown here is intended for specimens, which may consist of shells, butterflies, coins and various kinds of fossils etc. It is a departure from the usual kind of case, inasmuch that here there are two distinct cases so designed and arranged that one fits within the other, making for compactness and economy of space.

The body of the cases is constructed of  $\frac{3}{8}$  in. soft wood simply butted together at the corners and screwed to a base. The outside surfaces of the cases are intended to be covered with Rexine or Pegamoid paper or any other suitable covering material.

White lining paper as used by paper-hangers is as good as anything and will help to show up well any exhibits. Each of the two cases will be treated independently, but it must be borne in

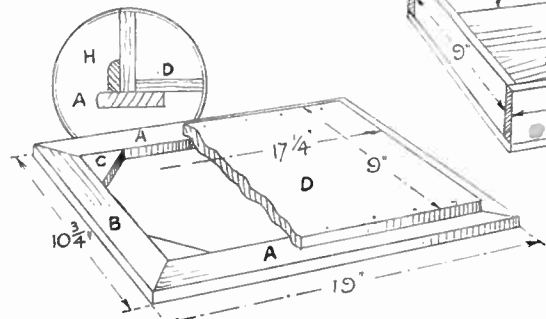

Fig. 2 - Details of floor and base construction

mind that the body of each must be identical in size so they fit exactly one over the other.

When made and put together the cases will appear as Fig. 1, and here it will be seen the top one has plain wood handles attached to the ends for ease in lifting when the lower case has to be exhibited.

The base of the lower case should first be set out and made, and in Fig. 2 this is shown with also a section of the floor screwed to it. Cut two pieces as (A) and two pieces as (B) all to length shown, by  $1\frac{1}{2}$  ins. wide by  $\frac{3}{8}$  in. thick. Cut the mitres to 40 degrees on all the ends using a set

square for the purpose.

Then cut four angle blocks as (C) and glue all the eight pieces together. On the top of them then glue and pin a panel of wood measuring  $17\frac{1}{4}$  ins. by 9 ins. by  $\frac{1}{4}$  in. thick. The whole base then should be well stiffened up and ready to take the sides and ends of the frame.

As both cases are identical in size, four rails 18 ins. by 3 ins., and four rails 9 ins. by 3 ins. and all  $\frac{3}{8}$  in. thick may be cut and framed together as shown in Fig. 3. This illustration shows the upper case with floor (G) attached and flush with the sides and ends all round. The lower case, however, will not of course have a floor this being already supplied as (D) in Fig. 2.

To strengthen the base, as well as to add to the appearance, a member as (H) in the enlarged diagram in Fig. 2 is added all round and mitred at the corners. The four pieces are  $\frac{3}{4}$  in. by  $\frac{1}{4}$  in. in section and are glued in place. This member is seen again in the cross section through one side at Fig. 4.

The lower case, being glass-covered, the fillets to support the glass may next

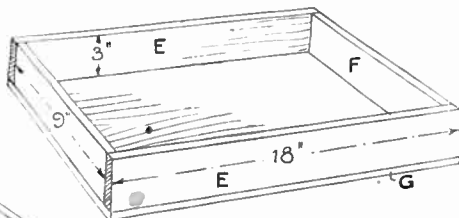

Fig. 3 - Framework of the case

be added, and these are  $\frac{1}{2}$  in. by  $\frac{1}{4}$  in. in section and are glued and screwed at a distance of  $\frac{1}{2}$  in. down from the top edge of the case, as seen again in detail in the enlarged view in Fig. 4. On these fillets will be glued strips of washleather or felt to form a bedding for the sheet of glass, the size of which should be taken direct from the made-up case.

A tight fit should be avoided when fitting the glass, and this is held in place by  $\frac{1}{4}$  in. angle beading mitred and glued or screwed in all round. By using screws the beading is readily removed in case the glass should ever become broken and needs replacement.

We have got as far as making the frame and the floor of the top case, and it now remains to add the top frame. The glass top to this upper portion is made in the

form of an open frame. Each side of it is made up of three strips of  $\frac{1}{4}$  in. thick wood glued or screwed together. A detailed corner view of the frame is shown in Fig. 4, with an enlarged sectional detail in the circle.

The outside of the frame comes flush with the outside of the display case, see enlarged detail. All three pieces of each side, twelve pieces in all being therefore required, are  $\frac{3}{8}$  in. by  $\frac{1}{4}$  in. in cross section. The lower member, that resting on the top edge of the case, is plain in section, whereas the middle piece should have its outer edge rounded neatly.

The extreme top member has a chamfer planed along one edge for effect, and to get as full a view of the interior of the display as possible. Cut the mitres carefully at 45 degrees and in gluing the two lower rails together, keep the middle or shaped one  $\frac{1}{8}$  in. in from one edge as shown to form, as it were, a rebate for the glass. Test the mitres before actually gluing up the four sections of the frame.

To hold the frame firmly together four wide flat brass angle plates will be used and they should be held with countersunk brass screws to the underside of the frame when this is placed in position on

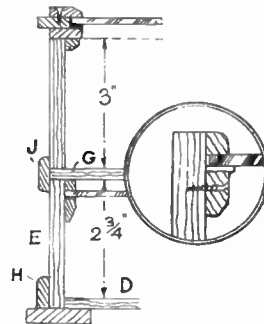

Fig. 4 - Section at end

the case. Shallow recesses may be cut in the top surface of the case to receive the plates.

To the inside edges of the glass framing, fillets  $\frac{3}{8}$  in. by  $\frac{1}{4}$  in. with chamfered edges will be attached to hold the frame properly and rigidly in place, see the enlarged detail Fig. 4. Glass of about 21oz. will be used for both top and lower case, the top glass again being bedded on either felt or washleather as shown.

The glass and its bedding will be put in the rebate of the frame and the top member then screwed on. This screwing on being again adopted in case the glass requires renewing.

This completes the making of the show cases, which can be lined and finished as previously suggested. To hold the cases together a fillet strip (J) is put round at the junction as seen in Fig. 4. The strips are  $\frac{3}{8}$  in. wide and  $\frac{1}{4}$  in. thick and they are mitred at the angles of the top case and glued and pinned to it.

# Some suggestions for practical and ornamental ORANGE BOX USES

Given a little beauty treatment the humble orange box can be converted into a really useful piece of furniture. When you consider even a modest storage cabinet may cost £3 or £4 in the shops, it is certainly an economical proposition to buy a shilling orange crate from your greengrocer and try your hand at converting it into one or other of the uses described here.

A little paint or varnish stain and odd lengths of brightly coloured material for draping will work wonders. Provided you know the business end of a hammer or screwdriver there is no need to worry about the carpentry side of the job. Most orange boxes are divided into three compartments, so you will have two useful shelves already in position.

There is just one point to note particularly. The majority of orange boxes have ventilating apertures down each side. If necessary, these could be covered with the wooden slats forming

The dust curtain hangs from a length of stiff wire or tape held in place by two  $\frac{1}{2}$  in. screw-eyes (seen in Fig. 1). Make a narrow hem at the top of the curtain through which to thread the tape so the draping may be pushed aside when using the cabinet. A vase of flowers on the top of the box will add a finishing touch.

## A Wall Cabinet

If you propose making the hanging book-case (see Fig. 2) paint and stain as previously described. As the box will hang in a horizontal position, the sliding curtain must be fitted the long way.

Picture wire is the best means of suspension and should be secured to two 1 in. screw-eyes. These should be screwed about 3 ins. in from the back of the box in order the bookcase shall hang flush with the wall. You may have to plug the wall so a 4 in. wire nail can be driven firmly home on which to hang the case. A useful wall rack for kitchen

material. Brass or leather-headed furniture tacks could be used for fixing the covering material around the seat, and a neater finish is achieved if you use an edging of  $\frac{1}{2}$  in. upholsterer's braid (from ironmongers and furniture shops).

A sliding curtain, fitted as for the hanging book-case, should be added, although you may prefer to drape the four sides completely if you have enough material. The three compartments will be useful for housing slippers, knitting materials, books and so on.

## Vegetables Holder

A vegetable rack (see Fig. 4) will prove a boon in the kitchen. The crate is canted at an angle of approximately 45 degrees and kept in that position by two strips of wood (each about 12 ins. by 6 ins) screwed or nailed in place at either end as shown, which act as feet.

The three compartments will prove very handy—you could store potatoes in

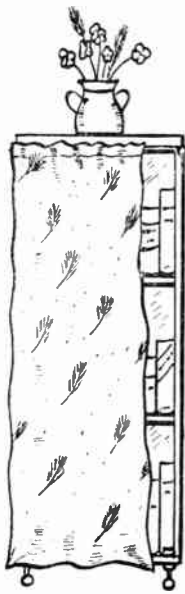

Fig. 1—A bookcase

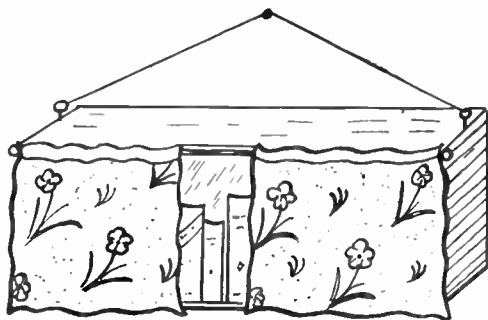

Fig. 2—A suitable hanging cabinet

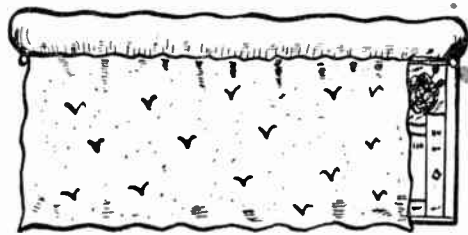

Fig. 3—A fireside seat with curtained front

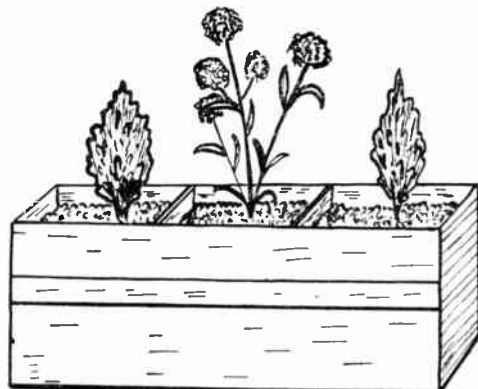

Fig. 5—As a box for small shrubs or plants

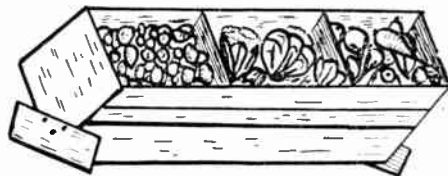

Fig. 4—Tilted to form a vegetable holder

the lid or fourth side of the box, which could be nailed with  $\frac{1}{2}$  in. tacks to cover the apertures. Although this would not be essential in the case of the bookcase, it would be necessary for the vegetable rack to prevent loose dirt from falling on to the floor.

## A Book-case

Here are a few hints on the articles illustrated. For an upright bookcase or storage cabinet (see Fig. 1), the inside could be painted cream and the outside given a coat of light or dark oak varnish stain. Four cotton reels could be screwed underneath to act as legs, or you may prefer to use small castors.

materials could be made on similar lines, the front curtain being optional.

A fireside seat is seen at Fig. 3. The most important job here is to strengthen the upper side of the box which forms the seat, as the thin slats of the crate would not stand up to their job. Two strips of floor board cut to the correct length and nailed in place will solve the problem.

To pad the seat, first tack any odd material loosely over the top of the box, leaving one end open. This will form a pocket which may be stuffed with kapok or flock. Distribute the padding material evenly, then tack down the open end.

Cover the padded seat with colourful

one, greens in the second and roots in the third.

A garden box for plants and shrubs such as shown at Fig. 5 might well occupy a corner of the lawn or stand beneath a window. First paint the box green or any colour that takes your fancy. Fill each compartment with a mixture of earth and leaf mould to within an inch or two of the top. It may be necessary to make a few drainage holes in the bottom of the box (a brace and bit or a red-hot poker will soon do this). Your box will be ideal for small shrubs or geraniums.

(220)



# If you are wanting pets then you should know ALL ABOUT GUINEA PIGS

**H**AVE you ever seen a cavy? Of course you have, although you do not recognise its name. It is another name for the guinea pig. If you go to the Zoo you will see an enormous guinea pig called the Patagonian Cavy, which is the wild relative of our pet guinea pigs and comes from South America.

If you visit a fur and feather show you will see lots of different kinds of pet guinea pigs and one with beautiful rosettes in its fur is called the Abyssinian Guinea Pig. There is another kind which has very smooth fur, almost silky, with a large head. The guinea pig you may see with very long silky fur which needs brushing and combing is called the Peruvian kind.

## An Open Enclosure

Now how would you look after one of these beauties if you had it for a pet? Do not keep them always shut up in a little hutch. Guinea pigs enjoy an outing on the grass and the author used to let his have a small portion of the garden lawn enclosed with mesh wire during the summer. They will not burrow under the ground like rabbits.

Nowadays it is not so easy to have oats and bran with which to feed them three times a day, but fortunately our little pets eat a very varied bill of fare. If you have an allotment or garden you will often have some old beetroots and turnips to chop up for your pets. Also some old cabbage leaves which are thrown away by your mother when preparing dinner, and they will like the tops and the peelings from the carrots.

## Grass and Plants

Fresh sweet grass provided by the lawn mower is another item on the menu, providing it is not given too often. Whenever you go for a walk in the country lanes and on the common, take a bag with you and fill it up with dandelion leaves, groundsel plants, the broad leaves of the plantain and any other soft plant growth. But do not give your pets any rhubarb leaves or any tea leaves.

## Cleaning

Straw or hay will make the bedding for your guinea pig hutch, but be sure to shake it out once a day to keep it sweet. In the hot weather of summer the hutch will not need so much litter as in winter. Once a week, on a fine day, put your guinea pigs into the play pen on the lawn while you clean out the hutch.

This means that you will scrape it out first with a piece of blunt metal or slate, then scrub it out with very hot water and soda, and then rub it out well with a handful of dry hay or straw. Make sure it is thoroughly dry before you put the guinea pigs back into it.

It is better that you should feed your guinea pigs and clean out their hutches yourself for guinea pigs are usually very shy and timid with strangers. They soon trust the person who cares for them, however, and in this way you will make the best of pets.

## Handling

If you are careful you should lift up and hold the guinea pigs in your hands. Talk to them and stroke their fur each time you visit the hutch, for this is the only way to make them really tame. If you only look at them they run away to the other side of the hutch.

Another thing to do for them is to have an old chair, or a small table, or a large, upturned box which you will use regularly as a 'grooming table'. Every time you brush your guinea pig's coat (this should take place once or twice

each week) you must lift him out of the hutch and place him on the grooming table. Stroke him well, and if you have handled him often before he will not be frightened and he will not try to run away.

You should scratch the guinea pig on the top of his head when you wish to make friends with him. The way to lift him is to place both hands around his chest so your two thumbs meet across his back. Please do not lift him by the back of the neck.

## Young Ones

If you have any baby guinea pigs, do not handle them until they are six weeks old. You can lift your pets out on to the grooming table when you want to show them to your friends; but do not do this until they have first got used to your handling them. (251)

## Provide a Bird Table—

**A**HARD winter entails suffering for our little feathered friends, deprived of their usual sources of food. Why not knock up a bird table—a practical good-looking affair—rather than scatter crumbs, etc., in a haphazard way on the ground?

Apart from humane considerations, considerable interest is afforded by the antics of our feathered guests, specially the tits, who perform quaint acrobatics whilst pecking at partially cracked nuts hung on strings. In the country a great number of different species will be noted, even to occasional rarities, whilst even in the heart of a big city robins, tits, thrushes and others will gather—besides the inevitable sparrows.

## A Suitable Type

The accompanying sketch gives a good idea of the general proportions of a suitable 'table' for a garden or camp-ground. The little details you can work out for yourself. The idea of a roof, of course, is to keep the food dry, whilst the rim, made removable for easy cleaning, prevents the food from being blown away.

The roof is made of two pieces of wood fitted to a couple of triangular frames, and is afterwards covered with straw thatch, or cedar shingles if you can get them. It will be noted that the supporting post can either be sunk firmly in the ground, or fitted with a base, so that it is portable. Precautions should be taken with regard to neighbouring cats!

As a very rough guide we may say that the table itself can be 18ins. square and 5ft. from the ground. The roof starts at 12ins. from the table and is made of ½in.

wood with holes drilled for the thatch, the latter being about 1in. thick. The roof is about 2ft. long, and supported on a triangular framework of 1in. by ½in. battens.

Oak is good stuff to use, but in any case all wood must be well painted. Practically anything will be welcome for the birds—crumbs, pieces of bacon rind, etc.—whilst a warm potato makes a treat. A little jar of water should stand

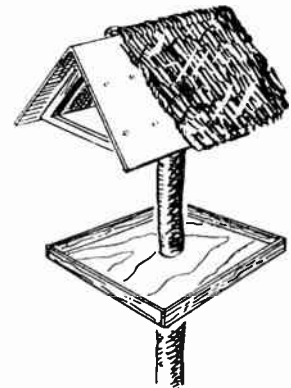

on the table and be changed when it gets frozen.

Many of our readers will doubtless regret that they have no garden suitable for such an erection. Almost as good is to make a slightly smaller version of the table and roof part (with a conical roof if you can manage it) and support the contraption from a wooden arm about a yard long, fixed to a window frame. A close-up view of the birds is thus obtained from the window.

# You can get grand winter sport in FISHING FOR DACE

**T**HE dace is a grand fish for sport, and appeals to both young and older anglers. They are river-haunting fish, and seldom found in still and stagnant water like ponds. Dace prefer quick streams, scours, eddies, currents, gravelly shallows, runs below a weir, and sandy bottoms in sharp, clear brooks. Such rivers as Thames, Trent, Kennet, Hampshire Avon, and most lesser rivers that hold roach, will also provide a few dace.

Dace have been taken weighing as much as 1lb. to 1½lbs., but the general run of these fish is about 6 to 8ozs., and such fish, though small, give excellent sport.

## Rod and Hooks

During autumn and winter dace are at their best. You need a light cane rod of 10ft. or so in length, an easy-running reel, a fine plaited silk line, and a Nylon cast of 3x thickness. Hooks—tied to short gut—should be No. 12 or 14; very small hooks are not recommended. You miss more 'bites' with tiny hooks than with big hooks.

The best method in autumn for catching dace is 'trotting' a bait down a long 'swim'. That is, letting the current carry the float and baited tackle down river, either by paying out line from the reel with your left hand, or allowing the current to draw the line direct off the reel. When your float has travelled say, twenty yards or so down-stream, withdraw and recast.

## The Line to Use

The line must be well greased with lineflote, Mucilin, or Vaseline so it floats well on the surface. The float is a swan quill or a porcupine quill, and the gut cast must be shotted so that just the tip of the float shows above the water.

As the baited tackle and float travels down the 'swim' you try to keep the line between float and rod-tip as taut as possible, quietly checking the float from time to time, so the baited hook keeps a little in front. By doing this the bait is presented to the dace in a natural manner. There is thus no drag on the line, and striking is rendered cleaner and easier.

## Bait

Baits are many—caddis grubs, maggots, small red worms, paste, breadcrust, pearl barley, wasp grubs, and hemp. When fishing with maggot on the hook you should ground-bait with small maggots, throwing in a thimbleful from time to time, a little upstream so the current will carry them down into the place where you are fishing.

When fishing deeper places a good plan is to try what old anglers call 'bag-baiting'—that is, put your groundbait in a small paper bag, weighted with a

pebble. Twist the top of the bag round tightly, pierce one or two small holes in the sides, and cast into the 'swim'. The maggots will wriggle out of the holes and float away down stream, thus attracting the dace. Until the bag disintegrates—as it may do—the wrigglers will keep working their way out, and maintain a steady flow of ground-baiting. Some anglers use pieces of old lace curtaining instead of a paper bag, for this purpose.

Other ground-baits include bread and bran, which can be used plain, or mixed

with maggots. Balls of stiff bread and bran stuffed with a few maggots, and cast into the 'swim', are effective where the stream is a trifle fast.

## Raking

Another way of attracting dace is by raking the bed of the river. You can do this with a long-handled rake. If fishing from a punt or moored boat get a friend to accompany you, and sit in the stern and ply the rake. This disturbs the bed

(Continued foot of page 43)

## Simple Wire Straightener

**W**HEN wire is bought by the coil, and often it is very tightly wound, it can be most annoying trying to get it straightened out in a satisfactory manner. Hammering is not to be recommended, as it badly dents the wire, besides making it a very tedious task, especially if a good length is needed.

The simple little tool described and illustrated in Fig. 1 on this page will make the task of straightening wire a very easy one. At the same time it adds to the quality of the wire by hardening it considerably.

## Different Sizes

The handyman who does a good bit of wirework will find that two or three of these tools made in different sizes will not only save a lot of time but will turn out a really first class job.

The tool is a simple affair and consists of two blocks of wood, one of which holds a zig-zag row of pins through which the wire to be straightened is pulled. The other block of wood acts as a cap to keep the wire in position.

The actual size of the blocks will depend on the thickness of the wire to be dealt with. A useful size for general work would be about 4½ins. long, 1½ins. wide and ¾in. thick: the cap being made to the same size. Beech, walnut or some such hardwood is the best material to use for both the block and cap.

## Panel Pins

The pins used for this block are 2in. panel pins, having a diameter of ⅛in. and with the heads cut off to length after they were driven in. Draw a line down the centre of the block and place the pins ⅓in. apart alternately on either side of the line. For fine or medium sized wire these pins should be very nearly in a straight line—the finer

the wire the straighter the line of pins. Fig. 2 shows the layout for this.

The cap should be drilled to slide over the tops of the pins, making it a fairly easy fit. It is meant to keep the wire flat and also to keep the pins from bending as the wire is pulled through.

## How to Operate

The best method of using this tool is to place the end of the coil of wire in a vice, as shown in Fig. 3. Then thread the wire between the pins, as in Fig. 1. place the cap on and draw slowly along the wire starting from the vice end.

It is usually only necessary to pull the tool along the wire once, but if this does not straighten it sufficiently the process can be repeated.

Best results are obtained when the pins are highly polished, so it will pay when making up the tool to see that they are smooth. Use fine emery paper and then burnish the pins by rubbing with a piece of round hard steel such as a knitting needle. (273)

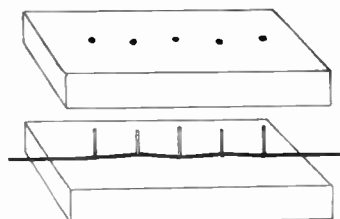

Fig. 1—The holed board and when complete



Fig. 2—Placing the holes

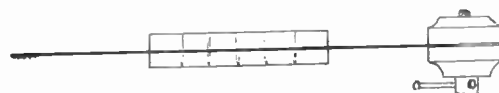

Fig. 3—Plan view showing wire held in vice and in the tool

# Novel table decoration easily obtained by GROWING MINIATURE TREES

**A**CORNS will soon be dropping from the oak trees, and many readers may care to consider the profitable hobby of growing miniature oak trees in bowls, on the Japanese system, either for their enjoyment or for sale.

It is a hobby that requires patience, of course, since Nature cannot be hurried. Three years or more are required before the first trees are saleable, but if one increases the stock every year, one has a hobby that is really an investment. Miniature oak trees cannot be mass-produced in a factory to satisfy a passing craze, nor can some imitator 'cash in' overnight on your hobby. You are fairly safe from competition.

## Tiny Oaks

As the picture suggests, miniature oak trees are perfect replicas in miniature, fully alive, of the grand old giants of the woodlands. Instead of growing tall and requiring tons of earth for anchorage and much space for development, they flourish in an ordinary bulb bowl.

The first step is to plant some acorns, either in a corner of the garden or in pots or seed boxes and wait for them to come up. When the seedling is big enough to handle, it is transplanted into a small pot containing a mixture of half ordinary garden soil and half sand.

The pots are then buried up to their rims in the garden soil (or even in a window box filled with soil). They are then left to complete a year's growth, i.e., until the leaves fall.

The stem is then gently manipulated into a decorative S shaped kink, and kept

thus by tying, with raffia, to a stick which is pegged into the pot. Thus confined, the little tree is left to grow for another year, still in the same small pot. At the end of the second season the stick and raffia may be cut away. The little tree is permanently kinked.

## In a Bulb Bowl

The little tree is then transplanted to a bulb bowl, its final home. Arrangements should be made for draining, but the soil should not be rich. It is the fact that the pot is root-bound that makes the tree grow in miniature.

In early summer, the young shoots are pinched back to prevent further growth, and during summer the plants should be watered sufficiently but not too generously. In winter, very little water is needed, and if the soil is covered with moss it will prevent too rapid evaporation of moisture. A very little manure (liquid, perhaps) can be given during the growing season.

Although we have spoken of the miniature tree's final home, it will be found that every five years or so, the plants benefit from a repotting. This does not necessarily mean to a larger pot. Such is needed only if inevitable. When the trees are repotted, about a third of the old soil is removed and replaced by new. The roots will be very pot-bound and old earth has to be prised very carefully from them with a skewer, etc.

For those who want rather quicker results though in a less substantial form, the following can be recommended. Scrape all the pulp from a large cut orange or grapefruit, fill the skin with soil and plant an acorn in it. Keep the



soil at room temperature and rather moist, and before long a young plant will appear.

As soon as any shoots grow through the rind, cut them off and repeat every time they do so. This, too, will result in a dwarf tree, only some 6ins. or so in height.

## Suitable Trees

A great many other trees can be grown in miniature, though the most suitable appear to be those which have a long life—oak, yew, pine, chestnut, cypress, beech, maple, etc. But cherry, apple, pear, and so on may be grown from pips and stones.

Unless one has 'green fingers', it is not particularly easy to raise plants of pine, cypress and yew, and one-year plants may have to be obtained from a seedsmen or nurseryman. Acorns and chestnuts, however, are quite easy to raise.

## Dace Fishing—(Continued from page 42)

of the stream, dislodging all kinds of food, bringing it down with mud and sand, colouring the water and bringing the fish 'on the feed'. Sometimes big lots of good dace are taken by such procedure, the angler 'swimming the stream' with his baited tackle travelling down the muddied water.

## Seasonal Differences

Sometimes, in summer, you can catch dace on the artificial fly, but in autumn you will do better with maggot bait. In later autumn—and later on—when rivers are full and running a strong current, it is better to try out the eddies and slacks, where the water is somewhat deeper than usual, and fish well on the bottom, holding the float some distance below where you sit, right on the edge of the eddy, using small red worms as bait, or maggots.

Dace seem to delight in the swirly eddies of a scour below a weir. You will doubtless be surprised at the display dace—if about half-a-pound or over—will give when hooked in such a water.

We have known them to fight, as valiantly as trout, size for size. Here, again, a red worm will be found a taking bait in late autumn and winter.

Dace collect in schools, for they are gregarious, like roach. They move in the water with swift darting movements, and in olden times they were referred to as 'river swallows' or as the 'dart'. General habits are closely akin to roach and they frequently haunt the roach 'swims'. After October dace show a tendency to retreat to deep waters, slacks, and quiet eddies; earlier in the season they prefer the quick, shallow runs.

## Different from Chub

Dace are often confused with chub by the beginner. But note that the anal fin of the chub is longer and has a rounded edge. The anal fin of the dace is a trifle broader and is hollowed out on the edge, or concave in shape. The head of the chub is more 'chubby' and blunt. Altogether the dace is more slender and graceful than the chub. To identify

readily, remember—in the chub the anal fin is rounded or convex; in the dace, hollowed or concave.

## Speed Needed

Dace 'bite' quickly. The float is 'banged' under in a flash, no preliminary jerking or bobbing as when perch bite at the bait. Thus, the 'strike' must be almost instantaneous. If you can 'strike' as the float goes down all the more likely are you to hook the fish.

However, do not be discouraged if you miss quite a lot of 'bites' when dace-fishing; even experienced anglers often fail to hook the fish. Practice will help you to time your 'striking', but dace bites are tricky. It is a case of 'tip-and-run' with the sprightly and lively dace, and you simply must be extra quick on the strike.

Anyway, dace are well worth fishing for. You will find them excellent fish to try your 'prentice hand on—and when you have been angling fifty years or more!

# An easily made delight for a youngster is A TOY MODEL SHOP

**M**OST youngsters like to play at keeping shop so the model one illustrated may make a welcome gift. It is so designed that the child can stand behind the counter instead of on one side, as was the case in the older pattern of stores. For construction the reader can use  $\frac{3}{4}$  in. deal for most of the work, or  $\frac{1}{2}$  in. fretwood for part, with deal, of the thickness stated in the article, for the remainder.

Fig. 1 is a front elevation, Fig. 2 a side section, with dimensions. For economy's sake it is, perhaps, better to use the  $\frac{3}{4}$  in. deal mentioned for the shop sides and top cross piece. Cut these to dimensions given, and round off the rear top corners. At the spots where the counter will be nailed later, square lines across as a guide, to get the counter level, and not on the skew.

## The Front

From  $\frac{1}{2}$  in. fretwood (or deal) cut the counter and front of the shop. The latter is glued and nailed across, then the counter nailed to the front and to the sides. See this counter lies truly along the pencil lines. Across the top nail the 2 in. wide strip shown; deal,  $\frac{3}{4}$  in. thick for this part. Between the counter and top strip, two vertical 1 in. wide strips of the fretwood are to be nailed. Here again guiding lines should be squared

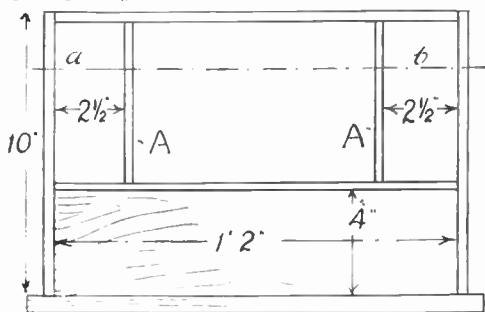

Fig. 1—Plan of the front

across to ensure their accurate positioning.

The baseboard can now be cut. The wood for this is a bit stouter than the rest, say,  $\frac{1}{2}$  in. or more according to what is available. It may be mentioned at this stage, that an odd length of  $\frac{1}{2}$  in. planed matchboarding, which finishes  $\frac{3}{4}$  in. thick, could usefully be employed for the sides and other parts, excluding the baseboard, if available. A secondhand piece would serve equally as well as a new one. This completes the carcass.

Inside the shop a set of shelves should be made and set up each side. These are seen in Fig. 2, and consist of two pieces (B) fixed to a pair of vertical uprights. The width of top shelf (B) is just  $2\frac{1}{2}$  ins., so that its further end can fit between the vertical front strips. (A).

The rest are cut from 2 in. wide wood.

Cut the side parts, then the middle shelf to height and width in Fig. 2, and glue each side to butt up against the counter. The top shelf (B) is cut 7 ins. long, but is to be nailed on top later.

The spaces between the sides of the shop and strips (A) represent the shop windows. To finish the front of the shop and also provide a rebate for the glass to cover the windows, cut from  $\frac{1}{2}$  in. fretwood two of (C), Fig. 4. It will be seen that a 7 in. by 14 in. panel of the wood will provide these and leave a bit over. Now glue and nail these parts over the window openings.

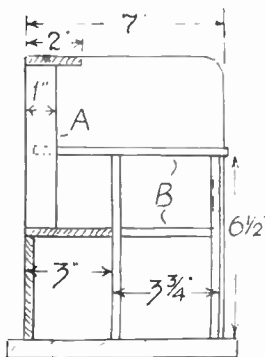

Fig. 2—End section

While the glue is drying, cut two pieces of thin glass or clear plastic to fit the window openings. Fit in position, then nail top shelf (B) in place, with its further end touching the glass to prevent the latter falling out. The transverse section of the shop, across line (a—b) (half) as shown at Fig. 3, will explain the above and make all clear.

To finish off the constructional work, a fascia board will be needed. This should be cut from  $\frac{1}{2}$  in. wood or nearabouts, to shape at (D) Fig. 4, half length only being given. Glue it to the top of the shop, and stiffen it a little with small angle

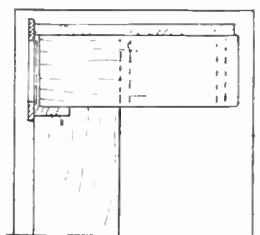
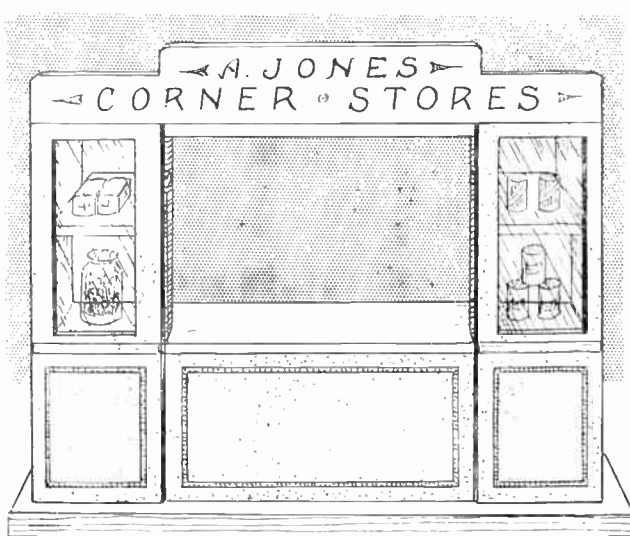

Fig. 3—Half section of top



brackets, glued behind in the angle.

The whole work should now be well cleaned up with glasspaper, then painted. Several spare bits of wood will be left, and from some of these, two strips,  $\frac{1}{2}$  in. wide, could be planed half round and glued across parts (C) just under the window openings, where shown by the dotted lines.

## Painting

Painting can be dealt with, naturally, at the discretion of the reader. A more professional effect is obtained by painting the name, etc., on the fascia board, not a difficult job if a fine brush is used, accompanied by a little patience. Simulated panelling in the front, by painting in the lines shown, will also improve the job. The counter and shelves are better left plain.

For stocking the shop, small bottles of sweets could be obtained for a commencement. Mock packages are easily made up from squares and rectangles of wood scrap, covered with paper. Tins from bits of dowel rod, covered with neatly inscribed labels.

A small pair of scales will also be needed, but readers will, most likely, buy this ready made.

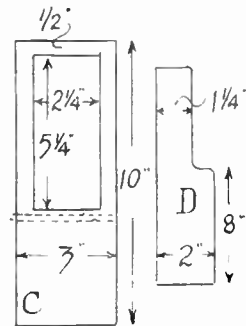

Fig. 4—Windows and fascia

# A PHOTOGRAPHIC ALPHABET

## T for—

### Tele-photo Lens

WHEN you take a snap of a distant scene the items come out very small, perhaps too small even to enlarge well. At times the trouble can be overcome by getting nearer—but it is not always possible to do this, as, say, when snapping birds in flight, a yacht race some distance from land, or even a cricket incident from the boundary line. If, however, you were to fit a telescope to your camera quite big images could be obtained from these removed positions and photographs have actually been taken through field glasses and telescopes. But such an arrangement is hard to fit up and here is where the tele-photo lens comes in, for it gives a telescopic effect in a lens that is no bigger than an ordinary camera lens.

The tele-photo lens can be a complete

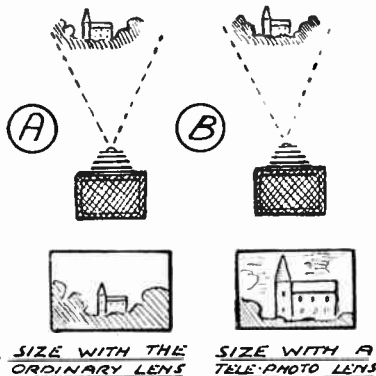

unit in itself, which replaces the camera optic, or it can be an attachment to go in front of the ordinary lens. For simple cameras in which the lenses are fixed, the attachment idea is always used.

As explained in an earlier paragraph the size of the image on the film depends on the focal length of the lens. The longer the focal length the bigger the image. A tele-photo lens, therefore, has the effect of giving a longer focal length than that of the lens fitted to the camera in the usual way.

### Tank Development

THERE are two ways of developing a film—either by using an open dish or by tank. In the first case the film is held by its ends and run through the developer by dropping first one hand and then the other, while in the second it is placed in a light-tight container with the solution for a predetermined time. In the dish method you can see the pictures coming up by means of the red light in which you work, and so observe

when development is complete, but in the second case correct development is judged entirely by the length of time the film is in the tank.

A tank has many advantages and a great number are now used. No dark-room is required with most kinds, it being possible to load the film into the container in ordinary daylight.

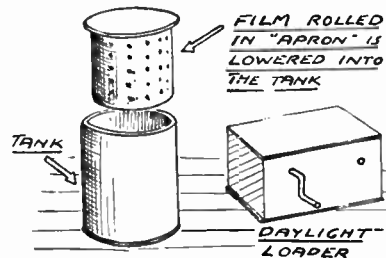

With a tank comes a chart which gives exactly how many minutes to leave the film developing—this generally being worked out against the temperature of the solution. When development is complete a cap is unscrewed and the developer poured out, following which the hypo fixer is put in. Everything is now left for a time and then the film is removed, when it is found to be fully developed and fixed.

Many workers contend that a tank gives the more perfect negatives as it is much easier to tell by the 'time and temperature' calculations just what is perfect development than by visual observation in a dim red light. Both methods, however, have their advantages.

### Toning Prints

MANY prints look better if changed from black and white to a pleasing brown (sepia). The process known as 'toning' is not hard, and the two solutions necessary can both be obtained in tabloid form from any photographic chemist or dealer. The first solution 'bleaches' the picture, that is makes it almost disappear, but the second brings it back dark again, but in the new livery.

Prints that you intend to tone must be well washed, as if all the hypo is not removed there will be areas of lighter or darker brown, which can spoil the whole effect.

A simple way of toning prints brown is to mix a solution of ordinary hypo with a little alum. This is placed in a metal container over a slow heat, say, a low gas ring, and the prints are placed in one at a time. As the temperature rises, the prints, it will be found, change from black and white to sepia. As the print must be kept on the move and as the

solution gets very hot, a pair of forceps is necessary to work the process well.

Prints that you intend to colour should always be toned to a sepia tint first and this is another reason why the art of simple toning should be mastered, for sooner or later everyone likes to try their hand at colouring.

## U for—

### Under-development

THIS is a negative trouble you should be able to recognise from under-exposure. With the latter it means that the lens was not left open long enough and consequently the light did not act for a sufficient space of time on the sensitive emulsion of the film. In the first case, however, the light acted for the correct period but the process of bringing out the pictures (development) was cut too short.

With under-development, therefore, we have the usual detail of a good negative present but it is all too thin and transparent. This means that the print will be flat and lifeless.

With under-exposure, however, the highlights in the subject—that is the black areas in the negative—are heavy and dense, but there is no all-over detail. The shadows, that is the thinner areas of the negative, are devoid of detail, often, in fact, being just clear gelatine.

## V for—

### View Meter

THIS is a very useful photographic accessory and is made up of a frame, either the exact size of your film or a proportionate size, and a small pin-hole 'eye piece' set a little distance from it.

By putting the pin-hole up to the eye it will be found that both the frame and view beyond are in sharp focus. This would not be so if the eye-hole was big, when the frame would be fuzzy.

The frame is thus, as it were, laid over the view and as it takes in the same amount of country that your film will, it is easy to judge the best composition for a picture, and whether this or that item improves or spoils the general effect.

A view meter is readily made, a simple one being merely a flat strip of card turned up to right angles at the ends—a distance apart equal to the depth of the camera. In the one 'turn up' a frame the size of the film is cut and in the other the eye pin-hole agreeing with the centre of the frame.

This hole is best made by touching the card with the end of a red-hot knitting needle, which makes the aperture cleaner than boring does. If the frame is smaller than your film size, then the distance from eye-hole to frame must be shorter in the same proportion. Paint the inside of the card a matt black.

The advantage of a view meter over a view finder for closely studying a subject is that everything is seen full size.

(To be Continued)

# THREE SIMPLE HOME GADGETS

If the lady is not lucky enough to have a full-sized ironing board for skirts and sleeves this simple adaption should be welcome in any home. The handyman should have no difficulty in making it.

The ironing board is 24ins. long and 4ins. wide. The wood is 1in. thick and must be well glasspapered and rounded at the corners. It can be covered with a

Space is often limited, but it is handy to be able to have a small rail for a few things which will fix on the edge of a shelf such as shown at Fig. 2. This can always be taken down when not in use. The two ends are made from  $\frac{1}{2}$ in. plywood and cut to take three 36in. dowel rods which are screwed in at intervals of 2ins. The design is such that the supports slide on to the edge of the shelf and the

weight of the hanging article keeps it in position.

A tray for the sick room (see Fig. 3) or for those who indulge in breakfast in bed is handy when it can be stood up a bit and not flat on the bed. Take an ordinary tray and measure some plywood to the same width as the narrow part of the tray. Take out an arched shaped section. Clean off well to prevent damage to

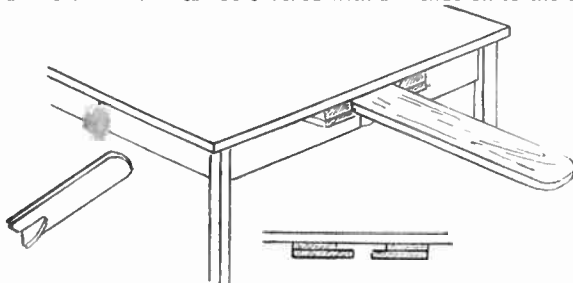

Fig. 4—A spare shelf

piece of old blanket or cloth. The idea is to fix it to the ordinary whitewood kitchen or scullery table.

Now make the two underside bracket supports. The brackets measure 5ins. long and  $1\frac{1}{2}$ ins. square. A recess is cut in each one  $\frac{3}{4}$ in. by  $1\frac{1}{2}$ ins. and then they are screwed firmly into position. They should be so fixed that the board can slide into them. Keep the board in position by the rounded wooden bracket (Fig. 1) and this should be as deep as you can make it to take the pressure.

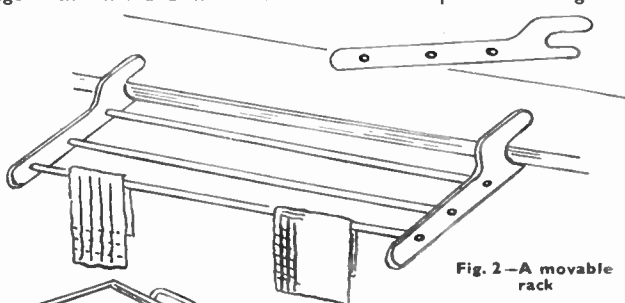

Fig. 2—A movable rack

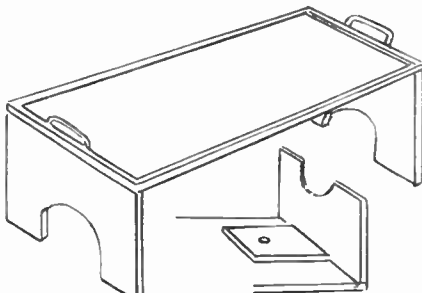

Fig. 3—A bed-table tray

bedclothes when in use.

Fix the two panels on with small neat hinges so that the flaps fold inwards. Fasten two blocks on underneath with screws so that they can be screwed round to hold the flaps up but without jamming. This tray will also be found very handy to anybody who cannot stoop down too much and also when you are in the garden having tea. It saves putting it right flat on the ground. (214)

## BE TALLER

1 Guarantee to increase your height in 12 days or return your money. New gland and spinal discovery increases height 2 to 5 inches.

'I have gained  $4\frac{1}{2}$  inches in height and feel fresher first thing in the morning. My weight increased from 9-stone 4-lb. to 10-stone 3 $\frac{1}{2}$ -lb.—P.D., Witham. 'Since taking your Course I have increased in stature from 5 feet 1 inch to 5 feet 4 inches, a matter of 3 inches'.—H.G., Chesterfield. 'My increase is 2 inches and I really do feel ALIVE'.—E.T.

Guaranteed harmless. Full Course 10/- post free, Air Mail 14/-. Details free for 1d. stamp. Sent under plain cover.

**J. H. MORLEY**

(H/83), TERRY HOUSE, NAPHILL, HIGH WYCOMBE, ENGLAND  
Established 1936



### THE BOLSTER HOME WATCH AND CLOCK REPAIR OUTFIT

These precision jewellers instruments, include watchmaker's magnifying eyeglass, finest watch tweezers, set watchmaker's screwdrivers, watch and clock oil, oilers, dusting powder, clock brush, plus illustrated instructional manual for the amateur. In container 12/9 post free.

Senior Outfit includes everything above, plus watch jewels, luminous compounds, dial renewer, jewellers rouge, explanatory book. Price 21/- post free.

**BOLSTER INSTRUMENTS, (Dept. H. W.), 5a Station Parade, Ashford, Middx**



MURRAY HILL & CO., BEDFORD SQUARE, SIDMOUTH, DEVON

**BOYS!!! BOYS!!! BOYS!!!**  
With the aid of our amazing assembly outfit you can quickly and easily assemble this superb scale model of the famous 'Ferguson' tractor. All parts supplied in finished state. All plastic construction, real rubber trakgrip tyres. Can be dismantled and re-assembled with ease. Send P.O. today for 7/6 post free.

## YOU CAN BECOME A HANDICRAFTS INSTRUCTOR

**Experience not essential**

Men who enjoy making things in wood or metal can turn their hobby into a permanent and interesting Career. Short hours, long holidays, and security in a job you would really enjoy, can be yours if you become a Handicrafts instructor. Let us send details of the easiest and quickest way to get the necessary qualification.

**We definitely guarantee "NO PASS—NO FEE"**

If you would like to know about our unique method of preparing you for one of these appointments, write to-day, and we will send you our informative 176 page Handbook—free and without obligation. Mark your letters "Handicrafts Instructor."

**BRITISH INSTITUTE OF ENGINEERING TECHNOLOGY**

595 Shakespeare House  
Stratford Place, London, W.1

# BIET

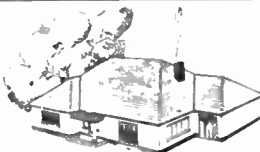

**TURN YOUR SPARE-TIME INTO CASH**

**Men and women wanted to make Bennett Model Bungalows at home.**

*Fascinating, simple, well paid work*  
*No selling involved.*

Send penny stamped, addressed envelope for full details.

**BENNETT MODELS,**  
137, Grays Inn Road, London, W.C.1

## HOBBIES BRITISH FRETSAW BLADES



**YELLOW LABEL 1/2 per doz. 10/6 gross**  
**BLUE LABEL 11d. per doz. 13/6 gross**

From Hobbies Branches or by post (21d. extra) from Hobbies Ltd., Dereham, Norfolk

## A NOTE TO AMATEUR PHOTOGRAPHERS

The old-fashioned method of developing roll films by splashing them up and down in a dish is out. The modern method, used by amateur and professional workers alike, is to employ a daylight developing tank.

### JOHNSON J-20 TANK

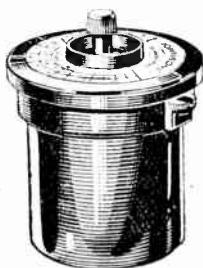

A most economical little tank specially designed for the popular size 20 film (2½ ins. wide). The one-piece spiral film-holder is easily loaded in the dark, the lid is replaced and then developing and fixing can be carried out in daylight. Only 10½ozs. of the developer are required to fill the tank. The lid is triple light-trapped and has an extra deep, built-in funnel for easy filling. An ivory rotating calculator gives the correct developing time for most popular films, when using Johnson developers. A pouring lip on the side of the body for emptying.

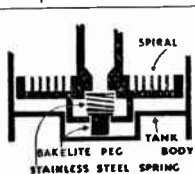

All the latest J-20 developing tanks are fitted with the new Two-way agitation movement which ensures even development

**PRICE 22/6**

Your dealer will let you examine one and explain how it works.

**JOHNSONS OF HENDON**

# PROFITABLE LEISURE

Everything wanted for Perfect Pastimes for Pleasure and Profit is listed in:

## CRAFTWORKER

THE MODERN MAGAZINE OF CRAFTS FOR ALL

- Every kind and type of tool and material is offered in *Craftworker*
- Instructions in all Crafts at Home are published in *Craftworker*
- A Market Section is included in each issue of *Craftworker*

A COMPLETE SERVICE

Specimen Copy 1/2d. from the Publishers

**Craftworker (DEPT. H.W.), Broadway, Broadstairs**

## HAND PLANING FROM 'A' TO 'Z'

Revised, Enlarged Edition of

### 'PLANE CRAFT'

The Craftsman's workshop companion and an invaluable instruction book for apprentice or beginner. Many thousands sold since 1st edition in 1934. An ideal Christmas Gift.

20 CHAPTERS!

278 ILLUSTRATIONS!

covering

The History of the plane; plane adjustment, grinding and wetting the iron; holding the plane; planing difficulties solved; fundamentals of planing; rabbeting, ploughing; combination, circular, router and multi-planes, spoke-shaves, bench and vice; workshop hints.

Obtainable through tool stockists,

**3/6** [NET. OR [POST\_FREE] 4/1

direct from the publishers:  
**C. & J. HAMPTON, LTD.,  
SHEFFIELD, ENGLAND.**



## BRITFIX BALSA CEMENT

★ The ideal transparent cement for Balsa Ply Wood, Hard Woods, and Plastics, combining rapid drying with utmost tenacity.

Small Tube  
Now  
4d.

Large Tube  
7d.

Remember  
**STICK BY  
BRITFIX**

**THE HUMBER OIL CO. LTD., HULL**

## NICOTEXIT

THE GUARANTEED SMOKING DETERRENT

- ★ POSITIVELY STOPS SMOKING IMMEDIATELY and for several hours after each application. Purchase price refunded if it fails to do so.
- ★ ONE BOTTLE IS USUALLY SUFFICIENT to establish control of smoking in any form. It is not poisonous.

*Invaluable to all who smoke too much*

**5/6** Per Bottle  
Post Free

Obtainable only by post from Sole Concessionaires for Great Britain:—

**THE NICOTEXIT COMPANY (Dept. B.6.)  
62 High Street, Croydon, Surrey**

# RAWLPLUG PRODUCTS

**INDISPENSABLE  
IN THE WORKSHOP  
HANDY IN THE HOME**



*The Rawlplug Popular Outfit costs only 2/6 complete. Larger sizes are obtainable.*



## FIXING DEVICES AND TOOLS

Whatever your fixing problems, there's a Rawlplug Device that will solve it for you—easily and quickly. Rawlplugs make neat and absolutely firm fixings in any material from brick or tile to stone or slate, with a size for every screw from No. 3 up to 1/4" coach screws. Rawlplug Tools are easy to use and ensure a perfect hole without damage to surrounding surfaces. Other Rawlplug Devices include Rawbolts for heavy duty fixings, Rawanchors and Toggle Bolts for thin or hollow materials and Rawclips for instant fixing of conduits and cables to girders—a device in fact for every need.

Rawlplug fixing devices and products can be obtained from Ironmongers, Hardware Dealers, Stores or Model Makers Suppliers.



## SCRAPER

A remarkably efficient and economical scraper, built to last a lifetime. Gives smooth finish without chatter or scratching. Easy-grip handle made solid with blade carrier in seasoned hardwood, polished and varnished. Total length approx. 6". Fitted with Cadmium Plated Steel Blade, with cutting edge ground like a razor. 3/- each.



## DUROFIX

The indispensable adhesive for instant use on crockery, glass, wood, metal, celluloid and the thousand and one things handled by the hobbies enthusiast. Instant drying, insulating, waterproof and heatproof. Durofix is grand for repairs to electrical, sports and leather goods. Tubes 9d. and 1/3d. Tins 2/9d. and 7/6d.



## DUROGLUE

**UNDILUTED ANIMAL GLUE OF INCOMPARABLE STRENGTH**

Ready for instant use for the many purposes for which an extra strong glue is needed. Wood, cloth, fabric, felt, leather and any greasy surface can be stuck with Duroglue. Tubes 6d. and 1/- Tins 2/3d. and 3/9d.



## PLASTIC WOOD

**APPLIED LIKE PUTTY, DRIES LIKE WOOD**

Can be cut, planed, polished & painted like wood. Will take nails and screws like wood. It does not blister, crack or decay. Rawlplug Plastic Wood is actually the best quality product of its kind on the market. Tubes 9d. Tins 2/- and 5/-.



## TILE CEMENT

Rawlplug Tile Cement is a liquid cement possessing very strong adhesive qualities.

For replacing tiles to walls, floors, fireplaces, hearths, curbs, etc., in kitchens, lavatories, bathrooms, halls, bedrooms, reception rooms, etc. 2/3d. per tin.

8389c

**THE RAWLPLUG COMPANY LTD. LONDON. S.W.7.**

# ENGINEERS

## ★FREE BROCHURES★

Technical training is vital to your success. Our Home Study courses bring you sound, up-to-the-minute instruction.

Write or 'phone for FREE BROCHURES detailing our courses of TECHNICAL TRAINING IN ALL BRANCHES OF ENGINEERING covering such degrees as A.M.I.Mech.E., A.M.I.E.E., A.M.I.P.E., City and Guilds, etc.

**'THE COLLEGE BACKED BY AN INDUSTRY'**

Write to Dept. 31

## E.M.I. INSTITUTES

10, PENBRIDGE SQUARE, NOTTING HILL GATE, LONDON, W.2. TELEPHONE: BAYSWATER 6131/2

Associated with "H.M.V." MARCONIPHONE COLUMBIA ETC.

*One plastic material*  
**MAKES MANY PERMANENT MODELS**



and utility objects, from simple instructions in illustrated Booklet—please read below.



**ONLY 4D IN STAMPS BRINGS BOOK**

... showing how such models as those above, and many others, can be made, without skill or special tools, from Sankey's **PYRUMA** Plastic Cement. Ready for immediate use in its plastic state, Pyruma sets or bakes to stone-hardness, and can be painted or enamelled in all colours according to instructions.

Pyruma is inexpensive, and easily obtainable in tins from Ironmongers, Art Material Dealers and Hobbies Shops. Send 4d. in stamps for illustrated Instruction Book.



**J H SANKEY & SON, LTD.**

ILFORD

Est. 1857

ESSEX

Printed by BALDING & MANSELL, LTD., London and Wisbech, and Published for the Proprietors, HOBBIES LTD., by HORACE MARSHALL & SON, LTD. Temple House, Tallis Street, E.C.4. Sole Agents for Australia and New Zealand: Gordon & Gotch (A'sia) Ltd. For South Africa: Central News Agency Ltd. Registered for transmission by Canadian Magazine Post.



# Hobbies

## WEEKLY

### CONTENTS

	Page
Blackboard and Toy Cupboard	- 49
A Mains Transformer	- 51
A Model Garage	- 53
Mini-Soccer Game	- 54
A Jet-Propelled Boat	- 55
Ship Modeller's Corner	56
Photography	- - 57
A Child's Abacus	- - 59
Replies of Interest	- 60
Woodturning	- - - 61

October 25th, 1950

Price Fourpence

Vol. III No. 2869

## A COMBINED BLACKBOARD AND TOY CUPBOARD

**H**ERE is just the thing for the tiny tots, a toy cupboard and shelf for books and a blackboard all combined. In Fig. 1 we give two views of the cupboard, one with the cupboard closed at (A), and the one, (B), with the door of the cupboard turned up and forming a most convenient blackboard. The cupboard is quite spacious and capable of holding quite a lot of toys.

Along the front edge of the shelf too, there is formed a recess for chalks for use on the blackboard. The whole article should be made of deal as it is not advisable for it to be too heavy. The rod fixed between the two sides forms the support for the cupboard door when opened up as a blackboard, and it also serves as a handle when it is desired to move it from one place to another.

### Suitable Wood

Wood  $\frac{3}{4}$ in. thick is suitable for all the main parts of the cupboard, with  $\frac{1}{2}$ in. stuff for the shelf supports and edging pieces. The backing to the cupboard consists of one single J3 standard panel obtainable from Hobbies Ltd. In Fig. 2 we have a front view of the cupboard with all necessary dimensions given for setting out the work.

As will be noted from this illustration the cupboard is three feet high and 16 $\frac{1}{2}$ ins.

wide and its depth from front to back 11ins.

Fig. 3 gives a sectional view showing the shelving and their supports, also the swing door showing the two positions, open and closed.

It will readily be understood from this diagram also, and from the enlarged section Fig. 4, how the door must be prepared for hinging by means of screws

passed loosely through the sides of the cupboard and run into the edges of the door. To commence construction we take in hand the two sides, and if it is not possible to get boards 11ins. wide, then the best way would be to glue up two

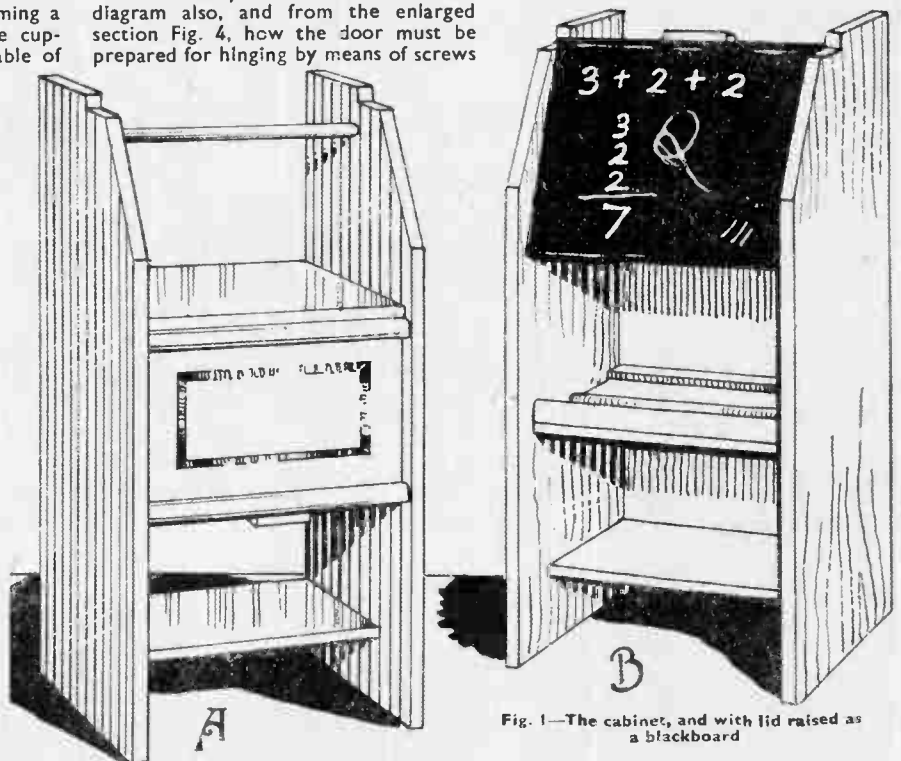

Fig. 1—The cabinet, and with lid raised as a blackboard

All correspondence should be addressed to The Editor, Hobbies Weekly, Dereham, Norfolk.

battens as (A) and (B) and dowel them together edge to edge.

Dowels about 1in long and 1/4in diameter should be used, and the holes for them must be carefully bored to keep the edges of the battens true and level. It will be noted from Fig. 3 that one board in each pair, constituting one side, is 1 1/2ins. shorter than the other and that the front member only is cut to shape, the measurements here being given. The triangular piece so cut away can be done

Next prepare the shelves (D), (E) and (F), the latter as seen is the lower and 8ins. wide while those above as (D) and (E) are 10ins. wide. All shelves are 15ins. long. Drill holes through the ends of the cupboard to take the screws which fasten the shelves, and countersink the holes which are later filled level with putty or wood filler.

### Dowel Fixing

Some workers may choose to use dowel pins instead of the screws, the pins being carefully driven into 1/4in. holes after being dipped into glue. The dowels should be of tough wood and the outside surfaces at the ends nicely cleaned off at completion. The top edges of the supports (C) should be coated with glue before the shelves are inserted. Round off the front top edge of shelf (E) to allow the door to clear it when the latter is thrown back, see Fig. 4.

Next prepare two fillets (G) 15ins. long and 1in. by 1/4in. and glue and nail them along the backs of the shelves (D) and (E) as shown to take the panel forming the back of the cupboard. The fillets will be put in 1/4in. from the back edges of the shelves to form the rebate for the panel shown as (H) in Fig. 3. The supports (C) under the shelf (E) can now be put in, the back edges of them being notched out to fit round the fillet (G).

The back panel is held in place by small round head screws. The door (J) being 15ins. wide, would be best made from three narrow battens each 5ins. wide and 11 1/2ins. long, and glued edge-ways together and strengthened by the two cross rails (K) as seen in Figs. 2 and 3. The overall size of the door is 15ins. by 11 1/2ins. and the top edge must be

rounded to an exact semi-circle as in the enlarged section Fig. 4.

This shaping allows the door proper clearance for the shelf against which it is fixed. Note too, the cross rails, measuring 15ins. long and 1 1/2ins. wide are each differently placed on the door, the lower one being close against the lower edge while the upper one must be 1in. down from the top as seen in Fig. 4.

The rails should be screwed on from the back so the heads do not show on the face of the door. The heads at back can be countersunk and filled before the black matt paint or special blackboard paint is put on. The correct position of the support rod for the door is given in Fig. 3.

### The Cross Rod

The rod should be 3/8in. or 1/2in. diameter beech or birch wood, and the ends must be let into the upright ends and glued firmly and afterwards cleaned off level with the outside surfaces. If the rod does not fit the holes closely after they have been made then the ends may be sawn across for about 1in. deep with the tenon saw and then, when the rod is in place, drive in thin wedges of hard-wood dipped in glue. The wedges will open the ends of the rod and a very firm fixing result.

It only remains to form the tray just inside the front of the cupboard for chalks etc. Two narrow rails cut the width of the cupboard and about 1 1/2ins. or 1 3/4ins. wide by 3/8in. thick are glued and screwed to the shelf (D) as seen at (L) in the section Fig. 3. Round the top edges and make them smooth.

Go over all the woodwork with fine glasspaper and finally lay on two coats of oil paint. Choose a good art shade of green perhaps for the finishing coat and panel out the door for good effect with some contrasting colour scheme.

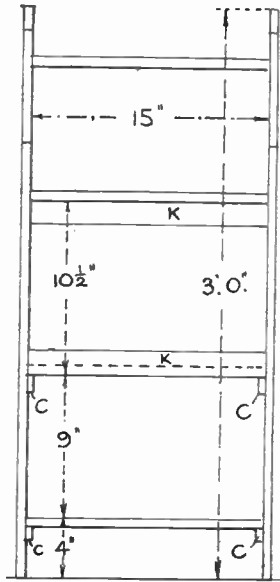

Fig. 2—Front elevation

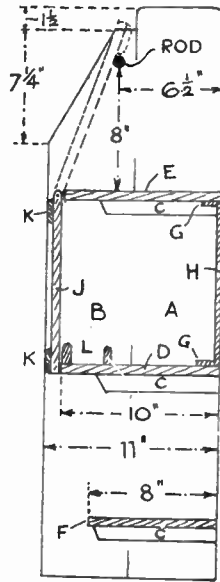

Fig. 3—Side elevation

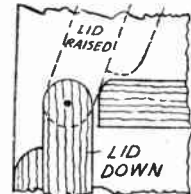

Fig. 4—Section, showing position of raised lid dotted

with a fine-tooth tenon saw or even the fretsaw. Round off and glasspaper smooth the top, corners and edges of the long back battens.

### General Framework

When the sides have been made lay them together side by side and even at top and bottom, and set across the lines of the three shelves. Below the shelves will be the supports (C), these are 7 1/2ins. long by 1in. by 3/8in. Six supports in all are wanted, but the upper pair will not be nailed in until after the backing to the cupboard has been fixed.



### BRANCHES

#### LONDON

78a New Oxford St., W.C.1  
(Phone MUSeum 2975)  
87 Old Broad Street, E.C.2  
(LONDON Wall 4375)  
117 Walworth Road, S.E.17

#### GLASGOW

326 Argyle Street  
(Phone CENTral 5042)

Head Office & Factories—HOBBIES LTD., DEREHAM, NORFOLK

#### MANCHESTER

10 Piccadilly  
(Phone CENTral 1787)

#### BIRMINGHAM

14 Bull Ring

#### SHEFFIELD

4 St. Paul's Parade

#### LEEDS

10 Queen Victoria Street  
(Phone 28639)

#### HULL

10 Paragon Square

#### SOUTHAMPTON

25 Bernard Street

#### BRISTOL

30 Narrow Wine Street  
(Phone 23744)

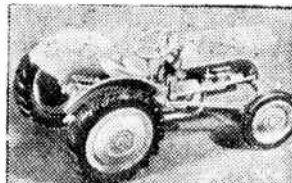

MURRAY HILL & CO., BEDFORD SQUARE, SIDMOUTH, DEVON

### BOYS!!! BOYS!!! BOYS!!!

With the aid of our amazing assembly outfit you can quickly and easily assemble this superb scale model of the famous 'Ferguson' tractor. All parts supplied in finished state. All plastic construction, real rubber trakgrip tyres. Can be dismantled and re-assembled with ease. Send P.O. today for 7/6 post free.

## THE MOTOR SHOW IS COMING! "WHERE'S THAT CAR FROM?"

and  
"POPULAR CARS"

(40 illustrations)

6d. each

from all Booksellers and Stationers

Raleigh Press, Exmouth

# How the amateur electrical enthusiast can make A MAINS TRANSFORMER

**T**HE electric current supplied to houses usually has a pressure of 200 to 240 volts. This voltage is too great for electric trains or other models to be driven directly from the mains and a transformer is used to 'step-down' the current to a lower voltage.

The making of transformers is a simple and fascinating hobby and a transformer suitable for driving a model electric train can be made for less than quarter the price of a new one.

## How the Transformer Works

In Fig. 1, R is an iron ring with two sets of coils wound on to it, a large one at P (the Primary coil), and a smaller one at S (the Secondary coil). These coils are wound from INSULATED wire. When P is connected to a source of alternating current (A.C.) a current also flows through S and can be shown by means of a meter at M.

This current is called an Induced current. If S has half the number of turns that P has, then the current through S will be half the voltage of the current passing through P. This is called a Step Down transformer because it lowers the voltage of the mains supply.

In his early experiments Faraday used

a metal ring but modern transformers have cores built up with thin metal strips. The strips are made from Stalloy iron and are called Stalloy stampings or Stalloy laminations. The two most common pairs of shapes that are used are shown in Fig. 2.

Almost any electrical or radio dealer will sell an old transformer for sixpence or so. The old wire can be stripped off and the laminations used again.

The easiest transformer to start with is one that has U and I shapes for the stampings. Build the stampings up as shown in Fig. 3 and fasten them tightly together with small nuts and bolts as shown.

## Working Out the Size of the Coils

Frequency of current	Area of cross section	Number of turns per volt
50 cycles per second	$\frac{1}{2}$ sq. in.	16
	1 sq. in.	8
	2 sq. ins.	4

The frequency of the mains supply can be found out from the meter. It is usually 50 cycles per second. The table printed above is based on this frequency.

Next measure the cross-section of the

core. If this cross-section is 1 sq. in., we see from the table that the coils must have 8 turns of wire for every volt.

What is the voltage of the mains supply? Again this can be found out from the meter. If it is 240 volts, then the Primary coil will need 240 by 8 equals 1,920 turns of wire.

The number of turns for the Secondary coil is worked out in the same way. To give a current of 14 volts the coil must have 14 by 8 equals 112 turns.

## Making the Formers

The wire is not wound directly on to the iron core but is put on to formers which can be slipped on to the arms of the core. The next step is to make two of these formers.

From some thin strong wood cut two end pieces as shown in Fig. 4A. The actual size will depend on the size of the iron core that is being used. Cut out the shaded portion shown in the diagram so that the end pieces will just slip over the arms of the pack of U-shaped stampings.

The tube on to which the wire is wound between the end-pieces is made from stiff cardboard (Fig. 4B). Compare the length I in Figs. 3 and 4B, and the length S in Figs. 4A and 4B.

The tube and two end pieces are glued together to make the complete

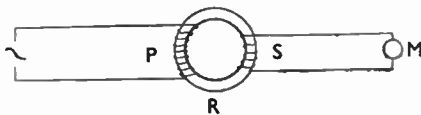

Fig. 1—A circuit of the transformer working

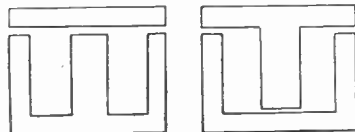

Fig. 2—The E and I and U and T shapes

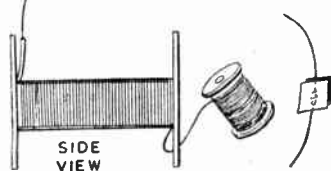

Fig. 5—The coil and insulating tape

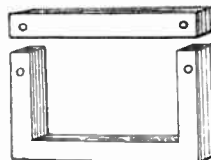

Fig. 3—The built-up stampings

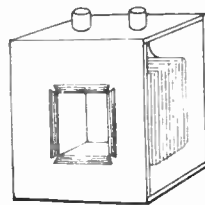

Fig. 6—Perspective and section of former holder

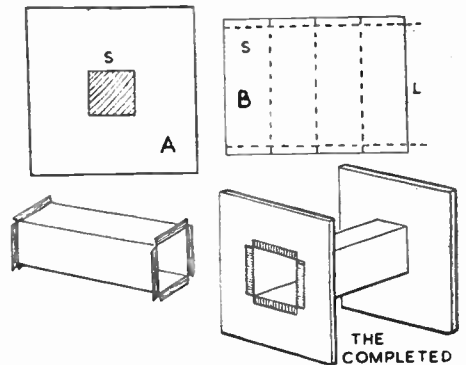

Fig. 4—Parts of the former and when completed

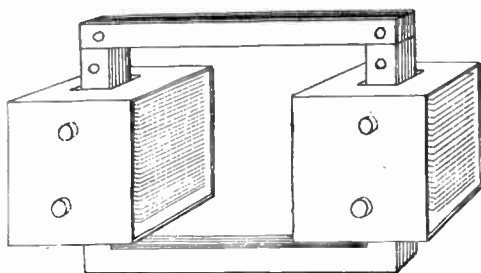

Fig. 7—Two coils fitted to iron core

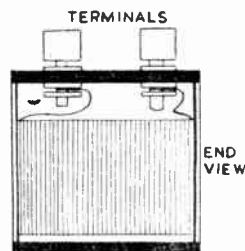

Fig. 6—Perspective and section of former holder

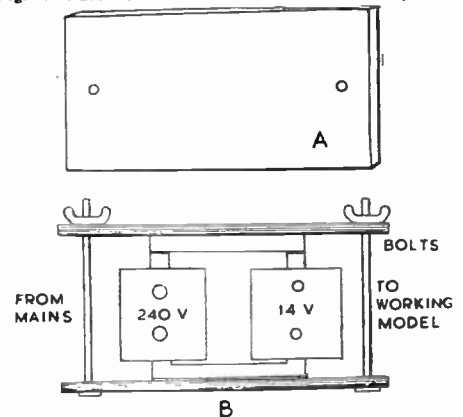

Fig. 8—Parts to hold the transformer

former as in Fig. 4C. The cardboard tube can now be bound with adhesive strip to give it greater strength.

### Winding on the Turns of Wire

Use d.c.c. (double-cotton-covered) copper wire, its gauge (or thickness) being from 20 to 24 S.W.G. Two  $\frac{1}{2}$  lb. reels of wire will cost about 5/-.

Leave a free end of about 8 ins. and put on the first layer of wire, placing the turns closely side by side (Fig. 5). Cover this layer with adhesive paper, then put on the next layer, winding in the same direction all the time. Keep winding backwards and forwards,

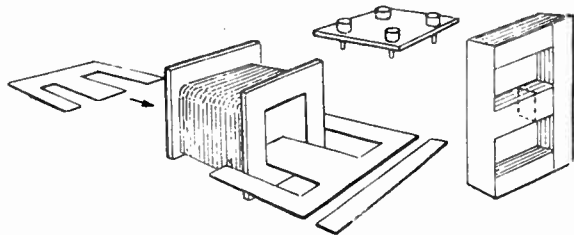

Fig. 9—Detail of stampings to fit the former

separating each layer of wire with a layer of sticky paper until the full number of 1,920 turns has been added.

Finally, leave another free end of about 8 ins. and finish off with a layer of insulating tape. If it is found necessary to make a join in the wire, solder the two ends together as neatly as possible, and insulate the join with two stamp-sized pieces of insulating tape (Fig. 5).

The former can be fitted on to a lathe or on to a Meccano-made winder, but the author has turned out neater jobs by putting the turns on by hand.

Now cut another two pieces of wood to form a top and bottom to the former. These can be fixed with some  $\frac{1}{2}$  in. nails. The top piece is fitted with two terminals to which the bare ends of the two 8 in. wires are firmly fixed (Fig. 6). These ends can, of course, be shortened to a more convenient length.

This is the complete Primary coil and

will take the full mains voltage.

### The Secondary Coil

The Secondary coil is made in exactly the same way but will, of course, have only 112 turns. The d.c.c. copper wire can be as thick as is convenient to put on, the thicker the better, but size 20 S.W.G. is quite all right for general purposes.

The coil can be made to give any voltage, remembering that if V is the voltage wanted, then V by 8 is the number of turns to put on.

Fig. 7 shows how the two

required as before. First of all wind on the Primary coil. When this winding has been finished, twist the two ends together so that they will not be mixed up later on. Now put the Secondary coil on top of the Primary windings. The square of wood for the top of the coil is fitted with four terminals—two for the primary coil (preferably red in

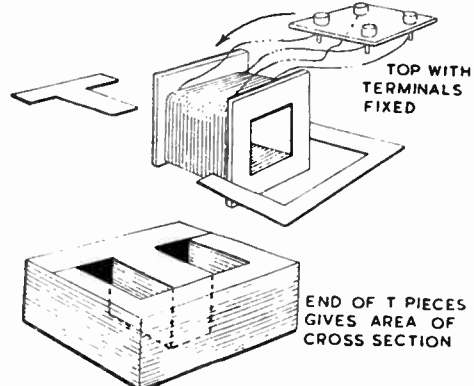

Fig. 10—Details of construction

coils are fitted on to the iron core. Cut two pieces of  $\frac{1}{2}$  in. thick wood (Fig. 8A) and use these together with two bolts and winged nuts to bind the transformer together (Fig. 8B).

It will be wiser to fit the transformer into a box, as the Primary coil carries the full mains voltage and would be dangerous if someone were to play about it while it is in use. With proper treatment the transformer is perfectly safe and efficient.

### Using E/I or U/T Shapes for the Core

Using the shapes shown in Fig. 2 gives a much more compact transformer. Only one former is needed but greater care has to be made in making the former to an exact size. Figs. 9 and 10 show how these stampings fit exactly into the former. Notice how the cross-section is measured.

Work out the number of turns

colour) and two for the Secondary coil.

In using E and I pieces (Fig. 9) first of all slip in one of the E pieces as shown. Put in the next piece from the opposite direction and lay the I piece on top of the first stamping and against the end of the arms of the second stamping. The stampings are pushed in from opposite directions each time and the I pieces are put first on one side and then the other. Pack them in as tightly as possible so that they cannot fall out.

For using U and T pieces (Fig. 10) the procedure is the same—the second U piece goes into the coil in the opposite direction to the first U piece. The T pieces must, of course, alternate as well.

As with all transformers the terminals of the Primary coil should not be handled while the current is on. With ordinary treatment these transformers will give years of reliable and steady performance. (263)

## A Model Garage—(Continued from page 53)

the lamp holder, complete with leads, should be fixed to the roof before the unit is assembled, and place made for a third switch on the rear wall of the office.

The end door is cut from three-ply and is hung with a 1 in. brass hinge.

### The Electric Sign

The lamp house on which the sign is fixed is a three-sided box cut as shown in Fig. 1. This is fixed on to the main base before the two lamp holders are screwed into position.

The slot in the roof of the house is cut to the length and breadth of the piece of perspex used for the illuminated sign. Extra care should be taken in construction of the lamp house as any leakage of light will spoil the effect of the sign.

Mark out the word GARAGE to actual size on a strip of paper and paste this on to the Perspex. Cut out the letters with a fretsaw so they are left mounted on a Perspex base (Fig. 4), and

finish them off with a light file.

The general plan of the model (Fig. 5) shows the relative position of all the units.

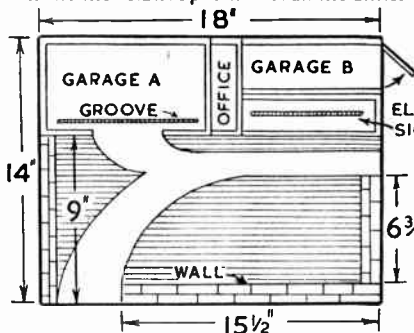

Fig. 5—General plan of lay-out

The surrounding walls not only give a finish to the model but also give extra rigidity to the base. Cut the walls to the dimensions shown in Fig. 5 and Fig. 6.

Paint a brownish colour and when dry, mark out the bricks with indian ink. Finish off with a coat of clear varnish, but do not fix to the base until that, too, has been painted.

### Painting the Model

Use ordinary poster paints to colour the model and when this is dry give a final coat of clear varnish. A suggested colour scheme is as follows: roofs—red; office—light brown; rest of walls—blue; paths—brown; rest of base—green.

Before beginning to paint see all the nails are punched in, and their heads covered with plastic wood or putty. If available, glue a square of baize or stout card to the bottom of the base to allow the model to be used with safety on the dining room table.

Use a 4.5v. lamp for the main garage and two 2.5v. lamps for lighting up the sign. (269)

# Complete lay-out and details for lighting, filling and name in A MODEL GARAGE

THE model garage shown in the photograph was designed for simplicity of construction. Apart from the use of a brace and bit for boring four  $\frac{1}{4}$  in. holes, the only tools used were a saw and a hammer and nails, yet the original model has already stood up to nearly twelve months' hard use.

The main garage is electrically lit and fitted with sliding doors. The sign GARAGE can also be lit up and is worked independently of the other lighting. The Office (the section with the sloping roof) houses the battery, and the miniature switches are mounted on its rear wall.

The two lots of garage space allow for the convenient storing of all the cars, pumps, road signs and telephone kiosk when the model is not in use. The walls are all made from  $\frac{1}{4}$  in. ply-board and the roofs from three-ply. The whole model is built in a series of units.

The base, 18ins. by 14ins. is also three-ply wood. This should be cut first and the edges smoothed down with glasspaper.

## The Main Garage

Cut out the walls and roofs of the main building to the measurements shown in Fig. 1 for Garage A. The L-shaped door guide is cut from a piece of wood 8ins. by  $\frac{1}{4}$  in. by  $\frac{1}{4}$  in. and is fixed behind the front panel (Fig. 2).

Screw a 2.5v. lamp holder to the underside of the roof and fix two lengths of insulated wire to its terminals. Bore a  $\frac{1}{4}$  in. hole in the wall adjacent to the office so the wires can pass through to the battery. Use ordinary bell wire or

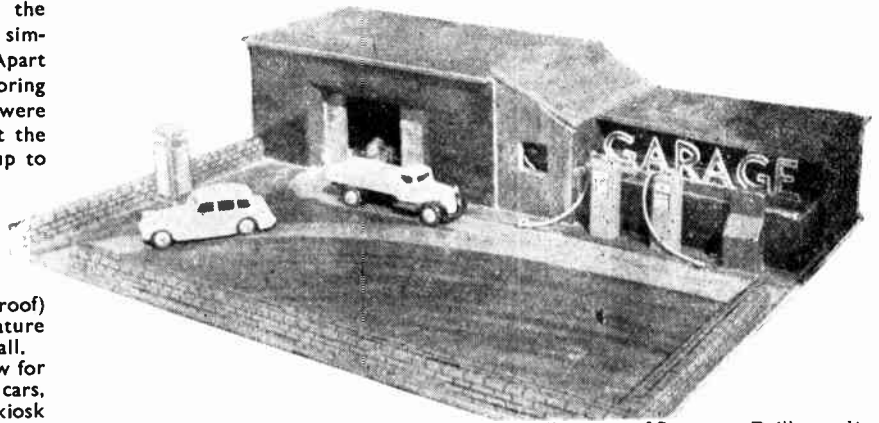

d.c.c. copper wire for all the lighting circuits.

The two sliding doors are made from three-ply and the top and bottom of each one must be well smoothed down to give a free sliding action.

Glue and nail the unit together. Place the complete garage into position on the base and mark along the bottom of the doors. This will give the position of the groove in the base into which the doors fit. Cut the groove 8ins. long.

Rub the glue brush along the base of the walls and fix the garage on the base by nailing from underneath.

## The Office

The office unit consists of three walls and the roof for which measurements are shown in Fig. 1. The square for the window is rebated on the inside to hold

a small square of Perspex. Drill two  $\frac{1}{4}$  in. holes in the rear wall through which the wires can pass to the switches, and one  $\frac{1}{4}$  in. hole next to the lamp house to admit the wires from the lamps underneath the sign. For details see plan of wiring in Fig. 3.

The roof is held in position by two small brass screws so that when necessary it can easily be removed. The complete office unit is glued and nailed to the base so that it fits snugly against the garage already in position.

The next unit to be fitted is Garage B (Fig. 1). This garage, too, can be fitted with electric light, and if this is desired,

(Continued foot of page 52)

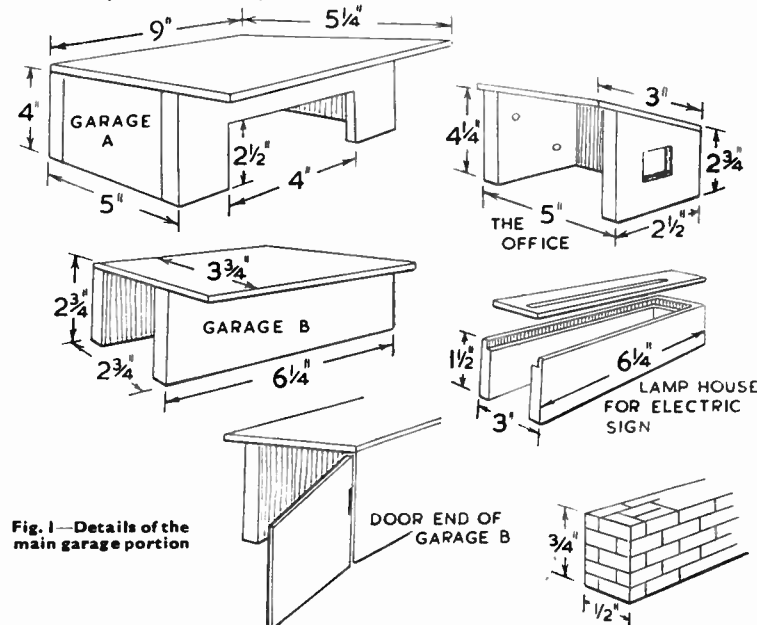

Fig. 1—Details of the main garage portion

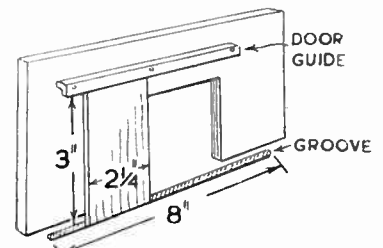

Fig. 2—Rear of front panel showing sliding door

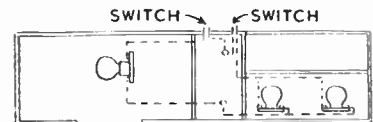

Fig. 3—A plan of the wiring



Fig. 4—Letters and plan of Perspex sign

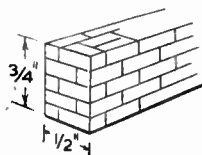

Fig. 6—The wall effect

# Easy to make and entertaining to play— THE MINI-SOCCER GAME

**H**ERE is an amusing game, guaranteed to keep all boys—and girls—from eight to eighty happily occupied for hours. The game can be played by either two or four players, and the rules are very simple. After practice, considerable skill is acquired, a fact you realise when you come up against a more experienced player than yourself. Mini-Soccer is very popular with the Swiss peasants, who carve out realistic and elaborate figures.

## The Playing Box

The materials used will depend largely on what you have on hand. Plywood is preferable for the men, while the 'field' may be constructed from ordinary wood of any convenient thickness. For the base a fairly large area of material is needed.



If you are not fortunate enough to possess a large sheet of wood, there are several ways of 'making do'. Besides joining pieces together, you have the choice of using pressed board, asbestos cement sheet, linoleum, or even cardboard. An idea is to convert an old table into a Mini-Soccer table, then you need not worry about a base.

The actual size of the table can vary considerably from the one described here, but the dimensions stated provide a convenient size of field. The sides are 4ft. long by 3ft. wide, and 6ins. high.

If you must economise in wood you can make them, say, 4ins. high, and drill the holes for the control spindles nearer to the top, but the full size is better as the ball is less likely to be kicked over the 'wall'.

In the long side pieces, drill holes of  $\frac{1}{2}$ in. diameter equally spaced, to take the  $\frac{1}{2}$ in. dowel rod used for the control spindles. The length of each spindle should be at least 5ft.

## Figure Shapes

Cut out the eight footballers,  $5\frac{1}{2}$ ins. tall, to the shape shown, using a fretsaw, and screw or nail them on to the spindles. The centres of the figures defending the goal should be 18ins. apart, and the attackers (those in the centre of the field) 12ins. apart.

Fix them about waist high, so their feet just clear the surface of the ground. The figures should remain upright when the control spindle is released. If they tend to turn somersaults you should glue on a piece of wood to weight the lower part.

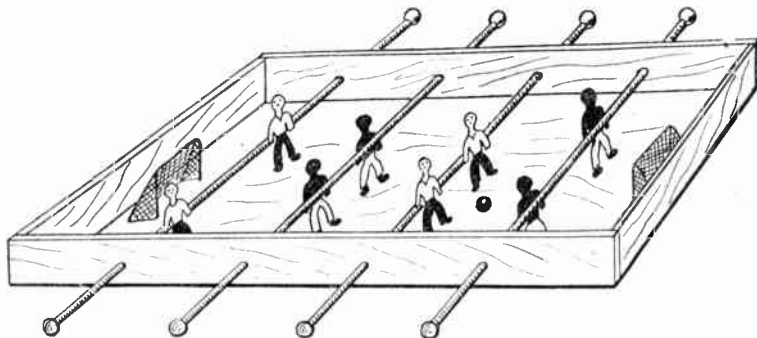

Paint the figures in, say, the colours of two local rival teams: it makes the game even more lively. Notice that the two opposing teams occupy alternate spindles. That is, starting from A team's goal, you have first A's defenders, then B team's attackers facing A's goal. Next, facing B's goal is A's attacking force, then comes B's defence line, defending their own goal. The illustration makes this clear.

The side pieces should be joined preferably by dovetail joints, but no doubt many constructors will rely on nails. Extra strength will be obtained by using an iron angle piece on the inside of each corner.

Cut the base to size, and nail this on to the frame. For ease of control of the spindles during play, you should screw small door knobs on to the ends of the spindles. Make the goals from pieces of stout wire, bent to shape, fixing them to the base by drilling two small holes for each goal.

Alternatively, construct the goals from strips of wood. Make the goalmouth about 5ins. wide, and place it 4ins. from the rear. Pieces of muslin will serve as a net, thin wire supports being used. Attach the muslin with cotton thread.

## The Ball

For a football, use either a marble or a ping-pong ball, and that is the Mini-Soccer game complete, except for the M.S.A. rules. The idea of the game is for the attackers to get the ball past the defence and into the opponents' net. The players are not allowed to kick backwards, as this is a foul, with a free kick for the other side. Play is started by dropping the ball in the centre of the field. When a goal is scored, or the ball gets kicked off the field, the ball is bounced again in the centre.

The duration of the game should be arranged beforehand, or a goal limit fixed—the first to score, say, ten goals wins the game. (219)



same style as the main house. Notice, too, the addition of the fancy pots of shrubs adorning the front. The whole work of construction occupied pleasant evenings for only 3 months but will undoubtedly provide fun and interest for the little lady for several happy years.

## An Extended Model

Showing how the ingenuity of a reader, H. A. Brown of Patcham, Brighton, altered our Tudor Doll's House Design (No. 237 Special) to make an even more attractive model for the use of his daughter. As you see by the interior picture he added two extra rooms, a staircase and outside, a garage in the

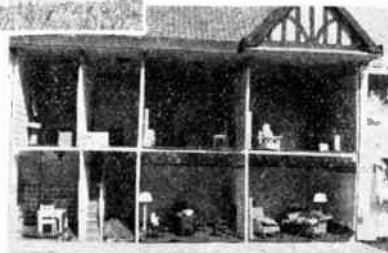

# Wooden hull, lamp and boiler make a small model JET-PROPELLED BOAT

**T**HIS is an interesting little model vessel which is sent along through the water by the reaction set up by a steam jet located at the stern. It is not very ornately finished but as an experimental craft and one that demonstrates very clearly travel by 'reactive agency' it can give quite a lot of scientific amusement.

The parts are shown in Fig. 2. One thing needed is the small tin (A) with a fairly tightly fitting and well overlapping lid. Around this a strip of tin (a) is taken as indicated. This is of such a length that when the ends are turned out to a right-angle they are just a little distance apart.

A hole is drilled in each of these lips through which a small bolt is passed.

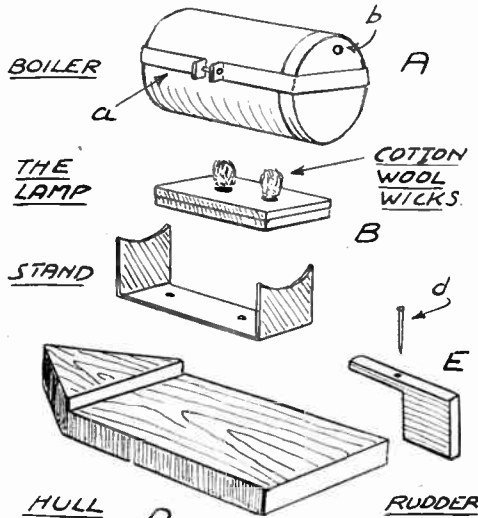

Fig. 2—Detail of the various parts

The purpose of this strip is to keep the lid firmly in position, though with many tins the original tightness of the lid is sufficient without further aid. However, it is better to be on the safe side. This tin constitutes the boiler and it is completed by drilling the small hole (b) in the lid near its outer edge.

## The Lamp

Now comes the lamp (B). For this is required one of those vest-pocket tins which chemists often sell for throat pellets. These tins are extremely shallow, but fairly long and broad. Two holes are punched in the lid of this tin and a wad of cotton wool is placed in the lower part with a tuft coming through each hole.

To charge, the lid is raised slightly and methylated spirits is poured in on to the wad—as much as possible being put in. This soaks up through to the tufts which when lighted burn like the wicks of an ordinary oil lamp. The burning

goes on as long as there is methylated spirit in the tin, the flame given being very hot but smokeless—which is just what is wanted.

Next make the support (C). This is cut from a single length of tin, the ends being curved out as shown. The cutting of the curves is done while the length is still flat and when this has been carried out each end is turned up at a right-angle thus making a frame to hold the boiler. The exact amount

of tin turned up depends on the depth of the tin being used for the lamp, but the boiler can be made to sit quite tightly down on the cotton wool wicks—in fact the nearer without stopping actual burning the better it is.

## Making the Hull

Lastly we come to the hull (D) and rudder (E). The hull is a flat piece of wood of sufficient size to comfortably support the boiler and lamp (the boiler being half full of water) without fear of capsizing or the weight causing too much list. On the other hand do not make the hull too large.

To make for easy progress through the water and for the sake of appearance the bow is cut to a point and a raised deck is put in front. This later can be an extra triangle added or the original piece can be shaped this way. A small mask in the bows, too, adds to the general impression of a boat of some sort.

The rudder (E) is cut from a single

piece of wood to the shape shown its width being rather generous as a pin (d) has to go down through the top bar.

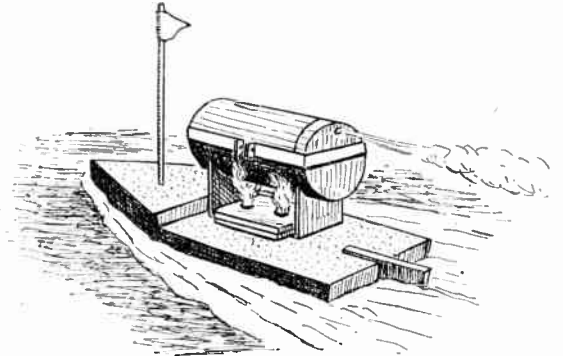

Everything ready now let us assemble the parts. The support (C) has two holes made in it and it is fixed centrally on the hull with small screws. Upon this, after filling with boiling water, to about the halfway line, lay the boiler. It is not attached but will sit firmly if the curved cuts have been truly made. Under this put the lamp, light the wicks and finally attach the rudder with the short pin (d). Push this well down so that the rudder fits stiffly and will stay in any position that it is set.

## Operating Hints

Incidentally, when filling the boiler the bolt holding the strap (a) is loosened when the strap slips easily off. When the boiler has been filled it is just as easily replaced and a turn of the bolt with a small screwdriver makes all tight. Also note that the hole (b) must come at the top of the end.

While putting on the boiler the water will have lost heat a little, but the spirit lamp soon raises the temperature again and shortly a jet of steam will be coming from the hole in ever-increasing velocity, and as the jet gets really fast our craft, which now should be afloat, begins to move forward—a perfect example of jet propulsion travel.

## Aquarium Cement

*I AM going to glaze an aquarium; would you kindly let me know what cement or composition to use? (W.B.—New Silks-worth).*

**T**O make the joins of aquarium watertight, use a cement made as follows:—

- 2ozs. of well-sifted sand
- 2ozs. of plaster of paris
- 2ozs. of litharge
- 1oz. crushed resin

Add sufficient linseed oil and a spoonful or two of driers, to enable the ingredients to be worked to the consistency of putty. Use as soon as mixed,

and allow ten to fourteen days for the joins to harden.

## Repointing Brickwork

*I WISH to point up the outside brickwork of my house. What should I use, and can anything be added to make the mixture waterproof? (B.C.H.—Leicester).*

**F**OR repointing, you can use a cement of three parts sand to one part cement, and when set, apply a coat of Grangers Solution over it. The same could be applied to the walls, inside and out. Inside, let the damp dry out as far as possible, then plaster up in the ordinary way.



# The SHIPMODELLER'S Corner



## HISTORICAL NOTES ABOUT

### Tudor Flags

AS far as present knowledge extends, the Cross of St. George first became the English National Flag toward the end of the 13th Century; it remained the National flag until the union with Scotland under James VI.

The Royal Banner although it was in a sense a National Flag, was the personal banner of the sovereign, and it should not be flown by a subject without authorisation; towards the end of the reign of Elizabeth it became confined to the Admiral of the Fleet as far as naval usage was concerned.

In early accounts appear banners and streamers primed and painted in oil colours.

Until the death of Elizabeth the banner known as the Royal Standard consisted of the quartering of the arms of France (3 fleurs-de-lis on azure blue) with the arms of England (3 rampant lions on red).

See diagram 1 below and note shape of Standard. I have seen them on

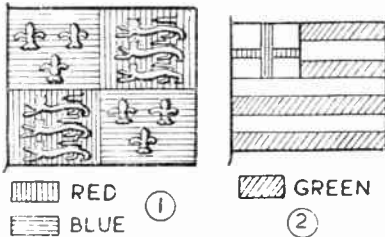

models where they have been out of proportion in length to depth.

The earliest orders known directing the Lord High Admiral to fly the Royal Standard at the masthead are dated 1545 and this instructs that he shall fly the Royal Standard at the main top and the flag of St. George at the foretop.

It was also flown by other high officers when commanding a fleet.

Customary at the time was also the flying of a banner bearing the personal arms of the owner's or commander, sometimes the arms of the port to which they belonged.

As an example of the size and shape of Royal Standards the naval accounts of 1574 list four standards with the Royal Arms measuring 15ft. by 13ft. 6ins., of fine linen cloth and fringed; average size would be about 12ft. by 7½ft. deep.

Streamers varied from 36ft. to 84ft. long and from 9ft. to 6ft. broad at the head.

Elizabeth ensigns were striped in colours with a white upper canton bearing the cross of St. George. This canton consists of the top quarter of the flag next the staff, see diagram 2. These ensigns were flown on the poop deck.

## OUR NEW FEATURE

Already readers are writing their interest and delight in this regular series of notes now appearing exclusively in 'Hobbies Weekly.' Specially written by 'Whipstaff' who will be pleased also to answer any individual problems which the reader may have.

These short notes are by no means exhaustive and modellers in difficulty about the right flags for their model are invited to write in for any information they require.

Flags of individual 'Hobbies' models will be dealt with fully at a later date, when the building of each model will be dealt with in separate articles.

## RESEARCH OF THE ROMAN SHIP

### 'Naumachia'

OF those modellers who find interest in the ships of the Ancient World such as 'Hobbies' past designs of an Egyptian Galley and Roman Ship, I wonder how many have heard of the Roman 'Naumachia'?

With every school boy I had read and heard of the Roman Arena where the spectacle of Gladiators fighting to the death was one of the high spots of Roman entertainment, but until I came across details during some of my researches, in common with them, I did not know that this idea of entertainment was extended by the Romans to maritime and naval affairs.

The 'Naumachia' consisted of a large reservoir or lake excavated in the ground and measured some 1,800ft. by 1,200ft. wide.

This expanse of water was surrounded by seats in the form of an amphitheatre and provided entertain-

ment in the form of spectacular naval battles.

In this arena there was room enough to stage a battle in which some 30 large fighting vessels and many smaller ones could take part, as many sometimes as 3,000 fighting men were engaged, apart from the large number of rowers necessary to the galleys.

What a model this would make! Who will be the first model enthusiast to make the research and complete such a piece of modelling?

## CONSTRUCTIONAL NOTES ON Gallery Brackets

IN the making of period models it is often necessary to make numbers of small brackets exactly alike, mostly for fitting underneath stern galleries, etc.

Cutting these singly by fretsaw is not only tedious, but very often it is difficult to avoid slight differences in individual brackets.

In my present model of a Stuart warship I required 26 for the stern galleries alone and to speed up the work while getting all exactly alike I adopted the following mass production method.

The required brackets being as in sketch 1, I cut a piece of walnut 5ins. by ¾in. by ¼in. and marked the upper surface as in diagram 2.

Cutting along these lines I made a piece of moulding the exact shape of the brackets required, it simply remained to cut off each bracket ¼in. thick with a jeweller's small hacksaw, after rounding upper and lower edge with sandpaper.

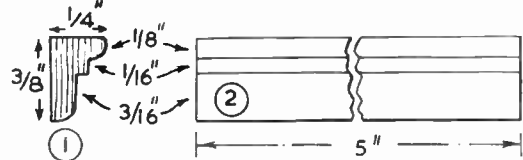

CUT 1ST LINE TO 1/8" DEEP  
AND 2ND LINE TO 3/16" DEEP

To facilitate this work I made a small cutting box which can be used for many such jobs.

Many other parts can be made in this manner where many duplicates are required.

The above measurements are only an example and must be adjusted to measurements required by your model.



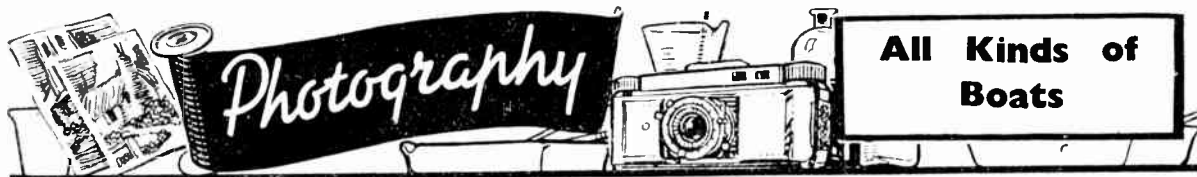

**T**HE subject selected for this month's photographic article is 'Ships' and surely it is one that will appeal to every reader, whether he has a camera and is anxious to find another field for its use, or, even if he is not the least bit interested in the hobby of photography. It does not matter what your age may be, for young and old find pleasure and fascination in watching a boat pushing its way through the water.

It may be only a toy yacht on the pond in the local park, a barge on the canal, a pleasure steamer visiting the pier at a seaside resort, or, best of all, a majestic liner arriving at the landing stage, or a battleship anchored off shore.

What is there about ships that has such an intense appeal that we are quite willing to forget all else on purpose to spend a few minutes watching the movements or to note how fast they go or how quickly they will get away from their moorings, etc.?

#### London Bridges

Ever since the writer can remember he has had the urge to spend time hanging over one of the London bridges watching the fussy little tugs plugging along with smoke pouring out of their funnels. Perhaps with a line of barges at their sterns. And, if he happened to go across the Tower bridge, then it was a real heyday! Both sides of the bridge received attention and much time was spent trying to conjure up in imagination where those cargo boats had come from or were going to, what sort of goods they carried, and how long each trip

the famous Saltash Bridge on the old Great Western Railway.

The train the writer was in was just passing over the bridge and by hanging out of the window he waited until he could see not only the boats, but also the sweep of the bridge in the viewfinder. It was a 'potshot', but what a thrill when on developing the negative it proved to be a real good one.

#### Liners Berthing

On another occasion on the landing stage at Liverpool it was his good luck to see the liner Aquitania being berthed.

just London side of the Tower Bridge and off the Tower wharf. That gave him the opportunity of exposing two or three films before the boat started on the trip.

From start to finish the excursion took about three hours and all that time he was kept busy clicking the camera on large and small craft, liners, barges, Thames Hoys, historic buildings and places, police boats that are always on the alert for catching smugglers and others whose occupation is not altogether legal, L.C.C. pleasure steamers or River Buses as they are sometimes termed.



An avenue of big ships in King George V Dock

Yes, the camera was ready and some good records of that giant being guided by those comparatively miniature craft—the tugs—were made.

Well lots of water has found its way under the bridges since and it has been his good fortune to spend many happy hours with the camera in places where the ships that sail the seven seas come and go. But it is very doubtful whether

In fact there was an endless variety of subject which, to a photographer, is known and recognised under the heading of Marine Subject. The climax was reached when the launch turned into the Royal Docks; and, perhaps, you will remember this month was just when that very bad dock strike was on. In consequence, every dock was just chockful of liners and large cargo vessels.

#### A Dock Full

One of the illustrations here shows the King George Vth dock, which was just one long avenue of some of our biggest ships. Never before had so many been in the dock; it was so full that some had to anchor outside in the river. There were ships from practically every quarter of the globe and representing many millions of money value and tonnage. What an opportunity for one's imagination to wander, and what an extraordinary and unprecedented experience for a keen photographer.

Well, the camera did some good work that afternoon but, unfortunately, some really good pictures were lost because soon after entering these docks, a terrific thunderstorm occurred and lasted till we were well out in the river again and on our way back. Despite this, however, it was a trip that was well worth while and one that should not be missed if an opportunity arises.

The reason for describing some experiences fairly fully is that it is possible that many readers may be living or staying in the neighbourhood of one of our,

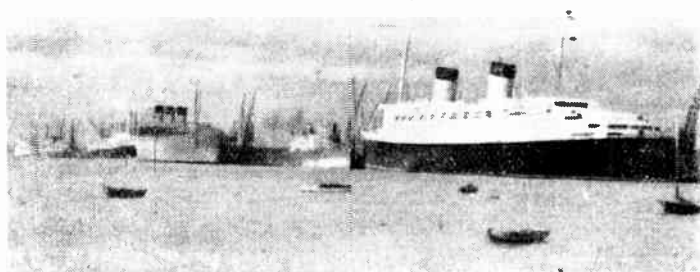

The Queens—Mary and Elizabeth—at Southampton

took and did they encounter some very heavy gales, etc. etc.?

Later on when a camera became a proud possession the urge became stronger than ever and many a plate was exposed from the wharves or bridges and other suitable places where ships could be found and 'shot'.

The mention of suitable places calls to mind the taking of a photograph of some submarines lying at anchor just under

any experience will equal the thrill that came in July, 1949.

#### An Unique Opportunity

An invitation was received to join a party visiting the London Docks by the Port of London motor launch. Needless to say, it was accepted without any hesitation and with a camera re-loaded, and a couple of spare spools in his pocket, the writer reached the launch

let us term them, commercial waterways, such as the Thames, Mersey, Clyde, the Bristol Channel or the Humber. Should the opportunity present itself for a similar excursion, by all means take advantage of it and give your camera a chance.

#### Suitable Film

Have a good reliable brand of fast film such as Ilford H.P.3, and remember you are not only exposing on moving objects at times but you are on a moving boat where there is possibly a certain amount of vibration constantly going on. There-



fore fast exposure time is necessary and a large stop required.

If it is not possible to make such an excursion by boat there may be many places along the riverside where excellent positions can be taken for securing some really good pictorial scenes of boats. At the same time, you might be favoured with some characteristic backgrounds, such as wharves with cranes or derricks. Not forgetting the W. W. Jacob type of landshoremans who are often to be seen at some of these bankside waterfronts. Or possibly a quaint old inn much frequented by the men that go down to the sea in ships.

In some of these out-of-the-way places an old barge or the hull of a small sailing craft no longer seaworthy, has been left unowned and just waiting till it falls to pieces and its last tide comes in to remove all traces of what was, perhaps, in its day something really worth looking at.

What about sailing boats? Unfortunately our old harbours like St. Ives, Brixham, Whitby and the many others around our coasts cannot now offer us pictures of Fishing Boats in full

sail. Motors have supplanted those delightful red, brown and sometimes white sheets which so fascinated holiday visitors and particularly those with cameras. It is, we must presume, another indication of the march of progress and, therefore, we are forced to turn our attention from that hardy and rugged type of sailing boat to the more gentle and graceful lines and build of yachts.

#### Sailing Boats

Yachting and sailing is a popular hobby wherever there is a sufficient stretch of water to justify its pursuit. Fortunately such conditions prevail at most seaside holiday resorts and at many places on our principal rivers. Most certainly we must include those picturesque and well kept expanses of water known as the Norfolk Broads, with numerous narrow channels opening out into the wider Wroxham, Walsham, Ranworth, Hickling or any of the other Broads.

The writer was recently staying on the Norfolk coast—an easy run to Wroxham where a party was made for a motor launch trip. The weather was just right for photography; soft sunshine with numerous white fluffy clouds and a couple of spools of a very good brand of fast film. Quite a good number of yachts of varying sizes were passing or being passed, and when tacking they offered a 'broadside' view of themselves which is always a good position for a photograph.

#### On the Clyde

There is a good deal of the 'natural' about the banks and this, combined with the many varieties of trees and other growth, gives good backgrounds. The rippling water in the foreground, and lovely clouds to prevent bald-heads, make the neighbourhood a perfect paradise for the photographer. In a matter of two to three hours a camera can shoot a couple of dozen exposures, the negatives of which are very pleasing.

Another very good spot for sailing boats is the Clyde and here a word or two must be mentioned about pleasure steamers. Every photographer who has spent a holiday in this part of Scotland will agree, that the steamers and the trips on the Clyde and in and around the Lochs are some of the best around our

coast. The boats are well appointed and the trips are selected to cover some of the most beautiful scenery. This district simply teems with beauty, therefore, it is ideal for camera work.

Sometimes the views are so extensive and beautiful as to influence one's better judgment on the question whether to take or not to take. But as the light is often so good it is possible to expose successfully and to secure those mountains as a background, although they are anything from five to ten miles away.

#### Canal Barges

Well, we have dealt with liners, cargo and other big boats and with yachts and sailing craft. Now a few words about the humble barge. Generally speaking we are inclined to think of canals as the waterways where these are to be found and, therefore, the surroundings are hardly what could be termed pictorial. But it is a mistake to think of a canal as a muddy stream running through a town or thickly populated district.

What about the countryside it traverses and what about those quaint little bridges and the lock-keepers cottages and the barge passing through the lock gates? One canal in Wales passes through some beautiful scenery where several pictorial records are obtainable during a short stay.

#### Stiff Tin Lid

OFTEN when one wants to open a tin one finds it difficult to get the lid off. An easy way to remedy this, is to place the tin on its side, on the ground, and roll it backwards and forwards several times with the foot pressing fairly hard. The lid will then be found to slip off quite easily.

It is always worth while to take a tramp by the side of a canal and hope that you will be favoured with the coming into the picture of a well decorated barge complete with the Skipper and his or her family on board, a spot of washing hanging out, and the old horse that has towed the barge for many years is on the bank with one of the youngsters on its back.

Yes, there are some good subjects for the camera to be found by the canal. It may be a line of hopeful anglers on a Saturday afternoon, or a group of young urchins sitting on the bank waiting and watching—for what?

#### An Abacus—(Continued from page 59)

for this article, and it will be understood that any thickness can be used if the mortises and tenons are cut to suit. The width of 9ins. just allows the sides to be cut from a single board, a piece 2ft. 6ins. long being enough with an extra 1ft. for the cross-bars.

The fretwood for strips (C) is just a

2in. wide strip, 1ft. 2ins. long, or if fretwood is not available, strips of  $\frac{3}{4}$ in. or  $\frac{1}{2}$ in. deal could be used just as well, but to keep the distance for the balls to travel the same, the cross-bars should be increased proportionately in length.

Most hardwood stores could supply the stout gauge wire needed, about 10ft.

being required. It would be as well to take a sample ball to test the wire for the right gauge to pass the balls. Readers who may prefer to buy the set of balls ready-made, can obtain the name and address of the firm supplying, on application to the Editor.

# As a gift for a youngster you should try MAKING AN ABACUS

**T**HE abacus or counting frame is one of the oldest aids to instruction known. Something of the kind was in use by the ancient Greeks and Egyptians, and it has not materially altered in its essentials through the ages. It is well worth making nowadays, as an aid to teaching youngsters to add and subtract, and interest them at the same time.

It is of simple construction. The necessary parts of the frame are shown in Fig. 1, and can be made from any available wood, a convenient thickness being  $\frac{1}{2}$  in. The sides (A) can be drawn out direct to the wood, being simple triangles.

## Marking the Sides

The best method is to draw the base line across the wood, then to erect a centre line to the length given and join the tip to the ends of the base line. At spots,  $\frac{1}{2}$  in. in from bottom and rear edge, cut the three mortises shown, making them  $\frac{1}{2}$  in. square.

Three cross-bars will be needed, shown at (B). Cut these to the length given, plus extra at each end for the tenons, these being  $\frac{1}{2}$  in. square to fit the mortises, and  $\frac{1}{2}$  in. long or more if the wood for the sides exceeds the  $\frac{1}{2}$  in. mentioned. To hold the wires on which the counting balls move, two strips of  $\frac{1}{4}$  in. wood will be needed, cut to size given at (C), and fixed with screws to the inside surface of the sides.

## Wire Holes

Round the ends of these, run a pencil line down their centres and on this mark off the places where the holes for the wires are to be drilled. These are spaced  $1\frac{1}{4}$  ins. apart, and start and finish  $1\frac{3}{8}$  ins. from each end. Fix these to the sides, where shown in the detail sketch, Fig. 2, with a round-headed screw at top and bottom, after the holes for the wires have been drilled, of course.

The holes should suit the wires,

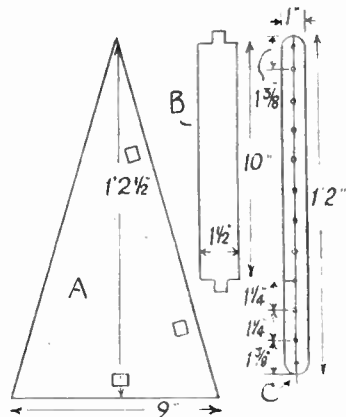

Fig. 1—Framework details

naturally, and the wires should be stout enough not to bend when the balls are pushed along. Wire about  $\frac{1}{16}$  in. thick, would suit well enough, and should be cut into 10 in. lengths and be carefully straightened out.

## Cross-bars

The cross-bars can now be glued between the sides of the frame, and left for awhile for the glue to set. When hard enough, the sharp corners of the sides should be rounded off to conform to the curved ends of strips (C). The wood should then be well glass-papered, and the whole frame painted, preferably a nice attractive colour.

The wires should now be tested for fit between the sides. Remove the top screw holding strips (C) in position, then swing the strips out. The wires can now be inserted, then if all are correct in length, strips (C) can be pushed back to their former position, but do not rescrew them until the balls have been made and strung on.

## The Beads

For the balls, 100 of which are required, readers who own a lathe can turn them to the size given at (D), drilling them through the centres  $\frac{1}{16}$  in. or to suit the gauge of wires used. Where no lathe is available readers can purchase the balls ready-made (really the best idea) or make up the number from  $\frac{1}{16}$  in. round wood rod, cut into  $\frac{1}{16}$  in. thick discs, and bored  $\frac{1}{16}$  in. like the balls.

If the latter method is decided on, a jig of the pattern shown at (E) in Fig. 3, will considerably expedite the job of cutting the rod into pieces. It is practically self-explanatory, this jig, being made of the right size to admit the wood rod in, and having saw guides cut across at  $\frac{1}{16}$  in. from the end.

The holes must be bored truly central, and to better ensure this a simple gauge, as at (F), should be made. It is a

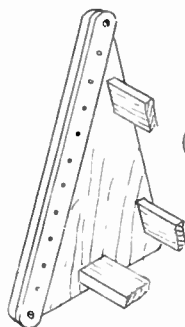

Fig. 2—Side construction

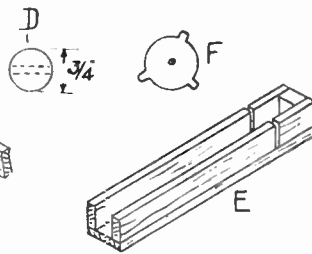
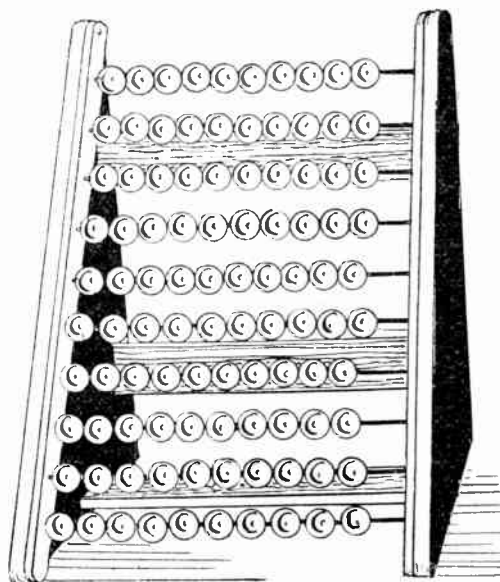

Fig. 3—A cutting jig



$\frac{1}{16}$  in. circle of tin, with 3 tabs left round, the tabs being bent over at right angles, and a small hole punched through the exact centre of the circle. In use, the discs from the rod have the gauge fitted on top, then an awl is pushed through the centre hole.

This leaves a definite mark for the point of the drill bit to enter, and if the drill is kept upright each hole should be as central as matters. The finished balls can be left plain, but look much better if brightly coloured.

## Colouring

It might be considered too much of a job to enamel each ball separately, though that makes the best and most attractive finish, but a reasonably good finish would be to make up a small dish of spirit stain, red, blue, etc., and dip the balls in it. They could be strung on wires, too, and a number dipped at one go.

Any of the aniline dyes would do for the work, but those soluble in spirit are much to be preferred to the water soluble ones. When dry, the balls, still on the wires, could be varnished with a small brush and some quick drying clear varnish, and stood on end until the varnish dries.

The balls should then be drawn off the wires, and the wires carefully cleaned of all traces of varnish. They are then pushed through the strips (C), the balls being threaded on in the process, and then the strips can be rescrewed in position to complete the job.

There is not much wood wanted

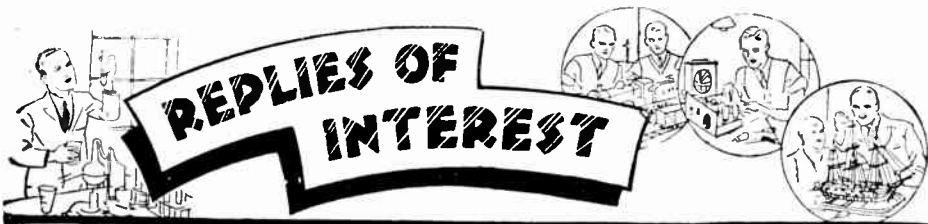

A selection from replies to readers' letters which we receive on electrical and radio matters.

### Lathe Motor Speeds

I AM using a  $\frac{1}{2}$  h.p. motor with a wood-turning lathe, but am unable to gear it to more than one speed (2,000 revs.). I find this speed is too fast for my requirements, but see only one way of varying the speed; by means of a rheostat. Is this possible, and if so, what type? (D.P.—Southampton).

UNFORTUNATELY reducing the speed of the motor by means of a rheostat will considerably reduce the power provided by the motor. As a result, the lathe speed will be high when no work is being done, dropping severely, even to a standstill, when cutting is in progress. Because of this, the only practical method for normal work is to use additional reduction gearing between motor and lathe, allowing the former to run at full speed. This may present constructional difficulties, but it should be possible to obtain suitable wheels, possibly for use with a V-belt, and with these a suitable arrangement could be made up. Local garages and scrap yards will probably have suitable items.

### Model Motor Drive

I HAVE been trying vainly for some time, to construct an electric motor that would drive models. They just stopped when I tried to connect them up with anything. (I.T.—Crumlin).

IF the motor stops when required to drive a model, the lack of power is probably due to your having wound the armature with too thin wire. For the armature, use 24 or 26 S.W.G. insulated wire, for 4-6 volt supply, with 22 or 24 S.W.G. wire for the field (fixed) magnet, unless a permanent magnet is used here. Wind on as many turns as can be accommodated. Ensure that the commutator is in the best position by turning it a little each way to obtain best results, if necessary. All electric motors should be allowed to run at good speed, and this means with most models a good deal of reduction, provided with light belts or gearing, should be between motor and model, or the motor will be unable to run at full speed and thus develop the power of which it is capable.

### A Suppressor

PLEASE tell me how to make a suppressor for my electric motor, as when it is working, interference is caused in the wireless. (R.S.H.—Welling).

THE usual and most effective interference suppressor consists of two chokes, one in series with each mains lead, with two condensers of about .5 mfd. each from each motor lead to the

earth plug on the mains socket. The chokes must be capable of carrying the current required, and this will depend on the size of the motor. If interference is not too bad, the trouble may be cured by using the condensers only, one from each mains lead to the power-plug earth point. If necessary, it may also prove of advantage to wire similar

condensers from each motor brush to the metal casing, which should also be earthed to the power-plug (large pin). A 2 mfd. condenser in series with the motor is not usual, and possibly you have mistaken connections here. It would not appear to perform any useful purpose in suppressing interference.

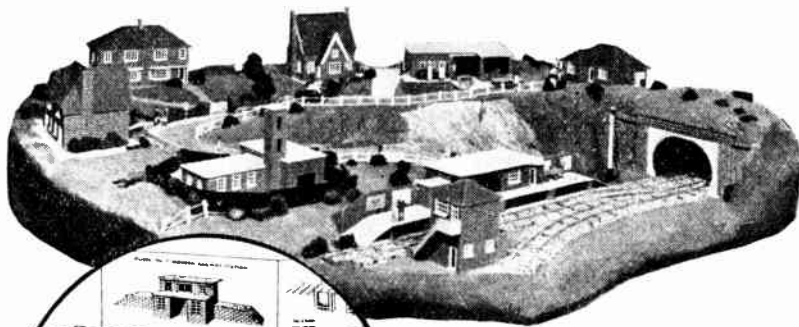

Build this Realistic Model Village with

**BRICKPLAYER**  
Bricks and Mortar Building Kit and Accessories

### ENTER FOR THE BRICKPLAYER COMPETITION

Prizes of £10 10s., £5 5s., and £3 3s. and a number of consolation prizes of Brickplayer Accessories will be awarded for winning models.

Write for full details.

The Brickplayer Kit contains miniature bricks in all required shapes, mortar, roofing, metal windows and doors, plans and instruction booklet. All models are architect designed to 'O' gauge scale. Buildings can be permanent or dismantled by merely soaking in water, and the bricks used again and again. Brickplayer Kits at 25/- and 47/6 and Accessories are available from good toyshops and stores.

If your dealer cannot supply, write for address of nearest stockist to:

**J. W. SPEAR & SONS LTD.**  
Dept. "H", Enfield, Middlesex

**YOUR IDEAL CHRISTMAS GIFT**

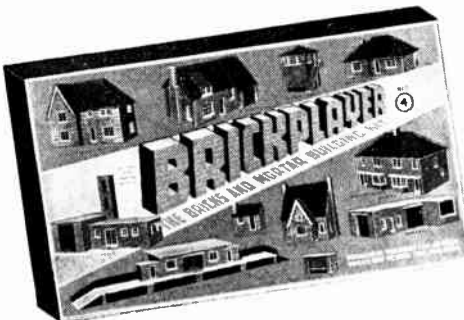

# Some simple exercises in the second step in WOODTURNING

**A** FEW words about timber may not be out of place at this stage. Not every wood is suitable for turning. A straight grained, evenly textured timber gives the best results, and for this reason the softwoods such as spruce and deal are likely to prove disappointing in use. Beech, birch, oak, ash and walnut, on the other hand, are admirable turnery timbers.

One easy and cheap way of building up a stock of suitable wood is to get in a supply of beech firewood logs. These should be kept under cover for some months and allowed to dry out thoroughly, after which they can be cut up into suitable lengths for working. Candlesticks, lamp-shades, tool handles and numerous other items can be turned up from these firewood logs if selected pieces are well seasoned, but for practice any odd lengths of hardwood will suffice.

## Centring

Before turning can be started, a piece of wood must be 'centred' between the head and tailstock. For practice a piece of wood 12ins. long by 2ins. square can be taken, and the centre point marked in each end-grain with a Bradawl. Take off the long edges of the wood to make it

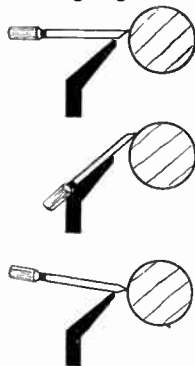

Fig. 1—Tool angles

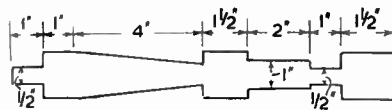

Fig. 2—Marking out the work

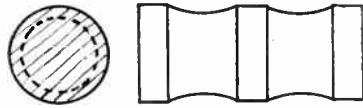

Fig. 4—End and side view of finished work

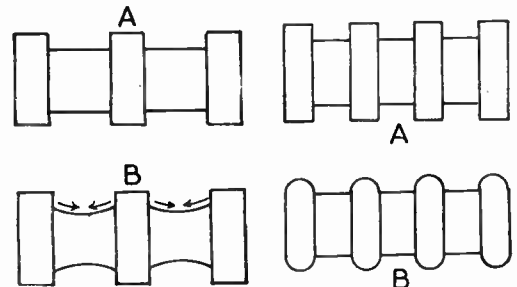

Fig. 3—How the cylinder is processed

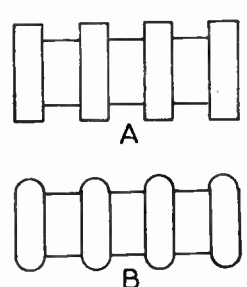

Fig. 5—Another useful exercise

roughly octagonal in shape, then place it between the lathe centres (putting the latter in the Bradawl holes) and screw up the tailstock so the wood is firmly held.

The tool-rest must then be adjusted midway between the centres, about  $\frac{1}{2}$ in. away from the wood, and with the top edge of the rest just above the lathe centres.

Preliminary roughing down is done with the gouge. The wood must be kept turning at a good speed, then the gouge is taken in the right hand, is laid back downwards on the tool rest (right hand below the latter) and is held firmly by the left hand on the blade. The tool is then moved slowly from left to right to take off a long shaving, the process being continued as often as

necessary until the wood is approximately cylindrical.

The wood is then turned to its finished cylindrical shape with the chisel. This tool is handled in much the same way as the gouge, but makes use of the centre of the cutting edge to take off a finer shaving than is possible with the half-rounded tool. The smoothing must be continued until the diameter of the cylinder (measured with the callipers) is about  $1\frac{1}{2}$ ins.

## Scraper for Smoothness

It sometimes happens that the texture of the wood is such that it is impossible to get a good smooth surface. If this is so, the scraper must be used. This tool must also be held in both hands, but its edge is horizontal to the turning cylinder.

To mark lines that are to be chiselled down where the diameter of the cylinder is to be reduced, a rule can be laid along the tool-rest and a pencil point held against the revolving wood. As necessary, the parting tool is used to cut down these lines, and the waste wood between them is taken out with a chisel. The parting tool is held at a slightly different angle than is the scraper, the right hand being lifted a little. Fig. 1 shows (from the top downwards) the relative positions of the tool rest, the wood being turned, and the scraper, chisel (or gouge) and parting tool.

## A First Experiment

For the first experiment in wood turning the 12ins. by  $1\frac{1}{2}$ ins. cylinder can be shaped up to the dimensions shown in Fig. 2, using the parting tool and chisel. Every care should be taken to get the measurements exact. Constant tests with the callipers will be necessary, and although it is possible for the skilled worker to use these on the revolving wood, the beginner is advised to stop the lathe before making such tests.

Having practised two or three similar shapings, a start can be made in working hollows. The process is much the same as before.

The wood is first reduced to cylindrical form, the sides are cut in to a depth of  $\frac{1}{2}$ in. and the waste wood taken

out with a chisel (Fig. 3a). A gouge is used for the remainder of the hollowing, working from the outside to the centre alternately from left to right of the hollow. The direction of the shaping cuts is shown by the arrows on Fig. 3b. The gouge must not be allowed to go too deep with any cut.

A third exercise could be done on the making of shallow hollows. With these the parting tool is not used at all, the gouge alone doing all the hollowing. The finished appearance will be as at Fig. 4.

For the fourth exercise, reduce a piece of wood to  $1\frac{1}{2}$ ins. diameter, and cut  $\frac{1}{2}$ in. wide slots  $\frac{1}{2}$ in. deep at distances of  $\frac{1}{2}$ in. apart. Then, with the chisel, work over the edges of the projecting portions to get the half-round shapings shown at Fig. 5b.

Complete the preliminary exercises by making a combination of the last two types of turnery to produce the shaping shown at Fig. 6.

## Use of Glasspaper

All practice turnings should be thoroughly glasspapered. For ordinary cylinders the glasspaper can be held in the palm of the hand and the wood allowed to revolve inside it. For inside edges the glasspaper can either be folded and held against the wood, or can be wrapped round a pencil or something similar. Obviously, the lathe will

be rotated as the glasspapering is being done, and varying grades of paper will be used, finishing with a fine-cutting quality.

Try your hand at these various shapes before you begin work on an actual subject. Treading and tool control become easier with practice and experience.

In the next (and final) article of this series, working instructions will be given for the making of some small but useful turned items, and mention will also be made of face-plate turning. (262)

(To be Continued)

# MISCELLANEOUS ADVERTISEMENTS

**SOUTH Africa Set, 10 free.** Stamp approvals.—Ashmount House, Marshfield Road, Goole, Yorks.

**I**f you have nothing to occupy your leisure, why not try something interesting and profitable? Experience is not required in leathercraft. Send large S.A.E. for our brochure, free of obligation.—Leathaweave (Dist. 37), 3 East St., Leicester.

**STAMPS**—world mixed, 1/- a 100; S5/- a 1,000. Gift voucher free.—Selby, 66 Donnington Road, London, N.W.10.

**INTRODUCTIONS.** Pen friends, companionship or marriage.—V.C.C., 34 Honeywell Road, London, S.W.11.

**STAMPS FREE!!** Twenty unused S(2½d.).—G. H. Barnett, Limington, Somerset.

**PENNY** Black and Sir Rowland Hill on stamp of Cuba, absolutely free. Request approvals.—Hubert Rajski, 211a Thornes Road, Wakefield.

**EMPIRE** stamps—200 different, 4/- 10 Victory, 9d. Free pictorials with approvals.—Robert J. Peck, 7A Kemp Road, Bournemouth, Hants.

**SAVE** pounds. Sole your shoes in five minutes. Self-stick leather soles, no nails, no glue. 2/- pair.—Butterfield, Powell Road, Bingley, Yorks.

**5x5** SNAP enlargements, 6d. Films developed, 6d. Return service.—Bailey, 72 Marshfield Road, Goole, Yorks.

**BE** Taller. Quickly! Safely! Privately! No appliances—no tablets—no dieting. Details, 6d. stamp.—Malcolm Ross, Height Specialist, BCM/HYTE, London, W.C.1.

**MODELS.** You can make lasting stone-hard models with Sankey's Pyruma Plastic Cement. Supplied in tins by Ironmongers, Hardwaremen and Builders' Merchants. Ask for instruction leaflet.

**TRANSFERS** for decorating toys, trays, furniture, fancy goods. List and samples free. Flowers, pixies, dogs, nursery rhymes.—H. Axon Harrison, Jersey.

**PRESSED** Metal Wheels. 1½ins., 1/3; 2ins., 1/9 per dozen. Or in stove-enamel finish, red, green or blue at 6d. per dozen extra. Tax included. Post paid.—The Joyden Toy Co., 193 Chase Side, London, N.14.

**PERSPEX** and acetate, cut any size from 2/6 sq. foot.—W.M. Products, 2 The Mall, Ealing, W.5. Eal. 3881.

**BE** Taller in 14 days or money back. Details, 1d.—Stebbing System, 28 (HB) Dean Road, London, N.W.2.

**CONSTRUCTIONAL** Kits, 4mm. and 7mm. scale Lorries. Also large range spare parts from which to build to your own design. Price lists, 1d.—Wilson's Lorries Ltd., Dept. H., 1/6 Gt. Winchester Street, London, E.C.2.

**£5** to £20 weekly earned at home, running your own Mail Order business. Details, 1d.—Stebbing Publications Ltd. (HB), Naphill, High Wycombe.

**HARDWOOD** Wheels. 2ins., 1/-; 3ins., 2/- per set of four. Tax included. Post paid. Other sizes available.—The Joyden Toy Co., 193 Chase Side, London, N.14.

**100,000** Government surplus bargains. 70 ohm. variable resistances, 9d., post 3d.; 20 amp. toggle switches, 9d., post 3d.; 12 or 24v. blower motors, complete with fan, approx. 4½ins. long x 2½ins. dia., 9/6, post 1/-; spring-loaded plunger switches, make ideal foot switch for motors, models, etc., 1/-, post 3d.; sponge rubber strip, approx. 18ft. x 1½ins. x ½in., 2/-, post 9d.; aluminium rivets, approx. 1 lb. asstd., 2/6, post 6d. Send 3d. stamp for full list of these and other bargains.—Milligan's, 24 Harford Street, Liverpool, 3.

**PLYWOOD** offcuts. Birch and Gaboon in various thicknesses. Handy sized parcels for the cabinet, toy, model maker, and all handicrafts. Parcels made up in £1 and 10/- lots. Carriage paid. Send P.O. to Reeves, Plywood and Timber Merchant, 33 Front Street, Monkseaton, Whitley Bay. Tel. W.B.4677. Parcels are now despatched on day of receiving order.

**BLUSHING,** shyness, nerves, self-consciousness, fears, ended. Details under plain cover, 1d.—Stebbing Treatment, 28 (HB) Dean Road, London, N.W.2.

**AMERICAN** Magazines post free for A1 year. Popular Mechanics, 32/-; Popular Science, 28/6; Mechanix Illustrated, 22/6; Popular Homecraft, 18/-. Stamp for full list of others.—Willen Ltd. (Dept. 57), 101 Fleet Street, London, E.C.4.

**MAKE** your own Jig-saw Puzzles. Fine Art Pictures, various reproductions and sizes. Also suitable for framing. Stamp for full list.—Joyden Toy Co., 193 Chase Side, London, N.14.

**9.5** Film Library, projectors, films, for sale. Stamp for lists.—Wayland, 223 Longley Road, Tooting, London.

**PLYWOOD** Offcuts, ½ in. and ¼ in. up to 12 x 9ins. Ideal toymaking, etc. In parcels, 5/6 post free. Apply, Ansell's, Barnabas Road, Birmingham, 23.

**NOVEL** Calendar Designs painted on plywood for cutting out. With date cards. Inexpensive gifts, profitable to sell. Sample, 2/-; half dozen, 10/-, including postage.—Cleaver, 50 Windsor Road, London, N.W.2.

**HOMEWORKERS** required, either sex, light assembly, part or full time. S.A.E. Esprey, Box 18, 41 Wade St., Lichfield.

**HOME** Watch and Clock Repair Outfit. Includes watchmaker's magnifying eyeglass, tweezers, screwdrivers, oilers, oil, brush, dusting powder, plus illustrated explanatory book. Watch and clock repairing simplified. In container, 12/9 inclusive.—D. Bolster (Dept. H), 5a Station Parade, Ashford, Middx.

**HARDWOOD** Ball Beads, ¾ in. diameter, suitable for children's counting frames, etc. 5/3 per hundred, plus 1/9 P.T.—Joyden Toy Co., 193 Chase Side, London, N.14.

**DOLL'S** House fittings and papers; send S.A.E. for list. Doll's House plan special; send 2/6. Trade supplied.—Zimplan, 88 Ware Road, Hoddesdon.

**FASCINATING** and profitable hobby. Casting ornaments, toys, etc. You can easily make these yourself. Paints, brushes and all accessories. Illustrated catalogue of 700 Moulds, plus latest list of rubber moulds, with instructions, 9d., post free.—Cock of North Moulds (H), 140 Hollings Road, Bradford.

**PLYWOOD.** 72 x 4½ x ¾ in., 20 for 25/-; Gaboon, sanded two sides; Birch, 36 x 9 x ¾ in., 10 for 15/-; Veneered Plywood, 24 x 24 x ¾ in., 5 for 35/-; ½ in. thick, 2 for 25/-; Strips Block-board, ½ x ½ x 27ins. long, 3/- doz. Softwood lids, 39 x 13½ x ¾ in., 7 for 20/-. List of other plywood and Oak, 2d. All above prices carriage paid for C.W.O. Dept. H.3, JDD. Storage, 71 Northcross Road, S.E.22. BRI. 7441.

**2½ins.** Pressed Metal Wheels, 2/- dozen; 8/6 half gross, 15/- gross. Enamelled red or blue, 6d. dozen extra. Hardwood, pressed metal, metal disc wheels, doll's house windows, doors, papers. Catalogues, 6d.—Jasons, 135 Nags Head Road, Enfield, Middlesex.

**CONJURING.** 3d. for new lists and free magical competition.—De Hempsey, 363 Sandycombe, Kew Gardens.

**PITMAN** or Gregg Shorthand. Rapid postal courses. Particulars—Shaw's Commercial School, Lancaster.

**USE** spare time on profitable home-work making fancy goods—write for free booklet.—(Area 544), 54 Southgate Street, Leicester.

**MADE** big money, you can do same. Send envelope for my system tells you how.—J. H. Wamsteker, Box 34, Wynberg, Cape, South Africa.

**MAGICIANS** Tricks, crazy cut-outs, only 1/3; parcels, 5/6. An evening's entertainment. Lists, 3d.—De Hempsey, 363 Sandycombe, Kew Gardens, Surrey.

**PERSONS** wanted to make model bungalows at home. Simple, interesting, clean, regular work. Top rates paid. Send stamp addressed envelope for details.—Bennett Models, 137 Gray's Inn Road, London, W.C.1.

# WOLF ELECTRIC SOLDERGUNS

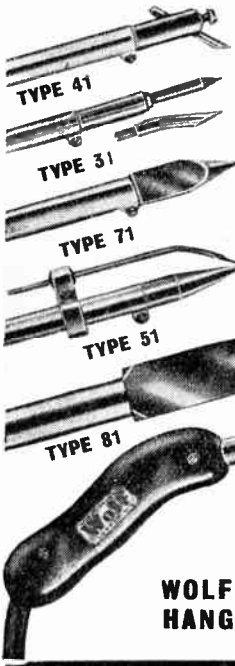

**OFF-STRAIGHT EASY-GRIP HANDLE  
PERFECT CONTROL  
QUICKER HEAT-UP  
LOCALISED HEAT  
LOW CURRENT CONSUMPTION  
MAINTAINS CORRECT HEAT  
A MODEL FOR EVERY PURPOSE**

Write for FREE illustrated technical literature with full descriptions of each model, its range of applications, and the features which make these fine Wolf solderguns the best value ever offered.

From all leading tool merchants and factors



**WOLF ELECTRIC TOOLS LTD.,  
HANGER LANE, LONDON, W.5.**

Telephone: PERIVALE 5631-4

# PROMOTION

WITH INCREASED PAY

That is what the younger generation are seeking—Promotion, and more money. How to get it is the big question. There's only ONE certain way and that's by systematic training such as the I.C.S. have given to millions and are giving today to tens of thousands of ambitious young men striving to add to their earning power.

Find out how the I.C.S. can help YOU. We teach a wide range of subjects. Here are some of them:

Accountancy	Commercial Art	Radio Engineering
Advertising	Commercial Training	Radio Servicing
Architecture	Coal Mining	Salesmanship
Building	Draughtsmanship	Sales Management
Business Management	Electrical Eng.	Sanitary Eng.
Carpentry and Joinery	Horticulture	Structural Eng.
Chemical Engineering	Mechanical Eng.	Surveying
Civil Engineering	Motor Engineering	Works Management

## LETTERS AFTER YOUR NAME

Do you wish to put 'letters after your name' that will give you recognized professional status of great and life-long value? I.C.S. students have won brilliant successes in various Technical, Commercial, Professional, Civil Service, and other Examinations, including the following:

<i>Technical Exams:</i>	Home Office Mining	C. Inst. Accts.
F.I.B. Arcts.	M.O.T. Certifs.	C. Inst. Secs.
Inst. of Builders	B. Inst. Radio	Corp. Inst. Secs.
Inst. Civil Engrs.	P.M.G.	Inst. Book-keepers
C. & G. Elec.	C. & G. Wireless	Inc. Sales Managers
Inst. Fire Engrs.	R.A.F. Wireless	U.C.T.A. in Sales
Inst. Marine Engrs.	I.I.A. Foremanship	General Certificate
Inst. Mech. Engrs.		of Education
L.M.E. for Bldg. Insps.	<i>Commercial and Educ.</i>	University Entr.
Inst. Municipal Engrs.	<i>Exams.</i>	School Certif.
Inst. Struct. Engrs.	Advertising Assoc.	Coll. of Precepts
R.I.C. Surveyors	I.I.P. Advertising	

I.C.S. Examination students are coached until successful and all Instruction Manuals and Textbooks are supplied to them free.



**International Correspondence Schools Ltd.**

(Dept. H.B.9) International Buildings, Kingsway, London, W.C.2

# EVERY DAY

Use Sellotape for fixing labels 'for keeps' on tins of screws and nails, etc. — then you can spot the tin you want at a glance.

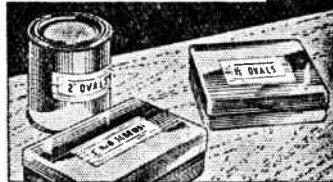

# YOU'LL NEED

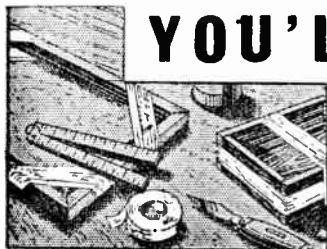

Use Sellotape to hold small parts in position while gluing. It's much quicker than string and just as strong.

# SELLOTAPE

Whatever your hobby—Sellotape can help. It's self-adhesive, sticks at a touch, leaves no mark on wood or metal. Get some today—

**BUT INSIST UPON SELLOTAPE**

Stacked by all good Stationers

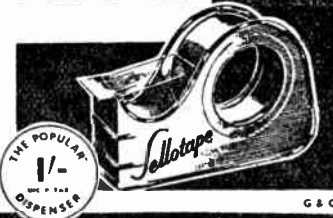

G & G

## AMAZING <sup>Ex. Govt</sup> BARGAIN SIGNAL LAMP

In stout double-compartment water-proof steel case.

- 3½-inch lamp, for day or night use.
- Swivel base with metal screw-in stand.
- Viewfinder and reflector.
- Morse key-board. Fully wired fitted to folding lid.
- Adaptable as car, motor cycle or studio spot light and numerous other uses.

# 7/6

Post 1/3



Write for illustrated lists.  
**PRIDE & CLARKE LTD.**  
Dept. P.W., STOCKWELL RD., S.W.9. Phone: BRIXton 6251

## YOU CAN BECOME A HANDICRAFTS INSTRUCTOR

### Experience not essential

Men who enjoy making things in wood or metal can turn their hobby into a permanent and interesting Career. Short hours, long holidays, and security in a job you would really enjoy, can be yours if you become a Handicrafts instructor. Let us send details of the easiest and quickest way to get the necessary qualification.

**We definitely guarantee "NO PASS—NO FEE"**

If you would like to know about our unique method of preparing you for one of these appointments, write today, and we will send you our informative 176 page Handbook—free and without obligation. Mark your letters "Handicrafts Instructor."

**BRITISH INSTITUTE OF ENGINEERING TECHNOLOGY**

595 Shakespeare House  
Stratford Place, London, W.1

# BIET

# THE STEPPING STONES TO SUCCESS!

Don't hesitate about your future! Go forward, confident that The Bennett College will see you through to a sound position in any career you choose. The Bennett College methods are individual. There's a friendly personal touch that encourages quick progress and makes for early efficiency. Take the first important step NOW and fill in the coupon below.



## CHOOSE YOUR CAREER

Accountancy Exams.	General Certificate of Education Examination	Radio Service Engineering
Aviation (Engineering and Wireless)	General Education and G.P.O. Eng. Dept.	Road Making and Maintenance
Book keeping, Accountancy, and Modern Business Methods	Heating and Ventilating	Salesmanship
Building, Architecture, and Clerk of Works (A.R.I.B.A. Exams.)	Institute of Housing Institute of Municipal Engineers	Sanitation
Cambridge Senior School Certificate	Journalism	School Attendance Officer
Carpentry and Joinery	Languages	Secretarial Exams.
Chemistry	Mathematics	Sheet Metal Work
Civil Engineering	Matriculation	Shipbuilding
Civil Service	Metallurgy	Shorthand (Pitman's)
All Commercial Subjects	Mining, All Subjects	Short Story Writing
Commercial Art	Motor Engineering	Surveying
Common Prelim. E.J.E.B.	Naval Architecture	(R.I.C.S. Exams.)
Diesel Engines	Novel Writing	Teachers of Handicrafts
Draughtsmanship, All Branches	Plastics	Telecommunications (City and Guilds)
Engineering, All branches, Subjects and Exams.	Play Writing	Television
	Police, Special Course	Transport Inst. Examinations
	Press Tool Work	Viewers, Gaugers, Inspectors
	Pumps and Pumping Machinery	Weights and Measures Inspectors
	Quantity Surveying	Wireless Telegraphy and Telephony
	—Inst. of Quantity Surveyors' Exams.	

If you do not see your requirements above, write to us on any subject. Full particulars free.

**COUPON. CUT THIS OUT**  
IF YOU ATTEND TO THIS NOW  
IT MAY MAKE A WONDERFUL  
DIFFERENCE TO YOUR FUTURE.

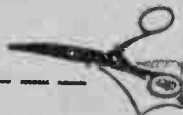

**TO DEPT. 62**  
**THE BENNETT COLLEGE LTD.**  
**SHEFFIELD, ENGLAND.**

Please send me (free of charge)

Particulars of..... (Cross out line which does not apply.)

Your private advice

about

PLEASE WRITE IN BLOCK LETTERS

Name.....

Address.....

# WOODWORKING FOR PLEASURE AND PROFIT

## MYFORD

The ML8 Woodworking Lathe (8" swing x 30") costs only £16 12s. 6d., and by means of numerous Myford attachments can be built into what is almost a complete woodworking workshop—compact, self-contained and driven by the one lathe motor. Pictured is the Compound Slide Rest which enables the turning of metals and plastics.



Other attachments enable:  
**SAWING**  
**GROOVING**  
**PLANING**  
**REBATING**  
**GRINDING**  
**SANDING**  
**POLISHING**  
**BOWL TURNING**

For further details consult any leading Tool Merchant or write to us now for free leaflets.

Myford Engineering Co. Ltd., Beeston, Nottingham



For every purpose in the small home workshop... use a BROOK 'CUB' 1/4 h.p. motor. Single or split phase.

Electric Motors from 0.25 to 200 h.p.



IMPRESS WORKS MOTORS HURDLESPICED I.H.M.148