

Hobbies

WEEKLY

CONTENTS

	Page
Model Viking Ship	353
Warehouse Lift Model	355
A Resistance Controller	356
Flood-Lighted Vase	357
Bookbinding	358
A Pencil Box	359
Craftsman's Notes	360
A Galleon Lamp	360
Brick Coal Bunker	361
Photographic Alphabet	362
Silver Solder Finishing	363
New Stamp Issues	364
Viking Ship Patterns	367

SUPPLEMENT DESIGN
FOR A DOLL'S CRADLE

September 6th, 1950

Price Fourpence

Vol. 110 No. 2862

A SMALL MODEL VIKING SHIP

It is now some little time since the Danish Viking ship 'Hugin' visited these shores to commemorate the landing of Hengist and Horsa on the Isle of Thanet some 1,500 years ago. Many thousands of holiday makers gave the 'Hugin' a tremendous welcome when she came up the Thames. She later visited many seaside resorts and received enthusiastic welcome from all those who had the privilege to see her.

We feel certain there are many model makers who would like to make a model of a Viking ship, so in this issue we are giving a full-page pattern sheet of all the necessary parts, as well as full instructions for building the ship seen in our illustration Fig. 1.

Historical

The length of the model is 11½ ins., its beam just on 2½ ins. and its height from keel to mast tip 6½ ins. Before proceeding further, it might be a good plan to give our workers a few particulars of one of these interesting ships of northern origin. Oslo has two well-preserved specimens of Viking ships, both dating from the ninth century A.D.

One of these, named the Gokstad ship, was found in a burial mound near Sande Fjorde in 1880. This vessel is a large double-

ended open boat, 79ft. long, with a breadth of 16-8ft. She is high at stem and stern but lies very low in the water amidships.

The ship is built of oak with heavy external keel, and the planking consists of sixteen strakes a side laid on clinker-fashion.

The Gokstad ship pulled sixteen oars a side, each about 18ft. long, and these projected through small circular oar-ports cut in the side of the vessel some

18ins. below the gunwale. Steering was effected by means of a steering paddle set on the starboard quarter and controlled by a tiller stepped in its upper end.

A very striking feature of the ship is its figure-head in the form of a dragon with large open eyes, curiously pointed ears and wide-open mouth with rows of large teeth showing above, and below a gracefully curled and hanging tongue. This figure-head extends to more than 14ft. above the level of the water.

So much then for a brief description of a Viking ship. Now we intend continuing with the construction of our model. The first piece to prepare and cut will be the main centre keel upright (A), see patterns on the sheet.

It will be understood from the latter that the full length could not be shown, so the two halves are given with a centre

Fig. 1 — A
12in. model
complete
on base

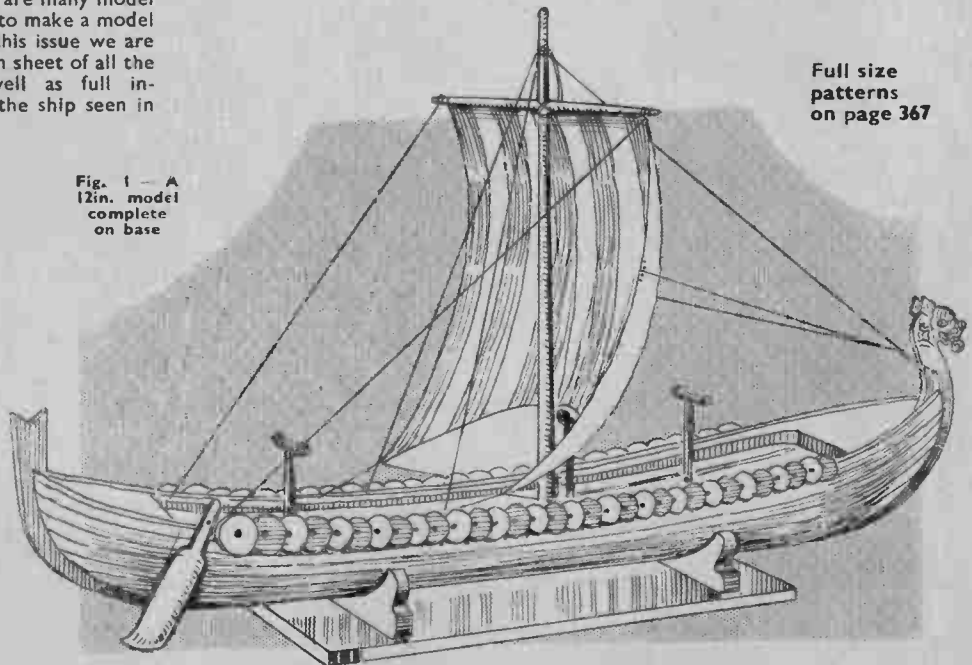

Full size
patterns
on page 367

All correspondence should be addressed to The Editor, Hobbies Weekly, Dereham, Norfolk.

line to which they must be pasted up on the wood. When pasting the pieces together see the lower keel line is level and in alignment.

The Hull

Wood $\frac{1}{4}$ in. thick is used for this. For the head at the bow of the boat, an extra piece of $\frac{1}{4}$ in. stuff should be glued on each side to the dotted line, so it may later on be carved in simple fashion.

To form the hull of vessel, two pieces of soft wood such as American white-wood, if this is obtainable, is cut $10\frac{1}{2}$ ins.

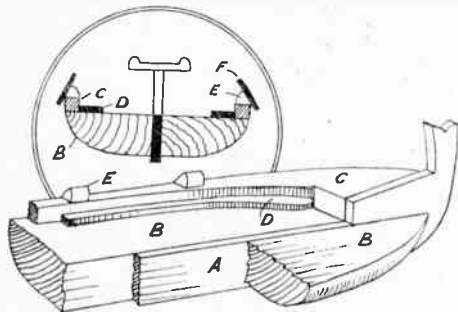

Fig. 2—A section and cut-away view of hull

by $1\frac{1}{2}$ ins. wide by $\frac{1}{2}$ in. thick. On the top surface of one piece stick down the two halves of the pattern (B) from the pattern sheet, joining them up to the centre lines as before advised. Cut round the curved outline with the fretsaw and clean round the edge with glasspaper. Lay this on the second piece (B) and mark round it and cut out similarly.

Both pieces are now to be shaped with rasp, file and glasspaper to the section shown on the pattern sheet and in the two diagrams given in Fig. 2. The larger of these two diagrams gives in section form the various pieces as they are glued up and shaped to form the hull of the ship. The circled diagram in Fig. 2 gives a midship cross section of the hull, with the upper deck pieces attached and the true position of the shields and their fixing blocks.

A good deal of the shaping of pieces (B) can be finished off when they are

actually glued in place to the keel piece (A). Care must be taken to get the shaping symmetrical. This can be checked from time to time by viewing the hull from end on at the bow and at the stern.

The next two pieces to make to complete the hull are shown as (C) on the pattern sheet. Here again two halves are given which must be stuck down again to $\frac{1}{4}$ in. wood. Follow out the previous instructions regarding cutting and gluing up, but now note that the top surface must be shaped down towards

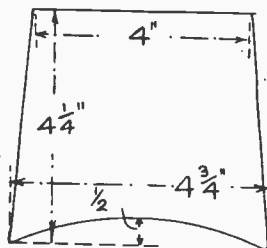

Fig. 4—The sail plan

the centre from the bow and stern, as shown at side view of piece (C) on the pattern sheet.

This gives the necessary sweeping and shapeliness of the whole side view, and needs to have careful attention. When the two parts are glued on, the outside surfaces can be further glasspapered to merge properly with the lower shaped pieces.

At each side of the ship and glued inside the pieces (C) just mentioned, are the $\frac{1}{4}$ in. thick strips (D) seen on the pattern sheet. Half only of the piece is given, but as it is of so simple an outline it can be traced off full size from the centre line given and transferred to the wood. The two pieces can be cut together at one time by pinning the two layers.

The shields alongside the ship are cut from thin wood or card to the pattern given, the outline only, of course, being

cut. The remainder of the circles completing each shield will afterwards be drawn in or slightly recessed with the carving tool. The shields are held to the sides of the ships by the shaped blocks (E), cut $\frac{3}{8}$ in. long from $\frac{1}{8}$ in. square blocks rounded at one angle, as seen in Fig. 2.

Paddle and Support

The steering paddle, given full-size on the pattern sheet, is cut from $\frac{1}{8}$ in. wood and rounded off on its outside edges, while the projecting pin is rounded and bored for fixing to the side of the ship.

The upright T-shaped supports are made in two parts, as seen at (H) and (I) on the pattern sheet. Wood $\frac{1}{4}$ in. thick would answer for these three additions which are let into the centre of the keel piece of the hull, see also Fig. 3. The mast is 6 ins. long and is made and shaped from $\frac{1}{8}$ in. round rod. It must not taper much towards the top, as can be seen in the sketch Fig. 1.

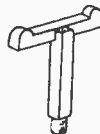

Fig. 3—The T support

The cross spar to take the sail is given full size on the sheet and shows how it is tapered both ways from the centre from $\frac{3}{8}$ in. rod.

The sail outline is given in Fig. 4, and should be made from some thin cotton or silky material and lined up with reddish brown stain. It is lashed in place to the mast with running lines to the deck and fixed by tiny eyelets to the deck and to the keel head.

All the woodwork should receive a light glasspapering before being coated with dark stain. The deck and seat portion inside should be lighter. The shields should be painted alternately light and dark, and short brass pins let in to mark their centres.

A simple form of stand for the model should be made from $\frac{1}{2}$ in. or $\frac{3}{8}$ in. wood. Dimensions for the base (J) are given on the pattern sheet, while keel supports are given as (K). Two of each will, of course, be wanted to glue to (J) in the position shown by the dotted lines. The stand would look well painted glossy black. (244)

From THE EDITOR'S Notebook—

GR^EAT interest was shown in our articles on puppet making a little time ago and there is now an increasing popularity for those quaint figures manipulated by strings or the fingers of the hand. The subject has even been televised, and the opportunity to show their ability fell to 15-years-old Bruce Ernest of Greenford and 13-years-old Paul Abigal of Sudbury. They only took up the hobby about a year ago, but now they have over 30 puppets of various kinds ranging from a dancing girl and a pianist, to a seal which balances things on its nose, and a skeleton which falls to pieces.

Their variety show, which they have performed at children's parties and similar events, now totals 14 individual

acts and even includes a circus with the traditional comic horse.

I^EXPECT many readers have already seen the film *Treasure Island* and examined with interest the ship *Hispaniola* which takes such a part.



Their interest, of course, is in comparison with the model of it which they can make from our design sheet and Kit (No. 2852) published in June last. Even apart from the film there are probably some who saw the actual ship whilst on holiday at Scarborough. It was bought by the Corporation and adapted as an Exhibition Ship. Those who saw it will have an added incentive to make a model from our design.

THE Doll's Cradle shown can be made from the patterns given with this week's free sheet and the Kit (No. 2862) of planed wood. You can purchase the Kit from any Hobbies Branch for 5/4 or 6/2 post free from Dereham.

The Editor

A novel working model to make of a WAREHOUSE GOODS LIFT

THIS working model will provide much interest to youngsters, and some little puzzlement to those unable at first to understand exactly how it works. The mechanism is very simple, and unlikely to go wrong, being founded on the gravity principle. Briefly, a lift rises and falls in the lift shaft provided in the model building. A weight causes it to rise, and a second, and more heavy weight, causes it to fall and that is all there is to it.

Fretwood or substitute plywood, can be used for making, with a piece of thicker wood, say, 1in. deal, for the base. Cut two sides as at (A) in Fig. 1. Make the tenons of these 1in. long and $\frac{1}{2}$ in. in from the ends. They can be $\frac{1}{2}$ in. deep to fit securely in the baseboard.

The Shaft Side

The right hand side is left plain, the left hand one is divided into halves by a pencil line down its middle, as shown by the dash and dot line, the left half being one side of the lift shaft. Down the centre of this half two strips of $\frac{1}{4}$ in. thick wood are glued, $\frac{1}{8}$ in. apart. These provide a central groove as a guide to the movement of the lift. The strips are short of the top by just $3\frac{1}{2}$ ins.

At the top, cut a slot $\frac{1}{4}$ in. by $\frac{1}{2}$ in., as shown. The cross lines on the right hand half of the side show where the floors

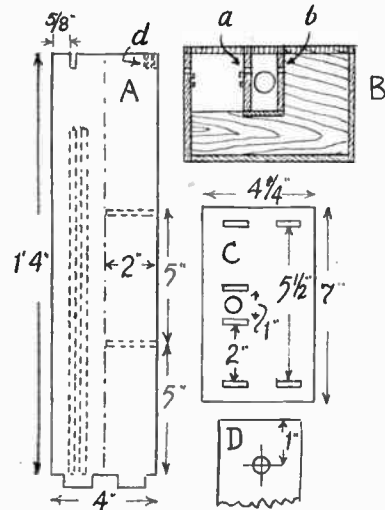
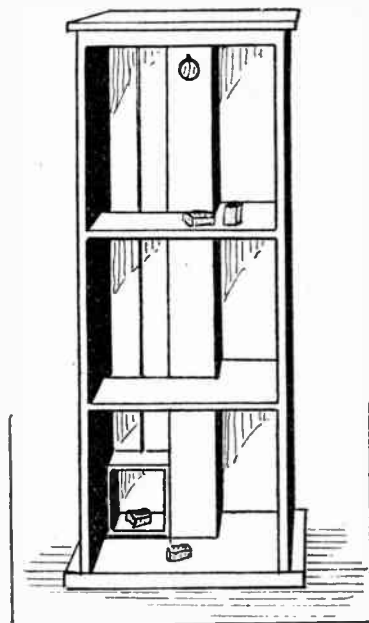

Fig. 1—Detail of sides

come. Now take a look at the plan view (B). Here it will be seen that two narrower strips of wood, each 2ins. wide, are fitted, separated by a space of 1in.

This space is the weight shaft, down which the weight descends when drawing the lift up. Provide these two strips, lettered (a) and (b), with 1in. tenons at their bottoms. The strip (a) forms the right side of the lift shaft, as the plan reveals, and should have



similar strips of $\frac{1}{4}$ in. wood glued down its middle exactly the same as was done for the other side. For lift guides a slot is cut at the top of both, to correspond with that at the top of side (A), but the slot in strip (a) is made $\frac{1}{2}$ in. wide to allow the lift cord to pass, as will be noted later.

The Base

The base (C) is cut to dimensions given. Lines, $\frac{1}{2}$ in. apart, are marked across the base, where shown, at $\frac{1}{2}$ in. from each end, also for the strips (a) and (b). On these the position of the 1in. mortises can be set out and cut. Those for the sides are $\frac{1}{2}$ in. from the front edge of the base, so that the sides will come $\frac{1}{2}$ in. short of the back edge and leave room for the back of the model to be nailed on. In the centre of the weight shaft bore a $\frac{1}{2}$ in. hole through the base.

All parts can now be glued to the base and the back, a plain piece of wood, 6ins. wide and 1ft. 4ins. long, fitted in place. Nail strips (a) and (b) to the back, and ensure that the sides of the lift shaft are truly parallel to each other by drawing pencil lines on the back as a guide. Finish off this part by nailing a $\frac{1}{2}$ in. square strip of wood across the front, at the top, as shown (d).

Two Floors

The two floors can now be cut. These measure 4ins. by $5\frac{1}{2}$ ins., with a piece 2ins. by $3\frac{1}{2}$ ins. cut out to leave space for the two shafts. These can then be nailed across, or nailed to side fillets instead if the wood is too thin. It would be

better here, perhaps, to cut these floors from $\frac{3}{4}$ in. deal, they would be more substantial.

Across the slots in side (A) and strips (a) and (b), a piece of $\frac{1}{4}$ in. by $\frac{1}{2}$ in. wood is to be glued, to which the pulleys over which the lift cord passes, can be fitted. This is shown in position in Fig. 2 (E). Place it across temporarily, and pencil lines on it exactly in the centre of the lift and weight shafts.

Pulleys

Small metal pulleys are now fitted to rotate easily on round-headed screws. Position these so that the cords passing over them drop down the centre of both shafts, as shown in the diagram. This being satisfactory, the wood fitting with pulleys, can be glued across.

The lift (G) is made up to sizes given from thin fretwood. So far as the width is concerned, it would really be best here if it were made about $\frac{1}{2}$ in. less to ensure absence of sticking anywhere in the shaft. Exactly at the centre of each side, top and bottom, drive in round-headed screws, partly only, so that when their heads are filed off, pins $\frac{1}{8}$ in. long are left.

These should engage in the grooves on the sides of the lift shaft and guide the lift on its journey up and down. In the exact centre of the top, drive in a tiny screw eye. To this knot a length of fine cord.

Pass the cord over the pulleys and draw the lift up and down to see it moves freely. Let the lift down, then tie a wire hook to the free end of the cord at about 1in. from the top. Cut the

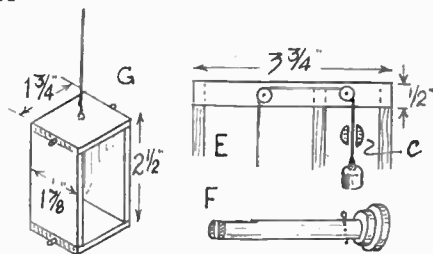

Fig. 2—The lift and mechanism

surplus cord off. From a scrap of some thin material, a bit of old handkerchief would do, make a little pocket affair and hang it to the hook on the cord. In this place some scrap bits of lead until the weight is sufficient to bring the lift up promptly.

The Weight

Add a bit or two of lead extra to make up for loss in melting, then melt the lead in a ladle or tin, and pour into a wood mould to make a weight, some $\frac{1}{2}$ in. in diameter. Bend up a bit of wire to make an eye and press this into the lead before it sets. Hang this weight on

the cord, and it correct, up will go the lift. A small nail can be driven in the sides of the lift shaft to prevent the lift rising above the top floor.

Suitable Braking

It is not desirable for the lift to go either up or down too quickly, so some form of braking is desirable. This is shown at (F). It is a 2½ in. length of round wood rod, ¾ in. diameter, with an ¼ in. slot cut through lengthwise some 1 in. long.

To the opposite end of this a knob, formed of two discs, one ¾ in. and the other ½ in. glued together, is fitted. A cover piece of wood, 1½ ins. wide, 6 ins. long is now to be cut. This covers the weight shaft above the top floor. In the centre of it, a ¾ in. hole is bored, as shown at (D) in Fig. 1. Screw this in position.

Push the brake through the hole in this, and if it is correctly positioned, the cord will pass through the slot cut in it. It will be seen that if the brake is turned a little, it will check the speed (see detail (E), (c)) or stop the lift if turned far enough. A small nail is driven in the rod on the other or inner side of the cover piece, to keep the brake from working out.

The movement here should not be too free, but rather friction tight. A

small cloth washer, between the knob and cover piece will help if the brake does move too easily. This being satisfactory, cut and fit two more cover pieces over the weight shaft on the ground and first floors.

Prepare a few model bales for the lift to convey up. These can be made of cardboard, and should measure about 1 in. long and ¾ in. square at the ends. Cover them with paper, or glue material over them to make them look more real. Needless to say they must be light in weight. A test should now be made, and if all is satisfactory, the lift should raise the bales up, the speed being controlled, as far as may be necessary, by careful movement of the brake.

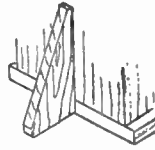

Fig. 3—Back struts

Counterbalance

To ensure return motion, place some bits of lead on the lift until the weight is sufficient to overbalance the other weight on the cord and bring the lift down again. Add a bit or two extra, melt, and cast into oblong form. This can have paper or material glued over it to hide its composition.

It will now be seen that when the lift is up, it is only necessary to include the weighted bale amongst the rest to send the lift on its downward journey again, and to those not in the secret of the loaded bale, the whole thing works apparently on its own.

Steady Struts

It may be found that the model tends to tilt over backwards when working. If so, steady it by gluing to the back a suitable wood strut, as in Fig. 3 and provide a lid to cover the top. Do not fix the lid but let it just lay on. Corner pieces of wood, glued to it underneath, will keep it in place. The completed model can then be nicely painted and form an interesting piece of work.

So far as the wood is concerned, it may be added that few readers will wish to employ good quality fretwood for such a job. Any of the substitute plywoods, or, of course, the actual plywood, will be better employed. For the floors and top pieces, ¾ in. matchboarding would do nicely.

In fact, except for the back of the model, the matchboarding could be employed throughout, as long as the interior widths of the lift and weight shafts remain unaltered.

For dimming lights or controlling model speeds use a RESISTANCE CONTROLLER

THIS easily-made resistance controller can be put to a number of uses. It can be used to control the speed of electric trains or any model operated by an electric motor. It may also be used as a dimmer with one or more electric bulbs, or to adjust the charging rate where the constructor uses a small home charger to keep his batteries in order.

It is, however, in controlling motors and lights that it will probably be of most general use.

Cutting the Parts

The controller is built on a wooden base about 2½ ins. by 2½ ins. by ¼ in. thick. On this, mark off a semicircle with a radius of about 1 in. and divide this into nine or ten equal sectors. At each point screw in a small brass round-headed wood screw, as shown (A) in Fig. 1. Do not drive these screws in completely yet.

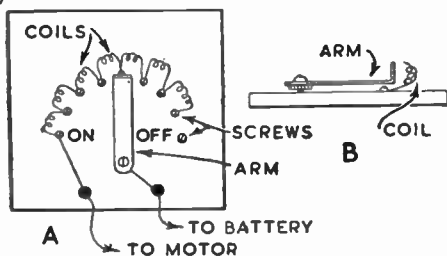

Fig. 1—Lay-out of circuit and side view

For preference the arm should be cut from fairly stout brass, but other metals will do. It is about 1½ ins. long and ¾ in. wide, with one end turned up to form a handle. Pivot it in the centre of the semicircle, using another screw with a washer, as shown at (B). Place a loop of wire round under the washer. The arm should swivel easily so that it can touch any of the screws.

Two small terminals are mounted on the base. The loop of wire mentioned goes to one. The second is connected to one screw in the semicircle, marked 'ON' in Fig. 1.

As the resistance coils are in the open it does not matter if they become hot and consequently any thin wire can be used. Copper wire of 32 to 26 S.W.G. can be employed, or a length of ordinary flex bared and untwisted so that single strands can be taken out.

One contact screw is left vacant to be the 'OFF' position. Between each pair of the other screws connect a spiral made by winding about 2 ins. of wire round some small object such as a slender pencil. As the spirals are put on, tighten the screws home.

To use the controller, it is only necessary to connect it in series with one of the leads to the model. Cut one lead and

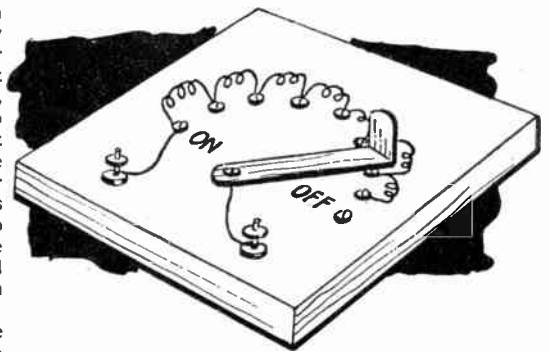

join the two ends thus formed to the terminals (see Fig. 1). When the switch is in the 'OFF' position no current will flow. The current will increase as the arm is moved round, reaching maximum at the 'ON' position, with no resistance in circuit.

Resistance

If the controller gives too abrupt operation the coils are of too high a resistance. Shorten them to 1 in. or so of wire each, or use thicker wire. In the event of insufficient control being achieved, the resistance is too low and thinner wire must be used, or the coils wound so that each contains more wire.

It should be quite easy to obtain proper results, when the model can be controlled as desired by turning the arm.

A rotating disc gives varying colours in a novel FLOOD-LIGHTED VASE



ALMOST every house has some dark corner or recess which could be made more cheerful. As a change from the more serious forms of model making, why not try your hand at fashioning this simple gadget for brightening up the home?

A glass flower vase or jug, filled with water, is placed on a wooden stand in which is housed an ordinary electric lamp. When the current is switched on, the water in the vase begins to glow with a variety of ever-changing colours, merging from pink to mauve, purple, blue, green, yellow, orange, and so on. The effect is very beautiful and fascinating to watch, and to the uninitiated not a little mysterious.

Revolving Disc

Actually, however, the effect is quite simple to produce. The colours are painted on a disc of celluloid which pivots above a 40 watt electric lamp, the heat from which, rising through a number of sloping vents cut in the celluloid, cause it to rotate slowly. A piece of white card placed above the revolving disc and at an angle to it, reflects the light into the water which consequently appears to glow with ever-changing hues.

The Materials

The chief materials required are: a piece of celluloid from which to cut a disc with a 3in. diameter, an electric lamp (40 watt), a piece of stout white card, batten-holder and flex, and a length of fairly stiff wire. The stand could be a framework with cardboard panels, or made entirely from battens and plywood. Detailed measurements

are not given, but it is suggested that the overall height should be about 15ins. and the width at base 10ins.

In the model seen in the photograph and diagram, the head, or top section, to which the cardboard reflector is fixed, was made as a separate unit, but this is not essential.

The Disc

The most important task is making the rotating celluloid disc. It should be approximately 3ins. in diameter and twelve flanges should be marked out as seen in Fig. 2, each being about $\frac{1}{4}$ in. by $\frac{1}{2}$ in. It will be noted that only two sides of the flanges are cut. Each flange is bent upward along the dotted line to an angle of 45 degrees. Celluloid is not easy to mark, so a good plan is to make a drawing of the flanged disc on paper, then paste on to the celluloid. A small chisel (or a sharp-ended screwdriver if no chisel is available) is suggested for cutting the flanges.

Colouring Celluloid

Colouring the celluloid may give a little trouble, owing to the fact that water will not readily 'take' to the material. After much experiment it was found that if the celluloid was held in front of an electric fire, and transparent colours or coloured inks used (such as for colouring photographs), the colour dried as soon as it touched the celluloid.

Four different colours will be sufficient. It is immaterial if they are applied unevenly, or in what design or pattern they are painted on to the disc. In order to guide the rising heat from the lamp through the flanges, a band of stout paper 1in. in width should be fitted tightly around the edge of the disc.

The Stand

The stand may now be made on the general lines of the one illustrated, but there is plenty of scope for some modified design. The wire pivot arm should be fixed to the wall of the front panel, as seen in Fig. 1. The end of the wire which acts as the actual pivot should be filed to a sharp point. It is, of course, vital to determine the exact centre of the disc. Should the disc not balance correctly, appropriate trimming of the paper band should rectify matters.

The slot which permits the light rays to fall on the cardboard reflector should extend from side to side of the roof section, and may be anything from $\frac{1}{2}$ in. to 1in. in width. By altering the width of this slot (or its position in relation to the celluloid), a number of different effects can be originated.

Various Effects

For example, if the slit is near the outer edge of the revolving disc, the colours will change more rapidly, giving the effect of boiling water with the colours rising upwards. If the slit is

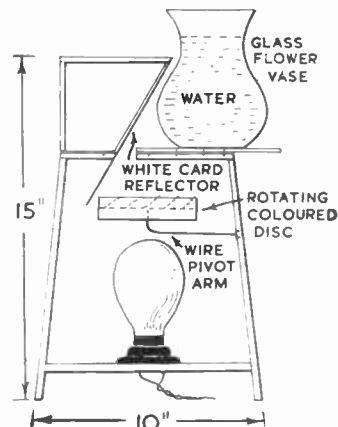

Fig. 1—Section showing parts in place, with card reflector

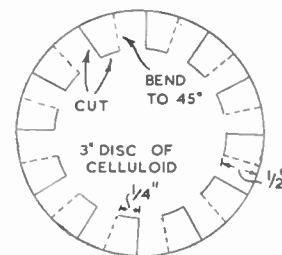

Fig. 2—The disc marked for cutting and binding

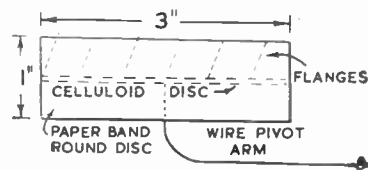

Fig. 3—The disc on its wire pivot point

near the centre of the disc, the colour changes will be much slower, the various hues changing almost imperceptibly.

The stand should be adequately ventilated, but any vents should be screened so no direct light escapes except by the slit referred to. (221)

**HOBBIES HANDBOOK
FOR 1951 WILL BE ON
SALE THIS MONTH**

A practical example of how to undertake BOOKBINDING

THE previous article on bookbinding described a method of binding single section booklets. No doubt many readers have practised this technique and are anxious to progress to the binding of multi-sectioned books. The method here described is fundamentally similar to that used previously, but differs in one or two small yet important details.

It is particularly suitable for the binding of Penguin and Pelican books. These publications, unfortunately, spoil

The stitch, however, must be varied, as shown in Fig. 1. This causes each consecutive section to be knotted at a different part of the spine, and ensures that a bulge will not form. Whichever stitch is used, however, care must be taken that the reef knot is tied over the inner thread and that no knots are allowed to slip through to the outside of the spine.

Stapled or Wire Stitched Books

Occasionally one comes across a book which has not been sewn at all, but was, during the war, stapled or wire stitched by virtue of the prohibitions imposed upon labour and materials at the time. The procedure for rebinding these books differs only in respect of the manner of sewing to the mull and this is, therefore, fully described separately here.

In order to remove the cover, it will have been found necessary to remove the staples or wire stitching. This has the effect of literally allowing the book to fall to pieces. The book is sorted out into its separate sections and the pagination checked.

Each section must be fastened to the hinge as described above, but each one is taken separately. Sections are taken in order of pages, and carefully sewn as close to their predecessors as possible and square with their neighbours.

'Tipping'

The last page of every section except the very last in the book is treated by pasting a $\frac{1}{2}$ in. line along the inner edge nearest the spine. When this has been done, the book is closed and the paste will cause each section to join to its neighbour at the spine, and make the book a 'whole' instead of a number of separate sections. The pasting process used here is known as 'tipping' and will be referred to again in the later stages of the binding.

The rest of the binding proceeds as follows, irrespective of the method used for the sewing.

The Endpapers

Four sheets of cartridge are now required, each to be cut to the same height as the book, and double the width. They are folded at the centre and pasted together in pairs (see Fig. 2). The two sets of endpapers are when dry assembled inside the hinges, one at the front, and one at the back of the book. They are sewn to the mull through the

division nearest the inside of the book, the same stitch being used as before.

The endpaper next to the first page of the book is tipped in order to join it and the first page, and the endpaper nearest the last page of the book is treated likewise. This prevents an unsightly gap appearing between the endpapers and the book itself.

Cleaning the Edges

Before the boards are cut or fitted it may be necessary to clean the edges in the following manner. The book is placed in a vice or press, with its fore-edge facing uppermost and the vice screwed up tight.

A piece of very fine glasspaper held over a square wooden block is used lightly on the fore-edge to remove all grubby marks. As well as cleaning, this operation may be prolonged in order to smooth away any irregularities in the book edges, of course, it must be repeated with the top and bottom edges of the book.

The Covers

The card covers are now cut to the dimensions described in the last article. They should each be the same width as the front page but $\frac{1}{2}$ in. longer. Each cover is pasted in turn to its respective hinge. Remember to allow $\frac{1}{8}$ in. overlap on top, bottom, and fore-edge, but $\frac{1}{4}$ in. short at the spine.

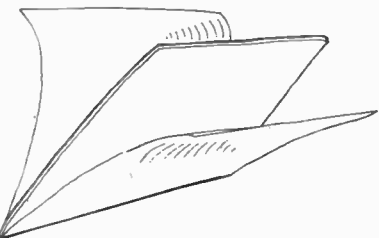

Fig. 2—The endpaper assembly

The width across the spine is now measured and the measuring and cutting of the cloth undertaken. Remember the measurement formula for the cloth:—

Length equals length of book plus $1\frac{1}{2}$ ins.

Width equals width of open book plus width around spine plus $1\frac{1}{2}$ ins.

Covering

The procedure for covering is exactly the same as for a single section binding. Remember to look inside the boards first and ensure that the endpapers have not adhered to the boards because of loose paste.

Do not forget to paste a piece of cartridge paper of the requisite size centrally on the cloth for strength before attempting to cover the boards.

(Continued foot of page 359)

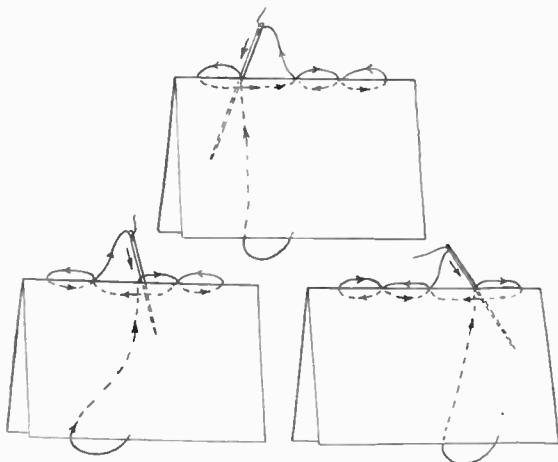

Fig. 1—Diagram of alternative stitches

easily, and this method of binding them is the cheapest and most effective way to render them permanent. It is no exaggeration to say that the handyman can by this means soon build up a first-rate personal collection of books at very little expense.

Preparation

A mulled hinge must first be made, as described in the last article in this series. If an old cloth-backed map is available a piece cut to the required size will serve admirably without any further strengthening.

The thin cover is removed from the book and any spare glue adhering to the spine is softened with clean water and wiped off. The mull is folded over the spine as it was for the single-sectioned binding. The book is opened then at the centre of its first section and sewn through this to the mull—exactly as if it were a single section. The manufacturers' machine sewing must not be cut or damaged in any way, and the original sewing holes used as far as possible.

It is necessary to sew through each section of the book in this manner until all are securely fixed to the mull. If there are more than five sections to the book, it will suffice to sew each alternate section only.

Sliding drawer and hinged lid are fitted to this HANDY PENCIL BOX

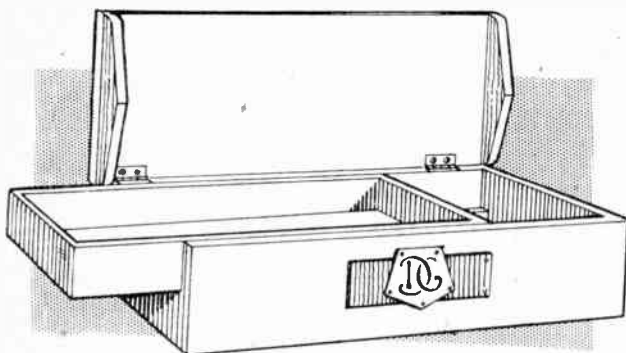

WE have purposely designed the box illustrated on this page on very simple lines so the worker with the fretsaw and a few tools can make it up easily and quickly. The box is designed on ample lines, being 8 ins. long and 2½ ins. wide. There are two distinct compartments, the top one being designed as a sliding tray to pull out from one end as our sketch, Fig. 1, shows. It will be seen also from this sketch how, when the tray is pushed back into place, it is held secure by a rail fixed to the underside and at end of the lid. A similar rail is, of course, fixed to the opposite end of the lid to make the box look uniform when closed.

If it is intended to carry the box about then a suitable catch should be added to keep it securely fastened. This catch would come just above the monogram plate shown in the sketch. The lid may be attached to the box by a pair of brass hinges, or by a strip of stout tape ½ in. wide lapping on to the lid ¼ in. and to the top edge of the side.

Make Good Joints

As before mentioned, the construction of the box is very simple, but it should be impressed upon the worker that the glued joints must be carefully made and strongly put together. Before commencing to make the box the constructional diagram Fig. 2 should be carefully studied.

Note here, for instance, how the ends (C) and (D) go between the main sides

(B), and how the floor (A) drops in between sides and ends and is glued to the runners (E). No joint is thus visible from the outside which makes for neatness of appearance.

Tray Portion

Note, too, how the floor of the tray goes between the ends (H) and is fixed—by glue and fret pins, to the sides (G). All these little points need watching when drawing the various pieces of the article before actually cutting them.

The tray should be made 'full' regarding length, width and height, so it can be rubbed down on a glasspaper board to make a perfect sliding fit. A glasspaper board is just a stout piece of straight-grained wood cut to the size of a sheet of glasspaper with this latter glued down to it flat and even. Such a board will always be found useful for any such jobs as this where surfaces are to be rubbed down evenly with the grain of wood.

To proceed with the box, first mark out the floor (A), 7½ ins. by 2½ ins. by ¼ in., and the two sides (B), 8 ins. long by 1½ ins. by ¼ in. Then make parts (C) and (D), (C) being 2½ ins. by 1½ ins. by ¼ in., and (D) 2½ ins. by 1½ ins. by ¼ in. Glue these parts together excepting the floor (A) and test them for squareness with a try square or a set square.

Next test the floor with the glued-up rails and see it fits accurately but not tightly enough to burst the joints of the rails. Wipe the four edges of the floor with glue and place the 'frame' over it, gently pressing down until the bottom of the floor is flush with the lower edges of the frame.

Allow the glue to harden, and then make the two runners (E). These are 7½ ins. long by ¼ in. wide, by ¼ in. thick. See that the long edges are flat and even after cutting them—our glasspaper board comes in well again for this job. Wipe one side and one edge of the two runners with glue and press them down inside the box as shown in Fig. 2. In this diagram, parts of the sides, etc. have been shown cut away to make construction clear.

Making the Lid

The lid can now be prepared and this is cut from ¼ in. wood and measures 8½ ins. by 3 ins. by ¼ in. All our edges should be slightly rubbed to a curve with coarse and fine glasspaper and the end rails (I) then drawn out and cut. These measure 2½ ins. by ½ in. wide and are of quite a simple shape as shown. Glue them to the underside of the lid so that there is just clearance between the ends of the box allowing it to open freely. Fix the lid to the box as suggested.

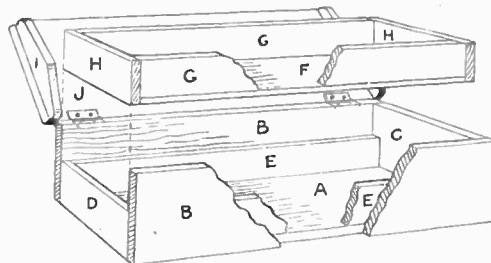

Fig. 2—Cut-away constructional detail

The tray of the box consists of the floor (F), a piece of ¼ in. wood 7½ ins. long by 2½ ins. wide being required. Glue the ends (H) to this, two pieces, 2½ ins. by ½ in. by ¼ in. being here wanted. The sides (G) are 7½ ins. by ¼ in. by ¼ in., and they are glued to the top edge of the floor. Test the tray to see it runs smoothly, and if it works too stiffly glasspaper it on the sides a trifle.

Hardwood such as beech or mahogany should be chosen for the box if possible, and the finish can be any that will suit these boards. The monogram plate on the front of the box might be of brass or ivory with the initials either cut in or painted on.

Bookbinding—(Continued from page 358)

When the boards are covered with cloth it is most important to wipe down with a clean rag to exclude any air bubble before folding in the edges.

The corners are trimmed across, and it is essential that ¼ in. spare cloth is left at each corner. The overlapping cloth edges may now be folded in and pressed well down on to inner sides of boards.

The first and last endpapers are now pasted down inside their respective boards, so as to leave a tidy ¼ in. border of cloth on three sides. The endpapers will require smoothing to remove air bubbles.

It is important that the completed book is placed in a press and allowed to dry fully to prevent warping. Only

when it is dry should it be removed and the finishing touches added by printing the name of the author and title neatly on the spine.

A further article on the subject will appear shortly dealing with decorative finish. This will end the series which provides a practical knowledge of the subject. (196)

A Craftsman's Notebook

Archery is Popular

ARCHERY, or toxophily as it is called, has always been popular as a sport. Besides big clubs, like the Royal Toxophilite Society, founded in 1781, and the Woodmen of Arden, there are many smaller ones who hold regular meetings and contests, and, no doubt, there are lots of youthful enthusiasts enjoying the sport with simple home-made equipment. The name 'Toxophily' derives from two Greek words meaning Love of the Bow.

I see that bows can now be had made of steel, with arrows of aluminium. The favourite, however, has always been Yew (the Spanish or Italian species being best) or a combination of different woods. Ash and hickory are also useful for the purpose. Real craftsmanship goes into the making of the outfit, correct seasoning and expert finishing being necessary for good shooting.

One cannot think of archery without thinking also of Robin Hood and his men, so it will be of interest to mention that I have just seen a photograph of a bow still in existence said to have been actually used by Little John. The usual full-size bow is some 6ft. long, but this giant measures 6ft. 7ins. Further, it requires a pull of 160lb. to draw it to its full extent, whereas the normal type now used requires only 60lb. It is made of spliced Yew and measures 5ins. circumference at the centre.

A Nature Note

SHORT time ago I was impressed at the way birds, especially tits, conceal their nests. Not all birds are so cautious in their choice of site, however. In fact, I think the thrush is rather careless in this respect.

These birds have built in my garden and one of the most unsatisfactory places chosen was behind a gate leading into a busy street. This particular nest was only 5 or 6ft. from the ground in a corner of the wall near the hinges and I am surprised the frequent opening of the gate did not displace it. Virginian creeper covered it to some extent, but barely enough to hide it.

Nevertheless, young ones hatched out, and I managed, incidentally, to get a fairly reasonable snap of the nest. The position, however, proved to be hopeless—too easy for cats. The young birds survived for a time, then one day the nest was found destroyed, the occupants victims of a four-footed marauder.

Hints for Hikers

IF country rambles take you along roads where there are no proper footpaths you will find it best to walk on your right-hand side, that is, facing the

traffic coming towards you. Approaching vehicles will then be seen as soon as they come into view, allowing you plenty of time to draw well to the side out of the way.

For pleasant travelling remember that a rucksack ought to be carefully packed so softer articles, such as clothing, come next the back. Also, brace it well up on the shoulders, as a sagging pack hangs heavy and uncomfortable. The same applies with just a light haversack slung over the shoulder, a long strap with a heavy bag dangling at the end being cumbersome.

The feet do such a great deal of good work on a hiking holiday that their comfort must be considered by wearing shoes well soled but not tight, and do not choose the occasion for breaking-in

a new pair. Socks with feet too short soon become as unbearable as tight shoes.

To 'Frost' Windows

QUICKEST way to obscure the view through the window of a workshop, garage, or other outhouse to make it more private is to cover it with ordinary whitening. This blocks the view from the outside while admitting a good amount of translucent light, and it is so easy to clean off and renew.

A little Paris White is mixed to a thick cream with water, then applied to the glass with an old shaving brush. A pleasing pattern can be added either by dabbing all over with the tips of the bristles or by drawing the brush across in different directions.

The Craftsman

A Galleon Lamp—

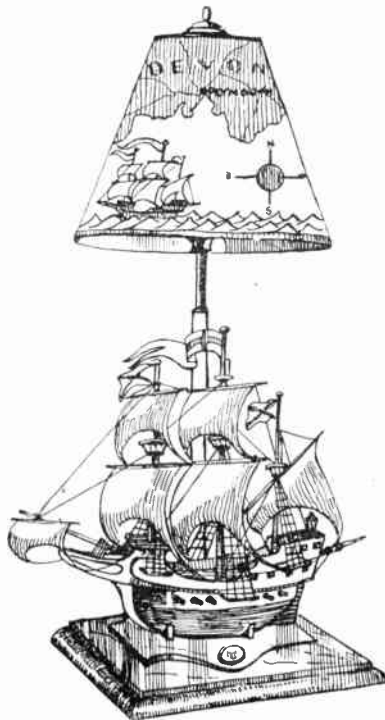

THE picture shows a novel method of using one of the models of our galleons. The model itself is of our Design No. 2778 of the Ha'penny Galleon, and is constructed in the ordinary way, before being converted into an attractive and unusual table lamp.

The actual base, however, is duplicated as you see in the diagram, the front hole in the upper base being made to hold the halfpenny as usual, but the hole behind containing the pillar forming the actual lamp standard.

This is a wooden tube turned to represent a ship's spy-glass, and realistically painted before being glued in place. The flex, of course, is carried through this tube, and the normal electrical fitting for holding a bulb is added to the top.

The base is of double thickness with the lower portion of wood having a rounded edge, as can be seen. The shade is made from ordinary parchment, but is added to be more in keeping with the old-time ship below it.

Indian ink is used to give the impression of an old ship's chart, the one in the illustration indicating a Devon coast. The light drawing of the ship is added to the shade with the four cardinal points of the compass shown also. This is but one of the many ways in which the ship galleons of our designs can be converted to even more attractive form. (207)

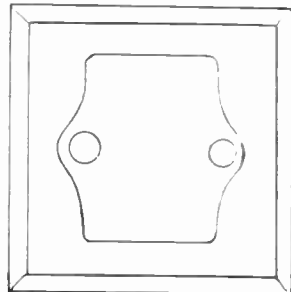

Keep your fuel dry and accessible by building a BRICK COAL BUNKER

THE building of a brick coal bunker is not so difficult as might be imagined and the durability of it as compared say, with the galvanized variety recommends it to the handyman. The sketches show the construction details for a bunker that will hold about 1½ tons of fuel.

First prepare the site. You need an area of 8ft. by 5ft. to take the actual walls of the bunker, which measures 7ft. 6ins. long by 4ft. 2ins. wide. Dig the ground area to a depth of 9ins., put down rubble and ashes to take footings of two bricks' depth and two bricks in width. Then fill in the whole area with rubble.

Broken bricks and stones or any small pieces of hard material will be suitable for this purpose and when it is all rammed well down, pour in cement in the proportions of one part cement to two parts of sand and three parts of shingle. Now smooth this all to a nice top surface, leaving, of course, the brick footings standing above the surface by about 3ins.

one part cement to three parts of sand) you will soon get into the hang of the thing.

You will find, too, that corners have to be built first preferably about three 'layers' high and then the remaining bricks will fill in and around them quite easily. Half bricks are, of course, necessary at various stages but, with a little knack in cutting with a trowel you will find that bricks can soon be shaped to the size needed.

Complete the back and two side walls first and then deal with the front which needs two apertures through which to shovel the coal as required. This need not prove a difficult task. Place two pieces of stout timber over the top of each aperture and then build the bricks round them and over them.

The baulks of wood need to be strong and 3 by 3 is best, seeing the weight of the bricks that they will have to carry is not inconsiderable. A little trial and error might be experienced in this tricky part of the job, but it will not be long before the shell of the coal bunker

types of fuel to be stored if required, and the partitioning wall gives great strength to the whole structure.

The bunker slopes from a back height of 4ft. to a front height of 3ft. and it is proposed to cover the top with wood and make two filling apertures, one for each half of the bunker.

Four pieces of timber 4ft. 6ins. long and 3ins. square are needed to fit across the top of the roof where they can also serve as sides for the apertures. As indicated in the diagram, these pieces of wood must be placed on the brick edges back and front and bricks built around them to bring the whole of the back and front walls level to the edge of these timbers.

The next job is to roof the bunker with boards and it would be well to make the front edge a very solid job for the coal delivery man is certain to rest his sacks here to empty them. Covers for the two apertures can be made to fit snug in grooves. These grooves are formed quite naturally by the edges of the boarded roof where it is cut away to

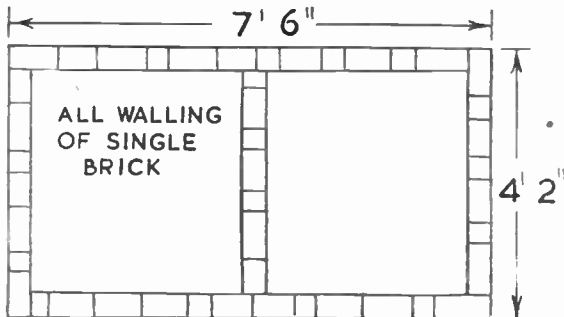

Plan of the brick walls

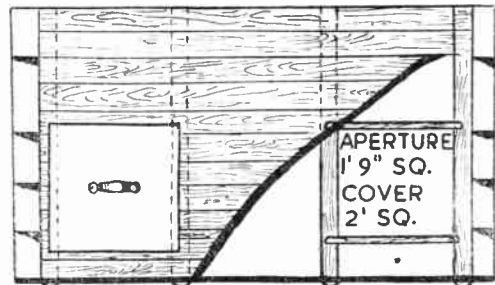

Cut-away roof view to show framing

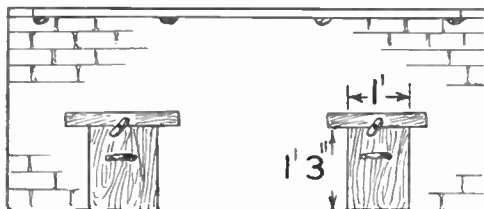

Front elevation with doors



Door grooves made in cement

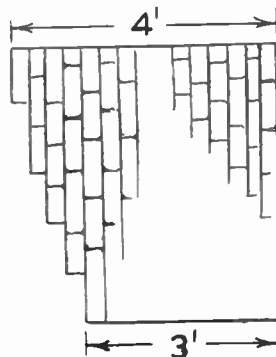

The side wall

Next begin laying the bricks for the walls. It will be as well to make a large set square out of rough pieces of timber and you will find that this, together with an improvised 'plumb line' and a spirit level will enable you to build the walls square and level. By laying the bricks in place first, about six at a time, before cementing them (with a mix of

is completed.

You will have noticed from the drawings that the walls are all of one-brick thickness throughout. To add strength to the longer back wall it is divided in its length and a brick partition built across the bunker from back to front. This gives two compartments to the bunker, enabling two different

let these covers fall into place.

Hinged lids are not advisable, for careless banging back of a lid will, in time, inevitably damage both the wooden top and its hinges. Instead, fit two pull handles one on each of the covers to enable them to be lifted out and replaced quite easily when necessary. The whole of the top can now be covered with roofing felt and the two covers similarly treated, allowing about 1½ins. overlap to prevent rain seeping through on to the fuel.

The front apertures are not hinged either, but slide in grooves. At the base of the two apertures, make a cement channel wide enough to enable the doors to slide in and out easily. These fasten very simply on a button fixture attached to the strut at the top, and a handle similar to the type used on the roof covers is fixed to each door to make for easy manipulation.

The whole job can be improved if the brickwork is finished off with rough cast (small pebbles and fine cement, washed or brushed on), and all woodwork painted black. (243)

A PHOTOGRAPHIC ALPHABET

O for—

Orthochromatic

THIS is a word which you will come across quite a lot in photography, for it is often marked on the side of film cartons and plate boxes.

It refers to the degree to which the enclosed material is sensitive to various colours in the spectrum. 'Ordinary' films respond to the 'colours of the rainbow' in a rather untruthful way, certain of the hues coming out too dark and others too light. This kind of material can be assisted by using a tinted piece of glass before the lens, called a filter, which helps to improve the rendering.

Certain films and plates have, as it were, the filter included in the emulsion and give a truer rendering of greens, and yellows—two hues which the ordinary material brings out very poorly. This improved material is called orthochromatic.

There is better material still, however, called 'Panchromatic'. This gives a very fair rendering of all the hues, 'pan' meaning 'all' and 'chromatic' denoting 'colour'.

P for—

Printing Paper

THIS is the general name given to a whole range of sensitive papers upon which a positive print can be obtained from a negative. The three main kinds are (1) Printing-out paper, (2) Gaslight and (3) Bromide paper.

With the first kind (unobtainable during the war but now coming back) you put the negative in a frame with a sheet of the paper at the back. The two are then put out in daylight and the picture slowly appears on the paper, which you can examine from time to time by opening half the back of the frame. When dark enough, the print is 'fixed'.

Gaslight paper (see earlier paragraphs) is printed by artificial light. Nothing in this case appears till the sheet is put in a developer, when the picture comes up like the image on a plate.

Bromide paper is in effect a very sensitive gaslight paper. It only requires a fraction of a second exposure and must be developed in a yellow light.

All these papers are made in various grades to suit different negatives and in a range of surfaces like smooth, matt (rough) and velvet (fairly rough). The great art in using printing paper is to find the correct grade of paper for the negatives in question.

Pin Holes

SOMETIMES when you look closely at a print you will see that it is covered with minute disfiguring black dots. An examination of the negative will show that it, too, is covered with dots, but dots of clear gelatine. These are spoken of as 'pinholes' and are caused by dust being on the film while it was being exposed. The light, of course, could not get through these tiny grains with the result that beneath each has been left a similarly tiny unexposed area, which in the fixer becomes a minute clear area.

Should the dots be white on the print, then the trouble has been dust on the negative while printing.

Dust is a definite thing that has to be guarded against during taking by occasionally going over the inside of the camera with a soft brush, slightly dampened.

Printing frames should be similarly treated and the face of all negatives given a good dust over before putting in the frame.

Plates

APHOTOGRAPHIC plate is a sheet of glass upon one side of which has been poured the sensitive emulsion and it

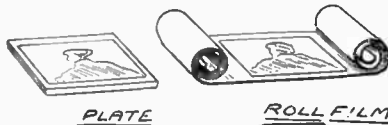

goes in the camera in a slide on holders—one plate at a time, except in old time magazine cameras.

Most amateurs use roll films, but plates have certain advantages which if you are taking up photography seriously you should know. Plates are, of course, more cumbersome and weighty to carry about, but against this it is possible to take one or two pictures and develop them, whereas with a roll film one must wait till six or eight have been taken.

Plates, too, seem less liable to get scratches and marks on them—a fault to which roll films are very prone.

A glass plate, too, is on the whole easier handled in development and during printing. All the various speeds and emulsions found on films are also found on plates; indeed, there is a greater range in the latter.

Plates, too, can be obtained in all sizes, 3½ ins. by 2½ ins. being a very popular dimension.

Q for—

Quarter Plate

THIS is not a type of plate but a picture size, quarter-plate material being

obtainable in both plates and films.

Quarter-plate is 3½ ins. by 4½ ins. and is just a quarter (area) of the old time whole-plate which for long studio photographers took as a standard. The

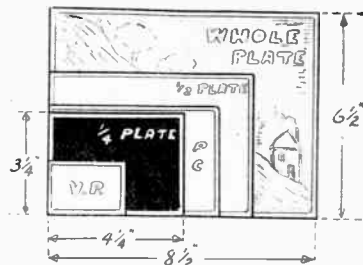

whole-plate is 8½ ins. by 6½ ins. Other sizes are half-plate and post-card. Miniature and semi-miniature cameras of recent years have brought in a whole range of sizes that do not fall under the old standards, e.g. 2½ ins. by 2½ ins., V.P.K., 35 mm. and other sub-sizes.

R for—

Reflex Camera

THERE is no doubt about it but that one of the difficulties of taking photographs with many cameras is getting sharp focus, for it is not easy for beginners, or indeed anyone unless they are taking pictures all the time, to judge distances accurately and quickly. A reflex camera is to overcome this trouble.

Here instead of having to judge a distance and set the estimated figure on a scale, you look down on a sheet of ground-glass the same size as the film. On this appears the picture in front of the lens and by revolving a ring, or

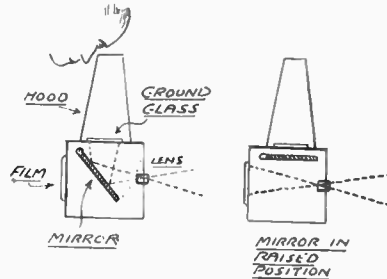

working a lever, the subject you want can be got absolutely pin-sharp in a second or so. This means it will be pin-sharp on the film, too, when you press the release.

The sketch shows how a reflex camera works, the mirror reflecting the rays from the lens up on to the ground glass.

You will probably wonder why the mirror doesn't get in the way of the rays going to the film and prevent the picture being taken. The secret is that the mirror swings up a split second before the shutter goes, the going up of the mirror and movement of the shutter all being one action actuated by your press of the release.

The final stage for silver soldering is that of SILVER FINISHING

A RECENT article in *Hobbies Weekly* gave some very helpful hints about silver soldering and now the present article goes a stage further and explains some processes regarding the finishing process. This process of restoring the colour and polishing silver articles after hard soldering is quite an art in itself.

When a silver or gold article has been hard soldered the joints will be covered with a hard layer of flux and oxide and the metal will generally be badly discoloured, which is due to the great heat used. All this must be properly cleaned off, the colour restored and the article

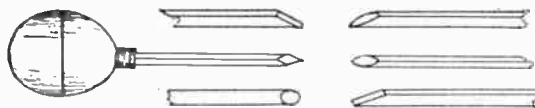

Fig. 1—Shapes of graters for cleaning

polished before it assumes the high class finish which we expect of gold and silver wares.

We will assume that the article we have to finish is made of silver. This is certainly the easiest to work, besides being much the cheapest of the precious metals. It is capable of receiving a large number of different finishes, varying from its natural white to many shades of colour, and also of various degrees of brilliance. The same treatment applies in most cases to gold articles also.

'Pickle'

The first job is thoroughly to remove all traces of flux and the hard crust of oxide which forms when soldering. This is done by placing the article in 'pickle'. Dilute sulphuric acid in the proportion of 1 part of acid to about 8 parts of water is the pickle mostly used by jewellers and silversmiths. Do not, by the way, forget to pour the acid slowly into the water when mixing and never the reverse way.

Before placing the article in the pickle remove any iron binding wire that may have been used to hold the parts together for soldering, as this will make a nasty stain if left on. Leave the metal in the solution just long enough to do the job—a few minutes will generally be sufficient and if the pickle is used warm the work will be done quicker and better.

Warm water can be used to make the

pickle or the glass or china jar containing it can be stood in some warm water. Never use a metal container for doing the pickling in.

Thoroughly wash the article in clean water after pickling and dry well. Jewellers generally use warm boxwood sawdust to place the article in, which absorbs any remaining moisture, afterwards brushing off any of the sawdust.

The next job is to clean any rough edges or other irregularities caused by the process of soldering. Small files of different shapes and sizes according to the nature of the work are most useful for this purpose.

A sharp pocket knife can be helpful in some awkward places, although this is not really a jeweller's tool. He much prefers to use different shaped graters, a few of which are shown in the drawing at Fig. 1.

We now arrive at what is probably the most interesting process—the actual polishing job where the metal begins to assume its true beauty whether it is a matt surface or a highly polished one that we desire.

To produce a first-class finish we shall need a few buffs which can be made quite easily. Strips of wood about 8ins. long, ½ in. thick and of various widths and shapes as shown in Fig. 2 are covered with different grades of emery cloth and soft leather strips. From medium to very fine for the emery cloth; and chamois leather is probably the best kind of leather to use. Stick them on with a thin glue and allow to dry well.

Unless the surface to be polished is very rough and badly scratched it will not be necessary to use the medium grade emery buff, but start with a fine one. Continue until all marks are removed, using the buff in one direction only.

We are now ready to start using the leather buffs. These are not used dry but must be charged with a polishing paste. Start with a mixture of pumice powder and thin lubricating oil well mixed and rubbed into the buff. Proceed with this until all the emery marks are removed.

It is then time to change to a finer

grade of paste, and for silver this can be putty powder (or stannic oxide as it is called) and oil. For gold articles rouge is usually employed although it can be used for silver if a warm tone is required.

Final Polish

For a final polish these two powders can be applied dry on a clean buff. The circular polishing buff described in a former issue of *Hobbies Weekly* is an excellent tool to use for the finishing process and the powder is again used dry on a wool buff or mop.

The polishing process can be stopped at any stage depending upon the type of finish required. Some articles look quite well in the rough state or with a matt finish. But it will be generally found that the very high polish will look best for most articles.

There is another very successful way of producing a matt finish which is very beautiful on silver. After using the emery buffs the work is finished with a slip of stone known in the trade as water-of-ayr stone (a good ironmonger should be able to supply this). Water is used as a lubricant on the stone and if the strokes are kept even a very pleasing



Fig. 2—Simple polishing buffs to make and use

finish can be attained.

It is not possible to polish all shapes of articles with a flat buff. A different method must be adopted for round shapes such as jump rings. Take about a dozen lengths of silk or wool and tie together at one end forming a loop which can be hooked over a nail. By holding the loose ends the article can be rubbed up and down the strands which are charged with polish in the same way as the buffs.

Only the fringe of the art of polishing and finishing precious metals has been treated in this short article. There are many other powders and polishing agents that can be used to obtain different finishes and it can be most interesting to experiment with these. Then by means of different chemicals it is possible to oxydise and colour silver to many delightful shades. (247)

Stamp Collecting—(Continued from page 364)

looking towards the centre of the stamp. There are designs on the 2 annas implying rejoicing crowds, on the 3½ annas a quill pen in an inkwell, on the 4 annas a very primitive plough, and on the 12 annas a spinning wheel. We illustrate the 2 annas.

No doubt readers of *Hobbies* have already noticed that the stamps of India

are not nearly so common as they were a few years ago. They are not likely to be either, for under the present constitution there are far fewer white people there so there will be fewer letters or parcels sent to this country.

Eire had a not very attractive design to commemorate the death of a poet, J. C. Mangan (1803-1849). France has,

on the other hand, a very nice portrait to commemorate Raymond Poincare. There does not seem, however, to be any reason for this for he was born in 1860 and died in 1934. As they have been giving us some portraits of famous Frenchmen lately it may be just one more of those.



Notes on New Issues

SINCE our last article on New Issues we have had some very attractive stamps adorning our letters. Although we cannot help reiterating that the United States of America is still issuing far too many new stamps on every possible occasion, the readers of *Hobbies Weekly* are lucky in that Mr. R. Gibbs sends specimens of these so they are available for illustration.

The Wright Brothers

First, we will mention the 6c. air stamp which shows portraits of the brothers Wright, Wilbur and Orville. They were born in 1867 and 1871 respectively. In 1903 they made a biplane, which is shown on the stamp and which for quite a long time was to be seen in the Imperial Institute in London. It is now back in U.S.A.

In this machine they flew for 59 seconds at the rate of 30 m.p.h.! (their first attempt was 12 seconds). It is an interesting air stamp but its claim to be the 46th anniversary of the first flight seems to be rather silly.

A Banker's Anniversary

Another stamp is for the 75th anniversary of the American Bankers' Association. It is a three-cents issue with the dates 1875 and 1950 on either side of the central picture. This picture appears to be inside a coin, for it shows the milling round the edge so we will assume that that is what it is intended to be. Inside one can see a picture of a factory and a farmstead, but whether these are to represent industry and agriculture is not very clear.

Then there is the three cents light blue, commemorating the sesquicentennial of the National Capital. It shows a

'Cannonball Express'. He started late in bad weather and was trying to make up time when a freight train suddenly appeared ahead. Jones told his fireman to jump clear to safety but he stayed on the footplate blowing his whistle and applying the brakes so the men on the freight train might have warning and time to jump clear of that train and so save themselves. He stayed to the end and when his body was recovered he was found still grasping the brake and the whistle. We seem to remember a popular song which also commemorated the event.

Currency Changes

There has been a change of currency in some of the West Indian Islands where they are using cents and dollars instead of pounds, shillings and pence. One of these is Barbados. Although some of her stamps in the past have been pictorial, most of them have been of the old chariot type.

Now she has twelve new pictures to give us. Each has a small medallion portrait of H.M. King George VI as well as the picture, that is except the highest value. The 1c. shows a picture of the old guns on Dover Fort, the 2c. is illustrated here and shows a picture of the breeding of sugar.

Breeding Sugar

Quite a number of people seem to think that plants just grow from a seed which in their turn produce seed and so on. But there is quite a lot more than that. Man has had to work very hard to produce the type of seed he wants for a certain type of soil, or that he wants in a certain kind of climate. And here you see the way in which some of this work is carried out. Notice the bags which

monument to Nelson, but this appears to be rather doubtful as another island lays claim to have the particular oldest statue.

The 6c. is to us a very curious scene as it shows a native throwing a net from the beach into the sea. The way in which the net is entering the water, fully stretched out, should be noted. If we tried it then the net would be all of a heap and no fish would be caught.

Flying Fish

The inter-colonial schooner shown on the 8c. adds one more to our collection of beautiful sailing ships. How many more stamps can you think of which have



The Inauguration of a Republic

sailing ships on them? The 12c shows the flying fish which is such a novelty to those who sail for the first time in these waters.

The fish make spasmodic leaps or skip from the water by means of their enormously enlarged pectoral fins. These are not flapped like the wings of birds, but merely used as parachutes, the fish supplying the motive power by a strong flick of the tail as it leaves the water. Generally the flights are close to the water, but occasionally they come right on to the deck of the boat, and sometimes go as much as 150 yards on a flight.

The 24c shows the old main guard garrison and the 48c. a view of the Cathedral. The 60c. gives us a view which is unique in philately—careenage. The picture illustrates what the word means, for there are some boats lying on their side so men can clean them and repair them. The \$1.20c. shows a map of Barbados with some wireless masts and the \$2.40c. the Royal Cypher and the Seal of the Colony. This is a very attractive set and one which is not very dear to buy.

India commemorates the Inauguration of the Republic by a set of four stamps on each of which there are two natives

(Continued foot of page 363)



Casey Jones, railroad engineer

Sugar Cane of Barbados

Flying Fish off Barbados

large picture of the Statue of Freedom, which is on the dome of the Capitol in Washington. The American specimen we have chosen to illustrate is one that has been issued to honour the Railroad engineers of America. The stamp shows two very different types of locomotive; the one on the right is a present day type while that on the left is fifty years old.

In the centre there is a portrait of Casey Jones who 50 years ago was driving the

have been placed over some of the flowers to keep them pure.

Buildings and Statues

There is nothing much to say about the 3c. They are public buildings about which one cannot enthuse unless they are either very old or very famous. The 4c. is an upright shape and shows a statue of Nelson. Some of the Barbados stamps

Plans for a model of the Inca raft 'KON-TIKI'

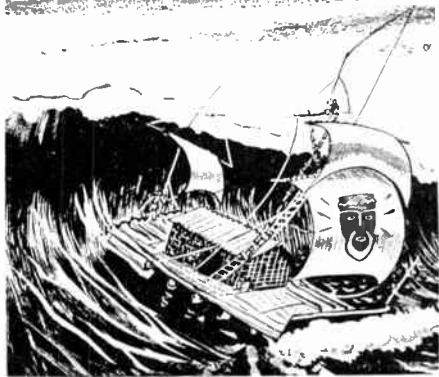

The Craft which drifted from Peru to the South Sea Isles

Thos. Heyerdahl, the builder of the 'KON-TIKI', believed that the South Sea Isles were first populated by a fair-skinned race, who fled from Peru by raft when the Incas conquered them about 1,000 years ago. To demonstrate that his theory was plausible he and five companions, five Norwegians and a Swede made the same journey on a balsa wood raft of the type which the ancient inhabitants of South America are known to have used and which the Incas inherited from them. It is an epic story which you should read and commemorate by making a model of Heyerdahl's 'ship'. Four sheets of plans size 20ins. by 15ins. 2/8 post free.

MODEL CRAFT LTD.
77 (F) GROSVENOR ROAD, LONDON, S.W.1

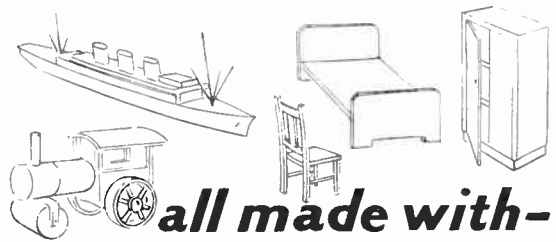

all made with-

Croid
THE MODERN GLUE



Aero Glue. The strongest glue in the world.

Universal Glue. Cold glue ready for use from tube or tin.

Waterproof Cement. Specially prepared for balsa wood.

Whyte Paste. For paper work and photo-mounting, etc.

CROID LTD., IMPERIAL HOUSE, KINGSWAY, LONDON, W.C.2



OVER 5,000
ex-R.A.F. Apprentices

have reached commissioned rank



So may you — one day.

If you are chosen to be an R.A.F. Apprentice you will be trained for a skilled trade, and continue your general education. You will have far more opportunities for sport than most boys. You will be well fed and cared for, and receive good pocket money. And you may end up not only with a commission — but with a flying commission.

Send the coupon, it will not commit you to anything. It may lead to great things.

TO:—AIR MINISTRY, DEPT. HS.44G,
VICTORY HOUSE, KINGSWAY, LONDON, W.C.2.

I am between 15 and 17½. Please send details of R.A.F. Apprenticeships.

NAME

ADDRESS



EXTRA CASH
IN SPARE
TIME

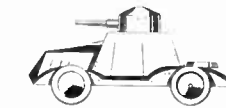

A fascinating way of earning extra cash in spare time from odd pieces of lead. Small Outlay—Large Profits. Sample mould 3/6d. Casting moulds, deep-cut and ordinary type Aeroplanes. Soldiers, Farm and Wild Animals, Cars, etc. Stamped envelope for full list. Illustrated Catalogue 9d.

MASTERCRAFT MOULDS
69, ST. MARKS ROAD, HANWELL, LONDON, W.7

NICOTEXIT

THE GUARANTEED SMOKING DETERRENT

- ★ POSITIVELY STOPS SMOKING IMMEDIATELY and for several hours after each application. Purchase price refunded if it fails to do so.
- ★ ONE BOTTLE IS USUALLY SUFFICIENT to establish control of smoking in any form. It is not poisonous.

Invaluable to all who smoke too much

5/6 Per Bottle
Post Free

Obtainable only by post from Sole Concessionaires for Great Britain:—

THE NICOTEXIT COMPANY (Dept. B.6.)
62 High Street, Croydon, Surrey

PEDAL MOTOR CAR

This new simplified chart enables any amateur to make a strong smart modern Pedal Car suitable for children 2 to 5 years. Complete plan and instructions

2/6 post free

Wheels and other parts for Pedal Cars and Dolls Houses available. Send stamped addressed envelope for list

ZIMPLAN 88 WARE ROAD
HODDESDON, HERTS.

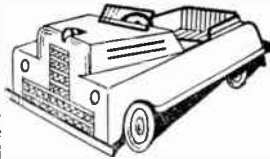

NEW PLYWOOD CASES!

Make IDEAL Tool Boxes. 16½ × 6½ × 12ins. Painted khaki. 3/10 each; or filled with plywood, 2/6 extra. All post paid.
Figured Oak Plywood. 24 × 24 × ½ ins., 5 for 35/-; 24 × 24 × ¾ ins., 2 for 25/-, post paid. List of Plywood Sheets and Offcuts, 2d.
JDD. Storage, Dept. H., 71 Northcross Road, SE.22.
BRixton 7441/2

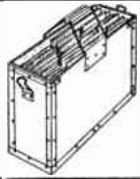

THE BOLSTER HOME WATCH AND CLOCK REPAIR OUTFIT

These precision jewellers instruments, include watchmaker's magnifying eyeglass, finest watch tweezers, set watchmaker's screwdrivers, watch and clock oil, oilers, dusting powder, clock brush, plus illustrated instructional manual for the amateur. In container 12/9 post free.

Senior Outfit includes everything above, plus watch jewels, luminous compounds, dial renewer, jewellers rouge, explanatory book. Price 21/- post free.

BOLSTER INSTRUMENT, (Dept. H. W.), 5a Station Parade, Ashford, Middx.

BUY A FOYLES HANDBOOK!

Leatherwork • Basketry

by F. J. Christopher . Price 2/6 each

From all Booksellers or the Publishers

W & G FOYLE LTD
119-125 CHARING CROSS ROAD LONDON WC2

BE STRONG

I Guarantee, as a Builder of Men for 22 years, to give you 10 to 25 inches more Muscle in 30 days—or money back. Full details of famous 4-in-1 Course, recommended by 'Health & Strength' since 1928, sent under plain cover on receipt of 1d. stamp. Lionel Stebbing Institute (HB/16), 28 Dean Road, London, N.W.2. Established 1928

YOU CAN BECOME A HANDICRAFTS INSTRUCTOR

Experience not essential

Men who enjoy making things in wood or metal can turn their hobby into a well-paid, permanent and interesting Career. Short hours, long holidays, and security in a job you would really enjoy, can be yours if you become a Handicrafts Instructor. Let us send details of the easiest and quickest way to get the necessary qualification.

We definitely guarantee "NO PASS—NO FEE"

If you would like to know about our unique method of preparing you for one of these excellent appointments, write today, and we will send you our informative 175-page Handbook—free and without obligation. Mark your letters "Handicrafts Instructor".

BRITISH INSTITUTE OF ENGINEERING TECHNOLOGY

595 Shakespeare House
Stratford Place, London, W.1

BIET

EXCITING NEW FILM STRIPS

★ DENIS COMPTON'S 'MY CRICKETING DAYS' ★

'BRUMAS' THE LOVABLE BABY POLAR BEAR

SPECIAL PRESENTATION BOX COMPLETE WITH CINE VIEWER **5/-** EACH

From all good Toy and Sports Shops or post free from

FILM STRIPS EDLESBORO Nr. DUNSTABLE

P.S. Why not send for complete list of films from 10/11 (Battery Model) 6d. to 2/6 and details of the WONDER Home Strip Projector. 19/6 (All mains Model)



Swann-Morton
CRAFT TOOL

The perfect, razor-sharp utility tool for modellers in Balsa Wood, also for Biologists, Students, Commercial Artists, Photographers, etc. 2 interchangeable blade shapes. Handle and two blades 2/- post free. Spare blades six for 2/6 post free. Send P.O. to

FAMILY PRODUCTS
92-94 BRADFIELD RD.
SHEFFIELD 6.
Trade enquiries invited



BRANCHES
LONDON

78a New Oxford St., W.C.1
(Phone MUSEum 2975)
87 Old Broad Street, E.C.2
(LONDON Wall 4375)
117 Walworth Road, S.E.17

GLASGOW
326 Argyle Street
(Phone CENTral 5042)

Head Office & Factories—HOBBIES LTD., DEREHAM, NORFOLK

MANCHESTER
10 Piccadilly
(Phone CENTral 1787)

BIRMINGHAM
14 Bull Ring
SHEFFIELD
4 St. Paul's Parade

LEEDS
10 Queen Victoria Street
(Phone 28639)

HULL
10 Paragon Square
SOUTHAMPTON
25 Bernard Street

BRISTOL
30 Narrow Wine Street
(Phone 23744)

**VIKING
SHIP
PATTERNS**

See page 353

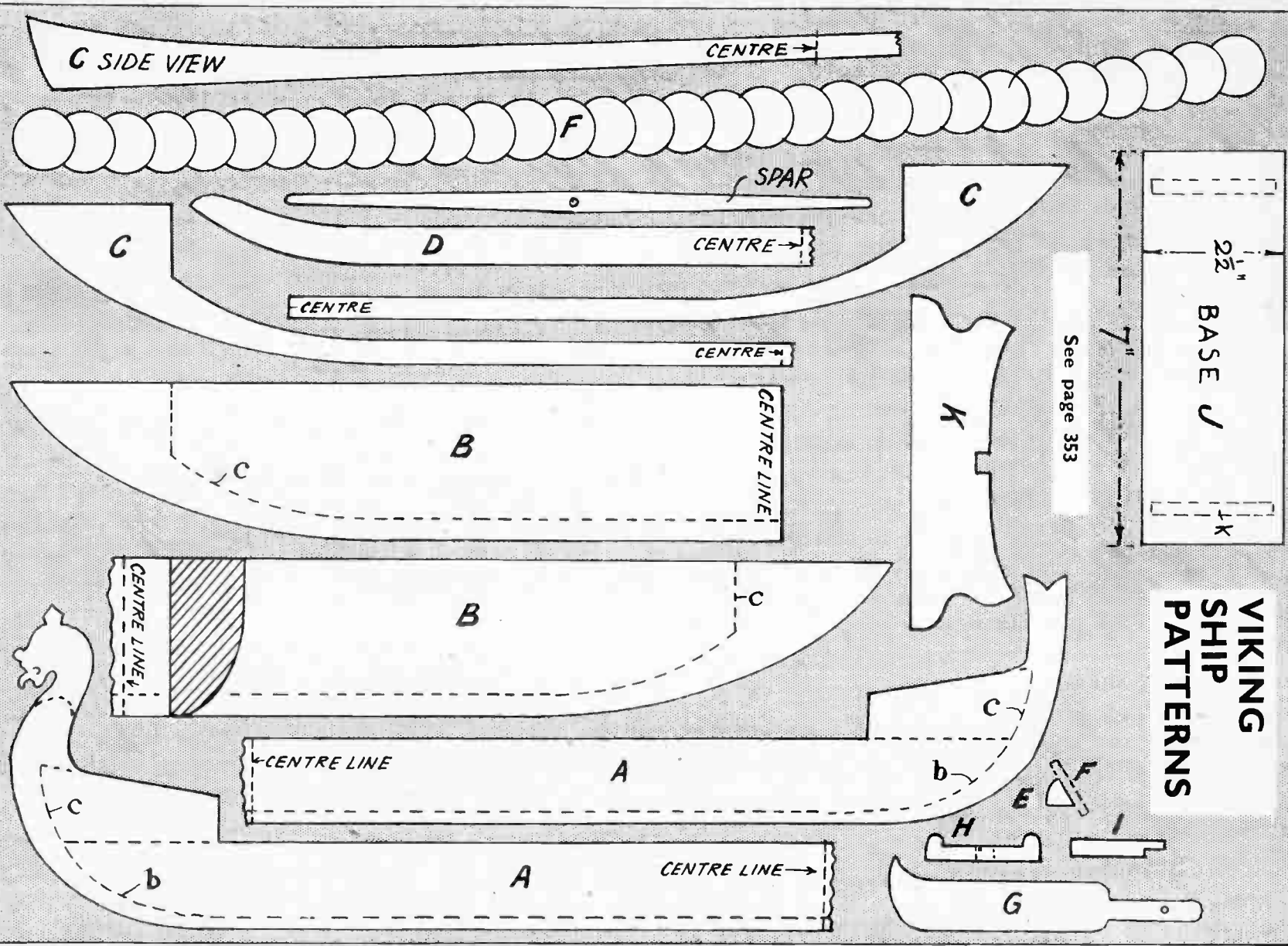
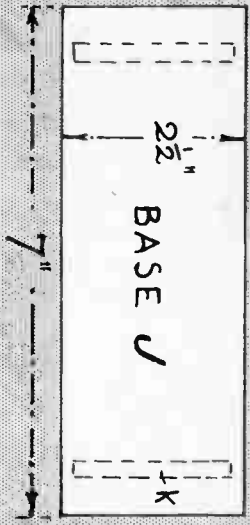

'PERSPEX' and 'CRINOTHENE'

for the handicraft worker

'Perspex' acrylic sheet is available in transparent, translucent and opaque colours in a wide, useful range of sheet sizes and thicknesses. It can be fabricated as easily as wood or non-ferrous metals, using standard equipment.

'Crinothene', a decorative plastic sheeting supplied in many attractive colours, is ideal for lampshades.

For further information, please apply to the nearest I.C.I. Sales Office.

'Perspex' is the registered trade mark of the acrylic sheet manufactured by I.C.I.

'Crinothene' is the registered trade mark of the polythene sheet manufactured by I.C.I.

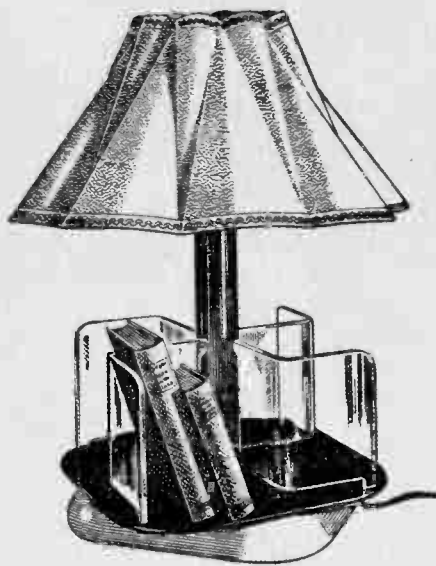

IMPERIAL CHEMICAL INDUSTRIES LIMITED, LONDON, S.W.1.

P423

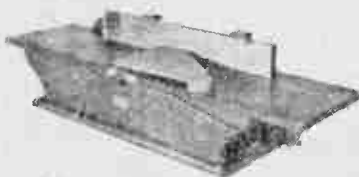

6" and 9" JOINTERS

Mounted on high quality ball bearings. Operation at 8,500 R.P.M.

Fixed retail prices, postage paid in Great Britain:

6": £10/15/- — 9": £15/5/-

LIBERAL TRADE DISCOUNTS

'AHOR HANDY MACHINES'

will soon be introduced to England. Range is of 14 various woodworking machine tools, which includes 6" and 9" jointers as illustrated, 6" planer, circular and band saw benches, single and double vertical spindle machines, wood lathe, vertical and horizontal band sanders, etc.

All 'AHOR HANDY MACHINES' are mounted on ball bearings, and fully guaranteed. With a nice french finish, they are manufactured in bulk, and so cut in price that the marvellous 'AHOR HANDY MACHINES' are the cheapest in the world for their size, being as good and effective as the most expensive.

Over 15,000 machines are already in service throughout the French Empire, and are used by hobbyists, farmers, craftsmen and manufacturers. Several hundreds of French Schools are already equipped with 'AHOR HANDY MACHINES' and over 1,000 customers have written enthusiastic letters. For instance, the illustrated 6" jointer is the only machine of its kind in the world to allow single cuts of over $\frac{1}{8}$ " on hardest woods, with a motor of $\frac{1}{2}$ H.P. only at 8,500 R.P.M.

'AHOR HANDY MACHINES' are very effective for all kinds of woodworkings: toys, cabinets, furniture, joinery, and even light carpentry. Last exhibit in Paris Fair was done in a 17' x 14' barrack, entirely made by 'AHOR HANDY MACHINES'.

'AHOR HANDY MACHINES' permit savings to such an extent that they pay for themselves from the first day of using.

Illustrated literature, with characteristics and performances, free of charge on request. Every reader who writes before 30th September will be notified personally in time for the next demonstrations in London or large provincial towns, and will receive a coupon for 5% discount on every order placed before the end of year.

All enquiries to : { **AHOR HANDY MACHINES — H —**
25 bis, rue Emile Duclaux, SURESNES (Seine) FRANCE

Hobbies

WEEKLY

CONTENTS

	Page
Garden Carrier	- - 369
Reader's Photos	- - 370
A Door Gong	- - 371
Rubber Patter Prints	372
Ship Modeller's Corner	373
Shoe-cleaning Stool	374
Old Curiosity Shop	
Model	- 375
Handy Map Case	- - 376
Electrical Queries	- 376
Toy Fruit Stall	- - 377
Kitchen Gadgets	- - 378
Home-made Garden	
Roller	379
Book-binding	- - 380
Modern Fire-screen	- 381

September 13th, 1950

Price Fourpence

Vol. 110 No. 2863

A HANDY SHOPPING OR GARDEN CARRIER

THIS is a simple version of the popular shopping carrier, which can easily be made at home, and be quite as efficient as the commercial article. Apart from its use for shopping purposes, it can be utilised in other ways as a carrier, carting dead leaves in the garden, for instance, or conveying small quantities of vegetables from allotment to home.

Large Wheels

A pair of 6in. rubber-tyred wheels will be required, obtainable almost anywhere now, and for these a wood axle bar of 1½in. square hardwood will be required, shown in Fig. 1. A fairly tough wood is necessary here for the axle screws, on which the wheels turn, to grip strongly enough. Bore holes for these screws in the exact centres of the ends of the bar.

At the back of the bar chisel out two grooves, ½in. wide and ¾in. deep, for the handle-bars to enter. Space these grooves just 5ins. apart. In the front of the bar a central wooden leg is fitted to keep the carrier on an even keel as it were, when at rest.

The Rest

Cut this from any thick wood to the shape shown and at the rear end of it cut a ½in. thick tenon, ¾in. long. Cut a suitable mortise to fit this tenon in the centre of the bar, in front. Note that the front edge of the leg is cut to a slope, shown quite clearly in the finished view of the article.

Glue the leg in place, and ensure a good fitting by making the joint a close

one and well gluing it. To strengthen this part screw over the leg and bar, underneath, one of those useful steel furniture plates, as at (A). These plates, in several patterns, can be bought at almost any hardware shops. One ½in. wide and about 3ins. long will serve nicely.

Handle Portion

Fig. 2 shows the handle-bars. These are cut to the length given from ½in. by ½in. wood. For 1½ins. up from the bottom ends reduce the bars to half thickness to fit the grooves already cut in the axle bar.

At the top, and about midway, fix across 5in. lengths of ½in. round wooden rod. These can be quite securely jointed across with round-headed brass screws. Glue and screw the handle-bars firmly to the axle, then fit the rubber-tyred wheels on.

The Carrier

The carrier box or basket is a separate fitting. It is shown, with dimensions, in Fig. 3. The ends and bottom are cut from ½in. wood, or, perhaps, wood slightly thinner, say, ¼in. would do.

The front and back are cut from plywood or a good quality substitute board, as may be available. It will be

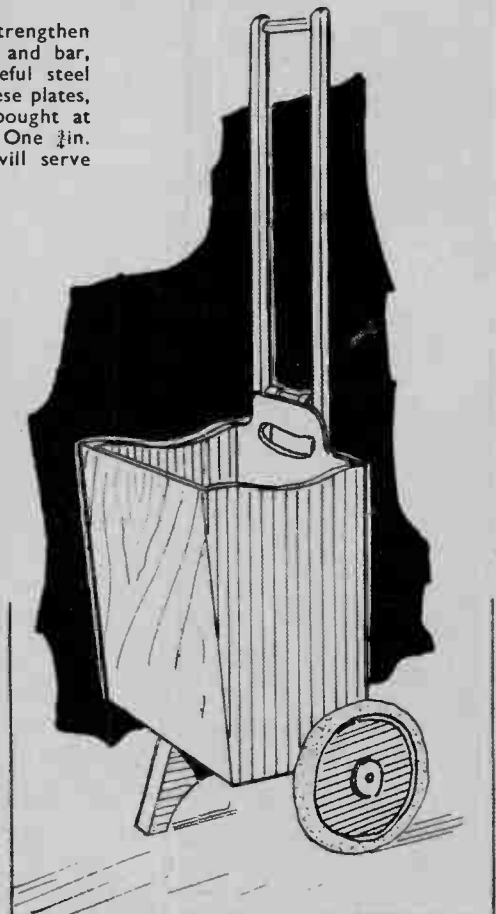

All correspondence should be addressed to The Editor, Hobbies Weekly, Dereham, Norfolk.

seen from the diagrams that the back of the box is 2ins. higher than the front. In this an opening for the fingers is cut out, 4ins. long and 1in. wide. Give the edges a slight curve, as shown.

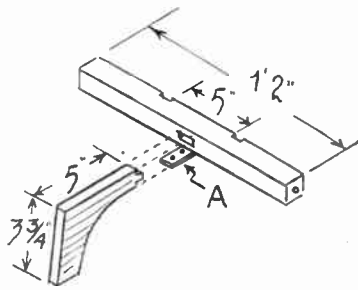

Fig. 1—Axle bar and front foot

MATERIAL LIST

Axle bar—14ins. by 1 1/2ins. by 1/2ins.
 Leg—2in. by 3 3/4ins. by 6 1/2ins.
 Handle-bars (2)—1/2in. by 3in. by 2ft. 9ins.
 Cross bars—10ins. of 1/2in. round wood rod.
 Box sides (2)—1/2in. by 8ins. by 12ins.
 Box front—13ins. by 12ins. plywood.
 Box back—13ins. by 14ins. plywood.
 Box bottom—1/2in. by 7ins. by 11ins.

The ends of the box are now glued and nailed to the bottom, and the front and back glued on and strengthened with the addition of a few small round-headed brass screws. When the glue is hard give the box a thorough rubbing all over with medium glasspaper, paying par-

ticular attention to the edges of the fingers hole. The box should now stand firmly enough on the leg of the carrier.

Prepare two bent metal fittings. These are 3in. pieces of brass or iron

The box should not need any additional fitting and can be lifted up until the metal additions at its rear can drop over the top cross bar on the handle. In this position it will come about level

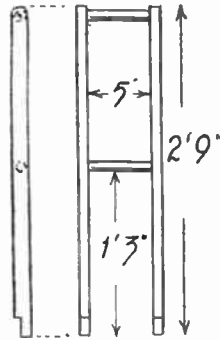

Fig. 2—Main framework and handle

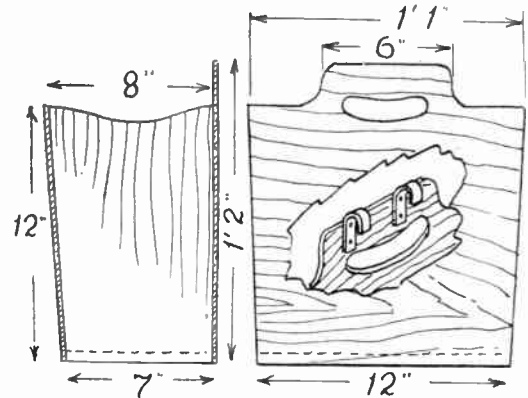

Fig. 3—Shape and parts of the carrier portion and handle

bar, 1/4in. thick and about 1/4in. wide, or thereabouts. Some 1 1/4ins. of these are to be screwed to the rear of the box, and the remainder bent over to just drop easily on the lower rod across the handle-bars, as in the inset, Fig. 3.

It is important these metal fittings should be just 5ins. apart, they will then keep the box in the central position, otherwise it may ride sideways, and foul the wheels.

with the shop counter and be convenient for packing the goods in. The box, well packed, it is lifted off and set to its former position over the middle rod for carrying away.

The whole article can be varnished or painted, as preferred. Probably a light stain before varnishing will be preferable if a white wood is employed for making. Use a varnish which will stand up to the weather and everyday usage.

Miniature Buildings for the Garden

PICTURES in these pages suggest from time to time there is no end to the variety of pastimes enjoyed by craftsmen. Here are illustrations of two similar types of work each carried out unknown to the other. The photograph at the top was taken in the back garden of Mr. S. Simmons, a retired master builder of Bridgend, Glam. He has constructed attractive miniatures from broken masonry and chipped tiles, and apart from the model of the London Tower Bridge shown here there are others of a lighthouse and an old Cotswold cottage.



THE one actually at work in the lower picture is Mr. Fred Slaymaker of Clensham Lane, Sutton, Surrey, who has built a scale model village in his garden. It is complete with church, castle, windmill, the 'Coach and Horses' Inn, post office, houses, etc. His cottages are historically accurate, there are roads and gardens around the village and even a flowing stream and its waterwheel.

Instead of the usual noisy bell you can easily fit A DOOR GONG

MANY people object to the strident ringing of the average door bell, and wish for something a little less noisy and nerve racking. The door gong, illustrated, would meet this desire quite satisfactorily, emitting the pleasant sound of a clock gong, when the pull is pressed.

What is required for making this article are an old electric bell, and a clock gong. Many readers may have an old bell, or could, of course, make use of one already in service. A clock gong, if not in possession, could possibly be obtained cheaply from a local clock repairer or bought new, not being an expensive article. For the case a small quantity of fretwood is required, or cheaper wood possibly.

Case Parts

Make the case first. A front and side view (sectional) are given in Fig. 1, less the cover which hides the electric bell works. The width given will, most likely, suit the gong, but it is as well to purchase this beforehand, then if the width is not quite enough to accommodate it, a little can be added. The upper part of the case constitutes not only a mounting for the gong, but also a sounding board to amplify the tone.

The backboard should be long enough to allow ample room for the bell works to be screwed to it, with room each side for a wooden cover to fit over. Cut the backboard from $\frac{1}{2}$ in. thick fretwood. To

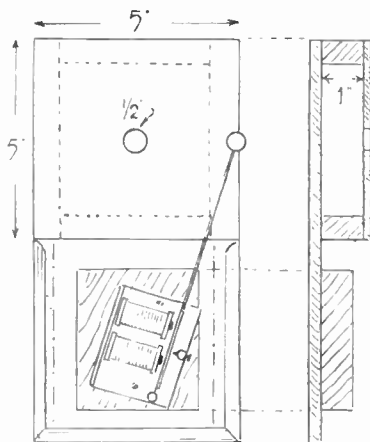

Fig. 1—Front and side view

the top portion glue a framing of $\frac{1}{2}$ in. by 1 in. strips of wood, as shown by the dotted lines.

Over this glue a piece of $\frac{1}{2}$ in. wood, preferably of pine, as the sounding board. In the absence of anything better, a piece of well glasspapered chocolate box wood could serve. In the centre of it bore a $\frac{1}{2}$ in. hole.

Take the bell works, cut off the arm on which the bell is mounted, then cut a wood block a trifle larger on which the

works can be screwed. The thickness of this block is important, as it, when screwed to the backboard, should bring the works to the correct height for the clapper to strike the gong.

Fixing the Gong

Fix the gong in place by screwing the brass block, to which it is attached, to the framing behind the soundboard, as seen in the general view. The exact thickness of the block can then be accurately estimated.

A little adjustment may be necessary here for the clapper to strike the gong most soundingly, the necessary battery and push being connected up, and the bell works tested. All being satisfactory, the gong can be removed for the time being, also the works, while the case is finished.

The side and bottom edges of the backboard are neatly bevelled off, then the dimensions of the wood cover over the works can be assessed. This cover, Fig. 2, is just a bottomless box, made up from fretwood. $\frac{3}{8}$ in. to $\frac{1}{2}$ in. thick.

The Cover

It should extend each side nearly to the bevelled edges, about where shown in Fig. 1 by the dash and dot line. It butts up against the lower side of the soundboard above, and comes level with the bevel of the bottom edge of the backboard.

Make up the cover to those dimensions and the inside deep enough to admit the works comfortably. In the front saw out a slot for the wire of the clappertowork in.

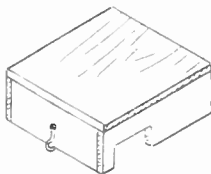

Fig. 2—Box cover

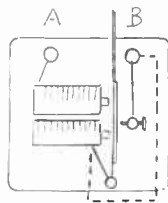
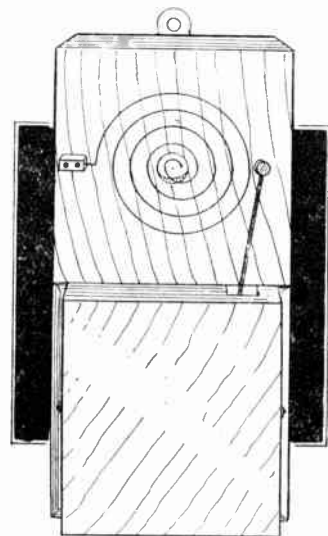

Fig. 3—The works

backboard one side, with a hook and eye fastener the other side. The latter fitting might be preferred of the two, as being less likely to shake with vibration.

The whole of the woodwork can now be well glasspapered, and the completed article stained walnut colour and varnished. The front of the sound box should be unstained, but can be varnished. At the top of the case a brass wall plate should be screwed for attachment either to the door, or wall of the



passage, or wherever the gong is to be positioned.

Battery and bell push are fitted, of course, as in the usual practice. It will be necessary, by the way, to cut a notch in the works' cover to allow the connecting wires to emerge, that of course, will be obvious.

For Single Note

As now fitted, the gong should reverberate when sounded, but to those who might prefer a single stroke some slight alteration to the wire circuit must be made. Quite a simple alteration.

A diagram of the usual connections is given in Fig. 3, from which it will be seen that one wire from the magnet goes to terminal (A), the second wire from the magnet going to the armature, and a third wire connecting the contact breaker to terminal (B). Leave the connection to (A) alone, and take the magnet wire leading to the armature, direct to terminal (B), as shown by dotted lines. This will do the trick.

Cleaning Gramophone Records

HERE is how to clean gramophone records and make old ones sound like new. Mix two parts of white vinegar to one part of light oil and stir well. Paint the records with it and leave for two or three minutes, then wipe with a clean rag and leave to dry. It will be found they play very much better.

A variety of lino-cuts can be made with RUBBER PATTERN PRINTS

THE business of making lino-cut blocks is a very interesting art-hobby, but it has been described so many times, and is practised so extensively in schools, etc., that it is not a novelty. We mention it, however, because in taking up the hobby the participants have, in their mind's eye, the familiar rubber stamp much used in offices.

It is hardly practicable to gouge out a design in thick rubber as one does in soft linoleum, but interesting work may be done with sheet rubber taken from motor-car inner tubes. (Cycle tubes are a little too thin).

The sheet rubber can easily be cut with scissors and then mounted on a wooden block (Fig. 1). Naturally, very fine work should not be attempted. Keep to bold silhouette designs, as illustrated at Fig. 8. Remember that even the most weird and wonderful abstract shape as at Fig. 9 will, if repeated, as at Fig. 10, usually form a pleasing pattern.

The Design

A design is worked out on paper and then this is sketched on a sheet of rubber (a piece of opened-out inner tube). The rubber is then cut with scissors, just like paper. Small inside openings can be managed by pinching the rubber and then cutting across with scissors, though small parts can be cut out after the block is mounted. It is possible to cut out the various motifs

used, follow very carefully the instructions on the tube. In many cases a layer of the cement has to be applied, first, to each of the surfaces and allowed to dry. Glue under pressure.

With a chisel or knife, make a cross at the top of the block (Fig. 3) and bear this always in mind to avoid the disappointment of having an upside-down print.

Rubber-stamp Ink

As regards ink, the usual office rubber-stamp pad may be used, but one can also employ water colour or powder colours with a little flour paste added to give 'body'. Oil paint (of the stiff kind sold for artists' use) can also be tried, so can printers ink (often sold, by art suppliers, in small tubes for amateurs' use).

The water paints can be brushed on with a wide brush, taking care not to have the paint too sloppy. Experience is the best guide here. The old paints can also be applied with a brush. Printers ink is best applied with a small rubber roller such as is used by photographers. Get a piece of glass (plate glass if at all possible) and lay a streak of ink across one end. Then roll out the ink until the glass has a uniform film of ink. Then either press the stamp on the ink or run the inked roller over the rubber stamp.

Suitable Paper

Practically any kind of paper can be used for printing except, perhaps, the

every impression to be exactly the same as regards definition, alignment and colour. It is the variations which give hand-done work its charm and distinguish it from mass-produced machine-made materials.

Monogram Marking

In cutting the monogram (Fig. 5), it will be easiest to cut a T and a C separately, then cut the C, as shown in Fig. 7 and remount the lot on the block. This is another example of the principle illustrated in Figs. 11 and 12.

Oil paint and printers ink are easily removed from the block with a little paraffin oil, so that the same block can be used for printing in different colours. One can have alternate stampings in, say, red and black. (Do all the red stampings first). One can stamp one design over another. In Fig. 14 (note that these are very much reduced in size from the originals) we see a block consisting of seaweed shapes which can be printed in blue-green. Another block, Fig. 14, has been cut in the form of a fish and this is stamped, in a different colour, over the seaweed (or, to vary the design), the seaweed can be stamped over the fish (Fig. 15).

Owing to limitations of space, Fig. 15 shows just one fish on a small portion of seaweed, but the main idea is to have a background possibly several square feet in extent and to have a number of fish, not evenly spaced, but in groups and at varying angles. Try them out in

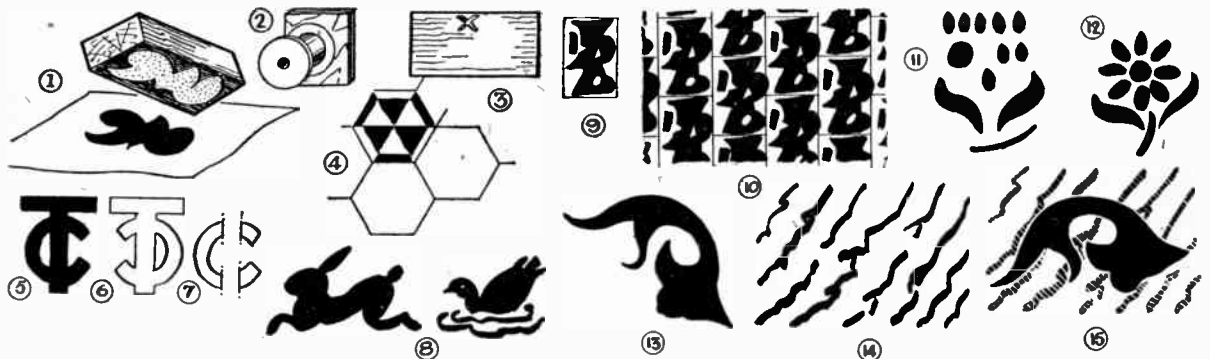

first and then assemble them on the block, as in Figs. 11 and 12.

Sometimes you will proportion your design to fit an existing block of wood, though it is very easy to cut a small pad of wood to fit the block. The thickness of the block is not critical. So long as it is easily held the thickness does not matter. Cotton reels make useful handles, as shown in Fig. 2.

Waterproof Cement

A waterproof cement is essential for mounting the patterns on the wood. Rubber cement is useful. Whatever is

very shiny and hard varieties. Printing can also be done on cloth (for head scarves, etc.), using fabric printing inks. Single impressions (on paper) make interesting pictures for framing and for such things as bookmarks, bookplates, monograms, etc. Remember to plan lettering in reverse, as in Fig. 6. Overall patterns (i.e., a simple motif repeated dozens of times on a 'half drop' arrangement—see Fig. 10—or on a honeycomb pattern—Fig. 4, can be used for making patterned papers for amateur book-binding, wall papers, and so on.

Do not expect, in an overall pattern,

various positions and distances for the best effect.

Guide Lines

In connection with Fig. 9, it should be pointed out that the rectangular outline merely indicates the area of the wood on which the design is mounted. When using such a 'half-drop repeat', as at Fig. 10, it is an advantage to rule guide lines faintly in pencil, but when using an hexagonal block, as at Fig. 4, no guide lines are needed. Those that the artist has drawn are merely to show how the pattern repeats.



The SHIPMODELLER'S Corner



In this, the opening article of a new series, let us consider those details that make a good ship model. They are, in my opinion, sincerity, accuracy of technical details, and good craftsmanship.

The first, sincerity, is often lacking in models that are splendid examples of craftsmanship. There is something absent and the first thought on seeing such a model is, 'What fine workmanship' or 'What a beautiful ornament it would make'.

On the other hand is the model whose workmanship is not above average, sometimes even mediocre. And yet the first reaction to this model is something like this:—'What a fine ship, she looks almost ready to sail'.

Where lies the difference in these two models? I would say that one has sincerity, while the other lacks it.

Now, presume you have decided on your ship and obtained your kit or plans. Before commencing work think around your ship and its history. Try to see your ship as she was in her original

know and love the sea and their books, more enthralling than any thriller are full of the romance and mystery of the sea.

To learn something of the daily life, on shipboard, of the early sailors read the

The Ship Modeller's Corner A New Regular Feature By 'Whipstaff'

books of Smallett, Capt. Marryat and Daner and other worth-while writers of the sea.

If you approach your model in this way, believe me, you will gain added interest and enjoyment in the building of your little ship. You will put into it something of your own enthusiasm, some of the knowledge you have gained and, instead of a model of wood, cord and paint, you will have a live little model that has in her very appearance something of the spirit and romance of the sea.

Our second point, Accuracy of

To avoid this sort of error is not difficult, for there is plenty of accurate information available for the modeller who is prepared to do a little research work on his own. And very interesting such research can be.

It is because we know that the large majority of amateur ship modellers have neither the time nor opportunity for such research that this section of *Hobbies Weekly* has been called into being.

This is your corner and we invite you to make full use of it. Have you a problem or difficulty with your model? Or would you like to know something of the history of the original ship? Do, please, write in and let us help you.

The articles and notes appearing in this page of our magazine will cover all subjects connected with ships and ship models of interest and practical use to model makers. Such information, based on personal research and reference to the works of the leading authorities in Maritime History and Naval Architecture, will be as accurate and reliable as present day knowledge can make it.

Articles will also cover home-made tools, methods of construction used by amateur and professional model makers in obtaining their result. Our aim is to make this feature of such practical use, that even the beginner can turn to making his first piece of work confident that he can complete a worth-while representative model.

Hobbies Old-Time Ship Designs while, of necessity simplified to enable anyone to build a satisfactory model, are in the main details, historically accurate and form an excellent basis on which the more advanced modeller can use his skill and knowledge to make a model of real value.

In future articles I will deal with separate kits in the Hobbies range, incorporating details based on my own research when building these particular Ship Models.

I would suggest you obtain a loose-leaf book, quarto size. Cut out each article when it appears and paste on one of your leaves. Insert the leaves in alphabetical order and within a few months you will find your book growing into a unique and valuable work of reference, always at your hand to help you build finer and better models.

On the point of craftsmanship, given the right tools and material, together with patience, it is a matter of practice. You will be surprised how quickly skill will develop.

And now, a hearty welcome to all ship model makers, to their own corner.

(231)

Something New in Model Boat Building

By D. H. Matheson, Pub. Hutchinson's

THIS is a book to delight the heart of any young model maker and, indeed, older modellers with young sons. The author has provided us with eighteen models ranging from a South Sea Out-rigger canoe through the pageant of shipping to the modern Electric Launch.

A volume that really lives up to its name. It is different, its great attraction being that while all models are simple to construct, being designed especially for the junior modeller, they are all working models. Tools required are few and materials cheap to obtain. There will be no difficulty in the building of any model from the clear instructions and drawings.

prototype. Use your imagination to visualise yourself standing on her deck, feeling the spray on your face, hearing the wind humming through the rigging and looking up at the sails swelling outward, full of wind.

Conjure up in your mind the vision of her captain and crew, their life on shipboard both above and below decks. Travel with them on their voyages and share in their experiences. You can do, you know. Use your local library and read the books of such writers as John Masefield, Keble-Chatteerton, Frank Bowen and Basil Lubbock. These men

From an educational and instructive viewpoint this is one of the best juvenile books I have seen. The range of models covers many different methods of ship propulsion from sail to steam and even jet propelled and electrically driven models. Whatever the interest of the young craftsman, whether small sailing craft, power boats or a submarine that actually submerges, he will find it between these pages. I believe even the older modeller will find interest in the sailing model of a Galleon.

At the modest price of 5/- it is excellent value and will make an ideal gift for any who delight in making models, providing him with many hours of real enjoyment.

Technical Detail need not deter anyone from making a model. It is quite possible, even in a simple model, to see that what few details are incorporated, are correct.

There are plenty of models about which, though beautiful creations of the craftsman's art, are not Ship Models. In some cases the hull is of such a shape that no ship like it ever sailed the seas. In some, the colour scheme seems to have been inspired by a child's cheap painting book. Yet others have rigging which would give any seaman of the period a nightmare were he called upon to handle a ship rigged in such fashion.

Choice of a simple and a more elaborate type of SHOE-CLEANING STOOL

ALTHOUGH a boot-cleaning stool is not exactly a glamorous article, it is extremely useful, and every household should have one. We show, herewith, two versions of the same model. One (Fig. 15) is quite plain and will serve in an average household. The construction is quite straightforward.

An Alternative Type

The other (Fig. 14) is a more elegant model suitable for, say, a hotel or boarding house bedroom. For such purposes it is well worth while to go to

The only parts likely to cause the slightest trouble are the blocks (a) and (b). (Fig. 5 and also on Fig. 1). The best way to get the bevels is to make cardboard templates, as in Figs. 11 and 12, Fig. 11 being used for (a) and Fig. 12 for (b). These templates may well be made twice the size (or even three times). They can also be laid out on the edge of a smooth plank and an adjustable bevel set from them.

The blocks are shaped up from 3ins. by 1in. section stuff, 5ins. long. The position of the blocks is clearly seen in the diagrams.

A simple piece of 1in. by $\frac{1}{2}$ in. wood fitted across the lower end for the shoe rest completes this model.

For the more elaborate model, the top and the front and back legs are cut to the same size before, but are shaped. For this reason, $\frac{3}{4}$ in. plywood is recommended. Figs. 9 and 10 give, respectively, the half-shapes for the legs and the top.

The Legs

As regards Fig. 9, remember that the legs are in two different lengths as before, though only one length is shown in Fig. 9. The slot to take the cross rail is nominally 2ins. by $\frac{3}{4}$ in. but, as Fig. 16 shows, adjustment must be made for the fact that the rail does not pass through the legs at right angles.

The rail itself is shown at Fig. 4. This is of $\frac{3}{4}$ in. plywood. It is better to mark out the holes (for the wedges) after the stool has been partly assembled.

The blocks (a) and (b) are made as before. The action of the wedges is clearly seen in the diagrams, particularly Figs. 13 and 14. The wedges should be of hardwood and neatly cut so as to have a decorative purpose. The wedges, as drawn, will only prevent the legs splaying outwards, and, in actual use, this is what is required. It is possible, by extending the slot, to have wedges on both sides of the legs. A touch of glue on the wedges before final knocking in will make a firm fixture.

Shoe Rest

Both in the simple model and in the more elaborate one, the top and bottom edges of the legs need a slight bevel.

The shoe rest (Fig. 8) is cut from thick plywood. It should be quite $\frac{1}{2}$ in. thick, so that two or more pieces of thinner wood can be cut and glued together. For finish, glasspaper well and give two or three coats of copal or spar varnish.

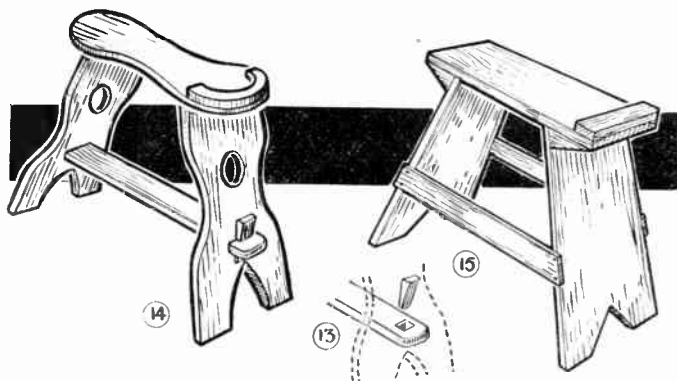

the extra trouble of shaping the curved parts.

Straightforward Model

We will describe, first, the simple model (Fig. 15). The top (Fig. 7) is just a plain piece of 15ins. by 5ins. by $\frac{1}{2}$ in. plank. The front and back pieces (Fig. 6) are, respectively, 16ins. and 14 $\frac{1}{2}$ ins. long, tapering from 5ins. to 7 $\frac{1}{2}$ ins., as shown. The inverted V-shaped notch at the bottom is not just for decoration but to enable the stool to rest more firmly on a slightly uneven surface.

The side rails, seen in Fig. 15 are of about 2ins. by $\frac{3}{4}$ in. stuff and are best cut to about 18ins. long. They can be cut to exact size, flush with the ends of the stool, after being fixed. A neater job would be achieved by making grooves and letting these rails in flush with the sides. The stool will be about 14ins. high at the back and 16ins. at the front, and the legs will be about 18 $\frac{1}{2}$ ins. apart at the bottom, as shown in Fig. 1. (The rail in this drawing refers to the more elaborate model). The grooving must be undertaken carefully to make a neat job for which accurate marking is essential.

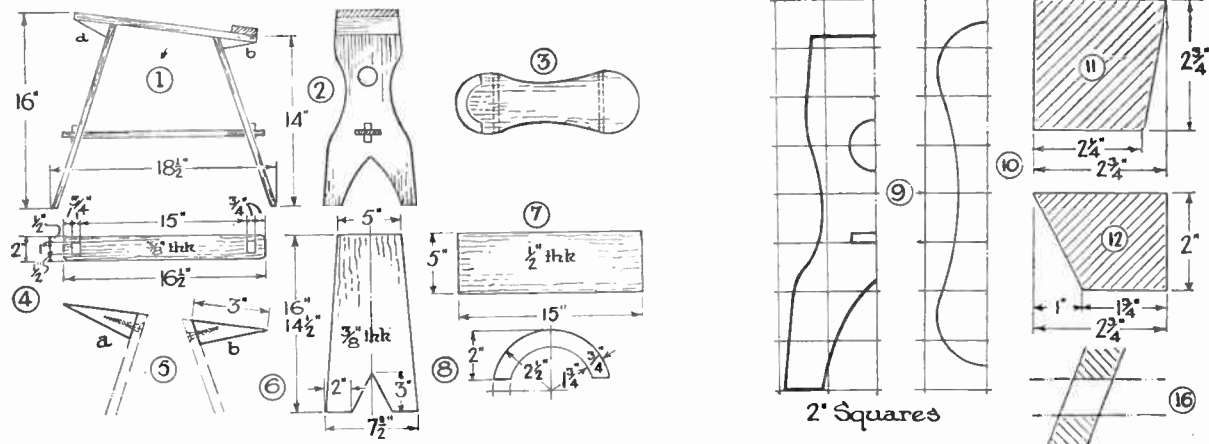

An attractive and colourful model of any popular OLD CURIOSITY SHOP

THE quaint old model 'Curiosity Shop' here described is based on a picturesque weather-boarded cottage in a Kentish village—a good example of old-world architecture. Readers in London may be able to compare it with and obtain 'local colour' hints from the quaint Curiosity Shop (reputedly Dickensian) in Portugal Street, behind the Stoll Theatre in Kingsway.

First cut out the Upper Front (1) in $\frac{1}{4}$ in. plywood to the dimensions given in the drawings. The chain-dotted lines indicate the position of the roof, chimney and dormer window—to be fitted later. Note the window-opening to be cut out. Two Upper Sides (Part 4) are required. The window is cut in one side only, the other piece being a perfectly plain rectangle, measuring $6\frac{1}{8}$ ins. by $2\frac{1}{4}$ ins.

A pair of Lower Sides (5) is cut in $\frac{1}{4}$ in. plywood. Here again, the window is cut in one piece only, whilst the other side is quite plain. The diagonals, by the way, indicate where a part is to be cut out.

afterwards removed. Lay the bottom one first, and the next over it, slightly overlapping, as in actual weatherboarding. Do not trim the ends until the glue is quite dry.

Smear the lower sides with plastic wood, alabastine, or one of the new plastic paints, to give the effect of much patched, bulging walls. The plastic wood, etc. will hold better if you scratch and pit the wood with the point of some sharp tool.

Before the windows are 'glazed' the carcase made so far can be coloured. It

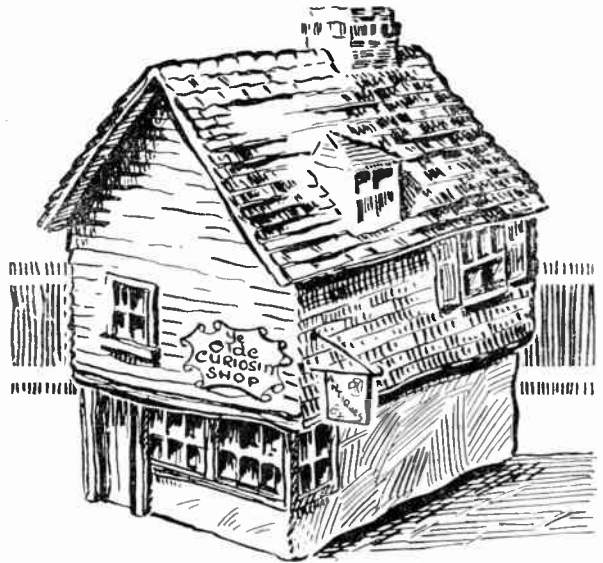

the varnish in a warm room, so it runs fairly easily and does not "pull."

Windows

The windows (except that of the dormer, Part 9) can now be glued in from behind, care being taken not to let the glue ooze out on to the front. The 'glass' is actually celluloid from old roll-film; either negatives that are perfectly blank, or where the image is very faint. There is no need to soak off the image in this case. The greyish look will give the impression of rather grimy windows.

Draw the window bars full size on a piece of paper. Then lay the celluloid over and trace with indian ink, if possible. Allow about $\frac{1}{4}$ in. margin all round for fixing.

Ordinary tube glue fixes the celluloid. Curtains, cut from scraps of paper are pasted behind the windows in the upper portion, which represents domestic quarters, whilst the back of the shop

(Continued foot of page 378)

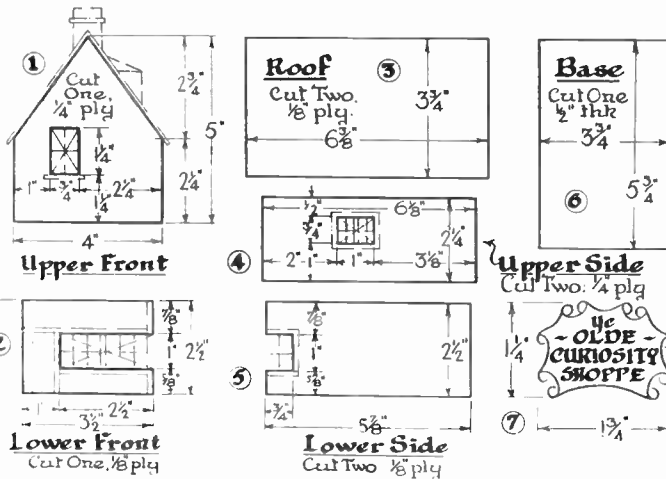

They are not window bars. A Base (6) is cut to the dimensions shown.

Take the Upper Front, and glue it over the Lower Front so that it overlaps by $\frac{1}{8}$ in. Similarly fix the Upper and Lower Sides. This done, nail the Front and Sides to the Base. Fig. 2 shows the work in progress.

Weatherboards

The next step is to glue lengths of $\frac{1}{4}$ in. square stripwood around the windows, the door-posts, etc. See there are no ragged edges to the cut-out windows. Two lines are scored on the door where shown to represent planking. The Upper Front and Upper Sides are now 'weatherboarded' with strips of fairly stout cardboard $\frac{1}{16}$ in. wide, and rather longer than actually required, applied with glue, and tacked down, if necessary, with ordinary pins, the points of which are

will be found more convenient to fit [the roof afterwards. Poster paints are used: green or brown for the woodwork of the windows, door, etc., yellow ochre for the lower walls, and a light brown for the weather-boarding.

As with all such models, care should be taken to give the effect of antiquity and not of careless painting. When the paint is dry, a coat of varnish should be given. This not only fixes the paint, but prevents dirt working in. Use

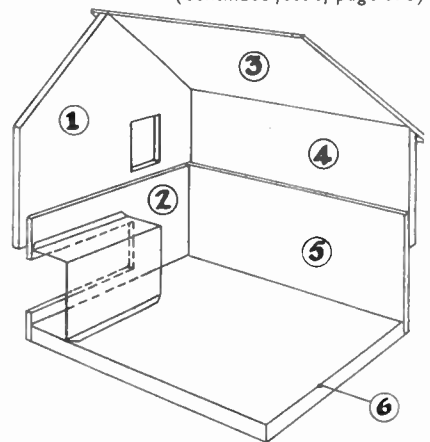
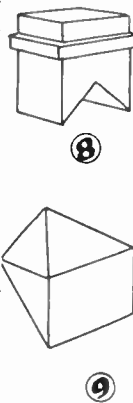

Use an old bag to make this HANDY MAP CASE

WHOLE villages swallowed by a yawning crater; main roads rent asunder by chasms; footpaths vanished! This is the state of most maps after they have been used a season or two. This tattered demalio sheet is supposed to guide you along intricate ways! Hikers might justifiably plead that they cannot afford a decent map case. Well, why not make one?

The map case illustrated is of leather, of such a size that it will hold a one-inch Ordnance map with two sections showing. A small case which only shows

punch and die. If you make use of a flap the slots for it are easily cut with a knife.

Before the front and back are joined the window must be sewn in. There is practically only one way to do this—on the sewing machine. The ends of the cotton must be made secure. The machine stitch is unlike that of the needle, and a pull at one end will result in the whole chain of stitches coming undone. There is no means of re-machining once the article is made up.

Thonging Joint

A good way of joining the two pieces is with a leather thong, as shown. Alternatively you can sew them together with an overhand stitch, using shoemaker's wax thread (obtainable on a card, with needle) and making the holes with an awl.

Should you use a thonged border, it is as well to match it by making a plaited loop, as shown on the right. Otherwise a plain narrow leather strap is used. The length of the loop depends on the wearer.

Artful and crafty people will now want to decorate the case, probably with Red Indian tracking signs. Don't overdo the

Buffalo Bill touch. The leather thonging and plaiting are sufficient decoration in themselves, and lift the case out of the rut of the mass-produced shop-bought article.

Thonging is more quickly done if a thonging punch (shown at (g)) is used. With this, one can punch a line of holes, and then move the punch along, placing a prong against a hole just punched and rapidly and neatly making a line of holes.

The sketches at (c) (d) (e) (f) are diagrammatic only, with the thongs shown as single lines and the slots as plain holes. The first sketch (c) shows a simple way of starting thonging.

The thong is laid against a few holes and the thong is simply taken over and over. The end of the thong that is to be clamped down may well be tapered off in thickness with a knife. It will be much easier to thread the thong through the slots if a piece of tin-plate (cut from any old tin can) is bent round the end, very similar to a tag on the end of a shoe lace.

The sketch (d) shows how this thonging is ended. The end is just slipped under the turns. The sketch (f) shows another kind of thonging. Indeed, books on art leather-work should be consulted if further details are required.

Some Electrical Replies of Interest

Telephone Wiring

I HAVE bought an ex-govt. self-energised telephone set. There are only two wires required, but would it do any harm to the telephone magnets if I used one wire for a bell circuit to run off a transformer on A.C. mains? (J.C.—Wallasey).

HAVING one wire common to both telephone and bell circuits will not harm the telephone units, provided the return circuits of both bell and telephone are kept separate. If the bell is operated from a bell transformer from the mains, however, severe humming will probably be caused in the telephone receivers, and this would make wholly separate circuits necessary.

Interference

I AM picking up very bad interference from electrical gear, e.g., when someone switches on a light in the house. It is not coming through the aerial, but actually through the mains as it is still there with the aerial off. Is there any way to cure it? (R.G.H.—Nottingham).

THE usual cause of hum developing in an eliminator is a broken down smoothing condenser, and a condenser known to be in good order should be connected in place of the present condensers. Other possible causes exist, but from the details given this seems most likely. Mains-borne interference is difficult to eliminate, and should if possible be suppressed at the source. However, an improvement can usually be obtained by connecting condensers of about .05 mf. (500 volts working) from the mains leads to a good earth point. If necessary, further suppression may be obtained by including mains-type H.F. chokes in the leads.

Battery Trouble

I HAVE made an electrical beam engine which runs quite smoothly off a 6 volt car battery. I have since bought a 6 volt dry battery but the engine does not run off that. Could you please tell me what is wrong? (C.B.—Bristol).

IF the engine operates satisfactorily from the accumulator but not from the dry battery, the latter may not be 6 volts, or may be in poor condition so that its voltage drops severely when current is taken. As a dry battery cannot deliver a heavy current, take particular care that all moving parts work with absolute freedom, and that the contact is correctly adjusted as explained. For a 6 volt dry battery 24 to 26 S.W.G. wire should be more suitable; this will enable more turns to be got on. The greater the number of turns, the greater the solenoid's pulling power, but very thin wire must not be used or the current flowing will be too much reduced.

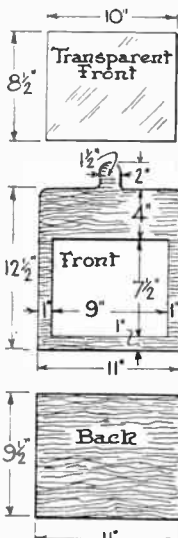
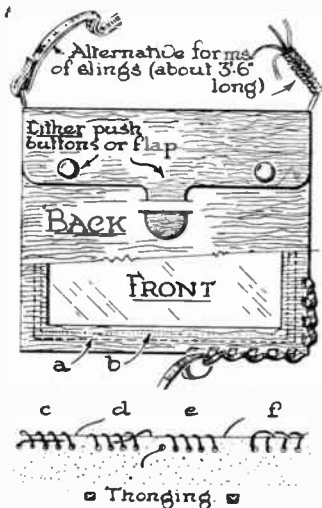

one section is not much use, as in order to fold the map to bring a particular section to view, a clumsy packet results.

The window is of celluloid, whilst it has a strap so the map may be slung under the right arm.

Leather is used for the case. The writer cut up an ancient portmanteau, but many readers may have to buy it. For the window the writer bought a damaged windscreen and from it cut a suitable panel, but there are plenty of plastic, etc. sheets about nowadays.

To economise in drawing space, note that in the main drawing, the front and back views have been combined, whilst both button and flap fastenings have been shown, together with two forms of sling. Obviously only one of the alternatives is to be used.

Suitable Sizes

The sizes of the back and front are given in the smaller sketches. The window panel can easily be cut out with a razor blade, or a sharp penknife. Note that you have the option of securing the back with a flap or push buttons. The latter are the better, and they can be bought in boxes together with a special

An attractive and unusual piece to make— A TOY OPEN FRUIT STALL

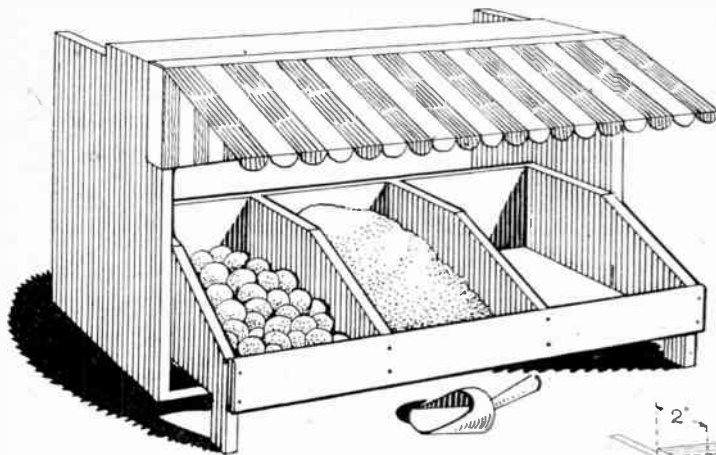

Fig. 1—Just the plaything for a youngster

HERE is a topping little model to make, and one which should give endless fun to the youngsters. It is for a Toy Fruit Shop, and is of ample size for dealing out the goods to the young customers. It measures overall 14ins. long and 8ins. wide and 8ins. high.

The simplest of construction is adopted throughout and the whole thing should not take longer than a couple of evenings to make. Wood $\frac{1}{4}$ in. thick is used, and glue and nails hold all the parts well together. Our sketch, Fig. 1, gives a good idea of the finished shop which consists of a more or less open-fronted frame of wood with the three or more racks for the goods in the front. Above the racks is an oriental type canopy which greatly helps the attractive appearance of the whole thing.

Although the main measurements given make a conveniently-handled shop for the younger folk, there is no reason why these measurements should not be increased if a larger number of racks or compartments is needed. There is also the possibility of making four racks in the length of 14ins. instead of only the three shown.

A New Plane

IT is advisable to treat a new plane before using it. All you need is a very little putty and a small quantity of linseed oil. Fill hole in plane with putty and pour in all linseed oil. Let all of this soak in the grain of the wood which it should do over-night. This will prevent any likelihood of the plane splitting and will lengthen the life of it as well as making it run very smoothly.

Commence construction by marking out and cutting the main floor (A) in Fig. 2. This measures 14ins. by $3\frac{1}{2}$ ins., and to this are attached the upright ends (B), measuring 8ins. by $3\frac{1}{2}$ ins. Cut all these pieces square, using for the purpose a

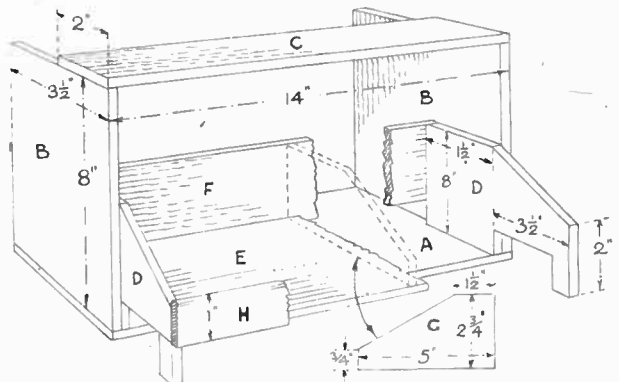

Fig. 2—Cut-away view showing constructional details

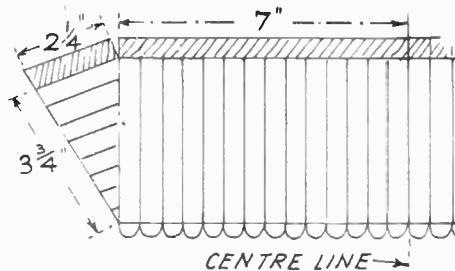

Fig. 3—Shape and size of canopy

square and for the cutting a coarse fretsaw.

Connect the tops of the pieces (B) with a narrow board measuring 14ins. by 2ins. Put some glued blocks in the angles under (C) to further strengthen the joints.

The Racks

For the ends of the racks we shall want two pieces cut to the shape and dimensions shown on the right-hand end of the frame, as (D) in Fig. 2. After making one end, lay this on the next piece of wood and draw round it to get both shapes identical. For the interior divisions of the rack, two or three, according to the number of spaces required, will be cut to the outline

shown as detail (G) in Fig. 2. These are again of $\frac{1}{4}$ in. wood, of course.

Next mark out and cut the floor of the rack (E) in Fig. 2. This is 13ins. long and 5ins. wide, glued and nailed between the two ends (D). To the back edge of (E) and also to the back upright edges of the ends (D), the back of the rack (F) must be glued and nailed. This piece is $13\frac{1}{2}$ ins. long by 3ins. wide, and before fixing, the top edge should be rounded with coarse and fine glasspaper. The back edge of piece (C) should also be rounded off.

The interior divisions (G) may next be added and glued to the floor and to the back (F). Wherever possible add some wooden block fillets, glued well in the

angles to strengthen the joints. If triangular stuff is unobtainable, then some odd small blocks can be cut from the $\frac{1}{4}$ in. wood.

The front (H) of the rack is $13\frac{1}{2}$ ins. long and 1in. wide and $\frac{1}{4}$ in. thick and the top edge should be rounded as shown. Glue and nails are used as fixing here.

At this stage all surfaces of the parts should be given a rub up with glasspaper previous to painting in bright colours. A further interesting addition will be the striped outside canopy. This must be made of stoutish card, and the diagram Fig. 3 shows the dimensions, etc., for marking out and cutting.

Half only of the canopy is shown, and note should be taken of the shaded portions to the back edges. These form the gluing strips which go on the roof (C) of the model and on the end (B). The stripes on the 'canvas' are spaced at $\frac{1}{2}$ in. intervals and every other one should be painted red. The valance hanging down might be scalloped with the scissors.

Small metal scoops can be bought, such as is shown in our picture for dealing with the goods in the racks.

These simple gadgets and space savers are practical IDEAS FOR THE HOME

SPACE saved in the kitchen or scullery is always a welcome move. Quickly adapted rails on which to dry off clothes and dusters can be made on the end of the existing draining board. If you have not the space here perhaps you can get three or four on the edge of the table.

Measure up the width of the usual cloths when folded in half and plan the supports to fit these and fold away as in Fig. 1. You should taper them at the ends and well glasspaper all rough edges down. Two will have to be set back to allow the middle one to fold in. By this arrangement you will have to turn out the centre one first and then the two side ones.

A Bath Economy

Space in the bathroom is often limited when there is a baby in the house. In the sketch at Fig. 2 is shown a board which will conveniently fit across the large bath and thus prevent the energetic youngster from causing so much spare water when he or she splashes about.

The board must be made to fit firmly on the bath with the two 1 in. by 1 in. square struts. It is reinforced with rubber strips which one can pick up at the store so it does not damage the bath and also keeps it from sliding about.

The main hole in the centre is made to take the small bath of the papier mâché type which is in general use to-day. Make the board a fair width so there is no fear of the unit falling over. Apart from being useful, it prevents the person bathing baby from bending so much. Also, all the accessories of the bathing job are close at hand.

Folding Table

When sitting around in home or on verandah or even in the garden, provided it is not damp, it is useful to have a quickly knocked up table for playing cards or games. This table illustrated at

Fig. 3 is of the knock-up type because it has not delicate legs to get damaged.

Plywood squares are now available at most woodyards and some of them have the 4- and 5-ply variety. The square for top should be at least 2ft. by 2ft. To keep it firm and hold the legs you require two pieces of wood 2 ins. wide and 1 in. thick which should be screwed the full length and 3 ins. in from the edge.

For the legs you can use hardboard panel which is light and durable. Measure the height at which you want to have the table and adjust the leg measurements to come to this, bearing in mind the fact the table legs cross over as shown.

The leg panels can be shaped at the base as illustrated and are then cut in the centre with two slots going half-way across. This allows the two sections to slip together and fit firmly inside the

a large garden or when you want just a few odd tools it is handy to have something in which to hold them without always having to get out the garden barrow. If you have an old deck chair frame you can use it for this purpose as seen at Fig. 4.

Remove the chair part to leave the two sides and the original stand down part. The top rail will make a convenient handle. Put another rail across so you can make a small light box to fit, with a ledge round the top. In this you could keep a few of the smaller tools used for light jobs, fork, dibber, trowel and lines.

For collecting the vegetables one can have a basket obtained from the greengrocers and to which you could add handles. Failing this the greengrocer often has light wood boxes which would suit you.

Now fix two of the larger-sized toy

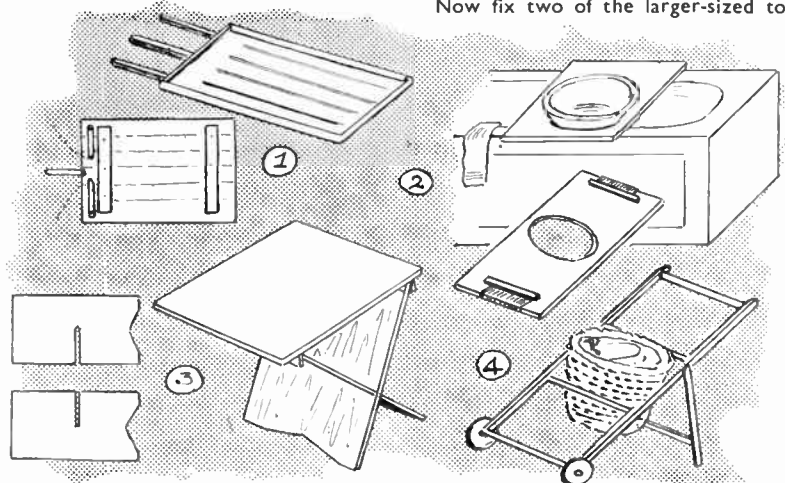

runners underneath the table. To dismantle the table take off the top and then slide the legs apart.

Garden Runabout

When collecting the vegetables from

wheels, as these are strong and have a wide tread which is more suitable for the lawn and garden. When not in use the boxes or basket can be removed and the framework folded up for storage purposes. (252)

Curiosity Shop—(Continued from page 375)

window is formed from cardboard bent up and glued in place as seen in Fig. 2.

Now make the Roof (3) which is formed of two pieces of $\frac{1}{4}$ in. plywood each $6\frac{1}{2}$ ins. by $3\frac{1}{2}$ ins. These are nailed on to the sloping side of the front, so that the front as well as the side projects in an eave. The upper edge of Part 4 will probably need bevelling. There is no back to the model, though the modelmaker can easily provide one if he desires.

Chimney and Tiles

The chimney (8) is shaped from a 1 $\frac{1}{2}$ ins. by 1 in. by $\frac{3}{4}$ in. block with a $\frac{1}{4}$ in. square stripwood surround. The shape of the Vee can be ascertained by reference to the shape of the top of the Upper Front. The dormer (9) is made up from a solid block as shown. The front measures 1 $\frac{1}{4}$ ins. by 1 in.

It now remains for the roof to be 'tiled'. This is done with strips of corrugated cardboard, about $\frac{5}{8}$ in. wide, the grooves, of course, being vertical. 'Stagger' the strips very slightly, to give the impression that each tile has been laid separately. Use plenty of glue, and press the strips down by pressing the valleys of the cardboard with the tip of a pencil. Tiles can also be modelled in Pyrama or similar modelling paste.

The roof is given a coat of size and, when dry, painted red. Before painting, neatpen up the ridge and edges of the roof with plastic wood.

This completes the model in its simplest form, but there are a lot of ways in which skilful modellers can add more details. Try to visit actual old buildings for details. Take, for example, the windows. The sash windows in the

upper front could be shown half open or fitted with shutters. The dormer windows could also be shown open.

Weather-boarded houses of this type have often been repaired by cutting many of the boards away, in a rectangular shape, and inserting fresh boards, not always in perfect alignment with the original work. This sort of thing could be shown on the model.

When cutting the strips for the 'weather-boarding', for example, have a slightly irregular edge. Do not have a pre-fab-like precision.

The words 'THE OLD CURIOSITY SHOP' can be painted on, as indicated in the drawings, and a swinging sign provided at the side. The model can be mounted on another, larger, base modelled to represent a pavement, etc.

How the handyman can easily and cheaply make a USEFUL GARDEN ROLLER



A GARDEN roller is a very useful thing to have, for with one it is possible to keep your grass plot in much better condition, for nothing so quickly stops those inequalities that come in even the best cut turf, like a periodic rolling after rain.

But garden rollers are dear, and your piece of grass may not be large enough to justify the expense. Here, however, is how you can make one of these useful items for a very few shillings.

The main thing required is a paint or oil drum of the kind that has no outside binding—that is, one that presents a smooth outer shell from upper to lower rim. It need not be very large, but on the other hand, a too small drum cannot be readily made weighty enough to give satisfactory rolling.

The Spindle

Having obtained the drum, the next thing is to get from a blacksmith a metal rod about $\frac{1}{2}$ in. diameter of such a length that it will pass right through the drum from end to end and leave about 4 ins. protruding at either side, see (A) in the figure.

A thread must now be turned on the end of this rod for a little more than this distance in at either extremity. The smith may be able to do this for you, if not, the threading could be done at any of the bigger working ironmongers, or of course perhaps you have the stock outfit yourself. You will also require nuts to fit on the threaded ends.

The next thing is to find the exact centres of the top and bottom of the drum. This must be done with some care, it being best to try several methods as a check one against the other. Thus, a paper circle can be cut just to fit the end. This is then folded in half and then folded

in half again (D). Placing the sector so formed back on the drum the point of the paper gives the centre.

This can be checked by taking several diameters and halving, while a final check can be made with an improvised compass made by screwing two pieces of wood together, or with a blackboard compass if you have one.

Being sure of the centre, now with an ordinary small scribing compass make two circles at the points found, of the diameter of your bar, the whole idea being to run the bar through from side to side and screw it in position with the nuts.

Adding Weight

Before final fastening, however, we must give the roller weight, and this can be done by inserting the rod and turning the drum end in soft ground (so that the protruding bit of rod will sink in) filling it with sand.

A better job is made if this filling is with a rough-made concrete, that is, a little cement mixed with plenty of sand. This makes the inside of the drum solid and there is no likelihood of dents appearing should the metal receive a knock. Once filled, the lid is put in position and the second nut fitted and taken tightly home.

The Frame Handle

We now have a quite heavy little roller, complete with axle, and the next thing is to fit the simple frame handle as indicated. Here the bearings are the only parts that need any detailed explanation, the rest being straightforward. Obviously if the axle ends (especially as they are threaded) ran on the wood they would very soon wear this away and form a groove, so the points of contact must be metal lids.

The main members of the frame (a) are of $1\frac{1}{2}$ ins. by $1\frac{1}{2}$ ins. section if a soft wood is being used, narrower, if fairly tough strips can be obtained. They must not be less than 3 ft. in length but can be slightly longer with advantage. Much depends on your own height, but it is always easier to push and pull a roller if the angle of the handle to the ground is not very great—that is, the flatter the handle angle, the easier the manipulation.

On to the underside of these members the bearings are secured and these are two garden gate bolt-holders of the heavier kind. If desired, the bearing can be made up of two strips of metal, the

one flat, and the other bent to a semi-circle in the centre to take the axle end. Corresponding holes are drilled in these pieces which are then held in position by two stout screws.

Easy Running

When finally fitting the frame to the roller two thick washers go either side of the axle between the locking nut and the wood as (E). These both give easier running and act as spacers keeping the drum from the spars.

The handle square is a simple frame made up of the main spars and two cross-pieces, the one just above the drum and the other across the top, which as well as completing the square acts as a pushing bar and so for comfortable gripping should have its edges rounded off.

The length of these cross-pieces depends of course on the size of the drum being used so no dimension is given. Slightly sunk joints are used to give greater rigidity (but not full half joints as these would tend to weaken the main members too much) and these are completed with a nut and bolt each.

Bolts are better in this case than screws, as tightening up can be readily effected with a spanner should vigorous work loosen the frame at any time. Give the nuts and threads a touch of grease when fitting.

Our roller is now completed and a very efficient article should have been produced. It still requires a coat of paint however, to preserve against rust and rot and also to give a neat appearance.

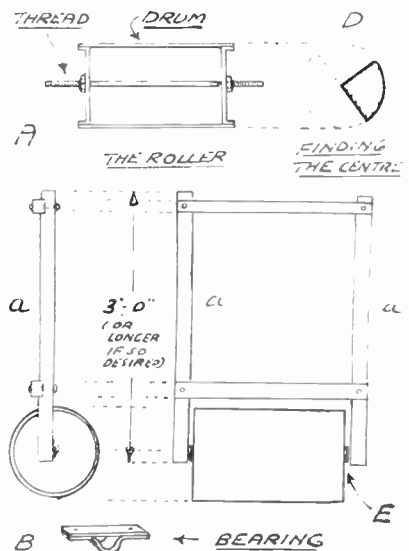

The Editor is always pleased to receive suggestions from readers on what they would like included in these pages.

Another chapter on our series of binding—all about BOOK FINISHING

WE have dealt, in the two previous articles, with the technical side of simple book-binding, and in this, the third of the series, it is time to consider the artistic and decorative aspect.

The possibility of a two-colour binding has no doubt occurred already to some readers, and we shall be best served if we begin applying decorations to our methods with this. There is another kind of standard binding besides the full cloth kind so far described.

This has its origin in the desire for additional strength and protection at the point most heavily worn, namely the spine, which was bound in leather. Of late however, a trend towards quarter bound books which have cloth on the spine only but are finished in thick paper, has appeared from the economic viewpoint, since it gives a considerable saving in cloth.

The books bound by the methods described in these recent articles are invariably small and light and it is therefore this economic factor combined with that of artistic design, rather than strength which makes the variations in binding desirable.

The Quarter Binding

The diagram shows three-quarter-bound books. It is obvious that from a point of view of proportion the centre picture is by far the most attractive, irrespective of the materials or colours used. It is also obvious that the factor which regulates the pleasing proportions is the amount of cloth showing on each side of the spine.

These proportions are simply described in this formula which will enable the reader to cut both cloth and paper to the correct sizes.

Spine cloth.

$$\text{Width} = \frac{2}{3} \text{ths cover width} + \text{spine width.}$$

$$\text{Length} = \text{Cover length} + 1 \frac{1}{2} \text{ins.}$$

Paper.

$$\text{Width} = \frac{2}{3} \text{ths cover width} + \frac{1}{2} \text{in.}$$

$$\text{Length} = \text{Cover length} + 1 \frac{1}{2} \text{ins.}$$

When binding a book in this fashion, it is necessary to cover the spine in cloth first, and then to paste the paper over the rest of the board so it overlaps the edge of the cloth by about $\frac{1}{2}$ in. The corners of the paper are, of course, trimmed acrosswise, just as if a full cloth binding were being dealt with, before folding in the overlapping edges on to the insides of the boards.

Finally, the endpapers are pasted down inside the boards in the manner already explained. The paper most suitable for this work is that which has approximately the same texture and strength as ordinary cartridge paper. Almost any pleasantly coloured pieces of paper may be used providing they are of the correct strength.

Colour Schemes

Before commencing the actual binding, it is as well to consider how best to match the colours available. Some colours are very reliable and will appear tasteful with any colour. Grey is one such colour, and the bookbinder will do well to always have available a stock of grey cloth which will match readily with almost any paper he cares to select.

A pleasing combination is that produced by the proportionate placing of red and black. A red spine with black paper on the rest of the boards gives an air of distinction to the book. Other colours which look well with red are blue and brown. Brown itself is also an accommodating colour and looks well with cream, yellow, gold or pale blue.

Colours to avoid matching are those which are known as opposites. Blue and yellow for instance, may catch the eye on an advertisement, but most certainly clash if placed next to each other. Red and green likewise, are suitable companions for traffic lights, but not for bookbinding.

Making Decorative Endpapers

When we consider that cartridge paper is suitable for the paper covering, it would seem a pity not to construct some of our own decorated papers from this source. Those readers who have

smudge proof by polishing it with a good clear or light coloured floor polish. But it must be perfectly dry first.

All paper covers should be polished in this manner whether manufactured or home made. They will then last longer and be less inclined to pick up dust or fingermarks. It is of course, most necessary that they be polished before attempting to use them for covering.

Paste Graining

This is one of the simplest and yet most attractive kinds of cover paper, and no special kinds of skill or tools are required. A large pot of paste is mixed, and this is coloured by the addition of powder, water or poster colour. A fairly strong colour is required and this may be tested on a piece of scrap paper until the desired shade is reached.

The coloured paste is then pasted evenly all over a large sheet of cartridge paper. A cardboard 'comb' is cut about 2ins. long and this is drawn across the paste surface in the usual manner used for graining. By repetition the graining is made to cover the whole sheet. The comb may be drawn straight across the paper, diagonally, or in an S bend. The lines produced may be angular, curved, or 'squiggled', and cross-hatched at any angle.

If the first attempt is unsatisfactory it is merely necessary to re-paste the

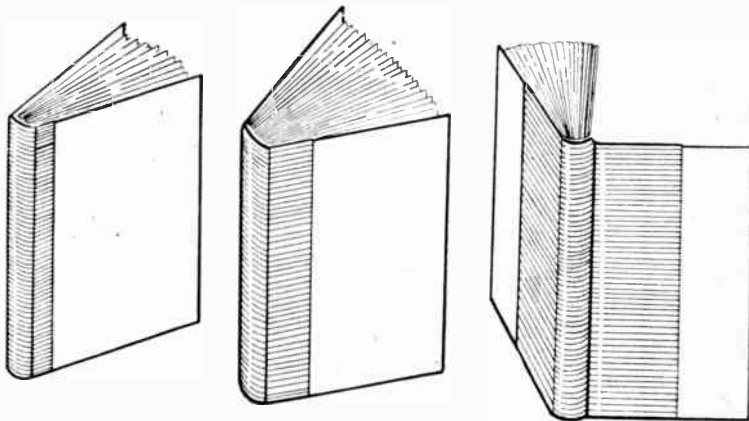

Some examples of quarter-bound books as described

practised lino cutting may like to make a simple motif on a block 1in. square. This repeated printed all over the cartridge paper will often produce a surprisingly effective patterned paper.

It is useful to mount the lino-cut on a small wooden block to facilitate printing. If the block is to be printed in black it is very effective if the cartridge paper is first given a water colour 'wash' and the black printed over the wash when it is dry.

The pleasing tone and black result will be particularly attractive when matched with a suitable cloth. When the printed paper is finished it should be allowed to dry. It is then made waterproof and

surface with the coloured paste and begin again. A little practice will show the beginner the limitless possibilities and patterns which may be produced by this means. When the desired result is achieved it is allowed to dry thoroughly and polished in the manner described.

Finally, it is important to remember whenever home-decorated cover papers are being made that the paper used must be big enough to provide for both sides of the book in question.

A final article will appear shortly on making and decorating suitable and simple paper jackets or dust covers for your completed books. (213)

Have something 'different' in the home by making A MODERN FIRE-SCREEN

HOWEVER stereotyped, or mass-produced, the rest of the furniture in the modern home, it is not unusual to find that the fire-screen, boasting the most prominent of positions, is the individual product of the family handyman.

The finished article may be further enhanced by the hand of an artist but our intention here is simply to show, in non-technical language, how the beginner, with even the minimum experience, can fashion a durable screen which can be left 'ungilded' and yet retain its attractiveness. The type in mind is made almost exclusively of 3-ply wood, only the feet (or shoes) requiring anything thicker than that.

Size and Shape

The size necessary to provide all the material would be 3ft. 6ins. by 1ft. 9 ins. Alternatively, there should be one piece measuring 2ft. 3ins. by 1ft. 9ins. for the screen itself, and a smaller piece measuring 1ft. 6ins. by 15ins. from which to cut the fittings.

As seen in Fig. 1, the screen is an oval shape taken from the rectangle. When this has been successfully accomplished by marking and cutting in the usual way the edges must be smoothed off with glasspaper and may be left with a bevel on each side. As far as carpentry is

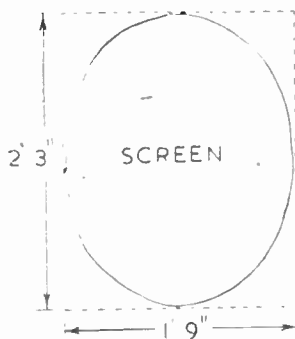

Fig. 1—The oval of the screen

concerned, no further attention need be paid to the screen.

The Stand Portion

The next stage is perhaps rather more exacting, but ought not to present a serious problem to the determined handyman. The fittings, as designed in Fig. 2, are cut from the board and it is essential to see that their position is satisfactorily established before gluing or tacking.

Remember that the centre piece forms the basis of the screen when assembled, and on it will depend whether your screen stands upright or not. A mistake in assembly will be difficult to remedy after fixing.

This centre piece is sandwiched between the outside pair, allowing an inch or more at the top, giving adequate 'bed-space' for the screen bottom. It should also protrude from between the other two pieces by $\frac{1}{4}$ in. (or more) all along the bottom edge.

Assembly

After testing for an exact fit with the parts in place, mark the screen as a future guide and hammer home one or two nails to facilitate further handling. Attention should now be given to the outside edges. However careful the amateur woodworker may be, there may be a difference between the measurements intended and those achieved. Luckily a remedy can usually be found.

When your 'sandwich' is made up to take the screen in what will be an upright position, you may find that, as a result of 'fiddling', these outside edges do not now exactly correspond. The overlap of one piece or another will be too great to deal with by glasspapering.

You will need the aid of a rough file to pare down to uniformity. Afterwards a finer file will be necessary, and then a good smoothing down with glasspaper.

You are now ready to tackle a comparatively easier job. That of the feet, or shoes. These are of any soft wood, workshop scraps if necessary, measuring 9ins. by $2\frac{1}{4}$ ins. each. The thickness is of

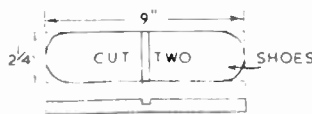

Fig. 3—Plan and side view of the flat shoe portions

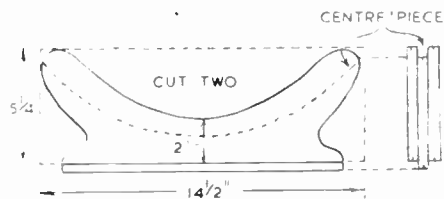
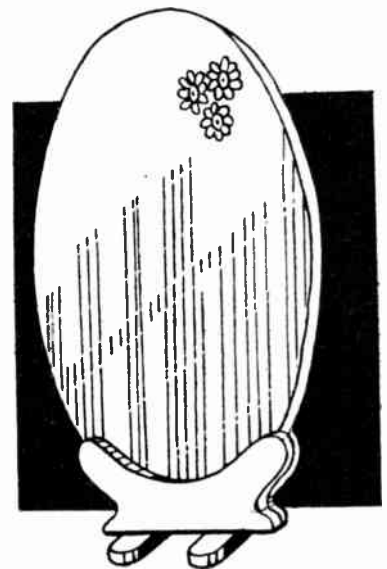

Fig. 2—Side and end view of sandwich support piece

less importance, as long as you can allow for the $\frac{1}{4}$ in. grooves which are made at the half-way mark, into which is slotted the overlap from the centre piece of your base structure.

Cut them out, round off the ends, and make a line across the middle of each. The widths of the grooves here will depend on the thickness of your plywood which differs in different manufactures. They should be deep enough however to let the shoes fit snugly home against the two outer pieces above them.

All your pieces are ready now for assembly. You have your screen, lower fittings, and two shoes. Having heated a pot of glue, apply the necessary quantity down inside the recess and slip the lower



edge of the screen into position. There may be some difficulty about clamping but it is not entirely necessary. The screen will be found to be well gripped by the fittings and even the glue itself may seem superfluous. Leave it to set before fitting the shoes.

Finishing Decoration

When quite set, turn up and mark the position intended for the shoes (an equal distance from each end) then glue, and leave standing to set. The woodwork is now finished and you have the foundation on which to lavish whatever other touches you think fit: varnish, paint, transfers, or beading.

If you fancy making your own fretwork designs, you will find that, with the measurements mentioned here, there is material for a few small flower shapes or corner decoration left over from the plywood used.

A fire-screen, owing to its purely decorative purpose, is apt to outlast anything else in the room. Perhaps for this very reason one should aim at achieving a result as pleasing and satisfying as possible. (223)

Note

The large design supplement sheets are given free with alternate issues of 'Hobbies Weekly', but are not supplied with back numbers. They can, however, be obtained separately by quoting the reference number of the actual issue concerned. These back numbers of designs cost 6d. each (postage 1d.) apart from the actual issue of 'Hobbies.'

BE Taller. Quickly! Safely! Privately! No appliances—no tablets—no dieting. Details, 6d. stamp.—Malcolm Ross, Height Specialist, BCM/HYTE, London, W.C.1.

MODELS. You can make lasting stone-hard models with Sankey's Pyrama Plastic Cement. Supplied in tins by Ironmongers, Hardwaremen and Builders' Merchants. Ask for instruction leaflet.

TRANSFERS for decorating toys, trays, furniture, fancy goods. List and samples free. Flowers, pixies, dogs, nursery rhymes.—H. Axon Harrison, Jersey.

LEARN Shorthand by October 13th (1 hour's study nightly). 1st lesson, 2½d. stamp.—Duttons (Dept. HB), 92 Gt. Russell St., London, W.C.1.

RUBBER Tyred Metal Disc Wheels finished in red, green or blue enamel. 2ins., 2/6; 3ins., 3/- per set of four. Post paid. Other sizes available up to 9ins.—The Joyden Toy Co., 193 Chase Side, London, N.14.

DOLL'S House fittings and papers; send S.A.E. for list. Doll's house plan special, send 2/6. Trade supplied.—Zimplan, 88 Ware Road, Hoddesdon.

CONSTRUCTIONAL Kits, 4mm and 7mm scale lorries. Also large range spare parts from which to build to your own design. Price lists, 1d.—Wilson's Lorries Ltd., Dept. H., 1/6 Gt. Winchester Street, London, E.C.2.

BLUSHING, shyness, nerves, self-consciousness, fears, ended. Details under plain cover, 1d.—Stebbing Treatment, 28 (HB) Dean Road, London, N.W.2.

WHEELS for toys, and other accessories. Full lists will be sent on application to The Joyden Toy Co., 193 Chase Side, London, N.14.

100,000 Government surplus bargains. Brand new electrical switches for models, etc. Single toggle 20 amp., 9d., post 3d. 3-bank (3 single switches in one neat case), 3/-, post 4d. 5-bank, 4/6, post 6d. 16-bank, 7/11, post 1/-. (Many others in stock). Single bell flex, 25yds., 1/-, post 6d. Small indicator lights (red), 6d., post 3d. Aluminium rivets, approx. 1lb. asstd., 2/6, post 6d. Sponge rubber strip, approx. 18ft. x 1½ins. x ½in., 2/- per roll, post 9d. Send 3d. stamp for illustrated list of these and other bargains. Money back guarantee.—Milligan's, 24 Harford Street, Liverpool, 3.

BE Taller in 14 days or money back; details, 1d.—Stebbing System, 28 (HB) Dean Road, London, N.W.2.

PLYWOOD offcuts. Birch and Gaboon in various thicknesses. Handy sized parcels for the cabinet, toy, model maker and all handicrafts. Parcels made up in £1 and 10/- lots. Carriage paid. Send P.O. to Reeves, Plywood and Timber Merchant, 33 Front Street, Monkseaton, Whitley Bay. Tel. W.B. 4677. Due to exceptional demand we cannot promise delivery under eight days.

£5 to £20 weekly earned at home, running your own Mail Order business. Details, 1d.—Stebbing Publications Ltd. (HB), Naphill, High Wycombe.

AMERICAN Magazines post free for one year. Popular Mechanics, 32 -; Popular Science, 28 6; Mechanix Illustrated, 22 6; Popular Homecraft, 18 -. Stamp for full list of others.—Willen Ltd. (Dept. 57), 101 Fleet Street, London, E.C.4.

FASCINATING and profitable hobby casting ornaments, toys, etc. You can easily make these yourself. Paints, brushes and all accessories. Illustrated catalogue of 700 moulds, plus latest list of rubber moulds, with instructions, 9d., post free.—Cock of North Moulds (H), 140 Hollings Road, Bradford.

IMEDIATE delivery: Figured Oak Plywood, 24 x 24 x ½in., 5 for 35/-; 24 x 24 x ¼in., 2 for 25 -. Mahogany box bottoms, 7½ x 9½ x ¼in., 9/- doz. New Birch, grade III, 30 x 9 x ¼in., 10 pieces, 15 -. Box sides, 35 x 6 x ¼in., 10 for 15/-. All post paid. C.W.O. List of plywood, 2d.—H4/JDD Storage, 71 Northcross Road, East Dulwich, S.E.22. Open every Wednesday from 6—9 p.m.

PRIME imported recessed hardwood wheels, 2½ins. diameter, 3/- dozen, 14/- half gross, 26 6 gross. Post free. Pressed metal, hardwood and metal disc wheels, doll's house windows, doors, papers. Catalogues, 6d.—Jasons, 135 Nags Head Road, Ponders End, Middlesex.

KALEIDOSCOPES. Fascinating novelty for all ages! Ingenious optical creation of ever-changing colour designs. Endless variety. 2 6, post free.—'Stymit' Dept. H., 1 6 Gt. Winchester Street, London, E.C.2.

HOMEWORKERS required either Hsex, light assembly, part or full time. S.A.E.—Esprey, Box 18, 41 Wade Street, Lichfield.

CONJURING. 3d. for new lists and free magical competition.—De Hempsey, 363 Sandycombe, Kew Gardens.

PITMAN or Gregg Shorthand. Rapid postal courses. Particulars—Shaw's Commercial School, Lancaster.

USE spare time on profitable home-work making fancy goods. Write for free booklet—(Area 544), 54 Southgate Street, Leicester.

Imade big money; you can do same. I send envelope, for my system tells you how.—J. H. Wamsteker, Box 34, Wynberg, Cape, South Africa.

MAKE your own Jig-saw Puzzles. Fine art pictures, various reproductions and sizes. Also suitable for framing. Stamp for full list.—Joyden Toy Co., 193 Chase Side, London, N.14.

PLYWOOD Offcuts, ½in. and ¾in. up to 12 x 9ins. Ideal toymaking, etc. In parcels, 5/6, post free. Apply Ansell, Barnabas Road, Birmingham, 23.

MAKE and save money. Learn French polishing. Included with this invaluable course are 12 formulae for manufacturing polishes and stains. Send only 5/- to BCM MERCIA, London, W.C.1.

ARTIFICIAL Marble. Entirely new plastic for casting ashtrays, book-ends, wall vases, statuettes, etc. Easy to use; simply mix powder with liquid. Sets granite hard with scintillating crystalline structure very closely resembling marble or alabaster. Highly heat resistant, impervious to water. Any type of natural 'veining' can be simulated in any colour. Also Synthetic Rubber Moulds. Liquid preparation for making permanent elastic moulds for repetition casting plaster wall plaques, etc. Send 1 - for full details of this easy, fascinating and profitable hobby. Money refunded to bona fide enquirers.—Dept. H., Karlena Art Stone Company, 55 Deansgate Arcade, Deansgate, Manchester, 3.

9.5 Film Library, projectors, films for sale. Stamp for lists.—Wayland, 223 Longley Road, Tooting, London.

NOVEL Calendar Designs painted on plywood for cutting out. With date cards. Inexpensive gifts, profitable to sell. Sample, 2/-; half dozen, 10/-, including postage.—Cleaver, 50 Windsor Road, London, N.W.2.

PERSPEX, flat sheets, clear or 18 colours, cut to size and shape. Corrugated Perspex rooflights. Aluminium sheets, 24—16G. (panel flatness). Mouldings, Plastics.—Henry Moat & Son Ltd., Atom Works, Newcastle, 1.

HOME Watch and Clock Repair Outfit. Includes watchmaker's magnifying eyeglass, tweezers, screwdrivers, oilers, oil, brush, dusting powder, plus illustrated explanatory book. Watch and clock repairing simplified. In container, 12/9 inclusive.—D. Bolster (Dept. H.), 5a Station Parade, Ashford, Middx.

PERSPEX and acetate, cut any size from 2 6 sq. foot.—W.M. Products, 2 The Mall, Ealing, W.5. Eal. 3881.

INTRODUCTIONS. Pen friends, companionship or marriage.—V.C.C., 34 Honeywell Road, London, S.W.11.

ACASTLE rated as a ship in H.M. Navy. The Maltese Castle of St. Angelo as H.M.S. St. Angelo on the ¼d. stamp in a set of four, ¼d., ½d., 1d., 2½d. used Maltese stamps. Catalogued at 8d. or free to all sending 4d. for postage and requesting our approval selections.—E. F. C. Townsend, S.C.A., 92 Tenby Rd., Edgware, Middx.

SPACE fillers 3 a 1d. Foreign, Colonial. S—Jeffreys, 2 Bay View, Craigavon, Port Talbot.

STAMPS — 10 different French Colonials, large mint pictorials to approval applicants. Send 3d. postage please.

GOLDEN HAMSTERS—the wonderful new pet, like miniature bear. Their antics are a never-ending source of entertainment. Fine healthy youngsters, 5/- each; 9/- pair. Carriage, 1/-.—W. E. Hewison, 190 Victoria Road, Scarborough.

SOUTH Africa set, 10 free. Stamp approvals.—Ashmount House, Marshfield Road, Goole, Yorks.

Topical Tips on Taping!



Toys have no ending with "Durex" mending

There are no tears when you can tape with "DUREX"! Broken toys are speedily and invisibly repaired without fuss or mess. It's just one of a thousand jobs "DUREX" does.

"DUREX"

Cellulose TAPE

Trade Enquiries:
Durex Abrasives Ltd., Birmingham, 8

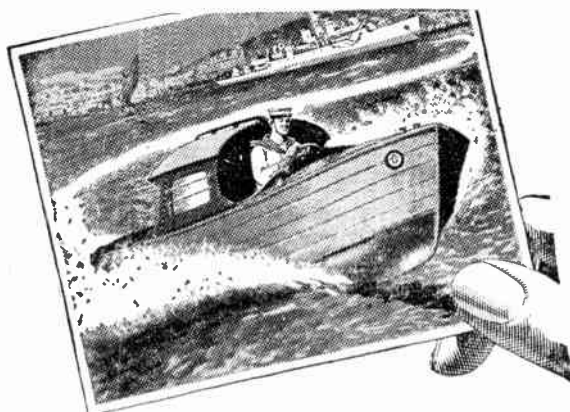
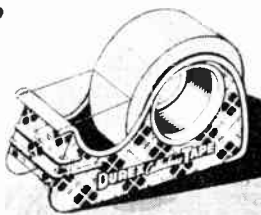

"Sam's doing a sweep . . .

He's coxswain, you chump — he *doesn't* clean the funnels. He's doing a sweep — a wide turn — to bring the boat's head into the wind so's he won't bump when he comes alongside. I started as coxswain when I stepped up to Leading Seaman last August. It's one of the best jobs going, but you've got to be smart — they say a ship's known by her boats. I remember the first trip I made . . . in Alex. harbour . . ."

For full details of how to join and descriptive booklet 'Here is the Navy,' write to THE DIRECTOR OF NAVAL RECRUITING, Dept. 1/37, ADMIRALTY, LONDON, S.W.1.

Make the **ROYAL NAVY**
your career



MODEL CONSTRUCTIONAL KITS

that are well known for quality and low price

AIRYDA MODEL AIRCRAFT



Include both flying and non-flying types; sizes and prices to suit all Modellers. Each kit complete with plan, building instructions and all necessary parts.

AQUILA MODEL SHIPS & BOATS

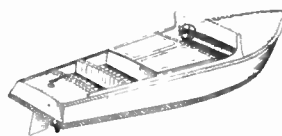

This series includes Motor Launches, Cabin Cruisers, Motor Yachts, Cross Channel Steamers, etc. Sizes range from 20ins. to 39ins. in length; and prices from 18/- to 62/6.

ANORMA MODEL BUILDINGS



This range of Model Buildings includes shops, houses, factories, railway buildings, etc., which are all designed to 4 mm. scale suitable for OO gauge Model Railway lay-outs, etc.

Full particulars can be obtained from your local dealer, or send for particulars to:

MODELLERS SUPPLY LTD.

DEPT. HO 1

ASPLEY, HUDDERSFIELD

YOU CAN BECOME A HANDICRAFTS INSTRUCTOR

Experience not essential

Men who enjoy making things in wood or metal can turn their hobby into a well-paid, permanent and interesting Career. Short hours, long holidays, and security in a job you would really enjoy, can be yours if you become a Handicrafts Instructor. Let us send details of the easiest and quickest way to get the necessary qualification.

**We definitely guarantee
"NO PASS - NO FEE"**

If you would like to know about our unique method of preparing you for one of these excellent appointments, write today, and we will send you our informative 175-page Handbook—free and without obligation. Mark your letters "Handicrafts Instructor".

**BRITISH INSTITUTE OF
ENGINEERING TECHNOLOGY**

595 Shakespeare House
Stratford Place, London, W.1

BIET

Indispensable to all interested in motor cars.

The two popular Car Books

**"WHERE'S THAT CAR FROM!"
"POPULAR CARS ILLUSTRATED"**
6d. each

From all Stationers and Booksellers

or from **RALEIGH PRESS, EXMOUTH**

WEBLEY

AIR PISTOLS

Marvellously accurate for target practice.

No licence required to purchase.

Senior Mark 1

Junior Webley Air Rifle

Write for List. **WEBLEY & SCOTT LTD.**
166 WEAMAN STREET, BIRMINGHAM, ENG.



GREATEST VALUE for MONEY
IN HOME WORKSHOP
& HOME HANDYMAN
TOOLS

You will be amazed at the many jobs you will do with new power, speed, confidence and real enjoyment. The Wolf Cub is more than an electric drill—it is the power unit of all the kits you see illustrated. Once you own the 'Cub' a small additional outlay enables you to widen the scope of your activities to the extent you desire. Think of the economy and the new profitable pleasure that will be yours! There's never been anything like this before!

WOLF CUB
 HOME CONSTRUCTOR
 ELECTRIC DRILL



PRICE
£4-19-6
COMPLETE

Wolf
Cub HOME CONSTRUCTOR
 ELECTRIC DRILL
 also
POWER UNIT
 TO ALL THIS EQUIPMENT



WOLF CUB
 HOME CONSTRUCTOR
 LATHE KIT

£7-19-6
 INCLUDING
 WOLF CUB



WOLF CUB HOME CONSTRUCTOR
 DRILLING, GRINDING AND
 POLISHING KIT

£6-17-9
 INCLUDING
 WOLF CUB



WOLF CUB
 HOME CONSTRUCTOR
 SAW KIT

£8-8-0
 INCLUDING
 WOLF CUB

★ **LOW PRICE CONVERSION SETS**
 Converts Wolf Cub or any Kit to form complete Wolf Home Constructor Equipment at attractive low prices.

Ask your tool supplier today for full details or write direct to:

WOLF ELECTRIC TOOLS LIMITED, PIONEER WORKS
HANGER LANE, LONDON, W.5. Telephone: PERIVALE 5631-4

THE STEPPING STONES TO SUCCESS!

Don't hesitate about your future! Go forward, confident that The Bennett College will see you through to a sound position in any career you choose.



CHOOSE YOUR CAREER

- | | | |
|----------------------------------------------------------------|---------------------------------------|--------------------------------------|
| Accountancy Exams. | General Education | Road Making and Maintenance |
| Aviation (Engineering and Wireless) | G.P.O. Eng. Dept. | Salesmanship |
| Book keeping. | Heating and Ventilation | Sanitation |
| Accountancy, and Modern Business Methods | Institute of Housing Officers | School Attendance Officer |
| Building, Architecture, and Clerk of Works (A.R.I.B.A. Exams.) | Institute of Municipal Engineers | Secretarial Exams. |
| Cambridge School Certificate | Journalism | Sheet Metal Work |
| Carpentry and Joinery | Languages | Shipbuilding |
| Chemistry | Mathematics | Shorthand (Pitman's) |
| Civil Engineering | Matriculation | Short Story Writing |
| Civil Service | Mining, All Subjects | Surveying (R.I.C.S. Exams.) |
| All Commercial Subjects | Motor Engineering | Teachers of Handicrafts |
| Commercial Art | Naval Architecture | Telecommunications (City and Guilds) |
| Common Prelim. E.J.E.B. | Novel Writing | Television |
| Draughtsmanship, All Branches | Plastics | Transport Inst. Examinations |
| Engineering, All branches, Subjects and Exams. | Play Writing | Viewers, Gaugers, Inspectors |
| | Police, Special Course | Weights and Measures Inspectors |
| | Press Tool Work | Wireless Telegraphy and Telephony |
| | Pumps and Pumping Machinery | |
| | Quantity Surveying | |
| | — Inst. of Quantity Surveyors' Exams. | |
| | Radio Service Engineering | |

If you do not see your requirements above, write to us on any subject. Full particulars free.

COUPON. CUT THIS OUT
 IF YOU ATTEND TO THIS NOW
 IT MAY MAKE A WONDERFUL
 DIFFERENCE TO YOUR FUTURE.



TO DEPT. 62
THE BENNETT COLLEGE LTD.
SHEFFIELD, ENGLAND.

Please send me (free of charge)

Particulars of..... (Cross out line which does not apply.)

Your private advice

about

PLEASE WRITE IN BLOCK LETTERS

Name

Address

Hobbies

WEEKLY

CONTENTS

	Page
Rowing Machine - -	385
Jig-Saw Puzzles - -	387
Leather Scrap Uses -	388
Corner Linen Basket -	389
Home Articles - - -	390
Bottle Mysteries - -	391
Decorating Book Jackets	392
Models in Pictures -	393
A Design Portfolio -	394
Garden Photography -	395
Child's Rocking Chair	397

September 20th, 1950

Price Fourpence

Vol. 110 No. 2864

A SIMPLE HOME-MADE ROWING MACHINE

ROWING is a pastime that exercises all the muscles in the body, but unfortunately, it is not everybody who can get out on the river in a racing skiff. But any handyman can rig up this simplified form of rowing machine that will give him plenty of healthy exercise without the necessity of leaving his own bedroom.

General Dimensions

A plan and side elevation of the framework is given at Fig. 1. The two long sides are 5ft. long, 3ins. wide and 1in. thick, and these have three bottom rails (1ft. 9ins. long by 1in. thick) screwed to their lower edges so the inside edges of the long rails are 1ft. 1in. apart. Of the bottom rails, two are 4ins. and the other 8ins. wide, the positions in which they should be fixed being clearly shown on the drawing.

In addition to these bottom rails, two 1ft. 4ins. long, 4ins. wide and 1in. thick rails are set across the top of the framework, their ends fitting into $\frac{1}{2}$ in. deep grooves in the long sides. To give the framework a neater appearance the ends of the long sides are rounded over as shown on the elevation.

If the rowing machine is to work

properly it is very necessary that the framework described above be made as accurately as possible, for the sides form a track along which the wheels of the sliding seat can run.

The Seat Board

The seat is of 1in. thickness and is simply a piece of wood 10ins. long by 12ins. wide. If it is not possible to get the full width in one board, two or more boards may be used provided the edges of adjacent boards are planed dead square so that the timbers may be glued edge to edge.

A three-sided framework of 1in. square wood is screwed to the top of the

seat from underneath, two of the strips running the 10ins. length of the seat and the third the width, the outer edges of all strips being kept flush with the outer edges of the seat.

Runners

Four wheels are fitted to the seat, each being made up of two circles of wood. The larger circle is $2\frac{1}{2}$ ins. in diameter and $\frac{3}{4}$ in. thick, and the smaller $1\frac{1}{2}$ ins. in diameter and $\frac{1}{2}$ in. thick. The smaller circle is screwed over the centre of the larger with four well countersunk screws. A centre hole is drilled through the composite wheel, and the wheels are then screwed into place.

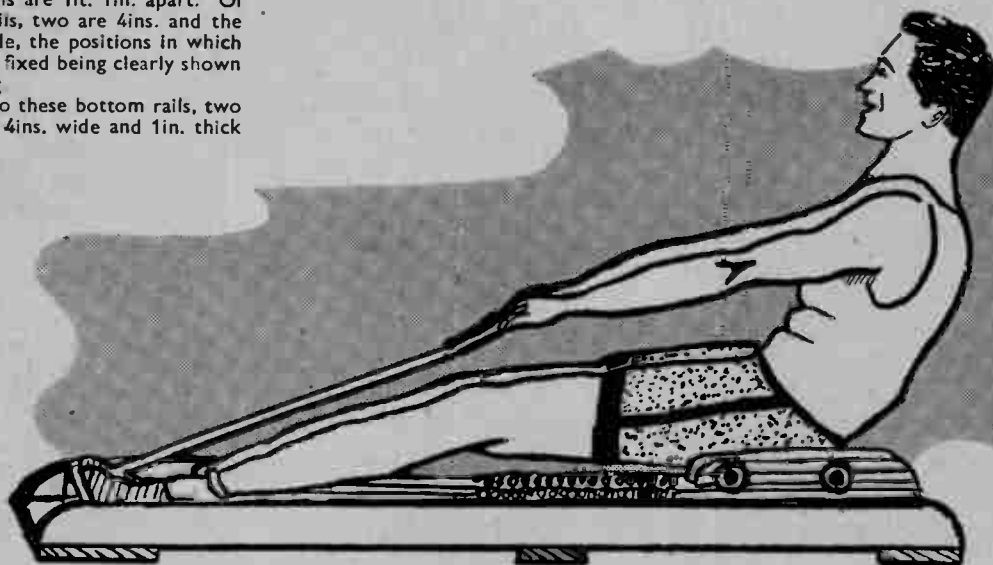

All correspondence should be addressed to The Editor, Hobbies Weekly, Dereham, Norfolk.

There are two wheels on each side of the seat, their securing screws running into the edge of the seat bottom. When screwed home these flanged wheels should enable the seat to run freely along the long rails of the framework. Fig. 2 shows two elevations of the wheel.

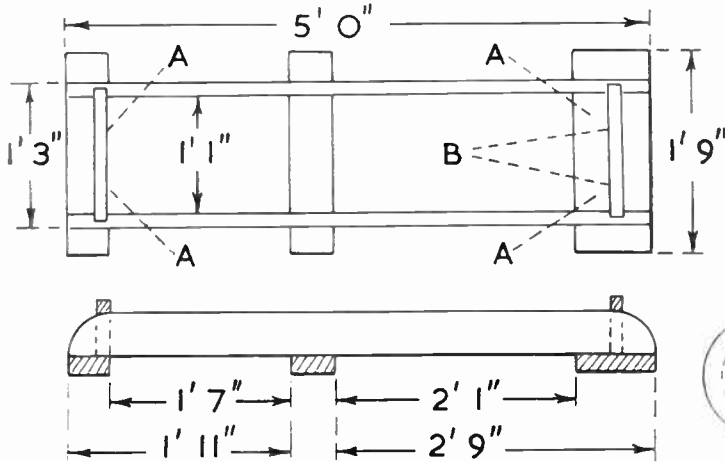

Fig. 1—Plan and side view of main frame parts

Pulley Wheels

Two pulley wheels are also needed. Each wheel is cut from three circles of $\frac{1}{4}$ in. wood, which are then screwed together. A $\frac{3}{8}$ in. diameter hole is drilled right through the centre of each pulley, and a $1\frac{1}{8}$ ins. long piece of $\frac{3}{16}$ in. diameter mild steel is tapped through this hole to form a spindle (see Fig. 3).

The pulley wheels are fitted into a bracket, each bracket being made from a piece of reasonably stout metal $3\frac{3}{8}$ ins. long by $1\frac{1}{4}$ ins. wide. The outline is filed to the shape given at Fig. 4, and at the positions indicated two $\frac{3}{8}$ in. diameter holes are bored for the spindles, and four $\frac{1}{4}$ in. diameter countersunk holes for the screws by which it is fixed.

It will be seen from the drawing that dotted lines $1\frac{1}{2}$ ins. apart have been drawn across the outline, and at these

places the metal must be bent upwards at right-angles to complete the bracket.

These brackets have then to be screwed to the inside face of the front upright cross-rail of the framework. Their position is indicated by the dotted lines running from (B) on the plan at

popular stores) are fastened through the two screw-eyes at the front of the framework, their other ends being made fast to screw-eyes in the front edge of the seat.

Hand Grips

Two handle-grips should be made from $\frac{1}{4}$ in. thick galvanized wire to the shape shown at Fig. 5, the grips being completed by fastening the two prongs into the ends of a 4 in. length of 1 in. diameter dowelling. A 3 ft. 6 in. length of strong plaited cord is then fixed through a hole bored through the middle of the dowel.

The free ends of these cords each pass over one of the pulleys and back along the framework under the seat. Their ends are made fast to two more springs, the opposite ends of which are fixed into

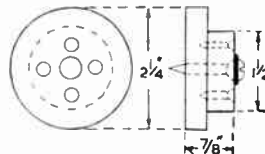

Fig. 2—The flanged wheels

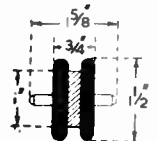

Fig. 3—Pulley wheels

Fig. 1, there being a distance of $3\frac{1}{2}$ ins. between their inside edges. The brackets are screwed in the centre of the width of the rail and the pulleys fixed in place by means of their spindles. It will be necessary to tap each spindle back a little to enable it to be slid into its holes, and it will be found advisable to slip a thin steel washer over the spindle between the wheel and the inside of the pulley bracket at each end.

At the positions marked (A) on the plan, strong screw-eyes are fastened into the framework. Two 9 ins. long stout springs (which may be bought at an ironmonger's shop or at one of the

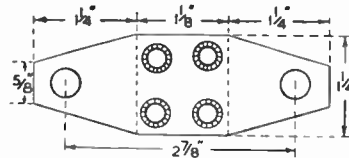

Fig. 4—The pulley wheel bracket shape

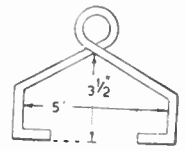

Fig. 5—Grips shape

the screw-eyes on the back vertical cross-rail. This completes the construction.

Tension Adjustment

If experience proves it necessary the cord can be shortened or lengthened as desired to adjust the tension of the sliding seat, and the flanged wheels made to run more easily by lubricating the side rails with candle grease. (237)

Felt Hat Uses

AT a recent Jumble Sale, several felt hats (good) were not disposed of, and I should like to know if there is anything you could suggest to make out of them—except toys. (E.M.D.—Ballynabola).

SALEABLE articles which can be made from old felt hats, include oven mittens and iron holders. The mittens are made like gloves, using the felt for the inner sides and any other material for the outside. Iron holders can be made of two thicknesses of the felt, backed with some fancy material. Another useful article is a floor polisher. This is a piece of wood about 5 ins. wide and 9 ins. long, with a broom handle attached. To the wood, the felt several layers thick, is tacked, tacking at the side edges of the wood. A coat of varnish to the wood makes an attractive article.

Plaster Setting

HOW do I mix a good compound for a plaque. I have tried Alabastine and plaster of paris, and each time it has not hardened. (C.T.—Upton).

IN all probability, the reason the Alabastine and plaster of paris did not set hard, is because the quantity of water used was excessive. When mixing plaster of paris for mould making, the plaster should be stirred gently into the water until it is the consistency of fairly thick cream, and then at once poured into the mould. It should then set within 30 minutes and harden and dry out in 36 to 48 hours.

Both Alabastine and plaster of paris are air hardening, and, therefore, the moulds must be open to the air, as if closed moulds are used, the exclusion of air will prevent the plaster setting. We do not know of any more suitable

material for moulds, and suggest you try the above method.

Aquarium Heating

PLEASE tell me how to make a small water heater for a tropical aquarium. (C.D.H.—Stretford).

TO maintain the temperature at the proper level is most essential in keeping a tropical aquarium; the failure of the heating apparatus might result in the loss of all your fish. Therefore you must have a reliable heater. We would not advise you to attempt to make one yourself, but to purchase a suitable make, and whether oil, gas or electricity is used, be sure the heater is to be depended upon. Electric heaters are popular nowadays with many tropical aquarists. You should be able to get a good one for about 16/-.

For gifts, parties, or home use think of the possibilities of JIG-SAW PUZZLES

THE making of jig-saw puzzles of all kinds is one of the happy possibilities with the fretsaw, which should really cover a very wide range of pleasure. The completed jig-saws provide endless amusement in fitting them together, apart from the pleasure of knowing that they are homemade. Besides this individual enjoyment, there are also a number of other suggestions which should appeal to the keen fret-worker, and now that plywood is again obtainable, the opportunity is provided for several varieties of the work.

Various Uses

You could, for instance, cut a number of small ones little larger than a postcard, and have them ready for the Christmas parties. You could even provide original Christmas cards by cutting the pictures on thin plywood suitable for sending by post. You could undertake a number of them, particularly if you have a fret-machine, and offer them to suitable shops for sale.

You could cut an enormous picture with 200 or 300 pieces which will provide lasting entertainment in putting together again. You could even run a jig-saw lending library by having a dozen or 20 of the pictures distributed amongst your friends, passing them round at weekly intervals.

So, you see, the use of the fretsaw in cutting these puzzle pictures provides a wide variety of work and pleasure, and now is the time to consider the matter

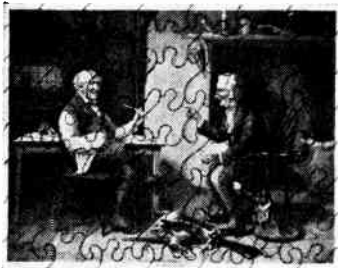

A typical picture for jigsaw

with the longer evenings approaching. It may seem early to talk about Christmas, but it is surprising how quickly the time flies, and how often the work remains undone.

Moreover, if you are proposing to offer the jig-saws for sale, then it is essential you get the finished articles in the hands of the shopkeepers so they may be ready for early display. More of this side of the matter, however, will be mentioned later.

Essential Materials

First, let us consider the essential materials and work involved, so we may know what we have to take in hand, and plan accordingly. It is most disheartening when one has worked up a lot of enthusiasm, to find some essential part or piece of material required has not been obtained, and enjoyment has to be stood down for another day or two whilst these things are obtained.

The main materials are, of course, wood, paste, and pictures, and apart from that, you need the ubiquitous fretsaw and its companion cutting table. Not every picture is suitable, but there is at present such a wide range of them obtainable of the needed style, that their supply should not be a source of much trouble.

If you only need two or three of the pictures, then it is a simple matter to get



A factory at home with a motor fretmachine

suitable. This must be used only for the small subjects, however, because it would be impossible to keep the large picture flat in such thin material. Moreover, the Christmas card could then easily be backed with a piece of thin cardboard suitable for sending by post.

The thickness of the actual wood, however, may vary with the size of the picture. Obviously, if you have a puzzle the size of a postcard, and have cut it in $\frac{1}{4}$ in. wood, then the whole thing will be unsightly and clumsy. Normal pictures measuring up to, say, about 10 ins. on each side, or smaller, can be of $\frac{3}{8}$ in. wood. But if they are much smaller than this, then $\frac{1}{4}$ in. ply is satisfactory. From the 10 in. picture upwards, the $\frac{3}{8}$ in. wood must be definitely employed, and for very large subjects, you can then go to $\frac{1}{2}$ in.

When we speak of large subjects, we mean those measuring up to 2 ft. on each side. These are the very large pictures supplied by jig-saw libraries, and really need a separate card table or side table for their use, because the solution of the puzzle may take a week or 10 days, and it is necessary to leave the portion solved until you can get down to it again later.

For pasting the picture down, ordinary paste is suitable, providing it does not deteriorate and go 'mouldy'. Proprietary paste is much better, and for the purpose in hand it is best to use the photo mountant obtainable from chemists, or the creamy white adhesive obtainable in tins, such as Grip-Fix. A flat, clean paste brush should be used, and the paste sufficiently liquid to apply reasonably quickly to the surface of the back of the picture itself. Have it applied evenly and not too thickly, putting the picture down immediately on to the wood.

Have a clean duster of soft material handy, and lightly rub the picture down

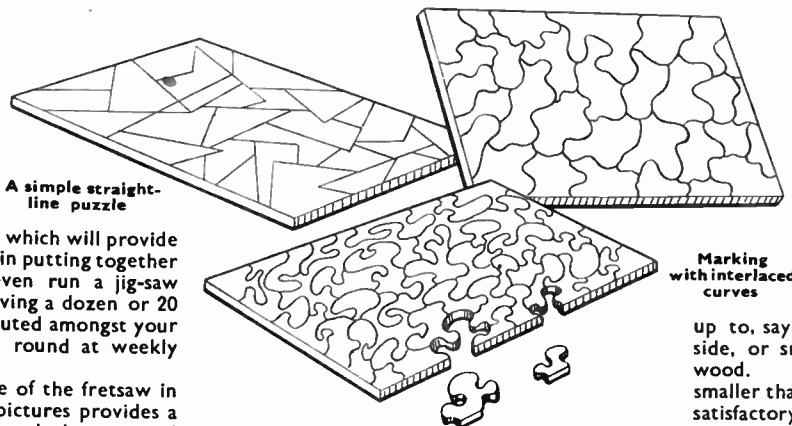

The type of interlocking puzzle

them from a local bookseller or stationer. If you are proposing to undertake a quantity of them, then there are firms who supply the pictures reasonably cheaply. One essential to the subject, of course, is that it must have a straight edge—whether it is square or rectangular is really immaterial.

Where to Get Pictures

The picture, too, can be a coloured subject, which is much more attractive, or just a plain black and white drawing. Very often those on the front of magazines form ideal subjects, and very often periodicals have coloured 'plates' which can be used equally well. The pictures should be bright and colourful, and printed on reasonably strong paper. If they are very thin, then there is a likelihood of the material stretching when being pasted down, and so getting distorted.

The wood should be 3-ply generally, $\frac{3}{8}$ in. thick. If you are undertaking the Christmas card type previously mentioned, then the 1 mm. plywood is more

to the wood, working outwards from the centre. If any air bubbles have occurred, lift the picture along the nearest edge, and flatten it down again, wiping towards the edging with the duster to take away the offending bubble.

Paste on Wood

In the case of large pictures, a better plan is to apply the paste to the wood itself, and then lay the picture on to it. Hold the paper at the two corners, letting the opposite side drop into its appropriate place on the wood, and gradually lowering the rest of the paper on to the wood. Again smooth the paper out, pressing it fairly firmly. Finally cover with a piece of blotting paper and a weight, such as books, until the paste has dried.

All this can be done before actually working out the shape and style of the jig-saw puzzle itself. There are several varieties of these, each involving a certain amount of work beforehand.

Interlocking Parts

The ideal, of course, is an interlocking type of jig-saw. In this, each piece holds on to the adjoining pieces, with the result that the whole thing can be picked up by one corner and no part falls out. This is the ideal which should be aimed at, but the cutting of an experimental



A typical completed puzzle

piece should be undertaken first to try one's 'prentice hand to get a satisfactory result.

Straight or Curved

There are, however, several other styles which, although not so elaborate, are more simple to cut and equally simple to solve. Straight lines or curves can be incorporated into the picture quite easily, and an example of these is shown in the detail herewith. The lines can be drawn in pencil, and there need be no standard shape or size in their execution. The same can apply to curves, although this is perhaps a little more difficult in obtaining the graceful lines both in the pencil work and in the actual cutting.

Obviously with the small pictures, the actual pieces cut will be equally small. A piece the size of a postcard, for instance, would look absurd if only cut into, say, six pieces. If you make a first attempt by marking out your shapes in pencil on the size of paper to be used, you can tell roughly what looks satisfactory. You can see by the drawings herewith, an idea of the number which have to be cut.

The picture should be a subject in a frame, as it were. You see the style of thing in the illustration below, where a duplicate of the subject is contained with the cut pieces in a box.

Suitable pictures are frequently mentioned in our Miscellaneous Advertisement columns, or the Editor can give you the address of firms supplying them. On the other hand there must be a number of odd prints about your own home or that of your friends which could very well serve the purpose. They must, of course, be quite flat and clean—a rubber would probably take off any odd marks at present upon them.

Marking Out

A good plan is to mark out a suitable sheet of paper in pencil, altering it as required until you have got the satisfactory result. Then outline the whole thing in ink so you can trace it off on a piece of transparent paper with a reasonably hard pencil. By turning this over on to the actual picture, you can retrace the outline and transfer it quite

clearly to the subject itself. The fact that the tracing will be in reverse is immaterial. By doing the first in ink, you have the original which can be kept for future use, should the actual tracing be worn or lost.

Having traced the outline on to the paper, the next job, of course, is the cutting. As usual, the owner of the fretmachine has the advantage because he has both hands free to handle the work and operate the turnings as required. Whether it is the fretmachine or the handframe, however, absolute control of the saw must be maintained. For you must remember that no part of the picture is wasted, so that any badly cut or overrun saw will show.

The Cutting

There is, of course, the advantage that if you happen to overrun a piece, you can probably turn the saw into another direction and by altering the shape slightly, make the mistake less obvious.

(To be Concluded)

Practical Suggestion for Using Leather Scraps

MOST leather workers wonder what to do with the pieces which remain when a skin has been cut up to make articles like handbags, wallets and purses. These remnants need not be wasted; here are a few hints for making useful and easily-produced articles.

Tea Cosy

A very attractive tea cosy can be completed from oblong pieces of leather. Make a pattern from wood or cardboard 3ins. by 1½ins. and use this to cut out a number of oblongs. Take five of these pieces, and sew them by their shorter sides; which will give you a strip about 14ins. long. When sewing, place the smooth surfaces face to face, and stitch about ½in. from the edge.

Make a further strip of six pieces, then sew the two strips together, taking care to stagger them. The seams of one strip thus come in the centres of the oblongs of the other, rather like bricks are sometimes arranged in a wall. The third strip should have five pieces, the fourth six, and so on. Six strips should give sufficient height.

Construct the other side similarly, then cut the sides to the shape you desire. Sew the two sides together, smooth sides facing. For the lining, use silk or poplin, and stuff the cosy with kapok. To attach the bottom edge to the lining, you can either turn the leather over ½in., and stitch, or you can use a cloth or imitation leather binding. There you have a tea cosy which will give many years of warm service.

By sewing leather in strips, as just

suggested, you can make other articles, like pyjama cases, shopping bags and handbags.

How about a very fine unique chess board? You can make one by using leather 2in. squares. You will need 64 pieces of leather, half of which should be black, the other half a lighter colour, say brown.

These require to be glued on a wooden base, taking care to select leather of uniform thickness, and cutting the squares carefully. If the leather is crumpled, smooth it with a warm iron before cutting. Some beading tacked round the edges of the board afterwards will impart a really handsome appearance.

Table Mats and Belts

This idea of sticking squares of leather on to a base can be used for making table mats. Make the pieces smaller—1in. square should suffice—and stick them on to stiff cardboard. Old cork table mats can be revived by surfacing them with leather in this manner.

The use of rubber solution or paste is to be recommended where heat would melt glue.

Still another way of using those odd pieces is to make fancy belts. They may be of the chain variety, requiring no stitching, or they may consist of ovals or diamonds of leather sewn together. Use strong leather that is not likely to stretch out of shape, and cut the leather very carefully, with the help of a pattern.

These few tips will serve to show you that there is no need to throw away any leather that has length and breadth of any worth-while dimension. (241)

A simple wood framework with card covering to make a SOILED LINEN BASKET

A MOST useful article this for the reception of soiled linen. It can stand inconspicuously in a corner of the bedroom, and is not inartistic in appearance in the least. As it needs very little wood, and can be made mostly from scrap materials, it is an inexpensive article well worth the making.

Details of the sides and bottom are given in Fig. 1 and diagram. Fig. 2 shows the general build up of the article. First make up a couple of light wood frames to dimensions given in Fig 1 (A). These are constructed from $\frac{1}{2}$ in. by 1 in. wood strips and joined together at the corners with the simple halved joint, shown at (C), which every reader is well acquainted with, we think.

Note that the frames differ in width, one being 11 ins. and the other $10\frac{1}{2}$ ins.

TIMBER LIST

$\frac{1}{2}$ in. by 1 in. wood strip for frames. 12 ft. run.
 $\frac{1}{2}$ in. by 5 in. board for curved rail. 1 ft. 6 ins. run.
 Bottom— $\frac{1}{2}$ in. by 1 ins. by 1 ins.
 Lid— $\frac{1}{2}$ in. plywood, square foot.

wide, so that when joined together, L shape, both sides will measure the same. The joints should be glued and nailed, and the two front top corners, to which the curved front rail is to be screwed, should only have nails at the spots shown, leaving the centre free for the fixing screws of the rail.

Bottom Board

The frames can now be glued and nailed together. For the bottom cut from $\frac{1}{2}$ in. board the quadrant-shaped piece shown at (B), then nail and glue the sides to it. The position of the sides is indicated by dotted lines, also the curved front rail.

This rail is cut from $\frac{1}{2}$ in. board from

the solid, a piece about $4\frac{1}{2}$ ins. wide being suitable for the job. The curve can be struck with compasses, or the bottom of the carcase can be stood on the wood and a pencil drawn round it instead. The thickness of the rail is $\frac{1}{2}$ in. so a second curve, that distance away from the first should also be struck. The rail can be sawn out with a keyhole saw if reasonable care is taken.

Fix the rail across with glue and a single countersunk screw at each end. A small wood angle block might be glued each end, if thought necessary, to strengthen the rail where it joins the sides.

The Lid

At this stage cut the lid, shown at (D) in Fig. 3. This can be cut from plywood, or good quality hardboard might serve. Lay the lid upside down on the bench, and stand the carcase of the basket on it, also upside down. See the lid extends beyond the basket about $\frac{1}{2}$ in. each side.

Then run a pencil round the top of the framing and the curved rail. This will mark on the underside of the lid the exact position for two strips of wood, shown by dotted lines in the drawing, which are to be nailed to the lid to keep the latter in place. Do not fit these strips dead to the pencil lines but $\frac{1}{16}$ in. inside them.

Cardboard Front

The sides and curved front of the basket are covered with cardboard, as in the constructional detail in Fig. 2. You can, of course, buy a sheet or two of cardboard for this part of the work, or if you feel like being economical, use the cardboard from grocers' containers,

which can generally be obtained free for the asking now.

If the sheets are not large enough to cover their respective areas, join them together, edge to edge, with tape, glued over the joint back and front. Fix the cardboard with glue and shoemaker's brads.

Covering

The whole basket, except the lid, should be covered. For the curved front there is a good opportunity to use any remnant of suitable material that may be in the reader's possession. A sufficiently large piece of cretonne, or tapestry, or indeed any stuff that would look nice and wear well. For the sides, as these stand against the wall, plain brown paper would do, or fancy paper—scrap from a roll of wall-paper would serve quite well.

(Continued foot of page 390)

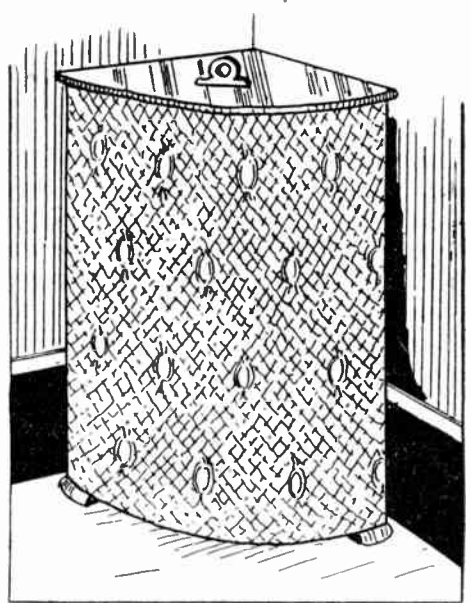

Fig. 3 - The lid, feet and handle

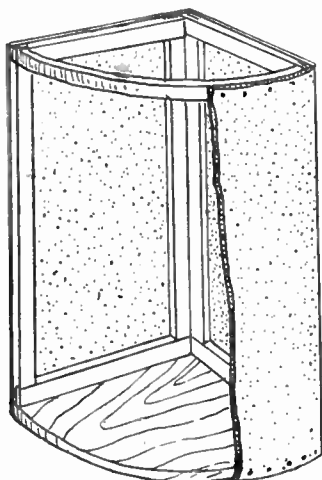

Fig. 2 - Constructional details

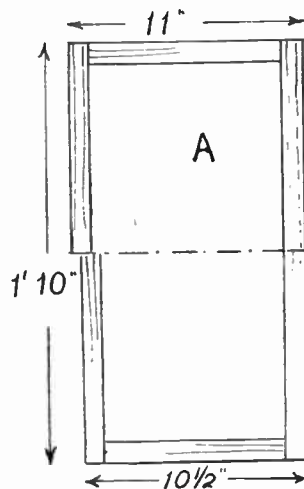
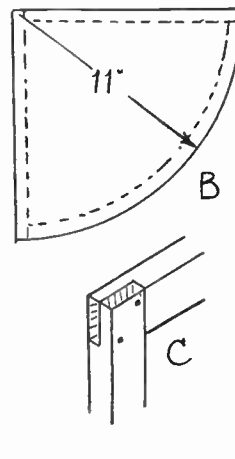

Fig. 1 - Side frames and bottom, with joint detail



How the handyman can alter furniture to make modern HOME IMPROVEMENTS

THE home handyman can always be busy even if the wood situation is still difficult. Panel board or composition is available, odd bits and pieces can still be picked up at the local wardrobe dealers and you will enjoy making the article as well as improvising it.

In a fairly large household we always find one mass of shoes in one room or the other. When we want them we grumble and cannot find them, and when we do find them they are all dusty and probably mildewed at the bottom due to standing too long.

A Shoe Rack

Here is a simple little gadget to make up and all you need is one of those old-fashioned towel horses which our old folks used to treasure.

As a rule these have a curved structure with three bars, two each side and one in the centre. Remove the bar from what will be the back and leave the centre and front one. Shoes will then rest with heels on middle rail and soles on outer rail (see Fig. 1). If you want more space then add another set of bars between the existing sets. Give a coat of stain and the fixture can stand in any odd corner.

Washing-up Board

When we have company we often find that we have an extra lot of china to be washed up. Perhaps there is not space in the scullery for another table, so the obvious thing is to make a slide-in shelf in the window recess if you have one. If you cannot fix it there then perhaps it can be fitted near a wall with a short leg fitment as shown in separate sketch.

The board for this (shown in Fig. 2) can be $\frac{1}{2}$ in. thick or made from panel board with a 1 in. square edge, rounded at the corners. Use panel fine pins for fixing. The top could be linoleum covered to save damage from water, and if possible fix it at window level. It can, space permitting, extend out about 3 ins. from the wall or alcove.

Now for the side supports. You will require four of these, two each side, made from $\frac{3}{4}$ in. square wood well sanded.

Allow sufficient space for the board to slide in and out. Note the position of these in the separate sketch.

A Linen Trolley

Washing day is always a hard day when it comes to carrying the wet clothes in and out of doors and chasing the peg bag. The workmanlike garden washing day trolley seen in Fig. 3 is made from a drawer from an old chest of drawers. It is cleaned up, with handles added at each end and lined with some light American cloth, put on with paste.

Legs of $1\frac{1}{2}$ in. prepared wood are added at each end and 6 in. wooden turned wheels mounted on the bottom. Large

seen these quite recently reposing outside the local secondhand dealers presumably having lost the springs and wheels. Why not turn one of these into a needlework box (see Fig. 4) for the family? It can be very useful and not unsightly.

Clean it up and fix a hinged lid with panel board with 1 in. beading all round. Line the inside with light coloured chintz or some other material. This can be pasted in with lino paste. Pad the inside of the lid and neaten round with furnishing tacks. This will do for the cotton on reels and also needles and other items.

Procure a set of table legs and join up

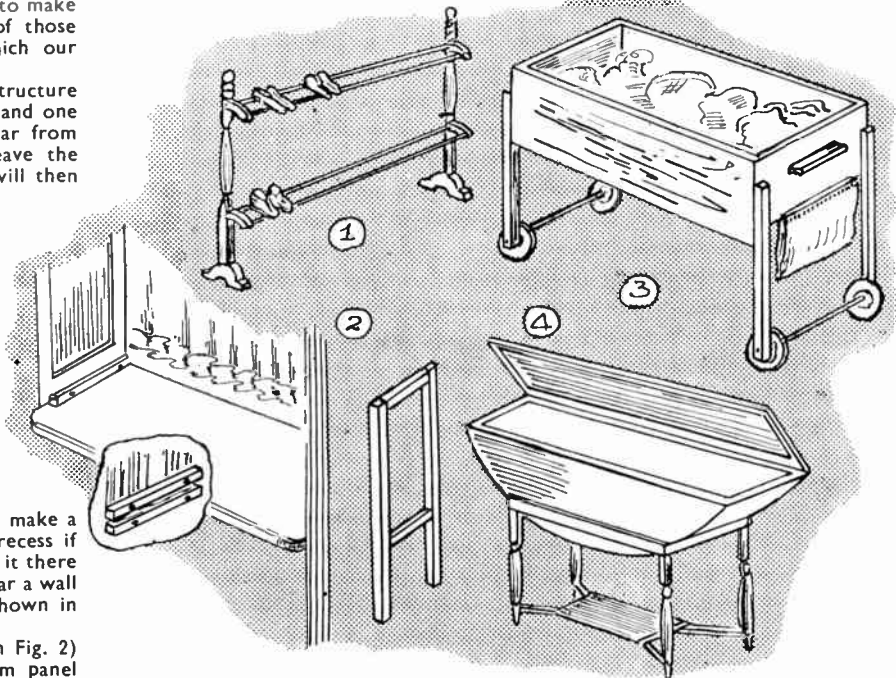

wheels are a great advantage on account of the undulating surface of the garden. A strong damask peg bag is added to one end and another bag the opposite end to take care of the rope clothes line.

Needlework Holder

Many families possess somewhere an old-fashioned perambulator and we have

as shown with a wooden surround at the top to take the needlework box. Fix this so the box can be removed at any time. This can be fitted with a short length of narrow beading on each side of the curved part just where it meets the surround. When the lid is closed down it will make an ideal table. (174)

Linen Basket—(Continued from page 389)

Paper can be pasted on, and should be neatly folded over to the inside of the basket and the bottom. The material can be fixed with small tacks similarly. A few yards of banding, or gimp, would look well if tacked along the top and bottom to finish off.

From any scrap bits of wood, cut two

feet with curved front edges, as shown at (F), and fix these with screws to the bottom of the basket, in the places seen in the general view of the article. At the back, screw a plain square of similar wood to act as a third foot to bring all level.

Cut a handle for the lid, to pattern at (E), and fix this at the place indicated.

The lid should fit comfortably on the basket, and if found too tight, the strips of wood attached to it underneath should be prised off and planed a little until the fit is quite satisfactory. The lid and feet of the finished article should be painted or enamelled in some pleasing colour, then the basket is ready to use.

Readers have written to us about some MORE BOTTLED MYSTERY

In our issue of December 14th, 1949 we originally published an article on 'The Nail In The Bottle', and this was followed by another (May 3rd, 1950) on an alternative, and in many ways an improved, method by a reader who kindly sent his ideas to us.

This novelty further seems to have inspired the ingenuity of several readers. Mr. M. Minster of Johannesburg in South Africa writes to tell us that instead of one nail, he puts three in, one below the other, in an extended wooden 'cork'. He does this, of course, by drilling one hole lengthways and three sideways. Mr. Minster is apparently one of those who think that if you can do a thing once, it may be just a lucky fluke. If you do it twice, it may be a coincidence, but if you do it three times there is something definite about it!

Another Method

Another method has come to the writer's notice, and one that has several advantages over the original model. Instead of a nail there is a wooden screw, which considerably increases the mystery. Then the stopper, instead of

Actual dimensions cannot be given as these depend on the size of the bottle. Always allow for the thickness of the glass. The interior dimensions are smaller than the outside ones.

Stopper and Shaft

The stopper, though appearing as one unit, is in three parts, and is best turned out of plastic. The stopper itself (B, Fig. 1) does not go very far into the neck of the bottle but just has a shallow rebate so that it can 'sit' on top of the bottle. The end of the shaft (A) is screwed into (B). It considerably simplifies construction and turning if the hole is taken right through (B) and then a cap (C) added. Though it adds to the work involved, it would be a great advantage if (C) were made with a screwed boss, as shown in Fig. 3.

The wood screw is not actually screwed in but is in a tapered hole. In addition to this transverse hole, another is required going the length of the rod (A) to just past the tapered hole.

Full Size Drawing

Note that the screwed part of the rod (x) is made much longer than will finally be retained. A study of Fig. 4 will show the reason: to enable a grip to be maintained on it during the insertion of the wood screw. Readers are advised to make a full-size drawing such as Fig. 4,

make sure that the tapered hole will take the screw properly).

The rod is then drawn up and the surplus screwed rod is cut off (take care that the wood screw does not drop out whilst doing this). The stopper (B) may now be screwed on.

The Needle Work

Now comes a subtle part that is unsuspected. Obtain a knitting needle or similar stiff steel rod, of such a thickness that it will slide down the central hole without any shake. The far end (which will touch the screw) is pointed. The length of this needle must be very carefully adjusted so when the cap (C) is glued or screwed on, the rod is pressed down on the wood screw (it will engage in one of the turns of the screw) and prevent it moving.

A little plastic cement should be smeared on the screws connecting parts (A) (B) and (C) so that they cannot be unscrewed by the curious who would stop at anything short of smashing the bottle to find out 'how it is done'.

A 'Ladder' Mystery

Our South African correspondent also enquires after another 'bottled mystery', this time, the ladder in a bottle. This is a tapered ladder, as shown in Fig. 5. Each rung is properly dowelled into the stiles (Fig. 7). How is it done?

As with the 'Ship In The Bottle' (the classic of bottled mysteries) there is no one way. Possibly after reading this and getting to work, readers may tell us of other methods.

As before, the bottle should be measured for internal dimensions and the ladder made and assembled outside the bottle. The joints can be fairly easy fitting since, when the ladder is assembled inside the bottle, the bottle is filled with liquid. This causes the wood to swell and the joints get tight. If the joints are too loose, however, the model will fall apart. The rungs had best be tapered so they can have an easy start in the hole but can be pushed in tightly. Ends that project from the holes can be cut off (inside the bottle).

Rung and Thread

Each rung has a thread attached to either end. (Make a small slit with a razor blade and insert the thread). These threads run through the holes in the stiles. Note well that the threads need be much longer than shown in Fig. 6, where the threads are shown shortened for economy in drawing. It will be an immense help if each rung has a differently coloured thread. A single knot can be tied to each end of the threads for the first rung: two knots for the second, and so on.

It is a sound precaution to tie the ends of the threads to large buttons

(Continued foot of page 392)

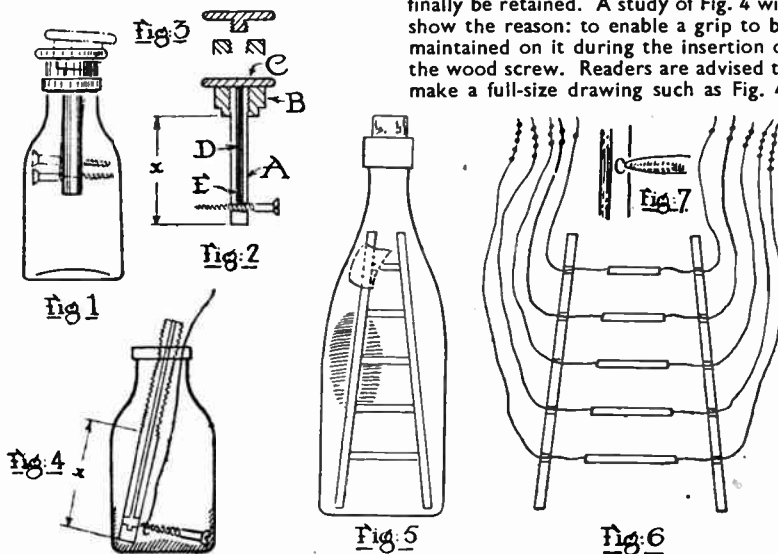

being sealed in the neck of the bottle (which always seems a bit suspicious) is withdrawable — well, almost. (See dotted lines in Fig. 1). The wooden screw in the shaft attached to the stopper prevents complete withdrawal.

How was the screw ever driven in? The method is subtle and not at all difficult though to do it practically, requires the use of a model-maker's lathe and screw-cutting taps and dies. There must be many of our readers who are engineers, or who have such friends, whilst for others a description of the method will be interesting.

based on the bottle being used. This will enable them to find the size of the largest wood screw that can be used. Again we warn readers to allow for the thickness of the glass (shown shaded in Fig. 4).

Inserting the Screw

With the aid of a piece of wire hooked at one end, the screw may, inside the bottle, easily be inserted in the tapered hole (make sure that the taper is the right way round), and by swinging the rod, the screw may be forced into the hole. (Before doing this in the bottle,

The last of our series on bookbinding deals with DECORATED JACKETS

SOMETIMES a secondhand book is a sorry sight and smells musty enough to be worth half an hour in a slow oven to kill the offending fungi causing the smell. Even after the edges of the pages have then been rubbed with a rubber to clean them up a bit, the dilapidated cover remains to make the book an eyesore. Brown paper covers are the simplest and quickest solution to make the book fit to lodge in an open shelf, but brown paper is not very decorative.

It is possible to make much more pleasing covers with little trouble, so that instead of a drab brown the covers have instead a gay and bright pattern.

Potato blocks

The method involves block printing. Lino blocks are usable, of course, but it is possible to use ordinary potatoes to make patterns which can be quickly altered.

Once cut, lino blocks are permanent—whereas potatoes are plentiful and the patterns can be made in a minute or two. A whole print of well over a square foot may be done in half an hour. The latter time would be taken to stick a square of

blade cut one or two channels about an eighth of an inch wide and about as deep on the flat surface. Curved and straight channels and triangular nicks are easy to make. The method and result are shown at Fig. 2.

The block can be tried out on any paper without a high glaze, even newspaper will do. Mix up a good strong watercolour wash, then with a fairly dry paint brush paint over the potato and press it down firmly on the paper. Print other squares neatly about the first to be done, and thus get an idea of the sort of pattern you have made. Other cuts can be made, or if the pattern is unsatisfactory then the knife can remove the pattern with one slice, and a fresh surface is ready for another try.

You will notice that if a channel goes off the face of a block then it links up with whatever has been cut away at the same level

The type of paint known as 'Poster Colour', which is identical with distemper colourwashes, suits this method of pattern making very well, but should

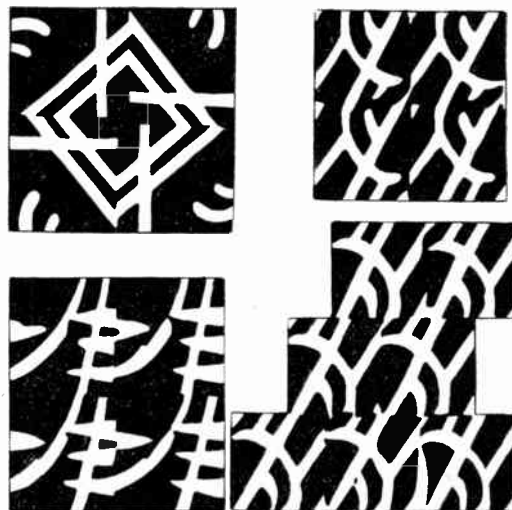

Fig. 1—Designs and applications for jackets

be used thinly.

The patterns shown below in Fig. 1 were done with this type of colour. It is possible to make many designs with one potato block. For instance printing can be carried out in a checkerboard manner, leaving alternate squares blank.

Or the block can be used shifted half a block along every row, the blocks therefore being arranged like the bricks in a wall. Sometimes good patterns can be got from an otherwise unpromising block by turning it ninety degrees each time it is set down.

When the printing is finished and the pattern is thoroughly dry then a cover can be cut out of the shape Fig. 3 and fitted on the book you wish to conceal or adorn.

If you are going to make covers for several books from the same block, all the prints should be done within a few hours—the blocks soon shrivel. If the same pattern is wanted again in the future it would be necessary to copy the pattern with a new potato. (194)

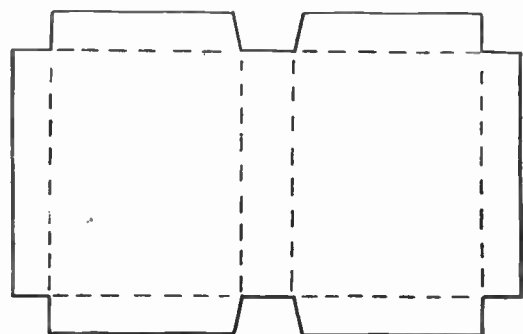

Fig. 3—Shape of finished cover paper

lino on a wood block ready to start a lino cut pattern. Here is how to do it.

Cut a potato in half with a flat knife, and square up one of the halves as shown to make an inch-sided surface. The potato surface can be oblong, but make sure the angles at the corners are exactly square.

With a penknife or old safety razor

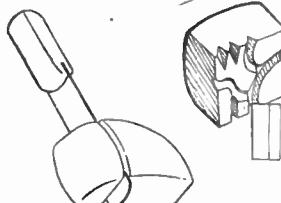

Fig. 2—Cutting and shaping the potato block

on the opposite side of the block. The blocks merge well and thus make good patterns if cuts are made with an eye to this linkage. When you have decided

on the colour, then a sheet of paper large enough for the book cover can be printed over with the design. The paper should be lightcoloured wrapping paper—brown, unless it is light, is not the best colour.

Art shops sell cheaply paper known as 'Bakers Wrapping Paper', with a cream surface, but many other equally suitable grades are available at printers' offices.

Bottled Mystery—(Continued from page 391)

(wider than the mouth of the bottle) as, in the excitement of erecting the ladder inside the bottle, one of the threads may slip inside.

Fig. 6 shows a purely diagrammatic view, though the work may appear like this if set out on a table before actually inserting in the bottle. One of the stiles is first dropped through the neck of the bottle, then each of the rungs and lastly the other stile.

By pulling gently on the threads and with the help of a piece of wire and other improvised tools, the rungs are coaxed into their appropriate holes. Obviously, patience is needed and some skill. The beginner may try a ladder of, say, four rungs or even three, to get the 'feel' of the job.

Apart from the fun in tackling this job, and for the interest it causes amongst ones friends and relations, such ladders

in a bottle form good advertising novelties if a label bearing an advertisement is pasted to the bottle. The whole job is placed on a revolving platform in a shop window.

The bottle is filled with slightly coloured water and then firmly corked or stoppered. The ends of the cotton are removed with a piece of safety razor blade soldered to the end of a length of stiff wire.

INTERESTING MODELS IN PICTURES



THIS Big Ben stands 6ft. 6ins. high and was turned out on a Hobbies Lathe, by S. Briffa of St. Roque's Street, B'rara, Malta. It was copied from our earlier design and is fitted with a Westminster 8-day quarter chime. Mr. Briffa, who has done other smaller models only for the last 13 months, is Petty Officer Stoker on H.M.S. Brigand.



(Photo Kettering Leader and Guardian)

THESE fascinating miniatures are fashioned from silver and silver gilt, made by Mr. R. Crane of Holcot, Northampton. Size can be gauged from the newspaper behind. Mr. Crane developed his hobby during an occupational therapy course undertaken after nerve trouble following a raid whilst in the R.A.M.C.

THE first attempt of W. J. Lawrence of Sheldon Road, Chippenham, who entered it with a Model Stage Coach in a Work's Exhibition with 500 others on display. The Coach was awarded a Certificate of Merit. The sailing ship-cum-steamer is from our Design No. 239Sp. of the famous R.M.S. Britannia.

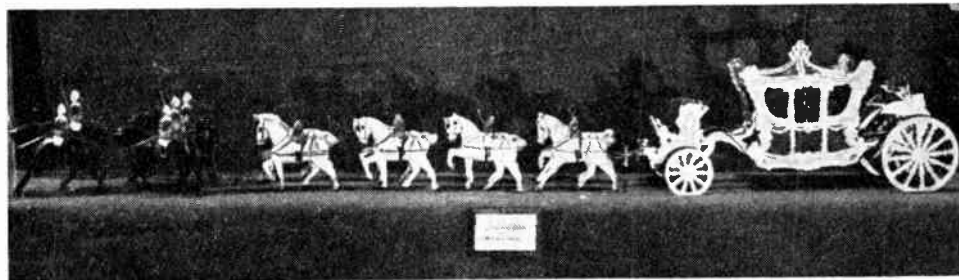
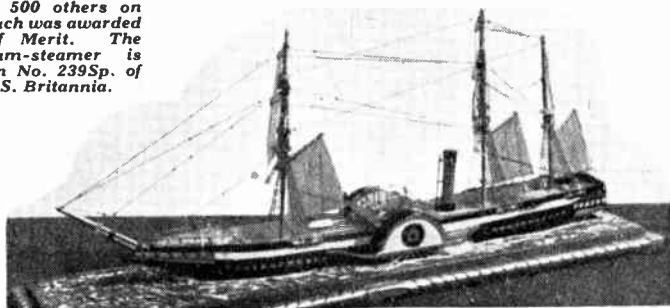

THREE weeks of spare time went to this Coronation Coach model with its escort of Life Guards. The pre-war design of ours was completed by Mr. A. Oxley of Primrose Hill Road, Huddersfield, who has now completed five of these models, in addition to Doll's House, Railway Stock, Toys, etc.

PENSIONERS of the famous Coventry firm of Herberts Ltd. co-operated in making toys for Hospitals and here you see Mr. A. L. Goodwin of 7 Croft Road, Coventry at work. He is the proud possessor of our design No. 1 and has himself made a lot of toys for the W.V.S.

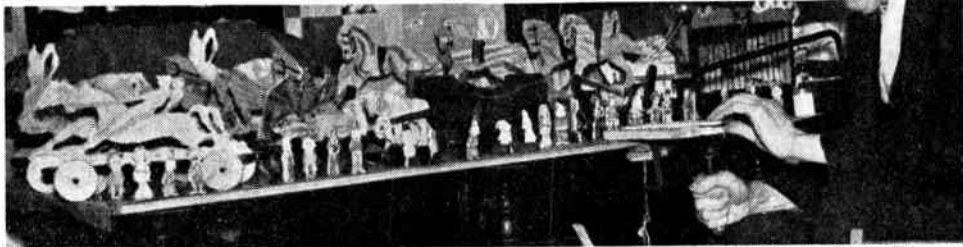

(Photo Coventry Evening Telegraph)

Keep your supplement pattern sheets in this DESIGN PORTFOLIO

MANY readers, doubtless, keep their fretwork designs for future use, and a valuable practice, too, as one never knows when a certain one may be wanted. For storing such designs there is nothing better than a portfolio, as it keeps them both flat and clean. The subject of this article shows a suitable portfolio, one just the right size for the standard designs published. As it can be made very easily and cheaply, it would be well worth the little trouble involved.

For the cardboard sides, the stouter material named strawboard could be used, but for cheapness, a double thickness of such cardboard as is used for grocers boxes, and can usually be obtained now for the asking, would serve as well. Two thicknesses of the latter should be glued together to make the sides of the portfolio strong enough.

The Sides

Cut these sides to the dimensions given in Fig. 1, and at the centre of both, glue a 12in. length of tape, as shown. A strong fastening here is necessary, and it

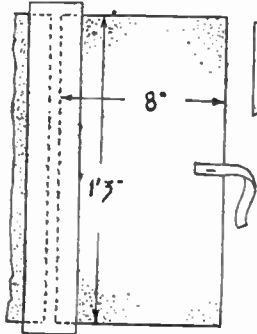

Fig. 1—The cover pieces

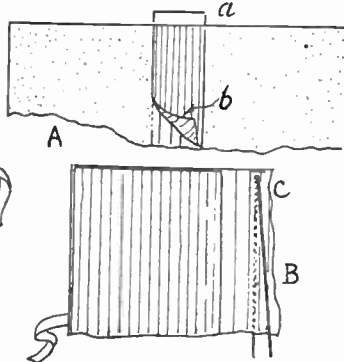

Fig. 2—Details of spine and threading

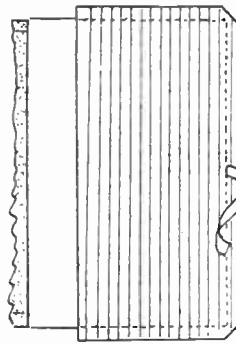

Fig. 3—Cover and tape

second strip, this time a linen for preference, or strong paper, the same width as before and the length of the sides exactly, and paste this over the middle joint, as at (b), in Fig. 2A.

Rub down, then paste or glue the laps (a) down over on the inside. Now leave the work for a little while to allow the glue and paste to harden.

Covering

The next operation is to cut the outside covering material. This can be a fancy paper, bookbinders cloth, or anything that could be usefully employed, provided it is pleasing enough in appearance.

It should overlap the covers $\frac{1}{2}$ in. at front, and top and bottom edges, and wide enough to overlap the material covering the joint by $\frac{1}{2}$ in. Snip a piece off each corner at the front, and where the tape comes, make a scissor cut to let it through, as in Fig. 3.

Turn the paper over and paste well. Let it stand a minute or two for the paste to soak into the paper, then lay it over the sides, pull the tape through the cut, and rub the paper well down. Turn over and rub down the overlays to

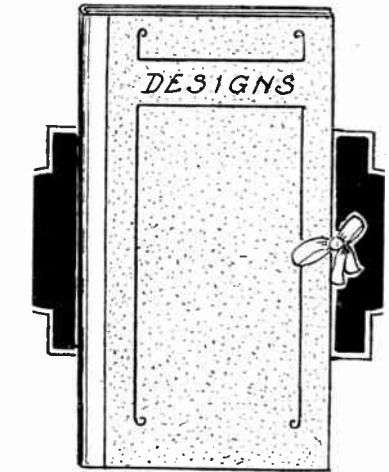

pasting paper, leave it for a minute or two before applying it to allow the paper to expand. Then, when dry, it should be taut and quite free from creases.

Open out the portfolio, and on the back cover, at spots close to the joint, and $\frac{1}{2}$ in. down from the top and $\frac{1}{2}$ in. up from the bottom (see (C) in diagram) make small holes through with any suitably sized sharp pointed instrument, the steel point of a dart is just about right for this job.

Through these holes thread a length of some fine coloured cord, like that known as 'macrame'. Draw tight, and tie on the inside with a neat bow. Under this the designs are drawn when inserted in the portfolio. This completes the work of construction, what we may call an evening's interesting job.

Decoration

The cover can be decorated according to the reader's ability. Probably a simple design put on with indian ink, as in the general view, would serve as well as anything and call for no artistic ability in particular. It may be added, though perhaps unnecessary, that a portfolio on the above lines, with the necessary amendments to dimensions, could be made for other things besides designs; drawings and sketches, or photographs, for example. Or even for letters you want to keep.

would be as well to strengthen the glue with either a thin wire staple or a stitch of thread.

For joining the sides together, cut a $2\frac{1}{2}$ in. wide strip of some suitable material, as a dark coloured linen, bookbinders cloth (if you have it), American cloth, in fact anything of a suitable nature handy. Lay the sides of the portfolio $\frac{1}{2}$ in. apart, and glue the strip over, as in the diagram. The strip, by the way, should be long enough to extend over the ends by $\frac{1}{2}$ in. each way.

Rub the stuff well down to the cardboard and turn the whole over. Cut a

the inside. Fold neatly at the corners, and let dry for a bit. While drying, cut the paper to line the inside of the covers.

Inside Lining

This should, for choice, match the outside covering, but is not imperative at all. Cut each piece to within a $\frac{1}{8}$ in. of the front, and top and bottom edges, and wide enough to overlap the covering over the middle joint by $\frac{1}{2}$ in. Diagram Fig. 2 (B) shows this. Paste the inside covers and lay carefully in position.

Then rub gently down and avoid creasing the paper. Always when

The Branches of Hobbies Ltd. are at LONDON—78a New Oxford St., W.C.1 (Phone MUSEum 2975); 87 Old Broad Street, E.C.2 (LONDON Wall 4375); 117 Walworth Road, S.E.17. GLASGOW—326 Argyle Street (Phone CENTral 5042). MANCHESTER—10 Piccadilly (Phone CENTral 1787). BIRMINGHAM—14 Bull Ring. SHEFFIELD—4 St. Paul's Parade. LEEDS—10 Queen Victoria Street (Phone 28639). HULL—10 Paragon Square. SOUTHAMPTON—25 Bernard Street. BRISTOL—30 Narrow Wine Street (Phone 23744).

HEAD OFFICE AND FACTORY—DEREHAM, NORFOLK.

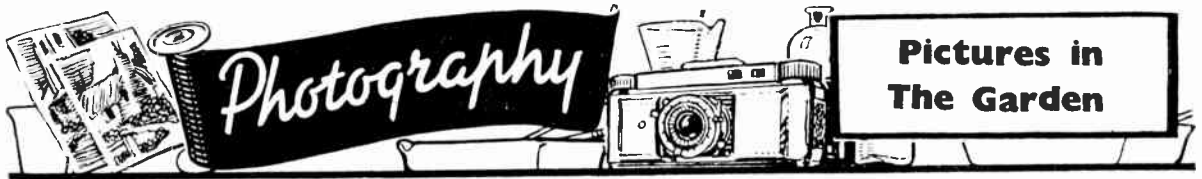

WHAT a drab and dreary place this world would become if it became impossible to grow any more flowers. Such a calamity would affect everyone, some more than others perhaps, but we should all miss the joy of our gardens or the beauty of the colourful flower beds in our public parks and open spaces.

It is the very natural pleasure derived from gardening that has made it the most popular hobby of man and woman throughout the ages. Thanks to our horticulturists and their continued research we are able to work with assurance that our efforts with seeds and plants will yield good results in due course. It is surely this faith that impels us to devote some time each week to digging, planting, weeding, or other essential work in order that those results may be achieved.

Changing Aspects

Some folks have been able to combine or spare a portion of their ground for the cultivation of vegetables. During the 1914/18 war years every plot or piece of waste ground was carefully measured into recognized 'standard' sizes suitable for individuals who could spare time at week-ends to removing rubbish or other



Proof of a 28in. savoy!

accumulation likely to restrict growth and then to dig thoroughly and eventually plant vegetables easy to cultivate and which were in regular demand for the table.

What a remarkable change developed on those plots, or as they eventually became known, those allotments. From ugly places overgrown with weeds or covered with unsightly rubbish, we were able to cut fresh greens, pick our 'morning gathered' peas or beans and dig fresh potatoes as the home supply ran short.

Such an experience was bound to have a lasting effect. The result can be seen wherever there is open land or idle spots awaiting the builders. It is good to note

too how the authorities have given their blessing to clubs and societies which have been formed in villages and towns, encouraging the members to improve the soil and procure better results.

If you are a gardener or allotment



Playtime in the Garden

holder you are probably wondering what all this has to do with your other hobby, photography. Well, the camera, besides being used in almost every industry, has proved extremely useful and successful in agriculture and horticulture research and there is no doubt that a keen amateur photographer can use a few films to advantage. The author endeavours to pass on a few hints which have proved helpful to others.

Prints of Progress

It is somewhat surprising to find what a small percentage of amateur gardeners read text books or even follow explicitly the directions on a packet of seeds, but that bad habit is found among those practicing other hobbies. If you are really keen on your digging, etc. and do not mind making a few exposures with the camera, you will certainly find some value in having a selection of prints showing the progress during the season of your garden or allotment.

One print should show the ground after it has been dug over and ready for seeds. It should be mounted with a white margin on which details of the seed in each row, the brand and the date of sowing and any other detail or data which may help you to make a comparison with the next year's print. This may help you to decide that one end of the allotment is not so good for such and such a vegetable as probably the other end.

When the young plants are showing through is another good time to make an exposure and to make notes and possibly suggestions. When the time arrives for picking or cutting then a few more exposures should certainly be made.

Useful Records

To get the most satisfactory results recorded it is best to make use of a rule. For instance, if you wish to keep a record of an excellent crop of beans, pick a dozen representing a good average, pin them to a card or board and place above or below the display a 12in. rule and make the exposure. Also weigh the dozen beans on a scale and make a note of the weight.

The resulting print should have the date of picking, the weight of the dozen and if possible the total weight of the crop, whether the season was very wet or moderately so. In fact, any item of information that can be of interest.

We all know about the giant gooseberry and the 'biggest-ever' marrow but if a photograph is taken of that marrow, pumpkin, potato, bean, tomato or any other prodigy of your allotment, with a foot rule you can refute any doubt or contradiction which may arise when you happen to be comparing notes with your neighbours or friends. It would save a lot of doubtful yarns if anglers could be prevailed to take photographs with a rule placed alongside of their 'imaginary' captures.

The author worked two 'standard' size allotments for some years and had



A fine hang of pears

the experience of growing practically every kind of useful vegetable. Knowing the value of keeping records in connection with the hobby of photography he found the same practice was well worth while with the plots and the garden.

Some seeds or plants did much better in the middle or away from the extreme

ends of the plots or even at the ends of the rows, as was very clearly demonstrated on the prints. On one particular year peas had a most remarkable run, very full and very free from pests and one outstanding note on the print states that the summer was particularly dry and it was impossible to water the crops.

The planting and also the 'pricking out' of the young seedlings is quite important and if you take a photograph do make a note of the space between each plant and whether the extra space proves more satisfactory than the shorter space of the last season.

The Flower Garden

The flower garden calls for much the same close attention regarding the actual position of individual plants. We all know that there is a 'best' bed in every garden and, of course, there is a bad one where it seems difficult to get any plants to grow let alone bloom. What about trying half-a-dozen different plants in that and taking a photograph at their flowering time. It should certainly help you in your selection for next year.

Among some gardeners there is a desire to produce blooms of exceptional large size. A friend of the author who was a keen grower of chrysanthemums for exhibition succeeded in producing some very fine specimens of white incurving species. When asked what was the width of his largest bloom and if the average size was bigger than those of any previous year he could only give an indefinite reply. Something more of a guess than anything else.

Exhibition Pictures

The writer suggested photographing the exhibition specimens before they were sent into the show and he readily agreed. The flowers had to be displayed uncut, in other words the plants were required and, of course, this meant the pots also. In order to make a successful photograph he bored a hole in the ends of a 12in. rule and fastened this to a wall.

Then by selecting three of the finest blooms the pots were arranged in such a manner as brought the blooms fairly close together. The tops of the blooms just reached or near enough to the rule to indicate their actual widths. The print was marked with all the useful data possible and corresponding photographs were made each subsequent year. It all proved an interesting and instructive collection of records for future reference.

In Public Gardens

This same idea of collecting records can be adopted for many other types of flowers and plants. In some parks and public gardens it is in common practice as regards beds of flowers as an aid to what particular flowers are best suited for any particular part of the park.

Having given a few hints on how the hobby of photography can be of service to you in the pursuit of success in growing flowers and vegetables, let us turn the tables somewhat and to show you how the garden can be of help to your photography.

When you happen to be laying out a new garden, or perhaps making some alterations in the present lay-out, have in mind the possibilities of making use of it as a place for taking some of the family portraits which amateurs are so frequently persuaded to do. You might be

A free design of A WEATHERHOUSE

This novel Old-English Weatherhouse can be made from patterns on our supplement sheet. A complete kit (No. 2864) of wood and gut is obtainable from Hobbies stockists for 4/6 or by post from Hobbies Ltd., Dereham, Norfolk, for 5/4.



able to plan and construct something that will prove very attractive.

Background Effect

A simple illustration will bring this point home to most readers. Many back garden portraits are spoiled pictorially by having to include some wretched shed, fence or backdoor. Now if that shed had a rambling rose climbing over it or a fairly full flowering bush hiding it, and if that fence was covered with a

A Bread and Milk Clock

THIS little gadget 'set' every morning, for the milkman and baker, will relieve the housewife of the necessity of going to the door to them. How to

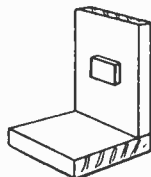

make the 'clock':—Cut a piece of 3-ply 5½ins. wide by 7ins. long. At one end glue another piece 5½ins. wide and 1in. thick to form the base. Pin on the other side a piece of cardboard to fit. Print clearly and screw a pair of pointers into the face, 3ins. down from the top centre to a 1in. square of 3-ply at the back, and the 'clock' is ready for use. Place in the

trellis placed so that the squares became diamond shaped, and a clematis or honeysuckle trained about it you would be sure of having two spots in the garden that would make moderately good backgrounds.

Side fences dividing one's garden from the neighbouring gardens can be very difficult at times. But a little planning and a spot of carpentering will help. Select where the best position would be for taking portraits. Then cut away sufficient of the flower bed to enable a path to turn in as a dead end to the fence. A few shovelfuls of gravel will give a finish to this but the actual completion is reached when you have made an ornamental gate painted white or light colour that can be placed against the fence whenever a photograph is wanted. This makes an excellent background piece and does make a charming break in an otherwise ugly fence.

Pictures from Above

Those living in London or any other large town are sometimes prevented from making any alterations and there are times when gardens are too small or too narrow. The writer overcame this experience by making a number of exposures from the first floor back window. It, of course, meant looking down on the friends but the lawn proved a much more artistic background and the fact that the folks had to raise or tilt their heads slightly made the results rather more interesting.

Finally, make a point of studying some of the efforts of landscape gardeners. Near the author's house one has made good use of a strong imagination. In the garden, which consists of an adjoining plot to the house, there is a very artistic and ornamental bridge built over an imaginary brook, on the banks of which are lovely ferns. A few yards from this is a small pond and in a corner the tool shed very cleverly hidden and decorated with rambling roses and one or two hanging baskets of flowers.

kitchen window, set to the quantities of milk and bread required, leave rest to the tradesmen concerned.

Lid Stay

A LID stay for a small box in fretwork or carpentry can be made as shown in the accompanying drawing. It can be cut with a fretsaw from brass or iron, or

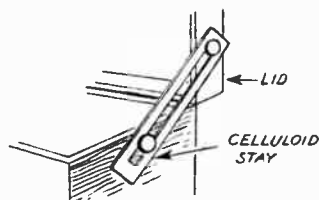

any metal with the slot down the centre. One end is screwed to the lid, whilst another screw works loosely in the slotted portion.

Attractive shape and colour make a novel CHILD'S ROCKING CHAIR

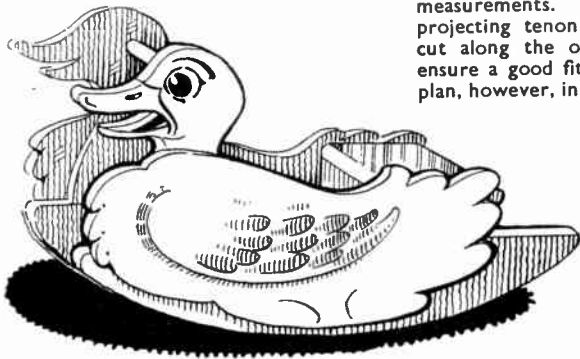

THE rocking horse seems the favourite rocking toy for most of our children, but for the tiny tot we think a low type of seat with rockers attached is, perhaps, safer and just as enjoyable.

It is, therefore, of the younger folk we were thinking when we set out to design such a toy as that shown in our illustration Fig. 1. Here is a roomy seat on rockers with attractive handle-bar supports shaped and painted up to simulate a duck's head.

The Rockers

The overall length of the toy is 31ins., its height 18ins. and breadth 14ins. Commence on the rockers, for which we want two pieces of wood 30ins. long by 6ins. wide. Straight-grained pieces of $\frac{3}{4}$ in. or $\frac{7}{8}$ in. flooring board would answer well. The correct curve to suit the given length should be set out as shown in Fig. 2. A sheet of stout brown paper should be got and the top-line, with length set out on it.

Then centrally on this, that is, at 15ins. from one end, set up a centre line vertically as shown. From the bottom edge of the wood set up 24ins. on the centre line and from this point draw in the segment of the circle to form the shape of the rocker.

Next set out on the brown paper pattern the two sinkings shown, one for the head of the duck at 6ins. from the left-hand end of the pattern, and the other for the seat support. The brown paper pattern can now be reduced in size by cutting away that top part which originally showed the point from which the arc was struck. The pattern is thus made more convenient for handling and pinning down to the wood.

All the chief points of the sinkings can be pricked into the wood and afterwards connected up with pencil. For the curve, points should be pricked out along the curved line and these then connected up as before.

The next two pieces to make will be the plain supports for the seat. These are shown in Fig. 3 with the necessary

measurements. When cutting the projecting tenon piece, 3ins. by 2ins., cut along the outside of the line to ensure a good fit. It would be a good plan, however, in this respect, to set out the tenons direct from their respective open mortises before actually doing the cutting.

This also applies to the tenon on the head of the duck which is let into the rocker in a similar way. The outline and the interior lining in of the duck's head can be taken from Fig. 4, each square shown here being 2ins.

The Head Shape

Use light brown paper or white drawing paper for drawing the head and making the enlargement, then transfer this to the wood by means of carbon paper. Make two heads by using one of them as a template for drawing round in the same way as the rockers.

Note in each head the position of the $\frac{3}{4}$ in. round hole which will later be filled with the ends of cross rod which is 13ins. long and which will be securely glued in. Glue the seat supports and the heads to the rockers, making sure they lie flush with the rockers themselves. Both rockers can now be connected by nailing or screwing on the seat, a piece of $\frac{3}{4}$ in. or $\frac{7}{8}$ in. stuff 13ins. long by 6ins. wide. To stiffen up the seat connections, glued blocking pieces $\frac{3}{4}$ in. or $\frac{7}{8}$ in. square and the width of the seat could be glued underneath the seat and the rockers themselves.

side. The top edge of this board and the two top edges of the seat board should be rounded off with rasp and file and finished smooth with coarse and fine glasspaper.

Wing Shapes

To form the sides of the rockers two outside shaped pieces are glued on. In Fig. 6 an outline of one of these sides is given, crossed with 2in. squares for easy enlargement. The 'copy' can be transferred to the wood by carbon paper. Two pieces of wood measuring 25ins. by 11ins. wide by $\frac{1}{2}$ in. or $\frac{3}{4}$ in. thick should be used. If wood of the width suggested cannot be obtained, then each side may consist of two 6in. boards glued edge-ways together.

When the boards are securely glued and pinned to the rockers and to the head and seat supports, it will be found to be perfectly stiff and rigid.

All the woodwork must, at completion, be thoroughly cleaned with glasspaper and given two coats of paint. The first will be light in colour so the finishing coat of paint or enamel may be brilliant. The whole thing may be white, relieved with grey-brown for certain wing feathers. The bird's beak must be bright chrome and the eyes dark blue. The inside faces of the sides could well be light grey or a pale blue as relief from the outside white.

A padded cushion should be made and tied on with tapes to the seat or a permanent padded seat formed of hessian and canvas stuffed with straw or other suitable material nailed on with large brass-headed nails.

Or you can have the cushion made removable, but fitted with tapes for tying on beneath the wooden seat itself.

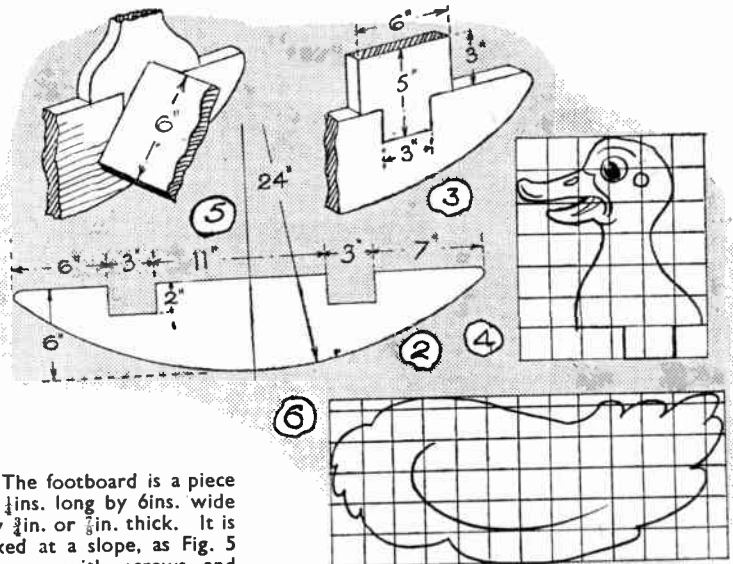

The footboard is a piece 11 $\frac{1}{2}$ ins. long by 6ins. wide by $\frac{3}{4}$ in. or $\frac{7}{8}$ in. thick. It is fixed at a slope, as Fig. 5 shows, with screws and glued blocks on the under-

YOU CAN BECOME A HANDICRAFTS INSTRUCTOR

Experience not essential

Men who enjoy making things in wood or metal can turn their hobby into a well-paid, permanent and interesting Career. Short hours, long holidays, and security in a job you would really enjoy, can be yours if you become a Handicrafts Instructor. Let us send details of the easiest and quickest way to get the necessary qualification.

**We definitely guarantee
"NO PASS—NO FEE"**

If you would like to know about our unique method of preparing you for one of these excellent appointments, write today, and we will send you our informative 175-page Handbook—free and without obligation. Mark your letters "Handicrafts Instructor".

**BRITISH INSTITUTE OF
ENGINEERING TECHNOLOGY**

595 Shakespeare House
Stratford Place, London, W.1

BIET

PHOTOGRAPHY

Build Your Own Enlarger

Contains full instructions and clear, large-scale working diagrams for constructing seven different types of enlargers and enlarging accessories. 77 diagrams. (Postage 4d.) ... 7/6

Colouring Tinting & Toning Photographs

Gives full details of all methods of colouring photographs—a most fascinating hobby. Well illustrated (Postage 4d.). 8/6

Obtainable from photo dealers or in case of difficulty from

THE FOUNTAIN PRESS

(Dept. H.W.) 46/7 CHANCERY LANE, LONDON, W.C.2.

NICOTEXIT

THE GUARANTEED SMOKING DETERRENT

- ★ POSITIVELY STOPS SMOKING IMMEDIATELY and for several hours after each application. Purchase price refunded if it fails to do so.
- ★ ONE BOTTLE IS USUALLY SUFFICIENT to establish control of smoking in any form. It is not poisonous

Invaluable to all who smoke too much

5/6 Per Bottle
Post Free

Obtainable only by post from Sole Concessionaires for Great Britain:—

THE NICOTEXIT COMPANY (Dept. B.6.)
62 High Street, Croydon, Surrey

HANDCRAFT SUPPLIES (NORTHERN)

Buy your materials from the Largest Handicraft Shop in the North. STOO LAND TABLE LEGS (Plain Turned). TWIST PATTERN BEECH. SEAGRASS. Natural. 1/11 lb.; Coloured, 2/9 lb. (approx.) BEADINGS. MOULDINGS. PLYWOOD. HARDBOARD. HARD WOODS. VENEERS. QUEEN ANNE LEGS. MAIN HOBBIES STOCKISTS. Discounts for Schools, Clubs, Hospitals, etc. Orders up to 15lb. weight can be sent C.O.D. PLYWOOD OFFCUTS, 5/-, 10/-, 20/- bundles. Carriage Paid. Send s.a.e. for latest price list. You can order by post with complete confidence.

15-17 RIDLEY PLACE, NEWCASTLE-on-TYNE. Phone: 27950

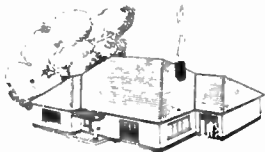

**TURN YOUR
SPARE-TIME INTO CASH**
Men and women wanted to
make Bennett Model
Bungalows at home.

Fascinating, simple, well paid work

No selling involved.

Send penny stamped, addressed envelope for full details.

BENNETT MODELS,

137, Grays Inn Road, London W.C.1.

CASCO

COLD water GLUES



supersede this



Most hobbies require Glue—"CASCO" fills the bill for either new work or repairs. It is an absolute necessity for the Modelmaker for Fretwork, Toymaking, etc. Easy to mix in cold water Casco is simple to use and almost impervious to heat and moisture. "CASCO" Grade "A" is the world-famous Casein Cold Water Glue manufactured in Great Britain, Australia, U.S.A. and Scandinavian countries. Conforms to MODERN BRITISH STANDARDS SPECIFICATION 1444, TYPE A.

Stocked by Ironmongers, Builders' Merchants, Hardware Stores, etc.



DISTRIBUTORS:

Gt. Britain: Charles Cleeve & Co. Ltd.
45 Gt. Peter St., London, S.W.1.

Eire: C. B. Waller, 60 Middle Abbey St., Dublin
M. J. Galligan, 16 Oliver Plunkett St., Cork

FREE! Send for literature and Free Sample to the manufacturers

LEICESTER, LOVELL & CO. LTD.
(Dept. HW), NORTH BADDESLEY, SOUTHAMPTON

CRAFTWORKER

THE MODERN MAGAZINE OF CRAFTS FOR ALL

- Every kind and type of tool and material is offered in *Craftworker*
- Instructions in all Crafts at Home are published in *Craftworker*
- A Market Section is included in each issue of *Craftworker*

A COMPLETE SERVICE

Specimen Copy 1/2 from the Publishers

Craftworker (DEPT. H.W.), Broadway, Broadstairs



THE BOLSTER HOME WATCH AND CLOCK REPAIR OUTFIT

These precision jewellers instruments, include watchmaker's magnifying eyeglass, finest watch tweezers, set watchmaker's screwdrivers, watch and clock oil, oilers, dusting powder, clock brush, plus illustrated instructional manual for the amateur. In container 12/9 post free.

Senior Outfit includes everything above, plus watch jewels, luminous compounds, dial renewer, jewellers rouge, explanatory book. Price 21/- post free.

BOLSTER INSTRUMENTS, (Dept. H. W.), 5a Station Parade, Ashford, Middx.

NEW PLYWOOD CASES!

Make IDEAL Tool Boxes. 16 1/2 x 6 1/2 x 12 ins. Painted khaki, 3/10 each; or filled with plywood, 2/6 extra. All post paid.
Figured Oak Plywood. 24 x 24 x 1/2 ins., 5 for 35/-; 24 x 24 x 3/4 ins., 2 for 25/-, post paid. List of Plywood Sheets and Offcuts, 2d.
JDD. Storage, Dept. H., 71 Northcross Road, SE.22. BR1xton 7441/2

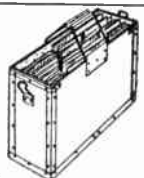

1950 JOHNSON PHOTOGRAPHIC COMPETITION FOR AMATEURS

JOHNSONS hold a print competition twice a year. The current one closes on 31st October, 1950. All amateur photographers may enter. Any camera may be used. Contact prints or enlargements may be sent. No entrance fees to be paid and no entry forms have to be filled in. All you have to do is to stick a label or title panel from a JOHNSON photographic chemical bottle or package on the back of each print you send in. No limit to the number of entries which may be submitted.

£125

IN PRIZES

Ask your dealer for a leaflet giving fuller details. Look out some of your best prints and send them in NOW. You may win one of the big cash prizes.

- 3 prizes of £10 each
- 3 prizes of £5 each
- 15 prizes of £2 each
- 15 prizes of £1 each

and twenty consolation prizes of 10/- worth of Johnsons chemicals.

ALSO A NOVICES CLASS WITH 18 SPECIAL AWARDS FOR BEGINNERS.

- 2 prizes of £5 each
- 3 prizes of £2 each
- 5 prizes of £1 each
- 8 prizes of 10/- each

Every type of subject is eligible. Children, animal, home and holiday snapshots. Landscape, seascape, river or street scenes. Garden, flower or tree studies. Architectural, interior or table-top subjects. Prints need not be mounted. Enlargements need not exceed whole-plate size. Name of camera, size of film or plate, developer used and exposure given should be recorded where possible. Write your name and address clearly in block capital letters on the back of each print. Do not send the negative, although we may wish to buy or borrow it if you are a prize winner.

CLOSING DATE OCTOBER 31

Prize winning prints, not the negatives, will become the property of JOHNSONS. All others will be returned if sufficient postage stamps are enclosed with the entry. All entries must be marked COMPETITION DEPT. and be addressed to

JOHNSONS OF HENDON
335 HENDON WAY, LONDON,
N.W.4

ENGINEERS

★FREE BROCHURES★

Technical training is vital to your success. Our Home Study courses bring you sound, up-to-the-minute instruction.

Write or 'phone for FREE BROCHURES detailing our courses of TECHNICAL TRAINING IN ALL BRANCHES OF ENGINEERING covering such degrees as A.M.I.Mech.E., A.M.I.E.E., A.M.I.P.E., City and Guilds, etc.

'THE COLLEGE BACKED BY AN INDUSTRY'

Write to Dept. 31

E.M.I. INSTITUTES

10, PENBRIDGE SQUARE, NOTTING HILL GATE,
LONDON, W.2. TELEPHONE: BAYSWATER 5131/2

Associated with
"H.M.V."
MARCONIPHONE
COLUMBIA
ETC.

£16 · 12 · 6

STARTS A MODERN

MYFORD

WORKSHOP

The ML8 8" x 30" Woodworking Lathe, priced £16 - 12 - 6, is the basis of woodworking workshops all over the world. A range of major attachments, which may be clamped into position in a matter of minutes, enables practically every woodworking operation to be carried out on this single machine. These include sawing, sanding, planing, rebating, grooving, grinding, polishing and metal turning and spinning. Pictured below is the Disc Sander mounted for operation.

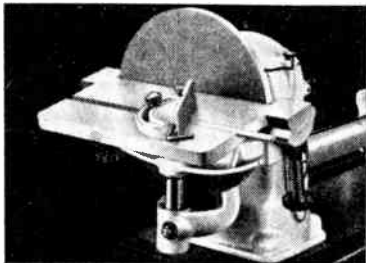

For further particulars see your Tool Merchant or write to us for illustrated leaflets.

MYFORD ENGINEERING CO. LTD. BEESTON, NOTTINGHAM

EVERY DAY

Use Sellotape for fixing labels 'for keeps' on tins of screws and nails, etc. — then you can spot the tin you want at a glance.

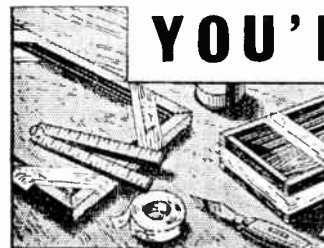

YOU'LL NEED

Use Sellotape to hold small parts in position while gluing. It's much quicker than string and just as strong.

SELLOTAPE

Whatever your hobby—Sellotape can help. It's self-adhesive, sticks at a touch, leaves no mark on wood or metal. Get some today—

**BUT INSIST
UPON SELLOTAPE**

Stocked by all good Stationers

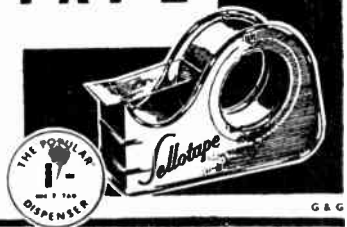

G & G

RAWLPLUG PRODUCTS

**INDISPENSABLE
IN THE WORKSHOP
HANDY IN THE HOME**



DUROFIX

The indispensable adhesive for instant use on crockery, glass, wood, metal, celluloid and the thousand and one things handed by the hobbies enthusiast. Instant drying, insulating, water-proof and heatproof. Durofix is grand for repairs to electrical, sports and leather goods. Tubes 9d. and 1/3d. Tins 2/9d. and 7/6d.



DUROGLUE

UNDILUTED ANIMAL GLUE OF INCOMPARABLE STRENGTH

Ready for instant use for the many purposes for which an extra strong glue is needed. Wood, cloth, fabric, felt, leather and any greaseless surface can be stuck with Duroglue. Tubes 6d. and 1/-. Tins 2/3d. and 3/9d.



PLASTIC WOOD

APPLIED LIKE PUTTY, DRIES LIKE WOOD

Can be cut, planed, polished & painted like wood. Will take nails and screws like wood. It does not blister, crack or decay. Rawlplug Plastic Wood is actually the best quality product of its kind on the market. Tubes 9d. Tins 2/- and 3/-.



DUROLASTIC

ELASTIC SEALING COMPOUND

Forms permanently elastic waterproof joints with great adhesive qualities to any dry surface. Resists vibration or shock and will not break away with expansion or contraction. Non-crumbling, non-staining, does not exude oil. Can be painted in a few hours. Ideal for boat-builders. In easy-to-use tubes at 1/6d.

B389B



SOLDERING IRONS

MAKES SOLDERING CERTAIN AND SIMPLE

This is a guaranteed electric tool which will pay for itself many times over by repairing and giving longer life to metal household goods. In the workshop it is indispensable. Supplied with Standard bit for 21/-, Hatchet or Pencil bit for 22/-, Voltages 100/110, 200/220, 230/250. Universal AC/DC.



HEATLESS SOLDER

No iron is needed with Rawlplug Heatless Solder which is in paste form and dries in a few minutes. It is very useful for quick repairs to metalwork, but is not suitable for wireless or electrical connections. Tubes 9d.



IRON CEMENT

Water and Gas pipes, Radiators, Cisterns, Buckets, Kettles, Saucepans, Stoves, Kitchen Utensils, etc., etc. 1/- per tin.

RAWLPLUG FIXING DEVICES & TOOLS

Whatever your fixing problems, there's a Rawlplug Device that will solve it for you—easily and quickly. Rawlplugs make neat and absolutely firm fixings in any material from plaster or brick to stone or slate, with a size for every screw from No. 3 up to 1/2" coach screws. Rawlplug Tools are easy to use and ensure a perfect hole without damage to surrounding surfaces. Other Rawlplug Devices include Rawlbolts for heavy duty fixings, Rawlanchors and Toggle Bolts for thin or hollow materials and Rawlclips for instant fixing of conduits and cables to girders—a device in fact for every need.

Rawlplug fixing devices and products can be obtained from Ironmongers, Hardware Dealers, Stores or Model Makers Suppliers.

THE RAWLPLUG COMPANY LTD. LONDON. S.W.7.



**FOR A
REAL
Professional
'FINISH'**

'FINISH' is the true test of craftsmanship. It's easy to impart a real professional 'finish' to woodwork and furniture you make at home with "COLRON" WOOD DYE—the finest stain for all practical purposes.

One coat of "COLRON" is all that is required to emphasise the natural beauty of the wood grain. No smears—no "overlaps"—no trouble. Leave from two to three hours, burnish with rough dry cloth and you have a perfect base for french polishing or for waxing with "RONUK" FLOOR POLISH.

COLRON WOOD DYES

12 SHADES—ALL SIZES

Write for colour guide and full details to:

RONUK LTD. (Dept. 62) Portslade, Sussex

One elastic material

MAKES MANY PERMANENT MODELS

and utility objects, from simple instructions in illustrated Booklet—please read below.



ONLY 4^D

**IN STAMPS
BRINGS BOOK**

... showing how such models as those above, and many others, can be made, without skill or special tools, from Sankey's PYRUMA Plastic Cement. Ready for immediate use in its plastic state, Pyruma sets or bakes to stone-hardness and can be painted or enamelled in all colours according to instructions.

Pyruma is inexpensive, and easily obtainable in tins from Ironmongers, Art Material Dealers and Hobbies Shops. Send 4d. in stamps for illustrated Instruction Book.



J H SANKEY & SON, L^{TD}

ILFORD

Est. 1857

ESSEX

Printed by BALDING & MANSSELL, LTD., London and Wisbech, and Published for the Proprietors, HOBBIES LTD., by HORACE MARSHALL & SON, LTD., Temple House, Tallis Street, B.C.A. Sole Agents for Australia and New Zealand: Gordon & Gotch (A'sia) Ltd. For South Africa: Central News Agency Ltd. Registered for transmission by Canadian Magazine Post.

Hobbies

WEEKLY

CONTENTS

	Page
Stand Aquarium - -	401
Craftsman's Notes - -	402
Cutlery Box - - -	403
Handyman's Ideas - -	404
Transformer Couplings	405
Making a Clothes Horse	406
Stuffing Birds - - -	407
Damp House Repairs -	408
Ship Modeller's Corner	409
Cigarette Servers - -	410
Books to Read - - -	411
Aquarium Cements -	411
Wood Hints - - - -	412
Photographic Alphabet	413

September 27th, 1950

Price Fourpence

Vol. 110 No. 2865

A CHEAP STAND AQUARIUM

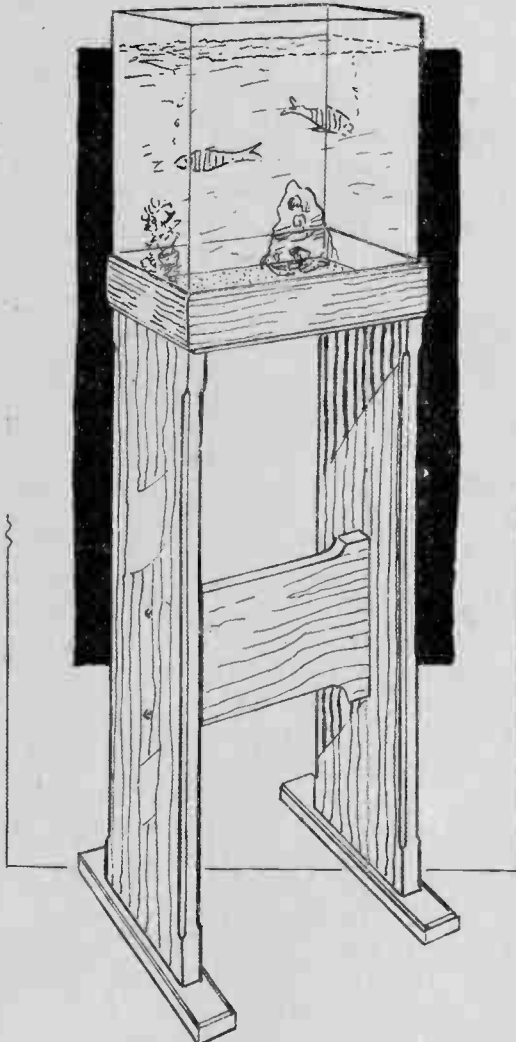

THOSE readers who have interest in aquarium life, an absorbing study, may care to make for themselves the very simple and inexpensive aquarium illustrated. Really it is a substantial stand, to hold one of the solid glass aquariums now on the market. There are several sizes of these, but the stand is designed to hold one measuring 8½ ins. by 14½ ins. which is quite large enough, for a start at any rate.

Of course, it is quite possible to use the aquarium without the stand, but it means sacrificing perhaps a side table, or something equally suitable, which may well be needed later on for another purpose.

The simple stand designed holds the aquarium at a nice height for studying its occupants, and also covers little floor space. Cleaning can be carried out underneath it without disturbing the fish, which is rather important. It may be mentioned here that the present cost of the aquarium is about 15/-, and as only a small quantity of

wood is used the total cost is unlikely to much exceed £1 or 30/-. Not a dear outfit, even for a slender purse.

The Wood Necessary

A side and front view of the stand are given in Fig. 1. A good quality deal will do for the timber, 1in. thick and 9ins. wide. From the board cut the two sides to length given, plus 1in. extra for the bottom tenons. The sides can then be planed to the width given.

It will be seen on studying the outside dimensions of the stand that they are the same as those of the aquarium mentioned. It would be wise to purchase the aquarium first though and to measure it, then if any slight differences are apparent, the stand dimensions can be amended to conform to them.

The Cross Bars

At the bottom of the sides cut two tenons, 2ins. long, and spaced 1in. from each side. These sides are now to be joined together by two top cross bars, and one lower down. The top ones are 1½ ins. wide and are cut from the 1in. thick board. They are jointed across with a single dovetail, as at (C) in Fig. 2. Dovetails are really easy enough to mark out and cut, but a plain tongued-and-slotted joint could be substituted, if preferred, as long as a pin is driven through the joint from the top to prevent any tendency to draw apart.

The cross bar lower down is cut from the 9in. board. It acts as a stiffener to the stand, and is provided each end with two tenons, just ½ in. deep, and 2ins. long. When cutting this bar to length do not

All correspondence should be addressed to The Editor, Hobbies Weekly, Dereham, Norfolk.

forget to add $\frac{1}{2}$ in. at each end for the tenons. The position of the cross bar is at 9 ins. up from the bottom, and in the

very accurately, and chisel these out $\frac{1}{2}$ in. deep. Make a close joint here.

Cut a centre bar, $1\frac{1}{2}$ ins. wide, and fit this across the top bars, as at (A), with a mortise and tenon joint. Before gluing up, fix the parts temporarily, and drive in (partly) round-headed brass screws through the sides into the tenons of the lower cross bar, as at (B), to draw the joint up tight. All fitting together satisfactorily, glue

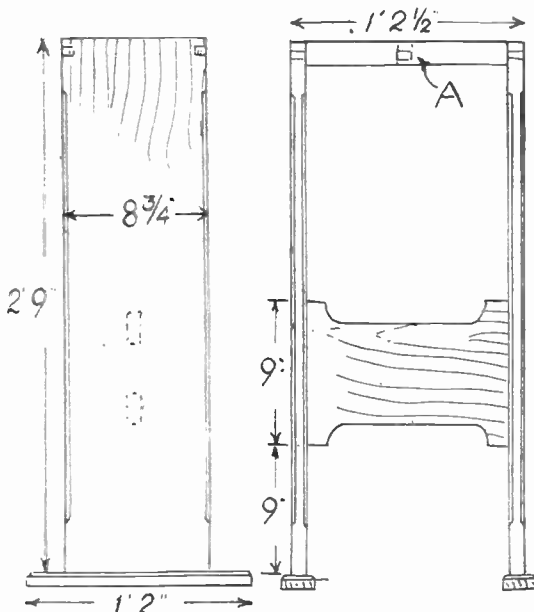

Fig. 1—Side and front view with dimensions

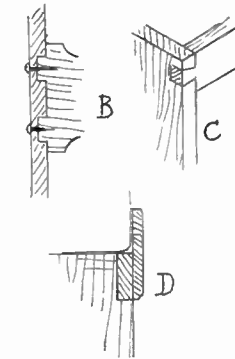

Fig. 2—Details of joints and construction

centre of the sides. Mark out the position of the mortises for the tenons

the joints, knock them well home, and drive the screws into the lower cross bar.

A chamfer should be worked on the edges of the sides, as seen in Fig. 1, starting from 3 ins. up from the bottom and finishing the same distance from the top. This lightens the appearance of the stand. For the same purpose, the lower cross bar can have a little cut out from its width at-top and bottom, as shown in the diagram, and look much better.

The Feet

The feet are 2 in. wide strips of the wood, cut to the length given in Fig. 1. In these the necessary mortises for the tenons on the sides must be cut through. Bevel the top edges, and glue the feet on. The aquarium should now, if placed in position, stand quite firm, but a rim must be added all round to keep it so.

For this rim, cut four pieces of $\frac{1}{2}$ in. thick wood, 3 ins. wide, and long enough to go round the four sides of the stand. Fix these in place with glue and nails to extend above the stand $1\frac{1}{2}$ ins. as in detail (D). The top and bottom outer edges of these rim pieces are bevelled a little. Ordinary butt joints will do at the corners, or mitreing for those who prefer a neater finish.

This completes the work of construction. Stain and varnish up the stand, then fit the aquarium in position, ready for its occupants. For this piece of woodwork an 8 ft. 6 in. length of 1 in. by 9 in. deal board will be needed, with just over 4 ft. of $\frac{1}{2}$ in. by 3 in. wood for the rims.

THE CRAFTSMAN'S NOTES—

How About Pipes?

ARE you trying to think of something a bit out of the ordinary to start collecting? Well, by the way of a suggestion, how about Pipes? Modern briars alone would keep you busy for a long time, short stems and long stems, smooth, rough, and bent, big bowls and little bowls, offering variety in plenty.

Then there would be cherrywoods to go at, an amusing example I have seen among this species having a 10 in. stem with a bowl shaped like a funny face. Then there would be another large assortment of clay's, not forgetting the long Churchwarden.

Meanwhile you could be enriching your collection with any earlier and rare specimens you can obtain, such as the ornate Meerscham. You may even be able to include some of the peculiar types met with abroad. Egypt way, for instance, a favourite native fashion is to attach the stem to a tube passing through water. And if you can get hold of a Red Indian Peace pipe—well, your collection's getting somewhere.

Lagging the Boiler

A USEFUL little job you can do about the house, if it is not already done, is in connection with the hot water boiler.

Three or four layers of material should be wrapped around the boiler

and held neatly in place with pins or paste, or string. Corrugated paper does the job well and sacking is also satisfactory.

Even a good thickness of newspaper is better than nothing, finished off for the sake of appearance with a top covering of brown. The wrapping should cover as much of the boiler as possible.

The effect of this simple treatment is to help keep the heat in, so the water gets hot more quickly and the temperature is retained for a longer period after the heating apparatus is shut off.

* * *

The Early Birds

THE skylark always gets credit for being the early bird; at any rate, we talk about being 'up with the lark' when we are early out of bed. But it seems there is another bird been heard already astir and twittering while the lark is still snoozing—namely, the curlew.

Ornithologists make a careful study of birds to find out everything possible about their movements and habits, and in summer bird watchers everywhere listen for early morning bird sounds and report on the time and place as well as the weather conditions.

Observations made in June in a recent year reveal that the curlew was heard at 2.52 a.m. Next came the skylark at 3.10 a.m., then a redstart four minutes

later, followed by a swallow, pheasant, and cuckoo. The main bird chorus began round about 4 o'clock.

* * *

Plane Talk for Beginners

IF your wooden planes do not seem to run as smoothly as you would wish, try lightly dressing the sole occasionally with raw linseed oil. And do not set the blade too deeply; rather set it extra fine at first and adjust slightly if you find it does not cut.

With smoothing planes one hand will be curved around the front and the other around the back, whereas with the jack plane the left hand (or right hand if you are left-handed) will rest across the front of the plane with the thumb on the near side and the fingers on the far side. Give yourself elbow room while working by not getting too close on top of the plane.

Slight extra pressure at the back as you start the stroke, slight extra pressure at the front as you finish—but for the most part apply firm even pressure with both hands.

In consideration for the cutting edge, which needs to be kept keen for good working, remember to lay the tool on its side during breaks from planing, and retract the blade into the body when putting it away for a time.

The Craftsman.

Use your fretsaw to make this sensible CUTLERY BOX

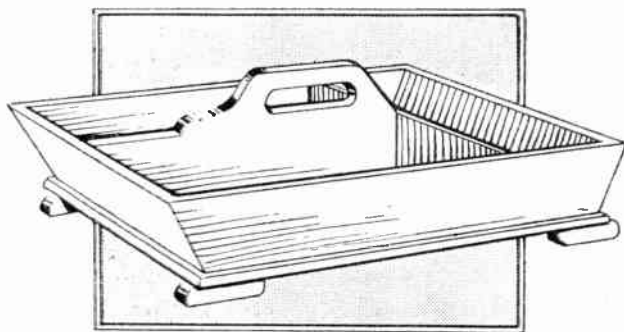

A REALLY well-made cutlery box is not only pleasing to make for one's home, but makes a very acceptable wedding gift or present for a friend. For home use a fairly cheap hardwood like beech or elm for example is a good choice. Deal of good quality and free from knots and shakes however, would answer equally well, but the finish to this wood is a little difficult to determine. American whitewood and mahogany too, are good woods to use, and they can be stained and finished in quite a professional manner.

The design given here provides for three compartments, the smaller one perhaps being set aside for spoons while the two larger ones are suitable for knives and forks.

Handle Shape

The rather unusual shape of handle coupled with the addition of fairly substantial feet impart to the box just that little out-of-the-ordinary effect which so pleases the eye. Stuff $\frac{1}{2}$ in. thick perhaps might be chosen when using the softer varieties of wood, while $\frac{3}{4}$ in. thickness would answer for the better qualities of wood.

The outlines of the ends and sides are shown at (A) and (B) in Fig. 1 while the centre division, with handle, is shown at (C) in the same figure. Draw the outlines of these parts on to the wood and cut round with a coarse blade fretsaw. Then clean up the cut edges with glasspaper. See the sloping ends of pieces (B) are identical by putting them together and checking them.

Grooved Fitting

Where shown on the end and side, form shallow grooves $\frac{1}{2}$ in. deep and in width equal to the thickness of the wood used. One end only, of course, will have a central groove, the cross partition having a similar groove to take the handle or long partition.

The ends of the side pieces (B) should now be reduced to about half its thickness to allow the ends of the box to be housed or recessed in to it as seen in the two details, Fig. 2. Take some care over

making these joints, for, simple as they are, they need to be carefully marked out and cut.

The cutting down can be done with a fine-tooth tenon saw and the waste wood cleaned away afterwards with the chisel. This method of cutting down will also be adapted for the cross grooves in the sides and cross partition.

Fix the sides and ends of the box together with glue and nails. The top and bottom edges of the end pieces (A) should be planed away so they lie level with the sides (B). Allowance must be made in cutting the ends to get sufficient width for this planing away, $\frac{3}{8}$ in. being allowed in the width shown in the diagram for this purpose.

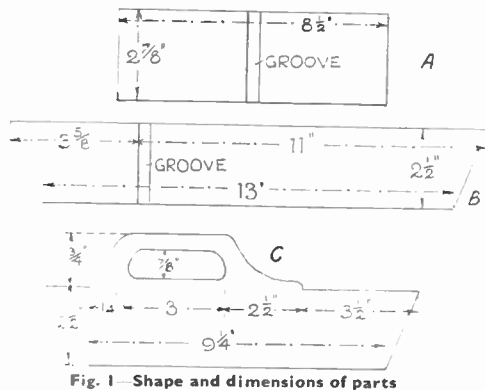

Fig. 1—Shape and dimensions of parts

The cross partition, not shown here separately, extends across the box, and to get its exact length, measure from groove to groove. When it has been set out and cut check in the grooves before actually gluing. It should be noted that the length of the cross partition is the same as that of the ends, and in the partition a groove will be cut centrally to receive the end of the handle partition.

Centre Partition

The handle partition, (C) Fig. 1 is next drawn out and cut. Note the handle extension piece at the top and its end shaping. There should be no difficulty in drawing the correct shape either direct on the wood or on to paper ready for transference by carbon to the wood. The full measurements shown should make the work easy for copying.

That part of the handle gripped by the fingers and all round the hand-hole should be neatly rounded off and shaped

and made smooth with glasspaper. Try out the partition in place for fit, but do not actually fix it until later on.

The Floor

The floor of the box can now be prepared, of $\frac{1}{2}$ in. or $\frac{3}{8}$ in. wood. Let the panel of wood extend $\frac{1}{2}$ in. or $\frac{3}{8}$ in. beyond the sides and ends of the box and allow for rounding the edges as shown. Fix the floor with glue and screws or wire nails. Take note that when driving the nails into the ends of the box they must be driven in at an angle corresponding to that of the ends themselves. This correctness of angle will be solved by holding the bradawl at the slope of the ends when making the holes for the nails.

Four corner feet will help the finished appearance of the box, and a detail of one is shown in Fig. 2. They may be any width from $\frac{1}{2}$ in. to $\frac{3}{4}$ in. and are glued and nailed on. If they are made fairly wide they will need extra support by adding short square or triangular fillets glued in the angle on the floor underneath.

The box can now be finished as

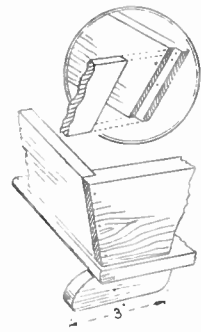

Fig. 2—The corner joint and feet

desired after the nails or screws have been well set down and the heads filled level and cleaned over with glasspaper.

If hardwood has been employed for making the box then it can be polished or varnished. The edges of the floor and the feet can perhaps be stained darker than the rest of the wood.

If softwood has been used, the whole could be given two coats of paint, each successive coat being rubbed down lightly with fine glasspaper before the finishing coat of paint or enamel is put on. Art shades of paint make for good appearance for such an article as this box.

The floor of the box inside should be covered with baize which must be cut accurately to fit close to sides, etc. and flat to the floor. It should be remembered to round off all the top edges of the sides and ends and make them properly smooth with coarse and fine glasspaper.

Make somebody happier by carrying out these HANDYMAN'S IDEAS

Portable Clothes Line

THERE is hardly anything in this but how useful it is! We simply take a long length of strong white cord, not too thick, and thread a dozen clothes pegs on it, passing the cord through the turn



in the wire spring. At each end tie a bowline. The bag, which will probably require the enlistment of feminine help, should have drawstrings, and, of course, be large enough to take the pegs.

Steel Wool is Useful

STEEL wool is a useful material for Shandy men, though its less obvious uses are not generally appreciated.

Except, perhaps, for the fine grade, one should always wear gloves when using this material, especially when pulling it from its packet. The writer has a friend who had a finger-tip completely cut off by a razor-keen strand of coarse steel wool—cut off as cleanly as a grocer cuts cheese with a wire.

An original idea is to get an old india-rubber (e.g. tennis) ball, large or small according to requirements, and cut it in half. One of these hemispheres is used to hold the steel wool without danger of cutting the hand.

At a hotel abroad, the writer saw men cleaning wooden floors by fixing a wad of steel wool to a shoe and working the foot back and forth over any stained places. Rubbing is done with the grain of the wood.

Steel wool, in general, is used in place of glasspaper, pumice, emery paper, and other abrasives. Apart from wood and metal it may also be used on glass, tiles, kitchen sinks, etc. On metal surfaces the wool is used wet, but on wood it is used dry.

Periscopes

THE Festival of Britain may be some months ahead yet, but it is not too

early to think about making periscopes to watch (over the heads of six-footers in front of us) the various processions and festivities that will take place in London and in the provinces.

The periscope is merely a long box with a mirror top and bottom. Both mirrors, one of which has an opening outwards and the other inwards, slope at 45 degrees, and both face each other. The top one reflects the view, and the lower one reflects the top one and consequently the view as well (see Fig. 1.)

You can make the periscope any height—as high as a house if you like—but the taller they are [the bulkier they are to carry, and the more tiring to hold. In Fig. 2 the artist has used a conventional 'break'. This does not mean that the material is to be cut in two parts, horizontally, but merely that, to save space, the drawing has been shortened. The case, as made up, will appear as in Fig. 3. 2ft. high is a suitable size, and the mirrors can be $3\frac{1}{2}$ ins. by 2 ins. Any glazier will cut these for you quite cheaply.

For the case, it is a good plan to buy a sheet of stout strawboard in a stationer's rather than rely on cardboard from old boxes, etc. There is no reason why the case should not be made in plywood, aluminium, or even light sheet metal.

Cut to the sizes indicated in Fig. 2 and 4. You need one main case, and two mirror supports. The former is merely a plain box 2ft. by $3\frac{1}{2}$ ins. by 2 ins., with 'windows' cut out as shown. The latter are triangular boxes, to the sloping faces of which the mirrors are bound by means of rubber or paper bands. Score all lines with a penknife before bending. Rubber bands will hold the parts whilst the glue is drying.

Smear some glue to the back of the mirror supports, and push them into the box so they stay there. The bottoms of the mirror supports thus become the top and bottom of the main case. The mirrors slope away from the openings, and by looking in the lower mirror your line of vision should be raised about two feet.

Bind all edges with stout gumstrip or passe-partout tape, and then cover the case with either plain brown paper, or, better still, leatherette paper.

Make several of these, not just for yourselves but for friends and relations. They should sell well, too.

Ready-to-Fix Shelves

HERE is an original idea for a handicraft article for sale. Supply ready-to-fix shelves. The sketch shows the idea. The brackets are already screwed to the shelf and blocks, and these blocks are already drilled to take the screws for fixing the shelf to the wall.

The safest way to fix the shelf on the wall is to use fibre wall-plugs. You can

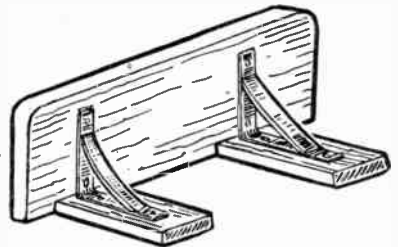

either charge a price which includes fixing free, or charge extra to fix the shelf where the customer wants it.

Shelves can be made in all sizes, the larger ones having three brackets. Do not forget triangular corner brackets. You might suggest to prospective customers that you will make a shelf 'to measure'.

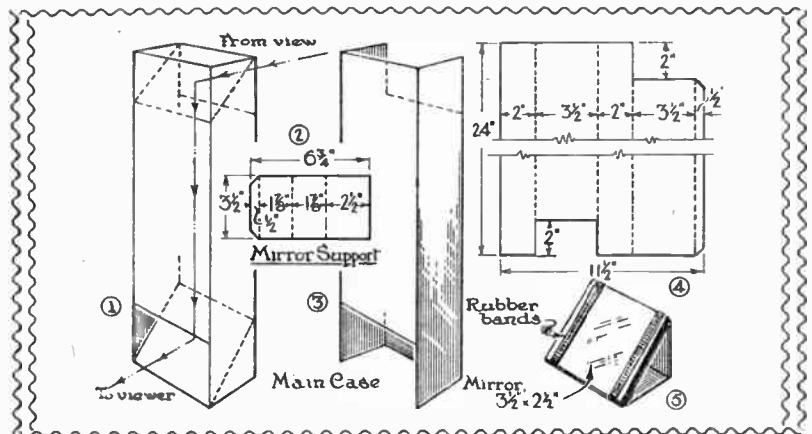

Radio constructors will be glad of these notes about TRANSFORMER COUPLINGS

THE different types of transformers in common use seem to present difficulties to some readers. This most important component should always be employed correctly, or poor results may be caused. In both mains and battery receivers transformers may be used for coupling the valves. A suitable speaker transformer, suitably connected, is essential, while some types of microphone cannot function properly unless a transformer is wired in circuit. Thus errors may easily be made and reproduction spoiled.

Between Valves

Transformers are often used to couple one valve to the next and the most popular transformer for this purpose is shown at (A) in Fig. 1. The shape and

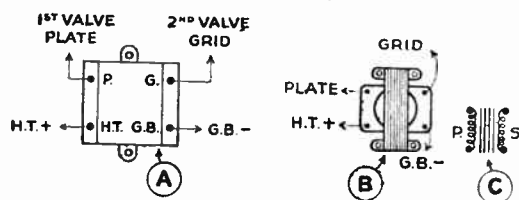

Fig. 1—Directly coupled transformers

size of the component may vary, and in some cases the relative position of the terminals will be changed, but all such transformers are normally marked 'P', 'HT', 'G' and 'GB' and these terminals must be connected up as shown.

The best secondary connections to some extent depend upon the receiver circuit. If there is any tendency towards uncontrollable howling, the effect of reversing the secondary connections should be tried. That is, take 'G' to grid bias and 'GB' to the valve grid. (This reverses the phase of the signals in that part of the circuit following the transformer.)

Some transformers are not enclosed in a bakelite case and may have soldering

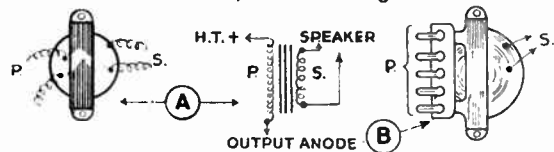

Fig. 3—Loudspeaker transformers

tags only. These are used in just the same way.

Small or old-fashioned transformers may merely have 'P' by one pair of tags or terminals and 'S' by the second pair. This stands for Primary and Secondary. The leads should be connected as shown at (B) in Fig. 1, secondary connections being reversed over if necessary, as explained.

Locating Connections

Each such transformer has two wind-

ings, the primary and secondary, as shown at (C) in Fig. 1. No connection exists between the two windings. (The lines between them indicate the iron core.) If a transformer with no markings, or with coloured leads, is to hand, tests for continuity can be made between the various ends. This will show which pairs of leads or tags are connected internally by the windings; one pair will be the primary, and the second the secondary, connections. If a meter is available, test the resistance of the windings. The lowest (about 2,000 to 5,000 ohms) will be the primary, and the other (about 5,000 ohms upwards) the secondary.

Because of the high resistance of the windings these tests cannot be performed with a battery and bulb, but a small dry cell and headphones can be used. The

phones will click most loudly when the current is passing through the primary.

Do not connect up a transformer with unknown connections at random because if one winding is taken to G.B. negative and H.T. positive the current flowing will destroy the fine wire inside the component. If no connection is found to exist between one pair of tags then the winding has been burned out or has corroded and the component cannot be used as it stands.

If the bobbin is so made that the ends of the leads (which will be soldered to the windings themselves inside) can be seen, then normally connections will be

as follows: end nearest centre of bobbin is 'P' (A) in Fig. 1; next lead, slightly outwards, is 'H.T.'; third, slightly farther from core centre, is 'G.B.', and the outermost, near the edge of the bobbin, is 'G'.

Parafeeding Transformers

Midget or very small transformers are wound with such very thin wire the primary cannot carry any current and these should be connected as shown in Fig. 2. Here, the anode or plate current

of the valve passes through the 50,000 ohm resistor. Signals pass through the .05 mfd. condenser and to the primary of the transformer. However, no direct current needs to pass through the latter and because of this many small transformers will give best results when used in this way.

Leads

A transformer of the type shown in Fig. 1 can be used. Transformers especially intended for feeding in this way are usually marked differently, 'C' being used for the condenser point, and 'E' for the earth, or H.T. negative, connection.

Some such transformers only have three terminals or leads. Here, the 'E' end of the primary is connected internally

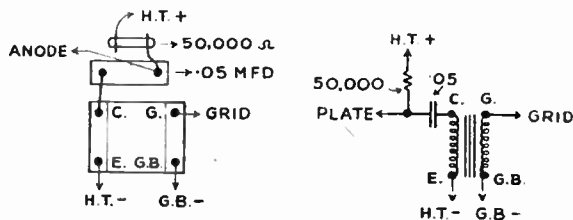

Fig. 2—Parafed transformers

to the 'G.B.' end (which is virtually the same as earthing the winding), and so no connection to the H.T. negative line is required. The coupling condenser should have good insulating properties, so a mica one is best. Any value between .01 and .1 can be used, though .05 is generally a little the best.

Speaker Transformers

Moving coil speakers cannot have many turns on the speech coil. Their impedance is consequently low and an output or speaker transformer must be used to couple them to the output valve in the receiver, as shown at (A) in Fig. 3.

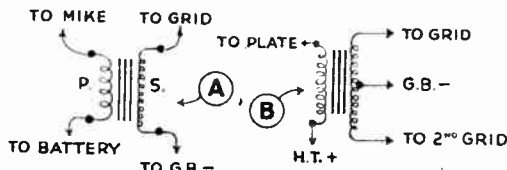

Fig. 4—Microphone and push-pull transformers

In such transformers the secondary consists of only a few hundred turns of fairly thick (about 22 S.W.G.) wire, and it can therefore be easily distinguished from the primary (consisting of several thousand turns of thin wire).

Different valves function best with different anode impedances. Therefore some speaker transformers have windings so the number of primary turns in sequence can be modified. Such a component is shown at (B). If used, it is merely necessary to try taking leads to

the various tags to determine which give best volume and quality of reproduction. With battery pentode valves, the full winding will normally be needed (outside tags). Battery triodes or mains pentodes will require less turns, and the centre and one outside tag can be used.

With push-pull circuits, take the centre tag to H.T. positive. One valve anode will go to one outside tag, and the other valve anode to the other outside tag, thus providing equal ratios each side for each valve anode. The ratio of such transformers is normally between about 20 and 80:1.

The exact ratio for any particular valve and speaker can be found as follows: divide the optimum load of the valve by the speech coil impedance and determine the square root of the result. This is the correct transformer ratio.

Microphone Transformers, etc.

Carbon microphones must have a transformer permitting a constant current to flow, and such a component will have a low-resistance primary, as shown in Fig. 4 at (A). (Actually, a

speaker transformer with secondary employed as primary is quite useful here.) A step-up ratio of about 1:50 or 1:100 is usual in such transformers. (The second microphone connection is taken to the remaining battery tag, a switch being included to stop the current when the apparatus is not in use.) No carbon microphone can function properly without it.

Where a coupling transformer for use between valves has three secondary terminals or tags it is intended for push-pull operation, the centre tap going to grid bias negative. This can, if desired, be used with a single output valve by ignoring the second grid terminal.

Alternatively, if the grid bias connection is taken to the latter, instead of to its centre tap, the ratio of the transformer will be doubled. In a few cases the primary of such transformers may be intended for parafeeding, as in Fig. 2.

Transformer Ratios

Most intervalve transformers (those intended for coupling between valves) have a ratio of about 1:3 to 1:5

step-up. For various reasons higher step-up ratios are rather impracticable, though ratios of up to 1:10 may occasionally be found. It will be found that the ratio, here, does not have much effect on the results obtained. Normally, any ordinary coupling transformer can be used, whatever its ratio.

With Triode Valves

With triode valves, an output transformer does not need to be very critically adjusted, but with pentode valves the ratio is fairly critical. Here, a ratio that is too low will cause loss of volume and slight distortion in reproduction. Accordingly, always adjust the output leads to those tapings giving best results.

If no alternatives are available, as at (A) in Fig. 3, the transformer is intended for one particular class of output valve. It will work with others, but not quite as well as would a transformer with the correct primary impedance. A tapped transformer is therefore usually much more useful for the experimenter.

There are several special things to know in making A CLOTHES HORSE

THERE is hardly a family household where a clothes-horse is not required at some time or other. It is a piece of equipment which never goes out of fashion. There is always need, after washday is over, for somewhere to place small items of clothing;

with ordinary metal butt hinges, but the most popular method is the cloth or webbing hinge which allows the frames to be opened in either direction. This is convenient, and causes no delay when setting up the clothes-horse. If, however, metal hinges are used, screw a pair of $\frac{1}{2}$ in. butts to the back of the hinge uprights.

be glued, preferably with waterproof glue, and also pinned through with thin 1 in. nails having small heads. Clean off the ends of the tenons.

Hinges are simple to fix if the two frames are tied together with string first. The pieces of webbing can then be

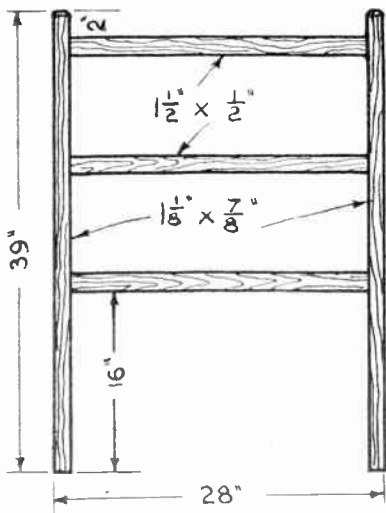

whether to complete the drying process, or after the ironing has been done.

If your present clothes-horse is looking the worse for wear, or you need an extra one, why not have a go at making one yourself with the aid of these instructions and the accompanying sketches?

A clothes-horse is simply a pair of frames hinged together. Some are hinged

Frames

Frames are each made of two uprights 39 ins. long by $1\frac{1}{2}$ ins. by $\frac{1}{2}$ ins., joined by three cross rails 28 ins. long by $1\frac{1}{2}$ ins. by $\frac{1}{2}$ in. The ends of the rails are cut down to 1 in. wide tenons, 1 in. long, centrally, to fit 1 in. by $\frac{1}{2}$ in. mortises in the uprights. The top edges of the rails should be rounded off, and the top ends of the uprights chamfered.

The positions of the rails are shown on the drawing. The lower rail is 16 ins. from the floor, the top rail is 2 ins. from the top, and the middle rail centrally placed. The positions can be arranged to suit individual requirements.

As it is practically impossible to obtain deal, the sizes of the material are arranged to suit hardwood, preferably straight-grained beech. If deal is available, however, increase the width of the uprights by about $\frac{1}{8}$ in. for extra strength at the joints. For the same reason, it is not a bad idea to make the mortises and tenons with rounded corners, instead of cutting them square.

Glue and Hinging

Take off all sharp corners left from planing and glasspaper all the strips before fitting together. The joints can

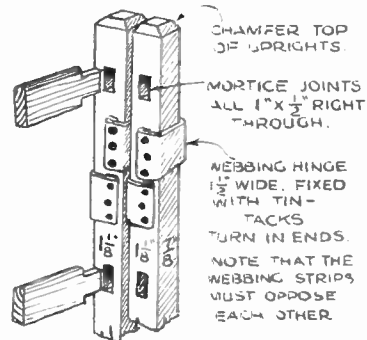

slipped between the hinge uprights. Turn in the ends of the webbing before fixing with tin-tacks, and make sure that the pieces are pulled up tight.

Four pieces will be required, each $5\frac{1}{2}$ ins. long, two for the top and two for the bottom hinge, just below the top and bottom rails. Make sure that the pieces of webbing are opposed to each other in pairs as seen in the diagram, otherwise the hinges will not function correctly.

As the cross rails will have to take the weekly wash no finish must be applied. Perhaps a coat of clear varnish on the uprights alone would add a final professional touch to a really useful article.

(217)

The first of two practical articles on STUFFING BIRDS

THE craft of taxidermy, to give the art of stuffing and mounting birds its proper name, is one that can be learnt reasonably easily. Once the elements are known, skill comes quickly with more and more practice. It is a fascinating craft, and none gives more delight when the finished article is nearing completion—for there is a peculiar attraction in a finely-mounted specimen, and each new one is unique.

A steady hand and patience are two essentials, and if the newcomer to the craft has an interest in birds and animals in their natural state this will be an added advantage. When the stuffing of the subject has been completed a good mounting depends largely on the ability of the taxidermist to give the model a poise which is, above all, natural. The nearer it comes to resembling a natural study of the creature concerned the finer model it will be.

Choosing Early Subjects

While it is more easy in many ways to handle animals, there are two good reasons why it is advisable to practice with birds at first. Birds are normally easier to procure, and most people are more familiar with them in their natural state than with a very great variety of animals.

It is suggested that the specimens be shot with the smallest of ball shot, thus ensuring as little damage as possible. Many of the smaller birds, such as finches and tits, have such fine skins that the apprentice would be wasting his time in attempting to skin them.

As a general rule it is wise to remember that birds which feed on a variety of fare usually have fairly tough skins, while those which are chiefly seed- or insect-eating are usually fine-skinned. Most birds of prey, but not all, have fairly thick skins.

A Simple Start

One common bird in particular is recommended for the beginner: it has a tough enough skin for less nimble fingers, and is far more pleasing when seen close to than when foraging or perched on a chimney. It is the starling, whose feathers have a fine purple sheen and most delicate whorled markings in many colours.

Skinning the Specimen

Work is best begun on skinning the bird as soon as it is cold. It is not wise to delay this part of the proceedings because of the setting-in of *rigor mortis*, when the body stiffens, and also because of the onset of decay.

One cut only is made in the skin, from the throat to the anus. When this is done, commence peeling the skin away from the flesh along the length of the cut. Few tools are needed for taxidermy, but

a small pair of scissors, a mustard spoon, and a sharp penknife are essential. Work the skin away from the flesh until it is completely free of the body except at the head, tail, wings and legs.

Deal with the joints at the tail, wings and legs next, leaving the neck until last. Work the skin as far as possible at these points, and then sever it carefully. The knife will be needed to cut the strong tendons at the wings and legs. Clean all these points well, as it is most important that no flesh is left on the skin. Any

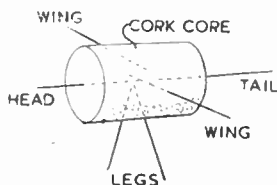

How wire and cork are fitted

small holes that are made will have to be repaired later.

Lastly, sever the neck at the base of the skull, scooping out the brain and eyes with the aid of the small spoon and point of a knife blade. Go over the skin while it is still damp, removing any bits of flesh which may still be adhering to it. Then wash it carefully with a little cotton wool and soap and water, taking care not to wet the plumage.

Curing the Skin

For the next stage some arsenical paste is required, and this can be procured from a chemist if its use is stated. When the skin is reasonably dry, paint the inside of it with a thin coating of the paste, using a fine brush. Make sure the whole skin is treated, paying particular attention to the skull.

It should be draped over a cup or similar object to dry when this has been completed. It is not advisable to pin out the skin, as this will damage it.

Stuffing the Skin

For the stuffing of the specimen wires

and corks of various sizes are needed. These are quite cheap, and can be bought from a professional taxidermist (names on request to the Editor). The cork forms the central core of the body of the model, and should be chosen by size accordingly. The wires, when fitted to the cork, must be cut off at the required lengths.

Wire Skeleton

Fig. 1 shows the skeleton which must be aimed at in constructing the cork and wires, and only the wire from head to tail pierces the cork right through. Those for the wings and legs should only be fixed firmly into the cork. For larger specimens stronger wires should be used, and in these cases all the wires may pierce the cork.

When the skeleton is complete force the front wire well into the skull, packing it tightly with cotton waste or tow, using the small spoon. Next, deal with the tail wire, embedding it into a small ball of the cotton waste plugged into the skin at the tail.

The wing wires are dealt with in a similar way, but the leg wires must be forced through the legs to emerge at the ball of the claw and left to protrude. The last point is important, because these are used in the mounting. When all the wires are in place, build up the body to life-size with cotton-waste, keeping the cork in a central position.

Sewing Up

Lastly, sew up the skin carefully with fine thread, using the smallest possible stitches. Imitation eyes, with a small fixing wire attached, can be obtained from the taxidermist. These should be given a coating of glue when plugged into the cotton waste at the eye sockets. A gentle squeeze at this stage should be sufficient to give the body of the model its final form. The wings and legs can be adjusted later by their wires, and also the poise of the head.

The next article will deal with the mounting of the specimen. (239)

Television Aerial

*P*LEASE send me details for the construction of a television aerial. (A.C.T. —Cowley).

A HALF-WAVE dipole is the usual aerial used, and for the London transmitters a length of 10·4ft. will give resonance approximately between the vision and sound transmitters. (In some cases it may be desirable to obtain maximum efficiency on vision frequencies; if so, the length of the aerial will have to be modified by experiment to find most suitable dimensions). Aluminium tubing of about $\frac{1}{2}$ in. diameter

is the most suitable material. Two 5·2ft. lengths may be clamped by insulating material at the centre and leads taken from the inner ends. It is also possible to use two 5·2ft. lengths of stout wire, supporting these on a lath about 11ft. long with stand-off insulators. From inner ends of wires or tubes the twin lead-in is taken. This must be at rightangles to aerial for at least $\frac{1}{4}$ th wavelength, and coaxial cable or transposed wires will be used according to receiver: Feeder cable should for preference be any length which is an odd number of multiplications of the transmitter wavelength.

The handyman should be able to undertake these DAMP HOUSE REPAIRS

A DAMP house is unhealthy and unpleasant; furniture and wallpaper may be ruined, and the floor boards may contract dry rot. The home handyman can do much to cure dampness in the house, and so prevent these ill effects.

Moisture can enter the inside of a house from three main directions—from the ground, through the walls or through the roof. Bricks and most building stones are porous, and hold a considerable amount of water, while they can lift up moisture from the ground by means of capillary attraction. Houses built on heavy land, like clay, are more likely to be damp than those on porous rocks, like sand.

Damp Course and Ventilators

Most houses have a damp course of non-porous material such as slate inserted between two layers of bricks above ground level, to prevent moisture from being drawn up from the earth into the house. The absence of a damp course is a serious defect, and is expensive to remedy. This is a job for the builder.

Make sure that the ventilators are not obstructed by leaves or earth, as this would prevent a drying current of air from passing beneath the floor. Perhaps in your gardening enthusiasm you have heaped the soil above the level of the damp course, thus allowing moisture to enter.

Re-Pointing

When it rains, the walls of the house become thoroughly wet, and this moisture may seep through to the inside. The cause may be that the mortar between the bricks has become perished. The walls should then be re-pointed by scraping out the old mortar and replacing with fresh.

This is a job any handyman can do. Make the mortar of two parts cement and three parts sand, and thoroughly wet the cavity before applying the new mortar.

The bricks themselves may have increased in porosity due to age. There are several methods of reducing this porosity and preventing access of water. One old method is to coat the outer wall with tar. A more modern method is to use cement paint, which is easy to apply, and extremely effective.

Downpipe Defects

There are also proprietary liquids which fill in the pores of the bricks without altering the colour of the wall. Any builder's merchant can supply these. Ordinary water-glass (egg preserver) is effective, too, if you apply several coats of the diluted liquid.

Walls which do not allow penetration of water from an ordinary rainstorm cannot, however, withstand the con-

stant gushing of water from a leaky gutter or drain pipe. Watch out for these defects, and put them right before blaming anything else. Drain pipes which overflow from the top may have a bird's nest lodged inside somewhere. This will be a job for flexible rods of the type used for chimneys and drains.

Faulty window frames allow water to enter, and cause damp patches underneath the window. Fill all cracks in the woodwork with putty, and renew any perished cement. Badly rotted frames should be replaced.

Roof Repairs

Rain can enter through broken tiles or slates in the roof, and at the place where a chimney stack joins the roof. The latter region is protected by a lead flashing, but if this is defective, leaks will occur here.

Similarly, at the junction between a roof and a wall, flashing is used, and may be at fault. Unless you are keen on 'mountaineering' over roof tops you

should get a builder to do the job.

Make an expedition into the region just below the roof, and inspect for loose or broken slates. A temporary repair to a small hole in the roof can be effected by sticking a piece of roofing felt on to the underside of the slate by means of one of the adhesives sold for such purposes.

Interior Walls

If you cannot find the source of the damp which is entering your house, or are unable to take any action to cure the defect, the next best thing is to coat the interior walls so that wallpaper and distemper can be used without discolouration taking place. Various preparations are sold for this purpose. Much depends upon the type of surface on which you wish to use these products, and it is best to seek the advice of the stockist.

A final word, now is the time to go to war against the damp; do not leave it until the winter sets in. (242)

A Complete Island Model

FOLLOWING our article recently suggesting models of areas and districts Mr. Eric L. Richardson of Brentwood Avenue, Whitley Bay sent us this picture of a similar model he had completed at his first attempt. Many readers may recognize it as St. Mary's Island and Lighthouse—a prominent feature of Whitley Bay. Those in the district should take an opportunity of seeing the model which will be on exhibition at the October show of the Tyneside Society of Model and Experimental Engineers. It is built to a scale of 16ft. to an inch, which means that the overall size of the base board is 30ins. by 20ins. and the tower of the lighthouse is approx. 8ins. above ground level. The contour and shape of the island were cut out of 1/4in. thick wallboard. The tower is made of discs of the same material with a hole running up the centre to give passage to the wire to the 8-volt bulb in the lantern. By means of a bell transformer this is lighted from the domestic circuit and a "flasher" incorporated simulates the flashing period of the prototype. A coating of Pyruma cement was given to the wallboard, and marks cut in the surface to imitate the rocks and the surface of the sea was also worked up in Pyruma. Poster paint was used over the whole model. A certain amount of grass grows on the Island and this was achieved on the model by using model maker's green flock. The houses were constructed of cardboard, although it would have been easier and just as effective if they had been made solid from blocks of wood, balsa, say, for ease of writing.



(Photo by courtesy of the Shields Evening News)



The SHIPMODELLER'S Corner

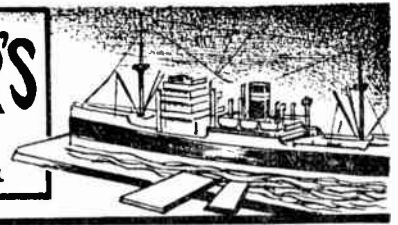

Perfect deck work makes all the difference

THE first item that attracts the attention of the expert when viewing an amateur-made Ship Model is the deck; usually it is quite flat. This was never the case on sailing ships, the decks always being crowned. That is, given a camber from the centre to each side. This was done in order that any

sides to simulate the waterways. Or better still cut them to the correct curve from thin veneer and glue in position. Make them $\frac{3}{8}$ in. wide on the small models and $\frac{1}{2}$ in. on the larger models.

Deck Planking

After this is completed, deck planks must be ruled in scale. For the smaller models (Golden Hind, etc.), make them $\frac{1}{8}$ in. apart and for the larger $\frac{1}{4}$ in. apart. This will give slightly over scale planks, but it is the smallest practical and gives the right effect at this scale.

Now give your deck a coat of shellac and allow to dry. When dry mark out the position of deck houses and hatch covers. When ruling your planks leave a

margin around each hatch or deck house, about the same width as your planks. Having pencilled in your deck markings take a single edged razor blade and metal ruler and score in each line about $\frac{1}{2}$ in. deep.

Now take a tube of artist's oil colour, burnt umber, and some turps and paint

Get better results by following these notes
by 'Whipstaff'

the whole surface of the deck. This done, take a clean rag and wipe off all the paint evenly. This method will leave your deck a rich warm colour, and as the paint will be left in the scored lines, it will show up very well, simulating the caulking between the deck planks in a very realistic manner. A point to note is that, as deck planks do not, of course, run the whole length of the ship, nick across your planks, staggering your cross cuts to avoid monotony of effect, as in the diagram.

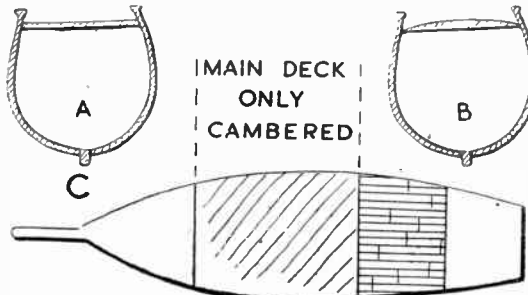

water falling on deck would strain away to the scuppers. (See diagrams A and B).

Let us then make a deck for our model, that will be realistic and look right. Having cut your deck piece according to plan, usually in $\frac{3}{8}$ in. or $\frac{1}{2}$ in. wood (sycamore if possible, as this gives the best result), we must shape this to proper camber with a small block plane and glasspaper.

From the Centre

First draw your centre line the whole length of the deck. Working from this, work down each side in a gentle curve to the outside edge, the finished deck to be like section in diagram (B).

In strict scale models it is necessary to work out the correct degree of camber, but this will not be necessary in this case. For small models in Hobbies range, like the Golden Hind, camber your deck to be $\frac{1}{8}$ in. lower at the edges than in the centre. For large models—The Ark Royal, etc.—finish them $\frac{1}{4}$ in. lower at the edges.

Main Deck Only

Do not forget that in most galleon models the main deck piece extends the full length of the hull. Only that part forming the actual main deck should be cambered, otherwise you will have trouble fitting on the upper works correctly.

This done and the deck smoothed nicely with finest glasspaper we must mark out a line around the edges at both

Some Simple and Useful Home Made Tools

IN the making of Ship Models there is much fine and delicate work which can be simplified by the use of the right tools, most of which can be made by the modeller himself at small cost.

The drilling of small parts is but one and drill points of the small number type are not cheap. Moreover, they break very easily. To facilitate this work you need a small watchmaker's pin vice. This will take the finest drill points and is used by twisting between the index finger and thumb, steadying the butt in the palm of the hand.

Drill Points

Now to drill points. To make these, first obtain a packet of assorted steel sewing needles. The best cost only a few pence. Commence by breaking off the eye, as in diagram (A) and then sharpen to an arrow point, as in diagram (B). For wood these will not need tempering, but if you propose to use them on metal, temper them by heating red hot and then stick into a bar of common household soap to cool.

Your packet of needles will make several sizes of drill points; I keep one set for wood and another for metal.

Carving

In some models there is a large amount of imitation carving, especially in models of the Stuart period. Why not really decorate such models with real carvings? It is not as difficult as some modellers believe and they rely on roughed-up glue or plastic wood.

Make yourself a set of miniature

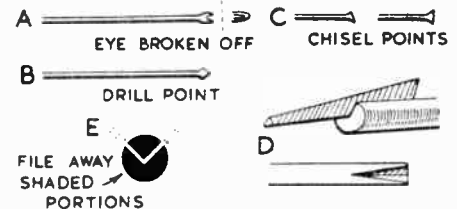

carving tools from darning and sail needles by breaking off the eye as you did for your drill points and grinding to chisel points (as in diagram (C)) on an
(Continued foot of page 410)

For help-yourself occasions you should provide CIGARETTE SERVERS

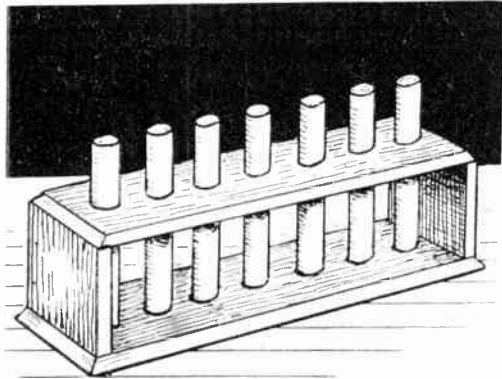

CIGARETTE 'servers' are very useful things to have at a party or on a dinner table, or indeed at any function where guests are expected to help themselves. They save all the 'digging out' that seems to take place when 'smokes' are supplied in a box or other container, and put the cigarettes more on view. Neatly made servers also are quite attractive items to have about.

Fig. 1 shows a server that is particularly easy to construct. The base is merely a rectangular strip of $\frac{1}{2}$ in. material, $6\frac{1}{2}$ ins. by $1\frac{3}{4}$ ins. Any good wood will do, or a piece of plywood could be used. Sides and ends of this piece are bevelled for a $\frac{1}{4}$ in. inwards as shown in Fig. 2, and to the extremities are secured the end-pieces (A). These are also $\frac{1}{2}$ in. thick and are $1\frac{1}{2}$ ins. by $1\frac{1}{2}$ ins.

The Holder Top

Before fitting however, cut the top rectangle (B), which is $5\frac{1}{2}$ ins. by $1\frac{1}{4}$ ins. and of slightly thinner material than the base. The edges of this piece are also bevelled inward for a little distance. Down the centre are bored seven holes of an easy $\frac{3}{8}$ in. diameter to take the cigarettes. As the diameter of a standard cigarette is $\frac{3}{8}$ in., also it is best to make the holes $\frac{1}{16}$ in. first of all and then enlarge them off a little with a circular file.

The spacing down the centre of (B) is shown in the sketch. Marking $\frac{1}{16}$ in. from either end of the unbevelled strip and then divide the distance between these two into $\frac{3}{8}$ in. lengths, the division coming out equally. The positions for the holes are then given by the alternate lengths.

The holes in (B) have to agree exactly with part holes in the base, which only go down for $\frac{1}{4}$ in. These lower depressions take the ends of the cigarettes and it is essential that they align perfectly with the corresponding holes above or the cigarettes will not fit perfectly.

Cut Together

A good way to secure accuracy is to fasten the two pieces together temporarily with a couple of fine sprigs and then bore right through till the base is reached, but only marking this. The pieces are then separated and the correct depth obtained in the under strip with a little more careful boring. Getting a similar depth all along is rather important if the cigarettes are to present a good straight line along their top—and it is the even appearance of the cigarettes that gives this server its attractiveness.

Assembly

The four parts now being ready we come to the assembling. The ends are secured to the base with glue and two almost headless sprigs taken up from below which gives strength to the frame should it ever receive a sideways knock. The top (B) is fixed with glue alone.

All is now complete and the finish can be according to taste. If good wood has been used polishing alone may suffice. Or stain and polish can be adopted, or again if quickness of completion is desired staining alone will do.

As an added refinement a rectangle of very thin baize (green for preference) should be glued on the under side of the base so that the server can be placed or pushed about on the most highly-polished surface without the danger of doing damage.

In Quantity

In making several servers of this type it is best to keep to the same kind of wood and finish, or alternatively work to a very contrasting finish.

The server as given is for the standard cigarette, but should you require one for the smaller varieties only, i.e. like Woodbines etc. the holes need only be $\frac{5}{16}$ in. diameter—the rest of the dimensions can be the same. In a server made for the larger cigarettes the smaller brands do not look well as they tend to lean over at unsightly angles and so take

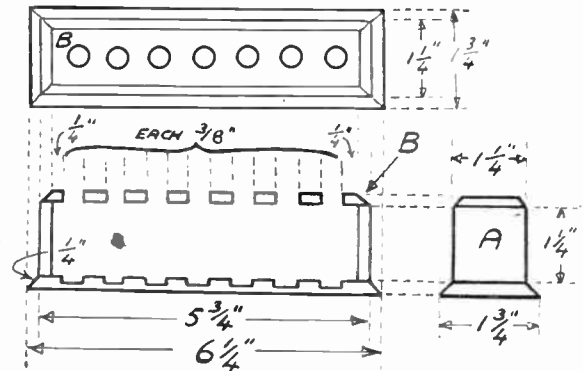

away from the general neat appearance.

The making of cigarette servers opens up quite a large field to the imaginative craftsman who will be able to think of a number of possible designs to suit his own special conditions. Details, however, of a more elaborate server will be given in a later article.

Shipmodeler's Corner — (Continued from page 409)

oilstone. With these you can make carvings of your designs in scraps of boxwood or holly, with a little patience and practice.

Have your wood about $\frac{1}{4}$ in. thick and draw your design in pencil first. Even quite a simple carving looks really well when finally painted, gilded and mounted on your model. These tools can also be used for shaping imitation carvings from plastic wood if you prefer this method of reproduction.

Gouges are, of course, a necessity for carving and you can provide small gouges in the same way. Old umbrella ribs cut into short lengths, mounted in a handle of dowel and sharpened, make excellent small gouges.

You can also make a selection of gouges from different sized nails. Mount your nail by tapping it into the dowel handle and then cut off the head with a hacksaw or file. Proceed to file a V groove lengthways in the end of the nail,

using a three-cornered file, as in diagram (D), after which turn the nail over and complete by filing away the waste on each side of your V groove, see diagram (E).

Then sharpen on an oilstone and you have an excellent V gouge for small work, usable also in large models for grooving your plank lines on deck. All chisels and gouges should be mounted in suitable handles made from dowel rods.

'Whipstaff'

Books to Read!

A review of interesting books for craftsmen which have been recently published. Obtainable through newsagents or booksellers or direct from the publishers mentioned.

Unforgettable Snapshots

A SPLENDID 'bobsworth' for the beginner in photography and one which we can guarantee to produce better results after perusal. No long tedious chapters to read and study; no technical data to work out and memorise. Large actual pictures and small humorous diagrams, with a minimum of essential factual text provide clear concise instructions which are a definite aid to those haphazard users of a camera who so frequently bemoan their inability to get satisfactory pictures. With a book like this improvement is certain, and the learning of it is undertaken lightly but with sound technical sense.

Published by Focal Press Ltd., 31 Fitzroy Square, London, W.1—Price 1/-

Inexpensive Television for the Home Constructor

by C. Overland

MANY readers will have pleasant memories of the 1920's when radio was in its infancy and the keenness, pleasure, and excitement we obtained in progressively making cat-whisker crystal sets, one valve, two valve, four valve and then superhet sets. Nobody just buying their radio set today can understand the thrill we got from the building and operation of those home-made tie-ups. And now we have come to a similar stage again apparently, but instead of radio listening sets we have progressed to television. The same opportunity for home built sets is again before the enthusiastic amateur, and from our mail bag interest shown in our regular radio articles we know there will be a great appeal. This new book, therefore, is just what is wanted, for it is a revised and enlarged edition dealing with the construction of receivers from ex W.D. surplus equipment or components which are reasonably easily obtainable. Some technical knowledge is, of course, essential, but apart from the actual instruction on the various sets, a number of addresses are given from which the components are obtainable.

Published by Amalgamated Short Wave Press Ltd., 57 Maida Vale, Paddington, London W.9—Price 2/6

New Developments in Scale Railway Modelling

by Edward Beal

IT is a pleasure again to have a book by this expert author, because one can always be sure of sound advice, accurate construction and clear details of the

needs of the miniature railway enthusiast. His quarter century experience and the popularity of his previous books prove his reliability and popularity and this new manual will add to his wide circle of friends. The photographs of lay-outs, scenic effects, stations and stock must be an incentive to any keen modeller, whilst the drawings, diagrams and details enable him to imitate and complete with interest and ease. The book has over 300 illustrations in its 268 pages, and is printed and bound on paper and boards which will stand up to the constant reference such a book is sure to have in the hands of keen railway modellers.

Published by A. & C. Black Ltd., Soho Square, London, W.1—Price 15/-

Radio Control for Models

by G. Honnest-Redlich

THREE statements made in the Introduction to this book by the author are, perhaps, surprising, but well worth noting. One is that he gives the 'birthdate' of Radio Control as June 30th, 1905; another is that Radio Control today is no longer solely in the hands of the specialists; and thirdly that

Radio Control is nearly at the point of standardisation. The author is an acknowledged expert himself, but in the book he sets forth his knowledge clearly and easily, so that profound technical understanding is not necessary to find it fascinating and helpful. The book is the first of its kind, deals with the subject clearly, and covers a helpful field where snags have an unhappy knack of occurring. Circuits for transmitters and receivers are shown and explained, with very many photographs of them in use on a variety of occasions, both here and on the Continent. Being a Harborough Publication one can rely on its technical accuracy, clear printing and pictures, and a handsome book to handle and keep for reference.

Published by Harborough Publications, The Aerodrome, Stanbridge, Nr. Leighton Buzzard—Price 8/6

Model Railway Clockwork Mechanisms

by Ernest E. Carter

THE periodical articles in these pages dealing with model railways have, we know, a very wide appeal, and to all

A number of readers have asked about AQUARIUM CEMENTING

AQUARIUM tanks, for the beginner who takes up this very interesting hobby, are divided into three main types. There is the bell jar, the tank with metal frame and glass sides with a base of slate, and the home-made affair made out of a strong wooden box, with glass front.

The metal framed tank is the best, for the glass sides can easily be renewed if broken by accident. You can purchase a welded frame from dealers in aquarist stores, and fit it with a suitable base of glass or slate. If you can obtain some secondhand plate glass, this will prove very good and economical. A useful size for the beginner is about 18ins. long by 12ins. wide by 18ins. deep.

Waterproof Putty

Many makers of aquariums at home seem to find difficulty in finding a putty that will keep the water from seeping through. Putty for this purpose must be best linseed oil putty, painting the inner sides of the frame and edges of the glass with gold size. Press the glass well home, and clean off all surplus putty with a suitable scraper or knife.

It is, however, better to use a good

cement, a special cement we might add. There are several mixtures that can be used, including the following:

Ten parts by measure of well-sifted dry white sand, ten parts of plaster-of-paris, ten parts of litharge, and two parts of finely powdered or crushed resin. Sufficient boiled linseed oil is needed to mix the ingredients into a fairly stiff kind of 'putty'. To be used as soon as mixed, and you should allow a week or more for the joins to harden.

Variety of Uses

This cement will stick wood, stone, metal, or glass, and hardens thoroughly if left awhile before you put water into the tank. It does no harm to leave it a fortnight to set. It is also useful for marine aquaria, as it resists the action of salt water.

Another useful cement which can be tried is as follows: Six parts of whiting, three parts of plaster-of-paris, three parts of dry white sand, three parts of litharge, and one part of crushed resin. Mix thoroughly into a stiff 'putty', with best oil varnish, and after using leave for a week or ten days to harden before putting water in tank. (256)

those readers interested we can recommend this new small manual on the subject. Mr. Ernest F. Carter has written a number of books, and his extensive knowledge is conveyed in an interesting and non-technical manner. Clockwork, as a driving mechanism, has come to be considered rather 'low-brow', but there is no doubt it is still a reliable motor power for any railway. The usual trouble is, of course, breakages and damage, and that is exactly where this book comes in. Apart from practical information on the subject in general, the owner will be able to undertake his own repairs, and perform necessary running adjustments on his clockwork locomotives with skill and success. That point alone makes the book an economic investment to save a lot of money on repairs and a lot of irritating delays waiting for them to be done. Published by Percival Marshall & Co. Ltd., 23 Great Queen Street, London, W.C.2.—Price 3/-

Modern Furniture Projects

by W. A. G. Bradman, F.R.S.A.

AS its title suggests the book is a thoroughly up-to-date in concept and constructional advice, covering those comparatively small pieces of furniture to fit modern limited home space. The author (whose work has appeared in *Hobbies Weekly*) has cleverly designed several double-purpose pieces which will particularly appeal to the home handyman who is working out his own planning for home usefulness. There are, for instance, a combined bookcase and lounge table, a floor lamp and cabinet, combination, a firescreen-cum-table, a low workbox-seat and so on. Another excellent point is that early chapters give some particulars of various

prepared boards which can, in certain cases, be substituted for natural wood. The peculiarities and manipulation are shortly given in concise and helpful manner. The author truly maintains that almost any amateur woodworker with a few tools can undertake the work, and successful joints are assured by the early chapters devoted to those used. Processes are clearly shown in the progressive drawings, and having dealt with these, the following chapters deal with many practical everyday pieces of home work. The 182-page book is well printed and a joy to read, with its clear type and simple helpful drawings. Even though the excellent pictures of the finished subjects are rather small, they are clear enough to be attractive. The book can be thoroughly recommended. Published by Herbert Jenkins Ltd., 3 Duke of York's Street, St. James's, London, S.W.1—Price 7/6

Robinson Crusoe Miniature Theatre Puppets

WE have previously reviewed the first of these cardbook cut-out books of popular stories as model theatre plays, and are now pleased to note an addition to the series. The book is large (10½ ins. by 8½ ins.), of stiff card, printed in bright attractive colours throughout with the figures, script, and even music, for a simple but clever puppet show which can be made and manipulated for the delight of the constructor and the pleasure of any audience. The pantomime story is simple to follow in cutting out and fitting, because helpful diagrams are provided. The figures and scenery are printed full size in colour, for playing out on the theatre stage and front provided. A book worth bearing in

mind to provide unusual entertainment, apart from the pleasure of construction and manipulation.

Published by Medallion Press Ltd., 5 Dowgate Hill, London, E.C.4—Price 3/-

The World's Airways

AIR travel throughout the world has now become so accepted as part of normal civilization that few of us give thought to the amazing advances made and the organisations necessary to maintain an increasing demand and accident-free performances. The science of air operation has to cover a multitude of details from intricate parts of a 3,500 h.p. engine to a steward knowing the most comfortable way to help you into an overcoat! In this book a dozen experts hand out much of their knowledge in non-technical language so the quite uninitiated can understand and enjoy. The story of all types of machines is a fascinating one, the operation of air lines a source of wonder and amazement, and the explanation of modern jet, turbo-prop and jet-assisted engines provides a sense of pride at the scientific knowledge which produced them. A well-bound book of over 300 pages, with more than 30 explanatory wash drawings and nearly 300 photographs of features of peculiar and human interest to any reader. Whatever your age such a book as this provides delightful, fascinating reading from the foreword by Sir Wm. P. Hildred, C.B., the director general of the International Air Transport Association, to the helpful index at the end of its 320 pages.

Published by Odhams Press Ltd., Book Department, Long Acre, London, W.C.2—Price 8/6

Colour stains, warping, repairs etc. worth knowing in SIMPLE WAYS WITH WOOD

ON the same principle that a stitch in time saves nine, and prevention is better than cure, and a good old thing is better than a shoddy new one, the hints here given are well worth recording.

To obtain BLACK STAIN immerse one pound of iron nails in ½-gallon of vinegar and a small quantity of verdigris, and a good black stain will result. For MAHOGANY STAIN boil ½-pint madder (which is the root of a plant originally, and yields a red dye) with ½lb. fustic (which is the wood of a West Indian tree and used alone yields a good yellow dye) in one gallon of water. This must be used whilst boiling hot on the wood to be stained, and applied until the desired colour is obtained.

To give wood the appearance of EBONY take one ounce of borax and two ounces of ebony. Put this mixture on the fire in one quart of water. Dissolve until thoroughly mixed, then add one teaspoonful of glue substitute. After

mixing add enough aniline black (soluble in water) after which it is ready for use.

A coloured stain is often required when making lamp-stands, trays etc. and a pretty GREEN STAIN for wood can be obtained by mixing verdigris, sal ammoniac and vinegar and dipping the article to be stained.

The Cheapest Stain

Of course, the cheapest and easiest way of staining wood floors is to dissolve 2 ounces permanganate of potash in warm water, and merely painting the wood evenly with it. The colour may be toned to light or dark oak or walnut according to the amount of water added.

In craftwork it is as well to know exactly what to do to make the best of odd pieces of wood and sometimes a neat patch-up will do the trick. To repair cracks in wood dissolve one part glue in 16 parts water and when nearly cool stir in sufficient quantities of sawdust and prepared chalk in equal quantities to make a paste, and just smooth in the cracks.

Another excellent cement for wood is easily made at home. Powder ½-ounce isinglass between the hands, place in a wide mouthed bottle and dampen thoroughly with acetic acid. Stand the bottle in water and bring to the boil—minus the cork of course. When cold the cement will solidify, but it may easily be melted again by warming when required for use. Be sure to remove the cork when heating.

Sometimes it is unavoidable to make articles without a few marks appearing on the woodwork. An easy-to-make polish is made by heating to simmering point (not boiling), ½-pint linseed oil, then mix whilst hot with ½-gill turps. Apply mixture when cold to the marked wood with a circular movement until the mark disappears.

In craftwork where wood is used the dangers of warping are removed by the following method. Saturate the wood with copaiba balsam; if one side is already warped soak the other side with the liquid. (245)

A PHOTOGRAPHIC ALPHABET

More helpful hints in our practical series. Points the beginner and amateur should know. Look out for further pages.

R for—

Range Finder

ARANGE-FINDER is another idea for helping photographers to get their pictures in sharp focus with certainty.

Here we have a small box containing mirrors or prisms set in such a way that when you peep through an eye-piece in the back you see two overlapping images. By turning a knob on the top the images can be made to coincide and if the finder is 'coupled' to the lens this means that the image on the film will now be in pin-sharp focus.

In 'non-coupled' finders, the coinciding of the image gives on a disc the exact distance away of the item in

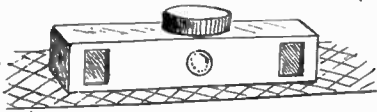

question, and this reading has to be set on the camera scale in the usual way.

A range-finder can be used separate from the camera and need not necessarily be attached, unless, of course, of the 'coupled' type. The coupled type is really the better, being entirely automatic in action.

Reducers

WHEN a plate or film is dense and heavy and difficult to print from, it can be improved by reduction—a process which makes the deposits on the 'base' thinner.

Reducers can now be bought in tabloid form which is very handy, as each tabloid just makes enough solution for dealing with one or two negatives.

There are several reducers on the market but two main ones should be known by every photographer as they have rather opposite actions. The first is *Farmer's* and this has the effect of first clearing out the shadows, which makes the negative and final print brighter and more contrasty. The second is *Ammonium Persulphate*. This digs into the heavy deposits first and so renders the highlights more transparent without touching the shadows greatly. Thus it tends to even out a too contrasty negative (as well as, of course, reducing it) which is just the opposite effect to *Farmer's*.

The reducers are easy to work, but in both cases action is quick once it starts and the process must be watched carefully. But a little practice with old negatives will soon give the idea.

S for—

Squeegee

THIS is a very useful photographic accessory and its use is to give an even pressure all over a surface. Thus a squeegee is employed to press prints into good contact with the glazing plate when putting the high gloss on them.

Squeegees can be either of the 'roller' or 'non roller' type. The roller kind, however, are the more popular and one can be made by stretching a length of discarded cycle inner tube over a similar length of round rod (say, from a brush stale) and fitting a simple frame handle.

A non-roller type can be put together by cutting a strip of really thick rubber from, say, an old car tube and fixing this between two rectangles of wood, with just a little of the rubber extending below.

When squeegeeing wet prints on to a glazing plate, the roller should be used in one direction only, i.e., going from one edge to the other, then lifting again. The aim is to squeeze every bit of air from between the print and plate. A

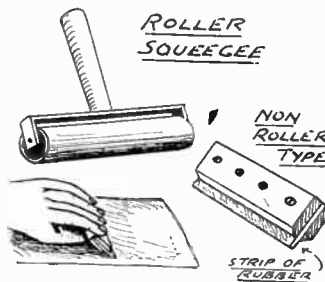

sheet of clean blotting paper must be placed over the prints before applying the roller.

Squeegees have other uses also which make themselves apparent as you try out more and more photographic processes.

Stains

STAINS on gaslight and bromide prints often bother amateurs when they first start to do their own work. These can be anything from a nearly all-over yellow tinge to definite areas of discoloration. The trouble can be caused by several faults in working, the most important being (1) Prints too long in the developer (a very common cause), (2) Stale or overworked developing solution, (3) Too weak hypo, (4) Prints not being quickly immersed in the hypo but left half floating on the surface.

All solutions should be fresh and

exposure so adjusted that the picture always develops up readily without having to 'force' it out. Hypo is cheap, so a new bath should be mixed for each batch of prints, and rinsing water must be kept clean.

Slight stains can often be removed by placing the affected prints in a dish of water to which a few drops of hydrochloric acid have been added.

Gaslight paper tends to stain more readily than bromide, and so a greater care than usual has to be taken with solution strengths and correct exposure when using this material.

Shutter

THE shutter is the mechanism in a camera which while normally keeping all light from the inside, is capable of being opened for a brief space of time to impress the picture on the film.

Shutters are of two main types: (1) Those set at the front end of the camera near the lens and (2) Focal plane shutters which operate at the back of the

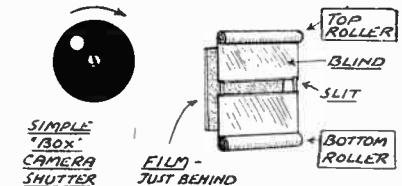

A simple shutter and the focal plane type

instrument right against the plate or film. Most cameras have the former.

With very simple folding and box cameras the shutter is often just a circle of tin rotating on its centre and with an opening on its outer edge. When the trigger is pressed this is twirled through half a revolution by a spring and the picture is taken as the hole passes over the lens, thus for a split second allowing light to pass to the sensitive material.

More expensive cameras have precisely finished and wafer-thin metal vanes which move from the surface of the lens and then close in again.

Focal-plane shutters are simple in action and very efficient. Here a blind of opaque material passes down the face of the film or plate—the nearer the better. In this is a slit from side to side which scans the surface as the blind moves from a top roller to one located at the bottom. Through this slit the picture is taken.

The focal plane shutter is capable of very high speeds, exposure running into thousandths of a second being possible. This kind of shutter is used, therefore, for very exacting action pictures.

SOUTH Africa Set, 10 free. Stamp approvals. — Ashmount House, Marshfield Road, Goole, Yorks.

JIGSAW puzzle library. Unique new service. S.A.E. details.—J.E.S., 46 Laisterdyke, Bradford.

STAMPS Free!! Twenty unused (2½d.).—G. H. Barnett, Limington, Somerset

500 STAMPS free. Request approvals and details; send postage.—Myers, 58 Sydner Rd., London, N.16.

HAND mortise machines, £4 7s. 6d. Send 2d. and S.A.E. 1d. for particulars.—Cook, 37 Springhill Avenue, Penn. Wolverhampton.

FILMS—all popular sizes available, all well-known makes. 2½d. for list.—Asdo, Bracklesham Bay, Sussex (1).

MINIATURE railway exchange. Enthusiasts interested in sale, purchase and exchange of model railway equipment, write enclosing S.A.E. to M.R.E., 19 Claredale Estate, Hackney Road, London, E.2.

50 GOOD stamps free, mainly pictorials. Send for approvals, enclosing 2½d. Junior or medium.—Beeze, 116 Newton Rd., Mumbles, Swansea.

EARN £2 weekly in your spare time. £2.6 P.O. will bring you three tested trade formulas.—Dept. H.—BCM/INAB, London, W.C.1.

40 DIFFERENT stamps free, including Silver Wedding, U.P.U., Victory, Silver Jubilee, Coronation, Pakistan, etc. Send 3d. postage and request approvals.—J. F. Smith, 60 Boyne Road, London, S.E.13.

HOMEWORKERS required, either sex, light assembly, part or full time. S.A.E.—Esprey, Box 18, 41 Wade Street, Lichfield.

WATCH repairers and experimenters. 20 Geneva watch movements, take 20 - the 20; 20 English lever movements, £2 the 20; all from gold and silver cases. — Merckels, Jewellers, Pilgrim Street, Newcastle-on-Tyne.

PERSPEX and Acetate; cut any size from 2 6 square foot.—W.M. Products, 2 The Mall, Ealing, W.5. Ealing 3881.

PERSONS wanted to make model bungalows at home. Simple, interesting, clean, regular work. Top rates paid. Send stamp addressed envelope for details.—Bennett Models, 137 Gray's Inn Road, London, W.C.1.

STAMPS—1,000 unsorted, 5/-. 500 different, 5/-. Free pictorials to approval applicants.—Robert J. Peck, 7A Kemp Road, Bournemouth, Hants.

IF you have nothing to occupy your leisure, why not try something interesting and profitable? Experience is not required in leathercraft. Send large S.A.E. for our brochure, free of obligation.—Leathaweave (Dist. 37), 3 East St., Leicester.

STAMPS—world mixed, 1/- a 100; 5/- a 1,000. Gift voucher free.—Selby, 66 Donnington Road, London, N.W.10.

PLYWOOD offcuts. Birch and Gaboon in various thicknesses. Handy sized parcels for the cabinet, toy, model maker and all handicrafts. Parcels made up in £1 and 10 - lots. Carriage paid. Send P.O. to Reeves, Plywood and Timber Merchant, 33 Front Street, Monkseaton, Whitley Bay, Tel. W.B. 4677. Due to exceptional demand we cannot promise delivery under eight days.

BLUSHING, shyness, nerves, self-consciousness, fears, ended. Details under plain cover, 1d.—Stebbing Treatment, 28 (HB) Dean Road, London, N.W.2.

BE Taller in 14 days or money back. Details, 1d.—Stebbing System, 28 (HB) Dean Road, London, N.W.2.

£5 to £20 weekly earned at home, running your own Mail Order business. Details, 1d. — Stebbing Publications Ltd. (HB), Naphill, High Wycombe.

FASCINATING and profitable hobby, casting ornaments, toys, etc. You can easily make these yourself. Paints, brushes and all accessories. Illustrated catalogue of 700 moulds, plus latest list of rubber moulds, with instructions, 9d., post free.—Cock of North Moulds (H), 140 Hollings Road, Bradford.

AMERICAN Magazines post free for one year. Popular Mechanics, 32 -; Popular Science, 28/6; Mechanix Illustrated, 22/6; Popular Homecraft, 18 -. Stamp for full list of others.—Willen Ltd. (Dept. 57), 101 Fleet Street, London, E.C.4.

HARDWOOD Wheels. 2ins., 1 -; 3ins., 2/- per set of four. Tax included, post paid. Other sizes available.—The Joyden Toy Co., 193 Chase Side, London, N.14.

IMMEDIATE delivery. Figured oak plywood, 24×24×¾in., 5 for 35 -; 24×24×½in., 2 for 25 -. Mahogany box bottoms, 7½×9½×½in., 9 - doz. New birch, grade III, 30×9×¾in., 10 pieces, 15 -. Box sides, 35×6×½in., 10 for 15 -. All post paid. C.W.O. List of Plywood, 2d.—H4/JDD Storage, 71 Northcross Road, East Dulwich, S.E.22. Open every Wednesday from 6—9 p.m.

2½ ins. PRESSED Metal Wheels, 2 - dozen, 8 6 half gross, 15 - gross. Enamelled red or blue, 6d. dozen extra. Hardwood, pressed metal, metal disc wheels, doll's house windows, doors, papers. Catalogues, 6d.—Jasons, 135 Nags Head Road, Enfield, Middlesex.

CONJURING. 3d. for new lists and free magical competition. — De Hempsey, 363 Sandycroft, Kew Gardens.

PITMAN or Gregg Shorthand. Rapid postal courses. Particulars—Shaw's Commercial School, Lancaster.

USE spare time on profitable home-work making fancy goods. Write for free booklet—(Area 544), 54 Southgate Street, Leicester.

I Made big money, you can do same. I send envelope for my system tells you how.—J. H. Wamsteker, Box 34, Wynberg, Cape, South Africa.

9.5 Film Library, projectors, films for sale. Stamp for lists.—Wayland, 223 Longley Road, Tooting, London.

PLYWOOD offcuts, ¼ in. and ½ in. up to 12×9ins. Ideal toymaking, etc. In parcels; 5/6 post free. Apply—Ansells, Barnabas Road, Birmingham, 23.

BE Taller. Quickly! Safely! Privately! No appliances—no tablets—no dieting. Details, 6d. stamp.—Malcolm Ross, Height Specialist, BCM/HYTE, London, W.C.1.

MODELS. You can make lasting stone-hard models with Sankey's Pyrama Plastic Cement. Supplied in tins by Ironmongers, Hardwaremen and Builders' Merchants. Ask for instruction leaflet.

(Continued foot of page 415)

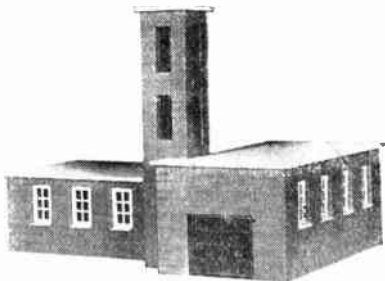

YOU can build this Fire Station

WITH



BRICK & MORTAR BUILDING KIT

It enables you to build Houses, Garages, Railway Stations, Signal Boxes, or from your own imagination. All railway models will fit 'O' gauge scale. Buildings can be permanent, or dismantled by merely soaking in water and the bricks used again and again.

BRICKPLAYER KITS AT 25/-. AND 47 6 ARE AVAILABLE FROM GOOD TOYSHOPS, HOBBY SHOPS, AND DEPARTMENTAL STORES.

ACCESSORY PACKS

No.	Contents	Price
100	100 Full size Bricks	2/6
101	52 ½-Bricks and 72 ¼-Bricks...	2/6
102	Gable and Peak Bricks	2/6
111	Capping and Roof Tiling	2/-
112	Concrete Roofing	2/-
114	Bag of Brickplayer Cement	1/2
115	Roofing Cement	6d.
8107	2 Bay Windows with 31 Splay Bricks	3/6

METAL WINDOW AND DOOR FRAMES

F1	F2	F3	F4	F6	F8	F10
8d.	6d.	7d.	4½d.	3½d.	5d.	7d.
8108 Sheets of Glazing, 1½"×6" (Plastic) 1d.						

If your dealer cannot supply, write for address of nearest stockist to:

J. W. SPEAR & SONS LTD.
(Dept. H) ENFIELD MIDDLESEX

PROMOTION

WITH INCREASED PAY

That is what the younger generation are seeking—Promotion, and more money. How to get it is the big question. There's only ONE certain way and that's by systematic training such as the I.C.S. have given to millions and are giving today to tens of thousands of ambitious young men striving to add to their earning power.

Find out how the I.C.S. can help YOU. We teach a wide range of subjects. Here are some of them:

Accountancy	Commercial Art	Radio Engineering
Advertising	Commercial Training	Radio Servicing
Architecture	Coal Mining	Salesmanship
Building	Draughtsmanship	Sales Management
Business Management	Electrical Eng.	Sanitary Eng.
Carpentry and Joinery	Horticulture	Structural Eng.
Chemical Engineering	Mechanical Eng.	Surveying
Civil Engineering	Motor Engineering	Works Management

LETTERS AFTER YOUR NAME

Do you wish to put 'letters after your name' that will give you recognized professional status of great and life-long value? I.C.S. students have won brilliant successes in various Technical, Commercial, Professional, Civil Service, and other Examinations, including the following:

<i>Technical Exams:</i>	Home Office Mining	C. Inst. Accts.
R.I.B. Arcts.	M.O.T. Certifis.	C. Inst. Secs.
Inst. of Builders	B. Inst. Radio	Corp. Inst. Secs.
Inst. Civil Engrs.	P.M.G.	Inst. Book-keepers
C. & G. Elec.	C. & G. Wireless	Inc. Sales Managers
Inst. Fire Engrs.	R.A.F. Wireless	U.C.T.A. in Sales
Inst. Marine Engrs.	I.I.A. Foremanship	General Certificate
Inst. Mech. Engrs.		of Education
I.M.E. for Bldg. Insps.	<i>Commercial and Educ.</i>	University Entr.
Inst. Municipal Engrs.	<i>Exams.</i>	School Certif.
Inst. Struct. Engrs.	Advertising Assoc.	Coll. of Precepts
R.I.C. Surveyors	I.I.P. Advertising	

I.C.S. Examination students are coached until successful and all Instruction Manuals and Textbooks are supplied to them free.

International Correspondence Schools Ltd.
(Dept. H.B.8) International Buildings, Kingsway,
London, W.C.2



Indispensable to all interested in motor cars.

The two popular Car Books

"WHERE'S THAT CAR FROM!"
"POPULAR CARS ILLUSTRATED"
6d. each

From all Stationers and Booksellers

or from **RALEIGH PRESS, EXMOUTH**

DOLL'S HOUSE KITS

for the Craftsman

Now is the time to begin making a Doll's house for Xmas. Three styles to choose from. Complete kits of parts, with paper, boards and interior fittings. Or design separate if desired. With complete illustrated details for straightforward construction. Any home handyman can undertake them. Free illustrated leaflets from any Hobbies Branch or Hobbies Ltd., Dereham, Norfolk.

Miscellaneous Advertisements—(Continued from previous page)

PRESSED Metal Wheels. 1½ ins., 1 3/4 ins., 1 9 per dozen. Or in stove-enamel finish, red, green or blue at 6d. per dozen extra. Tax included. Post paid.—The Joyden Toy Co., 193 Chase Side, London, N.14.

DOLL'S House fittings and papers; send S.A.E. for list. Dolls House plan special; send 2 6. Trade supplied.—Zimplan, 88 Ware Road, Hoddesdon.

MALAYA calling all pen pals! Hobbyists! Scouts! Join Correspondence and Hobbies Exchange, the only one of its kind in Malaya.—52 Jalan Meriam, Muar, S.4.

100,000 Government surplus bargains. Tool or instrument boxes (wooden) with hinged lids and fasteners. 9×5×4 ins., 1 6 each, post 9d.; electric blower motors, complete with fan, 12 or 24 volt, 9 6, post 11-; spring loaded plunger switches (make excellent foot switch), 1/-, post 3d.; 70 ohm. variable resistances, with knob, 9d., post 3d.; sample parcel (at least 15 - worth assorted switches, etc.) in plywood box, 5 - , post 1 6. Send 3d. stamp for full list of these and other bargains for the handymen.—Milligan's, 24 Harford Street, Brownlow Hill, Liverpool.

TRANSFERS for decorating toys, trays, furniture, fancy goods. List and samples free.—Flowers, pixies, dogs, nursery rhymes.—H. Axon Harrison, Jersey.

CONSTRUCTIONAL Kits, 4mm. and 7mm. scale Lorryes. Also large range spare parts from which to build to your own design. Price lists, 1d.—Wilson's Lorries Ltd., Dept. H., 1/6 Gt. Winchester Street, London, E.C.2.

INTRODUCTIONS. Pen friends, companionship or marriage.—V.C.C., 34 Honeywell Road, London, S.W.11.



BRITFIX BALSACEMENT

★ The ideal transparent cement for Balsa Ply Wood, Hard Woods, and Plastics, combining rapid drying with utmost tenacity.

Remember
**STICK BY
BRITFIX**

Small Tube
Now
4½d.

Large Tube
7d.

THE HUMBER OIL CO. LTD., HULL

YOU CAN BECOME A HANDICRAFTS INSTRUCTOR

Experience not essential

Men who enjoy making things in wood or metal can turn their hobby into a permanent and interesting Career. Short hours, long holidays, and security in a job you would really enjoy, can be yours if you become a Handicrafts instructor. Let us send details of the easiest and quickest way to get the necessary qualification.

We definitely guarantee
"NO PASS—NO FEE"

If you would like to know about our unique method of preparing you for one of these appointments, write today, and we will send you our informative 176 page Handbook—free and without obligation. Mark your letters "Handicrafts Instructor."

**BRITISH INSTITUTE OF
ENGINEERING TECHNOLOGY**

595 Shakespeare House
Stratford Place, London, W.1

BIET

AMAZING Ex. Govt BARGAIN SIGNAL LAMP

In stout double-compartment waterproof steel case.

- 3½-inch lamp, for day or night use.
 - Swivel base with metal screw-in stand.
 - Viewfinder and reflector.
 - Morse key-board. Fully wired fitted to folding lid.
 - Adaptable as car, motor cycle or studio spot light and numerous other uses.
- Spare bulbs 1 3 each.

7/6

Post 1/3

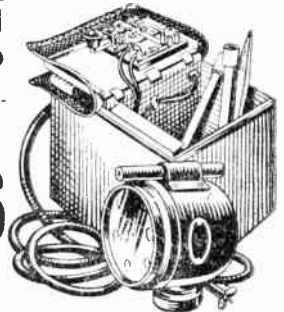

Write for illustrated lists.

PRIDE & CLARKE LTD.

Dept. P.W., STOCKWELL RD., S.W.9. Phone: BR1xton 6251

DON'T WANDER IN CIRCLES

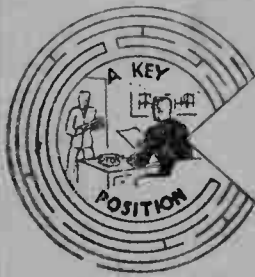

**GET THERE
-DIRECT!**

The quickest way to the top is by studying at home in your spare time, guided by the world's most successful correspondence college. Individual tuition by experts fits you for highly paid key positions, prosperity and an assured future. Write TODAY for FREE advice on the work that interests you, on the coupon below.

CHOOSE YOUR CAREER

- | | | |
|----------------------------------------------------------------|--------------------------------------------------------|--------------------------------------|
| Accountancy Exams. | General Certificate of Education Examinations | Radio (Short Wave) |
| Agriculture | General Education | Road Making and Maintenance |
| Applied Mechanics | G.P.O. Eng. Dept. | Sanitation |
| Auctioneers and Estate Agents | Heating and Ventilating | School Attendance Officer |
| Aviation (Engineering and Wireless) | Institute of Housing | Secretarial Exams. |
| Blue Prints | Institute of Municipal Engineers | Sheet Metal Work |
| Boilers | Journalism | Shipbuilding |
| Book-keeping. | Accountancy, and Modern Business Methods | Shorthand (Pitman's) |
| Builders' Quantities | Languages | Short Story Writing |
| Building, Architecture, and Clerk of Works (A.R.I.B.A. Exams.) | Mathematics | Social Welfare |
| Carpentry and Joinery | Metallurgy | Speaking in Public |
| Chemistry | Mining. All Subjects | Structural Engineering |
| Civil Engineering | Mining. Electrical Engineering | Surveying (R.I.C.S. Exams.) |
| Civil Service | Motor Engineering | Teachers of Handicrafts |
| All Commercial Subjects | Naval Architecture | Telecommunications (City and Guilds) |
| Commercial Art | Novel Writing | Television |
| Common Prelim. E.J.E.B. | Plastics | Transport Inst. Examinations |
| Concrete and Structural Engineering | Play Writing | Viewers, Gaugers |
| Diesel Engines | Plumbing | Inspectors |
| Draughtsmanship. | Police, Special Course | Weights and Measures Inspectors |
| All branches Engineering. | Preceptors, College of Press Tool Work | Wireless Telegraphy and Telephony |
| All branches. Subjects and Exams. | Pumps and Pumping Machinery | Works Managers |
| | Quantity Surveying —Inst. of Quantity Surveyors Exams. | |
| | Radio Service Engineering | |

If you do not see your requirements above, write to us on any subject. Full particulars free.

COUPON. CUT THIS OUT

IF YOU ATTEND TO THIS NOW IT MAY MAKE A WONDERFUL DIFFERENCE TO YOUR FUTURE.



To DEPT. 62
THE BENNETT COLLEGE LTD.
SHEFFIELD

Please send me (free of charge)

Particulars of.....
Your private advice.....
about.....

(Cross out line which does not apply)

PLEASE WRITE IN BLOCK LETTERS

Name.....
Address.....



For every purpose in the small home workshop... use a BROOK 'CUB' 1/4 h.p. motor. Single or split phase.

Electric Motors from 0.25 to 200 h.p.



EMPERE WORKS Huddersfield I.H.M.148

Wolf ELECTRIC SOLDERGUNS

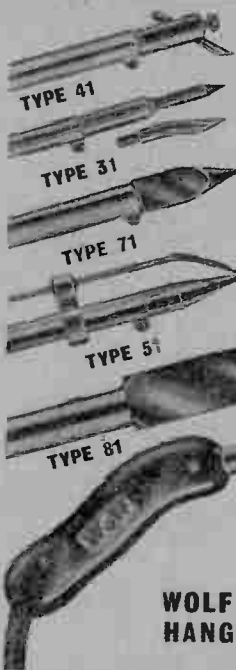

- OFF-STRAIGHT EASY-GRIP HANDLE
- PERFECT CONTROL
- QUICKER HEAT-UP
- LOCALISED HEAT
- LOW CURRENT CONSUMPTION
- MAINTAINS CORRECT HEAT
- A MODEL FOR EVERY PURPOSE

Write for FREE illustrated technical literature with full descriptions of each model, its range of applications, and the features which make these fine Wolf solderguns the best value ever offered

From all leading tool merchants and factors



WOLF ELECTRIC TOOLS LTD.,
HANGER LANE, LONDON, W.5.

Telephone: PERIVALE 5631-4