

Hobbies

WEEKLY

CONTENTS

	Page
Light Car Trailer	65
Dog and Duck Toy	67
Perspex Signs	68
Laying Concrete	69
Chemical Gardens	70
Garden Sundial	71
Bottle Novelties	72
About Mainsprings	73
Home Cements	74
Stamp Collecting	75
Leatherwork	77
Toy Patterns	79

SUPPLEMENT DESIGN
FOR A FERN POT
HOLDER

May 3rd, 1950

Price Fourpence

Vol. 110 No. 2844

THIS particular design of trailer is specially suitable for the conveyance of moderately light loads, being of strong construction though light in weight. For carrying the paraphernalia of camping apparatus it would prove useful. Construction is very simple, and the wheelwork, etc., can be put together easily enough, or bought ready-made if preferred.

Fig. 1 shows a side view of the trailer, and Fig. 2 an end view. From these the general dimensions of the vehicle can be taken. The wheelwork is of importance, however, and if the reader can purchase a second-hand chassis in good order, of course, it would be wise to see to that part first, as any amendments to the dimensions of the box body can then be noted to ensure the body fitting the bought chassis.

The Box Body

The box body is constructed in the same way as a box would be, hence its name, probably. It consists of two sides and ends, firmly nailed and screwed

A LIGHT CAR TRAILER

together, with a stout bottom or floor nailed on. For economy and lightness combined, the sides and ends are made as frames, covered with plywood.

For the frames use $\frac{3}{4}$ in. by 2 in. wood. Make up these to the sizes given (or amended as may be necessary), using mortise and tenon joints. These are not difficult to any woodworker, and make a far preferable appearance to the finished article than the common halved joints, though the latter are useful enough in their sphere.

For the corners cut the tenons with a shoulder to them, as at (B) in Fig. 1. When cutting out the accompanying mortises, it is as well to allow the wood

to be 1 in. longer than the proper length, and then to saw off the surplus after the joints are glued up. There is no danger then of splitting the wood at the ends. The vertical intermediate bars are also tenoned in, but in this case the tenons need not be deeper than $\frac{1}{2}$ in., as at (C) Fig. 3.

Framework

Now glue up the frames, all four of them, and put aside for the glue to harden. The surplus, if any, at the ends can then be sawn off and the ends trimmed smooth. The corner tenon joints can be strengthened by driving a wire nail through them, to act as a pin. This will prevent any possible tendency of the joints to open at all, if the wood gets wet.

Screw the front end frame to the sides securely, either countersinking the screw heads, or employing round-headed screws. Preference can be given to the latter, they look less unsightly. Get a piece of wood (scrap) and nail this across the sides at the open ends to keep them at their correct distance apart, i.e., 3ft., until the floor of the body is fixed on.

For the floor, the most suitable wood

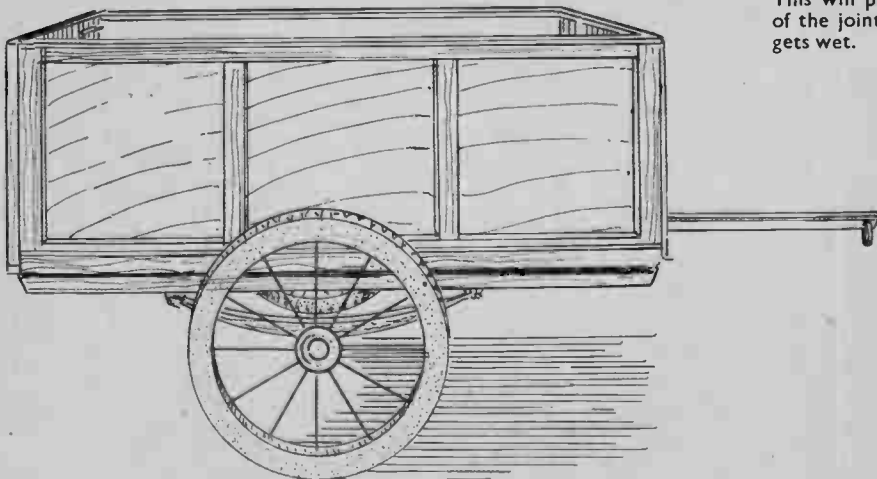

All correspondence should be addressed to The Editor, Hobbies weekly, Dereham, Norfolk.

is tongued and grooved floor boarding. This is strong and will stand the wear and tear of loads being dragged across it quite well. Of course, other strong boarding can be used, but if square edged, the edges should be glued together during the course of nailing on.

Assembly

Starting from the front end, nail and screw the boards to the body. It will make a stronger fixing here if screws are mixed with the nails, say, a screw and a nail alternately. It will be as well to cut each piece of board to its correct length before nailing; it will save time later on.

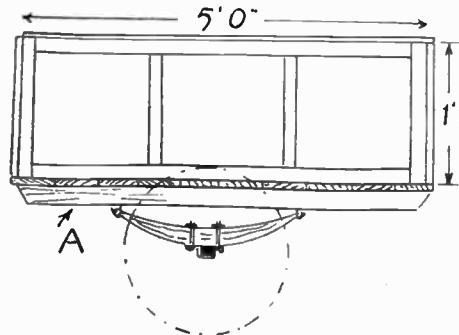

Fig. 1—Side view of body and spring

When all the boards are laid across, the scrap bit, previously fastened to keep the sides level, can be knocked off. Let the rear end of the boards extend beyond the body just $\frac{1}{4}$ in. for the rear frame to rest upon.

With the smoothing plane make the cut edges of the floor level with the sides. Now cover the front and sides, on the inside of the body, with a strong plywood, or a good substantial substitute. There are several of these on the market. Choose the kind that can be sawn like wood, not those made of some pressed pulp material, which are quite unsuitable to this job.

Trim off the edges of the plywood to make them quite level with the top of the frames. Now prepare a few feet of wood to a section of $\frac{1}{2}$ in. by $1\frac{1}{2}$ in. and nail this to cover the top edges of both frames and plywood, all round, as in detail (D) Fig. 3. The outer edges of these pieces could be curved a little, and the meeting ends at the front made a neat fit to mitre together.

Rear Frame

Take the rear frame now. The plywood here is panelled in, not laid on. This can be neatly effected by first

nailing a small bead round on the insides of the frames, then fitting the panels in the rebate thus formed, and keeping the latter in position with a planed slip, nailed behind, as at detail (E). A quite nice effect will result if the job is done with care.

To keep the rear frame in position, despite the inevitable shaking during travel, at the bottom some $\frac{1}{4}$ in. in from each side, screw pieces of $\frac{1}{2}$ in. by $\frac{3}{4}$ in. iron bar, as shown at (F) in Fig. 4. These should extend beyond the bottom edges of the frame just the thickness of the flooring.

A pair of sockets, into which these

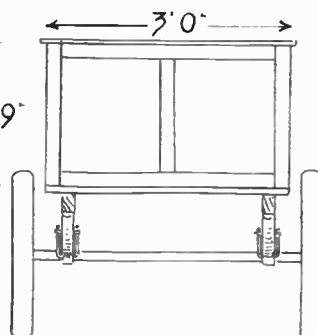

Fig. 2—End view with wheels and chassis

irons can drop, are bent up from similar iron bar, and screwed to the back edge of the floor, as seen in Fig. 4, in the correct position, naturally.

Try the rear frame in place, and file up the irons, as may be necessary, for them to drop in fairly easily and not stick. To keep the frame closed up to the body, fit a cupboard bolt, one each side, on the inside. Bolts with a bent end are required, so the necessary holes for them to slip in can be bored in the sides of the body.

Finish this part of the job by screwing an iron bracket each side, just behind the rear frame, to keep the sides of the body firm and erect at their open ends. Fig. 4 shows all the foregoing details.

Prepare two strips of deal to a section of $\frac{3}{8}$ in. by 2 ins. and as long as the body of the trailer. The top edges of these are bevelled off, then the strips are nailed along the sides of the body, at the bottom outside to cover the sawn edges of the floor, as at (G), and leave a neat finish at this part of the trailer.

As now made the body could be screwed to the complete chassis, if of the bought pattern, new or second-hand. With a made-up chassis, however, a pair

CUTTING LIST

Side frames (4)— $\frac{3}{4}$ in. by 2 ins. by 5 ft.
 Side frames (8)— $\frac{1}{2}$ in. by 2 ins. by 1 ft. 9 ins.
 End frames (4)— $\frac{1}{2}$ in. by 2 ins. by 3 ft.
 End frames (6)— $\frac{1}{2}$ in. by 2 ins. by 1 ft. 9 ins.
 Bearers (A) (2)—2 ins. by $2\frac{1}{2}$ ins. by 5 ft.
 Flooring— $\frac{1}{2}$ in. by 4 ins. boarding, to tongued and grooved, 50 ft. run
 $\frac{1}{2}$ in. by $1\frac{1}{2}$ ins. planed slip, 14 ft. run
 $\frac{1}{2}$ in. by 2 ins. planed slip, 10 ft. run
 Plywood or substitute board, according to size of sheets available. Bedding from spare wood

of bearers, cut from 2 in. by $2\frac{1}{2}$ in. wood, and shown at (A) in Fig. 1, should be prepared. These are to be bolted to the floor of the body in the right position to suit the springs attached to the wheels.

Chassis

The complete chassis, already mentioned, includes wheels and springs, with a frame attached to them on which the body can be screwed, also towing bar and mudguards. As bought new the whole affair may be too much for many a reader's pocket, but a second-hand one can often be picked up through the advertisement columns.

Failing this, about the best plan is to buy a pair of second-hand wheels, of 24 ins. to 30 ins. diameter, a pair of moderately light springs to accompany

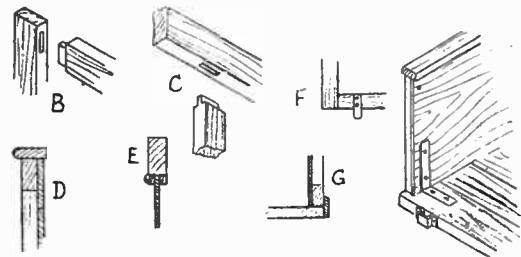

Fig. 3—Details of joints Fig. 4—Fittings for the back

them, and fix the springs to the axle in the usual manner.

A suitable axle might be made locally, or ordered from any firm doing such work. If the axle is to be made to order, then have it the right length for the wheels so that they clear the body of the trailer satisfactorily.

Tow Bar

Underneath the body a length of angle iron can be bolted, as a tow bar, allowing it to extend beyond the body some 30 ins. or so, enough to allow the trailer to swing round without knocking against the car. A steel link on the end of the bar can be fitted to engage in a suitable fitting attached to the rear of the car. A complete tow bar and fitting can be purchased if preferred.

The body should be varnished or painted for protection against the weather, and a tarpaulin cover provided for the same reason. Mudguards would make a valuable addition and, of course, the usual rear lamp and number plate should be added.

Electric Solderguns

THIS is a new type of soldering iron which has many practical points. The handgrip is comfortable, the heat localized round the copper bit, economy in current consumption, fitted with 6 ft. of 3-core cable. Full details from Wolf Electric Tools Ltd., Hanger Lane, Ealing, London, W.5.

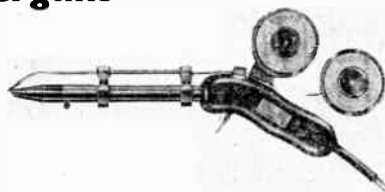

Full-size Patterns on page 79 for this mechanical DOG AND DUCK TOY

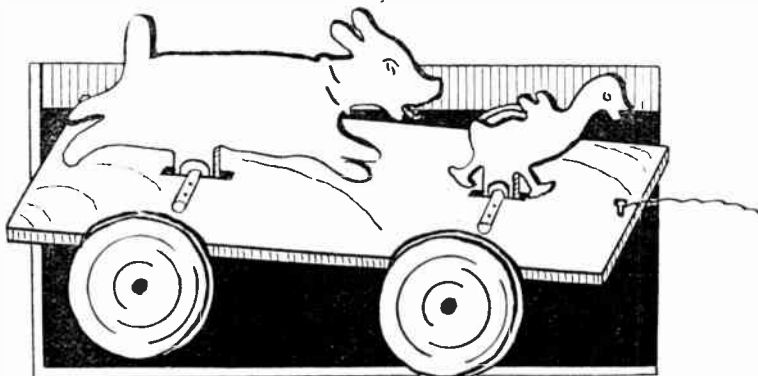

THE novel pull-along toy illustrated will be welcomed by any small child. As the toy is pulled along the Dog and Duck move backwards and forwards in an amusing manner.

Full size patterns for the cut-out dog and duck, and the other small pieces, are given on page 79 in this issue. In addition to a piece of wood to take these, the only other material needed is a piece about 13ins. by 4ins. for the base and some odd pieces for the four spindle-supports; 2ft. of $\frac{1}{4}$ in. dowelling, and four wheels of 3in. diameter, which may be obtained from Hobbies Ltd.

Plywood makes the strongest job, if available, or alternatively sound box-wood will do quite well. The measurements given allow for wood of $\frac{1}{4}$ in. thickness being used but the exact thickness is not important as long as it can be cut with the fretsaw, and the measurements can easily be adjusted to suit it. The dowelling, too, need not, of course, be exactly $\frac{1}{4}$ in. diameter, but if any other size is chosen, the various pieces that fit the dowel must be varied accordingly.

The principle of the toy will be readily seen from the sketches. The base has four pieces let into it at the sides, to carry the two spindles cut from dowel. The wheels are glued to these spindles, and in the centre of each spindle is a small eccentric wheel, marked (A), which at its highest point pushes against extension pieces on the cut-out dog and duck.

The dog and duck themselves are held loosely on to other pieces of dowel screwed to the top side of the base board, and the extension piece on each figure projects through a slit in the base immediately over these eccentric wheels.

The figures are so balanced that they tip forward on to their front legs, when at rest, and as the eccentrics revolve, the dog and duck are tipped slightly backwards and then allowed to fall forward.

Cutting Out

Paste the full size patterns on to a piece of wood, and on another piece draw out the base and side pieces as at Fig. 1. It will be seen that there are quite a number of holes of $\frac{1}{4}$ in. diameter to be cut out, and it is a good plan to cut all these out first. Although these can easily be done with the fretsaw, a quicker and even better job is made with a brace and $\frac{1}{4}$ in. bit.

When boring thin wood, however, one must, of course, remember to turn the part over as soon as the point of the bit is through, and (placing the bit in the same hole) describe a circle on the back of the wood. If the wood is then turned

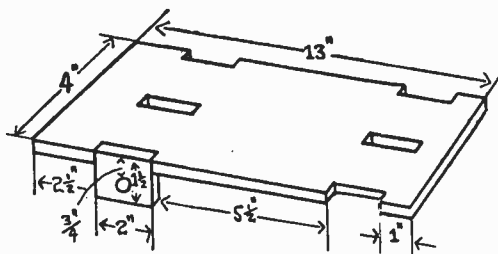

Fig. 1—Dimensions of the base

back on to its face again and the boring completed, the piece comes out, leaving good clean edges on both sides of the wood, and the hole will be exactly right for the $\frac{1}{4}$ in. dowels.

The holes in the pieces marked (B) (which are glued to the two dowels on which the dog and duck swing, to hold the latter in place) are much easier to cut out in this way.

Assembly

When all the pieces are cut and glasspapered, the assembly can begin. Glue or screw the four spindle supports to the base, and cut two pieces of dowel about 6 $\frac{1}{2}$ ins. long for the spindles. It is better to leave these a little longer than is necessary and then trim them to the exact size later on. Glue the eccentrics in position exactly in the middle of these spindles, and set aside to dry.

Cut two more pieces of dowel each 2 $\frac{1}{2}$ ins. long, push on the two cut-out figures, and glasspaper the holes until the figures swing easily on the dowels. Make sure that the slits in the base are wide enough for the dog and duck to move easily in them, whatever thickness of wood may be used.

Next screw the dowels, with figures on them, down on to the base, with the projecting pieces on dog and duck extending through the slits in the base provided for them. Glue on to the dowels the four pieces marked (B), one on each side of the figures. These should almost, but not quite, touch the cut-out figures, to hold them in position but allow them freedom to move backwards and forwards.

Fix the wheel spindles, with the eccentrics on them, into the supports temporarily, and try out the eccentrics. The eccentrics at their highest points should just tilt the figures backwards a little, and then release them again when the lower portion of the eccentric comes into position (see Fig. 2).

When putting in these spindles care must be taken to ensure that they go in with the eccentrics the right way round. So, when the toy is pulled forward, the eccentrics reach their highest point gradually, and then drop to their lowest. This ensures a smoother backward-

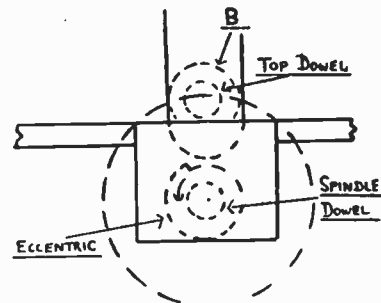

Fig. 2—The action of the discs

and-forward movement of the cut-out figures. A little glasspapering may be necessary to ensure that they only push the dog and duck back a little, and are not tight enough to bind as the wheels go round.

The Wheels

See the spindles turn smoothly in their supporting pieces on the base. Then bore out the wheels as necessary to take the $\frac{1}{4}$ in. dowel and glue them squarely on to the spindles, first adding the small discs (marked C) between base and wheel in each case, to prevent the wheels from rubbing on the side supports.

Finish off the toy in bright enamels or paint, and add a ringed screw at the front, on which to tie the string for pulling along. (127)

The use of Perspex in making attractive ILLUMINATED SIGNS

GOING hand in hand with ordinary Perspex signs, the construction of which was described in a previous issue of *Hobbies Weekly*; are those which are utilised for both day and night display. Here the methods employed to make the display units themselves are similar to those used on day signs but several new 'tricks of the trade' are introduced, plus a cunning system of simple lighting. To give the craftsman a wide scope for developing his own ideas, only suggestions and working principles are given here.

Direct Lighting—Jigged Letters

In the example indicated in Fig. 1, the

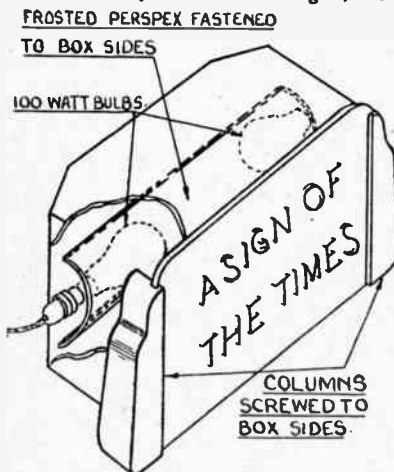

Fig. 1—A box type display

display plate consists of a sheet of $\frac{1}{4}$ in. or $\frac{1}{8}$ in. (maximum) opal Perspex on which the required letters are cemented. The latter should be fretted out from clear (i.e., transparent) $\frac{1}{4}$ in. thick sheet Perspex. Opal is used for the backplate because, although having an attractive dense white appearance, it will allow light to pass through, thus illuminating the coloured letters.

Made Interchangeable

The plate can be made to fit in slots (for interchangeability with other signs) in ornamental side pieces, either made from Perspex, wood, or polished metal. These side pieces are fastened to the light box. The latter can be made from scrap ply, thick card, sheet metal, or black Perspex.

Illumination is provided by using either two 100-watt bulbs or fluorescent strip light. If bulbs are used it will be necessary to fit a further sheet of Perspex between the bulbs and the back of the display plate to diffuse the light. This sheet will be frosted (standard) $\frac{1}{4}$ in. thick and can be fitted either flat or curved round the bulbs.

Shaping is done by heating the

material, as described in the earlier article, and holding it with tape round a large dowel or other suitable object until cool.

Direct Lighting

Where letters built up from strip are required on the sign plate, a similar lighting unit can be used. The edges of the letters themselves, however, should be directly exposed to the light to provide a good effect. The effect is, indeed, most attractive with this arrangement, the light passing through the letters giving them a 'liquid' effect.

To expose the letters it is necessary they should be fixed in the front plate with their edges, which must be polished, lying flush with the rear surface of the display plate. To do this, the shape and size of the letters must be arranged as required on the opal Perspex (using a very sharp pencil). After which they are fretted out, taking special note that it is the plate and not the letters cut away that is required.

Finishing and Fitting

The plate is then finished by filing carefully down to the fine lines with small toolmaker's files. This is then fixed to a clear (colourless) sheet of Perspex $\frac{1}{4}$ in. thick and the same size as the opal by using cement round the edges. The insides of letters such as O, P, R, etc., will then have to be cut and cemented on the clear panel in their appropriate positions.

When set, the really tricky work starts. Lengths of clear coloured Perspex strips, the edges of which have been polished previously, are cut to fit the grooves formed in the opal plate. It will be seen that if the strips are cut from $\frac{1}{4}$ in. sheet and fitted edge down, the width of the grooves, i.e., the width of the letter strokes, must be very little bigger than $\frac{1}{4}$ in. to provide a snug fit for the strips.

Instead of having an opal Perspex front plate, sheet metal or plywood may be used. Here, of course, only the letters will be illuminated.

Edge Lit Signs

For simplicity and effectiveness these are the best night signs considering the quite small outlay. All that is involved, as seen from Fig. 2, is a simple light box fabricated from sheet metal, wood, card or Perspex. A slot $\frac{1}{4}$ in. wide is provided in the casing. This is to accommodate the sign plate which must be made from clear Perspex.

The letters that make up the sign are not, in this case, cut from separate material but are marked on the surface

of the Perspex plate itself. If an engraving machine (hand type is admirable) is available, this operation is simplified. Otherwise the marking will have to be done by hand with a scriber or other sharp-pointed tool. In either case, the result will be a roughened (matt) surface to the letters.

The depth of the marking is not vital but the matt finish is. The reason for this, which provides the working principle of the sign, is that the light shining from the polished edge of the plate is refracted at right angles by the roughened surface—thus showing up just the letters with a bright luminous effect.

Colours

If colourless Perspex is used, the letters will show up silver. On the other hand if the edge of the sign in the light box is fitted with a thin strip of clear coloured Perspex (about $\frac{1}{4}$ in. thick and polished), then the letters will glow that colour. This is fascinating, since the strip and light will be out of sight.

The light box itself can be made from sheet brass and afterwards chromium plated. Alternatively, opaque coloured Perspex may be used, thus giving an additional attractiveness to the sign at night. The light should be the strip type (preferably) and connections taken either through the back or the ends.

The type indicated in the sketch is intended for suspension, but the reverse is equally effective, especially if a fancy base is evolved.

It should be borne in mind that letters built up from clear strip and

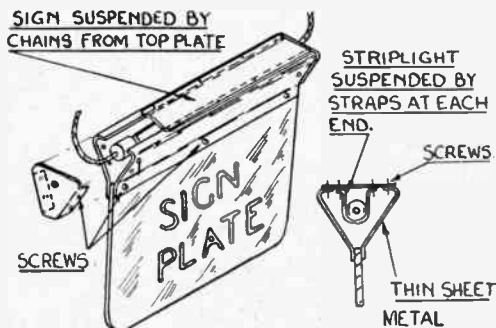

Fig. 2—A strip lighted word panel

cemented directly over the marks in the plate will also be illuminated, but not with the same brilliance as those lit directly from behind.

Perspex is now more easily obtainable and there are many advertisers who can supply it. We have also had previous articles in these pages on how to use it, or, there is a number of books on the subject of interest to those who are proposing to undertake the hobby.

For shed, garage or workshop the amateur can lay A CONCRETE FLOOR

WHEN a garden shed, workshop or garage is to be erected, it is important the foundation on which the structure stands is sufficiently firm to prevent subsidence at some later date. A concrete floor, well laid, will form a good foundation, and in these days of timber shortage it will also prove more economical than laying a wooden floor. Generally, this type of structure is erected on soft garden soil, therefore, under these circumstances, it is essential that the job is done thoroughly, otherwise, the floor will eventually crack with subsequent uneven sinking.

Preparing the Site

If the ground is soft it will be necessary to remove the top soil to a depth of 10ins. First, mark the four corners of the site by driving in four wooden pegs.

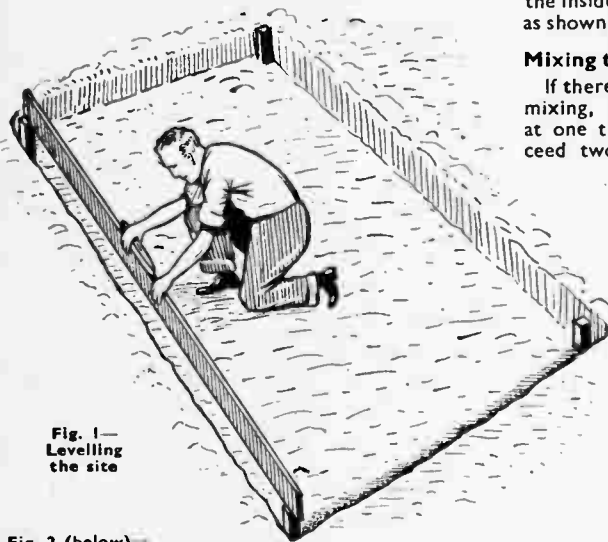
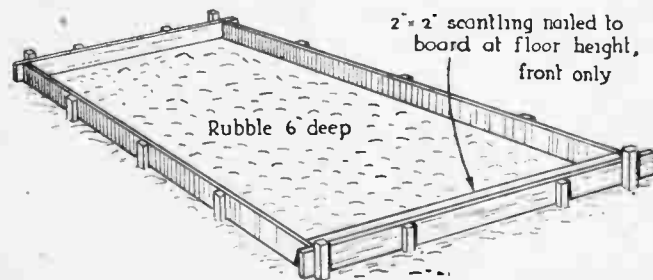

Fig. 1—
Levelling
the site

Fig. 2 (below)
Site ready for
concrete



2" x 2" scantling nailed to
board at floor height,
front only

Rubble 6 deep

Then, using a selected piece of timber as a straight-edge, together with a spirit level, check the height of the pegs as shown in Fig. 1. The pegs should be driven in all to the same height, and the soil removed so that the same length of peg is showing. The height of the pegs

should be several inches above that of the finished floor.

The clearing should then be filled with a quantity of ashes or broken bricks to a depth of 6ins., leaving 4ins. for the concrete. Next, join the four corner pegs with string, and drive in several pegs parallel with the string on each side and 1in. from the site boundary.

Checking Levels

These pegs should be driven in to the required level of the finished floor, each peg being checked against the other with the straight-edge and spirit level. Nail 4in. by 1in. boards to the inside of the pegs, forming a frame into which the concrete is poured.

If the floor is for a garage, provision must be made for the garage cross member to be let in level with the floor. This is done by nailing a scantling, of similar size to the one on the garage, to the inside of the front board, as shown in Fig. 2.

Mixing the Concrete

If there is only one person mixing, the amount mixed at one time should not exceed two to three barrow-

A suitable mixture can be made up of one part cement, two parts sand, and four parts aggregate. The material called aggregate may consist of coarse gravel, broken bricks or clean stones. The sand should be clean and sharp, and free from impurities such as soil and mud. The amount of material required for any particular site can be worked out roughly on the assumption that a ton of dry mixture is approximately 1 cubic yard.

Mix all the ingredients together, first in a dry state until the cement is well distributed and the mixture is a uniform grey colour. Hollow the heap in the centre and add water in small quantities through the rose of a watering can, the heap being turned over and water added alternately until the

(Continued foot
of page 70)

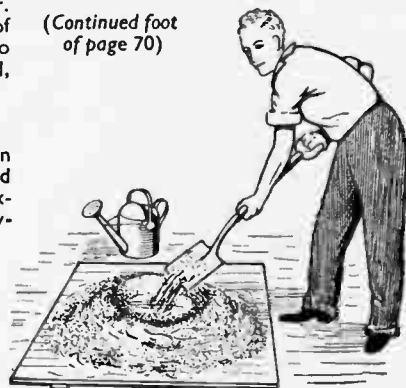

Fig. 3—How to mix the concrete

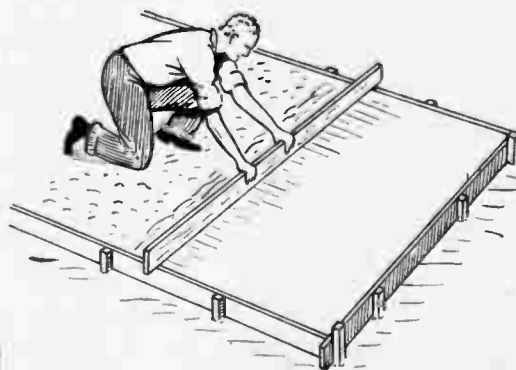

Fig. 4—The board levelling the concrete



Fig. 5—Using the float on the work

loads, otherwise the job will be very laborious. The mixing should be carried out on a mixing board not less than 3ft. 6ins. square, formed by 1in. thick boards nailed to battens. If a concrete drive is available, this serves just as well.

Interesting experiments in crystallisation to make CHEMICAL GARDENS

A READER has written to enquire about 'chemical gardens', and as the subject is of wide interest, we have prepared this special article for all to read. None of the experiments calls for uranium, plutonium or other rare and expensive chemicals and all are quite safe if common-sense precautions are taken.

It is because some fellows mix, at random, various chemicals 'to see what happens', and because they try to make fireworks, etc., in garden sheds . . . sometimes with disastrous results, many chemists will not sell chemicals to boys.

We give several formulas, partly so that interested readers can try them all, and partly so that if readers cannot get the chemicals for one, they may be luckier with others.

Chemical Seeds

Mix six parts by weight of copper sulphate, one of iron sulphate, one of cobalt chloride, six of manganese sulphate and four of plaster of paris. Add just enough water to make a stiff paste and from this make 'seeds' about the size of an ordinary bean. Leave to dry thoroughly.

Now into a glass jug, goldfish bowl or jam jar, put up to 2ozs. of waterglass (silicate of soda), such as is sold for preserving eggs, and add water. When the waterglass has had a chance to dissolve, drop one of the 'seeds' in. As in all 'chemical garden' tricks, the jar must be placed where it will not be disturbed, but where it can be admired. Any attempts to move the jar results in the chemical 'plant' collapsing.

In the present case, a tree-like sprout will form on the seed and continue to grow in different colours. One must give the 'seed' time to grow, of course.

A Group of Crystals

This is somewhat on the same lines as the foregoing. Take equal parts of alum, copper sulphate, iron sulphate, magnesium sulphate (Epsom salts),

sulphate of potash, sodium carbonate (washing soda) and zinc sulphate (white vitriol). Dissolve them separately (in water) in separate vessels, using just enough water to dissolve.

Then pour all the solutions into one large transparent vessel, such as a large glass jug. As the water evaporates, the crystals will shoot up in a most beautiful manner. The fellow who wants to entertain his friends with chemical displays will, no doubt, arrange an electric light behind the crystals.

Alum Baskets

Dissolve, in hot water, as much alum as it will take up—about 1lb. of alum to a quart of water. If desired, a few crystals

can be hung up to dry.

When the water dries out, the basket, etc., will be covered all over with jewel-like crystals.

A variation of this is to make up a strong alum solution. Evaporate it, and from the crystals that form, select one that has an attractive shape. Tie it to the end of a cotton, and suspend it in another solution of alum. The crystal will continue to grow.

Care must be taken to remove any other crystals that may start growing on the cotton, or any irregular offshoots on the main crystal.

The Camphor Tree

If you can get any ethyl alcohol ('spirits of wine'), dissolve some camphor in it until it will take no more. Then pour some of the solution into a cold glass (either from a refrigerator or one left outside in the cold). The camphor will instantly crystallize into beautiful tree-like forms.

Similarly, those fellows who happen to have a microscope will find that if they make up a solution of chloride of ammonia (sal-ammoniac) and apply a fine film of it to a perfectly clean glass slide, they can watch the tree-like branching as the crystals form. Under science laboratory conditions, this can be projected on to a screen, and is very fascinating to watch.

There are scores of other formulas, but we have excluded those which call for poisonous chemicals (such as lead acetate) or those which readers will have difficulty in getting. The basic formula for 'chemical gardens' is that given under 'Chemical Seeds'.

If an object is suspended in a solution of a chemical capable of crystallising (as in the alum crystal experiment described), the crystals will form only on rough porous surfaces. Thus if we take a glass rod and attach some strands of wool to it, somewhat after the manner of branches on a tree, and dip this in a solution of, say, copper sulphate, crystals will form on the wool but not on the rod.

FERN POT HOLDER

Patterns free with this issue. Kit of wood (No. 2844) for all parts for 4/9 from Hobbies Branches or 5/6 post free from Hobbies Ltd., Dereham, Norfolk.



of copper sulphate can be added to turn the mixture blue, or a few crystals of iron sulphate will turn it green. Chrome alum has its own special self-colour. The mixture must then be filtered through filter paper in a funnel, into a large china bowl.

Dip in such things as toy wicker-work baskets, reeds, rushes, split wood, mascots made of wool or anything of a slightly rough porous nature. (Smooth articles will not do). The articles should have a piece of cotton attached, so that after the articles are dipped, they

Concrete Floor—(Continued from page 69)

mixture is in a semi-fluid state, see Fig. 3.

The mixture is then carried to one end of the site and laid to a level slightly above that of the frame, taking care to work it well down at the corners and edges with a shovel or spade. When a strip of 2ft. or 3ft. is filled in, 'float' the surface with the edge of a board, as shown in Fig. 4.

If the concrete is evenly knocked down with the edge of the board, the fine mixture will work to the top, leaving a smooth finish which can be run off level with the top of the frame. Later when the surplus water has drained away, the surface can be still

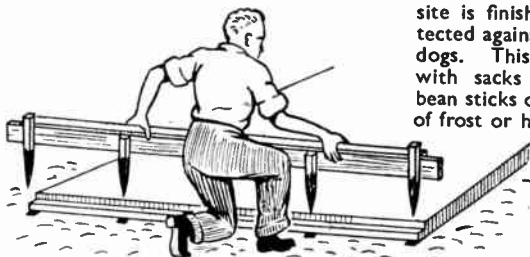

Fig. 6—Removing the framework finally

further smoothed with a metal hand float, see Fig. 5.

Continue mixing and laying until the

site is finished. It must then be protected against heavy rain, frost, cats and dogs. This can be done by covering with sacks or matting supported on bean sticks or scantlings. In the absence of frost or hot sun, the covering can be removed in 24 hours.

If frost or sun prevails, the covering should be left on for at least 48 hours. After this the framework can be removed, see Fig. 6, but the surface should not be walked on for several days. The whole lot should then be quite solid and stand up to constant use without cracking.

Add to the garden beauty and usefulness by building a GARDEN SUNDIAL

MAKING a sundial, such as shown in our illustration at Fig. 1, is a most interesting job, and the materials required for it can be obtained very cheaply. Looking at Fig. 2 we see a view of one of the sides, giving the arrangement or 'bond' of the bricks, together with the height of the pedestal. The whole should be set on a layer of concrete about 3ins. or 4ins. thick, made square or circular in shape.

The whole thing may be made from old bricks, providing they are whole and in good condition and free from cracks and broken edges. New bricks, perhaps, would be preferable, as there would not be any cleaning off of old mortar as when old bricks are re-used.

Number of Bricks Needed

If the pedestal, its base and its capping are made to the dimensions and planning shown, then sixty-eight to seventy whole bricks will be found sufficient for the whole job. Some cement and sand will be wanted, and even if the worker has never used a trowel and cement before, he should not find the jointing and building up at all difficult.

Having made the concrete base and given time for it to harden thoroughly, the first course of the brick base can be laid. It should here be mentioned that the top surface of the concrete must be properly levelled and tested with a long spline and spirit level.

The Cement Mortar

For cementing the joints of the bricks, etc., a good mortar may be made by mixing one part cement to two parts of sand. On a piece of board or platform

spread out the cement and sand and mix thoroughly together in the dry state. Then, with the watering can, add the water until the mixture is a thickish paste. Take the precaution to add the water gradually so as not to make a 'sloppy' mortar.

Keep turning over the mixture until all is thoroughly wet and of an even moisture. Decide on the actual direction of the pedestal and set out a square of approximately 22½ins. This is for the lower member of the base as (A) in Fig. 2 and Fig. 3.

Next set aside twelve bricks, sprinkle them with water and commence straight away to lay them on a bed of cement mortar spread evenly on top of the concrete. Fill in the centre if desired with a bat or half brick, and trowel up the joints evenly about ½in. thick. Clean off any excess mortar and with the tip of the trowel make smooth and even the actual outside joints.

Upper Base

This completes base (A), which is topped by the second layer, course (B). This course is two bricks square, that is approximately 18ins. across. Lay a good bed of cement mortar again and repeat the bonding, following that shown at (B) in Fig. 2. Eight bricks will be wanted here, and care must be taken to keep an even margin all round on layer (A).

Always remember to wet the bricks prior to laying them in the cement. If this is not done the porous nature of the bricks will not allow the cement to adhere properly. This means, the bricks absorb the moisture from the mortar before the latter can penetrate the pores of the bricks.

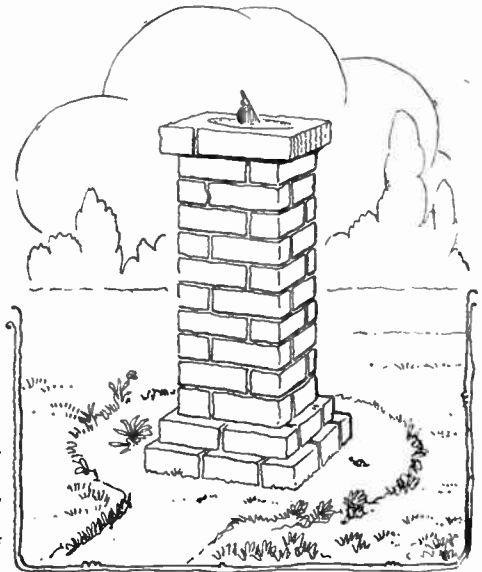

Fig. 1—The completed garden ornament

shows the arrangement of the bricks. Note now that the arrangement of each course is the same, but every other course is turned, so that what is the face of one course, the next is at the side. This is more easily explained by the perspective view Fig. 4.

The hollow space in the middle of the pedestal could, if desired, be filled all the way up with half bricks laid and cemented in as each course is completed. Great care must be taken to get the sides perfectly upright, and to assure this being done a plumb-line (see Fig. 5) should be used.

A Plumb Line

The amateur bricklayer could easily make one of these himself from a strip of board about 2ft. long and 3ins. wide by about ½in. thick. At one end of the piece cut a hole with the fretsaw to allow a metal 'bob' to rest comfortably in as shown. Then at the upper end, and exactly central in the board, drive in a screw round which a piece of cord is wound. The string ('S' in the sketch), will hang down and support the weight below.

It will be seen that as the pedestal is erected course by course the plumb-bob is held against the brickwork and a check made, noting how the string and weight hangs in relation to the hole in the board. Flush up or 'point' the courses of brickwork neatly and then finish the top of the pedestal with a capping course as (D) in Fig. 2. This capping is simply a repetition of the course (B) at the bottom of the pedestal.

It only remains now to obtain a

(Continued foot of page 72)

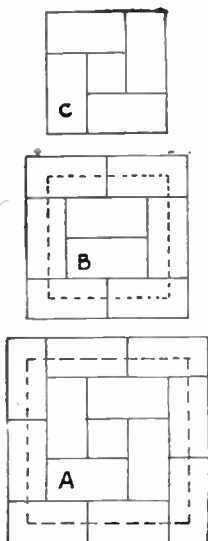

Fig. 3—Showing the brick courses in the pedestal

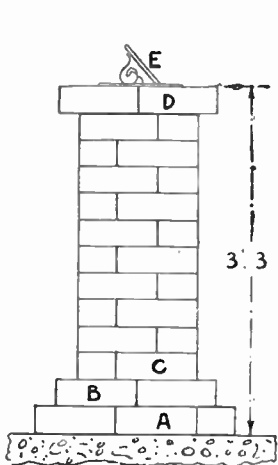

Fig. 2—Side view with base and dial

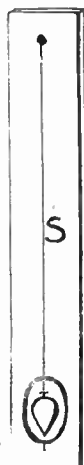

Fig. 5—A line

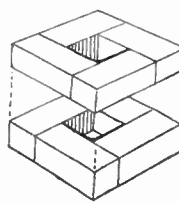

Fig. 4—Locking courses

Now for the actual pedestal which is ten courses of bricks high, or about 2ft. 6ins. Four bricks are required here for each course and plan (C) in Fig. 3

More addition to our earlier novelties about BOTTLE MYSTERIES

IN our issue of December 14th, we described a method of accomplishing the curious result shown in Fig. 1—a nail or short bar inserted through a cork at a point inside the bottle. One of our readers, Mr. T. E. Parr of St. Helens, Lancs., has written to describe another, and perhaps, simpler method. As will be seen from Fig. 2, the cork, glasspapered down to pass easily, though not shakily, through the neck of the bottle, is impaled on the end of a long knitting needle. The cork has a hole for the nail already bored through.

Fixing the Nail

The nail is placed in the bottle and a wire with a loop at the end may be used, if necessary, to coax the end of the nail into the hole in the cork. The loop in the wire should pass easily over the head of the nail.

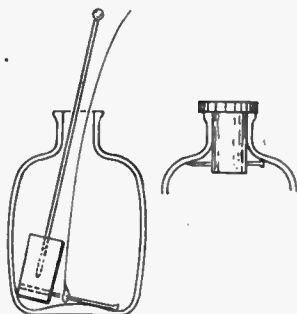

Fig. 2—How to fix the nail

Once the nail is fairly in, the cork may be swung over by means of the knitting needle and the nail centred. The wire with a loop, if used at all, is now withdrawn and the cork hauled up. A little colourless rubber cement smeared on the inside bottle neck, just prior to raising the cork, is an advantage, especially if it is desired to glue on a metal cap as shown in Fig. 3. This cap, however, is not really necessary. Plenty of sealing wax may be used instead.

It is important to note that the cork to be used will be longer than that normally used for the bottle in question. The nail passes through just where the neck ends and, of course, there must be some cork below this.

By the method shown in Fig. 2, a longer nail than that used in the method



Fig. 1—How did the bar get there?

of Fig. 1 may be employed. Instead of a cork, a wooden stopper may be used. Instead of a knitting needle, a gimlet blade brazed to the end of a thin rod can be used.

A Bulb Mystery

Mr. Parr also mentions another novelty, not quite so mysterious as the one just described, and not a match for the celebrated Ship In The Bottle (already described in our pages) but, nevertheless, quite interesting. The idea is to get one of those plastic animals, etc., ornaments, of the type illustrated, and to place it in an electric light bulb. The 'classical' horse illustrated is a good type of ornament to use, but there are other animal shapes and also ship designs. They cost about fourpence each and are obtainable at the usual stores.

First twist off the brass cap of the bulb and extract the filament. Each model will require its own special treatment but in the type shown, the finest available fretsaw blade is used to cut off the legs at (A) and (B); the mane at (D) and the neck at (C). It will be found that the design follows these lines. Naturally, the idea is to get the largest possible model inside the bulb and with the fewest cuts.

Inside Fixing

The model is re-erected in the bulb, using plastic cement. Naturally, great care is needed to obtain accurate results. Take care not to use too much cement, as otherwise it will ooze out and immediately betray the secret. If well done, it is very difficult to see the join.

To manipulate the parts, long tweezers may be made from two halves of old

hacksaw blades as shown in the sketch. It is best to play for safety and join one part to another at a time, allowing to set.

Hacksaw Tweezers

As will be seen from the diagram, the two halves of the hacksaw blade are joined with a rivet after being spaced with a washer. The ends are ground to the shape shown. The holes for joining will, of course, be the holes already in the hacksaw blade. The sketches show (top) a plan view and (below) a side elevation.

When the model is finally assembled, it should be raised to the top of the bulb (the bulb looked at sideways, as illustrated). With a long spoon, apply some liquid plaster of paris to the bottom of the bulb. Take very great

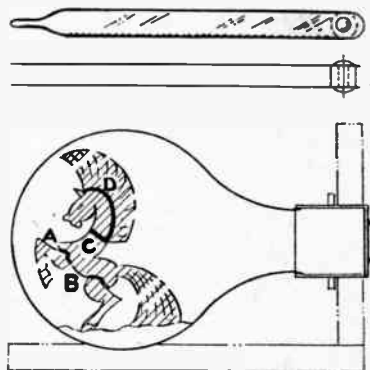

Fig. 3—A figure in the bulb, with tweezer detail

care not to spill any where not wanted, as it is almost impossible to clean up afterwards.

With the tweezers, etc., place the model in position in the plaster and hold it until the plaster sets. The brass cap of the bulb is replaced by plaster.

Readers may have varying ideas on how to display the bulb. One good way would be to join two pieces of wood, about 3ins. wide at right angles, something after the style of a book end. The vertical part would have a hole bored through, exactly the same size as the neck of the bulb. In fact, it should be a reasonably tight fit here. The flat part could have a shallow depression scooped to hold the bulb where it touches. The stand should be nicely made and polished. (126)

Sundial—(Continued from page 71)

suitable sundial consisting of a circular plate of brass, having fixed to its centre the 'gnomon' or upright which casts the shadow across the plate while the sun shines, see (E) Fig. 2.

It will be understood that the plate must be correctly placed on the capping, the twelve o'clock marking being put north and checked when the sun is shining. Small blocks of wood should be

let into and cemented in holes drilled in the brickwork. These holes can be made with a Rawlplug jumper or other suitable tool. Lightly drive in a small wire nail into each block of wood exactly where the holes come in the brass plate.

Then cover the whole top of the capping with a ¼in. or more layer of cement and slightly bed in the plate, keeping the holes of same exactly over

the nails previously put in. When all is set, insert two round-head screws.

As an alternative suggestion the pedestal could quite well be topped with a cement bird bath or one of the many cement modelled ornaments seen in garden shops. One of the principal points is to have a good foundation, so the ground does not sink and cause the whole thing to lean over.

An experienced craftsman gives you a lot of hints ABOUT MAINSPRINGS

It is rather alarming to think what we should do without mainsprings. They form the motive power of all our watches, for most of our clocks, and a large number of gramophones, musical boxes and recording instruments. All clockwork toys would be absolutely helpless without mainsprings, while in industry the demand is enormous.

There are the time switches, factory time recorders and a whole host of scientific instruments, all of which rely on the modest mainspring to keep them going.

With all this popularity for mainsprings it is only fitting, therefore, that the handyman should know something about them. With a knowledge of their habits and peculiarities, how to repair them, and the correct fitting and adjustment of new ones, a keen handyman should have quite a busy time.

Special Steel

Because a mainspring is made of steel many people are inclined to treat it rather roughly. Instead of which it is a somewhat delicate and fragile piece of mechanism. Special steel of a very high grade is used in its manufacture, and its shaping, hardening and tempering is a specialized job calling for a great deal of skill.

The majority of mainsprings in use today are fitted into a circular box or case of brass or steel which is known as the barrel. The outside end of the mainspring is secured to the barrel rim by means of a small catch or hook, while the inner end of the spring hooks on to a circular piece of steel called the barrel arbor, which is free to rotate in the barrel.

Necessary Dimensions

There is a correct width, thickness and length of mainspring for every job and special attention should be given to this when fitting a new spring. The width

should be just sufficient to allow the spring a very little freedom when the barrel cover is snapped on. Not too tall to bind nor too narrow so it wobbles about when wound.

The length and thickness will govern the number of turns that a spring may be wound. The ideal mainspring occupies one third of the barrel area (see Fig. A), and the arbor should take up another third, thus leaving one third free. When wound up the mainspring will be as shown at (B). This, however, is not always the case and there are many barrels which owing to bad designing and bad fitting are far from the ideal.

Stress and Strain

Many people think that the longer the spring is the longer it will go. This is a great mistake, for if the mainspring takes up too much space in the barrel, there is no room left in which to wind it.

A mainspring should be just thick enough to be able to do the job allotted to it with comfort. An extra strong one will get over the work but the extra strain would cause the parts of the instrument to wear out very quickly and probably give a lot of trouble. Do not take any notice when someone tells you to 'put a good strong mainspring in it'.

Mainsprings are hooked into the barrels in quite a number of ways and it is important to pay special attention to this matter. Let us consider the barrel hookings first. The usual kind is that shown at (C), which is either screwed or riveted in, or it could be a combination of the two. It should be made of mild steel for the best work, although an iron nail will make a quite good hook if it is not an important job.

The shape of the barrel hook should be similar to the head of a countersunk screw so that the more pressure exerted by the spring the tighter it will grip the hook.

Holding Hooks

Some of the cheaper type barrels have a hook made by pressing out a portion of the actual barrel, as shown at (D). This is quite satisfactory while the hook holds, but, unfortunately, it is a weak spot and we generally find that after a time a break will occur here. The best method then is to drill a hole in another part of the barrel and fit a type (C) hook.

The diagram at (E) is yet another hook which deserves a mention, and is made by cutting a nick in the barrel rim. Its use, however, is mostly confined to watch work where there is not a lot of power employed.

The centre hooking, where the mainspring is attached to the barrel arbor calls for rather more care and consideration than the outer hook. It is generally in the first or second coils from the centre that a mainspring

breaks, and a carefully made hook and well fitted spring can do much to avoid this disaster.

The hook in the arbor, while being sufficiently large to hold the spring secure should not protrude far, nor should it have any rough edges. It should be remembered that when a spring is being wound up tight the inner coils will be forced out of shape if the hook sticks out too far. In time this will weaken the spring here or start a nasty bend which will eventually break:

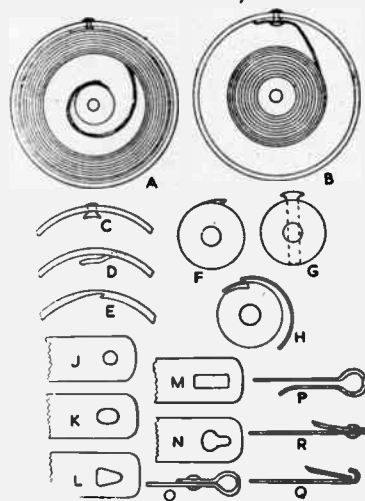

Various types and parts as mentioned

Fig. (F) shows the best hook of this type, which is employed in all first class watches, clocks and scientific instruments. The hook protrudes from the arbor just a fraction more than the thickness of the spring and, therefore, allows the next coil to lay flat on the first coil, thus forming the ideal hooking.

Gramophone Springs

The hook shown at Fig. (G) is designed to stand the considerable strain required in gramophones and such like instruments, but on account of the large portion that sticks through the spring it is a bad hook. Nearly every break in a spring employing this type of hook occurs in the first coil near the hook.

The ideal gramophone centre hooking and one that is becoming popular is the 'hub centre', shown at (H). A nick is cut in the arbor and the spring is shaped to fit snugly into this, thus allowing the following coils to lie flat.

Now we come to the very important problem of the correct manipulation of the steel in order to obtain a perfect mainspring hook. When a spring breaks, in nearly every case it is either near the outer end or near the inner end—very rarely does it occur in the middle.

Should the break be near the inner end there is only one thing to do and that is to fit a new spring, as it is almost im-

Cardiff Ship Models

SOME ship modellers of Cardiff are very keen to expand the membership of their club—the Cardiff and District Ship Model Society. They are very keen, and can produce many actual and interesting results of their energy. One, for instance, is a tiny model in an electric light bulb only 1in. in diameter. Readers in the district who are interested should contact the Secretary at the Glastonbury Arms Hotel, Bute Street, Cardiff.

possible to rehook it in a satisfactory manner. We must, therefore, confine our remarks to repairing the outer end and there are numerous ways of doing this.

Figs. (J to N) show some of the chief shapes of hooking eyes, the first three being those most used. (K and L) are used for the pushed-in type of barrel hook, shown at (D), while (N) is a very firm type much used in gramophones. The long rectangular eye (M) is a watch hooking and is very suitable for that purpose.

Detempering Steel

Mainsprings are made of specially hardened and tempered steel and it is useless trying to rehook them without first drawing the temper. To do this place the end of the spring in the flame of a spirit lamp or gas jet, withdrawing it when the steel turns blue. Some steels may be somewhat tough and will want heating rather more but that you will find out when you start working on the job.

It is quite an easy matter to punch a

hole in the spring now that it is softer. Place the end of the spring on a block of lead and with a good punch held centrally over it give a smart tap with a hammer. This should result in a nice clean hole which can be brought to size and shape by filing—the spring being held securely in a vice. The end of the spring should be rounded somewhat and the rough edges removed with a file.

Punches

The same procedure is applied to the small and delicate watch springs, but a little extra care is needed: a blunt ended needle making an excellent punch for the job. When you have filed the hole to size and made sure that it will fit over the barrel hook, the spring should be well emery papered and made quite smooth.

Alarm clock mainsprings employ the hooking shown at (O) and (P) and it is a simple job to rehook one of these—withdraw the temper by heating, bend round a piece of metal while hot if possible and nip together with pliers.

(Q) and (R) are typical watch hooks, the first has the end turned over and a short oscillating bar of spring tucked in. (R) is very similar but has the bar riveted on to the end, making it a fixture.

Type of Oil

All mainsprings should be perfectly smooth so one coil will slide over another. To help them to do this easily some form of lubricant is necessary. For watches, just a spot of a highly refined thin oil is sufficient, while clocks can have a few drops of good machine oil. Heavy type springs such as gramophones need a good graphite grease which is not too thick.

It is a very good plan when you have finished using a gramophone or toy motor to let the spring run down. The mainspring will thus have a 'rest' period and will maintain its energy for a longer time. By remembering these points you can add life to your various spring mechanisms.

Another selection for a variety of jobs with SIMPLE HOME CEMENTS

Envelope Gum

THE trade gum used on envelope flaps is made up by dissolving finely powdered dextrine gum in cold water and diluting as necessary. Hot water must not be used for solution. This gum has a slight tendency to absorb moisture from the atmosphere, and thus envelopes so gummed should be stored in a dry place.

Cement and Filler for Iron Castings

ONE part of finely ground graphite or black-lead and 2 parts of sulphur (in flowers or block) are melted together in an iron ladle or tin lid. When the two are thoroughly amalgamated the mixture should be poured out on a stone slab to cool. To use the composition a sufficient quantity is broken up and placed in the blow-hole of the casting, when it is soldered in with a hot iron in the same manner as ordinary soldering is carried out. It is best to do the work out of doors as the sulphur fumes are exceptionally irritating to both eyes and throat.

Cementing Oil-stones in their Cases

WHITE lead should never be used for this purpose because it is taken up by the oil used on the stone and tends to harden on the under surface of the stone, thereby rendering it impossible for the latter to be turned over and the reverse side used. A mixture of hot glue and red lead in proportions such that a thick syrupy solution is formed, will never really harden nor enter too deeply into the open pores of the stone.

Non-cracking Glue

ORDINARY glue can be treated to stop the annoying cracking which appears when it is set hard by the addition of a little chloride of calcium whilst it is still in the fluid state in the glue-pot.

Preparing Liquid Gums

ORDINARY liquid 'gum' can easily and cheaply be made by purchasing dry gum arabic and carefully dissolving it in twice as much water—by weight. Gum made up in this way is infinitely cheaper than that purchased in small bottles, particularly if a large quantity is needed.

Gum dextrine may be used in the same proportions as those mentioned above, but a slightly larger amount of dextrine is needed to produce an adhesive with the same characteristics as those of gum arabic, and the solution is also usually of a darker colour than the latter gum.

In both the aforementioned gum solutions a few drops of carbolic acid should be added to prevent them going mouldy. No heat should be applied to hasten solution, as the adhesive qualities of the gums is thereby impaired.

'Roman' Cement

EQUAL quantities of clean clay, lime, and iron rust are separately heated till calcined, being then finely powdered and well mixed together. The cement should be kept in a tightly closed vessel and mixed to a paste with water when used.

Stone Cement and Artificial Marble Material

IN liquid chloride of zinc dissolve 3 per cent. of either borax or chloride

of ammonia (sal ammoniac); add oxide of zinc which has been previously heated to redness, until the mixture is of the proper consistence. This cement, when thoroughly hard is as firm as marble, and may, moreover, be cast into moulds like plaster of Paris. It is largely used in imitation marble mosaics.

Chlorine-proof Cement Lining

ONE part of best pitch and 1 part of rosin are separately melted down, and one poured into the other; then into the mixture 1 part of plaster of Paris is slowly stirred. The cement should be used in a medium stiff state, and laid on to the thickness of about $\frac{1}{4}$ in.

Hydraulic Cement

THREE pounds of iron rust is stirred into 1 lb. of boiled linseed oil, and the whole brought to the boil to form a stiff paste.

'Birdlime' Cement

TRUE 'birdlime' cement is made from the inner cortex of the holly, being taken from the tree in summer-time. This is boiled with water till soft, the water is drained off and the pulp allowed to ferment; being finally ground in a mortar and kneaded well. It is kept under water till required.

An artificial 'birdlime' may be made up by boiling linseed oil for many hours, till it becomes really 'tacky' whilst yet another preparation consists of boiled linseed oil 3 parts, Venice turps 1oz., and castor oil 1oz. All these cements are much used for preventing belts slipping in workshops, as well as for 'banding' trees against the onslaughts of insects.

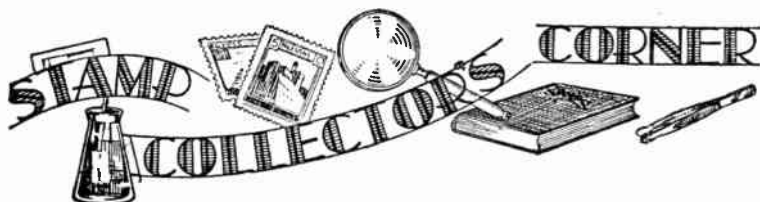

NEWFOUNDLAND PORTRAIT GALLERY

WHEN dealing with the stamps of Newfoundland some time ago we mentioned that this colony had the finest Royal Portrait gallery of any stamp-issuing area. Now we propose to discuss those stamps. We could do this either by taking each portrait stamp as it was issued (and this would give a very slipshod order), or we could describe each portrait (and this would

celebrate this, the 300th anniversary. The first illustration is the first stamp of this set and shows James I. It was he who granted a charter to Guy to enable him to go and settle there.

Kings and Dukes

Well, now we have to pick very carefully the stamps that we wish to mention because there are so many. The second illustration came out in 1880 and shows King Edward VII when he was the Prince of Wales.

Another Prince of Wales is shown on the 1c. stamp of the 1897 set. A very young child is given here — Prince Edward, now the Duke of Windsor. In 1928 he was again shown on the 4c. of that set, but the third illustration seems a very much better

portrait. It shows the Duke in the uniform of the Welsh Guards, which is surely most suitable for the Prince of Wales.

Now if you were to take a piece of paper and write down the names of King Edward VII and Queen Alexandra, then below them King George V and Queen Mary, and again, below them, all their children, you would have what is called a genealogical tree and you would find the portraits of all these on the 1911 set, the Coronation set.

Queen Elizabeth appears on the 7c. value of the 1932 set when she was Duchess of York. Princess Elizabeth is shown on the 6c. of the 1932 set and then again on the 1938. Hers was the last portrait to appear—in 1947.

One cannot help feeling rather sorry that this Royal-stamp-issuing country will no longer give us these beautiful portraits.

NOW in addition to portraits, Newfoundland has issued some very good air stamps; good both from the point of view of value and also from the point of view of interest. Take the last illustration. It is the highest value, namely 1 \$ (one dollar) of a set of three issued in 1931 for air postage.

The 15c. shows a dog team going over the snow with an aeroplane above. The 50c. has rather a long caption, which says 'Vickers Vimy leaving St. John's with first trans-Atlantic air mail passing over the first carrier of ocean mail', and this fully describes the design.

The illustration given here shows the routes of seven historic flights across the Atlantic. The first, which started in 1919, was never completed, and you can see the dotted line finishes in mid ocean. It was the flight of Hawker.

Just north of that route you can see another, dated 1919, and labelled 'Sir John Alcock—St. John's to Ireland'. That was with Sir A. W. Brown to win the Daily Mail £10,000 prize. Another 1919 flight is shown in the extreme south, the 'U.S. Navy Trepassy to Azores'.

Memorable Flight

Of the seven routes only two of them are from East to West and the reason for this was, of course, the prevailing wind. Koehl and Kingsford Smith were the two to go in the contrary direction.

Sir John Alcock's flight is further commemorated on the 15c. of the 1928 Publicity issue, a stamp which gives quite a good picture of 'The first airplane to cross the Atlantic non-stop'. Un-



King James I
granted a Charter
to Guy

King Edward VII
when Prince of
Wales

The Duke of Windsor
when Prince of Wales

make the article very long and somewhat like a catalogue).

Actually we propose to mention the King, Queen or other member of royalty in their chronological order and give some idea why the portrait was produced.

As Newfoundland was our oldest Colony it is not surprising that we should have to turn the pages of history back many years to our first king. That was King Henry VII who was on the throne from 1485 to 1509, and his portrait comes on the 60c. of the 1897 issue.

Two Anniversaries

This date was the 400th anniversary of the discovery of Newfoundland by Jean Cabot, so that it was Henry VII who was on the throne and who gave permission for the expedition which found the island to set out.

The year 1897 was also the 60th anniversary of the accession of Queen Victoria, and the first stamp of the set shows her in her widow's weeds. Her husband, the Prince Consort, is on the 10c. stamp of the 1866 issue, but by mentioning him so soon we have left out a monarch, Queen Elizabeth, who was on the throne from 1558 to 1603. We have her portrait on one of the stamps of the set which came out in 1933—the Humphrey Gilbert set.

This commemorates the 350th anniversary of the annexation of the island by Sir Humphrey Gilbert. The stamps are dated 1583—1933.

In 1610 Newfoundland was settled and in 1910 a set of stamps came out to



A stamp showing seven historic flights across the Atlantic

fortunately some of the air stamps be longed to Newfoundland are expensive.

The map illustrated here is catalogued at £5, but a stamp actually used on letters taken by Alcock and Brown is priced at £15. A stamp used on letters carried by Hawker, although he did not get right across is up to £400. The stamps used on letters carried by De Pinedo in 1927 are £200, but unused specimens are up to £800. De Pinedo's route is shown lowest but one on the illustration.

Although this map is rather too expensive for many collectors, yet there are a number of map air stamps which give similar routes, but which are quite cheap. They make very interesting stamps to show, even to the person who knows nothing about stamp collecting.

5,000 superb Triangular and Pictorials packets free, await first 1,000 joining universal stamp circle. Splendid magazine, smashing badge. Golden opportunity to obtain rarer stamps. Pen friends league. 3d. postage.—Circle Stamps, Court Farm, Hambledon, Godalming, Surrey.

UWANTIT stamps introduces their new discount approvals with 100 different stamps, including Sarawak Butterfly to all sending 3d. stamp and requesting same.—Uwantit Stamps, 100 Stanstead Road, Hoddesdon.

WOODWORKERS and others, new fireside craft, make pounds for the holidays. Full instructions and sample, 2/9.—J.J.D., Hazelwood, Prehen, Londonderry.

TEN miracles of modern magic. Including Escape from Sealed Bag, To Make a Solid Object Vanish, Hindoo Rope Trick, Palming Cards, Coins. Definitely no skill or apparatus required. Complete course, 3/6.—Smith's BCM/Eversmart, London, W.C.1.

ABUNDANCE! Everybody wants it. Success, happiness, health, power. The Thought-bricks course teaches you how to build by directed thought, all that your real self desires in life. Wonderful testimonials from delighted students. Fullest details, stamp.—Williams, Higher Trewen, Altarnun, Launceston, Cornwall.

MALTESE stamps for colonials.—Rapa, Church Street, Ghajnsielem, Gozo, Malta.

STAMPS FREE!! Twenty unused (2½d.).—G. H. Barnett, Limington, Somerset.

KUKLOS Annual. Indispensable Cyclists' Handbook. 160 pages. Tours, Resthouses, money-saving hints, 2/9 post free.—Burrow, Publishers, 2 Imperial House, Cheltenham.

BLUEPRINTS and instructions of the following, 3/9 each post free. Easy-way Electric Engraving Tool, Electric Fire with Electric Cupboard Ailer, Westminster Door Chimes, Lathe Chuck. All specially designed for the homemaker. Send now. Postal Orders to—24 South Drive, Brentwood, Essex.

FOR SALE, Diesel Engine, 'Frog 100', £2/10/-. —Saunders, Muirshiel, Lochwinnoch.

YOUR stamps—do you still want them? Why not turn them into cash? Private collector wants Victorian collection, Liberia, Borneo, etc., Forgeries, specimens, anything unusual.—Tombs, 31 Frances Rd., Windsor.

STAMPS—Gifts—Discount. Applicants for our Overland Approvals can obtain our free gift stamps (including Greek, Salonika) 20 1. Pictorial (Cat. 1/6). Enclose 3d. requesting approvals.—Overland Stamp Co. (HO), 203 The Avenue, West Wickham, Kent.

PERSONS wanted to make model houses at home. Interesting, clean, easy work. Top rates paid. Send stamped addressed envelope for free details.—Bennett Models, 137 Grays Inn Road, London, W.C.1.

U.P.U. packet contains 100 different Empire stamps, including 10 U.P.U. (no G.B.), 2/6 post free.—Bisson, 46 Sumatra Road, London, N.W.6.

INTRODUCTIONS. Pen friends, companionship or marriage.—V.C.C., 34 Honeywell Road, London, S.W.11.

THE GLORY that was Greece. Beautiful ancient designs on modern Greek stamps. Long Classic set, 12 mint stamps catalogued at 3/9, only 1/-. Set of six Winds mint air mail stamps catalogued at 1/2, only 6d. Set of three Glory of Psara, 3d. Postage 2½d. extra. Many other cheap sets on our approval sheets. A selection sent on request.—E. F. Townsend, 92 Tenby Road, Edgware, Middlesex.

MONEY in lead toymaking. Up to £10 weekly can be earned making and selling lead toys. Lead toymaking for Pleasure and Profit is an entirely new course prepared by a manufacturer with many years experience. The plans, ideas and hints therein will enable you to start earning big money right away. Little capital is required. Complete course, 6/3 post free. Money back if not satisfied. Please leave P.O. blank.—BCM/DEVNISH, Dept. H.W.1, Mono House, London, W.C.1.

FREE Bahawalpurs, Colonial discount Approvals. Postage.—Bishop, 40 Marine Parade, Hythe, Kent.

£500 a year earned at home. Send stamp for details.—Eversell Modern Publications (Dept. 10), 37 Duke St., Brighton.

BOOKS WORTH HAVING

SHIPS IN BOTTLES. All about this fascinating hobby. Post free 3/9

WOODTURNING FOR BEGINNERS. Complete guide with details of a home-made lathe. Post free 3/9

PRACTICAL VENEERING by Chas. Hayward. All the tricks of the trade described in easy stages. Post free 7/11

CARPENTRY FOR BEGINNERS by Chas. Hayward. A well illustrated and practical book. Post free 7/11

THE WOODWORKER ANNUAL. The ideal book for the man who makes things at home. Post free 13/3

If you want ANY book on ANY subject, please make use of our free information service.

QUADRANT BOOKS (Dept. 4)

17 Quadrant Arcade, Regent Street, London, W.1



MONO - GOLD

Amazing new Discovery. Decorates Leather, Perspex, Plastics, Lampshades, Wood, etc. in beautiful gold, silver and colours. The Mono-Gold Embossing Outfit is easy to use and gives astonishing results. Complete Outfit costs only 7/6, yet will earn pounds. Remit crossed p/o or cheque.

J. BULL

246, High St., (HOB) Harlesden, N.W.10.

BUY A FOYLES HANDBOOK!

Leatherwork • Basketry

by F. J. Christopher . Price 2/6 each

From all Booksellers or the Publishers

W & G FOYLE LTD

119-125 CHARING CROSS ROAD LONDON WC2

Indispensable to all interested in motor cars.

The two popular Car Books

"WHERE'S THAT CAR FROM?"
"POPULAR CARS ILLUSTRATED"
6d. each

From all Stationers and Booksellers
or from **RALEIGH PRESS, EXMOUTH**

SENSATIONAL SALE OF A "SWISS" COMPANION KNIFE

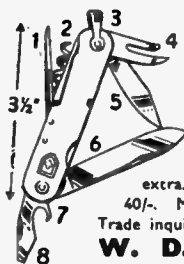

with EIGHT attractions — Awl, Corkscrew, Safety Ring, Tin-Opener, 1½in. Blade, 3in. Blade, Bottle Opener, Screwdriver. Finest French make, razor-sharp, strong yet light and handy. Easily worth double. Send 9/- for immed. delivery. C.O.D. 1/- extra. 3 for 25/-. 5 for 40/-. Money back guarantee. Trade inquiries invited.

8/6 POST etc. 6^p

W. D. MORGAN & Co., Ltd.
Dept. HBI., 2 GRAY'S INN RD., LONDON, W.C.1

KITS for OLD TIME SHIPS

Hobbies range of Ship Models includes Elizabeth Jonas, Cutty Sark, Victory, Mayflower, etc. Complete kit of wood, sail material, guns, pulleys, cord, etc., with full size pattern of parts and planed wood ready to cut out, shape and construct. A fascinating pastime. Kits for models 12½ins. long and upwards.

Ask for free illustrated lists at Hobbies Branches or from Hobbies Limited, Dereham, Norfolk.

Concluding details for undertaking LEATHERWORK

In our issue, dated April 12th, we gave helpful instructions and illustrations on how to undertake leatherwork—a hobby becoming increasingly popular. The instructions are continued and completed this week.

Rub lightly all over the design when the swab is almost empty of colour or the model may be obliterated. If the leather has been made dirty or greasy by handling too much, the stain will be very patchy. It is possible, though unorthodox, to wash the pieces with soap and water before staining. Again do not rub too hard or the surface will be bruised.

A very good polish can be produced by rubbing with another piece of leather, with a light brisk movement, while the leather is still wet. If the pieces are polished in this way as well as an extra stained piece for the thongs, no other polish is needed.

For a design in monochrome—e.g., the same colour but different portions lighter or darker—it is advisable to stain the background quickly a lightish tone and, with a paint brush, colour in the portions, such as borders and initials in darker tone. It will be necessary to have several jars with the dye mixed to various strengths to do this successfully. The painting can be done in exactly the same way as with water colours, by mixing and diluting to give the desired effect.

Punching

Heavy decorative work can be done by punching holes with a single or slit punch in a border or over a design and thonging with different coloured thongs. These punch holes should be carefully thought out and measured or the work will look very poor.

For thonged edges the preparation for punching must also be very careful. For beginners and general use, the holes should be $\frac{1}{8}$ in. apart and $\frac{1}{16}$ in. from the edge. A faint line can be ruled around the work to assist in keeping the punched holes straight and points can be pricked at distances of $\frac{1}{16}$ in. with the edge tool to keep them even.

If the thonging is to join two pieces together, make sure that the holes correspond. As it is very difficult to punch two pieces at the same time without them slipping, one piece should be punched and the centre of the holes marked through with a pencil on the other piece which should be finished separately. To save the edges of the punch from becoming blunted very quickly, always place a piece of scrap leather under the piece to be punched.

Thonging

Thonging can be cut from a straight piece of leather slightly thinner than

that used for the main pieces or to save material from a circular piece cut round and round from the edge to the centre. If coloured thongs are needed, the staining and polishing should be done first, in the above method.

Thongs may vary in width, according to the size of the article being made on method of thonging, but for the measurements already given for punching, the thongs should be $\frac{1}{8}$ in. wide when stretched. It is possible to cut thongs with scissors, but a sharp knife gives a much better edge.

Stretching

After cutting thongs, damp them, and they will stretch out straight. The length of the thonging is determined by the article to be thonged. In an ordinary article, the thonging is about three times the length all round. In a large object, it is difficult to work with a large thong, therefore, you will have to join. It is difficult to join thongs with glue. However, the alternative method is to bind in the old end and the new in the same way as for starting.

Start thonging from a corner by pushing the pointed end of the thong through the first hole from back to front (or between the pieces, if two are to be joined together), leave about $\frac{1}{16}$ in. at the back or between, and bind over this end with the next few stitches. Pull the thongs as tightly as possible towards yourself, and not upwards towards the edge or the holes may break.

The neatest type of thonging is that which lies close together, and covers the edge completely. The corners may be slightly rounded so that there is no break in the edging, or the corner hole may be thonged into twice, one stitch lying on each side of the point. To finish, pull the last three stitches loose with a tracer tool, and slip the end back under them. Pull each up tightly again with the tracer—pull the end, and cut off.

Various Methods

There are numerous methods of thonging which should be practised on scrap leather. Button-hole stitch thonging makes a stiffer edge. Cross-double thonging in two colours is very attractive. The holes are punched farther apart, one colour thonged slanting one way, and the other in the opposite direction to form crosses.

Threaded thonging must have perfectly evenly punched holes made with the slit punch. The thong is then threaded flat through the holes like ribbon, and does not go over the edge.

Thongs should be hammered flat when finished, and if the article has been stained, the edges of the thongs will need touching up with a paint brush. This will give a professional touch to the finished article.

Letter Holder

HERE is an idea for a simple letter rack. First secure an old mouse trap, and remove the catch so only the spring remains. The spring keeps the

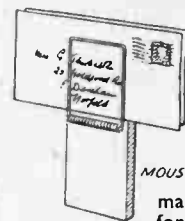

MOUSE TRAP

letters firmly in position if fixed to a board as shown, and if the holder is painted and screwed to the wall it makes an excellent article for everyday use.

Pea Guards

IF you can obtain old bicycle wheels, they are ideal for pea guards in the garden. Half submerge the wheels in the ground (one at each end) and tie twine from one spoke to another to form a complete net.

For Rusty Tools

PUT the tool (say, a chisel) into a jar of vinegar for a day or two. Immerse rusty part only as shown in sketch, but do not put in the wooden handle or where it joins on the blade. Take tool out, wipe and dry; there will be no trace of rust.



Wood Cleaner

TEA leaves make an excellent cleanser for varnished woodwork. Just soak them in water for half an hour, then strain the liquor off and use it for your cleanser.

Cork Extractor

IF tape is put around the cork as in the drawing, and then inserted, you will have a tight fitting cork. If you want to

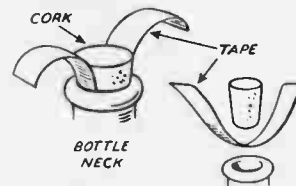

remove the cork, the only thing you have to do is to pull both ends of the tape, which should be left long enough for the purpose.

Cigarette End Insecticide

SAVE cigarette ends for making nicotine insecticide. When you have got them, put the ends in a jar of water. Place the jar in a saucepan of water and simmer for six hours. An ounce of ends may be diluted in order to make eight gallons of insecticide.

TRIANGULAR DUTCH free



SEND NOW
to the Windsor Stamp
Co. for this really
magnificent Triangular
Stamp of HOLLAND
(Netherlands)
which we will
send to you—
ABSOLUTELY
FREE.

This very lovely stamp depicts Pallas Athene (Minerva), and was issued in 1936 to Commemorate the 300th Anniversary of Utrecht University. It is a stamp that every collector wants, and you can have one from us to improve and add interest to your collection. **ABSOLUTELY FREE.** Just send 3d. stamps for postages and lists, ask to see an Approval selection (no obligation to purchase any), and ask for **TRIANGULAR DUTCH STAMP FREE.**

WINDSOR STAMP CO. (Dept. 12) Uckfield, Sussex



This **PARA Ridge Tent** comes to you with an inner tent plus a separate fly sheet. Absolutely portable outfit in Valise complete with all accessories. Popular size 5ft. 6ins. by 7ft. 3ins. along wall 4ft. 6ins. wide 3ft. 6ins. high. New wall, brand new. Yours for 15/-: 6 monthly payments of 9/9. Without fly sheet, 9/6 deposit. 6 monthly payments of 8/-. **EX-GOVERNMENT SOLID LEATHER HAND SEWN BOOTS** 12 6 postage etc. 1 3. Boys, Ladies and Mens with small fittings, finest quality brand new solid leather Boots represent the finest value ever. No stronger Boot was ever made. Sizes 3 up to 7½. Also Mens 11 to 13 same price.

GREAT SURPLUS OFFER "PARATROOP" BINOCULARS



7 oz. Crystal-Clear Lenses. Ideal holiday, sporting events. 42/6. W.D. model, full size, £3 10/-. Very Special 6-Lens Achromatic Model, £3 19/6. Both complete in case, &c. All post 1/-

Other **TENTS, MARQUEES, TELESCOPES**, etc. Terms. Send for list. **HEADQUARTER & GENERAL SUPPLIES LTD., (Dept. MOB), 196-200, Coldharbour Lane, Loughborough Junc., London, S.E.5** Open all Saturday. Closed 1 p.m. Wednesday.

ALL ABOUT FRETWORK

by **W. F. Chambers**
(Editor of Hobbies Weekly)

The book for all fretwork enthusiasts

Bound in paper covers, **2/6** net.

Or there is a cloth bound edition at **5/-** net.

Obtainable from all booksellers, branches of Hobbies, or from the publishers :

VAWSER & WILES (London) LTD.
356/358 KILBURN HIGH ROAD, LONDON, N.W.6

BE TALLER

I Guarantee to increase your height in 12 days or return your money—New gland and spinal discovery increases height 2 to 5 inches.

'I have gained 4½ inches in height and feel fresher first thing in the morning. My weight increased from 9-stone 4-lb. to 10-stone 3½-lb.'—P.D., Witham. 'Since taking your Course I have increased in stature from 5 feet 1 inch to 5 feet 4 inches, a matter of 3 inches'.—H.G., Chesterfield. 'My increase is 2 inches and I really do feel ALIVE'.—E.T.

Guaranteed harmless. Full Course 10/-. Details free for 1d. stamp Sent under plain cover.

J. H. MORLEY

(H/82), TERRY HOUSE, NAPHILL, HIGH WYCOMBE, ENGLAND
Established 1936

YOU CAN BECOME A HANDICRAFTS INSTRUCTOR

Experience not essential

Men who enjoy making things in wood or metal can turn their hobby into a well-paid, permanent and interesting Career. Short hours, long holidays, and security in a job you would really enjoy, can be yours if you become a Handicrafts Instructor. Let us send details of the easiest and quickest way to get the necessary qualification.

We definitely guarantee
"NO PASS—NO FEE"

If you would like to know about our unique method of preparing you for one of these excellent appointments, write today and we will send you our informative 176-page Handbook—free and without obligation. Mark your letters 'Handicrafts Instructor'.

**BRITISH INSTITUTE OF
ENGINEERING TECHNOLOGY**

595 Shakespeare House,
Stratford Place, London, W.1

BIET

Something New in Model Boat Building

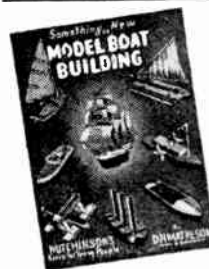

tells you * how to model
your own electric launch
* how to model your
own battleship and many
other models **5/-** net.

with 53 line illustrations and 4 full colour plates.

**HUTCHINSON'S
BOOKS FOR YOUNG PEOPLE**

Please supply me with one copy of "Something new in Model Boat Building". Hand this to your Bookseller.

NAME.....

ADDRESS.....

HUTCHINSON HOUSE W.1

All-Steel Tool Rack

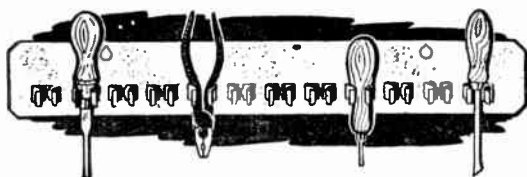

Hobbies Ltd.,
Dereham, Norfolk
and Branches.

Strong spring steel clips fixed on a wallplate. To hang on the wall or in tool cupboard. Pierced for hanging. In 2 sizes: 13" 4/6; 18" 6/-. Post 5d. & 9d.

PATTERNS OF DOG AND DUCK TOY

See page 67

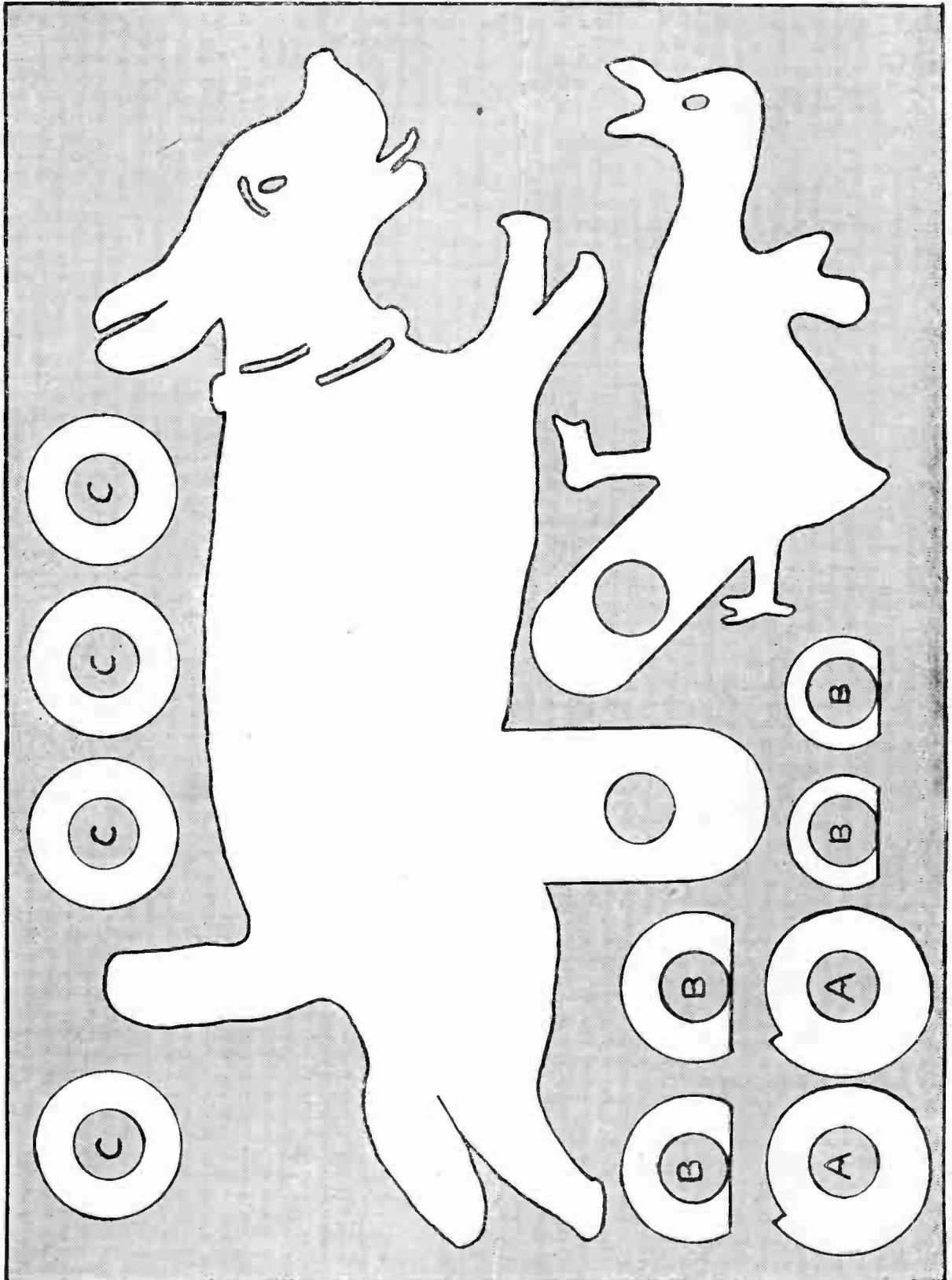



HERE AT LAST!
THE
MULTITOOL

- ★ FRETSAWING
- ★ GRINDING
- ★ DRILLING
- ★ SANDING
- ★ BUFFING
- ★ SAWING

SIX TOOLS IN ONE—ELECTRICALLY DRIVEN

Here is the automatic precision machine which Handyman and Craftsmen have wanted for years. Accurate precision work in wood, metal or plastics can be done in a fraction of the time taken by hand labour. The change over from one tool to another takes less than ten seconds.

- The revolving disc is fitted with—
- (1) General purpose single grinder, 6ins. diameter.
 - (2) Drill Chuck, $\frac{3}{8}$ th capacity.
 - (3) Circular Saw with base plate and guard, 6ins. diameter.
 - (4) Sanding Disc, 7ins.
 - (5) Circular Buffing Mop, Polisher, etc.
 - (6) Fretsaw fitting on top of casing, with clearance of $9\frac{1}{2}$ ins.

Driving power is supplied by 1.3rd H.P. Motor 220/250 volts A.C. or D.C. fitted in case.

SMALL POWER MACHINE CO., LTD.

45 Marloes Road, Kensington, London, W.8

Telephone: Bayswater 8203

The complete MULTITOOL machine ready to plug-in and use immediately, costs £36 nett. Convenient hire-purchase terms are available.



OVER 5,000
ex-R.A.F. Apprentices
have reached commissioned rank



So may you — one day.

If you are chosen to be an R.A.F.

Apprentice you will be trained for a skilled trade, and continue your general education. You will have far more opportunities for sport than most boys. You will be well fed and cared for, and receive good pocket money. And you may end up not only with a commission — but with a flying commission.

Send the coupon. It will not commit you to anything. It may lead to great things.

TO: AIR MINISTRY, DEPT. HS.44C,
VICTORY HOUSE, KINGSWAY, LONDON, W.C.2

I am between 15 and 17½. Please send details of R.A.F. Apprenticeships.

NAME

ADDRESS



TOOLS FOR THE HANDYMAN



TOOL CLIP

For holding any handed tool. Spring steel. Holed for hanging.
6½d. Post 2½d.

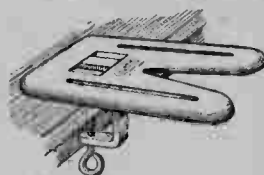

STEEL CUTTING TABLE

With cramp for easy fixing to bench. 6ins. by 4ins. strong and light. 2/6. Postage 4d.

BENCH STOP
3½ins. by 2ins. — Spring loaded top. Price 5/6. Post 3d.



SINGLE HANDED SCREWDRIVER

5ins. long. Ideal for small work. 1/6. Postage 2½d.

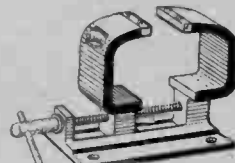

MODEL MAKER'S BENCH VICE

Strong, light and rigid, 3in. opening, 5/6. Postage 9d

Obtainable from Hobbies Branches in London, Glasgow, Manchester, Birmingham, Leeds, Sheffield, Hull, Southampton, Bristol and ironmongers everywhere. Orders by post to Hobbies Ltd., Dereham Norfolk.



FRETWORK HAMMER

8ins. long. Strong and light for small work 1/3. Postage 3d



DOLL'S HOUSE
How to make in a simplified step-by-step manner a desirable four room Doll's House with electric light and separate garage if required

ALL MATERIAL EASILY OBTAINABLE
Send a 2/6 P.O. now for complete Plan and instructions Doll's House Paper and Doors and Windows, which open, are available. S.A.E. for list.

TRADE INQUIRIES INVITED

ZIMPLAN 88 WARE ROAD
HODDESDON, HERTS.



BRANCHES

LONDON
78a New Oxford St., W.C.1 (Phone MUSEUM 2975)
87 Old Broad Street, E.C.2 (LONDON Wall 4375)
117 Walworth Road, S.E.17

GLASGOW
326 Argyle Street (Phone CENTRAL 5042)

MANCHESTER
10 Piccadilly (Phone CENTRAL 1787)

BIRMINGHAM
14 Bull Ring

SHEFFIELD
4 St. Paul's Parade

LEEDS
10 Queen Victoria Street (Phone 28639)

HULL
10 Paragon Square

SOUTHAMPTON
25 Bernard Street

BRISTOL
30 Narrow Wine Street (Phone 23744)

Head Office & Factories—**HOBBIES LTD., DEREHAM, NORFOLK**

Hobbies

WEEKLY

CONTENTS

	Page
Garden Archway - -	81
Model Gondola - -	83
Craftsman's Notes -	84
Two Simple Kites -	85
Children's Novelties -	86
Three-legged Stool -	87
Paperhanging - - -	88
Metal Etching - - -	89
Paint Brush Hints -	90
Hobbies in Pictures -	91
Garden Games - - -	93
Metal Work Patterns -	95

May 10th, 1950

Price Fourpence

Vol. 110 No. 2845

AN ATTRACTIVE GARDEN ARCHWAY

TO those readers who may not care for the rustic arch in their garden, the design illustrated, made from ordinary planed wood, may have some appeal. Painted a white or green colour, it would have a pleasing ap-

pearance, either at the entrance to the garden, or as a division between the flower and vegetable portions. Sizes of timbers used are given at the end of the article.

A front view of the framing is given at Fig. 1, also a side view. Dimensions are

shown, but if the arch is required wider, to more effectively straddle an existing path, it is an easy matter to increase the width of the archway as required.

Cut the vertical posts to length, and reduce the ends at top and bottom to form $\frac{1}{2}$ in. tenons, $1\frac{1}{2}$ ins. long, as at (A), except in the case of the outer posts, where no bottom tenons are required. The top bar is mortised for these tenons at correct distances apart, the mortises going right through. When fixing this top bar, which is cut from $1\frac{1}{2}$ ins. by $2\frac{1}{2}$ ins. wood, remember it is laid on the posts with its wider side downwards, to overhang the posts each side by $\frac{1}{2}$ in.

Grooved Crossbars

The middle crossbars are grooved into the posts, one each side, as in detail (B). These bars are reduced by $\frac{1}{2}$ in. at each end, and the posts grooved for them $\frac{1}{2}$ in. deep, then, when the bars are fitted in, a space between them of $\frac{1}{2}$ in. will be left, into which the vertical rails will fit.

The lower crossbars consist of a single one, to each pair of posts, these being at the front, no rear bars being wanted. Fit all at the respective distances up the posts given in the diagrams.

The inner posts are strutted to stiffen the archway against stresses of weather. The ground rails are cut to length and mortised in the centre to receive the posts. These mortises are cut $1\frac{1}{2}$ ins. deep, so do not quite go through the whole thickness.

Fixing the Posts

Fix the posts in with a thick lead paint, unless some waterproof glue is to

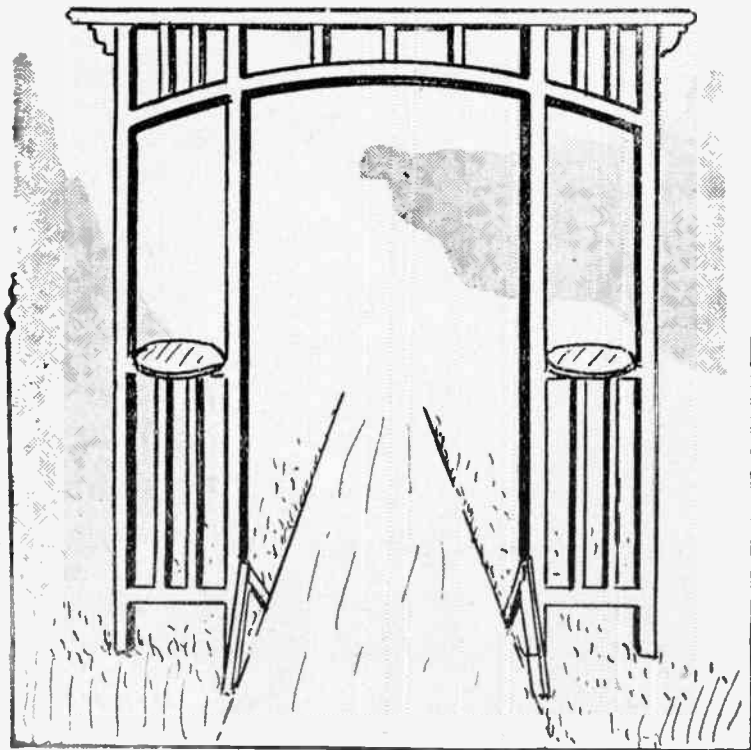

All correspondence should be addressed to The Editor, Hobbies Weekly, Dereham, Norfolk.

hand, in which case it could be used. Nail the struts to ground rail and trim them at their top ends to butt together against the posts, where they are again strongly nailed. The whole framework can now be glued and nailed together.

For the top curved rail strike a double arc of 2ins. thickness on a length of 1in. thick board, as at (D) in Fig. 2. This can be done with the old gadget of a length of string, tied to a nail and with a pencil tied to the opposite end. Alternatively,

rail at 6ins. down from the top of the arch, in the centre.

The vertical rails, introduced for an ornamental effect, are nailed to the curved rail at the rear. They are evenly spaced in each division. Underneath the top rail of the arch, a 1in. wide strip of wood is nailed along in each division, shown at (F) in Fig. 2, for nailing the vertical rails to top.

The lower vertical rails are nailed between the horizontal bars, and then to the rear of the lower bar, as in detail sketch, Fig. 2. To the middle pair of bars a small shelf is nailed, cut to the shape and size given at (C). The structure can

To do this part of the job thoroughly, and unless it is done so, the life and stability of the arch may not be so

LIST OF TIMBER

Posts (4)—2ins. by 2ins. by 7ft. 8ins.
 Top bar—1½ins. by 2½ins. by 6ft. 6ins.
 Ground rails (2)—2ins. by 2ins. by 2ft. 0ins.
 Horizontal bars and struts—17ft. of 1in. by 2in. wood.
 Vertical rails—6ft. of ½in. by 1in. wood, perhaps cut from waste in board used for the curved rail.
 Curved rail—6ft. of 1in. by 8in. board.
 Remainder from spare wood available.

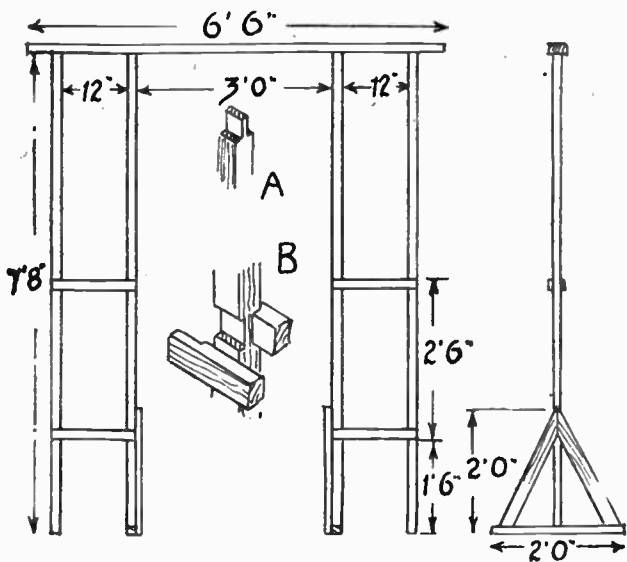

Fig. 1—Plan and side view, showing underground support parts

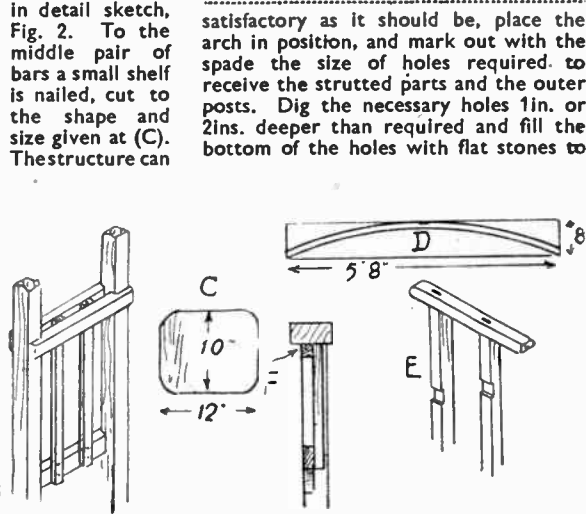

Fig. 2—Details of construction of various parts

a long flexible strip of thin wood could be bent to the arc, laid on the board, and a pencil drawn along it. In either case a clean sweeping curve is desirable for a good effect.

This curved rail is grooved at its rear, ½in. deep, where it passes over the posts, the posts themselves being grooved at the same spots, also, as shown at (E). The rail can then be nailed in flush with the outer surface of the posts. Fix the

be stiffened up with small corner brackets at the top, seen in the view of the finished arch. This completes the work of construction.

The arch is embedded in the ground to a depth of just 12ins., and the wood to this depth is thoroughly creosoted as a preservative against rot. The remainder can be painted the colour preferred. Let the paint thoroughly dry before erection.

satisfactory as it should be, place the arch in position, and mark out with the spade the size of holes required to receive the strutted parts and the outer posts. Dig the necessary holes 1in. or 2ins. deeper than required and fill the bottom of the holes with flat stones to

provide a firm foundation for the posts to rest upon. Drop the arch in, then fill up with dry earth, in which a number of small stones are mixed, ramming it down until hard. The arch should then stand firmly enough.

Remember the archway will have to withstand heavy winds at some time or other, so make sure the foundations are good and the whole thing rigid.

Tape Recording

MMAGNETIC tape recording is cheaper and simpler than disc recording, due to the fact that the tape may be used repeatedly. Please provide me with details of a tape recording and reproducing unit and the mains operational details. (B.P.—Poole).

IN magnetic recording, the tape is drawn at regular speed past an electro-magnet. To do this, suitable drums with a gramophone or similar motor can be used, and it is essential the whole should run smoothly, as any vibration of the tape will be found to cause loud noises and variation in volume when reproducing. The tape must pass as close to the magnet pole as possible without touching. The magnet is fed from an amplifier capable of delivering several watts output; the

amplifier is operated from a microphone in the usual way.

To play back recorded material, the tape is re-wound on to the original drum, then wound past the magnet, as when recording. The magnet now provides the input to the amplifier, which operates a loudspeaker.

To wipe out recording to re-use tape, latter is wound past the magnet when a strong direct current is flowing continuously through the windings.

Enlarging Plans

IHAVE some plans which are too small, and wish to double them accurately. Is there any drawing device which I could make which will help me? (W.K.—Tooting).

THERE are two methods by which you can enlarge the drawings you

require for the steam engine model. One is by means of a device called a pantograph. This is an instrument with movable arms, by which a mechanical enlargement is produced with a little practice. Details for making such an instrument appeared in our issue, dated 28th September, 1940, and a copy is available for 3d. post free.

The second method is by the squared paper process. Over the existing drawing you should mark out, say, ½in. squares in pencil; then on a larger sheet of paper, draw out squares 1in. across. By re-drawing the shape through these 1in. squares, watching carefully to get the same positions on the larger size, you should produce an accurate drawing double the original. You can frequently check up the accuracy with a pair of dividers, doubling up from the original to the enlargement.

A novel and attractive piece of work is this waterline MODEL GONDOLA

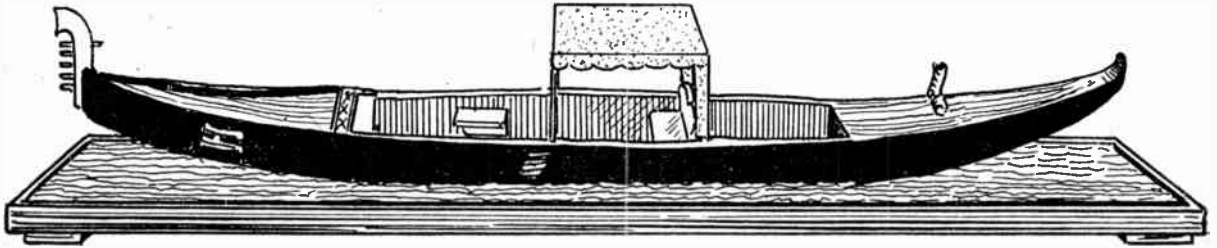

THIS small, but attractive model, would make an interesting addition to the miniature boat series. The Gondola, as most readers know, serves the same purpose in Venice as road transport vehicles here, and has traversed the canals for hundreds of years. It is a light and speedy little craft, propelled through the water at a rate remarkable considering the Gondolier uses but a single oar.

It cannot truthfully be said that it is a gay vessel in appearance, as the laws of Venice decreed many years ago that it should be painted black, but its history surrounds it with interest, and it is worth modelling.

A side view and half plan is given in Fig. 1. To commence, draw on a sheet of paper a rectangle, 11ins. long and $1\frac{1}{2}$ ins. wide. Divide this lengthwise into $\frac{1}{2}$ in. strips and mark off into 1in. divisions, as in the diagram.

Cutting the Sides

Now copy the full outline of the craft, and transfer this through carbon paper to a piece of $\frac{1}{8}$ in. fretwood, and saw carefully out. Take particular care in sawing the battleaxe prow to avoid breaking the delicate parts.

From the same pattern transfer the shaded portion of the craft to a piece of $\frac{1}{8}$ in. thick deal. Cut two of these. These pieces should, after cutting to shape, be trimmed to the plan outline, which is divided into 1in. divisions for easy copying. The rest of the shaping can then be carried out much the same as is done when modelling small craft.

The well, the size of which is shown in

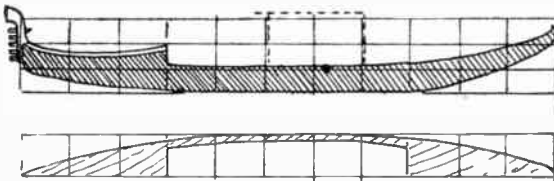

Fig. 1—Side view and half plan of deck



Fig. 2—Shaping of sides and decks

Fig. 1 plan view, can then be sawn and chiselled out. Take notice here that the bottom of the vessel under the well must be kept quite flat. The front part of the top from the well to the prow is bevelled off. The detail sketch, Fig. 2, will help to show how the sides are shaped.

Framework

These two sides are now glued to the complete shape cut from the $\frac{1}{8}$ in. fretwood. Clamp together tightly with tape, and when the glue is quite hard, with a fretsaw saw away that part of the fretwood across the well that is not wanted. Finish the shaping with a file and glasspaper, working the forward half to a sharp edge at the prow and to a rounded section from the rear of the well to the stern.

The stern, it will be noted, curves upwards at its top, and needs shaping up with a round file to look effective. The narrow strip of fretwood sticking up above the deck from the well to prow, should be rounded off, giving a rib-like effect.

Decoration

At this particular part a decorative strip, or rather two separate strips, is glued, as in detail (A) Fig. 3. These strips are cut $\frac{3}{8}$ in. wide, from the $\frac{1}{8}$ in. fretwood, and glued in place, being mitred together neatly where they meet at the centre. A little carving is done to these with a file or penknife, as in the diagram, nothing elaborate need be attempted, just

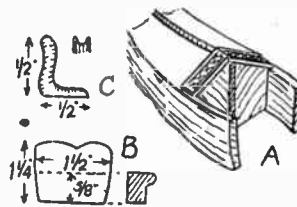

Fig. 3—Shape at the prow

straight lines near the side edges, and crossed lines between, will suffice.

At this stage, cut the baseboard, shown at Fig. 4, from $\frac{1}{2}$ in. wood. Plywood or artificial board would suit quite well here, and save the more valuable fretwood for more important use. This baseboard has an edging of fretwood, $\frac{1}{8}$ in. wide, glued and pinned round it, making it a kind of shallow tray.

Fitting to Base

Place the boat on the board, exactly in the centre, and with a pencil run round the inside of the well and mark its shape on the board. Cut this shape out. Then glue the boat to the board, the well of the boat then extending through the board and deepening it a little. Cover the hole at the bottom with a piece of fretwood, as shown by the dotted outline in the diagram.

This part of the work can now be finished by gluing 1in. squares of fretwood to the underside of the baseboard, one near each corner, to serve as feet, the corners of the edging, by the way, should be neatly mitred to make a workmanlike joint. Give the whole work a good rubbing now with medium and fine glasspaper to make it smooth all over.

Now for the seat, on which the passengers recline. This is shown at (B). Cut the back of the seat to the shape shown, and trim it to fit in the well. The seat board is a piece of wood, $\frac{1}{8}$ in.

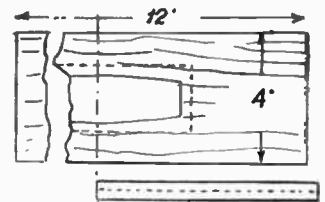

Fig. 4—Plan and side view of base

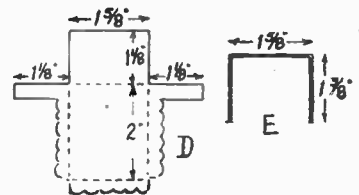

Fig. 5—Canopy details

section, shaped as seen in the diagram and trimmed to length to fit across the well. Glue this to the seat back, and glue the completed seat at about $4\frac{1}{2}$ ins. distance from the stern of the vessel.

Seat and Rowlock

In the actual craft, this seat is upholstered, and the reader who cares to make this model as true to prototype as possible, can make the seat more realistic in appearance by simulating the upholstery with some suitable material glued to it, for example a scrap of thin leather, or American cloth. The edges of the seat back and front edge of the seat board should be rounded off for this.

A kind of rowlock is to be added, in which the Gondolier places his oar for rowing. This is drawn at (C) and is cut from $\frac{1}{2}$ in. fretwood, and filed to a round section, except that part at the bottom which is fastened to the deck.

A notch is filed out at the top for the oar to work in, and the rowlock glued to the deck at approximately where shown in the general view of the boat. Painting and general finishing can now be undertaken.

The outside of the boat, except the battleaxe prow is painted black. The decks are left plain. The rest, including the decorative carved work on the foredeck, stained a light brown. The baseboard is painted, and the edging either painted or stained and varnished. A light brown would look well here, or black paint if the effect would not be

considered too sombre.

A canopy over the seat is provided, and this should be in some gay colour to impart a touch of liveliness to the model. The canopy supports are bent up from stiff wire to the shape shown at (E) in Fig. 5. They bridge the well, the lower ends entering in holes bored in the top edges of the sides of the boat, at 2 ins. apart.

The approximate position of these is shown by dotted outline in Fig. 1. The width, given at (E), must be considered approximate, it being best to measure the width across the boat to make sure. Press the supports securely in their holes.

Canopy Details

Approximate dimensions of the canopy are given at (D) in Fig. 5. Make a paper pattern of this and try it over the supports, noting any amendments that may be necessary in size, and allow a trifle extra for narrow hems. Lay the pattern on the material and cut out. If you can obtain the assistance of a lady friend, the scalloped edges of the canopy would look much better if over-stitched or buttonholed. Fix the canopy to its supports with a few stitches where needed.

The canopy should be stretched tightly over its supports, with the scalloped edges hanging over sides and front and the rear part of it covering the back of the seat. It should then look very nice and impart a pleasing effect to

the vessel. To add to the general effect, a touch of silver of aluminium paint, if you possess it, given to the battleaxe prow would be very effective.

Water Effect

Now cover the baseboard to a depth of $\frac{1}{8}$ in. with putty, worked to softness between the fingers. This should be pressed down to the baseboard, smoothed over, and then slightly rippled to imitate water. The rippling can be best effected with a rounded strip of wood or metal. A wave-like effect is not required, as the waters of the Venetian city are more like those of a river or canal, than sea.

Let the putty dry, this will take a few days, then paint the surface blue or green, as preferred, as a realistic finish. The edges of the baseboard are varnished, also the decks of the gondola. Pieces of the seat strip, similar to that used for the seat, without the backboard, can be glued inside the well, either side, seen in the general view.

Another seat strip could be added, just below the foredeck of the vessel, and opposite the passenger's seat. These need not be upholstered, but just stained to match the rest.

This completes the model, and should, if carefully made and finished, be a pleasing ornament or a valuable addition to a model series of craft. Beyond the small amount of fretwood needed, only scrap wood, etc., is required for the materials.

From the Craftsman's Notebook—

Butterflies and Buddleia

HOBBIES certainly help to make life interesting, so I was not surprised to learn that it was need for a hobby which started a mining engineer out in West Africa to collect butterflies and moths. His specimen case includes one with a 9 in. wing span.

Absorbing with unusual and colourful insects, places like Africa are certainly ideal for such a hobby, though enthusiasts can find dozens of butterflies and scores of different moths for study here in England. Where I sometimes stay in the country I have only to turn on the light and at once large moths come gliding up and down the window pane.

Even though I do not collect them I like to identify different specimens and in fact have some coloured pictures to which I can refer when in doubt. The best place to see butterflies, I find, is on the buddleia in a corner of the garden. This, incidentally, is now 6ft. or 7ft. high, having grown from a mere twig planted one autumn. During the August weeks when buddleia is in flower it has a great attraction for butterflies, which cling to the purple flowers as though stupefied. One can watch them in one position for long enough.

There have been few winged visitors on the shrub this year, in contrast to last when they were so numerous. Unfortunately most of them were

common whites which I do not welcome to the garden in such numbers, but there were also several coloured specimens. Red Admirals were frequent visitors, and once or twice there was a Painted Lady.

* * *

Idea for a Stool-Box

ACOMBINED stool and box I made incorporates an arrangement by which catches for holding the lid down and the need for a projecting handle are both dispensed with. The idea is also handy for other kinds of workbox which have to be carried about.

In the centre of the lid an oval piece was cut right out, making an opening just large enough to admit the fingers for lifting the box. Level with the top of the box inside, a piece of $\frac{1}{2}$ in. wood 2 in. or 3 in. wide was nailed across to each end, ample space still being left for putting in the brushes or whatever the box is intended to contain. Mid-way across this strip an oval piece was taken out to correspond with the hole in the lid.

When the lid is closed it thus falls on this strip of wood and the two openings come together. No catch is needed to hold the lid down, for the fingers pass right through both openings when carrying it and grasp the fixed cross-piece inside.

Nature by Night

TRAVELLING by cycle or car in the country after dark one gets a glimpse of the activity still going on in the animal world. While many beasts and birds are resting from their daytime exertions, others are on the roam in search of food, and their fleet movements are sometimes revealed for a few moments by the headlamps.

Several times I have seen a stoat streak across the highway in front of us and clear the opposite hedge with remarkable agility. Once a vole preceded us for hundreds of yards before scurrying through a hole in the bank. On a rare occasion I have seen a hare in the evening. It suddenly appeared in front of us, and my companion pulled up only just in time to avoid running it down.

Only a couple of yards away the hare stopped and remained motionless for a minute or more, as though mesmerised by the dazzling lamps. We could easily have 'bagged' it had we wished. At last the hare recovered its senses, and although it probably had no idea of direction in that glare, it managed to dart successfully out of the beam of light and disappear into the darkness again.

The Craftsman

Now is the time to get ready for the summer with TWO SIMPLE KITES

THE flying of kites is still an interesting pastime, and an additional pleasure is afforded by making them oneself. The materials are few and inexpensive, and the designs endless. For the subject of this article, two of the more simple patterns will be dealt with.

One important point to be remembered is balance, failing this the kite will be erratic in its flight, and in fact, may not fly at all. Balance is achieved by making each half alike on a framework sufficiently rigid. The wood for this framework must be light and straight grained, given these qualifications a selected piece of planed deal would serve as well as anything.

Simplest Style

Fig. 1 shows the simplest pattern of kite, but quite a good flying one if carefully made. For the framework use strips of the wood $\frac{1}{4}$ in. square. Cut these to the lengths given and rub off sharp edges with a light rub down with fine glasspaper. At the spot on the backbone, where the cross strip comes, cut a shallow notch, as at (A). This should not be deeper than $\frac{1}{8}$ in., or it may weaken the backbone of the kite.

Mark the exact centre of the cross strip and glue it in the backbone. Strengthen the joint with a wrapping of strong thread, as at (B). With some of the thread, tie at the top, then to each point of the framework, finishing off at the top again.

Get this thread fairly tight, but be most careful not to distort the framework in the least. If the thread is inclined to slip from the ends of the strips, just cut slight notches with a penknife into which the thread can sink, and be held in place.

Covering

For the covering, a thin but strong coloured tissue paper will do nicely. This should be cut symmetrical to fit the framework, both sides being alike. Then glue or paste the surface of the wood,

tube glue is the strongest, press the paper down and rub lightly. Cut the paper $\frac{1}{8}$ in. larger than the framework, to leave a hem, the hem being folded over the threads, and pasted down.

For the bridle line, bore fine holes through the backbone, one at 4 ins. from the top and the other 5 ins. from the bottom. Use a fine fretwork drill for these. The bridle line is a double length of thread, strong stuff or fine twine.

Make it about 3 ft. long, doubled, of course. For some 12 ins. of the middle, the doubled thread should be knotted to form a succession of loops, as at (D), in Fig. 2, so that the position of the kite line can be adjusted, as may be found necessary.

A simple gadget can be made for the looping job, shown at (C). It is just a piece of scrap wood, with two nails driven partly in, 1 in. apart. The threads are tied together, placed against the first nail and then tied again at the back of the second nail. This being repeated until the required length of line is looped. Twist the ends of the bridle line together, push through the holes in the backbone of the kite and there knot them to prevent them working out.

The Tail

For this design of kite a tail is necessary to further stability in the air. The tail is shown (partly) at (E), and for a kite of the dimensions given, should be about 12 ft. long. Strips of thin crêpe paper, at 9 in. distances apart, are tied to the thread of the tail, and the bottom finished with a small tuft of the paper.

A pattern of kite, called the 'Indian' is drawn at Fig. 3. As this style of kite requires no tail, but depends on a fin instead for stability, it should prove interesting, both to make and fly. The backbone is a length of similar section

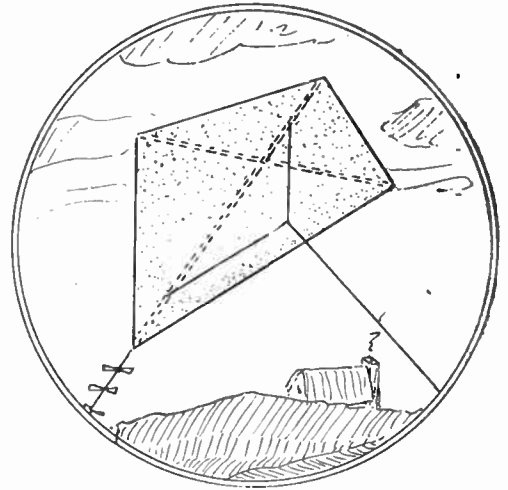

wood to that used for the kite just dealt with, and about 20 ins. long. At 6 ins. from the top cut a notch, $\frac{1}{8}$ in. deep and $\frac{1}{2}$ in. wide, for the curved cross strip.

Cross Strip

This strip is a piece of cane, $\frac{1}{4}$ in. square section. It should be centred and be glued in the backbone, the joint being bound with thread, as before. Cut the paper to size given, and glue it to the backbone. Leave for a bit for the glue to harden and hold the paper alright, then bend the cane to the right and left corners, and fix there with narrow pieces of gummed tape.

The holes for the bridle line should be bored through the backbone at 3 ins. from the top, and 4 ins. up from the bottom, and the bridle line itself made from thread or fine twine, as advised for the previous kite.

The Fin

For the fin, cut a piece of stiff paper to the shape given, and glue to the kite, approximately where shown in the diagram. The curved cane should keep the paper quite taut, and help the flying qualities of the kite efficiently.

In place of the paper, it would be a good plan to try using a fine fabric, parachute silk, for example. In this case small pockets are made at each corner of the stuff, into which the ends of the framework can enter. The fin can be of the stiff paper, as before, gummed or stitched to the fabric.

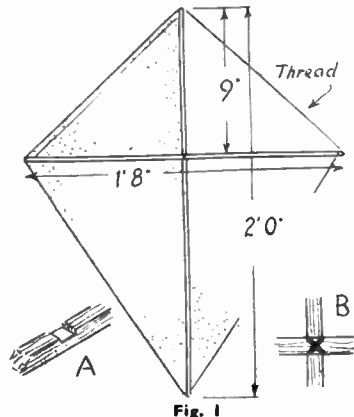

Fig. 1

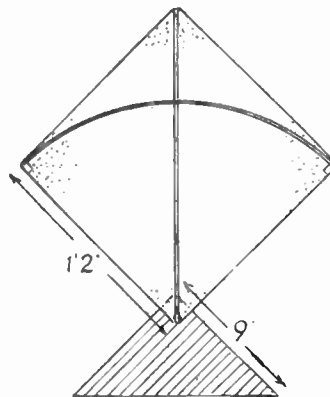

Fig. 3
85

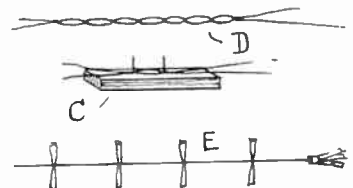

Fig. 2

Paper, feathers and stamps can be converted into simple CHILDREN'S NOVELTIES

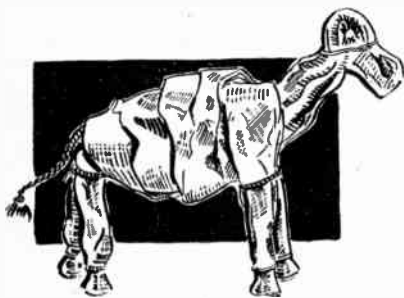

Fig. 5—The novel animal completed

CONSIDERABLE fun at practically no cost can be had by making weird 'animals' out of rolled-up newspapers. The curious creature shown at Fig. 5 might be something from prehistoric times. Here is how to make it.

Take a double-spread sheet of newspaper and roll it up, as shown in Fig. 1. Tie the ends, like a sausage. Then prepare another roll (Fig. 2).

Double up one roll and lay the other behind it as in Fig. 3. Wrap the 'arms' round the 'body', as in Fig. 4. You can now bend these arms . . . or is it legs? . . . down and tie them together, each pair, just under the body. This will prevent them spreading out. This string can be seen in Fig. 5, which also shows how the head is shaped by tying a string round.

By pressing and moulding the paper between your fingers, you can shape the body better. The legs will usually have

to be trimmed so that the model will be able to stand properly. This may mean that you will probably have to untie the string you first tied around the feet and, after trimming, retie.

When you are an expert at making these models you need not tie the ends of the paper rolls until the model is quite finished, but, at first, it is much more convenient to tie in the first place.

It is possible to get more accurate modelling by working up to the stage already described and then wrapping strips of crêpe paper of appropriate colour all round the model, so that the newspaper is hidden and the surface becomes smoother. Naturally, you will not forget a piece of string for the tail!

Feather Gliders

For the feather glider which you see illustrated at Fig. 6, you will need one large cork, two large feathers and two small feathers. Each pair of feathers should be alike in shape and size.

For the wings of the glider, stick the two large feathers into the front of the cork, at a slight upward angle, as seen in the sketch. Then stick in the two smaller tail feathers, taking care that they are at the same angle.

At the front of the glider put some sort of small weight. A hobnail or a cricket-boot spike would do very well.

The glider may now be launched. Usually one has to adjust the feathers before a smooth non-rolling flight is obtained, but this is all part of the fun.

A novel idea for using odd bits of plywood is the postage stamp jigsaw (Fig. 7). Most fellows, having some

foreign stamps in duplicate like to keep them for 'swap', but there are some stamps that are so common that they are left on our hands and we should be able to spare a few for a very interesting and novel jigsaw.

Stamp Jigsaws

A piece of plywood about the size of a postcard is obtained (larger, if you have more stamps to spare). First paste a piece of black paper over it and then paste the stamps on. As stamps are of all different sorts and sizes, it is hardly likely that they will all fit in exactly, but the idea of using a black background is so any gaps appear black.

Whilst the paste is drying, keep the board under pressure, to prevent it warping. On the reverse side of the board pencil out the jigsaw divisions and cut out, taking care to smooth off 'whiskers'.

Putting this jigsaw puzzle together is a good test of philatelic knowledge as, if we know our stamps, we can spot adjacent parts, quite unlike ordinary jigsaw puzzles.

In cutting out the parts it is best if the pieces are arranged to interlock, as in the piece shown separate in the lower right corner. It is much more convenient to assemble the puzzle if this is done. (125)

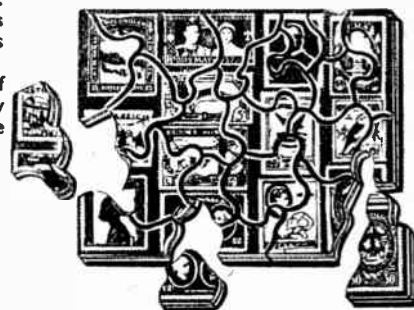

Fig. 7—A small jigsaw of stamps



①



②

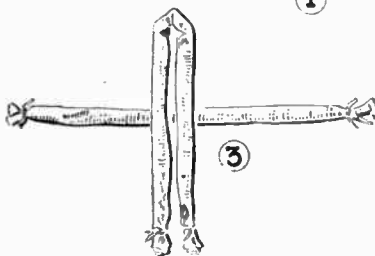
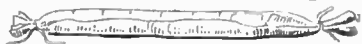

③

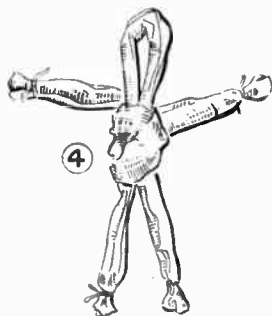

④

Details of how to roll and fold the paper figures



Fig. 6—A simple feather giro glider

An Index for Vol. 109, up to the end of March is obtainable for 1/- post free. Useful for reference or binding.

For fireside or garden you will find a use for A GAY LITTLE STOOL

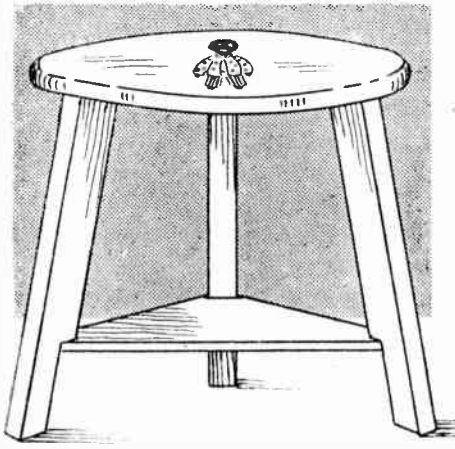

THE stool shown here is easy to make and, with its gaily painted little golliwog or a suitable colour transfer or picture affixed, is sure to prove a popular favourite with any child. A plan and elevation are given and in these you will find the chief dimensions and the general lay-out of the work.

It will be seen from these views that the three legs are let into the top to a depth of $\frac{1}{2}$ in. and are notched out at the bottom to provide a fixing for the triangular brace that keeps the lower ends of the legs securely fixed in their correct position.

Making the Legs

The first job will be to make the legs. After the wood has been planed to thickness the shape of the legs should be marked out as shown in Fig. 1.

The angle at each end and the end of the notch should be carefully marked out with the aid of a bevel to get them all alike. It will simplify the work here if one leg is marked out first and then the three of them put side by side and the remaining two marked out from the

first one. This method will ensure all the legs being exactly the same length and that the stool will stand firmly when it is assembled.

The bevells on the ends of the legs can now be sawn. Then the notches are cut at the lower ends and the tenons $\frac{1}{2}$ in. long cut at the top. These operations are quite straightforward and should not need any further explanation.

The Top

The next job is to set out the circular top and the positions of the sinkings into which the ends of the legs fit, as shown in the plan view at Fig. 3.

If the circle is drawn and then the radius stepped round it carefully it will go exactly six times. Now join every other mark to the centre of the circle and you will have the centre lines for each of the three sinkings. These lines are shown in the plan.

The outer end of each sinking is 1 in. in from the edge of the circle and the length of the sinkings will be equal to the width of the tenon on the tops of the legs. A glance at the plan should make this part of the marking out clear. The sinkings are cut out by making a series of chisel cuts across the grain and then removing the waste wood by using the chisel with the bevelled edge underneath so it has a cutting action similar to a plane.

If you have a small router this can be used instead. Care must be taken to ensure all the sinkings being the same depth, otherwise the stool will not stand firm when it is assembled.

To complete the top, cut out the circle with a bow saw and finish off the edges with a spokeshave and glasspaper.

The triangular brace is the final part of the work

to be made and details of this are shown in Fig. 2. An odd piece of plywood will do admirably for this part but any piece of thin wood can be used instead.

An equilateral triangle with $7\frac{1}{2}$ in. sides should be set out with the aid of a compass and then the corners marked out as shown, to leave an end 1 in. wide where it will finally fit in the notch in the legs. This part can now be sawn to shape and the edges cleaned up with a plane.

Finishing Off

All the parts should now be cleaned up, glasspapered and fixed together. A $1\frac{1}{2}$ in. oval brad should be driven through the top and into the top of each leg, punched below the surface and the hole stopped up. The triangular brace is glued and screwed into the top edges of the notches from underneath so that the screw heads will not show.

When the glue has set the work should be given a final clean up and then two or three coats of paint or enamel. It will look best if done in a pastel shade of some colour, that will go with its surroundings. The light colour will thus form an excellent background for the painted design and throw up its bright colours.

The Design

The next stage is to draw out the golliwog design and, for the benefit of those readers who may not be very good at art, it is shown in Fig. 4 drawn

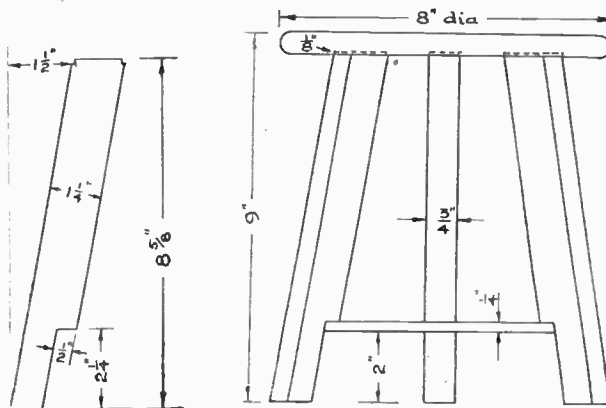

Fig. 1—Details of leg shape and elevation of table with legs in place

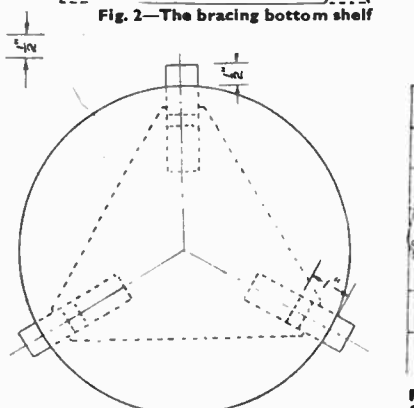

Fig. 2—The bracing bottom shelf

(Continued from page 89)



Suggested figure for top



Fig. 4—Drawing of figure in squares for enlarging

Household hints which are useful to those undertaking PAPERHANGING

WALLPAPER which for years has been almost unobtainable, can now be bought more easily. Before the war most handy householders knew how to paperhang, but with the lapse of seven or eight years, these people have almost forgotten, and the younger generation who were but children in those far-off days, have never had the chance to show their skill.

With the shorter working week and the high cost of living, more people will want to do their own jobs about the house, and while these notes are not a full treatise on paperhanging, they do emphasise the points where the amateur is likely to trip up.

For instance, in dealing with paste, in the pre-war days it was general practice to make your own from flour, but this method is not now recommended, as the present-day flour cannot be relied on.

Preparing the Walls

If the walls have been previously papered, all the old paper should be stripped off. A good way of doing this is to dab or brush hot water on to the old paper, giving the whole surface three or four applications, starting at one corner and working round the room. When the paper is thoroughly soaked, it will peel off in sheets. If at the first attempt the paper does not leave the wall easily, it is much better to continue with the hot water treatment than try to pull the paper off in small pieces, a slow and tedious job.

A proper stripping tool can be bought for a few pence, but a bricklayer's float will do just as well. In fact, the writer found that by using one of these tools, it was much quicker.

If the walls are damp or very porous, they should be sized before re-papering. This can be done by dissolving $\frac{1}{4}$ lb. of concentrated size to $\frac{1}{2}$ gallon of hot water and applying it to the walls with an old white-wash brush.

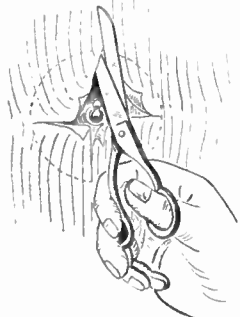

Fig. 2—Round a switch

The ceiling must be attended to before the papering is started, and if any painting is to be done, all but the finishing coat should be applied. When the last coat is put on after papering, do not paint right up to the paper, as this will cause it to run and spoil the whole job.

Amount of Paper Needed

English wallpaper is supplied in rolls

12yds. long and 22ins. wide, but it is advisable to reckon on only 11yds., as the ends are almost always damaged, and the width should be reckoned as 21ins., as 1in. is used up in trimming. If a piece of cardboard is cut 21ins. long, this can be used for measuring round the room.

The number of pieces and their length are added up in feet and divided by 33, giving the number of rolls required. If it is a patterned paper, at least half a roll extra should be added for a medium sized room, or, say, for every four or five rolls used.

If it is possible to get the paper machine-trimmed at the shop, it is much better, but if the job is done at home, care should be taken to cut off every trace of the dark edging line, this applies especially when dealing with light coloured papers. At the same time if it is a patterned paper, too much cut off will spoil the matching of the pattern.

Matching the Paper

Care should be taken when dealing with patterned papers, as it is very easy to make a mistake. The simplest way of tripping up is to measure one length of paper and cut the other lengths to it. This is alright when the lengths cut off make up so many complete patterns, but if the lengths are, say, $4\frac{1}{2}$ patterns, half a pattern will have to be cut off each time to make the lengths match up.

Another point when dealing with patterned papers, try to start at the picture rail with a complete pattern, this will add greatly to the appearance of the finished job.

Where to Start

Where to start is very important; it has a direct bearing on the visibility of the joints. First stand in the doorway and then in the middle of the room and observe the source of light. If the overlap on the paper is made away from the light it will throw a shadow and show clearly the position of the joints.

Therefore, start near the window and work towards the door, as shown in Fig. 1. When butt jointing the paper this does not matter, but it is not advisable to try butt jointing unless the paper has been machine trimmed and the operator has had some experience.

The Paste

The success or failure of the whole job can depend on the paste. Do not start the job until you are perfectly sure the paste is alright. The best plan is to buy a well known brand of paste powder and follow the instructions very carefully. Most powders are first mixed in a drop of

cold water, and it is this first mixing that is very important.

It is a good idea to finish this preliminary mixing with great care, ensuring that the smallest lumps are broken up, as these lumps will increase in size when the boiling water is added. It is important that the correct amount of boiling water is added. If the paper is very thin, slightly more water than is

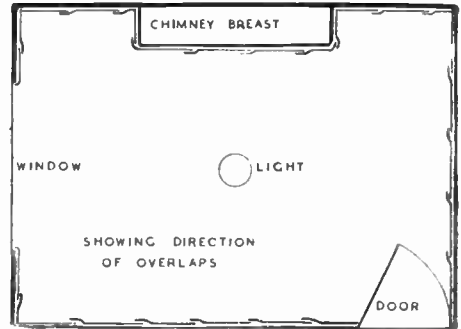

Fig. 1—A diagram showing direction of operations

given in the directions can be added, and for thick papers, slightly less. It should be remembered that the paste thickens considerably as it cools off.

For medium thick paper the paste should be about the consistency of cream. If the paste is too thick, it can be thinned down by re-boiling and adding more boiling water. Do not start the job until you are perfectly satisfied that the paste is right. Too thin a paste will cause the paper to leave the wall in patches, and too thick a paste will leave unsightly lumps under the paper.

Pasting and Hanging

Not many amateurs possess a pasting board, and to use the polished table will be asking for trouble. Quite a good job can be done by using the floor. Sweep the floor and lay down sufficient newspaper to take one full length of paper. Cut off a length of paper, leaving it several inches longer than the wall measurement and lay it on the newspaper face downwards. Place the bowl of paste in a convenient position and have the pasting brush handy.

Have handy also a paperhanger's brush, a pair of scissors and a piece of soft cloth. Apply the paste evenly, making sure to cover the whole surface. Do not draw the brush inwards over the edges, as this will cause paste to collect on the underside. One fold about a third of the length from the bottom will be sufficient, unless one is skilled too much folding will get paste on the wrong side. If the paper is thick, allow it to stand about two minutes before hanging.

Offer the paper to the wall, holding

(Continued foot of page 90)

Decorative plates for book-ends or letter rack made by METAL ETCHING

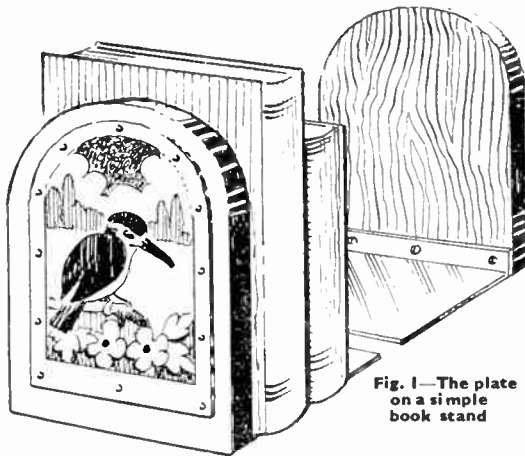

Fig. 1—The plate on a simple book stand

Another method of etching the surface, and one which gets, perhaps, a more effective picture, is to coat the plates with wax all over and then draw on the design with a needle point, hatching in certain surfaces just as seen in the picture of the book end at Fig. 1. The metal plate is immersed in a nitric acid and water solution of about two to one, using a photographer's flat tray.

If the etching or action of the acid proceeds too violently, add a little water to it. After an hour or so of the action, remove the plate with kerosene and wash thoroughly with soap

and water. used, as this will hold the line well during cutting. The work can also be done more quickly than if a finer saw were used. The edges must be carefully glasspapered and the true semi-circle not lost in the cleaning and papering.

Each upright has a metal plate attached by countersunk screws. The turned edge for attachment is a true right angle by being bent over the jaws of a vice and hammered to make a neat finish. The full-size brass plate for mounting on each upright is given on the pattern sheet with the position of the holes for screwing on. The edges of the brass plates must be filed off and made smooth before attaching.

It should be best to coat the etched brass plates with a uniform coating of lacquer to preserve the finish.

Letter Rack

The letter rack design is of very simple outline and construction. It could be made entirely from $\frac{1}{4}$ in. wood, with, perhaps, a base of $\frac{3}{8}$ in. wood to make a stiffer job. We give a full-size outline of the front and the back of the rack on the pattern sheet, and these can be transferred to the wood by means of carbon paper.

Cut the base to the size given, and $\frac{1}{4}$ in. or so in from the front edge of it, draw the mortise as shown. The length of the mortise should be checked from the tenon (A) on the front, before it is actually cut.

The decorative 'Kingfisher' plate of this rack and of the book stand should be screwed to the face of the wood after it has been stained and polished or oiled,

HERE is a very interesting and effective method of decoration, and one that will be quite new to many Hobbies readers and workers. For such articles as book-ends, book stands, letter pockets, letter racks, and a host more that will suggest themselves to the reader, the art of etching on brass or copper can be practised, just as is shown in the two examples given here.

The method is simply this. A sheet of the metal is obtained of the right thickness—about No. 16 gauge, and cut to the required size. The edges are smoothed off with the file. The face should be polished with a piece of fine emery cloth and the design to be etched on the metal laid out ready to be transferred to the surface by means of carbon paper.

Some ordinary black grate enamel may be used; if it is too thick, thin it with turpentine or a turpentine substitute.

Acid Action

All the main surfaces of the pattern of each panel shown on the pattern in cover three of this issue, will be very slightly sunk by the action of the acid which will later be applied. The lines of the design will stand up and it will be these lines, therefore, which will be covered with the asphaltum or enamel.

and water.

If the first method has been adopted, then a colourful effect is obtained by painting in with a good enamel all the sunken surfaces. In fact the enamel could almost be floated between the raised lines. Appropriate colours should be chosen.

If the worker is going in seriously for etching and, perhaps, making it a paying pastime, we advise him to get a cheap treatise on the art of etching. He will find the work most interesting.

Book Holder

Now to describe the two articles suitable for the mounting of etched and

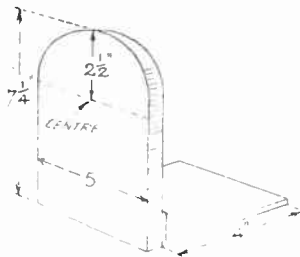

Fig. 2—The book-end and base

enamelled plates such as given full-size in this issue. For the book-end, a piece of $\frac{3}{8}$ in. or $\frac{1}{2}$ in. hardwood should be cut to the outline given. A coarse fretsaw is

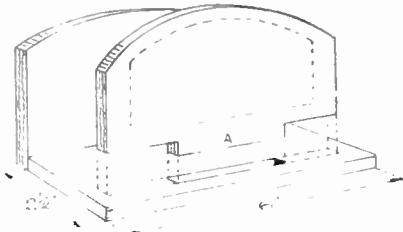

Fig. 3—How the letter rack is built

whichever finish is applied. Note in Fig. 3 that the back upright of the letter rack is screwed to the back of the base to make a very secure fixing.

Stool—(Continued from page 87)

out in $\frac{1}{2}$ in. squares. If a larger figure is preferred the squares can be made a little bigger and the diagram copied in exactly the same way.

Design

It is best to draw the design out on a piece of paper first and then, when you are satisfied with it, transfer it on to the wood with the aid of a piece of carbon paper. Or, of course, you can put down

one of the gay transfer pictures.

Painting

The colours for this part of the work should be as bright as possible apart from the black for the face, hands and feet. Those suggested are scarlet for the mouth and for the coat (leaving spots where the undercoating will show through), white trousers with blue stripes, and white for the collar and

teeth, and yellow for the bow and shirt.

An ordinary artist's paint brush, about No. 7, can be used for applying the colours and, when painting the figure, one colour should be allowed to dry thoroughly before an adjacent one is applied. The brush can be cleaned out in turps or paraffin when one colour has been finished with.

Or you may like to glue on a colour picture and varnish over it.

Economy and longer life ensured by proper use of PAINT BRUSHES

DURING early summer most handymen do a little house painting and make acquaintance once more with that most useful article—the paint brush. Despite the value of this friend of ours there is, perhaps, no 'tool' that is often more ill-used when no longer in immediate requirement than the paint brush, and no tool that has to be so frequently replaced. Actually, brushes correctly looked after should last almost a life time.

Let us see, therefore, how they should be treated. In the first place, always buy the best brush you can afford, and also the correct one for the job in hand. Brushes are a big price at the moment but even so a dearer brush is the better investment, for it will give a finer finish to the work and yield years of service.

Indeed, the older it grows within reason the better it will work. With paint brushes the adage that 'new brooms sweep clean' is not altogether correct, for brushes of this kind do nicer work after they have been used for some time—the bristles then lying more evenly and producing a smoother surface.

Hair or Fibre

With brushes now-a-days one has largely to take what can be got, but normally there is the choice of animal hair or fibre. If you see the stamp 'Pure Bristle' it means that only the hair of the pig or boar has been used. You can tell if a brush is bristle or fibre by holding a single 'hair' in a flame. If a charred knob comes on the end it is bristle. Should it burn away to an ash you are dealing with fibre.

There are a large number of types of brushes on the market from the small $\frac{1}{2}$ in. to the wide 'white-wash brush'; there are also flat and round varieties. For the home handyman, flat brushes are

the best, and it is good to collect a set of several widths as, say, 1in., 2ins. and 3ins.

Another reason for obtaining fairly expensive brushes is that they always contain a greater weight of hair and so hold more paint at a time—a factor which quickens the job and in itself reduces the danger of brush marks.

The first thing to do when you have got a new brush is to ease up the hair. This is done by working it up and down in the palm of the hand as though painting. This action also shakes out any dust that may have collected and removes loose strands.

Soak before Use

If set in wood the brush should now be soaked for an hour or so in cold water, as this will swell the 'stock' (the handle) and cause the hairs to be gripped tightly. Many persons use a new brush right away and then are surprised when it at once begins to shed bristles. The soaking would have prevented this. Brushes in which the hairs are held in a rubber solution do not need this treatment. After the soaking, shake well and again rub on the palm and work can start.

To put the first lot of paint on, dip in the brush for about three-quarters of the length and then press out on the side of the pot. Repeat this several times and work the brush on an old board to get the paint well to the centre.

You can now get on with the job, but even so a new brush should never be used for a first coat, as even the best to start with are fairly stiff and leave brush marks to say nothing of the early tendency to shed a few hairs.

Also after use the ends of the bristles wear slightly into a good shape which makes them cling together and lay on the paint better. In the trade a brush that has reached the good condition is spoken of as being 'worn in'.

The most important thing in the preservation of brushes is naturally, the

storage in between jobs. Despite the recommendation, brushes should never be wiped out and left dry, but should be stored in a 'keeper'. The 'keeper' is a container of water in which the brushes are suspended and the best way of suspending is to bore a hole in the stock of each and run a wire through.

As much paint as possible must be pressed after use from a brush, but it is never possible to clear the top entirely where the bristles enter the stock. With any dry storing this always in time hardens and so causes brush marks on the next piece of work. With a 'water keeper' the top always remains pliant.

Even if it only means that you will not be requiring a brush for a few hours, scrape it out and place in the 'keeper'. Left standing in the paint, while certainly keeping it soft, will bend the bristles. If storing for many months, keep an eye on the water in the keeper, as it evaporates in the course of time.

Cleaning and Keeping

Brushes that have been used for enamel work should have a solution of half turpentine and half linseed oil in the keeper in place of water, as enamel paints will harden under water. Never store enamel brushes in turpentine alone, or they will become a gummy mass.

A keeper for varnish brushes also should contain linseed oil and turpentine. When taking a brush from the keeper, scrape out the oil and work up with a little of the new paint, say, in a tin lid, and it is then ready for use.

'White-wash' (distemper) brushes should be well washed out with soapy water after use and hung bristle down in some cool dry place—and, incidentally, where mice will not get at them. Sometimes it is necessary to change a brush over from one paint to another, and this can be done satisfactorily by well washing in turpentine.

Paperhanging—(Continued from page 88)

each side with the thumb and forefinger about 1in. from the top and keeping it parallel with the corner. Fix it about $\frac{1}{2}$ in. over the picture rail. Take one sweep upwards with the paperhanger's brush, keeping to the centre of the paper, then unfold and brush down the centre of the paper to the skirting board.

Next brush outwards from the centre, and from top to bottom. Draw the back of the scissors along the picture rail and the skirting, marking the correct length of the paper. Pull the paper away at the top and bottom and trim to length. Finish by brushing from top to bottom, first down the centre and then from the centre to the edges.

If fresh newspaper is laid down before pasting the next piece there will be no risk whatsoever of the paste getting on the wrong side. Offer the second

length, resting the forefingers on the wall while the eye is cast down the joint.

Adjust this to give about $\frac{1}{2}$ in. overlap, and finish off as with the first piece. Do not play too much on the joints. Extra pressure will squeeze out the paste and smear the pattern, and if it is raised paper, the extra pressure will flatten it out and make the joint plainly visible. If for some reason the joint opens, very careful dabbing with a soft cloth will put matters right.

Some amateurs make a joint at each corner, and this is a good idea, because if the corner is out of square, creasing will occur. To make the joint in the corner may mean cutting down the whole length, and for the amateur this is best done before pasting. Measure to the corner, then fold the length to the

measurement and draw a carving knife down the fold. It sometimes pays to cut down the length when dealing with the chimney breast, as these corners are invariably out of square.

If a raised light switch comes in the middle of a length, hang the piece as usual, brushing the top half. Next, pierce the paper with the scissors at the centre of the switch and then cut across as shown in Fig. 2. The paper can then be pressed round the switch with the back of the scissors, thus marking it for trimming.

If the paper is accidentally cut short, either round the switch, or at the picture rail or skirting, pull the paper away from the wall, fit a piece of pasted paper, then brush back the main piece into position.

HOBBIES in PICTURES



THERE is such a thing as being too good at one's work (or rather hobby) and Charles Wilkin, last war Gannery Sub-Lieutenant, has found it out. In his car park manager's office at Southend-on-Sea he makes many fine models of sailing ships. His finest work, the barque 'Pamir' was so well made that burglars broke in—and the 'Pamir' sailed away. The 'Pamir' is very like the 'Catty Sark,' the famous tea clipper of which so many models are made from our design and kit of materials.



A CINEMA with the lid off! Brian Marshall, 13-year-old schoolboy, of Chasefield Road, Tooting, S.W., with a 4ft. long, scale model of the Granada Cinema, Tooting, which has taken him a year to make. Brian's shilling-a-week pocket money for the past 12 months has all gone to buy balsa wood, cardboard and glue for the model. He took his measurements for it in the empty cinema on Saturday mornings after his friends had gone home from the children's club matinees, and worked on it at home after finishing his homework every evening.



ANOTHER idea for a use of model boats. This one is a replica of a two-masted brig such as formerly sailed from Wells-next-Sea, Norfolk, and is one of a collection in the Parish Church, being accumulated as representing the maritime activity of that old port. The Rector, formerly Merchant Navy, is naturally keen.

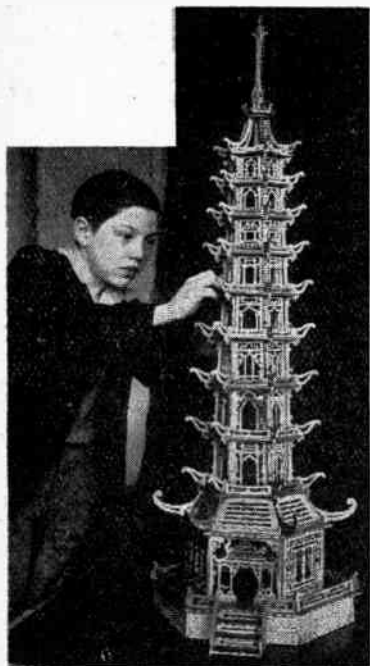

HOW'S this for a piece of fretwork? No wonder the young man is proud of it—and of the fact he didn't break one piece in putting it together! He is Albert Wilson of 23 Parliament Street, Burnley, Lancs., who had only been doing the work just over three months. Of course, he used a Hobbies Fretmachine and completed the whole thing in a month. Parts are all glued—no nails being used.



ANOTHER ancient ship, but of quite a different type. Note the bright colours of the sails of 'Golden Hind,' compared with the drab work-a-day appearance of the trading brig. This model was made by Alexander Walters of Lamond Drive, Edinburgh, whose next effort is Captain Scott's famous exploration ship 'Discovery.'

MAKE 5/- an hour, genuine home employment. Full instructions, 3/-. 6 different advertising magazines, 1/-.—R. Lowes, Rectory Terr., Simonburn, Hexham, North'nd.

100 DIFFERENT stamps free (including triangular and pictorials), to approval applicants enclosing postage.—N. Johnson (Dept. H), 19 Hillside, Slough, Bucks.

500 COLLECTORS' duplicates, 2/6. Amazing variety.—Belfields, Stour Hill, Quarry Bank, Staffs.

PERSONS required to fill vacancies in our out-work department. Write—Dept. 11, Empire Co., 117 Nottingham Road, Loughborough.

REQUEST stamp approvals. Receive small album, stamps, hinges, free. Postage 6d.—A. M. Day, 73 Thornton Gate, Cleveleys.

SELBY for stamps. 50 Norway, 2/6; 50 Airmails, 4/6. S.A.E. for catalogue.—66 Donnington Road, London, N.W.10.

YOUR stamps—do you still want them? Why not turn them into cash? Private collector wants Victorian collection, Liberia, Borneo, etc., Forgeries, Specimens, anything unusual.—Tombs, 31 Frances Rd., Windsor.

U.P.U. packet contains 100 different Empire stamps, including 10 U.P.U. (no G.B.), 2/6 post free.—Bisson, 46 Sumatra Road, London, N.W.6.

STAMPS—Gifts—Discount. Applicants for our Overland Approvals can obtain our free gift stamps, including Greek (Salonika) 20 1. Pictorial (Cat. 1/6). Enclose 3d. requesting approvals.—Overland Stamp Co. (HO), 203 The Avenue, West Wickham, Kent.

AMERICAN Magazines post free for 1 year. Popular Mechanics, 32/-; Popular Science, 28/6; Mechanix Illustrated, 22/6; Popular Homecraft, 18/- stamp for full list of others.—Willen Ltd. (Dept. 57), 101 Fleet Street, London, E.C.4.

ENTER the Juneero National Model Making Competition. Cash and kit prizes to the value of £150. Send now for details or see the Juneero Annual, 1/-, from all Juneero Dealers, or 1/2 post free from Juneero Ltd., Boreham Wood, Herts.

PLYWOOD. New selected, 27×19× $\frac{3}{8}$ in., 7 for 20/-; Veneered Oak, 6 for 30/-; 20×20× $\frac{3}{8}$ in., 9 for 20/-; Veneered Oak, 7 for 29/9; see list (2d.) for other veneered panels. B.C. Pine Ply, 17×7× $\frac{1}{2}$ in., 24 for 16/-; Parana Pine Ply, 17×6 $\frac{1}{2}$ × $\frac{1}{2}$ in., 48 for 16/-; all post paid C.O.D. Box Bottoms, 18×16× $\frac{1}{2}$ in., Birch, 8 for 20/-; Teak, 5 for 20/-; Pine Lids, 39×17×1 $\frac{1}{2}$ ins., 10/- ea.; one side clean. Ex-W.D. Stretchers, very good condition, 10/- ea. All sent Carr. forward cash with order.—H2/JDD. Storage, 71 Northcross Road, S.E.22.

PERSONS required make fancy goods at home. Write for details.—Melton Manufacturing Co., Southgate Street, Leicester.

ENGRAVING on Perspex; send drawing and S.A.E. for quotation.—Geo. Cleaver, 50 Windsor Road, London, N.W.2.

2 $\frac{1}{2}$ ins. Pressed Metal Wheels, 2/- dozen; 8/6 half gross; 15/- gross. Enamelled red or blue, 6d. dozen extra. Hardwood, pressed metal, metal disc wheels, Doll's House windows, doors, papers. Catalogues 6d.—Jasons, 135 Nags Head Road, Enfield, Middlesex.

INTRODUCTIONS. Pen friends, companionship or marriage.—V.C.C., 43 Honeywell Road, London, S.W.11.

BE Taller. Quickly/ Safely/ Privately/ BNo appliances—no tablets—no dieting. Details, 6d. stamp.—Malcolm Ross, Height Specialist, BCM/HYTE, London, W.C.1.

MODELS. You can make lasting stone-hard models with Sankey's Pyrama Plastic Cement. Supplied in tins by Ironmongers, Hardwaremen and Builders' Merchants. Ask for instruction leaflet.

TRANSFERS for decorating toys, trays, furniture, fancy goods. List and samples free. Flowers, pixies, dogs, nursery rhymes.—H. Axon Harrison, Jersey.

PRESSED Metal Wheels. 1 $\frac{1}{2}$ ins., 1/3; 2ins., 1/9 per dozen. Or in stove-enamel finish red, green or blue, at 6d. per dozen extra. Tax included. Post Paid.—The Joyden Toy Co., 193 Chase Side, London, N.14.

DOLL'S House fittings and papers; send S.A.E. for list. Doll's House plan special; send 2/6. Trade supplied.—Zimplan, 88 Ware Road, Hoddesdon.

CONSTRUCTIONAL Kits, 4mm and 7mm Scale Lorries. Also large range spare parts from which to build to your own design. Price lists, 1d.—Wilson's Lorries Ltd., Dept. H., 1/6 Gt. Winchester Street, London, E.C.2.

100,000 Government surplus bargains for model makers and hobbyists. Micro switches, universal, make or break, 250v 5amp., 125v 10amp., brand new, 3/6, post 3d. Cellulose acetate, thin, slightly cloudy, 10ins.×10ins., 4 for 1/6, post 6d. Sponge rubber strip, approx. 18ft.×1 $\frac{1}{2}$ ins.× $\frac{1}{8}$ in., 2/-, post 9d. Aluminium rivets, approx. 1lb. assorted, 2/6, post 6d. 20amp. toggle switches, 9d., post 3d. 70 ohm variable resistances, 9d., post 3d. Metal boxes, very well made (by Roneo), ideal deeds, tools, etc., 15ins.×10 $\frac{1}{2}$ ins.×10ins., 8/6, post 1/6. These are just a few of our interesting bargains—send 3d. stamp and S.A.E. for new illustrated catalogue.—Milligan's, 24 Harford Street, Liverpool, 3.

£5 to £20 weekly earned at home, running your own Mail Order business. Details, 1d.—Stebbing Publications Ltd. (HB), Naphill, High Wycombe.

LONELY? Then write Secretary L.U.C.C., 5B.B. Hay St., Braughing, Herts. Genuine. Est. 1905.

HARDWOOD Wheels, 2ins., 1/-; 3ins., 2/- per set of four. Tax included. Post paid. Other sizes available.—The Joyden Toy Co., 193 Chase Side, London, N.14.

PLYWOOD offcuts. Birch and Gaboon in various thicknesses. Handy sized parcels for the cabinet, toy, model maker, and all handicrafts. Parcels made up in £1 and 10/- lots. Carriage paid. Send P.O. to Reeves, Plywood and Timber Merchant, 33 Front Street, Monkseaton, Whitley Bay. Tel. W.B. 4677.

BLUSHING, shyness, nerves, self-consciousness, fears, ended. Details under plain cover, 1d.—Stebbing Treatment, 28 (HB) Dean Road, London, N.W.2.

FASCINATING and Profitable hobby, casting ornaments, toys, etc. You can easily make these yourself. Paints, brushes and all accessories. Illustrated catalogue of 700 Moulds, plus latest list of Rubber Moulds with instructions, 9d. post free.—Cock of North Moulds (H), 140 Hollings Road, Bradford.

FURNISH that Doll's House with the latest model furniture, glassware, food and accessories. List 8d.—Sutton Models, Billericay.

HOBBY plaster casting with flexi-mould.—Dohm Ltd., 167 Victoria Street, London, S.W.1.

BE Taller in 14 days or money back. Details, 1d.—Stebbing System, 28 (HB) Dean Road, London, N.W.2.

STAMPS free—Empire Packet including Pictorials and Victorians free to approval applicants.—Robert J. Peck, 7A Kemp Road, Bournemouth, Hants.

KALEIDOSCOPES. Fascinating novelty for all ages! Ingenious optical creation of ever-changing colour designs. Endless variety. 2/6 post free.—'Stymit', Dept. H., 1/6 Gt. Winchester Street, London, E.C.2.

COLLECTORS' delight—my world-famous Oxford approvals. Generous discount and free packet with each selection. Postage please.—Frank Kennedy, 37 Juxon Street, Oxford.

HOME Watch and Clock Repair Outfit. Includes watchmaker's eyeglass, tweezers, screwdrivers, oilers, brush, oil, plus explanatory booklet fully illustrated. In container. Skill unnecessary. Invaluable for all fine work, 12/9 inclusive.—D. Bolster (Dept. A.), 5A Station Parade, Ashford, Middx.

ARE you interested in the fascinating hobby of Radio Construction? Send 2 $\frac{1}{2}$ d. now for details of full Constructional Manuals how to build professional-standard Radio Sets, Radiograms, Amplifiers, etc., to—Northern Radio Services, 16 Kings College Road, London. N.W.3.

HOMEWORKERS required, either sex, light assembly, part or full time. S.A.E.—Esprey, Box 18, 41 Wade Street, Lichfield.

CONJURING. 3d. for new lists and free Magical Competition.—De Hempsey, 363 Sandycombe, Kew Gardens.

Simple home-made apparatus helps immensely in SOME GARDEN GAMES

THE nice weather is here again and once more the attractive grass of the lawn draws us out-of-doors into the garden. There is nothing more pleasant than a game in the open, and here are several that the home craftsman can fix up quickly to entertain the family—as well as enjoying them himself.

Ring games are always very popular, so first let us fix up a simple one of this type. Here we require a block of heavy wood 8ins. by 8ins. and about 2½ins. deep, a light rod 2ft. long and some lengths of stiff rope each of 18ins. For the rod part of a discarded broom stave will do quite well.

Rope Rings

Cut a hole in the middle of the heavy block and fit in the rod, thus giving a solid upright as shown. Also make some half-dozen rings with the rope, of approximately 6ins. diameter. To make these really neatly the ends of the rope should be teased out a little, then interlaced by pushing the strands into one another with something blunt like a nail. The joint is finally bound tightly with strong thread or string of the kite-cotton variety.

With rope of sufficient stiffness it will be found that the rings retain their circular shape—which is, of course, what

final score set according to the time the players have at their disposal. Players take alternate throws.

Miniature Golf

'Castle Golf' can be fun, too. Here we must shape six rough castle fronts with a peaked archway in the middle, as shown in Fig. 2. Quite thin plywood can be used. The 'finish' here is, perhaps, the most important part. Give each shape a coat of grey paint and then boldly line in stone work, also supply each with a number in some contrasting colour. All this does not take long and the effect it will be found is good.

Complete each castle with a triangular back leg, made by a triangle of wood held by a hinge so that it will turn in for storing purposes. The gateway in each case must, of course, be big enough to take a standard golf ball.

The 'castles' are set out in a roughly circular path and the game is to go round the course in the smallest number of shots possible, using a usual golf club and ball, 'putting' strokes, of course, only being employed. The ball must be sent through the doorway of each castle in correct order.

How to Play

In 'Castle Golf' contestants play alternately, even though in the course of

still be bought for children) and two simple uprights made by the two crosspieces (A) to act as a base. The upright (B) should be about 4ft. tall. The hoop is attached near the top as indicated with simple lashings which can be unfastened when putting the game away—or small bolts could be used. This completes the equipment.

If a child's hoop cannot be obtained, a circle can be made with a pliant cutting from, say, a willow tree. Or if you are very hard put to it for a ring, a metal hoop from a barrel will do as a last extremity. A ring of wood is infinitely better, however.

With Tennis Racquets

Play is with tennis racquets and a medium soft ball. If racquets cannot be obtained, simple ones can be shaped from flat pieces of wood as (D). Contestants stand to start with at an equal distance either side of the hoop and pass the ball backwards and forwards. Each time a player gets the ball through the hoop he scores one point. Twelve points make a game.

Have a strong piece of cord with each game. When putting the parts away, tie the sections tightly together. There is nothing more irritating than to suggest a game and then not be able to start because this or that part cannot be found.

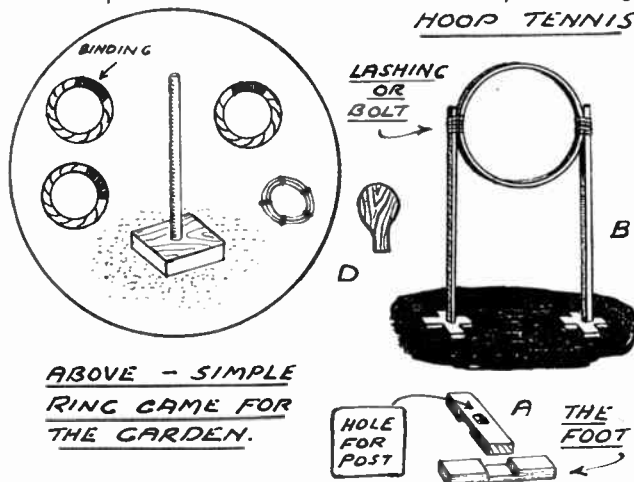

ABOVE - SIMPLE RING GAME FOR THE GARDEN.

Two simple but enjoyable games described

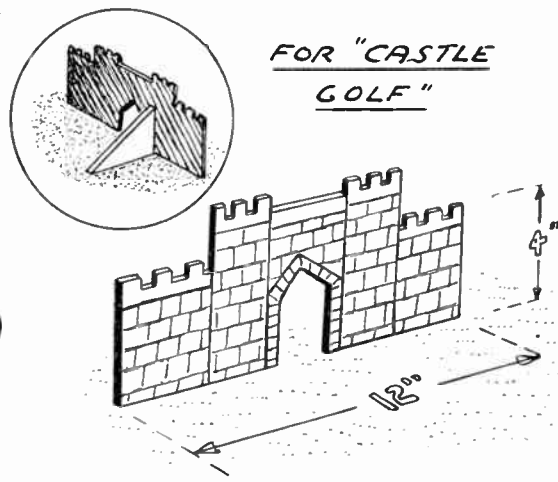

The stand wanted for 'Castle Golf'

is wanted. To give a nice appearance, colour both wood and rings brightly. Dye is best for the latter. If only thin rope is available, use two coils and then bind at intervals all round.

To play, the upright is set a distance away from a base line, varying according to the skill of the players. 10ft. is a good average range—and the aim is to get the rings over the upright in hoopla fashion. A point is scored for each success and a

the game the balls become well separated. The appearance of 'the course' is improved with cards on stakes showing the number at each castle, and these are quite worth making to go with the equipment.

Hoop Tennis

Hoop tennis is another easily rigged-up and interesting garden game. Here we require an ordinary cane hoop (as can

The art of a garden game is to be able to suggest and have it under way within minutes. Interest always seem to wane when people have to hang about waiting.

One final point about garden games—keep layouts 'tight' and compact. The general idea of such is gentle but skillful strokes and throws, rather than hard 'slogging', but this is invited if everything is too widely spaced. Keep everything, therefore, within reasonable distance.

Look out for another Article on making a Canoe

THE STEPPING STONES TO SUCCESS!

Don't hesitate about your future! Go forward, confident that The Bennett College will see you through to a sound position in any career you choose. The Bennett College methods are individual. There's a friendly personal touch that encourages quick progress and makes for early efficiency. Take the first important step NOW and fill in the coupon below.

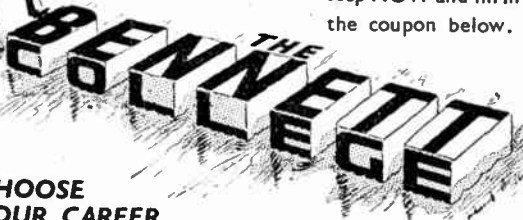

CHOOSE YOUR CAREER

Accountancy Exams.	General Education	Road Making and
Aviation (Engineer-	G.P.O. Eng. Dept.	Maintenance
ing and Wireless)	Heating and Ventila-	Sanitation
Book keeping. Ac-	counting, and Institute of Housing	School Attendance
countancy, and	Modern Business	Officers
Methods	Engineers	Secretarial Exams.
Building, Architec-	Journalism	Sheet Metal Work
ture, and Clerk of	Languages	Shipbuilding
Works (A.R.I.B.A.	Mathematics	Shorthand
Exams.)	Matriculation	(Pitman's)
Cambridge Senior	Metallurgy	Short Story Writing
School Certificate	Mining. All Subjects	Surveying
Carpentry and	Motor Engineering	(R.I.C.S. Exams.)
Joinery	Naval Architecture	Teachers of Handi-
Chemistry	Novel Writing	crafts
Civil Engineering	Plastics	Telecommuni-
Civil Service	Play Writing	cations (City and
All Commercial	Police, Special	Guilds)
Subjects	Course	Television
Commercial Art	Press Tool Work	Transport Inst.
Common Prelim.	Pumps and Pumping	Examinations
E.J.E.B.	Machinery	Viewers, Gaugers,
Draughtsmanship,	Quantity Surveying	Inspectors
All Branches	—Inst. of Quantity	Weights and Mea-
Engineering.	Surveyors Exams.	sures Inspectors
All branches, Sub-	Radio Service En-	Wireless Telegraphy
jects and Exams.	gineering	and Telephony

If you do not see your requirements above, write to us on any subject. Full particulars free.

COUPON. CUT THIS OUT

IF YOU ATTEND TO THIS NOW IT MAY MAKE A WONDERFUL DIFFERENCE TO YOUR FUTURE.



TO DEPT. 62
THE BENNETT COLLEGE LTD.
SHEFFIELD, ENGLAND.

Please send me (free of charge)

Particulars of.....
Your private advice.....
about.....
(Cross out line which does not apply.)

PLEASE WRITE IN BLOCK LETTERS

Name.....
Address.....

YOU CAN BECOME A HANDICRAFTS INSTRUCTOR

Experience not essential

Men who enjoy making things in wood or metal can turn their hobby into a well-paid, permanent and interesting Career. Short hours, long holidays, and security in a job you would really enjoy, can be yours if you become a Handicrafts Instructor. Let us send details of the easiest and quickest way to get the necessary qualification.

**We definitely guarantee
"NO PASS—NO FEE"**

If you would like to know about our unique method of preparing you for one of these excellent appointments, write today, and we will send you our informative 175-page Handbook—free and without obligation. Mark your letters "Handicrafts Instructor".

**BRITISH INSTITUTE OF
ENGINEERING TECHNOLOGY** **BIET**
595 Shakespeare House
Stratford Place, London, W.1

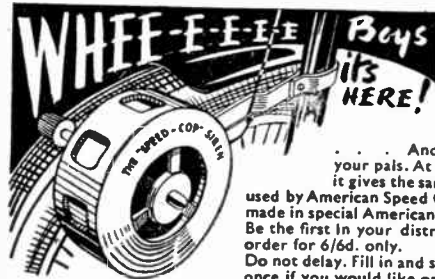

FIT THIS SPEEDCOP SIREN TO YOUR CYCLE

And be the envy of all your pals. At the pull of a string it gives the same loud warning as used by American Speed Cops. It is strongly made in special American Die-casting Metal. Be the first in your district. Send a postal order for 6/6d. only. Do not delay. Fill in and send the coupon at once if you would like one.

G. Whitehouse & Co., 1 Sunleigh Grove, Acocks Green, Birmingham 27.

Please send Speedcop Sirens at 6/6d. each.
Name
Address
H.I.

WEBLEY AIR PISTOLS



Marvellously accurate for target practice. No licence required to purchase.

Senior Mark 1
Junior Webley Air Rifle
Write for List. WEBLEY & SCOTT LTD.,
166 WEAMAN STREET, BIRMINGHAM, ENG.

BE STRONG

I Guarantee, as a Builder of Men for 22 years, to give you 10 to 25 inches more Muscle in 30 days—or money back. Full details of famous 4-in-1 Course, recommended by 'Health & Strength' since 1928, sent under plain cover on receipt of 1d. stamp. Lionel Stabbing Institute (HB/13), 28 Dean Road, London, N.W.2. Established 1928



BRANCHES

LONDON
78a New Oxford St., W.C.1
(Phone MUSEum 2975)
87 Old Broad Street, E.C.2
(LONDON Wall 4375)
117 Walworth Road, S.E.17

GLASGOW
326 Argyle Street
(Phone CENTral 5042)

MANCHESTER
10 Piccadilly
(Phone CENTral 1787)

BIRMINGHAM
14 Bull Ring
SHEFFIELD
4 St. Paul's Parade

LEEDS
10 Queen Victoria Street
(Phone 28639)

HULL
10 Paragon Square
SOUTHAMPTON
25 Bernard Street

BRISTOL
30 Narrow Wine Street
(Phone 23744)

Head Office & Factories—HOBBIES LTD., DEREHAM, NORFOLK

Decorative panels for Metal Work See Page 89

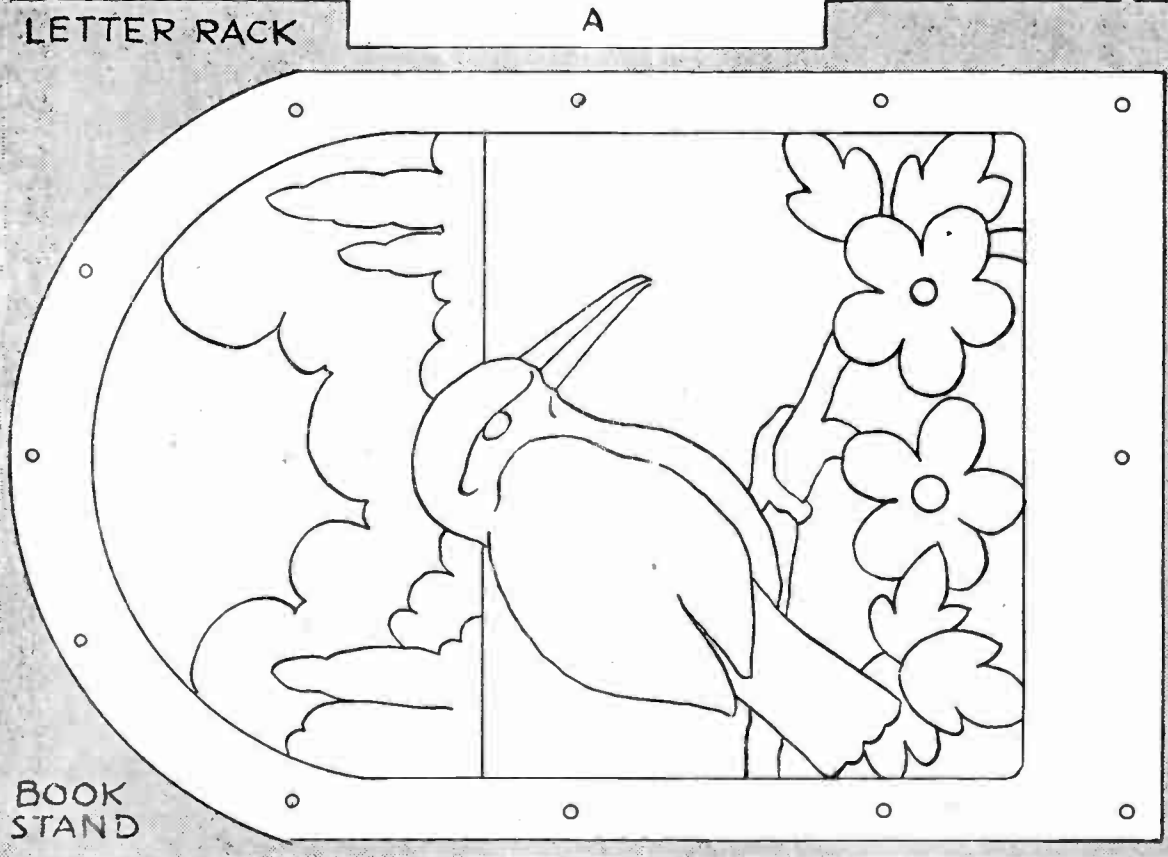
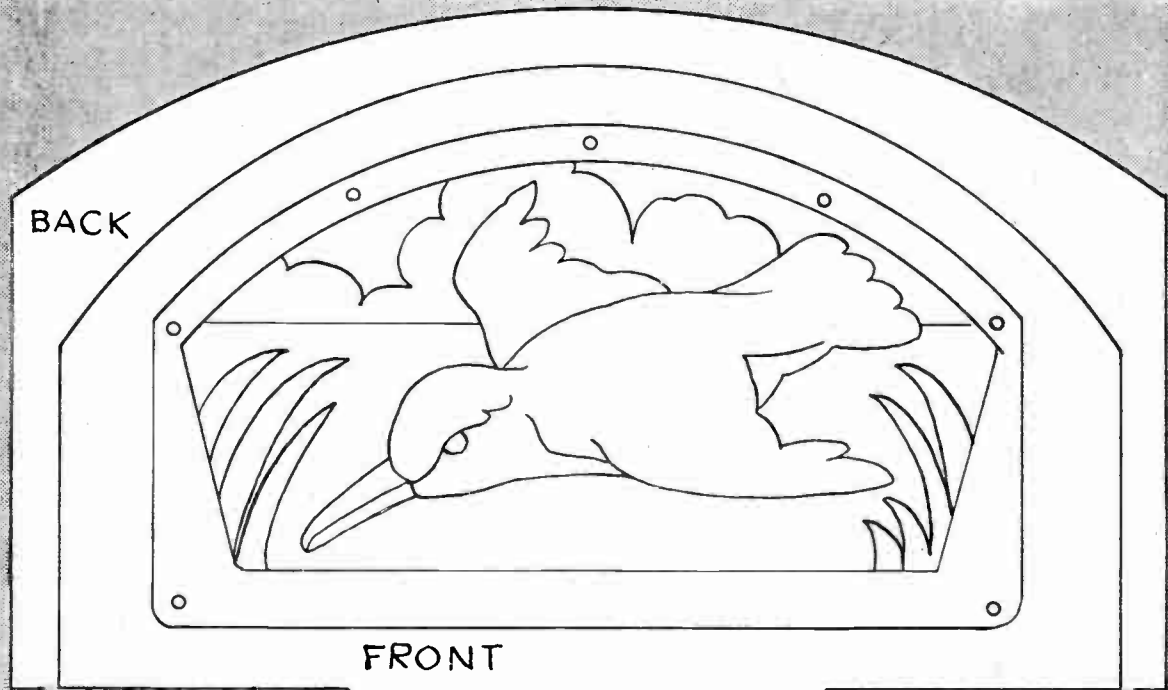

PROMOTION

WITH INCREASED PAY

That is what the younger generation are seeking—Promotion, and more money. How to get it is the big question. There's only ONE certain way and that's by systematic training such as the I.C.S. have given to millions and are giving today to tens of thousands of ambitious young men striving to add to their earning power.

Find out how the I.C.S. can help YOU. We teach a wide range of subjects. Here are some of them:

Accountancy	Commercial Art	Radio Servicing
Advertising	Commercial Training	Salesmanship
Architecture	Coal Mining	Sales Management
Building	Draughtsmanship	Sanitary Eng.
Business Management	Electrical Eng.	Structural Eng.
Carpentry and Joinery	Mechanical Eng.	Surveying
Chemical Engineering	Motor Engineering	Works Management
Civil Engineering	Radio Engineering	

LETTERS AFTER YOUR NAME

Do you wish to put 'letters after your name' that will give you recognized professional status of great and life-long value? I.C.S. students have won brilliant successes in various Technical, Commercial, Professional, Civil Service, and other Examinations, including the following:

Technical Exams:	Home Office Mining	C. Inst. Accts.
R.I.B. Arcts.	M.O.T. Certifcs.	C. Inst. Secs.
Inst. of Builders	B. Inst. Radio	Corp. Inst. Secs.
Inst. Civil Engrs.	P.M.G.	Inst. Book-keepers
C. & G. Elec.	C. & G. Wireless	Inc. Sales Managers
Inst. Fire Engrs.	R.A.F. Wireless	U.C.T.A. in Sales
Inst. Marine Engrs.	I.I.A. Foremanship	Matric—London,
Inst. Mech. Engrs.		Durham, Wales
I.M.E. for Bldg. Insps.	Commercial and Educ.	University Entr.
Inst. Municipal Engrs.	Exams.	School Certif.
Inst. Struct. Engrs.	Advertising Assoc.	Coll. of Preceps
R.I.C. Surveyors	I.I.P. Advertising	

I.C.S. Examination students are coached until successful and all Instruction Manuals and Textbooks are supplied to them free.

International Correspondence Schools Ltd.
(Dept. H.B.3) International Buildings, Kingsway,
London, W.C.2



MODEL CONSTRUCTIONAL KITS

that are well known for quality and low price

AIRYDA MODEL AIRCRAFT



Include both flying and non-flying types; sizes and prices to suit all Modellers. Each kit complete with plan, building instructions and all necessary parts.

AQUILA MODEL SHIPS & BOATS

This series includes Motor Launches, Cabin Cruisers, Motor Yachts, Cross

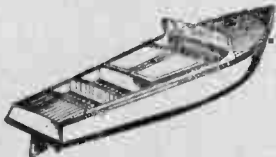

Channel Steamers, etc. Sizes range from 20ins. to 39ins. in length; and prices from 18/- to 62/6.

ANORMA MODEL BUILDINGS

This range of Model Buildings includes shops, houses, factories, railway buildings, etc., which are all designed to 4 mm. scale suitable for OO gauge Model Railway lay-outs, etc.



Full particulars can be obtained from your local dealer, or send for particulars to:

MODELLERS SUPPLY LTD.
DEPT. HO/1
ASPLEY, HUDDERSFIELD



Topical Tips on Taping!

Toys have no ending with "Durex" mending

There are no tears when you can tape with "DUREX"! Broken toys are speedily and invisibly repaired without fuss or mess. It's just one of a thousand jobs "DUREX" does.

"DUREX"
Cellulose TAPE

Trade Enquiries:
Durex Abrasives Ltd., Birmingham, 8

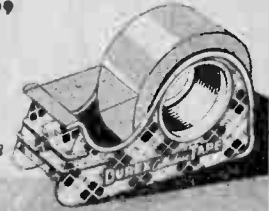

A TOY WITH A PURPOSE

ARTS AND CRAFTS BRUSH MAKING SET
INTERESTING AND INSTRUCTIVE FOR
BOYS AND GIRLS OF ALL AGES



15/- each

Complete set Carriage paid

TOY CENTRE

95 Lower Marsh, Lambeth, London, S.E.1.

Tel.: WATerloo 4559

Hobbies

WEEKLY

CONTENTS

	Page
Model Yawl - - -	97
Mechanical Miller Toy	99
Curing Rabbit Skins -	100
Garden Listening - - -	101
Simple Games Novelty	102
Group Modelling - - -	103
Concrete Garden Frame - - -	105
Home-made Chequer Board -	106
Photography - - -	107
Worn Rivets and Holes	109

DESIGN FOR O-GAUGE
GOODS SHED MODEL

May 17th, 1950

Price Fourpence

Vol. 110 No. 2846

A 17in. Model SAILING YAWL

THE time for model yacht sailing will soon be here, and many of our young enthusiasts will, no doubt, like to make up a little yacht all on their own. We give here instructions and details how to make up a model Yawl.

This type of boat is of rather picturesque rig and makes a suitable model for the beginner, as it is broad of beam and the masts and sails simple in cut and design. A good idea of the model may be gained from the sketch on this page, which, with the diagrams, should make the construction quite clear.

Our model is 17ins. long, from the tip of the bowsprit to the end of the boom of the back sail. The beam or width of the boat is 4ins., and the height overall is 11½ins. The hull is made from a piece of deal 12ins. long by 4ins. wide by ¾in. thick and cut to the shape shown in Fig. 1. The lower half of this diagram is crossed with 1in. squares to assist the worker in enlarging to actual size.

Full Size Drawings

He should set out the squares full-size on a piece of paper. Then, following each square carefully in the diagram, run a line through the full-size 1in. squares. Then trace on thin paper this half outline and, turning the paper over, complete the opposite side, thus completing the full plan of the bottom of the boat.

Transfer the outline to the wood and cut round with the fretsaw and clean up the edges with glasspaper. Next cut and fix the stern piece 2½ins. by 2ins. by ¼in. thick. It is pinned to the square end of the hull section as Fig. 2. A small bow

block is fixed to the pointed end of the boat, the actual shaping being done after it is fixed on, see again Fig. 2.

Sides

The sides of the boat consist of thin strips of wood bent round and glued and nailed closely to the floor of the boat and to the stern and bow pieces, see Fig. 2. In this diagram the forepart of the side is shown cut away, so the interior can be

seen. Each side piece is 13½ins. long by 1½ins. wide.

Take especial care to first nail the thin wood to the stern block, and then bend it round to meet the bow block where it should be cut neatly and chamfered and then nailed firmly. Waterproof glue is essential to a good fixing and a water-tight hull.

Prick the holes carefully for the fine brass fret pins which should be used for

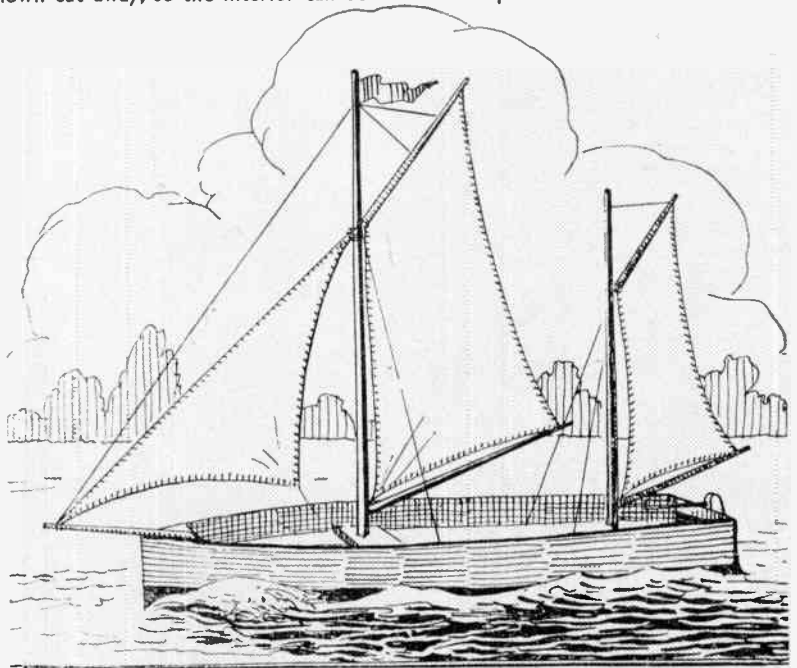

All correspondence should be addressed to The Editor, Hobbies Weekly, Dereham, Norfolk.

the fixing of the sides in conjunction with the glue. Brush some waterproof glue round inside the sides of the boat where they meet the floor. Two cross planks will be glued and nailed on inside the boat to take the ends of the masts.

The distance these planks should be kept from bow and stern is shown in the plan Fig. 1. The length for each plank

WOOD REQUIRED

- 1 piece deal—12½ ins. by 4½ ins. by ½ in.
- 1 piece hardwood—10 ins. by 2 ins. by ½ in.
- 2 pieces thin bendable wood—see article.
- 2 pieces round rod—½ in. diameter, 20 ins. long.

may be measured direct from the plan so far made up, while their width is 1 in. and depth ½ in. Bore ¼ in. holes centrally through the pieces, as shown, and continue down into the floor piece for

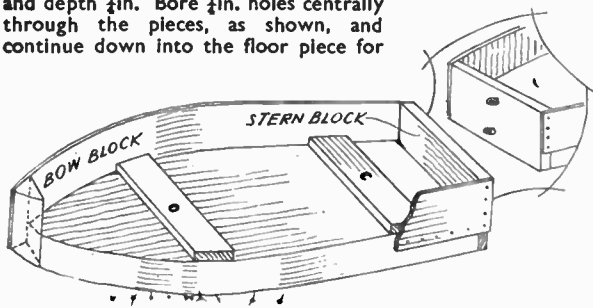

Fig. 2—Showing construction of hull

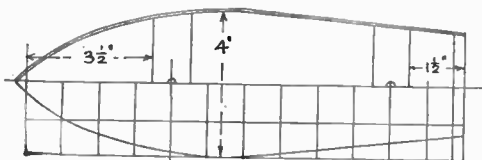

Fig. 1—Plan of main hull portion

another ½ in. or so to gain a good fixing for the masts.

The masts are of ½ in. round rod tapered upwards, as shown in Fig. 3. The mainmast is 11 ins. long and the rear mast 8 ins. long. To them will be fixed the spars which are also of ½ in. rod, shaped and tapered off as before. The fixing is done with small brass eyes screwed in, as shown in the detail Fig. 4.

The diagram of the sails is given in Fig. 3 and from this each can be drawn out full-size on to stout brown paper. Pieces of light linen will answer well for the sails, and the paper patterns should be pinned to it and the scissors used in cutting round. Each sail should be turned in all round and hemmed neatly, a narrow margin of the material being allowed for this 'turn in' all round.

The corners where the cords come are made double and neat button-holes stitched round ready for the rigging. Small brass screw eyes run into the top surface of the floor will take the running rigging.

of paint thoroughly brushed into the grain of the wood. A light glasspapering should next be given, and finally a coat of enamel of the chosen colours. The inside of the boat should receive the same amount of care in the painting to make it perfectly watertight.

For Floating

The hull when finished should be tested for buoyancy in a bath of water and note made regarding the depth to which the sides sink in the water. It will be found that by tacking on strips of lead temporarily and of varying widths, the correct buoyancy can be got. The

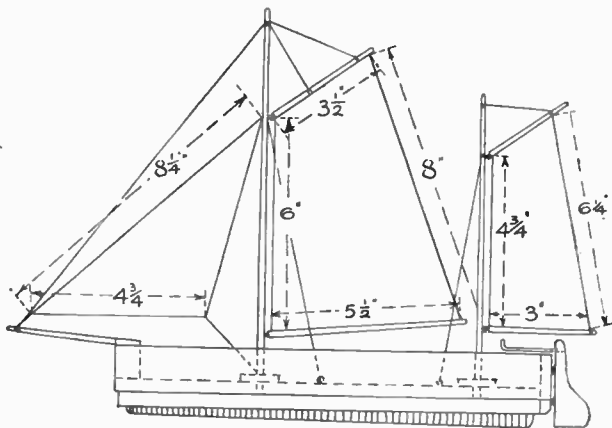

Fig. 3—Side view of hull with details of sails

The bowsprit rests upon the bowblock and is pinned to this and to other small blocks each side and in the boat.

The rudder is cut from a piece of ½ in. wood, as shown in Fig. 5, and the tiller arm made from a piece of wire 1½ ins. long pushed through a hole in the top and bent down to make a secure fixing. Two brass eyes will be put centrally in the stern of the boat to receive the two projecting wire staples fixed in the rudder, just as the diagrams show.

The whole boat must first receive a thorough cleaning off with coarse and fine glasspaper, and then given two coats

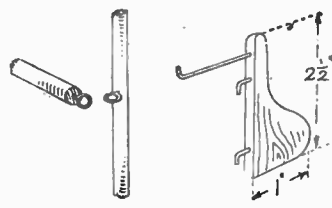

Fig. 4—Spars fixing Fig. 5—The rudder

actual strip of lead nailed on should be in one piece and of the full weight required, after test. A coat or two of paint should be given on the lead.

The rigging may consist of coarse thread looped, tied and bound to bowsprit and masts, as the full diagram Fig. 3.

This Week's Gift Design for a Model O-Gauge Goods Shed

The large Design Sheet this week is for another of our series of O-Gauge Model Railway Series. With it you can make quite easily a realistic addition to your lay-out. Station and Engine shed have already appeared. A complete kit of material for the Goods Shed shown here (No. 2846) is obtainable from any Hobbies Branch for 10/2, or sent post free for 10/11 from Hobbies Ltd., Dereham, Norfolk.



BRANCHES

LONDON

78a New Oxford St., W.C.1
(Phone MUSEum 2975)
87 Old Broad Street, E.C.2
(LONDON Wall 4375)
117 Walworth Road, S.E.17

GLASGOW

326 Argyle Street
(Phone CENTral 5042)

Head Office & Factories—HOBBIES LTD., DEREHAM, NORFOLK

MANCHESTER

10 Piccadilly
(Phone CENTral 1878)

BIRMINGHAM

14 Bull Ring

SHEFFIELD

4 St. Paul's Parade

LEEDS

10 Queen Victoria Street
(Phone 28639)

HULL

10 Paragon Square

SOUTHAMPTON

25 Bernard Street

BRISTOL

30 Narrow Wine Street
(Phone 23744)

How to make an interesting working model of THE JOLLY MILLERS

HERE is a toy that will cause great amusement for the youngsters. The endless stream of millers as they plod along, laden with sacks of corn, from the corn shed to the mill, the turning sails and the man in the mill popping his head out of the window, are all set in motion by turning the handle.

A toy like this is always welcome for boys between the ages of four and eight, and the making is well within the scope of most readers. The toy can be made from scrap pieces of wood and metal, and although all the details are given, these may be varied to suit the available materials.

Making the Base
Details for making the base are shown in Fig. 1. The sides and ends are made from $\frac{1}{2}$ in. planed softwood and the top

prevent the inquisitive from seeing how many millers there actually are.

The Corn Shed

This can be made from plywood or pressed board. If plain wood is used, it should be thick enough to take the fixing screws which secure it to the base of the toy. If plywood is used, $\frac{3}{8}$ in. square strips should be tacked and glued on in the positions shown in the drawing. The hinges for the doors are shown in Fig. 1, made from strips of rubber (car

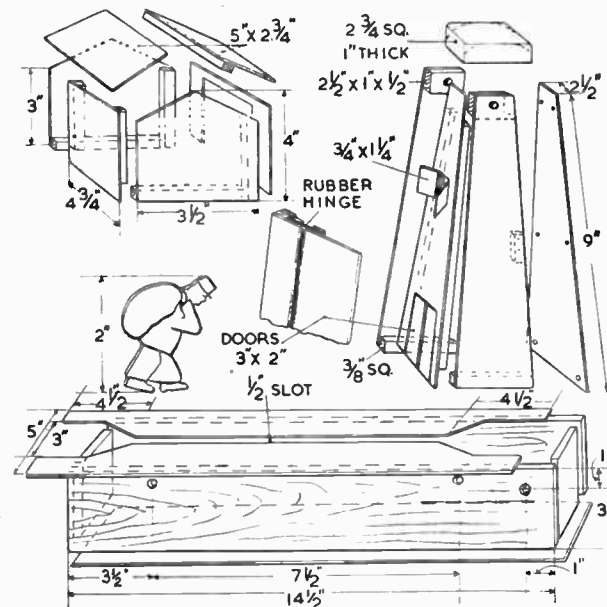

Fig. 1—Details of various parts in construction

and bottom from plywood. When the two sides have been cut to shape, they should be gripped together and drilled. It is important the drill is held square so the holes are exactly parallel in both sides. When this is done, screw the sides to the ends.

The top is made in two pieces. These should be identical so the slot for the figures to move along in is in the centre. The wide slots at each end should be tapered off into the narrow slot. This will give a lead in for the figures as they travel along. The two pieces are screwed in position after they have been fixed to the corn shed and mill.

The bottom is cut to size but it is not screwed in position until the end. It is fitted mainly to hide the works and

The Mill

The four sides can be economically cut from one piece of plywood. Strips $\frac{3}{8}$ in. square are glued and tacked in position as shown in Fig. 2. The pieces which are cut out for the doors and window spaces, if cut carefully, can be used as doors and windows. The doors are fitted with rubber hinges, the same way as for the corn shed, taking

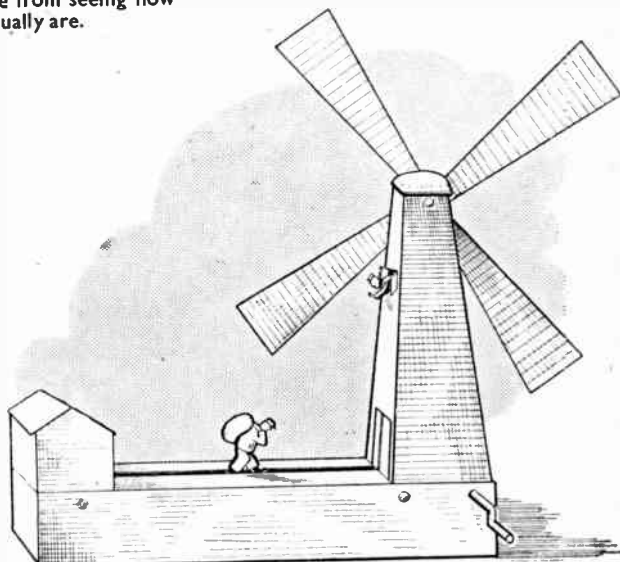

inner tube).

When in action the figures push through the doors which automatically close afterwards. To prevent sticking, it is important that a gap of about $\frac{1}{8}$ in. is left all round the doors. The strips of plywood which secure the hinges can be fixed with panel pins.

care, as before, to leave an $\frac{1}{8}$ in. gap all round.

The windows are fixed in the open position. If they were made to shut, they would tend to trap the man as he bobs back. The roof is cut from a piece of 1 in. thick stuff, chamfered at each side.

The holes for the sail spindle must be exactly parallel, so after the 1 in. by $\frac{1}{2}$ in. strips through which the holes are drilled, have been fixed to the sides, the sides should be gripped back to back and drilled. The holes should be about $\frac{1}{8}$ in. diameter to allow for the slope of the sides when built up. To reduce friction the spindle is best mounted in metal

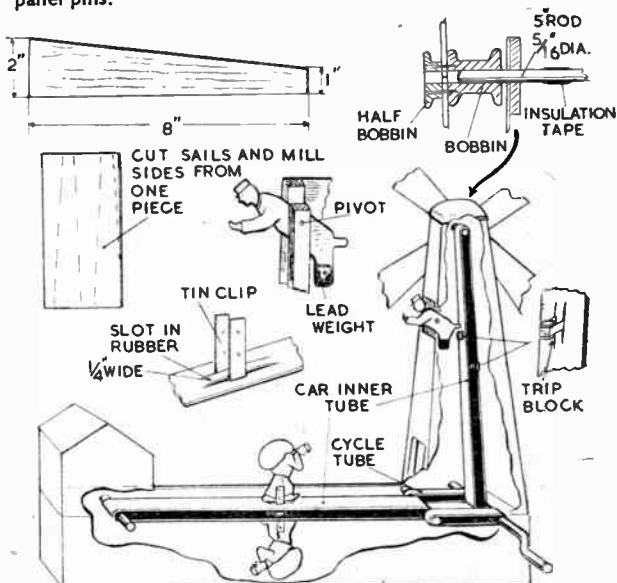

Fig. 2—The sails and general mechanism

plates screwed to the sides, but these are not absolutely essential.

Before the mill is assembled, the figure for the window should be made. This is cut from plywood and a piece of lead is tacked to the lower end to form a counter weight. A $\frac{1}{8}$ in. hole is drilled through the waist line for the pivot pin. The two $\frac{3}{8}$ in. square strips which are

in steel, about $5\frac{1}{2}$ ins. long. The handle is made from the same material, about 9ins. long.

Assembling

First screw the corn shed and the mill to the two pieces which form the top of the base, leaving a $\frac{1}{2}$ in. slot in the centre, between the two pieces. Screw the

sulation tape. This will keep the drive band running in the centre and provide a better grip. Thread on the main band with the two figures, and on the middle shaft, the two small bands, one each side of the main band.

Pass the two shafts through the second holes, fit washers to each end, and burr over to keep the washers on. Fit the handle and wrap the centre with tape, add the drive bands and fit a washer to the other end and burr over. Fit the sails and spindle and connect up the drive belt. When it is seen that the model is working correctly on turning the handle, screw the back of the mill in position. Finally fit the bottom of the base.

Painting

Give the model a coat of priming paint of a neutral shade—such as grey—and follow with a coat of the selected colours in enamel or hard gloss paint. A suggested colour scheme is as follows. The base—bright green, the mill and corn shed sides—bright red, the roofs and sails—cream, the figures—red and blue. (143)

LIST OF MATERIALS

Base	Figures
14 $\frac{1}{2}$ ins. by 3 $\frac{1}{2}$ ins. by $\frac{1}{2}$ in.—2 off, planed soft wood	3ins. by 1 $\frac{1}{2}$ ins. by $\frac{1}{8}$ in.—3 off, plywood,
14 $\frac{1}{2}$ ins. by 3 $\frac{1}{2}$ ins. by $\frac{1}{8}$ in.—2 off, plywood	Metal rod
5ins. by 3 $\frac{1}{2}$ ins. by $\frac{1}{2}$ in.—2 off, planed soft wood	$\frac{1}{8}$ in. diameter
Mill	5in. length, 1 off
9ins. by 4 $\frac{1}{2}$ ins. by $\frac{1}{8}$ in.—4 off, plywood	5 $\frac{1}{2}$ in. length, 2 off
3ins. by 3ins. by $\frac{1}{8}$ in.—1 off, planed soft wood	9in. length, 1 off
24ins. by $\frac{3}{4}$ in. square—1 off, planed soft wood	Sundries
6ins. by 1in. by $\frac{1}{2}$ in.—1 off, planed soft wood	Old car inner tube
Corn shed	Old cycle inner tube
3 $\frac{1}{2}$ ins. by 4ins. by $\frac{1}{8}$ in.—2 off, plywood	Cocoa tin
5ins. by 3ins. by $\frac{1}{8}$ in.—4 off, plywood	Sins. of $\frac{1}{8}$ in. diameter wire
24ins. by $\frac{3}{4}$ in. square—1 off, planed	6— $\frac{1}{8}$ in. washers
Sails	Screws, panel pins, glue
8ins. by 2ins. by $\frac{1}{8}$ in.—4 off, plywood	

fixed to the side are then drilled to take a piece of $\frac{1}{8}$ in. wire, on which the figure swings. A 5in. length of $\frac{1}{8}$ in. wire is then pushed through the holes, with the figure threaded on, and the wire is then bent over at each end.

The two plain sides of the mill can next be glued and tacked to the door side. The side opposite the doors is not screwed in position until the end, after the toy is in working order.

The Sails

The sails can be cut from plywood and in a similar manner to that of cutting the mill sides, from one piece. The four pieces are then screwed to a cotton bobbin into which is driven tight, a 5in. length of $\frac{1}{8}$ in. rod made of metal. Another bobbin is sawn in half and screwed to the front of the sails to hide the joints. The spindle is later passed through the mill, a washer fitted and the end of the rod burr over.

The Working Parts

The figure for the window has already been made. The two other figures are cut from plywood, as shown in the drawing. These are secured to a band of rubber 1in. wide cut from a 5in. car tyre inner tube; a suitable piece of old tube can be bought from the local garage for a few pence. The figures should be fixed diametrically opposite so there is always one of them in view.

For fixing each figure to the drive band, make two $\frac{3}{4}$ in. long cuts a $\frac{1}{4}$ in. wide in the centre of the band. Cut a strip of cocoa tin about 1 $\frac{1}{2}$ ins. by $\frac{3}{4}$ in., bend it through the band, as shown in Fig. 2, and tack on the figure with four small panel pins.

The drive band for the sails is cut from a 5in. tube, $\frac{3}{4}$ in. wide. Two small plywood blocks are fitted diametrically opposite to operate the figure at the window. The blocks are fixed to the band by strips of cocoa tin. The two short drive bands are cut from cycle inner tube and are about $\frac{3}{4}$ in. wide.

The two drive shafts which drive the figures are made from $\frac{1}{8}$ in. rod or tube

assembly to the base. Fit the two driveshafts, and wrap the centre of each shaft with three or four layers of in-

Curing Rabbit Skins

CURING rabbit skins is really quite easy—when you know how. The cured skins can be used for glove making and so on. It will be best to start on the skin that has been stripped from the rabbit due for the dinner table and then, when the small difficulties have been met and overcome, a good quality pelt can be tackled.

No Fat Wanted

To start off put the skin fur side downwards on to a board and fasten it in this position with four $\frac{1}{2}$ in. nails. Carefully pull off every bit of fatty tissue. Quite often this will peel away, but if it does not, use a fairly sharp knife to scrape it away. Take great care not to cut through to the furry side.

When the skin side is completely clean, prepare a mixture of one tablespoonful of salt and one of powdered alum. Take a little of the mixture at one time and with a circular motion rub it well into the skin. This part of the operation is most important. See you cover every part of the skin and make the rubbing-in thorough and complete.

Four Week's Dripping

Take the skin off the board, fold it as illustrated, and hang it up in a dry place. It must stay here untouched until it has finished dripping, which might take anything up to four weeks.

When the dripping has finished, take the skin down and wash it thoroughly in clear warm water.

Prepare another bath of warm water but this time add toilet soap or soap flakes to make a really good lather and

give the skin another good wash in this. Finish off with a bath of clear warm water, fold the skin as before and again hang it up until it stops dripping.

Part of the operation is now called 'working over'. For ten to fifteen minutes every day, while it is drying, the skin must be rubbed and stretched

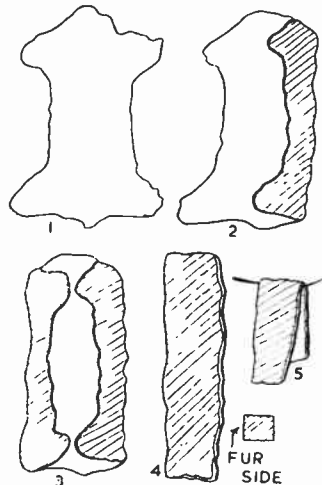

between the fingers to stop it from stiffening.

When it is nearly dry, rub in a little saddle soap. If, in spite of your 'working over' the pelt still appears to be rather stiff, get a little neatsfoot oil and rub this into the skin.

Your pelt is now thoroughly cured and ready for whatever use you have in mind for it. (141)

Now is the time to make radio preparations for GARDEN LISTENING

THOUGH the instructions given here are particularly applicable to summer-time outdoor listening, they can also increase the sphere of interest and usefulness of a radio within the house. Quite often it is worth while having a speaker in a second room (for example, in the kitchen, or in a bedroom), and it may be driven from the receiver without disturbing the latter.

Sometimes it will be found such extension systems are very much appreciated. Outside the house they can increase the pleasure of evenings in the garden, while special uses for parties, etc., will soon come to mind.

The simple diagrams have been drawn so that those with little knowledge of radio should have no difficulty in fixing up the system they decide will suit them, while the handyman used to radio should gain valuable hints.

Simplest System

This is shown in Fig. 1 and has the advantage that only a single wire is used, and that no direct current flows along it. Consequently there will be no danger of shocks from mains sets, and thin wire, only temporarily hooked up if convenient, can be used.

A condenser of about 1 mfd. should be connected to the anode of the output

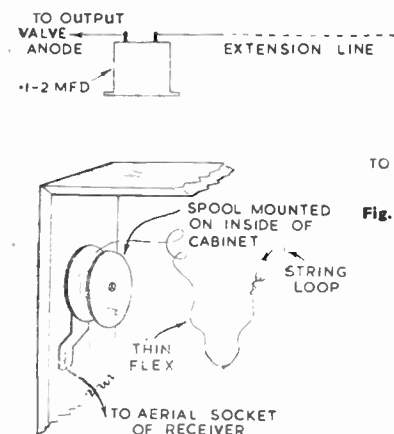

Fig. 3—A throw-out aerial

valve. (A wire will go from the anode to the speaker transformer, and this will help identification of the correct point). This condenser may be placed inside the receiver cabinet and the extension wire is taken from its second terminal.

The other end of the extension wire (which may, of course, be many yards long) is taken to the extension speaker. In the diagram a switch is included in circuit so that the listeners at the extension point can switch their speaker off if desired. The speaker is returned to a metal skewer or other earthed object.

For best results the receiver should

also be earthed in the usual way, though this is not wholly necessary. The speaker must be of the ordinary high-impedance type. If it is being used in a bedroom, then a second lead may be returned to the earth socket of the receiver, if this is more convenient.

Low-Impedance Extension

If a moving-coil speaker with no coupling transformer is to be used, then the connections shown in Fig. 2 should be adopted. Twin flex is taken from the secondary of the transformer to the extension speaker, a switch again being put in circuit if desired. This switch may be mounted on the speaker cabinet.

If it is required that the extension speaker should operate alone, the speaker in the receiver may be silenced by connecting a switch in the lead at the point marked (X) in Fig. 2. Some receivers have provision for this on the back. Extension Speaker sockets may also be fitted, and this will simplify connections.

If the speaker shown in Fig. 1 is returned to the receiver instead of to a separate earth, twin flex should not be used for the two leads unless these are not more than a few yards long. Otherwise the capacity will make reproduction somewhat low-pitched. Separate

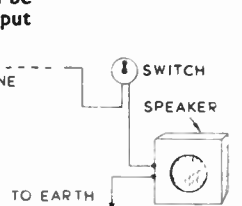

Fig. 1—A condenser-fed speaker

leads should, therefore, be used, though twin flex is suitable for Fig. 2, where the impedance is low.

Throw-Out Aerial

Most receivers will give ample volume on the more powerful stations with no earth and only a short wire for an aerial. This enables the receiver to be made into a type of portable, which may be taken outside or into another room as necessary.

To do this, a reel should be mounted on a metal bracket inside the back of the receiver. (A typewriter spool is ideal). The metal bracket is connected to the Aerial socket of the receiver, as shown in Fig. 3. About 3yds. of thin flex are wound on the spool, the inner end being connected to the metal so that the circuit is completed through the pivot bolt and bracket. A loop of string (to provide insulation), is tied to the other end of the flex.

In use, it is merely necessary to draw

out the wire (the full length need not be used if inconvenient) and an aerial is immediately available, already connected to the receiver. The wire may be laid along the floor, hooked to a picture, or otherwise extended as circumstances allow.

A small handle can be fitted to the spool to facilitate rewinding when the receiver is to be moved again.

Remote On-Off Switching

With the two systems described in which extension speakers are used, the receiver cannot be switched on or off from the remote listening point. Often this is little inconvenience, but if it is desired the receiver be controlled from the extension speaker, a switch wired as shown in Fig. 4 can be used.

Though a pear switch is often most convenient, any other type can be used if no bare connections are left. As the twin flex leads will carry from about .25 to .5 amp., good-quality wire is essential, especially if the leads are at all long (over, say, 10yds.).

In the case of a battery-operated set the switch is merely introduced in one low tension lead, as shown. With a mains set it is introduced in one mains lead.

Some voltage drop in the mains

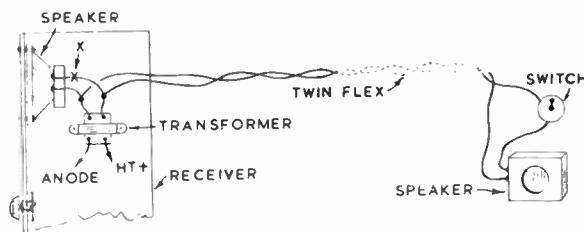

Fig. 2—Low-impedance extension



Fig. 4—Extension on-off switch

circuit will be immaterial, but with a battery receiver the accumulator only provides 2 volts and, because of this, volume will be reduced slightly if the leads are too long. But provided the flex is reasonably stout, several yards may be used, as mentioned.

Relays, Volume Control, etc.

A relay which closes circuit when energised could be used to switch on the receiver, but this is only necessary when the extension point is a long distance away and direct operation (as in Fig. 4) becomes impossible because of the resistance of the leads.

A volume control at the extension

(Continued foot of page 102)

Napoleon is said to have passed the time with this SIMPLE GAMES NOVELTY

THERE is rather more in this game than might at first appear. It is very old and comes from the Far East, where it was employed to amuse young and old alike. Napoleon used it to while away the time during his exile in Elba and it is reported that he made the necessary pieces from black cardboard.

Plywood, $\frac{3}{8}$ in. thick, is really best for the sections, and to make the game a rectangle 5 ins. square is required. This is then marked out as Fig. 1, the points (A) and (B) being midway along two adjacent sides. With this in mind and the knowledge that the line (C) bisects the

$\frac{1}{2}$ in., but are bevelled at the corners to meet each other, as shown.

A simple lid is then fitted. This is a $5\frac{1}{4}$ ins. by $5\frac{1}{4}$ ins. piece of thin plywood held by a cloth hinge as (D). The strip of cloth is well glued and fitted along the end of lid and box, and then taken over both for about $\frac{1}{2}$ in. The strip must be pressed into good contact with the ends as it is required to stick firmly here and bend only along the crease.

Lid Fastener

At the further end a tab fastener is put on. This is a strip of thin leather glued below and taken over a pin head on the lid. A small draper's pin is used for the

Quite rough suggestions of features will do as indicated.

The Figure Pieces

All is now finished and the object is to build up various figures with the sections. There are an infinite number that can be made and four are given here. The range of possible attitudes is very large and the scope increased by having both a full and side face to play with. It is strange how lifelike are some of the make ups, while quite a lot will be really humorous.

If the sections are in black, the best effect is secured by giving 'players' a small sheet of white card upon which to do the arranging.

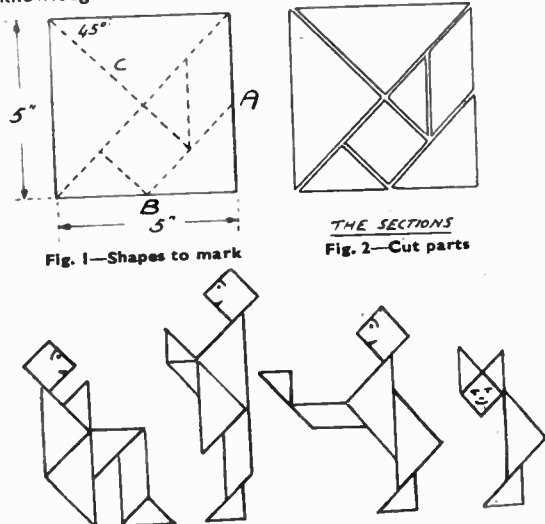

Fig. 1—Shapes to mark

Fig. 2—Cut parts

Fig. 4—Queer people made with the parts shown

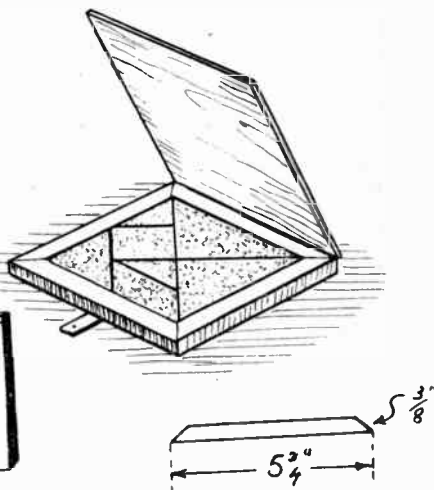

Fig. 3—Details of box, lid, hinges and fastener

angle from which it extends (that is, divided into two angles of 45 degrees each), the lines are easily put in.

The square is now divided up as Fig. 2, some little care being taken to get accurate cutting, as the pieces must fit neatly side by side whichever way up they happen to be.

A Tray Box

So the sections will not get lost, and to give a good effect when handing the puzzle out to a friend, now make the shallow tray container as Fig. 3. This is a square of $\frac{1}{2}$ in. plywood, $5\frac{1}{4}$ ins. by $5\frac{1}{4}$ ins., upon which is glued four border strips that to start with are $5\frac{1}{4}$ ins. by $\frac{3}{8}$ in. by

lid—being pushed right through and then bent over.

Now back to the sections. These must be smoothed off and then coloured one uniform tint. Black can be used like Napoleon. This is not as sombre as might be imagined and was often used for the individual 'section games' of the Victorian era. Thus dominoes still often have black backs. Other colours may, of course, be put on, but all the pieces must be the same back and front.

Lastly take the small square section and in white or a variety of colours, paint two faces, one on either side. The first must be a side face (comical, if possible) and the other a full face.

The shallow box container can be left in plain wood, stained and polished or painted, but the lid looks well finished with a silhouette of one of the figures that can be made up, say, the sitting man which is shown first. This can be carefully drawn out on card and then blackened in with Indian ink and glued on. There is, of course, no need to indicate the divisions of the pieces in this silhouette.

Quite a lot of fun can be obtained from this section game and it should certainly be made to go with your collection of wood puzzles, to be brought out with the rest when some indoor entertainment is required.

Garden Listening—(Continued from page 101)

point, to operate on the extension speaker only, may be provided by connecting a variable resistance of about 5 ohms to 10 ohms (the value is not critical) in series with the speech-coil. This control can be mounted on the cabinet holding the extension speaker.

If it is desired to select various stations from the extension listening point, this can be done by means of relays and pre-set condensers. Relays and pre-sets should be mounted in the receiver, the latter being adjusted so that the desired stations are brought in

when the appropriate relay is energised. The writer has found this a very simple and trouble-free system. However, this particular adaptation is not by any means necessary, though the radio enthusiast may like to try something out along similar lines.

Geography, town, country or seaport realistically illustrated in AREA MODELLING

WHILST the fretsaw may have been primarily thought of in connection with fretwork in former days, it is, undoubtedly, now being used for a much greater variety of work. Here are some suggestions of the usefulness of this tool in conjunction with a specialised type of work which will, undoubtedly, appeal to many readers. It is particularly appropriate, and is much in demand, we find, for schools, for groups of modellers, and even for architects and surveyors.

Its usefulness in these spheres could cover such practical and educational purposes as map making, town planning, village layout, and even small housing estates. A number of readers have, as we know, even gone to producing a layout of their own district, which incorporates certain historic buildings, monuments, etc.

Simple Small Work

All of it, of course, is miniature work, but the scale is so small there is really no need to get a great deal of detail in the actual parts. Let us then look at some of the possibilities of such work which may suggest itself to readers for their own particular need or ingenuity.

During the war, for instance, we published a series incorporating miniature ships of war, and with them was a complete layout for a harbour,



Fig. 1—Showing the building up of rising ground

quaysides, wharves, docks, etc. There is not, of course, now the demand for these war-time types, but the idea could quite easily be carried into effect by those living at seaports or those who are desirous of making models of some special seaside layout, such as Southampton, the Mersey mouth, etc. If you are undertaking your own particular district, then you could enlist the assistance of local authorities who would be helpful.

A large-scale map of the place would help, and you first of all have to prepare

your scale to know that all the parts are in correct proportion. A port authority would help in this, or the local surveyor's office could provide the necessary scale plans if you approached them properly.

The whole of the layout should be undertaken first as a drawing, in order that you may know the area decided upon, and the space which the actual model would take. The dimensions of the over-all subject would be fairly large, and this is where co-operative effort in a school or a club would be of advantage. If you are having a large layout, have trestled tables big enough to take it all, and roughly draw the layout in position.

Land Contours

The contour of the land, the shape of the river and harbour, and the dimensions of docks, tidal basins, etc., would be first of all put in place. The actual land portions could be cut in plywood if you can obtain it, or failing this, some of the fairly thick composition board would do quite well. It should be at least $\frac{1}{4}$ in. thick to raise the land portion of the sea.

If then you had further heights in the land, additional layers of wood could be added when worked out to their proper contours according to the map. These 'hills' can be built up by layers of wood of varying thickness, and an idea of them is shown in Fig. 1. At (A) you have the plain contour, at (B) is a section drawing showing the three layers of wood which build up the main substance of the hill. Finally at (C) you have the wood shaped off into one piece by tapering down to form the continuous hillside.

Ground Work

The sharp angles where the pieces of wood are joined together, can be smoothed out slightly by filling in with plastic wood, Pyruma or similar filler. This is shown by the solid black portions in the diagram at (B), then finally when the whole lot is filed down, you get to the shape shown at (C). The surface can be given a roughcast covering with glue and sand before it is painted with suitable colour for ground effect.

The buildings will be quite tiny compared to the general layout, and it is unwise to endeavour to incorporate all of them, or much detail in those which are shown. Small blocks of shaped wood are sufficient indication, unless you are

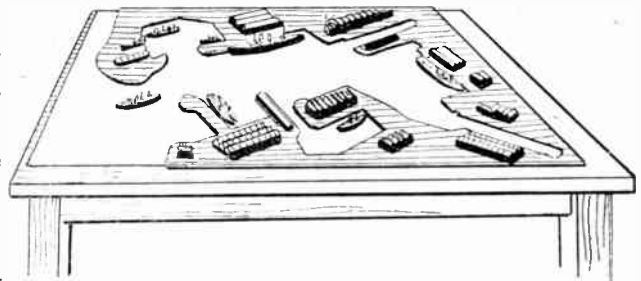

A layout of a Tidal Basin with Quays, Wharves and Ships

having a large-scale subject. If it is large enough, you could paint on very tiny doors, windows and outstanding features, but otherwise the plain rectangles or shapes of the wood are sufficient. Some suggestions are shown at Fig. 2.

Building Shapes

The tops should be planed to the slope of a roof, and this is one of the points you will have to note in the preparation of the plan itself in comparison with the actual buildings. Modern buildings are more easy to indicate because in many instances they are straightforward cubes, and frequently even with a flat roof.

If, again, there is some unusual shaped building, this definitely helps to identify the part concerned, and should be as nearly as possible in scale with the others. Special buildings such as churches, dock board offices, warehouses or open wharves should be clearly identifiable, and even finished a different colour from the rest for that reason. These miniature buildings can quite well be solid blocks of wood, and if the area has a number of rows of houses, quite a lot of them can be incorporated in a single piece.

Sizes to Scale

One general failing in this type of work is that the buildings themselves are too large in proportion to the rest of the work. It is better to keep them quite small so they do not overpower the general layout, but at the same time are obvious in their positions.

The position of each of these buildings should be marked on your original layout, but the parts themselves should not be fixed in place until the whole thing is virtually finished. This involves further preparation for the final details of painting. There are roads to be added, with their sidewalks indicated if the scale is large enough.

If wooden fences are provided, they can be indicated by tiny strips stood on edge. The actual pavements need not be raised from the ground level, but can be clearly shown by a white line painted to show the line and angles of the curve. If

you have a large-scale layout, then you may like to add the pavement as a thin layer of material.

Water and Wharves

if, continuing our original suggestion of a harbour, you have water, it can be painted in light blue, with splashes of white to indicate the flecks of the waves. This is if the water indicated is supposed to be tidal. If it is inland water—

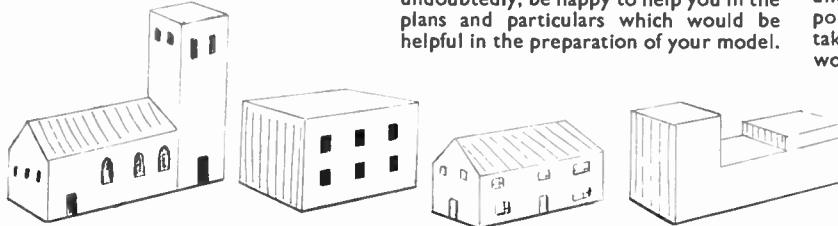

Fig. 2—Examples of simple blocks forming large buildings of different shape

lakes, etc.—then, naturally, a perfectly smooth surface is sufficient. In the harbour effect you will need the tiny boats lying at the quaysides or, perhaps, buoyed in the middle of the river. The wharves can be fitted with tiny cranes and merchandise piled up on the quays. All this, of course, is very small, but a realistic effect is obtainable without a great deal of trouble. We have elaborated largely on this picture as of a port.

Your Town Centre

A little thought, however, will show how the same general plan could be carried out in relation to other sites. You may like to plan your own market or city square with its streets, radiating from the centre, the station, city hall, churches, etc., in their position in the district. In this case, the roads will contain tiny specimens of traffic-island sites, traffic lights, trolley buses, tram or ordinary double-deck buses such as seen in the local service.

Most of these tiny parts can originally be cut with the fretsaw, but can be shaped with a sharp knife and finished smooth with glasspaper. Here again, paint is added to get the finished result, but this should not be undertaken except by those capable of getting a good result.

So often we have seen otherwise good models spoiled in this way. Portholes have been made on ships much too large, windows on houses are out of all proportion to the prototype. Motor cars may have a huge number plate on them, which spoils the whole effect. It is this attention to detail which will make or mar the subject, and in no case should the work be hurried.

Painting Hints

A fine brush is used for painting and poster paint or enamel is useful to get the style required. Brickwork can be indicated by very thin lines indicating the course of the bricks, and here again, if you cannot get it in proportion, that work is best left undone. The architect or surveyor frequently uses this type of model for a single house, or for illustrating a layout in a new estate. It gives

a much better visual idea of the whole thing than many paintings or drawings.

If you live in such an estate yourself, it would be interesting for you to make such a model, or you could even approach the people concerned, with the suggestion that they might be pleased to display the subject after you had completed it for them. If there is a new theatre coming along, or a new swimming pool suggested, the promoters would, undoubtedly, be happy to help you in the plans and particulars which would be helpful in the preparation of your model.

Schoolteachers or those in charge of children would probably like the idea for their pupils to prepare a complete layout of the school buildings and surround. Such a subject would, undoubtedly, appeal to the children themselves as being of interest in their own parts. Extended to a matter of geography or history, there is much that can be planned in these directions.

If a visit is being paid during the

summer to some historical building or place, an added interest could be worked into it by getting each of the visitors to pay particular attention to some part so that when they return, they may be able to draw, or by a co-operative effort, model up the whole layout of what they have seen.

Programme of Work

The beginner should not attempt to undertake too much at first. A small portion of the town or site should be taken in hand to see how best to do the work, and what standard of result can be obtained. It is necessary to arrange and plan, and draw out as much as possible before the actual work of construction is undertaken.

There is no need to attempt to complete the whole thing in one or two evenings. Each piece is given whole attention until a satisfactory result is obtained, and then that can be put in its place in the general scheme of things.

In this way, the worker gets a variety which will prevent the likelihood of getting tired before the subject is completed. In this way, too, the worker is gradually building something which will be attractive, novel and an everyday reminder of his practical ability in turning his craftsmanship into sensible results.

TWO TYPES OF MODEL



THE delighted 5-year-old you see is, naturally, proud of the Doll's House which her father, Mr. R. H. Davison, of Chudleigh Road, Nr. Crumpsall, Manchester, made for her. The house and garage fitted with electric lighting, rooms have skirting and picture rail, chromium handles to doors, and a fully balustraded staircase. The house, of course, is complete with furniture, and curtains are hung at all windows. As a keen reader of several years standing, Mr. Davison can be justly proud of his work.

THE Stage Coach you see was, of course, made from our design (a copy of which is seen) but it is very different from the ordinary ones in that it is constructed of matchsticks! The clever builder is Mr. Chadwick of Hull, who used over 9,000 matchsticks in the attempt and ensured their being held together satisfactorily by using Britfix Balsa Cement as the adhesive. The work involved was certainly more 'fiddling' than if the normal method of wood and fretsaw was adopted.



How to make one or several units of a modern CONCRETE GARDEN FRAME

A HOME-MADE Garden Frame will pay for itself in one season, providing it is used properly. In the spring it can be used for rearing bedding plants, which are followed by cucumbers, and at the end of the summer it can serve for protecting chrysanthemum stools. Or it can be filled with autumn sown sweet peas, onions, lettuce and snaps.

Garden frames can, of course, be made in several ways and of various materials. The materials chosen in this article were arrived at after using wood, brick, and asbestos for the sides, and glass for the light. Concrete was finally chosen for the sides, because it is economical, takes less room than bricks, and is warmer than wood or asbestos.

Windowlite was chosen for the light because it is easy to fix, light in weight, does not stop the ultra-violet rays, and small seedlings do not get scorched in

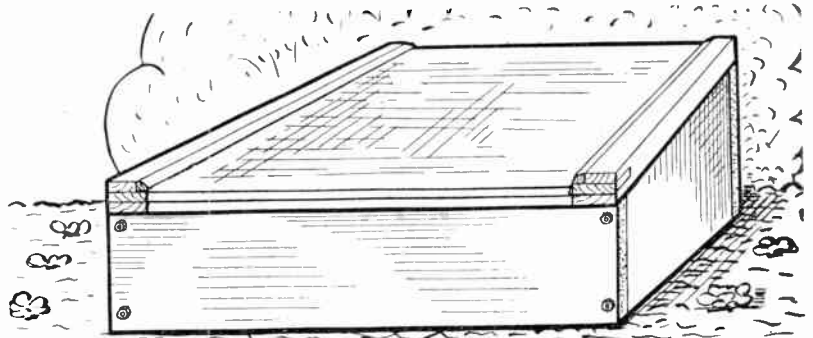

Fig. 1—View of completed frame made as one unit

the dividing side and fitting connecting plates, as shown in the drawing.

The sides are made of a mixture of gravel, sand and cement to the proportions of 2 : 2 : 1, respectively. These are cast in wooden frames 2ins. deep made of timber at least 1in. thick. The frames for casting should be nailed together at the corners, and provision must be made for casting in the fixing bolts and the bolt holes. Holes should be drilled in the frames at the appropriate positions to take the fixing bolts. The bolts should be a push fit in the

holes so that they keep in position while casting.

When the concrete is set, the frames are knocked apart, leaving the bolts in position. A size of $\frac{3}{8}$ in. diameter is quite suitable. The holes for the bolts are cast in by leaving pieces of $\frac{1}{2}$ in. dowel in position until the concrete is almost set. The dowels should be greased to prevent sticking and they should be pushed into the concrete while it is wet, using a drilled board as a locating gauge. The gauge should be drilled to suit the position of the bolts in the mating sides and it should be held in the same position on the frame each time it is used. This will ensure interchangeability.

Casting Process

The frames should be placed on a flat floor for casting. A concrete floor will do nicely, but precautions must be taken to prevent the concrete sticking to the floor. Sticking can be avoided by spreading the surface with a coating of grease, but if a path or drive is being used to cast on this will be out of the question. Another method to prevent sticking is to

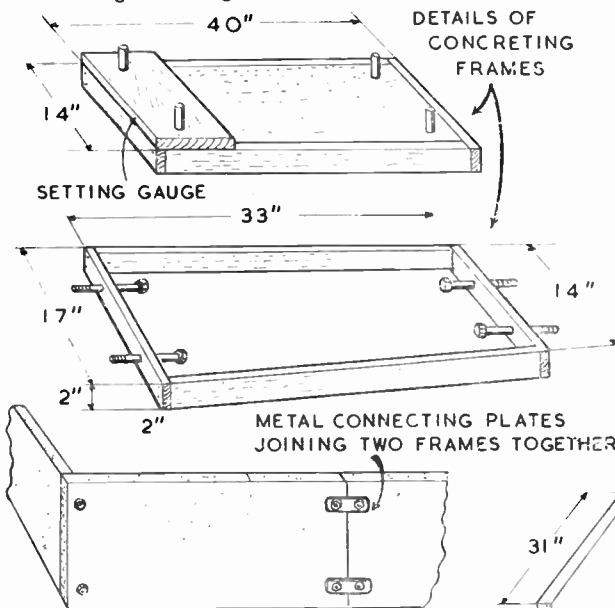

Fig. 2—Details for casting and extending

the hot sun. All the materials needed to make a frame to cover about 1 sq. yd. should not cost more than £1.

Your Own Size

The size of the frame will be to suit one's own requirements, but in order to give some definite instructions a convenient size of 38ins. by 35ins. is given, as this will use just 1 sq. yd. of Windowlite. The frame, too, will be sufficiently large to accommodate a handy number of bedding plants and later, one cucumber plant.

The area can be increased, of course, by making as many of these units as required and joining them by leaving out

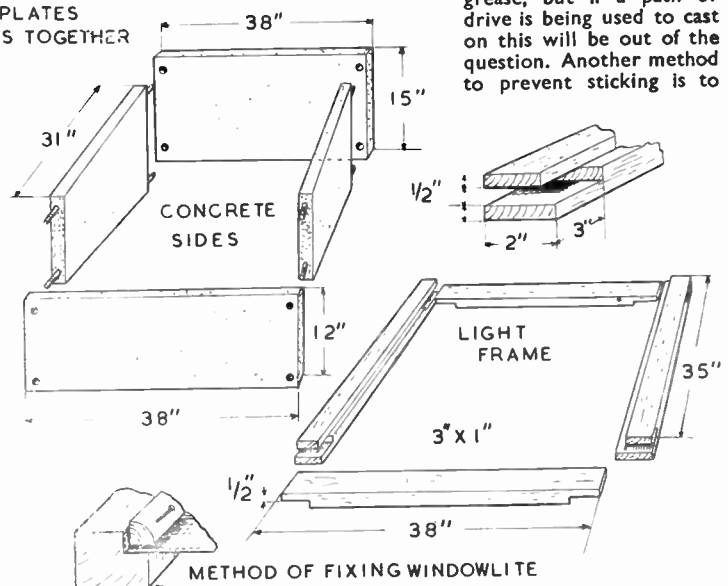

Fig. 3—Main dimensions and constructional details

place a sheet of newspaper in the frame before pouring in the concrete.

Approximately 1½ heaped buckets of sand and the same amount of gravel, together with a flat bucket-full of cement will be required for each piece. These should first be mixed dry, either on a board about 1yd. square or on a concrete floor. Water is then added through the rose of a watering-can and the mixture turned over until it is in a semi-fluid state.

Smoothing

The mixture should then be poured into the frames, taking care to work it well into the corners with a trowel. A piece of board about 4ins. by 1in., a few inches longer than the width of the frame should be used to level off the concrete. The wet concrete should be knocked down with the edge of the board, this will bring the fine stuff to the top and leave a smooth finish.

After an hour or so, the surface should be smoothed over with a plasterer's float or a bricklayer's trowel. The castings should not be manhandled

MATERIALS REQUIRED

Timber
 35ins. by 2ins. by lin., planed and rabbeted—2 off
 38ins. by 3ins. by lin., planed and rabbeted—2 off
 ½in. quarter moulding, 35in. lengths—4 off

Concrete
 Washed gravel. Approximately 1½ cwts.
 Washed sand. Approximately 1½ cwts.
 Cement. Approximately 1 bag
 Rough timber for casting frames

until they are thoroughly dry. Under normal conditions this should take two or three weeks. When they are a light grey colour and lost all the green look, they can be assembled and secured with washers and nuts.

It is essential that as much light as possible is admitted into the frames, therefore, sashbars are not used. First the wood frame is made, consisting of two side pieces of 2ins. by 1½ins., each with a ½in. square rabbet to take the Windowlite. The top and bottom rails are made of 3ins. by 1in., all of it planed.

Mortise and tenon joints are made as shown in the drawing, and the joints are held together with wooden pegs. The frame is assembled and given a coat of priming paint. When dry the Windowlite, 1 sq. yd., is secured in position with ½in. quarter-round moulding, down the sides and top and bottom as shown in the drawing.

If it is decided to make extensions, all that is necessary is to unbolt one side, move it away and fit an extra end piece at the top and bottom, joining up with connecting plates as shown. Another light is made of the standard size, and double the area is covered. (144)

For Draughts or Chess make yourself A CHEQUER BOARD

THIS Chess Board if carefully made will be equal to any that can be bought in the shops, added to which is the satisfaction of having made it yourself. The drawings are practically self explaining and no difficulty should be found in following the instructions.

Contrasting Wood

First of all choose the woods you would like to use. These days there is no trouble getting hardwoods, particularly the small amount required for this Chess Board. Two suitable woods are sycamore for the white squares and walnut or mahogany for the black squares. Four strips of each are needed,

edges are truly parallel and square to the face. (The 'face side' incidentally in this case is the underside of the strips when placed in position). They should be 1½ins. wide when planed.

Now get a flat board big enough to take all the strips when laid side by side, a drawing board or baking board will do very well. Next lay a sheet of newspaper on this board and glue the strips side by side, face down alternately light and dark strips (see Fig. 1). The strips should be well rubbed together, leaving as little glue as possible between them. The newspaper will prevent the strips

backing and old glue still adhering to the face.

To a Baseboard

It will be seen that the strips now consist of light and dark squares. These are again glued (still face down) on to a piece of paper placed on the baking board as before. Great care must be taken to ensure the strips are placed in the right order, that is, with the strips laid so the familiar check pattern of the Chess Board is formed (Fig. 3).

When this is set, place it on the plywood square so a border is left all

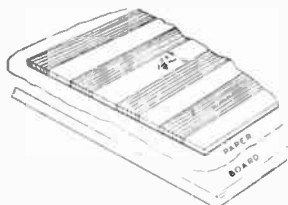

Fig. 1—The strips together

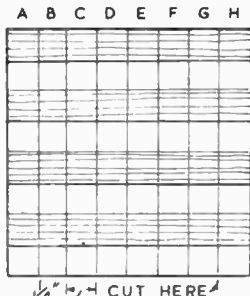

Fig. 2—Marking to cut

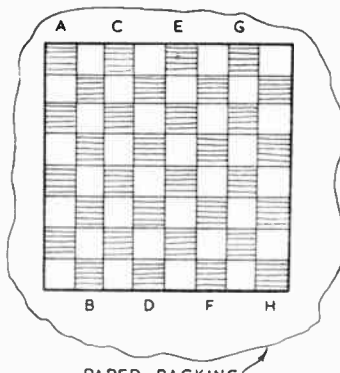

Fig. 3—Moved to alternate squares

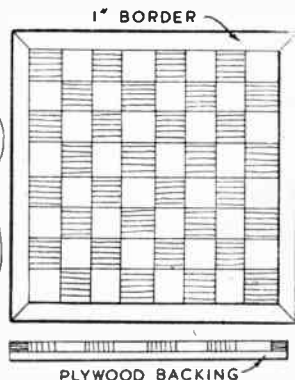

Fig. 4—The board with border

each strip being 1½ins. wide by ½in. thick and at least 12ins. long to allow for cutting and trimming. For the border four strips 1½ins. wide by ½in. thick and at least 13ins. long. For the backing a piece of plywood is required, which should be 12½ins. square.

First of all prepare the strips. Great care is needed here to ensure that the

striking to the baking board. Put them aside to thoroughly set.

When set, square the end and mark a strip 1½ins. wide (Fig. 2), allowing for planing to correct size. Now plane the sawn end again and mark, cut and plane to size another strip. Continue preparing strips until you have eight of them. Carefully clean off the paper

round. Glue it in place and while it is setting, prepare the border strips. These should be 1in. wide. Finally clean the edges of the Chess Board and mitre the border strips to fit and glue in place (Fig. 4). When all is set, level off the playing surface and either wax or french polish to suit. (135)

Improve your photography this season with these CAMERA HINTS

WHAT a glorious month is May! Have you ever realised what an extraordinary difference there is in almost everything in the world of out-of-doors this month and a couple of months ago? If the sun is shining there seems to be a complete change; brightness instead of dullness and, in fact, one might almost say, liveliness seems to pervade everywhere.

What a difference a spot of sun makes. It not only reawakens the natural growth of our woods and fields, it somehow makes itself felt in our minds and bodies, recreating the desire to get out and get busy again with the camera.

Light and Pictures

Do you remember that day in February last? My diary says it was the 17th—sunny all day and an extraordinary contrast to the many wet days that preceded it. We felt the urge to spend the morning in some woods not far away, with the result that some more negatives of early spring sunshine were captured.

It is of the great variation which can occur in the power or light value of the sun in May that we wish to warn you amateur photographers. It is highly important to calculate, with more precision, or at any rate use rather more care, in arriving at your exposure time



Bars of silver, each approximately 1,000 ozs.

during this month than, say, August or September.

Let us take an example. Using a fairly fast film such as Selochrome, and stop F8, the exposure time at 11 o'clock to 2 o'clock can vary from 1/150 to 1/300th of a second for a subject such as an ordinary landscape or open river or water scene. This can be accounted for by such atmospheric conditions as overhead mist, or the fact that some fleecy clouds happen to be passing at the time.

There is always the fact that we have not got quite accustomed to the full

effect of sunshine. We have still in our minds the somewhat duller days of March and April and for this reason the use of an exposure meter, with which you are familiar and know to be reliable, is most strongly advocated.

It is not our intention to deal with any one particular subject this month because we very much want to try to induce the reader to make use of the hobby this year in one particular direction. This will give you and your friends considerable interest and enjoyment and, further, if you happen to have a literary bump or a flare for writing, it should prove a means for developing that 'bump' or flare. Well, here is the idea and it is hoped that many readers will make at least one effort to produce something really good.

Several years ago it was the writer's good fortune to be asked to join a party of friends, ten all told, for a fortnight's holiday in the West Country. It was late in August, and although that holiday occurred about twenty-five years ago, practically all the interesting incidents, and even many of the smaller and trivial details, of that period of enjoyment are indelibly fixed in the memory, and in those of friends, for all time as the result of an experiment which was tried for the first time.

A Pictorial Diary

The party included some real wits, and also others who were always ready to join in a practical joke. What was of greater importance, everyone was fond of walking and not too fond of sitting on the beach for hours on end. The writer, therefore, decided to have a note book in his pocket all the time, in which to keep a record of every-day occurrences. And, of course, to make very good use of the camera for illustrating as far as possible something connected with these happenings, as well as the places visited.

We all met at Waterloo Station and the first photographic venture was to take a shot of the party outside the carriage before the train started. During the journey the note book came into use and recorded some of the items which tended to make that journey memorable. A small motor coach was to collect and take the party and the luggage to the hotel three miles from the station. It arrived half-an-hour late, but meantime we were in conversation with the station master who interested us by putting his dog through many tricks, one of which was snapped.

The coach suddenly stopped when going down a very steep hill and the driver got down and rolled underneath to find out the cause of the trouble. After a few minutes his head re-appeared and he asked if anyone had got a piece of string? It is easy to imagine the dismay and after a few seconds the laughter that this caused. Needless to say, this

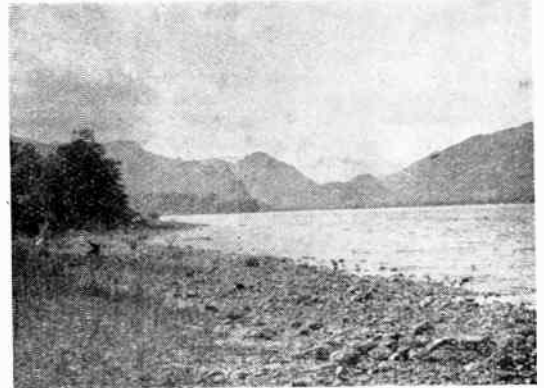

The mountains here are eight to ten miles away

funny situation was the cause of another shot, as well as a very full account in the note book.

A Pleasing Record

Those are simply to give examples of what was considered worth while recording. When the holiday was completed and the negatives printed, the notes were carefully edited and written in a well-made album with a goodly number of the prints pasted on the same page or adjoining one to illustrate the written story. When this was finished it was passed round to the members for them to read and enjoy.

Since the venture proved so successful, all subsequent holidays have been treated in a similar manner. In some instances, instead of writing a full report, lantern slides have been made from the most interesting negatives and these are now used in connection with a lecture on the 'Beauty Spots of Great Britain' with jokes and historical or interesting remarks on each view as it goes through the lantern.

Preparation Helps

Every reader will gather from the foregoing what is meant by the advice which has constantly been given in these articles; to encourage a purpose in your photography. What a huge number of films are wasted every season by the unfortunate habit of taking anything and everything without giving a little thought as to whether it is likely to make a good picture or whether the print will have any more interest after it has once been seen, or can it be used for illustrating a few words in a magazine.

Church Pictures

Perhaps it would not be out of place if one or two examples regarding that last remark were given. While on a visit to one of the South Coast watering places, a suggestion was made that a visit should be paid to a little village lying between the hills at the back of the town where there was a very old church and some marvellous carvings. This appealed to the writer who was very glad to join the party and to have the opportunity of photographing the carvings which are really very wonderful.

They are life-size and hand painted, twelve in number and supposed to represent the twelve Apostles. Records indicate that they were put in position somewhere about the year, 1480. The remarkable thing about them is that both painting and woodwork is still in wonderful condition. Well, a print from the negative was readily accepted by the editor of a magazine and the description which went with the print occupied a column.

In the Works

The second example is the result of a visit to a smelting works, where, fortunately, a large quantity of silver was being smelted and turned into bars or ingots and the writer was able to secure a photograph of a stack of these. Each bar weighs approximately 1,000 ounces. This stack, as you can gather from the illustration, is worth some money!

Now, what we should all realise is, that if it is our good fortune to secure a negative of some object or view of general interest, a print from it should be submitted to a journal or magazine, not so much with the idea of receiving payment (which, of course, may be very acceptable), but to give it publicity.

You will have gathered from the foregoing that the advice intended, for the beginning of another season for most amateurs, is to keep eyes open always for items of general interest or of a curious or unique character. Quite frequently it will be found that these subjects have a very unfortunate habit of coming into vision just when they are least expected; just round a bend in the road or round a corner.

Inn Signs

For example, it may be a unique Inn Sign, a splendid group of wild flowers on a roadside bank or a peculiar bit of rock formation looking somewhat like a lion's head. The author recalls a lychgate with a room built over it, a lighthouse of only one storey, and, in the main street of a Cornish village, a farmer pushing an ordinary one-wheel barrow with a sheep firmly tied down with a rope net; presumably he was on the way to the slaughter house with the animal.

Probably this was quite a common sight to the villagers, but a very unusual one to a town dweller. Well, these will give you a little idea of the type of subjects that are useful when the camera is being used for a purpose.

Finally let us revert to the subject of the first two paragraphs—sunshine. It is the photographer's best friend. There

are still many camera owners who have the idea that their particular camera will only 'take photographs' if the sun is shining on the subject and they would not think of 'taking' anything without.

This impression may be the result of reading rather too much into the instruction booklet where exposures are discussed. It may be the outcome of a remark made by the salesman. With the cheaper form of box or folding cameras the lens has only two stops, one much larger than the other.

Stops

Generally speaking it is the small one that can only be used when the sun is shining; but when the sun is obscured by white clouds and provided there is a good light otherwise (as, for example, at midday in summer), it is quite possible to get an efficient exposure by using the large stop, which, obviously, permits more light to travel through the lens to the film.

If you happen to be wanting to make an

exposure on the beach and the sky is very full of clouds and no actual sunshine, you must bear in mind that the water will give considerable light reflection from those white clouds and if you have a fairly fast film you might even get a good result by using the small stop. Even wet pavements reflect light, so, in order to learn the possibilities of your camera, it will pay you to make a few tests.

Keep the Details

Be sure, however, to make a note in your diary of all the details connected with exposures—the time of day and condition of light, the stop used and the exposure, and also the name and speed of the film. Then, if you study the finished negatives and prints with these details, you will gain a lot of valuable information. This will serve you in good stead in the future and possibly enable you to make exposures on subjects and at times which, without this knowledge, you would not consider worth while.

Helpful Replies of Interest—

Graining

PLEASE advise me as to the best way to grain the doors of my house. (T.S.—Dyker).

TO carry out some simple oak graining, first paint the wood with the following undercoat. 1 lb. white lead ground in oil; 1 oz. yellow ochre, 1 oz. driers thinned to working consistency with linseed oil and turpentine. When dry, apply a coat of graining colour, very thinly, and grain while the paint is still wet. The graining colour is made up of two parts yellow ochre, one part burnt umber, with 2 ozs. driers to each pound of pigment. Thin down with the oil and turps.

Study a door already grained, to get the idea. For the straight graining, an ordinary domestic comb covered with a slip of calico can be used, the wide tooth end only being utilised. For the panel markings use the finger nail, covered with calico. When dry, coat with clear oak varnish. An article on this work has appeared in 'Hobbies Weekly'.

'Smeared' Polish

MY utility bedroom suite of light mahogany colour has a good polished surface, but the top of the wardrobe doors look as if heavy with grease of some kind, no matter how light or heavy we rub them, the smears remain. (G.H.—Kirkby-in-Ashfield).

IT is difficult to give a reason definitely for the smeary appearance of your wardrobe, but it is probably due to excess of linseed oil at that spot, the excess oil working out through not being properly spirited off.

We can only suggest you rub the spot over lightly with a pad of cotton wool, moistened with methylated spirit, repeating this as necessary, until the smeariness ceases. Go carefully, or you may remove the polish as well. If the spot afterwards shows, a less polished appearance than the rest, go over it with a pad moistened with thin polish.

Transformer Conversion

COULD you advise me on how to convert a rotary transformer ex-R.A.F. type, into an AC motor 210 volts. The input is 24-volt. D.C. and the output is 250-volt 50 m.a. + 6.5 volts 2.5 amps. (T.C.—Bristol).

WITH most of the units of the type mentioned, it is not possible to re-wind the coils. However, with most models quite satisfactory running from 200 to 230-volt mains will result if the mains are connected to the 250-volt points normally giving the output when the unit is used for its proper purpose.

Proper and well-insulated connections are essential, and if the motor shows any signs of overheating, the supply should be switched off.

With some types it is an advantage to connect the various windings on the field and armature in series, and this can be tried if necessary. Exact instructions on this point cannot be given because so many different types have been produced. If windings are tried in series, try reversing the ends to each because there will be a correct, and an incorrect way of connecting each winding. If the unit will run for a long time without excessive heating, connections are correct.

The handyman should know how to deal with WORN PIVOTS AND HOLES

NO piece of machinery, however simple—even a fretmachine—can be expected to give satisfactory service if it has got worn pivots or large badly shaped holes. It is very bad to let a clock, gramophone or some other piece of machinery keep running with worn pivots and holes. They should be repaired before they get worse, or they may cause further damage to the works.

The job of repairing worn pivots or holes, or of fitting new ones is not a difficult one and the average handyman is quite capable of tackling it. There is a certain amount of pleasure to be got from doing work of this kind, added to which the keen workman can add to his income very nicely by this means.

The Best

The ideal pivot, as shown at (A) is perfectly round and highly polished, its sides are parallel and straight and are a continuation of the shaft which it leaves with a nice clean square shoulder. It should be made of a hard material such as steel.

The hole in which the ideal pivot works should likewise be quite round and have straight parallel sides. Steel, hard drawn brass and bronze are the metals mostly used, while for the best class work, such as clocks, watches and scientific instruments some of the pivots run in jewel holes made of garnet or sapphire.

The chief faults that are likely to occur with pivots are shown from (B) to (E). A bent pivot (B) is quite a common source of trouble and if it is not too badly bent it can generally be straightened by the use of a pair of flat nose pliers. Go carefully and only attempt a little at a time—do not try to get it straight in just one bend. If the pivot is of hardened steel it must be softened first by placing in a gas jet or spirit lamp—it would, perhaps, be as well to adopt this method in any case.

Bent Pivots

Another very good way to straighten a bent pivot, and one much used by watchmakers, is to take a piece of brass tube that just fits over the pivot and by gradually easing it over, the bent pivot can soon be uprighted.

It sometimes happens that a pivot is worn like (C); this is commonly called a drum stick and occurs when the plates in which the pivots run are made too thin. If it has not worn down too much it can be filed parallel and polished and the pivot hole made smaller by bushing, but if it is as bad as shown at (C) a new pivot must be fitted.

The best way to file and burnish a pivot is shown at (F) where a block of hard wood having a V shaped slot cut to take the pivot is used. A file is placed on the pivot and moved to and fro, keeping

it perfectly level while the pivot is rotated either by the fingers or better still by a drillstock or small hand vice.

The same treatment can be used for the pivot shown at (D). It is unlikely that it had worn that shape, but rather that it had been badly machined when made.

A broken pivot like (E) is of very frequent occurrence and may be the result of shock such as a mainspring breaking or it may have broken when trying to straighten a bent pivot.

Fitting a new pivot is really quite a simple job, as well as being an interesting one. The steel must be softened by heating it, then file off the old piece of pivot and after very carefully centreing it, drill a hole about the same size as the old pivot. It does not matter if the hole is slightly larger, but it must not on any account be smaller.

Drilling and Fitting

The hole should be drilled down to a depth of about $1\frac{1}{2}$ times the length of the pivot. Pay very special attention to getting the hole perfectly central. It may not seem very important but the extra amount of time spent in doing an accurate job here will be well worth while. It is also very necessary to keep the drill quite upright when drilling the hole.

Next take a piece of steel wire, such as a knitting needle or sewing needle and draw the temper by placing in a gas or spirit lamp flame until it is blue. Adopting the same method as shown at (F) for reducing and polishing a pivot, file the needle to fit in the drilled hole, but make it slightly tapered, so that it can be driven in tight with a few blows from a hammer. Do not make it too tapered or too tight a fit, or you may split the spindle. If it has been made carefully and is a good fit, it should not be necessary to solder it in.

Cut off the pivot to the correct length and file it down to fit the hole, round off the end and burnish the whole to a high polish.

A good shape pivot in a well fitting hole is shown at Fig. G. There is a very small gap down the sides of the pivot which is called side shake, while a little more is allowable for end shake. The top of the hole is neatly countersunk into what is called the oil sink—this should be quite shallow and is to keep the oil from spreading all over the plate and eventually drying out altogether. Fig. H is the end view of a perfect hole and oil sink, both being true circles.

The most common type of worn hole is shown at (J) where the power of the mainspring has caused the metal to wear away on the right side. If the hole has not worn too much and the plate is not too thick, the hole may be closed by punching round the worn side. Use a round-ended punch and with light taps

from a hammer, gradually go round the worn side until the hole is practically round again; and do this only on the outside of the plate. It does not matter if you close the hole too much, it is in fact an advantage for it can then be opened out with a round tapered burnisher such as the end of a needle. This method hardens the metal and makes it wear longer, besides producing a perfectly round smooth hole.

When the hole is worn rather badly it will be necessary to bush it, and Fig. K shows the first job of centreing up which is done with a round file,

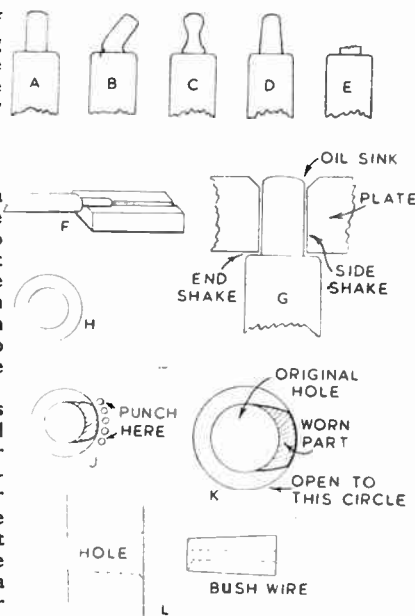

bringing the hole back to its original position only very much larger.

There are two types of bush that can be used, the first is a solid one that has to be drilled out. Fit a piece of brass or iron rod in the hole and carefully rivet it tight, countersinking both ends slightly before doing so. The kind of metal will depend on the type used for the plates. Carefully centre and drill to fit the pivot.

The other method which is adopted by most watchmakers is to open out the hole as before, but this time making it slightly tapered from the inside of the plate. Then push in a specially prepared tapered bush (see Fig. L) which is already drilled out perfectly true and central, and rivet it over. The hole is then opened out to the correct size to take the pivot. These bushes can be obtained from watch and clock material dealers or from an ordinary watchmaker.

It is very important to drill all holes perfectly upright when fitting bushes and also to leave all holes well polished and to leave no rough edges. (136)



The Modelcraft **TREE MAKER-KIT**

This is the greatest help yet produced for the scenic modeller. All who have a model railway layout, or who want to develop the scenic aspect of farmyard or doll's house modelling will need it. The information, photos and drawings contained in the instruction leaflet are invaluable, but even without it the kit would be superb value.

★ The Kit contains: NATURAL SPONGE, SPONGE RUBBER, GREEN AND BROWN FLOCK POWDER, ASSORTED WIRE LENGTHS, **3/-** Post Free BINDING STRIPS, INSTRUCTIONS.

The Modelcraft 1950 List gives details of over 600 plans, plan books, kits and accessories for the modeller, many useful hints and tips, historical notes and practical editorial articles. 1/-, including refund voucher.

MODEL CRAFT LTD.

77 (F) GROSVENOR ROAD, LONDON, S.W.1



This pocket EXPOSURE CALCULATOR will help you to obtain really good bright photographs.

A quick, simple and remarkably accurate exposure calculator. Works equally well in summer or winter. By 'dialling' the time of day, subject, weather and film speed the exact exposure for any lens aperture is instantly indicated. Strongly made in white ivory with clear black and red figures. Provision is made for filters.

Photographic Dealers
everywhere sell these
Johnson Calculators

PRICE **2/6**

JOHNSONS OF HENDON LTD., LONDON, N.W.4

YOU CAN BECOME A HANDICRAFTS INSTRUCTOR

Experience not essential

Men who enjoy making things in wood or metal can turn their hobby into a well-paid, permanent and interesting Career. Short hours, long holidays, and security in a job you would really enjoy, can be yours if you become a Handicrafts Instructor. Let us send details of the easiest and quickest way to get the necessary qualification.

We definitely guarantee
"NO PASS — NO FEE"

If you would like to know about our unique method of preparing you for one of these excellent appointments, write today and we will send you our informative 176-page Handbook—free and without obligation. Mark your letters 'Handicrafts Instructor'.

**BRITISH INSTITUTE OF
ENGINEERING TECHNOLOGY**

595 Shakespeare House
Stratford Place, London, W.1

BIET

Indispensable to all interested in motor cars.

The two popular Car Books

"WHERE'S THAT CAR FROM!"
"POPULAR CARS ILLUSTRATED"
6d. each

From all Stationers and Booksellers

or from **RALEIGH PRESS, EXMOUTH**

NEW PLYWOOD OFFCUTS

Approx Details: 20 oblong pieces, largest 36" x 5"; 14lbs for 6/6. Carr. Pd. Ideal for Toy and Modelmakers.

DUNLOPILLO UPHOLSTERY

Used, Seat type, 3½" at front, heavy gauge rubber. Approx sizes, 34" x 15" 12/- each; 17" x 15" 6/6 each. Easily cut and joined. Cash with order. Refunded if not satisfied.

B & M SALES

16 Hamm Moor Lane, Weybridge, Surrey
Telephone: Weybridge 3311.

A TOY WITH A PURPOSE

ARTS AND CRAFTS BRUSH MAKING SET
INTERESTING AND INSTRUCTIVE FOR
BOYS AND GIRLS OF ALL AGES

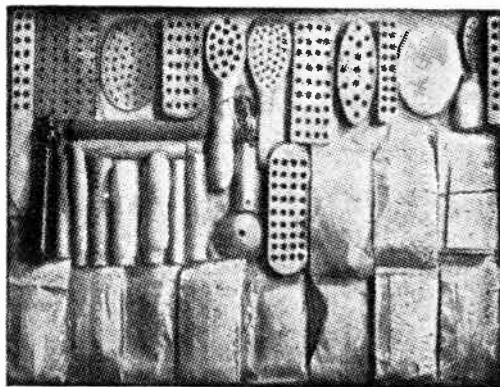

15/- each

Complete set Carriage paid

TOY CENTRE

95 Lower Marsh, Lambeth, London, S.E.1.

Tel.: WATerloo 4559



**FOR A
REAL
Professional
'FINISH'**

'FINISH' is the true test of craftsmanship. It's easy to impart a real professional 'finish' to woodwork and furniture you make at home with "COLRON" WOOD DYE—the finest stain for all practical purposes.

One coat of "COLRON" is all that is required to emphasize the natural beauty of the wood grain. No smears—no 'overlaps'—no trouble. Leave from two to three hours, burnish with rough dry cloth and you have a perfect base for french polishing or for waxing with "RONUK" FLOOR POLISH.

COLRON WOOD DYES

12 SHADES—ALL SIZES

Write for colour guide and full details to:

RONUK LTD. (Dept. 62) Portslade, Sussex

another JUNEERO model

FREE! COAL MINING
PITHEAD GEAR'
DESIGN SHEETS

given with the May issue of JUNEERO NEWS—which will be quickly snapped up by thousands of Juneero Fans. Get your copy now from your Juneero Dealer at 6d. or 7d. post free from Juneero Ltd.

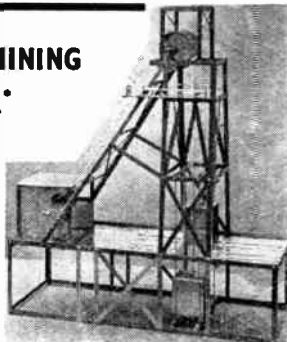

Have you your JUNEERO ANNUAL yet? Given FREE with each copy are Design Sheets enabling you to make a smashing working model Bulldozer. Hurry! Buy a copy today from your Juneero Dealer, 1/-, or 1/2 post free from Juneero Ltd.

*This superb working model is easily and inexpensively constructed with the famous Juneero constructional tool, gauge bar and accessories—all readily obtainable at Juneero Dealers everywhere. If any difficulty write to:—



JUNEERO LTD. STIRLING CORNER,
BOREHAM WOOD, HERTS.

CASCO

**COLD
water
GLUES**



supersede this

Most hobbies require Glue—"CASCO" fills the bill for either new work or repairs. It is an absolute necessity for the Modelmaker for Fretwork, Toymaking, etc. Easy to mix in cold water Casco is simple to use and almost impervious to heat and moisture. "CASCO" Grade "A" is the world-famous Casein Cold Water Glue manufactured in Great Britain, Australia, U.S.A. and Scandinavian countries. Conforms to MODERN BRITISH STANDARDS SPECIFICATION 1444, TYPE A.



Stocked by Ironmongers, Builders' Merchants, Hardware Stores, etc.



DISTRIBUTORS:

Gt. Britain: Charles Cleeve & Co. Ltd.
45 Gt. Peter St., London, S.W. 1.

Eire: C. B. Waller, 60 Middle Abbey St., Dublin
M. J. Galligan, 16 Oliver Plunkett St., Cork

FREE! Send for literature and Free Sample to the manufacturers

LEICESTER, LOVELL & CO. LTD.

(Dept. HW), NORTH BADDESLEY, SOUTHAMPTON

**The bristles won't
come out!**

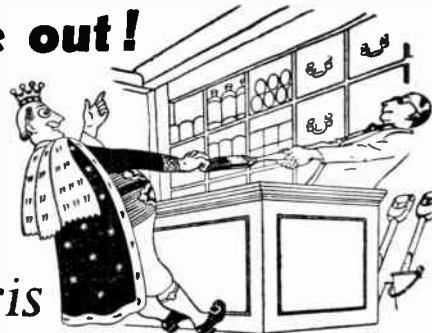

Harris

the paint brush with a name to its handle



There are 3 grades of Harris Brushes. "Junior" good. "Standard" better. "Super" best.

L. G. HARRIS & COMPANY LIMITED, STOKE PRIOR, WORCESTERSHIRE
CRC23

EXTRA CASH IN SPARE TIME



A fascinating way of earning extra cash in spare time from odd pieces of lead. Small Outlay—Large Profits. Sample mould 3/6d. Casting moulds, deep-cut and ordinary type Aeroplanes, Soldiers, Farm and Wild Animals, Cars, etc. Stamped envelope for full list. Illustrated Catalogue 9d.

MASTERCRAFT MOULDS
69, ST. MARKS ROAD, HANWELL, LONDON, W.7

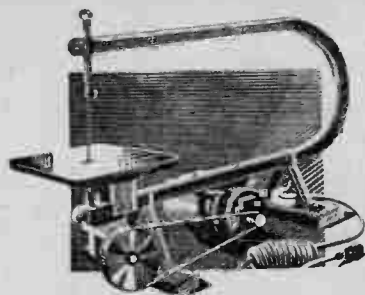

For wood, card, plastic, leather, metal etc.

TREADLE OR MOTOR FRETSAWS

Whatever the handyman or craftsman is cutting or making, one of Hobbies Fretmachines will help with the job. For toy making, fretwork, model making, it provides easy and speedy cutting in all kinds of material. A pleasure to use, a factory for output, a lifetime of service.

From 70/- to £10

Ask to try one at any Hobbies Branch or good class Ironmonger or hardware stores. Or free illustrated leaflets on request to:

HOBBIES LIMITED, DEREHAM, NORFOLK

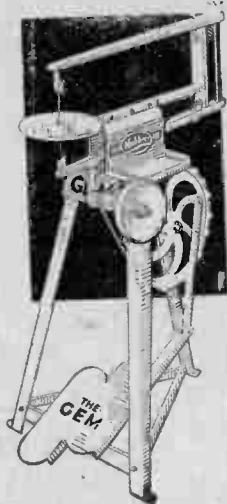

BOYS!

your chance to GET ON!

If you are over 14 and under 16 here is a golden opportunity. For three years you can enjoy all the amenities of a fine boarding School, entirely without cost to you or your parents. You will be well boarded, fed, clothed and cared for and paid while you learn to handle modern tools and equipment with skill and precision. Your training over, you will be ready to take your place in one of the Army's crack Technical Corps with every chance of quick promotion to Warrant Officer and opportunities of reaching Commissioned Rank. Don't waste this chance. Send the coupon NOW for Free Booklet and date of next Entry Exam.



DETAILS FREE Send this coupon Entries for the next Examination must be in by 31st May

Commandant, ARMY APPRENTICES' SCHOOL, Arborfield, Berkshire • Commandant, ARMY APPRENTICES' SCHOOL, Chepstow, Monmouthshire
Commandant, ARMY APPRENTICES' SCHOOL, Harrogate, Yorkshire • Commandant, ARMY CATERING CORPS CENTRE, Aldershot, Hampshire
Post to whichever of these addresses is nearest to you, or to War Office, A.G. 10, London.

Please send me details of Army Apprentice School training and conditions of entry

NAME

ADDRESS

3

Hobbies

WEEKLY

CONTENTS

	Page
Old Time Paddle Ship	113
An Electric Nursemaid	115
Scrap Wood & Dowels	117
Model Railway Curves	118
Lady's Handbag - -	119
Home-made Cements	120
Bedroom Wall Cabinet	120
A Square Occasional Table -	121
Overhauling the Primus -	123
Triple Photo Frame -	124
Paddle Boat Patterns	127

May 24th, 1950

Price Fourpence

Vol. 110 No. 2847

Patterns on page 127 for a miniature model OLD-TIME PADDLE SHIP

It was last January that we published in this journal a supplement design sheet of the liner 'Pretoria Castle'. This splendid vessel belonging to the Union Castle Line is engaged in the weekly mail service between England and South Africa. We mention these facts because we now present our readers and model makers with patterns for just such an interesting vessel which also carried the African mail from England, but before the turbine and propeller were introduced as the driving power.

Our model shown here can well be contrasted in size to illustrate the tremendous strides shipbuilding has made. The model is of the waterline

type, and measures—without its base—13½ ins. long overall and its height is 8 ins. The plan at Fig. 1 and side view, Fig. 2, will be found very useful when assembling the various parts of the model. The full-size patterns, too, of many of the important parts, are given on cover iii.

The hull is a piece of ½ in. thick wood cut to the shape of the two patterns

(A) on the pattern sheet. Now, as we were unable to give the full-length diagram of the parts, we have cut it into two. All the worker has to do is to stick to the wood, each pattern (A), butting them together at the lines shown and marked by the crosses. This lower hull piece when completed will measure 9¾ ins. long.

To the top surface of this main piece glue the raised deck block (B), at the bow, and also another block at the stern of the model, as (C). These two pieces are identical in outline to the lower hull piece, but each must be about ¾ in. less in width all round (see dotted lines), so the raised sides or

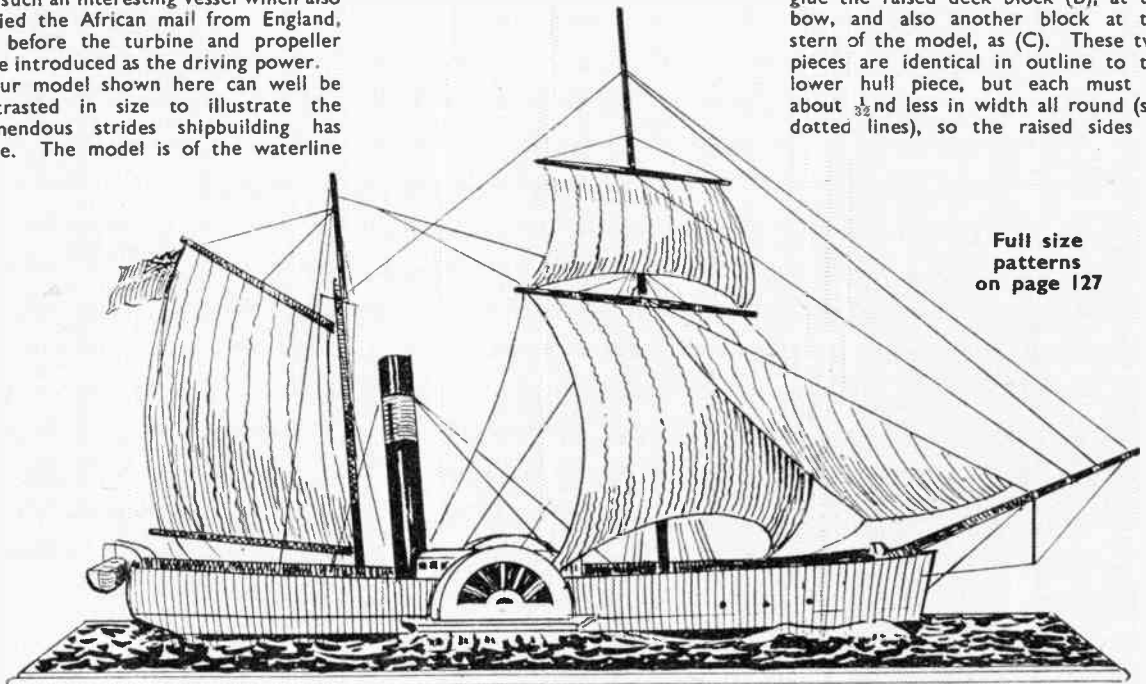

Full size patterns on page 127

All correspondence should be addressed to The Editor, Hobbies Weekly, Dereham, Norfolk.

bulwarks can be glued on and come flush with the lower hull.

Therefore, first take a piece of $\frac{1}{4}$ in. wood 6ins. long and lay the already made bow portion of the hull on it, and draw round it to get an exact outline. Next take a piece of $\frac{1}{4}$ in. wood 4ins. long and repeat the process for the raised stern block. Where the two pieces meet on the lower hull is indicated by the dotted line on the pattern sheet. Note the position of the masts on pieces (B) and (C).

To make the raised sides of the vessel use thin bendable plywood or stiff thin card which will be cut to the shape shown at (D) on the pattern sheet in two

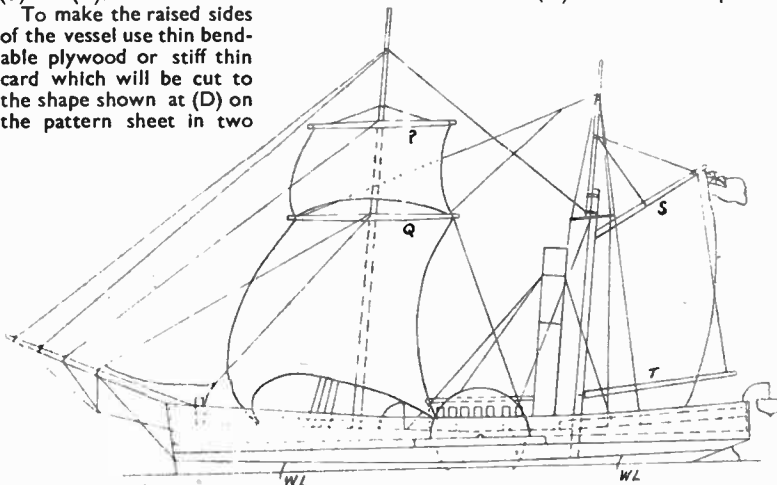

Fig. 2—Side view, with dotted lines of adjoining parts

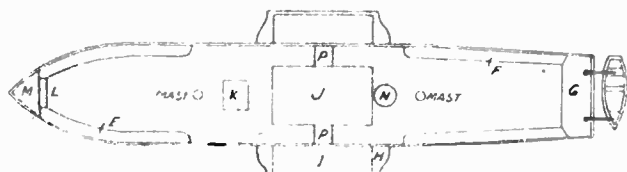

Fig. 1—Plan of deck and hull

sections. The plan of the ship, Fig. 2, and the view showing construction, Fig. 3, show how the bent sides appear when glued to the raised blocks at bow and stern. A large portion of the foremost side is shown cut away for sake of clarity.

The raised sides, seen at (D) on the pattern sheet, are shaped to slope towards the funnel. The stern board of thin wood is given on the sheet and is glued between the raised sides. The ribbon shown in outline is to be painted on later.

To stiffen the raised sides of the model two pieces as (E), and two pieces as (F), will be cut from $\frac{1}{4}$ in. wood and glued in at bow and stern respectively. The wide piece (G) is also cut from $\frac{1}{4}$ in. stuff and glued in to stiffen the stern board. It also takes the davits of the swinging boat over the stern.

Paddle Box

The paddle box frame (H) is of $\frac{1}{4}$ in. wood. Two are cut and glued to the sides in the position shown. On top of these frames glue the semi-circular pieces (I) representing the casing to the paddle-wheels. Two will be cut to the pattern given on the sheet, the markings shown being later painted on.

The engine room and cabin (J) can be cut as a solid block from $\frac{1}{4}$ in. wood and measures $1\frac{1}{2}$ ins. by $1\frac{1}{2}$ ins., with windows and doors painted on. The shaped companion head (K) is a simple block, as given in two views on the pattern sheet. The upright (L) also on the sheet, carries the bowsprit and is of $\frac{1}{4}$ in. wood. Just in front of this piece (L) is a small angular piece (M) glued between the pieces (E) on the sides. Fig. 3 shows the position of all these parts.

The funnel (N) is made from a piece of

Fig. 4, to draw on parchment paper or ordinary cartridge drawing paper. Glue the sails to the spars as shown and bind with fine cord at places, excepting the foresail which will have cords attached. The rigging of the masts can be carried out with fine thread, the arrangement being taken from Fig. 2.

Painting the Model

In painting the model use ordinary oil paint or enamel. The hull should be black with a bright red waterline (marked W.L. in Fig. 2). The upper sides of the model above line of deck, should be painted cream. The deck is light brown lined up to represent the planking. The cabin is white with windows painted blue with black frames.

It should be mentioned that the little semi-circular blocks (P) on the pattern sheet are cut from $\frac{1}{4}$ in. wood and shaped to represent the deck casing to the spindles carrying the paddle-wheels. Note their position on the plan, Fig. 2. The funnel is painted red with a black banding.

A base is made for the model from $\frac{1}{4}$ in. or $\frac{1}{2}$ in. wood, 14ins. long by 5ins. wide. A plastic substance such as

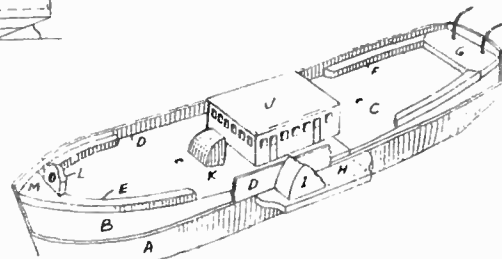

Fig. 3—Constructional details of hull and paddle box

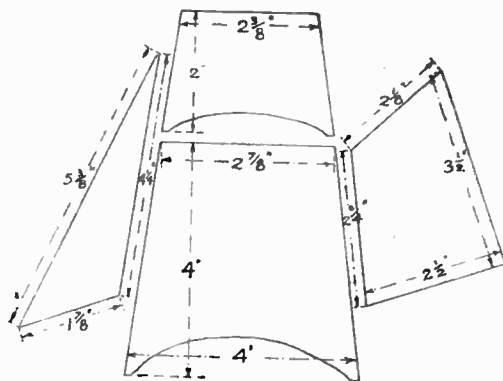

Fig. 4—Scale drawing of the sails

$\frac{1}{4}$ in. round rod to the full-size given. The stern boat is shaped from a thin block of wood $\frac{1}{4}$ in. in thickness to the outline given, the seats, etc., being either carved in and painted or just painted.

We give a pattern full-size of one of the davits for the boat, and pieces of suitable wire may be bent and fixed in the two holes shown in piece (G). Short pieces of thread or fine wire suspend the boat (see Fig. 2) plan and side view. The two masts are from $\frac{1}{4}$ in. diameter round rod, the fore mast being shaped to taper slightly upwards. The mizzen will not be shaped at all, as there will be a top spar spliced to it, as seen in Fig. 2. The main mast is $7\frac{1}{2}$ ins. long; the mizzen $4\frac{1}{2}$ ins. long, and the top spar or mast $2\frac{1}{2}$ ins., $\frac{1}{4}$ in. of this being used for splicing on the mast.

The cross spars supporting the sails are made from $\frac{1}{4}$ in. rod and taper towards the ends. The spars are given full size on the pattern sheet, as is the bowsprit.

Scale outlines of the sails are given in

Pyruma, suitable for moulding up to form waves, should be spread on the board and the model laid in it. All can be painted realistically at the finish. (130)

**Design for a novel
mechanical Race
Game next week**

Baby's cries upstairs transmitted downstairs by this RADIO NURSEMAID

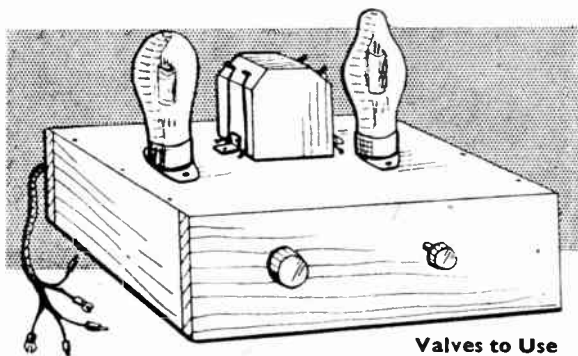

THE apparatus generally referred to as an electric nurse maid consists of a microphone, speaker, and amplifier, giving a good degree of amplification. The microphone is situated in the child's room, and the speaker in the living room. Cries or other sounds are then relayed and amplified, warning the parents that their attention is needed.

The amplifier described here can, of course, be used for other purposes. It will give very good results with a gramophone pick-up employed for playing records; with a suitable microphone, it can be used for 'home broadcast' items, including instrumental and vocal performances. It can also be added to a 1-valver or crystal set, to bring the volume up to good speaker strength.

Circuit Parts

The complete circuit is given in Fig. 1 and it will be seen that very few components are necessary. The volume control (a desirable refinement) can be of any value between about .25 megohm and 1 megohm, though if a new one is being obtained .5 megohm is most suitable. For coupling the valves, any ordinary low frequency coupling transformer can be used. The ratio of these components is usually about 1:3 or 1:5, and is not critical.

Some transformers only have Primary and Secondary indicated. With these, the primary is taken to the first stage valve plate and to H.T. positive. The secondary is taken to the output valve grid and Grid Bias. With all transformers slightly better results will usually be obtained when the secondary is connected in a certain way. The effect of reversing the two secondary connections should, therefore, be tried, even when the transformer is fully marked, as in Fig. 2.

A small on-off switch of any type is also required,

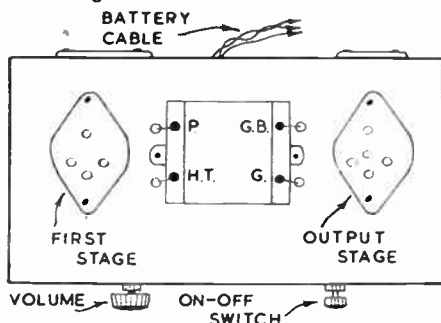

Fig. 2—Top plan of the unit

and two valve holders. One should be a 4-pin type. If a pentode or tetrode valve is to be used for output, a 5-pin holder will be required here. If a triode is going to be used, a 4-pin holder will do. Alternatively, the 5-pin holder may be wired up as shown and the centre socket ignored.

Valves to Use

Fig. 2 will show the positions in which the valves are to be inserted. For the first stage, a general purpose low frequency amplifying valve can be used. The Osram HL2 is suitable, but many other manufacturers have valves equally satisfactory and any equivalent can be used.

For the output stage, a pentode or tetrode will give maximum amplification. A suitable valve is the Cossor 220HPT or any of its equivalents.

For many purposes a triode may be used here, though the overall amplification will be slightly reduced. A small power valve such as the LP2 is suitable. Alternatively, any valve to hand can be tried.

Chassis Construction

A tidy layout is obtained by using a chassis about 2ins. deep, and this can easily be made from plywood, with slightly thicker wood for the two short sides. A chassis 4ins. by 6ins. is amply large. Holes about 1½ins. in diameter should be cut with a fretsaw for the valve-holders, the sockets of which project below.

The underneath wiring is shown in Fig. 3. Small socket strips can be used for speaker and microphone connections, or four small terminals can be

used. Provided the plywood is dry and has been varnished, it will be in order for the terminals to be mounted directly on the rear strip, leaving at least ½in. between each two terminals, with 3ins. or so between the nearer speaker and microphone terminals.

The volume control and switch are mounted on the front strip. All the battery leads can be taken through one hole about ⅜in. in diameter drilled in the centre of the rear strip. For these leads, insulated flex cut to suitable lengths can be used.

Wiring Details

No difficulty should arise in connecting up correctly, following Fig. 3. Suitable insulated connecting wire can be obtained from the popular stores and soldering (avoided by some constructors) will prove easy if cored solder and an iron almost, but not quite, red-hot is used. It is necessary to secure the valveholders as shown, because the dissimilar socket-spacing prevents the valves being inserted in the wrong manner.

Four leads pass through the chassis, and reference to the diagrams will make the connecting up of these quite clear. After checking the wiring against the diagrams, the unit is ready to try.

Battery Connections

For high tension, a 120 volt battery will provide most volume, though a 90 volt battery is good, and satisfactory results for some purposes will be

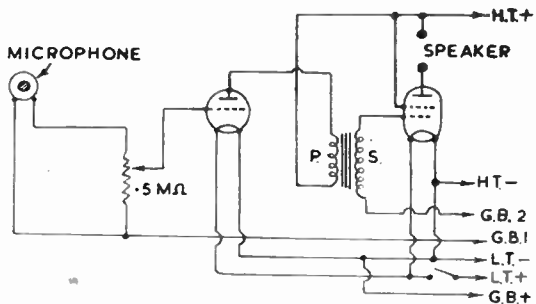

Fig. 1—Full theoretical circuit

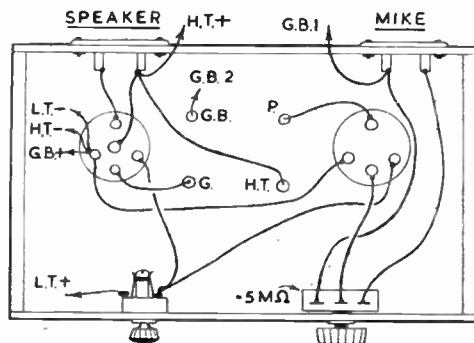

Fig. 3—Complete wiring diagram

obtained with a 60 volt battery. The grid bias voltages used will have to be found by trial because they depend upon the high tension voltage and exact valves used. Normally, 1.5 to 3 volts will be best for G.B.1 and 4.5 to 7 volts for G.B.2.

Select the highest value of grid bias which can be applied without causing distortion, or too severely reducing volume. The higher the grid bias voltages used, the longer will the high tension battery last. An increase in 3 volts bias on a pentode output valve can double the life of a H.T. battery.

Valve Insertion

Insert the valves before connecting the batteries. This is necessary because with some types of valveholder it is possible to touch the pins on the sockets in the wrong position, when trying to insert the valves, and if filament contact is made to the anode socket the valves may be damaged, or the primary of the transformer burned out.

For low tension, use a 2-volt accumulator. All the batteries can be situated at any convenient point, possibly in the cabinet, if a record player is being made.

Mike and Speaker

Any permanent magnet moving coil speaker with transformer can be used. For a pentode valve, a pentode speaker transformer is desirable, the impedance

of this being higher than that used for a triode power valve. However, speaker transformers usually have several tapings, so the most suitable impedance can be selected. With the correct impedance, volume and quality of reproduction will be at its best. The speaker should be enclosed in a cabinet, or it cannot give its best.

For record-playing purposes, reproduction will be a little high-pitched. If this is objected to, connect a .01 mfd. condenser across the loudspeaker sockets on the amplifier.

Many different types of microphones are available, and each will give satisfactory results if properly used. A moving coil microphone is a good type, but must have a matching transformer, just as a moving coil speaker must. Actually, a small moving coil speaker will be found to function well as a microphone.

Carbon microphones give maximum volume, but must be used with a carbon-microphone transformer. The latter has a step-up ratio of about 1:100, and a low-resistance primary, which is connected to the microphone and a small dry battery. This enables a steady current to flow through the microphone, and without this a carbon microphone cannot function.

An earphone with cover removed will function as a magnetic microphone, and does not require any battery or trans-

former. Its disadvantage lies in the fact that it does not pick up sounds at much distance. This may be overcome by using one of the old type moving iron speaker units, if to hand, with a fairly large cone. With this, conversation at quite a distance from the 'microphone' will be heard.

Twin flex can be run from the microphone to the amplifier, the leads being kept well away from those connected to the speaker.

If instrumental or vocal items are performed, the performers should be in a separate room, if possible. If in the same room as the speaker, the sound from the latter should not be allowed to reach the microphone directly. If it does, continuous howling will be caused.

Pick-Up for Records

The popular electromagnetic pick-ups are generally best for ordinary use, being comparatively inexpensive and robust. With one of these, more than ample speaker volume will be obtained with the volume control at maximum.

If the amplifier is switched on with nothing connected to the 'Mike' sockets, howling will probably arise, unless the volume control is turned down, and this does not indicate a fault. For preference, the unit should not be switched on with no speaker connected since the open anode circuit is eventually detrimental to the output valve.

Photography is FUN

with a **Coronet D20 Box Camera**

Here is a camera you can easily afford yourself and be justly proud to own. With a Coronet D20 Box Camera you can depend on really first class results; it makes photography so easy—no complicated adjustments or involved calculations. It is straight forward 'shooting' every time. It's inexpensive, robustly made and thoroughly reliable—the ideal hobby camera.

Always ask for
DUFAY
NON-FLAM SAFETY
FILM
on sale everywhere



**BUY YOURSELF A
DUFAY-CHROMEX LTD.**

FREE!

Write for the Free booklet 'PHOTOGRAPHY IS FUN'. It tells you how easy and absorbing photography can be as a hobby with Coronet Cameras and Dufay Film.



Coronet
D20 Box
Camera
£2 3 0
Tax Paid

Coronet

CAMERA

(DEPT. P.2.) ELSTREE HERTS — — — Telephone Elstree 1733

Some useful articles for the home made from SCRAP WOOD AND DOWELS

WITH a supply of prepared dowelling, some scrap wood, and a few simple tools, the craftsman can keep himself employed for many hours in making simple fitments that are useful in every home. Suggestions are given for the making of five such items, but although definite sizes have been quoted for them the measurements can be varied to suit individual needs. The keen reader will also see that the type of item described does not exhaust the possibilities of dowelling as a woodwork material.

Book-trough

The two ends are of $\frac{3}{4}$ in. or $\frac{1}{2}$ in. thickness, each being cut from a piece 6 ins. square. The quarter-round shaping at the front can be taken out with a fretsaw, and to ensure an even curve the two pieces of wood may be tacked together while the sawn edges are glass-papered.

As books tend to be heavy, dowelling of not less than $\frac{1}{2}$ in. diameter should be used for the trough. Five lengths will be needed, and holes for these must be bored in each end.

The lowest hole has its centre at $1\frac{1}{2}$ ins. in and $\frac{3}{4}$ in. up from the back bottom edge, as shown on drawing

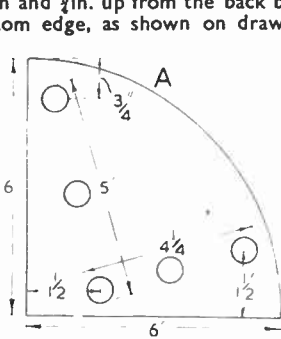

(A). The front dowel has its centre point at $1\frac{1}{2}$ ins. from the bottom edge, while the top dowel centre is at $\frac{3}{4}$ in. from the top edge. The distance apart of these holes is shown on the drawing, and it will be seen that the two remaining dowels are spaced midway between those already mentioned.

In length, the dowels must be 9 ins. plus the combined thickness of the ends. Dowel ends can be slightly eased with glasspaper to make a good hand-tight fit, then a little glue is dabbed on them before they are forced into their holes.

If it is thought that the end-grain showing on the quarter-round ends is unsightly, each dowel can be allowed to project $\frac{1}{4}$ in., and this projecting part of the dowel slightly hollowed out round the edge. With the book-trough assembled in this way it will appear as if there are five small bosses on each end.

Towel-airer

As before, the two ends are cut from a 6 in. square piece of $\frac{1}{2}$ in. softwood. In the original model these ends were actually cut from a margarine-box.

A slot $1\frac{1}{2}$ ins. deep by $\frac{1}{2}$ in. wide is cut on the top back corner, and the remainder of the front is shaped out to some simple outline with the fretsaw. A suggested shaping is given on drawing (B).

Towels are not particularly heavy, so the size of dowel used does not greatly matter, but $\frac{1}{2}$ in. diameter will be found very suitable. A hole of the required size is bored in each arm of each end, these holes having their centres at $1\frac{1}{2}$ ins. from the extreme ends.

Two 18 in. lengths of dowel are glued into these holes, while a similar length of $1\frac{1}{2}$ in. by $\frac{1}{2}$ in. wood is screwed into the slot at the top to make the fitment more rigid. The completed article can be fixed to the wall by screws through the back bar, or by brass hangers.

Sink Soap-dish

This is shown on drawing (C), which practically explains itself. The back is cut from $\frac{1}{4}$ in. wood of 9 ins. by 6 ins.

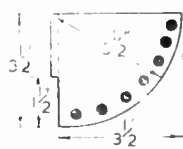
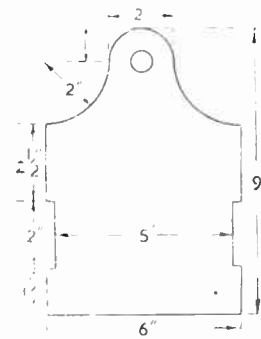
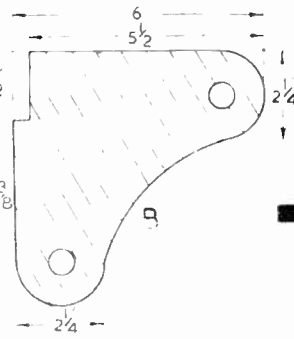

overall measurements. Its shape is clearly shown at (C). A small hole should be bored towards the top of the back so the fitment may be hung over a convenient nail.

The two shaped sides fit into the slots on the back. Before they are fixed seven 6 in. lengths of $\frac{1}{4}$ in. diameter dowel are glued into holes spaced equidistant round the shaped edge of the soap container. This is then screwed into its slots so its lower edge comes level with the bottom edge of the back.

Bath Soap- and Sponge-holder

Two end plates (10 ins. by 8 ins.) are bored with twelve $\frac{1}{4}$ in. diameter holes as shown on drawing (D). Towards the top of these plates two $\frac{1}{2}$ in. diameter holes are drilled.

Twelve lengths of $\frac{1}{4}$ in. dowelling are glued into the lower holes so there is a distance of 7 ins. between the inside faces of the ends. The two thicker dowels (shown black on drawing) are then forced through their holes. These thick dowels need to be about 2 ft. in length, to rest on the two sides of the bath. Their full

(Continued foot of page 118)

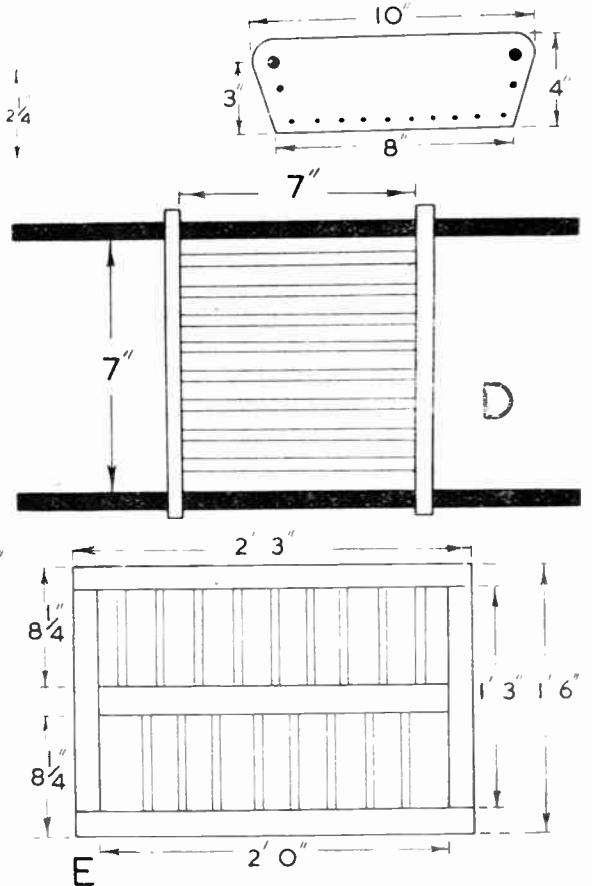

Some interesting and helpful notes about Curves in MODEL RAILWAYS

ONE often hears remarks about 'scaling down' the prototype to arrive at the sizes required for working in a given scale, but, whilst considering the inevitable smallness of radius of O and OO scale curves, the writer was prompted to 'scale up' the model curves to the full-size railway, allowing 6ins. to the mile on the diagram.

This scale was chosen as it is that used in the 6in. Ordnance Survey sheets, and the diagrams drawn could be compared with the curves of the real railway as they appeared on the writer's map of his own district.

On transferring the diagrams (here shown full-scale—6ins. to one mile) to the 6in. survey map, the effect was positively shattering! As will be seen from the football field (450ft. by 300ft.) drawn true to scale, the 4ft. 6in. radius curves of O gauge are just nicely accommodated in the length of the field when scaled up. Yet we still ask a 'Pacific' locomotive to haul a twelve coach train around such an inordinately sharp curve, and to pull well into the bargain!

Radius for Curves

The 4ft. radius curve in OO is admittedly slightly better, and as the scale speeds are only about half that of O gauge (in model feet per second), the disproportion of both curve and speed is not so acute.

The O gauge 4ft. 6in. curve scales up to a 145ft. radius (!) and the 4ft. curve in OO to a 305ft. curve. Comparing these curves with the 10 chain (minimum unchecked) radius curve drawn to the same scale (6ins. to 1ft.), one cannot but be impressed with the absurdity of even the very largest of our model curves.

The reproduction of the 10 chain curve of the real railways would require a radius of approximately 10ft. in OO gauge and about 15ft. 9ins. in O gauge; both of which are quite out of the

question except out-of-doors or in the very largest railway room.

The '1,400ft.' curve of which an arc is shown, represents the minimum prototype radius curve for high-speed working and would be represented in OO scale by a curve of about 25ft. radius, whilst in O gauge it works out to approximately 36ft. radius! Just a sheer impossibility in either gauge.

Train Lengths

Train lengths too, provided an interesting comparison when sketched in to a scale of 6ins. to 1ft. and 'placed' on the survey map. A 12-coach main-line train and loco were assessed at about 900ft., and it was found that it would reach almost half round the O gauge oval of track shown, being twice as long as the 'soccer' pitch.

The distance between the two long vertical lines is 3ins., which equals $\frac{1}{2}$ mile in the scale of the diagram which is reproduced in these pages full-size for comparative purposes.

Reversing the scaling, we find that our

train and loco would be about 12ft. long in OO scale, and 21ft. long in O gauge; whilst the football field becomes 6ft. by 4ft. in OO scale and 10ft. 6ins. by 7ft. in O gauge—the size of what many of us have to do with for our whole layout!

Troubles Overcome

The study of these curves and areas should make one and all fully appreciative of the colossal difficulties under which the greater majority of us work. Difficulties which are completely insurmountable unless ones' railway is laid in the Albert Hall or similarly large building.

Compromise we must, and compromise we do, but it is not until we actually see our model curves drawn in on a map of a district with which we are really familiar, that we really comprehend just how great the need for compromise and tolerance is.

Try these diagrams on a map ('6in.' scale) of your district and see for yourself how things stand. You will be surprised!

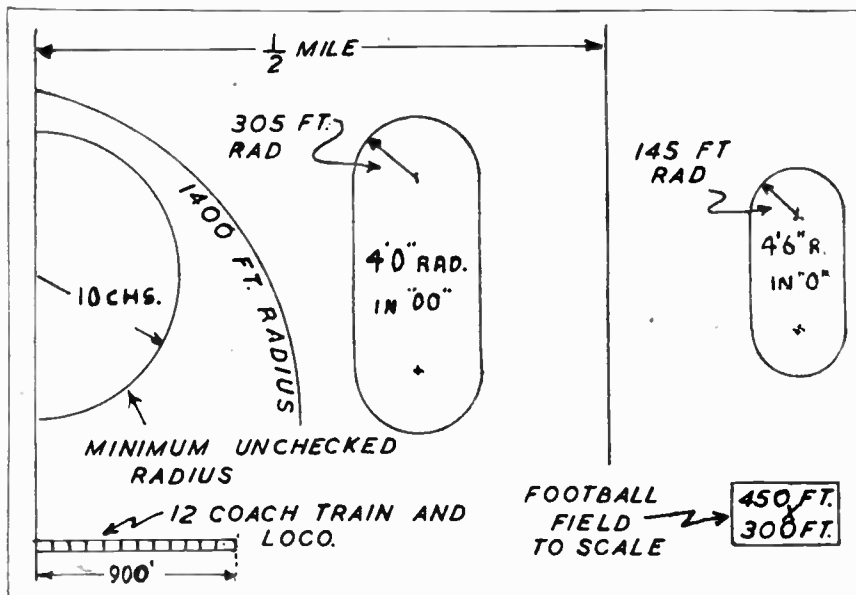

The scale of lay-outs shown here is 6ins. to the mile

Wood and Dowels—(Continued from page 117)

length has not been shown on the drawing.

Plate-rack

Wood $1\frac{1}{2}$ ins. square is used for the uprights and $\frac{3}{4}$ in. square for the rails, with $\frac{3}{8}$ in. diameter dowelling. Outside rails are connected by screwing them into slots on the uprights, while the middle rail is half-lapped into place. Before securing the joints all holes are bored and the dowels fitted.

Nine holes are drilled on the lower edge of the top rail and top edge of the middle rail, and eight holes on the lower

edge of the middle and top edge of the bottom rail. Holes are spaced an equal

distance apart, and are bored to a depth of $\frac{1}{2}$ in.

Two such frameworks will be needed. For each framework seventeen $7\frac{1}{4}$ ins. long dowels are cut, glued into their respective holes, and the framework assembled (drawing E).

The rack is completed by adding six spreader rails, 6ins. long, $\frac{3}{4}$ in. wide and $\frac{1}{4}$ in. thick. These are screwed on to the projecting thicknesses on the inside of the uprights, level with the various rails. Drawing (F) shows one corner of the completed framework. (134)

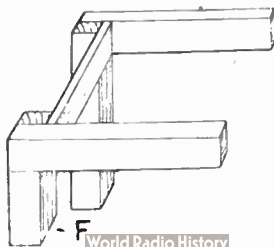

Leather workers could undertake this useful LADY'S HANDBAG

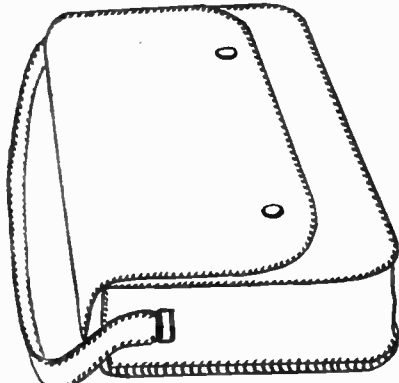

Fig. 1—Completed bag and handle

A HANDBAG in leather will outlast more than one bag of the mass-produced type. Also, as the constructor knows how the bag is made up, he can attend better to any repairs that become necessary. A simple bag for the handyman to make is shown at Fig. 1.

You will need a small skin, obtainable from leather or handicraft suppliers. Many different colours and figured patterns are available, so it is advisable to take the future user along with you to make the choice. Do not have a leather which is very limp or too thin.

The bag will need a lining of skiver. Choose a colour to match the leather—it need not be the same colour: brown and maroon go well together, for instance.

Materials You Need

While you are in the shop you should buy about 12 yards of thonging, preferably the same colour as the leather. Get the plastic covered variety. You will also need two D rings for handles and a pair of fasteners for the flap and you will have plenty of choice here. The D rings, which do not require stitching, being merely pushed through a slit in the leather and

Fretmachine Hint

WHEN using a treadle fret-machine, you will find that if put against the wall, the driving wheel catches. A good thing to stop this is to get a block of wood $1\frac{1}{2}$ ins. by 1 in. and $\frac{3}{4}$ in. thick and put it behind the back leg of the machine. Press it against wall and the wheel will not catch any more.

secured, are quite strong enough for a handbag.

If you do not possess a set of stud-fastening tools, or do not wish to invest in a set, there are several kinds of fasteners which are simple to fix, and are of neat appearance.

For tools, you will need a sharp knife or razor blade, scissors and a leather punch, the latter to make holes for the thonging.

Mark out on the leather the pieces required, as shown in Fig. 2. Use a pencil on the rear of the leather. It is best to cut out paper patterns first, then you can arrange these on the skin in order to use it to the best advantage.

Of the two panels which you cut to the same size, one is for the front, the other for the rear of the leather. Cut the handle and gusset in one piece if possible. If you must join two or more pieces, leave sufficient overlap to give the necessary strength.

For Shoulder Strap

Some ladies prefer a shoulder-bag. If this is the case, the 'handle' will have to be about 4ft. long, and this will take much thonging. So try to persuade her that shoulder bags are out of fashion!

Cut out the pieces carefully, then arrange them on the skin of skiver which is to be used for lining the handbag. Place the inner or rough sides of each together, as these surfaces have to be stuck. Make some flour and water paste, or use one of the proprietary pastes. As you stick each piece, cut it out, not too closely, and smooth the skiver to dispel any wrinkles. Allow to dry naturally, then trim off the skiver edges.

Next comes the construction of the bag. First, thong the top edge of the inner pocket. Here are a few hints about thonging. Punch the holes of just sufficient diameter for the thonging to pass through easily. Make the holes an equal distance apart and at an equal distance from the edge. To determine what length of thonging you will require, multiply the length of the leather to be thonged by $2\frac{1}{2}$. Where several layers of leather have to be thonged, multiply by 3.

Start in the centre and work towards each edge in turn. Finish off by threading the remaining thong under the last three 'stitches', pull tight, and snip off the spare thong.

Having thonged the inner pocket top edge, place it in position on the back panel. Apply a little glue or rubber solution around the edges, and stick the two panels together. In the same way, stick the gusset around the inner pocket. You will notice that the gusset is longer than necessary, so trim this off, and then round the edges. It is best to use strong steel paper clips to hold the leather in position until punched and thonged.

Now thong the edges of the back panel completely. It is possible to do this with one long piece of thong. Start in the middle of the top edge, working round to the bottom of the bag. To finish off, push both ends through to the inside, and tie a knot.

Front Panel

The front panel goes on next. Put this on carefully, or the bag may assume a crooked appearance. Do the thonging in two parts, firstly the bottom and sides of the front panel, then the tops of the gusset and the top of the front panel, all in one piece.

Fix the D rings on the gusset about 2ins. from the top edge. For the handles, punch holes and thong up to about 3ins. from each end. Taking each end in turn, push it through a D ring, and finish off punching and thonging (see Fig. 3).

Lastly the fasteners. Whatever kind you use, pay special attention to their fixing. Punch the flap holes first, and then

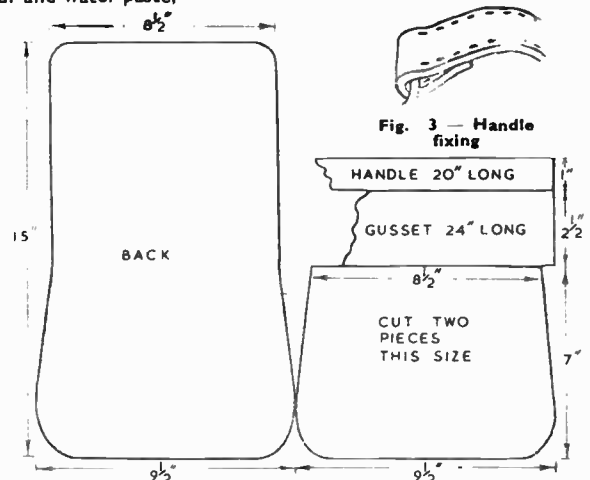

Fig. 2—Shape and dimensions of the various parts

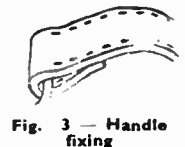

Fig. 3—Handle fixing

you can locate the places on the front panel. If you are using press studs for the first time, experiment on an old piece of leather, not on the bag itself. This is much better than ruining your completed or nearly completed piece of work.

There is the handbag complete. The rear compartment is for identity card, ration book and so on, the main compartment for the usual impedimenta which ladies carry! (133)

Some Useful Home-made Cements

Wood-block Floor Cement

MASTIC asphalt is sometimes used for this purpose, the blocks being dipped therein before being laid, alternatively a mixture of 2 parts pitch and 1 part creosote is used hot, as also is bitumen.

Shellac Cement without Spirits

CCHEAPER shellac cement which is useful for fixing paper labels, etc., to tin and to glass which is exposed to moisture can be made by boiling 1oz. of borax in 16ozs. of water and adding 2ozs. of shellac finely powdered; finally boiling in a covered vessel till the shellac is completely dissolved.

Oriental Jewel Cement

THE cement largely used in the East for uniting jewels, and glass with metals is made by dissolving 5 or 6 pieces of gum mastic about the size of peas in just as much methylated spirit as will render the solution liquid. Then make up a second solution by softening some isinglass in water, drying it, and dissolving as much of it as will make a 2oz. bottle of strong glue; finally adding a small piece of gum ammoniacum of the size of a pea. Mix these two solutions and store in a well-closed bottle. When used the mixture must be made liquid by standing the bottle in hot water.

Earthenware Cement

FUSE together 2 parts of shellac and 1 part of Venice turpentine and cast the mixture into sticks ready for use. The broken edges of the joint must be heated as well as the cement when the latter is being used.

Antique China Cement

FOR joining valuable articles of china which are for show only and will not be expected to contain hot water, an excellent cement may be made by mixing together the white of an egg thoroughly beaten to a froth, with quicklime and grated cheese to form a stiff paste. The mixture should be used whilst quite fresh, and is water-resisting but only moderately resistant to heat.

Glass Flux for China and Glass

MIX 3 parts of red lead, 2 parts of silver-sand and 3 of boric acid crystals, fusing the mixture, then grinding it and applying it to the broken edges with thin gum tragacanth. The article should be heated slightly during the process.

Jewellers' Diamond Cement

AHOT-WATER-PROOF cement used by jewellers for fixing precious stones is generally made of alcohol, gum

galbanum, isinglass and gum ammoniacum, in the usual proportions of 4, 1, 1 and 8 parts respectively. There are many different recipes for the purpose, each one being preferred by

the user, but the one cited above may be taken as a fair average. Naturally, the two gums should first be dissolved in the alcohol before being added to the water-soluble isinglass.

Sensible Bedroom Cabinet

NCESSITY arose when a certain piece of furniture was required. It had to be modest in price and quick and simple to make. The sketch shows the result and it cost well under 20/-.

Sufficient seasoned wood was obtained at an auction sale when a large table was bought for 10/-.

In addition, width was made. A table flap was also included for early morning tea, etc. Its main purpose was to ensure room when needed; bedside tables have a habit of filling up.

The only part requiring care in making was the flap support. This should be made out of oak or similar hardwood. The centre hinge should be

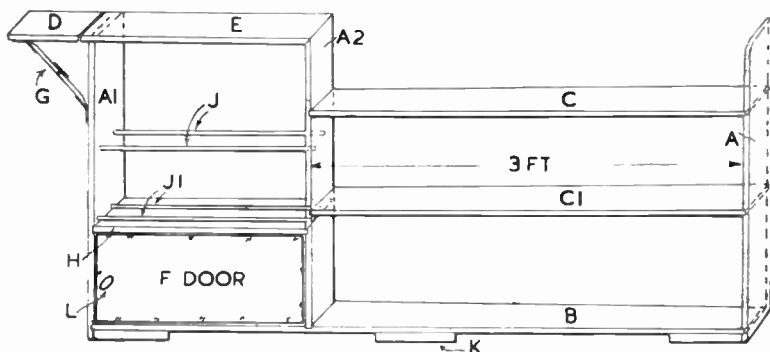

REQUIREMENTS

- 2 ends (A and A1)—2ft. 2ins. by 8½ins.
- 1 end (A2)—2ft. ½in. by 8½ins.
- 1 bottom (B)—4ft. 6½ins. by 8½ins.
- 2 shelves (C and CI)—3ft. ¾in. by 8½ins.
- 1 flap shelf (D) 8½ins. by 8½ins.
- 1 table (E)—1ft. 6½ins. by 8½ins.
- 1 door (F)—1ft. 3½ins. by 8½ins.
- 1 flap support (G) (oak) 9ins. by 1in. by ½in.
- 1 cupboard top (H)—1ft. 4½ins. by 8½ins.
- 4 dowelling rods (J and JI)—1ft. 6ins. by ½in. dia.
- 6 feet 9ins. by ¾ins. by ¾in.
- 1 door handle (L)—To choice.
- 1 table extension (see below) 1ft. 6½ins. length of hardboard.
- 4 doz. screws, 1½ins., No. 9.
- 3 flapjack hinges, 1½ins., with screws.
- 2 door hinges, 2ins. by ¾in., with screws.
- 1 door ball snap.

NOTE: If extension table is fitted, flap will have to be increased to suit.

there were hinges, screws, stain and hardboard to purchase. The table top was made up of boards 8½ins. by ¾in. by 60ins. long.

Over the cupboard, there are two racks for damp shoes and the bottom shelf will take care of dry shoes and slippers. The middle and top shelves are for books.

As the whole piece was carried out in 8½in. timber, the bedside table part was found to be rather on the narrow side and additional

screwed on before cutting in half. The two end hinges may then be screwed on and one of them screwed on end (A1) and about 6ins. down. The other hinge position is a case of trial and error. Again, about 6ins. is a starting point.

The support possibly looks as though it had been fitted on the wrong way, but it is perfectly safe and more easily fitted, as shown.

The whole was backed with ½in. hardboard. All letting-in was done by marking off and cutting with a tenon saw the required depth and then cleaning out with a chisel. All joints were glued and screwed. Screwhead countersinks, etc., were filled with Alabastine and papered off when dry.

When finished, the surface was given two coats of stain varnish. If a better finish is required, the wood can be planed and papered before starting work, and afterwards polished. (149)

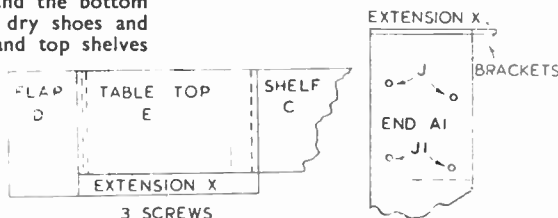

A practical job for the home carpenter is this OCCASIONAL TABLE

THIS simple table makes up into a robust piece of furniture and will be found a useful addition for those odd corners of a room in need of 'that something extra'. There is nothing very difficult in the construction; all the frame joints are $\frac{1}{2}$ in. wide mortise and tenons, and the only matter calling for a little extra care is the fitting of the panel to the top frame. This is explained in the text.

The original table was extremely economical, being made from dry ash cut from the cross-bearers of an old lorry bed that would otherwise have been used for firewood! Oak is probably the best wood for the job, but almost any reasonably good-looking hardwood may be used which will take polish. It is best to choose a wood if possible to match with the furniture beside which the finished table will stand.

Approach to Construction

Small table frames are easily spoiled by slight inaccuracies in the jointing, resulting in a twisted construction. It is important that, after planing the pieces of timber to size, the four legs and the rails in two lots of four each should be marked off together for correct lengths and mortice and tenon positions.

A good way to do this is to place the four pieces of wood side by side in a vice and square the lengths and joint positions across, using a set square and a scribing knife, or pencil where it will be visible on the finished job. The cutting of tenons and all chisel work must be square and clean; mortise and tenons should be a smooth friction fit.

Before any parts are glued together they should be skimmed off lightly with a smoothing plane and glasspapered with a fine glasspaper block. This makes for a cleaner job than if all the glasspapering is left until the table is being prepared for polishing.

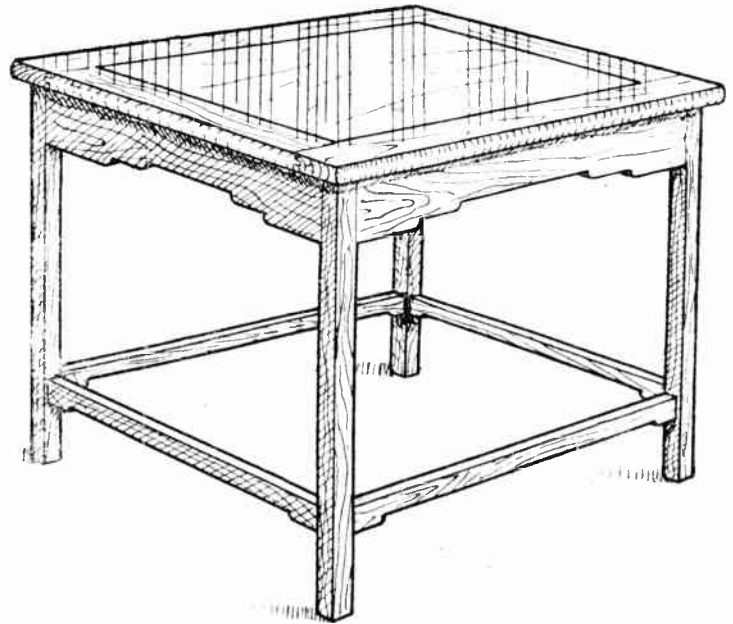

The legs are each $17\frac{1}{4}$ ins. long, 1 in. by $\frac{3}{4}$ in., and have the lower rails $3\frac{1}{4}$ ins. up from the floor. The wide top rails are fitted flush with the top of the legs. The $\frac{1}{2}$ in. wide mortises are cut through to meet at the corners, at which the ends of the tenons must be bevelled off to 45 degrees.

Rail Joints

Cut the top rails to $2\frac{3}{4}$ ins. wide, $\frac{3}{4}$ in. thick: the longer pair being $15\frac{1}{2}$ ins. from shoulder to shoulder, and the shorter pair $13\frac{1}{4}$ ins. The long pair have tenons $\frac{3}{4}$ in. long with a $\frac{3}{8}$ in. haunch at the top edge. The shorter pair have tenons just a little less than this with similar haunches.

The cutting of these tenons must be carefully executed, for being deep and

narrow there is no room for error. It is better to cut them a little full in thickness than the opposite, and pare down carefully to fit the mortises. Beware of a twisted tenon. It is poor practice to have to pack a joint if too loose. Note that the rails fit flush with the outside faces of the legs: that the outside shoulder is $\frac{1}{2}$ in. deep and the inside shoulder $\frac{3}{8}$ in. deep, total with $\frac{1}{2}$ in. tenons, $\frac{3}{4}$ in.

In order to lighten the appearance and still retain the deep joints, the top rails are cut down to $2\frac{1}{4}$ ins. in two steps of $\frac{1}{4}$ in. each, with rounded corners (see Figs. 2 and 4).

The lower rails, 1 in. by $\frac{3}{4}$ in., are lightened in a similar manner, but have only one step $\frac{3}{8}$ in. deep. They are the same length as the top rails with similar tenons the same length and thickness, the full depth of the rails (see Fig. 2).

Top Fixing

If the top is to be fixed to the framework by the normal method of screwed 'L' shaped blocks (Fig. 3a), cut out the necessary $\frac{1}{2}$ in. wide by $\frac{3}{4}$ in. deep slots in the top rails on the inside, $\frac{3}{8}$ in. down from the top edge.

Glue up the two long sides first, and clamp tight while the glue sets. If you do not possess four screw sash cramps, it is advisable to make some wooden ones, as shown in Fig. 5. The pressure is applied by means of the folding wedges, tightened with a hammer. Do not put so much pressure to the frames that the lower rails begin to bow.

When the side frames are set, clean off surplus glue, skim off where necessary with a smoothing plane at the top rail joints, and proceed to glue in the short

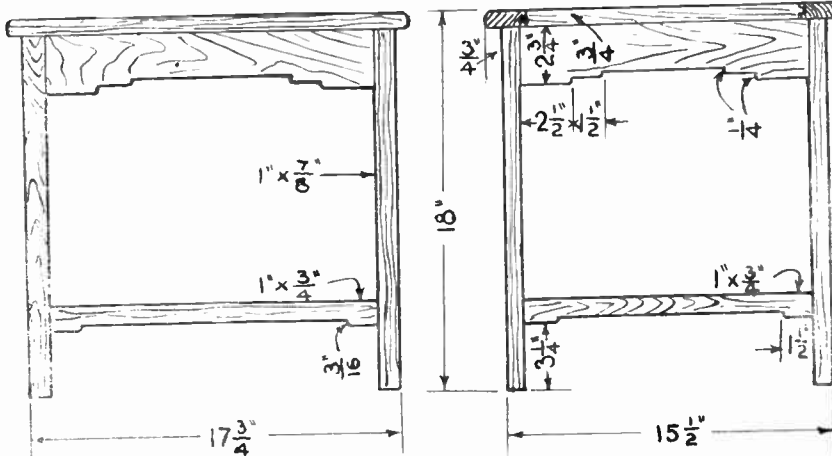

Fig. 4 Side and front elevation with details of dimensions

cross rails, so completing the framework. Cramp together with sash cramps, or as shown in Fig. 6, with a tight cord around. Check for 'square' with a strip of wood marked off diagonally from corner to corner on top, and use a large set square at the joints. When satisfied that all is well, and the frame stands solidly on a level surface, put aside for a

the rubbing tight. Lean the board against a straight strip while the glue sets. A board so glued is stronger than a natural full-width board. The edges of the panel have a $\frac{1}{16}$ in. rebate worked on them to fit the grooves in the frame. It is important that the panel should fit the frame perfectly. The limits of the rebate are

glue will not fill the vee joint. Clean off any excess with hot water before it sets. Cramp together. The edge of the frame is slightly rounded (Fig. 4), after which the whole top surface should be skimmed off with a finely set smoothing plane and fine glasspaper block. The table top may be fixed by any of the three methods shown in Fig. 3, but the usual method employing 'L' blocks is, perhaps, the best, as it allows for slight shrinkages and exerts a constant pressure.

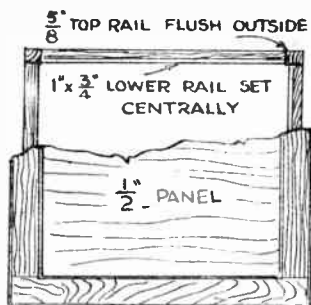

Fig. 1—Cut-away plan view

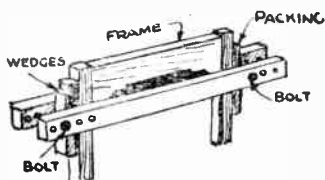

Fig. 5—Gluing the rails in a frame

day or two; in the meantime construct the table top.

Panelled Top

The top measures $19\frac{1}{2}$ ins. by 17 ins. and consists of a frame grooved to carry a $\frac{1}{2}$ in. thick panel. Plane the frame pieces to $1\frac{1}{2}$ ins. by $\frac{3}{4}$ in., and run a $\frac{1}{2}$ in. square groove on the inner edges centrally. Cut the $\frac{1}{2}$ in. mortise and tenon joints in line with the grooves. Notice that they are stopped tenons, i.e., do not go right through to the outer edge. Do not forget the small filling-up piece to be left with the tenons on the outside to close the groove where it shows.

Put the frame together and check up that the joints fit snugly. Next prepare the panel.

This can be a piece of $\frac{1}{2}$ in. faced plywood, or a single board if one can be found wide enough. The original panel was of beech—three pieces 5 ins. wide rubbed together with glue to make a 15 in. board.

If you make one like this be sure the edges to be glued are dead straight and true and perfectly square. It is not necessary to cramp the pieces together if the edges fit well, the glue is thin, and

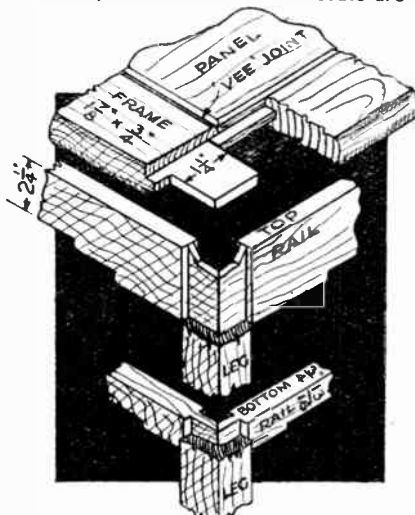

Fig. 2—Detail of leg and rail joints

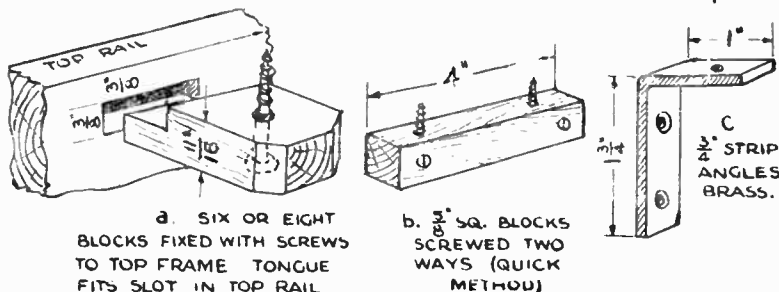

Fig. 3—Three methods of fixing the top without any visible screws

easily marked by placing the frame over the panel and scribing round the inner edge with a knife, or mark with a sharp pencil. After cutting the rebates just down to the lines so marked, work a small vee on the upper arrises to relieve the joint.

Try the frame together with the panel in the grooves. If there are slight gaps at the tenon joints the panel is a little too wide. However, beware of cutting away too much in rebating. A slack panel in width and length is unsightly. When gluing the frame and panel together, place glue on the bottom edge of the panel only so that excess

Colon mahogany wood dye. Vigorous wax polishing a week later brought out the strong grain of the ash in relief, while the beech panel toned to a deeper brown, the whole having a most pleasing effect.

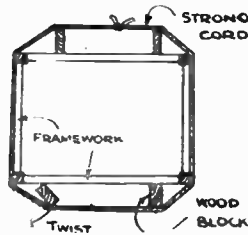

Fig. 6—Plan showing cord as a gluing cramp

Ready-made Masts

AS a hint to boat makers who are stuck for a mast on their models, they are advised to cut off about half a penny paint brush, and use that ready-made.

Pictures Worth Keeping

IF you have an old calendar which has a picture worth keeping, it is best to

frame it. Take a piece of plywood about $\frac{1}{2}$ in. larger than the picture, stain it a suitable shade, then glue on the picture, leaving a $\frac{1}{2}$ in. margin. Cover with Cellophane and glue at back. Fix a strut behind as a stand, and it is ready.

Fixing Hammer Heads

HERE is a way in which to fix an axe or hammer head which may cause trouble by flying off when in use. Screw

on the end of the shaft a plate from an old rubber heel. When screwed firmly down, the head will never again cause trouble.

Clock Face Figures

IN modern clocks, actual figures are not often used. Used gramophone needles hammered in so that the ends just protrude from the face, look well. Tap them carefully with a light hammer so as not to damage the actual face of the clock.

Before you go to camp take care to OVERHAUL YOUR PRIMUS

THE whole point about camping is that you depend entirely on your own efforts and if the primus stove gives a despairing gasp in the middle of cooking breakfast, it means no breakfast at all. If you check your stove before the season starts, this sort of thing will not happen to you. Spares and replacements, with the exception of the burner, cost only a few coppers and it is a small price to pay for safety.

Spreader

First examine the flame spreader. This is the cap with holes around the side which fits on top of the burner. If it looks at all badly burned, it is advisable to buy a new one and carry it along as spare.

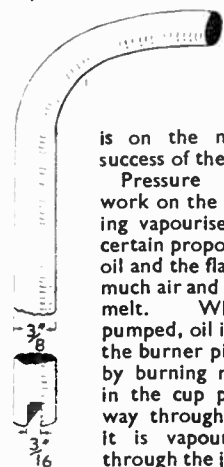

Fig. 1—A pipe key

Next remove the nipple and fit a new one. This is important, for it is on the nipple the whole success of the stove depends. Pressure paraffin stoves work on the principle of burning vapourised oil and air in certain proportions. Too much oil and the flame is smoky, too much air and the burner would melt. When the stove is pumped, oil is forced through the burner pipes, first warmed by burning methylated spirit in the cup provided. On its way through the warm pipes it is vapourised and issues through the jet as invisible gas.

On its way up to the flame spreader, this jet takes in a certain amount of air, dependent on the force of the jet. Since this air intake cannot be regulated, the only way to ensure the right amounts are burned together is to see the nipple is the right size. As the nipples are cleaned with wire prickers the holes grow too large, the flame becomes smoky with constant blocking and cleaning of nipples which soon makes the stove useless. By far the best way is to fit a new nipple and carry a spare.

The burner, that is the set of pipes to which the flame spreader and the nipple are attached, is seated on to the body of the stove on a soft metal washer. Put a spanner on to the hexagonal part of the burner, just above the spirit cup, and you will probably be able to give it half a turn. If there is a suspicion of a leak, buy a new washer and fit it.

Next unscrew the pump and remove its plunger. The leather washer is screwed on to a brass holder fitted loosely on to the plunger. Pump efficiency depends on the leather being soft and pliable and secure on its seating.

Non-Return Valve

The non-return valve at the bottom of the pump can cause trouble and should certainly be checked. On some types of stove the whole pump can be screwed out but in others the pump body is securely soldered. In the first kind the removal of the valve is easy but in the latter it is something of a problem.

A key to remove both nipples and valves can be made quite simply from $\frac{3}{16}$ in. mild steel rod. At one end a $\frac{3}{16}$ in. slot is cut and the other end is bent at right angles to form a handle (see Fig. 1). On the other hand these keys can be bought quite cheaply.

With the key unscrew the valve in the bottom of the pump. Touch will have to be used to find it, for it is impossible to see. Like the burner, the non-return valve is seated on a metal washer which spreads slightly. Sometimes the valve has to be fished out with a bit of wire, but more often it will fall out.

Stripping the Valve

Once out the valve can be unscrewed into two halves. One end has a slot for a screwdriver and the other the keyway. The screwdriver end is just a cylinder with holes in the side through which air enters the stove body. Inside the cylinder is a plunger tipped with a leather washer. This works up and down on a spring and the leather pad seats on the valve body when the two halves are

screwed together. These are shown separated at Fig. 2.

Through the valve body is a hole admitting air from the pump. Pressure lifts the leather away from its seating against the tension of the spring. As pump pressure drops at the end of the stroke, the spring forces the leather back on its seating and pressure inside the stove holds it there.

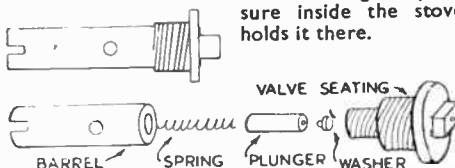

Fig. 2—Parts which form the valve

The biggest snag to look for here is wear on the leather. Perhaps it does not seat properly or a frayed edge may prevent it moving freely just at the critical moment in camp. The leather can be lifted out, in many cases, and put back the other way round, but it should be renewed if it is badly worn. Underneath the filler cap you will find another washer. Check this to see it is in good condition. Change if necessary.

If all these points are checked and parts replaced where needed your primus will serve you well for the rest of this year. One word of warning. When buying spares make sure they are right for your type of stove, for these materials are not interchangeable.

A One-Man Exhibition

THIS delightful range of models and fretwork is an exhibition in itself, although it was completed by one man—Mr. T. Smith of 7 Station Avenue, Bolton. Every one is made from our designs, galleons, locomotive, St. Paul's Cathedral, ships, wheel match box, wheelbarrow pincushion, etc. Mr. Smith started when he was 17 and his first model was a 17ft. long Indian Palace. After a break of 30 years he has now become an enthusiastic user of the fretsaw again and made the St. Paul's Model, from our design, in two weeks. His ambition is to form a model and fretwork club in Bolton, so if any other readers in the district are similarly interested they should contact Mr. Smith. Or any firms who could make use of such an adept craftsman. Perhaps too, they would like to help him with his idea of making a scale model of Bolton Parish Church.



Photo: Courtesy of The Bolton Journal

The family pictures would look nice in this TRIPLE PHOTO FRAME

ALTHOUGH this frame has been designed to hold photos, it could be easily altered and made suitable for a picture or a mirror. The frame is made with two end rails of thicker material than the rest of the parts; and to these rails are framed top and bottom rebated rails, while narrow rebated rails are also fixed on the inner edges of the end rails. When the frame is intended for photographs the opening is divided with rebated rails. A frame of this kind is usually made to hold cabinet size photos; it will not look well with less than two or three openings. Often four or even six are provided, the length being increased in proportion.

For Photos or Mirror

The frame shown at Fig. 1 and Fig. 2 is made with three photo openings. The frame for a picture or mirror is made in a similar manner, but the rebated rails which form the divisions between the photo openings are omitted. And whereas in a photo frame certain dimensions have to be observed in forming the openings, in a picture or mirror frame the size of the opening may be adjusted as desired.

Size of Parts

To make a photo frame of the design shown in Fig. 1, the following parts will be required. Two end rails 10½ ins. long by 3½ ins. wide and a top rail—moulded, 2 ft. 2½ ins. long by 2½ ins. wide by ¾ in. thick. Top rail 1 ft. 7½ ins. long by 2 ins. wide, bottom rail 1 ft. 7½ ins. long by 1½ ins. wide, two end rebated rails 6½ ins. long by 1 in. wide, and two dividing rebated rails 6½ ins. long by 1½ ins. wide, all of ½ in. wood.

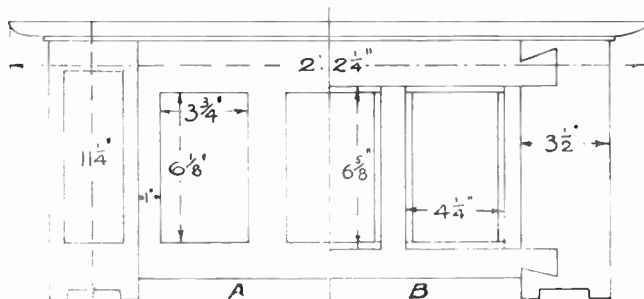

Fig. 2—Details and dimensions of framework and openings



Fig. 5—The decorative carved panel work

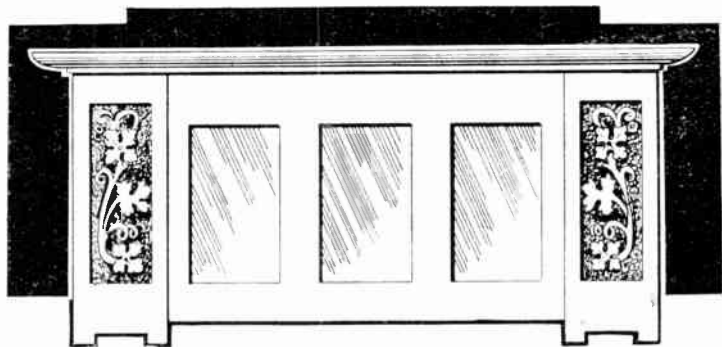

Fig. 1—Three openings for pictures with end carved panels

In construction the inner edges of the top, bottom, and inner end rails, and both edges of the dividing rails should be rebated, as shown in Fig. 3, to form recesses for the glasses and photographs. The top and bottom rails are then dovetail lapped into the end rails, as shown at (B) Fig. 2 and in detail Fig. 4. It will be noticed that half only of each face of the frame, front and back, is given here in Fig. 2.

The Rails

The lapped portions of the joints on the ends of the top and bottom rails are cut half the thickness of the rails with a tenon saw or fretsaw, while the dovetail recesses in the end rails are chiselled out. The end rebated rails are lapped into the rebates in the top and bottom rails, and fit against the end rails. The dividing rails are also lapped into the rebates in the top and bottom rails.

It will be well to carve the end rails before proceeding further and a pattern is shown in Fig. 5. Its actual size being

6 ins. by 2½ ins. Draw in the simple leafwork on to paper, and transfer it by means of carbon to the wood. Turn the pattern over and make the second outline in the same way with the carbon paper. The pattern given in Fig. 5, is for the left hand panel, and should be reversed for the right hand.

Carved Work

The carving is fairly straightforward, but to interpret the design correctly, some care must be given to the modelling. The groundwork should be taken to a depth of ¼ in. The main stem of the design is lowered where it goes behind the leafwork. The stem, too, must be rounded to look natural. The background may be finished rough with a matting tool. All the parts should be carefully finished before fixing.

The bottom edges of the end upright rails are shaped with the fretsaw and the extreme top rail should be shaped to some simple profile, like that shown in Fig. 2. The ends of the rail are cut and shaped to the same profile as the front part. First fix the top and bottom rails to the end rails, securing with glue and screws.

Rail Fitting

Then fix the end rebated rails in place, skew-nailing them to the top and bottom rails and driving long but fine wire nails into the end rails, as shown in

Fig. 3. The inner rebated rails are also skew-nailed to the top and bottom rails, and the extreme top rail—or shelf, as it may be called, glued and screwed from above.

If the frame is to be used for photographs, separate backs should be fitted to each opening, and clips used for holding them in place. The size of the glass for the three openings will be 6½ ins. by 4½ ins.

A good plan to make the pictures or mirrors more dust proof is to paste a piece of stiff brown paper over the whole of the back to cover the openings. If this paper is all slightly dampened before pasting down it will stretch drum tight when dry.

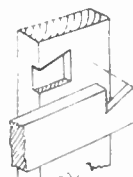

Fig. 4—Dove-tail joint in the rails

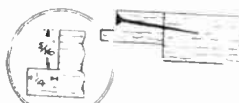

Fig. 3—Nailed joint

MAKE 5/- an hour, genuine home employment. Full instructions, 3/-. Six different advertising magazines, 1/-.—R. Lowes, Rectory Terr., Simonburn, Hexham, Northnd.

REQUEST stamp approvals. Receive small album, stamps, hinges, free. Postage 6d.—A. M. Day, 73 Thornton Gate, Cleveleys.

SELBY for stamps. 50 Norway, 2/6; 50 Airmails, 4/6. S.A.E. for catalogue.—66 Donnington Road, London, N.W.10.

INTRODUCTIONS. Pen friends, companionship or marriage.—V.C.C., 34 Honeywell Road, London, S.W.11.

THE GLORY that was Greece. Beautiful ancient designs on modern Greek stamps. Long Classic set, 12 mint stamps, catalogued at 3/9, only 1/-. Set of six Winds mint air mail stamps catalogued at 1/2, only 6d. Set of three Glory of Psara, 3d. Postage 2½d. extra. Many other cheap sets on our approval sheets. A selection sent on request.—E. F. Townsend, 92 Tenby Road, Edgware, Middlesex.

MONEY in lead toymaking. Up to £10 weekly can be earned making and selling lead toys. Lead Toymaking for Pleasure and Profit is an entirely new course prepared by a manufacturer with many years experience. The plans, ideas and hints therein will enable you to start earning big money right away. Little capital is required. Complete course, 6/3 post free. Money back if not satisfied. Please leave P.O. blank.—BCM/DEVNISH, Dept. H.W.1, Mono House, London, W.C.1.

BE Taller. Quickly! Safely! Privately! No appliances—no tablets—no dieting. Details, 6d. stamp.—Malcolm Ross, Height Specialist, BCM/HYTE, London, W.C.1.

MODELS. You can make lasting stone-hard models with Sankey's Pyrama Plastic Cement. Supplied in tins by Ironmongers, Hardwaremen and Builders' Merchants. Ask for instruction leaflet.

TRANSFERS for decorating toys, trays, furniture, fancy goods. List and samples free. Flowers, pixies, dogs, nursery rhymes.—H. Axon Harrison, Jersey.

LEARN Shorthand by June 24th (1 hour's study nightly). 1st lesson, 2½d. stamp.—Duttons (Dept. HB), 92 Gt. Russell St., London, W.C.1.

RUBBER Tyred Metal Disc Wheels finished in red, green or blue enamel. 2ins., 2/6; 3ins., 3/- per set of four. Post paid. Other sizes available up to 9ins.—The Joyden Toy Co., 193 Chase Side, London, N.14.

WHEELS for toys, and other accessories. Full lists will be sent on application to The Joyden Toy Co., 193 Chase Side, London, N.14.

DOLL'S House fittings and papers; send S.A.E. for list. Doll's House plan special; send 2/6. Trade supplied.—Zimplan, 88 Ware Road, Hoddesdon.

CONSTRUCTIONAL Kits, 4mm. and 7mm. scale Lorries. Also large range spare parts from which to build to your own design. Price lists, 1d.—Wilson's Lorries Ltd., Dept. H., 1/6 Gt. Winchester Street, London, E.C.2.

100,000 Government Surplus Bargains. Strong metal boxes with lid and handle, 12ins. x 7ins. x 6ins., 1/6, post 9d. Metal boxes (made by Roneo), 15ins. x 10½ins. x 10ins., ideal for tools, etc., 8/6, post 1/6. Mains AC/DC electric motors, approximately 1/8th H.P., 20/-, post 1/6. Send 3d. stamp and S.A.E. for illustrated catalogue of other bargains for the Handyman.—Milligan's, 24 Harford Street, Liverpool, 3.

LONELY? Then write Secretary L.U.C.C., 5B.B. Hay St., Braughing, Herts. Genuine. Est. 1905.

PLYWOOD offcuts. Birch and Gaboon in various thicknesses, handy sized parcels for the cabinet, toy, model maker and all handicrafts. Parcels made up in £1 and 10/- lots. Carriage paid. Send P.O. to Reeves, Plywood and Timber Merchant, 33 Front Street, Monkseaton, Whitley Bay. Tel. W.B. 4677. Due to exceptional demand we cannot promise delivery under eight days.

BLUSHING, shyness, nerves, self-consciousness, fears, ended. Details under plain cover, 1d.—Stebbing Treatment, 28 (HB) Dean Road, London, N.W.2.

BE taller in 14 days or money back. Details, 1d.—Stebbing System, 28 (HB) Dean Road, London, N.W.2.

£5 to £20 weekly earned at home, running your own Mail Order business. Details, 1d.—Stebbing Publications Ltd. (HB), Naphill, High Wycombe.

FASCINATING and profitable hobby, casting ornaments, toys, etc. You can easily make these yourself. Paints, brushes and all accessories. Illustrated catalogue of 700 Moulds, plus latest list of Rubber Moulds with instructions, 9d., post free.—Cock of North Moulds (H), 140 Hollings Road, Bradford.

FURNISH that Doll's House with the latest model furniture, glassware, food and accessories. List, 8d.—Sutton Models, Billericay.

AMERICAN Magazines post free for one year. Popular Mechanics, 32/-; Popular Science, 28/6; Mechanix Illustrated, 22/6; Popular Homecraft, 18/-. Stamp for full list of others.—Willen Ltd. (Dept. 57), 101 Fleet Street, London, E.C.4.

ENTER the Juneero National Model Making Competition. Cash and kit prizes to the value of £150. Send now for details or see the Juneero Annual, 1/- from all Juneero Dealers, or 1/2 post free from Juneero Ltd., Boreham Wood, Herts.

PLYWOOD, new selected, 27 x 19 x 3/8 ins., 7 for 20/-; Veneered Oak, 6 for 30/-; 20 x 20 x 3/8 ins., 9 for 20/-; Veneered Oak, 7 for 29/9. See list (2d.) for other veneered panels. B.C. Pine Ply, 17 x 7 x 1/2 ins., 24 for 16/-; Parana Pine Ply, 17 x 6 1/2 x 1/2 ins., 48 for 16/-; all post paid C.O.D. Box Bottoms, 18 x 16 x 3/8 ins., Birch, 8 for 20/-; Teak, 5 for 20/-. Pine Lids, 39 x 17 x 1 1/2 ins., 10/- ea.; one side clean. Ex W.D. Stretchers, very good condition, 10/- ea. All sent carr. for., cash with order.—H2/JDD. Storage, 71 Northcross Road, S.E.22.

PERSONS required make fancy goods at home. Write for details.—Melton Manufacturing Co., Southgate Street, Leicester.

PRIME imported recessed hardwood wheels, 2 1/2 ins. diameter, 3/- dozen; 14/- half gross; 26/6 gross. Post free. Pressed metal, hardwood and metal disc wheels, Doll's House windows, doors, papers, catalogues, 6d.—Jasons, 135 Nags Head Road, Ponders End, Middlesex.

HOBBY plaster casting with Flexi-mould.—Dohm Ltd., 167 Victoria Street, London, S.W.1.

STAMPS free.—Empire packet including Pictorials and Victorians free to approval applicants.—Robert J. Peck, 7A Kemp Road, Bournemouth, Hants.

KALEIDOSCOPIES. Fascinating novelty for all ages. Ingenious optical creation of ever-changing colour designs. Endless variety. 2/6 post free.—'Stymit', Dept. H., 1/6 Gt. Winchester Street, London, E.C.2.

COLLECTORS' delight—my world famous Oxford approvals. Generous discount and free packet with each selection. Postage please.—Frank Kennedy, 37 Juxon Street, Oxford.

HOMÉ watch and clock repair outfit. Includes watchmaker's eyeglass, tweezers, screwdrivers, oilers, brush, oil, plus explanatory booklet fully illustrated. In container. Skill unnecessary. Invaluable for all fine work, 12/9 inclusive.—D. Bolster (Dept. A.), 5A Station Parade, Ashford, Middx.

ARE you interested in the fascinating hobby of Radio Construction? Send 2½d. now for details of full Constructional Manuals how to build professional-standard Radio Sets, Radiograms, Amplifiers, etc., to—Northern Radio Services, 16 Kings College Rd., London, N.W.3.

HOMEWORKERS required, either sex, light assembly, part or full time. S.A.E.—Esprey, Box 18, 41 Wade Street, Lichfield.

CONJURING. 3d. for New Lists and Free Magical Competition.—DeHempsey, 363 Sandycombe, Kew Gardens.

SURPLUS Goods—7ins. Plane, 6ins. Set Square and Spokeshave—All Guaranteed. 15/-. The Three—Postage 1/6.—Young, 49 Bath Road, Wolverhampton.

A TOY WITH A PURPOSE

ARTS AND CRAFTS BRUSH MAKING SET
INTERESTING AND INSTRUCTIVE FOR
BOYS AND GIRLS OF ALL AGES

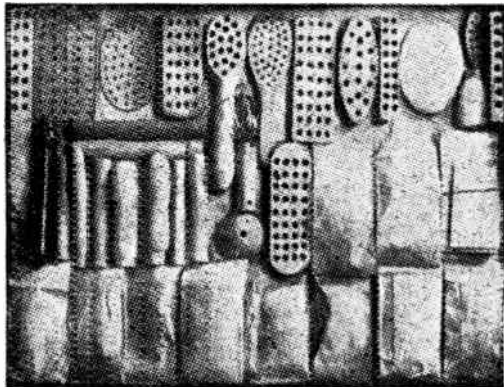

15/- each

Complete set Carriage paid

TOY CENTRE

95 Lower Marsh, Lambeth, London, S.E.1.

Tel.: WATERloo 4559

BE A MASTER OF JU-JITSU



Amazing new methods show you how to 'get tough' and make any attacker helpless with lightning speed—or money back. The Morley Rapid Ju-Jitsu Course teaches you all the knock out blows, shows you how to throw a stronger man helpless to the ground, gives absolute mastery. Develops body, gives self confidence. You can acquire this devastating weapon

in a few weeks. For both sexes. Complete fighting system, 10/- (or \$1.00 bill and 40 cents in stamps).

Details 1d.—JOHN J. MORLEY (H/83), Terry House, Naphill, High Wycombe, England. Established 1936

THE WOODWORKERS' STORES

Plywoods — Mouldings — Cabinet Legs

Stains — Varnishes — French Polish

— Hobbies —

Fretwork Sets — Kits — Fretwork Designs

EVERYTHING FOR WOODWORKERS

92-94 HAWKHILL, DUNDEE

YOU CAN BECOME A HANDICRAFTS INSTRUCTOR

Experience not essential

Men who enjoy making things in wood or metal can turn their hobby into a well-paid, permanent and interesting Career. Short hours, long holidays, and security in a job you would really enjoy, can be yours if you become a Handicrafts Instructor. Let us send details of the easiest and quickest way to get the necessary qualification.

We definitely guarantee

"NO PASS—NO FEE"

If you would like to know about our unique method of preparing you for one of these excellent appointments, write today and we will send you our informative 176-page Handbook—free and without obligation. Mark your letters 'Handicrafts Instructor'.

BRITISH INSTITUTE OF ENGINEERING TECHNOLOGY

595 Shakespeare House,
Stratford Place, London, W.1

BIET

AMAZING ^{Ex. Govt.} BARGAIN SIGNAL LAMP

In stout double-compartment water-proof steel case.

- 3½-inch lamp, for day or night use.
 - Swivel base with metal screw-in stand.
 - Viewfinder and reflector.
 - Morse key-board. Fully wired, fitted to folding lid.
 - Adaptable as car, motor cycle or studio spot light and numerous other uses.
- Spare bulbs 1/6 each.



7/6
POST 1/6

Write for illustrated lists.

PRIDE & CLARKE LTD.

Dept. P.W., 158, STOCKWELL RD., S.W.9. Phone: BRixton 6251

NICOTEXIT

THE GUARANTEED SMOKING DETERRENT

- ★ POSITIVELY STOPS SMOKING IMMEDIATELY and for several hours after each application. Purchase price refunded if it fails to do so.
- ★ ONE BOTTLE IS USUALLY SUFFICIENT to establish control of smoking in any form. It is not poisonous.

Invaluable to all who smoke too much

5/6 Per Bottle
Post Free

Obtainable only by post from Sole Concessionaires for Great Britain:—

THE NICOTEXIT COMPANY (Dept. B.6.)
62 High Street, Croydon, Surrey



BRANCHES LONDON

78a New Oxford St., W.C.1
(Phone MUSeum 2975)

87 Old Broad Street, E.C.2
(LONdon Wall 4375)

117 Walworth Road, S.E.17

GLASGOW

326 Argyle Street
(Phone CENTral 5042)

Head Office & Factories—HOBBIES LTD., DEREHAM, NORFOLK

MANCHESTER
10 Piccadilly
(Phone CENTral 1787)

BIRMINGHAM

14 Bull Ring

SHEFFIELD

4 St. Paul's Parade

LEEDS

10 Queen Victoria Street
(Phone 28639)

HULL

10 Paragon Square

SOUTHAMPTON

25 Bernard Street

BRISTOL

30 Narrow Wine Street
(Phone 23744)

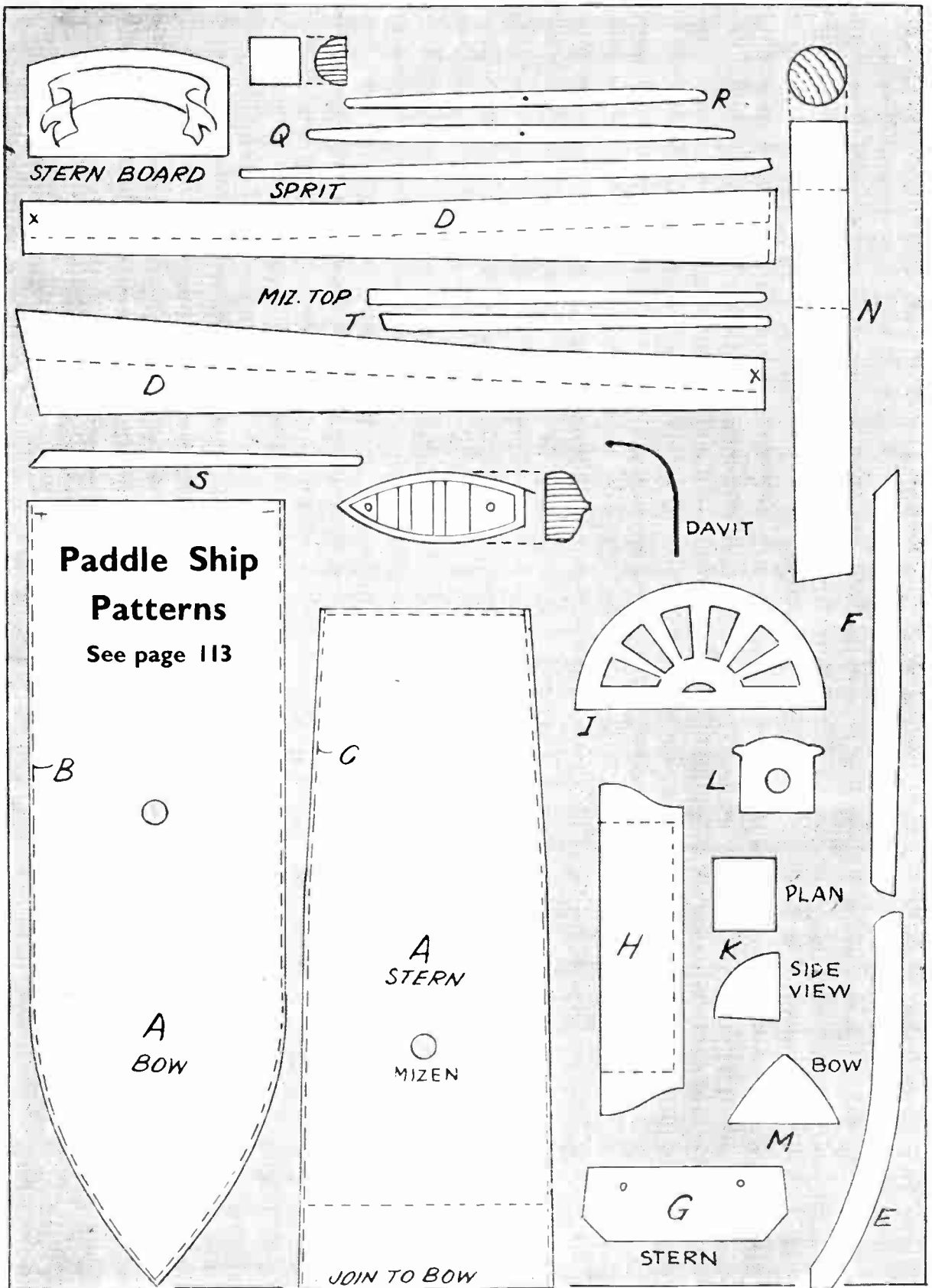

THE STEPPING STONES TO SUCCESS!

Don't hesitate about your future! Go forward, confident that The Bennett College will see you through to a sound position in any career you choose. The Bennett College methods are individual. There's a friendly personal touch that encourages quick progress and makes for early efficiency. Take the first important step NOW and fill in the coupon below.



THE BENNETT

CHOOSE YOUR CAREER

Accountancy Exams. (Engineering and Wireless)	General Education G.P.O. Eng. Dept. Heating and Ventilating	Road Making and Maintenance
Book keeping. Accountancy, and Modern Business Methods	Institute of Housing Officers	Salesmanship
Building, Architecture, and Clerk of Works (A.R.I.B.A. Exams.)	Journalism	Sanitation
Cambridge Senior School Certificate	Languages	School Attendance Officer
Carpentry and Joinery	Mathematics	Secretarial Exams.
Chemistry	Matriculation	Sheet Metal Work
Civil Engineering	Mining. All Subjects	Shipbuilding
Civil Service	Motor Engineering	Shorthand (Pitman's)
All Commercial Subjects	Naval Architecture	Short Story Writing
Commercial Art	Novel Writing	Surveying (R.I.C.S. Exams.)
Common Prelim. E.J.E.B.	Plastics	Teachers of Handicrafts
Draughtsmanship. All Branches	Play Writing	Telecommunications (City and Guilds)
Engineering. All branches, Subjects and Exams.	Police, Special Course	Television
	Press Tool Work	Transport Inst. Examinations
	Pumps and Pumping Machinery	Viewers, Gaugers, Inspectors
	Quantity Surveying	Weights and Measures Inspectors
	Inst. of Quantity Surveyors' Exams.	Wireless Telegraphy and Telephony
	Radio Service Engineering	

If you do not see your requirements above, write to us on any subject. Full particulars free.

COUPON. CUT THIS OUT
IF YOU ATTEND TO THIS NOW IT MAY MAKE A WONDERFUL DIFFERENCE TO YOUR FUTURE.



TO DEPT. 62
THE BENNETT COLLEGE LTD.
SHEFFIELD, ENGLAND.

Please send me (free of charge)

Particulars of..... (Cross out line which does not apply.)

Your private advice

about..... PLEASE WRITE IN BLOCK LETTERS

Name.....

Address.....

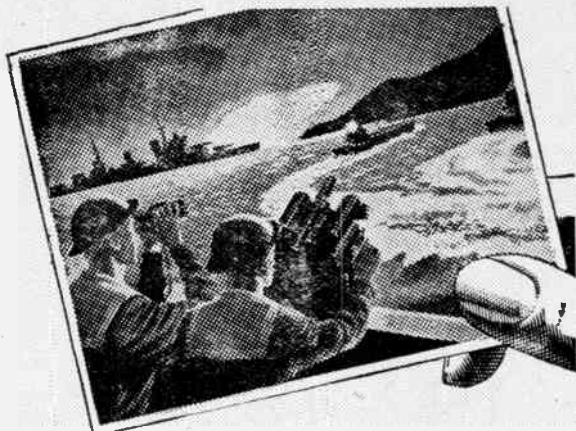

"The Marines tell it to us . . ."

We were having a rare old time on a 'ships versus shore-batteries' exercise—when our Marine Commandos' landing craft nipped back from shore and signalled 'We've captured everything but the F.A. Cup!' These Combined Ops exercises are first-rate—I got recommended for promotion on the last one, too! We're off to Majorca next trip. Yes, same ship, same big cats, same pals—it's going to be good-oh . . ."

For full details of how to join and descriptive booklet 'Here is the Navy,' write to THE DIRECTOR OF NAVAL RECRUITING, Dept. B/37, ADMIRALTY, LONDON, S.W.1.



Make the **ROYAL NAVY**
your career

WOLF ELECTRIC SOLDERGUNS



TYPE 41



TYPE 31



TYPE 71



TYPE 51



TYPE 81



TYPE 21

From all leading tool merchants and factors

OFF-STRAIGHT EASY-GRIP HANDLE
PERFECT CONTROL
QUICKER HEAT-UP
LOCALISED HEAT
LOW CURRENT CONSUMPTION
MAINTAINS CORRECT HEAT
A MODEL FOR EVERY PURPOSE

Write for FREE illustrated technical literature with full descriptions of each model, its range of applications, and the features which make these fine Wolf solderguns the best value ever offered.

Showing at B.I.F. **STAND c603**
(Castle Bromwich)

WOLF ELECTRIC TOOLS LTD.,
HANGER LANE, LONDON, W.5.

Telephone: PERIVALE 5631-4

Hobbies

WEEKLY

CONTENTS

	Page
Garden Swing Seat	- 129
Craftsman's Notebook	130
Model Sailing Boat	- 131
Pick-up Playing Table	133
Plastic Paperknife	- 134
A Pin-hole Camera	- 135
Home-made Plastic Wood	- 136
Home Handyman Hints	137
Poleless Camping Tents	138
Sea-Shell Novelties	- 139
Wooden House Signs	- 140
Cotton Reel Lamp	- 141
DESIGN PATTERNS FOR A MECHANICAL RACE GAME	

May 31st, 1950

Price Fourpence

Vol. 110 No. 2848

A SWING SEAT FOR THE GARDEN

WHAT can be more comfortable on a sunny afternoon than a rest in a swing chair like the one illustrated here? A few feet of timber (red deal for preference) plus canvas for the seat is all that will be wanted, with, perhaps, a yard or two of iron chain to support the swing chair in place of the rope shown in the sketch. So the whole thing should be really inexpensive, seeing what pleasure can be got out of it.

For Ordinary Use

There is an advantage, too, in making the seat as shown here because it can be unhooked from its chains and used as an ordinary garden chair just as desired.

Figs. 1 and 2 show side and front views respectively of the completed thing with dimensions of the supports and the chair. The actual canvas seating has been omitted in each diagram. The Cutting List given will be found most useful when cutting off the various lengths of wood.

Make the trestle legs first and trim the top ends to an angle of 20 degrees. Then cut a notch on each to half the thickness of bar (A), so when the legs meet at the top the slot, formed by the notches, will admit the bar. Join the legs in pairs by the cross rails, grooving the latter as in Fig. 3. Glue and screw well together to make a strong joint. The lower cross rails should be 3ins. from the ground, and the top ones 6ins. down. Hinge the trestle legs together with backflap hinges.

Cross Rail

Now open the legs and drop in place the rail (A). This is screwed to one pair

of the legs, and not to the other or they will not close or fold up so conveniently. The seat frame is composed of rails (H) and (G), screwed together. Note that rails (H) are fixed beneath (G), see Fig. 2, and that $\frac{1}{2}$ in. of the latter are cut away underneath where they fit over (H). The sides (B) of the chair are cut to length 4ft. 6ins. first.

Now cut the rear legs (F) 2ft. 9ins. long and make the bridle joint shown in detail in Fig. 6 to fit the side rails (B). The grooves in the sides are cut to an

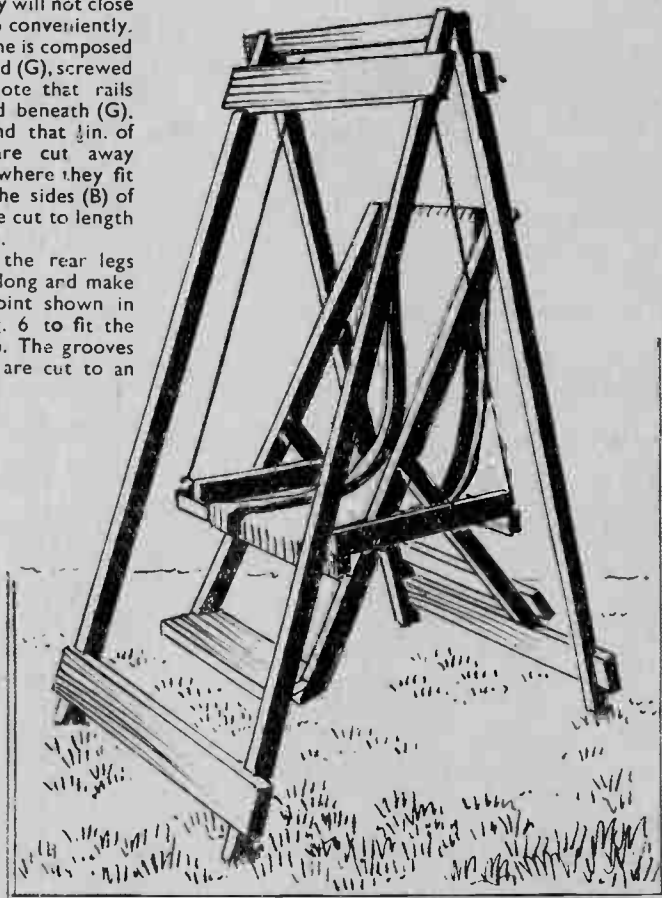

All correspondence should be addressed to The Editor, Hobbies Weekly, Dereham, Norfolk.

angle of 112 degrees. Glue and screw the joints firmly together. Join the sides of the chair by the top rail (C), and the footboard (D), the latter being 1ft. 10ins.

Now join the rear legs together by a cross rail 2ins. up from the extremities. Recess or groove them together as for the trestle legs. Fit the seat frame to the

The chair should swing about 9ins. from the ground or to any height that may be thought convenient, according to the wish of the user. Give all the woodwork two coats of either paint or good varnish, and let this thoroughly harden before attempting to fix on the canvas seating.

Seat Canvas

Rather more than a yard and a half of striped chair canvas will be required. About 3/4in. strip of the canvas is doubled over and tacked to the under edge of top chair rail (C) and from here it is brought down and tacked in a similar

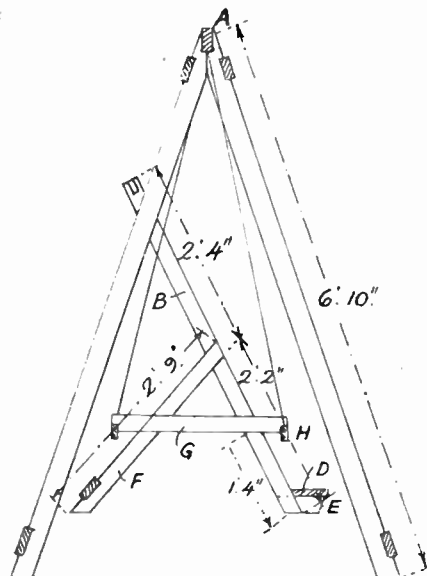

Fig. 1—End view with lettered parts

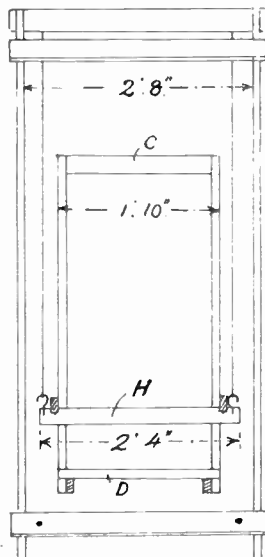
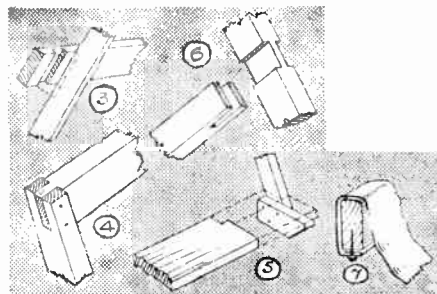

Fig. 2—Front view showing chair position



Figs. 3 to 7—Details of various joints

long. The rail is jointed to the sides as in Fig. 4 and pinned.

To hold the footboard, nail or screw two pieces of 1in. by 2in. wood, 6ins. long at the bottom on the inside of rails (B) (as at E), and to these nail on the footboard, as in Fig. 5.

It will be seen that it is notched on each side to fit between the side rails (B) of the chair. It is also nailed through the sides. Care should be taken to keep strictly to the measurements given in Fig. 2, so that the seat frame fits over the frame uprights, making a close and good fitting.

sides—rails (B) and (F) and there screw securely at a height of 1ft. 4ins. up, as seen in Fig. 1.

Chain Suspension

For suspending the chair, galvanised iron chain is recommended as better than rope. At each end of bars (H) bolt and screw in a strong hook. In the top bar (A) put in similar hooks or hooks having threaded shanks so that they pass through the rail and are held by a nut on top with a thin iron washer in between the wood and the nut.

manner under edge of front rail (H), see Fig. 7. The sharp edges of the rails should be rasped away and made rounded and smooth so the canvas shall not become frayed or worn along the edges.

To finish the job two lengths of strong sash cord should be stretched between the trestle legs and fastened to the cross rails about 2ins. in from the ends, as shown by the holes in the rail in Fig. 2. These ropes will help to take the strain off the hinges at the top of the legs.

The Craftsman's Notebook—

Tube-Cap Uses

THOSE small plastic or metal caps of various shapes and sizes on tubes of tooth paste, etc., may be turned to good account when the tube is finished with. Model makers will find them just the thing for knobs on miniature furniture and doors of model houses. By giving the centre a bright touch of aluminium or white paint they would make headlamps for model cars.

Four such caps make feet for small ornamental boxes, trays, and so on. They will convert ordinary nails into pleasing pegs for hanging pictures, the cap being fixed to the head after the nail is in position on the wall.

For many jobs the cap can be secured to a wooden peg to hold it in position or placed over the head of a nail or screw and made firm with some hard-setting substance such as sealing wax.

Making Hats a Hobby

MOST people who take up collecting for a hobby turn their attention to the more popular subjects, like stamps and autographs. But there are also quite a number who find it most fun to hit on something quite different from anyone else, so they can get together a collection that is definitely unique.

Nowadays, however, it is rather a problem to find anything really original, for every kind of collectable article seems to have been thought of by someone or other. Buttons offer plenty of scope, bus tickets and bottle labels suggest possibilities, though they are not original ideas. How about hats?

I do not mean real hats—most of us prefer something more compact that can be easily housed and displayed. But what one might consider is making miniature replicas from wood or metal,

and it would provide an opportunity to combine handicraft work with collecting. As a matter of fact I recently came across a perfect tiny model of a helmet, little larger in size than an egg.

Skill in carving from wood or working in metal would be necessary, but anyone interested could find lots of examples—the hats which postmen used to wear with peak at front and back. Then there are those which telegraph boys used to wear, naval and military hats and helmets, the fireman's helmet, mortar-board, the straw boater, bowler, top hat. Even during recent years distinctive types have been superseded by the modern flat type, so they are now interesting relics.

In most cases actual specimens would probably be difficult to find for use as a model, but old photographs and drawings are helpful. And when those of recent years have all been dealt with it would make the collection even more interesting to look up headgears of earlier centuries.

The Craftsman

Hours of pleasure in constructing and using this MODEL SAILING YACHT

THIS fine sailing yacht has a hull measurement of 24ins.; quite a good size vessel, and capable of providing much interest in sailing it. The hull is built on the bread and butter principle, consisting of several layers, glued together and subsequently shaped up. There is nothing difficult in the work, and some scope for individual skill in the work of modelling.

The wood must be carefully chosen, boards of good quality deal being required, planed to a thickness of $\frac{3}{8}$ in. Only wood entirely free from knots should be used and it should be as straight grained as possible. At Fig. 1, a side view and half plan are given; from these the exact length and shape of each layer can be obtained.

Hull Shapes

First cut the layers to their exact length. To facilitate this matter, the lengths are as follows. (A) 24ins., (B) 23ins., (C) 20ins., (D) 15 $\frac{1}{2}$ ins. Their exact position, relative to each other is shown clearly in the side view. Now mark on each the shape, taken from the half plan view. Each shape must be symmetrical, and about the best way to ensure this is to draw the half shapes on stiff cartridge paper and cut out.

On each layer strike a pencil line along the middle, lay the pattern one side of the line and run a pencil round it, then reverse the pattern to the opposite side of the line and pencil round again. Both sides should then be alike. Note the stern ends of layers (A) and (B) are cut to a slight curve.

Cutting to Outline

The layers can now be cut to shape with a keyhole or bow-saw, and accuracy should be observed to better ensure a shapely and well-balanced craft. The work of cutting out the interior of the hull, necessary to lighten the vessel, can best be carried out before the shapes are glued up, as such a job can be laborious afterwards. Proceed in this manner.

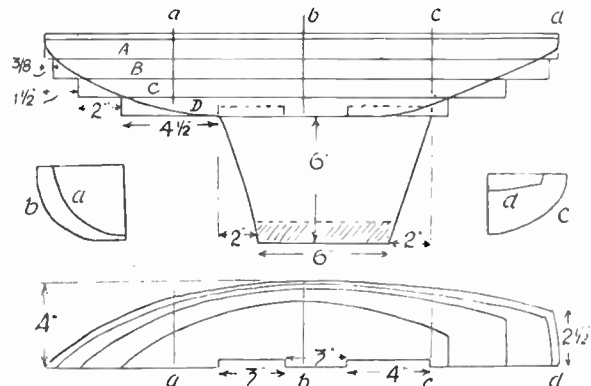

Fig. 1—Side view and plan of hull parts

Take shape (A) and lay it face downwards on the bench. Place shape (B) on it, in its exact position, and pencil round it to (A). Lift (B) and on the pencilled shape marked on (A) run a second shape, just $\frac{3}{8}$ in. inside it. This should be sawn right out, quite an easy job if a couple of holes are bored through at the stern end to admit a keyhole saw.

Place shape (C) on to (B) and pencil round that, cutting out the shape $\frac{3}{8}$ in. inside the line, as done for (A). Shape (D) should then be placed on (C) and the latter similarly sawn out, the result being shapes (A), (B) and (C) having their unwanted wood removed at the start, and saving a lot of hard work afterwards. Shape (D) is solid, but has two mortise slots chiselled out along its centre, just $\frac{1}{2}$ in. wide and deep, to admit the keel of the yacht.

The shape of the keel is given in the side view. It is cut to the shape and dimensions given, plus $\frac{1}{8}$ in. at the top for the tenons. Cut it from $\frac{1}{2}$ in. thick wood, with the grain running from top to bottom, and reduce its thickness by careful planing to $\frac{3}{8}$ in. at the bottom edge.

The whole four layers are now glued together in their correct respective positions. Use a waterproof glue, and clamp tightly up for some hours for the

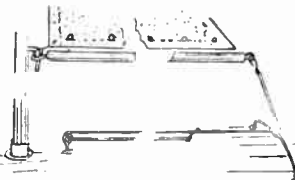
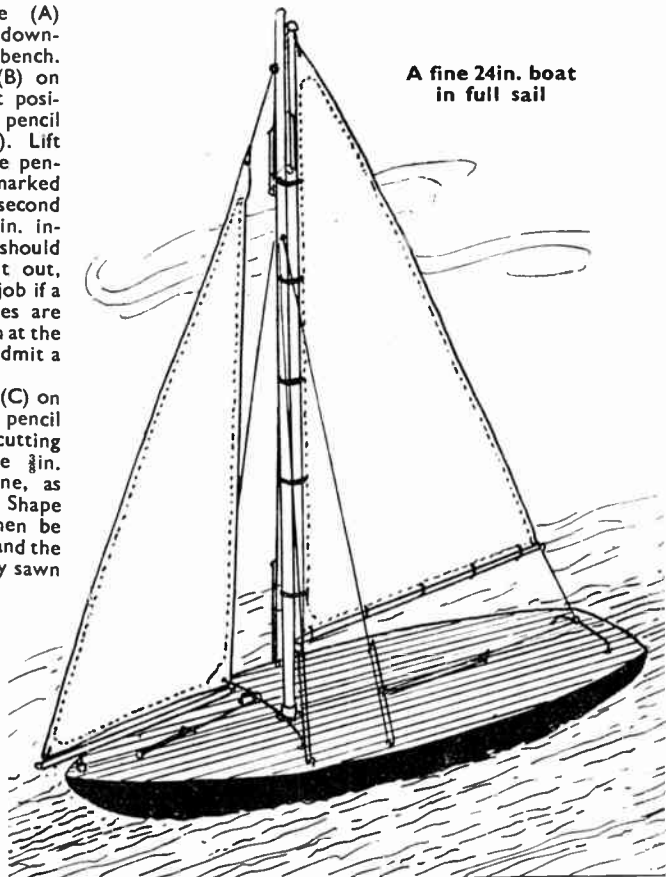

Fig. 3—Mast, boom and lines

A fine 24in. boat
in full sail



glue to get really hard before shaping the hull.

Shaping the Hull

Shaping should be commenced by bevelling off the 'steps' until the side view follows the lines in diagram Fig. 1. The shaping can then be continued, and here the half-sections shown of the vessel at parts (a), (b), (c) and (d), will be helpful. A sharp chisel and mallet will speedily remove the rough, and a spokeshave is about the best possible tool to continue the work with. Finish off with a file, then coarse and medium glasspaper, until a shapely vessel results.

The deck can be cut from $\frac{3}{8}$ in. fretwood, and a hole should be bored through at 8ins. from the bow end for a mast socket. The deck can be then glued and screwed on, the whole turned over and the keel glued in place. Clamp up again for the glue to harden. Then finish off the shaping, as may be necessary, the front edge of the keel being rounded a little, but the back edge left square.

The keel must be weighted, for this make a wood mould,

cutting out the shaded portion of the keel in a piece of $\frac{1}{2}$ in. thick wood and nailing a spare piece of wood underneath, as a bottom to the mould. Melt some lead in a ladle or old tin, and pour in the mould. Make two of these casts, both of equal thickness, then drill them for holding screws and screw them either side of the keel.

For the deck fittings a pair of travellers will be required, a mast socket, and several metal clews for tightening up the lines. Also a few screw hooks and eyes of the smallest size. Fix the mast socket, the mast itself can be planed up to $\frac{1}{2}$ in. tapering to $\frac{3}{8}$ in. at the top. It is 25 ins. long. The fore and main boom are of $\frac{1}{2}$ in. round section, and measure $8\frac{1}{2}$ ins. and 13 ins. respectively.

Both these booms are provided with a screw eye at each end. The fore boom has a small hook, driven in at 2 ins. from its fore end, and a screw eye is driven in the deck for it to engage in. It should be free enough to swing round under wind pressure.

For the main boom to swing on, a small wire nail is bent at right angles and is driven in the mast at about 2 ins. above the deck. The position of the travellers will be seen from Fig. 2, one being near the mast and the other close to the stern. A small ring is slipped on each traveller.

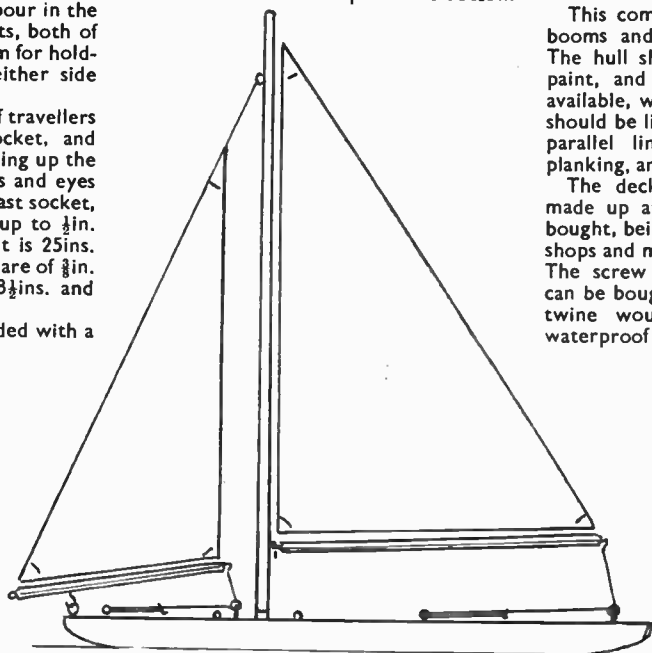

Fig. 2 - Outline of sails and hull to waterline

back corner of the sail, a wire hook is sewed, which enters the screw eye of the boom at the mast end. The sail is lashed with fine cord to both mast and

boom, and tightened to the screw eye at the opposite end.

Painting and Fitting

This completes the main work. The booms and mast should be varnished. The hull should be given two coats of paint, and finished with a coat of, if available, waterproof enamel. The deck should be lined with a soft lead pencil in parallel lines, $\frac{1}{4}$ in. apart, to imitate planking, and is then clear varnished.

The deck fittings can, of course, be made up at home, but are really best bought, being very reasonable. Most toy shops and model stores can supply these. The screw hooks and eyes mentioned can be bought almost anywhere. A fine twine would do for the lines, but waterproof fisherman's line would be better and last longer. All fittings should be in brass if possible, to avoid rust.

Reference has already been made to the quality of the wood. It will be better here to purchase short ends for the shapes, rather than a long enough board, as some waste may well be saved. All layers are cut from $\frac{3}{4}$ in. thick board, 8 ins. wide.

A piece of fretwood, 24 ins. long and 8 ins. wide will be needed for the deck, and a small piece of $\frac{1}{2}$ in. wood, 10 ins. wide and $6\frac{1}{2}$ ins. long for the keel. The mast and booms could, most likely, be planed up from scrap wood.

Rigging

For tightening up the sails, lines are provided. Fit each with a wire hook, pass through the ring on the traveller, and thence to a screw eye driven in the deck. The lines are fitted with metal clews for rendering them taut. The detail, Fig. 3, shows how these lines are used to tighten up the mainsail. The fore sail is similarly fitted up.

For staying the mast, two screw eyes are driven in, opposite sides, about 6 ins. from the top. From these, lines are attached and are threaded through screw eyes driven in near the edge of the deck. Both lines are tightened up with clews, as before. The general view of the completed yacht shows these stays quite clearly.

For the sails any fine but strong material can be used. A pattern for each must be made, and to get these out, draw the sail plan, shown in Fig. 2, full size. Having put in the mast and booms, the size of the sails is just a matter of copying the diagram. Cut these patterns out and pin to the material. Allow $\frac{1}{4}$ in. extra all round for hemming.

Strengthen the corners with an extra triangular piece of the stuff, sewn across.

The back edge of the mainsail, and its bottom edge, are stiffened with a tape, sewn along. In these a few small brass eyelets are fixed for lashing the sail to mast and boom.

The foresail is tied to its boom at each end. At the top a line, fitted with a wire hook, and threaded through a screw eye in the mast, is used to draw

Plait Your Own Belt

HERE is a fine hint for those who wear a plain belt and would prefer to have a fancy one. Simply cut it into

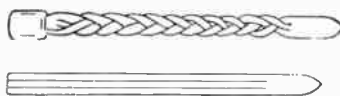

three strips as in diagram, and plait as you do when you plait string. Your belt will look so nice, and the end can be re sewn to finish off.

Simple Beehive Shelf

OBTAIN an ordinary flower-pot with a base of about 4 ins. diameter. Then with hacksaw, cut off the base at a

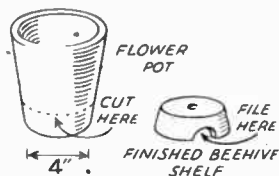

point about 2 ins. away from it. You have then only to file a semi-circle in the side to complete this serviceable and cheap piece of apparatus, as shown.

Age on Models

HERE is a hint if you are making a model fort or anything that wants to look weather-beaten. It is a good tip before painting, to paint the model with glue and throw on cork bits such as grapes are packed in. When the glue is hard, paint over in the usual way. The same tip can be used with good effect to represent a shrubbery.

Bedside Switch

HERE is a way in which to switch off the light after getting into bed, in cases where there is no two-way switch

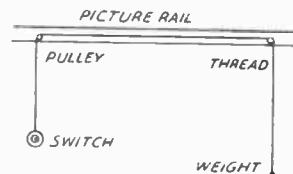

over the bed. First fix a small Meccano pulley on the picture rail above the switch. Next put another pulley at a point above the bed where a thread could be reached easily. Now just tie a piece of strong thread to the dolly of the switch, then hang it over the pulley and tie small round weights on the end to keep it taut.

Save money and enjoy making this practical PICK-UP PLAYING TABLE

THE construction of this Gramophone Pick-up has been simplified as far as possible and it may be built without special tools. Even soldering is not necessary, but despite this results are good. It has been compared with expensive ready-made pick-ups, both of the magnetic and crystal type, and the results obtained were a pleasant surprise. With a little care there is no reason why a unit giving equally good results should not be made at a cost almost negligible compared with that of the ready-manufactured article.

The Pick-Up Arm

This is cut from a light close-grained wood and is shown in Fig. 1. The thickness of the wood used is of no importance, but material about $\frac{1}{4}$ in. thick is most convenient. The shape shown is about $\frac{3}{4}$ in. wide at the narrow end, increasing to about $1\frac{1}{4}$ ins. at the rounded end. At the narrow end a piece $\frac{1}{2}$ in. by $1\frac{1}{4}$ ins. is cut out, forming a recess into which the pick-up itself will fit.

A groove about $\frac{1}{4}$ in. wide and $\frac{1}{4}$ in. deep is cut along the underside of the

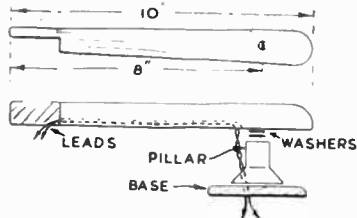

Fig. 1 - The pick-up arm and mount

strip so the leads which will be used can run out of sight. The top edges of the arm should be well rounded, after which the arm is glasspapered and varnished brown.

The arm is pivoted on a bolt, one of 2 B.A. being suitable in size. This bolt passes directly down through the arm and into a supporting pillar or mount. A cotton-reel with one end sawn off can be used for the latter and the bolt should be made a tight fit down its centre. Two metal washers are placed between arm and mount to avoid friction. If the bottom of the pillar is drilled out, lock-nuts can be run on the bolt.

A base is formed from a disc of wood about 2 ins. in diameter. Drive a number of countersunk screws upwards through the base to hold the pillar in position. The whole mount can then be screwed down to the motorboard when required, by passing three or four small screws downwards through the disc, near its edge.

Important Points

The arm must turn freely on the bolt, yet not be able to wobble sideways. It

should, however, have a small free up-and-down movement at the thin end. To arrange for this, the pivot hole should be lengthened slightly at the bottom to form a slot, as shown at (C) in Fig. 3. This can easily be done with a small chisel, taking care to keep the slot as smooth as possible inside so that there is no sideways wobble or impediment to the motion.

It will then be possible to lift the end of the arm to remove the pick-up from the record, and the pivot bolt should not be tight in the arm itself, of course. The metal washers between arm and pillar are essential or the friction of the wooden surfaces will drag the needle to one side of the groove, when playing.

A small hole is drilled straight down through the bottom of the pillar and disc so the leads from the arm may pass through. This flex should be used for these leads. They may be held in the pick-up arm groove by means of small pins driven in at an angle. A little loose wire should be left between arm and mount so that the arm can turn freely.

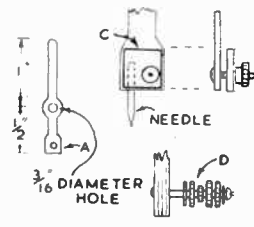
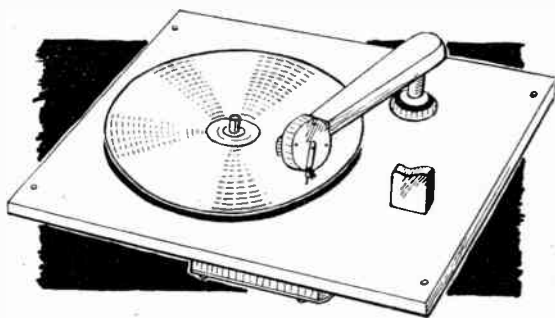

Fig. 2 - The needle-holder

The needle-holder is shown in Fig. 2, and is cut from some fairly stout metal; aluminium or brass will prove easy to work. The bottom of the strip, marked (A) in Fig. 2, is drilled for the smallest bolt to hand. (8 B.A. is suitable, and a size readily obtainable). This bolt also holds a small square piece (C), a terminal-head being used, so it can be tightened and loosened with the fingers.

The small piece (C) serves to clamp the needle in position and this proves quite secure if the front edge and top of the piece (C) are bent sharply over at right-angles to prevent the needle slipping out.

If the constructor can solder, a needle-cup could be made by soldering a short length of small-diameter tubing to



the end (A) and arranging a small set screw which will pass through the side to grip the needle.

The Pick-Up

This is made from one of the easily-obtainable ex-service balanced-armature headphones. Remove the cover and leads. The diaphragm is held in place with four small bolts. One of these is removed and will form the pivot for the needle-holder shown in Fig. 2.

So the needle-holder may vibrate freely but without rattle five small washers are cut from thin rubber such as that taken from an old cycle inner-tube or puncture-mending patches. Four of these washers should be about $\frac{1}{4}$ in. in diameter. The other will be about $\frac{1}{8}$ in. in diameter and will go right inside the centre hole in the piece (A).

To assemble the parts, place a small washer on the bolt that has been removed, then two rubber washers. Then place on the small rubber washer and needle-holder, completing with two more rubber washers (see (D) in Fig. 2, and also Fig. 3). It will be seen that the needle-holder is now pivoted without being in contact with the bolt. This insulation is not used for electrical reasons, but to prevent chatter or

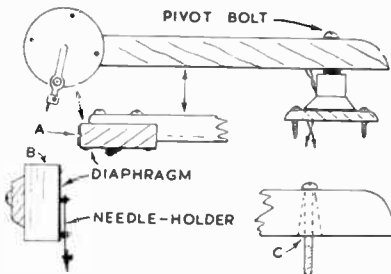

Fig. 3 - The completed pick-up and arm

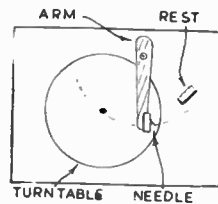

Fig. 4 - Turntable and pick-up positions

vibration between holder and bolt. The small bolt should not be screwed up too tightly.

Diaphragm Fixture

It is now necessary to fix the upper end of the needle-holder strip securely to the centre of the earpiece diaphragm.

With the type of unit mentioned, a small bolt is used in the centre of the diaphragm and if this nut is removed the strip can be screwed securely in place.

If a type of earphone is to be used which has no such bolt (and it will not be found on the older type phones), some other method will have to be employed. It may be possible to drill a small hole through the centre of the diaphragm (which can easily be lifted off), taking care not to distort the latter. Or a small projection may be bent over on the top end of the needle-holder strip and secured with a touch of solder or sealing-wax to the centre of the diaphragm. The method used is not important so long as a sound joint is obtained.

Completing the Unit

The pick-up is secured to the arm by means of two small bolts from the back. These pass through the wood into the holes found in the back of the earphone unit. The needle should slant a little in the direction of rotation of the record, as shown in Fig. 3. Here (A) is a top view of the pick-up and arm, and (B) a view looking directly at the arm from its

thin end.

Take two leads from the earpiece windings right along the arm and through the mount as described.

Turntable Position

The drawing at Fig. 4 shows a view of the completed motor board. The pick-up mount is secured in such a position that when the arm is swung inwards as shown by the dotted line, the point of the needle comes just beyond the centre of the turntable spindle. A rest, cut from wood, is screwed at a convenient position so that the arm may be rested on this without the needle touching the motorboard when records are being changed.

The motorboard itself should be cut according to the size of the cabinet which is to be used or made. Details of motorfixing will also depend upon the motor itself, and whether it is spring or mains driven. Usually, no difficulty will arise. If a new motor and turntable are purchased, the turntable will usually be a simple push-fit on the spindle, which will be slightly tapered.

The motor is normally secured under the motorboard by means of three or

four bolts, hidden from sight under the turntable, which is placed on afterwards.

Final Details

Leads are taken from the pick-up to the pick-up sockets of a receiver or amplifier. If the receiver has no such sockets, the leads should be connected to grid bias negative and the grid socket of the valve coming before that which operates the speaker. This point has been covered in detail in past issues.

Unless the amplifier is very powerful it is unlikely instability will arise. If it does, screened flex must be used for the lead from valve grid to pick-up. The outside screened covering should be wired to some earthed point, as should the metal parts of the earpiece. But normally this is not required.

If the earpiece used is rather heavy, the arm may be counterbalanced by screwing a piece of lead on the underside of the rounded end of the arm. This will reduce the pressure with which the needle runs on the records, reducing scratch. The pressure must not be too light, however, or rattling will result. In practice, it will be found in no way critical.

Useful for office desk or at home is this simple PLASTIC PAPERKNIFE

THIS Perspex paperknife never fails to draw admiration from those who see it used. It has a finish like glass, and can become as important to the office desk, as a key to a lock. Out of a piece of Perspex 3mm. thick, 6ins. wide, and 7½ins. long, you can make six attractive paperknives, and sell them easily to clear your costs and make some profit.

First of all make a template of the paperknife on a 7½ins. strip of 1in. gumstrip buff coloured sealing tape. You can copy the outline of the diagram at Fig. 1 for this purpose. Then, with a sharp pair of scissors, cut out the template from the gumstrip. Now divide the width of the sheet of Perspex into 1in. sections, as shown in Fig. 2, and then with a ruler, preferably a steel one, and a scribe or a long sharp-pointed nail, firmly scratch the 7½ins. lines down the Perspex at 1in. intervals. When these white lines appear the Perspex will show six sections.

Cutting to Shape

In the first of these stick your gumstrip template of the paper knife. Now you require a fretsaw and blade, and if possible a V-block screwed to the side of an old table, or a wooden draining board near the sink. If you cannot fix a V-block, use a firm bench or the top of an old desk to cut the Perspex round the contour of the template.

When you have released the shape from the Perspex piece, remove the template by soaking the rough model in

water. When it has been dried, it is ready for filing and tapering. For this work you will need a 10in. smooth parallel flat file, a 3in. half-round smooth file, glasspaper No. 1 and OO, an old sock, a piece of silk, and a tin of Silvo polish.

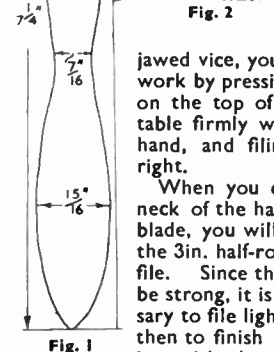
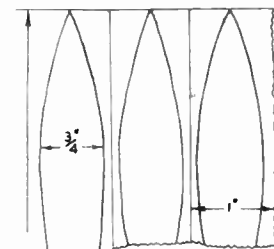

Fig. 1

water. When it has been dried, it is ready for filing and tapering. For this work you will need a 10in. smooth parallel flat file, a 3in. half-round smooth file, glasspaper No. 1 and OO, an old sock, a piece of silk, and a tin of Silvo polish.

Begin on the sharp edges of the handle of the paper knife, by draw-filing with the 10in. file. If you have not a smooth-

jawed vice, you can do the work by pressing the shape on the top of your work table firmly with your left hand, and filing with the right.

When you come to the neck of the handle and the blade, you will have to use the 3in. half-round smooth file. Since this neck must be strong, it is only necessary to file lightly here and then to finish the smoothing with the No. 1 glass-

paper. You will be wise to file one surface of the edge first. Complete this by constantly turning over the paperknife. When you have smoothed down all the edges of the model with glasspaper, place the paper knife down on a clean piece of drawing paper and examine for symmetry. If you are satisfied that the curves of one side balance with those of the other you can begin the finishing.

Polished Finish

To ensure the glass transparency of the finished model, you must be very careful and patient with the tedious first removal of all face scratches. Work at them all, never mind how faint they may seem. To do this work, wrap a strip of glasspaper No. OO round an empty matchbox, or a similarly shaped wood block, and rub along the faces firmly but evenly, and always in the same direction.

When you think one face is clear of all scratches, turn the paperknife over on a damp cloth, and work on the other face. Occasionally hold the model to the light to detect all the very fine scratches.

Now to bring out the glass finish of the Perspex soak a portion of the old sock in the Silvo, and rub one face vigorously until a thin fine, almost dry film of paste appears on the Perspex. Then change the sock for the silk, and rub vigorously again. Now turn over this face on a damp cloth, and treat the other face in just the same fashion.

When you have finished this rubbing you should have a Perspex paperknife, a treat to behold.

You can get quite good photographs by making and using A PIN-HOLE CAMERA

PIN-HOLE cameras are, of course, no novelty, as they were made and used in the earliest days of photography. Some very good photographs, indeed, were taken with these simple cameras, comparable to those taken with the more normal cameras of the period. Very little has been seen or heard, however, of the pin-hole camera in recent years, due, no doubt, to the perfection of the modern camera. The pin-hole camera, however, is extremely simple to make and to use, and provides an instructive and amusing hobby with no great initial outlay.

How it Operates

As the name suggests, the pin-hole camera operates without the more usual kind of lens. The image is projected on to the sensitised plate emulsion through the medium of a small pin-hole located in the front of the camera. This optical phenomenon can be demonstrated by making a pin-hole in a piece of cardboard, holding a sheet of dark paper a short distance beneath, then placing both under a lighted electric bulb. A perfect image of the glowing filament will be cast upon the lower sheet of paper.

To make the camera, two pieces of smooth wood, 4ins. long by 5ins. wide by $\frac{1}{4}$ in. thick are required for the sides, and

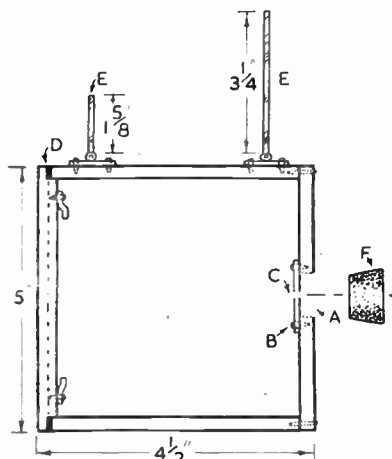

Fig. 1—Sectional view through camera

two further pieces, 4ins. long by $3\frac{1}{2}$ ins. wide by $\frac{1}{4}$ in. thick for the top and bottom respectively. These are made into a box by butt joining the edges with strong glue and panel pins. The front end of the camera is made from a piece of wood, 5ins. by 4ins. by $\frac{1}{4}$ in.

In the centre is drilled a $\frac{1}{4}$ in. diameter hole (Fig. 1 A). A disc of thin tinplate, $1\frac{1}{2}$ ins. in diameter is then placed over the hole and screwed into position with several small screws (Fig. 1 B). It is advisable to interpose a thick paper

washer between the disc and wood before screwing into position, to form a light-tight joint.

Care should also be taken to see the screws do not penetrate through the outer surface of the wood. Otherwise it is probable that a light leakage will occur at this point, and spoil the results of the camera.

The Pin-hole

A small pin-hole is next made in the centre of the metal disc (Fig. 1 C). This cannot, of course, be made with a pin owing to the extremely soft nature of the metal. The best procedure to adopt is to support the disc on a firm block of wood, then remove a skim of metal from the centre of same with a small metal drill.

It is absolutely essential the metal in the vicinity of the pin-hole is reduced as thin as possible with the drill, without actually breaking through the metal. This is to obviate the refraction of the light through the edges of the pin-hole, which would otherwise tend to blur and distort the photograph.

When the metal has been reduced as far as possible, a small hole is started by gently tapping with a small nail. Then a needle is placed in the puncture and gently but firmly pushed through. The diameter of the needle should be approximately that of an ordinary pin. When the needle has been removed, the hole should be inspected for any rough edges, which should be carefully removed with fine emery paper.

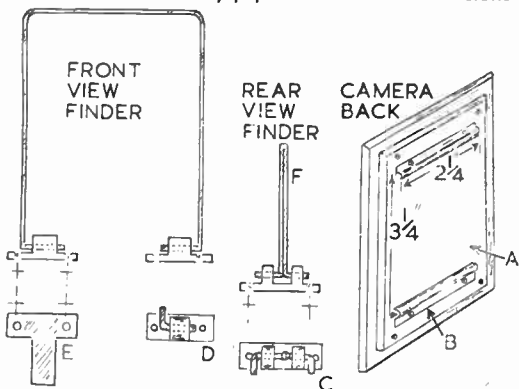
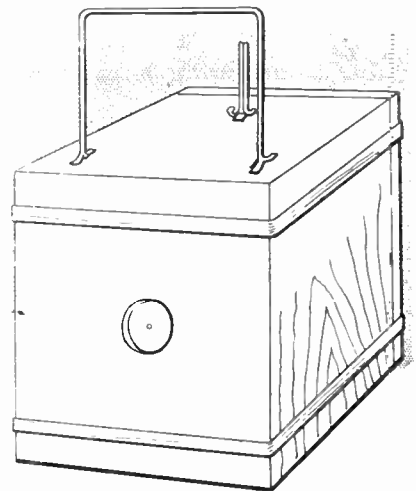

Fig. 2—Details of view finder assembly and camera back

A spot of indian ink is then applied to the hole, and the hole cleared of any surplus ink by gently blowing through until clear. The camera front is then fastened into position with glue and panel pins, with the disc side inwards.

The camera must now be held up to a strong light, sunlight preferably, to detect any light leakages along the seams or around the pin-hole assembly. During this examination, a pin should be inserted in the pin-hole to make detection easier. In the event of a light



The camera completed and ready for use

leakage, the affected part should be covered with a strip of adhesive tape, which will effectively stop the leakage.

Painted Interior

The interior of the camera must next be painted with a dead matt black paint. This paint can be purchased from any photographic dealers, or a good alternative is indian ink carefully applied with a soft brush.

The back of the camera is constructed from a piece of wood of similar dimensions to that of the front, to which is screwed a further piece of wood, $4\frac{1}{2}$ ins. by $3\frac{1}{2}$ ins. by $\frac{1}{4}$ in. (Fig. 2 A). The back must be a very accurate and tight fit in the camera end, and the rebated design ensures an efficient light trap. Two tinplate runners of the shape illustrated in (Fig. 2 B) are then screwed into the back. The runners are $2\frac{1}{4}$ ins. in length and positioned equidistant with $3\frac{1}{4}$ ins. distance between the top and bottom slots. The depth of the slots is $\frac{1}{4}$ in.

The back end of the camera must now be planed and glasspapered until absolutely level and smooth. Then thin strips of red plush or velour are glued around same to form a light seal, as in Fig. 1 D. The inside of the back is painted with the black finish as previously mentioned, particular care being taken to cover well the bright parts of the plate-runners.

The view finders are of the dimensions, and are fitted, as in Fig. 1 E. They are simply made of stout wire secured to the camera by brackets as shown (Fig. 2 E). As will be seen, this is in the form of a

(Continued foot of page 136)

Some various methods of making HOME-MADE PLASTIC WOOD

PLASTIC woods are more than useful for small filling jobs such as covering the heads of screws, obliterating 'shakes' and shrinkage opening in timber and the like.

If you want to do anything big with fillers of this kind (and quite big work can be attempted), the home-made varieties certainly run out much cheaper. Even the filling of cracks over an apparently small area of timber before painting can become a 'big job' in the end and take more of the filler used than at first seemed possible.

When plastic wood is employed to replace, say, a section of broken wooden moulding (which it can do well), then a lot of it is required from the start, as one has to be liberal in the first rough outline of the missing part—the final precise shape being obtained by sandpapering, etc., later when complete drying has taken place. Allowance has to be made with most plastic woods for shrinkage, some contracting more than others.

Simple Mixtures

Now about making your own wood fillers. There are several types that can be concocted but the simplest is just a mixture of fine sawdust and glue. The glue should only be of medium thickness, if anything on the thin side, and the sawdust must be poured in slowly, mixing and pressing till a stiff pasty mass is produced. This is worked into the openings to be filled and pressed well home. Considerable shrinkage takes place with this simple variety of plastic wood and a good allowance must be made for this by watching the fillings as they dry and working in more as required.

For the filling of holes in wood—as against long openings, etc.—a good plastic is made out of:—

- (1) Powdered white lead.
- (2) Whitening.
- (3) Linseed oil.
- (4) Lard.
- (5) Japan drier.

Mix the powdered white lead well with the whitening first and work in the sawdust, then slowly add the linseed oil till a consistency like putty has been secured. Now put in the Japan drier till a more plastic paste-like mass comes into being, when the filler is ready for application.

Colour pigments can be added if desired to match up with various woods. A quite good mahogany tint is given by working in powdered Burnt Sienna. Oak can be matched with Raw Sienna and Vandyke Brown gives walnut. The actual shade required is obtained by slowly adding the pigment till the desired shade comes about. For very tiny holes this filler can be used without the sawdust, but this is necessary if the job in hand is the making up of a definite wooden surface.

Here is a type of plastic wood filler which has the characteristic of setting rock hard. It is made by heating and mixing beeswax and resin to the proportions of:—

- | | |
|-------------|------|
| Beeswax ... | 1oz. |
| Resin ... | 1oz. |

To this compound is mixed a little very fine sawdust, also pigments for matching up purposes as above. This filler has to be applied hot. As with the previous pastes, for very small work the sawdust can be omitted and used in this way, they might be considered 'fillers' rather than plastic woods, but this next mixture is truly a wood, and is rather like the stuff you buy in tubes.

Required are:—

- (1) Wood Wool.
- (2) Wood Meal.
- (3) Cellulose.

These three constituents are mixed

well together into the familiar pasty mass, which, if not being used at once, must in this case be put into an airtight tin. Or some old tubes can be opened up and filled, the ends then being pressed over again. Should this plastic wood become hard even with all your care, it can be brought back to a state of workability by kneading in either acetone or amyl acetate.

Whitening and linseed oil alone can be used as a filler. Matching in this case is done by introducing a little of the correctly tinted pigment mixed with a small quantity of gold size and a few drops of turpentine. To this again can be added finely powdered wood if the dimensions of the holes justify it.

Plugging

At all times when applying plastic wood make sure that the holes to be filled are free from obvious grease, especially when the plastic has to adhere to a surface. When a really large hole has to be filled it is best to roughly fill it first with a wooden plug, finishing around this and above with the plastic. Imitation grain can be obtained by carefully working on the surface with a knife, connecting up the ends of the surrounding grain marks.

When quite dry any of the plastics suggested can be worked on with the usual tools like chisels and files and they respond well to sandpapering. A screw or nail can also be run in as with solid wood. Indeed, there is no better way of repairing a too large screw hole than to fill it with plastic wood, wait until complete drying has taken place, and then replace the screw in the usual way.

It saves a certain amount of time and trouble, however, when a screw has to go into plastic wood, if a Bradawl hole is first made while the filling is still damp. The screw must not be put in, however, till it has dried right out. (138)

Pin-hole Camera—(Continued from page 135)

capital 'T'. The long part of the blank is curled round to form a guide for the view-finder wire. In the case of the rear view-finder, the guide is divided into two. With the front view-finder wire inserted through the guides, the projecting wire should be bent at right-angles towards the front of the camera. As will be seen in Fig. 2 F, the rear view-finder consists of a length of wire bent double, and the projections through the guide should be bent at right-angles towards the rear of the camera.

In this way, when the camera is in use, the view-finders are supported vertically, and after use they can be folded unobtrusively away along the top of the camera. The front view-finder is screwed exactly central to the front of the camera whilst the rear is aligned so

that, when viewed through, it is exactly central to the axis of the front view-finder. A tight-fitting cork is next required for the pin-hole aperture (Fig. 1 F) and the camera is completed.

The correct size of plate to use is $3\frac{1}{2}$ by $2\frac{1}{2}$. A fairly fast plate should be used, and it is inserted in the runners in a dark-room by using a safelight. Many plates, notably of the ultra speedy panchromatic type, have to be loaded in complete darkness. This is not so difficult as at first appears, as these plates are generally packed in pairs with the emulsion side inwards. By careful manipulation, loading becomes a relatively simple matter.

When the plate is in position, the back is securely fastened to the camera with two strong elastic bands, which are

passed from the back to the front of the camera, and the cork is inserted in the pin-hole aperture.

As regards the necessary period of exposure, the chief factors are the prevailing light intensity and the speed of the plate used. Generally speaking, for normal conditions an exposure of some 15 seconds should be sufficient, but a certain amount of personal experiment will, doubtless, be necessary to familiarize one with the capabilities of the camera.

When taking a photograph, the object should, of course, be perfectly still for the duration of exposure. The camera should be supported on a firm object, the cork removed for the necessary amount of exposure, then replaced upon completion.

Practical improvements follow if you undertake these HOME HANDYMAN HINTS

THE happy handyman is the one who keeps a selection of odd jobs in hand for the days when he cannot get outside and is confined to his shed or workshop. He is quite content then, because he feels he is not wasting time and he enjoys variety in hobby. Here are a few suggestions which will do for any household.

When the milkman calls only once a day, the average family collects quite a

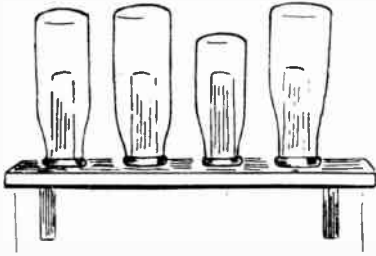

Fig. 1—For holding empty milk bottles

few bottles and these stand about and get kicked over and often broken. Failing this they take up valuable room on the draining board. The drawing at Fig. 1 shows a useful gadget.

In accordance with the number you have, cut a board about 5ins. wide and 18ins. long. On this, carefully spaced by measuring the bottles, screw lengths of broom handle or wooden dowel, the thicker the better.

Milk Bottle Rack

Milk bottles are about 9ins. high, so allow the spikes to be at least 6ins. high. If the board slopes a little this will allow the water to drain off. Fix board in a suitable place and paint or enamel to

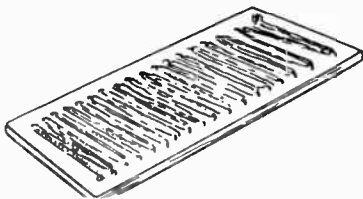

Fig. 3—A rope scraper door mat

prevent drips of milk spoiling the woodwork.

Shoe brushes are not the easiest things to use and often the fingers slip off and the hands get blacked up. Try fixing the majority of these brushes with the ordinary screw on handles purchased at the local store (see Fig. 2). Prevent the usual confusion in the home over which is black and which is used for brown polish. Enamel the handles to show.

Boot Scraper

Most of the household will be helping in the planting session in the near future and this means more muddy boots than ever. Scrapers are expensive and mats

spoil when the mud is really thick. Make a home-made mat for this purpose, such as seen in Fig. 3.

Take a substantial wooden board about 12ins. wide and 18ins. long. Measure it as shown in the sketch so you can start at one end, near the edge with a knot in a piece of odd rope fixed to a staple to hold it. Now follow across the board from side to side at intervals with spaces of about 1in. between. Secure with staples at each end. Finish off with a knot. If you are unable to get a mat for a sunken well in the hall, then try this idea but make the rope strands closer.

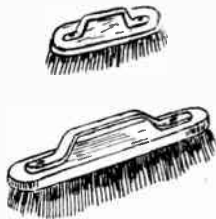

Fig. 2—Handles for shoe brushes

This can be removed for cleaning at any time.

If you have a cupboard for saucepans, you will always probably find the lids sliding out each time you open the door. If perched on the saucepans they are dangerous, so where can one put them? The answer is make a small rack along the base of the door, as seen in the drawing at Fig. 4.

See there is space and that the saucepans will not jar on them. Most saucepan lids only need about 2in. clearance with handle so the depth required is not great. The width of even a large saucepan

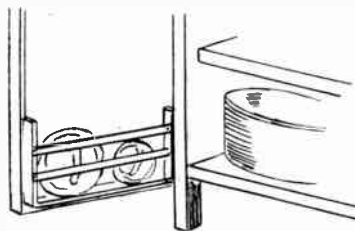

Fig. 4—A lid holder

is not more than 11ins. but design the rack to fit the articles you have. It is made by two uprights about 9ins. high at each end and screwed on the edges of the doors with a similar piece along the base. The usual 1in. laths are then placed across from side to side. You will find this a good home for all the lids.

Handy Holdall

There is always a collection of oddments around the average scullery such as dusters, polishing rags, boot and shoe

creams and brushes. You may find you just have space for this handy little low cupboard which is specially designed to be fitted, perhaps, between the gas stove and the copper. It will make a little seat and it will hold a lot of materials. Opening as it does, there are no doors to get in the way.

You may be able to find a strong fruit box to form the main frame which you can cover with composition building board. This is now off permit and polishes nicely on one side. The size could be 15ins. high and 12ins. deep. Do not make too deep as this will probably

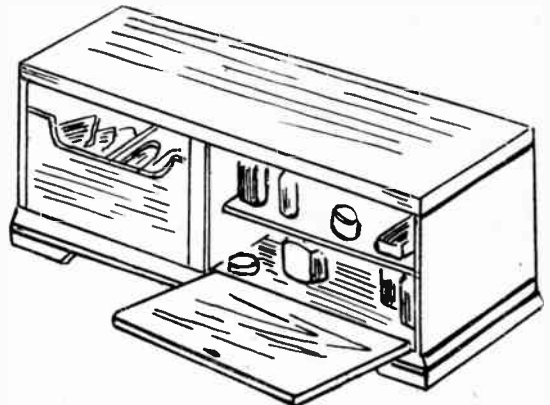

Fig. 5—A convenient cabinet for general materials of the kitchen

make it awkward when things get pushed at the back. It is divided half-way as shown and the first half has a neat half-front with pleasing cut-away to give easy access to the goods.

Two or three divisions can be put in this and the part is left open at the top. The second side, with lower hinged lid has a half-way shelf. Plan this to take all the bottles which will be kept in it and space out so brushes can be put in the bottom. Raise off the floor a little with some square wood or four cotton reels. You may be able to manage two like this and you will certainly be surprised how welcome this accommodation will be. (142)

Cutting Glasspaper

HERE is a useful tip. If you are in difficulty about cutting glasspaper, get a hacksaw blade and place it on the paper. Tap it once or twice with a hammer, remove blade and paper will tear off easily, as the teeth have perforated it satisfactorily.

Some useful suggestions for campers on THE POLELESS TENT

WE have become so used to central tent poles (or two, one either end) that it seems that no tent could be put up without them. Yet in other countries and among certain nomadic peoples the central or other vertical pole is dispensed with. Thus we get the gipsy's frame tent—seen in this

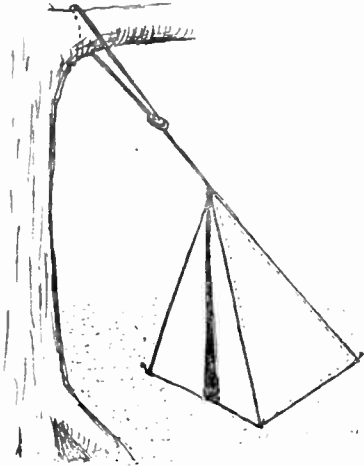

country—in which side pieces bent inwards and locked together give a frame which is covered with material.

The absence of middle poles is a tremendous advantage. Getting in or out of the tent immediately becomes infinitely easier while there is given rather curiously, a sense of much greater space, despite the fact that the pole or poles at the most only take up a very few inches of actual ground.

Bivouacs can easily be erected without poles, but it generally means that use has to be made of a tree or trees, and

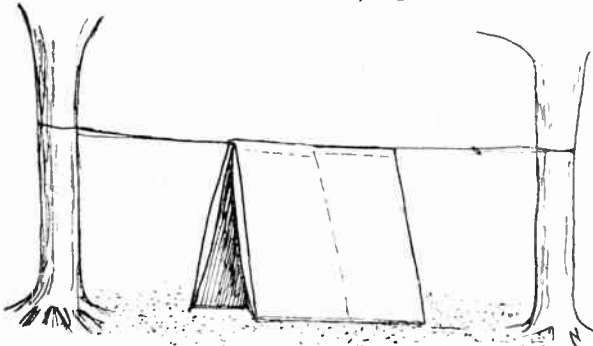

camping under trees for any lengthy time is not good. For a single, warm, dry night there is no harm. But in long periods of bad weather trees can be dangerous on account of their liability to attract lightning or occasionally let drop a bough without warning.

Also in wet weather, while a tree holds off the rain for a time, there is no wetter place when it starts to 'drip', as

great blobs of water then come down that will go through any light fabric.

However, suppose you want to make a poleless bivouac, the simplest is the 'A' tent. This is built up of three triangles of material and is supported by a sloping rope which goes from a strong peg in the ground to the limbs of a suitable tree, as shown.

The door can be placed in towards the tree or to one or other of the sides, according to your own special liking. An al fresco shelter of this kind is very convenient for carrying about.

A small bivouac ridge tent can also be used without poles by making use of two trees not too far apart. A tent of this

top. Over this conical outline go the skins of the tent proper. These 'wigwams' are sometimes very large and a fire is often made in the centre, the smoke escaping through a hole in the top where the skins do not quite meet.

The idea of a frame tent can be copied with a small ridge tent or bivouac, as indicated. Four sticks are obtained a little longer than the sloping sides. These should, if possible, be forked at the top, or it will do if there is a fork in one and a fair-sized projection in the other. These pieces are pushed into the ground at an angle and a third piece, also suitably notched, placed across the tops. On this frame goes the canvas or material

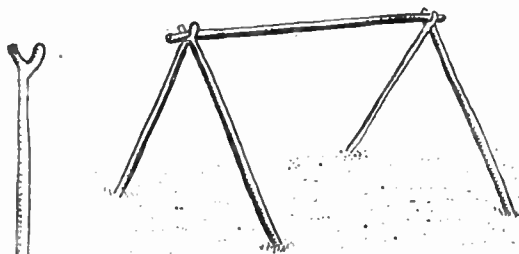

ERECT
THE FRAME
LIKE THIS

FOUR
PIECES AS
ABOVE ARE
REQUIRED

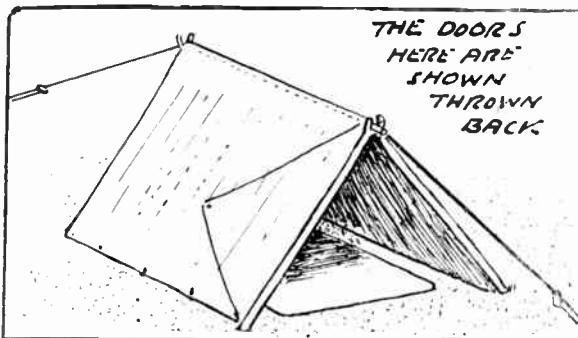

THE DOORS
HERE ARE
SHOWN
THROWN
BACK

kind must be of light material, or it will sag too much. The supporting ropes can be made adjustable by putting a 'runner' at one side or the other which can be taken up when the heat of the day causes the tent to droop. Remember, however, to slack off a little if rain starts or a heavy dew sets in, as the rope will go like fiddle string and may snap.

The Red Indian tipi is, of course, without a centre pole, although the whole frame is made up of wood members. In this case a good number of spars are used, as good straight wood is plentiful in the Indian country. These are 'stacked' together and secured at the

of the tent.

If this is very light the tent will stand alone on these under-lying spars. If heavy, or the day is rough, then guy lines should be run out from the peaks. Even so, however, the entrance to the tent is quite clear and the sense of greatly added space given. The whole tent, too, becomes more rigid than the entirely rope-held kind.

So then, we see from the gipsies, Red Indian and others that the central or end poles are not an absolute necessity to every tent—a fact which is amply proved by our own camping authorities who are always experimenting with various new types of tents, and from whom the 'A' and similar tents have come.

The whole idea is rather intriguing, so try some experiments yourself this summer. You might still drop on some entirely new and highly useful design of canvas home.

Your seaside visits are more interesting if you make SEA-SHELL NOVELTIES

THE illustrations that go with this article show, at a glance, a few of the dozens of artistic novelties that can be made from sea shells. One man and his wife, known to the writer, paid for their seaside holiday by making up, during the winter months, novelties from shells they had gathered and saved.

But apart from any considerations of financial profit, a good deal of interest can be gained from this class of work. Readers who are going on a seaside holiday should collect a good supply of shells, but those who are not likely to be going to the seaside are reminded that mussel and scallop shells, mentioned in this article, are easily obtainable in towns, from fishmongers.

Popular and Simple

Whilst we will describe some up-to-date novelties, mention must first be made of the good old favourite, the decorated jar. There is no reason at all why it should not enjoy a revival. After all, one of the very 'latest' fashions in ladies dress ornaments is the Victorian and earlier cameo brooch.

Another reason why we describe the process is because, simple as it is, few people do it right.

Any jar can be used—a jam jar, pickle jar, flower pot or, if an umbrella stand is required, a length of earthenware drainpipe. As regards the latter, one that has been slightly damaged may be obtained cheaply at a builder's yard, no doubt.

Now, assuming the jar is clean, it must first be painted with an undercoating

paint. Any colour will do. Unless the jar is painted first, the putty to be applied will crack and peel off. When the paint is dry, apply putty in an even layer all round.

The shells, previously washed clean of salt and sand, are now pressed in—not too deeply. Do not try for any formal arrangement but let the shells be in a haphazard form, as shown in Fig. 3. When all the shells have been applied, stab any exposed putty with a blunt pencil so as to 'dot' it, and then leave the putty to dry. This may take a week or so.

The exposed dotted putty is then painted with gold or aluminium paint (though we can use coloured enamels such as sea-green or blue).

Two More Novelties

The paper weight (or doorstop according to size) (Fig. 4) is made in a somewhat similar way, the core in this case being a piece of brick or stone with a flat bottom. In this particular case the shells can be arranged in some sort of order.

The Shell Figure (1) is a distinct novelty and is intended for a sideboard,

etc., decoration.

The arms and legs are formed by threading limpet shells, previously

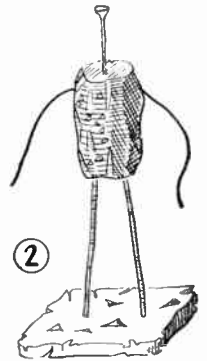

NOVELTY SHELL FIGURE



DECORATED JAR



PAPER WEIGHT or DOORSTOP

drilled, over wires. Those forming the arm can be reasonably flexible, but the legs had best be made from the kind of round rod sold with Juneero sets.

Fig. 2 shows the foundation. The body is very roughly shaped from wood, not only because it is entirely hidden afterwards, but also because the roughness is essential for 'keying' the putty used.

Framework

Though Fig. 2 shows the assembled framework, it is necessary to apply the base afterwards, in order to allow the shells to be threaded on. The shells go one under the other, giving a flounced Latin-American effect to the trousers legs and sleeves. The shells should bed down well inside each other. A little putty inside each may be an advantage. Small mussel shells form the feet.

When the legs have been made, the base may be applied. This is of wood, roughened, two holes being bored for the legs. The rods are held in a tight fit here. The base is

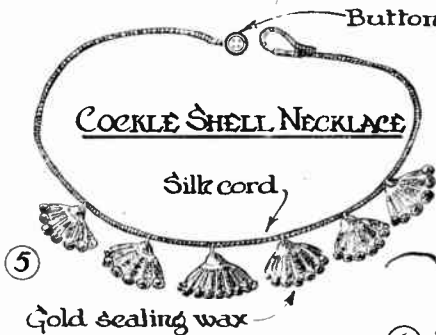

COCKLE SHELL NECKLACE

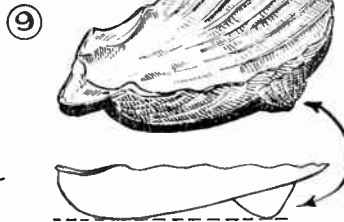

TWO FORMS OF SCALLOP SHELL - ASH TRAY

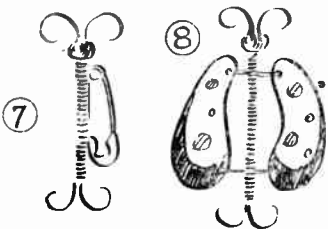

BUTTERFLY BROOCH



given a layer of putty and then very small shells or shell fragments are applied. Fine pebbles as sold for aquariums may also be used on the base.

Figure Work

The body is also built up of putty. Apart from two or three 'buttons' made from small shells, the rest of the body can be, like the base, of small shell fragments pressed in.

The arms are made like the legs. Epaulettes at the shoulders mask the joint here.

The head is a ball of putty modelled around the nail that was driven in. One shell does for a hat and another, the face. This may have Latin features painted on, simply. In Fig. 1 note the 'sideboard' whiskers.

It is impossible to avoid some putty showing, but this can be carefully painted, as in the case of the decorated jar. Avoid getting any paint on the shells.

Cockle-shell Necklace

The Cockle-shell Necklace is well worth making for bazaars, etc. The shells have each a hole drilled in them with a fretworkers drill. The shells are very soft, so no great pressure is needed in drilling. The shells can be painted or stained pink and dabs of gold sealing wax applied to the edges as shown in Fig. 5. They are then stitched on a length of silk cord or one of the new-style shoelaces.

There are various necklace fastenings that can be purchased, but Fig. 5 shows a very simple way of fastening.

Another piece of jewellery from

Neptune's jewel box is the Butterfly Brooch seen in Fig. 8. This is made from the two halves of a mussel shell. Two holes are drilled in each half, as seen in the diagram. Twist two pieces of wire together, as in Fig. 6. Slip on a coloured bead and bend the top ends of the wire over, as shown. Then, with fine wire, bind a safety pin on, as in Fig. 7. Then bend up the bottom wires.

Our design for a MECHANICAL RACE GAME

Design Sheet for this Novelty given with this issue. Kit of parts (No. 2848) for making, 4/- from Hobbies Branches or for 9d. extra from Hobbies Ltd., Dereham, Norfolk.

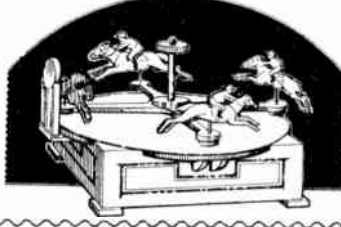

With thin wire, the 'wings' can be bound to the body, but not, for preference, too closely. See Fig. 8, which also shows how the wings are gaily painted; light and dark blue, orange with red spots, yellow with green spots, or anything you most fancy. Use enamel paints. Other shells besides mussels can be used.

Few homes have really too many Ash Trays and two ways of making these

from scallop shells are shown in Figs. 9 and 10. In the first, the large shell is prevented from tilting by having a smaller shell, say, a limpet, stuck underneath it. Two such smaller shells may be required.

How To Fix

Just how to stick on these smaller shells is something of a teaser, but the present writer suggests filling the small shells with Pyruma modelling material, and pressing in position against the large shell. The modelling paste should be rather overflowing, so that some is squeezed out. Keep the shells carefully in position, under pressure, until the cement has hardened. Wipe the surplus off first.

Carefully mark the position of the small shells on the larger by scratching round with a sharp-pointed tool. The shells will not, at this stage, be cemented to the large shell but the modelling paste will have been moulded into a surface that conforms exactly with the places on the large shell. They can then be finally cemented with Tiluma.

Another way (Fig. 10) is to get a slab of wood and very roughly cut a hole in it to take the shell. Putty is used to fill up gaps. Another way is to lay the scallop shell face down on a sheet of glass. Where it does not make perfect contact with the glass, use plasticine to fill gaps. Build a fence of cardboard round the reversed shell and seal this well, also, with plasticine. Now pour in plaster to a depth of, say, 1in. When the plaster has set the shell can be turned right way up. It will be firmly and accurately embedded in a block of plaster. (153)

GARDEN GATE NAME PLATES IN WOOD

WE usually think of fretwork as a form of indoor decoration, but it can also be used to provide ornamental features in the garden. For example the illustration at Fig. 1 shows an interesting name plate for the garden gate. The design was cut out in fretwood and glued on to the front of the gate. Before being fixed into position it was painted with enamel in a colour to contrast with that of the gate.

An even more distinctive effect is



Fig. 1—Distinctive design for door or gate

shown in Fig. 2. This takes the form of a hanging sign which was cut out from a sheet of asbestos with the aid of a fretsaw, using a medium grade blade.

The design is an attractive one which could be adapted to suit any house by simply altering the lettering as necessary. When completed the sign should be given a coat of black enamel and hung up after the manner shown.

Fig. 3 illustrates another novel idea. It is a sort of sign post which could be fixed by the garden gate pointing up the path towards the house. The ornamental bird was copied from a Hobbies fretwork



Fig. 3 Original type of garden sign

design and cut out in outline. The details of eyes and feathers were merely painted in with white paint. (162)



Fig. 2—An attractive hanging nameplate

A simple, novel, attractive, and practical article— A COTTON REEL LAMP

MANY cotton reels are far too well made and of too nice wood to throw away, and so it is good to hear of items that can be quite satisfactorily made with them. Looking round there are really a lot of things in which reels can be introduced and the table lamp shown in the illustration—made by the writer—is one of them.

There was some question at first as to whether reels would look well as the stem of a lamp which comes under close scrutiny, but there need have been no worry on this score, for the effect is very good—indeed, better than suggested in the photograph.

A Suitable Height

Height was another of the initial questions when thinking out the design, but it seemed that eight or nine reels fitted one on the other brought the bulb to about the right elevation above the table for comfortable reading. There is no reason, however, why a shorter stem should not be used, as, say, for a bedside lamp, when it is, perhaps, better to keep the light low.

Having decided the height, the first thing is to get together the desired number of reels—of the same diameter, design and colour of wood. It is worth going to some trouble to get matching reels, for while reels may look the same

on the point of fitting a quite strong thread can be forced into its sides by rotating the socket, at the same time keeping a steady pressure downwards. Fig. 2 shows the socket in position. A perfectly firm joint can be made this way.

Essential Fitting

It is, of course, essential that this joint must be rigid as it has to take the weight of the holder, bulb and shade, plus the metal frame for the shade. An amazingly tight connection can be secured, however, as proved by the lamp shown which has been doing good service for over a year.

Should the hole become too big while scraping it out, it is best to discard the reel and start on another. In getting a sound thread in the wood the secret is to keep the sides of the hole parallel—any tapering is fatal.

The reels can now be fastened together, this being done with strong tube glue. Glasspaper the ends first and then heat the extremities to be joined. Rub on the glue, heat again, and bring the surfaces in contact. Once touching, never break and reset. A glue joint made this way is virtually as strong as continuous wood.

The Base

Next comes the base. This can be any square of good material of 6in. or 7in. sides and of about 1in. thickness. Cut off the corners to give a neat effect and take a hole down the centre of about $\frac{1}{2}$ in. diameter, and from this cut a channel to one of the edges, deep enough to take two strands of electric flex. The lamp in the illustration has a piece of mahogany for the base—taken from the bottom of a discarded bedroom looking-glass. This smoothed and with a coat of french polish looks really very attractive.

When the reels are dry, the whole stem is attached to the base, also with glue. Make sure that the reels stand at a true right angle. Given that the bottom reel is not faulty they will do this automatically, but just give an eye to the point.

With everything tightly together apply the finish. The reels are first given a good rubbing with a dark brown boot-polish. Everything is then treated with French polish—or the reels can be left as they are, just stained with the boot preparation.

Now attach the ends of the flex to the socket and feed the length down the centre of the reels. Screw the socket

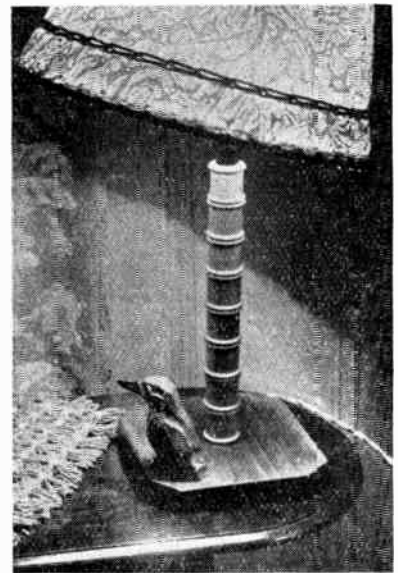

Fig. 1—A delightful stand lamp in use

tightly into position and give the flex a pull to make sure it is lying nicely inside and then pull the wire to one side along the underside channel and secure it here with one or two electric cable staples.

Baize Under Base

Finally finish the bottom of the base with a piece of baize. This both covers the channel containing the flex and allows the lamp to stand on polished furniture without doing any harm. Also it looks nice and gives the whole lamp a well-finished appearance.

On the socket go the shade frame and shade. These are, of course, standard articles which can be obtained at any chain store. The socket should contain a switch, but if desired a plain socket can be used and a torpedo switch let into one of the leads.

The shade can, of course, be to personal choice but one of about 1ft. bottom diameter gives a nice effect of 'balance'—a thing which is rather important in lamps of this kind, but often overlooked. Both a too small and too large shade can spoil the whole effect.

Squeaky Woodwork

WHEN making drawer cabinets, etc., oil the working parts sparingly with raw linseed oil. Afterwards rub the parts over with white paraffin wax. It will be surprising how smoothly the drawers will work.

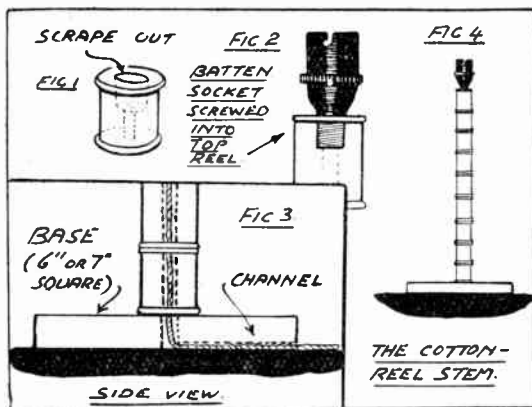

there is often some trifling difference which becomes very obvious when a series are put together.

Lamp Fitting

Next purchase a batten electric lamp socket, that is one with an externally threaded lower section, and then selecting the reel which is to go on top of the stem, enlarge the central hole as Fig. 1, in the diagram. The aim is to make this just large enough to take the threaded end of the socket which is screwed in there, producing its own thread. Reels are normally of hard wood, some exceedingly hard, and if the hole is gently scraped out till the socket is just

MISCELLANEOUS ADVERTISEMENTS

The advertisements are inserted at the rate of 3d. per word prepaid. Name and address are counted, but initials or groups, such as E.P.S. or £1/11/6 are accepted as one word. Postal Order and Stamps must accompany the order and advertisements will be inserted in the earliest issue. Announcements of fretwork goods or those shown in Hobbies Handbook are not accepted. Orders can be sent either to Hobbies Weekly, Advert. Dept., Dereham, Norfolk, or Temple House, Temple Avenue, London, E.C.4

PERSONS wanted to make model houses at home. Interesting, clean, easy work. Top rates paid. Send stamped addressed envelope for free details.—Bennett Models, 137 Grays Inn Road, London, W.C.1.

FREE Bahawalpurs', Colonial discount approvals. Postage.—Bishop, 40 Marine Parade, Hythe, Kent.

£500 a year earned at home. Send stamp for details.—Eversell Modern Publications (Dept. 10), 37 Duke St., Brighton.

THE GLORY that was Greece. Beautiful ancient designs on modern Greek stamps. Long Classic set, 12 mint stamps, catalogued at 3/9, only 1/-. Set of six Winds mint air mail stamps, catalogued at 1/2, only 6d. Set of three Glory of Psara, 3d. Postage 2½d. extra. Many other cheap sets on our approval sheets. A selection sent on request.—E. F. Townsend, 92 Tenby Road, Edgware, Middlesex.

PROFITABLE use of old photograph films, genuine new idea. Full instructions, 1/-.—Gray, 61 St. Albans Avenue, Bournemouth.

PERFOKATION gauge free! To all applicants for our approvals. Ideal for beginners and medium collectors. Send 2½d. stamp for trial selection.—Box No. 33, Hobbies Weekly, Dereham, Norfolk.

PRACTICAL wireless circuits. How to build all types of radio receivers from crystal sets to superhets, mains or battery. 59 circuits all in one book, only 6/6 post paid, by post only.—T. Smith, 49 Woodvale Parade, Belfast.

AMATEUR woodworkers! Produce a professional finish and earn 10/- per hour. Becoming increasingly popular, materials plentiful, no restrictions. Money back guarantee. Send 2/- P.O. to—P.B. 50964, 'The Pastimer', 183 Bowes Road, London, N.11.

BOYS! Send for our super price catalogue of tricks, jokes and novelties. Terrific selection. The best jokes of the century. Cig-bangs, plate lifters, itching powder, etc. S.A.E. to—Chung Lee's Magic Shop, Streatham, S.W.16.

BENSON'S gent's 11-jewel pocket watch, silver, 50/-. Gent's 15-jewel Buren rolled-gold pocket watch, 60/-. Both perfect order and condition. Approval.—A. Keys, 61 Orchard Ave., Lancing, Sussex.

THOROUGHLY seasoned pine, hardwood, ply offcuts, board and strip. Useful to toy and model makers. Genuine assorted parcels, 5/- including postage. Supply limited.—Barnett, 4 Council Houses, West Ashton, Trowbridge, Wilts.

STAMPS FREE!! Twenty unused (2½d.).—G. H. Barnett, Limington, Somerset.

BEACH balls, 4ft. diameter, multi-coloured, 5/6 each, post 6d. Order now.—Manor Trading Supplies, 42 Manor Farm Drive, Chingford, London, E.4.

APPROVALS that will delight. All fine stamps at lowest prices. Generous discount and applicants receive grand free packet. Send with postage 2½d. to—G. Morris (Dept. H.B.), Vallemount, Southways Lane, Crownhill, Plymouth.

LUMINOUS ink. Easy to make. Instructions, 2/- post free.—L. Aquilina, 147 Dockyard Street, Pawla, Malta.

LEIPZIG Spring Fair, 1948, two unused large pictorial stamps free. Request approvals.—Hubert Rajski, 211d Thornes Road, Wakefield.

HOME WOODWORK. Fifty useful things to make. A practical handbook with 188 illustrations, 2/6 posted. Modern Wood Toymaker, with 192 effective designs and illustrations, 2/6 posted.—G. F. Rhead, Thurston End, Hawkedon, Bury St. Edmunds.

SPACE fillers from 3 a 1d. Packets, 54d., 6d., and 8d.—Jeffreys, 2 Bay View, Craigavon, Port Talbot.

PRINTING—private notepaper headings, from 3/6 per 100. Send 2½d. stamp for style sheet and samples, etc.—Cailes, Printer, 210 Stewart Road, Bournemouth, Hants.

ALL different. 20 Argentine, 5d.; 20 U.S.A., 5d.; 50 Austria, 9d.; 50 Hungary, 9d.; 50 French Colonials, 1/3. Postage extra please. No approvals unless requested.—J. Watts, Linby, Notts.

TRICKS for boys. Cut and restored rope, 1/3; window mystery, 1/3; Eastern papers, 1/3; Blondin ball, 2/-; It's off, 1/9. Free trick to everyone spending 5/-.—Magician's Den, 644 Wimborne Road, Bournemouth.

STAMPS. World mixed. 1/- a 100; 5/- a 1,000. Gift voucher free.—Selby, 66 Donnington Road, London, N.W.10.

STAMPS. 250 different, 2/6; 500 different, 5/-; 1,000 different, 12/6.—Thomson, 46 Beil Dr., Glasgow, W.3.

MONTENEGRO 1905 Constitution set cat., 10 9. Free to approval applicants enclosing 6d.—Ramsey, 36 Totley Brook Road, Sheffield.

AMINIMUM of £5 per week can be earned running a postal stamp business. Details, 2½d.—Philatelist, 17 Springfield Avenue, Padgate, Warrington.

500 all different, or 1,000 mixed world stamps, 3/9 only.—H. Whitby, Godshill, Fordingbridge, Hants.

MINIATURE theatres. Toys or scale models. Lighting, scenery, puppets, sound equipment. Details, 3d., trade enquiries invited.—Silsex House, Half Moon Lane, Worthing.

(Continued foot of page 143)

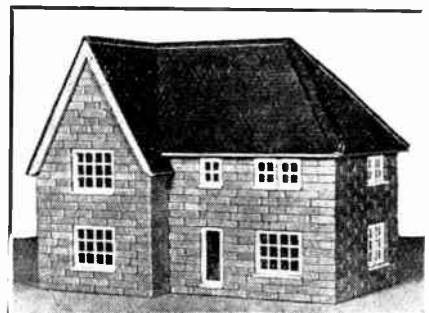

YOU can build this Model

WITH

BRICKPLAYER

BRICK & MORTAR BUILDING KIT

It enables you to build Garages, Fire Stations, Railway Stations, Signal Boxes, or from your own imagination. All railway models will fit 'O' gauge scale. Buildings can be permanent, or dismantled by merely soaking in water and the bricks used again and again.

BRICKPLAYER KITS AT 23/10, AND 44/- ARE AVAILABLE FROM GOOD TOYSHOPS, HOBBY SHOPS, AND DEPARTMENTAL STORES.

ACCESSORY PACKS

No.	Contents	Price
100	100 Full size Bricks ...	2/6
101	52 2-Bricks and 72 1-Bricks ...	2/6
102	Gable and Peak Bricks ...	2/6
111	Capping and Roof Tiling ...	2/-
112	Concrete Roofing ...	2/-
114	Bag of Brickplayer Cement ...	1/2
115	Roofing Cement ...	6d.
8107	2 Bay Windows with 31 Splay Bricks	3/-

METAL WINDOW AND DOOR FRAMES

F1	F2	F3	F4	F6	F8	F10
7d.	5d.	6d.	4d.	3d.	5d.	6d.
8108 Sheets of Glazing, 1½" x 6" (Plastic) 1d.						

If your dealer cannot supply, write for address of nearest stockist to:

J. W. SPEAR & SONS LTD.
(Dept. H) ENFIELD MIDDLESEX

BE A MASTER OF Scientific BOXING

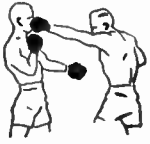

You can become a successful Boxer—more than a match for a really tough opponent—with the Wharton Rapid Course in Scientific Boxing—or money back. Teaches you the smashing knock-out blows, vital guards, training for results, footwork, ringcraft—the closely guarded secrets of the 'top-notchers.'

Develops your body, gives you self-confidence, shows you how to win. You can master Dynamic Boxing Science in a few weeks. Complete Course 10/- (\$1.50). Details 1d. Sent under plain cover. Wharton Course, 28 (HB) Dean Rd., London, N.W.2.

Established 1928

Swann-Morton
CRAFT TOOL

The perfect, razor-sharp utility tool for modellers in Balsa Wood, also for Biologists, Students, Commercial Artists, Photographers, etc. 2 interchangeable blade shapes. Handle and two blades 2/- post free. Spare blades six for 2/6 post free. Send P.O. to

FAMILY PRODUCTS
92-94 BRADFIELD RD.
SHEFFIELD 6.
Trade enquiries invited

EVERY DAY

Use Sellotape for fixing labels 'for keeps' on tins of screws and nails, etc. — then you can spot the tin you want at a glance.

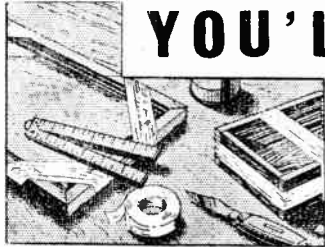

YOU'LL NEED

Use Sellotape to hold small parts in position while gluing. It's much quicker than string and just as strong.

SELLOTAPE

Whatever your hobby—Sellotape can help. It's self-adhesive, sticks at a touch, leaves no mark on wood or metal. Get some today—

BUT INSIST UPON SELLOTAPE

Stocked by all good Stationers



Miscellaneous—(Continued from opposite page)

INTRODUCTIONS. Pen friends, companionship or marriage.—V.C.C., 34 Honeywell Road, London, S.W.11.

LARGE pictorial stamp packet, 3d., or album, stamps, hinges, 6d., providing my superb approvals requested.—Day, 73 Thornton Gate, Cleveleys.

5/- HOURLY spare-time income. Full instructions, 3/-. Six different advertising magazines packed with bargains, 1/-.—R. Lowes, Simonburns, Northumberland.

SMASHING gun plan. Powerful firing, easily constructed. 1/- P.P.—Richmond, 21 Fawcus Road, Dormans-town, Redcar.

FREE—stamps catalogued 5/- to applicants for 3d. approvals.—Cox, 17 Stoneleigh Park Road, Ewell.

REQUEST approvals, send 3d. for special album.—Goddard, 41 Kimberley Road, Bournemouth.

RADIO. Full range of components at attractive prices. Send for list.—M. Watts & Co., 8 Baker Street, Weybridge, Surrey.

INTRODUCING a complete practical course of study, covering all aspects of Perspex and Waxcraft modelling. Containing all necessary tools, materials, etc., with non-technical, fully illustrated plans and instructions. Other kits and accessories. Catalogue, 6d.—Plastics Home Products, 18 St. Mary's Road, London, N.9.

35 m.m. cinematograph films. Cowboy, comedy, drama, etc. 50ft., 2/6; 100ft., 4/6; 200ft., 7/6. Sample set, film strips of above subjects, 1/3.—Jones, 51 Cranford Drive, Hayes, Middx.

YOU CAN BECOME A HANDICRAFTS INSTRUCTOR

Experience not essential

Men who enjoy making things in wood or metal can turn their hobby into a well-paid, permanent and interesting Career. Short hours, long holidays, and security in a job you would really enjoy, can be yours if you become a Handicrafts Instructor. Let us send details of the easiest and quickest way to get the necessary qualification.

We definitely guarantee "NO PASS—NO FEE"

If you would like to know about our unique method of preparing you for one of these excellent appointments, write today, and we will send you our informative 175-page Handbook—free and without obligation. Mark your letters "Handicrafts Instructor"

BRITISH INSTITUTE OF ENGINEERING TECHNOLOGY

595 Shakespeare House
Stratford Place, London, W.1

BIET

Indispensable to all interested in motor cars.

The two popular Car Books

"WHERE'S THAT CAR FROM!"
"POPULAR CARS ILLUSTRATED"

6d. each

From all Stationers and Booksellers

or from **RALEIGH PRESS, EXMOUTH**

DOLL'S HOUSE KITS

for the Craftsman

Now is the time to begin making a Doll's house for Xmas. Three styles to choose from. Complete kits of parts, with paper, boards and interior fittings. Or design separate if desired. With complete illustrated details for straightforward construction. Any home handyman can undertake them. Free illustrated leaflets from any Hobbies Branch or Hobbies Ltd., Dereham, Norfolk.



THE EFFICIENT
"FRACTIONAL"

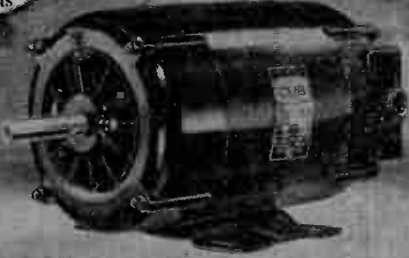

For every purpose in the small home workshop... use a BROOK 'CUB' 1/4 h.p. motor. Single or split phase.

Electric Motors from 0.25 to 200 h.p.



EM PRESS WORKS HUDDERSFIELD I.H.M.147

One plastic material
MAKES MANY PERMANENT

MODELS and utility objects, from simple instructions in illustrated Booklet—please read below.



ONLY 4D

IN STAMPS
BRINGS BOOK

... showing how such models as those above, and many others, can be made, without skill or special tools, from Sankey's PYRUMA Plastic Cement. Ready for immediate use in its plastic state, Pyruma sets or bakes to stone-hardness, and can be painted or enameled in all colours according to instructions.

Pyruma is inexpensive, and easily obtainable in tins from Ironmongers, Art Material Dealers and Hobbies Shops. Send 4d. in stamps for illustrated Instruction Book.



J. H. SANKEY & SON, LTD.

ILFORD

Est. 1857

ESSEX

MYFORD LATHES

turn LEISURE into PLEASURE

★ — ★ — ★

QUALITY MACHINES AT LOW COST

ML7 (Metal Working) Heavy Duty Bench Lathe.

— Also available on Cabinet Stand—3 1/2 ins. by 20 ins. (10 in. swing in gap), complete with motor drive unit and fully guarded at no extra cost. For £39 17s. 6d. you can buy the finest Lathe in its class. Over 50 accessories designed for the ML7 ensure complete versatility and adaptability.

ML8 (Woodworking) Lathe. 8 in. swing-over bed, 30 ins. between centres. Attachments include Saw Table, Disc Sander, Compound Slide.

A quality Lathe with a high reputation. Ideal for the home workshop. Turns—Saws—Planes—Sands—Grooves and Polishes. Price (including Drive Unit and Motor Pulley, Prong Centre, Cup Centre and Face-plate) £16 12s. 6d.

We invite you to write for further details.

MYFORD ENGINEERING COMPANY LIMITED
BEESTON, NOTTINGHAM - Phone: 54222 (3 lines)

BAR CRAMPS

A strong well-made tool for the carpenter and handyman. Takes work up to 1 ft. 6 ins. long. Easily adjusted varying lengths as a sash cramp or for wide boards. Strong steel bar with square edges for rigidity

10/6

Postage 11d.

At Hobbies Branches or from Hobbies Ltd., Dereham, Norfolk.

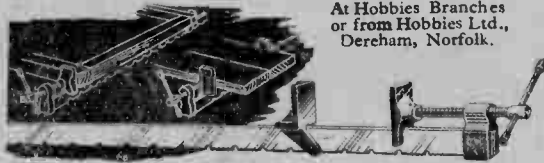

BRANCHES

LONDON

78a New Oxford St., W.C.1

(Phone MUSEum 2975)

87 Old Broad Street, E.C.2

(LONDON Wall 4375)

117 Watworth Road, S.E.17

GLASGOW

326 Argyle Street
(Phone CENTral 5042)

Head Office & Factories—HOBBIES LTD., DEREHAM, NORFOLK

MANCHESTER

10 Piccadilly

(Phone CENTral 1787)

BIRMINGHAM

14 Bull Ring

SHEFFIELD

4 St. Paul's Parade

LEEDS

10 Queen Victoria Street

(Phone 28639)

HULL

10 Paragon Square

SOUTHAMPTON

25 Bernard Street

BRISTOL

30 Narrow Wine Street

(Phone 23744)