

# Hobbies

## WEEKLY

### CONTENTS

	Page
A Small Milk Trolley	273
The Editor's Notebook	274
Marquetry Inlay Work	275
A Tray Table - - -	276
The Craftsman's Notes	277
A Pendant in Perspex -	277
Home Chemistry - -	278
Novelty Clock Addition	279
Home Handyman Jobs	280
A Modern Cabinet with Bookshelves -	281
Hints and Tips - -	282
Automatic Gaslighter -	283
Stamp Collecting - -	285

February 1st, 1950

Price Fourpence

Vol. 109 No. 2831

## A Novelty Toy

# MILK TROLLEY

between the lines for the screws or nails which will be driven up from the underside of the floor.

The two sides of the trolley will be marked out and cut according to the measurements given in Fig. 3. Glue and screw them to the floor and then make the two ends which will go in between the sides, as shown by the dotted lines in Fig. 2.

### The Handle

One end, that with the handle attached, will be  $6\frac{1}{2}$  ins. long by  $6\frac{1}{2}$  ins. wide, with the top edge rounded over and made smooth. The other end will be also  $6\frac{1}{2}$  ins. long but only  $4\frac{1}{2}$  ins. wide, the

HERE is an interesting little toy to make up, and one that will give endless fun to the kiddies. The trolley shown in our illustration Fig. 1 is made entirely of wood, all parts being  $\frac{3}{8}$  in. thick except the wheels which are ready-made and nicely turned ready for the job. This is just the piece of work for the fretworker who takes an interest in kiddies and makes them amusing and fascinating toys from time to time.

The size of the Milk Trolley is, length 16 ins., height to tip of handle 17  $\frac{1}{4}$  ins. and width 9  $\frac{1}{2}$  ins. Now the trolley must be made carefully, although it may be said 'it's only just a toy' and to some, anything will do, providing nails and glue hold it together.

Of course, there is much in the actual finish of the toy in respect to painting, and it should be well cleaned up after all the woodwork is done, and a couple of coats of paint given, or one coat of paint and one coat of enamel.

### Floor First

The floor of the trolley is first made, and one piece of  $\frac{3}{8}$  in. stuff 13 ins. by 8 ins. will be wanted for this, or two 4 in. battens may be glued up to get the width.

Looking at Fig. 2 we see a plan of the floor with measurements added where the four mortises are to be cut, two for the side wheel brackets and two for the front wheel brackets.

When cutting the mortises with the fretsaw keep rather inside the drawn line so when the tenons are made on the wheel supports they will fit tightly.

The dotted lines on the plan of the floor show where the sides and ends of the trolley will come. It will be advisable to mark these lines on the wood so that holes may be accurately bored midway

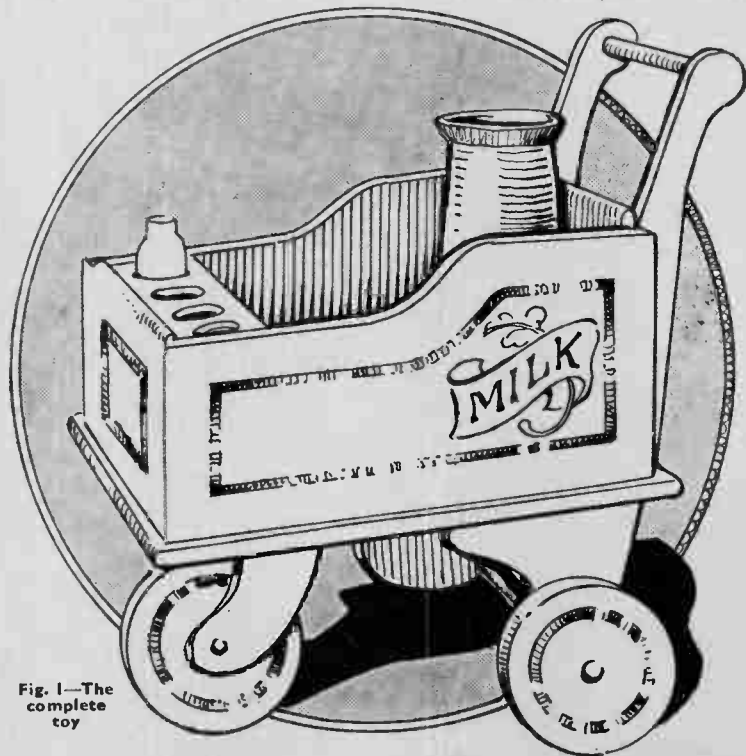

Fig. 1—The complete toy

top edge again being rounded off.

We now come to the wheel supports, and as these are shaped and cut wholly with the fretsaw, the outlines must be enlarged from the squared diagrams in Fig. 4. On a sheet of paper, light brown

edges and then see that the tenons of the supports fit the mortises correctly. Glue these securely in place and allow the glue to harden before fixing on the wheels.

Next prepare the two handle sections

To form the milk-bottle rack two pieces of  $\frac{3}{4}$ in. stuff will be cut, as shown in Fig. 5, but in one the holes will be omitted. Both pieces will be fixed between the sides of the trolley, as seen in Fig. 3. Miniature bottles may be made by shaping some pieces of  $\frac{1}{2}$ in. diameter rod and painting them up realistically.

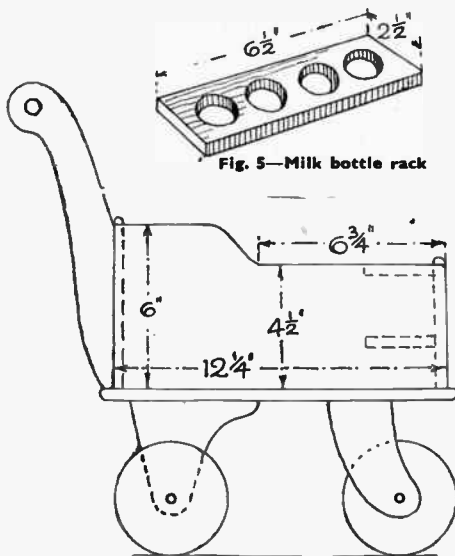

Fig. 3—Outline of side view with dimensions

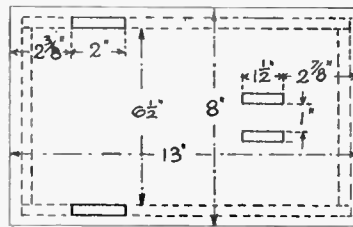

Fig. 2—Details of the floor portion

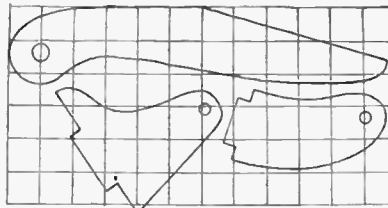

Fig. 4—Outline of the shaped parts

paper would answer admirably if no other is available, line in the seventy-two 1in. squares shown and prepare the outline of each section by following carefully each square.

Next trace off each outline and transfer it to the wood and cut round in the usual manner. Glasspaper up the

by first cutting a 5 1/2in. length of  $\frac{1}{2}$ in. diameter round rod and gluing the ends of it into the tops of the pieces. Then mark lines on that end of the trolley where the handle sections will come, and bore holes for the screws which form the fixing. Glue and screws should form a sufficiently firm fixing.

shown in Fig. 1, in bright colours.

A milk churn—or two, could be made by shaping up a block of wood about 2ins. square and about 4 1/2ins. long. Aluminium paint should here be used as a finish. A cross shelf may be added inside the trolley about half way up to take the churn or churns.

### Wheel Fixing

There are two methods which might be followed in fixing the back pair of wheels. A piece of  $\frac{3}{4}$ in. diameter rod may be cut to the length required and passed through the holes loosely in the supports and glued into the wheels. Or a rail consisting, perhaps, of a bar of wood about  $\frac{1}{2}$ in. by  $\frac{1}{2}$ in. in section is fixed in between the supports and the wheels, then put on with round-head screws, a washer being inserted between the heads.

The wheels should run freely on the screws, but at the same time, not loosely, so that they wobble. The front single wheel should revolve round a piece of  $\frac{3}{4}$ in. rod whose ends are glued into the supports. Mention has been made regarding cleaning and painting the trolley and if desired the sides may be panelled, as

## From the Editor's Notebook—

I AM continually hearing from readers who are delighted with the model made from our design of St. Paul's Cathedral. It was certainly very popular and many have made additions to it for extra realism. For instance, Mr. H. B. Manning, of Grimsby, has fitted a tiny loud speaker inside, and whenever his wife listens to a church service on the radio it produces a very pleasing effect. Others I know have fitted the inside with much furniture, altar, etc., and many have added interior lighting to show through the windows. What ingenious people, some of our readers are, to be sure.

DID you know there are no less than six places named Seaton? Probably not—and you may not think it matters much. It does to somebody I expect, because a reader wrote me recently for a reply and just put Seaton as his home town. I really cannot ask the Post Office to go to every place of that name to see if Mr. — lives there, can I? So I must wait until he writes again—probably to go 'off the deep end' at me for not answering. You'd be surprised! Just remember this will you, when you

write—your full name and address please—including the name of the county.

HAVE you ever thought of the planning, time, and constructional work behind those free designs you get every other week? Or the fact that over 2,000 different ones have been published in these pages since we started? I am reminded of this by reader E. G. Barley who wrote from Frenchay Hospital, Bristol, where he had been for 11 months. And one of his joys on returning home, he said, would be to browse through 40 copies of Hobbies Weekly which had accumulated in his absence! He also mentions a letter from a pen-friend in Austria who had been a reader before the war and said it was quite popular out there. 'Yours must be' remarks Mr. Bailey 'one of the few periodicals you can enjoy from boyhood to old-age'. How right he is!

AREMINDER to readers in the Bristol area that there is now a fully-stocked branch of Hobbies Ltd. in the centre of that city. Although opened only late last year it already

serves a very great number of customers, who get all their needs with service and civility. A great godsend for any keen craftsman. The Hobbies shop is at 30 Narrow Wine Street, and the 'phone number is 23744.

READERS living in Devon may like to know of a Hobbies Exhibition now being organized by the Youth Service Committee of Tiverton. It is being held from March 28th to April 1st and an opportunity for all is provided in the various classes and age groups into which the schedule is divided.

YOU never know what hobby can come from small beginnings, do you? In 1936 Mr. and Mrs. Rose of Bowling Green Avenue, Kettering, bought a bird as a pet for their small son. Keeping it proved fascinating and led to more and more interest, in keeping, breeding and showing. The success is shown in the fact that since that small start Mr. Rose has won nearly 300 awards, including many valuable cups. He also now owns over 100 birds!

The Editor

# The second and final article for craftsmen on SIMPLE MARQUETRY

**R**EADERS who have perused the first article on this artistic craft can now go a step further. It is not always feasible to use a complete sheet of veneers every time for each kind of wood used, the waste would be disheartening, as it often happens that one portion of the design calls for quite a small bit of one kind only.

For example, Fig. 1 shows a pediment, in marquetry, and it will be observed that the central ornaments intended to be cut in some light wood, such as sycamore or holly, occupy a small portion of the total area. Here we can adopt a different method and save a lot of wood, besides using up some scrap pieces from previous work. Proceed in this order.

## The Pattern

Make a drawing of the decoration, full size, of course, on thin paper, and at the same time make a carbon copy on brown paper beneath. Now refer to Fig. 1. The

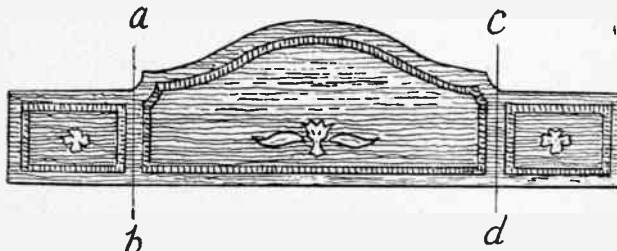

Fig. 1—A suggested panel with shaped pediment

background of the design should be of similar veneer to that used elsewhere on the article for which the pediment is intended. The bordering should be of a wood that will harmonise, or pleasantly contrast, with the rest, while the central decorations can be in holly, as stated.

Place a sheet of veneer for the background on a flat surface, and on this glue the carbon copy of the design. It may be mentioned here that if the length of the pediment is too much for the press (mentioned in the first article) the marquetry design can be cut across at a-b-c-d and each part glued down to a separate piece of the veneer. This makes it easier to manage, and can be adopted for similar outside designs if preferred. Save unnecessary waste in material by previously trimming the veneers to nearly the size of the design, or its parts.

## Border Veneer

The veneer chosen for the bordering can now be glued to the design to cover those parts generously, but avoiding waste. Place the pieces of veneer with the grain running from top to bottom, not lengthwise. The pieces of holly, or sycamore required to cover the central ornaments can now be glued in their proper places, and to fill the spaces

around, to make all level, glue thick brown paper, one or two layers, as may be required. The whole is now covered with several thicknesses of waste paper, and laid in the press for a few hours.

## Fine Fretsaws

Remove the pressed veneers, then paste the design accurately over the top. When this is dry, and a few hours in the press will help, the design can be cut out with the fretsaw. As stated before, only the finest blades should be used, and if knife-cut veneers, which are much thinner than the saw-cut varieties, care should be taken when cutting to keep the fingers pressed lightly, but firmly on the work as it is moved over the cutting table.

Cut the bordering first, and lay this and the outside shape, cut away with it, carefully aside. Then the ornaments can be sawn out. Split the veneers cautiously with a thin knife; avoid fracture or breakage, if you can, but do not worry if any occur, as the subsequent gluing will cover defects. Be careful, however, to keep all parts in their correct position to each other, to render the subsequent gluing and piecing together easier. Fig. 2 shows the parts of the pediment and how the scrap pieces of

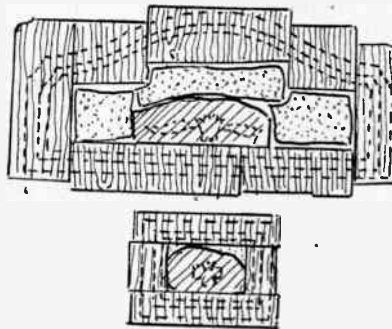

Fig. 2—Veneer pieces in position

veneers are laid to cover the design, and will be helpful.

Now remove as much of the unwanted paper and glue as can be done without damage, then, having selected the parts required, lay all, face upwards, on a flat surface protected by a sheet of waste paper.

Press them flat, then go over the surface with the glue brush and press a sheet of thin paper down. Give all a nip in the press, remove and see that all parts of the design lie quite flat, then let remain in the press for a while, not too long, when the decoration can be glued

to the pediment.

Turn the design over carefully, and remove with the scraper any blobs of glue or lumps of paper that might be adhering to the underside and prevent close contact with the wood. Scratch the surface of the latter (a piece of coarse glasspaper will do this), and glue both wood and design.

Press them closely in contact and see that all three parts are in true alignment to each other. If the design is trimmed close this will make aligning an easy job. Now press the whole until the glue is hard.

Unless the pediment is unduly long, the press already used may suffice, but if not it could be placed between spare boards first and then nipped in the press, as in Fig. 3. If too long for either method, then lay a board over and a weighted box on top, this will answer the purpose usually. The family tool box, if you possess one, makes a good heavy load to weight with as a rule. When the glue is hard, remove the pediment.

## Cleaning the Wood

The design is now covered with its protective paper and glue, and must be removed. This, it must be owned, is generally a rather tedious job, as the work must be carefully carried out to avoid damage to the veneers. Unless saw-cut veneers are used in which case most of the unwanted paper, etc., can be cleaned off quickly with a smoothing plane, set very fine.

Otherwise, a good rubbing with medium glasspaper should be resorted to to shift the outside paper, then a cabinet scraper can be employed to remove the glue and reveal the inlay work on which

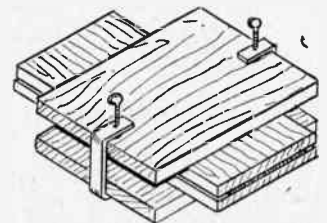

Fig. 3—Cramping the parts between boards

the time and trouble has been expended.

Any bad defective spots in the surface should be carefully filled with coloured stopping, and the outer edges of the pediment glasspapered to smoothness. Go over the finished design with fine glasspaper until the surface has a satin finish, then it is ready for polishing.

Those parts of the central ornaments, which can be improved with a little staining, can be touched up with a brush, using as little of the stain as possible, before polishing. It will be as well to give any stained parts a light coating of shellac varnish to set the stain before polishing generally is commenced.

# The woodworker can easily make this convertible TRAY TABLE

**T**HIS useful article comprises a tea or supper tray of generous size, with the addition of legs, which convert it, when desired, to a low table. An ingenious double purpose piece of furniture now on the market. Its advantages are obvious for afternoon tea on the lawn or in front of the fire, as the weather dictates.

The general appearance of the tray is shown in the view of the finished article. The legs, which fold under, and are hidden from view ordinarily, when opened out present the appearance seen in Fig. 1.

For making the article,  $\frac{1}{2}$  in. thick wood can be used for the tray sides, with plywood for the tray bottom, and leg rails. The legs can be from 1 in. by  $\frac{3}{4}$  in. wood, or cut from a  $\frac{3}{4}$  in. thick piece of board. Choice of wood is limited, of course, a hardwood such as oak, beech, etc., if obtainable, or deal if nothing better can be got.

## Parts Required

Parts of the article are shown with dimensions, in Fig. 2, and will be easily distinguishable. The long sides are cut to the length shown, the ends being sloped, the slopes starting at  $\frac{1}{2}$  in. in from each bottom corner, outwards. The dotted lines show where the bottom of the tray is to be fitted in. This should be of any thin wood available, not less than  $\frac{1}{2}$  in., however. Plywood would be quite good here. A groove,  $\frac{1}{8}$  in. deep, is chiselled out each side for its reception.

The ends of the sides are rebated  $\frac{1}{4}$  in. deep for the tray ends to join to, as in detail (A). These tray ends are cut to the shape shown in the diagram, the shape being squared in 1 in. squares as a guide.

A good plan is to reproduce these squares full size, of course, on to a piece of stout paper, pencil in one half of the shape, then to double the paper outwards and cut through both thicknesses at once to the curve. Both sides must, perforce, then be alike. Lay the pattern on the wood and run a pencil round the curves to mark them plainly for cutting.

A keyhole saw will do this job quite

well, without labour, or a fretsaw, if a coarse blade is employed. For cutting the finger holes, bore a hole at each end of openings through the wood, and remove the wood between the holes either with the keyhole or fretsaw. The sharp edges of the openings should be nicely rounded off to ensure a comfortable grip for the fingers.

## Assembly Hints

Now fit the parts together with glue and nails or small screws, making sure that the tray bottom is cut to the correct size to fit in place without straining the corner joints. A safe plan here is to fix one end of the tray with small screws first, then to test the fit of the bottom with the free end held in position with the fingers. Any necessary adjustment in size can then be carried out, and the joints permanently glued.

If the screws are also to be permanent, use those round-headed ones that look so much neater. To support the bottom of the tray each end, where no groove exists, a small slip can be glued in the angles underneath. A triangular strip, not larger than  $\frac{3}{4}$  in. sides, should be used, to leave room for the legs to swing up for folding.

## The Legs

The legs are cut to length and the ends trimmed to semi-circles, with  $\frac{1}{2}$  in. radius. Holes for the fixing screws are bored in the centres of the semi-circles. These legs are fixed to the sides, inside of course, at the place indicated at (C) in Fig. 3, so they, when pulled down, splay out slightly. Note particularly that the cut-away parts of each leg face the same way, and are not paired. This will be apparent in Fig. 1. Fit the left side legs first, then the correct way to fit the right ones will be seen at once. Any error here will simply result in the legs not folding together properly.

It is a good idea to fit one side with stout brass screws and a washer, as at

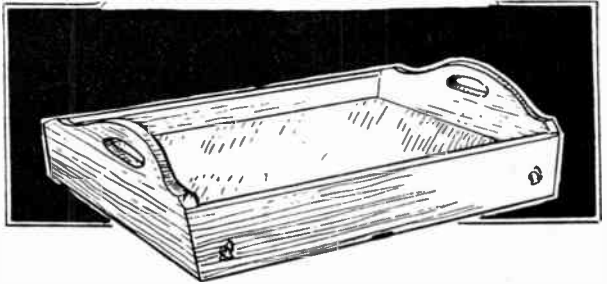

(D) and the other side with brass bolts and a fly nut; it helps to fix the legs and ensure better stability. The legs can now be removed for fitting across rail between each pair.

This rail is shown in the inset sketch (B) in Fig. 1. Cut the rails from  $\frac{1}{2}$  in. or  $\frac{3}{4}$  in. wood, to the correct length, measured between the sides of tray, underneath. The ends are cut to form tenons, 1 in. long and  $\frac{3}{4}$  in. apart, and the legs mortised to suit. Glue the rails in and refit the legs to the tray. This completes the job, except finishing.

## Finishing Work

The whole work should be smoothed with a vigorous glasspapering and any nails punched down and stopped level. With a nice clean grained wood a stain of oak or mahogany would be as suitable as any, with a couple of coats of clear varnish to add a gloss. The stain and varnish combined could be used, naturally, but does not seem to produce such an even colour as when used separately.

However, that is not a point that need be stressed, as good results often depend more on careful application than the particular brand employed, most of which are fairly reliable. The staining, etc., should be done with the legs removed, and could well be attached after the rails are fixed across.

To keep the legs up after folding, a half button can be employed, as at detail (E) (Fig. 1). These are screwed to the under edges of the tray sides, underneath, of course, and in the centre. A slot should be cut for each, just deep enough to sink the half-button level, and allow the tray to stand firm.

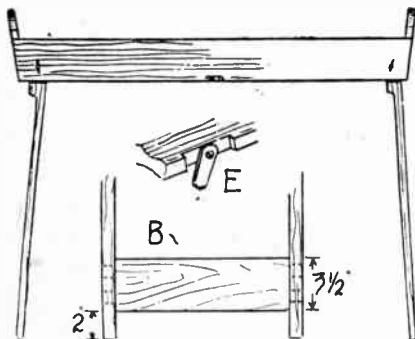

Fig. 1—Side view and details of fixing

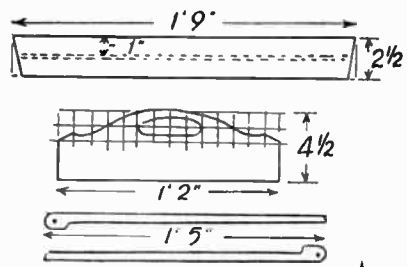

Fig. 2—Side and size of parts required

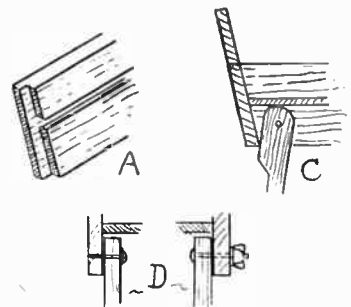

Fig. 3—Leg fixing details

# A Craftsman's Notebook

making extensions and developments as the fancy takes him.

## Increasing Cupboard Accommodation

IT seems to me that in many cupboards some useful storage space is wasted, yet the home woodworker could soon alter matters with a few odd pieces of wood.

The idea is to fix up small shelves or fairly shallow racks on the inside of the door itself. They are arranged in such a position that when the door is closed the racks come just under the upper shelf but are high enough to be well clear of articles on the shelf below. Measurements need not be given here, as these will vary with different cupboards and woodworkers interested in the idea will soon be able to arrange such fittings to their own liking.

Besides making the most of available space these extra shelves prove very handy. In workbench cupboards the space behind the door can be utilised for screwdrivers and other small tools to keep them easily accessible and in ship-shape order. In kitchen cupboards they provide a convenient place for small articles such as salt and pepper pots, leaving the main shelf space available for larger articles.

## A Nature Note

WHERE do so many creatures of the countryside get to in winter time, those animals and reptiles so frequently seen in summer yet entirely absent at this time of year? Their snug retreats are so carefully chosen that only by making a definite search could one hope to find them.

So far as frogs are concerned, at any rate, I found an answer to the question quite by chance. I came across some members of this family one morning early in the year while I was clearing away a pile of old bricks, mortar, and similar rubble that had stood undisturbed for some time in an out-of-the-way corner.

Soon after I started on the heap out came a large frog, and by the time I reached the bottom three or four more had made a sudden exit from nooks and corners among the stones. This, then, was one of the various places chosen by these creatures when they abandon the adjoining field.

How they fared after this untimely interruption to their winter slumbers I do not know. They jumped vigorously away towards a nearby hedge and were soon lost to view in the grass beyond.

## The Model Way

THERE is nothing like an exhibition of work done to make one realise how much skill there is among model makers. Ability to use tools, a fine sense of proportion, attention to details, accuracy

and patience are some of the qualities to which those who enjoy this popular hobby can give full reign.

Besides providing an outlet for energy and skill, making models can help one to realise to a certain extent big ambitions that might not otherwise be practicable.

One home craftsman has always fancied planning and building a modern factory, but the real thing is beyond his means. With wood, composition board, cardboard, and other stock-in-trade of the model-maker, however, he aims to satisfy his ideas with a miniature, setting the buildings out on his own lines and

## A Workroom Aid

WHEN busy in the workroom occasions occur when we want to make quick calculations or temporarily jot down measurements, or we may even wish to make rough sketches and work out figures to explain a job to others who are interested.

Better than having to resort to paper and pencil every time is to have a slate or small blackboard permanently fixed on the wall convenient to the bench. Time will be saved and the big legible figures can be seen at a glance.

If the blackboard is preferred we can make this ourselves at next to no cost. After smoothing up a suitable board, a black surface can be obtained with one or two coats of Drop Black from the paint stores.

## The Craftsman

# A Perspex Heart Pendant

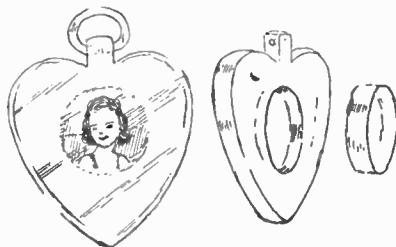

The heart is immersed a few moments in hot (not boiling water) and taken out when hot. The inside of the hole is quickly dried, the cut-out snaps are then inserted along with the plug, which is easily inserted, as the hole is now expanded.

When the whole thing is cold it will be found the plug has become sweated in very tight. The protruding part of the plug can now be filed down flat with the surface, all corners of the heart rounded, and the whole given a high polish.

## Hanging Loop

A small loop can be made for the top by cutting a thin strip of Perspex carefully rounded and polished, and bending into the small hole at the top while it is hot. A small chain can also be made in the same way, or the heart can be attached to a string of beads.

The above article was made some time ago by the writer and looks very nice, as one can hardly tell how the snaps have got inside of the heart.

THE sketch herewith shows a useful little article that can be made out of a small piece of Perspex about 2ins. square. The novelties make an acceptable little present, especially for courting or engaged couples.

First, the shape is cut out of the Perspex which should be 'clear' and about  $\frac{1}{4}$ in. thick. A hole is then drilled in the centre of the shape, about  $\frac{3}{16}$ in., preferably with a steel twist drill that has rather a flat grind on the cutting edge. At the same time a small hole is drilled in the top of the heart to take the hanging loop.

## Hole and Plug

The  $\frac{3}{16}$ in. hole should be taken into the Perspex just over half the thickness and should be finished to give a flat inside surface with a small penknife or scraper. The hole is then cleaned with fine glasspaper and finished to a high polish with ordinary metal polish.

A plug is now cut out about  $\frac{1}{32}$ in. larger in diameter than the hole and also given a high polish. This is important so that when the plug is inserted it does not show a join.

Two photo heads can now be cut out of some old snapshots, the same diameter as the hole, and pasted back to back. The whole job is now ready to assemble.



# Some interesting forms of analysis for non-metals in HOME CHEMISTRY

ONLY very seldom are non-metals found uncombined in a substance. Nearly always they are found linked up with other non-metals forming 'acid radicles'. For instance, nitrogen is found as a nitrate or nitrite; carbon as a carbonate; phosphorus as phosphate, etc.

The only non-metals which you will find on their own so to speak, are fluorine, chlorine, bromine, iodine and sulphur. When they are found in a substance, the first four change the 'n' in their names for a 'd' and become fluorides, bromides, etc. Sulphur becomes sulphide.

Well then, now to analyse for these acid radicles. Boil the substance you wish to analyse with a solution of washing soda (sodium carbonate). Filter if necessary and reject any ppt. Divide the filtrate into four portions.

Acidify one portion with hydrochloric acid and add barium chloride. A white precipitate shows the presence of a sulphate.

## More Results

Acidify another portion with nitric acid and add silver nitrate. You may get one of the following ppts.:—(a) white, insoluble in ammonium hydroxide—means either a chloride, cyanide or thiocyanate is present; (b) white, insoluble in ammonium hydroxide—means ferrocyanide; (c) pale yellow—means bromide; (d) yellow, insoluble in ammonium hydroxide—means iodide; (e) orange—means ferricyanide; (f) black—means sulphide present.

Now take another portion of your original filtrate and acidify it with acetic acid. Add ferric chloride. Here again, you may get one of several ppts. Deep-blue means ferrocyanide present. Blood-red means sulphocyanide. White, soluble in dilute hydrochloric acid shows phosphate present.

## Those Present

To another portion of the original filtrate add ferrous sulphate solution. A deep-blue colour shows presence of ferri-cyanide. If no blue colour forms, add ammonium hydroxide. A yellow ppt. formed now shows oxalate present. If you get no ppt. either, then add strong sulphuric acid down the side of the test tube. A brown ring shows presence of a nitrate.

To distinguish between chloride, cyanide and thiocyanate precipitated by silver nitrate in the first of these tests, you carry out the following experiments. Remove the ppt. from the filter paper and place it in strong light. If chloride is present it will slowly turn violet.

If it does not turn violet add hydrochloric acid to a very small sample and smell. An odour of bitter almonds shows presence of cyanide. This odour is poisonous; do not smell more than necessary and dispose down the sink as soon as possible.

To test for thiocyanate, dissolve some of the ppt. in ammonium hydroxide and add ferric chloride. A blood-red colour shows the presence of this radicle.

The only other radicle which is commonly present is carbonate. You test for this by adding hydrochloric acid to your original substance and passing the evolved gases through lime-water. Use the apparatus shown in the drawing. If the lime-water turns milky then carbonate is present.

For all these acid radicle tests you just place an inch or two of your original filtrate in a test tube and add the necessary substances to produce ppts. or a colour change. Where the solubility of the ppt. is used as a guide to identification there is no need to filter before adding the dissolving liquid.

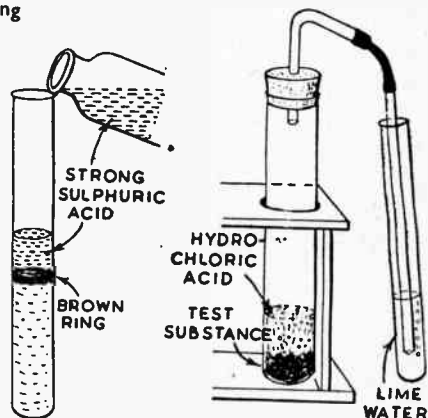

The experimental apparatus in use

For example, if you add silver nitrate and get a white ppt. you can immediately add ammonium hydroxide to the test tube. Then, if the ppt. dissolves it is either chloride, cyanide or thiocyanate; and if it does not dissolve it is ferrocyanide.

## General Remarks

Work on a small scale and keep your apparatus clean. Mop up anything you spill as soon as you spill it. Make sure your chemicals are in air-tight bottles (not tins) and are properly labelled. Wash up used test tubes as soon as you have finished an analysis or you may not get them clean again! Never rush an analysis; give a ppt. time to form and a colour time to develop. If you are not sure of a result, do it again and again until you convince yourself it is either negative or positive. Enter up in a note-book not only the results of an analysis but also the procedures which produced those results. In this way you will soon memorise the procedures. And please do not be disappointed if experiments do not go well at first, or if you get confused. Experience will ensure success.

Now finally, if you have any problems or queries about analysis or chemistry in general, write to us and we will do our best for you.

## A Model of The Taj Mahal

Many readers who did service in India during the War may recognize the great Monument in miniature. It is a magnificent mausoleum rising from a marble platform, built entirely of white marble, erected in 1629/49 by an emperor as a memorial to his favourite queen. That was the real Taj—the model here was made with the penknife you see held by the maker, Mr. Arthur Wells, a retired nurseryman of Heston, Middlesex. Evidently a very clever craftsman!

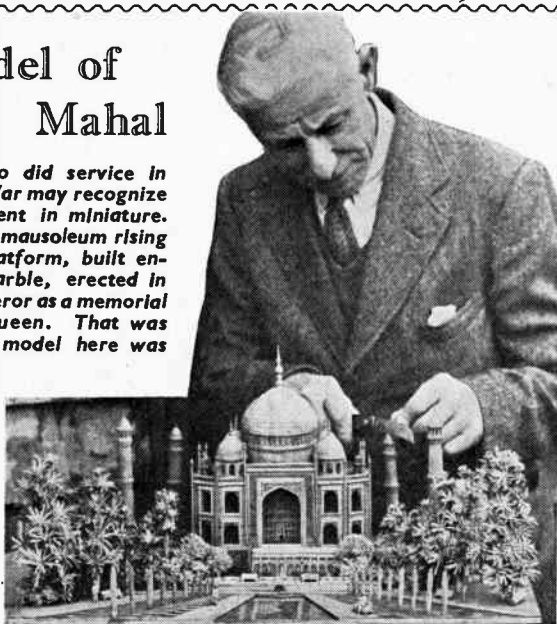

# A practical clockmaker gives instructions for forming A NOVELTY CLOCK

**T**HERE is always a certain amount of fascination about a mechanical toy, and when it can do a really useful piece of work the interest is greatly increased. The novelty clock described on this page, besides being an amusing working model, is quite an attractive and accurate timekeeper. Before the war these clocks were very popular and could be often seen in the clock shops, where they were always an attraction to both young and old alike.

Many of you may have wondered how they worked and would have liked to make one. Like lots of mechanical novelties the job of making this clock is really quite easy when you know how. The first and most important part needed is a drum clock—it can be just a timepiece or an alarm clock. The alarm part is not wanted and can be left as it is.

A clock usually found in a 3½ in. or 4 in. diameter case is the best for the purpose, and it should be in reasonably good going order, as it will have a

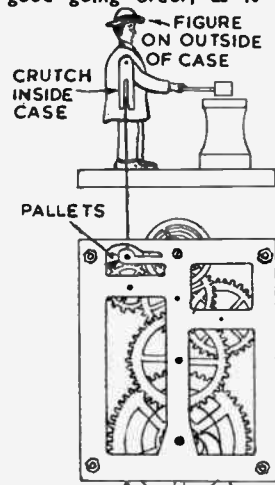

Fig. 2—Details of figure mechanism

certain amount of extra work to do besides just telling the time. For this reason the working parts must be as light as possible without being too fragile. It will be seen by referring to Fig. 2 that the moving arm of the figure is worked by a thin wire fixed on to the pallet staff of the clock. The to-and-fro motion of the pallets is transmitted via the wire to the slotted plate fixed to the man's arm. This action causes the hammer to rise and fall with every beat of the clock.

Cut a piece of wood for the front of the clock case 5 ins. wide, 7½ ins. long in the centre and sloping off to 6 ins. at the sides. Any kind of wood is suitable but a piece of ⅜ in. oak-faced ply or other hardwood would do nicely.

## Fixing to the Front

The next job is to fix the clock to this front part of the case. It would probably be best to leave the original metal or enamelled drum case on the clock. Then you can cut a circular hole just large enough to push the case through,

letting it project about ¼ in. It can be fastened to the wood front with metal brackets soldered to the drum case. Or an easier method would be to cut the drum from the back into three or four strips, bend over and screw on to the wood.

Some drum clocks have the balance wheel at the top and some are at the bottom. If the clock you have is of the latter type, you must either change the dial round half a turn and bring the balance to the top, as in Fig. 1, or you can put the clock at the top of the case with the figure beneath. Either way is satisfactory and just as attractive.

## The Working Parts

When the mainspring of the clock is completely unwound, undo the nut holding the plate together nearest the pallet staff, lever up the plate slightly and carefully remove the pallets. Now you can fix on a piece of thin brass wire about 2½ ins. long, make a loop on one end and solder to the staff, as shown in Fig. 3. The other end is bent at right angles so as to slide in the slotted crutch. Replace the pallets in the clock and screw up the nut, making sure that the balance pivots are in the cup screws and the balance impulse pin is in the centre of the pallet fork. Wind the spring up a few turns and the balance should then swing freely, with the wire moving backwards and forwards with each beat.

## The Figure

The figure can now be cut from a piece of ¼ in. hardwood. A piece 2 ins. square will make the figure, base and anvil, which are all cut in one.

The arm of the man and hammer are cut in one piece from thin sheet brass for lightness. A piece of needle about ½ in. long is used for the arm pivot wire, the arm being soldered on one end and the slotted crutch on the other.

The crutch is cut from thin sheet brass and is ½ in. long and ⅜ in. wide, the slot is just wide enough for the wire to slide in it easily. It is very important that this should be a good fit and not too large nor too small. The sides of the slot should be quite parallel and smooth—they can be burnished smooth with a needle.

## Reducing Friction

Now very carefully measure up to find the position for the figure. Glue it on to the front and when dry drill the hole for the arm pivot wire. This hole can be larger than the wire because two small plates of metal are pinned on to each side to act as bearings, as shown in Fig. 3. There is, therefore, much less friction and it reduces the work the clock is called upon to do. Before fixing the slotted crutch on to the pivot wire a small washer is pushed on and

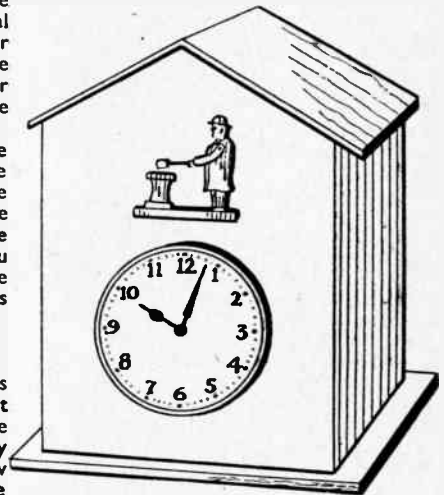

Fig. 1—The figure fitted to the clock front

soldered at the back to reduce the end play. Then the crutch is put on and soldered.

## Testing

The clock is now ready to be tried out, and if you have followed the instructions carefully the man should start his monotonous task of beating the anvil. A spot of thin oil on the two pivot bearings and another on the wire in the crutch will make his task much easier.

You may find it an advantage to add a small counterpoise arm on the back of the pivot wire to balance the weight of the arm and hammer, but that you must find out by experiment.

## The Case

When the clock is going nicely we are ready to proceed with the making of the case, as so far we only have the front board. For the two sides cut pieces 6 ins. long, 3 ins. wide and about ¼ in. thick. Each side of the sloping roof is 3½ ins. long and 4 ins. wide and this can be of thinner wood. The base is 6 ins. long, 4 ins. wide and ¼ in. thick. All these

(Continued foot of page 280)

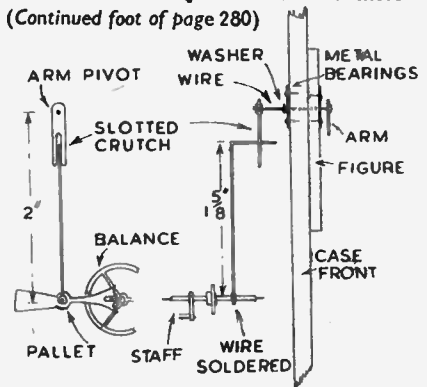

Fig. 3—Details of the wire to the figure

# The handyman can employ his time well with these PRACTICAL HOME JOBS

ONE advantage of being a handyman is that you can often make and fit in that odd little piece of furniture which no regular firm would ever think of making. Also, one's valuable knowledge as a hobby enthusiast is useful because it enables you to make neat finishes and take time over the job.

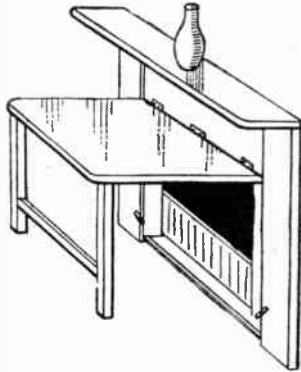

Fig. 1—A fireplace folding table

The plentiful supply of hardboard, now off permit does help quite a bit because hitherto one has not been able to get material for a large surface.

In Fig. 1 is shown a simple table device which would be a blessing in any small kitchen. Note that it is just a question of using up the disused fireplace space. The aperture should be carefully measured first so the flap (otherwise table) fits neatly in when not in use.

## Using Hardboard

It is not much use suggesting  $\frac{1}{2}$  in. plywood because this still seems to be unprocureable. The best medium is hardboard, which can be purchased in large sheets, some up to 4ft. by 6ft. One side is fine and smooth, the other is of a mottled texture. Have the smooth side to the top as it will then polish well.

On the outside corners round off and support all round the edge with a square wood about  $1\frac{1}{2}$  ins. by  $1\frac{1}{2}$  ins. See this is well sanded down to avoid damage to clothes. Glue and nail the edge on. Over the fireplace it will be held with three hinges.

The legs can be made from  $1\frac{1}{2}$  in. square wood with a cross-bar as shown. This fitment will hinge underneath so that legs will fold underneath flap when

table is let down or, in other words, closes up the front of the fireplace.

As it will fit right inside of the aperture you will need a small beading along the floor so that it closes flush. A small turn-button on each side of the fireplace, near the floor will hold the flap down.

## Bedside Table Cabinet

Small bedrooms often create a problem when it is necessary to have a bedside table. The best plan is to make a small one which will fit in anywhere. Measure the height of the bed and the space available before getting out a plan of the table first, because it involves a fair amount of framework to be made. The top, middle section and floor are all the same shape and size. Plywood can be used for this, or hardboard, whichever you can get. The Cabinet is shown in Fig. 2.

The top section is for books and the base part has a handy little cupboard. Cut the two sides out and fix the three-quarter shaped sections to make the whole framework firm. Added  $\frac{1}{2}$  in. strips under the shelf, base and top will be helpful. Cut the lower cupboard panel from thin plywood, taking the space for the door right out. Note that this can then be fitted in on the frame (Fig. 3), which provides the skeleton on which the door can be fitted.

The door is then made, as shown in sketch Figs. 4 and 5, and hinged in position. Small beading must be added to keep door in position when shut. To keep off the ground, three short cotton reels can be added on base. When not in use at the side of the bed this table will stand in any corner and by its shape will not be in the way.

Fitments in the kitchen are always welcomed but you should get busy with

pencil and paper and make out some sort of plan before you start. It sounds a little fantastic but a small drawing to scale will help you to visualise the space you have available.

Here are a few helpful measurements so that you can find the space you have and then see what you can fit into the room available. Pastry board 1ft. 6ins.;

rolling pin 16ins.; tea kettle about 9ins. high; bowls, as a rule 12 ins. wide and 4ins. high. Jam jars are about  $5\frac{1}{2}$  ins. high and a frying pan normally needs about 20 ins. with handle.

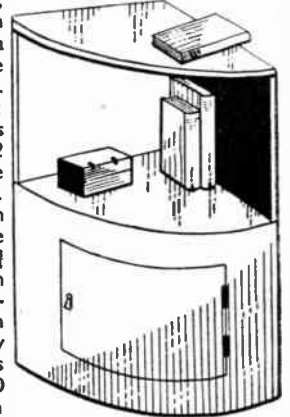

Fig. 2—The curved front cabinet  
Brooms are 4ft. 6ins., and mops around the same height. A carpet sweeper is 12ins. wide and 4ft. 6ins. high.

Buckets are always in the way. A space for them can be 12ins. wide and 14ins. high. Types vary, but this is a good average. Hand-brooms are 12ins. to 15ins. long. Bottles can go up high, if not too bulky and need a good 14ins. and width of 4ins. A general measure up in the kitchen and you will find that you can probably, with careful planning, get all these items, and many more packed away safely, conveniently and tidily.

The writer knows a craftsman who first did his own kitchen with well planned fitments. He now makes a living at it and has a thriving business!

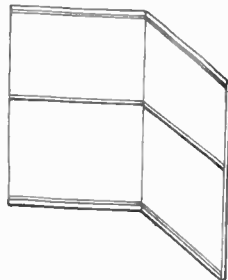

Fig. 3—The framework

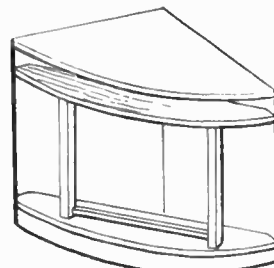

Fig. 4—The door holding parts

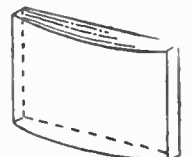

Fig. 5—The shaped door

## Novelty Clock—(Continued from page 279)

pieces should now be glued to the front board, angle pieces can be used to strengthen them if thought necessary.

A door is fitted on the back of the case to allow access to the works for winding the clock and any adjustments that may be necessary. This is quite a simple job and no instructions are

necessary to the home handyman.

The case is now ready for staining or painting in whatever finish takes your fancy. The figure should be done in gay colours, either poster colours and varnished or in enamels. A little time and trouble spent in this finishing will make the clock the envy of all your

friends and, perhaps, they will give you orders to make some for them.

It is not necessary to stick to the man and anvil type of figure. You will doubtless be able to design one of your own fancy, such as a hen pecking food from a bowl. Keep a look out for suitable subjects to use for this purpose.



# How the handy carpenter can add to his home with A MODERN CABINET

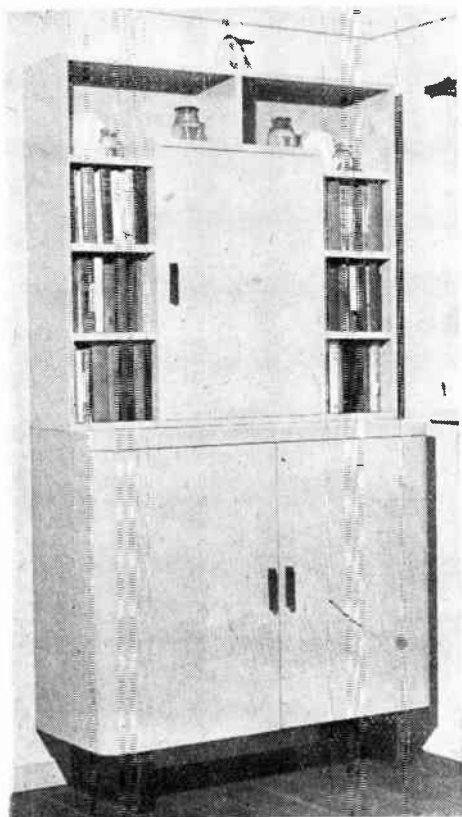

The cupboard and bookcase on the lower cabinet

**D**ESPITE the difficulty in obtaining suitable materials, the combined cabinet, bookcase, and cupboard shown in the photographs and drawings will appeal to most woodworkers because of the furniture's handsome modern appearance and the many practical uses to which it may be put. All the wood and board used in its construction have been obtained by persistent visits to stores, builders' yards, and even auction sales. Only few will say that the finished product is not worth while.

## As Two Units

For a house where living room is restricted, the furniture proves a boon, for it serves the triple purpose of bookcase, handy cupboard, and chest of drawers, but occupies only 6ft. by 3ft. 3ins. by 1ft. 2ins. It may be used, however, as two separate units, and experience shows that it fits in excellently with modern decoration schemes and will even function as a kitchen unit. Because it is finished in paint, its colour may be easily and swiftly changed to suit its surroundings.

Special features are the smoothly rounded edges to the cabinet doors; the

bevelled feet, painted black to contrast with the pearl grey of the whole; inexpensive, easily fitted magnetic door catches; and a 1½in. overhang to the cabinet's top both for constructional purposes and artistic effect.

Owing to the wood difficulty, it may be necessary to vary some of the following measurements according to the material obtained. In the furniture illustrated, the cabinet, or lower half, excluding feet, is 30ins. high, 39ins. wide, and 14ins. deep. Because of the weight of the filled bookcase, it is advisable to use good quality ¾in. tongued and grooved for sides, top, bottom, and middle shelf. Make up the sides and the top to 12½ins. deep, but note carefully that the bottom and centre shelf must be 13½ins., i.e., 1in. extra, to meet flush with the finished doors.

## Assembling

When assembling, use strong joints. A common dovetail is recommended for the top, bottom and sides, but the centre shelf requires only an ordinary housed joint. A single sheet of ½in. plywood is most suitable for the back, but you may well have to be content with an ¼in. board substitute, which is becoming increasingly easy to buy.

Next tackle the cabinet doors. These are flush, and let into 1½ins.

by 2ins. planed deal posts, which are finally rounded off, as in (E). The best door material would be ¾in. hardboard, but it may be necessary to make two ordinary small door frames and cover them with ply or board. Each frame should be of ½in. by 1½in. planed deal, made up to finish 28½ins. high by 17ins. wide, and jointed, as in (D). When you clothe the frame with ply or boards, you must have a ¾in. overlap at one side for fixing the door to the shorter side of the post. (See E).

Do not round the post until you have fixed the door. To achieve this, use a coating of glue, and panel pins driven through the ply overlap, as well as diagonally through the door frame into the post. A few long slender screws may also be used.

Careful measurements are important to ensure that the two finished doors, when fixed to the posts and hung, fit neatly, both across the width and in line with the bottom of the cabinet. Carefully round the posts with a plane before fixing the butt hinges, which should be 2in. brass; they are fixed finally to the side (not

the front) of the cabinet.

## Shelves and Doors

But before you can hang and close the doors you must saw out from each end of the bottom, and the middle shelf, a piece 2ins. long by 1in. deep approximately, to admit the posts when the doors are closed. The inside of the closed doors should then be flush with the bottom, and the centre shelf, which act as firm stops. But it may be necessary to plane ¼in. or so off these two to get the doors flush.

To the centre shelf, fix catches or locks, as you prefer. 2in. magnetic catches are a novelty, and easily fitted, comprising metal strips inside the doors, and the magnets themselves beneath the shelf.

When you have hung the doors, there should be a 1½in. gap at the top front of the cabinet, right across and approximately 2ins. deep. Close this gap with a length of wood sawn and planed to fit flush with the top and with the doors, and round the ends to match the rounded posts. Deliberately leave this job till last, because its size can be varied to overcome any small discrepancies in the height and thickness of the doors.

## The Feet

The feet are 14ins. deep by 6ins. high by 2ins. wide. They are fixed with 1½in. screws through the bottom of the cabinet, and the fronts are rounded. The door handles should be hardwood rather than metal. Those shown are simply-carved walnut strips, held with screws from inside the doors.

The bookcase and cupboard portion is 36ins. high by 39ins. wide by 8ins. deep. If possible, use ¾in. wood for sides, top, and bottom, but ½in. will do for the shelves. During construction, good halved joints will serve, as (C).



The lower cabinet as a separate unit

The centre cupboard is 28ins. high by 20ins. wide overall. That shown in the photograph is actually 1in. deeper than the bookshelves, to make the front project for appearance sake; otherwise the structure looks excessively flat. Projecting the cupboard is not difficult; the bottom of the bookcase is made up to

top assembly of the cupboard as (C) but the uprights are joined to the bottom with housed joints.

For all the shelves (see B) including that in the cupboard, and the 7in. upright above the centre of the cupboard, housed joints are also used. Note that, for concealment purposes, the trenches are stopped  $\frac{3}{4}$ in. from the front edges.

The cupboard door may be made up on a frame clothed

Painting will obliterate any small defects. Choose a colour to tone in with the surroundings. Thoroughly smooth all rough surfaces with plane and glasspaper, and stop any cracks with a suitable wood paste. Prime the woodwork without stint, and apply at least two coats of undercoat, though you may well need three.

Care at this stage to get a first class

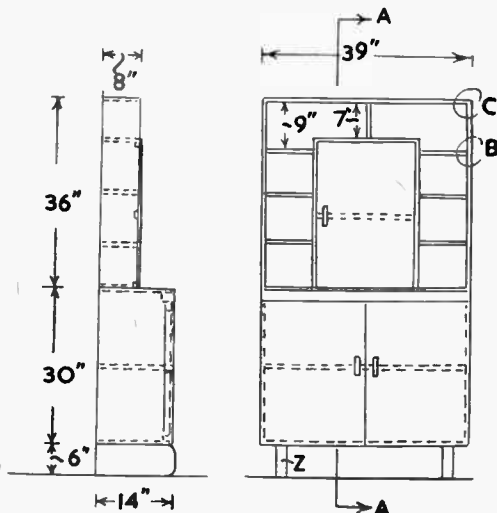

Section and elevation of cabinet

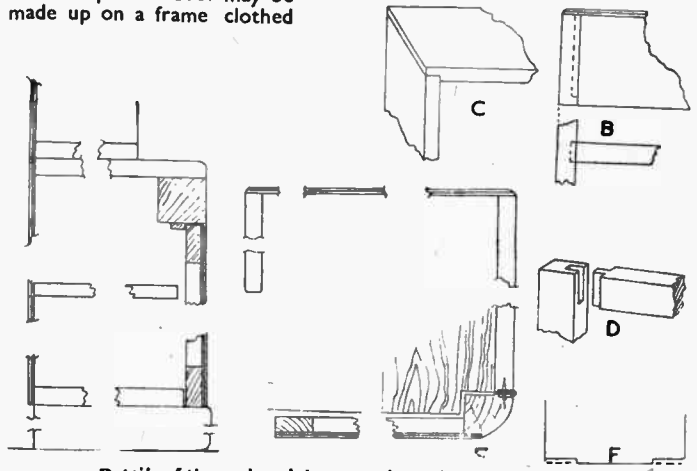

Details of the various joints mentioned in the construction

9ins. instead of 8ins. like the sides and top, and then a piece 1in. deep by 9 $\frac{1}{2}$ ins. long is sawn out from each end of the front edge, as at (F).

Both the uprights and top of the cupboard, of course, are also 9ins. deep. Halved joints are used for the uprights to

with board, as described for the cabinet doors, but in this case the butts are fixed in the customary position. If you wish, put additional shelves in the cupboard, bearing in mind what you will use it for, but these need only be on runners.

surface will make the application of the finishing coat both easier to apply, and better in the result. When the whole task is finished you will possess something of which, you will have a right to feel proud. That is, if you have done it well and followed construction carefully.

### Simple Light Switch

A SIMPLE but useful light switch can be made in the following way. Get a block of wood, a metal hinge and an ordinary staple. Screw the hinge down on to the wood and knock the staple down just in front so that when the

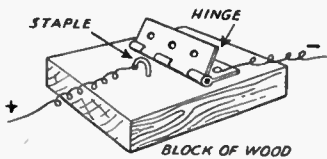

hinge is pressed down it touches the staple. Break the circuit wire into two, and fix one piece to the hinge and one to the staple. When the hinge is pressed upon the staple it completes the circuit and thus lights the lamp.

### Small Cupboard Knob

WHEN in need of a knob for a small cupboard or drawer, etc., try to get hold of an old hand brush. Saw off the ends and you will find they make quite handy little knobs.

### Balsa Cement

CUT a piece of white or transparent celluloid about 2ins. by 2ins. into small flakes, and place in a small jar or bottle. Next pour an eggcupful of

acetone on to it, cork tightly, then leave for 48 hours, but give it a shake now and again, after use, cork tightly.

### Metal Worker's Vice

WHEN model making in tin, it is often found that a piece of tin which has to be bent at rightangles, is too long to go into an ordinary bench vice, so this device will be found invaluable. Take two pieces of 2in. by 2in. hard wood about 12ins. long, and

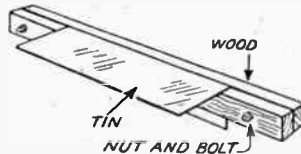

holding both together, drill holes at each end for nuts and bolts. To ensure a smooth surface on which to bend the metal, the two bolts should be tightened up and the top face smoothed with a plane. The sketch will make the idea clear.

### Guns For Model Naval Ships

WHILE making the guns of the small waterline models of battleships (the designs of which have appeared in *Hobbies Weekly*), instead of using wire for the barrels, an alternative is to use gramophone needles which are finished

with. They are hammered lightly into the edge of the turret and left projecting at a slight upward angle.

### 'Gem' Bearings

WHEN one is doing a lot of fretwork, dust collects round the bearings of the axle beneath the cutting table. A certain amount of this must go down the oil holes, and so gradually makes the running harsh. To prevent this, cut off the heads of two nails, leaving a stump of nail to them, and insert in the holes. They make fine caps, easily removed.

### For Aquarium

TO circulate water in your aquarium, all you have to do is to get an odd length of pipe and cut it to height of water level. When you have done this,

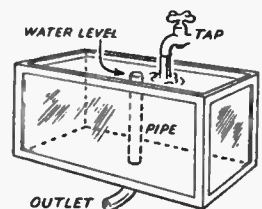

get some solder and Fluxite and solder the pipe into the aquarium as shown in the picture. The top is just below the edge, but forms a perfect overflow.

# The home mechanic needs only bits and pieces for this AUTOMATIC GAS-LIGHTER

**T**HE electric gas-lighter as shown in Fig. 1 is extremely convenient, useful and novel in that it requires no switch for its operation, the lighter being automatically switched on when inclined towards the gas-jet.

This is accomplished by an extremely simple and effective switch, as shown in Fig. 1 (A). The device consists essentially of a small copper or brass tube containing a loose steel ball. Both ends of the tube are sealed and one end incorporates a contact which is connected to the circuit. The assembly is secured to the battery casing by soft-soldering, which ensures a satisfactory mechanical and electrical connection.

When the lighter is used, it is naturally held past the horizontal plane pointing downwards. The steel ball rolls down the tube and comes to rest against the contact, thus completing the circuit and actuating the lighter. When, after use, the lighter is replaced in an upright position, the ball rolls back to its former position and so breaks the circuit.

## From a Handtorch

To construct the lighter, a fairly large hand-torch is required. The two-cell model is the most satisfactory type to use. A 6in. length of  $\frac{3}{8}$ in. external diameter brass or copper tube is required for the element extension (B) and one end is expanded with a hammer and opened sufficiently to take a M.E.S. bulb holder (C).

The expanded end of the tube is plugged below the expansion with a plug of cork or wood (D), a small hole being

drilled lengthwise down the same, and a length of insulated wire inserted and secured on the outside with a blob of solder, thus forming the contact. The other end is similarly blocked (E), bringing the connecting wire through and soldering as previously described. The plug in this case, however, should be flush with the end of the tube, with the contact appreciably protruding above.

## Tube Assembly

The tube assembly is then inserted in the torch bulb-holder, of course, previously removing the glass front, pushed down as far as possible, and well sweated into position with solder. Care should be taken to see the contact will make satisfactory connection with the centre electrode of the battery when it is in position.

The M.E.S. bulb-holder may be taken from an old torch or purchased for a few pence from an electrical stockist. This is inserted in the expanded end of the tube and well soldered into position, observing that the distance between the end of the holder and the contact, permits of easy connection when the heating element is screwed into position.

## The Tube

Before proceeding further, a few notes on the expansion of the tube may be helpful. The tubing should be fairly lightly held in a vice with lead-lined jaws. Too much pressure should be avoided, otherwise the tube may collapse internally and become useless. The drift should be tapering, and must be worked around the tube with a series of

light hammer taps, until the size is correct.

Copper is fairly easy to work, but extreme care should be used when working brass, to avoid any splitting or cracking of the metal. It is advisable, and, indeed, a necessity to anneal and soften the metal before and during work, to preclude any such possible damage occurring.

The automatic switch can be constructed from any convenient size brass or copper tubing, but for appearance sake it is suggested that the external diameter should not exceed  $\frac{3}{8}$ in., while the overall length could be between  $1\frac{1}{2}$ ins. and 2ins. The interior of the tubing should be perfectly bright and clean, and it is a good plan lightly to smear very light oil over the surfaces to prevent any subsequent formation of tarnish, etc.

The steel ball (F) must be a perfectly free fit in the tubing, and here again, the ball must be absolutely bright and clean, and also preserved in that condition with a smear of light oil. One end of the tube is closed by soldering a small metal disc into position (G). The steel ball is inserted, and the other end of the tube sealed by a cork or wood contact plug (H), made as previously described. A small hole is made in the torch casing adjacent to the reflector, the insulated wire inserted and soldered to a convenient part of the reflector (I).

It is not necessary to remove the torch switch, as it may be useful for operating the lighter in circumstances where the automatic switch will not work, i.e., when igniting a gas-jet with the lighter held in a vertical position.

## The Element

The heating element (J), which can be purchased practically anywhere for a few pence, is next screwed into the end of the extension tube, and the lighter is ready for instant and efficient service.

One precaution should, however, be observed, and that is to make sure that the lighter is always replaced in an upright position after use, to ensure the automatic switch breaking circuit. As a precaution, it is as well to devise a simple attachment to fit on the gas-stove or nearby, whereby the lighter can be returned in its correct position after use.

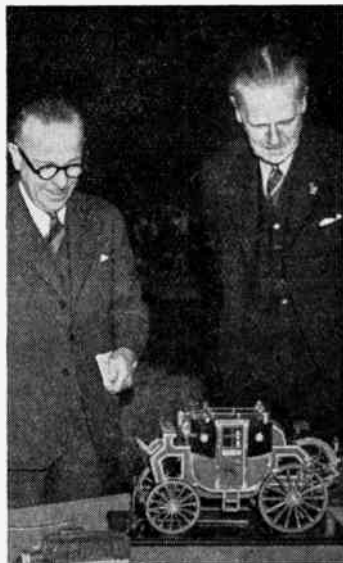
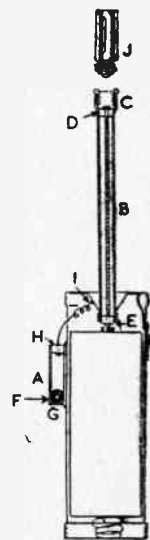

Photo—Huddersfield Examiner

## HOBBIES IN HUDDERSFIELD

**ALMOST** everything from a patchwork quilt to a model jet aeroplane was on show recently at a Hobbies Exhibition in Huddersfield, sponsored by the Rotary Club of that town. The range of work and models, of course, included many of our designs made by enthusiastic craftsmen, and the picture shows the interest in our model Stage Coach shown by the Mayor (Ald. D. J. Cartwright). With him is Dr. J. W. Hirst to whose efforts the success of the Exhibition was largely due. One novelty was an orange tree which bore ripe fruit, whilst another exhibit which drew much excited attention was the model jet plane which claimed a speed of 110 m.p.h. The exhibition continued for a week, and the interest shown was continuous and widespread. Hobbies are becoming more and more in demand as a palliative against the rush and mechanisation of these times. And the pages of Hobbies Weekly provide more help than any in this matter.

Miscellaneous—

(Continued from page 287)

**STAMPS!** Send stamp for approvals. Choose your own free gift. Packets, sets and single stamps.—H. W. Harman, 6 St. Patrick's Road, Coventry.

**WHEELS** for toys, and other accessories. Full lists will be sent on application to The Joyden Toy Co., 193 Chase Side, London, N.14.

**PLYWOOD** offcuts. Birch and Gaboon in various thicknesses. Handy sized parcels for the cabinet, toy, model maker, and all handicrafts. Parcels made up in £1 and 10/- lots. Carriage paid. Send P.O. to Reeves, Plywood and Timber Merchant, 33 Front Street, Monkseaton, Whitley Bay. Tel. W.B. 4677. Due to exceptional demand we cannot promise delivery under eight days.

**£5** to £20 weekly earned at home, running your own Mail Order business. Details, 1d.—Stebbing Publications Ltd., (HB) Naphill, High Wycombe.

**BLUSHING**, shyness, nerves, self-consciousness, fears, ended. Details under plain cover, 1d.—Stebbing Treatment, 28 (HB) Dean Road, London, N.W.2.

**AMAZING** new Craftwork discovery decorates leather, Perspex, plastics, lampshades, wood, etc., in beautiful gold, silver and colours. The 'Monogold' Embossing Outfit is easy to use and gives astonishing results. Complete Outfit costs only 7/6, yet will earn pounds.—Dawson & Co., M1, 130 Park Street, Oldham.

**FLEXIBLE** moulding compound for plaster casting.—Dohm Ltd., 167 Victoria Street, S.W.1.

**BE** Taller. Quickly! Safely! Privately! No appliances—no tablets—no dieting. Details, 6d. stamp.—Malcolm Ross, Height Specialist, BCM/HYTE, London, W.C.1.

**MODELS.** You can make lasting stone-hard models with Sankey's Pyrama Plastic Cement. Supplied in tins by Ironmongers, Hardwaremen and Builders' Merchants. Ask for instruction leaflet.

**TRANSFERS** for decorating toys, trays, furniture, fancy goods. List and samples free. Flowers, pixies, dogs, nursery rhymes.—H. Axon Harrison, Jersey.

**LEARN** Shorthand by March 1st (1 hour's study nightly). 1st lesson, 2½d. stamp.—Duttons (Dept. HB), 92 Gt. Russell St., London, W.C.1.

**RUBBER** Tyred Metal Disc Wheels finished in red, green or blue enamel. 2ins., 2/6; 3ins., 3/- per set of four. Post paid. Other sizes available up to 9ins.—The Joyden Toy Co., 193 Chase Side, London, N.14.

**DOLL'S** House fittings and papers; send S.A.E. for list. Doll's house plan special; send 2/6. Trade supplied.—Zimplan, 88 Ware Road, Hoddesdon.

**LONELY?** Then write Secretary L.U.C.C., 5B.B. Hay St., Braughing, Herts. Genuine. Est. 1905.

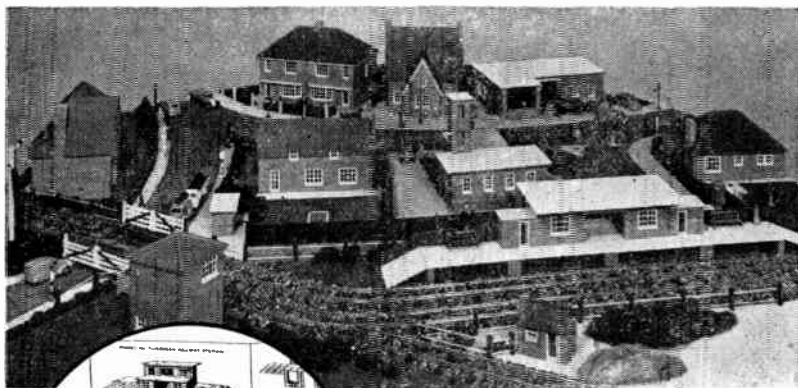

## Build this charming Model Village with

# BRICKPLAYER

Brick and Mortar Building Kit and Accessories

The Brickplayer Kit contains miniature bricks in all required shapes, mortar, roofing, metal windows and doors, plans and instruction booklet. All models are architect designed to "O" gauge scale. Buildings can be permanent or dismantled by merely soaking in water, and the bricks used again and again.

Brickplayer Kits at 23/10 and 44/- and Accessories are available from good hobby shops, toyshops and stores.

**ENTER FOR THE BRICKPLAYER COMPETITION**  
Prizes of £10 10s., £5 5s. and £3 3s., and a number of consolation prizes of Brickplayer Accessories will be awarded for winning models. Write for full details.

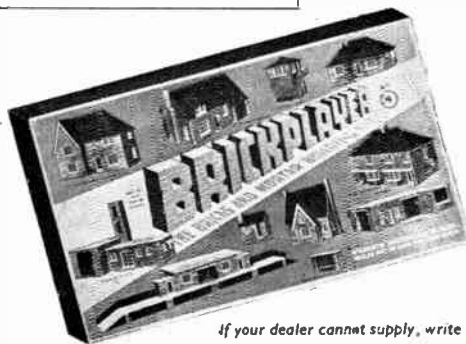

If your dealer cannot supply, write for address of nearest stockists to J. W. SPEAR & SONS, LTD., Dept. "H.", ENFIELD, MIDDXX.

**YOUR** Winter Hobby. Build a fleet of Wilson's Lorries. Photographically illustrated lists, 6d.—Wilson's Lorries, Dept. H., 1 Gt. Winchester Street, London, E.C.2.

**CONJURING** and Magical tricks, lists, 3d.—De Hempsey, 363 Sandycombe, Kew Gardens, Surrey.

**HOME** watch and clock repair outfit. Includes watchmaker's eyeglass, tweezers, screwdrivers, oilers, brush, oil, plus explanatory booklet and blue prints. In container. Skill unnecessary. Invaluable for all fine work, 12/9 inclusive.—D. Bolster (Dept. A.), 5A Station Parade, Ashford, Middx.

**HOME** Movies, 9-5 film library. Projectors, films, in great variety. Sale cheap. Stamp lists.—Wayland, 223 Longley Road, Tooting, S.W.17.

**SMASHING** gift of U.P.U. and Silver Wedding stamps free to all requesting approvals. (Without approvals, 1/6). Postage 3d.—H. A. Smith, 13 New Road, Scole, Diss, Norfolk.

**AMERICAN** Magazines post free for one year. Popular Mechanics, 32/-; Popular Science, 28/6; Mechanix Illustrated, 22/6; Popular Homecraft, 18/- Stamp for full list of others.—Willen Ltd. (Dept. 57), 101 Fleet Street, London, E.C.4.



## Some Hints for Beginners

**C**HIRSTMAS presents are very often the spur needed to commence the hobby of stamp collecting which should last a life-time. Now that we have a new album, how long will it remain in its present clean state? It should be for all time and if you are going to collect properly it will be for all time, too.

The writer is still using the two loose-leaf covers he bought second-hand in 1921. The leaves inside are new as the type of page has been changed and other similar covers have been bought to add to them, but the originals are still doing duty. The secret is care, and let it be said now that if you do not use care then you will never be a philatelist.

How often is the question asked 'What should I collect?' 'Do I put in stamps cut from off a printed card or from a letter card?' 'Do I keep stamps taken from a receipt or from some legal document?' Well, the answer to the



An Australian on Service

first question gives the answer to all the others. A philatelist collects ADHESIVE POSTAGE STAMPS. The word adhesive means that stamps already printed on a card are not acceptable and the word postage cuts out all stamps used for inland revenue purposes. Some countries—and Great Britain is one of them—uses her postage stamps for inland revenue purposes as well and the only way of telling if a stamp is a postage stamp is to make sure that the cancellation is postal.

You all know the way in which a stamp on a letter or parcel is cancelled—the ink is black and the stamp is generally metal (sometimes rubber on parcels). But the usual receipt stamp has writing on it or possibly a rubber stamp mark which is more often in violet than any other colour.

### Watermarks

Another worry which the beginner has concerns watermarks and perforations—should varieties of watermark and changes in perforation be collected? This is not quite such a simple question to answer. Later on you will certainly have to take both of these into account, but just at the start it is adding a difficulty at a time when things need simplifying.

So these might be left with advantage until a collector has a collection of about

1,000 stamps. By then he should have a stamp from each stamp-issuing country; be able to identify the various stamps and put them in their proper place in the album. He will then be wanting fresh fields to conquer and that is the time to tackle the new difficulty.

It is a great help if you know for what you are looking. That is to say, what is the possible water mark and just what it looks like. The early British stamps will generally have a crown and the letters 'C C' or 'C A' either single or multiple. That means that if it is what is known as 'Single Crown C.A.' then you would expect to find a Crown and the letters C A underneath and both in the centre of the stamp.

### How to Tell

When you hold the stamp up to the light you generally get the best view, but, of course, it will be reversed if you look at the back of the stamp. If you still have difficulty then wet the stamp, and if you still cannot decipher what it is, then put a little benzene on the back of the stamp. This will not hurt the stamp and will soon dry off.

In order to obtain some idea of what it is you are looking for take a piece of the stamp edging off the current postage stamp sheet. Hold that up to the light and you will clearly see the watermark—G V I R with a crown above it. This is repeated many times and is known as a multiple watermark. A watermark detector is a plain black surface. When you buy one it is frequently a small black pin tray, but any black surface will do.

### Perforation Differences

Next you will have to consider if you are going to take into consideration differences of perforation. Again, the state of your collection should be a good guide, also the size of the album. If you have a small album then you can hardly allow sufficient space to collect differences in perforation but if your album is large and will serve you for many years to come, then certainly you will want to deal in perforations.

### Rule of Measurement

You all know the reason for perforating sheets of stamps, but what is meant by 'Perforated 16'? It does NOT mean that there are 16 holes along the top of the stamp, unless the stamp happens to measure exactly 2 centimetres. That should be enough to show that 'Perforated 16' means the number of holes in 2 centimetres of stamp.

If the stamp is less than 2 centimetres then there will be less than 16 holes. If it is more than 2 centimetres then there will be more than 16 holes. Perforated

16 by 15 means that along the top and the bottom there are 16 holes per 2 centimetres of stamp and along the sides there will be 15 holes per 2 centimetres.

### Interruptions

Sometimes it happens that a different perforation is found on all four sides. In that case the figures would be given as the hands of the clock. Some countries find that the perforation so weakens the paper that they do not complete the perforating of the whole stamp. In that case it is called 'Interrupted perforation' and a glance at the illustration should be sufficient to make that clear.

Some countries have allowed firms to



Interrupted perforation from Holland

have their initials perforated in the stamps. The idea is to assist in catching a thief if the stamps are incorrectly used. Stamps which are so defaced should not be placed in the collection if it can be helped. Common specimens should be thrown away at once, but better stamps should be kept and as soon as opportunity occurs they should be exchanged.

There are some exceptions to the above. Occasionally you will come across stamps with the letters 'O S' perforated in the face; this means 'On Service'. The second illustration from Australia shows what is meant.

Shortly we will give some more notes on what should and what should not go in the Postage Stamp Album.

## The Health- Restoring Fretsaw!

*Many Hospitals are now restoring sick patients to good health quicker, by giving them something to do during their convalescence. And what they do is in strict relation to their injury or disability. For instance you can understand how the fretframe, properly used, can aid the arm movements. This modern science is called Operational Therapy, and Hobbies have recently published a small treatise on the subject. Anyone engaged professionally in this occupation can have a copy by writing to The Editor on the headed notepaper of the Hospital or Centre where they are employed.*

# QUALIFY FOR a BETTER POST —by Post!

Let the most progressive, most successful College in the world coach you by correspondence. Choose your career or be advised by us. We take a personal interest in all our students and provide the friendly individual training that quickly leads to success. Make the first move NOW—write for free particulars.



CHOOSE YOUR  
CAREER  
NOW!

Accountancy Exams.	General Education	Road Making and
Aviation (Engineering and Wireless)	G.P.O. Eng. Dept.	Maintenance
Book keeping, Accounting, and Modern Business Methods	Heating and Ventilating Institute of Housing Engineers	Salesmanship
Building, Architecture, and Clerk of Works (A.R.I.B.A. Exams.)	Journalism Languages Mathematics Matriculation	Sanitation
Cambridge Senior School Certificate	Metalurgy Mining. All Subjects	School Attendance Officer
Carpentry and Joinery	Motor Engineering Naval Architecture	Secretarial Exams.
Chemistry	Novel Writing	Sheet Metal Work
Civil Engineering	Plastics	Shipbuilding
Civil Service	Play Writing	Shorthand
All Commercial Subjects	Police, Special Course	(Pitman's)
Commercial Art	Press Tool Work	Short Story Writing
Common Prelim. E.J.E.B.	Pumps and Pumping Machinery	Surveying
Draughtsmanship, All Branches Engineering.	Quantity Surveying —Inst. of Quantity Surveyors Exams.	(R.I.C.S. Exams.)
Ali branches, Subjects and Exams.	Radio Service Engineering	Teachers of Handicrafts
		Telecommunications (City and Guilds)
		Television
		Transport Inst. Examinations
		Viewers, Gaugers, Inspectors
		Weights and Measures Inspectors
		Wireless Telegraphy and Telephony

If you do not see your requirements above, write to us on any subject. Full particulars free.

COUPON  
CUT THIS OUT

DEPT. 62  
THE BENNETT COLLEGE LTD.  
SHEFFIELD, ENGLAND.

Please send me (Free of Charge)

Particulars of.....

Your private advice about.....

(Cross out line which does not apply.)

PLEASE WRITE IN BLOCK LETTERS

NAME .....

ADDRESS .....

## INDO-CHINA AIR MAIL FREE

We will send to you, Absolutely Free, this really magnificent unused Air Mail stamp which was issued by INDO CHINA in 1933. It depicts a mail-carrying Aeroplane in flight, as illustrated.



It is a super stamp wanted by every collector.

You may have one Absolutely Free from the Windsor Stamp Co. Just ask for a selection of stamps on Approval (no obligation to purchase any); ask for Indo China Air Mail Free gift, and

send 3d. stamp to cover our posting costs.

**WINDSOR STAMP CO.**

(Dept. 12) - UCKFIELD - SUSSEX

## ALL ABOUT FRETWORK

by W. F. Chambers

(Editor of Hobbies Weekly)

The book for all fretwork enthusiasts

Bound in paper covers, 2/6 net.

Or there is a cloth bound edition at 5/- net.

Obtainable from all booksellers, branches of Hobbies, or from the publishers :

**VAWSER & WILES (London) LTD.**  
356/358 KILBURN HIGH ROAD, LONDON, N.W.6

## BRITFIX BALSA CEMENT



★ The ideal transparent cement for Balsa Ply Wood, Hard Woods, and Plastics, combining rapid drying with utmost tenacity.

Large tube  
7d.

Small tube  
(with special  
long nozzle)  
5d.

Remember  
**STICK BY  
BRITFIX**

THE HUMBER OIL CO. LTD., HULL

## BAR CRAMPS

A strong well-made tool for the carpenter and handyman. Takes work up to 1 ft. 6 ins. long. Easily adjusted varying lengths as a sash cramp or for wide boards. Strong steel bar with square edges for rigidity

**10/6**

Postage 11d.

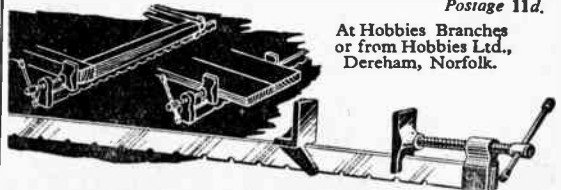

At Hobbies Branches  
or from Hobbies Ltd.,  
Dereham, Norfolk.

# MISCELLANEOUS ADVERTISEMENTS

**40 DIFFERENT** stamps free, including Silver Wedding, U.P.U., Victory, Silver Jubilee, Coronation, Pakistan, etc. Send 3d. postage and request approvals.—J. F. Smith, 60 Boyne Road, London, S.E.13.

**INTERESTING** selections of stamps. Discount approvals, ½d. upwards. Applicants receive Pictorial, Triangular, etc., packet free. 2½d. for postage.—Hodge, 45 Callcott Road, London, N.W.6.

**STAMPS FREE!!** Twenty unused (2½d.).—G. H. Barnett, Limington, Somerset.

**FREE** gift stamps, request approvals.—J. A. Mewis, 56 Great Stone Road, Birmingham, 31.

**SHIPS** in bottles. Complete guide to this fascinating hobby. 3/9 posted.—Quadrant Books (Dept. 4), 17 Quadrant Arcade, Regent Street, London, W.1.

**FREE**—Bahawalpurs', Colonial discount approvals. Postage.—Bishop, 40 Marine Parade, Hythe, Kent.

**STAMPS** free—Queen Victoria packet, including old Colonials free to approval applicants.—Robert J. Peck, 7A Kemp Road, Bourne, Hants.

**FURNISH** that doll's house with the latest model furniture, glassware, food and accessories. List, 8d.—Sutton Models, Billericay.

**EXPERIMENTERS!** Add to your apparatus. 1 retort stand, 1 boss head, 1 ring; complete set, 8/3, post. 1/6. Few clamps, 4/-, post free.—G. T. Stevens, 22 Park Crescent Rd., Erith, Kent.

**MOTOR** launch model kit, 21ins. x 4ins. x 2ins. Something good to put your motor in. 7/6.—Docton Works, Appledore, Devon.

**COLLECTORS'** delight—my world-famous Oxford approvals. Generous discount and free packet with each selection. Postage please.—Frank Kennedy, 37 Juxon St., Oxford.

**PHOTOGRAPHIC** enlargements. For specimen postcard and price list, send negative and 2½d.—Boucher, 228 Croydon Road, Beddington, Croydon.

**LONELY?** Join Victory Friendship Circle.—34 Honeywell Road, London, S.W.11. Details, 1/-.

**STAMPS**—world mixed, no G.B. 1/- a 100, 5/- a 1,000. Gift voucher with every order.—(H.W.13), Selby, 66 Donnington Road, London, N.W.10.

**BE** taller in 14 days or money back. Details, 1d.—Stebbing's System, 28 (HB) Dean Road, London, N.W.2.

**U.P.U.** packet contains 100 different Empire stamps, including 10 U.P.U. (no G.B.), 2/6, post free.—Bisson, 46 Sumatra Road, London, N.W.6.

**FASCINATING** and profitable hobby, casting ornaments, toys, etc. You can easily make these yourself. Paints, brushes and all accessories. Illustrated catalogue of 700 moulds, plus latest list of rubber moulds with instructions, 9d., post free.—Cock of North Moulds (H), 140 Hollings Road, Bradford.

**FREE**—U.S.A. Commems. Discount approvals from ½d. 2½d. stamp.—Sollars, 65 Cleeve Road, Birmingham, 14.

**STAMP** approvals from 10 a penny. Send 2½d. Albums free.—Day, 73 Thornton Gate, Cleveleys, Blackpool.

**AMERICAN** magazines! One year's subscription, Popular Mechanics, 32/-; Popular Homecrafts, 21/6; Profitable Hobbies, 32/-, etc. Send stamp for big lists.—Herga Ltd., 351 Waverley House, Hastings.

**100,000** Government surplus bargains. Magnets, powerful, 1/6 per pair (P. 4d.); strong metal boxes, approximately 12ins. x 7ins. x 6ins., 1/6 each (P. 1/-); aluminium rivets, approximately 1lb. assorted, 2/6 (P. 6d.); electric motors for models, etc., 2/6 to 35/-; sponge rubber strip, approximately 18ft. x 1½ins. x ¼in., 2/- (P. 6d.). Send 3d. stamp and S.A.E. for list of these and other bargains for the Hobbyist.—Milligan's, 24 Harford Street, Liverpool, 3.

(Continued on page 284)

## YOU CAN BECOME A HANDICRAFTS INSTRUCTOR

Experience not essential

Men who enjoy making things in wood or metal can turn their hobby into a well-paid, permanent and interesting Career. Short hours, long holidays, and security in a job you would really enjoy, can be yours if you become a Handicrafts Instructor. Let us send details of the easiest and quickest way to get the necessary qualification.

We definitely guarantee  
"NO PASS — NO FEE"

If you would like to know about our unique method of preparing you for one of these excellent appointments, write today, and we will send you our informative 175-page Handbook—free and without obligation. Mark your letters "Handicrafts Instructor."

BRITISH INSTITUTE OF  
ENGINEERING TECHNOLOGY

# BIET

595 Shakespeare House  
Stratford Place, London, W.1

## The GADGET MAGAZINE

1/- Monthly Lavishly Illustrated  
CRAMMED FROM COVER TO COVER WITH EASILY MADE  
● PRACTICAL GADGETS ●  
For Garden, Garage, Home, Nursery,  
Office, Workshop, Hobby and all other  
purposes

Enquire locally, or send 1/- for latest issue to:—  
THE GADGET, - 8 Swan House,  
Kingsbury, London, N.W.9

## TOYS WE MAKE AT HOME A BOOK WORTH HAVING

This book describes amusing toys that can easily be made from odds and ends. The subjects include Fun with Cotton Reels, Jumping Monkey, Comic Portrait Camera, Scooter, Easily-made Mousetraps, Parachute, Javelin, Blow Football, Mystic Paper Rings, Doll's House Furniture, etc. Working models are included such as: Sand-motor, Weather Vane, Elastic Pistol, Automatic Scales. Hundreds of illustrations make everything clear.

Published price 5/- net but,  
special price to readers of **HOBBIES** 2/9 post free  
from Ellison Howks, Ltd., Victoria House, Southport



## DOLL'S HOUSE

How to make in a simplified step-by-step manner a desirable four room Doll's House with electric light and separate garage if required

**ALL MATERIAL EASILY OBTAINABLE**  
Send a 2/6 P.O. now for complete Plan and instructions  
Doll's House Paper and Doors and Windows, which open,  
are available. Send S.A.E. for list.

TRADE INQUIRIES INVITED

**ZIMPLAN** 88 WARE ROAD  
HODDESDON, HERTS.

# RAWLPLUG PRODUCTS

**INDISPENSABLE  
IN THE WORKSHOP  
HANDY IN THE HOME**



## DUROFIX

The indispensable adhesive for instant use on crockery, glass, wood, metal, celluloid and the thousand and one things handled by the hobbies enthusiast. Instant drying, insulating, waterproof and heatproof. Durofix is grand for repairs to electrical, sports and leather goods. Tubes 6d. and 1/3d. Tins 2/9d. and 7/6d.



## DUROGLUE

**UNDILUTED ANIMAL  
GLUE OF INCOMPARABLE  
STRENGTH**

Ready for instant use for the many purposes for which an extra strong glue is needed. Wood, cloth, fabric, felt, leather and any greaseless surface can be stuck with Duroglue. Tubes 6d. and 1/-. Tins 2/3d. and 3/9d.



## PLASTIC WOOD

**APPLIED LIKE  
PUTTY, DRIES  
LIKE WOOD**

Can be cut, planed, polished & painted like wood. Will take nails and screws like wood. It does not blister, crack or decay. Rawlplug Plastic Wood is actually the best quality product of its kind on the market. Tubes 9d. Tins 2/- and 5/-.



## TILE CEMENT

**Rawlplug Tile  
Cement is a liquid  
cement possessing**

very strong adhesive qualities. For replacing tiles to walls, floors, fireplaces, hearth, curbs, etc., in kitchens, lavatories, bathrooms, halls, bedrooms, reception rooms, etc. 2/3d. per tin.

B389A



## SHARPENER

For re-sharpening Tools, Scrapers and Domestic and Garden Implements. An efficient Tool with a great number of uses. Hardwood Handle, polished and varnished with Sharpening Stone of medium grading. Use water, or a thin clear oil if stone cuts too rapidly. For cleaning stone—wash with paraffin. 2/- each.



## SCRAPER

A remarkably efficient and economical scraper, built to last a lifetime. Gives smooth finish without chatter or scratching. Easy-grip handle made solid with blade carrier in seasoned hardwood, polished and varnished. Total length approx. 6". Fitted renewable 2 1/2" Cadmium Plated Steel Blade, with cutting edge ground like a razor. 3/- each.



## FUSE WIRE

**BE PREPARED FOR  
BLOWN FUSES**

A useful card carrying 3 gauges of fuse wire (5 amp. for lighting, 10 amp. for heating and 15 amp. for power). Directions for use are printed on the card which is punched for easy hanging near the fuse box. 3d. per card.

## RAWLPLUG FIXING DEVICES & TOOLS

Whatever your fixing problems, there's a Rawlplug Device that will solve it for you—easily and quickly. Rawlplugs make neat and absolutely firm fixings in any material from plaster or brick to stone or slate, with a size for every screw from No. 3 up to 3/4" coach screws. Rawlplug Tools are easy to use and ensure a perfect hole without damage to surrounding surfaces. Other Rawlplug Devices include Rawlbolts for heavy duty fixings, Rawlanchors and Toggle Bolts for thin or hollow materials and Rawlclips for instant fixing of conduits and cables to girders—a device in fact for every need.

Rawlplug fixing devices and products can be obtained from Ironmongers, Hardware Dealers, Stores or Model Makers Suppliers.

**THE RAWLPLUG COMPANY LTD. LONDON. S.W.7.**

## MODEL CONSTRUCTIONAL KITS

that are well known for quality and low price

### AIRYDA MODEL AIRCRAFT

Include both flying and non-flying types; sizes and prices to suit all Modellers. Each kit complete with plan, building instructions and all necessary parts.



### ANORMA MODEL BUILDINGS



This range of Model Buildings includes shops, houses, factories, railway buildings, etc., which are all designed to 4 mm. scale suitable for OO gauge Model Railway lay-outs, etc.

### AQUILA MODEL SHIPS & BOATS

This series includes Motor Launches, Cabin Cruisers, Motor Yachts, Cross Channel Steamers, etc. Sizes range from 20ins. to 39ins. in length; and prices from 18/- to 62/6.

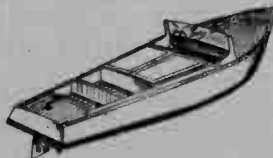

Full particulars can be obtained from your local dealer, or send for particulars to:

**MODELLERS SUPPLY LTD.**  
DEPT. HO/1  
**ASPLEY, HUDDERSFIELD**



**THE EFFICIENT  
"FRACTIONAL"**

For every purpose in the small home workshop.... use a BROOK 'CUB' 1/4 h.p. motor. Single or split phase.

Electric Motors from 0.25 to 200 h.p.



EMRESS WORKS HUDDERSFIELD

1.H.M.147



# Hobbies

## WEEKLY

### CONTENTS

	Page
Writing Table - - -	289
Model R.A.F. Crash Tender -	291
Cold Water Aquarium	292
Making a Lampshade -	292
A Spring Balance -	293
Garden Tool Repairs -	294
Workshop Fire Alarms	295
Model Crane Magnet -	296
Wire-frame Bed Lamp	297
About Timber - - -	298
Renewing Small Windows -	298
Replies of Interest -	300
Novel Pipe Stand -	301
R.A.F. Tender Patterns	301
Home Cements - - -	302
SUPPLEMENT DESIGN SHEET FOR A PAIR OF BELLOWS	

February 8th, 1950

Price Fourpence

Vol. 109 No. 282

**H**ERE is a useful piece of furniture which the handyman with a little knowledge and a few carpentry tools should be able to make in his spare time. Such an article as this would be most useful to the student, as he or she can have all books and papers ready at hand. The table contains two drawers which pull out from the ends so it is not necessary to move from the table when desiring access to the drawers.

The construction of the table is simplified by having plain square legs, which may be bought ready planed, and,

## WRITING TABLE AND CABINET

perhaps, grooved at the top for the ends of the rails. Or the grooves may be marked off in pencil carefully and cut in with tenon saw and chisel.

The working diagram, Fig. 1, gives a front view of the table, the dimensions of the rails and the spacing of the shelves. Fig. 2 gives a side view of the table with its connecting rails between the legs and the drawer. Each pair of legs is connected at the top by back and front rails measuring 1ft. 11ins. long by 4ins. wide, by  $\frac{3}{4}$ in. thick.

If the table is to be made longer, which it may well be, then these rails could be, perhaps, 2ft. 3ins. or so long, more the proportion that is of the table shown in the sketch of the finished article. The rails are glued into the slots made for them.

### Leg Framework

Fig. 3 clearly shows the construction of legs and rails. Each pair of legs is connected by end rails, the narrow top ones being 12ins. by  $\frac{3}{4}$ in. by  $\frac{3}{4}$ in. Then 3ins. below this is glued a wider rail 12ins. long by 1 $\frac{3}{4}$ ins. by  $\frac{3}{4}$ in. Between these two rails comes the drawer front. The lower rails are 12 $\frac{1}{2}$ ins. long by 1in. by  $\frac{3}{4}$ in., while the back rail corresponding with them are 2ft. long and is similar in width and thickness.

The length given for these last three rails include the tenons which should be previously marked on the legs 7ins. up from the floor and cut in with a chisel  $\frac{3}{4}$ in. deep. Runners  $\frac{3}{4}$ in. wide and  $\frac{3}{4}$ in. or  $\frac{1}{2}$ in. thick are glued to the lower edges of the back and front rails, see Fig. 4, and extend the whole length.

On the top of these runners, and glued in the angles between them and the side rails, are the guides. These consist of squared stuff, the front edges being flush with the inside edge of the legs.

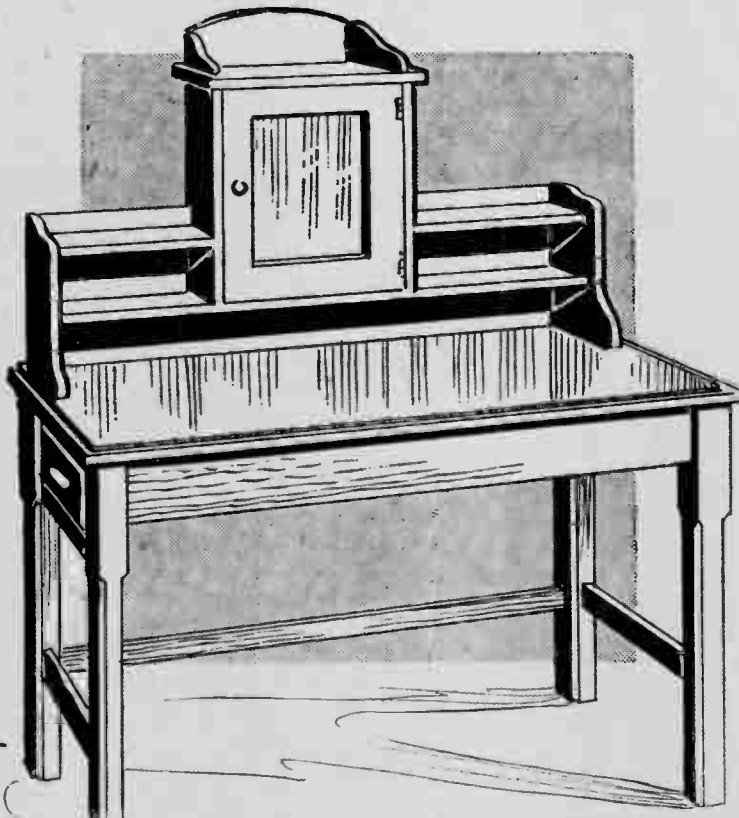

All correspondence should be addressed to The Editor, Hobbies Weekly, Dereham, Norfolk.

The table top consists of four rails mitred and glued together with a stiffening rail across the middle halved to the two longer rails. The two long rails measure 2ft. 3ins. by 2½ins. by ½in., while the two end rails measure 1ft. 4ins.

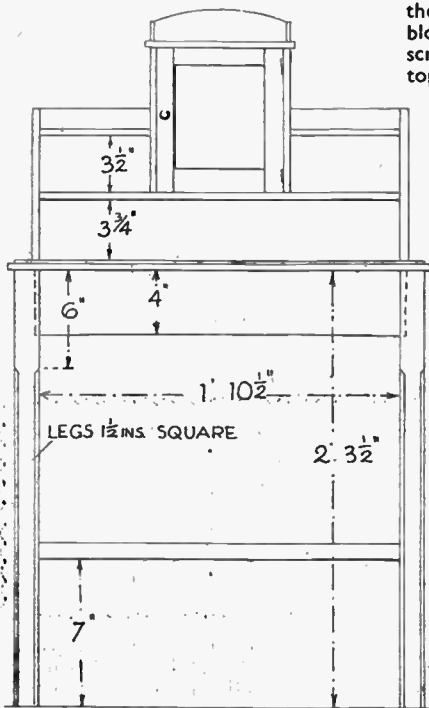

Fig. 1—Front elevation

will be nailed, these measuring 11ins. long by 2½ins. wide by ¾in. thick. A ply-wood bottom 11¼ins. long by 11¼ins. wide is nailed to the three.

The front of the drawers should, of course, be of the same kind of wood as the table. Handles may be formed of blocks of wood shaped and glued and screwed to the drawer from inside. The top shelves and the cabinet (see detail in

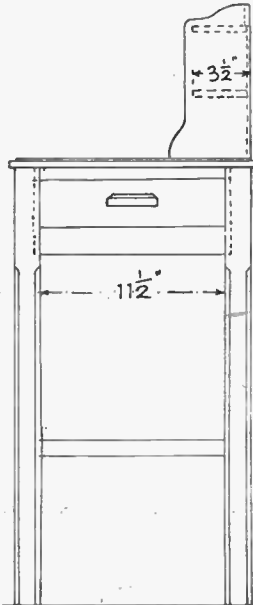

Fig. 2—Side elevation

by 2½ins. by ½in. The ends are cut to a 45 degree mitre and glued up, the stiffening angle blocks being glued in to give additional strength. The cross mid rail measures 1ft. 2ins. long by 2½ins. wide by ½in. thick, and sinkings will be cut for the ends of this rail in the long rails ¼in. deep. The ends of the cross rail will also be cut or halved to fit the recesses in the side rails; the whole top surface of the completed frame thus being perfectly flat and flush throughout.

### Table Top

The top of the table consists of an overlay of ¾in. or ½in. plywood measuring 2ft. 1½ins. long by 1ft. 2½ins. wide. A small quarter-round beading may be glued and mitred and pinned round the edges of the plywood to make a neat finish. Beneath the centre cross rail must be fixed a ¼in. fillet to form a stop to the back of the drawers.

The simplest way of making the drawers is shown in Fig. 5. The front has two pieces 11½ins. by 3ins. wide and ¾in. thick, backed up with pieces of commoner wood, measuring 10½ins. by 2½ins. wide by ¾in. thick. To the latter pieces the sides of the drawer

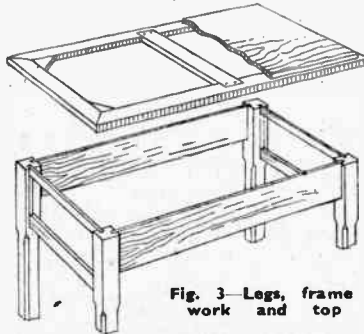

Fig. 3—Legs, frame work and top

Fig. 6) have two shaped ends cut from wood 10ins. long by 5½ins. wide by ¾in. This size allows for waste after cutting round to the outline.

Set out the shape from Fig. 2 and cut in the usual way with the fretsaw and then clean up the edges. Set out the spacing of the shelves as Fig. 1, and bore holes in the ends ready for screwing up. The main shelf is 1ft. 10½ins. long by 3½ins. wide by ¾in. thick. This is screwed to the ends, a space of ⅛in. being allowed along the back edge for the fixing of the plywood backing, see Fig. 2.

The sides of the cabinet are 9ins. long by 3½ins. wide by ¾in. thick, and each is screwed to the long shelf at a distance of 6½ins.

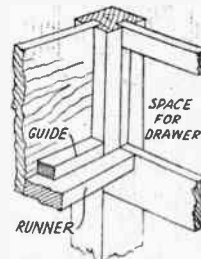

Fig. 4—Drawer detail

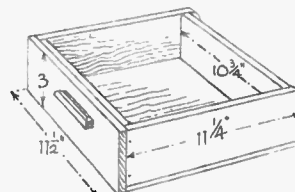

Fig. 5—Drawer construction

from the ends. The two shorter shelves are 7ins. long by 3½ins. wide and are fixed to the sides of the cabinet and the extreme ends at a vertical distance of 3½ins. from the long main shelf. Short back rails of ¾in. stuff are fitted and fixed between the sides of the cabinet and the main ends.

The top of the cabinet measures 9½ins. by 4ins. by ¾in. and three of its edges should be slightly rounded off. It will be screwed to the sides of the cabinet, small pieces of angle fillet being glued along inside to give additional fixing. A plywood back will be fitted to the cabinet, small fillets being glued up the angles inside to make a secure fixing.

### Backing and Door

The backing to the shelves should measure about 1ft. 10½ins. by 7½ins. A piece will be cut away from the middle of this backing board to allow for the space occupied by the cabinet. In Fig. 8 is shown the shaped back rail and two side rails which make up a pediment to the cabinet.

The three pieces mentioned may be of ¼in. or ¾in. wood shaped up nicely with the fretsaw with the edges cleaned with coarse and fine glasspaper. The proportions of these rails can be got from the main dimension of the back given in Fig. 7.

The door of the cabinet is of simple construction, a piece of ⅝in. plywood being first cut to the exact size of the opening in which it is to fit. Upon this plywood four ¼in. rails are glued and screwed, being butted together, as shown in Fig. 1. The two side upright rails and the top cross rail are 1½ins. wide, while the lower cross rail is 1¼ins. wide. Glue the rails securely to the plywood and then run in a few countersunk screws from the back of the door to bind all well together.

Cheap wood may be used to make up this useful table. Take care in cleaning not to spoil the angles of the wood, such as the chamfers on the legs. These are, of course, optional but necessary if the finished appearance requires to be lightened. All surfaces may be stained light oak or walnut and then finished with french polish or varnish carefully and evenly brushed on.

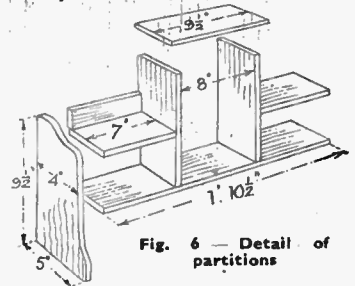

Fig. 6—Detail of partitions

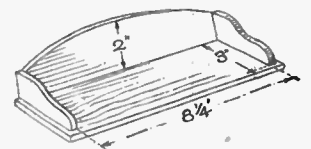

Fig. 7—Cabinet top and rails

# Full size patterns on page 301 for this miniature model R.A.F. CRASH TENDER

**H**ERE is an interesting little vehicle and one quite simple to make once you have acquired the habit of making the chassis framework as explained in previous articles in this series. The shape of cab and bonnet can be altered to your own ideas as the vehicles were mostly built on a well-known firm's chassis and the structure completed on the Royal Air Force Station to suit the type of aircraft using that particular 'drome. Patterns of the parts are shown full size on page 301.

## The Chassis

Make the main chassis first. Thin stripwood about  $\frac{1}{8}$  in. square will do in two lengths  $4\frac{1}{2}$  in. with the spacers between  $\frac{3}{4}$  in. The front part,  $1\frac{1}{2}$  in. deep, is covered by the floor panel in No. 3 and, therefore, you do not require bearers. The remaining part is covered with a flat platform and this needs cross-bearers (sketch 1),  $1\frac{1}{2}$  in. wide, to come right to the edge. All this part can now be assembled, with a  $\frac{1}{4}$  in. square beading all round the flat platform.

All sections of the cab must now be cut out and we suggest  $\frac{1}{4}$  in. wood for this. Join together with a strong adhesive or balsa cement.

## Cabin

In drawing No. 2 is shown the rear of the cabin measuring  $1\frac{1}{2}$  in. square with a small window. Pattern No. 3 shows the floor, also  $1\frac{1}{2}$  in. square, with cut-outs for the wheels. The wheels suggested are those bought at model aircraft shops, with about  $\frac{3}{8}$  in. diameter. Leave sufficient clearance, and put in a seat

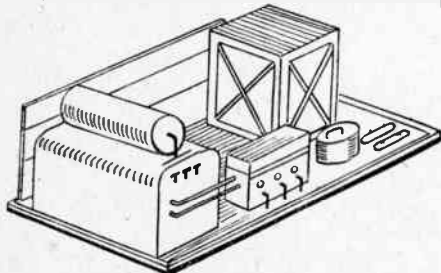

The equipment behind the cab

based on the floor and to hold up the back panel. This should be  $\frac{1}{2}$  in. square.

In No. 4 sketch is shown the two sides showing the wide cut-away window and the clearance for wheels. Size again is  $1\frac{1}{2}$  in. square, with a slope back of  $\frac{1}{8}$  in. from a distance  $\frac{3}{4}$  in. from base. This means you can follow on with the base of the front, which is  $1\frac{1}{2}$  in. by  $\frac{3}{4}$  in.

The driving-screen window (No. 5) is cut and can be made of cardboard if you wish. This mica can be placed in the frame and it can be edged with silver paper to give a better impression. To strengthen all these sections it is a good

plan to strengthen with some  $\frac{1}{2}$  in. square wood on the inside round the joins. This prevents them caving in when handled.

The roof is made from  $\frac{1}{2}$  in. soft wood and should be made to fit right inside the two sides, back and the front (No. 6). Add to this fitment by strengthening with tiny pins. Force in with pliers and then snip off the tops. You will then be able to glasspaper off to a nice round finish and blend the shaping into the assembled parts.

This type of cab is a little squarish but the art of taking off the corners is simple if you use garnet paper and then fine glasspaper. Few modern vehicles have ugly straight corners these days. Do not rub too deep and so take too much away because you will cause an unsightly gap.

## Vehicle Details

Make sure this part of the vehicle is satisfactory before starting on the equipment part. Note the buffer board from  $\frac{1}{2}$  in. wood and rounded. The bonnet is shown but you can design this to suit your own taste. It should be a simple design as shown in the finished cab drawing (No. 7).

Mudguards are shown here and thin tin measuring  $\frac{1}{4}$  in. wide, is the best for this. This allows a realistic rim showing, and this may be further rounded off to the side of the body with plastic wood. Or it can be done with balsa cement. Lamps may be made from pin-heads, door handles from bent pins.

## Tender Equipment

Now for the equipment on the

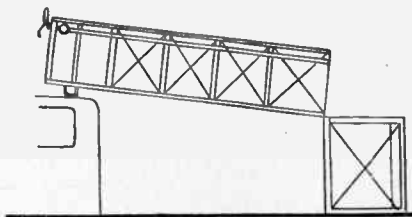

The lattice tower lowered

platform. One large foam tank is situated behind the cab. This is  $1\frac{1}{2}$  in. by  $\frac{3}{4}$  in. by  $\frac{3}{4}$  in. high, with well rounded top (No. 8). Above this is another container of compound, from  $\frac{1}{2}$  in. dowel, 1 in. long with rounded ends (No. 9). Fix on with pins. Various other gadgets and containers are shown in the sketches and also in position on the framework.

Note the various tiny taps, wheels and other items which all give a very complicated look to the whole layout. Just a little imagination will help you with these, for they are effective. You will find slide-on paper clips a great help as

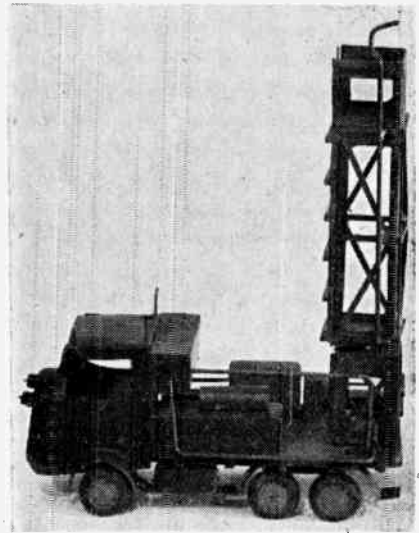

A photograph of the complete model

these are pliant and can represent pipes and hose.

## The Tower

Now we come to the tower. This is 1 in. by 1 in. square and the base is fitted to the platform. Make it of  $\frac{1}{4}$  in. square wood with cross struts as shown. It is a simple plan to make the whole shape in thin card. Cut this all out and then fit on your pieces of wood. If you have never done this before, then it is something worth knowing and saves endless trouble and damage later.

The main part of the tower is the same as the base but  $3\frac{1}{2}$  in. high and folds down when not in use. Note to make the platform for the operator  $\frac{3}{4}$  in. from top. Fix to base with thin card or passe-partout; fit in the hose nozzle and run the pipe up the side.

Wheels, petrol-tanks, etc., can all be added when this structure is completed. Mostly these vehicles were brown or olive green with a round bright yellow circle on the cab roof. Any vehicles of this series which would normally operate on the flying grounds would have this distinctive marking.

## Frame Decoration

**W**HEN you want to decorate or make a picture frame, get a few corks and cut them about  $\frac{1}{2}$  in. thick. Then cut these in half and stick them on the frame. They make quite a novel and attractive piece of work.

# There is much to interest if you make and stock a COLD-WATER AQUARIUM

**T**HERE is much interest in starting a small cold-water aquarium as an indoor hobby. First—the receptacle. Do not start with the once-popular goldfish bowl—it is not suitable in more ways than one. Instead, obtain a square or oblong tank with a slate back and glass front and sides. Or you may get a glass aquarium with angle steel joints or similar. Prices vary according to size. You may obtain a tank 18ins. by 10ins. by 10ins. for about £2—a somewhat larger one 24ins. by 10ins. by 10ins. for £2 10s. 0d.

In any case, a good size for a beginner to start with is one which holds two gallons of water. Anything smaller is likely to become overcrowded, and that is unwise. Allow at least 6 cubic inches for each fish. It is better to understock rather than overstock your tank, so be satisfied with just a few fish.

## Cover from Dust

Put a layer of clean washed sand at the bottom of the tank. Cover the top of the receptacle to keep dust from settling on the surface of the water. A sheet of glass will serve, propped up on pieces of wood to allow free passage of air. Place the tank where it will get light but no sun.

A cold-water tank needs no special aerating appliances. Aerate the water daily by lading out a jugful of water and pouring it back from a height. You will also need a few water-plants to assist aeration.

Such plants as Ancharis weed, as found in many ponds, is useful, but it grows quickly and must be kept in check. It is a good producer of oxygen; sprigs pulled off the plant will root easily. Other plants recommended include Vallisneria Spiralis and Water Milfoil—this is also to be found in ponds—recognised by its hairlike leaves arranged in whorls of four.

## Plants and Water

Collect the plants first and place in the layer of sand 2ins. deep at the bottom of tank. Arrange them in rows a few inches apart towards the back of tank. Next your supply of water, which can be half rain water and half tap water. Fill the tank and leave it for a few days before putting in your fish. In no case should specimens be introduced into the water until it has stood for some 48 hours.

When adding or changing water try to ensure that the fresh water is as near the same temperature and from the same source as that already in the tank. Never run tap water directly into an aquarium; allow it to stand for a time first.

If you have the right plants these, and the continual movement in the water

set up by the fish swimming around, will be sufficient to maintain aeration. If, however, the water in time becomes foul, it should be changed.

Water plants, by the way, you can obtain for yourself from the nearest pond. But if unable to do this, you can get them from most of the dealers supplying aquariums and accessories.

## Suitable Fish

Fish for the cold-water tank can be obtained from rivers and canals, or from the many dealers in Aquaria. Such species as minnows, tench, common carp, roach, etc., are recommended, to begin with. Sticklebacks are interesting in an aquarium, but, unfortunately, cannot be placed with minnows, as they quickly injure them, so if keeping sticklebacks have a separate tank for them; they are charming little fishes, worth having. You will, perhaps, also be able to get a few water snails, to act as scavengers in the tank.

Fish foods can be obtained from the dealers. Specimens over 1in. long may be given tiny earth worms from the garden, or if the worms are fairly big you can snip them in small pieces with a pair of scissors. Some consider this to be cruel, so instead, get some offal such as liver or kidney, and cut into small bits resembling worms. However, the

aquarium shop will supply you with suitable feeding stuffs if you are anywhere near one.

When you intend to stock your aquarium with local fish—this is, fish you catch yourself from a neighbouring pond or canal, it is a good thing to also get your plants for the tank from the same water. The fish thrive better when beside those plants they have been used to since birth.

Keep the tank clean. Do not allow uneaten food to collect on the bottom and there decay. Remove it. If you find your fish congregating near the surface of the water change it. Remember, do not overstock your tank, because it is a fault easily acquired by the beginner.

## Select Fish

Select the fish carefully. Small specimens, from 2ins. to 2½ins. long, thrive best in ordinary aquariums. Select only those which are apparently in perfect condition, with no scales missing, and no split fins, or with suspicion of fungus growths about the mouth or fins.

You will find a cold-water aquarium much easier to manage than a tropical tank. It is much cheaper to maintain, for fish can be easily replaced, when necessary, if you live near a pond, lake or canal. The cold-water tank is simple, the fish are hardy varieties, and do not make any special calls upon you in maintenance.

## To Mark and Make a Lampshade

**M**ANY craft workers seem to find it difficult to construct a conical lamp shade, but the work is really quite simple if done in the following manner. Of course, the top and bottom diameter must first be decided upon, also the length of the shade. The parchment is secured on a full size drawing board, or failing this a good flat table top, or even a sheet of three-ply would do.

First lightly draw the centre lines A B, and C D, in pencil, as indicated in the accompanying illustration. With O for centre, scribe the circle which will be the same as the shade base including, of course, a small amount for overlap to provide for lacing.

Draw the diameter of the base as indicated at E F, measure the distance X, which will be the length of the shade. Then draw the diameter of the shade top, indicated at G H, and complete the cone P E F, by joining the top and bottom diameters as clearly shown.

The side of the cone H F, is actually one edge of the conical lamp shade. Now, with P as centre, scribe an arc H J, and F K. By means of the 60 degree set-square, mark off the circumference of the base into twelve equal parts, as

indicated by O L, O M, O N. Set the dividers to L M, or M N, and step off twelve equal spaces round the arc F K, as clearly indicated.

From point K, draw the line K J, from point P, to point K, which will

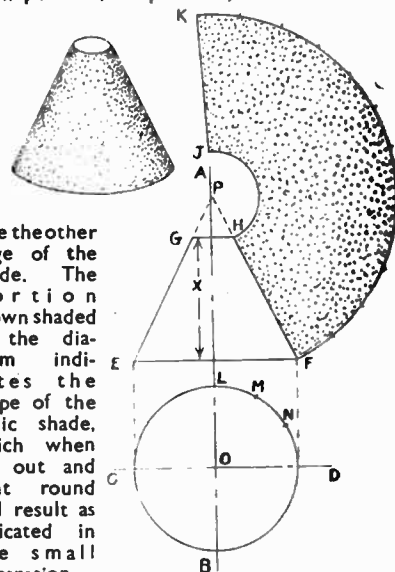

give the other edge of the shade. The portion shown shaded in the diagram indicates the shape of the conic shade, which when cut out and bent round will result as indicated in the small illustration.

# A useful piece of domestic apparatus is this HOME SPRING BALANCE

**T**HE spring-balance as shown in Fig. 1 is an extremely useful piece of domestic apparatus which can be quite easily constructed at very small cost. The design is novel and pleasing; there is nothing to go out of order, no loose weights to become mislaid and it is always ready for instant use.

A glance at the illustration, Fig. 1, clearly indicates its working principle. The lower tube (A) contains a compression spring (B). The upper tube (C) is an easy sliding fit in the lower tube and compresses the spring in direct relation to the weight placed in the scale-pan (D). A calibrated scale (E) is marked on the upper tube, which indicates the correct weighings.

## The Size of Spring

The dimensions given are, of course, capable of considerable modification if required, and are governed by the size and compressibility of the spring used. A suggested size of spring to use is of 7lbs. compression with a fair amount of travel before the coils close. Such a spring would probably have a 2in. diameter with an overall length of 5ins., reducing to 1½ins. when fully com-

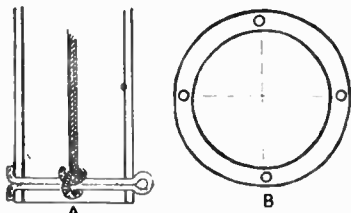

Fig. 2—The securing cord (A) and (B) pattern of collar for base

pressed. This would give a free movement of 3½ins., which would give reasonably accurate readings on the weight-scale.

Assuming that the reader has obtained a spring of the above dimensions, the lower tube which is of either brass or copper, must be 2ins. in internal diameter by 7ins. length. The inside must be nicely polished smooth and a very light smear of oil applied. The upper tube is of similar metal and must be 2ins. external diameter by 8ins. length. Two end-pieces, Fig. 1 (F), are soldered into place and the scale-pan carrier secured into position by a long bolt (G) which passes down the length of the tube and is bolted through and on the end-pieces.

## Metal Pan Holder

The scale-pan carrier (H) is constructed of strong metal, preferably brass, in the shape of an 'X' and the securing bolt is passed through the middle intersection. The ends are shaped to hold the scale-pan securely

into position as shown in the illustration. The scale-pan can be a fairly deep enamel plate or a shallow round cake tin, whichever is available or preferred.

Near the bottom of the larger tube is drilled two small holes and a split-pin passed through and secured by opening and turning the ends over—Fig. 2 (A). A thin cord or small chain is then fastened under the bolt (G), the spring inserted in tube (A) then the smaller tube (C) inserted inside the larger tube and pushed down until the spring is slightly compressed.

## The Stand

Holding the assembly in this position, the cord or chain is fastened to the middle of the split-pin. When the upper tube is released, the cord or chain will be under slight tension and will hold the assembly securely in position, thus preventing any displacement of the upper tube.

The stand should be made from a fairly substantial piece of wood. A hole is drilled nearly through of the same external diameter as that of the lower tube (I). The tube is then pressed in as far as possible and securely located in position by a collar or ring. The collar is made from brass ¼in. thick to the pattern as shown in Fig. 2 (B). This is slipped over and down the tube and is tightly screwed into the baseboard with four screws, Fig. 1 (J). It is then sweated with solder around the tube, thus making a firm and stable assembly.

## Etching the Figure

The scale calibrations are made by placing various weights in the scale-pan and noting the positions of the upper tube in relation to the edge of the lower tube. The scale is then marked where indicated with a scribe or similar tool. A better plan, however, is to etch the calibrations with acid. This is done by marking as previously described, then dismantling the tubes in preparation for the etching.

The ground or stopping for the etching process is prepared by slightly

## Lighter Filling

**T**O prevent spilling when filling a cigarette lighter, hold an unlighted match across the top of the bottle or container. The fluid will flow down the match and drip into the lighter with little loss.

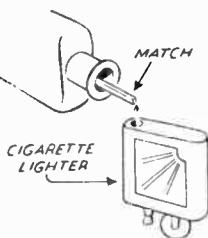

warming the tube and rubbing white beeswax over the required parts. Using the previous markings as a guide, the calibrations are made through the wax film with a scribe, noting that the tool cuts through to the metal in the process.

A small quantity of sulphuric acid is then obtained and is very carefully

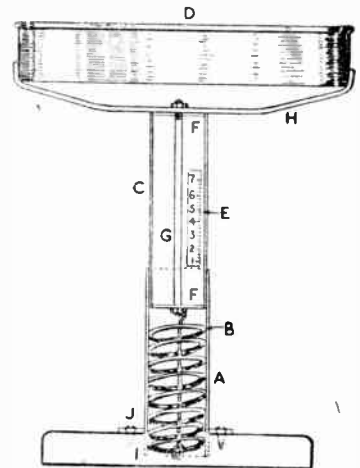

Fig. 1—Sectional view of parts and construction

applied over the markings with a brush, taking care that no acid comes into contact with any other unprotected part of the tube. Only a very cheap brush should be used as it will be quickly destroyed by the acid. It should be emphasised that the greatest care and caution should be exercised in the use of this acid, as its extremely corrosive nature destroys and burns practically anything it comes in contact with.

After two or three applications, depending upon the strength of the acid used, the tube should be placed for a few minutes in a strong hot soda-water concentration which neutralises the acid and removes the wax film. The tube is afterwards well washed for a few minutes in running water, then thoroughly dried. Upon inspection, it will be found that the tube has been cleanly and deeply etched where the acid has made contact with the metal.

## Painted Numbers

To render the etchings more easily readable, they could be painted with black paint, then any surplus paint on the tube removed with a non-fluffy cloth. It will be found that the paint has filled the etchings, thus making the calibrations clearly visible. Allow a sufficient time for the paint to dry, then re-assemble the components and the scale is ready for use. If desired, the scales may be painted in a bright enamel which will considerably enhance the finished appearance of same.

# Now is the time to overhaul and undertake GARDEN TOOL REPAIRS

**N**OW is the time to overhaul your garden tools and appliances and to carry out any repairs that may be necessary. Do not leave this work until you are ready to use them; there will be a whole host of other jobs to do then and you will not have time to fit them all in. The result is that those necessary repairs will probably be left over until another year.

It is a well known fact that in order to do a job in a satisfactory manner your tools should be in good condition, and not broken and dirty. Garden tools have to stand up to some hard wear, but if care is taken of them they will give satisfactory service over a considerable period.

## Handles' Repair

Spade and fork handles often break owing to exposure to the weather, but the trouble can generally be put right quite easily.

The T handle, Fig. 1, generally breaks off at the join with the shaft. It can be made as good as new by first cutting off all rotted or broken parts and then cutting down to a shoulder to fit tightly in the top bar and then to drive in a good wedge. It might be that only a nicely fitted wedge was necessary—cut this from hard wood and do not make the taper too sharp. All wedges should be glued before tapping home to prevent any possibility of them working loose.

Sometimes the top bar is just screwed on to the shaft. This is not at all satisfactory and should be altered to fit as in Fig. 1.

## Breakage

Fig. 2 is a common type of handle and often breaks at either (A) or (B). When the break is at (A) and the rest of the wood is intact, cut the top bar out to form a U as in Fig. 3. Fit a piece of dowel or broom handle into this, drill a hole right through and rivet it in place with a wire nail, putting a washer over the end.

If the break is at (B), Fig. 2, you can either fit a new handle or just a new

grip. It is not a difficult job to make an entirely new handle and if you have the time it is certainly the most satisfactory way.

## Strong Timber

A piece of ash or beech 30ins. long, 4½ins. wide and 1½ins. thick is cut roughly to shape as shown in Fig. 4. Then cut out the grip by drilling the two top corners and sawing out with a keyhole saw. Next round off the shaft and make the end to fit nicely into the spade or fork and then rivet this securely. The top of the handle should be rounded and the whole glasspapered quite smooth.

Provided the shaft is in good sound

The screw thread may be filed off, although it does not matter if this is left on.

Garden tools should not be allowed to lose their original polished surface and get rusty and caked with dirt. You will notice a good gardener always cleans the dirt off his tools and rubs them over with an oily rag when he has finished work for the day.

They do the job so much easier if they are kept in good condition besides looking so much more professional. So if you have allowed yours to get rusty it will be well worth the time spent by giving them a good emery papering to make them shiny again. It may seem a

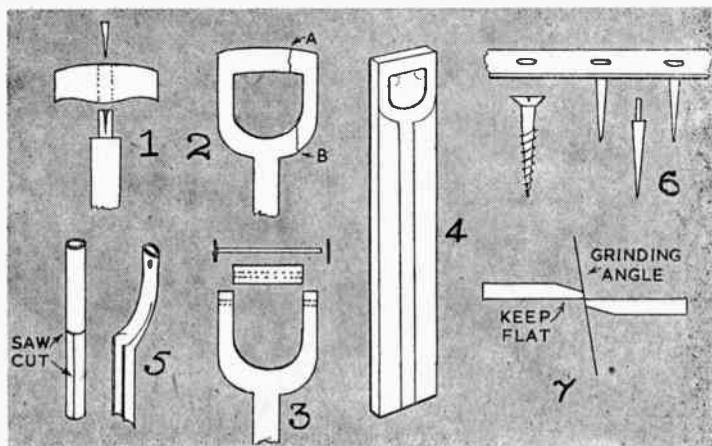

condition a very serviceable grip can be made from a piece of iron piping, one side of which is shown at Fig. 5. The top part is flattened and then bent to shape while the other end is sawn partly through and also sawn down the remaining length. This part is then opened to fit snugly round the shaft and fixed in position with two or three screws. The top end is drilled and a piece of dowel or broom handle fitted the same as Fig. 3.

No trouble should be experienced with rake and hoe handles. It is only necessary to cut off any rotted wood and refit the end. A hoe handle usually fits into a ferrule and is wedged in tight, while a rake is made to fit into a length of tapered tube and is held firm by one or more screws.

## Fork Prongs

It frequently happens that the prong of a fork works loose or is broken off altogether. It is an easy matter to tighten up a loose one by riveting, so also is the making and fitting of a new one. A really first class prong can be made out of a wood screw as shown at Fig. 6. It is only necessary to file the top down to a shoulder and rivet in place.

long and tedious job, but you will not regret it. Then with an oily rag or some vaseline, give them a good rub over. It is also a good idea to give all woodwork an occasional rub with linseed oil as this will preserve the wood and help to keep the wet from rotting them.

## Cutting Tools

Do not forget to include the cutting tools such as shears and pruners in your overhaul. These should be kept clean and bright, and the cutting edges sharpened from time to time.

It is only necessary to grind the edges, and the grinding angle is shown in Fig. 7. The inside surfaces should be kept flat and not ground. It is sufficient just to emery paper these to keep them shiny.

A lot of trouble is often given by the joint working loose due to a faulty nut and bolt. This trouble can generally be cured by fitting a spring washer, but should this not be satisfactory, it will pay to get a new nut and bolt that fits tightly.

When garden tools are out of use for a considerable time they should be well greased, wrapped round with waxed paper or a piece of oily rag and hung up if possible in a dry airy place.

**PAIR OF BELLOWS**

Made from this week's Design Sheet

Kit of Wood (No. 2832) for 6/- (post 9d.)

# There are several varieties of easy-to-make WORKSHOP FIRE ALARMS

**W**HERE woodwork is done and shavings accumulate there is always the risk of fire. This is not a matter that we like to think about too much, but it is one that should not be entirely ignored. It is a duty to take what precautions you can against such an event happening, especially if your workshop is located in a wooden shed. A fire is so easily started and it may be beyond control before you know much about it.

If you make a lot of shavings they should be gathered up and destroyed before they become too unruly. Perhaps you are lucky enough to have electricity in your workshop; then the installation should be checked over by an expert. It is quite easy for sparking to occur at a faulty connection and this

The application of heat near this will melt the wax and so cause the springs to close, thus completing the circuit and ringing the bell.

## The Base

The base can be made of any insulated material such as wood, ebonite or even stout cardboard about 3ins. long by 2ins. wide. Two clips of good springy brass are fastened to the base by the terminals about  $\frac{1}{4}$ in. apart. The spring part is  $1\frac{1}{2}$ ins. long with another  $\frac{1}{2}$ in. bent at right angles for the fastening, making a total length of 2ins. and with a width of  $\frac{1}{4}$ in.

An adjustable screw is fitted about half way along one of the springs for making the actual contact. It could be omitted, but it is possible that when the wax melts a certain amount would run over the contacts and act as an insulator. So it is advisable to put it in and be on the safe side.

Any number of these boards can be made and fitted where you think necessary, but they must all be connected in parallel, as shown in the wiring diagram in Fig. 3. There is one

very important point to remember when fitting this type of contact. Do not put where they may get the direct rays from the sun as there may be quite enough heat from this source to melt the wax and set the bell ringing.

The amount of current necessary to work the installation will depend on the length of the wiring. If your workshop is small and the wiring has been kept short then one cycle battery will be sufficient, but should you have a large number of alarms and a lot of wiring, two connected in series should be enough.

For the wiring ordinary bell wire can be used. A fairly powerful bell is best for the job and it should be placed in a position where it is possible to hear it easily wherever you may be.

Another type of alarm, which is

equally simple and efficient is shown in Fig. 2. Here we have a lever held up by a piece of thin cotton which, when flames approach it, is burnt through, allowing the lever to fall and make the necessary contact. The longer the cotton is left the more efficient will the gadget be. The only disadvantage with this alarm is that it must be fixed in one position only so that the lever is free to fall easily.

A piece of wood about 4ins. by 2ins. will be large enough to mount the parts on. Near the top is fitted a length of dowel rod with screw eyes to hold the cotton in position. The length can be according to the room you have at your disposal, but should not be too long.

## Wood Lever

The lever, made of a fairly heavy wood about 3ins. long, is fixed to the board by a small easily-moving hinge. Contact is obtained by using two brass round head screws, and make sure in the fixing to line them up so that when the lever falls the two screws do make perfect contact.

The two wires necessary for the operation of the alarm are fixed to these two contact points, the one on the lever is led off via the hinge so as not to hinder the lever from falling.

For the person who wants a really first-class job the following suggestions will be found helpful. The ideal system is one which automatically puts the fire out almost as soon as it starts. This may sound rather difficult, but such an installation is not beyond the skill of the average handyman.

The workshop ceiling is fitted with a series of water pipes which are broken at vital spots by little 'sprinkler' valves. These are no more than short lengths of pipe having a small hole, the end of which is plugged with a piece of paraffin wax.

The heat of a fire melts the wax and the rush of water from the jet puts the fire out. The water could come from the house supply, or a tank on the workshop roof might be sufficient to deal with an outbreak. Quite small pipes can be used as there need not be much pressure. If this system is adopted it would be as well to have an electric alarm in operation as well to give warning if a fire does actually start.

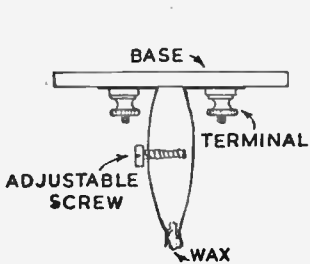

Fig. 1—A simple type

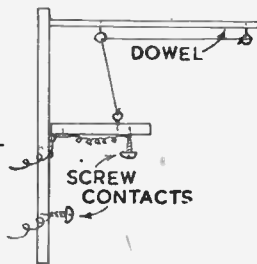

Fig. 2—Lever and cotton

could soon cause a fire.

The most satisfactory way to deal with a fire is to catch it as it starts, and the best method of giving you warning is to fit an automatic fire alarm. There are a variety of quite simple devices that are very efficient and may be made and fitted by any handyman. They all operate in the same manner—when a fire starts the heat causes a circuit to close which in turn rings an electric bell.

They can be fixed in places where you think it most likely for a fire to start, and there is no limit to the number that can be used.

## The Simplest Type

The simplest type is shown in Fig. 1 and consists of an insulated base on which are mounted two pieces of spring kept apart by a piece of paraffin wax.

## Machine Addition

**A** BOX about 6ins. by 4ins. by 4ins. is made to hold, say, three  $\frac{1}{4}$ in. and two 1in. deep drawers, and is made by drilling two holes in machine tray, also top of box, and fastened under either side of tray with two small nuts and bolts. It is handy for holding saw-blades, files, fret-nails, etc., and can be made out of odd pieces of plywood.

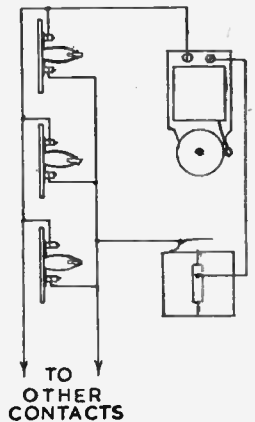
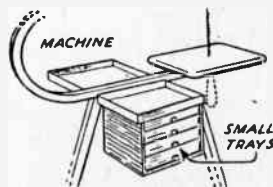

Fig. 3—An extended set

# Add novelty and power by attaching A MODEL CRANE MAGNET

A LOT can be added to the realism of a model crane if it can be made to pick up a load without any fumbling on the part of the operator. That is, if the lifting gear descends on to a package which, without anyone going near it, is raised as the gear once more goes up.

Well, such an action (which is ideal for demonstration purposes) can be obtained by using a simple electro-magnet, as described here. These magnets, as lifting agents, are used on cranes in scrap-iron yards, so you will not be

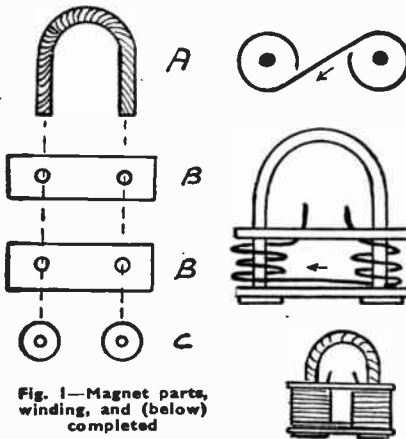

Fig. 1—Magnet parts, winding, and (below) completed

getting so far from real practice in putting one on your own crane.

In the scrap yards the electro magnet (which replaces the hook) is lowered into a pile of iron fragments, the driver switches on the current, the magnet becomes effective and as the crane is reversed, up comes the gear with half a ton of metal sticking to it. The jib swings, down goes the load, the driver switches off and the pile is released but in a new position. Much time is saved with this procedure as compared with the days when every bar almost would have to have been chained and hooked. Also one man can work the whole proceedings.

## Magnetic Attraction

An electro magnet, in its performance, is just like a very strong ordinary magnet. The electro magnet, however, only exerts attraction when a current is being passed through its make-up. Other types of magnets have an attractive force inside themselves which is there all the time. Thus, while 'permanent' and electro magnets in effect are the same, the electro magnet scores from the engineering point of view as the attraction can be entirely stopped or brought into action as the situation demands. Hence its use in crane work.

The principle of the electro magnet is

simple. There is a soft iron core around which is wrapped a length of ordinary electric wire. That is all. A current is sent through the wire and the soft metal core suddenly becomes a magnet, the strength of which depends on the amount of current. Switch off and it is once more a plain piece of iron.

## Making the Magnet

With these details well in mind let us see how we can fit our crane with one of these handy lifters. The crane to which it is attached must not be too small, as the whole magnet will measure about 1½ ins. by 1½ ins., and if the crane is too small this will look out of proportion.

The core (A, Fig. 1) in our case is made of several strands of soft wire twisted together to make a bundle of about ¼ in. diameter. It is 3½ ins. long. This length is then bent into a U-shape with about 1 in. between the legs, and with a height of 1½ ins.

Now cut two pieces of card as (B). These are 1½ ins. long and have holes bored so they will fit on the two prongs of the core. Make the holes smaller than ¼ in., so there will have to be a certain amount of forcing to get them on. Cut also two discs as (C) also with holes less than ¼ in. in the centres.

## Winding

Now fit the first card in position and proceed to wind the magnet. The wire, which is No. 22 S.W.G. D.C.C. double cotton covered, is led in through a hole in the card and given a good number of turns round the one leg of the U, always winding inwards. Start at the top of the leg close under the card and spiral down to about a ¼ in. from the end and then spiral up again over the first layer.

After doing the first winding it is good to put on the second card, as this keeps the wire tight, but takes more time as the wire has to be threaded each time.

Four layers of wire should be put on and then without breaking, carry through another hole in the top card and proceed to wind the second leg, the turns again always coming inward. The important point is that there must be

the same number of turns and layers on each leg.

To make the job firm and keep the wire in one solid mass, each layer of windings should be given a coat of shellac varnish before the next layer is put on. Also to give a finished appearance and to help further, still in keeping the coils solid, wrap strongly gummed paper round each completed leg. A touch of glue on the lower and upper cards where they meet the coils also helps further to keep everything tight. Finally put on the two washers (C) gluing to card above.

When all is dry, file the ends of the core (A) flush with the discs (C). Wrap also the top curve of the core with narrow strips of gum paper.

## On Test

Make a test now. Attach the ends of the winding wire to a battery and if all has gone well the U core will at once become a strong magnet, with the power of holding metal items when a current is passed through the winding wire.

Now to fasten the magnet to our crane. Two quite big lengths of that fine rubber-covered wire as found in ordinary flex stripped of its covering are required. These are to act both as lifting cable and leads. A start is made at the drum. Here two bands of tin, as shown in Fig. 2, are wrapped round near the end, being overlapped and held by single pins.

Before driving right home, however, the cables must be attached, one to each, by baring the wire and twisting it round

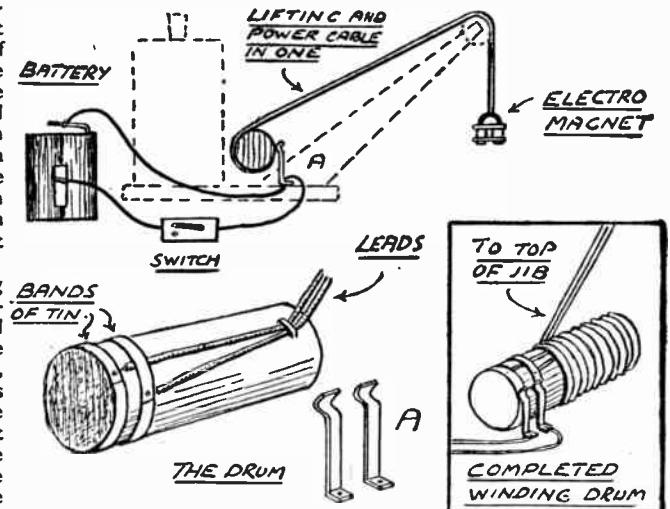

Fig. 2—Working parts and details of the crane

the pin between the band and the wood. The lead to the outer band has to go under the inner one and this is effected by cutting a channel. As flat a surface as

(Continued foot of page 300)



# A practical article to make for yourself is A WIRE-FRAME BED LAMP

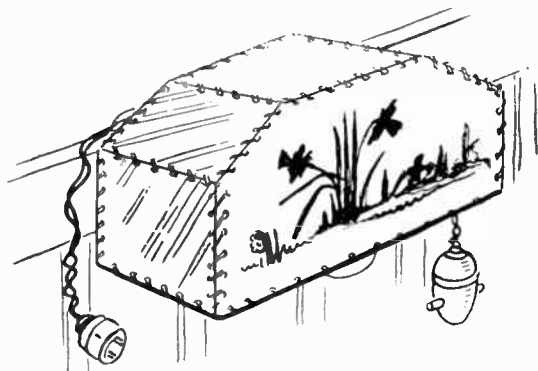

**T**HIS lamp is very easy, indeed, to make and lends itself well to a number of attractive decorative methods of finishing off. For the frame, any fairly stiff wire is suitable. Stout copper wire of about 14 to 16 S.W.G. can be used, and this is particularly convenient if the joints are to be soldered. However, soldering is by no means essential and any kind of wire available may be used. Thick iron wire can usually be obtained from an ironmonger.

## Bending the Pieces

Take a length of the wire and bend it to the shape and dimensions shown (A) in Fig. 1. Straighten the wire to begin with, and make the corners quite sharp, as shown, by using pliers to form the bends. The ends overlap about  $\frac{1}{8}$  in. at the bottom right-hand corner, and this junction is soldered or bound with thin wire or stout glued thread. Make two of these shapes, one being for the front of the lamp.

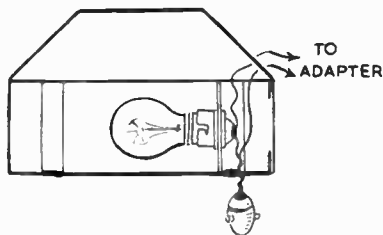

Fig. 2—Bulb mounting and switch

The wire shown at (B) is now bent into shape and fixed in the position illustrated. This wire is not required at the front.

## Lampholder and Brackets

The brackets (C) and (D) are cut from stout tin or other metal and the top of each has a hook which will enable the completed lamp to hang on the bed-rail. Strip (C) will need to be about  $4\frac{1}{2}$  ins. long and  $\frac{1}{2}$  in. wide. The bottom is bent firmly round the wire (A) and the top passes over wire (B), the hooked part

projecting backwards.

Bracket (D) is made in a similar manner, but has a flange and hole, as shown. This flange is bent at right angles so a bulb-holder can be screwed into position. As holders differ slightly in size it is well to make the hole accordingly, so the holder is quite secure when the two milled rims normally holding the shade in position are screwed up tightly on each side of the flange (see Fig. 2).

## Completing the Frame

Six wires of the size shown at (E) in Fig. 1 are now made, with projecting ends about  $\frac{1}{8}$  in. long. One of these is secured at each bend in the perimeter of the wire (A). This may be done by bending the projections once completely round the wire (A) and closing up tight with pliers. After placing the six wires in position, add the front wire which is similar in shape to (A) and bend the ends of wires (E) round, thus forming the box-shaped frame with sloping sides made clear by the illustration.

Many ways of covering the frame will

suggest themselves. Suitable tinted or patterned material may be cut and sewn in position, or six pieces of parchment or thin card may be cut and laced on with coloured ribbon passed through holes near the edges of each piece.

## Finishing the Lamp

The front of the lamp should bear some suitable design, and the craftsman who is handy with colours will have a good opportunity here for designing something interesting and attractive. Whatever type of covering is adopted, the material is placed on from the outside so that the wires, etc., are all concealed.

The electrical wiring is very simple and shown in Fig. 2. Twin flexible leads are taken from the lamp, and a small hanging switch is included in one of the leads so that the bulb can be switched off from the bed. The leads from the lamp may be fitted with an adapter which can be inserted in the ceiling holder, or

power can be taken from any other point, if more convenient.

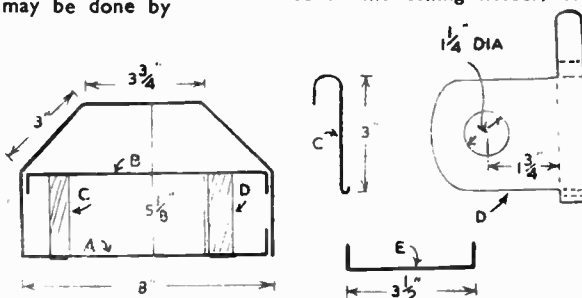
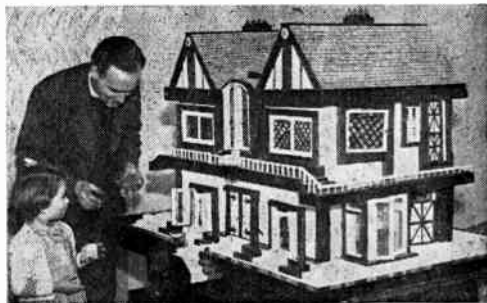

Fig. 1—Dimensions and shape of parts needed

## The Minister Builds a Home

No wonder the little lady gazes with delight and awe at the Doll's House her father has made! The Rev. J. L. Baille, of St. Andrew's Church, Holmfeld, near Halifax, has spent his spare time in four years building a 'dream house'—a combination of all the homes in which he has lived—for his daughter, Jane, age 4½. The house is a one inch to one foot model, has separate lighting in each room, with the switches cunningly concealed in the chimney pots. Two flights of stairs lead from an old-fashioned hall to a landing balcony. There are three bedrooms, dining-room, drawing-room, kitchen, bathroom and garage. Between kitchen and dining-room is a service hatch, while some of the rooms have sliding doors. Imagine the hours of enjoyment the minister had in planning and building, and now the hours of pleasure Jane is going to have using it. That's something like a hobby—pleasure for all concerned!



# This chapter about shrinkage and movement explains MORE ABOUT TIMBER

It will, no doubt, have been noticed by readers that most articles of furniture and the timber-made fixtures in the home, such as doors, window frames, and sashes, are all constructed on the principle of the frame. The two main reasons for this are:—

- (1). Reduction of shrinkage.
- (2). Increased strength.

Suppose for a moment you had a large tree, recently felled, and that from it you obtained a plank of timber the size of a front door, and for this purpose put it to use.

No doubt it could be made very attractive at first, but as the natural

The major solution to timber shrinkage is found in using seasoned or dried-out timber. This is material that has been stacked for lengthy periods and has slowly given up its moisture.

Alternatively, it may have been dried in a modern kiln, a much quicker process which has the advantage of being under control during its drying, also that the timber can be brought down to any degree of dryness. This degree is known as the moisture content. Timber dried out to approx. 14% M/C would be considered dry and is the usual amount for furniture or other high class woodwork intended for indoor use.

If timber with this moisture content were to be made up in an article of furniture, and finally placed in a damp atmosphere, the natural tendency of the wood, would be to absorb moisture until it found its own level

movement is seen in the construction of a panelled door or sideboard. Panels are put in a groove all round (Fig. 2), or are put in a rebate (Fig. 3) and 'beaded-in'. Whichever method is adopted the panel is free to move. Whereas had it been fixed at each outer edge any contraction would have resulted in a crack permanently marring the work.

For this reason it is as well to bear in mind that in fixing a moulding round the panel, avoid allowing the fixing nail entering the panel edges.

A drawing or pastry board is another typical example of provision for movement. A well-made board will have cleats screwed on the back with round headed screws engaging in slots instead of holes. It will be seen in Fig. 4 that the centre screw is not allowed to slide. This is to keep the panel central, the movement being equal each side.

The methods of holding down kitchen table tops, shop and bank counters, are very similar, the aim for all is a sound fixing yet allowing for movement. The kitchen table has probably the greatest

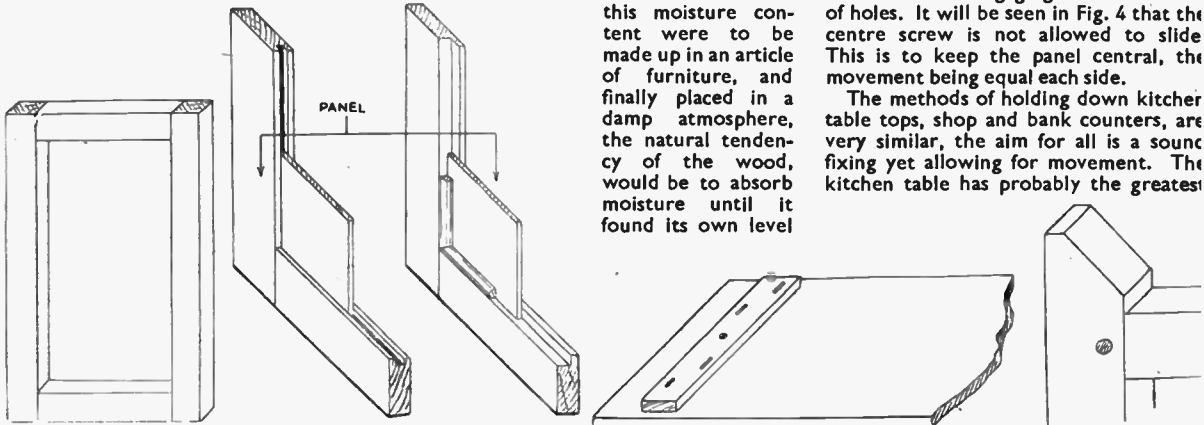

Fig. 1—The frame system Figs. 2 & 3—Two methods of fixing panels Fig. 4—A slotted truss to allow contraction Fig. 6—Dowel pin

shrinkage took place, its width would probably be reduced to such an extent as to render the door useless for its purpose. As timber does not shrink in its length the height of the door would be unaffected.

The fact that timber shrunk only in width as it gave up its natural moisture was learnt in the very early days, and the knowledge has been put to practical use ever since by constructing work where possible in the manner of a frame, as shown in Fig. 1.

## Shrinkage

Any shrinkage that takes place in the width of the timber is confined to the narrow members with consequent reduction in the total shrinkage possible. In addition, extra strength is obtained by the cross members having their grain running at right angles to the uprights.

The basic need for framing is the same whether the work is large, such as the front door, or part of a sideboard, but, naturally, the smaller the work the smaller the timber used and, therefore, less shrinkage takes place. Wide or narrow, however, there is bound to be movement in timber and provision must be made to reduce its effects to a minimum.

with the surrounding atmosphere. Similarly when the air became drier the timber would dry out again.

Temperature also has its effect. A hot day will cause the members contained in a piece of furniture to dry and warp, and during the night when the temperature drops the timber will tend once again to return to normal. This often creates creaking in the process, as a member gets released of its stress, especially where wide timbers have been used.

## Allowing for Natural Movement

A good example of provision for

need for freedom of movement, it being made of a white soft wood, after scrubbed, and frequently near an oven.

The fixing used in all of these articles is the time honoured 'button' in wood or metal. Both types are shown in use in Fig. 5. The wooden type is usually made from hardwood 2½ ins. square and ¾ in. thick with a ½ in. tongue engaging in the rail.

## On Dowels

It frequently happens that a dowel is required to give additional strength to a joint, or as sole means of fixing a tenon. Its position is once again governed by the known tendency of timber to shrink. Reference to Fig. 6 will show that the dowel is nearer the shoulder of the tenon. This, apart from extra strength on the pull of the tenon, ensures that the major shrinkage will take place at the outside edge of the work, leaving the shoulder a tight fit.

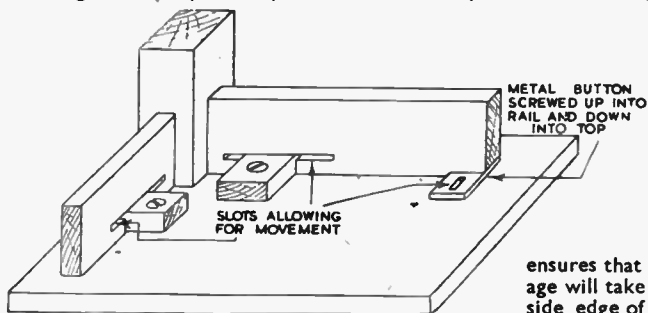

Fig. 5—Underside showing fixing to allow movement

# A worth-while job for the handyman is the way to RENEW SMALL WINDOWS

**M**ANY home-craftsmen show a profit on the sale of toys made in the course of their hobbies. But money—which will buy new tools and lead to more ambitious and interesting work—can also be made by doing jobs in the houses of neighbours and friends.

For example, although large windows are best left to experienced workers, even the most amateur of hobbyists can make a sturdy job of replacing small pantry windows. And, indeed, in many houses—especially where these little windows face on to someone else's property—they are often overlooked and become rotten through neglect.

By undertaking to renew such a window, experience, as well as profit can be gained. The plan given here calls for no special tools and only a small outlay of cash—an astonishingly small amount, in fact, when compared with the fee which would be charged by a jobbing builder.

## Measuring the Job

The first thing to do is to obtain the measurements of the window frame. Using a hammer and old chisel, knock away the cement from around the outside of the old window so the edges of the wood are revealed. Having taken the measurements leave the old window in place until the new one is ready for fitting.

This plan enables you to pre-fabricate the new window as a whole unit, and the wood wedge or wedges and the cement on the inside of the old window will hold it in place until you are ready to make the change.

Wood 2ins. square is ideal for the new frame. It will be strong enough to make a cross-bar unnecessary, and is easy to measure for the simple joints. It can be bought from a joiner or timber merchant, who will usually be willing to cut it to the exact lengths you want. The top and

bottom should be the whole width of the window frame and the sides the whole height so that the joints can be made.

## A Simple Joint

The simple joint shown in the illustration is quite suitable for this type of rigid, unmoving work. Mortise and tenon joints, though of better appearance, are more difficult and only really necessary when making a moving framework such as a door or in furniture which has to stand uneven stress and where appearance is of the greatest consideration.

On each end and on the same side of each of the four lengths of wood, mark off with pencil and ruler the wood to be cut away. This will be a block 1in. deep and 2ins. square. Use saw and chisel with great care so the frame fits together very evenly. The joints should be glued for a perfect finish, but one or two nails through each joint are sufficient to make the whole perfectly rigid.

A piece of perforated zinc or small gauge wire mesh is used on the outside to keep out flies. A neat job will be made by fastening it down with a frame of 3/4in. wood bars, but, if these are not available, an efficient and not unsightly finish can be obtained by merely turning under the edges of the zinc or mesh, gently hammering these flat and fastening with large-headed nails or screws at frequent intervals.

## The Moving Part

The moving part of the window can most easily be made from a single piece of 1in. thick, well-seasoned wood 4ins. shorter and narrower than the outside measurements of the frame. That is, it is cut to fit snugly inside the frame. All around this wood, measure off 2ins. and, by boring or chiseling a hole and using a fretsaw, cut out the centre marked off.

A sheet of glass 1in. longer and wider

than the cut-out portion is then fitted to the outside of this single piece window. It may be sunk in level and made water-tight with putty, but an excellent utility job can be made by merely fixing it with two large-headed screws at each of the four corners. The zinc or mesh will carry off most of the rain, so that an absolutely water-tight job is not essential.

This little window is hinged to the frame, either on the outside of the prefabricated unit, or, preferably countersunk on the inside of the 2in. square frame and the edge of the moving

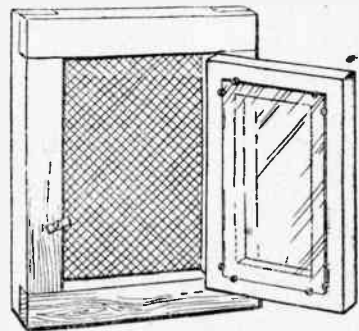

window. Finally, a simple catch is fitted to hold the moving window shut.

The new window unit is now complete. From around the inside of the old frame, knock away the remaining cement. One or two wedges will be revealed and these should be hammered and levered free. The old frame will then come out easily.

Any old cement remaining on the masonry should be scraped away. The new window unit is then put in position and fixed firmly with a wooden wedge of such a length that it will not stick out beyond the edge of the new frame. This single wedge will, in most cases, be quite sufficient to hold the frame perfectly rigid, but another may be driven in at the worker's discretion.

## Suitable Cement

Cement suitable for making the frame a part of the wall can be bought ready mixed in small quantities from most builders' merchants. 'Mastic' is ideal for the outside, but is slow to set indoors, so you should be careful to state your requirements fully. Economy in its use can be made by stuffing any wide gap between wood and masonry with newspaper. This will also make a foundation for the cement.

Although so simple and inexpensive to construct and fit, this finished job, when painted to harmonise with the general colour scheme of its surroundings, should be its own advertisement and bring you more work of a similar kind, if you wish it.

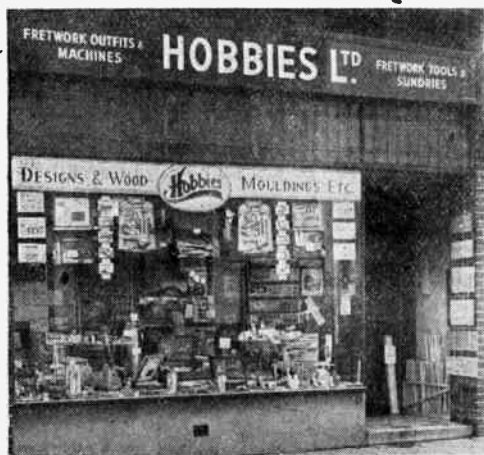

## HOBBIES IN BRISTOL

*This is a picture of the new branch of Hobbies Ltd., recently opened at 30 Narrow Wine Street, Bristol, and which has already become a centre for handymen and craftsmen in that busy corner of the country. Anyone living near should certainly call—there is a range of tools and materials to delight the heart of any reader. Or you can ring Bristol 23744.*



## Electric Guitar

I AM making an electric Hawaiian guitar, but the problem I have, concerns the making of the pickup to go under the six strings against the bridge. I have temporarily put a single headphone with the diaphragm off under one string, and it picks up O.K. I would be pleased if you could tell me how to pick up from the six strings. (J.J.—Norton).

As the magnets of the earpiece are not wide enough to pass under all the six strings, it is necessary to mount the phone under the bridge. To do this, replace the diaphragm, but leave the ebonite cover removed, if it is at all large.

A very low bridge is now cut from any hard wood, with small notches for the strings. This bridge is placed upon the earpiece, and it will be found that the tension of the strings will hold it in place. The bridge should be curved slightly in the centre, so that it does not push the diaphragm down on the magnet poles, and all the strings will then be reproduced.

## Table Heat Stains

I WOULD like to know the best way of removing hot iron stains off a polished table top. (R.A.—Knottingly).

SPREAD a little warm camphorated oil over the marks on the table, and rub well with a pad of clean rags folded up. As the marks disappear, sprinkle the face of the pad with spirit of camphor until it feels slightly damp but not wet. Follow up the rubbing with this, rather lightly at first, then bearing harder as the pad dries. Finally, remove traces of the oil with another pad dampened with brown vinegar.

## Developing Prints

WHEN developing prints in photography, my results dry a light red, where it should be white. Not all my prints are faulty. Please would you tell me what I do wrong. (D.P.—Levenshulme).

IT appears you are not fixing your prints properly. You should, im-

mediately after developing each print, give it a brief rinse in clean water (only a second or two), and then immerse it completely (this is important), in an acid fixing bath. The prints should remain in the fixer for at least ten minutes, and should be kept moving and well submerged for the first five minutes at least. Half an hour's washing in running water will complete the job.

An acid fixing bath of the correct strength for prints, may be made by adding 1 oz. of Johnson's Acid Hypo to 15 ozs. ( $\frac{3}{4}$ -pint) of warm water.

The red stains are due to the developer left in the print, after incomplete fixing and washing, oxidizing on contact with the air.

## Plywood Canoes

I AM designing a canoe, and I was thinking of using plywood as the covering, but I wondered if it would flake or warp in any way, even if it were painted properly. (D.W.—Aldermaston).

PLYWOOD by itself cannot be recommended as the web tends to separate the plies, even when painted. It can, however, be used as a support for canvas or twill covering when the design of the canoe permits, and therein lies its usefulness.

We suggest you coat the plywood with good quality lead coloured paint, then cover it while the paint is still wet, with a strong twill or calico; press down until it adheres all over. When dry, coat with boiled linseed oil to which a little driers has been added, and then when the oil has dried, it takes a few days, paint two coats all over. Don't forget to paint the inside surface of the plywood, too.

## Fire Balloons

I AM most anxious to construct a fire balloon, and have had several attempts without success. Can you supply me with some instructions? (C.M.—Sutton Coldfield).

THE best way to make a fire balloon is to construct the balloon with a series of shaped strips of thin tissue

paper. For a balloon about 2ft. diameter, you would require 12 strips 6in. wide in the centre, tapering to nothing (or a pointed end) at one end, and tapering from the middle to the other end which should be about 2in. wide. The strips should be about 3ft. long. Lay all the strips on a flat surface—side by side—then join them together by pasting their edges. Allow to dry, then roll the outside strips over and join them, thus making a ring, then gradually join all the edges by pasting them together.

Complete the top with a disc of tissue paper. Fix a very light wire ring around the bottom part, which should now be open and about 7in. diameter.

Fix two cross wires (very light) at rightangles to each other to the ring, fix a wad of cotton wool to the centre, soak it in methylated spirit. Hold the balloon up by a cotton loop fixed to the top, light the spirit and after a few seconds when the air has had time to heat up in the balloon, let go—and the balloon should ascend to a good height.

Coloured tissue paper gives a brighter and more attractive effect than plain white.

## Workshop Warming

WILL you tell me the best method of making my workshop cooler during the hot weather, as it is like a bakehouse in the middle of Africa. It is made of corrugated galvanized sheets, and is very cold in winter. (R.S.M.—Penrhwiweiber).

FUNDAMENTALLY, the only way to keep your workshop cooler in summer and warmer in winter, is to fix an inner lining to all the walls and roof area. For this purpose, use thick building board (about  $\frac{3}{4}$ in. to  $\frac{1}{2}$ in. thick). Nail this to a wooden framework and arrange it so there is a free air gap of at least 2in. between the inner lining and the outer walls.

Next arrange means to circulate the air in the gap between the walls; for instance, by providing air inlets all around the bottom and using a chimney or pipe about  $1\frac{1}{2}$ in. and some 3ft. or 4ft. long to draw the hot air out from the top.

A quick way of reducing the heat is to erect a span roof tent covering over the roof some 6in. or so above it—to provide shade and a free air flow. Spraying the exterior with water also helps keep it cool, but only for short periods.

## Crane Magnet—(Continued from page 296)

possible has to be given to the bands, so the pins are driven well in and the heads filed fairly flat.

Take the leads along the drum to the further end and fasten with a U-staple, and then wind a good length on to the wood. From here take the cables over the pulley on the jib and attach the magnet by binding them (over the rubber) to the top of the U core with fine wire. This takes the load, the electric connection being effected by

barring the separate ends and fastening them to the ends of the magnet winding, one to each, seeing that there is no shorting.

Back at the drum now cut two pieces of strong tin as (A) Fig. 2 (clock spring with the temper taken out of one end would be the best). These must be so fixed that they slide and press against the tin bands, and they may have to be fitted differently on different cranes. From their base two cables are led to a

cycle lamp battery, a simple switch being put in on one lead.

By this arrangement the magnet can go up and down with the lifting end of the cable and its power of attraction can be brought into force or cut off at will by the switch.

Finally, of course, the loads to be lifted should either be of metal or contain some metal parts. Thus, model bales could be made, bound with tin bands, etc.

# A few pieces of wood and the fretsaw will make A NOVEL PIPE STAND

THE novel pipe stand indicated in Fig. 1 of the accompanying illustrations is just the thing to make for a present, for the construction is quite simple.

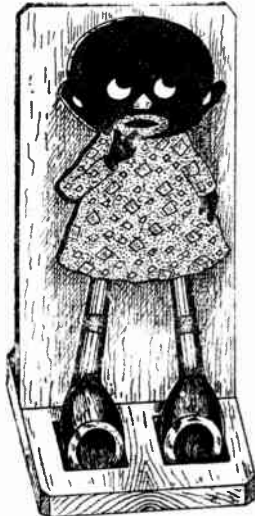

Fig. 1—The holder complete. The figure to be cut from a sound piece of wood  $\frac{1}{4}$  in. thick, is indicated in Fig. 2. First cut the wood to size  $6\frac{1}{2}$  ins. long by 4 ins. wide, and carefully divide one face into  $\frac{1}{2}$  in. squares, as indicated in Fig. 2.

It is now a simple matter to draw the figure on the wood from the outline given. Take care when marking off and cutting out the three mortise slots,  $\frac{1}{2}$  in. by  $\frac{1}{2}$  in. given in position in Fig. 2. Only the outline of the figure is cut out, since the hands, eyes, nose, mouth, and ears are treated with enamel paint.

The base is indicated in Fig. 3, and a nice piece of wood  $\frac{1}{2}$  in. thick is required.

Cut the wood to size  $4\frac{3}{4}$  ins. long, and 5 ins. wide, angle the corners off  $\frac{1}{2}$  in. 45 degrees, as indicated. Cut two mortise slots 1 in. by  $\frac{1}{2}$  in., in the positions indicated, to take the upright piece. Two recesses  $1\frac{1}{2}$  ins. by  $1\frac{1}{2}$  ins. are cut in the positions indicated, which are made  $\frac{3}{8}$  in. deep to take the bowl of the pipes.

The upright for the stand is indicated in Fig. 4, and this is made in wood  $\frac{1}{4}$  in. thick. Cut the wood to size 10 ins. long by 5 ins. wide, and angle off the top corners  $\frac{1}{2}$  in. 45 degrees, as shown. On the bottom edge carefully mark off the two tenons, as indicated, and cut them to a good fit in the mortise slots already made in the base. Mark off and carefully cut the three mortise slots  $\frac{1}{2}$  in. by  $\frac{1}{2}$  in.,

as clearly indicated (see Fig. 4).

It now remains to make three spacers which support the figure to the upright, and at the same time provide two partitions to take the pipe stems. Details of the spacers are given in Fig. 5, and these are made in wood  $\frac{1}{4}$  in. thick.

First cut the three pieces of wood  $2\frac{1}{2}$  ins. long by 2 ins. wide, and carefully cut the tenons on the centre of each end, making them  $\frac{1}{2}$  in. wide and a good fit in the mortise slots already cut in the figure indicated in Fig. 2, and the upright Fig. 4. Having made the items see they are smooth and nicely finished, and then fix together with glue.

First fix the upright into the base, then the three spacers into the upright, and finally the figure on to the front of the spacers.

The figure may be coloured with enamel paint, using black for the face, with red lips and black hands. The pinafore may be coloured in white enamel and spotted, as indicated, with black enamel. The rest of the stand may be nicely finished off with stain.



Fig. 2—The figure

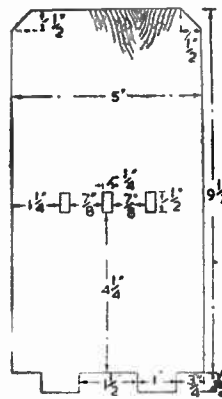

Fig. 3—Main back

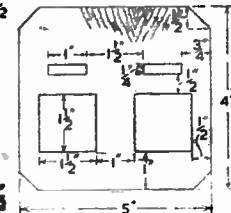

Fig. 4—The base

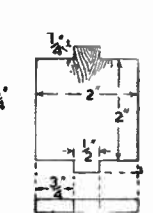
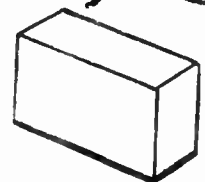
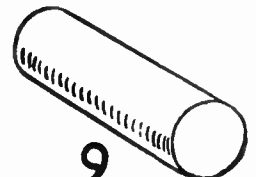
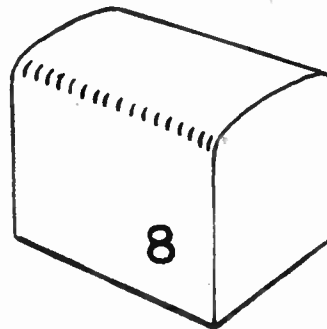
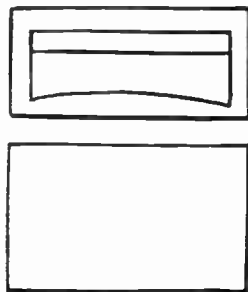
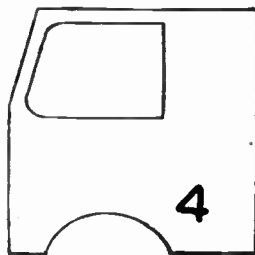
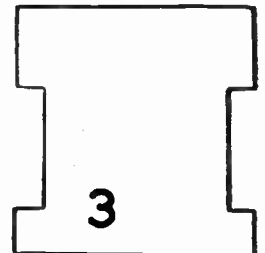
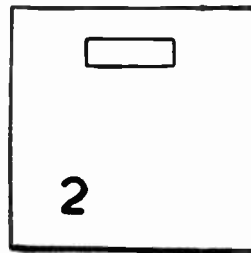
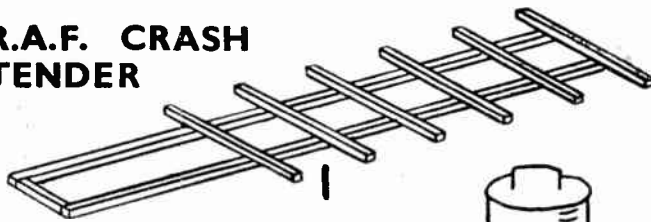

Fig. 5—Spacers

## R.A.F. CRASH TENDER



See details on page 291

# A further selection of practical and simple HANDYMAN CEMENTS

## Shoemakers' Paste

**S**ECOND-QUALITY glutinous wheat starch which has been allowed to putrefy at a temperature of about 50 degrees Centigrade for some time acquires special gummy properties which cause it to adhere to leather in an unrivalled manner. With it leather can be secured to woven fabrics as well as to leather.

6½oz. of this liquor with 6½oz. of water, and in it solve 1lb. of best gelatine; finally adding 1½oz. of strong (glacial) acetic acid and a few drops of carbolic acid as a preservative.

in a closed bottle filled with either amyl acetate ('pear essence') or acetone (dimethyl-ketone). As the celluloid swells up during solution only enough solvent should be used to form a creamy transparent liquid. The surfaces of celluloid being united must be roughened by scraping or sandpapering. They should also both be treated with the cement and placed in immediate contact, not being disturbed till thoroughly set.

## Celluloid Cement

**F**INE turnings or scraps of celluloid may be made into a perfect cement for celluloid by allowing them to digest

## Paste for Labels

**F**OR adhesive labels dissolve 1½oz. of common glue which has been immersed in cold water for a day, a little sugar and ¾oz. gum arabic, in 6oz. of hot water, stirring constantly till all are solved. This adhesive, applied to labels and allowed to dry, renders them suitable for use by moistening with the tongue.

## Non-moulding Paste

**A**PASTE for general office use equal to many of the branded varieties may be made from equal parts of dextrine and starch paste to which has been added a little magnesium chloride and oil of cloves. It may be thinned with cold water.

## Another Liquid Glue

**A**WELL-KNOWN recipe for liquid glue is scotch glue 12 parts, water 32 parts, spirits of salts 2 parts and zinc sulphate 3 parts. The mixture should be warmed for 12 hours and kept agitated. This glue does not gelatinize.

## 'Universal' Cement (Liquid)

**U**NDER this name are known many useful preparations that adhere strongly to almost any substance—wood, leather, metal, glass, etc. Here is a recipe for such a cement, and it is especially useful for repairing mineralogical specimens and similar articles. Grind down to a powder 2oz. of clear gum arabic, and dissolve it in a little water, then add 1½oz. best starch and ½oz. sugar to the solution, heating the mixture over a water-bath till the starch clears. The cement should be as thick as tar, and should remain so; and it can be kept from decomposing by the addition of a small lump of camphor or a few drops of oil of cloves or saffras.

## 'Universal' Cement (Solid)

**S**HELLAC in pre-cast stick form is a good cement for most articles, and a mixture of 2 parts of it and 1 part of Venice turpentine also forms a strong adhesive.

Another so-called 'universal' cement is made by dissolving ¼lb. sugar in 1½lb. water and adding to the thin syrup thus obtained 2oz. of slaked lime; and allowing the mixture to digest in a warm place for two days, after which the clear liquor is decanted from it. Now mix



Build this  
charming Model  
Village with

**BRICKPLAYER**  
Brick and  
Mortar Building  
Kit and Accessories

The Brickplayer Kit contains miniature bricks in all required shapes, mortar, roofing, metal windows and doors, plans and instruction booklet. All models are architect designed to "O" gauge scale. Buildings can be permanent or dismantled by merely soaking in water, and the bricks used again and again.

Brickplayer Kits at 23/10 and 44/- and Accessories are available from good hobby shops, toyshops and stores.

### ENTER FOR THE BRICKPLAYER COMPETITION

Prizes of £10 10s., £5 5s. and £3 3s., and a number of consolation prizes of Brickplayer Accessories will be awarded for winning models. Write for full details.



*If your dealer cannot supply, write for address of nearest stockists to*

J. W. SPEAR & SONS, LTD., Dept. "H.", ENFIELD, MIDDX.

302

# For Perfectly GLUED JOINTS

—follow modern professional practice. Use Croid. Scientifically prepared and supplied ready mixed, CROID is REAL Glue at its best and strongest. It gives you the same high strength every time you use it, avoiding messy preparation and uncertainty. Croid AERO Glue is a hot glue for deep penetration; Croid Universal in tubes for lighter work.



CROID LTD., IMPERIAL HOUSE, KINGSWAY, LONDON, W.C.2

**OVER 5,000**  
**ex-R.A.F. Apprentices**  
have reached commissioned rank

✦ So may you — one day.  
If you are chosen to be an R.A.F. Apprentice you will be trained for a skilled trade, and continue your general education. You will have far more opportunities for sport than most boys. You will be well fed and cared for, and receive good pocket money. And you may end up not only with a commission — but with a flying commission.

Send the coupon. It will not commit you to anything. It may lead to great things.

TO:—AIR MINISTRY, DEPT. HS.44,  
VICTORY HOUSE, KINGSWAY, LONDON, W.C.2.

I am between 15 and 17½. Please send details of R.A.F. Apprenticeships.

NAME .....  
ADDRESS .....



**SOLID LEATHER  
BRAND NEW  
ARMY  
JERKINS** 12/6  
Pt., etc., 1/3  
1st grade supple, solid, smooth brown leather jerkin. Army regulation quality. Worth £5. This warm garment made for the N.Z. Forces will last many years. Over or under jacket or as separate garment. For sports, golf, motoring, hard wear. State chest size. Buy NOW. Brand New. 12/6. Post, etc., 1/3. 3 Post Free. Also Ladies' Model.

**BRAND NEW  
COMMANDO  
BOOTS** 21/-  
Post 1/3  
The finest, hardest-wearing boots ever made to stand up to the biggest gruelling ever. Comfortable. All sizes. Solid leather tough grained uppers and hand-sewn welted soles that just won't wear out. To clear 21/- Post, etc., 1/3.

HEADQUARTERS & GENERAL SUPPLIES LTD. (Dept. HOB),  
196-200 Coldharbour Lane, Loughborough Junction, London, S.E.5.  
Open All Day Saturday.

## YOU CAN BECOME A HANDICRAFTS INSTRUCTOR

Experience not essential  
Men who enjoy making things in wood or metal can turn their hobby into a well-paid, permanent and interesting Career. Short hours, long holidays, and security in a job you would really enjoy, can be yours if you become a Handicrafts Instructor. Let us send details of the easiest and quickest way to get the necessary qualification.

We definitely guarantee  
"NO PASS—NO FEE"  
If you would like to know about our unique method of preparing you for one of these excellent appointments, write today, and we will send you our informative 175-page Handbook—free and without obligation. Mark your letters "Handicrafts Instructor".

**BRITISH INSTITUTE OF  
ENGINEERING TECHNOLOGY**  
595 Shakespeare House  
Stratford Place, London, W.1

# BIET

Indispensable to all interested in motor cars.

The two popular Car Books  
"WHERE'S THAT CAR FROM!"  
"POPULAR CARS ILLUSTRATED"  
6d. each

From all Stationers and Booksellers  
or from **RALEIGH PRESS, EXMOUTH**

## WEBLEY AIR PISTOLS



Marvellously accurate for target practice.  
No licence required to purchase.

Senior Mark 1  
Junior Webley Air Rifle  
Write for List. **WEBLEY & SCOTT LTD.,**  
166 WEAMAN STREET, BIRMINGHAM. Eng.

# BE STRONG

I Guarantee, as a Builder of Men for 22 years, to give you 10 to 25 inches more Muscle in 30 days—or money back. Full details of famous 4-in-1 Course, recommended by 'Health & Strength' since 1928, sent under plain cover on receipt of 1d. stamp. **Lionel Stebbing Institute (HB/10),** 28 Dean Road, London, N.W.2. Established 1928

## TOY AND MODELMAKERS SUPPLIES

1" Hardwood Wheels, Recessed	1/6 dozen	7/6 half-gross	14/6 gross
1 1/2" " " "	2/-	11/-	20/-
2" " " "	2/3	12/6	23/-
1" Pressed Metal Wheels	1/-	4/-	7/6
1 1/2" " " "	1/3	5/-	9/-
2" " " "	1/6	6/6	11/6

Stove Enamelled Wheels, Rubber Tyred Wheels, Doll's House Windows, Doors, Papers, Model Kits and Accessories. Catalogues and Lists, 1/-

**JASONS, 135 Nags Head Rd., Ponders End, Middlesex**

# A new solder

## FOR WORKSHOP AND HANDYMAN

- CONTAINS 2 CORES OF FLUX
- NO EXTRA FLUX REQUIRED
- REPLACES STICK SOLDER, FLUID AND PASTE FLUXES
- IF DESIRED FLUX RESIDUE READILY WASHES OFF WITH WATER
- SO FAST THAT IT WILL EVEN SOLDER BLUED SPRING STEEL WITHOUT PRE-CLEANING

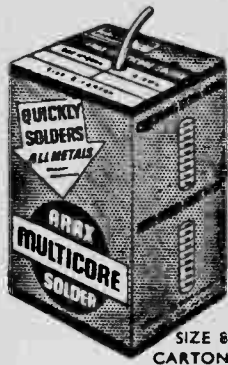

No. 10 KIT 2/- each

5/- each



Available in 5/- retail cartons (4 specifications) or 2/- Multicore Solder Kit contains 2 specifications Arax Multicore Solder and 2 specifications Ersin Multicore Solder for electrical wire to tag joints. Now obtainable from many stores. In case of difficulty 5/- cartons or 2/- Multicore Solder Kits sent post free on receipt of postal order or stamps.

MULTICORE SOLDERS LTD., MELLIER HOUSE, ALBEMARLE ST., LONDON, W.1

A MODEL REPAIR  
OUTFIT IN THE  
PALM OF YOUR HAND

TO SEAL AND MEND  
AS WELL AS ASSIST  
IN CONSTRUCTION

# "DUREX" Tape-it!

- STICKS AT A TOUCH
- SEALS WITHOUT MOISTENING
- TRANSPARENT AS GLASS

A broken 'plane wing, a damaged kite, a cracked doll—they're all put right in a jiffy with "DUREX" Cellulose Tape. Clean and easy to handle, it sticks at a touch, is as transparent as glass and is the handiest thing in the home for mounting snaps, for sticking parcels, repairing torn books and every other sticking job.

Trade Enquiries:  
Durex Abrasives Ltd., Birmingham 8

# "DUREX" Cellulose TAPE

Has every Sealing Job TAPED

# Treat Yourself to a Fretmachine!

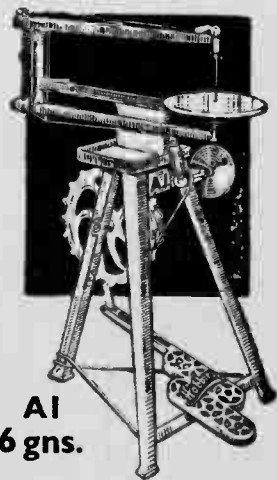

The trusted friend of woodworkers everywhere. A sturdy, sweet-running fretmachine, with tilting table for bevel cutting. It has a clearance of 19ins. behind the saw. Quick, positive tensioning to the sawblade by means of lever on top arm. Cuts wood up to 3/4in. thick.

Ever thought of the time you would save..... the increased output..... which a Hobbies machine provides. Time and time again, it is a definite money-saving opportunity. Moneymaking, too, if you make things to sell. Write for list to Hobbies Limited, Dereham, Norfolk, or see them at Branches, Stores and Ironmongers.

## THE MARVEL

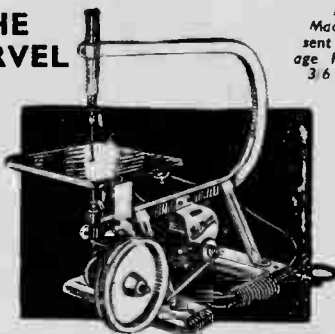

The Marvel Bench Fretmachine. Welded steel frame, vertical stroke adjustable saw tension, working parts made from hardened steel. 17ins. clear behind sawblade. With 230/250 AC/DC motor £10. Without motor 70/- Details on request.

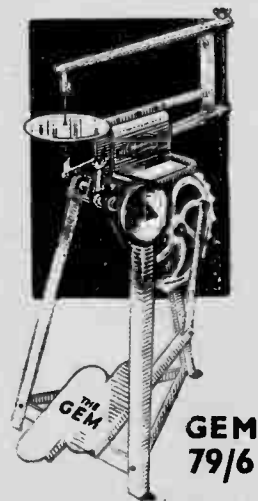

Made almost entirely of steel. Non-tilting table. 18ins. clear behind sawblade. Not a toy..... but a sound workmanlike machine built to last. Cuts wood up to 1/2in. thick.



# Hobbies

## WEEKLY

### CONTENTS

	Page
Concrete Work - -	305
Automatic Door Light	307
Electrifying Model Railways -	308
Novel Trotting Animal	309
Collapsible Bed Tray -	310
Multirange Radio Meter -	311
Home-made Slides -	312
Glove Making - - -	313
Household Chemistry	314
Photography - - -	315
Home-made Floor Polisher -	316
Animal Patterns - -	319

February 15th, 1950

Price Fourpence

Vol. 109 No. 2833

IN this uncertain climate the amateur gardener has all too little time for jobs essential to the proper cultivation of his 'blessed plot' without having to waste precious hours on jobs that need not be done at all.

The weeding of gravel paths, for example, is a task no gardener loves, and it must be done three or four times, at least, every season. There is nothing more unsightly than those long-tentacled tufts of green that not only disfigure the

path but burrow into the subsoil, and when extracted leave the golden surface pitted with what look like miniature bomb-craters.

The alternative to hand-weeding is to use a weed-killer—and as weeds usually flourish best at the sides of the path, the grass borders are likely to suffer as well from the application of poisonous solutions or powders.

#### Paths

So why tolerate gravel paths? Concrete ones can be equally attractive, and once they are down they need practically no attention. Concrete is clean and firm in all weathers. The warm golden colour of gravel is admittedly more attractive than the cold greyness of 'neat' concrete, but this objection is easily overcome by the admixture of powder colour with the concrete 'mix' used on the surface.

A concrete path should be from 3ins. to 4ins. thick, and if space allows should be at least 3ft. wide. The site should be excavated to such a depth as to allow the path when finished to be 1in. below the level of the bordering grass. This makes it easy to keep the grass edges trim and neat. The soil foundation should then be well rammed down, and a sprinkling of broken brick, clinker, or stones raked from the kitchen garden should be incorporated.

#### Proportions of 'Mix'

The first layer of concrete should be made of a 'mix' consisting of one part of cement to seven of hoggin—the kind of rough, unsifted gravel that is the raw material excavated from the pit. The proportion of cement to gravel may seem small, but it is quite sufficient.

## CONCRETE FOR USE AND ORNAMENT

Mix the cement and hoggin very thoroughly before adding water, and do not make too big a 'mix' at one go. It is surprising how heavy and sticky this stuff can be when water has been added. When thoroughly mixed into a compact, round heap, make a round 'crater' in the middle with the spade. Add water a little at a time, turning the edges of the heap over into the centre after each watering. Do not add too much water, but just sufficient to eliminate all dryness from the cement. Over-watering causes the cement to sink down to the bottom when laid, leaving the surface with nothing to bind it together.

For levelling out the 'mix' one needs a strong 'float'. One can easily be made with a flat oblong of hardwood about

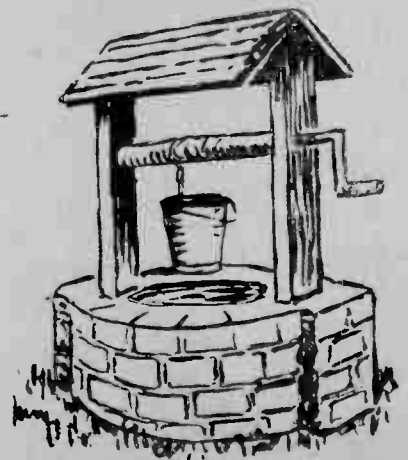
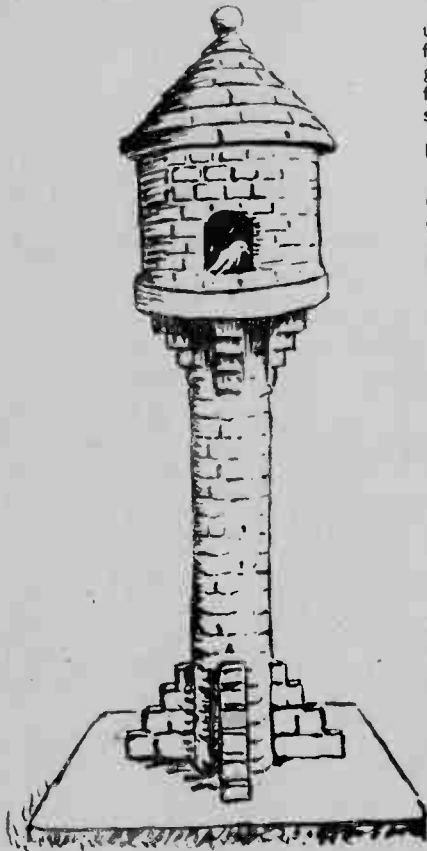

All correspondence should be addressed to The Editor, Hobbies Weekly, Dereham, Norfolk.

15ins. by 4ins., with a hand-grip of wood nailed or screwed on to the centre of the back.

To ensure that the path shall be of a uniform thickness, small wooden pegs should be driven along the middle of the path foundation at intervals of 1yd. or so, due allowance being made so that the finished path shall be 1in. higher in the middle than at the sides. The rougher the surface of this first layer the better, as it affords a more efficient 'key' for the smooth top layer.

### The Topping

This latter calls for a 'mix' consisting of one part of cement to either two or three of clean, sharp sand. The three-to-one mix gives the better non-slip finish, and in any case it should be mixed rather wetter than the under-layer, to permit of easy spreading. But it should never be watered to the point of sloppiness. It should be pressed, with the float, well into the crevices of the under-layer, and its average thickness need be no more than 3in.

A warm, portland-stone-like effect can be achieved by mixing yellow ochre powder with the dry cement and sand. One part of colour to ten of cement is best. A reddish-pink colour can be obtained by similarly adding red oxide powder. This is more intense than yellow ochre and only about a quarter as much of the red is needed.

### A 'Crazy' Path

To give a crazy or rectangular flagged effect to the path, either draw the point of a stick across the wet concrete 'freehand' according to your fancy, or place a short length of planking lightly on the surface and use it as a straight-edge for the lines.

Never attempt to lay concrete in frosty weather; if night frosts are at all likely, newly-laid concrete should be completely covered by sacking with an ample overlap and no gaps.

Concrete ornaments can add greatly to the interest of a garden—and one can get a lot of fun in the making of them.

The ready-made stuff always has a mass-produced look—and there is always the risk, if you buy an ornament, that you will find its twin in the garden next door.

### Concrete Bird House

The central feature in the writer's own garden is a concrete bird-house which has been a constant delight for over 20 years. Now weather-beaten and lichen-encrusted, no stone ornament could be more handsome, and nearly every spring a pair of robins takes possession and rears a family. The bird-house is about 7ft. high. The rectangular base is about 4ins. thick, and when it was laid a 7ft. length of old gas barrel was set upright in the centre to form a core for the main pillar.

This pillar was built up with little home-made, wedge-shaped concrete bricks to make the pillar circular in section. The round platform which serves as the floor of the 'living accommodation' was moulded in the

wooden frame of an old garden sieve, a hole being left in the middle to admit the end of the gas barrel. A cylinder of expanded metal lathing (a netting-like material obtainable from ironmongers and builders' merchants) was then made, and a 'mix' of cement and sand 1in. thick trowelled on—the cylinder having first been lined with cardboard and filled with soil to prevent the 'mix' from falling through. When it had set, it was placed on top of the round platform and cemented in place.

The roof was the next item; for this a cone of expanded metal lathing was made and dealt with in similar fashion to the cylinder. The central pillar was then given four buttresses at its base, and similar buttresses were placed under the round platform. These were tied in position with string until the cement had set. When the general structure was complete the roof was given another coat of cement and sand mixed with red oxide, and then marked out to resemble small tiles. The circular wall of the house was given a yellow ochre 'mix' which, when set, was marked to resemble small bricks, which were then pointed in green. The central pillar was similarly dealt with.

### A Garden Seat

Another item that is both useful and ornamental is a concrete garden bench 6ft. long. This is about 3ins. thick and was cast in a wooden frame made of odd bits of timber. This frame was laid on a

concrete path on which several thicknesses of brown paper had been placed.

First, into the frame went all kinds of old iron—including three or four old croquet hoops straightened out from their normal 'hairpin' shape, and odd bits of wire netting running through the whole length. Reinforcement of this kind is essential for a seat. The two legs were similarly cast. The seat is enormously strong; as a test five people have stood on it.

### Well-head or Sundial

The writer has also built in concrete the 'well-head' shown in the sketch. Hollowed out 1yd. or so into the ground and lined with concrete, it is fed with rain-water from the roof of a nearby summer-house, and being close to the kitchen garden is very useful for replenishing the water-can.

Other features such as a sun-dial pedestal and one or two concrete vases suitably placed all help to enhance the interest of the garden and are particularly appreciated in winter when there is so little else to look at.

The great point about making these ornaments is that they call for so little in the way of equipment, and one can utilize in their making all kinds of otherwise useless junk. In fact, with a load of sand and a few bags of cement one can recapture the joys of the mud-pie and sand-castle days of one's youth—with the additional joy of having something concrete to show for one's efforts!

## The Editor Judges!

*THE good-looking fellow in the picture is of the Editor in the role of judging! He helped the Editor of the Boy's Own Paper, and Major T. H. MacArthur in trying to sift the best in a display of handwork organized last year by the welfare section of the Army Cadet Force Association. The [task was no easy one, for the standard was actually higher than the previous year. The subjects covered models, toys, home furniture, etc., and some of the entries were really delightful, both as works of beauty and in their splendid finish. The first prize had to tie between an inlaid walnut coffee table and a pair of sturdy (also inlaid) book ends. The entries included model tractors, lamp standards, fruit stands, toy duck, bread board and a wide range of other utility articles. Major S. C. White, M.B.E. who was responsible for the organisation is certainly to be congratulated on the enthusiasm and ability he has promoted in the Association. The names of the actual winners were:—*

*Household Articles—  
Cadet D. Gateland,  
Cadet Hackwood,  
Cadet Woodhouse,  
L/Cpl. Cosgrove,  
Cadet Simmons,  
Cadet Blitz,  
Cadet Ridley,  
L/Cpl. D. Marshall,  
Cadet Coleby,  
Cadet G. Bassingthwaite,  
Cpl. R. Storey, Cadet Muff.  
Toys — Cadet P. Digby, Cpl. P. W. Buckley, Cadet John E. Baylis. Textiles—  
Cadet William Handshaw, Lance-Bombardier R. Theobald, Cadet R. E. Lewes.*



# For store cupboards, linen closets or dark places fit this AUTOMATIC DOOR LIGHT

**F**OR those who prefer to make, rather than buy, this simple yet effective device, which when placed in circuit with an electric light point, eliminates the need for a manual switch.

Being fitted to the door jamb as soon as the door is opened the plunger, held in the closed position by the inside face of the door when closed, is released. This allows the metal disc, actuated by the spring, to come into contact with the two metal strips and so complete the electrical circuit necessary to light the bulb.

The action of closing the door has the reverse effect. The inside face of the door depresses the plunger and spring and so extinguishes the light. From its action it will be seen that the risk of fire from spent matches dropped among the contents of most store cupboards situated under the stairs, is eliminated.

## For Clothes Cupboards

This device can be equally beneficial when fitted to a clothes closet. Its use makes the selection of the right coat or hat certain and prevents the need so often experienced of taking out practically the whole contents before the article that is wanted at that particular time can be found.

Measuring approximately  $1\frac{1}{2}$  ins. square it requires little or no engineering skill to make, beyond drilling and the soldering of a metal disc on to a tube.

The diagrammatic sketch shown in Fig. 1 gives the reader a complete picture of the assembled parts, consisting of a piece of  $\frac{3}{8}$  in. tube  $\frac{1}{2}$  in. in length (C). Plugs (A) made from dowelling of the same thickness as the tube, are necessary to eliminate the possibility of an electrical shock which would occur if the metal tube was extended to protrude at either end.

A washer is of ample section (B)  $\frac{3}{8}$  in. in diameter and having an aperture of  $\frac{1}{2}$  in. to receive the tube (C). A smaller washer (D) is also necessary to form the

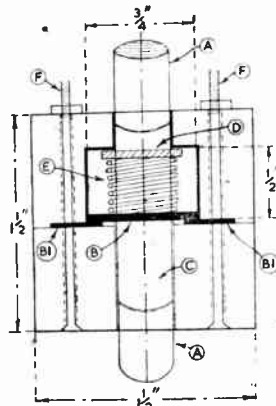

Fig. 1 - Lettered diagram section

base against which the spring (E) operates, while two metal strips—in length and shaped so as not to foul the tube (C) act as contacts which complete the electrical circuit when the washer (B) is held against them by the spring (E).

## Box Casing

These items are housed in a wooden case which, after three holes have been drilled, is cut in half. The centre hole is drilled with a  $\frac{3}{8}$  in. bit. The other two  $\frac{1}{2}$  in. either side of the centre hole are necessary to take the 4 B.A. bolts which, when the parts are assembled, hold them and the casing firmly.

To construct the piece of mechanism obtain a piece of well-seasoned timber 2 ins. square. Measure off the centre and drill a  $\frac{3}{8}$  in. hole. In line with this  $\frac{1}{2}$  in. on either side, drill a hole large enough to take the 4 B.A. bolts.

Now cut the block in half at right angles to the holes drilled. Select the half that is to receive the metal contacts (B.1) and drill a hole in each through which the 4 B.A. bolts pass. Next increase the  $\frac{3}{8}$  in. hole to  $\frac{1}{2}$  in. to a depth of  $\frac{1}{2}$  in., removing any swarf by means of fine glasspaper.

After cleaning, solder the disc to the tube at approximately the centre (see Fig. 2). It is important that this disc is at right angles to the tube itself to ensure a good contact is made with the two metal strips (B.1). These should next be sunk in to their depth, either side of the  $\frac{1}{2}$  in. hole. Cut dowel ends  $\frac{3}{8}$  in. in length and trim a  $\frac{1}{4}$  in. to fit in the ends of the tube.

## Assembling

Place the spring over the tube so it rests against the make and break washer soldered to the tube. Add the smaller washer which, when placed in the  $\frac{1}{2}$  in. hole, will rest against the base of the housing. Depress the plunger and hold in position while the two metal strips are placed in position—making certain that these do not foul the metal plunger. Place the second half of the housing over the plunger and insert the two 4 B.A. bolts and secure by nuts.

The plunger can now be released, when it should return to the 'on'

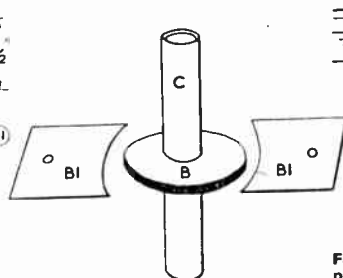
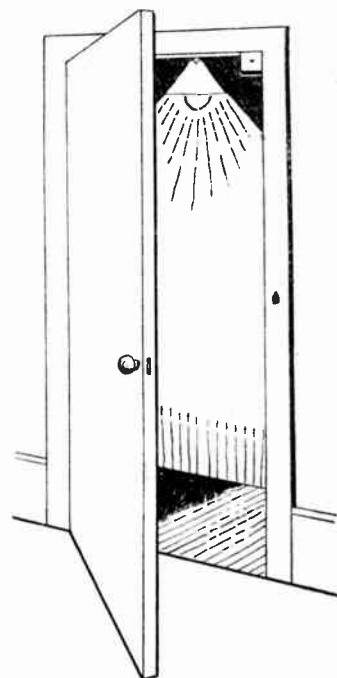

Fig. 2—Tube and disc fitting



position due to the spring's action. If any sign of sticking is observed take down and make certain that the tube moves easily in each half of the housing.

## To Test

In order to make a test obtain a pocket lamp battery and bulb holder, fix a lead from battery to one of the 4 B.A. bolts which act as terminals. From the other, bolt a lead to one point on the bulb holder. The other point on the bulb should be connected by a lead to the other side of the battery. This will then complete the electrical circuit and as soon as a bulb is inserted it should light.

Now depress the plunger and the light will go out. Repeat this several times ensuring that the switch operates satisfactorily before inserting the switch in the light circuit in place of the usual tumbler switch.

To fix to the inside of the door, drill two small holes to take wood screws of a slender size (Fig. 3). A certain amount of experiment will be necessary to ensure the correct position in relation to the inside of the door when it is closed. The plunger should protrude to a distance of no more than  $\frac{1}{4}$  in.

When satisfied this position is obtained, fill in with sealing wax the countersunk heads of the 4 B.A. bolts which, due to the fact that they pass through the contacts, are alive. If touched in their uncovered state a shock will result.

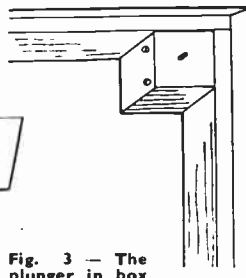

Fig. 3 - The plunger in box in position

# How to convert a tinplate model railway into an ELECTRIFIED TRACK

**B**ROADLY, there are two entirely different ways in which the amateur model railwaymen can convert his tinplate track into electric track, suitable for the running of Hornby and other electric locomotives.

In the first—and easiest method, the original tinplate rails are screwed down, through small holes through the end sleepers of each rail-length to a substantial baseboard to which the electric rail is subsequently added by means of being mounted by soldering to the heads of screws driven into the baseboard between the running-rails.

In the second method, small metal clips are used. These are wrapped round each sleeper, being insulated from the latter by a previous wrapping of thin card. To these clips the 'third rail' of copper wire is soldered, each rail-length being treated individually in this way. The ends of the 'third rail' are soldered or twisted together (the twists pointing downwards) to form a continuous electrified line.

## Disadvantages

Exploring the possibilities of each of these methods, we find that the outstanding point against the first is that it insists that the layout is permanent, or at least semi-permanent, and this entails a definite space, set aside for the use of the railway, which is not always possible in smaller houses and flats.

While there is no gainsaying the fact that a tinplate line electrified in this way is an absolute success from an operational point of view, it is not always productive of domestic felicity in smaller abodes, where every square foot of space is needed for household purposes.

## Equal in Cost

The second method is, of course, infinitely more complicated to carry out, and, though the cost of both systems are about equal, does not give quite such trouble-free running, due to the number of joints in the live rail, each of which can be the source of loss of power on the part of the locomotives, due to indifferent electrical contact.

Taking the first method. The lengths of tinplate rail are first drilled through the centre of each end sleeper with a  $\frac{1}{8}$  in. hole, and are then secured to the baseboard in the proper configuration to produce the final layout design by means of brass  $\frac{3}{16}$  in. round-headed wood-screws.

## The Lay-out

Great care should be taken over the design of the layout, as once the rails are secured and electrified, any alterations will be the cause of re-laying and re-electrifying over the re-designed portions of track. A little extra time spent with a pencil and paper will be rewarded by the satisfaction of running on a well-designed layout which has been

well-laid once and for all.

The material used for the third rail is tinned copper wire of No. 16 S.W.G., which is obtainable at almost any radio repair shop, and which is soldered into the screwdriver slots in the top of the wood-screws, which should be suitably widened to receive it by means of a triangular file.

Before use, the wire should be cut into 12ft. lengths and stretched by fixing one end in the vice (or twisting it round a door-handle) and firmly pulling from the other end with a pair of pliers until it has been stretched about 6ins. After stretching, the 12ft. length should be cut into 3ft. pieces, taking care to preserve them free from kinks. In this state they will be found to solder easily to the screw-heads on either straight or curved track.

## Good Contact

After laying, the ends of each length should be bent down slightly, so the collector-shoe of the locomotive does not catch up as it passes from one length to another. The ends must, however, be in good electrical contact, and this is achieved by soldering short lengths of 'flex' wire to each extreme (bent-down) end, by means of which the lengths may be joined into one electrical whole, i.e., in metallic connection throughout the whole layout.

Coming now to the second electrification scheme. It will be found best to produce twice as many metal clips as there are lengths of rail, making them from tin-plate obtained from old cocoa or 'Ovaltine' tins, these being first cut into  $\frac{1}{2}$  in. wide strips and finally into pieces about  $\frac{1}{2}$  in. wide by 2ins. long, each piece making one clip.

In use, each piece is first bent into a sharply angled inverted 'U', to the top of which the third rail will be eventually soldered. The arms of the 'U' are then bent inwards to grip round the tinplate sleepers, its ends wrapping right round the latter and being strongly nipped up underneath the sleeper.

## Wrapped Sleepers

Before this wrapping-round process is commenced, however, pieces of thin cardboard (such as old post-cards) must be cut and also wrapped around each sleeper so that the metal clips are not actually touching the sleeper. After placing the card insulators, the clips must be gripped in place, taking great care not to pierce the cardboard in the process.

As each rail-length is treated separately by this method, it is essential that 'flex' ends are soldered to each end of each third rail, and its ends bared, so that they may be twisted readily together to form a continuous rail.

(Continued foot of page 310)

## Painting Small Parts

**W**HEN small parts of models are stuck on pins and painted, one is a little perplexed how they can be easily dried. Procure a large piece of card-

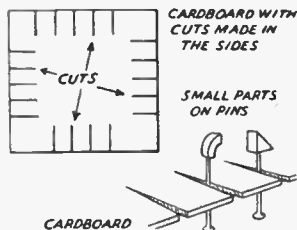

board and cut a fringe round the edges with scissors. The cuts can be 2ins. apart, 2ins. deep as shown. The pins with the parts painted can then be inserted in these cuts, thereby keeping them free from contact with any surfaces. The card can be rested on a couple of books or small box.

## Nailing Butt Joints

**W**HEN nailing a butt joint, it is a good tip to bend the point of the nail slightly at the end. This will cause the nail to follow a curved course, and thus ensure a good grip.

## Fretwork Hint

**W**HEN making an overlay, sometimes thin lines have to be cut for bits of trees, etc. If the model is darkly stained, the lines do not show up. To remedy this, run french chalk or flour in the lines. They will then show up.

## A Repetition Gauge

**F**OR repetition work it is handy to make fixed marking gauges. These consist of two pieces of wood fixed together with fret pins or fretwork nails. The position of the marking point is marked accurately, and a panel pin driven through. Then the pin is removed and driven through from the other side, the projecting point being then filed to a chisel shape (see sketch). The size of the pieces of wood will, of course, depend upon the size of the gauge to be made.

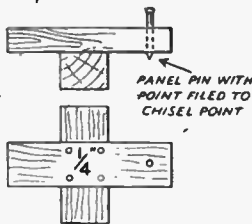

# Patterns on page 319 for the parts of this amusing TROTTING TOY

**D**ESPITE the most ingenious and complicated mechanical toys that come on the market, some grand old toys never grow old. The trotting toy is one of these, and on account of the numerous requests we get, we are publishing a full-size pattern, which appears on the inside back cover, page 319 of this issue.

In order to get the maximum size pattern, we have superimposed the parts one on another, and these have to be separated and traced off by the reader. But this is quite straightforward. As can be seen from Fig. 2, there are three shapes to cut, of which one is to be cut in duplicate, making four pieces in all, apart from the handle.

## Outline Shape

First, there is the complete outer shape of the rabbit, less, of course, the feet. It is possible to use  $\frac{3}{8}$  in. plywood for these, though thicker wood is recommended if available (A). Then there is shape (B) which is really the top part of (A) repeated. One of these parts is required, for preference,  $\frac{3}{8}$  in. thick. The wheel part (C) must be at least  $\frac{1}{2}$  in. thick. If part (B) is  $\frac{3}{8}$  in. thick, and is sandwiched between parts (A), wheel (C), which goes in the recess thus formed, has some play.

If the reader has a pantograph, or some other means of enlarging, the model can

and these pasted down on to the wood, unless the wood is light and clear enough to take the tracing direct. Those who intend making several models should make cut-out cardboard templates so that a pencil can be passed round quickly. You can also use strong smooth wall-board instead of wood.

## Cutting Together

It will save a considerable amount of touching-up if the two parts (A) are cut together. Those with fret machines and stout toymaker's saws may even cut the whole three thicknesses together parts (A) and (B). In this case the middle part can be the same shape as the outer and afterwards halved. The middle part can be of solid wood, comparatively soft and therefore easier to cut than  $\frac{3}{8}$  in. plywood.

Do not forget to bore a small hole where shown. Mark this off when tracing. The wheel (C) must be truly circular on the outside, i.e. the front parts of the soles and on the heels. It may suit some readers to cut circular discs first and shape the feet afterwards.

It may be mentioned, as a matter of interest, that it is possible to cut shape (A) from a solid piece of wood about  $\frac{1}{2}$  in. thick, and afterwards cut away, as though for a bridle joint, a deep recess  $\frac{3}{8}$  in. wide, to take the wheel. This is done by sawing down with two cuts and then chiselling out the waste. Those who work on a semi-commercial scale, for profit, and have machine tools, might easily mill out the centre part of a solid shape.

The middle part (B) is glued between the outer parts (A), and when the glue has set, any necessary trimming of the edges is done.

## The Handle

The handle is made from a strip about 18 in. long and of  $\frac{1}{2}$  in. by  $\frac{3}{8}$  in. section. It is not a bad

idea, when assembling the parts, to stick, first, the centre part (B) to one of the pieces (A). There will then be a rebate for the end of the handle, at the tail. The handle can be laid in, and the end trimmed off so that it follows the general curve at the bottom. The other piece (A) can be laid over and the whole job clamped up. As there is a strain on the handle, a screw can be driven through at the base of the handle when the whole is assembled.

If, by any chance, the model is made from a solid piece of wood, a  $\frac{1}{2}$  in. hole,

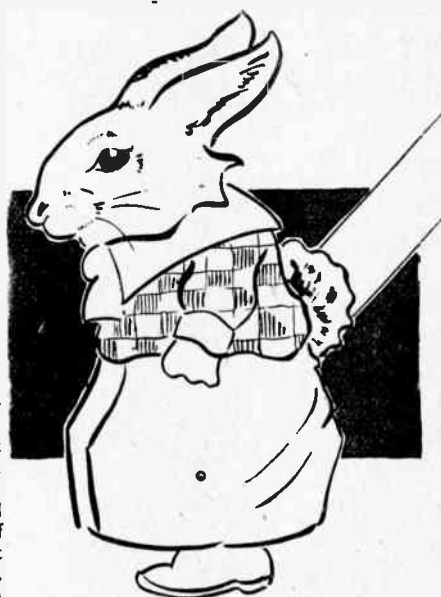

about 2 in. deep can be bored, at a slant, to take a dowel handle. This handle can be removed for convenience in storing the toy. The handle should have a cross piece at the top. This enables the tiny toddler to get a better grip, and even gives some support when he is learning to walk.

## Bright Colours

Before fitting the wheel, the job might well be painted with gay enamels. For a really good job, give an undercoat paint first.

The rabbit's face and paw can be light brown. The tail and collar are white. The jacket is a gay check pattern of, say, red and yellow. The wide, floppy knickers can be blue. Use brilliant colours with no subtle shading off. The feet can be dark blue or black. The eye markings and whiskers, etc., are put on when the groundwork has dried. The handle can be bright red.

When the whole has dried, the wheel is fitted in, using a split pin. It is a good idea to use a washer under the head, on either side of the disc, and under the turned-down ends of the split pin. You can get washers and split pins at any ironmongers.

*In our issue of Jan. 25th, the model of the Pretoria Castle was mentioned as a liner belonging to the P & O Line. This, of course, should have been the Union-Castle Line as mentioned on the design sheet. Further copies of this pattern sheet (No. 242 Special) are of course still available, price 9d. (post 1d. extra).*

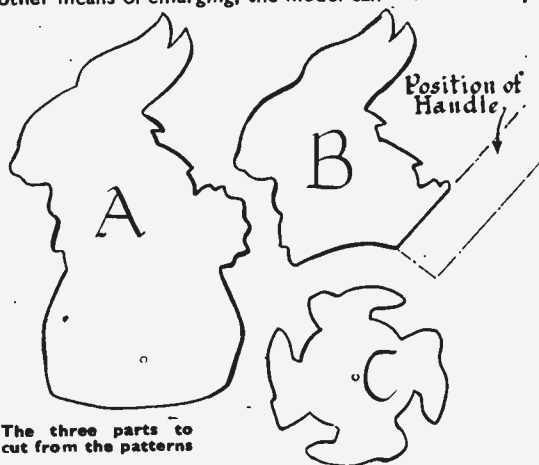

The three parts to cut from the patterns

be made about half as large again as printed. It should not, however, be so large as to be too heavy for a small child to handle, and it is very important to note that, in an enlarged model, there should not be much more than  $\frac{1}{8}$  in. gap between the toe of one foot and the heel preceding it. Otherwise the wheel will always be catching in the ground and the toy refuse to 'trot'. An extra foot might therefore be required.

However, assuming the model is made the same size as the pattern sheet, the parts should be traced on to plain paper

# For comfort or for an invalid make this COLLAPSIBLE BED TRAY



**W**E give details here of a useful form of bed table; very nice when a light breakfast is wanted in bed. It is very convenient, too, and takes up but little space when not in use, because the legs can be folded underneath. In fact, in this respect it could well be used as a tray for the ordinary serving of meals.

The overall size of the tray is 22½ ins. long by 12½ ins. wide and when the legs are raised it stands about 11 ins. from the surface of the bed. Economy of wood has been studied in the designing of the tray top, and instead of having a solid thick piece for this, we have suggested a framework of five rails halved together at the crossings and firmly glued and screwed.

Upon this a square of fibre board or plywood, if the latter can be got, is firmly glued and screwed on. To form an edging to the tray, and to make a presentable appearance all round, we have introduced strips of wood 1½ ins. by ½ in. in section to be screwed on. The strips are rounded neatly on the top edges and should be mitred at the four corners.

## Railed Edging

Looking at Fig. 1 we see the plan of the tray, showing the position of the rails underneath by dotted lines. All the rails are 1½ ins. by ½ in. in section, and in making the halvings, etc., care must be taken in the marking out to get the rails square. The tenon saw will be found useful in cutting the halving, a ¼ in. chisel being used, perhaps, in certain places to clear away and make clean edges.

When gluing the joints and before the screws are put in, test the frame with a

square. In Fig. 2 a cross section of the table is given with an inset detail showing the construction of the top frame. Here also is shown the method of holding the legs of the table rigid when they are erected.

A block of wood measuring about 3 ins. long by 2½ ins. wide and ½ in. thick is glued and screwed firmly to the middle cross rail of the top frame, and to this is fixed a strip of bendable wood such as hickory.

## The Legs

The legs, if fixed in the position shown in Fig. 2, that is, flush with the ends of the tray, will require the spring strip to be 21 ins. long, and it might be about 1½ ins. wide by ⅞ in. or ¾ in. in thickness.

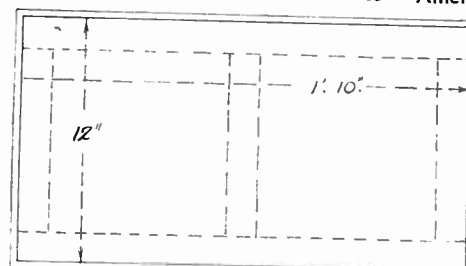

Fig. 1—Plan of the baseboard portion

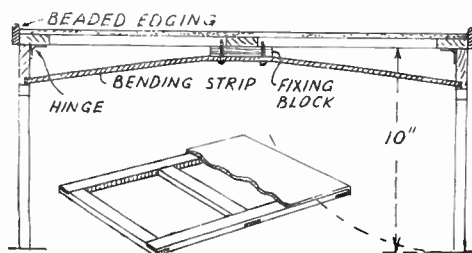

Fig. 2—Side section and detail of framework

the legs. The three members are halved together, as in the detail Fig. 4, and it will be noted that the legs are tapered down to 1 in. at the foot for a length of 7½ ins., that is from the bottom edge of the cross rail.

This latter rail is lightened in appearance by cutting away, as shown. Also a square notch is cut in the middle of the rail for the hickory strip to snap into when the legs are opened, see detail in Fig. 4, and cross section Fig. 2.

## Satisfactory Joint

Be sure and make a sound joint between the two legs and the top cross rail, keep the halvings clean, and even, and glue and cramp well together and add two countersunk screws to each leg joint. The legs are hinged to the top frame with a pair of back-flap hinges, as shown in the circled detail in Fig. 4.

When it is desired to lower the legs flat against the top, the hickory spring, on each side of its centre, is raised out of its notches and the legs thus lowered, the spring eventually lying flat on the wide surfaces of the leg rails.

The whole article when completed may be either painted or stained and varnished, the former being, perhaps, the most suitable finish for this type of article. The table top would service well if covered with either rexine or American oil cloth.

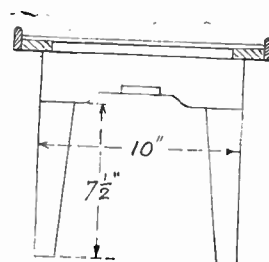

Fig. 3—End view, with legs open

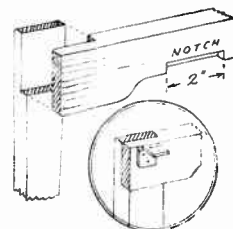

Fig. 4—Joints for strength

## Model Railways—(Continued from page 308)

Care must be taken to ensure that the twisted ends of bare flex do not touch the sleepers or running-rails, as this would cause a short-circuit which would quickly run the accumulators down, or would burn out the transformer if the railway is being run from the main house-supply.

It must be clearly understood that neither of these methods will produce such perfect track as the purchased article—from a spectacular angle, but will give a good, trouble-free layout if carried out with due care and attention to details.

No doubt the reader will himself be

able to improve considerably on the schemes outlined by sectionalizing the third rail as already explained in a previous article in this series, thereby still further improving the operational facilities which are the great feature of electrically-driven Model Railways. He should at least have a try at it.

# Radio enthusiasts will find it worth while to make A MULTIRANGE METER

**T**O the radio enthusiast, a meter covering several ranges is a handy piece of equipment. Such a meter can be made, both accurately and cheaply, by anyone with a small knowledge of electricity. The meter itself can be obtained from most Government Surplus Stores at a low price; the one in this model was 6s. 6d.

The resistance of the meter is 100Ω and a full scale deflection (F.S.D.) of 1 milliamp. The scale is marked from 0-1.5, 0-3, and 0-150. This can be taken as volts or milliamps, whichever range is in use. The theoretical circuit is shown in Fig. 1, while Fig. 2 shows a suggested lay-out of the parts.

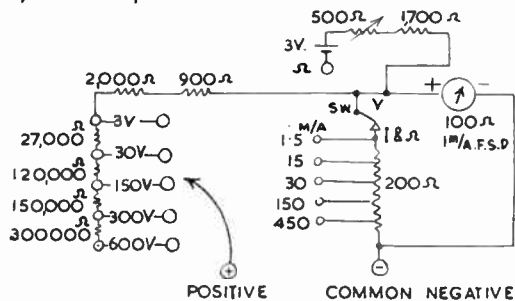

Fig. 1—The theoretical circuit

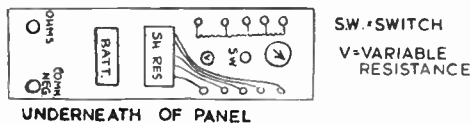

Fig. 2—Lay out of panel

Let us first deal with the voltage ranges. The resistance of the meter is 100Ω and the current necessary for a F.S.D. is .001 A. Therefore, if we wish to measure 3 volts, we must add a resistance in series with the meter, of a value so that when 3 V. is applied across the meter and resistance, a current of .001 A. flows in the circuit. The value of this resistance is given by ohms law.

$$\text{RESISTANCE} = \frac{\text{VOLTS}}{\text{AMPS.}}$$

$$\text{In this case } R = \frac{3}{.001} = 3,000 \text{ ohms.}$$

As we already have 100Ω in the meter itself, we only require 2,900Ω in series to measure 3 V. The other voltage ranges are worked out in exactly the same manner, always taking away from the resultant figure, the number of ohms already in the circuit.

## Accuracy

These series resistances should be of the type produced for meters, and accurate to within 1%. Ordinary resistances have a tolerance of 20% and are not suitable for meters, as the readings

shown by the meter, may as a result, be in error up to 20%.

The current ranges are somewhat different, in as much that all the resistances are in parallel with the meter. First of all, we must correct our scale, because although the F.S.D. is 1 M/A, the scale shows 1.5 M/A. This can be done by connecting a resistance in parallel across the meter, thus making the F.S.D. 1.5 M/A. The value of this resistance can be found by the following formula:—

$$\text{Shunt Resistance} = \frac{\text{Resistance of meter}}{n-1}$$

where  $n$  = the number of times it is required to multiply the F.S.D.

In our case we wish to multiply the F.S.D. by 1.5.

$$\therefore \text{Shunt res.} = \frac{100}{1.5-1} = \frac{100}{.5} = \frac{1,000}{5} = 200\Omega$$

This resistance can be made by purchasing some resistance wire. A 200Ω wire wound resistance would be suitable. Care should be taken to see the wire will carry 450 M/A safely, and also that it is of a good length, say, about 10yds., so the tapping points can be made accurately. It will be a simple matter to check that the 200Ω resistance is of the correct value, by connecting a battery through a suitable variable resistance to the meter, so that a current of 1 M/A is flowing in the circuit. If the shunt is connected across the meter, the reading on the scale will now drop back to the position marked 1 M/A, if the resistance is correct. Any error can be corrected by lengthening or shortening the resistance wire.

## Tappings

The tapping points can be found as follows: Connect up the meter as shown in Fig. 3. Adjust the variable resistance until 1.5 M/A is shown on the meter. This point is the 1.5 M/A tapping at the top of the 200Ω resistance. Now slide the wandering lead (marked with the arrow) down the 200Ω resistance until the meter shows .15 M/A on the scale. This point is the 1.5 M/A tapping. Leaving the wandering lead connected to this point, adjust the variable resistance until the meter shows 15 M/A.

Now slide the wandering lead down the 200Ω resistance again, until the meter shows 7.5 M/A on the scale. This is the 30 M/A tapping. Leave the wandering lead connected to this point, adjust the variable resistance, until the

meter shows 30 M/A. Now slide the wandering lead down the 200Ω resistance again until the meter reduces the reading to 6 M/A on the scale. This is the 150 M/A tapping.

Finally, leaving the wandering lead connected at this point, adjust the variable resistance until the meter shows 150 M/A. Again slide the wandering lead down the 200Ω resistance until the meter reduces the reading to 50 M/A on the scale. This is the 450 M/A tapping.

## Simple Winding

The easiest way to do the tappings is to wind the 200Ω resistance temporarily round four nails, driven into a large board. Connect up, and when the tappings are made, check that each tapping is well insulated. Then rewind on a convenient size former. The resistance range is also quite straightforward. The meter resistance is 100Ω and with 200Ω in parallel, makes a total resistance of:—

$$\frac{1}{100} + \frac{1}{200} = \frac{2-1}{200} = \frac{3}{200} = 66.6\Omega$$

With a 3 V. battery, the resistance required to give a F.S.D.

$$R = \frac{\text{VOLTS}}{\text{AMPS}} = \frac{3}{.0015} = 2,000\Omega$$

The 500Ω variable resistance is to allow for slight difference of the voltage of the

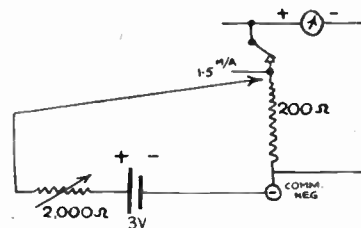

Fig. 3—Connecting for tapping

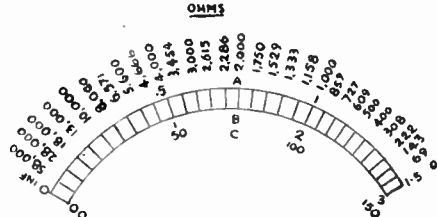

Fig. 4—Adding the scale to the meter

battery, as it runs down.

To use the resistance range, connect + wandering lead to the ohms terminal, short circuit + and - testing leads and adjust variable resistance until a full scale deflection is obtained. Then, without touching the setting of the scale, connect the unknown resistance between the

(Continued foot of page 312)

# Magic lantern announcements can be made with HOME-MADE 'LINE' SLIDES

**M**ANY readers will probably have a 'magic lantern' (or more correctly 'optical lantern') of one sort or another. Perhaps one that has been constructed from the several designs that have appeared in *Hobbies Weekly*, or maybe a film-strip instrument, or possibly one that projects the standard 3½ ins. square slide.

take every writing medium well, but it can be satisfactorily marked with carbon paper, if the carbons are placed on both sides.

Typing is a most convenient way of making a slide containing a notice, because quite a number of words can be got into the limited space. The illustration shows the large number of words that can be worked into the standard

square or other shape in question can be lightly pencilled, otherwise it is not too easy to see the area being filled, and the placing of a further sheet of plain paper on top tends to weaken the carbon marks.

When the typing or writing is completed, a suitable mask is prepared from black paper, and the Cellophane with the mask is placed between two cleaned-off slides, or two pieces of ready-cut cover glass. The point is that the two glasses must be perfectly clean.

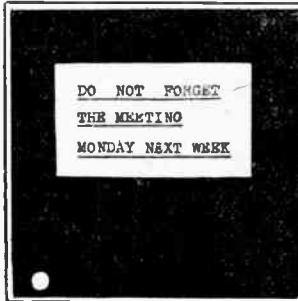
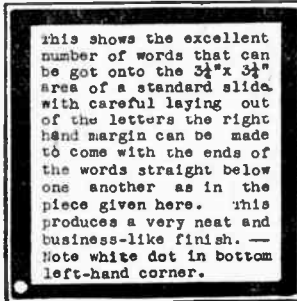

Examples of two forms of announcement

## Binding

Before finally binding, if the slide is the standard 3½ ins. by 3½ ins., put a small white dot in the bottom left-hand corner as indicated. This is to make it agree with other slides, the dot showing which way in the carrier the slide has to go.

The sandwich of glass, Cellophane and mask is completed by binding round the edges with narrow strips of gummed

Whatever kind it is, it is often good to be able to produce diagram or word slides yourself, for most lanternists find that occasions arise when such slides are of the utmost value. Thus, if the lantern is used greatly at a club or class, it is not hard to see how useful it would be to be able to flash on a notice on the screen, say, about the next meeting.

Years ago, 'line' slides could only be made by tediously coating glass with some preparation which made ink 'take', or using ground-glass (upon which marks can be put with a pencil), but this cut off a lot of light and made the screen dark.

## Transparent Base

Now, however, we have Cellophane, which is an ideal base, if the lines can be made dark enough. Being glossy, however, this useful material will not

(slightly masked) 3½ ins. square. Lettering, etc., however, can be put on quite well if done with a sharp hard pencil, the words being written on the carbon sandwich instead of typed.

To make a slide, place a bottom carbon face up, then the Cellophane and then another carbon face down on top. The carbons should be new and for the top carbon it is best to use one with a light-coloured back upon which the

A



- 1 GLASS
- 2 MASK
- 3 CELLOPHANE
- 4 GLASS

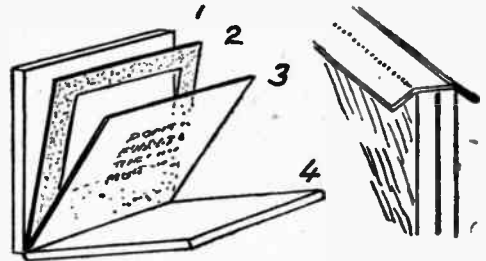

Making up the slide

Binding strips

paper, care being taken not to smudge the carbon marks while making up the slide.

## Multirange Meter—(Continued from page 311)

+ and — testing leads, thus breaking the short circuit. A certain current will be shown on the meter. This current is called I2. Thence by the formula:—

$$R_x = \frac{(R + RM) \times (I_1 - I_2)}{I_2} - R_x$$

$$= \frac{2,000 \times (1.5 - 1.2)}{1.2}$$

the unknown resistance can be found.

It is important that no other source of current flows through the unknown resistance while under test. The resistance range will measure from 0—58,000 ohms. The upper figure is based on the assumption that the meter can be read accurately down to 0.05 M/A, that is, 1/30th of full scale.

## A Marked Meter

Fig. 4 shows the layout of the scale as already marked on the meter used in this model. The resistance scale can be added as shown, but care must be taken to make this a neat job. Some readers may not like to chance spoiling the scale. If this is the case, you can either draw a copy of the scale, and fix it in the lid of the box containing the finished meter, and refer to it when measuring resistance. Or a table can be drawn up, giving the different values of resistances for a given deflection on the meter, and also kept in the lid.

When measuring volts or milliamps on a range that is not marked on the scale, it is quite an easy matter to multiply the given scales, to correspond with the

range in use. For example, on the 30 V. range multiply scale B by 10, and on the 15 M/A range, multiply scale A by 10.

The idea of a switch in the 200Ω parallel resistance circuit is to give greater accuracy on the voltage ranges, i.e., 1,000Ω per volt.

## Box Fitting

All the parts can be mounted under a panel, leaving only the meter dial, terminals, switch and variable resistance control visible on top. The panel can then be mounted in a suitable box of appropriate dimensions. This container can be finished neatly with polish or varnish to make it an attractive piece of work you may be proud to use and show to your friends.



# For garden or general use undertake your own SIMPLE GLOVE MAKING

It is commonly supposed by most people that glove making is a very intricate and difficult task, but this is by no means true. The most important thing is to obtain a good pattern and cut the pieces out exactly.

Handmade gloves if properly done will outlast all machine-made ones. Various grades of chamois leather can be used—it is fairly thin, and easier to sew. When selecting, and buying the leather hold it up to the light to see that it is not too thin.

The pattern has numbers at various points on the hand and thumb pieces. Place these numbers correspondingly together.

Begin sewing with a small knot at the back at No. 1, and sew right round. The quirk is sewn into the angle of the fourchette on the wrong side.

The fourchette goes to the back of the fingers, with the quirk on the inside. Begin sewing at the base, and when nearly to the top, cut the top of the fourchette to fit the side of the finger.

When all the fingers are sewn, stitch down the side of the glove.



The finished article

wrist you can use either a press-stud by itself or a press-stud fixed to a small narrow strap running around the wrist of the glove.

## Fancy Gloves

To make the gauntlet more decorative you can cut a fringe around the edge, or thread different coloured things through small holes. Another way is to punch or cut small designs in the gauntlet.

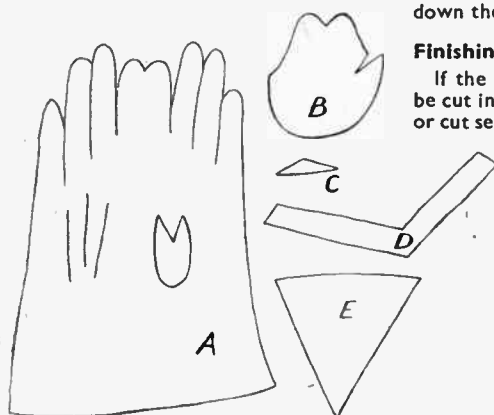

The parts are—handpiece (A), thumb (B), quirk (C), fourchette (D) and gauntlet gusset (E)

## Finishing

If the glove pattern is gauntlet it can be cut in one with the hand of the glove, or cut separately and stitched on.

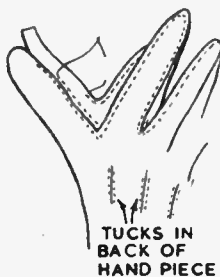

How fourchette is added



Completed thumb

Elastic wrist band

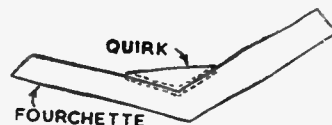

QUIRK  
FOURCHETTE

You should purchase your first pattern in the size you require. There are eight pieces to an ordinary slip-on glove—the hand, the thumb, three fourchettes, and three quirks. For a large gauntlet glove, a triangular gusset is used and sewn in below the wrist.

## Cutting Out

The piece of leather to be used should be pinned out on to a board or table so that it lies flat. The pattern is placed on, so the breadth of the leather, or the most elastic part goes across the width of the hand. Draw round the edge of the pattern with a finely pointed pencil, and then cut round it, making sure that you keep exactly to the line.

## Stitching

The thread used for stitching is mercerized size No. 8. You can obtain special three-sided needles for sewing leather, but if your pieces are of ordinary thickness you can use a sewing needle.

The general stitch to be used is a running stitch, which must be nice and even to ensure a perfect finish.

Over-stitching can also be used effectively.

## Making Up

The three marks on the back of the hand should be sewn first. These are made in the form of three small tucks. Then sew in the thumb piece. Usually

If desired a length of elastic can be put in the wrist to produce a tight fit. The elastic is stitched on in a zig-zag fashion or line of stitches, whilst it is stretched to its fullest extent.

For fastening the glove around your

Patterns for gloves can be purchased along with needles, and the mercerized thread in most Needlework Shops. Chamois leather or wash leather used mostly for gloves can be obtained at leather shops or Handicrafts shops.

## A Table-Top Fairground

*THE suggestions in our pages cover nearly everything, and offer endless ideas to the craftsman. Look at this ingenious and attractive piece of work—a complete fair, with all the detail and colour of 40 years ago—swings, roundabouts, helter-skelter, traction engine, caravans, etc. It has been made by Mr. M. Arthur of Manchester, during the last ten years, modelling with penknife and paint brush. It all works by electricity, too, and makes a very attractive set-up on the table. Readers around Manchester will be able to see it next month, when it is appearing at the Exhibition of the Northern Asstn. of Model Engineers.*



Photo—Daily Graphic

# Helpful jobs for the housewife can be performed with a little HOME CHEMISTRY

**W**ITH a knowledge of certain basic facts of chemistry you can derive a great deal more value from the various hints and tips given in the different household magazines than if you just carry out their instructions. The man with a little chemistry in his head can be of real use in the home.

For instance, except in the heart of the country our atmosphere is always polluted with, among other things, sulphur compounds which attack such things as silverware, forming silver sulphide. It is the film of silver sulphide that is usually called tarnish.

## Cleaning Silverware

Now this film is very difficult to remove without harming the silver underneath, but it can be done if you know a bit of chemistry. Furthermore, you can apply the same method in any other case where you suspect sulphur staining.

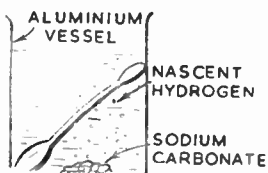

Removing tarnish from silverware

Take an old aluminium vessel that has ceased to be of proper use and place your tarnished silverware in it. Cover with water and bring to the boil. When the water is boiling vigorously add solid washing soda (2ozs. to each  $\frac{1}{2}$  gallon of water) and continue boiling for a few minutes. Then, when you have washed the silverware in warm soapy water, it will be as bright as new.

The washing soda (sodium carbonate) reacts with the aluminium vessel and forms a very reactive kind of hydrogen called 'nascent' hydrogen. This attacks the silver sulphide and turns it into hydrogen sulphide which passes off as a gas, leaving the silver untarnished.

## Kettle 'Fur'

You probably know that one way to clean the fur from a kettle is to stand it with dilute vinegar overnight. No doubt you could make more use of this knowledge if you knew the chemistry behind it all.

Ordinary tap water contains calcium carbonate, formed when rain seeps through limestone deposits, and this is one of the very few substances whose solubility decreases with rise of temperature. That is, it is more soluble in cold water than it is in hot water. Of course, in any sample of tap water there are only a few parts per million of calcium carbonate. But each time you boil a kettleful a very thin film forms on

the inside until at last an appreciable deposit is present.

Now, as you know from your analysis, all carbonates react with acids, giving off carbon dioxide. Vinegar contains acetic acid and this reacts with the kettle fur giving carbon dioxide and calcium acetate—which is soluble in water and is poured away when you rinse out the vinegar. Of course, any

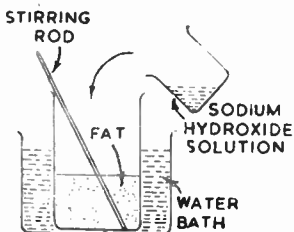

Increasing the fat allowance

other acid is just as good, but it must be dilute or it will attack the kettle itself.

## Making Soap from Waste

A very useful piece of chemistry to know these days is how to make soap from waste fat. Only a crude liquid soap can be made under domestic conditions but it is quite suitable for rough cleansing and laundering.

Take your waste fat—animal fat, cooked or uncooked, rancid butter or margarine—and melt it down in a vessel of hot water. Then, in a glass vessel dissolve in a little warm water  $2\frac{1}{2}$ ozs. of sodium hydroxide (caustic soda) for every pound of fat. When the fat is nice and hot, pour in the sodium hydroxide solution drop by drop with continuous stirring.

Continue heating, stirring occasionally, until the mixture turns milky. Then take a little of it and dilute with water. If it goes clear, the soap is finished, but if it does not you must go on heating until it does.

Fats consist of compounds of 'fatty acids' and glycerine called glycerides.

## Radio Gram Conversion

**P**LEASE explain conversion of a cabinet gramophone into a micro-gram. The type I have at present has a radio pick-up installed, but I wish to convert it to play through its own speaker. (F.H.—York).

**T**O play records in the way you suggest, you will need to use an amplifier, and various types of amplifiers have been described in various past issues of 'Hobbies Weekly', both mains and battery operated. Though one valve in an efficient circuit will give reasonable volume for domestic purposes, at least two valves are preferable. A complete amplifier of this type requires

When these are heated with sodium hydroxide they split up and give sodium salts of the fatty acids, and glycerine. The glycerine dissolves in the water so you do not see it. If you like you need not use water. Add solid sodium hydroxide; it will take longer but then you will get a solid soap floating above a quantity of glycerine.

## Stain Removal Hints

Now, just a few words on stains to finish up. The principle behind nearly all stain removing is to convert the coloured stain into a colourless compound. In a few cases you do try to remove the stain—as with cocoa which dissolves in alkali (ammonia, for ex-

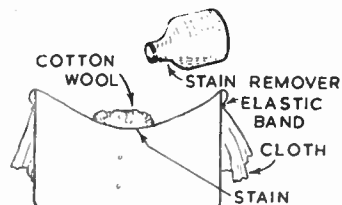

How to remove stains

ample)—but mainly you leave it there in a form you cannot see!

Remember that most coloured compounds found in fruit form colourless borates. So you are almost certain to remove a fruit stain by using borax. With all stains the best method is to drape the stained cloth over a jar, fasten with a rubber band and then pour on the stain remover. Place a piece of absorbent cotton wool on the cloth and soak this with stain remover, too.

## Ink Erasers

For ink stains use oxalic acid or citric acid (lemon juice). Red ink usually succumbs to ammonia. Citric acid can be used too, to decolorize iron mould caused by rusty metal. In both these cases, blue ink and iron mould, it forms iron citrate which is colourless.

very few parts, especially if battery-operated.

Construction should present no difficulties. It is necessary that the speaker be mounted on a suitable baffle-board with hole of appropriate size, and this can probably be screwed in the position previously occupied by the trumpet-horn. For convenience, the volume and tone controls may be mounted on the motor-board near the turntable, and the amplifier can go behind the speaker.

It is best that the cabinet lid should close over the turntable to reduce needle-scratch when playing a record.

# What to look for and avoid for good pictures in FEBRUARY PHOTOS

**T**O the many all-the-year-round amateur photographers it is always a matter of great surprise that they constitute only a small percentage of the camera-owners in this country. It is computed by those who are in a favourable position to judge that some 90 per cent of the total number, and this runs into millions, of cameras are never used for making exposures between the months of October and March.

The possessors, in many instances, must be aware that there are beauty spots of real photographic value to be found in the fields, lanes and villages even in the depth of winter. Most certainly there are plenty of places and objects of interest in the towns and cities in which they live and work. It should need only a slight amount of enthusiasm to re-awaken a desire to get another spool and make a few shots.

## Spring Rambles

A good way to conceive this spot of enthusiasm is to get a friend to take you to the local camera club one evening when there is a lecture or practical demonstration to be given. Or, perhaps, the club may be holding its annual exhibition. Whatever the programme may happen to be you are certain to be struck by the keenness of the members and the fact that very few of their cameras are ever allowed to remain idle for long.

Very shortly the bright days of spring



Sun and tree bareness made to help a picture

will be urging us to get out for a ramble. Will you have the camera ready with a spool of film or have you forgotten to get one? One very important point to remember is that at this time of the year it is often much easier to get a supply of films than at Easter or later.

The approach of Spring is a time when all country places are full of opportunities and pictorial subjects fairly easy to find. Even the town dweller who, because of his work or other circum-

stances is unable to get to the open country in time to make many exposures, can do a little prospecting locally among the old buildings and similar places. Even in the market place or some of the busy side streets during the lunch hour a few shots might be made.

In any case, it is useful to walk around noting how such-and-such a spot would look if the lighting was from the opposite direction, or if there was a splash of sunshine on that side of the building and the shadow was a little less pronounced. By making use of such thoughts you will unconsciously be drilling yourself and gaining some very valuable help in selecting the right lighting and position.

And most surely you will find that you are taking advantage of sunshine and shadow or light and shade as some prefer to term it.

Sunshine and shadow are two of the most important factors in the art of picture-making. Whether you are a beginner or expert specialising in Landscapes, Street Scenes, Architectural Subjects, River or Lake or in any other subject, these two factors demand attention. They have a great influence in all pictorial work, oil and watercolour, etching and sketching, as well as all branches of our hobby of photography. The more we study these influences the greater use we shall make of them and the better and quicker our work will progress.

Sunshine and shadow make for contrasts. As it is important that contrasts should not be too strong, it is necessary to do our picture-making when the sun is not at its brightest. Also when some detail can be seen in the shadows and is possible of reproduction in the negative.

If a particular church or cottage or any other object which would serve a useful purpose in a view, looks too prominent at midday, take a look at the same view in the early morning, or about 3 o'clock in the afternoon, when the sun is not so brilliant and when there may be a white

cloud or two.

That is a very simple illustration of the type of training everyone must be prepared to do if desirous of producing some really first class exhibition or competition results. It must also be recognised that making oneself familiar with the effects of light and shade does have a very strong influence on the eye



An attractive picture of a difficult subject

when seeking the truly pictorial either in nature or in the handiwork of man such as beautiful architecture.

The reference to architecture reminds one of the wonderful effects caused by the play of sunshine through the windows of a glorious cathedral. How it will reveal the carving in wood or stone, or show up the delightful and beautiful designing of pillars and arches, and even produce a soft contrast with the dark woodwork of the roof.

## Church Work

Several years ago one of our leading amateur photographers entered a remarkable picture in a popular exhibition. The title was something like 'Till the Day Breaks' and it showed a tomb of a bishop with a full-length and very life-like statue of the dignitary in his robes and lying on the top of the tomb. The whole of the structure was in marble and very outstanding because of its beauty. The photographer, however, had, doubtless, waited his opportunity, for when he made the exposure, a splendid beam of sunlight was pouring through a window on the other side of the aisle and completely enveloped the figure. That ray of sunshine made the picture one of the most successful of the year, for it was reproduced in many journals.

Another feature, common to this period of the year, which is distinctly helpful in the construction and composition of our pictures is that many of our trees are void, or almost so, of foliage. This must not be regarded altogether as detrimental.

It really means that instead of being reproduced as masses of heavy shadows they will appear with more detail and with a fair splashing of soft light sepa-

rating the branches and displaying the outlines of the trees. Possibly a few Elms may be close at hand to give an added charm by means of their delicate twigs looking like so much filagree work. Sunshine in the early morning, or after a frost, and while the twigs are still wet is certainly worth while picking out with the camera. So also are the rays of the sun piercing the mist between the trees.

### Trees and Buildings

A valuable prize was recently won in a competition held by one of our seaside towns by a picture taken of a medium size tree without a single leaf. The artist had secured an exposure just as the sun was throwing a perfect pattern of the tree across a large patch of grass and showing a shadowy tracery of other trees on the trunk of the one in the picture. The photographer certainly made excellent use of sunshine and shadow in this instance.

Mention has already been made of buildings and street scenes and while this may not seem a very exciting or full subject to the beginner, yet with a little concentration and a quick eye for the 'unusual' it is not such a dull one as would appear. It is a good plan to do a little 'rehearsing' by taking up a position in a busy marketing place and noting items and incidents among the passers-by which possibly could be turned into snaps. Do not take anything and everything that comes along. In fact, do not worry if the time proves a blank. Your object is to test the neighbourhood for any subject that may be good if the lighting was right.

### Persistence Pays

The author remembers a certain street in an old town which made him go there at least eight or nine times before getting what was wanted. Altogether he must have spent an hour seeking the right position and waiting for the right light effect. But patience was eventually rewarded, for on going there one day at about 1.30 p.m. the street was empty, folks had gone to lunch, and there was a beautiful white cloud over the main building at the other end. The emptiness, cloud, and the light made the picture.

Sometimes a wet pavement and roadway after a good shower will provide some very charming reflections of a church or other building, or even of a street trader's stall. It is possible to get something that is definitely 'unusual' even while rain is still coming down. It is easy enough to stand in a doorway of a shop and watch your opportunity. This is what is meant by 'rehearsing', it is just another stage of the training mentioned already.

### Snow Disappointment

It is always well at this time of the year to have the camera loaded because it sometimes happens that a fall of snow occurs at night. To get the best effects an early visit must be made to the most likely spots for securing one or two exposures before the snow has been

trampled or melted into a semi-liquid mess.

Snow scenes are not the easiest of subjects, for unless there is some sunshine and shadows the results are inclined to be very disappointing. The masses of white require to be broken up, if not by shadows then by something that in the photograph will serve as half-tones or gradations between the white and, perhaps, the black trunks of trees.

The illustration on the previous page show the effect of snow early one morning in February. It was not enough to cover completely the woodland paths and during that morning the sun refused to shine, but the whiteness was sufficiently broken by small heaps of leaves on the tracks and little dark clumps on the banks and waysides as to make it quite worth while to make one

or two exposures to get such pictures.

### Quality Work

It will be recognised by all our readers that this article has dealt specifically with a feature of photographic work rather more advanced than the ordinary 'snapshot' stage. But it is not beyond the scope of anyone who is prepared to make use of the suggestions put forward. The result of making use of sunshine and shadow, whenever a suitable opportunity serves, will, undoubtedly, mean an advance in the quality of the work, which should be the desire of each of us.

We must help the camera to do its work well. The painter has to learn to mix his paints to the best advantage, and we must learn to press the trigger when the lighting and all other details are just right if we wish to capture a real picture.

## A Home-made Floor Polisher

FROM plywood or deal board about  $\frac{1}{2}$  in. in thickness cut several pieces about 8 ins. by 10 ins. to comprise a total of 1  $\frac{1}{2}$  ins. These pieces should be glued and screwed together, and the bottom face planed flat, if deal board is used. At each end on the top glue and screw 8 in. pieces of  $\frac{1}{2}$  in. square ply or wood, as shown. From Meccano, Trix, Juneero or similar strip metal of about 3 in. width, make two 'U' shaped bars, as at (A). Screw these on at the ends of the wood block, allowing about 1 in. between the strips and the  $\frac{1}{2}$  in. square pieces of wood, so that the strips can be moved, as seen in Fig. 2. Now form a stirrup from wood (Fig. 3), and screw it securely to the centre of the top of the polisher. An ordinary broom handle is drilled through about 1 in. from the bottom, and fitted to the stirrup with a thin bolt, a nail, or length of heavy gauge wire. This

latter should fit tightly into each leg of the stirrup, but the broom handle should swivel freely on it. If the polisher is not sufficiently heavy, screw lead or scrap-iron plates on top. Or build two shallow plywood boxes, and put a small cloth bag, full of sand, in each, before nailing on the lid. A length of rubber draught-stop strip, nailed round the block, will prevent any damage to furniture, should the polisher bump into it. A coat of paint will make the whole thing smarter, and a piece of old blanket or thick polishing rag renders it ready for use, the ends being secured by pulling the metal clips outwards, slipping the rag under, then pressing the clips to the upright position.

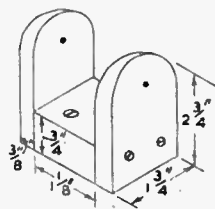

Fig. 3

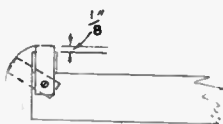

Fig. 2

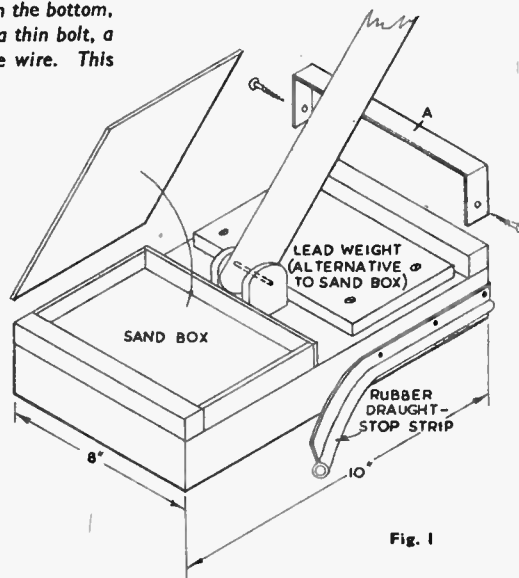

Fig. 1

# MISCELLANEOUS ADVERTISEMENTS

**COLLECTORS' delight**—my world-famous Oxford approvals. Generous discount and free packet with each selection. Postage please.—Frank Kennedy, 37 Junction St., Oxford.

**STAMP** approvals from 10 a penny. Send 2½d. Albums free.—Day, 73 Thornton Gate, Cleveleys, Blackpool.

**STAMPS**, world mixed, no G.B. 1/- a 100, 5/- a 1,000. Gift voucher with every order.—(H.W.14), Selby, 66 Donnington Road, London, N.W.10.

**STAMPS!** Send stamp for approvals. Choose your own free gift. Packets, sets and single stamps.—H. W. Harman, 6 St. Patrick's Road, Coventry.

**U.P.U.** packet contains 100 different Empire stamps, including 10 U.P.U. (no G.B.), 2/6 post free.—Bisson, 46 Sumatra Road, London, N.W.6.

**PHOTOGRAPHIC enlargements.** For specimen postcard and price list, send negative and 2½d.—Boucher, 228 Croydon Road, Beddington, Croydon.

**FREE Bahawalpurs'**, Colonial discount approvals, postage.—Bishop, 40 Marine Parade, Hythe, Kent.

**STAMPS free**—Queen Victoria packet including old Colonials, free to approval applicants.—Robert J. Peck, 7A Kemp Road, Bournemouth, Hants.

**ROYAL visit set free.** This mint complete set issued by Southern Rhodesia to commemorate the visit of the Royal Family, is absolutely free to all requesting bargain discount approvals. 2½d. postage please. Postal business only.—John Stone (Dept. H.W.), 264 Meadow Lane, Alfreton, Derby.

**WANTED**—back numbers of Hobbies.—Booty, Margaretting Tye, Ingatestone, Essex.

**EASILY made, easy weave, rug loom** blue prints, 3/6, crofter's Lancashire type, 1/6.—Hodgkinson Bros., Meopham Green, Kent.

**DISCOUNT approvals service.** Build your collection through our superb selections of worth-while stamps. Applicants receive grand free packet for postage 2½d.—G. Morris (Dept. H.B.), Valleymount, Southways Lane, Crownhill, Plymouth.

**BALSA Wood, Tissue, Dope, Cement, Rubber, etc.** The Modeller's postal service. List from—Foyurone Models, 31 Thrisk Road, London, S.W.11.

**40 DIFFERENT stamps free,** including Silver Wedding, U.P.U., Victory, Silver Jubilee, Coronation, Pakistan, etc. Send 3d. postage and request approvals.—J. F. Smith, 60 Boyne Rd., London, S.E.13.

**TOOLS for Woodwork** by Charles Hayward. An indispensable book for the woodwork enthusiast. Fully illustrated. 7/10 posted.—Quadrant Books (Dept. 4), 17 Quadrant Arcade, Regent Street, London, W.1.

**PUPPET Theatre Handbook**, 15/6. Everybody's Marionette Book, 5/6. Everybody's Theatre, 5/6. Specialised Puppetry, 5/6. Animal Puppetry, 5/6. Puppetry for Beginners, 5/6. 2½d. stamp for latest lists of marionettes, glove puppets, theatres, books, plays, blueprints.—John Morris, Marionettes and Glove Puppets, 2 East Albert Road, Liverpool, 17.

**INTRODUCTIONS.** Pen friends, companionship or marriage.—V.C.C., 34 Honeywell Road, London, S.W.11.

**HARDWOOD Wheels**, 2ins., 1/-; 3ins., 2/- per set of four. Tax included. Post paid. Other sizes available.—The Joyden Toy Co., 193 Chase Side, London, N.14.

**CONJURING and Magical tricks**, lists 3d.—De Hempsey, 363 Sandycombe, Kew Gardens, Surrey.

**PLYWOOD offcuts.** Birch and Gaboon in various thicknesses. Handy sized parcels for the cabinet, toy, model maker, and all handicrafts. Parcels made up in £1 and 10/- lots. Carriage paid. Send P.O. to Reeves, Plywood and Timber Merchant, 33 Front Street, Monkseaton, Whitley Bay. Tel. W.B. 4677. Due to exceptional demand we cannot promise delivery under eight days.

**£5 to £20 weekly earned at home,** running your own Mail Order business. Details, 1d.—Stebbing Publications Ltd., (HB) Naphill, High Wycombe.

**HOME Movies**, 9-5 film library. Projectors, films, in great variety. Sale cheap, stamp lists.—Wayland, 223 Longley Road, Tooting, S.W.17.

**BE Taller. Quickly! Safely! Privately!** No appliances—no tablets—no dieting. Details, 6d. stamp.—Malcolm Ross, Height Specialist, BCM/HYTE, London, W.C.1.

**MODELS.** You can make lasting stone-hard models with Sankey's Pyrama Plastic Cement. Supplied in tins by Ironmongers, Hardwaremen and Builders' Merchants. Ask for instructions leaflet.

**BE Taller in 14 days or money back.** Details, 1d.—Stebbing System, 28 (HB) Dean Road, London, N.W.2.

**TRANSFERS** for decorating toys, trays, furniture, fancy goods. List and samples free. Flowers, pixies, dogs, nursery rhymes.—H. Axon Harrison, Jersey.

**DOLL'S House fittings and papers;** send S.A.E. for list. Doll's house plan special; send 2/6. Trade supplied.—Zimplan, 88 Ware Road, Hoddesdon.

**HOMEWORKERS** wanted, light assembly work. Good pay. S.A.E.—Esprey, 29 Newmans Grove, Rugeley, Staffs.

**PRESSED Metal Wheels.** 1½ins., 1/3; 2ins., 1/9 per dozen. Or in stove-enamel finish red, green or blue at 6d. per dozen extra. Tax included. Post paid.—The Joyden Toy Co., 193 Chase Side, London, N.14.

**BLUSHING, shyness, nerves, self-consciousness, fears, ended.** Details under plain cover, 1d.—Stebbing Treatment, 28 (HB) Dean Road, London, N.W.2.

**YOUR Winter hobby.** Build a fleet of Wilson's Lorries. Photographically illustrated lists, 6d.—Wilson's Lorries, Dept. H., 1 Gt. Winchester Street, London, E.C.2.

**100,000 Government surplus bargains.** Aluminium rivets, approximately 1 lb. assorted, 2/6, post 6d. Ammeters, 0-25, brand new, 5/-, post 6d. Telephone send/receive sets complete (nothing else to buy), 8/6, post 6d. Sponge rubber strip, approximately 18ft. x 1½ins. x ¼in., 2/-, post 6d. R.A.F. insulation tape, really adhesive, 10 yd. roll, 9d., post 3d.; 50 yd. roll, 2/6, post 6d. Send 3d. stamp and S.A.E. for full list of interesting bargains for the handyman.—Milligan's, 24 Harford Street, Liverpool, 3.

**HOME watch and clock repair outfit.** Includes watchmaker's eyeglass, tweezers, screwdrivers, oilers, brush, oil, plus explanatory booklet and blue prints. In container. Skill unnecessary. Invaluable for all fine work, 12/9 inclusive.—D. Bolster (Dept. A.), 5A Station Parade, Ashford, Middx.

**FASCINATING and profitable hobby,** casting ornaments, toys, etc. You can easily make these yourself. Paints, brushes and all accessories. Illustrated catalogue of 700 moulds, plus latest list of rubber moulds with instructions, 9d. post free.—Cock of North Moulds (H), 140 Hollings Road, Bradford.

**FURNISH that Doll's house** with the latest model furniture, glassware, food and accessories. List, 8d.—Sutton Models, Billericay.

**LONELY? Then write Secretary** U.C.C., 5B.B. Hay St., Braughing, Herts. Genuine. Est. 1905.

**STAMPS FREE!!** Twenty unused (2½d.).—G. H. Barnett, Limington, Somerset.

**AMERICAN Magazines post free** for one year. Popular Mechanics, 32/-; Popular Science, 28/6; Mechanix Illustrated, 22/6; Popular Homecraft, 18/-. Stamp for full list of others.—Willen Ltd. (Dept. 57), 101 Fleet Street, London, E.C.4.

**ENTER the Juneero National Model** Making competition. Cash and kit prizes to the value of £150. Send now for details or see the Juneero Annual, 1/-, from all Juneero dealers or 1/2 post free from Juneero Ltd., Boreham Wood, Herts.



★ The most popular pactum package is M-Q developer (Meto - Quinol) containing all the chemicals required to make 10 oz. of solution for dish development. This M-Q pactum will also make 16 oz. of solution for using in a tank.

JOHNSON PACTUMS are exceptionally useful for those amateur photographers who like to make up small quantities of solution at a time. Toners, Intensifiers and Reducers are only needed occasionally, and to have the chemicals at hand in this convenient form saves time and trouble. Get a few PACTUMS of each kind and keep them ready in your dark room. You will need them.

The following packings are available.  
 ★ M-Q DEVELOPER (Meto-Quinol)  
 COPPER INTENSIFIER for 8 oz.  
 REDUCER sufficient for 8 oz.  
 BLUE TONER for making 10 oz.  
 SEPIA TONER to make up 8 oz.  
 GREEN TONER for making 10 oz.

Ask your Dealer for Scales Brand Pactums.

**JOHNSONS OF HENDON LTD.**  
 LONDON, N.W.4 ESTABLISHED 1743

## YOU CAN BECOME A HANDICRAFTS INSTRUCTOR

Experience not essential

Men who enjoy making things in wood or metal can turn their hobby into a well-paid, permanent and interesting Career. Short hours, long holidays, and security in a job you would really enjoy, can be yours if you become a Handicrafts Instructor. Let us send details of the easiest and quickest way to get the necessary qualification.

We definitely guarantee  
 "NO PASS — NO FEE"

If you would like to know about our unique method of preparing you for one of these excellent appointments, write today and we will send you our informative 176-page Handbook—free and without obligation. Mark your letters 'Handicrafts Instructor'.

**BRITISH INSTITUTE OF ENGINEERING TECHNOLOGY**

595 Shakespeare House  
 Stratford Place, London, W.1

# BIET

## The GADGET MAGAZINE

1/- Monthly Lavishly Illustrated  
 CRAMMED FROM COVER TO COVER WITH EASILY MADE  
 PRACTICAL GADGETS

For Garden, Garage, Home, Nursery,  
 Office, Workshop, Hobby and all other  
 purposes

Enquire locally, or send 1/- for latest issue to:—

**THE GADGET, - 8 Swan House,  
 Kingsbury, London, N.W.9**

## The bristles won't come out!



*Harris*  
 the paint brush with a name to its handle



There are 3 grades of Harris Brushes. "Junior" good. "Standard" better. "Super" best.

L. G. HARRIS & COMPANY LIMITED, STOKE PRIOR, WORCESTERSHIRE  
 CRC22

## AT LAST — The Perfect Precision Cutter

# MULTICRAFT

with the 4 in 1 PAK-A-WAY BLADES

The ideal Tool for every Hobbyist and craftsman. 4 Sheffield steel blades housed in handle. Interchanged in a moment. A shape for every job. From all good Hardware, Art and Hobby shops.

5/- including 4 blades. Clip 4d. extra.

Send for leaflet and name of your nearest dealer to:

**MULTICRAFT TOOLS**

29 BOLSOVER STREET, LONDON, W.1

Trade Enquiries Invited



**BRANCHES**

**LONDON**

78a New Oxford St., W.C.1

(Phone MUSeum 2975)

87 Old Broad Street, E.C.2

(LONDON Wall 4375)

117 Walworth Road, S.E.17

**GLASGOW**

326 Argyle Street

(Phone CENtral 5042)

Head Office & Factories—HOBBIES LTD., DEREHAM, NORFOLK

**MANCHESTER**

10 Piccadilly  
 (Phone CENtral 1787)

**BIRMINGHAM**

14 Bull Ring

**SHEFFIELD**

4 St. Paul's Parade

**LEEDS**

10 Queen Victoria Street  
 (Phone 28639)

**HULL**

10 Paragon Square

**SOUTHAMPTON**

25 Bernard Street

**BRISTOL**

30 Narrow Wine Street

(Phone 23744)

**Patterns for  
TROTTING  
TOY**

How the parts  
are to be cut  
is explained on  
page 309



# A KEY POSITION..

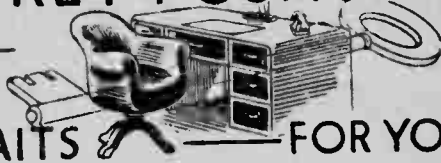

WAITS FOR YOU

Start training for it NOW!

There is still room at the top for the fully qualified man who is fitted for the job. YOU can be that man—successful, prosperous, with your future assured—by studying at home in your spare time, guided by the personal tuition of The Bennett College.

WE WILL HELP YOU TO ACHIEVE YOUR AMBITION

Get your feet on the ladder of success TO-DAY. Write to The Bennett College and learn how thousands of people just like you have reached the top with the right guidance. A well-paid job can be yours—start this pleasant spare-time study NOW.

## ★ FIRST CHOOSE YOUR CAREER

Accountancy Exams. Aviation (Engineering and Wireless) Blue Prints Books Book-keeping. Book-keeping, Accountancy, and Modern Business Methods Builders' Quantities Building, Architecture, and Clerk of Works (A.R.I.B.A. Exams.) Cambridge Senior School Certificate Carpentry and Joinery Chemistry Civil Engineering Civil Service All Commercial Subjects Commercial Art Concrete and Structural Engineering Draughtsmanship. All branches	Engineering. All branches. Subjects and Exams. General Education G.P.O. Eng. Dept. Heating and Ventilating Institute of Housing Institute of Municipal Engineers Journalism Languages Mathematics Matriculation Metallurgy Mining. All Subjects Motor Engineering Plastics Play Writing Plumbing Police, Special Course Pumps and Pumping Machinery Quantity Surveying—Inst. of Quantity Surveyors Exams.	Radio Service Engineering Radio (Short Wave) Salesmanship Sanitation Secretarial Exams. Sheet Metal Work Shorthand (Pitman's) Short Story Writing Structural Engineering Surveying (R.I.C.S. Exams.) Teachers of Handicrafts Telecommunications (City and Guilds) Television Transport Inst. Examinations Viewers, Gaugers Inspectors Weights and Measures Inspectors Wireless Telegraphy and Telephony Works Managers
---	--	---

If you do not see your requirements above, write to us on any subject. Full particulars free.

**COUPON—CUT THIS OUT**



TO DEPT. 62  
THE BENNETT COLLEGE LTD.  
SHEFFIELD, ENGLAND.

Please send me (Free of Charge)

Particulars of.....  
Your private advice about..... (Cross out line which does not apply.)

PLEASE WRITE IN BLOCK LETTERS

NAME .....

ADDRESS .....

Printed by BALDING & MANSELL, LTD., London and Wisbech, and Published for the Proprietors, HOBBIES LTD., by HORACE MARSHALL & SON, LTD., Temple House, Tallis Street, E.C.4. Sole Agents for Australia and New Zealand: Gordon & Gotch (A'sia) Ltd. For South Africa: Central News Agency Ltd. Registered for transmission by Canadian Magazine Post.

# EXTRA CASH IN SPARE TIME

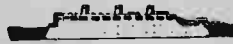

A fascinating way of earning extra cash in spare time from odd pieces of lead. Small Outlay—Large Profits. Sample mould 3/6d. Casting moulds, deep-cut and ordinary type Aeroplanes, Soldiers, Farm and Wild Animals, Cars, etc. Stamped envelope for full list. Illustrated Catalogue 9d.

MASTERCRAFT MOULDS  
69, ST. MARKS ROAD, HANWELL, LONDON, W.7

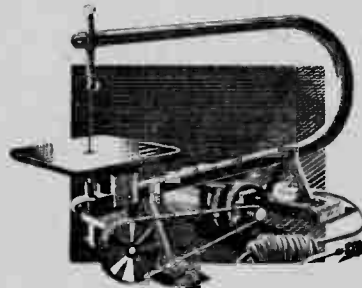

For wood, card, plastic, leather, metal etc.

## TREADLE OR MOTOR FRETSAWS

Whatever the handyman or craftsman is cutting or making, one of Hobbies Fretmachines will help with the job. For toy making, fretwork, model making, it provides easy and speedy cutting in all kinds of material. A pleasure to use, a factory for output, a 'life time of service.

From 70/- to £10

Ask to try one at any Hobbies Branch or good class ironmonger or hardware stores. Or free illustrated leaflets on request to:

HOBBIES LIMITED, DEREHAM, NORFOLK





# Hobbies

## WEEKLY

### CONTENTS

	Page
Table Fireplace Screen	321
Novel Battery Table	323
Chair Seagrass Seating	324
Wire Jewellery	325
Photographer's Printing Box	326
Handyman's Metal Accessories	327
The Editor's Notes	328
Simple Bed Rest	329
Model Cattle Siding	330
Books to Read	331
Home Improvements	332
Model Lamp Patterns	335

SUPPLEMENT DESIGN SHEET FOR NOVEL WALKING DOG TOY

February 22nd, 1950

Price Fourpence

Vol. 109 No. 2834

# A COMBINATION TABLE AND FIREPLACE SCREEN

**H**ERE is a little piece of furniture of unusual character, but one, nevertheless, that will be found most useful in the home. It is, too, an article that can be used in the winter time and in the summer. For winter evenings and for tea in front of the fire a very convenient table is formed. When summer comes this same table can be folded down and converted into a handsome firescreen.

### Screen Decoration

The construction is quite simple, but the care and attention required in the careful fitting and finishing, to say

nothing of the skill required in the decorative panel, calls for, perhaps, the more expert worker. Talking first about the top of the table, the reader has, no doubt, a suitable form of decoration which he can employ in forming the screen.

Perhaps he has a delicate piece of embroidery that would be ideal for mounting and putting under glass. Or a picture in inlaid woods or stains. Even a plain panel of good plywood having a suitable grain for polishing might be favourably considered.

For the frame or stand of the table oak is, of course, ideal, and this could be waxed after staining to give an excellent

result. If, however, this wood cannot be obtained, then American whitewood makes a very good second choice. This wood again could be stained and polished to resemble walnut or mahogany.

### The Main Frame

The main frame support for the table consists of four pieces, two uprights and two horizontal rails, with the addition of four pieces coupled to form suitable feet. In Figs. 2 and 3 the uprights (A) are first made and these are 1ft. 8½ins. long by 3ins. wide by ½in. or ¾in. thick.

The length given allows for ½in. depth of tenon to go into piece (B) of the feet, see detail Fig. 4. There must be two mortises cut in each piece (A), to take the ends of the horizontal rails. The measurement of 4½ins. must be taken up from the bottom of the upright, as in Fig. 3, the space between this mortise and the upper one being 14ins., as seen in Fig. 2.

### The Feet

A view of one of the feet is shown in Fig. 4. piece (C) being 5ins. long by 1½ins. by ½in. section, and piece (B), 3½ins. long by 1½ins. wide by ½in. thick. Mark off the mortises carefully in pieces (B) to fit the tenons of pieces (A). Then glue all firmly together.

The two rails (D) are next prepared and these are 21ins. long by 2ins. wide by ½in. thick. This length allows for a ¾in. tenon each end, as seen in the detail Fig. 5. At one end of each rail, too, there must be cut a recess, as shown in Fig. 5. This allows the upright rail (E) of the pivoted under frame, to close

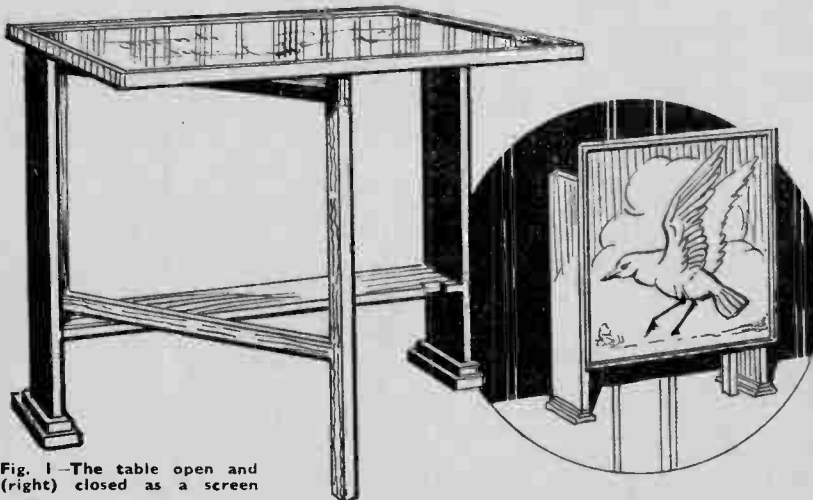

Fig. 1—The table open and (right) closed as a screen

All correspondence should be addressed to The Editor, Hobbies Weekly, Dereham, Norfolk.

in level with the outer surface of the end (A), thus enabling the table top to fall close when in the downward position.

This is again seen in the view Fig. 2 and in the plan Fig. 6. Glue the rails (D) in place in the uprights, making sure to get a close fit and, therefore, a rigid frame. At the opposite end to that containing the recesses, cut and glue in two small bracket pieces, as shown in Fig. 2. These are to strengthen the joint here and to help make a strong fixing for the pivoting screws which run up through both thicknesses of wood, see dotted lines for both rails (D).

### The Swing Frame

The pivoted frame which supports the table top when swung up is made from

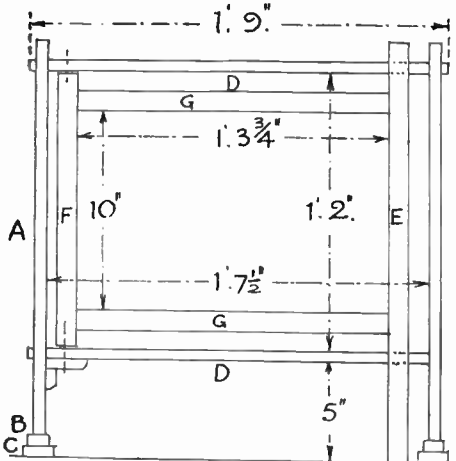

Figs. 2 and 3 Front and end elevation showing parts and dimensions

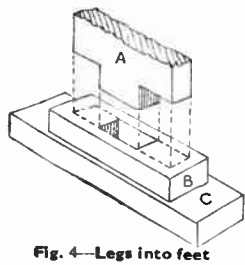

Fig. 4—Legs into feet

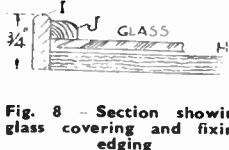

Fig. 8—Section showing glass covering and fixing edging

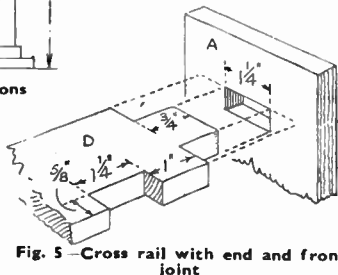

Fig. 5—Cross rail with end and front joint

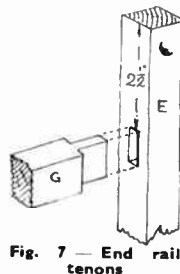

Fig. 7—End rail tenons

the rails (E), (F) and (G). Wood  $\frac{3}{4}$  in. or 1 in. square is used for all four rails, and the longer one (E) is 1ft. 9ins. long, (F) 1ft. 1 $\frac{1}{2}$ ins. long, and the two (G) rails 1ft. 5 $\frac{1}{2}$ ins. long.

Take care to cut the ends of all the rails square and then set out the mortises in the upright rails (E) and (F) to take the ends of the rails (G) which have tenons cut on them, as seen in Fig. 7 detail. All mortises and tenons can be cut with the fretsaw cleanly after a careful setting out.

Glue all mortises and tenons firmly and test the frame for squareness before the glue has hardened. Dowel pins  $\frac{1}{8}$  in. diameter may be run right through the tenons as an extra fixing if desired.

### Fixing in Place

The whole completed frame may be put in place between the horizontal rails (D) and long pivot screws run in as a fixing. The screws should pass loosely through rails (D) and screw into the

upright (F). Thin brass washers should be inserted between the ends of rail (F) and rails (D) so the frame swings out smoothly and does not allow of chafing between the wood surfaces.

### The Table Top

There are two or three ways of making the actual table top. Four lengths of tray moulding, having a deep rebate, may be mitred and screwed together and a square of plywood set into it. A piece of  $\frac{1}{2}$  in. plywood should be used and polished and a light framework made for the back for strengthen-

Then, to hold the glass securely in place, as well as to strengthen the framing, a beading of small section wood is mitred and glued round above the glass. In Fig. 8 we see a section through the table top. Here (H) is the plywood back, (I) the mitred edging and (J) the top inner beading. The glass is here shown lifted away from the plywood to make room for the decorative overlay on the backing.

As this table top might be used for the tea set and light foods, we should suggest a lightwood frame be made from, say,  $\frac{3}{8}$  in. thick stuff and, perhaps, 1 in. wide

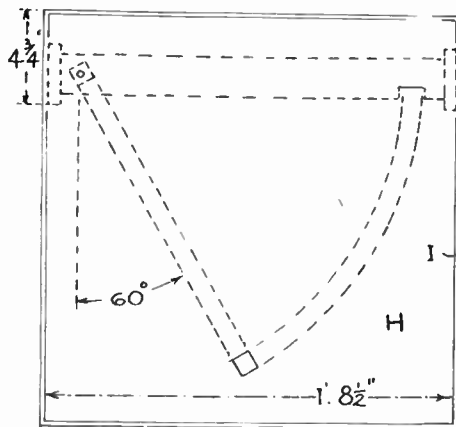

Fig. 6—Plan of top with swing of leg dotted

ing if glass is to be used with it.

We give in Fig. 8 a simple method of making the table top. First a square of  $\frac{1}{2}$  in. plywood is cut 1ft. 8 $\frac{1}{2}$ ins., and the rough edges carefully and thoroughly cleaned. Around this is then nailed an edging of  $\frac{3}{8}$  in. by  $\frac{1}{4}$  in. or  $\frac{3}{8}$  in. hardwood with the top edge rounded nicely and made smooth. If anything in the way of embroidery or a thin wood overlay is to be the decoration, then this is laid on the polished plywood and a sheet of glass laid over it. This glass is cut to the same size, of course, as the plywood.

and screwed to the underside of the plywood.

The finished table top is hinged to the uprights with hinges measuring about 2ins. by  $\frac{3}{8}$  in. wide. It would be best, and would make a neat job if the hinge flaps are recessed into the tops of the uprights, as in Fig. 3. Note the correct position of the table top in relation to the uprights, as in Fig. 6. The distance of 4 $\frac{1}{2}$ ins. is carefully measured and squared across so the frame hangs square when folded down. Test this out before finally fixing the hinges in place.

### Footlights

**S**IMPLE stage footlights may be made in this manner. Take an empty cocoa tin or similar tin, and cut in half downwards, leaving the bottom on to one half. Make a hole in the bottom and fix a bulb-holder into it. Wire up and fix bulb and you will find that half a dozen of these fixed to a long baseboard make good footlights for amateur theatricals.

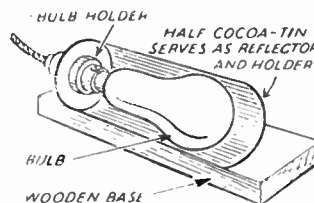

# Batteries in the box base provide for this NOVEL TABLE LAMP

**H**ERE is another novelty in the way of electric table lamps, and one that can be made from a few pieces of wood and metal. Our illustration, Fig. 1, shows at a glance the idea of the lamp. A docile looking giraffe stands beneath a palm tree. At a touch of the switch below, it lights and throws a mellow green light around, making the animal stand out in bold relief. It is a simple piece of work, almost entirely made with the fretsaw from some pieces of  $\frac{1}{2}$  in. wood.

## The Box Base

First make a shallow oblong box  $6\frac{1}{2}$  ins. long by  $3\frac{1}{2}$  ins. wide and  $1\frac{1}{2}$  ins. deep. The top of the box, piece (A), should measure  $6\frac{1}{2}$  ins. by  $3\frac{1}{2}$  ins. In it are cut the two slots or mortises, marked (E,E) in Fig. 2. Set out the two measurements shown, to get the proper position of the slots which each measure  $\frac{1}{2}$  in. by  $\frac{1}{2}$  in. and are spaced  $\frac{1}{2}$  in. apart. Cut these carefully with the fretsaw. The tenons which go into them must fit stiffly and accurately. Between the slots, next cut a hole large enough for the two wires of the flex to pass through to the lamp at the top of the tree.

## Pattern Parts

The sides (B), measure  $6\frac{1}{2}$  ins. by  $1\frac{1}{2}$  ins., and are glued on to the top (A), flush with the edge, as shown in Fig. 3. This gives an underside view of the construction of the box and its interior fittings.

The two ends (C) are shown full-size on the pattern sheet—included on page 335 in this issue. Thus all the worker need do is either to stick the pattern direct to the wood and cut round it in the usual way, or just lay the pattern on the wood from where it is intended to be cut, and just lightly prick in the corners. Then with a sharpened pencil join up these points to form the cutting lines. Use the one cut-out end for marking round to produce the second end piece. The side (B) can be got from the pattern sheet also.

We give on the pattern sheet a full-size view of the giraffe, and all that need be done is to stick this pattern down to the chosen piece of wood and cut round it.

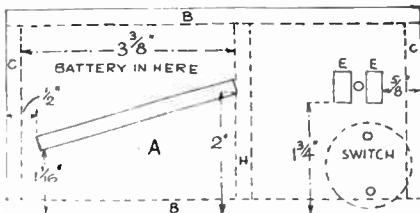

Fig. 2—Plan of the base board top

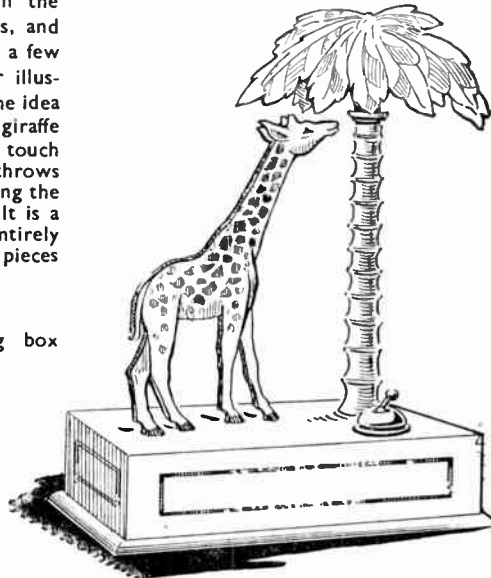

Fig. 1—The completed lamp with switch

There are two methods of making a fixing between the giraffe and the top of the box. On the pattern it will be noticed there is a base or strip connecting the feet. This, for sake of firm fixing, may be let into the top of the box as an ordinary tenon. Or, for simplicity, it may be simply glued to the flat top of the box, small fillets glued on either side.

To get the proper placing of the giraffe, the slot in the top of the box is indicated and figured in Fig. 2. If the slot is not to be made, then the position will be just pencilled on.

## Electrical Connections

It will be understood that a double-cell battery is to lie at one end of the box, as indicated in Fig. 2. A cross rail (H) bearing a brass strip will be fitted here to connect with the contact strip at the end of the battery, all as seen in Fig. 3. Then to form the second connection between battery and lamp, a raised loop of brass is screwed to the top of the box to contact that between the two cells of the battery.

Now turn again to the box construction and complete the floor. This

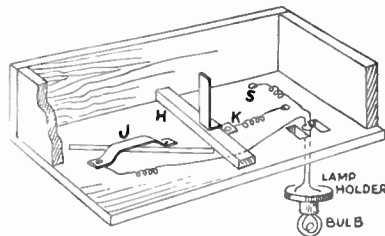

Fig. 3—Underview of box showing connections

is fixed to the sides and ends by means of screws so it may be removed readily. The floor will be a solid piece 7 ins. by  $3\frac{1}{2}$  ins., with its edges rounded nicely to present a good appearance.

## Lamp Pillar

We next come to the lamp upright, the base of which will fit into the two mortises of the top of the box. First, therefore, cut two pieces of wood  $7\frac{1}{2}$  ins. long by  $\frac{1}{2}$  in. wide, and two pieces  $\frac{1}{2}$  in. square. Looking at the detail (Fig. 4), we see how the four pieces are to be glued together to form a hollow tube as it were. Through this the wires are to pass to the lamp above.

On the two larger pieces of the uprights, as (E) in the diagram and on the pattern sheet, form tenons to fit into the slots of the top of the box. The smaller square sections will be flush with the tops of the tenons and will, of course, rest on top of the box. The whole upright may be rounded as shown by the dotted line and made to taper slightly towards the top.

## Tree Trunk

In addition to this shaping, the 'tree' may be realistically carved to give the appearance of a palm, as depicted in Fig. 1. (E) and (F) are given full-size. This grooving work can be done with a half-round rasp and file and finished smooth with glasspaper. When the 'tree' trunk is completed, glue the tenons into the top of the box and allow to harden before proceeding further with the work.

On the top of the 'tree' there is to be a disc (G) (see pattern sheet). This will be glued and nailed with fine fret pins to take the bulb holder which is screwed on top. To form the leafwork of the palm tree we need some thin cotton material such as butter-muslin. This will be cut to the shape of large oval leaves and then

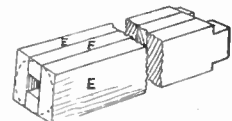

Fig. 4—The hollow 'tree'



Fig. 5—Shade frame

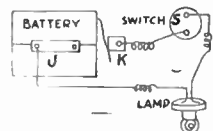

Fig. 6—The electrical circuit

dipped into a green dye. The leaves, of which there should be about sixteen, are intended to overlap each other and be wired or stitched to a simple two-way frame formed (Fig. 5) of a stiffish brass wire.

On the pattern sheet one of the sections is shown full-size, and the wire can thus be easily bent to this shape. The lower extremities of the wire are angled and pointed to fit into holes bored in the disc (G). Just above this the wire is flattened by hammering and then drilled with a tiny hole to take a brass fret pin. The top or peak of the two sections of wire are to be bound and stiffened with fine wire.

#### Leaves Frame

In fastening on the leaves, first wire four to the sloping tops of each frame, then stitch intermediate leaves to these, making thus eight in all. Then, between each pair of leaves, again stitch a further eight, so at the finish an attractive graduation of green light is got. From dark green at the crown of the tree to a paler green at the tips of the leaves.

It only remains now to add the bulb and make the wiring connections.

Before, however, this can be done, a switch must be fixed to the top of the box in the position shown in the sketch, Fig. 1. That is, just near the foot of the tree, and at (S) in Fig. 3. Here two holes are bored for the passage of the connecting wires.

#### Switch and Wiring

A neat little switch can be bought ready to screw in place above the hole. First then, in commencing to wire up the lamp with cotton-covered wire, of course, connect the end of two of the wires to the bakelite holder which is later fixed to the lamp standard, that is, to the top of the tree. When the wires are fixed, carry them down the centre of the 'tree' until they are taut and the holder held firmly in place.

Invert the box—having the base removed, of course, and run one of the wires from the lamp across the inside of the box and out through one of the holes to the switch. It will be best during these instructions of wiring to follow the wiring diagram given as Fig. 6. Now take the second wire from the lamp across the box to the arched brass connection at (J). Loosening one of

the screws there, wind the end of the wire round it and then tighten the screw again.

Next take a short length of wire and make a connection to the second fixing screw in the switch. Run this wire across to the upstanding battery connection at (K). The wires should lie flat and fairly rigid against the underside of the top of the box. If necessary one or two little staples could be made from bent pins to bridge the wires and be tapped into the wood.

#### The Battery

It only remains now to lay the battery in place on the bridge (J), noting that the brass strip at the end of the battery makes good connection with the upstanding brass connection at (K). The floor is finally screwed with counter-sunk screws to the sides and ends of the box. Before finally screwing on the floor, test the switch and connections and see that the light is good after inserting the bulb in the holder.

The woodwork of the box can be finished off as desired either by stain and varnish or oil, or the whole may be painted in matt, lined out as shown.

## How to renovate that worn seating by making A SEAGRASS CHAIR SEAT

**H**ERE is a cheap and easily accomplished way of renovating shabby bedroom chairs. All you require for making two chairs look as good as new is 1½ lbs. each of two different coloured seagrass, and a 1 lb. tin of the required colour varnish stain or enamel.

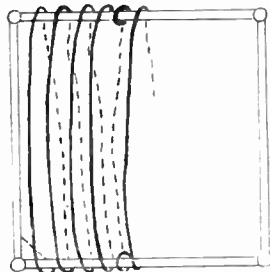

The first winding of seagrass



The knot in joining seagrass

For a chair that may be used in rooms where the predominating colour may be different, brown and natural are certainly the most useful shades. Otherwise you have a choice, as seagrass can be obtained in many different colours. Or you can arrange in two shades twisted together, orange and brown, green and natural, and many others.

#### Preparation of Chair

The first operation is to strip off all the covering of the chair, and clean the bars

of the seat thoroughly. Wind some of the seagrass into a ball, and nail one end firmly underneath the front bar of the chair seat. Now wind the seagrass from the front bar round the back four times, and then once round the back bar, going underneath and to wind round the front bar. This makes room for the second colour to be woven in and out across the chair.

If the chair is wider across the front than the back, it will be necessary to twist the seagrass round the front bar twice or even three times in order to fill the space.

#### To Prevent Slipping

It may be easier to fix a small piece of wood at the front of the chair, to prevent the seagrass slipping during weaving. This is especially necessary if the chair seat is of the curved variety.

When the seagrass, with each strand pushed securely against the next, has filled the space, join the second colour to the first. Push it between the strands to the opposite side, and begin weaving from side to side, over four and under four at the top and then underneath the chair.

Repeat this four times, then wind round the side bars as before, then in and out four times more, this time going over and under the opposite four.

#### To Prevent Sagging

Continue until the whole space is covered. Nail the seagrass firmly underneath the chair. Care is needed to pull the seagrass firmly, otherwise the seat of the chair may sag.

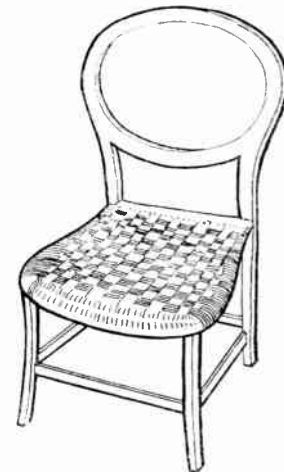

The completed chair seat

The best method of joining the seagrass is by untwisting one piece about 3 ins. from the end, and slipping the other end through the hole so made. Do the same on the other piece as seen in the diagram. This makes a firm and tidy 'knot'.

#### Material Cost

Seagrass can be obtained from any handicraft shop, and usually costs about 2/- a lb. for the natural, to 2/6 or 3/ a lb. for the more expensive colours. The best thickness to use for this work is the medium. The stools, which we see in the shops, and which are often marked at 20/-, can be made by anyone who has the time and patience for about 10/-.

# A fascinating craft to undertake is that of WIRE JEWELLERY

**T**HE art of the jeweller is one of the most fascinating crafts, and it is also probably one of the oldest. Jewellery has been esteemed and worn since the very early days, and the skill of the old craftsman was truly remarkable when we consider the crude tools used. They had to extract the precious metal from the crude ore, refine it and then work it into the finished article. Whereas today we can go to a shop and buy this already prepared in the form of sheet metal and wire.

## Simple and Pleasing

Many of you may think that the craft of the jeweller is beyond your skill, but this is far from the case. It makes a most enjoyable and, needless to say, profitable hobby for the average handyman. By starting with the making of simple articles it is possible to work through the various processes, until you become quite proficient and are able to set diamonds and precious stones in platinum, gold and silver.

Very few tools are needed to start with and if you like the work you can always add to them gradually. A very good starting point is with hand-made gold and silver wire jewellery. The work is quite easy and does not require any hard or silver soldering at this point. For tools, you will need a small pair of cutting nippers, a small pair of flat-nose pliers and a pair of small round-nose pliers. A convenient size for all of these is about 4ins.

## The Wire Required

Now for the material, which you can buy from a jeweller or a good class craft shop. You need hard drawn silver or rolled gold wire, or both if you like, either in round or square section. The best size is 22 S.W.G. One ounce of this size will provide you with enough wire to do quite a lot of work.

In order not to waste any of this wire it is a good idea to do a little practise work with hard drawn brass or copper wire. It is possible to make some attractive goods with either, but you

will find that they soon tarnish.

Start by making a plain necklet in round silver wire. First cut some of the wire into 1in. lengths—about 25 are wanted. With the round-nose pliers bend the end of the wire first, as shown at (A). Then with a backward bend, finish off as at (B). Do both ends of each link, but make the loops in opposite ways.

## Link Joints

Now we are ready for joining up. This is done by opening up one end of each link, slipping in the unopened end of another and joining up again. When opening a link do not pull it apart as at (D), but with a pair of flat-nose pliers lift it up as shown at (C). This method does not spoil the shape of the loop.

The making of the fasteners is shown in (E), (F) and (G). For the loop end bend up a length of wire as at (E), then continue bending until the two loop ends overlap like (F). Make the clip end from a longer piece of wire to the pattern (G) and join the two fasteners on to either end of the necklet. The length of an average necklet is 16ins., and 25 links should give you this length.

There are many ways of adding variety to this type of necklet. For instance, gold and silver could be used alternately, or some of the links could be made shorter and inserted in various places.

## Bead Patterns

Beads in various sizes and colours can be used to produce some very attractive designs. They are threaded on to the wire and the ends looped, as shown at (H). You can make a necklet entirely of these beads; or one or two plain links can be put between the beads; or you may put just a few in the centre.

Pendants of various designs add charm and dignity when hung from the centre of a necklet. A bead drop pendant, shown at (J), or a plain wire cross, as

(K), are very easy to make and are quite attractive.

## Easy Pins

Tie pins are yet another type of wire jewellery that are easy to make. A thicker gauge of wire is really needed for this job and 20 S.W.G. is about the right

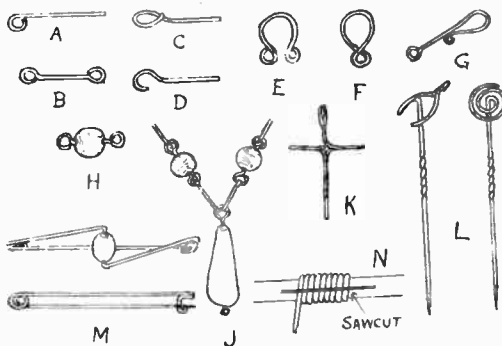

substance. If square section wire is used the stem can be given the twist, shown in Fig. L, which keeps the pin from slipping out so easily. Be careful not to overdo this twisting, especially if hard drawn wire is used, otherwise the wire will crack and snap off.

There is a wide range of patterns possible for the brooch designer, who will be able to turn out some very attractive wire work. A few examples are shown in Fig. M. All the letters of the alphabet are capable of being designed and used for brooch and tie pin ornamentation. It would be as well to draw carefully the letter you need, and work out the bends before attempting the actual work.

## Wire Rings

Small wire rings, or 'jump rings' as they are called, form an important part of the jeweller's stock-in-trade, and it is as well at this point to know how to make them. Take a knitting needle and wind on a length of wire, keeping the coils close together. Slip it off the needle and put it on a piece of dowel rod.

Then, with a fine metal-cutting fretsaw, cut through lengthways as shown at (N). You can make various sizes by this method, but the larger ones should be of thicker gauge wire. Whole chains can be made by joining up the rings, or they can be used between the links of a necklet to give variety.

In the joining up, two pairs of small flat-nose pliers are needed to open and close up the rings to avoid straining the rings out of shape.

Silver soldering or brazing the rings makes the job much stronger, besides being quite professional looking. The mysteries of this art will be explained in another article.

(To be continued)

## Polish Remover

*Is there any way of removing the polish from a table without having to scrape it off? (D.S.—Drighlington).*

**T**HE easiest and best way to remove the existing polish, is to use a proprietary paint and varnish remover, which you can buy at most oilshops or paint stores. It is far preferable to making one up oneself, as the ingredients are messy and unpleasant to use.

You do not state what colour stain and polish has been used for the table, but if mahogany or walnut, you may have

trouble in removing the stain for re-staining light oak. Everything depends on how deep the stain has penetrated.

After using the varnish remover, let dry, then lightly glasspaper. If too dark, apply a solution of one ounce of oxalic acid to 1½ pints of warm water as a bleaching fluid. Several applications may be necessary. When satisfactory, swill off with water and then wash over with vinegar. When dry, the light oak stain may be brushed over and then polished. On no account omit the vinegar, or the bleaching process may continue and spoil the work.

# The amateur photographer should certainly make this PRINTING BOX

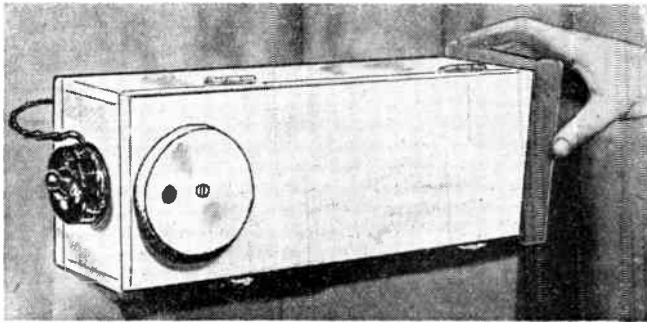

Fig. 1—Picture of the finished box in use

**T**HE printing-box herein described, is very useful and convenient for those amateur photographers who prefer to do their own film and plate printing. It should not be beyond the ability of almost any reader to construct if he follows the details carefully.

Amateur photographers are, of course, aware of the somewhat difficult conditions that exist when printing on gas-light paper. The handling of the paper is generally done in a dark-room illuminated by a yellow safelight. The exposure of the paper is either done in the darkroom with the aid of an opal bulb, or is carried out in an adjoining room, which entails much journeying back and forth, to the almost certain annoyance of any occupants therein.

## The Darkroom

The former method of exposure in the darkroom is to be deprecated, as any sensitised material left unwrapped or, perhaps, carelessly repacked will almost certainly be fogged and spoiled. In fact,

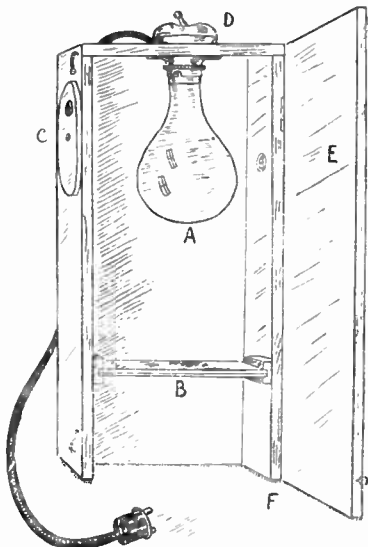

Fig. 2—Front elevation showing the constructional details

a golden rule to observe is, never illuminate your darkroom with a light other than that provided with your safelight.

With the aid of the printing-box, however, printing can be expeditiously and safely done in the darkroom, and as the printing distance is pre-set, much greater accuracy can be given to the exposures, resulting in far better and uniform prints and fewer wastages.

## Suitable Dimensions

The printing-box is not very difficult to make, and can be constructed for quite a modest sum by the handyman. The measurements given are for the popular 2½ins. by 3½ins. size printing frame, but these can, of course, be quite easily modified to suit the reader's individual requirements.

Before commencing the actual construction, the reader is advised to study Fig. 2 to observe the salient features. As can be seen, the set-up is quite simple. It consists of an opal or pearl bulb (A) of 60 watts with an opalising or diffuser screen (B) set at a predetermined position beneath. The combination of pearl bulb and opalising screen is necessary to ensure a perfectly even spread of light over the entire print. Should a plain bulb be used a patchy print would result, even if the opalising screen is in position, as the light would naturally be concentrated around the filament area.

## Ventilators

Two air ventilators (C) are fitted on the sides of the box to allow the escape of heated air. A switch is fitted to the top of the box (D) and one side is hinged (E) to allow for the replacement of bulbs, etc.

The printing-box is constructed from four lengths of smooth wood, two being 14ins. length by 3½ins. width by ½in. thickness, and two of 14ins. length by 3ins. width by ½in. thickness. The two smaller pieces are butt-jointed to the edges of the larger piece by gluing and screwing, and a piece of wood, 4½ins. by 2½ins. by ½in. is glued and screwed on to one end.

The remaining length of wood is then hinged to the assembly by two small hinges rebated into position, and secured in the closed position by two hooks and hasps. The dimensions of the completed box should be 14ins. length by 3½ins. by 2½ins., internal measurements. It will be noted that these measurements give a slight clearance between the opalising screen and the sides of the box. This is necessary for efficient ventilation.

## Light Trap

A 1in. diameter hole is drilled in each side of the box, 3ins. from the top, for ventilation purposes. A light-trap is constructed from a suitably-sized wax or polish tin. This is drilled with a 1in. diameter hole near the edge and screwed into position over the ventilation hole (see Fig. 3). The holes in the sides should be diametrically opposed to those in the tins, and it is advisable to paint the interior of the lids with a dead

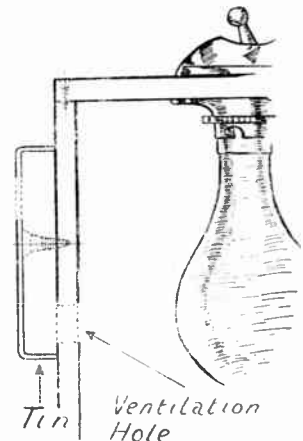

Fig. 3—Light trap and ventilator

black paint to prevent any undue light reflection occurring.

## The Screen

The diffusing screen is made from two pieces of clear glass, 3½ins. by 2½ins. Glass negatives that have been cleared of their emulsion are very suitable. A piece of tracing paper or double thickness of tissue paper is interposed between, and the two pieces of glass sealed together with adhesive plastic tape around the edges. Of course, if one can obtain ground glass, so much the better.

The diffuser carrier is constructed from two pieces of wood, 2½ins. by ½in. by ½in. These are grooved to a depth of ¼in. to take the glass screen, and screwed into position in the box, 4ins. from the open end as shown in Fig. 2. The interior and exterior of the box is now well cleaned up with sandpaper and

(Continued foot of page 329)

# Joins can be made or strengthened by using these METAL FITTINGS

**T**HE handyman who works about the home is continually finding odd jobs to do which not only provide interest, but occasionally some degree of difficulty which needs solving before the actual work is commenced. For this reason, he should be conversant with all those little gadgets and normal pieces of ironmongery which can be used on occasions to save much time and trouble.

These various small articles, undoubtedly, serve to strengthen and to help in the piece of work being undertaken. At the same time they should not serve as an excuse for shoddy work or bad carpentry. They are usually linked with various types of ordinary woodwork about the home, and although you

have an angle plate going to stiffen up a corner, see that the actual woodwork is glued in the ordinary way. Rails which may be held together with joints, or indeed, any other woodwork, should be built according to the ordinary carpentry plan, and then these little additions or substitutes be added.

The one shown (Fig. 1A) double-ended screw. It is normally obtainable in various sizes, and its reason should be fairly obvious. You cannot, of course, use it in every case because it may be impossible to turn the second portion of the work on to what will then be the projecting screw. You see a suggestion for its use in the diagram here at Fig. 2, which will immediately suggest possible other occasions on which it can be brought into play; in rigging up fittings or doing repair work.

As in all other types of screws, you

finally meets the other, and so provide a very strong joint.

A similar type of screw fixing is shown in Fig. 1B, but as you see, the screw portion is at one end only. The opposite end has a flat plate portion usually of fairly substantial metal which will not bend easily. This plate is used where one portion is screwed into the work, and the other portion serves as a support or retainer on the surface of the wood. You can see how it would be used under a shelf or rail, as shown in Fig. 3.

## Correct Boring

Its position must be marked carefully, and care taken that when the projecting flat piece is in position it is in the right place for adding the adjoining rail or shelf, or whatever the other portion is. Here again, too, a suitable hole should be bored with a bit slightly smaller than the screw portion. In this case, too, the fitting is turned home with a pair of pliers on the flat portion of the plate itself.

At Fig. 4 is shown three types of brass plate which frequently serve a very helpful purpose. In one case, as you see, the strip is bent at a flat right angle, and in the other case the strip is flat in itself, taking a different type of corner. The third instance is of a plain metal strip. Each of these has four holes which are usually countersunk.

## Plate and Hole

Here again, the angle plates and repair plates, as they are called, are obtainable in varying sizes, and it is, therefore, not advisable to buy them until you know which is required for the particular job in hand. The holes are countersunk, and the suitable screws should be purchased at the same time, to ensure their heads will bed nicely into the plate, and that the screw portion will not be too long for the woodwork. Even the fixing of these is not of the easiest, because you may shift the plate after fitting in one screw, and then the whole thing will be spoiled.

Illustrations are given at Fig. 5 of the method in which they can be used. The angle plate (A) should be stood in its corner, and a pencil mark made where the screw holes will need to be bored



Fig. 1—Two forms of screw-in plates

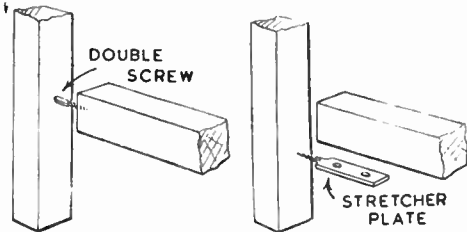

Fig. 2—Holding a rail Fig. 3—The support fitting

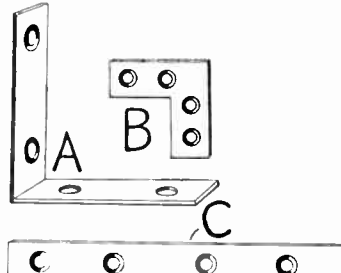

Fig. 4—A group of useful metal fittings

are not likely to be called upon to use all those illustrated, on any one job, it is worth bearing them in mind, then when you have something on hand, you will be able to visualise how its construction can be aided by these little pieces of metalwork.

Normally we recommend having a stock of what you want to save trouble if you happen to want them in a hurry. So often it is a case of a job being hung up because you have not the actual tool or implement on hand, and the shops are shut for the day so you cannot run out for one immediately.

## Size for the Job

In the case of this ironmongery now being dealt with, however, it is difficult to have all you may require as a stock, in your handyman's outfit. You see, there are several sizes in each one, and if you are going to obtain a range of all of them, the room and the cost involved are likely to be unnecessarily excessive. The better method, of course, is to plan your work in advance, and make sure you obtain all the necessary parts required before you actually commence upon the job.

We are not advising these parts here to be used entirely on their own, but simply as an addition to the ordinary work of joining. For instance, if you

should certainly bore a hole before driving it in. The hole to accommodate the threaded portion should be slightly loose in diameter, then the larger diameter hole will have to be bored to take the smooth shank portion. The screw is turned in with pliers, carrying it half way into one side.

The other adjoining piece of rail or shelf or similar fitment is then turned on. In boring a hole, by the way, be sure you get them perfectly straight to each other. Turn the wood on to the screw carefully, holding it at the right angle and gradually pressing home until it beds itself against the other portion required. You should, of course, put a touch of glue on the end of the rail before it

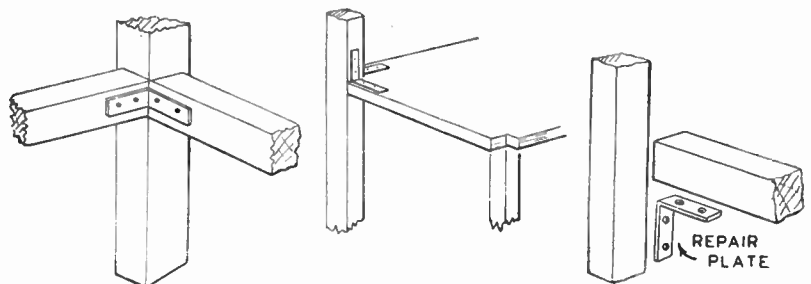

Fig. 5—Three examples of the use of metal angle plates

See the angle plate goes right into the corner first, and that it does not move until you have made a pencil mark of the screw positions. You will see quite easily that if you fix one side of the plate at a slight angle, then the other flat portion would not bed down on to the wood to provide a good sound joint.

### A Corner Plate

The second repair plate shown at (B) is as you can see, suitable for holding the angle joint of a frame. The mitre comes across beneath the actual corner, and the two screw holes provide sufficient holding on each. Here again, as in the other cases, it is advisable to add a spot of glue to the end of the wood, and to let this be tacky before joining together and finishing with the angle plate. If this plate happens to be of thick metal, you may think it worth while sinking it into the woodwork.

This would be particularly useful in the case of the picture frame where you are going to paste brown paper over the whole of the back to make it dust-proof. The backing would thus lie flat along the wood, and not have to be burst or turned because of the raised portion of the angle plate.

### Metal Stiffener

The part (C) in Fig. 4 is, as can be seen, merely a plain strip in which four countersunk holes are added. It is useful in joining two pieces of wood together, to stiffen additionally by glue. If you want to make a wide plank by

gluing two strips of wood together with a shelf, then the addition of such a strip as this on the underside, will prevent undue strain on the glue, and help to keep the shelf much more rigid.

In thick wood it could, of course, be recessed into the board by chiselling away a suitable sinking. The plate and the countersunk screws would then be flush with the surface of the wood.

At Fig. 6 we have another type of

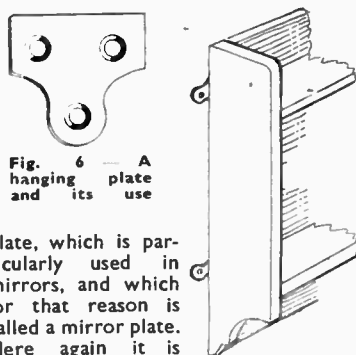

Fig. 6 — A hanging plate and its use

plate, which is particularly used in mirrors, and which for that reason is called a mirror plate. Here again it is obtainable in various sizes, but always it has two holes at the bottom, and one centrally in the circular top portion. Here again, the holes are countersunk so that the screws will go in flush. When they are being used on a mirror frame or picture frame, be careful to measure the thickness of the wood so the screw does not run right through.

These mirror plates are also useful,

and frequently recommended for holding bookshelves or bathroom cabinets or similar articles. Their use on the end of a bookshelf is shown at Fig. 6. For a mirror, they can be fitted in the same way, or of course, you can fix them to the back of the frame top and bottom. The portion of the plate on the woodwork itself should be fixed first, again making sure that the projection beyond is at rightangles.

Now hold the fitting in place on the wall or wherever you propose fixing it, and mark the position of the hole with pencil. Drill suitably for the fixing screw before driving home. If there is any tendency of the wall to crumble, you should certainly add a wall plug of some kind before the screw is driven home. This is particularly essential if the fitting which you are fixing is heavy, or in such constant usage that it might be pulled away from the wall itself.

### Strength in Fixing

These metal holding plates are usually quite strong. In larger sizes they are cut from solid strip, but in the case of the small ones they are of pressed tinplate or some similar thin material. Remember this when you get them, in conjunction with the requirement of the article on which they are to be affixed. A heavy article, of course, must not be fitted with a thin tinplate fixing. On the other hand, imagine how the finished fitting will look, and do not get an unsightly mirror plate so large that it projects in an ugly and too obvious fashion.

## From the Editor's Notebook—

THERE seems to be an international trade in matchbox covers. I learn that many collectors have postal contacts all over the world, and find a peculiar fascination in getting new and unusual kinds. Perhaps the King of Collectors is Jack Butter of Baldock who claims 63,000 labels! Then 17-year-old Tony Sharman of 174 London Road, Bedford, can boast of having two or three thousand. The idea, of course, like stamp collecting, is to get as many different ones as possible. It is the actual coloured label that counts, rather than the complete box, and guard books provide the scrap albums in which they can be mounted. The Match Label and Booklet Society issues a news-sheet, holds exhibitions and organises rallies. In London labels are auctioned, the same as rare stamps, and one specimen has been known to fetch as much as £500. Do not ask me why!

I KNOW a house which contains over 1500 dogs—and not a sound from one of them! You see they are all china ones, standing and lying about on tables, chests, mantelpieces and sideboards. The owner of this unusual collection is Mrs. L. Bofeys of Charlton Kings, Cheltenham, who has been getting them together over a quarter of a century. There is every kind imaginable, some

life-like in their realism, and some merely ornaments (?). And every one has a name, but does not know it! Well there you are—a suggestion for another collecting hobby.

THE Walking Dog Toy here shown is an amusing novelty made from this week's gift design. It is of solid wood, with jointed legs and body so that when pulled along it can be turned in any direction, with its little feet paddling along in delightful fashion. Those who want to make it should obtain the complete kit of materials (No. 2834)—wood, wheel, hinge, etc.—from a Hobbies Branch for 5/6 or post free for 6/3 from Hobbies Ltd., Dereham, Norfolk.

THERE is a surprising interest in making matchstick models, and I am frequently asked for the name of a book

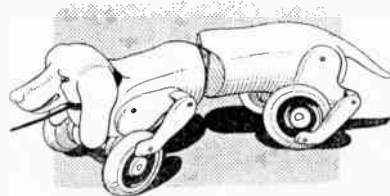

on the subject. Unfortunately there is not one published, that I know of, but it provides an opportunity for some budding author. Churches seem to be the most popular subjects, and the size depends largely on the number of matches available and the time allowed. Obviously, in these days of shortage, it is not the sort of hobby you can begin at once. The preparation and collection of thousands of matchsticks will take a little time!

I WAS interested to receive from Mr. L. Phillips, of Penywern, Neath, one of the letters which Hobbies sent to their customers as long ago as August, 1905, in connection with the 1906 Handbook. It mentioned wood, which was then obtainable in all kinds, and also presented the design of 'The Nelson Clock' to commemorate the hundredth anniversary of the Battle of Trafalgar! That design was very popular for a long while, and some readers may still remember it, and even have one in their possession. I wonder how many?

A READER from Co. Waterford, A. Eire, tells me he is still using a fretsaw frame he purchased from Hobbies 36 years ago, still the same as the first day he had it. But not with the same blade in it, I hope! **The Editor.**



# For ill-health or comfortable reading make this SIMPLE BED REST

**I**n times of illness, a bed rest is a great blessing to the patient; it allows of a comfortable position both for eating and reading. For a permanent invalid its use needs no stressing. Fortunately, it is an article particularly easy to construct, and requires little timber to make up.

In fact, as will be seen in the drawings, the woodwork part consists only of a frame, made up of 1in. by 2in. wood, hardwood if available, or just a good quality deal.

Some suggested dimensions are given in Fig. 1, but these can be easily amended to suit any particular size of bed frame, if desired. The frame is jointed at the corners, as at (A) in Fig. 2, using a mortised and tenon joint.

Note the tenons are shouldered at the top or bottoms—the usual practice for such forms of frame. To avoid splitting the wood, when chiselling-out the mortises, it is as well to cut the sides a little longer than necessary, as in detail (B), then to saw off the surplus after the joint has been glued.

## Webbing Back

Glue the frame up, knock the joints up tight, and leave for the glue to get hard. Then, as advised, saw off the surplus ends and plane the edges level at top and bottom. Give the woodwork a good glasspapering all over, leaving no rough edges anywhere, then stretch strong webbing over the frame, as at Fig. 1.

For this job a webbing strainer will be necessary, to bring the webbing up taut, before tacking it to the wood. A simple home-made form of strainer is shown in Fig. 3 (C), and is well worth making, as it is an invaluable tool for upholstery jobs any time. It is a length of hardwood,  $\frac{1}{2}$ in. to  $\frac{3}{4}$ in. thick,  $3\frac{1}{2}$ ins. wide and about 9ins. long.

The forward end is pared to an edge, and the rear end rounded off. Near the

front a slot,  $2\frac{1}{2}$ ins. long and  $\frac{1}{2}$ in. wide is cut through. It is made wedge-shape, the sides splaying out to  $\frac{3}{4}$ in. wide underneath the strainer. A wedge, to fit this slot is shaped up, and connected to the strainer with a cord, as seen in the diagram.

In use, the webbing is doubled and the loop pushed through the slot, the wedge is inserted, with the loop round it, so that the webbing, under strain, pulls the wedge up and prevents the webbing slipping.

Tack the webbing to one side of the frame, then place the strainer at the other side, as at (D), and press downwards to tighten up the webbing as much as possible. Keep it so while tacking it down to the wood. When tacking the cross webs, weave them under and over, as in the diagram Fig. 1.

Tack all securely, firstly with three tacks to each, then secondly, with two additional tacks, this time through the doubled-over ends as well.

The top edge of the frame should be rounded off to a neat curve. The edges and back of the frame can now be stained and varnished oak or walnut colour. The stain can be carried over the front to about  $\frac{1}{2}$ in., the remainder will be hidden by an outer covering of some material and so needs no colouring.

## Support

The material can be any strong stuff which may be available. A small oddment of tapestry would look nice and might be picked up cheaply from a shop. The edges should be folded and the stuff tacked through the double thickness.

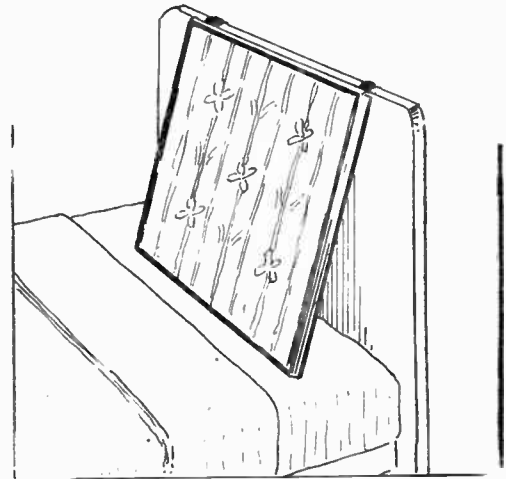

Draw it tight as tacking proceeds, to make a neat and creaseless job.

To support the bed rest, a pair of metal fitments will be needed. These can be bent up from  $\frac{1}{4}$ in. by  $\frac{3}{4}$ in. metal bar to the shape seen at (E) in Fig. 4. Allowing a little extra for the bend at the top, a total length of 11ins. for each will be about enough. The curved top parts should fit over the head of the bed, as seen in the general view of the completed article.

## Finishing Touches

They are drilled for fixing screws, and if slots, instead of holes, are cut, some adjustment can be made afterwards for setting the bed rest at the most convenient angle to suit the patient. Fix them to the back of the bed rest, as at (F). Unless these metal fitments are made from non-rusting metal, it will be as well to enamel them before screwing them in place.

If the head of the bed is of polished wood, instead of metal, a strip of baize or velvet, or some such material, can be folded over the carved ends of the fitments to prevent them scratching or otherwise damaging the woodwork. Alternatively, a short length of rubber tubing of the right size could be stretched over the metal ends instead, and would serve even better.

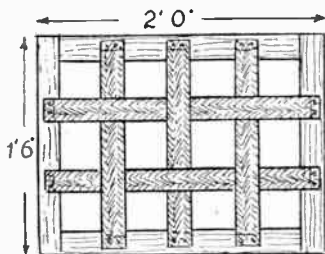

Fig. 1—The webbing on its frame

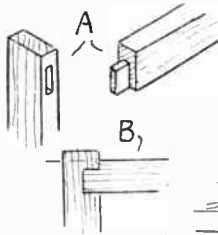

Fig. 2—Corner joints

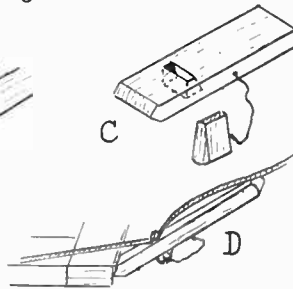

Fig. 3—The webbing stretcher

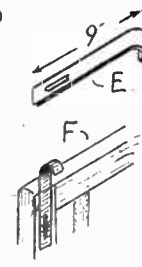

Fig. 4—Metal hangers

## Printing Box—(Continued from page 326)

the interior painted with a flat white paint. The exterior can be left plain or stained as desired.

The edges of the open end of the box are covered with red plush by lightly tacking and gluing into place, Fig. 2 (F). This forms an efficient light seal during the time that the printing-frame is held

in position during exposure. It may also be necessary to apply the red plush around the edges of the hinged door, but if the box has been carefully made, this precaution should not be required.

A flange fitting bulb-holder is screwed into position, and is wired up to the switch which is afterwards screwed into

position on to the top of the box. An adequate length of flex should be allowed for, which is connected up to a 5 amp plug. A 60 watt pearl bulb is inserted in the holder, the diffuser glass installed in its carrier, and with the closing of the hinged side, the printing-box is ready for use.

# Add to the realism of your model railway with A CATTLE SIDING

**M**ODEL railways are made or marred very greatly by their line-side effects, and here is a miniature cattle-loading stage and 'loading gauge' for your goods yard which will make it look just like the real thing. The dimensions given are for gauge O, but it would not be hard to compute the sizes of parts required for gauge OO. Or, going on the other side, for gauge 1.

First obtain a thin rectangle of wood  $7\frac{1}{2}$  in. by  $7\frac{1}{2}$  in. as a base upon which to work. The platform (A) is  $7\frac{1}{2}$  in. by  $4\frac{1}{2}$  in. and its height depends upon whether you are using scale-model track or tinplate. In either case the top of the platform must be 1 in. above the top of the rails. Tinplate track, it will be found, stands higher than scale. The block obtained, bevel off the one side as shown to suggest a ramp for the cattle to come up and then attach to the base with suitable screws up from below.

## Railing

Next put on the railing (B). This also is 1 in. high and is made up of ten upright posts (K) to which are carefully glued strips of thin basket-wood. Those plain

sidings where the main line is reached. We must consider ours to be in this last position, for cattle trucks only do not require the checking of a loading gauge. But there is no reason why trucks from lower down the siding might not have to pass our cattle stage and need a load check.

The main post is  $6\frac{1}{2}$  in. above rail level, so the total length is this plus the height of the rail. It is about  $\frac{1}{2}$  in. square at the bottom but narrows off towards the top. The cross-bar (D) is  $3\frac{1}{2}$  in. long and about  $\frac{1}{2}$  in. in section. Do not make this bar too thick or it looks clumsy and spoils the model. It is fastened to the upright by the simple inleting shown, and its end is supported by the wire (E) which goes at an angle to near the top of the post.

Now cut the metal swinging part (F). This is  $2\frac{1}{2}$  in. wide and its exact shape can be taken from the squared drawing.

This section is best cut out of a piece of zinc or tin. It will probably curl in the cutting, but can be straightened out later by lighthammering.

Finally, this metal outline must be hung from the crossbar by two lengths of wire as (H). This must be very fine and inserted through holes

carefully bored in the tin and wood above. The best way to bore holes in anything very small like the tin shape is to tap with the point of a tack and then file away the slight bulge that appears on the other side. The holes through the wood above can be made by pressing with a strong needle.

Some attention must be given, of course, to seeing that the gauge hangs quite level and  $3\frac{1}{2}$  in. from the tops of the rails. The whole loading gauge is fastened to the end of the platform by one or two sprigs carefully inserted. Lastly put down the rails. With the laying of these you will be quite familiar from doing this on other parts of your track, but the inside rail should be 1 in. from the front of the platform. Also, if

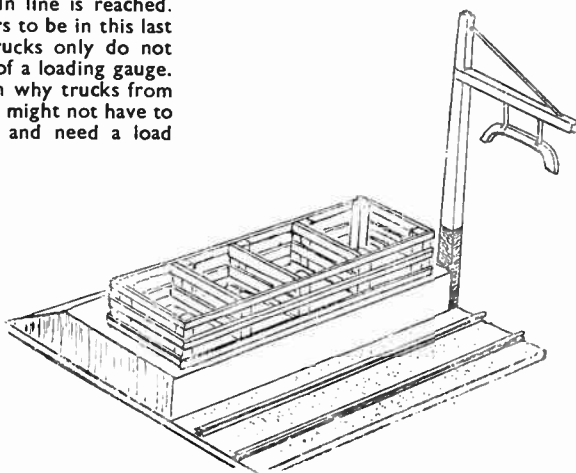

your system uses tin-plate it may be found necessary to put small pieces of wood under the ends of the sleepers, as with tin-plate track, sleepers are usually made less deep at one end than the other. This is to allow fitting in with curved rails which are always 'banked'.

## Permanent Way

However, it is quite an easy matter to level a length of straight tin-plate with slips of wood, the rail itself being held in position by screws through to the baseboard, through holes punched in the sleepers. In all cases it is better to have a permanent length of rail in front of our cattle stage, other rails of the layout being joined to this.

In front of loading stages of any kind the rails are usually littered or built up with cinders to well above the sleepers—to help walking about the yard safely. This characteristic can be well copied in our model by laying glued sand around the rails after they have been firmly fixed in position. This realistic touch adds to the appearance quite a lot.

## Painting

Lastly, we come to the painting of the stage and gauge. The post and crossbar is white from (L) upwards; below is black. The wire work and (F) are brown. The railings which represent the pens are white, as these in actual practice are invariably kept whitewashed.

The platform itself is brown with a white band along the front, while the slope at the back is painted with glue and then sprinkled with sand or powdered stone to give the idea of a concrete or similar approach. The colouring of this model is rather important and it is quite worth while spending some little time on it to obtain the correct effects.

The work should be done with a good class of paint and a small brush. In the case of any woodwork, give a priming coat first before the second coat is added.

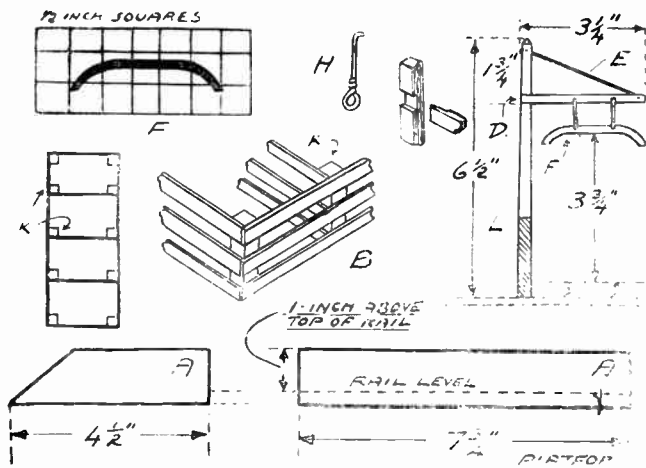

spills that are bought in bundles do excellently for the purpose.

If nicely built, there is really no need to sink the uprights into the platform as a touch of glue on the bottom of each makes a very firm job. If, however, making the model for someone who may be a little rough-handed the ends of the posts can be extended and let into small holes taken out of the platform top. Glue plus tapping into position will make a very sturdy finish.

## The Head Gauge

Next make the loading gauge. In full-size railways this gauge is to see that trucks are not loaded too high. They are generally set at the ends of loading stages, but often at the outlet of a set of

# Books to Read!

A review of interesting books for craftsmen which have been recently published. Obtainable through newagents or booksellers or direct from the publishers mentioned.

## The Young Cameraman

by Gordon Catling

AS the days get longer so our interest in photography seems to increase. Unfortunately many amateurs leave their enthusiasm as a summer pastime and, as our regular author in our monthly article points out, miss so much in the other months. The camera provides a hobby for all the year round, and this book tells you how. It is different from most, because it explains everything in a pleasing and straightforward way, illustrating the facts either with actual pictures or by means of simple diagrams. The author has a natural talent for writing as well as photography and success with the camera must attend all who read it. The older reader should not be 'put off' by the title, because there is nothing childish or juvenile in the contents. Any grown-up, and even experienced photographers would, undoubtedly, increase their knowledge and enthusiasm by a perusal of the pages. Published by Nicholas Kaye Ltd., 1 Trebeck Street, London, W.1—Price 8/6

## Models in Wood

by C. Baker

HAVE you ever given a thought to the fact that for all the scientific advance of most things, and the constant progress of alteration in modern life, wood, in itself remains the same as it did thousands of years ago? It cannot be copied or altered or imitated with any degree of success. No substitute or alternative can be found to undertake its great range of usefulness and beauty. Such a reasoning surely leads us to give more thought to the material, and this book helps in the appreciation of the subject in its relation to model making. It assumes an elementary use of the usual handyman tools, but gives endless hints on methods in use, production and completion which ensure a near-perfect result on any work. Chapters deal with cutting, fixing and building, provide general outlines for various models in general, and particularly for model railways, ships, aircraft, motor coaches and miniature furniture. Helpful diagrams add to the undoubted usefulness of an excellent treatise. Published by Percival Marshall & Co. Ltd., 23 Great Queen Street, London, W.C.2—Price 7/6

## How to Build and Manage a Canoe (2 Vols.)

by Alec R. Ellis and C. G. Beams

THESE two volumes are surely the most complete and comprehensive for any enthusiast who would like to

undertake the work. The details are for a 16ft. canvas covered kayak type to carry two. One volume deals entirely with construction and handling. The second volume is a dummy cover containing five large folded sheets of strong paper with full size drawings of the parts needed. It is thus a simple matter to mark out the material from the plans and put the parts together according to the straightforward instructions. Now is certainly the time to begin on such work if you are to be ready for the summer. Get these volumes and you will find an interesting, straightforward and satisfactory job for two to undertake. And having built the boat you can refer to Vol. 1 again for instruction on paddling, sailing, coastal work, and general hints in chapters lucidly written and amply illustrated.

Published by Brown Son & Ferguson Ltd., 52-58 Darnley Street, Glasgow, S.1—Price 7/6 each vol.

## The Woodworker Annual

THOSE of our readers who undertake the more serious work of carpentry are recommended to obtain this fine volume. It appeals to the home handyman, the expert carpenter, and the enthusiastic craftsman with its 200 large pages of practical advice and instruction. Those wanting to make their own furniture will find a wide range of modern pieces, whilst the range of general subjects is both wide and interesting—radio cabinets, toys, upholstery, plastic work, polishing, painting, finishes, etc. The instructions are helped by detailed drawings, and a comprehensive index provides immediate reference to a subject and such a wide list of ideas that one is at a loss to decide which piece of enjoyment to set about next. A thoroughly helpful and practical volume for any reader to enjoy. Published by Evan Bros. Ltd., Montague House, Russell Square, London, W.C.1—Price 12/6

## Children's Games

by Leslie Daiken

HERE is quite an original method of arranging games—by the month and season of the year for which they are most applicable. After all it is only common sense, because games, like many other events, have their appropriate occasion. And none knows better about it than the author—a well-known broadcaster on the subject. The originality mentioned earlier goes even further, for the illustrations are delightful drawings and half tones, mainly from paintings and prints of the 18th and 19th century. There is interest, for

instance in 'The High Borne James. Duke of York playing tennis'. 'The Cheat at Marbles' in 1850 and so on. Altogether a quaint, interesting and helpful book for any who organize such events for children, whether at home, school, outdoor events or even exhibitions. The illustrations alone are a source of pleasure and inspiration.

Published by B. T. Batsford Ltd., 15 North Audley Street, London, W.1—Price 18/-

## Teach Yourself Stamp Collecting

by Fred J. Melville

IN earlier numbers we have mentioned other books in this popular yellow-and-blue jacketed 'Teach-yourself' series, and the name of the author (who, unfortunately, died in 1940) of this one is sufficient guarantee of it being up to the usual high standard. Unless one has studied stamp collecting seriously it is impossible to realize the wide interest and fascinating knowledge to be obtained from the hobby. It teaches one to use eyes, brains and hands, covers history, geography, botany, music, natural history and many other sciences and the chapters of this book cover the subject thoroughly. It leads the beginner from his first knowledge through the various steps of knowledge—what to look for, what to retain, what to discard, how to recognize, etc., so that one becomes fascinated by the almost endless search and retention among the vast range of specimens which any collector is now able to gather together.

Published by The English Universities Press Ltd., Warwick Square, E.C.4—Price 4/6

## Leathercraft

by Eileen C. Greenwood, A.R.C.A.

THE art of turning leather into practical and decorative articles of use and beauty has been enjoyed for centuries, going back to the Egyptian dynasties. It can be more enjoyed now because modern processes and manufacture enable better material and finer tools for our use. The delights of the hobby are amply illustrated in the two volumes under the above title. Each volume is separate in itself—the first dealing with tools, materials, methods, processes and accessories, whilst the second volume goes a stage further in providing details of advanced work for ladies, for gentlemen, for general use, for clothing and dress accessories. Each volume has over 200 pages of practical instructions, with helpful diagrams. Published by E. & F. N. Spon Ltd., 15 Bedford Street, Strand, London, W.C.2—Price 9/6 per vol.

# Some straightforward suggestions for the carpenter for HOME IMPROVEMENTS

**A**NY time spent for home improvement is enjoyable. To be able to create comfort in the home is always something well worth the time. The question of what you can do must always depend on whether the property belongs to you or if it is rented. However, this precaution may not deter you if you are careful enough to make all fittings self-contained and not damage walls too much. Most of these suggested are simple and by careful planning most of the material could be used again if moved.

## A Window Seat

We often have the desire, especially when the view is charming, to fix up a window seat in the wide bay window.

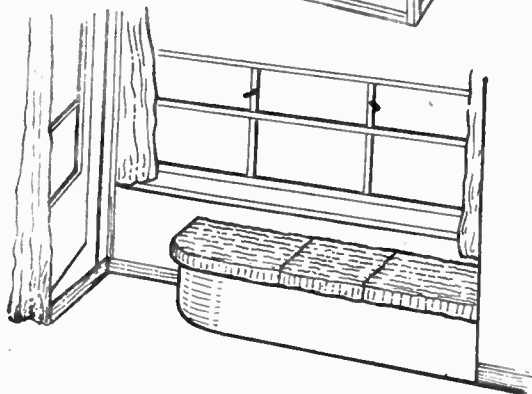
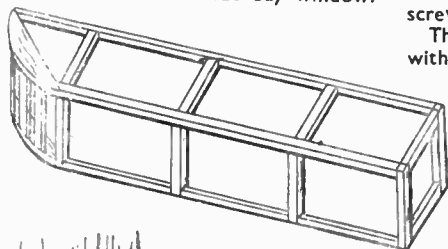

The window seat in place and (above) the framework in construction

It is such an asset and if the window is in a good position one can rest or work through many hours of the day and get the full benefit of the light. The one designed is specially built for the bay window with the door at the side as often found in houses to-day. The fact that the door is there is likely to put one off building a seat.

First of all take measurements and be sure that sufficient room is allowed for normal persons to get in and out of the door. If the bay is fairly deep you need

not take the depth right into the full width. It will, in fact look better with the wall jutting out beyond the seat. You must adjust the height and remember that if you are having cushions made they will be about 3ins. to 4ins. deep.

## A Low Seat

Therefore, the best plan is to measure an ordinary chair and keep the height of the window seat about 3ins. lower. Note that the framework is practically one self-contained unit made from 1½ins. square quartering prepared. This should be strong enough and the side facing away should be fixed to the wall with plugs. If this is not desired, then put in legs to correspond with those on the outside. It would be an advantage to screw all parts together.

The simple way to round the end is with a piece of 1in. board cut to shape with the pad saw or fretsaw. Fit in several 2in. by 1in. supports, as shown, to assist the panel board to bend and save it sagging inwards at a later date. Do not rely on the two pieces of board to keep it in shape, the uprights are very

they drop into the inside of the struts they will make a firm base for the cushions. Block in the rounded end to add strength and prevent goods getting in this part and difficult to extract.

An upholsterer will make cushions to match or you can now buy rubber cushion material which are often advertised in various journals. A neat beading on the floor and forced round the curve will finish the job off. To get beading round the bend take out little saw-cuts on the side to face the seat.

## Mantel Bookshelves

We may one day find ourselves with a small bedroom or boxroom all to ourselves as a 'den' or room of our own. It may only be on condition that the family can have it back occasionally when company is coming to stop. Under these conditions we are expected to retain the old traditional ornaments on the mantelshef. Well, why worry?

Have those practical books of yours on the shelf just the same. Note the neat bookshelves made to fit the top of the

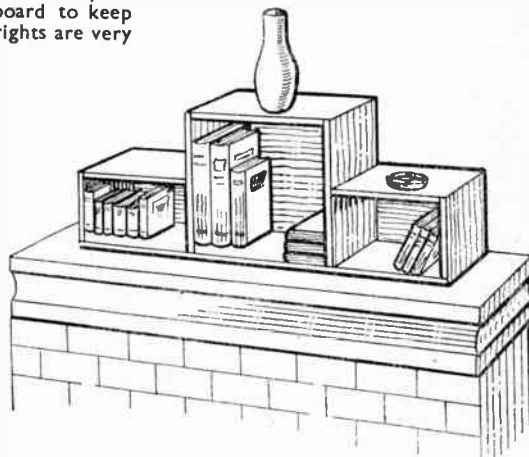

A pleasing book holder

necessary. For covering you can use wallboard or hardboard; the latter best for appearance. If in difficulties at the bend then substitute with thinner plywood panel.

## A Storage Space

Apart from its usefulness as a seat it will make a fine storage space. For convenience make panels to fit the three squares between the supports. If you make these with panel board and fix with 1in. square wood all round so that

fire-place. Your books will be stored conveniently and neatly and you can see them easily. Stain the shelves, which are well closed in and safe from dust and dirt.

Try not to have the fitment too high, just measure to the right height of the average book. If the books do not warrant it, do not bring it to the edge of the shelf. Try, as much as possible not to make it too bulky. By this means, the ornaments can be replaced and the room will look much the same as before the change over.

**There will be enough Hobbies for everyone in March when paper restrictions are ended. Tell your friends!**

# Don't hard labour it!

Spray it with the TRIGGA Spray Gun. It works off your vacuum cleaner. Switch on, press the trigger and you can paint or distemper a room, stain a floor, creosote the fence, spray away garden pests. Amateurs get professional results with the easy trigger control. The TRIGGA will last a lifetime: the saving in paint brushes will more than repay the initial cost.



*It works off  
your vacuum  
cleaner*

TRADE ENQUIRIES  
INVITED

**SPRAY IT** with the

# TRIGGA

SPRAY GUN

Write for free leaflet No. 18

THE IDEAL SPRAY GUN CO., 1 CRAVEN PARK  
LONDON, N.W.10 Telephone: ELGar 6754

SENSATIONAL OFFER  
FROM THE B.I.F.

**THE FAMOUS CINEFLASH  
FILM PROJECTOR**

ADVERTISING PRICE  
**15/- ONLY**  
POST 6/6

Battery model. An absolute first-rate machine complete with bulbs and two 35mm. films at the sensational price of 15/- only. Post 1/-.

12 varieties of spare films at 1/- each. Shows on any white background or we can supply white plastic screen extra 5/-. Entertains both young and old. Each machine guaranteed. A.C. MAINS MODEL 15/- extra.

**EX-MINISTRY R.A.F. GREY BOILER SUITS** 12/11 Post Pack. 1/3 A rare issue that may never be repeated. Fine quality grey gabardine, NOT a cheap cotton twill. Of excellent texture that will wear for years. The sleeves have adjustable cuffs for different widths. State chest measurements. Being Ex Ministry it is offered at a fraction of the original price. Don't delay. GET YOURS NOW. 12/11, Post, etc., 1/3

**W.D. Binoculars, Telescopes, Tents, Marquees, Tarpaulins, Camp Equipment.** Monthly Terms arranged.

Send for **BUMPER LIST.**

HEADQUARTER & GENERAL SUPPLIES LTD., (Dept. HOB),  
196-200, Coldharbour Lane, Loughborough Junc., London, S.E.5.  
Open all Saturday. Closed Wednesday P.M.



# BRITFIX BALSA CEMENT

★ The ideal transparent cement for Balsa Ply Wood, Hard Woods, and Plastics, combining rapid drying with utmost tenacity.

Remember  
**STICK BY  
BRITFIX**

Large tube  
7d.

Small tube  
(with special  
long nozzle)  
5d.

THE HUMBER OIL CO. LTD., HULL

# Have you TRIED SHIP MODELLING

If you are a beginner and feel you may not tackle a big model successfully why not make a beginning by building one of the Modelcraft miniatures? The miniature plans cover 6 clipper ships and 5 old-time ships from Columbus's 'Santa Maria' to Nelson's 'Victory'. To make things even simpler we issue kits of parts for two of them.

Postage is 2d. on plans and 6d. on kits.

Miniature 'GOLDEN HIND' Kit  
Plans only 2/6

**7/-**

Miniature 'VICTORY' Kit  
Plans only 2/6

**6/-**

★ Order your copy of Modelcraft 1950 list now. Besides the 600 and over items, plans, planbooks, kits and accessories listed, there are helpful notes to guide your choice, two long articles and sheafs of tips and hints. It's a good 'bob's worth' of any model-maker's money. 1/- post free or from your modelshop.

# MODEL-CRAFT LTD.

77 (F) GROSVENOR ROAD, LONDON, S.W.1

# AMAZING Ex. Govt BARGAIN SIGNAL LAMP

In stout double-compartment water-proof steel case.

- 3½-inch lamp, for day or night use.
- Swivel base with metal screw-in stand.
- Viewfinder and reflector.
- Morse key-board. Fully wired, fitted to folding lid.
- Adaptable as car, motor cycle or studio spot light and numerous other uses.

**7/6**  
POST 1/6

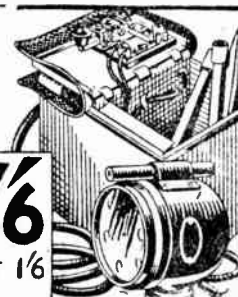

Write for illustrated lists.

**PRIDE & CLARKE LTD.**  
Dept. H.W., 158, STOCKWELL RD., S.W.9. Phone: BR1xton 6251

# CRAFTWORKERS!



You can't go wrong with a  
**"MONO-GOLD" OUTFIT**

The new and easy form of embossing in Gold, Silver and Colours on numerous materials including Leather, Wood, "Perspex", Lampshades, etc.

Complete outfit, including three special tools,  
all materials and instructions.

**7/6**

Trade enquiries invited.

Sole distributors:—

**CRESCENT PLASTICS LTD.**  
(DEPT. H.) 14a CRESCENT ROAD, HIGHER  
CRUMPSALL — MANCHESTER, 8



## Build this charming Model Village with

# BRICKPLAYER

**Brick and Mortar Building Kit and Accessories**

The Brickplayer Kit contains miniature bricks in all required shapes, mortar, roofing, metal windows and doors, plans and instruction booklet. All models are architect designed to "O" gauge scale. Buildings can be permanent or dismantled by merely soaking in water, and the bricks used again and again.

Brickplayer Kits at 23/10 and 44/- and Accessories are available from good hobby shops, toyshops and stores.

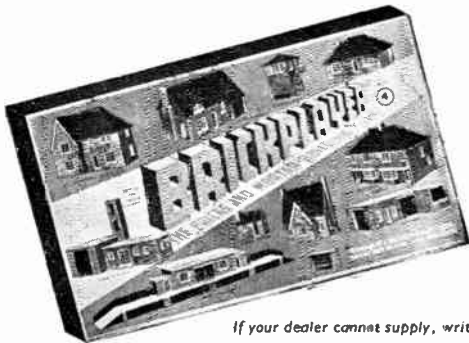

If your dealer cannot supply, write for address or nearest stockists to  
**J. W. SPEAR & SONS, LTD., Dept. "H.", ENFIELD, MIDD.**

## MISCELLANEOUS ADVERTISEMENTS

**STAMPS FREE!!** Twenty unused (2½d.).—G. H. Barnett, Limington, Somerset.

**50 STAMPS** for sale from my collection, 2/-, or in exchange for cigarette cards.—Box No. 22, Hobbies Weekly, Dereham, Norfolk.

**STAMP collector's outfit free!** Comprising stamp album, 500 stamps, 500 hinges, pair tweezers, catalogue of Europe from 1940. First edition 1949. 1,744 illustrations, 180 pages. This complete outfit free. Send 2½d. for particulars to—Sansoms, 4 Carnarvon Rd., Reading.

**FREE—stamps catalogued 5/-** to applicants for ½d. approvals.—Cox, 17 Stoneleigh Park Road, Ewell.

**STAMPS—free gift, discount approvals,** write—Ridley, 50 Fellside, Cleadon, South Shields.

**LEAD toy casting—a new book** with 126 illustrations, 2/6 posted with catalogue of moulds. Sample mould, 4/6.—G. F. Rhead, Thurston End, Hawkeston, Bury St. Edmunds.

**PROFIT and pleasure for model makers,** making ships in bottles. Complete plans and instructions, 2/6.—Phillips, Littlecraft, Kingswear, S. Devon.

**STAMP album, illustrated, 100** different stamps, mounts, 3/—Whitby, Godshill, Fordingbridge, Hants.

**35 m.m. cinematograph films;** cowboy, comedies, drama, interest, etc. 100ft., 4/6; 200ft., 7/6; 500ft., 15/9.—Jones, 51 Cranford Drive, Hayes, Middlesex.

**APPLICANTS for approvals** sending 6½d. receive special album, 8ins. 6½ins., 60 quadrille pages.—Goddard, 41 Kimberley Road, Bournemouth.

**STAMPS—Send stamp for approvals.** Choose your own free gift. Packets, sets and single stamps.—H. W. Harman, 6 St. Patrick's Road, Coventry.

**MAKE £1 an hour, genuine home** employment. Full instructions, 3/- Send 1/- for six different advertising magazines.—R. Lowes, Rectory Terr., Simonburn, Hexham, Northd.

Indispensable to all interested in motor cars.

The two popular Car Books

**"WHERE'S THAT CAR FROM?"**  
**"POPULAR CARS ILLUSTRATED"**  
 6d. each

From all Stationers and Booksellers

or from **RALEIGH PRESS, EXMOUTH**

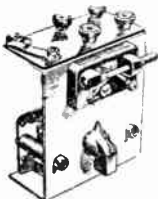

**RADIO is the hobby with the future.** Start learning by making this crystal set. D5 Coil with complete constructional drawings for crystal set, 5/-, Also includes simple circuits for one-, two-, and three-valve receivers.

Full kit of parts as illustrated, 15/-. Assembled ready to play, 18/-. All parts supplied separately.

Receives stations on long and medium waves.

**HILLFIELDS RADIO,**

**BURNHAM RD., WHITLEY, COVENTRY**

## YOU CAN BECOME A HANDICRAFTS INSTRUCTOR

**Experience not essential**

Men who enjoy making things in wood or metal can turn their hobby into a well-paid, permanent and interesting Career. Short hours, long holidays, and security in a job you would really enjoy, can be yours if you become a Handicrafts Instructor. Let us send details of the easiest and quickest way to get the necessary qualification.

**We definitely guarantee**  
**"NO PASS—NO FEE"**

If you would like to know about our unique method of preparing you for one of these excellent appointments, write today, and we will send you our informative 175-page Handbook—free and without obligation. Mark your letters "Handicrafts Instructor".

**BRITISH INSTITUTE OF ENGINEERING TECHNOLOGY**

595 Shakespeare House  
 Stratford Place, London, W.1

# BIET

Full Size Patterns  
for

# A Novelty Electric Table Lamp

For details of  
construction  
see page 323

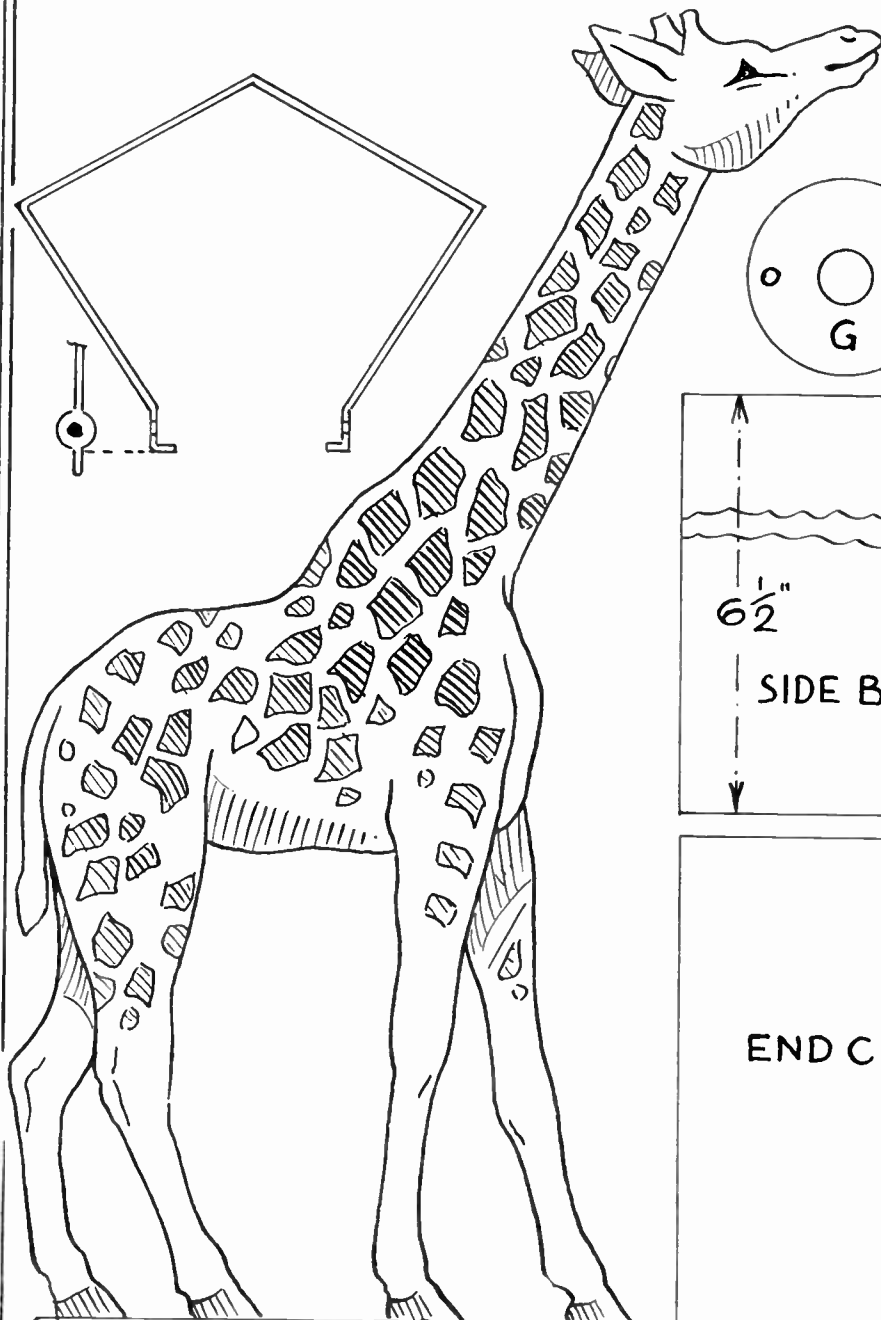
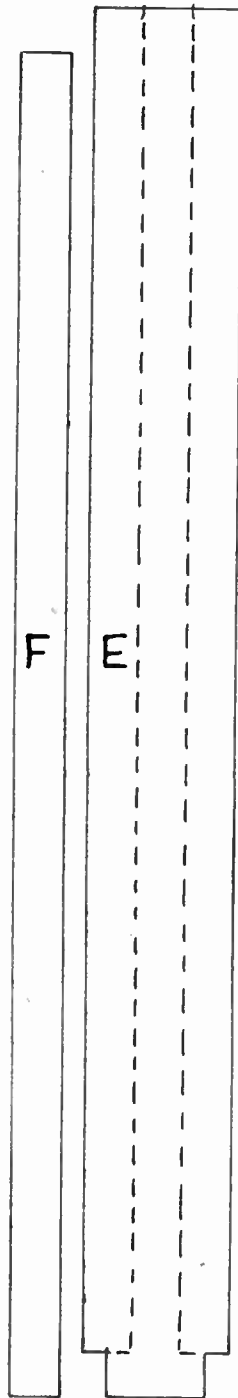
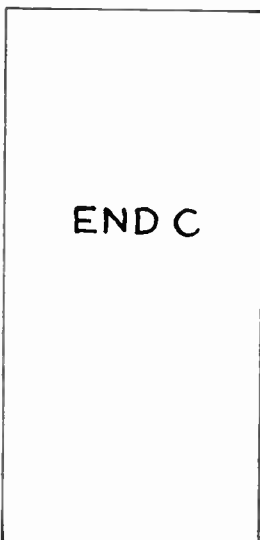
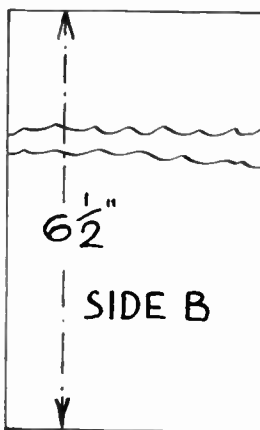
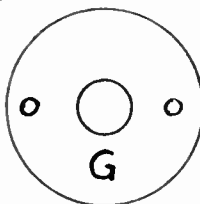
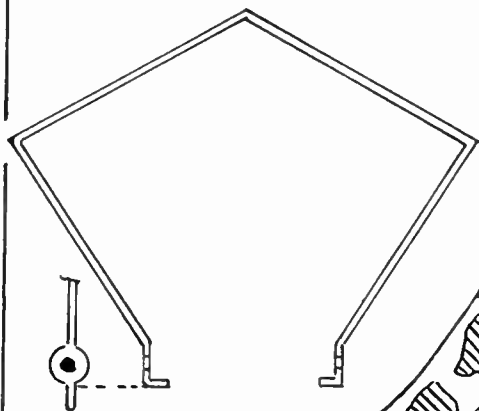

# SELLOTAPE

Bind tool handles with Sellotape to stop splinters and blisters. Gives a good grip — keeps handles clean.



# SELLOTAPE



Use Sellotape for holding small parts in position while gluing. It's much quicker than string and just as strong.

# SELLOTAPE

*- for a thousand uses.*

Whatever your hobby or occupation — Sellotape can help. It's quick, clean and so easy to use — just a touch and it sticks fast. Get some today! Stocked by all good Stationers



# MYFORD

**ML8**

**WOODWORKING LATHE**

NOW ONLY

**£16-12-6**

PRICE INCLUDES

DRIVE UNIT WITH VEEBELT AND MOTOR PULLEY, PRONG CENTRE, CUP CENTRE AND FACE PLATE

**URNS - SAWS - PLANES  
SANDS - GROOVES - POLISHES  
ETC., ETC.**

**MYFORD ENGINEERING COMPANY LIMITED  
BEESTON · NOTTINGHAM · Phone: 54222 (3 lines)**



**"Ever fired  
four guns at once?"**

Nearly five hundred rounds a minute whenever you squeeze your trigger finger — that's really shooting! This was taken on manoeuvres off Gibraltar when our team won top points for high angle gunnery. She was a grand ship — a great set of shipmates, good food and plenty of it, and lots of encouragement to put in for promotion (with extra pay). Here's hoping I'll be with her in the next commission . . ."

Make the **ROYAL NAVY** your career



WRITE TODAY for FREE copy of 'HERE IS THE NAVY' to: —D.N.R. Dept. CF/148, Admiralty, London, S.W.1

Name

Address



*Get this book  
- make these  
MODELS*

**HOUSES · SHIPS · ASHTRAYS · BOOKENDS  
SIGNAL CABINS · RAILWAY STATIONS  
AIRPORTS · DOCKS · RELIEF MAPS · PLAQUES  
MODEL FURNITURE · INKSTANDS · PAPER  
WEIGHTS · MODEL FIGURES & ANIMALS etc.**

**SIMPLE TO HANDLE · INEXPENSIVE**

The Instruction Book illustrated tells you how to make such models as above, without special tools or skill, in Sankey's "Pyrum" Plastic Cement. This material, modelled while plastic, dries or bakes to stone-hardness, ready for painting according to instructions. Obtainable at local ironmongers, hobbies shops and art material dealers.

Get Instruction Book by sending 46. in stamps to the address below



Dept. 3

**J.H. SANKEY & SON, LTD.**

ILFORD

ESSEX