

Hobbies

WEEKLY

CONTENTS

	Page
2ft. Sailing Boat - - -	81
A Wall Meat Safe - - -	83
Spray Painting - - -	84
Plant Holder - - -	85
Using Bits and Pieces - - -	86
Home Made Camp Bed - - -	87
Nail Varieties - - -	88
Cycling Tour Hints - - -	89
Using Perspex Scraps - - -	89
Radio Replies - - -	90
Canine Caricatures - - -	90
Mastiff Patterns - - -	91

SUPPLEMENT DESIGN
FOR A NOVELTY FIGURE
MONEY BOX

June 2nd, 1948

Price Threepence

Vol. 106 No. 2744

THIS boat, though small, is quite large enough to prove a practical sailing craft. It has a length of 24ins., and a beam of 6ins. Designed on the lines of a yacht it can develop a good turn of speed, but lays no claim to be a racer. The construction has been simplified to bring it within the scope of any fellow handy with his tools.

Fig. 1 shows a half plan view, and a side view. The hull is made bread and butter fashion, consisting of three boards, glued together, with a deck, fitted afterwards. The

A SMALL SAILING BOAT

shape of the three boards is shown in the plan view.

To get these out draw on a sheet of paper an oblong, 24ins. long and 3ins. (half width) wide, and divide into 12 squares. Now put in the three half shapes, shown in the diagram, copying them as accurately as possible. The shapes drawn, cut the first, or top shape, out with scissors.

Get a board of good quality deal, 6ins. wide and $\frac{1}{2}$ in. thick. Run a pencil down its centre, lay the half pattern on it, the straight edge exact with the pencil line, and transfer the curved edge to the wood by running a soft pencil round it. Turn the pattern over and draw the other half similarly. Now cut the shape out, and, at centre B, pencil a line across as a guide to fixing

the shapes together.

Transfer Patterns

With the scissors, cut the pattern to the second shape and transfer this to the wood, then the third shape. All three should have a line across at centre B and should be placed together temporarily, as in the drawing, all the B lines coinciding, and a pencil drawn round each shape on to the next above, or below it, as further guide to a correct assembly. The two top pieces are to be sawn away at their middles, as in Fig. 2. This can be done now, but it is really safer to do it after shaping the hull.

If the latter method is chosen, before commencing the shaping up, take the bottom shape and on a centre line chisel out two mortise slots, $\frac{1}{2}$ in. wide and 3ins. long, for the keel to enter. It will be seen on reference to Fig. 1 the distances apart these slots must be. Make these $\frac{1}{2}$ in. to $\frac{3}{4}$ in. deep.

The Keel

At this stage mark out and cut the keel from a piece of board planed to $\frac{1}{2}$ in. thickness. The size of this is given in the drawing, and extra should be added for the tenons at top. Try the keel for fit, and if satisfactory place aside.

Now fix the three shapes together in their correct relative positions with two screws. Turn the whole over and shape up with plane, and chisel. Owing to the cutting of the boards, the actual shaping is really simple, or if the "steps" are planed and chiselled

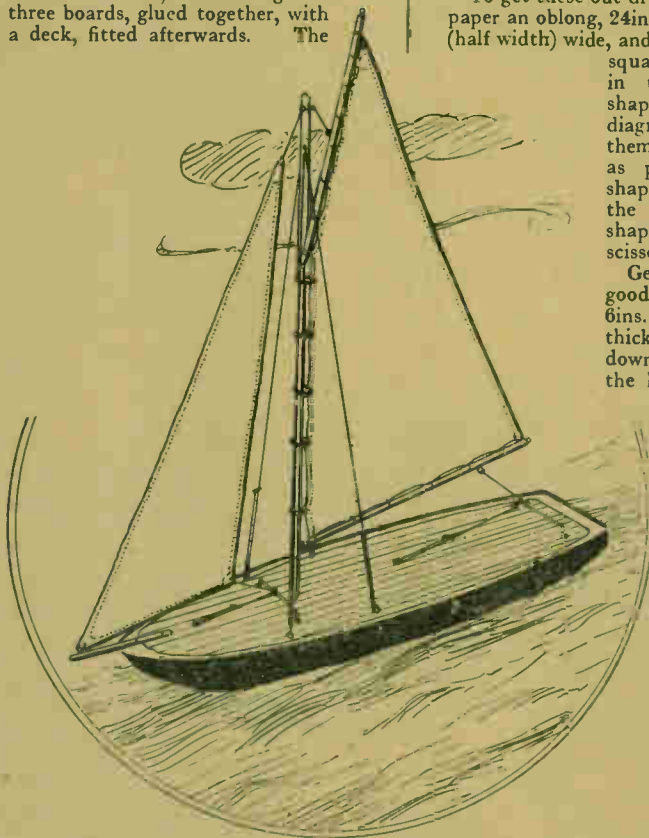

off, little will remain to be done, and that little is best done with a spoke-shave.

Leave the final finishing for the time, and unscrew the shapes. Now cut out of the two upper shapes the centre parts, leaving $\frac{1}{4}$ in., or slightly less, at the edges for gluing together.

The three shapes are glued with a waterproof glue—marine, or "Test"

the remainder of the board, planed to $\frac{1}{4}$ in. thickness, can be used for the keel, and masts, etc. so no waste ensues.

Cut the deck about $\frac{1}{16}$ in. larger all round than the boat, for subsequent trimming to the shape. A socket for the mast is provided by gluing a 1 in. square piece of board to the underside of the deck, where the mast is to come, and then boring a $\frac{1}{4}$ in. hole through the deck and into the block; do not bore right through, or water may seep into the hull.

board, making a frame $5\frac{1}{2}$ ins. long and $1\frac{1}{2}$ ins. wide. Melt the lead and pour into the frame. When set, cut the cast into two equal halves, lengthwise, bore, and screw to the keel each side. Paint the weights the same colour as the boat.

Rigging Fittings

Fittings for the rigging are shown in Fig. 4. The mast is planed round, $\frac{1}{4}$ in. at bottom, tapering to $\frac{1}{8}$ in. at the top. Small screw eyes, or wires, bent to eye form are fixed for the sails and stays. At $2\frac{1}{2}$ ins. from the bottom fix the fitting for the boom; it is a 1 in. wire nail, bent in the middle at right angles, and driven in the mast.

MAST

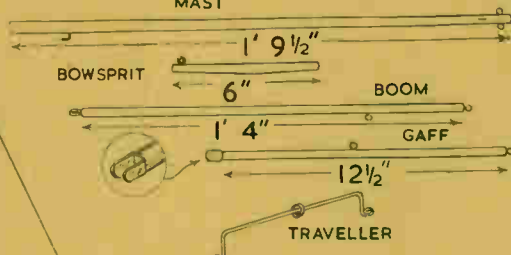

Fig. 4—Details of rigging and fittings

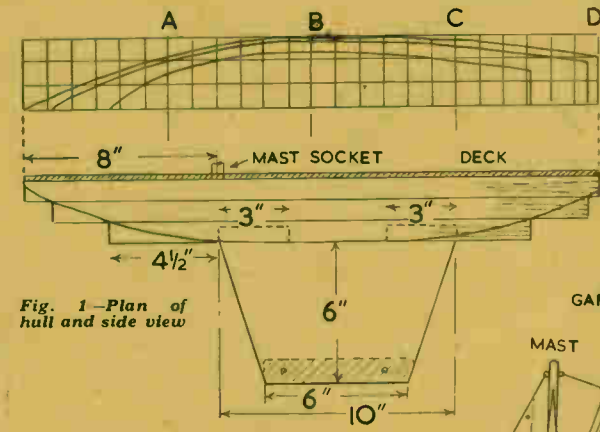

Fig. 1—Plan of hull and side view



Fig. 2—The two hollow frames

glue, for example—and cramped up for a few hours. It will, of course, be vitally necessary to glue them in their correct former positions. When the glue is hard, the final shaping with file and glasspaper is carried out.

The correct sections of the hull across parts A, B, C and D, are shown in the sectional sketch in Fig. 3. These shapes could be transferred to a thick piece of card and cut out, to be used as templates for testing, if desired.

Many readers may be competent to shape up accurately and evenly enough by eye measurement alone, but to some the templates are helpful, especially to a beginner in boat construction.

The Deck

The keel is rounded on its fore edge, and then is glued in place. For the deck a piece of $\frac{1}{4}$ in. wood is required, cut to the shape of the boat. A piece of fretwood can be used here, but by way of saving fretwood for better uses, as it is in short supply at present, a good plan is, when ordering the wood for the boat, to get the timber merchant to saw a slice about $\frac{5}{16}$ in. thick off a piece of the board, large enough for the deck, a job he can do quickly enough with a circular saw. This can be planed to $\frac{1}{4}$ in. thick, and

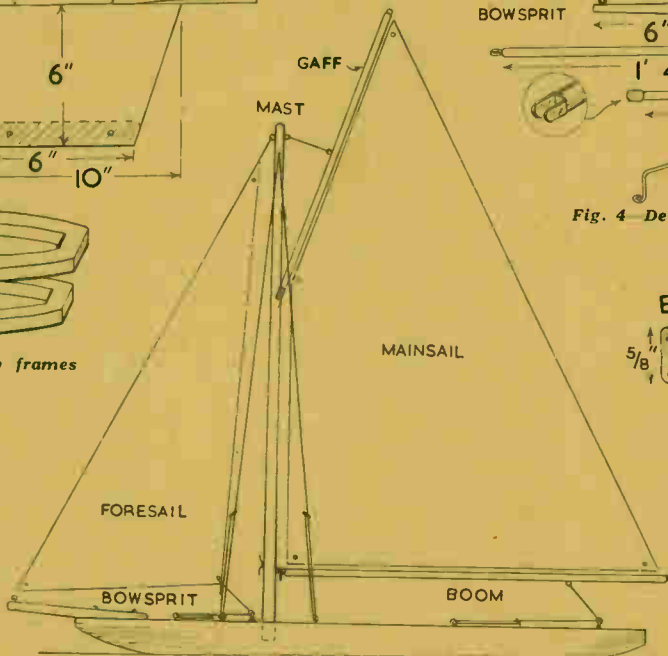

Fig. 5—Side view with sail and rigging details

Fix the deck with small screws, and seal the joint between deck and hull with thick paint. Now give the complete hull two coats of paint, and when dry a finishing coat of enamel. It makes for a smart appearance if the boat is painted a brilliant colour to the waterline, and white underneath.

The waterline, by the way, is just $1\frac{1}{2}$ ins. down from the deck, and should be well defined by a thin white, or coloured line.

The keel is to be weighted by a lead strip glued each side at the bottom, shown shaded in Fig. 1. The amount of lead required is found by experiment. Stand a small tin on the deck of the boat and drop pieces of lead in it until the boat, temporarily floating in water, sinks to waterline. Add a few small pieces to make up for loss in melting.

A mould can be made by nailing strips of wood to a spare piece of

The bowsprit, etc., are cut $\frac{3}{8}$ in. diameter. The deck end of the bowsprit is pared off a little so that its forward end tilts slightly. The boom has a screw eye at each end, one for slipping over the nail in the mast, so that it can swing as the wind directs.

At one end of the gaff a screw eye is driven in to hold the sail in position, and the mast end has a yolk, shaped as shown from sheet brass and fixed with a single screw. It should embrace the screw, easily, not tightly. Drive in a screw eye at $5\frac{1}{2}$ ins. from the yolk end to which the line can be attached.

Travellers

Two travellers will be needed for the main and fore sail. Make up from brass wire, as sketch. The deck is now lined with a soft lead pencil to simulate planking, and then varnished. The position for fixing the travellers to the deck with tiny screws, will be seen in the general view of the boat. Screw the bowsprit in place with half its length extending beyond the boat.

Slip the mast in and stay it with wire, or thin string, two each side. Screw hooks are driven in the deck,

(Continued foot of page 88)

Any housewife would be delighted if you make for her A WALL SAFE

WHEN space for an ordinary meat safe is not available on the floor, there may be room for a type which can be affixed to a wall, such as shown herewith. It is a matter of attaching it higher up, assuming there is wall space.

The meat safe to be described is designed to cut out the expense of metal wall brackets, and a backing of wood. Side frames carry a wooden bracket, and two cross laths are provided so the work can be screwed to the wall. The safe has two fair-sized compartments, and if necessary, the width could be easily increased an extra 2ins.

General Dimensions

However, one thing to bear in mind respecting wall safes is that they should not be too bulky or protrude unduly from a wall. Heads are liable to come into contact with the bottom of the safe—especially if one bends over below it to do something. Therefore, an overall width of 14ins. is just about right, but may be increased to 16ins. wide.

Quite frankly, there is no hard and fast rule regarding size, excepting for the width. The main carcass is 24ins. by 20ins. This could be 30ins. by 24ins., if necessary. However, a wall safe must be necessarily a small affair compared with ordinary floor models.

It is merely a special cupboard for meats—not a miniature scullery cabinet. If you increase the width by 2ins., you should also increase the main carcass in size by a couple of inches, thus making it 26ins. by 22ins. The side uprights will also require to be lengthened by 2ins.

The Side Frames

To make the safe the size shown, you need two side uprights 38ins. by 2ins. by $\frac{1}{2}$ in., and two 24ins. by the same width and thickness, including six cross pieces 10ins. These parts make the two side frames, as shown in the side elevation at Fig. 1.

The cross pieces are dowel-jointed to the uprights, following which the bracket is added, using glue and screws. The edges of the apertures are rebated at the inside for perforated sheeting. Alternatively, the edges, after the frames have been dowelled temporarily together and taken apart, can be rebated $\frac{1}{4}$ in. by $\frac{3}{8}$ in., using a cutting gauge and wood chisel, or a side rebate plane, bull-nose plane, etc. The grooving should not be carried beyond the apertures.

If desired, the apertures could be fitted with quarter-round beading, thus forming a rebate, or be covered on the outside with a half-round bead, thus forming a deeper rebate.

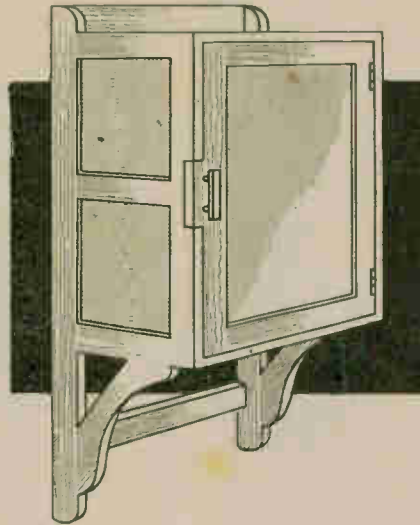

The latter methods are the easiest and simplest, assuming you have not the proper rebating tools. The door frame can be treated in a similar way. At the moment, the carcass must be completed, and squared, ready for the door.

Top and Bottom

The top and bottom boards measure 18 $\frac{1}{2}$ ins. by 14ins. by $\frac{1}{2}$ in. These must be of solid wood, and two lengths of 7in. wide deal shelving, rub-jointed together, could be used.

The jointing edges must be planed dead true and straight and a hot, thin glue applied, then the edges brought together and rubbed tightly together to squeeze out the excess glue and air. Such a joint is often stronger than the actual wood itself; a simpler alternative is to joint the boards with wriggle nails, i.e., corrugated joint fasteners.

When the ends are cut to length and trimmed, the boards are glued and nailed between the side frames, flush at the top and bottom. Use oval nails, about 2ins. long, and be sure to make holes for them with a Bradawl to facilitate the assembly.

Having attached the top and bottom boards, fit the bottom cross-rail, then the top cross-rail, both being 2ins. wide. It will be found more convenient, of course, to have the perforated sheeting attached to the frames prior to assembly of the carcass. If perforated zinc sheeting cannot be obtained, use a fine wire gauze material, if available. This is a fine wire mesh, having

small square holes, and is usually easier to fit than perforated sheeting.

The shelf is a piece of $\frac{1}{2}$ in. wood of similar size as the top and bottom, but about 1in. narrower to allow for the door thickness. It can be checked at the corners to fit inside the safe and rest on the central cross-piece of the side, or if cut 18 $\frac{1}{2}$ ins., it could rest on supporting fillets.

The Door

The door is a frame consisting of 2in. by $\frac{1}{2}$ in. stuff. One stile is made different to allow for a handle, and the projection is let into the edge of one of the side frames, as shown. This is a feature which may be omitted, however. If the checking is done neatly, and the projection made a neat, force fit, there is no need to fit catches to the door.

Two 2in. butt hinges are sunk in the door stile as shown and the door hinged in place. This completes the work which can be painted on the outside a light green colour, or any colour to match its surroundings.

Paint Warning

By the way, use an enamel paint; oil paint has too much of a smell. The application of a stain and a couple of coats of french polish, brushed on, would be a good finish. The inside should not be painted or stained.

The sheeting or gauze may be finished off, but this is not advised. Many meat safes, you will observe, are generally sold in the natural state, and as a matter of precaution, the wall meat safe should not be finished off in any way, either, unless its whiteness is too showy.

The door should be a neat, true fit. The safe will not be much of a protection from insects, dust, etc., if there are big gaps in the door.

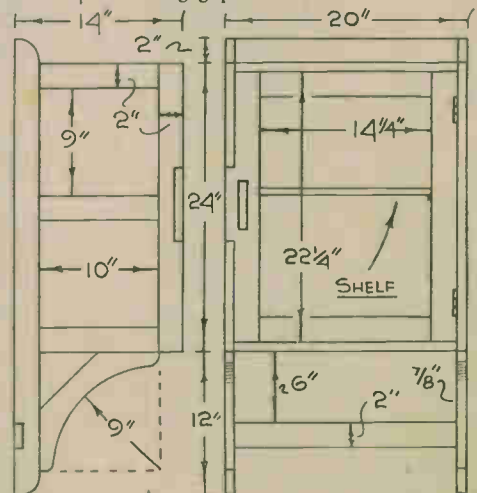

Fig. 1—Side and front elevations with dimensions

For toys or models you get best results from SPRAY PAINTING

SPRAY-PAINT equipment is now available to suit the requirements of most practical men, particularly the home craftsman. Small, self-contained outfits, independent of power, can be obtained, which are not too expensive, yet capable of dealing with all manner of jobs, such as painting woodwork, distemping a wall, re-cellulosing a car, etc.

These outfits consist of a spray gun, a hand-operated or a foot-operated air pump, an air chamber, or container, with air pressure gauge, plus a length of flexible air-line. The output is generally 20lbs. to 40lbs. per square inch, which is a good average. Fine "mist" spraying is possible, which is a highly desirable feature when using cellulose lacquers.

Air Pump Required

High-pressure spray guns, or atomisers, always require air-balancing chambers, and air is invariably supplied from an air pump, or compressor, worked by hand, electric motor or a small petrol engine. Low-pressure guns, on the other hand, do not require air compressors.

Such guns may be connected directly to an ordinary electric vacuum cleaner, and it should be noted that these atomisers are specially designed and manufactured for this purpose. Any other type of gun will definitely not do, unless adaptable for the purpose. A good type is the "Crystal" gun, which is well advertised in many papers and the address of which can be obtained from The Editor. This, plus a vacuum cleaner, constitutes a complete spraying outfit.

How Spraying is Achieved

However, it is not everyone who has an electrical supply for operating a vacuum cleaner or an air compressor unit. The alternative is a unit driven by a petrol engine. In view of the scarcity of petrol, or rather, the strict manner in which the spirit is restricted the next best thing is a self-contained outfit by which the air is compressed by a pump. This simple, but practical, equipment can be used anywhere.

Like all spraying equipment, it works on the same principle of the smallest scent-spray. Compressed air, at a pressure of about 20lbs. per square inch, issues from a jet in the spray gun. The velocity of the air, passing over another jet—which is suspended in the paint jar and the paint—creates a vacuum or suction, thereby drawing the paint up the tiny tube or feeder, the paint being forced forwards in a fine spray.

Since the air pressure is even and continuous, with good force, the spray is like a mist. In the case of a scent-

spray, of course, the air pressure is erratic, and blobs of scent are often projected forwards, this also occurring with air-pump garden sprays.

The latter, incidentally, could be used for spraying thin paints or stains on wood, but as "blobs" are usually present in the spray, syringe sprays are not recommended, since a good finish cannot be obtained.

Using a Spray Gun

If you have never used a spray gun before, the experience is one that will delight you. As you know, a brush, despite every care, often creates streaks and running blobs of paint, especially when enamelling. However, these defects can also happen when applying lead paints, french polish, etc., with a brush.

If applying cellulose lacquer, i.e., the special brushing lacquer, greater care is needed. This lacquer differs greatly from gum and shellac lacquers which have a methylated spirit solvent. Cellulose lacquer is made from celluloid, its solvent being a special chemical preparation smelling like pear-drops, which is very volatile and highly inflammable.

Cellulose lacquer dries rapidly, and as its solvent is very reactive on under-coats, great care is needed when applying it to avoid brush marks, streaks, and the softening of previous applications which have been allowed to harden. Thus, one has to be quick and careful not to make repeat strokes in any part of the surface to be finished.

Use a Spray Gun

All this botheration is overcome by using the spraying gun. In this case, the applications, once applied, are not touched. One allows 20 minutes for each coat to dry, and when three or more coats have been applied, a drying period of 24 hours is usually necessary to allow for complete

evaporation of the solvent and a slight sinking of the celluloid base or body.

After the drying period, an additional application is generally essential which, when dry in approximately 20 minutes, is rubbed down lightly, using a 320-grade abrasive paper for "wet" flattening, with a trace of household soap to prevent undue friction.

Having washed off the residue and wiped the prepared surface, allowed it to dry, then dusted it, the final gloss is obtained by means of a pad (made from wadding wrapped in a piece of chamois leather) and a special "pulling over" solution. Later on, the surface is rubbed with a car polish to produce a high-polished finish.

Swinging Must Be Avoided

Now, when spraying the surface of wood, a special cellulose lacquer, known as "wood finish", is required, and the above is the usual process for furniture which is being cellulose finished. The method, where car bodies, etc., are concerned, is slightly different. Usually, no pulling over is done, merely a fine mist spray of the finish applied, this amounting almost to a thin solution consisting mainly of thinners. When dry, the surface is polished with a special "tumbler" polish which produces a high gloss.

When applying the spraying paint, which usually consists of two parts of brushing lacquer to one part of thinners, the gun nozzle must be held at a predetermined distance from the surface of the work. It must not be swung from side to side, from the elbow, otherwise the applications will be uneven in regard to thickness.

The paint, in spray form, builds up quickly, and the gun should not be pointed in one place too long. It takes a little practice at the beginning, but after a few trials, the spraying comes natural to most people, and painting is a joy—not a heart-breaking, or back-breaking, task.

Primer and Filler

Note, however, that in the case of, say, re-cellulosing a car, much foundation work is necessary, whether dealing with a repair, dented mud-guard or new, bare metal. A special primer and filler is required and much putting on and rubbing off must be done before the first coat of the lacquer can be applied.

It is nearly always a case of applying and rubbing down until the surface is quite ready for finishing off. The next time you admire the lovely finish of a car, remember that many hours of patient work went into it—often a whole week's work by several men, in fact.

An Oil-Can Lamp

HERE is a handy little lamp that can be made quite easily from an oil-can. Cut off the tube, leaving half-an-inch to allow a wick to be inserted as shown in the sketch.

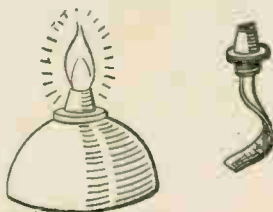

A combination of wood and metal in this PLANT HOLDER

NOW that timber is in such short supply we must cast about to find some other means to supplement it.

In the simple plant holder, shown in Fig. 1, we are using mostly wood, but its decoration solely depends upon metal angle pieces and top edge covering.

This metal consists of thin sheet iron commonly known as "tin". The container or box consists of $\frac{1}{4}$ in. thick wood, the sides being $6\frac{1}{2}$ ins. by $6\frac{1}{2}$ ins., and the floor $6\frac{1}{2}$ ins. square. First, therefore, cut four pieces for the sides of the box as given, and set out the pin joints detailed in Figs. 2 and 3.

Sides and Floor

Note that the depth of each side is divided equally into five parts, each part being $1\frac{1}{5}$ ins. and the depth of sinking $\frac{1}{4}$ in., of course, to meet and form a true corner. Glue the joints together and then clean off the surfaces with fine glasspaper.

Next cut a $6\frac{1}{2}$ in. square of wood and insert it between the sides to form the floor of the box. Before cutting the floor, however, check the measurements of it with the actual opening to insure a tight fit. Small nails or screws can be added and put through the sides and towards the corners as seen in Fig. 2.

To form feet for the box we next cut eight pieces as A, in Fig. 2. The top edge will be $1\frac{1}{4}$ ins. long tapered to $\frac{1}{2}$ in. at the lower edge. Note from Fig. 2 that the feet come behind the projecting metal corners (which are thereby strengthened) seen dotted on left of detail, Fig. 2.

Feet Stiffeners

Stiffen the feet on the inside by gluing pieces of triangular fillet as shown on the underside view, Fig. 4. The top projecting edging to the box is made of four pieces of $\frac{1}{4}$ in. thick wood mitred at their ends and nailed to the top of the box.

The pieces are $8\frac{1}{2}$ ins. long and

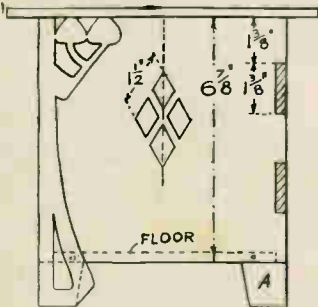

Fig. 2—Side view with dimensions

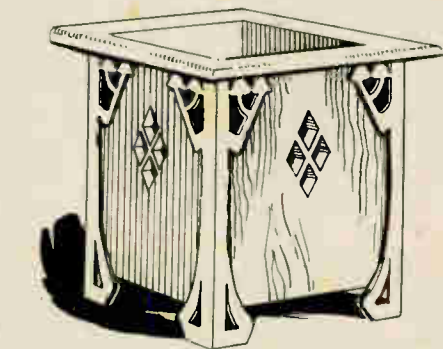

Fig. 1—A pleasing and useful holder

$1\frac{1}{5}$ ins. wide, with the end mitred at 45 degrees before cutting with the fretsaw. Fix them with glue and two screws each to the top edge of the box.

One edging piece is shown in the detail, Fig. 5, ready to fix, and it should be noted how the two screws are arranged to miss those which fix the metal edging which covers the edging strips.

For the metalwork of the box ordinary sheet "tin" such as employed for biscuit or food containers may be used. Dents must be carefully removed by hammering with a mallet on a flat hard surface. For shaping the metal, a pair of metal-cutting shears or snips will be required for cutting the outline and a $\frac{1}{4}$ in. cold chisel for cutting and a file for smoothing the interior openings.

Burnishing the Metal

Upon completion of the filing, each section is laid flat on the bench or table and vigorously rubbed with pumice powder and water applied with a cork. This treatment should remove the burr and any sharp edges and impart a nicely polished surface to receive the finishing coat of black paint or enamel.

In Fig. 6 is shown one complete corner section before it is angled up to fit the box. An enlargement must be made of this, the squared half of the diagram being found useful in making the outline, etc. Each square

equals $\frac{3}{4}$ in., and these should be drawn on paper with a square.

When the paper outline is complete, and both halves of the design drawn in, the pattern is gummed to the metal and the process of cutting and cleaning carried out.

Four of the corners will, of course, be wanted, and three of them can be outlined on the metal by scribing round the outline and the openings of the first finished corner. A centre line will next be scored on the metal, this not being cut too deeply to impair the strength of the metal.

Shaping the Corners

Each corner can then be angled up by putting the metal in a vice or bench screw. The centre line of the design is kept in line with the jaws of the vice during the bending over and hammering square with the mallet.

It should be mentioned here, perhaps, that in working on the metal the pierced parts should be removed first with a small chisel, keeping as near as possible to the drawn lines. Afterwards the outside shape is cut with the scissors or metal shears. Finish with file and pumice powder as suggested.

Next drill or pierce small holes in the places shown, and after filing away the burr that remains, the completed corner can be fixed to the box.

Top Edging

The metal covering to the top edging of the box is easily done, and four separate pieces are set out, angled up and screwed and pinned to the woodwork as shown in Fig. 5. The measurements for the pieces should be taken direct from the wood surround, allowing the metal to drop about $\frac{1}{8}$ in. or $\frac{1}{4}$ in. inside the box.

The outer edge of the metal is turned down over the edge of the wood. All four pieces of metal are pinned in place with the mitres fitting nicely at the corner junctions.



Fig. 3—The corner joints



Fig. 4—Under-view showing feet stiffeners

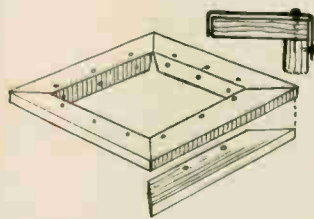

Fig. 5—Top edging to box



Fig. 6—Corner metal decoration

Economize by saving and making use of BITS AND PIECES

WOOD is scarce these days, particularly plywood. But we have to "make ends meet" in some way and in this article we show you a few hints that should prove invaluable and save you extra expenditure.

First of all, throw away nothing that looks useful. Keep all your bits and pieces of fretwood and plywood in a soap box or biscuit tin. Burn only the thin and narrow pieces of scrap



Figs. 1, 2 and 3—Methods of forming a circle

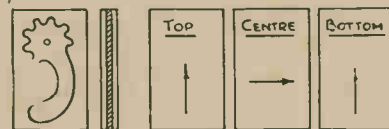

Figs. 4 and 5—A part in plywood

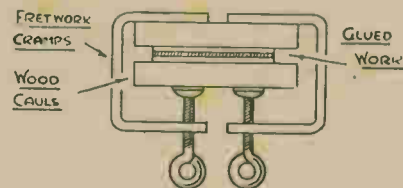

Fig. 6—Home-made plywood vice

that are too flimsy for practical purposes. Or better still, save these for lighting the fire in the morning.

Large squares and discs, plus "frames" of wood and odd corner pieces (see Fig. 10) are all jolly useful. From these you can cut small handles, corner brackets, feet, washers, small gun parts, ship parts, etc., etc.

Even slender pieces of wood about $\frac{1}{4}$ in. wide by $\frac{1}{4}$ in. thick will provide material for "dead eyes" and other similar tiny things, such as gun sides, cabins, boats, mast tips, lamps and so forth.

If you possess a soap box, this could be divided into four with a couple of pieces of wood (use the sides from a similar soap box). Thus, there would be a compartment for $\frac{1}{16}$ in., $\frac{1}{4}$ in., $\frac{3}{16}$ in. and $\frac{1}{2}$ in. thick wood. Thicker material could be kept in another box.

Inlaid Work

If you do inlaid work with different varieties of wood, there is usually a lot of waste stuff after you take the required parts away. Did it ever occur

to you, however, that you could make four striking inlaid picture panels instead of the original one?

It is assumed, of course, that you may be using four varieties of wood. The other three pictures will not be "coloured" so realistically—or naturally—as the original one, for you may have to use a mahogany part for the sky instead of a whitewood, with the latter for trees.

It is all very interesting, nevertheless, to see what pictures you can work out with the usual "waste" parts. The finished results may seem rather fantastic and unreal, but this weirdness will have an attractiveness and save you a lot of cutting.

No Waste

For example, a friend might admire the inlaid tray you have just completed and ask you to make one; it might end up by you having to make three trays.

You can, therefore, use up the waste pieces and thus save time and money. The difference in the colouring of the pictures will possibly not be noticed—unless the four trays are arranged together for comparison. Anyhow, it is an idea worth trying out.

You could, in fact, fit the parts together unglued to see the result and show it to the friend for whom it is intended. Don't forget that being cut identical, the parts are interchangeable so that different results can be obtained.

Using Up Scrap Pieces

It often happens that you have to cut out a disc of wood to a certain size and thickness. Take, for example, the seat of a stool—the old-fashioned circular three-legged type.

The only wood you may have available might be four soap box ends. The diameter of the seat means that two of the ends must be joined together by dowelling and gluing.

If you do not possess the necessary tools, the four semi-circles can be screwed strongly together. Place two of them together as at Fig. 1. The other semi-circular shapes are set on top as at Fig. 2 and screwed down; the arrows show the grain direction of the parts.

This means a strong seat. When screwed together, the edges are levelled with a spokeshave. If you have only three box ends, the alternative is to rub-join two semi-circles together (or dowel them together, if possible), then build up the thickness with quarter-segments as shown at Fig. 3.

If dealing with fretwood and you have to build up a small disc, the parts are simply glued together. It is possible to make up the thickness

from four quadrant-shaped pieces if the scrap wood does not allow two semi-circular pieces.

Home-made Plywood

When cog-wheels and gear parts are cut from plain fretwood, the teeth are apt to be weak where short-grained. Such a deficiency is made up by the central layer in a piece of plywood—hence the reason you are instructed to use plywood, if possible, for such parts.

Now, at Fig. 4 we show a geared lever part. It has to be cut, say, from $\frac{3}{16}$ in. thick plywood. Assuming you have no plywood this thickness, but possess several scrap pieces of $\frac{1}{16}$ in. fretwood, cut two of these to a suitable width and length, the grain running the long way. The third piece (for the centre) is the same size, but with the grain running the short way (see Fig. 5).

To make up the piece of plywood, therefore, you have only to sandwich the central piece between the top and bottom pieces and clamp them together (see Fig. 6) until the glue dries. Be sure to have flat scraps of wood at the top and bottom to ensure an even pressure.

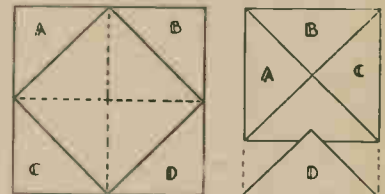

Figs. 7 and 8—A large square made a thicker one

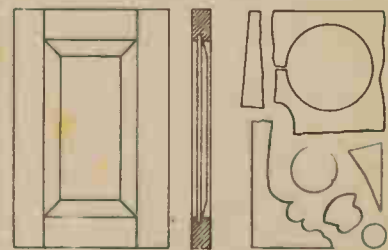

Fig. 9—Panels to a door

Fig. 10—Odd pieces of waste

Good $\frac{1}{4}$ in. plywood can be made from pieces of veneer. Ordinary veneer is about $\frac{1}{32}$ in. thick. Consequently, you will have to glue two short-grained pieces together to make up the centre, this being covered on each side with the long-grained single pieces. An alternative is to use $\frac{1}{16}$ in. fretwood for the centre, this saving the job of gluing two $\frac{1}{32}$ in. veneers together.

A Thick Square from a Thin Square

Supposing you have to make a

(Continued at foot of page 87)



INNER DISC G.
GLUED TO FIGURE

FRICITION DISC H
INSIDE BOX AND
GLUED TO INNER
DISC. CUT ONE
3/16in.



CURVED TOP TO
BOX. CUT ONE
PIECE THIN
WOOD TO SHAPE
SHOWN AND
BEND OVER AND
GLUE TO THE
FORMERS ON
FRONT AND
BACK OF BOX.



DUTCH GIRL
OVERLAY.
CUT ONE
3/16in.
GLUE DISC
G TO THE
DOTTED LINE ON
BACK.
SEE DIA-
GRAM.

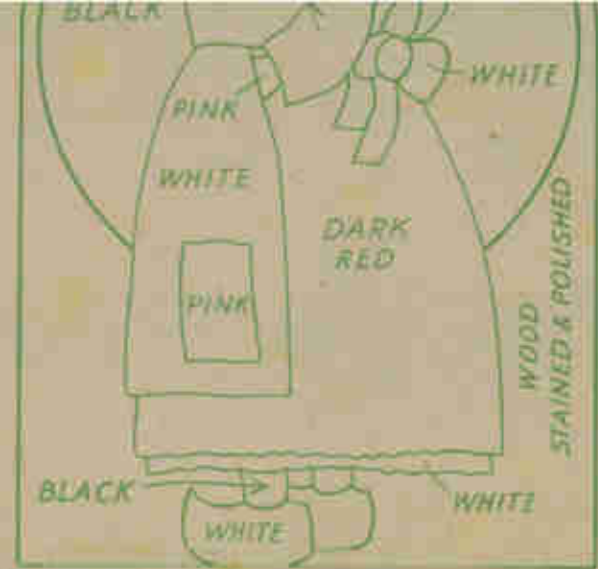
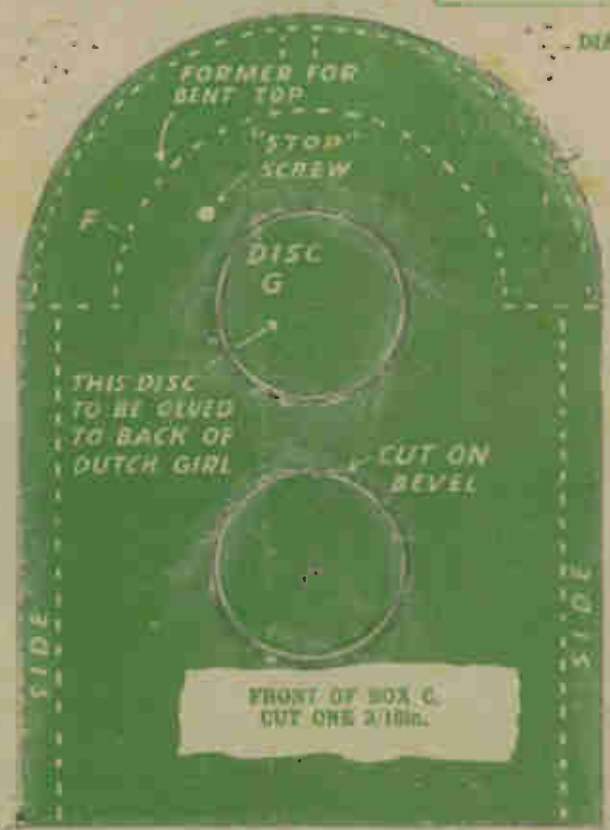
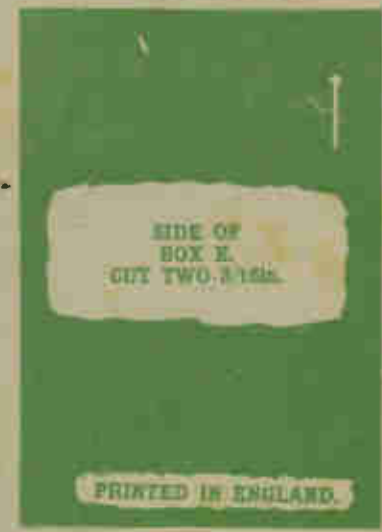

DIAGRAM SHOWING SUGGESTED
SCHEME FOR COLOURING.



CROSS SUPPORT I.
CUT ONE 3/16in.



PRINTED IN ENGLAND.



PIECE H IS SHOWN DRAWN AWAY FROM B TO WHICH IT MUST BE GLUED

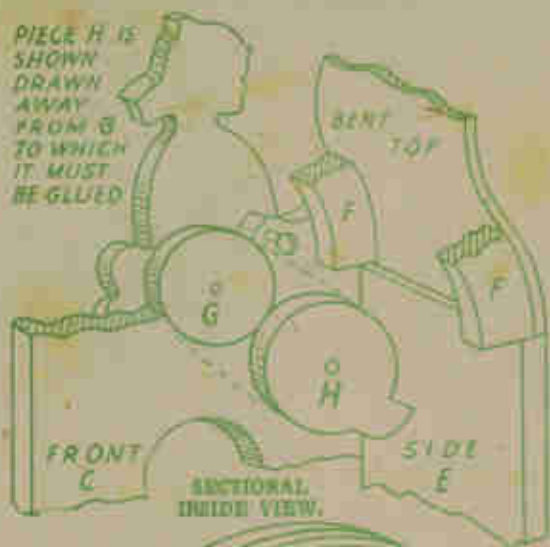

SECTIONAL INSIDE VIEW.

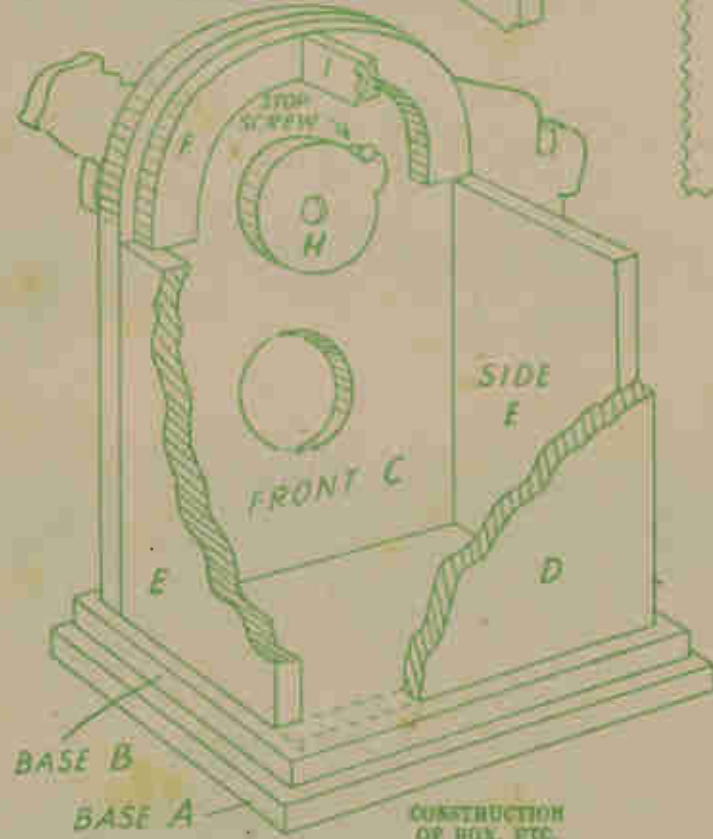

CONSTRUCTION OF BOX, ETC.

How to construct the Box

MARK the parts shown below on the pattern sheet and cut out with the pattern in the thickness of wood chosen. Study the diagram given to see what you have to assemble. The box has a slot in its back for the receipt of money, which cannot be larger than a 3d. or 6d. piece, and a circular opening in the front through which it can be extracted. When the Dutch girl figure is in place, however, there appears to be no means of getting the money out. The secret is to push the girl slightly, so making the front opening available. The detail here, which gives a clear back view of construction. The 'TAIL' has two under cut in it. The upper one must be quite thin across the circular piece which comes out, is glued behind the girl figure in the pattern sheet. This forms the pivot on which the coin rocks. It is held in place on the inside by an inner disc

larger than the tail. This is the inner disc. It is glued to the base on the girl. Now the little stop which acts against a screw driven in the back of the front at the position shown. This prevents the figure being swung too far. Put together the box of the four sides, but do not fit on the girl until painting has been completed. The top of the box is formed of a curved piece of thin wood or card stiff card, glued along the corners made by the parts, F, at the receipt. Use the width of the curved top according to actual measurements of the model. Base and box can be completed, and the back, D, should only be brought on temporarily. Now paint the whole thing, including the base and the figure, to the pattern shown. Take off the back and fix the figure by its disc as constructed, afterwards glue the back in solid. The completed box will prove quite a novelty as well as an ornament.

SUPPLEMENT TO HOBBIES No. 3744.

THE LITTLE DUTCH GIRL PUZZLE MONEY BOX

FOR THREE-PENNY AND SIX-PENNY PIECES.



NOTE.—This design sheet is only presented free with the current issue of Hobbies and not with back numbers. Further copies may be obtained.

PANELS OF WOOD REQUIRED FOR THIS DESIGN
ONE H3 ONE PPM
 The price is shown in Hobbies Weekly, June 2nd, 1948, but is subject to revision. See the current edition of Hobbies Handbook, or write for prices to Hobbies Limited, Dereham, Norfolk.

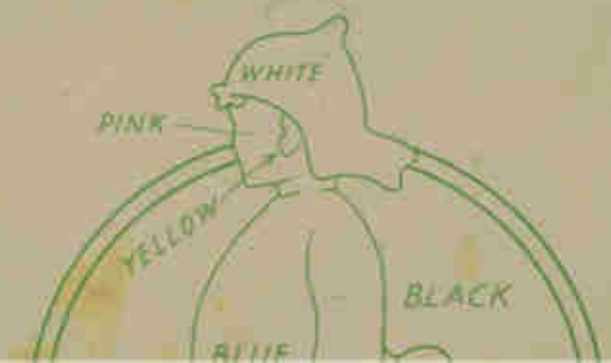

How those sleeping out can easily make for themselves A SOFT CAMP BED

If you go camping with bell tents and heavy equipment you will probably take palliasses (long thin bags) which can be filled with straw or hay on the site, thus giving most comfortable beds. People with lighter gear, however, always seem to think that sleeping on the hard ground is a necessary part of the *al fresco* game and never make any attempt to get something soft to lie on.

This is rather silly, for hard ground can become very hard, and dangerously cold even if the day has been hot. After all, one does not go to camp to get chills or even have restless uncomfortable nights. Good sleep is essential if you are going to enjoy the days; only the tenderfoot "roughs it" unnecessarily.

The Framework

If, then, your own gear does not include palliasses, why not make the mattress shown here? Straw, hay or even dried bracken will do, and all that is required in the way of material for construction is a ball of twine and some rough stakes which can be obtained at the pitch.

First cut the stakes—six of them—of sufficient length that they will be about 2ft. above the ground when enough has been pushed down into the ground to make them stand quite firmly. Arrange these stakes in two rows of three—the three of a set being 1ft. apart, and the rows being about 5ft. from each other.

Stakes and Twine

Now take the twine and run three lengths between the tops of the corresponding stakes as (b). The twine should be left fairly slack and may be readily attached to each piece of wood by the "clove hitch" knot, which, as most readers will know, is made by forming two loops and passing one behind the other. The knot has the advantage that it will never slip.

Bits and Pieces—(Continued from page 36)

thick square of wood from a thin square which, when doubled, gives the right thickness, how can you do it? Well, providing the thin square of wood is big enough, it is done as shown at Figs. 7 and 8.

Mark out the size of square required, then from the corners of this, mark the segments A, B, C and D. Remove these and glue them to the central square—and you have a suitable block of the correct thickness.

Try to plane the edges of the corner pieces so as to ensure neatness. Glue and clamp them together as at Fig. 6, or use screws or nails if dealing with large thick pieces of wood.

Three more lengths of twine (d) are now cut. These are about half as long again as the pieces just fitted and are tied at one end to three of the stakes and at the other to a cross-bar (f), which is about 2ft. 6ins. to 3ft. long.

All is now ready for "weaving" the mattress, except, of course, getting the material with which you are going to make it.

It has been the writer's experience that farmers if approached in the right way will always give a little

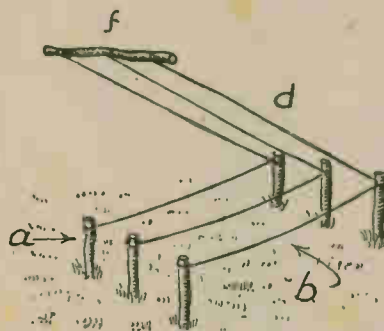

RIGHT-
THE COM-
PLETED
MATTRESS



straw or hay, especially if you are camping on their land and you let them see that you will not scatter it all over the place. If camping out on common land in very dry weather, plenty of dead bracken or long grass can generally be pulled.

Two persons are required to work the loom satisfactorily.

Method of Weaving

The method is as shown by the two right-hand sketches. The cross-bar with twines (d) is first raised high and a fairly tight wad of the straw, hay or bracken is pushed into position as (g).

While one person holds the wad well into the angle of two strings, the second brings the cross-bar down to position (h) shown in the lower sketch, and a second wad (k) is pushed well home, this time under the strands (b).

The bar is now raised once more and a third wad pressed into position. This process goes on till the end of the string is reached, the result being a series of wads of the material being used tightly strung together as per figure (A) and the sketch of the

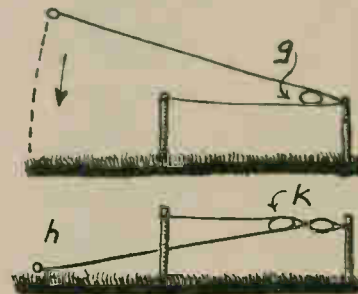

(A)
TWINE WRAPS
ROUND WADS
LIKE THIS

completed mattress.

Strings (b) and (d) are now securely knotted together at both ends and the mattress removed from the stakes. The end of the wads should be trimmed for neatness.

Mattresses like this can be made very quickly and neatly once the knack is secured. The main things to note are that the stakes are firmly pushed into the ground, so a good pull can be put on them without their coming out. Also that the wads of material are about the same thickness and each wad pressed right home before the cross-bar is raised or lowered.

Generally, a door frame is panelled with a piece of plywood or fretwood. Having neither plywood nor fretwood of the correct thickness, however, such as 1/2 in. or 3/16 in. or possibly 1/4 in., you are rather stuck.

You could, of course, take a piece of ordinary wood to a machine shop and have it sawn in halves or planed down to the desired thickness. If it is an ordinary piece of deal about 1/2 in. thick, a simple plan is to chamfer a bevel on the edges (as shown at Fig. 9) so the edges wedge snugly into the ploughed edges of the not-yet-assembled door frame parts.

Any thickness of wood can be used

in this way. It makes a strong job. The bevel side of the panel is, of course, kept to the back side of the door frame, unless you desire it to be seen.

Looking at it from the outside, you have apparently an ordinary door panelled with plywood. There is nothing new about this idea, seeing that it was invented in the days before plywood.

Indeed, the idea is still used a great deal today, especially in copied period furniture and when beautiful grained fronts are desired; instead of being plainly chamfered, these is sometimes a moulded bevel.

To use the right one for the job you should know SOME NAIL VARIETIES

WHEN the writer was very young he always thought that a nail was just a nail; some were longer than others, but that was all. Later he found that it would not be difficult to name at least thirty different types, each with its special use and shape.

Nails can be broadly classified according to their method of making, as "wire", "cut", or "cast". Wire nails, as the name suggests, are made from long strips of what is virtually wire, the material being cut into lengths and then pointed and headed. "Cut" nails are punched out of sheets of metal and are recognisable by their rectangular section, while "cast" nails are produced by a moulding process.

Wire Nails

Wire nails are sometimes spoken of as french nails and are made in a great variety of lengths, from 1in. to 6ins. and are officially referred to as having this or that gauge. This class of nail can be obtained either with a full circular cross-section or oval cross-section. It has been found that the oval section does not hold as well as the circular but that it gives less danger of splitting.

It will be found that with most wire nails the shank is given a rough area near the top. This is not poor finish but is to produce a better grip in the wood.

Nails punched from sheets of metal, as well as being rectangular in section, are wedge-like in shape, being, in effect a long thin triangle. Broadly speaking this type of nail is useful for coarse work only—or at least with timbers of a fair thickness—never less than, say, 1½ins., as the danger of splitting is considerable.

For Mortar

Cast nails are useful for going into mortar but should never be driven into anything hard as they break very easily.

Now for some of the varieties that come within these main heads.

Thus, there is the "floor" nail. This has an L-shaped head and is used for holding floor-boards down to

Sailing Boat—(Continued from page 82)

close to the sides, and 4ins. apart for the stays to be fastened to. Clews, cut from hard fretwood, as at E, Fig. 3, are used to tighten the stays, and all sail lines in the rigging. Fix them to the lines, as in detail, F, which explains itself.

A pattern for the sails should be drawn on stiff cartridge paper. Get out on the paper the side elevation of the rigging, Fig. 5, then the exact size and shape can be easily put in of

joists. It is so made that as it is hammered in it draws the two pieces of timber together.

Joiner's short ¾in. to 2in. nails are spoken of as "brads". They are used for nailing on backs of furniture and similar jobs, while the "lath" nail is especially made for securing ceiling laths in position. It is a wire nail and is made with a broad flat head. "Clout" nails, too, have a very broad head and these are mainly used for fastening down felt on roofs, etc. This type of nail is often galvanised so it will resist rust.

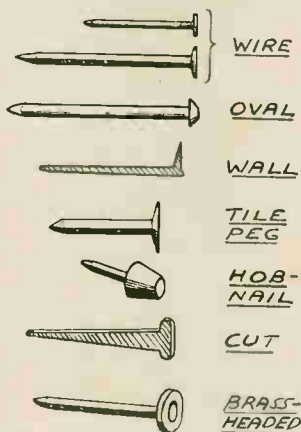

Most persons who have done any boot repairing will know of the "hob nail". This is short but has a sort of cut-off cone as a head. If put into the soles of heavy boots they give long life to the footwear. The nail can also be used for decorative purposes on woodwork.

The "panel pin" is really a long slight nail. It is made of thin wire with a conical-shaped but small head and can be of great service in securing thin pieces of material together. Indeed the expert woodworker almost invariably uses the panel pin when dealing with thin woods.

Other Varieties

Other nails that can be mentioned are the "brass-headed", the "wall" and the "pipe". The brass-headed

are used for decorative purposes in upholstery and for other jobs. The wall nail is rather in the nature of a spike and has a head which bends over to one side only.

There are also "hurdle" nails, "rose head" nails and "tile pegs", "tire" nails and "pelt" nails.

Broadly it will be found that the heads of all nails are made to counter-sink—that is go right into the material and be dead flush with the surface, or to lie on the surface and by their very size get a grip on a good area.

With all nails the hammer should always fall squarely on the head and be swung with a rather loose but rhythmic action. Satisfactory nailing can only be accomplished where the whole job is solid. Anything like springiness or "give" in the material is fatal to getting the nails right home. Anything that tends to be springy, therefore, should be temporarily wedged to a state of complete rigidity.

To Avoid Splitting

Splitting is, of course, a great trouble, but this may generally be avoided by slight boring first and by setting nails which have to be in a row a little out of line.

Where two pieces of wood have to be brought tightly together—as, say, floor boards—it is good to put the nails in at an angle. The last blows then tend to bring the pieces of wood up to one another. Clenching prevents a nail from being withdrawn and is effected by hammering the point over.

Finally, one of the secrets of good nailing not often spoken about, is having a hammer of the correct weight and size. For small brads, sprigs and pins a small hammer, and for big work one of considerable heaviness.

If the weight of the hammer is out of all proportion to the size of the nail it is hard to judge the exact weight of the blow. While if the size of the head is too great it is difficult to aim the blow squarely on to the nail. Thus the hammers supplied with Hobbies fretwork sets are ideal for brad and other "pin" work—for which they are intended.

the mains and foresail. Cut these out and join to a fine calico. Allow for hemming, and cut out the patterns. The sails are hemmed all round, and eyelets sewn in the corners.

The mainsail is laced with stout thread to the boom and gaff. A few brass rings are stitched to its back edge, which slide over the mast. The foresail is fastened to the bowsprit with a hook. To each traveller a small ring is slipped on.

Lines go through these rings to the fore and mainsail, and are drawn through screw eyes, or hooks, driven in the deck at convenient places. They are adjusted, as required by the clews.

One line draws the foresail to the mast at the top, and another pulls on the gaff to tighten the mainsail. Both are tied over hooks, or cleats, fixed either to the deck or to the lower part of the mast.

Read these practical hints before starting upon A CYCLING TOUR

YOU will not, of course, dream of going on tour without first seeing to it that the machine, which is to carry you and your luggage, is in first-rate condition. It may require "tuning-up" or renovating generally. If you are mechanically-minded it is not a difficult task to strip the bicycle, give every part a good and thorough inspection, and re-assemble it.

Otherwise, take it to a reliable cycle repairer and let him do the job. Never set off on a long tour without feeling confident that your "mount" is in a condition to stand up to anything you are likely to meet with on by-roads—and main roads for that matter—which have been sadly neglected during the war years and since.

No "Tinkering"

But, do not tinker with your machine unless you know just what you are doing. Above all, when going on tour, be sure that your brakes are perfectly sound and are adjusted so they act speedily and effectively. In these days of heavy motor traffic it is very essential to be able to "pull up" quickly.

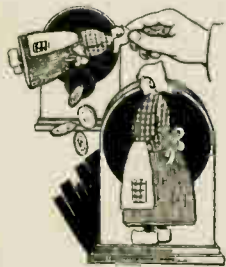

MONEY BOX

The design for this novelty is given with each copy of *Hobbies Weekly*. A kit of wood (No. 2744) is obtainable from Hobbies Branches for 1/9 or by post for 2/6 from Hobbies Ltd., Dereham, Norfolk.

On a long tour, doing anything from 50 to 80 miles or so a day, it is essential to ride in comfort. The obvious thing is to adjust your riding position to ensure this desirable end. On tour you do not expect to be a fast cyclist. Touring and racing are two different objects in cycling.

Therefore, your machine should be of a lightweight tourist model. If you are a heavyweight yourself, naturally, you will require a stronger and bigger cycle. In any case, never attempt to do a lot of cycling on a machine that is too big for you—it will only strain your muscles and prove very uncomfortable.

See that the bicycle "fits" you, as it were. The "fit" of a machine to the cyclist is as important as the fit of a suit of clothes. To find the correct position of the seat, sit astride your

bicycle and place one *heel* on a pedal at its lowest point.

The leg should then be slightly flexed, that is, not quite extended to its full length. When the saddle is adjusted to this distance from the pedal you will be sitting in the correct position. The peak of the saddle should be 3ins. behind an imaginary line drawn through the centre of the pedal-crank.

Handlebar Adjustment

Next adjust the handle-bars so when you are in the saddle your back is at an angle of 45 degrees from the seat, and your arms are slightly bent at the elbows. Some cyclists test the

riding position by sitting upright in the saddle and endeavouring to follow the pedals round by the heels. If this can be done quite comfortably, without stretching or swaying, and without any cramping, the machine may be said to be correct for frame height.

When going on tour this question of "fit" in a bicycle cannot be overstressed. Too high a machine cannot be ridden comfortably or efficiently, and when travelling long distances daily for, say, a week or fortnight—as when taking your annual holiday awheel—the strain tells and the pleasure you look forward to will probably prove a torture.

USING PERSPEX SCRAPS

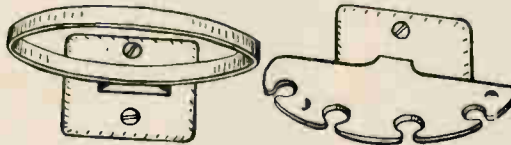

ALL readers who make things in Perspex know that the material is expensive to buy. Invariably a number of small pieces are left over, which, of course, represent wasted money unless they can be put to some use.

The usual method of using up the scraps is in the form of small decorative pieces, applied to larger articles, or for making handles and knobs. Scraps can also be put to effective use by being fashioned into buttons and brooches. The latter application is, of course, one of the normal uses for the material, but it is well worth while exploring the possibilities of your scraps, before cutting a brooch blank from a larger sheet. Intelligent planning will often show where enough material for, say, a brooch, can be obtained from a sheet from which a larger article is being cut. Often a slight alteration in laying out the pattern will do this, and it is good practice to experiment with different ways of laying out the pattern before cutting the sheet.

One of the great advantages of Perspex is its absence of 'grain' so that the various parts of an item can be placed in any direction on the sheet,

which, of course, could not be done with material such as wood.

Two simple, though none the less useful articles which can be made up from scraps, are a tumbler holder and a tooth-brush rack. Fig. 1 shows the details. The tumbler holder uses three pieces of material. Cut a strip of Perspex for the ring, obtaining the exact length by wrapping a strip of paper round the tumbler and marking where the ends overlap. Bend to shape and cement the joint. Details of the support and back-plate are shown in A and B. A mortice and tenon joint is used between the two parts as it is essential that it should be adequately strong.

Toothbrush Rack

The tooth-brush rack is also shown in Fig. 1 (c). The slots are formed by first drilling holes and then filing out the openings. The rack part and back plate are again fixed with a mortice and tenon joint. The back plate is similar in size to that used for the tumbler holder.

Fix both items to the wall with wall plugs and brass or chromium plated screws, to prevent rusting.

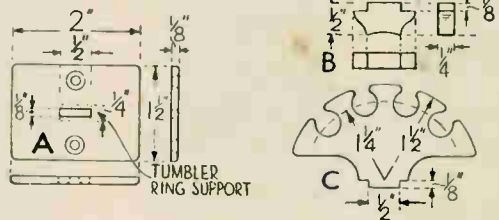

Many matters of general interest are in these REPLIES ON RADIO

Crystal Reception

WOULD you advise the maximum distance of reception on a crystal set? (E.C.R.—Reading).

THE average maximum distance of reception is about 50 miles. With a long outside aerial and a good earth, in conjunction with a sensitive pair of headphones, satisfactory volume can usually be obtained up to 75 or even 100 miles range, but reproduction is, of course, much less loud than when the receiver is used near a broadcasting station.

Accumulator Charging

HAVING purchased a small accumulator, I was wondering how to charge it at home. (C.F.H.—Hutton).

WE are afraid you would find it very difficult to make a rectifier which would give continuous satisfactory results, and it is unlikely it could be done at a lower cost than the price of a ready-made rectifier. If you cannot buy a cheap secondhand rectifier, it would probably be best to have the accumulator attended to at a charging station.

Microphone Amplification

IS it possible to connect a hand microphone straight on to a wireless without some form of amplification? (M.A.L.—Washbrook).

A MICROPHONE will not operate a speaker without additional amplification. This can most conveniently take the form of one or more valves. If an existing receiver is to be used to provide amplification, the microphone should be connected to the grid of one of the valves (terminal or socket usually marked "G"), and to Grid Bias about 1.5 to 6 volts minus (value depending upon valves and best found by trial).

Transformer Load

IHAVE a cheap miniature mains transformer designed for use with a 6 v. 3 amp. bulb; can you tell me if it is likely to stand 45 amps. at 5 volts? (P.M.—Cobham).

IF the transformer is of moderate quality, it would stand the overload mentioned for short periods. Overloading is not recommended, but a moderate increase above that intended by the makers is permissible. If the transformer is to be used for long periods, it may become overheated, as the winding will be intended for .3 amp. only.

The transformer may be tried at the overload. If it shows any signs of overheating, it should immediately be switched off. The overload is approximately 50 per cent., and cheap manufacturers do not allow such

latitude, although it should be safe for short periods.

Television Aerial

IWANT some information on how to build a television aerial. (S.A.W.P.—Shepherd's Bush).

FOR television a dipole is best. This consists of two wires one-quarter wavelength, long mounted end to end. Metal tubing may be used, but stout wire (14 S.W.G. or thereabouts) strained between stand-off insulators is suitable. The insulators may be screwed to a stout batten so that the whole can be set up where desired. An overall length of approximately 11ft. is necessary or the 7 metre band used.

The aerial should be mounted as high as possible in a vertical position facing the transmitter. From the two inner ends of the wires, a feeder cable or transposed twin line is taken to the receiver. In the immediate proximity of the aerial, this line should be taken away at right angles; at a greater

distance its angle in relation to the aerial is not important. Aerial and lead-in should be as far from walls and other earthed objects as convenient.

Earphone as Microphone

COULD you tell me if it is possible to convert an earphone into a microphone? I have heard of it being done, and am most interested. (R.A.S.—Nottingham).

AN earphone will function as a microphone without any alteration. It is merely necessary that the leads be taken from it to the input terminals or sockets of a suitable amplifier or radio.

As the earphone is not particularly sensitive (especially to sounds at some distance) some improvement may be noticed if a hole about one inch in diameter is cut in the centre of the ebonite cover, and a small horn, fashioned from tin, fixed to direct sounds against the diaphragm.

CANINE CARICATURES

The Mastiff

THIS is the second of our novel dog statuette figures, cut with a fretsaw from odd pieces of wood to the shapes shown full size on the opposite page.

The Mastiff is a big strong dog of very ancient origin. The St. Bernard, Newfoundland, Bulldog, etc., are all related to it. A characteristic of the Mastiff which is caricatured in the model, is the drooping of the "flews" or "chops".

The model is easy to make, only odd scraps of wood being needed. The difficulty of putting in the eyes (a tricky point with many amateurs) is ingeniously overcome by the use of round-headed screws.

Plywood is generally used. Though large sheets are very difficult (and expensive) to come by, odd scraps are more easily obtained (locally). Trace off and cut out the parts, taking note of the number of each required, and the various thicknesses.

Assembly and Shape

The two sides are glued and tacked with small panel pins, to the middle body. File up with a rasp, to ensure that all parts are in line. There will be a tenon projecting at the neck which fits into the slot in the head.

The earlier Dog was in the issue dated Feb. 11th, 1948

Before fitting the head to the body, however, glue the face to the head, and hold in position with a couple of small panel pins. The eyes are made from $\frac{3}{8}$ in. by 6 roundheaded black screws with the slots finally left horizontal (see sketch). It is very important to drill holes for the screws first, otherwise the wood will split.

The Legs

The flews are glued to the face, and the snout glued to the flews. The legs are then added, their position being indicated by dotted lines. They are glued and tacked, care being taken to ensure that the model stands equally on all four feet. Final adjustment in this matter is obtained by laying a sheet of glasspaper face upwards on a level surface, and rubbing the feet of the model over it.

The best colour is a lion-like tawny yellow-brown. When this is dry, paint the flews and ears dark brown, and the snout black.

Thus we have another amusing ornament for the mantelpiece. Some readers may be tempted to bevel off sharp square edges by whittling with a penknife. In the designer's opinion, this is not recommended in a model of this type.

A canine caricature



HEAD
Cut One, $\frac{1}{4}$ "

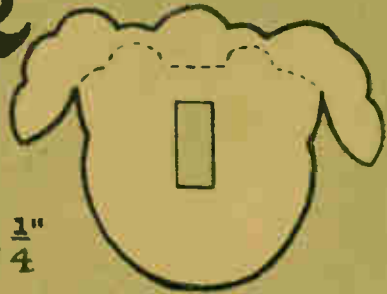

See elsewhere in this issue for full instructions

The Mastiff



FACE
Cut One, $\frac{3}{8}$ "

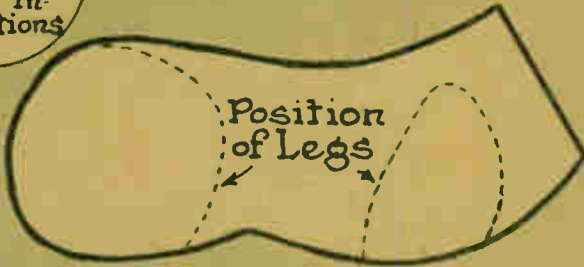

SIDE OF BODY
Cut Two, $\frac{3}{16}$ "



EARS
Cut One, $\frac{1}{8}$ "

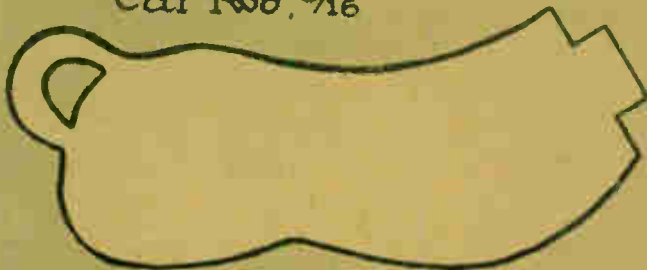

MIDDLE OF BODY
Cut One, $\frac{3}{16}$ "



SNOUT
Cut One, $\frac{3}{16}$ "

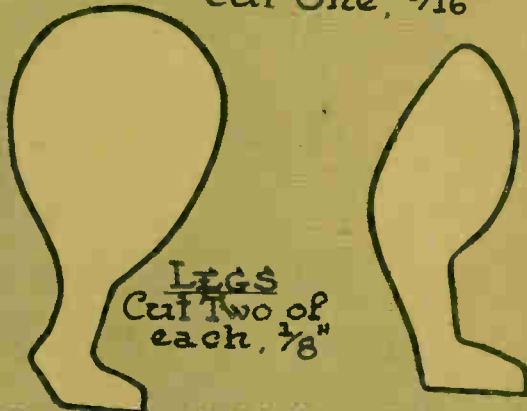

LEGS
Cut Two of each, $\frac{1}{8}$ "



Completed Head

**Mars
ARE
MARVELLOUS**



You'll certainly agree! Just taste these chunks of sheer delicious goodness made with *chocolate* to sustain, *glucose* to energise, *milk* to nourish you. Ask your sweet shop for Mars.

Mars 4½d.

MARS LTD., SLOUGH, BUCKS.

BELIEVE IT OR NOT - BUT

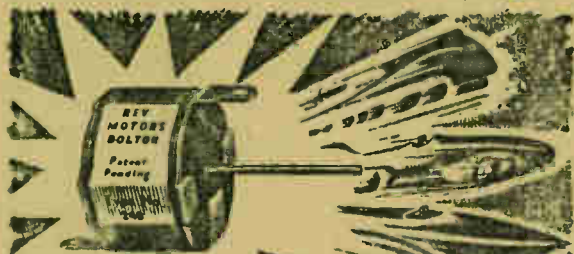

This complete Power Unit will drive your working models...

Mechanical hobbies now become more than ever an all absorbing thrill with the aid of the amazing **ELECTROTOR** - a phenomenon never before thought possible of realisation. Think of its size. Takes up less than a cubic inch of space, weighs only 7 of an ounce yet is powerful enough to work all kinds of mechanical models. Powered by an ordinary torch battery it develops approximately 5,000 r.p.m. and is adaptable to an infinite variety of drives. Must be seen to be believed. Ask your Retailer for full descriptive Leaflet.

Sole Manufacturers: **REV. MOTORS LTD.**, Knowsley House, Bolton
Model Retail and Mod^l Wholesale enquiries to Cartwrights Model Supplies Ltd.
19-21 Elystan Street, London, S.W.3.



**EXTRA CASH
IN SPARE
TIME**



A fascinating way of earning extra cash in spare time from odd pieces of lead. Small Outlay—Large Profits. Sample mould 3/6d. Casting moulds, deep-cut and ordinary type Aeroplanes, Soldiers, Farm and Wild Animals, Cars, etc. Stamped envelope for full list. Illustrated Catalogue 9d.

MASTERCRAFT MOULDS
69, ST. MARKS ROAD, HANWELL, LONDON, W.7

ELECTRIC MOTORS

TYPE 47 GM. Dimensions 11½ x 4½ x 4½ ins.

Converted into a Motor 220v. A.C., 50-Cycle, Single-Phase Fitted with reduction gear box with 3 intermittent cams and 1 slow drive. Air blower at the other end. Ideal for displays, experimental purposes and driving your model.

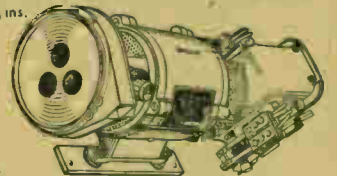

OUR PRICE **27'6** Plus 2/6 Postage and Packing

DOUGLAS HOUSE LTD.
WARREN WORKS, UPPER CULHAM,
NEAR WARGRAVE, BERKSHIRE.

SUPER TOY PLANS

- 10044 Engine and Tender
- 20044 Mechanical Shovel
- 30044 Tipping Lorry
- 40044 Paddle Steamer
- 60044 Toy Fortress

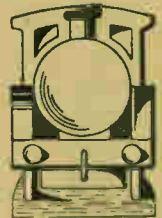

9d each from **HOBBIES** branches and principal stores or 1/- post free, from

ZIMPLAN 88 Ware Road
Hoddesdon, Herts

Hobbies

WEEKLY

CONTENTS

	Page
Stand Rabbit Hutch	- 93
Bird Table	- - - 95
Child's Play Cart	- - 96
Bicycle and Bivouac	- 97
Making Square Netting	98
Increased Radio Selectivity	- 99
Handyman Hints	- - 100
Emergency Bulb Holders	- 100
Solitaire Board	- - - 101
Stamp Collecting	- - 102

June 9th, 1948

Price Threepence

Vol. 106 No. 2745

RABBITS are hardy little animals and easily reared. It is wrong, however, to imagine that any sort of hutch will serve as a home for them. Crude hutches made from boxes knocked together roughly, and doors hanging by leather hinges, are

A simple standing RABBIT HUTCH

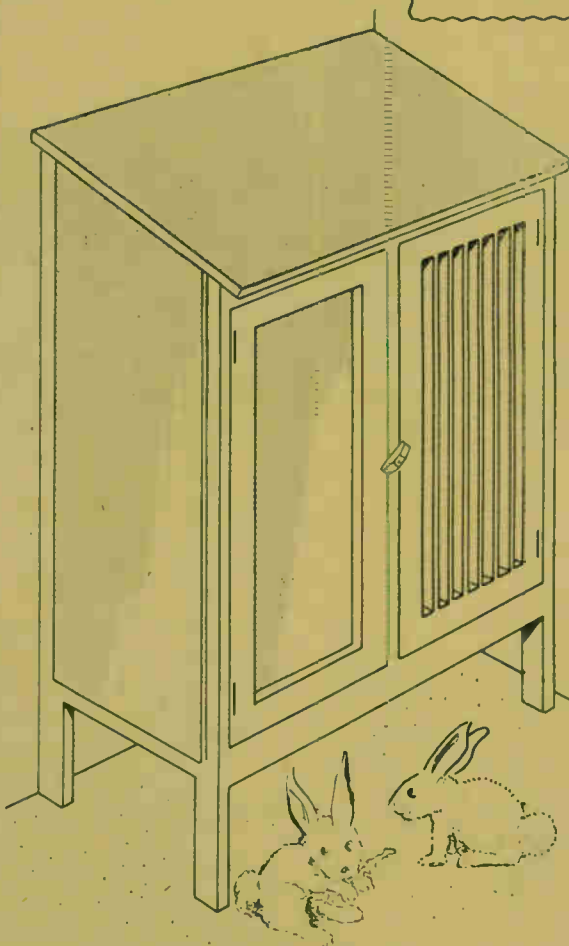

not suitable homes, unless all joints are closed or covered neatly with roofing felt, with doors properly fitting.

If the rabbits are being kept for breeding purposes, a few soap boxes, etc., nailed together, will not provide a good roomy hutch. There must be plenty of interior space.

Do not think, by the way, that wild rabbits in their burrows are rather cramped for space. Within the earth, at the end of the entrance tunnel, the rabbits provide a suitable room for themselves, and there may be various exits in order to confuse and foil Mr. Ferret.

Despite the draughty exits, it is cosy inside the earthen home. The same conditions for pets must be copied. All rabbits hate constant exposure. They like to hide themselves away from prying eyes and prowling dogs and

cats. The hutch, therefore, should always have two separate compartments, an open compartment and a closed compartment.

Mother Rabbit, while carrying her young, will prefer the closed compartment, and it is here that she will undoubtedly bear her off-spring. Father Rabbit will keep guard at the open compartment, and a watchful eye for the missus. Since rabbits breed fairly quickly, it is advisable to have an upper and lower berth, so to speak, in order to keep the sexes separated.

This has been allowed for in the design of the rabbit hutch illustrated. It is a fair-sized hutch, consisting mainly of narrow wood covered with roofing felt. The doors allow the four compartments to be cleaned out easily when necessary. The overall size of the hutch is 4ft. 8ins. high 32ins. wide by 18ins. deep.

The End Frames

As stated previously, the carcass work is mainly a framing. You need two end frames prepared to the shape and dimensions at Fig. 1, using 2in. by 7/8in. deal battens. The cross rails are either doweled or half-lapped over the uprights. Have the end frames made first, both identical in every way.

To harness the end frames together, you need five bearer rails 28 1/2ins. by 2ins. by 7/8in. These are affixed between the end frames with glue and oval nails about 2ins. long. The roof rails, it will be noticed, are bevelled to conform with the slope of

the roof. The edges should be bevelled prior to attaching the rails between the frames. The angle can be obtained with an adjustable square and this used for testing the edge during the planing.

The Partition Piece

Having the carcass framing assembled, the next part to fit is the bottom to it. This should be of solid stuff, made up to width, to measure 30ins. by 18ins. by $\frac{1}{4}$ in. The ends are checked 2ins. by $\frac{1}{4}$ in. for the uprights.

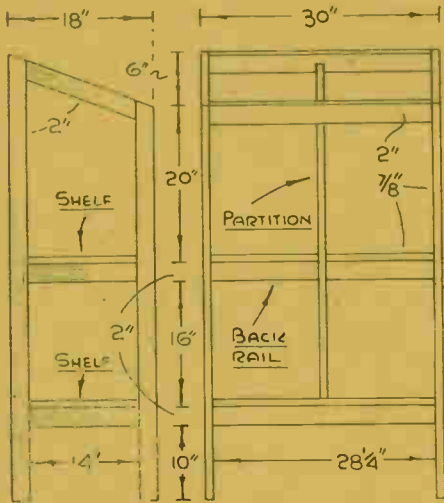

Fig. 1—End framework with front elevation

that the half-checking must be truly in alignment with the shelf and its half-checking. The shelf is 1in. less in width than the bottom piece to allow for the doors.

The remainder of the roof boards can be attached, using up scrap pieces which are $\frac{1}{4}$ in. thick or thereabouts. The roof is covered with bitumen-impregnated roofing felt, including the back. The sides are covered with the same material, as can be seen in the illustration of the completed work.

even if you have perforated zinc at hand, fit the slats or dowelling rather than attempt to make use of the other.

The doors are hung on 2in. butt hinges. A wooden or metal snib attached to the partition keeps both doors closed. Two handles or knobs could be fitted. This completes the hutch which should be kept close against a wall, particularly at a sheltered corner of the back garden or yard.

As to the finish, the interior should be coated with creosote or other preservative. The outside can be given two applications of grey oilpaint applied over the felt as well as the wood.

Now, although the hutch is protected to some extent by the wall at the back, it should be remembered that if rain is permitted to trickle down between the hutch and the wall, there is always sure to be a considerable amount of unnecessary dampness.

To prevent this, a flashing of sheet lead, zinc, or a strip of roofing felt, let into the wall between the bricks immediately above the hutch roof, then cemented, is the usual remedy. The projection of the flashing keeps the rain on the roof, and the wall at the back of the hutch will be dry.

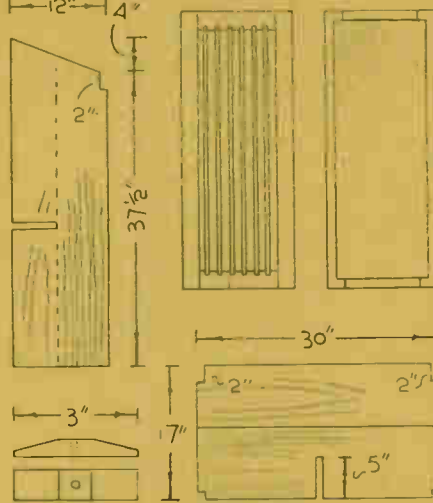

Fig. 2—Partition, doors, central shelf and snib

The bottom thus rests on top of the bottom end cross rails. When fitted and nailed to the cross rails and the back and front bearers, the central partition piece is made and fitted.

This, too, must be made up to width from $\frac{1}{4}$ in. wood, as shown at Fig. 2. The dimensions shown are approximate and the carcass should be measured to find the exact size, and the position of the half-checking for the central shelf. The partition, when prepared, is attached in place with nails. At the roof, use an 8in. wide roof board (see front view at Fig. 3) to hold it in place. The roof boards are $\frac{1}{4}$ in. stuff, 23ins. long.

Centre Shelf

At the moment, having secured the partition in place, make and fit the central shelf, this being detailed at Fig. 2. It is fitted in via the back of the carcass, and it will be realized

The doors are identical in size, lapped together. When assembled, the inside of one door is covered with roofing felt, as seen at Fig. 2.

The other door may be a "grilled" type, i.e., it is fitted with $\frac{1}{4}$ in. by $\frac{1}{4}$ in. slats, the ends of these being let into notches cut in the edges of the cross rails. Alternatively, one could use lengths of $\frac{1}{4}$ in. or $\frac{1}{2}$ in. dowelling.

Again, the door could be covered on the inside with wire netting or wire gauze. Perforated zinc could be adopted, but this, on rabbit hutches, is rather unorthodox. The netting, mesh, slats or dowel rods are more conventional; the rabbits can be easily seen through the openings.

This is not the case with perforated sheet zinc. The latter would give one the impression that the hutch was a meat safe. So,

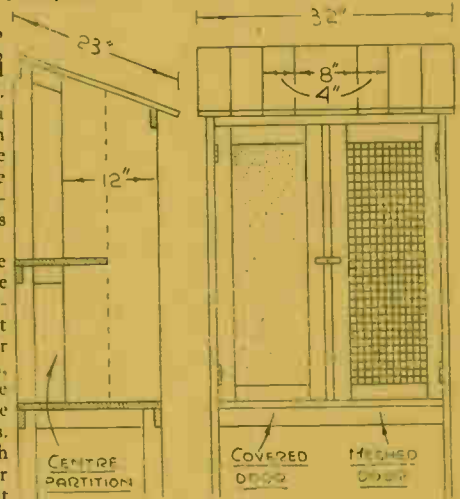

Fig. 3—Front view with sectional end

A Bird Table—(Continued from page 95)

It is between these bargeboards that the roofing material will be fitted and then nailed to the gables at either ends of the roof. We have shown the two roof slopes as being covered with thin slats of wood 13ins. long and 1 1/2ins. wide. Each slat has a lap on the underslat of $\frac{1}{4}$ in. The ridge may be rasped along to form a flat surface on which to nail a flat lath as protection against weather

at that part. The strip pieces can be glued over each other or short thin-nails added to bind the overlap. The ridge piece should fit between each end.

The choice of finish for the completed table lies between paint and creosote, the former, perhaps, giving the most attractive appearance. Creosote, however, offers a splendid preservative for the wood, and it is

cheap and easily applied, a fresh coat being given each year.

Final advice regarding the main post of the article. If this is to be let into the ground, the end which is buried should be well saturated with the creosote or even tarred above ground level. If a base or stand has been provided for the post, then this again should be well coated with the creosote.

You can enjoy the making and then watching A BIRD TABLE

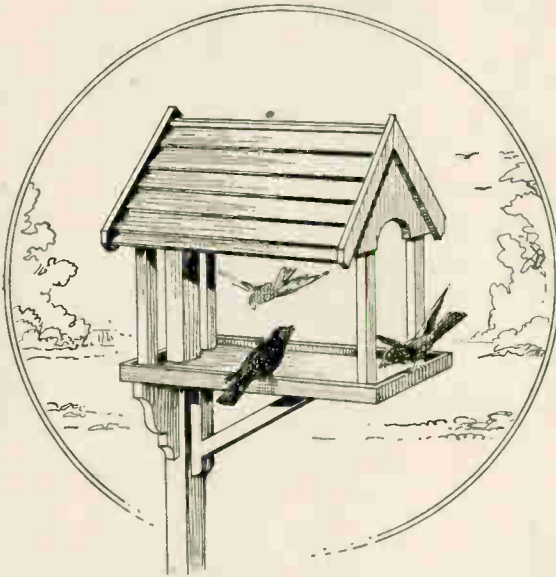

THE attractive bird table shown in our sketch on this page can be made up from ordinary packing-case box wood. This wood is usually straight-grained and fairly hard, but, of course, a careful choice of box should be made to get the required thicknesses of wood suggested here. The gabled roof makes the article very attractive, but the method shown here of thin slats of wood laid lapping over each other can, of course, be varied according to taste of design and material at hand.

The roof could be of Rubberoid, or even ordinary floor cloth or lino, painted. In this case, either of these materials would require support, and for this, one or two laths nailed lengthwise to the gable-ends would be quite sufficient.

The whole tray and its roof are

supported on an upright post, say, about 5ft. or so high. This post may be let into the ground or may have a wide and outstanding base so the whole can be moved about as desired to different parts of the garden.

The tray will be the first part to make and in Fig. 1 we see the piece of wood for this, with sizes given and the space cut away at one end through which the post passes. The post may be about 2ins. square.

An edging is formed for the tray from stuff about $\frac{3}{4}$ in. or $\frac{1}{2}$ in. by $\frac{3}{4}$ in. thick. This should be nailed on and the top edges

rounded off with glasspaper as seen in the enlarged section in Fig. 1.

Four uprights are next prepared from $\frac{3}{4}$ in. wood, each are 11 $\frac{1}{2}$ ins. long. The lower ends are cut square across, while the top ends are cut off to an angle of 45 degrees. Looking at Figs. 2 and 3 we see how the uprights are spaced, and they will be securely nailed to the tray from the underside of it.

Post Position

Note how the uprights at the post end of the tray come hard up against the edging of the tray, while at the other end they come $\frac{1}{2}$ in. or so in from the edging. This is plainly seen in Fig. 1.

Two cross bars of same section wood as the uprights are next nailed near the tops of each pair of uprights

as shown in Fig. 4. They will be 6ins. long. Two triangular gable-boards measure 12ins. along the base and 8 $\frac{1}{2}$ ins. up the slope as seen in Fig. 4. They will be nailed to the uprights. A notch of wood must be cut from the main post to allow the short cross bar, connecting the $\frac{3}{4}$ in. square uprights on the tray, to lie in and be nailed to the main post.

The top end of the main post may now be cut to a point, the gable boards forming a guide for the saw for this purpose. To give support to the tray and its upper structure, three brackets are provided, one large one, and two smaller ones. These spring from the sides of the main post, see Fig. 3.

Bracket Suggestions

Two methods are suggested for these brackets. They may each be built up from three distinct rails or pieces framed and nailed together as shown in Fig. 5 and to the left in Fig. 3. Or they may simply be plain cut-out brackets cut with the fretsaw from, say, $\frac{1}{2}$ in. wood to the outline at A, in Fig. 3.

Reverting to the gable boards it should be noted that the lower edges are shaped to a curve. This can be done with the fretsaw before they are actually nailed in place, or, of course, the edge of the boards may be left square.

End Boards

To the outer faces of each gable-board there will be nailed wide strips forming bargeboards. These are seen in Fig. 6, and also in Fig. 3. Each gable will have two strips measuring 9 $\frac{1}{2}$ ins. long by 1 $\frac{1}{2}$ ins. wide and they will come to a point at the ridge and, therefore, be mitred at 45 degrees. The lower ends of the boards will be shaped as the diagrams indicate.

(Continued foot of opposite page)

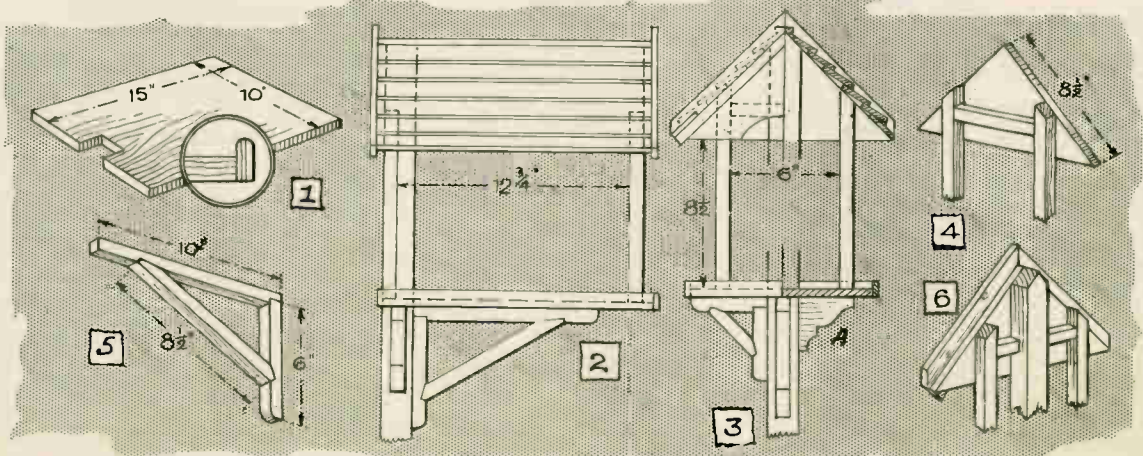

For home or seaside use you should build A CHILD'S CART

THE use of a couple of 10in. diameter rubber-tired steel disc wheels enables the simple toy cart shown herewith to be made. The body of the toy is of a size which will carry a youngster, seated in it, with the legs over the front end. The cart can be used on the streets or on sandy beaches. It also makes a novel truck for carrying goods from the grocer, etc.

The Wheels

Due to the special wheels, the toy is noiseless, and quite strong. Steel disc wheels are normally obtainable from 2ins. up to 10ins. in diameter. The latter have an axle hole about $\frac{1}{2}$ in. or $\frac{3}{4}$ in. By using a wooden axle and two 3in. iron coach screws, $\frac{3}{4}$ in. or $\frac{1}{2}$ in. thick, a simple axle is easily made. Advertisements for all kinds of wheels are shown in our Miscellaneous Announcements.

The writer, seeing a similar type of cart in use recently, and the enjoyment on the faces of the small owners, decided it was a toy which most readers would care to make. The cart, a home-made one, did not have steel disc wheels. Instead, some handy fellow had made use of two pram wheels and the usual axle.

To prevent toppling backwards, if the "horse" accidentally forgot about holding down the shafts, a small metal support is fixed at the back. This saves a "passenger" from getting a hard knock on the head and must on no account be omitted. When made from deal and brightly enamelled, a neat, strong, lasting toy is the result, and many kiddies will be highly pleased with it.

Body Construction

The body is made first. The sides require a piece of deal 24ins. by 12ins. by $\frac{3}{4}$ in. This can be made up to width easily, assuming only very narrow stuff is available. Old boxes can no doubt be utilised. If deep enough, and long enough, a box could be easily shaped with a keyhole saw, then the edges neatly spokeshaved and smoothed with glasspaper.

Some of you will prefer to break up

the box, plane the wood smooth, then shape it for construction on the lines shown. The back, front end, and bottom boards, like the sides, will need to be cut from $\frac{3}{4}$ in. wood, with the latter built up to width. The shaping of the sides is largely a matter of scribing a 12in. radius doing a spot of free hand lining, as in the elevation at Fig. 1, then cutting to shape.

The back piece, front piece and bottom are 14ins. wide, for nailing between the sides. Note that the upper edge of the front view is rounded (see Fig. 2). This is necessary, as the legs of the passenger hang over it. Any sharpness here, of course, would cause abrasion of the skin. In fact, there must never be any sharp edges on toys, no matter what kind of toy is made. Everything must be smooth to the touch, and enamel, if not ordinary paint, ensures further smoothness.

Adding the Axle

When the body is assembled, add the axle. This is a 14in. length of deal post or scantling 2ins. by $1\frac{1}{2}$ ins. It is attached with glue and screws 7ins. inwards from the rear end of the body.

As a 3in. by $\frac{3}{4}$ in. or $\frac{1}{2}$ in. coach screw is used for axles—or rather, axle pins, it will be necessary to bore $\frac{1}{2}$ in. or $\frac{3}{4}$ in. holes in the ends of the axle so the coach screws drive in easily, without splitting the wood. Screws $\frac{3}{4}$ in. thick require $\frac{1}{2}$ in. holes; screws $\frac{1}{2}$ in. thick require $\frac{3}{4}$ in. holes. But, test the screws in a scrap of wood to see the right kind of hole required. The screws must not be a loose screw-in fit; they need to be put in with the aid of a spanner, or wrench.

The Shafts

The shafts are cut from deal board 37ins. by 8ins. by $\frac{3}{4}$ in. Because of the shape, there is considerable waste wood, and by using a longer piece of material, two shafts could be cut from the single board, with a minimum of waste.

When shaped and smoothed with

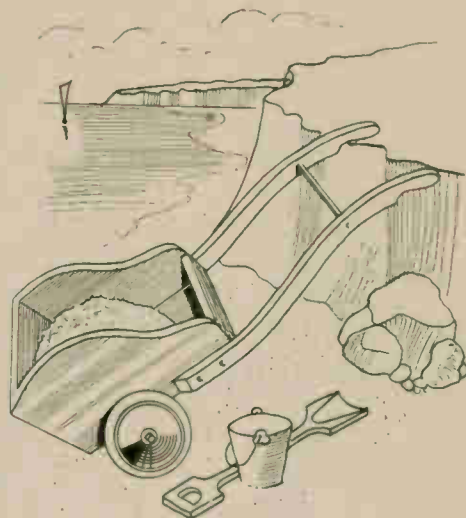

A handy and sturdy toy

spokeshave and glasspaper, and the handle ends rounded over in the usual way, the shafts are affixed with glue and roundhead screws, or alternatively, they could be strongly fitted by means of coach bolts. These differ from coach screws in that they are roundheaded, with a thread for nuts, not wood, like the coach screw. A dowel rail could be fitted between the shafts near the handles, as shown, to keep them more firm in the hands. The rail should be cut from $\frac{1}{2}$ in. or $\frac{3}{4}$ in. birch dowel rod.

Rear Stand Strut

The tiny rear strut is made from lin. wide by $\frac{3}{4}$ in. thick iron or mild steel bar, being screwed in place, central with the rear end of the cart body. When attaching the wheels, a metal washer should be at each side of the hubs to prevent undue friction and wear.

A spot of oil will help to loosen up the wheels if rather stiff, otherwise the axle screws may have to be filed thinner. Allow some little side play, because if the coach screw heads are tightly screwed on the wheel hubs, these, turning around with backward movement, may turn the coach screws tighter, thus jamming the wheels.

For a finish, apply two thin coats of bright coloured enamel paint. The outside could be bright green, and the inside a bright red, with black shafts and axle. The disc wheels, if not finished with blue or red enamel, must be painted to prevent rusting. If disc wheels cannot be obtained, a pair of old pram wheels would serve, if available. Even wooden types of wheels could be used, but these are not recommended.

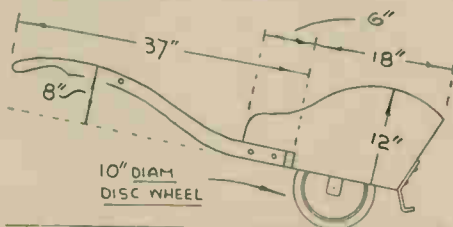

Fig. 1—Side elevation with main sizes

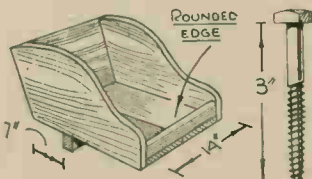

Fig. 2—View of body and wheel screw

A happy idea for weekend rides is a combination of BICYCLE AND BIVOUCAC

WITH the coming of the long warm days of Summer we think of the open-air and all its fun again. Happily, many of us are now able to enjoy long week-ends, and this concession allows us to get away from home on the Saturday morning until Sunday night—quite a nice time for a short bicycle tour.

Have you ever thought of a bivouac? Something quite simple and most economical, and easy to transport. Of course, for this one-night stunt you need to pick a fine, warm week-end. Have everything ready, then listen to the weather reports on the radio, and if the forecast is auspicious, get away as soon as possible, accompanied by a friend, if possible. It is better and more enjoyable to have a pal.

In Summer

Even without any protection from the wind and the dew you can spend a comfortable night—for a summer's dark is of brief duration, only a few hours from the vespers of the song-birds to their early matins—a tent unessential.

On a fine night it is possible to manage with just an eiderdown sleeping-bag, equivalent in warmth to three or four blankets. The next best is a good quality fine down bag. Though the cost may be somewhat stiff, it is worth it, both for the warmth and comfort and the convenience of packing, for a sleeping-bag can be folded up into quite a small compass.

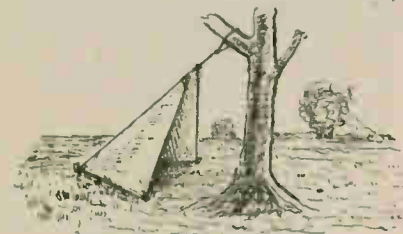

Fig. 2 A Simple shelter

However, if your purse-strings cannot be stretched so far, two good ex-army blankets can be substituted. Stretch the blankets on the ground, fold one in half, and turn the edge over about 2 inches and fix with a couple of blanket pins, obtainable at the camp outfitters. Now turn the blanket already arranged so that the pinned edge rests in the middle of the other blanket.

The outer blanket now folds over the inner one and is pinned in the same way. All that is now necessary is for the end to be turned up about 3 inches, and pinned with three more blanket pins. You have now a sort of blanket-bag and once snuggled in

it, cold draughts will never find their way in to disturb you.

When sleeping out on warm nights, you can make do with a bed of bracken, heather, or dry grasses, under your sleeping-bag. It is, however, advisable, for your health's sake, to have a rubber groundsheet to lay over the bracken, etc.

Another idea is to try and procure from a farmer a bundle of clean straw or hay, and spread it evenly between groundsheet and sleeping-bag or blankets. Always remember that you require the warmth underneath too.

Most cycle-campers of experience



Fig. 1—Arranging a sheet over a line to make a comforting cover

are hardy folk, innured to a spot of weather. All they ask is a bit of good turf beneath the groundsheet, having made a sort of hollow where the hip will fit when lying down. The difference this simple device makes will probably surprise you.

Beginners, however, may not feel quite so happy about trusting themselves merely to a couch of bracken and a sleeping-bag. Well, all that is needed can be got inexpensively. For all you want is a sheet of waterproofed canvas, some rope, a few tent pegs, and a shelter can be rigged up on two sticks or poles readily "scrounged" from a copse or wood. Or you can take them along with you, to be sure of them. A sheet of material about 7 feet or 8 feet square or thereabouts will serve nicely.

For holding down

To make a shelter bind the edges of the sheet of canvas with tape lin. wide and sew loops of same material at the corners and in the middle of each side. A few yards of strong cord and six pegs for pegging down the canvas, and there you are—a shelter that will keep off the night dews and moisture.

Fix up the two poles at a convenient distance apart, stretch a length of cord between them, and also have a guy rope pegged down at each end to hold the pole securely if a wind should rise in the night.

Throw the canvas over the line, stretch out so it is quite even and without any rucks, and then peg it down to the turf by the loops at the ends

and in the centre of the sheet. This gives you a sort of open-ended tent of the A pattern (see Fig. 1).

Tree Supports

Or you can erect such a shelter between two convenient trees if they are available. Tie one end of the rope to a suitable tree about 8 feet up or as high as you can reach, and peg out the sheet as directed. Or it can be fixed to a single tree and pegged as shown in Fig. 2, which will form a good wind and weather screen.

Note the direction of the wind when erecting your bivouac. We do

not recommend bivouacing under trees in windy weather. Indeed, we prefer the open, every time, but with a convenient fringe of trees or a tall hedgerow as a wind-break.

Pegs

Metal skewers make good tent pegs, but wooden pegs are better. It is not really necessary to carry these with you, for it is always possible to make do with suitable pieces of stick found under the hedgerows, and without breaking them from growing trees or shrubs! Never do any damage to other folks' property when camping!

Your other requirements may be equally simple and easy to transport. A small spirit stove and Meta fuel, a handy compact set of cooking utensils, and a tin opener—you'll have to rely chiefly on tinned stuff on a bivouac ride.

For a brief week-end, with one night only, or at the most, two nights, it is better to manage without having a lot of cookery to do, therefore cater for your wants accordingly. Most of your meals can be obtained outside of your bivouac—at wayside cafés, etc.

Your equipment for a bicycle bivouac is really very little and can be easily carried in an old army pack or a valise secured to the rear carrier of your machine. The idea is good, but it is essential to choose a fine, warm week-end.

In uncertain weather and showery conditions a small tent is safer. But, if you would enjoy the delights of the open-air and the fun of sleeping out then try the simple bivouac.

Our second article on the work deals with making SQUARE NETTING

READERS who have read the first article on "How to net" will remember that it deals with diamond netting, the usual kind employed for gardens and fishing nets, also hammocks. Sometimes square netting is used, for example, in tennis nets, also for that large mesh netting which has sprung into popularity recently for beans and peas to climb up in the garden. This article therefore, is devoted to explaining how this square netting is produced.

The Tools

Those readers who may not have read the previous article on the subject must know that two appliances, or tools, are required for the netting craft. They are a mesh stick and a shuttle, or needle, as it is some-



Fig. 1—The two tools

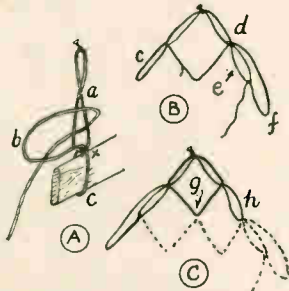

Fig. 2—Making the netting knot

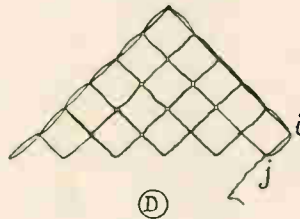

Fig. 3—How the loops are fitted to form the size required

should be nicely rounded on their edges, and be glasspapered to smoothness. Wind some twine on the shuttle and be ready to try the square netting craft.

Proceed in this way, studying the illustrations step by step. With a little practice no difficulty should be experienced, as the work is really quite simple.

Wind the twine twice round the mesh stick, and knot, remove from stick and suspend from a nail, or hook, driven in anywhere convenient. The gadget, illustrated in the previous article will be handy here.

Now place the stick under loop *a*, wind the twine round the stick and bring it through loop *a*, then at point *x* press down with the thumb to keep the twine from slipping. Draw it tight, throw the twine to the left to

number of meshes allowed to each row the same. This will be regulated by adding the extra loops at one side only, not both, as done previously. Work it this way, as in Fig. 3, D.

The Additional Loop

When the line of meshes finishes at point *i*, bring the twine to *j*, and then knot it. Now reverse the netting and carry on, but remember always to add the extra loop on the same side, whether it is right or left of the body. You can always tell, if the side to be thus looped is clearly marked with a scrap of coloured cloth, or thread, tied on.

Now continue the work until the netting is the required length. For convenience in working, the finished netting should, at intervals, be shifted higher so that the hook comes low

times called. Both are sketched in Fig. 1.

The mesh stick is a 5in. long piece of wood, $\frac{1}{4}$ in. thick, and as wide as the mesh required, less the thickness of wood. For instance, for a 1in. square or diamond mesh it should be $\frac{3}{4}$ in. wide. Now a tennis net has a mesh of 1 $\frac{1}{2}$ ins., so a mesh to suit would be 1 $\frac{1}{2}$ ins. wide.

The shuttle is 8ins. long and $\frac{3}{4}$ in. wide, and is cut to the shape shown from 3/16in. boxwood, or beech. Both

form a loop *b*, then pass it behind loop *a* and through *b*, and tighten with a jerk.

This is the netting knot. These motions are clearly shown at A, Fig. 2. Practice this knot a few times and you will soon get the knack of it.

This will leave an extra loop *c*. Leave this extra loop, and knot to *d*, then make extra loop *e*, and placing the stick under *e* make the long loop *f*. Slip the netting from the hook and turn over, then replace so that loop *f*, etc. is now on the left, as at C.

Now knot *g* and *h*, make the extra loop, then the long loop, as before, reverse the netting and continue. The netting is reversed after each line so that the work can be carried out from left to right all the time.

In Diagonal Rows

Though it may read a trifle complicated, it will really be simple to perform, but you must remember to finish each line with a single small loop and then a large one, as described. It will be seen, of course, that this square netting is worked in diagonal rows, instead of horizontal ones.

When the width of the netting is as wide as the work requires, it must be kept to that width by keeping the

enough above the work.

When enough practice has enabled the netter to make his knots quickly, it will not be necessary to withdraw the mesh stick from the loops each time, he can let them slide off as they accumulate, as they need not interfere with the knotting of the rest at all.

Completion

To complete the work, when the netting is long enough cease making the extra loops, they will not be required any longer. Instead, carry on as at E, Fig. 3, the dotted mesh lines being shortened by 2 at each row, until the corner is reached.

Readers who have made and used the holding gadget, sketched in the previous netting article, will find it useful now, as the rod can be threaded through the meshes, and will support the work equally as well as the diamond pattern of netting.

When experience has been gained, netting can be carried out, if desired, without any support at all. All that is really necessary is a cord, threaded through the top row of meshes, drawn over the knees and kept tight under the feet. The work can then be done on the lap.

A Loss to Hobbies

READERS will remember in a recent issue, a picture showing a Jubilee presentation being made to Mr. Chas. R. Bloxam on completion of 50 years service with Hobbies Ltd., and to mark the appreciation of the directors on his retirement. We now regretfully record his death at his home in Sidcup, Kent, after a troublesome illness. The number present at the funeral indicated the esteem in which he was held, and included representatives of the firm he had served so loyally.

How the interested amateur radio enthusiast can get MORE SELECTIVITY

SIMPLE receivers are often unselective and the local transmitter may spread unduly over the tuning dial. Distant stations on nearby wavelengths cannot then be received without interference. To cure this trouble methods of sharpening tuning are described here. The circuits may be applied to crystal or valve receivers.

Aerial Tappings

The easiest way to increase selectivity is to tap the aerial down the coil as provided by the connections 2 and 3 in Fig. 1. The nearer the tapping is to the earthed end of the coil the sharper will tuning

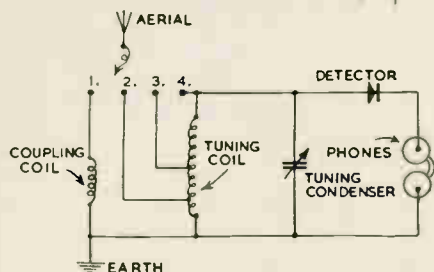

Fig. 1—How aerial tappings are added

be. Terminal 3 will give greater volume than terminal 2.

The tappings may be from about $\frac{1}{2}$ to $\frac{1}{4}$ from the bottom. With a valve receiver they may be as low as 1/10th the total number of turns from the bottom, with a consequent increase in selectivity.

Fig. 1 also shows a coupling winding, connected to terminal 1. This coil should have about $\frac{1}{4}$ the turns of the tuning coil and be about $\frac{1}{2}$ in. from it. If it is moved away from the tuning coil, selectivity will be increased. Frequently receivers have two or more aerial sockets so that the best for particular conditions can be selected.

Dual-Wave Use

Joining a condenser in the aerial lead increases selectivity. The higher the wavelength the greater the effect of the condenser. Therefore, by using a condenser and tapping, as in Fig. 2, the desired sharpness of tuning can be obtained on both long and medium waves.

The position of the tapping will mainly influence selectivity on medium waves; the capacity of the condenser the selectivity on long waves. For the condenser a value of about .0001 mfd. is most suitable for a valve set.

A pre-set condenser is even better, because it can be adjusted to the best value. As the capacity is reduced

volume will fall to some extent. This loss of volume as selectivity is increased is particularly noticeable with crystal sets but usually a useful balance between selectivity and volume can be found.

Wavetraps

When a coil with condenser in parallel is tuned to a station it refuses to pass that signal, which consequently passes through the detector and is heard. By using an additional coil and condenser connected in the aerial lead, as in A, Fig. 3, a wavetraps is made.

When this is tuned to a station, that station is prevented from

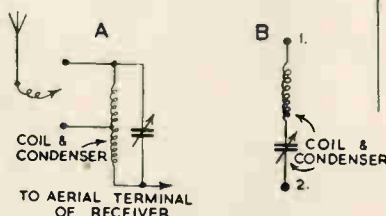

Fig. 3—How wave-traps are connected

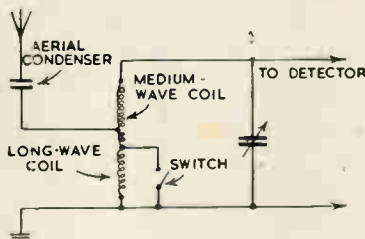

Fig. 2—For long and medium waves

reaching the receiver. It is accordingly adjusted to trap the unwanted local station when listening to distant stations.

With crystal sets this gives a very slight increase in volume as the aerial is tuned to resonance. For best results with valve sets the lead from the trap to the receiver should be short. A small screened coil tuned by a pre-set condenser is often used in this way, fixed inside the receiver. The coil may have tappings to adjust results, or a switch in parallel to cut it out if necessary.

At B, coil and condenser are in series and this passes the station to which it is tuned, the reverse of the trap mentioned. Accordingly terminal 1 may be connected to the aerial and terminal 2 to earth so that an unwanted station is by-passed. It may also be joined in series with the aerial (as with circuit A) to help keep

unwanted stations from the receiver.

Double-Tuning Circuit

This is frequently used in valve sets. It is shown in Fig. 4. Two similar coils are tuned by means of two similar condensers (usually forming a double or ganged condenser). This gives a most noticeable increase in sharpness of tuning and is more or less automatic for all wavelengths.

The signal is passed from one circuit to the other by the condenser "C", which is usually of very small capacity and can be best made by twisting together two insulated wires for about 1 to 2 in. The smaller this condenser, the sharper will tuning become. With a valve set good volume can be maintained.

Aerials

A very long aerial reduces selectivity. Usually a wire of about 30 to 40 feet is ample, even with a crystal set. A short efficient aerial (well insulated and away from buildings) is better than a long one which runs near walls, etc.

Joining a condenser in series with the aerial lead-in gives much the same effect as reducing the length of the aerial. With a valve set insulated wires twisted together for a few inches

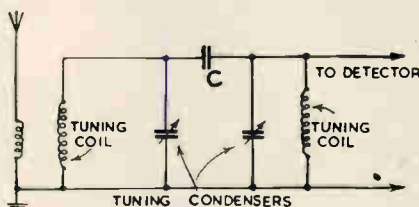

Fig. 4—The band-pass circuit

may be used.

An aerial receives stations more strongly from the direction in which it points. However, except in very troublesome circumstances, this can be overlooked as frequently the direction of the aerial is decided by convenience of erecting.

Other Circuits

All tuning condensers and coils are of the usual type. The crystal or valve detector, etc., are not indicated in Figs. 2, 3 and 4 because these are connected in the usual way. (The circuit in Fig. 1 is a full one for a crystal set).

Similarly the circuits are suitable for both long and medium waves, though a two-range coil is shown in Fig. 2 only. The circuits may be combined as convenient. E.g.—A wavetraps could be added to the set shown in Fig. 1 if necessary.

The handyman should know the answer when THESE THINGS HAPPEN

CURIOUS, inexplicable experiences often befall readers sometimes, we know, and being rather inquisitive, there comes the inevitable—why. We all like to get to the bottom of things, whatever such can be, and try to understand them. Generally, there is always an explanation. Here, then, is a selection of unusual experiences which will interest other readers:

"I futed an electric light extension in a wooden shed I made. Often, as I switch on the light, I become aware of a strange tingling in my arm. The switch is a new bakelite type, usually shock-proof. Am I, in some way, receiving a mild sort of electric shock? If so, can you explain why it only happens on occasions?"

Your shed, consisting mainly of woodwork, with a felted roof, we imagine, suffers from condensation, and the interior is, therefore, sometimes damp. Electricity can be conducted by extreme dampness. In fact, if the shock-proof switch is attached near a cracked window ledge, or against a post, leading to the roof where there is a slight leak, wet weather is the explanation for the mild shocks received. Change the switch to a new dry position. If a greenish encrustation has formed upon the switch terminals, this proves the theory regarding dampness.

"I recently bought a new screwdriver and used it when building a small radio set. I find that, since then, the tip of the screwdriver blade has become slightly magnetised. While appreciating this useful feature in regard to small iron screws, I am very curious to know what could have happened."

Obviously, while attending to some part of the circuit, you inadvertently touched the magnet of the speaker with the screwdriver blade. If you draw the blade several times over the magnet, it will magnetise it further. Do not, however, attempt to magnetise everything in this manner. By doing so, you draw some of the magnetism from the speaker each time and thus weaken its attracting powers.

"During my absence from home one day, my little girl turned the turntable of a gramophone in an anti-clockwise direction, and I now find the motor will not wind up. I thought that the spring was broken; next day, before taking the gramophone to a repairer, I tried winding the spring again, and it wound up! Will it, I wonder, continue to wind?"

Under the circumstances, we think so. The child, turning the table in the anti-clockwise direction, was actually winding up the spring. As the spring

is clipped to metal "spuds" on the winding spindle and the interior of the drum case, it is quite likely that the spring became unattached from the drum case spud. By winding the spring in the proper way with the handle, the slot became attached to the spud again and should give no further trouble. Next, please!

"A friend lent us a portable A.C./D.C. receiver, and as we have a D.C. mains supply, we thought we could use the receiver. To our disappointment and disgust, however, the set refused to

function. Personally, I think something has happened to the receiver, but cannot understand what."

Believe it or not, such receivers are often disposed of under the impression that something is amiss. Being a D.C./A.C. set, there is usually only one explanation for the set not to operate, providing nothing is wrong with the circuit or valves. It is imperative that the mains plug is inserted in its sockets the correct way. If you reverse the plug, the set should function.

Emergency Bulb Holders

IF finding yourself without commercially-made holders for the small 2.5 or 3.5 (dry battery) bulbs, there is no reason why any project you have on hand should be abandoned, as substitutes can be readily made as described below. The writer has at times coupled no less than one dozen together by their aid with every success. For model theatre work, window-dressing and decorations the smallness of the holders seem to offer certain very distinct advantages.

To make the substitutes, sections of card were first cut about 1 in. square as (a), (b), and (c). Fairly thick card was used for the (a) pieces, (about 3/16 in.), (b) however were thinner, while the (c) pieces were of quite thin material.

In the (a) pieces circular holes were taken out by burning with a red-hot round poker. These holes were made of such a size that bulbs could be screwed into them, the bulb thread forming its own channel in the material.

Burning the Holes

Burning the holes out was the method employed and a good number of holders could then be made quickly. Care was taken, however, to stop the burning just before the diameter of the bulb thread was reached. Then with a slight reamering action with the blade of a pair of scissors (closed) the charred inner edge of the hole was removed, giving the bulb when inserted and twisted, sound card to bite upon.

With a careful approach the writer found that a very firm fit could be secured. The pieces (b) also had a circular hole taken from the centre, but here this was not close fitting and the opening was left smaller than in (a). The pieces (c) were just solid squares of quite thin card.

Pieces of insulating tape (A) with a diagonal hole taken out of the centre were now prepared—one for each holder.

The "stringing together" was upon a length of radar aluminium foil (B) which can be bought in rolls, and a length of ordinary small-gauged wire (E) bared at intervals (in the writer's case) of about 1 foot.

Assembly

Assemblage of a holder is clearly shown in the sketches. The bulb is fed through the hole in the tape and screwed into (a). The piece (b) is then brought up underneath, then comes the radar foil and then the piece (c). Holding all tightly, the ends of the insulating tape are now brought down and under the "sandwich" and pressed into good contact, this having the effect of clamping everything solidly together.

The radar foil formed the one lead, but the second is supplied by the wire (E) bared at each lamp and twisted round the stem as (F).

Holders thus made are remarkably solid and positive in action, and if reasonably treated will take quite a lot of handling without damage.

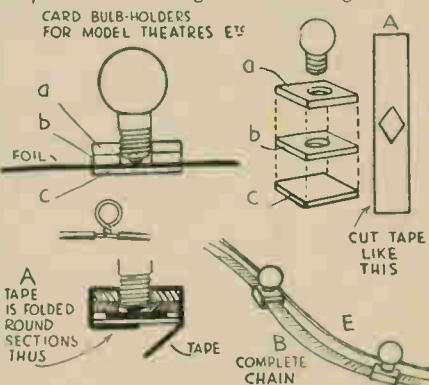

To have a game to amuse yourself you should make A SOLITAIRE BOARD

ONE of the most interesting games for a person to play by themselves is "Solitaire"—in fact, it can hold the attention for literally hours on end.

The game is played on a round or eight-sided board upon which there are depressions which hold ordinary marbles. There are thirty-three depressions but only thirty-two marbles, as the middle depression is left vacant.

How to Play

You play the game by "jumping" a marble over the next one to it in a square direction, not diagonally, and taking away the marble jumped over, just like one takes a man in draughts. Continue to move like this. The object is to leave one marble and one only—and this, if possible, in the centre hole. It may sound easy, but when you have got your board made—well, just have a try and you will find it harder than it seems, but great fun in attempting to work out a solution.

To make the board, first mark out a circle of 4in. radius on some fairly short-grained wood $\frac{1}{2}$ in. thick, and on this scribe radii at 45 degree intervals as shown in the illustration. Join the places where they meet the circle and you will get the eight-sided figure seen in the large drawing. Before cutting out, however, the marble depressions must be marked.

Ball Positions

The positions for these are found by drawing lines in both directions lin. to either side of the middle lines and then dividing the extensions as (b) into the same divisions. Scribing lines across these extensions give at once the positions of the six outside centres in each case. The middle nine centres are at once given by the intersection of the lines already drawn.

For absolute accuracy a little adjusting here and there may be required, but it is quite worth while going to some trouble to get the depressions evenly set out.

If you have a hemispherical bit, and brace to use it in, the holes may now be taken out to a depth which will just comfortably hold a marble

without any chance of it rolling away too easily if the board is tilted. The cross-section (A) shows such a hole.

Should you not have this sort of bit, then it is best to drill the holes right through the wood as shown in (B), taking great care to avoid splitting.

In either case, now shape the board by carefully cutting away the eight sides, and then from a piece of fairly thin plywood, cut the base (B) which is $\frac{1}{2}$ in. larger all round than the main piece. This is to allow making the small channel (E) outside the board into which the marbles can be dropped as they are "Taken".

First cut the triangular piece in one strip and then divide up into suitable lengths, bevelling each end to roughly a quarter of a right angle.

The board is now complete, apart from staining and polishing, or if you wish it, staining alone.

The Marbles

To look really well the marbles should all be of one type. If the stone variety is used they should be of one colour also. A red marble in this case looks very well, and sets of them can be bought. Curiously, the multi-coloured glass ones are not so effective.

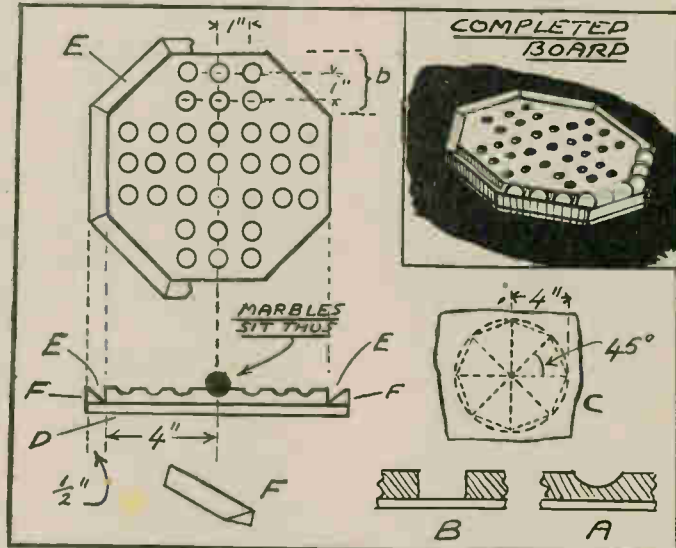

This refinement is very important for the comfortable playing of "Solitaire", as the taken marbles cannot be comfortably held in the hand, and placed on a nearby table, or even on the knee. They seem to be for ever rolling about and getting lost. With the channel they are all to hand and ready to be snapped back on the board "for another try".

The Channels

The channel is made by cutting eight triangular strips as (F) and bevelling their ends, fastening them by sprigs from the under side (and glue) to the extending base as shown.

To complete everything a small bag with a pull-to neck should be made for storage purposes. A piece of chamois leather is ideal for the purpose.

If you eventually find the solution and discover that you cannot help remembering it, thus spoiling future games, variety can be introduced by trying to leave the single marble at different predetermined holes about the board. Also by starting the game with the vacant hole in different positions. Incidentally, the official game is started with the centre hole vacant.

Stamp Collecting—(Continued from page 102)

coach drawn by six horses—presumably to indicate the means of transport 100 years ago.

It seems to the writer that too much has been attempted in one stamp—surely it would have been better either to contrast the means of transport then and now or else to have given a pretty picture of Cromwell.

But by trying to do both, neither has been done well. The stamp is illustrated here, so readers may judge for themselves.

The other two values are of buildings. The 3d. shows the first church at Dunedin, the capital of Otago, and the 6d. a view of the University of Otago.

Our thanks are due to Mr. Donaldson for the opportunity of showing these stamps. This is not the first time he has been so kind, and we know other readers will appreciate his helpfulness. We are always particularly pleased at the friendly spirit of readers who do this sort of thing for the sake of others.



Stamps of Mauritius

THE topic of this article is closely connected with two which have been discussed quite lately in these columns, namely "Stamps on Stamps" and the "Value of Stamps". In the article about the value of stamps we started by saying that many readers could not hope to possess such stamps as the "Post Office" Mauritius.

This week we have to contradict that statement, because now you can have a copy quite cheaply, but it will have to be on another stamp! This year marks the centenary of the issue of the famous Post Office Mauritius stamps, for it was on September 21st, 1847, that they appeared. Which means that Mauritius was the first British Colony to issue stamps, following the lead of the Motherland.

An Interesting Story

The story of these famous stamps is full of interest. It starts, in fact, with the order for their preparation. There was no one on the island really qualified to engrave stamps, so the order was given to a watchmaker, J. Barnard.

He had first of all to prepare an estimate for these and the estimate had to include everything necessary—designing, engraving, printing and even supplying the post-marking hand stamps with which to cancel the stamps when they were issued. Many years afterwards the estimate was discovered and is now in the British Museum.

Well, Barnard set about his task and made two engravings on a piece of copper. There seems to have been some doubt as to the instructions concerning the lettering that was to go on the stamps—Mauritius—Postage—and the Value went on alright. It is probable that he was to have had "Post Paid" as well, but he put "Post Office" on and that is the reason for their being called by that name.

Very Few Left

The next issue had this changed to Post Paid. As the wife of the Governor of the Colony was to give a Fancy Dress Ball and wanted to send the invitations out bearing the new stamps, Barnard was told to hurry on with the job. The postage rate was fixed at two pence for country letters and one penny for local town delivery;

the first named was printed in blue and the lower value in red.

The order was for 500 of each value but now only fourteen of the penny and twelve of the twopenny are known. And one of the fourteen was discovered only a few months ago!

Early Collectors

As soon as the stamps were put on sale they were popular and were soon sold out, many being used by Lady Gomm on her invitations. Of course, in those days, stamp collecting was not the hobby that it is now. In fact, there cannot have been very many who had so much as seen a stamp at all, and it was some years before people began to collect.

But when they did, just as today there is plenty of searching among correspondence, so there was then. As a result of this searching a few of these Mauritius stamps came to light. The wife of a Bordeaux merchant found about a dozen of these stamps and she sold them quite cheaply, either to a collector friend or else to a dealer. Now the history of each of the specimens known has been written, but it would be too irksome to repeat them all here; we will just mention one or two of the facts.

About 1870 the price they seemed to fetch was about four pounds, but

or less amused way, and among the common stamps the friend saw a "Post Office" Mauritius and advised that it should be shown to an expert.

This was done and it was pronounced genuine and was put up for sale and fetched nearly £1,500. That was for a stamp which the owner was about to give away.

Well, although 1,000 of these stamps were printed just 100 years ago, only twenty-six are now known. It is possible there may be some more about and the finder will be a fortunate person. For those who are not fortunate enough to find a true specimen, Mauritius has provided four.

The centenary of the stamp is commemorated by the issue of four values, each of the same design that we illustrate here, the values of the four being 5c, 12c, 20c and 1 rupee. The 5c and 12c show the 1d. and the 20c and 1 rupee the twopenny.

Reader's Notes of New Zealand

M R. Gordon Donaldson of Wellington, New Zealand, very kindly sends us a set of the



The centenary issue of the famous "Post Office" Stamp

The two immigrant ships on the Otago Centenary Stamp

A pretty view with old-time stage coach

now the price is about £2,000. One cannot give a definite figure, but just before the war one was sold for £1,350 and another for £2,500.

A Lucky Find

There is one romantic story about these stamps, which is worth repeating. A certain gentleman who had collected stamps as a boy was going through some of his papers many years afterwards and he came across the exercise book he had used as an album and in which he had stuck some stamps.

He was going to give it to a young relation, but that evening a friend came in who was interested in stamps. He showed him the book in a more

four stamps which have just been issued in connection with the Centenary of the Otago Province of South Island. The four values are 1d., 2d., 3d. and 6d. The first is illustrated here and shows the two immigrant ships "The John Wickliffe" and the "Philip Laing" at Port Chalmers in 1848.

From Otago

On the twopenny value the lower part of the stamp shows a view of Cromwell, Otago, which is situated at the confluence of the rivers Clutha and Kawarau. Then above this, as it were on the horizon, there is a rather indistinct picture of an old-time stage

(Continued foot of page 101)

MISCELLANEOUS ADVERTISEMENTS, etc.

The advertisements are inserted at the rate of 3d. per word or group of letters prepaid. Postal Order and Stamps must accompany the order, and the advertisements will be inserted in the earliest issue. Firework goods or those shown in Hobbies Handbook not accepted. Orders can be sent to Hobbies Weekly, Advertisement Dept., as below.

PERSPEKIT! The really profitable pastime. Outfit includes tools, lessons, plans, polishes, transfers, adhesive, clear and coloured Perspek for making the articles. Make your own gifts. Stamped addressed envelope brings full particulars.—White, 2 Alexander St., Coatbridge.

PERSONS required immediately to make leather shopping bags in spare time. Write Dept. 11, Empire Co., 117 Nottingham Road, Loughborough.

EX. R.A.F. headphones 5/6 pr. Hand-driven generators 100v. A.C. 7/6. Throat Microphones 6/- pr. Postage paid.—Barker, 14 Mardale Av., Manchester 20.

POST free. fascinating steel tracing machine for copying and enlarging magazine drawings, maps, etc. Price 5/-.—Clayton, 16 Westminster Road, Bradford, Yorks.

LOOK! 100 different British Colonial stamps 1/3. Bargain lots 5/-, 10/- and £1. Packets and sets for Beginners and Junior collectors. Approvals on request. Write now to—W. E. G. Smith, "Clarendon", Brettell Lane, Stourbridge.

LONELY? Join Friendship Circle. Details 6d.—Secretary, 34 Honeywell Road, London S.W.11.

CHARGING Sets. Petrol, new condition 288 watts. J.A.P. air cooled engine Mod-1 2A. governed, complete with switchboard. £14 10/0, carr. paid.—Parker, St. Peter's Power House, Jersey, C.I.

STAMPS FREE!! Twenty unused (2½d.).—G. H. Barnett, Limington, Somerset.

OBTAIN a good album, 8½×9½ holding over 2,000 stamps, by sending for some fine approvals. Send 1/9.—J. D. Shiner, 25 Myrtle St., Bristol 3.

WANTED Hobbies Designs Nos. 192, 189, 195 Special. Also 2066, 2204, good price given.—Tozer, 4 Thornton Road, Cambridge.

START making Dioramas, new, fascinating, profitable. S.A.E. particulars.—BCM/Easiplan, London, W.C.1.

WANTED unusual or patented design toothbrushes of years ago. Folding, double-end, silver handles, etc. 7/- offered for each specimen.—Dr. Francis Blauston, 33 West 42 Street, New York 18, N.Y., U.S.A.

URGENTLY required, spare-time workers to make leather goods. Apply—Dept. Y 3., Somat Plastic Co., 8 Middlemarsh, Nottingham.

HAPPY Circle Pen Pals Bulletin, 1/3. Contacts everywhere—176a, Shoreham Road, Hove.

BE TALLER. Quickly! Safely! Privately! No appliances—no tablets—no dieting. Details 6d. stamp.—Malcolm Ross, Height Specialist, BCM/HYTE, London, W.C.1.

LONELY? Then write Secretary U.C.C., 5B. B. Hay St., Braughing, Herts. Genuine. Est. 1905.

MODELS: you can make lasting stone-hard models with Sankey's Pyruma Plastic Cement. Supplied in tins by Ironmongers, Hardwaremen and Builders' Merchants. Ask for instruction leaflet.

TRANSFERS for decorating toys, trays, furniture, fancy goods. Selection 10/-, 20/-. Flowers, pixies, dogs, nursery rhymes. H. Axon Harrison, Jersey.

PERSONS required make fancy goods at home. Write for details—Melton Manufacturing Co., (Area 544) Southgate Street, Leicester.

PROFITABLE spare time ideas, money-making offers etc., free with 28 page "Opportunity" Magazine 9d. post free.—Hazlehurst, 25 Melrose Avenue, Hoylake, Wirral.

WANTED—Magnets, Gems, Boys' Friends, etc., or any old Boy's books.—H. A. Smith, 13 New Road, Scole, Diss, Norfolk.

HENLEY'S Book of Formulas. 10,000 formulas, processes, trade secrets and new ideas. 900 pages, new cheap edition 16/2 post free.—Herga Ltd., 251 Waverley House, Havelock Road, Hastings.

GOOD Printing, moderate cost, prompt attention. Note-paper headings (four line address) on good quality Bond or Bank paper (according to availability) 4/6d. per 100. Send stamp for catalogue—The Zodiac Company, BCM/Crucis, London, W.C.1

BOYS. Learn magic. The boy who does tricks is always popular. Send stamp for illustrated catalogue of tricks specially arranged so that you can do them.—The Boys Magic Service, Prestatyn, North Wales.

DOLL'S House fittings and papers, send S.A.E. for list. Doll's House plan special send 2/6. Trade supplied.—Zimplan, 88 Ware Road, Hoddesdon

SPOKE Wheels, treaded tyres, 8ins., 9ins. and 12ins., overall diameter. Also rubber tyred metal disc wheels ranging from 2ins. to 9ins. Small or large quantities supplied. Write requirements.—Joyden Toy Co., 193 Chase Side, London, N.14.

DOLL'S House papers, model supplies, kits, plans, engines and motors. Full lists 1/-.—Sutton, Hill House Drive, Billericay.

TOYMAKERS super casting moulds for lead toys and plastercraft, as used by all high class toy-makers in England and abroad. Over 600 latest designs. Fully illustrated catalogue 2/- P.O.—Agasee, 7 Stradbroke Road, Highbury, N.5.

PRESSED Metal Wheels (balloon tyre design) per dozen £in.—10d. 1in. 1/-. 1½ins.—1/3. 2ins.—1/6. Per gross £in.—6/-. 1in.—7/-. 1½ins.—8/-. 2ins.—10/-. Illustrated catalogue 3d.—Jason, 135 Nags Head Road, Ponders End, Middlesex.

WHEELS for Toys in metal, wood and plastic. Numerous sizes and types. Write for list, stating requirements to The Joyden Toy Co., 193 Chase Side, London, N.14.

"POWER Tools You Can Make". Famous "Popular Mechanics", plans and constructional details for building drilling machine, jig-saw, band saw, lathe, etc., all from readily available materials. 12 6d. only, post 7d. Illustrated lists 3000 American Homecraft books, plans, magazines 6d.—BCM PUBLICATIONS (H) London, W.C.1.

NOVELTY packet of unusual stamps free to approval applicants sending 3d. postage.—M. Edwards (N.3.) Westcroft, Northchurch Common, Berkhamsted, Herts.

THE interest in car numbers never ceases. "Where's That Car From?" containing all the car index marks alphabetically arranged. 54 pages 6d. Now in its sixth edition. From all newsagents.—Raleigh Press, Exmouth

W. McGARRIGLE for aeroplane and ship kits, all accessories. Stamps lists 3d. wholesale lists 4d.—64 Hillcrest Road, Romford.

SPECIAL Offer. Attractive Stamp Album, 50 stamps, packet of mounts. Post free 3/-. Gamut (Dept. C.) Supplies Co., 24 Gunnersbury Avenue, London, W.5.

TOY casting moulds, farm animals, soldiers, wall plaques, ornaments, dogs, etc. The largest selection of metal and plaster moulds available. 6d. illustrated catalogue, S.A.E. for list.—Nuthall, 69 St. Marks Road, Hanwell, W.7.

FREE! Extra special Br. Col. packet scarce Jubilee, Coronation, Victory, Zoological new issue stamps. Request approvals (2½d.).—Thompson, 2 Western Gardens, London, W.5.

Modelcraft's plans for **PERIOD FURNITURE**

This new series of plans for model furniture is to the scale of $\frac{1}{2}$ in. to 1 ft. and the drawings are isometric so that not only is a good picture given of each piece, but working measurements can be pricked off. The sheet size is 20 in. by 30 in., and the 'periods' will be chosen to fit in with those for which we have model house plans. First two are 'ELIZABETHAN', 'QUEEN ANNE'

2/6
POST 2d.

Modelcraft's Galleon **"SANTA MARIA" WOOD PARCEL**

To overcome the difficulty which so many modelers are experiencing nowadays of securing suitable 'clear', knot-free timber, we have made a parcel of 26 wood parts and also sail parchment for the large scale 'Santa Maria' model, plans of which have recently been revised and now cost 9/6 post 2d.

21/-
This parcel costs POST 1/-

JUST OUT! June issue (No. 6) of
MODEL-CRAFT MAGAZINE AND LIST
Nearly 500 plans etc. listed. Articles and hints by experts in every branch of the craft. 1/- post free. 4/6 for four issues

MODEL-CRAFT LTD.
77(F) Grosvenor Road, London, S.W.1

Pad hacksaw — the saw that has no limits



The Padhacksaw does the work of hacksaw, padsaw, keyhole saw, corrugated iron saw, shears, snips, chisels, pipecutters, etc. There is no frame to pass over or through the work, it makes cuts of unlimited length, and can be used in the most awkward places. A variety of blades for all classes of work can be quickly fitted.

Retail price

15/6

**The
Padhacksaw**

From sole distributors:

HALE, HAMILTON & CO., LTD.
107 OLD BROAD STREET, LONDON, E.C.2

Printed by BALDING & MANSELL, LTD., London and Wisbech, and Published for the Proprietors, HOBBIES LTD., by HORACE MARSHALL & SON, LTD., Temple House, Tallis Street, E.C.4. Sole Agents for Australia and New Zealand: Gordon & Gotch (A'sia) Ltd. For South Africa: Central News Agency Ltd. Registered for transmission by Canadian Magazine Post.

CUT YOUR OWN HAIR

TRIMS AS IT COMBS
with PENN'S
'EASY TRIM'.
For lady, gent
or child.



2/9 Post 3d.
with three spare blades.

This superior, unbreakable SELF-TRIMMING COMB with blade ready for use keeps your hair always neatly trimmed. Send NOW 3/- P.O. or stamps to:
Wm. PENN LTD. (Dept. THB),
585 High Road, Finchley, LONDON, N.12

PENN'S RUG MAKER

Recommended in 'Hobbies Weekly' 30-7-47

Makes full-size Rug on ANY machine in a few hours. Enables wool to be stitched on canvas without waste.



2/9
Post 3d.

Uses Coupon Free rug wool. No adjustment to machine. Profitable hobby. With simple directions. Send 3/- P.O., cheque or stamps. Direct only from:
Wm. PENN LTD. (Dept. HBR),
585 High Road, LONDON, N.12

BOYS! **ELECTRIC-MOTOR OUTFIT**

3/6

Post Free

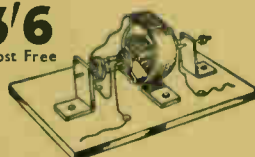

**WORKS FROM ORDINARY
TORCH BATTERY**
**6,000 REVS. PER
MINUTE**
EASILY ASSEMBLED

This outfit comprises ALL necessary parts and base ready for simple assembly by any boy to make this working Electric Motor exactly as illustrated. Apart from its novelty, this has very considerable technical and constructive value. More can be learnt from it regarding Electric Motors than by reading volumes. A most instructive and entertaining toy for boys. Complete with diagrams and very easy instructions. Send P.O. 3/6. Direct only from:—

Wm. PENN LTD. (Dept. EMD),
585, HIGH ROAD, FINCHLEY, LONDON, N.12

The Bristles won't come out...!

To tell you the truth it has been known for a faulty brush to slip through. Shame on us! If you should get one send it back and we'll replace it at once.



Production up - Prices down!



**Harris—the paint brush
with a name to its handle**

L. G. HARRIS & CO. LTD., STOKE PRIOR, WORCESTERSHIRE
CRC II

Hobbies

WEEKLY

CONTENTS

	Page
A Canvas Canoe - -	105
A Kite Winder - -	107
Two Modern Stand Frames -	108
Handy Hints - - -	109
Camera Action Pictures - -	109
Editor's Notes - - -	110
Holiday Sea Fishing -	111

**SUPPLEMENT DESIGN
SHEET FOR A MODEL
SMALL COMMERCIAL
MOTOR VAN**

June 16th, 1948

Price Threepence

Vol. 106 No. 2746

Enjoy yourself on the water by building A CANVAS CANOE

HERE is a single-seater canoe which will suit the weight and size of most readers. It has an overall length of 9ft. 8½ins., with a beam of 26ins. and a high bow and low stern to give a neat, streamline shape.

Although not flat-bottomed, the canoe has a comparatively shallow draft. Due to its length and width, there is good buoyancy, and unlike

most designs of canoes, this craft is a speedy type. It weighs about 36lbs. when completed, but, of course, a lot depends on the kind of wood used in making the framing, canvas, etc.

For cheapness, lightness and convenience, deal boards can be used, such as ¾in. stuff. Because of the difficulty in obtaining wood these days in any quantity, requirements have been reduced to a minimum. A rather fragile, but sturdy "skeleton"

framework is assured, if instructions are followed faithfully.

Method of Construction

The method of construction is quite simple. The hull consists of two light frames, the top (sheer) frame and the bottom (keel) frame, these being held together by end post pieces. As the sheer and keel battens are only ¾in. square, there is no difficult bending. These battens are simply glued and screwed to their respective bow and stern blocks. A waterproof glue should be used, including 1¼in. by 8 flathead brass screws.

The sheer framing should be assembled first. Therefore, secure 10ft. long battens to one block piece, then bend the wood to the opposite block piece. The block pieces, triangular in shape, are detailed at Fig. 3. You need four altogether, cut to the same size.

Note, by the way, how the battens are jointed to the blocks to allow for the fitting of protective nose pieces (see enlarged detail at Fig. 2). Once the battens are fitted, it will be necessary to "spread" the battens 24½ins. apart at the centre with a strip of wood. The spreader is removed later on when the formers, etc., are attached.

Having prepared the



All correspondence should be addressed to The Editor, Hobbies Weekly, Dereham, Norfolk.

sheer frame, fit the bow and stern posts, using glue and screws. These posts can be cut from 6in. wide by 7in. wood, as shown at Fig. 3. They are attached so the grain is upright. They are shown horizontal for convenience in marking out.

The Keel Frame

The keel frame is made similar as the sheer frame, excepting that it is smaller in size. The length is found by measuring the distance between the bow and stern posts. The blocks are glued and screwed to the posts, with allowance for the battens. Having secured the battens, these are spread 21ins. at the inside, as shown at Fig. 4.

The formers A, B, C, D and E are prepared from 7in. wood, as at Fig. 2, but it must be stressed that the dimensions are merely approximate and given as a rough guidance. It is almost impossible, unless working to a large scale, to give the true actual shape and sizes. The formers are best cut to suit the positions specified in the plan at Fig. 1.

Making the Formers

The complete shape of one former (A) is given only, the remainder being detailed in halves. These must be prepared in the complete shape, and all must be notched in a similar manner as A, to take the sheer and keel frame battens, including hull and additional stretcher, or filling, battens.

Now, whilst formers A, D and E can be cut from solid timber, the formers B and C are best assembled as frames, either half-lapping and screwing the joints or using dowelling. Deal boards are seldom more than 11ins. wide. As the formers B and C exceed this width, they must be assembled in the form of a frame. This, of course, gives extra lightness and also saves using up useful wood.

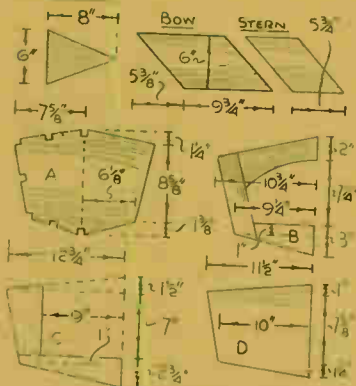

Fig. 3—End pieces and formers

Remember, please, that the sizes shown are rough, and that you must not depend on them being exact. If you mark off the true position of the formers on the canoe framework, as spaced in the plan at Fig. 1, you will be able to determine the exact size and shape of the formers.

To give further assistance in the matter, you should make and fit the central cockpit formers first. The shape and size is just about correct. The other formers can be more easily cut and fitted afterwards.

The Additional Battens

When you have fitted in all the formers, the additional battens can be added. These battens are 7in.

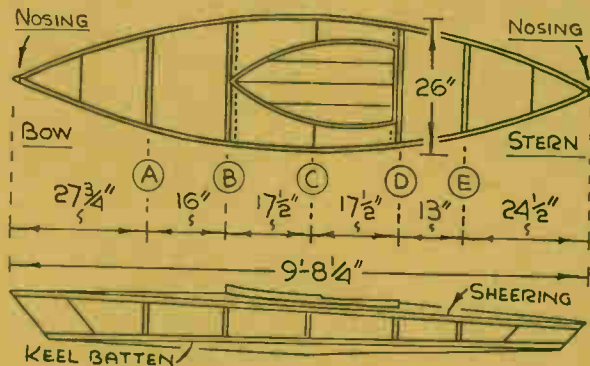

Fig. 1—Part top and side view of the constructional work

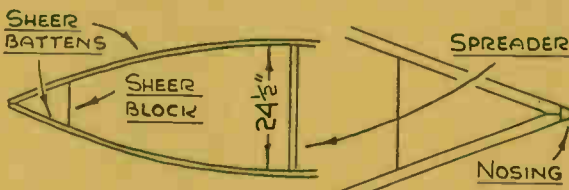

Fig. 2—Method of attaching sheer battens to the end blocks

square. Three are attached to the sheer and keel, keeping one in the middle. One is necessary at each side (hull) of the framework.

It will be necessary to plane and trim some of these battens to suit the shape of the formers. There should be no sharp edges, as arris edges tend to cut the canvas material. A rub with coarse glasspaper will remove the arris quickly.

Cockpit Details

To form the cockpit, a flanging of wood is necessary. One half shape is plotted in 4in. squares at Fig. 4. This, again, is a rough estimate of the shape. Use 7in. wood, and assuming it is not wide enough, have the shape broken centrally to make a joint. This joint goes over the top end of former C, and is supported by it, which means that the top ends require to be reduced by 7in. so the flanging lies level with the battens.

Another plan is to have the flanging fitted, not on top, but between former C, in which case, it will be supported by small fillets of wood. Fillets are also necessary across batten B, as indicated by the dotted lines at Fig. 1.

Narrow floor boards are fitted across the bottoms of B, C and D. A breakwater, consisting of thin wood, is bent to the shape of the flanging, with a back piece added; the wood should be attached with flathead or raised-

head brass screws. When you have completed the canoe framework, give it a coat of oil paint, and allow this to dry.

The Canvas

The canvas should be of the heaviest grade, which generally weighs 22 ozs. per square yard. It is best laid in two separate pieces, one being about 48ins. wide to cover the bottom and sides of the framework, and the other 24ins. wide to cover the top and so complete the deck.

To attach, turn the framework upside down and throw the wider canvas over it to drape it centrally. Put a tack into the bow, stretch the material, and tack it to the stern. Remove the breakwater edging, after turning the framing right way about and stretch the canvas for tacking to former C.

Work from this point towards the bow, at each side, then towards the stern. At the bow and stern, cut the material and affix it neatly with marine glue and tacks.

The deck canvas is put over the work, stretching it from end to end. Tacks should be about an inch apart. Use 7in. copper tacks, by the way—not ordinary blue-black tacks.

When fully tacked, fix the cockpit breakwater strips in to position again. The sheer edge tacks can be covered with a half-round wooden bead moulding or leatherette strapping.

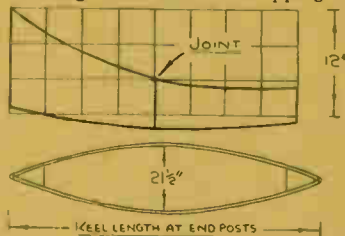

Fig. 4—Cockpit flanging and keel frame

Any wrinkles showing in the canvas will disappear when the material is sparged with water and allowed to dry. Apply a coat of lead paint to the canvas, allow to dry, then finish with a waterproof varnish, or an oil paint.

The completed canoe should certainly give you many hours of pleasure.



SUPPLEMENT TO HOBBIES No. 2746.

MODEL MOTOR VAN

"FORDSON-UTILECON" ALL-PURPOSE VEHICLE



WHEEL CAPS. CUT FOUR 1/8in. AND SHAPE TO SECTION.



WOOD CAPS FOR WHEELS. CUT FOUR FROM THIN WOOD OR CARD.



FRONT SEATS.



SECTION



MIDDLE SEAT.



REAR SEAT.



REAR SEAT.

PANELS OF WOOD REQUIRED FOR THIS DESIGN

ONE H4 ONE G4 TWO G2

The price is shown in Hobbies Weekly, June 10th, 1948, but is subject to revision. See the current edition of Hobbies Handbook, or write for price to Hobbies Limited, Dereham, Norfolk.



REAR SEAT.



Instructions on how to make this

MODEL MOTOR VAN

THE completed van shown on the other side is made with the fretsaw, a few tools and some thin wood. A parcel is provided as stated, and the completed model is 7 1/2 ins. long and 3 1/2 ins. high.

All the necessary parts are shown full size, and it would be as well to trace them off on to the wood so that reference can be made to the various notes placed on and next the patterns. Dotted lines on the patterns themselves indicate where other parts adjoin, and sectional drawings (the shaded parts) are a side view of the wood showing the shaping of the part to be done.

Cut out all the parts and clean them thoroughly after having studied these instructions with the various details. The excellence of the work largely depends on the shaping undertaken and the final painting of the model. Do not be in a hurry, but cut, shape and fix each part carefully. File and glasspaper will be necessary, and each part must be finally smoothed to a nicely rounded surface.

Chassis Parts

The model is built from the floor upwards, the undercarriage and wheels being left until later. To the floor is added one of the sides, having cut this out to its complete outline, saw through on the line marked, and then glue in place and fix with short fine fret nails at the position given.

The front portion of the side will thin taper inwards towards the bonnet. Notice that the floor is in line with the front lower edge of the side, so that the other portion

Before going any further, the inside should be completed. By the way, the imitation glass in the parts should not be added until all the rest of the work is done. It is held in place in each case by an overlay strip of card which serves as a support to which the transparent material is glued.

A view of the inside with a plan giving the measurements of distances is shown at Fig. 1. The seats are shaped and glued in place, then being painted and finished. Notice the steering column and wheel, the former being glued into the front at an angle when the wheel has been fitted. Notice, too, the acute chamfer on the edge of the front, which is to provide the fascia for the instrument board if you care to paint it on.

Having completed the inside, the second side and roof can be added. When the parts are put together they will appear as an elongated block shown at A, in Fig. 2. Then comes the shaping, which must be done carefully with a balanced curve to obtain the general shaping shown at B and in the picture of the finished model.

The Bonnet

At Fig. 3 we have a similar detail showing how the bonnet is made. At A, you have a cut-away view of the blocks and, B, the finished shaping. See these parts are rigidly glued together before finishing off. Then turn your attention to the mudguards. The back ones are composed

of two segments of wood glued together. The inner forms a lining behind a piece of card, which must be glued in to fill the space necessary. The outer portion forms the actual mudguard itself, and is rounded to the required shape.

The front mudguards are composed of four thicknesses of wood, and when these have been completed, they must be very carefully shaped on their outside edge, and then an inside portion of them tapered away so they may lie flush against the tapering front of the bonnet.

This can best be done by trial and error, cutting away a small portion until you have got them to bed evenly and in line with the main sides. The detail at Fig. 4 shows the process of building up these wings. When quite satisfactory they are glued in place on the body of the model.

Axles

An under-view at Fig. 5 illustrates clearly how the axles are mounted in their supports. The length of the axle rod is given, and also the position of some small washers which are glued on the axles themselves to prevent the side play of the wheels.

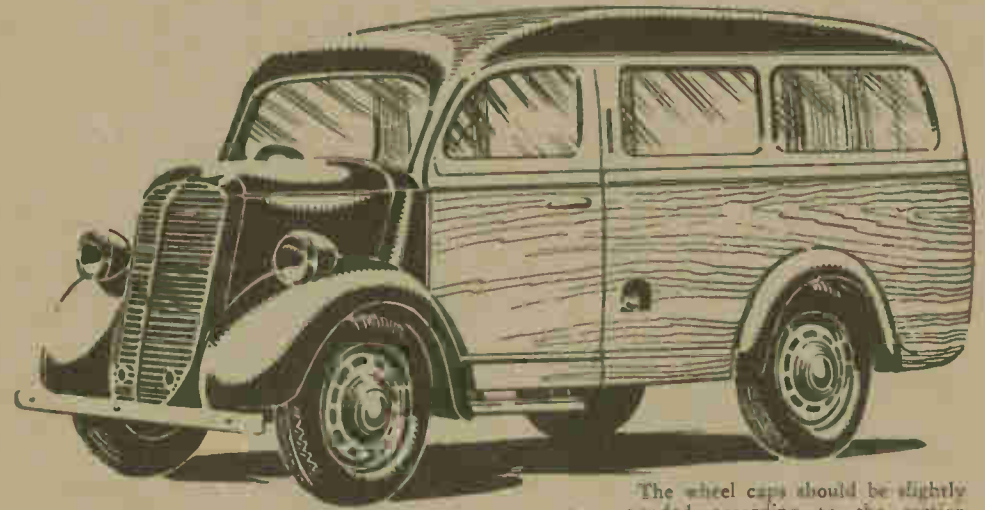

The wheel caps should be slightly rounded according to the section shown, and then a smaller circle made to form the cap, glued centrally on that. This cap can be a thin piece of wood shaped on the inside to bed to the hub, and on the outside to make a slightly raised hub cap.

Painting the Model

The model can be painted before the wheels are added, and most of it with the wood left in its natural state but varnished over. Brown or red or grey can be used for the various lines for the bonnet, roof, etc., and the mudguards and wheel centres can be black. Grey should, of course, be used for the tyres and the underneath portion can also be black.

A step is fixed where shown, being a little piece of wood held in place by right-angle strips of thin flat metal about 1/16 in. wide. Other various reinforcements can be added, such as a number plate, lamps, bumper, etc.

The radiator front should be painted on, as can handles, hinges, wiper, petrol filling cap, etc. It is by adding such details as this, carefully

You must glue the two supports in line in the position indicated on the pattern of the floor. Thread the axle through one support, and then put on the two washers before passing the axle through the other support. These axle rods should, of course, revolve easily, but the washers are glued to the rod, one each, just inside the supports.

A front and back wheel is illustrated at Fig. 6 to show the difference. Each wheel is made up of three pieces, the centre piece forming the hub, and the two outer rings forming the shape of the tyre. In the case of the back wheels, there is no need to shape the rim round, but there is in the case of the front ones because a brake drum is glued on the inside of each.

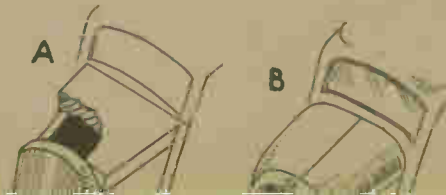

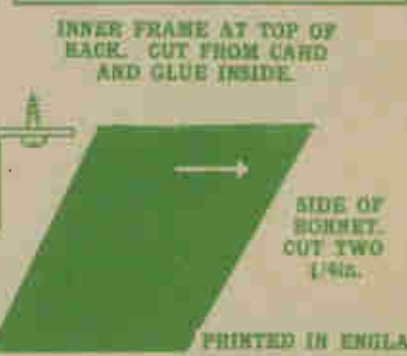
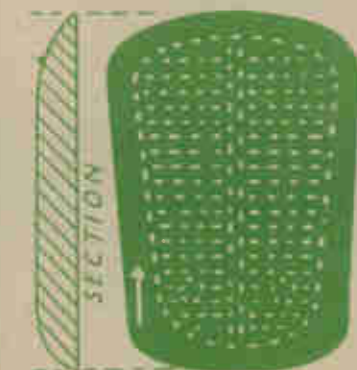
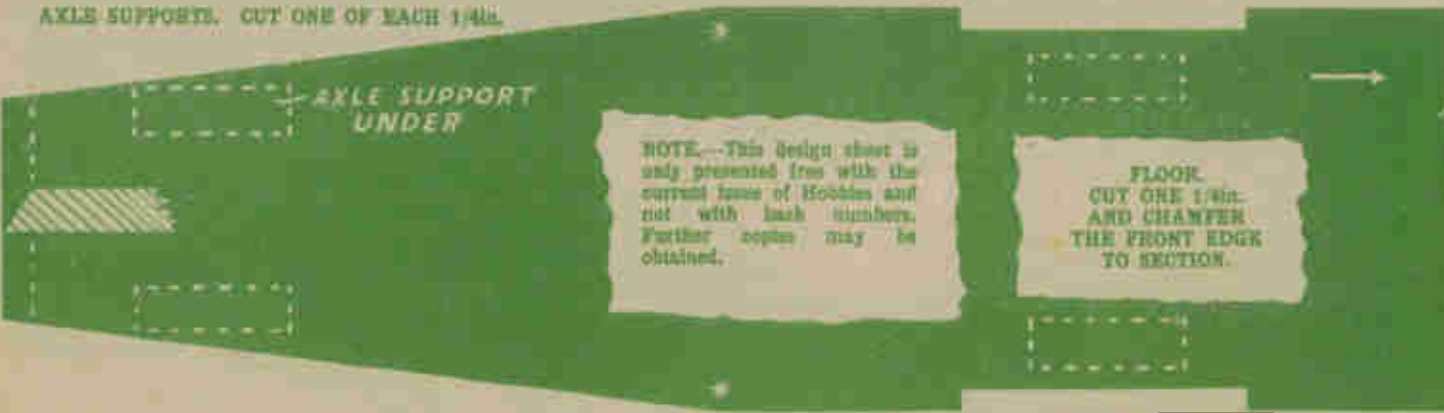
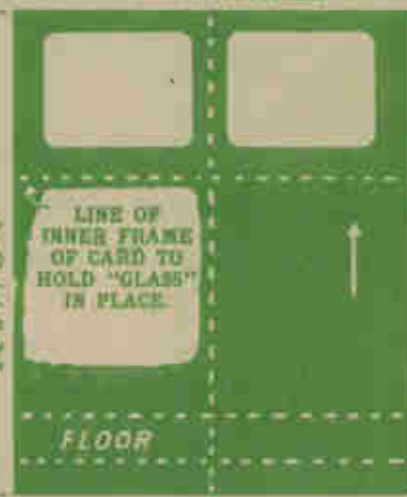
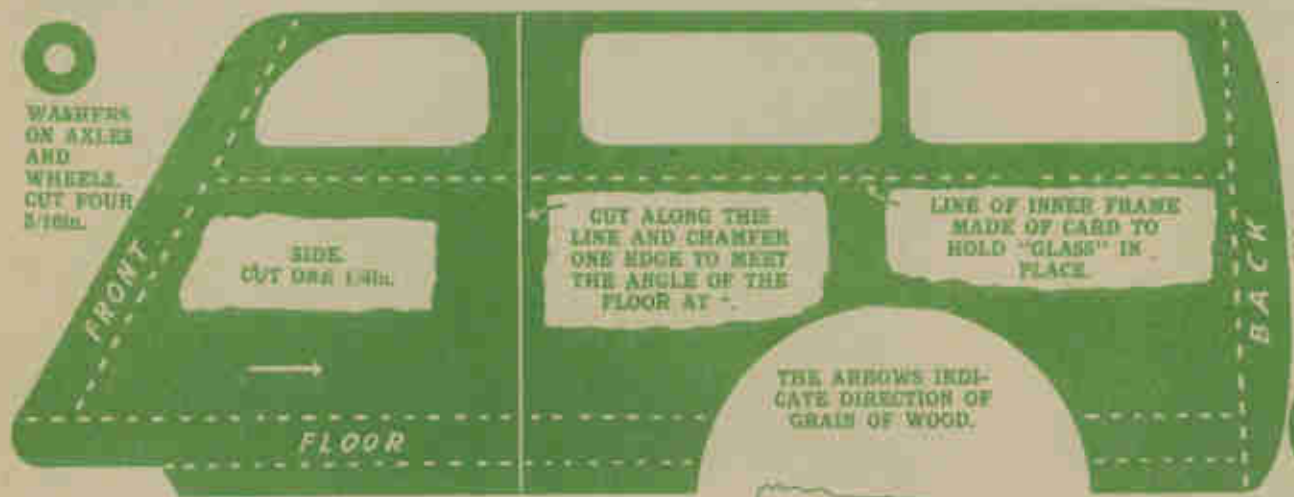

by the dotted line on the pattern of the side. The front and back of the van should next be added.

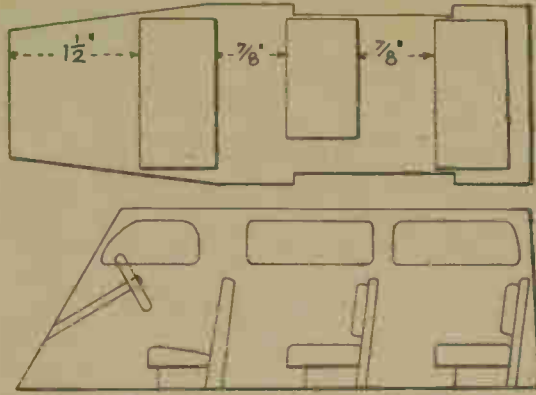

Fig. 1—Plan and side view showing inside positions

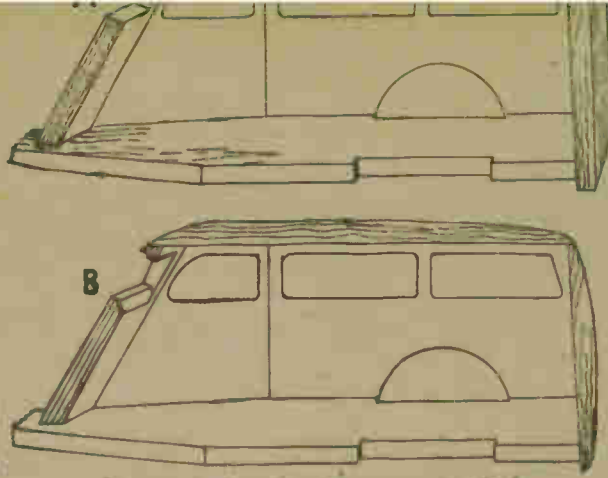

Fig. 2—Cut-away view before and after shaping

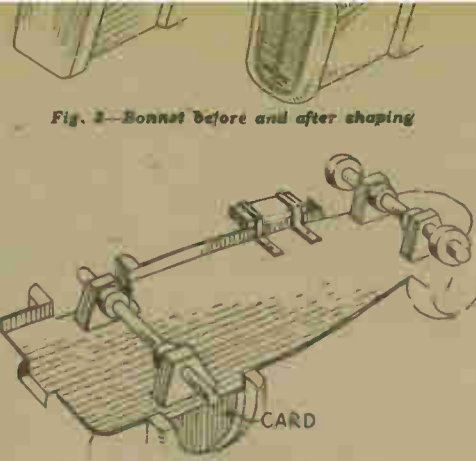

Fig. 3—Bonnet before and after shaping

Fig. 5—Underview of chassis and axles

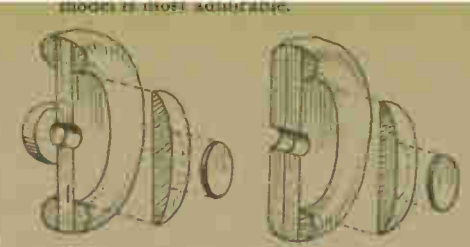
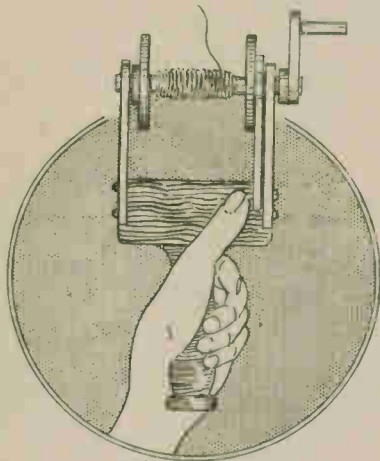

Fig. 6—Showing formation of wheels



Fig. 4—Mow madguards are formed and shaped

It is most helpful during flying to have A KITE WINDER



READERS fond of the sport of kite flying will find the winder sketched a real help. With ratchet control, the line can be let in and out rapidly, and no entanglement will result. It is not difficult to make—fretwood, 3/16in. thick being used throughout, except for the handle.

Handle Part

Fig. 1 shows a front view of the winder, and Fig. 2 a side view. For the handle, cut the shape from deal 7/8 in. thick. The sides of this are cut away to receive the supports for the reel. The part to be gripped in the hand is nicely rounded and shaped, then a lin. disc of 3/8 in. wood, with rounded edge, is nailed and glued on at the bottom. This is to prevent the winder slipping from the hand at an unexpected tug from the kite.

The reel supports are cut to the length given. At 7/16in. from the top of each, bore a 3/8 in. hole through for the axle rod of the reel. It is important to see these holes are truly in alignment, if the reel is to run freely. Fix them to the handle with round-headed screws. One side can have the addition of glue as well, but leave the other free to remove so as the reel can be inserted later.

Ratchet Parts

Grouped in Fig. 3 are remaining parts of the winder. A represents the cheeks of the reel. Cut two of each. For B, the ratchet wheel, strike the circle on thin paper, then a second circle inside it, this time 3/8 in. diameter. Divide into 12 equal parts and mark the teeth shown in the drawing. Paste this to a piece of the fretwood, preferably a scrap of three-ply, and cut out carefully with a fretsaw. Before glasspapering off the paper, mark the exact centre with an awl.

Take one of the cheeks of the reel, and from its centre strike a lin. circle, as shown by the dotted circle at A. With this as a guide, glue the ratchet wheel to it with its teeth facing the opposite way to that shown in the diagram.

Cheek Discs

Now bore a 3/8 in. hole through the centre of both. To the second cheek of the reel, glue a 3/8 in. diameter disc of plain fretwood, and bore similarly. These cheeks are now glued to an axle of 3/8 in. round wood rod, cut to the length shown at C. Glue them exactly 2ins. apart, approximately in the middle part of the rod, with ratchet wheel and discs on the outside, not inside.

One side support of the handle can now be removed and the reel put in place. It should rotate truly and be easy to turn. A little blacklead, made into a paste with grease, and worked in the bearing holes, will help to make the action smooth. Only a modicum, of course, is wanted.

The Handle

The handle, D, is cut from the fretwood to size given. At 3/8 in. from each end, bore a hole for fitting both to the axle and grip. A 3/8 in. diameter fretwood disc is glued to one end, the hole being continued through this also. This end is glued securely to the axle.

At the opposite end a short piece of the wood rod is glued in as a grip for the fingers. When the glue is set hard, the winder can be tested for action. A suitably fine hole can be bored in the axle, at about the centre, through which the kite line can be threaded, and be there tied. See this tie is a secure one, or the line may be drawn out and a chase for the kite ensue.

A ratchet check should be added to

provide more control over the line. The pattern for the check is shown, drawn over 1/2 in. squares at E. Copy these squares full size on to thin paper, and draw the shape of the check as accurately as you can.

The pattern can be pasted on to the fretwood, or transferred thereto through carbon paper. Cut out, and where shown by a black spot, bore a hole to fit a 3/8 in. round-headed screw. At the edge nearest to this spot, insert a tiny screw hook.

Engagement

Detail sketch, Fig. 4, shows the position the check should be fitted in, to engage with the teeth of the ratchet. Fit by driving the screw in the side support and see the movement is a free one, but not too much so. Take care, also, that when the check is pressed down it clears the ratchet all right. It would be as well to place a thin washer between check and support, to ease friction, and a second washer under the screw head.

The check is kept pressed against the ratchet, either by a small steel spring, or, as shown in the diagram, by a strong elastic band, the band being stretched between the hook on the check and a similar hook, driven in the handle at about the spot shown.

Finishing

Painting or varnishing the winder is entirely a matter of choice, but if done, care must be taken to avoid getting any on the axle of the reel. So far as the wood is concerned, many readers will find enough in the scrap box, but if it has to be bought, a panel 4ins. by 9ins. will be ample.

If you use varnish be sure to get a hard varnish. Unless you do, the warmth of the hand in use will make it tacky and uncomfortable.

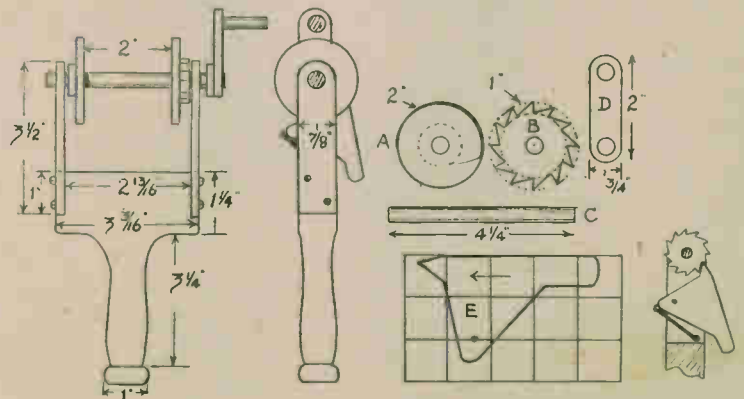

Fig. 1—Front view of winder with measurements

Fig. 2—Side view of parts

Fig. 3—A group of the parts forming control mechanism and ratchet

Look how attractive you can make these TWO MODERN FRAMES

THE type of photo frame shown in our illustration, Fig. 1, is now very popular. The principle of construction of these frames is simple.

There are three distinct layers of wood, so arranged and cut that the middle one of the three when sandwiched between the outer ones is somewhat smaller and forms, as it were, a slot in which the glass and photo will rest.

Looking at the first simple design of a frame to take a circular glass, that in Fig. 2, we note that the glass is $3\frac{1}{2}$ ins. in diameter and that it rests in a semi-circular frame, the outer layers of which are cut $3\frac{1}{4}$ ins. in diameter, thus making an $\frac{1}{4}$ in. groove or rebate $3/16$ in. wide.

Commence making by cutting and constructing its base shown in Fig. 3. Cut the two pieces from $3/16$ in. wood, and glue them together after cleaning off all the edges. See there is the correct amount of margin of $\frac{1}{8}$ in. all round. When the glue has hardened, mark across the two centre lines and set up the mortise $1\frac{1}{4}$ ins. long and $9/16$ in. wide from these centre lines. In cutting the mortise, keep the saw to the inside of the lines so the tenon on the three pieces of the frame will have a tight fit.

Three-piece Frame

The frame, being made from three distinct pieces will be marked out from the squared diagram on the right of Fig. 2. Each square represents $\frac{1}{2}$ in., should be set out on paper and the enlargement carefully made of the one half. The semi-circles are, of course, described with a pair of compasses. Trace and transfer the half design to the other side, or left side of the centre line, thus completing the whole outline.

On one of the pieces only, work to the larger radius shown for the semi-circle. This piece will later be glued between the other two. All three pieces should be $3/16$ in. thick, and if possible, where a fretmachine is

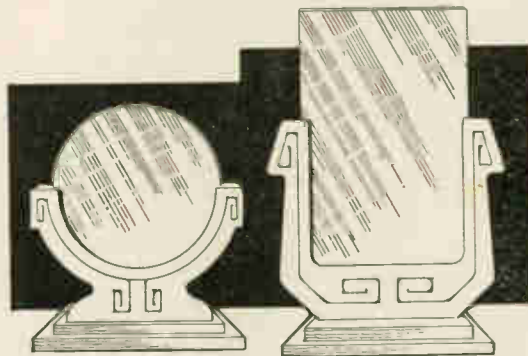

Fig. 1—These are the alternative styles offered

in use, cut the outline after the three pieces have been glued together.

In this respect, however, the centre layer must have its semi-circular piece cut away before the other two outer layers are glued to it. If all the pieces, on the other hand, are cut separately, then care must be taken to keep to the line of the design. Any cleaning off later will never present a really good clean edge $9/16$ in. wide.

Test the length of tenon with the mortise already cut in the base to ensure a good fit. Rub down both outer surfaces of the frame before it is glued to the base.

If a silhouette photograph is to be framed, then two glasses, of exactly the same size will be wanted and the cut-out photograph will go between these. If, however, an ordinary picture is wanted, then one piece of glass only need be used, and the picture put behind it with a stout piece of card as a backing piece.

The little detail, Fig. 4, shows one corner of the frame with its glass, G, and the backing, B, behind it.

The second frame design follows that just dealt with. The base is of similar design, mortise and all, and the edges of both members could be chamfered or rounded as desired. The frame is designed to take a postcard size glass—or glasses, and in Fig. 5

the actual appearance of the cut-out pieces can be seen from the left of the diagram. On the right the working details in the way of squares is included.

In this design the three pieces forming the frame are, perhaps, each a little more delicate to handle, but when all three are glued together, a strong job would result.

Fig. 6 gives a view of a portion of the frame in the process of being glued. Too much glue on each layer will squeeze out when under pressure and will

discolour the wood even when cleaned off with glasspaper. Pressure, however, must be applied if the parts are to hold well together.

Care must be taken, too, in gluing up to see the parts do not slip out of place after the glue has been brushed on and while being weighted or cramped up. Once the parts are together and the glue set, it is almost impossible to break the joints and re-glue them.

Suitable Finish

The finish for the frames wholly depends on the variety of wood used. A white wood calls for either paint or varnish, whereas mahogany could be brush polished or even just oiled and rubbed with a wax polish.

In some cases, some sort of simple decoration such as suggested in the two frames in Fig. 1 might be added, using an indian ink line or pressed in the wood with a blunted awl.

This has the effect of marking a shallow line when used against a rule. Get the pressure even so a standard depth and width of line is obtained.

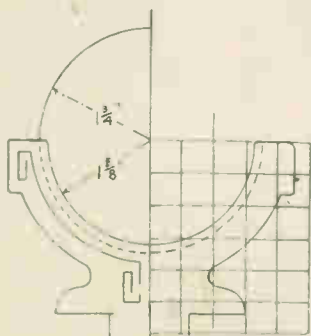

Fig. 2—Marking the circular holder

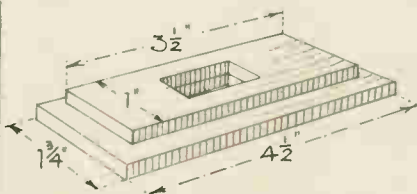

Fig. 3—The two-piece base part



Fig. 4—The glass groove

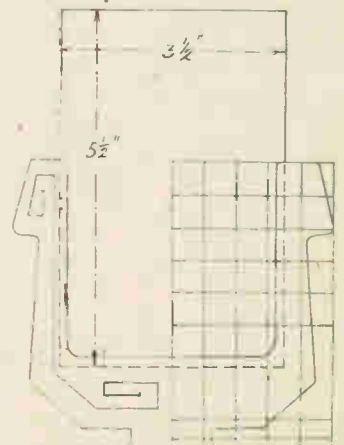

Fig. 5—The second style and shape

Staining and Painting are covered in these HANDYMAN HINTS

IN these days of shortage of material and labour, it is quite an asset to be something of a handyman, and we know that a large proportion of our readers, in addition to being craftsmen in wood, are also able to do quite a number of odd jobs about the home in a satisfactory and workmanlike manner.

Indeed, such jobs not only prove a pleasant change from the ordinary hobbies being undertaken, but will save money and the cost of having a tradesman in. So often when a job wants undertaking, the full-time tradesman is busy somewhere else, and it may be days or even weeks until he can come along and do the odd job wanted.

There are so many things one can undertake in the home, but like everything else, there is a right and wrong way of doing them. Occasion arises when a carpet has to be taken up, and the floor restained, or a new one given a coat of stain. There is nothing difficult in the work, but without considering a few points, an awful mess can be made of the job and the whole thing spoilt.

Cause of Dry Rot

Remember, in this connection, lino should not be laid quite close all round to the skirting board. This being done is the cause of much dry rot developing, because the air is not able to circulate to the wood under the linoleum, and the fungus is liable to be set up. The distance between lino and skirting is a matter of individual taste, but so long as the air can circulate to the wood surface, that is sufficient.

This surround if being stained, should not be carried well under the carpet or linoleum, and the first job is to measure off the area covered by the material, and then allow the extra for the stain to come beneath. It is advisable to carry it at least 6ins. inside the edge of the carpet in order to provide for any turn-up which may be necessary later.

Colour Range

Remember, too, these surrounds are best treated with water stain and then varnished over. There is normally quite a range of colour available, and the application is easily made with a wide soft brush. Do not use the spirit stain or you may be disappointed in the result, because the constant wear on the wood by chairs or feet, etc., will take down the spirit body of the stain itself.

The idea, of course, is to get the stain well into the wood so that if you get any shivers pulling up afterwards, the board below is still coloured. The

water stain takes a longer time than the spirit to dry out, but when hardened right in, a coat of varnish over the whole of it can be applied.

Home-made Stains

If you want to make your own stains you can get various colours by using raw umber, raw sienna, burnt sienna or mahogany lake, whilst permanganate of potash is a very cheap powder which can be mixed to a pleasing colour in lots of water. Be sure you have your floor clean before applying, and if grease or oil has been on it, glasspaper down to the natural wood.

After the stain has hardened in, you can give it a light rubbing down with

fine grade of glasspaper. This is to take away any raising of the grain—a liability with water stain.

Then apply varnish—a hard drying type such as church oak if possible. In using this, see that there is no dust allowed to fly about. Have the windows closed and do not move either yourself or articles of furniture unnecessarily.

If you do, the dust is apt to settle on to the face of the varnish and become embedded into it to the detriment of the finished appearance. Varnish, too, should be applied in a reasonably warm atmosphere. If it is very cold, the spirit drags on the brush and will not settle itself evenly or thinly.

Possibly you are undertaking some

How to take Action Pictures with a Simple Camera

DO you like action snapshots? Well, there is no reason why you should not get some in the next sporting event you attend, even though you only possess a simple folding or "box" camera.

With this sort of camera random "speed" snaps usually come out blurry, the shutter being too slow.

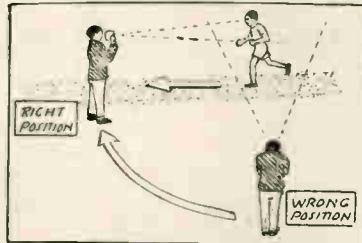

Right and wrong for walking

But, if you study one or two points about moving objects, successful pictures can be obtained.

The main thing to notice in such subjects is that they appear to have different speeds according to the angle from which they are viewed.

Look at the cars that you see on the road. Going "broadside" across the field of vision they just flash past, but if they are coming towards you there hardly, over any moment of time, seems to be any movement at all.

As you see things, so will your camera. The aim, therefore, is to snap competitors in races, etc., as nearly coming towards you as possible, for then there will appear to be very little movement, and the slow shutter

on your camera will be able to record a sharp picture. The same exposure taking a "broadside" picture would give just a blur.

High jumpers have an action of their own. They rise to a peak point, pause for a moment and then come down to earth. If you are dead in front and take at the top position your picture will be sharp—but it must be right on this top position. And it can be got.

Cyclists are best taken from a position on the outside of a bend, as the subjects for a time will be coming dead on—this applying more or less to all flat events on an oval course.

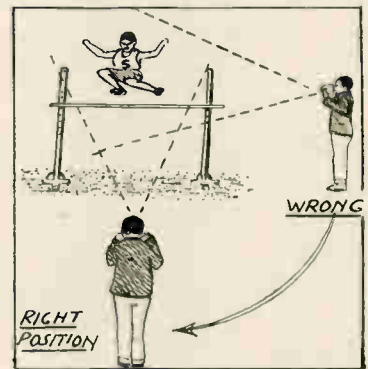

Right and wrong for speed

When possible, steady the camera against something as you press the trigger—this will prevent "camera shake" and help to make your picture sharper still.

painting or renovation of the wood-work, and here again, preparation beforehand adds a great deal to the excellence of the result. Too many people just rush into a job without giving any thought previously as to what will be needed, or purchasing the necessary material.

It largely depends what you are painting as to what type of brush will be used. Obviously, if it is a wide surface, then a 3in. brush is useful to save time and labour. Such a width, however, would be quite absurd if you were doing, say, a narrow window frame or some equally comparatively delicate work. Have your brush clean, as well as of the correct size.

Keep Brushes Soft

If they have been used before, they should have been kept with the bristles in water to prevent them going hard. If, however, this has not been done and the hair portion has become stiff, it can be softened with turpentine. See that all the old paint is squeezed well out of the hair, particularly down at the roots where it is apt to have become enmeshed very strongly. Too often, a trace of the previous paint has been left on the brush, only to come out again in streaks when another colour is used.

Apart from the ordinary paint brush, have a very wide sash brush. This is about 4½ins. wide with soft hair, used to brush away dust in corners or as required. You will see the professional painter carry one in his apron to use on the piece of work before he

actually commences with the paint brush.

Clean Old Work

Needless to say, apart from this, the work should have been cleaned with glasspaper. If your paint is to be over previous colouring, see there are no blisters left, but that the whole surface is flat and clear. Nail holes should be filled with putty, pressed well in and made flush with the rest of the surface.

Look over the work, too, to see if there are any other cracks or openings which can be dealt with in the same way before painting. All this preparatory work must be done before you begin. Have sufficient paint to complete the whole job. It is most unsatisfactory having a small quantity, getting half way through the work, only to find that a second tin of the same shade cannot be obtained.

In doors and window frames there are definite sequences to get the graining of the paint the right way. If you follow the grain of the framework of the wood, you will see which can be done in rotation.

Sequence of Painting

The cross frame of a door is done first so that the outer upright edges can follow through afterwards and make a line across the previous work.

Do try and keep the paint of the same consistency throughout the job by a fairly frequent stirring in the pot. Do not apply too much at once, but carry it forward to work into the wood over a fair surface. Do not, however,

pull it out too far or it may get thinned down and show badly when dry.

If you are doing outside work, of course, particular care must be taken in plugging and covering to see that rain is not likely to get to the wood afterwards. Some portions of the work may have become more worn than others. Windowsills, for instance, are generally a source of trouble with the paint worn off much more than on other parts.

Two Coats

In such cases, add a first priming coat and allow to harden before the second one is put on. You may, indeed, prefer to have two coats all round for this outside work, but here again, the scarcity of material may prevent this. Look for any damage or breakages which have occurred in the woodwork, and see they are repaired before you begin.

If floors are being treated as a whole, replace any cracked or worn or rotten work which wants repairing. You may think that a board is not sufficiently worn or damaged to come out, but will last a little time longer. It is a bad policy to leave it, however, and far better to make a good complete job now that you are doing.

If not, in six months' time you then have to take this board up and you will have all the trouble of painting or staining afterwards. Whereas, now you are doing the whole job you might as well save that later trouble. Look over the whole job before you begin.

From the Editor's Notebook—

THE picture here of a light Commercial Motor Van gives you an idea of the 8in. model you can make from Design No. 2746, which is presented with this issue free, or obtainable later as a separate design sheet for 6d. A parcel of wood for all parts, including enough to cut the wheels, as well as transparent material for windows and rod for axles is supplied as usual by Hobbies Ltd. It is obtainable from their Branches for 3/6 or from Dereham, Norfolk with an additional 9d. for postage.

I HAVE mentioned before the possibility of collecting names of inn signs as a hobby. It forms a very long list if you do much travelling and some queer signs are encountered. History is usually attached to them somewhere, and it is often intriguing to delve into the reason for their name. "The Duke of Wellington" was probably innovated at the time of the Battle of Waterloo, just as the more recent one called "The G.I." commemorated events in our own

time. I see, however, that Mr. W. E. Bratt, of Solihull, Warwickshire, has gone one better in collecting photographs of such signs. It commenced as a competition with his brother-in-law in Glasgow, and his collection already contains over 150.

A HOBBY, according to a dictionary, is "a favourable pursuit for pleasure". But numerous bright and energetic people get so

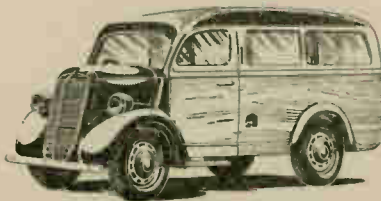

involved in its delight that it turns into a profitable business—a really marvellous combination. For instance, Peter Wilson of Hounslow, Middlesex, now runs a small factory

producing accurate and intricate models of aeroplanes which are in demand for window display, aircraft manufacturers, etc. He started his one-man business when only 12 years of age, and now, at 16, draws a substantial income from it. Every model is an exact replica, details and drawings of which are carefully checked from photographs and blue prints. You see what enthusiasm and continued keenness can mean?

I AM always pleased to have letters from readers, but will they remember to keep them separate from any order for goods. Obviously I cannot deal with the thousands of queries which are received every day about Hobbies goods. They are dealt with by a special department, and if a letter to me is mixed in with an order for some tools, it means delay before all is attended to. Orders and letters should be on separate sheets of notepaper, although they can be sent in the same envelope.

The Editor

How to enjoy the popular sport of HOLIDAY SEA-FISHING

SEA-FISHING is a popular sport at sea-side holiday resorts, attracting old and young. The sport is catered for at every watering-place, where angling festivals and competitions are frequently organised during the season.

Marine fish are game and give grand sport when hooked on rod and line. They are edible, too, and after a successful day you will have something worth bringing home, or to your boarding-house. The caterer responsible for satisfying the healthy appetite engendered by the sea air and exercise will assuredly welcome your catch.

Tackle Required

Perhaps you have already gone out in a boat and caught fish on a hand-line in the old primitive way, but unless you go suitably equipped with a sea-rod and proper tackle the best part of sea-fishing will be lost to you. When fishing with rod and line one enjoys all the thrills of "playing" a fish on fine tackle.

Tackle required includes a two-joint rod about 8ft. in length; a wood reel 5ins. diameter; a braided flax line about 50yds. long; gut casts 2x to 3x in thickness. Gut casts of the size known as "stout" will prove suitable for most of the general sea-fishing you are likely to get from pier, boat or beach. Hooks should be No. 1/0 for bass and similar fish, and No. 4 for flat fishes.

Methods

Paternostering is a good method when fishing from a pier. The tackle consists of a gut trace, a lead, and two or three hooks (see Fig. 1). When baited, the tackle is lowered into the water, and when the lead touches bottom, the line should be kept tight. The rod-top jerks when a fish bites, and that is the moment to "strike" and hook him.

Float-fishing is useful, but where water is deep, a sliding float (Fig. 2) is advised. It slides down the line as a fish is being hauled in, allowing the line to reel up freely. Find the depth—when angling on the bottom—and fix float so the bait is suspended a few inches from the bottom.

Finding Depth

To ascertain depth, you first "plumb" for it, using a small plummet on the hook. In a rising or a falling tide the float must be continually adjusted as needs be. Float tackle for pier fishing is similar to that employed by pike anglers in fresh-water (see Fig. 3).

The leger tackle, (Fig. 4), is very

useful for catching flat fish and when bass-fishing at the mouths of rivers.

Baits for Sea-fish

Baits are many and varied. Lugworms are good, they may be found by digging in the sand, just after ebb tide, near the numerous tiny craters. Ragworms also are popular baits, but it is advisable to buy these from the bait-merchants.

"King" ragworms, a larger kind, are excellent for catching mullet and other fish. To bait with ragworm, insert the point of the hook through the head—no more.

For cod and codling the best baits include prawns, crab, mussels, whelks and lugworm. For flat fish a piece of crab taken out of the shell, crushed and softened, or a piece of herring or mackerel. Dabs and flounders may be taken on worms or shell-fish.

Bass are the most sporting of sea-fish available from rocks, shore or pier. Methods can be roughly divided into pier fishing with float or paternoster; fly-fishing or spinning from rocks; and surf casting from the shore. Lugworm is the likeliest bait, second comes king ragworm. Soft crab is also killing; it should be secured to the hook by a piece of worsted.

Spinning from the rocks or shore for bass is most fascinating, if you can find a spot where the fish come close in to the rocks.

You can use a sand-eel mounted on a spinning flight and trace of gut, or an artificial lure such as a rubber sand-eel, Devon, spoon, or similar may be substituted. Spinning for bass is similar to spinning for pike, and the tackle is about the same as used by pike fishers.

Bass can also be caught on the fly, using a stiffish fly-rod. Almost any sort of fly resembling those used for salmon and sea-trout will serve, such as the Alexandra, or any fly with gaudy colours.

Another method for catching bass is "whiffing". In case you do not know, "whiffing" is a method of fishing while being rowed across the tide in a boat, or along gullies in submerged reefs. The holiday-maker will have to trust to the hired boatman to take him to the likely spots, and to manage the boat.

Sand-eels and prawns are best baits for "whiffing" or "railing", as

this method is often called. The bait is let out from the boat, and trailed along at the end of 30 yards of line. "Whiffing" for bass with an india-rubber sand-eel is good fun. Or you can use a baby spinner with two ragworms attached by the head to the hook.

The various flat fish, plaice, soles, and flounders, etc., are found chiefly on sandy and muddy coasts. Ragworms, lugworms, and shrimps are good baits for plaice and flounders, fished on leger tackle; dabs also like

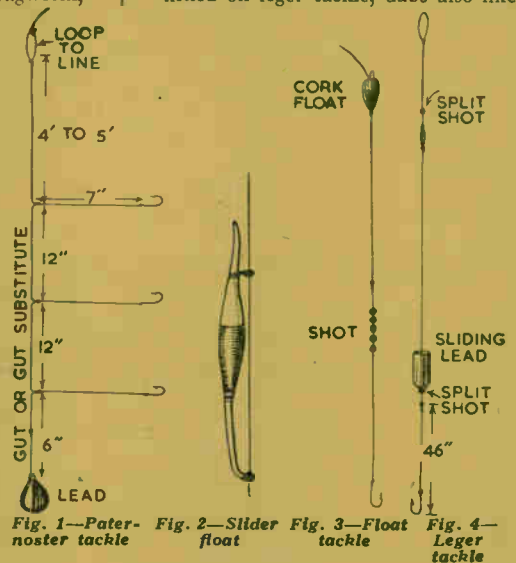

Fig. 1—Paternoster tackle Fig. 2—Sliding float Fig. 3—Float tackle Fig. 4—Leger tackle

mussels in addition to the above.

Mackerel afford good sport, and may be caught by such methods as fly-fishing, whiffing, float-fishing, etc. A bit of herring, strip of pilchard, or sand-eels are all good baits. Grey mullet take ragworms, and pollack can be persuaded to sample sand-eels.

Fly for Fish

Much pollack fishing with fly is done off the Scottish coasts. Coalfish, too, readily take a small white fly, easily made by tying with silk two strips of white gull feathers to form wings on a hook. Pollack and coalfish prefer rocky coasts.

Times for sea-fishing in summer should be noted. Generally speaking, before 7 a.m. G.M.T. is the likeliest period. Tides must be studied. High water is best for pier fishing. The beginner will benefit by accompanying an experienced angler, or he can pick up many a wrinkle by watching other anglers on the pier or shore.

If he prefers to go angling afloat he must put himself into the hands of the boatmen usually available.

"LET ME BE YOUR FATHER"

This famous phrase has inspired countless students to take the high way to higher pay. Let us help you into that higher paid position. The Bennett College is the most progressive, most successful Correspondence College in the World. Send now for full details and free advice. DISTANCE MAKES NO DIFFERENCE.

CHOOSE YOUR CAREER AND WE WILL SEE YOU THROUGH

Blue Prints.
Book-keeping, Accountancy and Modern Business Methods.
Building, Architecture and Clerk of Works.
Cambridge Senior School Certificate.
Carpentry and Joinery.
Civil Engineering.
All Commercial subjects.
Sanitation.
Shorthand (Pitman's).
Concrete and Structural Engineering.

Draughtsmanship, all Branches.
Heating and Ventilating.
Institute of Housing.
Languages.
Mathematics.
Matriculation.
Municipal & County Engineers.
Plumbing.
Quantity Surveying—Institute of Quantity Surveyors Exams.
Structural Engineering.
Surveying.
Teachers of Handicrafts.

If you do not see your own requirements above, write to us on any subject. Full particulars free.

Direct Mail to Dept. 62

THE BENNETT COLLEGE Ltd.
SHEFFIELD, ENGLAND

ANORMA

Constructional Kits for Model Buildings

4 MM. SCALE FOR OO GAUGE.

No.		No.	
1	Bungalow ... 5/-	20	Corner Shops (2) ... 5/6
2	Windmill ... 3/-	21	Semi-det. Houses ... 6/6
3	Modern Villa "A" ... 7/6	22	Farmstead ... 10/6
4	Country Station "A" ... 11/6	23	Det. Villa and Garage ... 7/6
5	Signal Cabin ... 4/-	24	Factory ... 11/6
6	Timber Mill ... 6/6	25	Country Goods Depot ... 8/6
7	Modern Villa "B" ... 8/-	26	Telegraph Poles, Kiosk and Bus Shelter ... 7/6
8	Shops and Flats ... 8/6	27	4 Extension Platforms ... 7/6
9	Semi-det. with Garage ... 7/6	28	Loco Water Tower ... 3/-
10	Semi-bungalow ... 5/6	29	Airport Control Tower ... 10/-
11	Church ... 10/6	30	Hangar ... 8/6
12	Public House ... 11/6	31	Loco Shed ... 7/6
13	Country Station "B" ... 10/-	32	Coal Office and Cattle Pen ... 4/6
14	Georgian Mansion ... 9/6	33	Café and Bank ... 5/6
15	Service Station ... 7/-	34	Rly. Footbridge "A" ... 2/9
16	Cinema ... 7/6	35	Post Office ... 4/6
17	Walk-round Store ... 5/6	36	Rly. Footbridge "B" ... 3/6
18	Town Shops ... 5/6		
19	Arcade ... 8/6		

Please write for full illustrated price list of the above and of the "Airyda" Model Aircraft and "Aquila" Model Ship Constructional Kits to:

MODELLERS SUPPLY LIMITED

AIRYDA WORKS, ASPLEY, HUDDERSFIELD.
Tel. 5511 (2 lines).

She might be YOUR ship

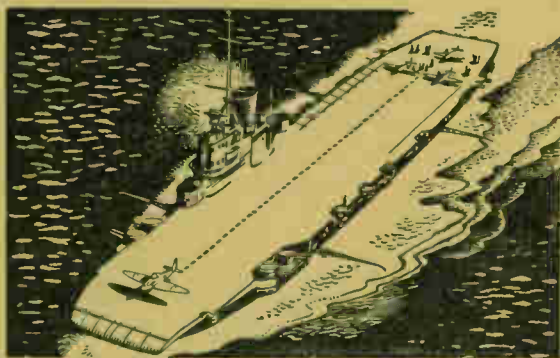

AIRCRAFT-CARRIER

When 'planes are landing she travels at 30 knots and everyone is busy — the men on the bridge, the men in the engine room and of course the pilots who have the tricky job of putting their aircraft down safely. In fact no matter what your job in a carrier you'll lead a full and interesting life.

For a good job with good pay and prospects, plenty of sport and a chance to see the world — you can't beat the Navy. If you are between 15-16 or 17-23 call at any Combined Recruiting Centre or write D.N.R., Dept. AK 148, Admiralty, S.W.1.

Make the
ROYAL NAVY
your career

Use CROID — the modern glue

With CROID handy, you can mend practically anything in the home. For craftwork, CROID 'AERO' completely outmodes the old glue-pot. CROID is the expert's glue for the handyman's use, needs no preparation, and always makes a clean steadfast job.

For Home, Hobby, or Factory

CROID LIMITED, 109, KINGSWAY, LONDON, W.C.2

Hobbies

WEEKLY

CONTENTS

	Page
Model Roman War Machine	- 113
Model-making Suggestions	- 115
Building Bricks	- 117
Camping Hints	- 118
Simple Inkstands	- 119
Netted String Bag	- 120
An Adjustable Lamp	- 121
Vertical Bicycle Stand	- 122

June 23rd, 1948

Price Threepence

Vol. 106 No. 2747

MODEL ROMAN WAR MACHINE

WE publish this week the third of our series of Roman war machines—the "Trebucket." This piece of Roman artillery was used for hurling large pieces of stone or rock into the ranks of the enemy, and it was fashioned like a catapult, as our illustration shows.

Like the one published previously, it relied upon the sudden release of a great beam for its propulsive force, a huge stone suspended from one end acting in place of the mechanical spring of the ballista which was used for arrow throwing.

The principle of the machine, can be easily understood from our sketch. At one end of this arm was suspended the weight consisting of a huge stone, while to the longer other end of the arm a kind of sling was attached, a leather "pocket" holding the missile which was discharged when the arm was released and thrown upwards.

The general outline and construction of the framing etc., can be gathered from the side view, Fig. 1, while the first stage in the actual building up is shown in Fig. 2. The two main rails (A), measure 9½ ins. long and are ¾ in. square. Indeed, all the framing is cut from wood of the latter section.

The cross rail, B, is 7 ins. long and is halved into A, as seen in the circled diagram Fig. 2.

The two uprights, C, measure 6 in., stand at the junction of A and B; and are glued and pinned through from below. To hold these uprights rigidly in place, add four braces, D, each 5¼ ins. long.

The feet of the braces are recesses

into rails, A, in either one of the two methods shown in Fig. 1, while the top ends of them are cut tapered and are notched into the uprights, C. They are held by long fret pins or thin wire nails.

The six crossbars forming steps on

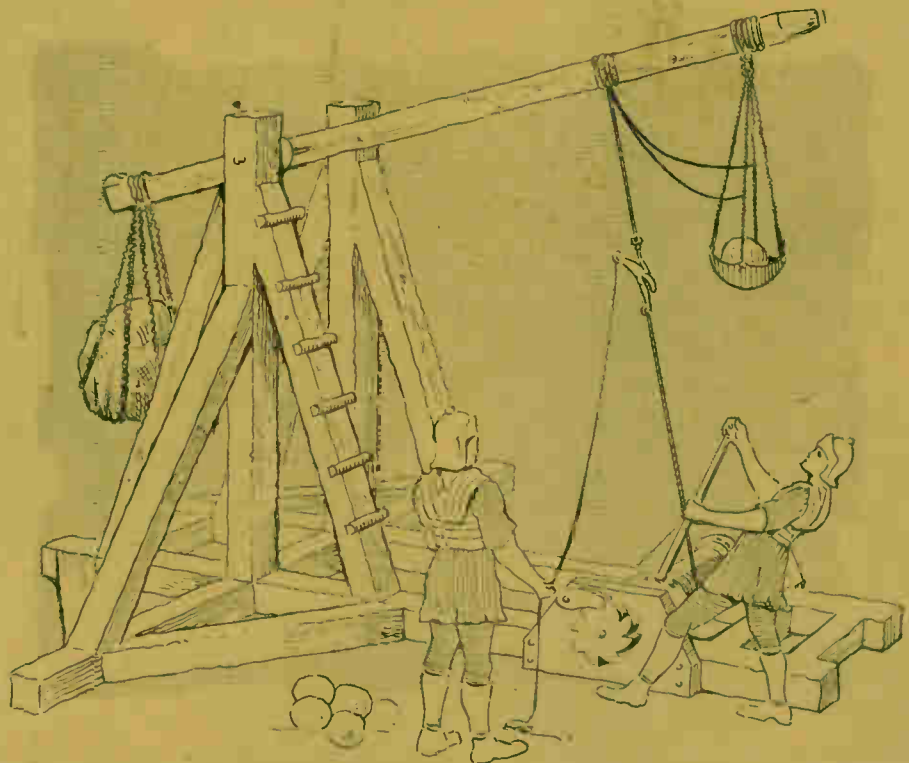

All correspondence should be addressed to The Editor, Hobbies Weekly, Dereham, Norfolk.

one of the uprights, D, are intended as access to the release hook. Each step is $\frac{3}{4}$ in. long, shaped as shown in Fig. 1, and glued and pinned on at $\frac{1}{4}$ in. intervals measured from centre to centre. These steps, however, should not be added until later.

The two side sloping braces, G, may be added next. They are $4\frac{1}{2}$ ins. long

through the two uprights and loosely through the arm.

On the insides of the uprights, between which the arm moves, there must be fixed washers or spacing blocks to keep the arm central on its pivot wire. These are $\frac{1}{4}$ in. thick and $\frac{1}{2}$ in. in diameter (see Fig. 3). On the lower end of the arm and at the extreme tip is a small block of wood which will hold the cords of the weight in place (see Fig. 1).
Now turn to the winch and its various parts seen in Fig. 3. Two shaped supports, I, are first made from $\frac{1}{4}$ in.

A clearance must be allowed between hub and upright so the drum revolves freely. The hubs will, of course, be a fixture on the drum, one end of which will project $\frac{1}{4}$ in. where the ratchet wheel will be glued on.

The ratchet wheel (Fig. 6), can be cut with the fretsaw as also will other shaped parts. First cut or mark out a true circle $\frac{3}{4}$ in. in diameter and mark across the diagonal lines as shown in the figure. Then describe an inner circle $\frac{1}{4}$ in. in diameter as the dotted lines again show. Form the shaped teeth of the wheel by carrying lines from one extremity to the inner line of the circle.

Glue this to the drum end and run in a round-headed screw as an additional fixing. Preferably, use a round wooden dowel pin which has been previously dipped into glue. The end of the wooden pin can be cleaned

Fig. 1 Side view of completed machine

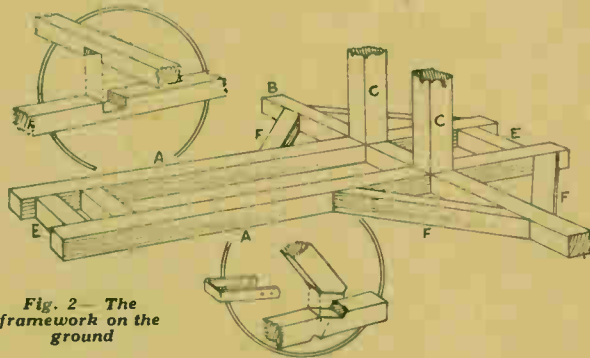
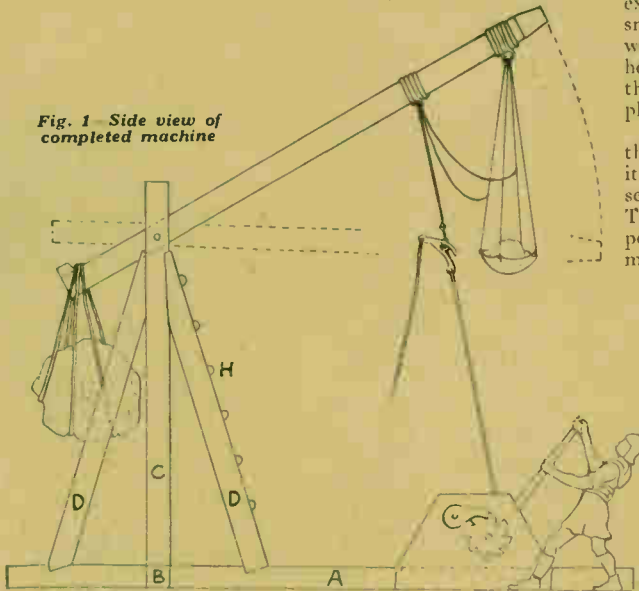

Fig. 2 The framework on the ground

and cut and framed into the other rails and posts in a similar manner to the other sloping members.

The three short rails, E, are each $\frac{3}{4}$ in. long and are glued and pinned into the rails, A, at the points indicated in Fig. 2. The four braces, F, run at an angle of 45 degrees with rails A and B and measure $2\frac{1}{2}$ ins. long. The two ends of each brace are cut to the angle mentioned to fit properly at the eight points.

The circled diagram below at Fig. 1, shows the type of joint which could be made at the feet of the sloping braces. The little stirrup irons are represented by pieces of tin cut to length, angled up and fixed with fret pins.

The moving arm of the model measures $8\frac{1}{2}$ ins. long. Measuring $1\frac{1}{2}$ ins. from one end, bore a hole to take the pivot wire. This is later driven

wood to the outline given in Fig. 4. Bore or cut the hole a full $\frac{3}{4}$ in. diameter for the ends of the drum to go through, and then attach the two pieces by glue and pins to the rail, A, $1\frac{1}{2}$ ins. from the extreme ends.

Next make two capstan-like hubs (Fig. 5), by gluing together three pieces of wood. Two are $\frac{1}{4}$ in. thick plain discs with $\frac{3}{4}$ in. holes in the centre, and one is $\frac{3}{16}$ in. thick disc cut with eight recesses, each measuring $\frac{3}{16}$ in. wide as seen in Fig. 5.

The winding drum is a plain piece of round rod $\frac{1}{4}$ in. in diameter and $2\frac{1}{2}$ ins. long. On this are glued the hubs juts mentioned. It will be understood that in assembling, the drum will have to be threaded through first one of the uprights, I, and the hubs then passed over it before the corresponding end of the drum is carried through the second upright, I.

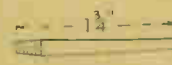

Fig. 7 (Top) The lever handle

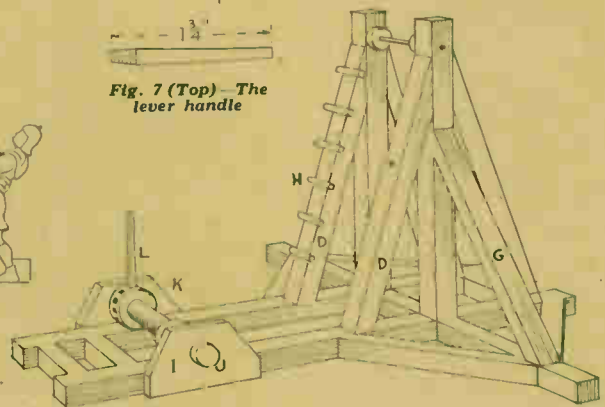

Fig. 3 Winding drum and ladder



Fig. 4 Winding drum sides



Fig. 5 Winding drum



Fig. 6 Pawl and ratchet

off flush with the ratchet wheel at completion.

A pawl to cog in with the ratchet wheel can be made from $\frac{3}{16}$ in. wood (see Fig. 6). It must work loosely on a round-head screw driven in the support, so it meshes into the teeth of the ratchet wheel.

The kind of lever suggested for pulling round the drum is shown in Fig. 7, and at L in Fig. 3. If two are being made, they can be cut from $\frac{3}{16}$ in. wood and shaped at one end to fit into the slots in the drum.

Some little way from the attachment of the sling on the arm is the release arrangement. It consists of a double action hook so that when the arm is lowered by means of the winch, this hook is actuated by the rope attached to it and pulled downwards. Its sudden release throws the arm upwards and its missile then ejected with some force.

For working alone or in groups here are some useful MODEL SUGGESTIONS

THE difficulty of obtaining the fancy wood which was so readily available before the war, certainly presents a present problem to many of our readers. It should not however, be insuperable, but they must compromise with circumstances and think out some way of utilising their small supplies with other materials more readily obtainable.

It is certainly no use giving up hobbies of this kind altogether because there are difficulties in the way at present. There is always scope and opportunity for the clever and thoughtful worker although he may have to alter his ideas, his process and his general production scheme.

Many readers would like to be able to make actual pieces of furniture, and we in turn should like to provide the instructions for doing it. It is, however, unnecessarily cruel to provide the article of instructions to people who find it impossible to get the necessary wood.

From Odds and Ends

We have to turn to something smaller, demanding merely odd bits which we may be able to pick up, and incorporating odds and ends of other materials more readily accessible. Instead of becoming irritated by the inability to obtain wood as freely as formerly, the reader should study the question of using his ability in other directions.

There is after all, a very wide range of things to do, in which the

use of the fretsaw and his knowledge of handcraft tools generally will come in exceedingly useful.

There seems to be a greater interest in scenic work just now, particularly relating to towns or villages, or even complete works layouts. There are, of course, the commercial firms which specialise in this job, and many readers will probably have seen the wonderful examples at various Exhibitions.

You have the layout for a suggested new town, or what the local park would look like under an improvement scheme. One of the local churches may be in need of funds, and a model of it makes an attractive display in an appeal. The ability of the commercial craftsman who makes these for a living is, after all, only a step further from the keen amateur who does similar work in his spare time.

The construction of these models certainly demands a little more patience than the usual and larger work, but there is a fascination in completing your own style from various "bits and pieces" which makes up for the additional labour involved. You may even specialise in this type of work as a result of your first attempts, gradually your name can become known so that offers of

work for similar jobs may come in as a result of the publicity obtained.

Your own town, for instance, must have a number of buildings which you can successfully incorporate into small models. They must, of course, be done to scale, true to life, and be to a high standard. Having completed them, there are occasions when they can be publicly shown to the admiration of those who see them, and reflecting on the ability of the maker.



(Photo by South Wales Echo)

This fine model is a splendid example of a church, built to a scale of 8ft. to 1in., and which took eight weeks to complete. It is the work of a 14 year old schoolboy - Leslie Michel, of Wyndham Str., Barry, and is a replica of the Church of St. Mary the Blessed in that town. It was greatly admired when loaned to an exhibition by the Cardiff and District Model Engineering Society.

The municipal buildings may lend themselves to such a suggestion, particularly if, as in so many cases, they dominate the town square with its tree-lined walks or gardens in front.

Preparatory Work

The preparation of the work in these cases needs just as much care as the actual work itself, and some time may be needed to produce the necessary plans and details before you can even make a start. In most cases, however, you will usually find somebody willing to help you in this direction, not only in supplying the actual plans and data, but possibly in the preparation of the layout and scale drawings.

If the model is to be of a town building, probably the local surveyor's department if approached nicely, will let you have photographs and particulars from which you can prepare your own needs. In the case of a church, the vicar or rector would be willing to help, and probably become equally interested. If you are going to make a real job of it, you may visualise even something more than a single building.

Your town may be an ancient one, and going back for many centuries would surely be an interesting model to make a replica of the place as it

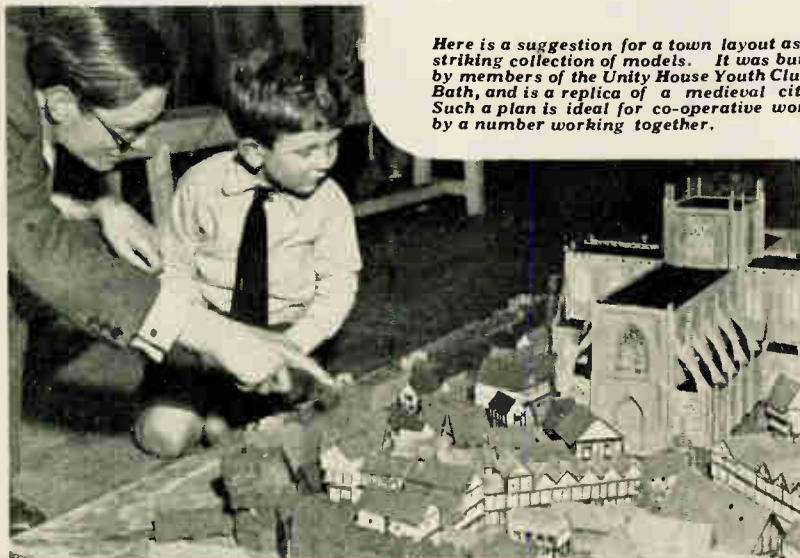

(Photo by permission of Bath Weekly Chronicle)

Here is a suggestion for a town layout as a striking collection of models. It was built by members of the Unity House Youth Club, Bath, and is a replica of a medieval city. Such a plan is ideal for co-operative work by a number working together.

might appear in the olden times. Reference books in the library will probably show you what the houses and shops looked like in the early days, and you could gradually build up the main streets and a portion of the surrounding country.

Bear in mind this question of making a large composite model before you actually start. You might otherwise begin with a model of, say,



The model maker may concentrate on small wheeled vehicles such as you see here. These were all made by R. P. Robinson of 170 Radcliffe Road, West Bridgford, (photo by permission of Nottinghamshire Guardian) a keen young man who puts in all possible detail from drawings and plans secured through the manufacturers or transport services. He includes springs, shafts, miniature engine, dashboard instruments, etc., in very realistic fashion.

a church which is really too large to incorporate into the wider panorama you hope to complete.

Seaport Models

Or again, if you live at a seaport, the local harbour works will be of sufficient interest to model up. You will get the quays, the wharves, the unloading sheds, the river and dock offices, travelling cranes, and even the ships lying at the quayside unloading with their attendant tugs, barges, tenders, etc.

In large models such as these, of course, the actual buildings and parts will be quite small, and this is an asset in some cases because the parts can be made up independently and you can spend a reasonable amount of time on each unit before putting it in

place on the background.

If, on the other hand, you are going to specialise in models only, then you can well attempt to make each one absolutely complete. The Hobbies designs are helpful in this respect, even if you have to make the model itself much smaller than provided for by the patterns.

Apart from wood, cardboard can be incorporated very often if stiffened up

can be applied, and its flat matt surface is often particularly applicable to the work in hand.

Paint to Use

If you want a glossy surface you should use the enamel lacquer paint. All of it is put on very carefully with a fine brush, and if a variety of colours is being used, then wait for one to dry before you apply another adjoining it. Another advantage of these small models is that you can use odds and ends of pieces of card which is now, like wood, difficult to obtain in really large sizes.

Use a safety razor blade in one of the holder gadgets for cutting the card, or a very sharp penknife. Sharpness is essential to get a clean, straight cut where you want it. Card need not be thick for the small models but, of course, if their size demands rigidity, then a thicker strawboard must be used and probably stiffened up inside with little blocks of wood in the angles.

Study Pictures

If you have photographs or pictures, study them well before you start on the actual building or part, and then gradually build up from your design, to be as nearly as possible like the original. If the tiny pieces are awkward to handle with the fingers, you can use a small pair of long-nosed pliers, or even fix the whole thing on the end of a knitting needle or awl to provide a handle whilst you are operating upon it.

Those who are really keen on making this type of scenic or commercial or rural layout, can read up the subject in books which have been published. The work involved is different in some ways from ordinary model making, but may form a fascinating and attractive variation which may appeal to many of our readers. Think it over and gradually work out details of a scheme.

at corners with the gummed strip paper now so largely used for wrapping parcels. In addition, of course, all kinds of wire and pieces of metal can be useful, whilst the plastic materials we mentioned in a former article—Plasticine, Pyruma, putty, etc.—are all useful adjuncts.

You will remember that the actual model will finally be painted, so there is not the same need to get the work neat and tidy. Joins must be good, but much which would otherwise show on a wooden model, can be covered by the paint being added at the end.

The best paint to use, by the way, is called poster paint, which is obtainable in small jars from good-class stationers or suppliers of artists' material. This is a water paint which

Preserving the Clothes Line

INSTEAD of winding up the clothes line and taking it into the house, it may be left on the clothes post by making up the little gadget

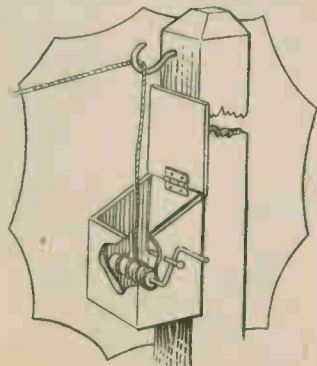

shown in the illustration. Make a box of the size and shape shown, with a hinged lid to keep out the rain. A short piece of broomstick, with a bent metal meat skewer driven into one end, makes the handle and roller. When in use, the line can be drawn tight by turning the handle, and a bolt can be placed into one of the holes bored into the side of the box to keep the reels from unwinding. When not in use the line should be wound on to the roller and the lid closed.

A Bottle Barometer

A VERY reliable barometer can be made from an empty glass jam-jar and an ordinary vinegar bottle. See that the bottle sits without wobbling when placed upside down in the jar. Mix a little red ink with water and half fill the bottle with it. Invert the jar over the bottle and

reverse, gently raising the bottle until only an inch or so of the coloured water remains in the neck. The barometer should be placed in some place where it will be easily seen—say, close to a window. When the column of water in the neck of the bottle rises to the level of the water in the jar, good weather may be expected, but when it falls to an inch or so, rain or high winds may be looked for in the near future. The state of the weather expected may be gauged by the amount of the rise and fall.

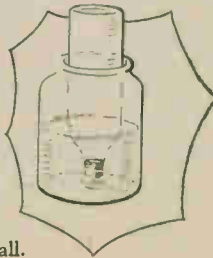

Cotton reel and home-made dowelling can form novel BUILDING BRICKS

THE novelty of this original set of bricks is that by using the small pieces of round rod, the bricks can be more or less fixed together. The dowels are made to fit fairly tight so the bricks can be fixed at various angles as will be seen in the sketch.

The little girl has made a very good attempt at a telegraph pole and you will see that many interesting things can be built up in this way. Fig. 1

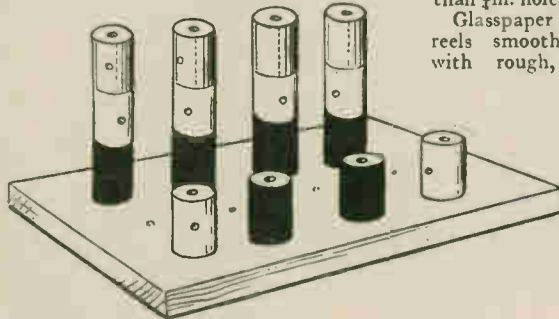

Fig. 1—The stack of "bricks" on a base

shows how to build patterns with matching colours.

Not the least attractive part of this little set is that it costs practically nothing; even odd drops of paint left over from previous jobs can be used for colouring.

The Reels

It is not essential that all the cotton reels should be the same size, but if the set is intended as a present it would be better for them to be as near as possible. It would be quite all right to have, say, six of one size and six of another in a set of a dozen.

The numbers of reels in a set depends, of course, upon the number you can collect and also upon the size of the box to contain them, but it would be advisable to aim at a round figure of one or two dozen. The "silks" reel, which is used in most homes, is an ideal size for our purpose.

Trimming the Reels

Having collected the reels, your first step is to pare away the flanges with a penknife or chisel, as shown in Fig. 2.

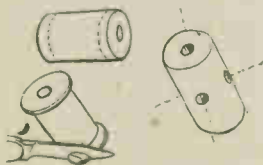

Fig. 2—Cleaning up the cotton reels

Measure the diameter of the holes in your reels and using the nearest diameter bit, bore through the sides of the reels, at right angles to each other (see Fig. 2). If you have no vice, get someone to hold the reel while you bore the holes. Your bit must be quite sharp or it is likely to split the reel in half. Most reels have slightly larger than $\frac{1}{4}$ in. holes.

Glasspaper the reels smooth, first with rough, then

with fine, and give them their first coat of paint. They are tricky things to paint and a good idea is to screw a piece of paper into a narrow spill, rather like a cigarette, and wedge it into one of the holes and hold

by this when you are painting. After painting, pin the paper to the edge of the bench, leaving the reel hanging down to dry.

Colouring the Reels

Use bright colours if you can; red, yellow, blue, green, etc., and try to have an equal number of each in each set. Varnish paint is better, but if you have only matt paint, try and spare some varnish for the final coat.

Two thin coats of varnish paint are sufficient, or two coats of matt and one of varnish. After the first coat they can be lightly glasspapered again.

The Base

The base on which the bricks are built is shown in detail in Fig. 3. An odd piece of wood from an old box will do. Make it $\frac{1}{2}$ in. thick and about 8 ins. long by 6 ins. wide. Or alternatively make it of suitable dimensions to fit the presentation box.

Holes the same diameter as those in the cotton reels can be bored,

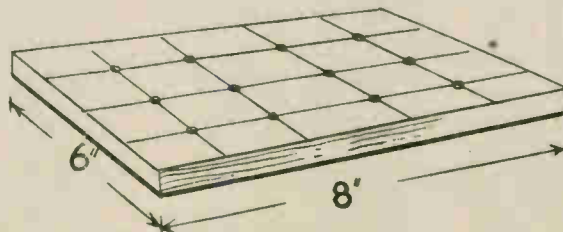
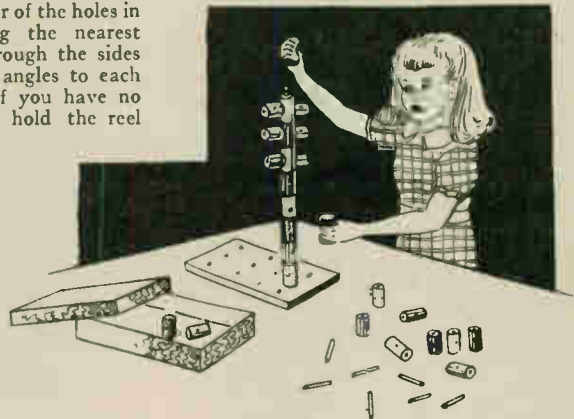

Fig. 3—How base board is squared off



preferably in line as shown in the sketch. Do not force the drill too deep or the wood will split.

Making the Dowels

The detail at Fig. 4 shows how to make your own pieces of dowelling. You may, of course, prefer to buy it ready made, but it is in such short supply that we offer this method for those who prefer it.

You will require a piece of fairly stout metal. If you cannot find a piece about the house, ask your ironmonger to cut you a small piece about 6 ins. square, or alternatively pay a visit to the nearest scrap dump.

You will need a hole the same diameter as those in the cotton reels bored in the plate, so if you buy it, ask them to do this for you.

Any odd pieces of wood can be made into dowelling, providing that the grain runs lengthwise. Fig. 4 shows the exact shape of wood, which should be fairly soft and about $\frac{1}{4}$ in. or $\frac{3}{8}$ in. square. Odd pieces from boxes can be used.

The method of making is clearly

(Continued foot of page 119)

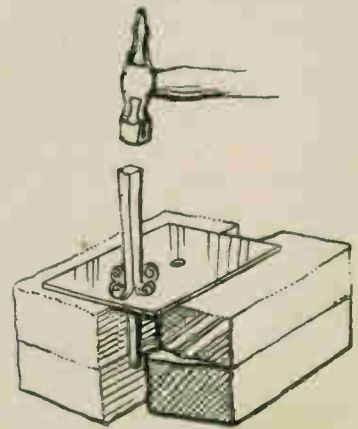

Fig. 4—Home-made dowel

Know the ropes if you want to enjoy GOOD CAMPING

CAMPING is a great out-door holiday, and it can be good fun.

The once-upon-a-time idea of camping was that you should learn to "rough it", but today "roughing-it" does not come into the scheme at all. You can enjoy all the freedom, the open-air life, and the "adventure" of spending a week or two in a little white tent under summer skies in comparative comfort.

Modern gadgets have made camp life easy. Air beds, air cushions, easy-to-run cooking stoves, nice roomy tents, modern travel facilities, and all the rest have brought camping within attainment by everybody. Of course, if you prefer to camp "rough" you can do so. And many folk—especially the young people—get a "kick" out of it.

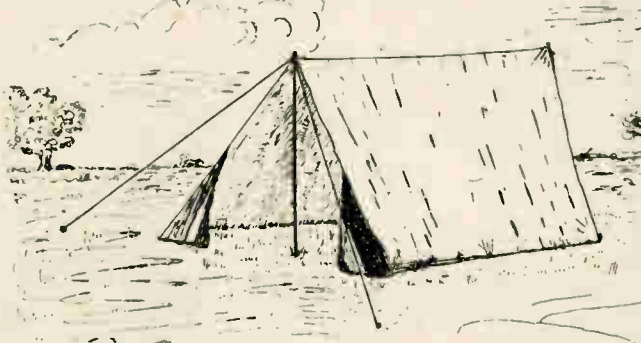

A wall-less tent 6½ ft. long, 4½ ft. wide and 4 ft. to the ridge

First, size of party. Limit your company to just a few members likely to prove a happy family. If your tent is overcrowded, comfort goes out of the door. Then set up a sort of rota, so each member knows his or her own "chores". All must be willing to do a fair share of the daily tasks in keeping the place tidy, in washing up after meals, and so on.

If one member is a good cook and likes the job, then you have a volunteer worth a lot. Well-cooked food and appetising dinners make a difference. "Scratch" meals at every end and turn pall in a while; you should have at least one really good wholesome meal each day.

Pool your Foodstuff

In these days of rations it is often necessary to "pool" foodstuffs, and to make the best of what there is, leaving the matter to an ingenious cook. That "too many cooks spoil the broth" is literally true when you are living under canvas.

If you intend to camp "comfy" be sure that your tent is a roomy one, for cramped quarters make you miserable. A good type of canvas dwelling is the "Cottage" pattern, with walls and

fly-sheet complete. Second-hand army tents are often available, and these, if in good condition, are much cheaper, yet serve your purpose.

You can hire a tent, but it pays to buy, for a waterproof portable home will last many seasons with due care and attention. When hiring or purchasing go to a store where the choice is varied. See that your tent has ample headroom, also that it is light, compact when folded, easy to pitch and to "strike". Above all else, it must be rainproof.

Sleeping Comfort

Many beginners are prone to take too much bedding; a tent is much warmer than might be imagined. The writer has camped in the snow and taken no harm; but prefers a cowslip

bank and the warm green turf for a spot of camping. Still, it is surprising how warm a party can be even on those summer nights when the air is chilly outside.

The vital thing for warmth under canvas is to have plenty to sleep on

rather than under. Eiderdowns and sweaters are perhaps best to ensure personal warmth. Sleeping-bags are popular too, and to creep into one and snuggle down is to realise what comfort a bed can be like.

Never sleep on the ground

without a waterproof rubber ground-sheet to lay on the turf; then your palliasses and blankets, and finally your sleeping-bag or eiderdown.

Now, if you have a decent cook in camp there need be no cause for grumbling about the food. Cooking has become a simple thing with the special stoves and fuel of today. The day of continuous canned meat, tinned fruit, and tea with a smoky flavour is past. There are reliable cookers for a three or four-course

repast at any time without smell, waste, or trouble, and compact sets of utensils for all vital needs.

Never be tempted to do your cookery over a wood fire; it may be gipsy-like, but that is all you can say. The air-pressure paraffin stove, such as the well-known Primus is an excellent cooker; you can get a kettle of water boiling in a few minutes. But make a sort of shelter for it, or have it protected by a useful wind-shield.

Test the stove before going on your holiday, and take a prickler to clean the jet. A Primus or similar stove seldom gives trouble, provided it is properly fuelled and kept perfectly clean.

Do not forget your tin-opener; you can open a tin of fruit with the hatchet, but it is advisable not to have to attempt the job! As regards pots and pans, you can select these from your home stock; unbreakable dishes, cups, etc., are the best to have about camp.

The Camp

Coming to the actual camp itself, choose a patch of level ground, preferably slightly elevated, thus providing natural drainage. Shelter from wind is desirable, but do not select a spot under trees—if it rains the drippings from boughs and twigs will prove troublesome. Do not camp along the margin of a stream; for during a rainstorm it may rise suddenly and wash you away!

Choose secluded surroundings, if

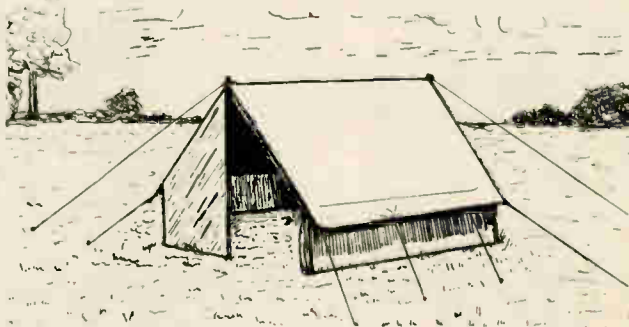

The popular "cottage" type, 7 ft. long, 6 ft. wide, 2 ft. walls

possible. Clear away from tent site all leaves, thorns, and long grass. Slacken the tent guy-ropes in the evening and tighten again next morning; then you need fear neither wind or rain.

In wet weather avoid touching the roof of the tent; but it is better to have an additional fly-sheet over your tent to ensure keeping your "house" free from raindrops seeping through the roof.

It does not take much wood to make these SIMPLE INKSTANDS

HERE are two little inkstands, easy to make, and the simplicity of their construction makes them at once attractive. Both stands are designed to take some simple form of ink bottle. If square glass ones, as depicted in our two illustrations, can be obtained, then the finished appearance is greatly enhanced. One design also has space allowed for a calendar pad which should be found useful for quick reference.

The fretsaw will be the primary tool in the making up of these stands, other tools required will consist merely of these usually found in any household. Sheets of coarse and fine glasspaper are essential, with small files, perhaps, for the cleaning off of certain surfaces after fret-cutting.

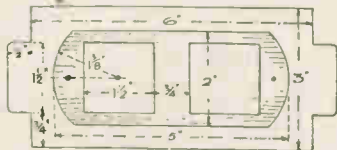

Fig. 2—Shape of bases

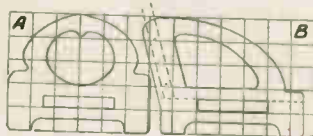

Fig. 3—Outline of ends

The actual finish to be put upon the wood at completion will not be dealt with here because so much depends upon the kind of wood used.

Looking at the design marked, A, in Fig. 1, we see a plain base with a raised overlay piece attached to it to form a recess in which the bottles will stand. The attractiveness of this stand, however, is in the fretted ends which are tenoned to the base for sake of strength.

In Fig. 2 a plan of the two parts of the base is shown, the overlay piece

with squares cut in it being put in the actual position it will ultimately take when glued on. Follow the measurements carefully in the draughting out, whether this be done direct on the wood or on to paper.

It would, perhaps, be preferable to use the latter course so the paper pattern can be used again for future use if a number of the stands are contemplated. The outlines can thus be transferred to the wood by means of carbon paper placed beneath the actual tracing of the parts.

We would recommend 3/16in. or 1/4in. wood for the main base bearing the tenons and 1/4in. thick stuff for the overlay. The uprights or ends for both designs, A and B, are shown in Fig. 3. The squares drawn across



Fig. 4—The calendar back support

these outlines are represented as being 1/4in., so by marking out a similar number of squares full size and drawing the interior work through them by following each square meanwhile, a true outline is produced.

A tracing of these outlines can then be made and used as a pattern for transferring to the wood. The length of the mortises in the uprights should be checked with that of the tenons on the base piece, and here a good close fit should be aimed at so that a perfectly rigid job is made after the parts have been glued together.

Further to stiffen the end uprights with the base, glued blocks may be added underneath in the angles each end. Two wire hooks, inserted in the front edge of the base piece would make a suitable pen rest.

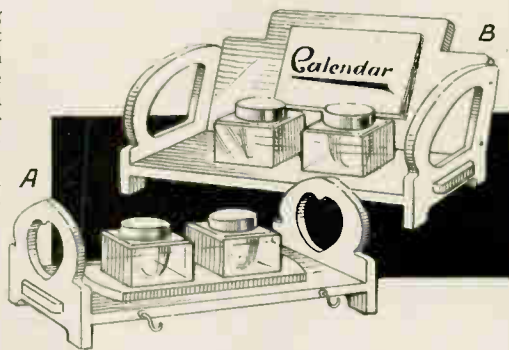

Fig. 1—Two forms of stand—easy to make

Design B, in Fig. 1, is very similar in construction to the foregoing. The floor in fact is exactly like that of design, A, only it has the two square openings cut from it instead of from a covering overlay. Then to take the ink bottles, or rather, to make a floor for them, a square of wood measuring 4ins. by 1 1/2ins. minimum is glued on underneath. The end uprights for this design are shown at, B, in Fig. 3, and the enlargement to full-size has already been dealt with.

Shaped Ends

These ends will be cut from the 1/4in. or 3/16in. wood and note must be made again regarding the checking of the mortises with the tenons on the floor. The sloping back, to which the calendar pad is attached, is shown drawn to scale in Fig. 4. This simple outline is made on paper or direct on to the wood and cut round and fitted between the ends as seen by the dotted lines in Fig. 3.

Note should be made that the bottom edge of the sloping back piece must be chamfered to fit on to the floor. A small plane would make a clean job of this or a file would do the work just as well. It should be advised that all flat surfaces be glasspapered clean and smooth before the assembling is taken in hand.

Building Bricks—(Continued from page 117)

shown in Fig. 4. Lay the plate on four bricks or something equally solid and after tapering the wood, knock it through with a mallet. Knock through and cut off one piece at a time, equal to the length of your reel.

The number of pieces required is not critical, but should be at least equal to the number of reels in a set. You will also require a few pieces half the length of the reels and a few about three-quarter the length.

You then have enough pieces of

different lengths to meet every requirement when building. One word of warning—make sure that the dowelling is not loose in the reels, at least not in those holes that have been bored in the sides.

Do not paint the dowels. Clean them up after cutting with fine glasspaper and if an odd one is found to be loose in the reels, give it a coat of varnish or polish.

Your cardboard or light wooden box should be nicely finished by covering with coloured paper. Pay

particular attention to the finish because it spoils the effect if the bricks themselves are well finished but presented in a shoddy box.

Pack the bricks neatly together and wrap the dowels in tissue paper. Better still, try to fit in a small cardboard box to contain the dowels by themselves.

Finally try and get some coloured wrapping paper to complete the effect and you have a present which will be much appreciated by any youngster whether girl or boy.

This article takes you to the stage of making A NETTED STRING BAG

READERS who have been interested in the previous two articles on netting may care to use their knowledge in making a bag. Such bags are very handy as they hold quite a lot of the right size of goods of course, and can, when not required, be crumpled in a small space and tucked away in the pocket or the shopping bag. Their use as union nets, also, is well known.

A thin strong twine is a suitable material for the netting, but almost any string can be utilised for the purpose. First knot rather a long loop, say about 4ins., hang this loop on a suitable nail or hook, as in Fig. 1, A, with the knot down at the bottom.

The Operation

Pass the needle through the loop, and with the mesh stick underneath, draw tight. Press with the thumb to prevent slipping, then throw the twine to the left side, making a large loop, carry the needle round the loop A1, then through the large loop, A2, and draw tight. This is the netting knot, which has been described previously.

Withdraw the mesh stick, place

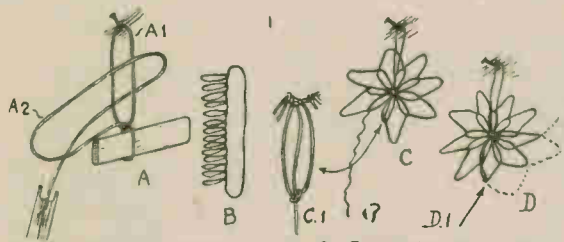

Fig. 1—The first operation Fig. 2—Continuing the meshes

again to the right of the half mesh just knotted and net a second half mesh. Continue this until the required number of half meshes are knotted on the loop, A1.

The number depends on the required size of bag, for this article it can be 16 in number, which, with a stick for 1in. meshes, will be enough for most purposes. A netted bag stretches quite a lot.

Lift the loop off the nail; it will then present, roughly, the appearance shown in sketch B. Cut the long loop with the scissors, take the ends and tie, drawing the row of loops, or half meshes, to a circle.

Hanging Loops

Tie the ends of the loop again, thus making an extra loop which is required for hanging the work on the nail again, ready to continue the netting. This latter loop is required only for that purpose, and has nothing

whatever to do with the subsequent work.

Fig. 2, C, shows the ring of half meshes suspended from the nail. To continue, draw the twine down to the bottom of the nearest half mesh, as shown at C1, and there knot it, using the netting knot once again, but omitting the mesh stick. Quite easy this.

Forming the Meshes

Just hold the double twine together at the bottom of the half mesh with the thumb and finger, to prevent slipping, then pass the needle through the half mesh and make the knot as previously described. Then, with the mesh stick, work a row of meshes all round, as at C, Fig. 2. The number of meshes is shown only as 8 in the sketch, for clarity, actually it will be 16 of course, or whatever number is chosen.

When the row is completed, carry the twine down to the bottom of the first mesh made, as at D1, and there knot, as done for the previous row of half meshes. Then carry on for the third row, as shown by dotted lines at D.

Continue the work, repeating the

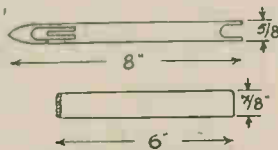
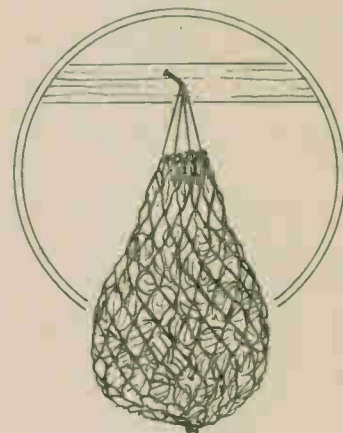

Fig. 3—Suitable stick and needle

process described, until the bag is long enough for the purpose it is destined for. Remove from the nail and tie off, at the same time cut off the loop at the bottom, used for suspending the work while in progress.

The bag is finished off, running either a strong piece of string or a cord through the top row of loops for hanging the bag up, and also drawing the mouth of it together. Allow enough cord to permit the bag to be



opened to its fullest extent.

The mesh of such bags will depend on the goods they are required to hold to some extent at least. Quite a large mesh would do for holding parcels or green stuff, while for small onions, etc. a mesh of 7/8 in. would be none too small. For all ordinary use, that is, shopping and holding average size onions and other vegetables, a mesh of 1in. would serve.

Stick and Needle

At Fig. 3, a suitable mesh stick and needle are shown, just right for the bag described. Both can be cut with the fretsaw from 3/4 in. thick hardwood. Glasspaper to smoothness for ease of working. The shape of needle shown is optional; readers can use one of the pattern described in the previous articles just as well.

One thing in favour of the needle illustrated is that its particular shape certainly holds the twine firmer, and there is no gap at the pointed end to catch in the work, which cannot be said of the shuttle type.

Readers who may desire to make one of these bags as a present, should not overlook the possibilities of thin coloured cord, like that known as macramé. It can be had in green and red, also other colours, and makes a definitely more pleasing article than the twine can. It is obtainable from most art and craft shops.

Doll's House Garden Paths

IF you have made a doll's house and want to add the paths here is a good tip. First get a piece of sack-cloth and cut it to any width or length required. Smear it with glue, then sprinkle some sand or sawdust all over. Sand is preferred, but either give a very realistic effect.

Keeping Paint Brushes Soft

PAINT brushes can be made to last much longer if, after use, they are cleaned in turpentine and then rinsed first in soda water and then in clear water. They can be reshaped with the fingers. If they are going to be put away, moisten the bristles with linseed oil to keep them soft and pliable.

For bench work, reading or writing you will find advantage in AN ADJUSTABLE LAMP

THE usual adjustable lamp is certainly very useful, but quite expensive, so the amateur may be pleased to make one for himself. The illustration shows it in use, and you can imagine the many occasions it will be of service when reading, model making, etc. Only ordinary material and odds and ends are needed in its construction.

The base consists of a hexagon inscribed in a 6in. circle, on which is mounted a roofed wooden cylinder of 3in. wide diameter (see Fig. 1) containing the weight. The three little feet beneath may be covered with baize to prevent their scratching a polished surface.

Weighted Base

A suitable weight, which should be approximately 2 lbs., can be made by melting pieces of lead pipe in a tin of the right diameter. The tin is then cut with a hacksaw $\frac{1}{4}$ in. above the surface of the lead, and the sides bent flat. A ready-made weight to fit inside the cylinder, such as that supplied with kitchen scales, may be used.

The cylinder in which the weight is retained is made of $\frac{1}{4}$ in. thick wood, using a coarse blade for cutting. The height is made equal to the height of the weight (approximately 1in. if possible). The lid and the cylinder should be glasspapered together before gluing, thereby maintaining the same diameter.

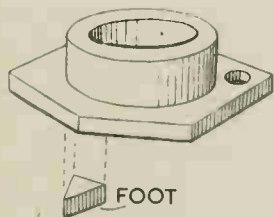

Fig. 1—The base assembly

There are three arms and their construction will be dealt with from the base upwards. All are constructed from $\frac{1}{4}$ in. by 1in. lath or similar wood, nicely smoothed. The first arm is 12ins. long from the square end to the centre of the bolt hole (see Fig. 2). When cut out, the pieces are glued, and after they have finished drying, they are smoothed

together and the corners nicely rounded off.

It is advisable to burn the holes rather than drill them, and this should be done with a piece of metal of the same diameter as the bolt to be used.

The construction of the second and shorter arm is exactly as the other, except that the distance between the holes is only 6ins. The construction of the top arm is as the first. At the square end of this arm, however, is glued the bulb holder which is cut from $\frac{3}{16}$ in. plywood, and a suggested size is shown at Fig. 3, where the circular hole is for the bulb and the dotted lines indicate the arm end. The arm itself is 6ins. long from the square end to the bolt hole.

Commencing Assembly

With parts completed we can commence assembly. The cylinder is glued on to the base, and the weight placed inside. A thin $1\frac{1}{2}$ or 2in. screw is passed through the centre of the cylinder lid and into the centre of the lowest arm, which is also glued to the lid.

The lid itself is glued to the cylinder, and a frame of four pieces of quarter round wood is glued at the base of the arm, as you can see in the picture of

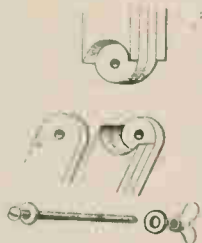

Fig. 2—How the joints work

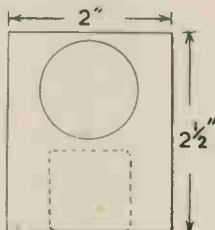

Fig. 3—The bulb-holder plate

the finished article. The second arm can then be bolted to the longer upright one, to be movable when the wing nut is slightly loosened.

Now glue the bulb holder to the square end of the top arm, which is attached to the lower one. Remember in making up the plate, the outside laths of the bottom and top arms are made longer, the inside laths



shorter. In the centre arm, the outer laths are shorter, the inside laths longer. This, and the way the ends are shaped, is shown in the diagram at Fig. 2.

In wiring up, the flex is passed through the hole in the base, a screw-eye in the side of the cylinder, through a screw-eye each side of each knuckle joint, and so to the bulb socket. The article is ready when the bulb holder is fixed.

Lamp and Shade

Type of lamp shade depends on the work for which the lamp is required. A wide beam for art and photographic purposes is obtained from a flattish cone, constructed from a circle of stiff paper 6ins. in diameter. The cut-out segment, if cut at a small angle, gives a flat reflector; if at a large angle, it gives more of a shade. The shape of bulb holder, before bending is shown at Fig. 3.

A concentrated beam for sewing, reading, etc., is obtained by forming a cylinder around the bulb. The back or end can be made of a suitable tin lid about 4ins. diameter, with the central hole cut out with a metal cutting fretsaw blade. This should leave at least an inch space round the bulb. In all cases the outside of the shade should be painted black, and the inside silver, thereby giving good reflection.

The arms and base should be finished in a pleasing shade of enamel or, if a good quality wood has been used, can be stained and varnished or polished.

Back numbers of Hobbies Weekly do not contain supplement Design Sheets, but they can be obtained separately, price 6d.

Details how the handyman can make a VERTICAL BIKE STAND

A NUMBER of cyclists, appreciating the compactness and the convenience of the vertical cycle racks provided by firms for the machines of employees, have asked for details of a similar form of rack, or stand, for a single bike. It is presumed, of course, that such a stand will require less space than the normal, horizontal stands, details of which we have already printed in these pages.

Now, in the case of a number of machines, there is certainly a great saving of space. The large, all-metal racks provided by firms are double-sided, and a single span-roof, consisting of corrugated iron sheeting, protects all the bikes. The roof is central with the racks, supported by central uprights only. The bike racks are lined up on each side, with good space between them for handling the bikes.

Almost any size of bike can be put up on the racks. Let it be realized however, that vertical racks, in any shape or form, are for the temporary housing of bicycles. A glance at Fig. 2 shows that all the weight is carried by the rear wheel—not only the weight, but also the balance or side support. The wheel holds the machine upright.

You see the drawbacks? Vertical stands are useless for the housing of bikes for long periods. And in respect to single machines, a great deal of space is not saved, because one cannot have the bike absolutely vertical.

A Wooden Stand

However, as it is our policy to try and please readers in every possible way, we give details of a simple, but practical, rack, built entirely from wood.

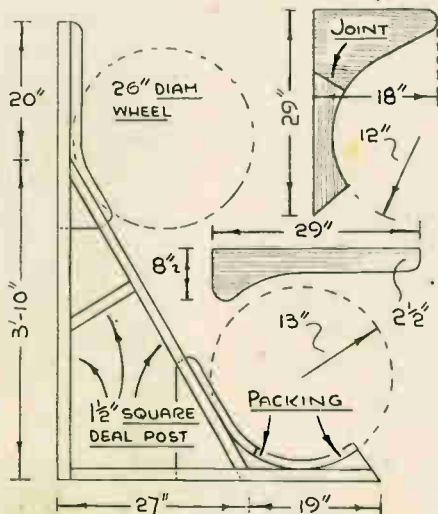

Fig. 1—Shape and size of parts

The rack consists of a framework built from 1 1/2 in. square post. The main upright is 5ft. 6ins. long, butt-nailed to a bottom piece 3ft. 10ins. long. These parts are then fixed against the wall and ground with heavy nails in the position required. The best place is near an adjoining building or shed, i.e., at a corner. Allow sufficient space for the handlebars of the bike which should not touch the wall.

A diagonal piece is fitted to the upright and bottom pieces. If the amount of tilt is marked on the wood, the length can be obtained with a measure. Therefore, tick off the distance of 20ins. from the top end, and the distance of 19ins. from the bottom end of the framework.

Having cut the diagonal piece to fit in place correctly, it is secured with screws or nails driven in slantwise, then the small crossbar added. All this is shown clearly at Fig. 1. Incidentally, this size of frame is suitable for machines having 26ins. diameter tyres, with an overall length of about 5ft. 6ins.

The Side Pieces

When the general framework has been assembled, a curvature, for the rear wheel, must be provided, using shaped pieces of 1 1/2 in. wood. The packing pieces, shaped to a 13in. radius, as shown, are glued and nailed in place.

The bottom side pieces are then prepared, cutting these from 1/2 in. or 3/4 in. wood. It will be necessary to build these up to size by means of a joint, as detailed. Note that the curve is made to a 12in. radius which forms a groove for the tyre only. If the rim of the wheel is to be held by the side pieces, a shorter radius is essential, such as 11ins. Be sure, consequently, to bear this in mind.

If you want the bike supported by its tyres only, have the side pieces cut to a 12in. radius. If you want a wheel rim support, cut to an 11in. radius. The latter gives a deeper groove for the wheels.

The sides, when shaped, are affixed with glue and screws in the manner shown. The top side pieces may be cut conveniently from lengths of 8in. wide board. The bike stand, when finished, is shown at Fig. 2. This view shows the maximum amount of tilt, but if space is still rather limited, a slightly more acute tilt is possible. This will have to be decided before construction commences.

Of course, the bike stand will need to be roofed in some way. A very narrow, tilted

roof, could be easily arranged, covered with old boards and roofing felt. There is no need to cover the exposed side and entrance end of the stand.

Waterproof the Wood

The stand should be given a coat of creosote, and when this dries, the wood is oil painted and left to dry. Such a stand is for the temporary housing of machines only, as pointed out at the beginning. It may, nevertheless, be used as a storage for machines during winter months, providing that the tyres are kept inflated hard, particularly the rear tyre.

It may be thought that, with an open form of shed, the bike may rust badly. Some rusting will take place, but not if the exposed parts are smeared with vaseline. A greater amount of rusting usually takes place when bikes are housed in closed sheds, especially wooden sheds.

One main reason is that there is usually condensation in such sheds—a heavy form of dampness, due to the lack of a free flow of air. This dampness, created by fog, mist or rain, being trapped within the shed, is prone to settle on everything in the shed, and where metal articles are concerned, the damp air “sweats” upon it, the metal being colder.

Thus, the bike may as well be left out in a shower of rain. Unlike rain, however, the dampness gets into every nook and cranny, and whatever type of shed is used, the cyclist is advised to have exposed metal parts protected with a thin layer of vaseline, or enamelled, if re-enamelling is necessary. It is the only way to avoid the bugbear of rust.

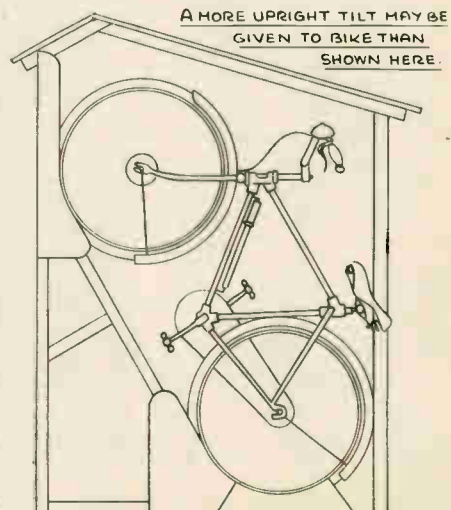

Fig. 2—A practical wooden frame

LATHES—Edwards and Drage (Tools), Ltd., specialists in all lathes and lathe equipment. Wood-working lathes—Hobbies, Coronet, Centrix and Gala. Engineers—Littlejohn 5ins., Atlas 5ins., Halifax 5ins., and Myford 3½ins. All in stock. Send us your enquiries.—131 Magdalen Road, Exeter, 56134 and 67645.

WANTED—unusual or patented design toothbrushes of years ago. Folding double-end, silver handles, etc. 7/- offered for each specimen.—Dr. Francis Blauston, 33 West 42 Street, New York 18, N.Y., U.S.A.

URGENTLY required, spare time workers to make leather goods. Apply—Dept. Y3, Somat Plastic Co., 8 Middlemarsh, Nottingham.

HAPPY Circle pen-pals bulletin, H13. Contacts everywhere.—176a Shoreham Road, Hove.

STAMPS FREE! Twenty unused (2½d.).—G. H. Barnett, Limington, Somerset.

WOOD Toymaking—a practical handbook with 180 effective designs and illustrations, 2/3 posted. **ENLARGE** your drawings mechanically with the Perfect Pantograph. Hardwood with metal fittings. With instructions 6/6 posted.—Industries, 2 Waldegrave Park, Twickenham.

BRITISH Colonial sets free. Send 2½d. requesting approvals. Large discount.—H. Rattigan, 236 Moston Lane East, Manchester 10.

CREAM laid notepaper, 8ins. by 5ins., attractively printed your address. 100 sheets 4/6, 250, 8/-—Firth, 38 Soho Street, Salford 5.

SEND S.A.E. for list of popular 1½/- designs.—BCM, Easiplan, London, W.C.1.

PERSPEKT! The really profitable pastime. Outfit includes tools, lessons, plans, polishes, transfers, adhesive, clear and coloured Perspex for making the articles. Make your own gifts. Stamped addressed envelope brings full particulars.—White, 2 Alexander St., Coatbridge.

PERSONS required immediately to make leather shopping bags in spare time. Write—Dept. 11, Empire Co., 117 Nottingham Road, Loughborough.

LOOK! 100 different British Colonial stamps 1/3. Bargain lots 5/-, 10/- and £1. Packets and sets for Beginners and Junior collectors. Approvals on request. Write now to—W. E. G. Smith, "Clarendon", Brettell Lane, Stourbridge.

LONELY? Join Friendship Circle. Details 6d.—Secretary, 34 Honeywell Road, London, S.W.11.

CHARGING Sets. Petrol, new condition 288 watts. J.A.P. air cooled engine Model 2A governed complete with switchboard. £14, 10/0 carr. paid.—Parker, St. Peter's Power House, Jersey, C.I.

NEW waterproof cycling jackets 10/-. American army lumber jackets 15/-. No coupons, war surplus.—BM GMKT, London, W.C.1.

BE Taller. Quickly! Safely! **P**Privately! No appliances—no tablets—no dieting. Details 6d. stamp.—Malcolm Ross, Height Specialist, BCM, HYTE, London, W.C.1.

LONELY? Then write Secretary U.C.C., 5B.B. Hay St., Braughing, Herts. Genuine. Est. 1905.

MODELS: you can make lasting stone-hard models with Sankey's Pyram Plastic Cement. Supplied in tins by Ironmongers, Hardwaremen and Builders' Merchants. Ask for instruction leaflet.

TRANSFERS for decorating toys, trays, furniture, fancy goods. Selection 10/- 20/-. Flowers, pixies, dogs, nursery rhymes.—H. Axon Harrison, Jersey.

PERSONS required make fancy goods at home. Write for details.—Melton Manufacturing Co., Southgate Street, Leicester.

PROFITABLE spare-time ideas, money making offers, etc. Free with 28 page "Opportunity" Magazine 9d. post free.—Hazelhurst, 25 Melrose Avenue, Hoylake, Wirral.

SET of Austrian Cuirty Stamps free to all requesting approvals (without approvals 9d.). Postage please.—H. A. Smith, 13 New Road, Scole, Diss, Norfolk.

GOOD Printing, moderate cost, prompt attention. Note-paper headings (four line address) on good quality Bond or Bank paper (according to availability) 4/6 per 100. Send stamp for catalogue.—The Zodiac Company, BCM, Crucis, London, W.C.1.

BOYS . . . Learn Magic. The boy who does tricks is always popular. Send stamp for illustrated Catalogue of tricks specially arranged so that you can do them.—The Boys Magic Service, Prestatyn, North Wales.

DOLL'S House fittings and papers, send S.A.E. for list. Doll's house plan special, send 2/6. Trade supplied.—Zimplan, 88 Ware Road, Hoddesdon.

DOLL'S House papers, model supplies, kits, plans, engines and motors. Full lists 1/-.—Sutton, Hill House Drive, Billericay.

TOYMAKERS' super Casting Moulds for lead toys and plastercraft. As used by all high class toymakers in England and abroad. Over 600 latest designs, fully illustrated catalogue 2/- P.O.—Agasee, 7 Stradbroke Road, Highbury, N.5.

PRESSED Metal wheels (balloon tyre design). Per dozen, 3in.—10d.; 1in.—1/-; 1½ins.—1/3; 2ins.—1/6. Per gross, 3in.—6/-; 1in.—7/-; 1½ins.—8/-; 2ins.—10/-—Illustrated catalogue 3d.—Jason, 135 Nags Head Road, Ponders End, Middlesex.

WHEELS for Toys in metal, wood and plastic. Numerous sizes and types. Write for list, stating requirements to The Joyden Toy Co., 193 Chase Side, London, N.14.

"POWER tools you can make." Famous "Popular Mechanics" plans and constructional details for building drilling machine, jig saw, band saw, lathe, etc., all from readily available materials. 12/6 only, post 7d. Illustrated lists 3,000 American Homecraft books, plans, magazines, 6d.—BCM, PUBLICATIONS (H) London, W.C.1.

THE interest in car numbers never ceases. "Where's That Car From?" containing all the car index marks alphabetically arranged. 54 pages 6d. Now in its sixth edition. From all newsagents.—Raleigh Press, Exmouth.

SPOKE Wheels, treaded tyres, 8ins., 9ins. and 12ins. overall diameter. Also rubber tyred metal disc wheels ranging from 2ins. to 9ins. Small or large quantities supplied. Write requirements.—Joyden Toy Co., 193 Chase Side, London, N.14.

W. McGARRIGLE for aeroplane and ship kits. All accessories, stamps lists 3d., wholesale lists 4d.—64 Hillcrest Road, Romford.

SPECIAL offer. Attractive stamp album 50 stamps, packet of mounts. Post free 3/—Gamut (Dept. C), Supplies Co., 24 Gunnersbury Avenue, London, W.5.

FREE! Extra special Br. Col. packet scarce Jubilee, Coronation, Victory, Zoological new issue stamps. Request approvals (2½d.).—Thompson, 2 Western Gardens, London, W.5.

SHORTHAND in one week. Test lesson 3d.—Dutton's (H.B.), 92 Gt. Russell St., London, W.C.1.

SMOOTHING Planes. 5ins. and 7ins. A really efficient tool at 7/- and 9/- each respectively. Satisfaction guaranteed. Cheques and postal orders (to include 6d. for postage and packing) to Branker, Ltd., 50 Brighton Road, Purley, Surrey.

MINIATURE Naval Ship Packet of Designs for complete Fleet and Base. Price 1/- (postage 1d.).—Hobbies Ltd., Dereham, Norfolk.

GALLEON Designs. Range of 8 historical models. Plans, materials and instructions. Write for list.—Hobbies Ltd., Dereham, Norfolk.

14 IN. Wateline model Queen Elizabeth. Design (No. 2624), wood and instructions 3/6 (postage 8d.).—Hobbies Ltd., Branches and Dereham, Norfolk.

DDOUBLE Deck bus model 7½ins. long. Made from pattern sheets, 2638—price 6d. Parcel of wood 3/8, postage 8d.—Hobbies Ltd., Branches and Dereham, Norfolk.



*Get this book
- make these
MODELS*

HOUSES · SHIPS · ASHTRAYS · BOOKENDS
SIGNAL CABINS · RAILWAY STATIONS
AIRPORTS · DOCKS · RELIEF MAPS · PLAQUES
MODEL FURNITURE · INKSTANDS · PAPER
WEIGHTS · MODEL FIGURES & ANIMALS etc.

SIMPLE TO HANDLE · INEXPENSIVE

The Instruction Book illustrated tells you how to make such models as above, without special tools or skill, in Sankey's "Pyrum" Plastic Cement. This material, modelled while plastic, dries or bakes to stone-hardness, ready for painting according to instructions. Obtainable at local ironmongers, hobbies shops and art material dealers.

Get Instruction Book by sending 4d. in stamps to the address below



Dept. 3

J.H. SANKEY & SON, L^{TD}

ILFORD Est. 1857 ESSEX

STAMP COLLECTION FREE



Containing new Canadian large 10c. pictorial, fine used; Set of 5 mint 1943 Roumania, all scarce King Michael issues; 2 mint Roumania King Michael high values, 1945/6 series, 160 and 360 lei; Set of 10 France including several scarce war and Petain issues; Ceylon, Australia, Nigeria etc. All absolutely FREE to approval applicants. Enclose 2½d.

D. J. HANSON, (Dept. H.28)
Eastrington, Goole, Yorks.



BRITISH NAVAL
Telescopic Gun Sight

35%
POST-PACK
LTC. 1950

Naval Telescopes. Powerful day and night lenses with modern micrometer automatic range focus apparatus. Splendid object lens.

Approx. 15 ins. in length. Picks out objects with clarity and precision at many miles range. Made by famous instrument manufacturers. To clear, 35/- only. Post and packing 1/6. Two or more carr. free.

Complete for use. Sectional centre pole and all accessories. Thoroughly reconditioned. Sleep 8.

Height 9ft. 6 ins., circumference 44ft. £8/15/-

EX ARMY BELL TENTS

£8.15.0.

MARQUEES. 30ft. by 20ft. Height 14ft. £38/15/- complete. Also larger sizes.

EX-RAILWAY & SHIP TARPULINS. Good condition and Waterproof.

70 sq. ft., 20/-; 140 sq. ft., £2/10/-; 280 sq. ft., £5; 360 sq. ft., £6; 720 sq. ft., £12. All carr. free.

All types camping equipment. Send 1d. for List.

HEADQUARTER & GENERAL SUPPLIES LTD. (Dept. HOB.),

196-200 COLDHARBOUR LANE, Loughborough Junction, LONDON S.E.5.

RHODESIAN ROYAL VISIT FREE

WE will send you ABSOLUTELY FREE this lovely green and black two-colour stamp, which shows both our Royal Princesses (Princess Elizabeth and Princess Margaret Rose). This very beautiful stamp was only issued in April, 1947, to commemorate the Royal Visit to SOUTHERN RHODESIA during the African Royal Tour. This attractive historic stamp was on issue for a very short time only, and is now scarce. We managed to



WINDSOR STAMP CO. (Dept. 12), UCKFIELD, SUSSEX

obtain a small supply, and now have pleasure in offering one to you, ABSOLUTELY FREE, for you to add to and improve your own collection. Just send us 3d. in stamps to cover our posts, and ask for free Rhodesian Royal Visit stamp. It will be immediately sent to you with our interesting approvals.

A V & W Hobby Book :

METALCRAFT

by Wm. A. Bagley

A new edition of an old favourite.

How to make decorative and useful articles without a special workshop or expensive tools.

paper 2/6 covers

VAWSER & WILES (London) LTD.

555, Lea Bridge Road, London, E.10

NOW AVAILABLE

SHADED POLE MOTORS



—of entirely new design suitable for room heaters, fans, air units, refrigerator condensers, etc. High starting torque, silent, strong, reliable.

Two types available : 24/- & 27/- each

S.P. 200 series, 130 grm/cms. 950 R.P.M. approx.

S.P. 300 series, 400 grm/cms. 1200 R.P.M. ...

with or without mounting lugs : 200/250 volts, 50 cycles, A.C.

J. C. BURKIN

SOMERSET HOUSE, TEMPLE ST., BIRMINGHAM

HOMECRAFTS PERFECT PASTIMES

Homecrafts

Modern Materials for
CRAFTS AT HOME

Plastercraft — Leatherwork — Lampshade making — Plastics
Models — Toys — Patterns

Send 1/- for specimen copy of the magazine "Craftworker" & Catalogue of instructions, tools and materials.

HOMECRAFTS

(Dept. 17), Albion Street, BROADSTAIRS, Kent

Printed by BALDING & MANSSELL, LTD., London and Wisbech, and Published for the Proprietors, HOBBIES LTD., by HORACE MARSHALL & SON, LTD., Temple House, Tallis Street, E.C.4. Sole Agents for Australia and New Zealand : Gordon & Gotch (A'sia) Ltd. For South Africa : Central News Agency Ltd. Registered for transmission by Canadian Magazine Post.

Hobbies

WEEKLY

CONTENTS

	Page
A Car Trailer - - -	125
Portable Receivers -	127
A Beam Compass -	128
General Replies - -	129
Cigarette Casket - -	129
Mounting Photographs	130
Abrasive Papers - -	131

June 30th, 1948

Price Threepence

Vol. 106 No. 2748

A light and easy-to-make open framework CAR TRAILER

A LIGHT trailer, suitable for drawing behind a car, is illustrated. It is not difficult to build, being a straightforward job of carpentry, with very little metalwork to worry about. Some regard to the scarcity of wood is shown by the framed body part, not a great lot being required, having regard to its size.

A side elevation is shown at Fig. 1, and an end elevation at Fig. 2. The sizes given provide for a carrying capacity equal to what is generally wanted. These dimensions can be increased, if desired, without undue trouble, or amended if the underworks require it.

The Chassis

As these underworks govern, to a certain extent, the size of the body, it is advisable either to buy, or make them up, before proceeding further.

A complete chassis for the body can be bought from a London firm which specializes in these, but may be too expensive for some. A considerably cheaper affair can be arranged, if the necessary parts can be picked up, secondhand. The actual putting together is not a difficult business.

A pair of wheels, about 24ins. diameter, with pneumatic tyres will be needed. These will require a steel axle some 1in. square in section. The length of the axle should be right to ensure a wheel base of that given at Fig. 2, if the width of the body is to be kept at 3 ft.

A pair of suitable springs will also be required, strong enough to carry up to 5 cwt., or according to personal

requirements. Mud guards are also necessary. To these a drawbar must be added, fitted with a suitable hitch. If one can be bought, all the better, but otherwise a length of 1½in. angle iron will serve.

Fixing the Springs

The springs are attached to the axle with the arrangement drawn in Fig. 3, where an iron scroll clamp, as at A,

is made to embrace the axle snugly, and is held rigidly in place with a pair of U bolts, B, which cramp the spring above as well, as in detail, C. The whole assembly is quite simple. On these underworks, a chassis frame, shown at Fig. 4, is bolted.

Frame Fitting

The wood for the frame is 2ins. wide and 1½ins. thick. Fit together with

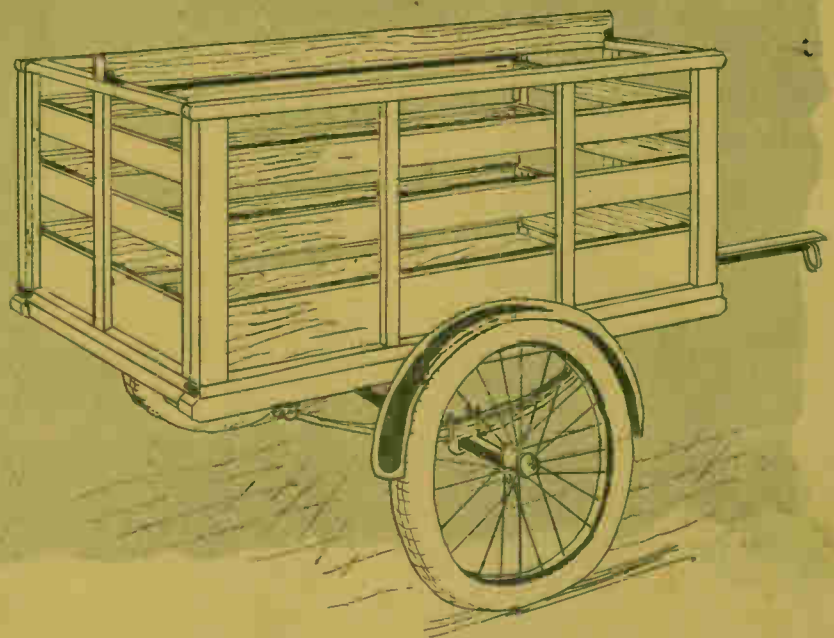

All correspondence should be addressed to The Editor, Hobbies Weekly, Dereham, Norfolk.

mortise and tenon joints, and note that the end cross rails are fixed to the side members just $\frac{1}{4}$ in. inside. The tenons are of the stub variety, entering about half way in, say 1 in. long.

Glue the parts together and lock the joints by driving a nail through each so as to penetrate the tenons at the middle. Take care to get this frame quite level. Steel corner brackets might well be added to the inside angles at the ends.

The springs are now securely screwed, or bolted to the underside of

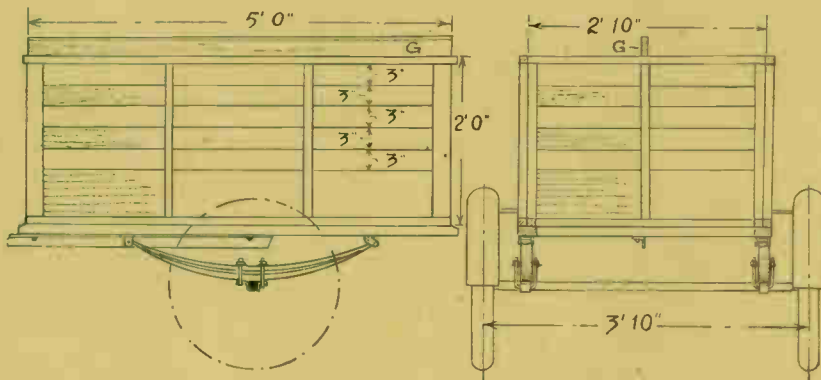

Fig. 1 & 2—Side and end view of trailer with various details

the frame. Fix, so that the axle is not dead in the centre, but 2 ins. away from the centre of the frame, towards the rear. On this frame, the body part of the trailer, now to be described, is to be screwed.

Details of the frames of the body are clearly shown in the side and rear elevations. Take the side frames first. With the exception of the end uprights, which are 1 in. by 2 $\frac{1}{2}$ ins., the rest is of 1 in. square timber.

Fixing Uprights

The top horizontals are cut 1 in. longer than the bottom, so extend $\frac{1}{2}$ in. over each end. A mortise and tenon joint is used throughout to fix the upright to the horizontals, these being 1 $\frac{1}{2}$ ins. long for the end ones and 1 in. long for the rest. They can go right through the bottom horizontals but need not be more than $\frac{1}{2}$ in. deep at the tops. Detail sketch, D, Fig. 5 shows these.

When marking off the end mortises at the top, remember to allow for the extra $\frac{1}{2}$ in. of horizontal at each end of the side frames. Glue and screw the whole firmly together.

The width of the end frames is given at Fig. 2, both being made from 1 in. square wood. The front frame

will be screwed between at one end, the rear frame is left free to draw out as may be necessary when loading, or unloading the trailer. This will be referred to further on.

The side and front frames are now screwed to the platform of the underworks. When screwing down, it is as well to insert the rear frame in place until all screws are in, to ensure this frame being a nice fit. This part of the work done, the flooring can be nailed between. Use tongued and grooved boards, if possible, for this part, any-

The horizontal boarding for the body part is prepared from boards $\frac{1}{2}$ in. thick. These are screwed on the inside, and spaced as shown in the diagrams. The actual width of the bottom boards, not given, should be obtained by measuring, after the other boards are fitted.

Mitre the ends of the boards to make a neat fit in the corners; also at the rear. Fit the rear frame in, and at the bottom corners of the body screw projecting iron plates 1 in. by 1 $\frac{1}{2}$ ins. as at F, Fig. 5, to keep the frame in place. To secure it, fit a small cup-board bolt each side at the top. Just inside the body, near to the rear frame, screw metal brackets, one each side, to stiffen this part, as shown by dotted outline, Fig. 5, E.

Tarpaulin Cover

This completes the body. It, and the chassis frame, can now be creosoted, or varnished, as preferred. It will be necessary, in most cases, to provide a tarpaulin, or other waterproof covering, as some protection in wet weather. This should be large enough to cover not only the top but also the sides and ends down to just below the opening between the bottom boards.

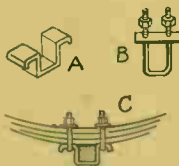

Fig. 3—Spring and clips

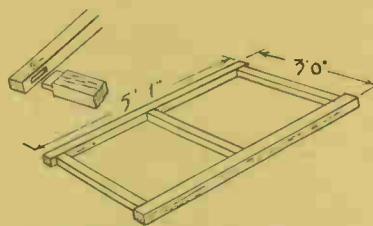

Fig. 4—Chassis frame and joint

thing between $\frac{5}{8}$ in. and $\frac{7}{8}$ in. thick. Nail the boards across, not down, and finish them 1 in. short of the rear, as at E, Fig. 5, to allow room for the frame to enter.

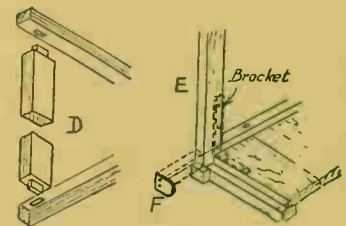

Fig. 5—Detail of joints

An addition which can usefully be added is a 1 in. by 4 in. board, G, in Figs. 1 and 2. This forces the tarpaulin cover up in the centre and allows any wet to drain off sideways. Without this addition, such waterproof covers are liable to sag in the middle and allow water to collect as a miniature pool.

Drawbar

The board is notched 1 in. by 1 in. at the bottom end corners so that it fits between and rises some 3 ins. above the body. It can be kept in position by screwing small single plates each side to form a slot for the board to enter.

The drawbar is screwed, or bolted, underneath the platform, and should project sufficiently to allow the trailer ample room for turning. The mudguards are now fitted, also the rear lamp and number plate.

TIMBER LIST

- Chassis frame sides (2)—5ft. 1in. long, 2ins. wide, 1 $\frac{1}{2}$ ins. thick.
- Chassis frame rails (3)—2ft. 10ins. long, 2ins. wide, 1 $\frac{1}{2}$ ins. thick.
- Body uprights (4)—2ft. long, 2 $\frac{1}{2}$ ins. wide, 1 in. thick.
- Body uprights (10)—2ft. long, 1 in. wide, 1 in. thick.
- Body horizontals (2)—5ft. 1 in. long, 1 in. wide, 1 in. thick.
- Body horizontals (2)—5ft. long, 1 in. wide, 1 in. thick.
- Body horizontals (4)—2ft. 10ins. long, 1 in. wide, 1 in. thick.
- Flooring— $\frac{1}{2}$ in. by 4 $\frac{1}{2}$ ins. Tongued and grooved boarding, 44ft. run.
- Side boarding— $\frac{1}{2}$ in. by 3 ins. 32ft. run.
- Side boarding— $\frac{1}{2}$ in. by 8 ins. (?) 16ft. run.

Wheels for Toys—

Here are wheels for every occasion in toy making or model making. Well turned and made in hardwood with centre hole for screw fixing. In sets of four. Obtainable from Hobbies Branches or by post from Hobbies Ltd., Dereham, Norfolk.

Wooden Wheels

- 1 $\frac{1}{2}$ in. 1/- Post 6d. up to 1 doz.
- 2 in. 1/- Post 6d. up to 1 doz.
- 2 $\frac{1}{2}$ in. 1/6 Post 6d. up to 1 doz.
- 3 in. 2/- Post 9d.
- 4 in. 3/- Post 9d.

Metal Wheels

- Disc metal wheels, with square rubber tyres. Bushed centre 2 in. diameter. 1/3 for 4 Postage 6d.
- 2 in. all metal cast wheel, painted red. With bush, washers and screws. 2/6 for 4 Postage 6d.

Construction and circuits for making your own PORTABLE RECEIVERS

IN portable receivers a frame-aerial winding takes the place of the first tuning coil. If the receiver would normally use only one coil (as when the circuit is a Detector followed by one or more amplifying stages) then no coil at all will be needed after a frame-aerial is added.

Such an aerial can be added to any receiver (except crystal sets) if space can be found for it. The receiver is then self-contained, because no external aerial or earth is needed. Therefore readers may find this worth trying, either by modifying an existing set or building a new one. The alteration of commercially-made receivers is not recommended, however.

Results to Expect

The signal pick-up is naturally less than with an outside aerial. It will

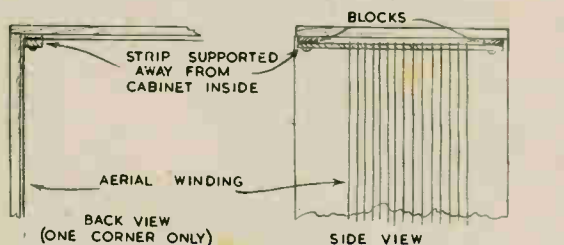

Fig. 1—Supported aerial in the cabinet

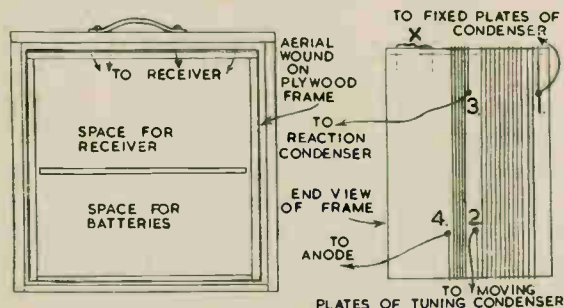

Fig. 2—The internal frame and connections

also depend on the size of the cabinet, since an aerial in a case, say, 1ft. 6ins. by 1ft. 6ins. provides a little louder results than one only 1ft. by 1ft.

As a guide, one valve will give satisfactory earphone results. Two valves will give speaker results, but on local stations only. For really good speaker results three valves are better, while a four-valve is often used when some distant stations are wanted. But it is easy to make up a frame-aerial, only fixing it in the receiver when results are found to be satisfactory.

Supporting the Wire

Fig. 1 shows a method in which four strips about $\frac{1}{4}$ in. wide are

screwed near the four corners of the cabinet. The strips extend from the front of the cabinet to the back and are spaced about $\frac{1}{2}$ in. away by the blocks shown. The wire is then threaded round and round these strips so it is supported inside the cabinet near the sides, top and bottom.

As the aerial will pass across the bottom of the cabinet, inside, batteries must not be stood on it. Instead a piece of plywood should be cut which will go in the bottom of the cabinet, so batteries may rest on this. The wood will rest upon the aerial winding, but this will not matter.

Fig. 2 shows a method in which a light plywood box-shaped frame is made up. This fits inside the cabinet with about $\frac{1}{4}$ in. space all round. It has the advantage that the wire is

slot as shown in Fig. 5. This makes a flat frame-aerial, quite efficient though slightly less so than when the wire is spaced.

Number of Turns

For Medium Waves about 75ft. of wire should be used, and if the perimeter of the cabinet is divided into this figure, the number of turns will be found. This will give about 18 turns for a cabinet 1ft. by 1ft.; or 12 $\frac{1}{2}$ turns for one 1ft. 6ins. by 1ft. 6ins. and so on. The exact number is in no way critical. If the cabinet is very small, rather less than 75ft. will be needed because the inductance increases.

Any wire between 22 and 26 S.W.G. is suitable and about $\frac{1}{4}$ in. should be left between turns. If there is insufficient space to spread the turns

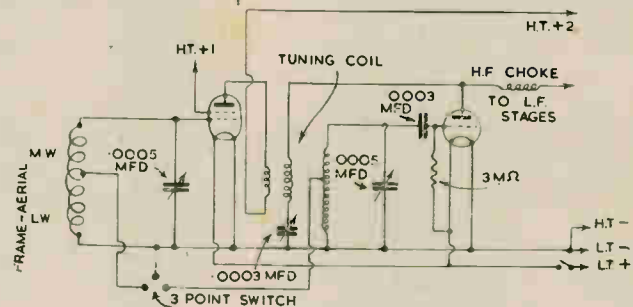

Fig. 3—A suitable circuit to make up

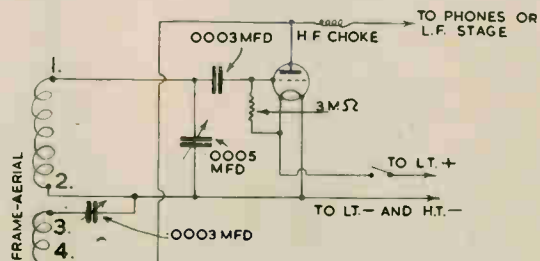

Fig. 4—Circuit for use with H.F. stage

protected and it can be wound before slipping it into the cabinet. It is the most convenient method when there is space for it.

Special Methods

With a small set in a home-made cabinet, the turns of wire can be wound directly upon the outside of the case, a long strip of American cloth being lapped completely round upon the top of the winding.

Another method is to cut a piece of plywood or thick cardboard a trifle smaller than the back of the cabinet. An odd number of slots (about 17) in. deep and $\frac{1}{4}$ in. wide should be cut round the edges of this and the wire wound in, passing it through each

out in this way, turns should be side by side and two or three less turns will then be necessary.

This forms the tuning winding, and is shown between 1 and 2 in Fig. 2. For reaction (between points 3 and 4) about one-third the turns on the tuning winding are required. Note how connections go and that both windings must be in the same direction.

If reaction is too strong, the reaction winding may be pushed away from the other winding, or the turns reduced. A space of about $\frac{1}{4}$ in. is generally suitable.

Fig. 3 shows a Detector, connections numbered to agree with Fig. 2. It could be used as a one-

valver, or one or two amplifying stages might be added for speaker reproduction.

If a H.F. stage is used, no reaction winding is needed, the winding between points 1 and 2 only being necessary, for medium waves. (This is because the tuning coil between the valves will have reaction).

If long waves are to be tuned in addition to medium waves, a second winding consisting of approximately 200ft. of finer wire, turns side by side, must be put on. This would go in the position shown by "X" in Fig. 2.

Instead of taking point 2 in Fig. 2 to the tuning condenser, it would be joined to the beginning of the long wave winding and to a wave-change switch. The end of the long wave winding would then go to the tuning condenser and to the wave-change switch, so that this section was shorted when the switch was operated for medium wave reception.

Such an arrangement is shown in Fig. 4, where a 3-point switch is used to switch both frame-aerial and coil. This also shows how the winding is simplified by having no reaction.

The frame-aerial must stand ap-

proximately vertical or it will not operate (radio waves are polarized vertically). It will pick up signals from all directions except those in line with its axis, volume being at maximum when the aerial is broad-side to the signals.

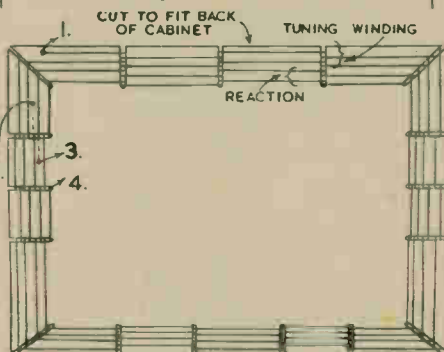

Fig. 5 Formation of a flat aerial

This is the principle of direction-finding, and if the receiver is turned about when tuned, the alteration in volume will be most noticeable. Some portables are fitted to a turntable so they can be rotated.

It is best to bring the connections through holes in the frame near the points to which they must be connected, even if this means an odd half-turn or so must be added to the winding.

The most important item is that the user should be able to advance reaction until the receiver is nearly oscillating. If this cannot be done (and neither winding is connected in "reverse") a few turns should be added to the reaction, or this winding pushed closer to the other.

Any of the valve-circuits printed in past issues of "Hobbies Weekly" may be used with such a frame-aerial. If earphone reception only is required, weight may be saved by using three or four small grid bias batteries in series for high tension, with a suitable dry battery instead of an accumulator for Low Tension.

If and when desired, an external aerial may be added by connecting it to point 1 (Fig. 2). A condenser of from .0003mfd. to .00005mfd. should for preference be added in the external aerial lead-in. This will increase volume and may be disconnected by means of a plug when the receiver is to be used as a portable.

For large circles or curves make yourself A BEAM COMPASS

READERS will find this a useful tool when large circles, or arcs of long radius are to be struck, and which are outside the scope of compasses. It is quite an easy tool to make and needs very little material. The scope of the beam compass depends, of course, on the length of the stick. This is planed to a section of $\frac{1}{4}$ in. square, and should be accurate throughout its length.

A convenient length is 2ft. 6ins. which allows of circles up to 4ft. 6ins. being struck, or arcs up to 2ft. 3ins. radius. When an extra large radius is required, which is not likely to happen often, at least not to the amateur craftsman, it is not a troublesome matter to plane up a stick long enough for the purpose.

Pencil Holder

Having prepared the stick, at some 1½ ins. from one end bore a hole through to admit the pencil. This should be $\frac{5}{16}$ in. or as near to that as possible. If a drill bit of that size is

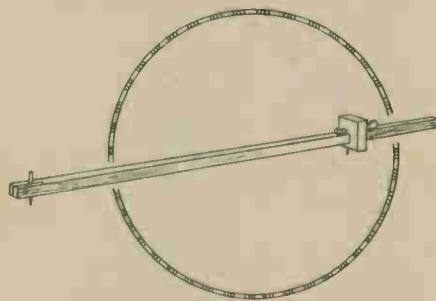

not handy, a $\frac{1}{4}$ in. hole could suffice, which could be enlarged by filing to admit the pencil, or the pencil itself be reduced in thickness by paring and glasspapering.

At right angles to this hole, and midway between it and the end of the stick, bore a second hole through, large enough to allow a brass bolt to pass by pushing.

Now, from the end of the stick, saw down the centre to just past the pencil hole, as shown in detail sketch, A. By screwing a nut to the bolt, the pencil can be securely gripped in its hole.

The sliding stock of the tool is shown at B. It is cut to the size given from a piece of $\frac{1}{4}$ in. thick wood, hardwood of some kind if possible. A small piece of beech, or mahogany, would suit nicely. Where shown cut a $\frac{1}{4}$ in. square hole right through,

by boring with a $\frac{1}{4}$ in. centre bit, and chiselling out the corners to square shape.

Smooth the inside of the hole and run it over the stick from end to end. It should travel along smoothly, and should it tend to stick at any part, owing to inequality in planing, a good rubbing with glasspaper should be resorted to.

The stock should then have a slot cut in the hole, $\frac{1}{4}$ in. wide and sloping upward from $\frac{1}{4}$ in. at one face side to $\frac{3}{16}$ in. at the other. At the bottom of the stock, exactly in the centre, drive in a 1 in. wire nail to a depth of $\frac{3}{8}$ in.

The Wedge

File off the head of the nail, and then sharpen it to a point. The stock is wedged in place on the stick, at any desired point, the shape of the wedge being shown at C.

Cut from $\frac{1}{4}$ in. thick hard, close-grained wood to the length given. Now draw a pencil line on it, sloping upwards from $\frac{1}{16}$ in. at the bottom, one end, to $\frac{1}{4}$ in. at the other.

Put in the curves at the ends, and saw out. It is as well to give the stock a coat of varnish. The stick can also be varnished, provided its fit is not so tight as to cause the stock to stick afterwards.



Forming the grip

Plan and section of slider

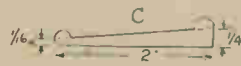

Shape of the wedge

Some replies of General Interest

Yacht Sails Material

I AM making a 3ft. racing yacht and am finding great difficulty in buying material for the sails. (F.J.P.—Slough).

THE most suitable material for the sails of a model yacht is Union silk, but if this cannot be obtained, you could use any fine strong light material such as cotton sheeting, cambric, plain natural colour case-ment curtaining, or even one of the plastic materials.

The main thing is to choose something that does not stretch readily, and is not badly affected by water.

Canoe Propelling

IS it possible to drive my home-made canoe by means of a hand-driven screw or by the same means as the jet-propelled toy boat? (R.W.—Morpeh).

YOU might be successful in driving a canoe by pedal gear, but the effort required to do so would be far greater than that expended by direct paddling in the usual way. In any case, the reaction of the "pedalling" or hand-turning movements, would cause the canoe to pitch or roll somewhat.

Initials on Leather Work

PLEASE inform me how to put initials and coloured designs on leather work. (J.F.—Stainforth).

DESIGNS are embossed on leather with a slightly warmed perfectly smooth steel stylus or round-ended pencil. This involves considerable artistic skill and dexterity if the result is to be first class.

Much work is done commercially by using embossing punches. These are made in innumerable forms, including initials (of small size). These are used by holding them in place on the leather, and striking a blow with a hammer on the punch.

Dimming Lights

COULD you tell me of any way in which I can gradually dim out the lights on a stage? (F.H.H.—Stoke-on-Trent).

TO dim the lights you must use a variable resistance, and the value and current carrying capacity of this will depend upon the number and wattage of the lamps in use. A variable resistance will be quite in order for the mains, provided it is so arranged that there is no danger from shocks, or fire due to heating. Some types of mains dimmers may be purchased ready to use.

How to make a modern attractive CIGARETTE CASKET

HERE is an attractive cigarette casket of modern style, having two compartments and a simple hinged lid. It is the unique shape of the box that makes it so attractive, and our workers should not find difficulty in making if the simple instructions given here are carried out.

Make the floor first, seen at A in the working sectional diagram in Fig. 1. This piece measures 6½ ins. by 2½ ins. and ¼ in. thick. The ends, B, are next marked out and cut 3 ins. by 2 ins., the very simple outline being got from the cross section of the box, Fig. 2.

Note here that the back top edge is somewhat higher and more blunt than the front edge. This is done to leave ample wood on the lower layer of the lid for the firm fixing of the hinges at that part.

Care should be given to the out-lining of these ends as the later shaping of the box and its lid depends upon this, see the right-hand smaller diagram in Fig. 1. It will be seen from this latter that the box can be made up almost complete. That is, the floor, the sides and the lid sections are all put together and then shaped to the ends, which virtually form shaping templates for cutting and glasspapering.

The sides, D, measure 6½ ins. by 1½ ins. by ¼ in. thick, and these can be glued to the floor and the ends, with pieces, C, of ¼ in. wood, measuring 2½ ins. by 1½ ins., glued inside the ends as the diagram top left of Fig. 1 indicates. The pieces, C, will greatly help to strengthen the construction and will form guides when gluing up the long sides of the box.

The Lid

The lid is made of two pieces of ¼ in. wood glued together, their size being 6½ ins. by 2 ins. To the underside of these pieces there must be screwed a ¼ in. or ½ in. piece of commoner wood cut to size to fit exactly inside the box.

This is intended solely as a means of

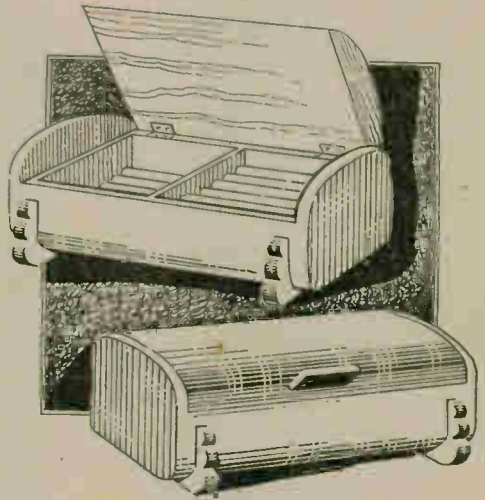

holding the lid in place, while the shaping is being carried out, see points, X, in small diagram in Fig. 1. This temporary piece can be seen as, E, in Fig. 1 and Fig. 2. The cleaning of the corners at, X, and, indeed, a good deal of the actual shaping, can be done with a small plane, and with the help of a wood or metal straight-edge or ruler, the whole process can be found not too difficult.

Cleaning and Colouring

The final cleaning is done with fine glasspaper, the finished shape of the box appearing as the section shows in Fig. 2. The temporary lid piece, E, is now removed and the lid fixed to the box by a pair of ¼ in. brass or chromium plated hinges, care being taken to cut shallow recesses in the back rail of the box to receive them.

Four shaped feet cut from ¼ in. wood and measuring 1½ ins. by 1½ ins. complete the box, the simple outline adapted being easily transferred from one piece cut as a template. Note how the feet fit on underneath the box, raising it ¼ in. off the table. A simple plain square of hard wood glued to the lid forms a handle for lifting it.

If a colour scheme is required the box part of the article can be plain, with the ends, feet and handle coated with ebonizing solution and waxed up as contrast to the other wood. A cross partition in the box of ¼ in. wood is glued centrally in place.

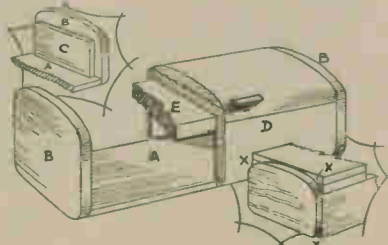

Fig. 1 Cut away constructional views

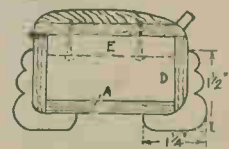

Fig. 2 End Section

There are several things to know when you are

MOUNTING PHOTOS

BEFORE delving too deeply into this interesting subject and discussing various ways and means, it will be as well first to ask the question "Why should a print be mounted?" There are at least three reasons which can be immediately put forward as answers. The first is protection, the second improvement and the third and, undoubtedly the most important, the addition of pictorial quality to the print.

Mounting is Advisable

Whether the print is a small contact or enlargement every amateur will agree that it is only by mounting it on a fairly substantial piece of card that one can hope to keep it in a good condition for any length of time. The paper on which it is printed is usually thin in substance and each time it is examined and passed to friends to be looked at, it is often subjected to handling which eventually tends to create markings, cockling and even the turning of corners or slight abrasions.

Even if it is kept in a wallet or pocket case, the edges do incline to fray each time it is removed. If it is relegated to a drawer or box and seldom looked at, well it may 'keep', but what purpose does it serve under such circumstances and why was it printed if it is never going to be seen except on special occasions?

Improvement

When thicker paper or, shall we say, thin card was introduced in our series of printing mediums, some professionals and advanced amateurs soon struck the idea that a print was improved if it was printed with a narrow white margin on each side. This proved to be exceptionally popular and the "D and P" finishers very quickly adopted the idea.

Why was this so universally favoured? Because it 'framed' the subject, for the white line on the edge was a means of preventing the eye from wandering outside the actual limits of the view. Whether the print was held at arms' length or laid on a table or pinned on the wall, the subject could be viewed as a whole without interference from other objects. This effect brings us to the third reason for mounting.

The Addition of Pictorial Quality

If instead of a white margin of only $\frac{1}{8}$ th inch wide, the print is mounted on to a piece of card which allows, say, 1in. margin, it will be found that the view becomes more enclosed or framed, and the eye finds more difficulty in wandering.

Such portions of the picture as lanes, paths, streams and even the more bulky subjects as hills and trees pass quite quietly out of the picture without any sudden detraction from the general visual interest which one experiences when examining the view.

While this white margin or blank space prevents any violent detraction from the subject, it, at the same time, has the effect of concentrating the eye on the whole of the picture. If the composition is good, you will not notice any one object such as the tree or cottage or the stream, but rather 'feel' the combination of these as a general view of a pleasing landscape which creates a sense of mental enjoyment.

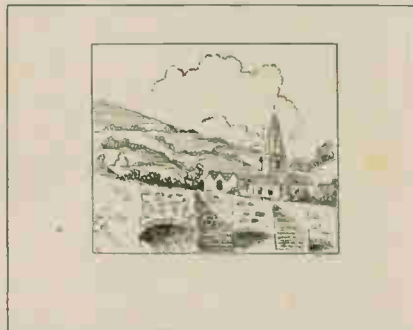

the first and this on the second and this on to the third. Finally this concentration of print and tints was mounted on to the main card. Quite honestly when the job was finished, it was often the mounting which attracted the most attention, and the actual print only came in for a small share.

Well, those ideas have passed—we hope for all time—and in place of such we have the much more sane method of using a white card only and so giving all the praise to the print. There are still, however, one or two

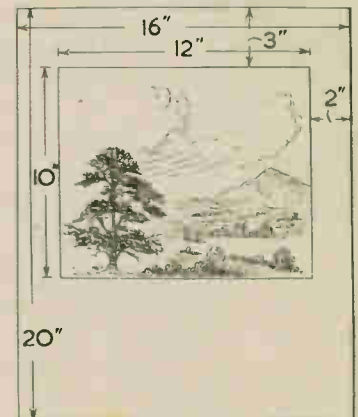

Two examples of mounting—one giving general dimensions for proportion

It encourages a desire to keep the result handy so as to examine it frequently and, perhaps, frame and give it a position on a wall in the home. In other words to live with it, and this is a sure proof that it is a good and a worth-while result.

How to Mount

So much then for the reasons for mounting. Now let us consider one or two important hints on how mounting should be best done. About twenty years ago amateurs had a fashion, which fortunately only lasted for a few years, of using several tints between the print and the main card.

To give an example, try to imagine a sepia toned enlargement to be mounted, the main mount selected was to be white, grey or light brown. The worker would look through his batch of thin papers and select two or three varying tints of brown; a light one, a medium, and one that was darker than the medium but not so dark as the main one. The first of these would be trimmed to allow it to be just about $\frac{1}{16}$ in. larger all round than the print. The second would be cut to allow for $\frac{1}{8}$ in. larger than the first tint and the third about $\frac{1}{4}$ in. larger than the first.

The print was then pasted on to

little points which have to be remembered and the chief is the 'position' of the print on the mount.

Upright or Horizontal

Most amateurs realise that an upright print should be mounted on a card having its longest measurement from top to bottom and a print of a very definite "wide" character subject, such as a long broad view of a landscape, obviously calls for 'horizontal' mounting. But if it is a woodland scene and only slightly horizontal in character, then it can be effectively mounted either way, provided there is a fair width of margin on both left and right hand sides.

It is quite impossible to give a whole range of sizes and the two examples illustrated must serve as specimens. These from actual experience have proved excellent, and if you use the measurements as a guide, then your results will undoubtedly give you and your friends satisfaction.

Some folks might be inclined to put down extravagance in the use of card, but if you have an enlargement to hang on a wall and enjoy, then do not spoil its effect by being 'stingy'.

(Continued on opposite page)

with these numbers. Further copies may be obtained.

DETAIL OF UPRIGHT SPINDLE, WASHERS, ETC.

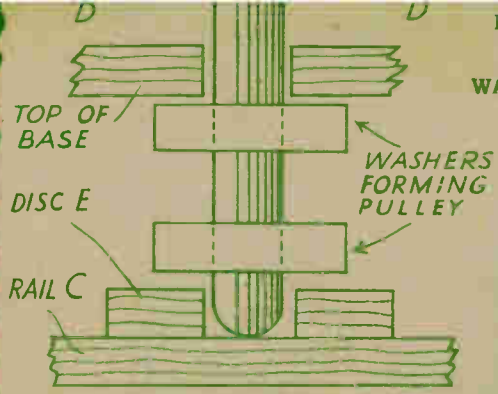

TOP OF BASE. HALF ONLY SHOWN. CUT ONE.

SIDE B

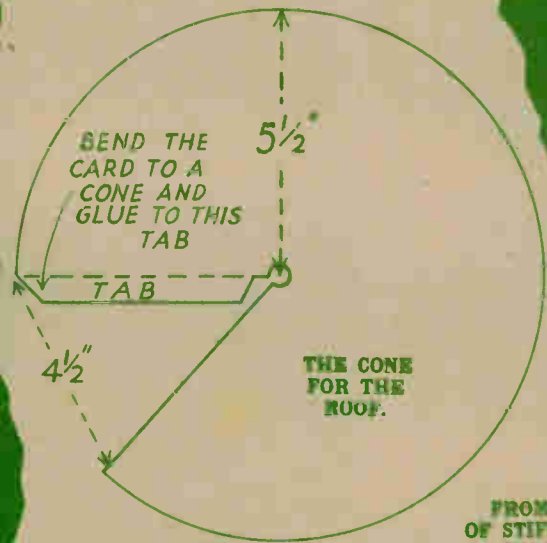

THE CONE FOR THE ROOF.

FROM A PIECE OF STIFF CARD OR STOUT BROWN PAPER. SET OUT THE CONE AS SHOWN ABOVE.

SIDE A



SIDE B. CUT TWO.



CRANK HANDLE.



SIDE A. CUT TWO TO LENGTH SHOWN.

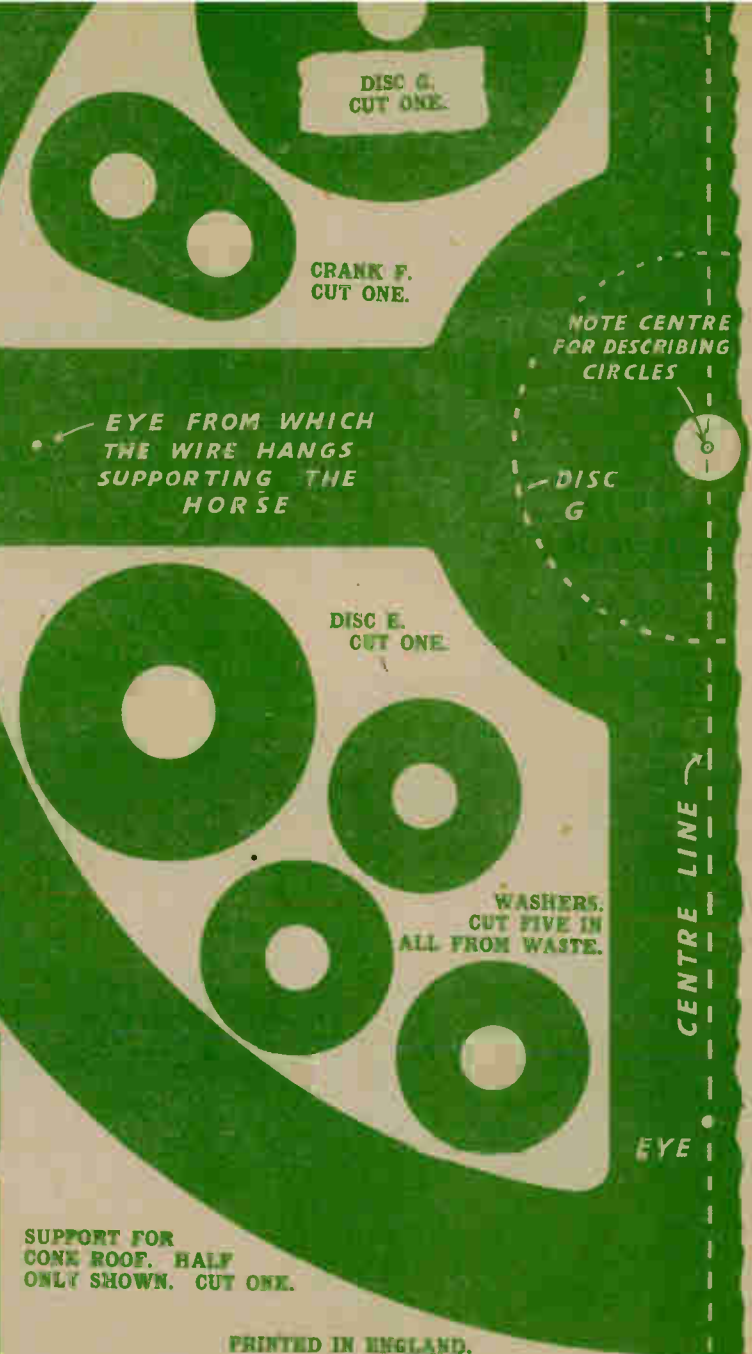

EYE FROM WHICH THE WIRE HANGS SUPPORTING THE HORSE

NOTE CENTRE FOR DESCRIBING CIRCLES

DISC G

DISC E. CUT ONE.

WASHERS. CUT FIVE IN ALL FROM WASTE.

EYE

SUPPORT FOR CONE ROOF. HALF ONLY SHOWN. CUT ONE.

PRINTED IN ENGLAND.

Fig. 1—Base, showing turning mechanism

The top has its four mortises D and its central spindle hole cut as shown. Beneath the top the four drop sides are added, the shorter ones (B) being glued between the longer ones (A). You can also cut out the cross platform, C, which is let into the open tenon in the shorter sides. Notice the hole for the cross spindle, which in turn takes the driving pulley.

This spindle is 9 $\frac{1}{2}$ ins. long and

revolve easily.

This upright piece of rod ($\frac{1}{8}$ in. diameter) is 10 ins. long, and the bottom end should be rounded off to reduce the friction when turning. Glue one of the pulley washers on the rod slightly above the disc glued to the centre rail. Allow room for the elastic band, and then glue on another washer (see Fig. 1).

Now build on the main platform,

Fig. 2—Broken view of central pillar

Fig. 3—Canopy and disc support

whole of this cone portion without the valance is shown in Fig. 3, with an under-view detail showing the eyelet for the wire.

Having tested all these parts temporarily in place, you can now fit in the whole mechanism glued to the cross strip, C, under the base. Fit it in place, put on your elastic pulley, and test out for satisfactory working. Instead of gluing the strip, C, in

Fig. 4—Construction of horse

you prefer.

The whole model is painted in bright colours of red, yellow, brown, etc. A first coat should be added and allowed to harden in case it sinks into the material, but the second coat can be of a bright enamel. Lining of panels can be painted on, and little flags added as shown in the picture of the completed model.

Fig. 5—The step parts

SUPPLEMENT TO HOBBIES No. 2748

TOY ROUNDABOUT



—SIZE—
9 1/2 ins. SQUARE.
10 1/2 ins. HIGH.

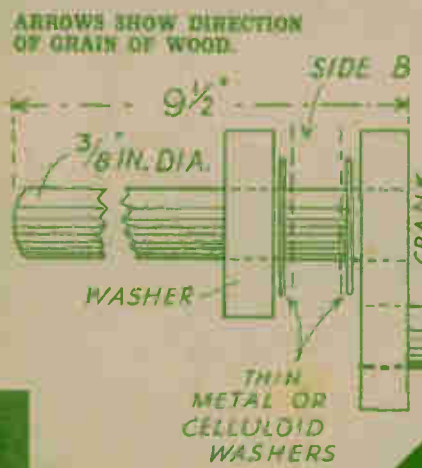
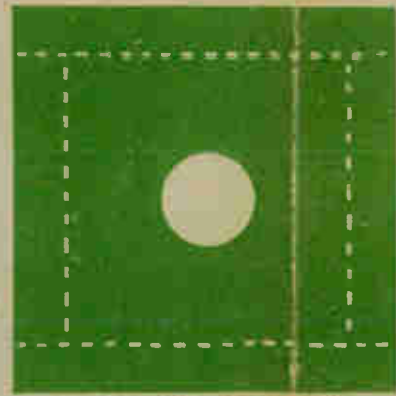
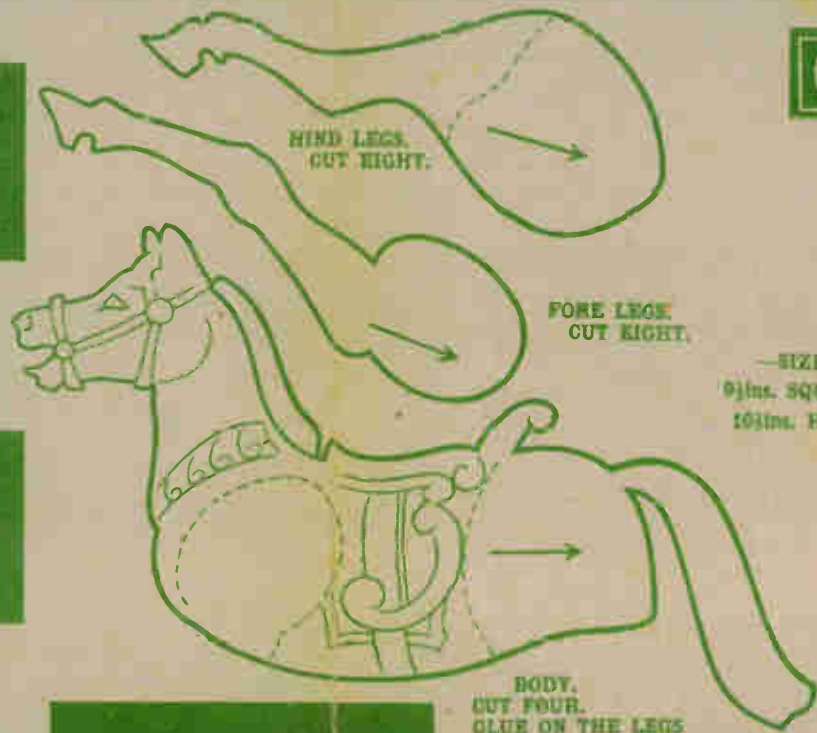

PANELS OF WOOD REQUIRED FOR THIS DESIGN
Two pieces of Compo Board 18 ins. x 12 ins.
The price is shown in Hobbies Weekly, June 30th, 1948, but is subject to revision. See the current edition of Hobbies Handbook, or write for price to Hobbies Limited, Dereham, Norfolk.

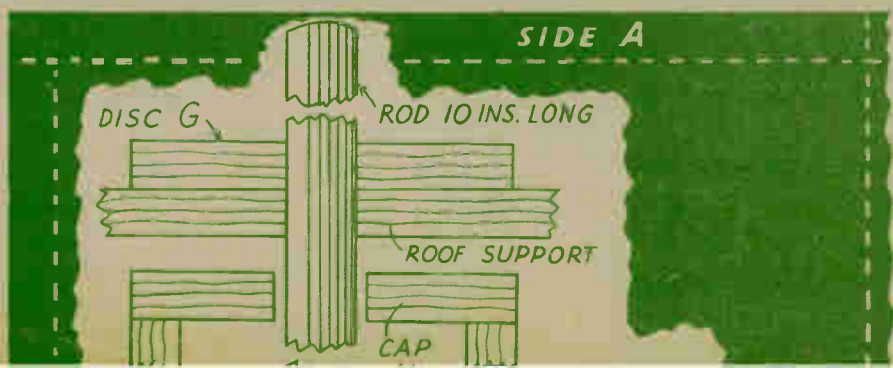

DETAIL OF CRANK, HANDLE AND CROSS SPINDLE.

NOTE—This design sheet is only presented free with the current issue of Hobbies Weekly.



Instructions for patterns on Design 2748 for making a WORKING MODEL ROUNDABOUT

THIS mechanical working roundabout stands 10 ins. high. The handle on the side actuates the central column by means of an elastic band, the horses hang by loose wires so that when the canopy is revolved they swing out in realistic fashion. If you are using ordinary wood, the boards are of $\frac{1}{2}$ in. thickness throughout. In the kit supplied by Hobbies Ltd. composition boards are provided, which can be cut and used in the ordinary way with the fretsaw.

In some cases, on the sheet the patterns are shown as a portion only, owing to lack of space. These must be completed, the second portion being transferred to the opposite side of the centre line again. Draw the parts direct on to the material and rule them in with pencil and square. Study the parts first to see you realise how the thing is constructed.

The Base

The base portion is shown at Fig. 1, with the top of it cut away to make the mechanism clear. Cut all parts square and true, and test them up before finally gluing firmly together. As the toy will be finally painted, you can use tiny nails or screws further to strengthen certain parts. Where possible, too, add angle blocks to stiffen up. You will see one in the far corner of the base in Fig. 1.

revolves smoothly in the holes. The dowel rod is $\frac{1}{16}$ in. diameter, and it will make for easier working if you can drill the receiving holes with a brace and bit. The spindle has four inside discs upon it, and these should be cut and fitted. Push the spindle through one end, and then thread on the three washers. One washer is glued to the rod just inside one side to prevent movement longitudinally.

The other two (see Fig. 1) are glued about $\frac{1}{2}$ in. apart centrally along the rod in line with the centre of the rail, C. One end of the rod is flush with the side of the platform, the opposite end projects sufficiently to fit on a turning handle. This crank and handle is shown in detail at Fig. 1, and the sectional side view giving actual positions is printed with the patterns. The whole base is lifted by four corner feet formed of discs glued on (see Fig. 1).

Central Spindle

Now build the upright centre spindle on the platform strip, C. This part—the upright centre turning column—can be built on to the platform C, but that strip cannot be fixed in place until later. Refer to the sectional detail on the sheet which shows actual positions of the parts. The disc D is glued centrally half way between the sides. The hole in the middle of this must be large enough for the upright spindle to

the four pillar uprights fitting into their joints at D. A detail of them is shown at Fig. 2., where the top capping piece is also indicated. The hole in this capping piece again must be large enough to allow the upright spindle to revolve smoothly.

Canopy

The top circular support for the canopy is fitted with a central disc, G, and the whole thing is glued on to the central spindle about $\frac{1}{2}$ in. above the top capping piece of the central pillar. Before finally fixing, however, screw in the small eyelets which are to take the end of the hanging wire of the horses. Their position is marked on the pattern.

The canopy itself is made of stiff paper or thin coloured card. A circle with $\frac{5}{8}$ in. radius is drawn out, a segment is cut through to the centre, and the tab left one side as shown by the diagram in the bottom left hand corner on the sheet. By folding it down as a cone, the tab forms a gluing surface to join, and then the whole thing is dropped over the central spindle to rest on the circular top.

It should reach to the edge (see Fig. 3) and if you like, a valance is put round the outside later. This valance is a $\frac{1}{2}$ in. strip of stiff paper long enough to go round the circumference to which it is glued. The construction of the

position, a good plan is to hold it in place with two small round-headed screws each end. This will allow the part to be taken away again later, should the mechanism want altering.

Each horse is composed of three thicknesses of wood, the body and two legs each side. Cut the patterns and glue the four legs at the angle indicated. The position is shown by the dotted lines on the pattern of the body part. Then in the top at the position shown, drill a hole to take the fixing wire. This wire is $\frac{1}{16}$ in. long, which will allow enough to make a loop at the top and enough to sink into the horse $\frac{1}{2}$ in. or more. Point one end, and drive firmly into the body, adding a spot of glue if necessary to fix stronger.

The Horses

Four horses are required, and each is hung the same height from the top, so they balance correctly with the feet just clear of the platform. Have the top of the wire as a turned loop only, so that they can be taken off for painting and re-hanging as required.

Steps are shown on the picture, but there was no room for the parts on the pattern sheet. If you want them, cut to the shape shown at Fig. 5. The two rightangle pieces form the ends, and the two strips between make up the steps. Glue centrally along one side as shown. Or they can be left movable if



Some interesting notes on makes and uses of modern ABRASIVE PAPERS

THERE are six distinct abrasive papers, each having its own special use, for wood or metal, such as the aluminous oxide, carborundum, emery, flint, garnet and glass papers. There is, or rather, used to be, a seventh paper, known as sandpaper, but this is no longer used, although the term is still applied to papers having a sand-like abrasive surface. As particles of sand, however, are not used, the term is a misnomer, and although incorrect, people continue to use the word.

For example, we speak of sanding machines. Sanding? No sand is used. The word is more convenient, and clearer in meaning, than belt grinder, band facer, etc. But, when we deliberately ask for sandpaper, and get sheets of abrasive paper bearing the word "glasspaper" on its back, it seems innane. Why not call a spade a spade and have done with it?

Sandpaper

The first abrasive paper invented, consisted of a flexible paper, glued on one side and sprinkled with graded particles of sharp (builder's) sand. Shore sand was not used, as its particles were too smooth. This, then, is the *real* sandpaper. As it is no longer manufactured, and thus obsolete, why mention it at all? It is the old-timers who are largely to blame for the misuse of the word; a habit, once formed, is hard to break.

Glasspaper

This is the modern abrasive paper used in woodwork. It is made similarly as the old-fashioned sandpaper, but by up-to-date methods, i.e., by an electro-coating process. The abrasive is glass—a blue glass, such as used for making beer bottles, being broken into particles, sifted into

various grades—flour, fine, medium and coarse—and applied to a strong flexible paper, known as kraft paper. The particles are very much sharper than sand and excellent for wood surfaces, smoothing paint, polish, etc.

Garnet Paper

Perhaps this type of abrasive paper may be rightly referred to as glasspaper, as the smaller, less pure parts of garnet—a precious stone—are used. Garnet is a natural, glass-like substance found embedded in gneiss rock in America and Africa.

MODEL ROUNDABOUT

Special composition board, round rod, and wire for making this design (No. 2748) from Hobbies Branches for 5/3 or with postage 9d. extra from Dereham, Norfolk

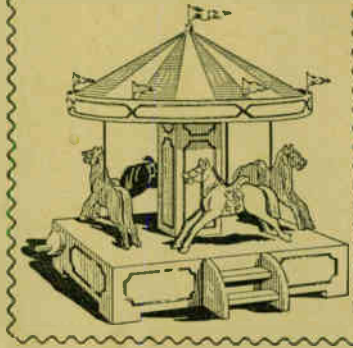

Garnet-paper is sharper than glasspaper. It also has a greater resistance to wear, and for woodwork, plastics, etc., it is highly recommended. But, please, ask for garnet-paper and not glasspaper. Sheets are nearly the same size as glasspaper sheets. There are various grades.

Emery Paper

This stuff, as we know, is used for

metals. Emery is a natural substance, being an impure form of corundum. It is hard and rapid-cutting, and for smoothing metals, or wood, or plastics, it is equally good. However, regarding wood, it is inclined to become choked easily with dust, and although usable on wood, it is unusable for the purpose.

It is graded like all other abrasive papers. Generally, a linen backing is used, this being more durable and flexible than paper. A special make, for engineers, is available. Emerycloth, therefore, is the more apt term to use.

Flint Paper

Flint is a natural mineral and makes a soft, cheap abrasive paper. It is used for smoothing wood, leather, etc., which is inclined to "choke" other types of papers easily. By using a cheap flint-paper first, it removes most of the choking dust and, due to its cheapness, can be easily replaced with better, finishing, papers. It is not so widely used, as few of us take the bother to change papers for any one particular job.

Aluminous Oxide Paper

An artificial product, obtained by fusing bauxite, an aluminium-bearing clay, at a high temperature. The ingots, or prepared lumps, are crushed into particles which are sifted into various grades. The abrasive surface is very hard, and a special feature regarding the particles is that, with wear, the cutting edges break and thus give new sharp edges so that the paper is lasting.

The paper, in strips or bands, is generally fitted to sanding (here we blunder again!) machines. Still, perhaps the term is not quite so inaccurate after all, as a man-made sand (of a kind) is used.

Photography—(Continued from page 130)

A fair display of white card does enhance and improve the print and does not detract the eye. Those of you who have the opportunity of visiting an exhibition of photographs such as can always be seen at the Ilford Galleries in Holborn, London, can always view for themselves what a splash of white card means to a good print.

It has often been said that a picture requires a title. This is an open question and will not be discussed here, but if you wish to put a title, then do not attempt to do this in any form of ornamental lettering. You may be quite clever at it, but it just will not do any good to your photograph.

Write the title in plain script

lettering and without any flourishes. The best position is at the bottom left hand corner about 1in. below the print, starting immediately in line with the left edge of the print. If you desire to add your name, then this should appear at the opposite corner.

Use Reliable Fixer

Finally, one more hint. Use a reliable photographic mountant such as Johnsons, who have specialised in this for over forty years. Place the print face downwards on a piece of glass and make it slightly damp with a wad of wet cotton wool. It will now take the paste more easily. Start with a portion of paste on the finger in the middle of the print and work in

a circular motion till reaching the edges.

The finger should be carefully run down each of these and any with too much paste can be removed on to the glass. Now be very careful to remove with a clean rag any paste that happens to be on the fingers and, having made slight pencil marks on the mount indicating where the print is to be placed, lift the print and place in position.

Give it a slight pressure in a couple of the corners, cover it with a clean piece of paper and finish the necessary pressure with a roller squeegee or hands. If any paste has found its way to the surface of the print it can be removed with the wet cotton wool without injury to the surface.



DEVELOP YOUR FILMS IN DAYLIGHT WITH THIS NEW JOHNSON J-20 TANK

Made of hard plastic for the popular SIZE 20 roll film spools. Very economical in use. Only needs TEN OUNCES of developing solution. There are four working parts. ONE-PIECE SPIRAL to hold the film. Tank body with light-proof locking-on lid and a stirring rod. Has a deep central tube for easy filling and temperature testing. Films are fixed and washed in the tank after development. Pouring lip enables solutions to be emptied away without splashing or mess.

ASK YOUR DEALER TO SHOW YOU THE NEW J-20 TANK

Price Complete **21/-**

JOHNSONS OF HENDON LONDON, N.W.4
PHOTOGRAPHIC CHEMICALS AND APPARATUS

One of the most brilliant forwards that ever came from Scotland . . .

Billy Steel

SAYS

"Here's MY way to cross a road"



"It's a forward's job to break through — on the football field. He must be able to dodge the defence — and have plenty of dash. But dodging and dashing is just asking for trouble when you're crossing a road. Here's my way:

- 1 At the kerb — Half.
- 2 Eyes — Right.
- 3 Eyes — Left.
- 4 Glance again — Right.
- 5 If all clear — Quick March.

No need to run, because I wait until there is a real gap in the traffic.

"In Soccer, you go all out to win; so of course you take risks — it would be pretty dull otherwise! But traffic's not a game. By taking a chance, you may get killed, or kill someone else. So just use your head, remember you're part of the traffic, learn to be a good Road Navigator, and cross every road the Kerb Drill way."

Billy Steel

GET HOME SAFE AND SOUND

Issued by the Ministry of Transport

ELECTRIC MOTORS

TYPE 47 GM. Dimensions 11½ x 4½ x 4½ ins.

Converted into a Motor 220v. A.C., 50-Cycle, Single-Phase. Fitted with reduction gear box with 3 intermittent cams and 1 slow drive. Air blower at the other end. Ideal for displays, experimental purposes and driving your model.



OUR PRICE **27'6**

Plus 2'6 Postage and Packing

DOUGLAS HOUSE LTD.

WARREN WORKS, UPPER CULHAM,
NEAR WARGRAVE, BERKSHIRE.

PACKET OF TOY DESIGNS

Full size patterns and instructions for making the eight popular toys shown. Simple to cut and complete. Wood and wheels also obtainable as indicated.

The Battleship is 1ft. long, the truck 9ins.

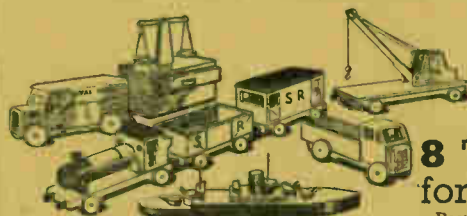

Hobbies Branches, or by post Hobbies Limited, Dereham, Norfolk.

8 Toys for 1/-
Postage 1d.

All-Steel Tool Rack



Hobbies Ltd., Dereham, Norfolk and Branches.

Twelve clips strongly fixed on a steel wall-plate. To hang on the wall or in tool cupboard. In two sizes: 13in. 4 6; 18in. 6/- Post 5d. & 9d.

WEBLEY AIR PISTOLS

Marvellously accurate for target practice.

No license required to purchase.

Senior Mark 1
Junior Webley Air Rifle

Write for List. WEBLEY & SCOTT LTD.,
166 WEAMAN STREET, BIRMINGHAM, ENG.



HOBBIES BRITISH FRESAW BLADES

YELLOW LABEL 1/6 per doz.
BLUE LABEL 1/3 per doz.

From Hobbies Branches or by post (24d. extra) from Hobbies Ltd., Dereham Norfolk



Printed by BALDING & MANSSELL, LTD., London and Wisbech, and Published for the Proprietors, HOBBIES LTD., by HORACE MARSHALL & SON, LTD., Temple House, Tallis Street, E.C.4. Sole Agents for Australia and New Zealand: Gordon & Gotch (A'sia) Ltd. For South Africa: Central News Agency Ltd. Registered for transmission by Canadian Magazine Post.